

HI-FI WORLD

MARCH 2018

UK £4.50

www.hi-fiworld.co.uk

FREE READER CLASSIFIED ADS IN THIS ISSUE!



LUXMAN D-380
CD player



ATC HDA-DP10
hi-resolution player



BEATLES
Sgt. Pepper's box set

ROHDE & SCHWARZ
MEASUREMENT



6 PAGES OF LETTERS - THE BEST WINS A PAIR OF TANNOY MERCURY 7.2 LOUDSPEAKERS! (UK ONLY)



CHORD POLY
ROOM SYSTEM FEATURE
NOVAFIDELITY X35 ALL IN ONE
SONUS FABER OLYMPICA I LOUDSPEAKERS

COMPETITION



2 WINNERS TO WIN A DUAL MTR-75 TURNTABLE WORTH £250! (UK ONLY)

EXCLUSIVE!

ACOUSTIC ENERGY
AE109
loudspeakers

MARCH 2018

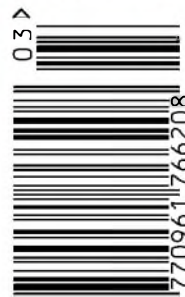

9 177096 1766208





It's got to be

Perfect

Your music deserves quality cables



We go to great lengths (and precise tolerances) to produce our class-leading cables. From solder and grubscrews upwards, everything is rigorously examined.

At the higher end of things, we build strictly to order. Every Signature, Sarum T and ChordMusic product is tested visually, electronically and audibly before being signed-off by senior staff.

All this care and attention helps maintain our international reputation for realistically priced audiophile interconnects and speaker cables - featuring our unique Super ARAY conductor technology and advanced (Taylon®) shielding materials, backed-up with over 30 years of innovation and experience.

Designed and built in England by music lovers since 1985. Enjoyed by music lovers all over the world.

Demonstration cables available from all good Chord Company retailers. Find your nearest at: www.chord.co.uk



"the difference will be immediately evident, such is the transparency of the interconnects and loudspeaker leads."

Chord Signature Range
Hi-Fi World Dec 2015



"It's rare that something truly different comes along in the world of loud-speaker cables - but Chord's new Sarum T is just that."

Chord Sarum T Speaker Cable
Hi-Fi World Dec 2017

THE
CHORDTM
COMPANY



EDITOR

Noel Keywood
e-mail: editorial@hi-fiworld.co.uk

DESIGN EDITOR

Faiza Chunara
tel: +44 (0) 20 8206 6018
e-mail: adproduction@hi-fiworld.co.uk

PRODUCTION EDITOR

David Noble
tel: +44 (0) 20 8206 6019
e-mail: classifieds@hi-fiworld.co.uk

SALES MANAGER

Louise Palfrey
mob: +44 (0) 7917 047 548
e-mail: louise@hi-fiworld.co.uk

ADVERTISING EXECUTIVE

Joanna Holmes
mob: +44 (0) 7958 602347
e-mail: joanna@hi-fiworld.co.uk

PUBLISHER

Noel Keywood
e-mail: publisher@hi-fiworld.co.uk

FREE READERS CLASSIFIEDS

tel: +44 (0) 20 8 206 6019
e-mail: classifieds@hi-fiworld.co.uk

SUBSCRIPTIONS

tel: +44 (0) 1442 820 580
fax: +44 (0) 1442 827 912
e-mail: hifiworld@webscribe.co.uk

PHOTOGRAPHY

David Noble
tel: +44 (0) 20 8206 6019

WRITERS

Paul Rigby, Jon Myles, Martin Pipe,
David Tutt



What was it that made me think of the radiogram when working on this issue? It wasn't that such a device gets a mention anywhere, so much as the current drive toward all-in-one solutions is similar in intent – the new Novafidelity X35 we review on p39 is a good example. This product is impressive in what it can do, using Class D amplifiers to achieve that magic 100 Watt output power figure people expect nowadays, from a compact box. Reviewer Jon Myles is our expert at dealing with the ethernet, Bluetooth and wi-fi connections that are an essential part of such products, as well as the apps – all of which the radiogram lacked of course. But at least you could stand a vase on top!

Reviewer Martin Pipe didn't review a radiogram either, instead he reviews a Roberts Radio on p23 reminiscent of the old transistor radios that were so popular in the same era, or shortly after as transistors took over from valves. But this traditionally styled portable has an ethernet connection and USB also. How radios have changed!

The gorgeous Lux D-380 CD player I review on p13 is also reminiscent of past values, as it is meant to be. Luxman have curiously but cleverly used a modern digital filter in conjunction with an old radiogram-era valve to achieve a sound that I've not encountered before. Here the best of today and yesterday have been mixed to give an intriguing result.

OK, we are a bit late with our Beatles Sgt Pepper album review. Last year this album was big at U.S. audio shows, but Abbey Road studios – nearby – somehow forgot us. We received a bona-fide review set recently and you can read Paul Rigby's expert view on p87. I hope you enjoy it.

And I hope you enjoy the many articles and views we publish this month, in the first issue of our 28th year. Sorry for the lack of radiograms!

Noel Keywood
Editor



hi-fi world

Audio Web Publishing
Studio 204,
Buspace Studio,
Conlan Street,
London W10 5AP
www.hi-fiworld.co.uk

verdicts

- OUTSTANDING
- EXCELLENT
- GOOD
- MEDITOCRE
- POOR
- £ VALUE

amongst the best
extremely capable
worth auditioning
unremarkable
flawed
keenly priced

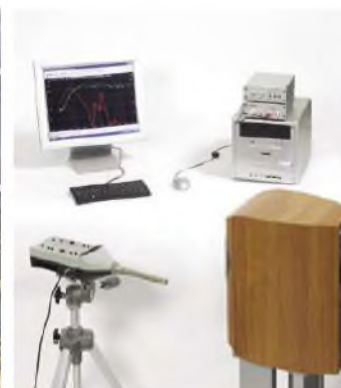

ELECTRONIC MAGAZINE

Go to our website www.hi-fiworld.co.uk to buy an electronic version of this magazine, individual issues, back issues or a subscription.

Distributed by Select Publisher Services Ltd. P.O. Box 6337, Bournemouth, BH1 9EH UK Tel +44 (0) 1202 586848

Printed by Precision Colour Printing Halesfield 1, Stitchley, Telford TF7 4QQ, United Kingdom Tel: +44 (0) 1952 585585

Our Agents in Malaysia Millennium Hi-Fi & AV Simon Chang Showroom & office, 500-1-3 First Floor Wisma Indah (Shen Court), Jalan Tun Razak 50400 Kuala Lumpur, Malaysia

Tel: 603 9283 8171 Fax: 603 9281 3762 e-mail: info@millennium-audio.com

All unsolicited submissions and goods are at the owner's risk. We accept no responsibility for such submissions, nor do we undertake to return them.

No material may be reproduced from this magazine without the publisher's written permission. © Audio Web Publishing Ltd

contents



39

NOVAFIDELITY X35 ALL-IN-ONE PLAYER



56

ATC HDA DP10 HIGH-RESOLUTION DAP



59

SONUS FABER OLYMPICA 1 LOUDSPEAKERS



17

IMR R1 EARPHONES

LOUDSPEAKERS

ACOUSTIC ENERGY AE109 LOUDSPEAKERS 10
Acoustic Energy's new floorstanders offer sophisticated sound at a realistic price, says Jon Myles..

SONUS FABER OLYMPICA I LOUDSPEAKERS 59
Innovative design from Italy's Sonus faber translates into a desirable standmount. Jon Myles explains all.

DIGITAL

LUXMAN D-380 CD PLAYER 13
Luxman's new CD player offers both valve and transistor operation. It also works exceptionally well, finds Noel Keywood.

CHORD POLY 35
Chord's Mojo DAC/headphone amplifier gets a streaming module. Jon Myles likes what he hears..

ROBERTS STREAM 94I RADIO 23
Martin Pipe is impressed by a new streaming radio by Roberts.

NOVAFIDELITY X35 ALL-IN-ONE 39
Digital storage, amplification and streaming combine to make the new Novafidelity a powerful proposition, finds Jon Myles.

ATC HDA DP10 PORTABLE PLAYER 56
Noel Keywood discovers a high-resolution portable digital player from ATC – and is taken aback by its qualities.



13

LUXMAN D-380 CD PLAYER

MARCH 2018

VOLUME 28 : NO. 1

CABLES

51 HIDIAMOND I RCA SIGNAL CABLES

Cable specialist HiDiamond's latest interconnects offer a taste of the high-end that doesn't cost a fortune says Jon Myles

FEATURES

19 ROON READY

More and more components now come Roon ready. But what does it mean? Jon Myles guides you through the details.

OLDE WORLDE

82 PSION WAVERIDER

A sophisticated computer based radio that was before its time perhaps. Martin Pipe investigates.

VINYL

84 NEWS

All the latest and greatest vinyl releases for you, from the pen of Paul Rigby.

87 SGT. PEPPER'S LONELY HEARTS CLUB BOX SET REVIEW

Paul Rigby on a new box set of The Beatles' classic album.

91 BLUE HORIZON SHELVING

Looking for the ideal rack for your turntable? This might just be it, says Paul Rigby.

93 TOTAL STATE MACHINE BOOK REVIEW

Test Dept mixed music with politics – Paul Rigby delves into the band's history told in this new book.



HEADPHONES

17 IMR R1 EARPHONES

Jon Myles finds a lot to like in a new set of in-ear monitors with filters to help tailor their sound.

37 FOCAL CLEAR HEADPHONES

French hi-fi giant Focal's new headphones are amongst the best, says Martin Pipe.

REGULARS

7 NEWS

Words from the world...

28 MAIL

Seven pages of your views, wonderful as always...

43 COMPETITION

A chance for two entrants to win a Dual MTR-75 USB turntable worth £250!

44 WORLD STANDARDS

Updated guide to the latest and greatest hi-fi hardware on sale.

54 SUBSCRIPTIONS

Ensure your copy every month and save money too!

62 AUDIOPHILE VINYL

Paul Rigby rounds up the latest audiophile vinyl releases

65,67,69,71,73 OPINION

The team get to grips with matters music, hi-fi and life!

75 BRISTOL SHOW

Come and meet the Hi-Fi World team.

76 WORLD CLASSICS

Brilliant designs that have stood the test of time...

88 DIAL-A-DEALER

A comprehensive guide to UK hi-fi retailers

95 CLASSIFIEDS

This month's second-hand bargains.

96 NEXT MONTH

What we hope to bring you in the next sizzling issue...

97 ADVERTISERS' INDEX

98 CLASSIC CUTS

Paul Rigby looks at The Eagles' 'Hotel California'.

Tellurium Q®

10 products of the year and most wanted components in just 2 years by preserving relative phase relationships in a signal



Introducing the new award winning Black II speaker cable

"Tellurium Q have surpassed themselves here. It is often said that all cables colour the sound of a system to some extent, but the Silver Diamonds do it to a lesser extent than any other product I've heard so far."

John Myles, HiFi World

"If you're looking for a major jump in your system's performance, I'd suggest buying a pair of these instead of considering a hardware upgrade. Before you write this advice off to cable delusion, expectation bias, or the recent Mercury retrograde phase, please take note: I have never said this in TONE's 11-year history"

Jeff Dorgay, Tone Audio

"Well, I have just stumbled upon a speaker cable that I'm very tempted to put in a class of its own"

Mono & Stereo



facebook.com/telluriumq

telluriumq.com

+44 (0)1458 251 997



email:news@hi-fiworld.co.uk

news

LUXMAN FLAGSHIP

Hot on the heels of Japanese manufacturer Luxman's LX-380 valve/transistor hybrid amplifier (see review in February 2018 issue) comes a new flagship from the brand – this time a Class A/B design offering 120 Watts of power into 8 Ohms and a claimed 240 Watts into 4 Ohms.

The L-509X features Luxman's distinctive throwback looks (as in rather gloriously late 1970s) with two big power meters, bass/treble tone controls as well as a loudness button.

There's also a built-in Moving Magnet/Moving Coil phonostage for connecting a turntable, and also a headphone connection.

Price is £8500 and as to how it sounds – well, we hope to bring you a review soon. For more information go to www.luxman.com.



MCINTOSH NANOTECH

Fancy making a real hi-fi statement? Then meet McIntosh's new XRT2.1K loudspeaker. Look at the picture and then take in the statistics; they are a seven-foot-tall full-range design featuring no less than 81 drivers.

So you get six 8-inch bass units, two 6.5-inch low frequency midrange drivers, 28 2-inch upper midrange units and no less than 45 three-quarter-inch tweeters – with power handling rated at some 2000 Watts.

You'll need a big room to accommodate them – and rather deep pockets too as they come in at £137,500.

For more information go to McIntosh's UK distributor Jordan Acoustics at www.jordanacoustics.co.uk.

NEW CAMBRIDGE STREAMER

Cambridge Audio has updated its award-winning CXN streamer to Mark 2 version.

The new model adds a faster processor and also brings improvements to the user interface, making it easier to search through tracks stored on a home network, Spotify Connect and USB devices.

Existing CXN owners will be able to enjoy the latter functions through a software update. Cambridge is also promising Tidal compatibility will be available for the CXN (V2) soon. The price of the new model is £800 and more details can be found at www.cambridgeaudio.com. We hope to bring you a full review soon.



IMR IN-EARS

New to the in-ear headphone monitor market are UK company IMR Acoustics – whose first model employs some interesting technology.

Priced at £500 the IMR-R1s employ a custom-designed 13mm hybrid unit consisting of a beryllium diaphragm coupled to a ceramic driver. Frequency range is said to extend from 14Hz-40,000Hz.

Packed in the box also is a set of five audio filters to tune the sound to individual preferences – each one offering different bass, mid and treble response.

And in one final twist (literally) a knurled dial on the rear allows the 'phones to be used as either open or closed-back to further tailor the sound.

Go to our review in this issue to discover just how they sound.



GLANZ TONEARMS

Turntable expert Dave Cawley has signed an exclusive deal to bring Japanese company Glanz's hand-crafted tonearms into the UK.

Reminiscent of the S-shaped arms which proved popular in the 1970s, Glanz uses modern engineering techniques to move vibrational energy away from the cartridge unit and minimise unwanted resonance.

Each tonearm in the range uses high-grade stainless steel with the headshell manufactured from a single billet for solidity. Prices start from £1499 for the entry-level B Series while the S Series comes in at £5600 and the flagship SD Series costs £13995.

Dave Cawley said "As an engineer myself I consider the Glanz tonearm to be a masterclass in precision. Its level of detail in design and craftsmanship is something I could happily wax lyrical about for quite some time. These are quite honestly the best tonearms I've heard".

Log on to www.glanztonearms.co.uk for more details.

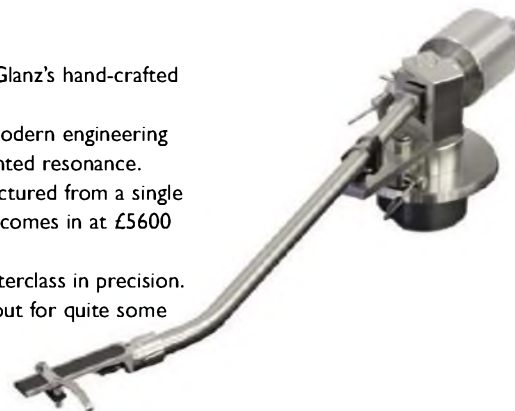

MUSIC SALES SOAR

Music sales hit a 10-year high in the UK in 2017 – with a rise in streaming helping push total revenue to some £1.2 billion. Figures from industry trade body the British Phonograph Industry (BPI) reveal vinyl sales also soared with sales reaching 4.1 million which is the highest level since 1991 when the likes of Simply Red's 'Stars' and Nirvana's 'Nevermind' topped the charts.

Interestingly the top three LP sellers were split between the new and the old. They included Ed Sheeran's 'Divide' as well as Liam Gallagher's 'As You Were' but also up there was Fleetwood Mac's classic 'Rumours' (pictured) – still going strong some 40 years after its initial release!

The overall increase in sales, though, was driven by streaming services with the equivalent of 68 million albums being listened to. That's a rise of over 51% on 2016.

Overall – across all formats – UK listeners bought 135 million albums. CD and digital downloads dropped by 12% and 23.4% respectively which shows how the rise in streaming from the likes of Spotify, Tidal, Amazon and Apple Music is becoming more dominant.

One so-called legacy format did make a bit of a comeback. Cassette sales were up by 43% - although that only equates to total sales on 22,000.

BLUESOUND JOINS AMAZON

The Bluesound/NAD range of products has added Amazon Music capability to its streaming options – which already includes Spotify, Tidal and Qobuz.

It means any BluOS-equipped device can now access the service once a software update has been installed (go to www.bluos.net for further details).

The update enables users to stream Amazon Music through a home network, as well as the ability to create playlists on iOS and Android devices.



AKG HIGH-END HEADPHONES

AKG has entered the high-end earphone market with its latest N5005 model, priced at £1000.

It goes up against models from the likes of Shure and Noble Audio in terms of design, featuring ceramic earpieces and four interchangeable sound filters that AKG say allows the wearer to tune the earbuds to their musical preferences.

They also come equipped with a wireless Bluetooth dongle to allow pairing with the latest smartphones that no longer have 3.5mm headphone ports.

Given AKG's track record in producing value-for-money headphones these could be interesting.

ASTIN TREW AT2-2100

In the review of the Astin Trew AT2-2100 integrated amplifier (Hi-Fi World February 2018) we mentioned that the product was manufactured in the UK. Astin Trew inform us that the amplifier is actually mostly manufactured in China, then shipped to the UK for final assembly and testing.

Following our Measured Performance analysis regarding the low input sensitivity Astin Trew also say they are aware of this issue and will be increasing it by 7dB on production models.

A SHAW THING

Cable experts the Chord Company has introduced a new digital cable to its popular Shawline range.

The Shawline streaming cable is priced at £220 and features four pairs of high-speed silver-plated copper conductors in conjunction with low-loss FEP insulation. Each conductor pair has been individually screened with a Mylar foil and a further foil-and-braid outer shielding system to protect from the RF interference generated by everyday household devices.

Other features include precision-moulded zinc hybrid RJ45 plugs with chrome-plated outer casings and gold-plated pins.

The cable is available in pre-assembled standard lengths of 0.75m, 1.5m, 3m and 5m priced at £220, £250, £300 and £400 respectively. Longer custom-made lengths are also available on request. Go to www.chord.co.uk for further information.



CHORD QUTEST DAC

Chord Electronics used the latest CES home entertainment show in Las Vegas to launch its latest compact DAC – the Qustyle.

The model directly replaces the well-regarded 2Qute with a new square-edged aluminium chassis, while internally it is based on the latest proprietary Rob Watts' FPGA technology developed for the Hugo 2 DAC/headphone amp.

However, at £1195 the Qustyle offers a significant cost saving over the Hugo 2's price of £1,800 mainly by sacrificing the headphone amplifier, rechargeable Li-ion batteries and crossfeed functionality.

Technically, though, its specifications are state-of-the-art with the optical TosLink connection accepting 24bit/192kHz files with the two BNC inputs rising to 24bit/384kHz and the galvanically-isolated USB-B socket going up to 32bit/768kHz as well as being DSD512 capable.

Chord's range of user-selectable digital features are also incorporated while there's a single set of RCA outs that can be varied between 1.2V and 3V RMS output.

Available in black only, the new Qustyle is on sale now. Go to www.chordelectronics.co.uk for further information.



ASTELL&KERN DESKTOP

Astell&Kern may be best known for its range of high-resolution digital audio players but the company is now moving into the desktop audio market.

The first product in its new ACRO range is the £799 L1000 which is a desktop amplifier, headphone amp and DAC housed in a distinctively-shaped aluminium body.

It contains 2.5mm, 3.5mm and 6.5mm as well as XLR audio outs for connecting headphones, as well as RCA outs allied to a 15 Watts per channel (into 4 Ohms) amplifier for connecting desktop 'speakers.

The digital section uses two AK4490 DACs for high-resolution audio up to 32bit/384kHz. A USB input also enables connection to a Mac or PC. More details and www.astellkern.com.



SPOTIFY SUED

Music streaming pioneer Spotify is facing a multi-million dollar compensation claim from a leading music publisher.

Wixen Music Publishing Inc has issued a lawsuit in California alleging Spotify used thousands of songs from the likes of Tom Petty, Neil Young, Stevie Nicks and the Doors without a license. It is seeking some \$1.6 billion in compensation.

The move comes as Spotify – which is estimated to be worth some \$19 billion – prepares for a much-anticipated stock market listing later this year.



Musical Energy

Jon Myles is beguiled by Acoustic Energy's AE109 budget floorstanders.



Floorstanding loudspeakers around the £500 mark with a good sound are relatively rare. The reason is simple – large cabinets cost more so there is less money to spend on the drive units. And then you have the problem of controlling resonances in a bigger enclosure.

None of this is simple. Give a designer an unlimited budget and free rein to do what they like may well come up with something special but us – the buyers – will have to stump up thousands of pounds for it.

If your budget doesn't stretch that far – where do you look? Acoustic Energy may just have the answer in their new AE109 floorstanders.

It's the flagship model in the revamped AE100 range that also includes the AE100 standmount model, a centre channel 'speaker and an active subwoofer.

I was impressed with the AE100s when I reviewed them last year (see *Hi-Fi World* November 2017). This is a small loudspeaker which produces a big, controlled sound with an even tonal balance. No surprise, then, that I was eager to see how their bigger brothers fared,

The AE109s are a two-and-a-half way design using a pair of 4-inch (100mm) mid/bass paper cone units similar to that used in the AE100 with the lower one augmenting lower bass response before rolling off. These are allied to a 1-inch (25mm) soft dome tweeter mounted in what Acoustic Energy calls a Wide Dispersion Technology waveguide to project sound further into the room.

These drivers are housed in a relatively slim mass-loaded MDF cabinet measuring

800mm x 160mm x 240mm (HxWxD) with cone shaped spikes at the base.

A pair of full-length magnetically-attached grilles are also supplied (although, as ever, I kept these off for reviewing) while finishes are Satin Black or Walnut vinyl veneer.

At the back is a single pair of 'speaker cable binding posts as well as a slot-shaped reflex port to reinforce the bass.

While not overly-flashy the AE109s are certainly well put-together, weighing in at 17.5kg each and feeling solid and sturdy. A solid rap with the knuckles on the side of the cabinet produced no unwanted resonances.

Acoustic Energy claim a frequency range of 40Hz to 35kHz (see Measured Performance for full details) with an 89dB sensitivity – meaning they should be able to go loud with moderately-powered transistor amplifiers or even valves.

SOUND QUALITY

A room-filling sound is a prerequisite for any decent floorstander – and the '109s have it in spades. Hooked up to a 40 Watts per channel Naim Uniti Atom via QED's excellent budget XT25 'speaker cables and playing The Clash's 'The Card Cheat' (24/96) with its Phil Spector-like production, the 'speakers set up an enveloping wall of sound.

The first notes from the piano were strikingly resonant with both accurate pitch and depth. When Topper Headon's drums came in they also sounded firm and weighty, propelling the track along with verve.

Switching to 'Fairytale Of New York' by The Pogues I was struck by the detail and delicacy these 'speakers can unearth. Spider Stacy's tin-whistle was never buried in the mix while the banjo, accordion and even the harp were reproduced with clarity. Kirsty MacColl's vocals also came through with exceptional sweetness and a light touch.

The 'speakers knitted all this together into a thoroughly engaging, toe-tapping sound that had energy, verve and bounce to it. The trio of drivers are well integrated with no obvious dip at the crossover frequencies so they work seamlessly together.

Of course, there are limitations. Playing my go-to test track of James Blake's 'Limit To Your Love' the AE109s could not reproduce the sub-sonic bass effects which will shake a

room through larger loudspeakers. Nor do they have quite the air and space in the treble that a ribbon tweeter brings.

But that is being especially picky. At their price of £500 these loudspeakers are not just good – they are exceptionally good. So much so that I even spent some time with them connected to our reference McIntosh MC152 power amplifier – which at £6000 would seem something of a mismatch.

But the Acoustic Energy's weren't overly fazed, sounding big and spacious on the San Francisco Symphony's DSD recording of Mahler's 'Symphony No 2'. The sound of the orchestra was thrown wide left and right and well into the room to convey the scale of the piece. They even managed to handle the apocalyptic crescendo in the third movement without sounding strained or congested.

CONCLUSION

These AE109s floorstanders are exactly what good budget hi-fi should be. Exciting with rock and pop, authoritative with classical and sparkling with everything in-between. You can pay a good deal more and get a great deal less for your money.



At the rear the Acoustic Energy's have a slot shaped reflex port to enhance the base response.

MEASURED PERFORMANCE

The AE109s had some treble lift (+2dB) when measured on-axis, but at approximately 20degrees off-axis, frequency response was relatively flat, making the 'speaker tonally accurate in effect when pointed straight down a room and not at listeners. This is now common in loudspeakers and it makes for a fairly obvious high-treble. A dip in

FREQUENCY RESPONSE

Green - driver output

Red - port output

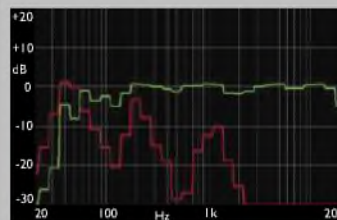

IMPEDANCE

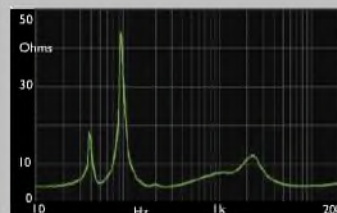

output at the 2kHz crossover region between bass/midrange and treble units will however soften the delivery overall.

Below 200Hz output gently decreases toward low frequencies, compensating for the presence of a rear wall. The slot port at rear is tuned to 45Hz and will provide low bass of a fairly bouncy nature as it is narrow-tuned. In all then the AE109 is a relatively accurate loudspeaker, a tad softer in the upper midband than some but still with plentiful high treble. Bass extends down to 40Hz, if not into subsonic regions, and with support from a rear wall will be in good balance, without boom.

A low measured impedance of 5 Ohms means the 'speaker draws current, but it also results in very high voltage sensitivity of 89.4dB, so at any particular volume control setting the AE109 will sound appreciably louder than most rivals.

The AE109 has been designed to work close to a rear wall, pointing straight down a room. It has an accurate balance, although high treble will still be obvious. Being unusually sensitive, it will play very loud from any amplifier. **NK**

ACOUSTIC ENERGY AE109 £500



OUTSTANDING - amongst the best

VALUE - keenly priced

VERDICT

An affordable floorstander with a refinement that belies its price. Goes loud with ease but remains poised and enjoyable at all times.

FOR

- good bass
- refined treble
- toe-tapping sound
- easy to drive

AGAINST

- nothing to speak of

Acoustic Energy
+44 (0)1285 654432
www.acousticenergy.co.uk



FOCAL | CLEAR

A year after Elear and Utopia, the latest addition to Focal's high-end headphone line is built around a new generation of full-range 'M'-shape dome speaker. Clear headphones reveal the tiniest details of musical creation. Made in France, Focal continues its quest for absolute sound with this new reference headphone. Clear promises listening worthy of the best loudspeakers.

Open Reference headphones

Distributed exclusively in the UK and Ireland by SCV | www.scvdistribution.co.uk | 03301 222500

Silver Machine



A sumptuous-looking CD player that offers both valve and transistor operation. Noel Keywood takes Luxman's D-380 for a spin and likes what he hears.

The new Luxman D-380 CD player I'm reviewing here complements their gorgeous LX-380 hybrid valve amplifier I reviewed last month, or of course you can use it alone. Unsurprisingly, this unit is hybrid too, using a single ECC82 double-triode output valve for a spacious valve sound, with an alternative direct output that bypasses this stage, giving the usual transis-

tor sound.

This CD player reflects the values of the 1970s – and why not? Its wooden sleeve is visually more appealing than a sheet metal cover and the silver fascia has dimensional relief, rather than being flat, featureless and bland. All the same, Lux keep the layout simple and easy to access; there are two filter options for example – but only on the remote control.

As an aside, I suspect a product like this has resonance in Japan where traditional values are important and where there is a generation that links strongly back to the 1960s and 70s when the country was an 'electronic superpower', manufacturing quality products few could match.

Apart from the usual transport controls comprising Play, Stop, Forward and Back, plus an eject button, the only other control is a lever switch to select Tube or Solid State. There is no volume control

on the player or the remote as the matching LX-380 amplifier has this, but two filters can be selected on the remote control only, identified simply as F1 (standard) and F2 (low latency).

The rear carries RCA phono socket analogue outputs only; there are no balanced XLR socket outputs. Optical and electrical S/PDIF digital outputs are fitted too. The player has no digital inputs so it cannot be used as a stand-alone DAC.

SOUND QUALITY

I connected the D-380 first into my preferred in-house reference system comprising Icon Audio Stereo 30SE single-ended valve amplifier driving Martin Logan Electromotion ESL-X hybrid electrostatic loudspeakers, all fed from an Isotek Genesis Evo3 re-generated mains power supply to eliminate mains distortion (3% in our part of London). The partnering LX-380 was also used.

The F1 'Normal FIR' filter selected in conjunction with Solid



The tube sits in a red illuminated window, with yellow fluorescent display at right.



HEAR OUR DIFFERENCE

Combining Italian design flair with British and Asian engineering.

BY ENGINEERS AND PURISTS,
BY PURIST ENGINEERS.



For more information:
please call +44 7534 104023

www.markaudiosota.co.uk

State output that together gave a nice enough presentation in itself, if not especially distinguished. I heard a wide and clear soundstage that was fairly strong in treble balance, so there was no holding back the spitch into the microphone from Willy DeVille singing 'Spanish Harlem' live. I accepted a small wash of muddle here because it was a live event so got a surprise when selecting F2 filter (Low Latency) that gave firmer and clearer images, with less shimmer to them.

Our measurements show this filter does lift upper treble and there was just the very slightest strengthening of that spitch, or sibilance. In all then the D-380 came across well with the F2 filter selected but it hovered toward glassy, according to what was being played. Where strong treble existed on a CD it became very apparent. In typical CD fashion bass was dry if well-defined.

Vacuum Tube slowed leading edges a bit, removing laceration, and it added body and space. Josefina Cronholm was now more fully embodied in front of me singing 'In Your Wild Garden.' I congratulated Lux in my head for managing to subtly mix the sonically interesting



The remote control carries transport functions and filters, but not volume.

F2 filter with Vacuum Tube to reach a tasty end result.

Spinning Nigel Kennedy playing Massenet's 'Meditation' the D-380 sounded solid in its imaging, again full-bodied and also sweet. Yes sweet! CD doesn't really suit violin, giving strings the wrong sort of harshness as it were, but the D-380 seemed magically able to correct this. With what I would term a luscious sound, the player's conveyance of Nigel Kennedy's Stradivarius was a lovely one, summing up what it could do.

The partnering LX-380 amplifier

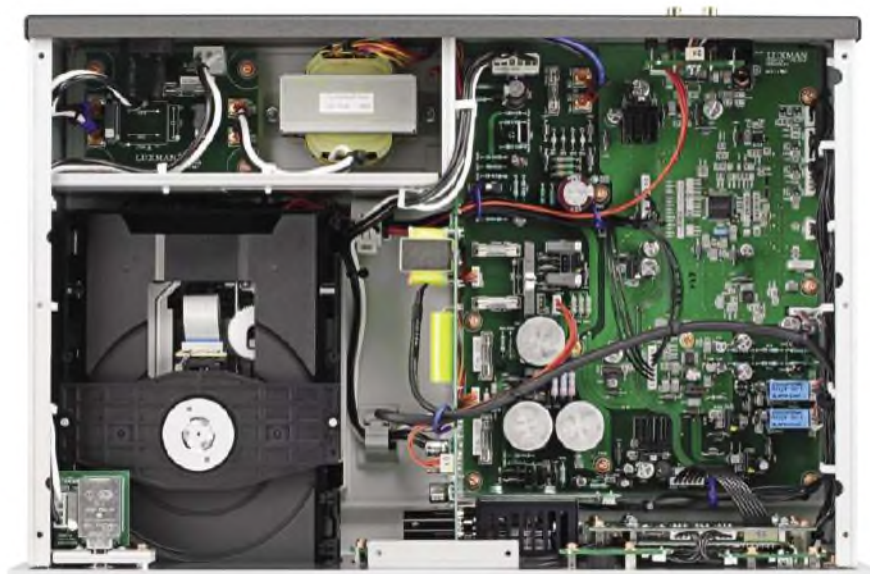

A screened linear power supply sits at rear left, producing 220V or so for the ECC82 valve. The transport mechanism lies in front of it and the main digital board at right. It possesses relays for silent action and a long life.

glossed up the sound from this CD player and the two – unsurprisingly – worked well together.

CONCLUSION

The D-380 is a simple package all round: easy to understand and easy to operate. But Luxman have quietly but cleverly inserted complementary

options: a subjectively effective digital filter and a Tube Output stage that together result in a beguiling presentation. I heard a modern, fast, clean delivery, with tube magic subtly supportive in the background. The D-380 is a great – even unique – package for those that want past values with a sound fit for today.

MEASURED PERFORMANCE

Frequency response of the D-380 measured flat to 21kHz, with the standard F1 filter. The result was identical from Solid State and Tube modes.

Switching in the 'low latency' F2

FREQUENCY RESPONSE

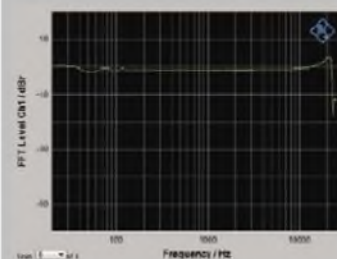

DISTORTION

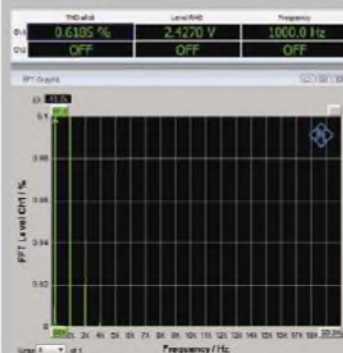

filter (shown) peaked upper treble and lessened stop-band attenuation.

Tubes are a little noisy unless run hard – into distortion on musical peaks – and this is what Lux have chosen to do, the tube stage producing 0.6% – mostly second harmonic our analysis shows – at full level (0dB). Although the figure is high this sort of distortion on peaks isn't easy to detect. The Solid State output produced 0.003% by way of contrast.

At -60dB distortion from both outputs measured 0.26%, a little higher than the 0.2% commonly achieved nowadays. Dynamic range was resultantly low at 98dB via both outputs, where 102dB is possible from CD.

The D-380 measured reasonably well, but its dynamic range was 3dB less than that common, due to noise and distortion from its DAC. The Tube stage was well engineered though and better than most. NK

Frequency response	4Hz- 21kHz
Distortion (24bit, -60dB)	0.26%
Separation	86dB
Dynamic range	98dB
Noise	-100dB
Output	2V

LUXMAN D-380
£3,800



OUTSTANDING - amongst the best

VERDICT

A modern CD player built to traditional values – and style. Easy to use and a great sound, with low latency Filter 2 and Vacuum Tube output selected.

FOR

- quality of build and finish
- sound
- ease of use

AGAINST

- no balanced output
- no remote volume control
- no DAC input

IAG
+44 (0)1480 447700
www.quad-hifi.co.uk

Purist natural sound

"Music produces a kind of pleasure which human nature cannot do without"

Confucius, from The Book of Rites



malvern audio research

ARTISAN HI-FIDELITY EQUIPMENT



+44 (0)7831 197019 / +44 (0)7875 527116 malvernaudioresearch.co.uk

Ming Da / Dynasty / Audio Detail / Planalogue / Albedo / hORNS / Gigawatt / KR Audio / Sonitus / J.Sikora

A Class Apart

An in-ear monitor from new firm IMR Acoustics offers something truly different, says Jon Myles.

No end of in-ear monitor (IEM) headphones pass through Hi-Fi World every year. Most are similar - delineated by price and a small design difference sufficient to give them individual appeal. Occasionally, a product comes along that makes us sit up and take notice, offering something very different from the norm.

So it was with the RIs from IMR Acoustics. My first reaction was that I'd never heard of the company before – so who were they? A phone call to owner Bob James revealed all. Bob recently worked with Trinity Audio helping design their well-regarded IEMs and has a background in studio engineering. He's also an avowed vinyl lover who places musicality as the prime consideration when voicing any earphone.

Hence the emergence of IMR Acoustics and its first product the RIs – that are decidedly different. At their heart is a 13mm custom-made hybrid driver consisting of two materials - ceramic and beryllium. Bob says this combination was tried in smaller sizes (9mm and 10mm) but only the 13mm proved truly effective.

Unpack them and you are presented with a rather large headshell which is constructed from an all-aluminium body. It looks heavy but, in use, is remarkably light. Also included in the box are five custom filters which alter bass, mid-range and treble detail (more of which later).

There's one other detail – a knurled wheel on the back allows the

RIs to be used as closed or open-backed. It's a novel feature that I haven't seen on other in-ear monitors but makes quite a lot of sense.

SOUND QUALITY

The first task with the RIs was for me working out which filter to use. The five are listed as Black for maximum attack with powerful impactful bass and a rich midband, Pink for a slightly decreased bass, Copper for fuller low-end but a recessed high-frequency response, Orange which brings a more balanced bass and midband and rolled off treble, and finally Blue which is the most balanced of the lot.

I tried them all and overall preferred the Blue filter - it had a natural and airy presentation with no undue emphasis on any part of the musical spectrum. However I can see others - especially those whose tastes veer towards dance or bass-heavy rock, opting for Black as it brings a little more punch and dynamic attack.

Whichever filter you choose, though, there's something wonderfully natural and organic about the sound of these in-ears. What they do especially well is present a big, expansive soundstage. There's

more of a loudspeaker-type feeling than some other 'phones that seem to be punching the sound directly into your eardrums.

So on The Verve's 'Bittersweet Symphony' I could hear the full range of the instrumentation via an iPhone 7. Things became even better with high-resolution tracks via a FiiO X5.

The electronic beats and lush synths on Kraftwerk's 'Minimum-Maximum' (24bit/96kHz) had superb atmosphere, the music ricocheting around my head. Tracking individual instruments was easy but the way the IMRs blended everything together into a whole meant they never sounded clinical.

They are not quite as detailed as my reference Noble K10 in-ears but compensate with a rather richer, free-flowing sound.

Switching between the open and closed back settings on Mussorgsky's 'The Great Gate of Kiev' brought out a slightly larger soundstage with the former but, in truth, it is not a night and day difference. Having the option though is a nice touch.

Even nicer is the way the R-Is just get on with the business of playing the music without drawing too much attention to themselves - which is exactly what a good in-ear monitor should do.

CONCLUSION

At £500 these are not the cheapest in-ears you can find but their build quality, range of filter options and sheer all-round musicality make them excellent value for money.



IMR ACOUSTICS R1 £500



OUTSTANDING - amongst the best

VALUE - keenly priced

VERDICT

Excellent-sounding in-ears that offer a range of tuning options allied to a big soundstage.

FOR

- wide soundstage
- tuning options
- natural, free-flowing sound
- build quality

AGAINST

- nothing

IMR Acoustics
www.imracoustics.com

twenty5 series

THE DEFINITION OF PERFORMANCE

A quarter of a century of research, obsessive design and craft has produced the **twenty5** series—loudspeakers that deliver all the passion of the original performance, conveying every nuance. The range refines our **ATL** bass-loading concept with new drivers, new materials, and **Laminair**, a revolution in audio dynamics. With its natural musicality, vivid audio picture and rich, enveloping bass at all levels, the **twenty5** series lets you feel the music, not simply hear it.



24

22

20

18

16



"This is a seriously talented speaker that has to be on everybody's shortlist at the price."

twenty5.21 - Hi-Fi Choice '17

Book a demonstration

See our dealer listing online, or contact us

T +44 (0)1767 686300
www.pmc-speakers.com

ATL™
Laminair™

Are You Ready For Roon?

More and more components are advertising themselves as Roon ready. But what does it mean and how does it work? Jon Myles explains all.

There's been an explosion in the number of manufacturers branding their products as "Roon ready" over the past 12 months. The likes of Naim, Novafidelity, Chord, Creek, NAD, Oppo, KEF and Auralic (to name just a few) are amongst the well-known companies affixing the appellation to their products. Which begs the question: What is Roon and why would you want it?

To answer the first part - Roon is a piece of software designed for digital audio systems that collates all your files no matter where they may be stored (computer, NAS drive, laptop etc) and makes them available for replay through one or more output devices. It also does a great deal more, but we'll come to that later.

First, though, some history. You may not have heard of Roon but the

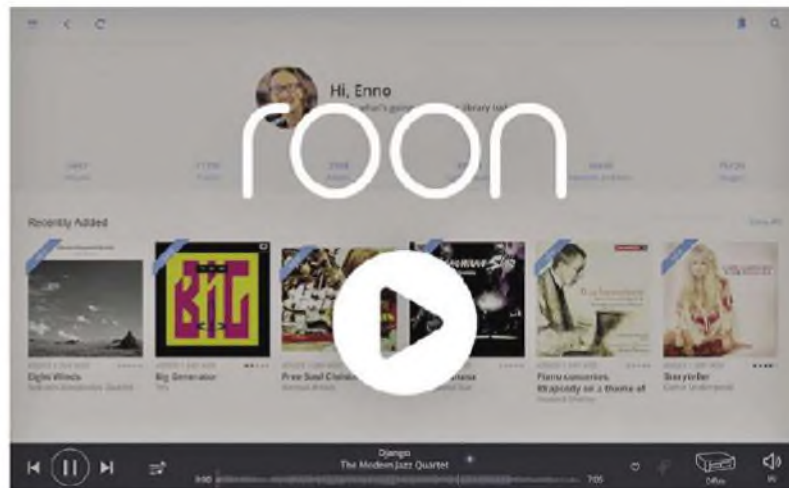

The Roon interface brings up album artwork from all connected devices in a simple, easy-to-use package.

team behind it have some serious hi-fi credentials behind them. They were responsible for the Sooloos music server which became something of

a gold standard in terms of storing and accessing digital files and was later acquired by Meridian Audio so it could incorporate the technology



Tablets, smartphones and computers are all supported by Roon.

Come Together
The Beatles
FLAC 192 kHz 24 Bit

4/5

4:16

LUMIN

LUMIN

THE
AUDIOPHILE
NETWORK
MUSIC | PLAYER
FAMILY

S1 / A1 / T1 / D1

NOW | WITH | NATIVE
TIDAL | SUPPORT



TIDAL

selectaudio[®]

Distributors of exquisite audio equipment
Tel +44 (0)1900 601954

WWW.LUMINMUSIC.COM

Come Together
The Beatles
FLAC 192 kHz 24 Bit

4/5

4:16

LUMIN



The Auralic Altair is one of a growing number of streaming devices that support the Roon system.

into its own streaming systems. That led to the establishment of Roon Labs in 2015 and the development of the Roon platform.

Of course you may be thinking that there are no end of other software packages that can access music from storage devices around the home, but Roon promises to do a lot more in terms of collating everything, analysing metadata and generally personalising your music experience.

WHAT IT DOES

If, like me, you have music files from iTunes on a Mac or PC, high-resolution downloads on one NAS drive and thousands of albums stored on another with an additional USB drive plugged into that, then easily accessing them all can be troublesome.

What Roon does is find them all and integrates them into one simple interface that can be accessed via a desktop computer, tablet or smartphone (both iOS and Android).

It also accesses an on-line database to add liner notes, photos, additional artist information as well as reviews by critics so you can browse all this while listening. This information is constantly updated with extra information being added daily.

All major file formats are supported and it can stream PCM up to 24bit/384kHz to Roon ready devices, as well as DSD.

Roon also integrates with the Tidal music streaming service (16bit/44.1kHz quality files) to give you access to millions of other tracks all under the same user interface.

One other interesting feature is Roon's Radio Mode. Switch this on, select a track and when it's finished playing Roon will automatically select another one which is similar in content – be it genre, subject, mood or an associated artist.

It might sound a little gimmicky but it's actually tremendously

addictive and if you have an extensive collection delves into the darkened corners of it to find music you might well have forgotten about.

After first installing Roon I played

download, install and try it out for two weeks with no commitment. To access this go to roonlabs.com and enter your details.

You'll need to install the programme on a computer, which acts as the core. This can be a PC running Windows 7 or above (10 is recommended for best performance) or a Mac with OSX 10.8 or higher (again Roon advises 10.12 or above). After that, controlling everything can be done either from the computer or the free Roon app for Android and iOS devices.

Set-up typically takes less than five minutes and once done everything is amazingly intuitive.

The Core

A Roon system starts with a core – it's the traffic cop, the housekeeper, and the brains behind the operation.

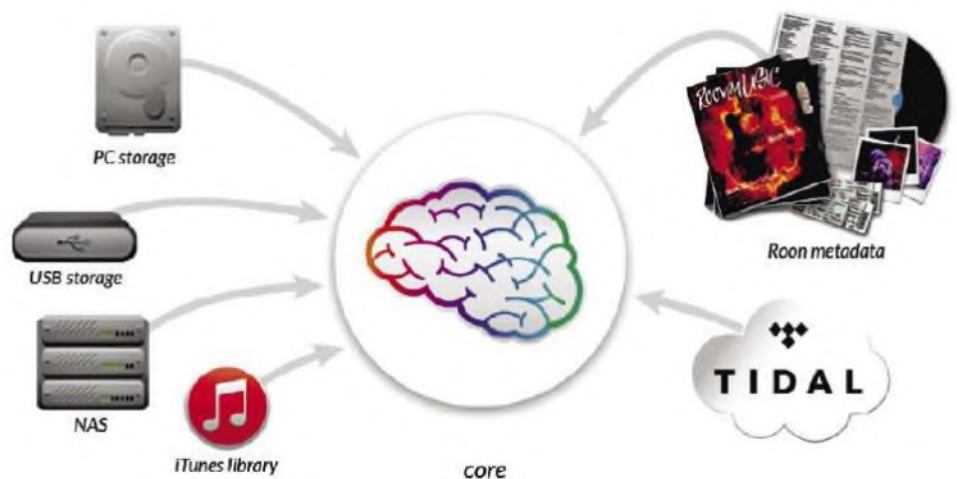

Streaming services such as Tidal, NAS drives, USB devices, computer hard drives as well as iTunes can all feed into the Roon software, bringing together all digital files on a network.

New Order's 'Bizarre Love Triangle' which was then followed by Soft Cell's 'Tainted Love' after which Roon led me through a catalogue of dance, pop, dub and even the odd ambient track. I stayed listening for longer than I really should have. If you don't like any particular track you can simply skip it and go on to the next.

COST AND INSTALLATION

Of course, all this functionality comes at a cost. At present you can choose between an annual membership at \$119 per year or a lifetime fee of \$499.

Fortunately, there's also a free 14-day trial on offer – so you can

THE FINAL QUESTION

So is Roon for you? That's a hard one to answer – it depends upon individual requirements and size and location of your digital library. If you have files scattered around various locations and want to pull them all together in one easy-to-use interface with extra information then the answer is an unequivocal yes in my opinion.

Those with smaller libraries may find the cost/benefit equation doesn't quite stack up. Either way the trial subscription gives you the chance to try before you buy – so take advantage if you fancy dipping your toe into the world of Roon.

BOX•DESIGN

BY PRO-JECT AUDIO SYSTEMS



Pre Box DS2 Digital pre-amplifier shown with Amp Box DS2 stereo power amplifier.

DS2 LINE

For over 10 years, Pro-Ject Audio Systems' Box Design range of compact hi-fi electronics has been a central part of the popular trend toward more convenient hi-fi systems.

By sticking to established hi-fi principles and ensuring each and every box is meticulously designed, the Box Design range allows for users to set-up a complete hi-fi system that suits their requirements, without encroaching on space or breaking the budget.

The new DS2 boasts a whole new aesthetic appeal, with wooden side-panels flanking the 206mm wide aluminium/metal sandwich case.

All DS2 products also benefit from superior technical designs, including new 4-layer PCB configurations, for extremely short signal paths with less interference and signal-loss. The quality also carries through to the pots, controls and enviable list of features each device in the range can boast.

VIEW THE FULL RANGE ONLINE NOW



Distributed by Henley Audio

T: +44 (0)1235 511 166 | E: sales@henleyaudio.co.uk | W: www.henleyaudio.co.uk

Stream radio

We've come a long way since the tranny, baby! Martin Pipe tunes into the Roberts Stream 94i

Readers of a certain age will remember iconic Roberts transistor radios from the 1950s and 1960s. At a time when 'trannies' imported from Japan were starting to dominate the market, sets like the RT1 R66 and R200 were seen as quintessentially British. Apparently inspired by the design of a contemporary handbag, they had a distinctive appearance with their metal grilles and top-mounted controls. It also helped that they performed well and were substantially-built. Many were sold across the decades, and Roberts – which originally opened for business in 1932 – produced 'luxury' versions finished in mink, leopard-skin and solid gold. The latter, a one-off, was stolen from a department store in 1961; to date, it has not been recovered.

Sets of the same classic appearance, but using 21st-century technology, are sold by Roberts today. You can choose from several of these 'Revival' branded DAB-capable radios. But the Revival 'look' won't appeal to everyone. Hence the modern-looking Stream 94i I'm reviewing here that has Bluetooth built in for streaming music from smart devices. You get a remote handset too; handy if you don't have an iPhone or Android device to run the Frontier Silicon 'UNDOK' app that Roberts recommends. The large front-panel display acts as a clock when the radio – which has multiple alarms with 'snooze' defeat, and sleep-timer functions – is in standby.

You don't however get the Revival model's provision for internal battery operation (four user-installable 'D' cells). This allows the nostalgic set to be used outdoors (certainly with FM/DAB radio, should it be outside Wi-Fi coverage). The Stream 94i's manual refers to using it with batteries, but no further information is given. After hassling Roberts for information, it turns out that you can use the £45 BP931 rechargeable battery pack (<http://bit.ly/2rb4quZ>) sold for use with an



earlier model. This clips rather inelegantly onto the Stream 94i's rear panel, plugging into the socket that's usually occupied by the 'wall-wart' mains adaptor. It is claimed to deliver up to 10 hours of use from a single charge.

I quite like the modern look of the Stream 94i, with its wood/silver/black finish and flexible carrying handle. The lower half of the front panel is dominated by the speaker grille. Behind this lurks two of the tiniest drive units I've ever seen, working to provide stereo – albeit with limited separation, as they're spaced a mere 130mm apart. At 20mm in diameter, they're almost tweeter-sized! To give the sound more body, a goodly proportion of the rear panel is given over to a common 60mm driver and bass-reflex port. There, you'll also find the DC input, Ethernet (handy if Wi-Fi is difficult) and a USB port

for playing local content – as with the DLNA player MP3, FLAC/ALAC, WMA, WAV and AAC content is supported. Interestingly, FLACs can be 24-bit as well as 16-bit. 3.5mm jacks are provided for auxiliary input, headphones (why not the side or front?) and line output.

USE AND PERFORMANCE

Most of the front panel's top section is dominated by the dimmable 70mm colour screen, which is flanked on either side by large knobs for volume and tuning/function selection. Between the two halves is a horizontal strip of buttons for standby, transport control, mode selection and presets amongst other jobs. It all looks neat, and hints to the enormous potential of this radio. The Stream 94i is easy to set up, seeking out and finding all available DAB (and DAB+) stations. Wi-Fi configuration is also friendly, not least because WPS is supported. I also found driving it to be straightforward. Rotating the mode dial sequences through the

SPENDOR

REVEALING EVERY DETAIL

Spendor D-Line loudspeakers reveal every nuance of the performance with absolute clarity, precision and realism. With their transparent, superbly natural sound and extraordinary resolution, they create an airy, spacious soundscape, then invite you in to explore, uncovering new depths, textures and definition in your music.

MADE FOR MUSIC.
DESIGNED FOR YOU.



available functions – pushing it selects the currently-highlighted one.

If you're listening to the radio, that dial then sequences through the stations. Internet radio stations can be selected by genre or location – there's also a 'search' function that involves a virtual keyboard, driven by the right-hand knob. The same intuitive approach allows you to choose DLNA servers or select tracks stored on these or USB for playback; the UNDOK app can also be used, as can Windows 'Play to'. I couldn't alas install UNDOK on my old-ish Samsung phone, and was thus unable to try it. Spotify Connect also requires an app, as well as an active account. On the whole, streaming worked well in usage terms although for some reason it wouldn't let me get to the end of a long list of music folders stored on my QNAP DLNA box. I found the Stream 94i to be very reliable, with no 'glitches' or lockups. Pretty good for a product that's so technically-involved.



Something you wouldn't have got with the handbag-shaped Roberts radios of yesteryear – a miniature remote control, powered by a lithium cell.

It also performs far beyond expectations in sonic terms. Sure, it's not going to compete with a full hi-fi rig or subwoofer-equipped home cinema. But the bass goes surprisingly deep, this radio achieving a well-balanced presentation from a wide range of music and speech alike. I was particularly impressed with the lack of colouration – speech isn't spoiled by the unpleasant hollowness that some radios add. Furthermore, I heard none of the annoying background 'squeaks' that my Pure Evoke adds to networked-audio playback. Volume is rather restricted, though – this isn't the radio to fill a large room with sound, unless you drive an amp and speakers from the auxiliary output – and naturally the stereo image is rather compressed, on account of the narrow spacing between the two front speakers. I also found the treble to be a little subdued – a common



These minuscule speakers reproduce the left and right channels. They work in conjunction with a rear-panel bass speaker, and the overall result is very satisfying – although there's little stereo separation to speak of.

trait with Roberts radios. However, the Stream 94i's menu-driven tone controls help to address this.

Headphones – even high-end models like the Focal Clear – fare reasonably well. The stereo image is naturally much wider, there's more room for dynamics and greater presence at the frequency extremes. Compared to an audiophile streamer coupled to a headphone amp, finer details can be masked by congestion – but it should not be forgotten that we're talking about

a radio that sells for £200! You can certainly hear the limitations of some DAB and Internet-radio broadcasts. With good ones – Radio 3, for example – it's amazing just how good the Stream 94i can sound. The line output is acceptable, but in my view a digital output would show this radio in an even better light. But surely that loses the point; the Stream 94i is after all a radio, and not a hi-fi component. That it performs so well is a credit to Roberts' design team.



There's an Ethernet port for 'hard wired' networking. A USB port is provided for playback of local media, and analogue sources can be fed to the 3.5mm auxiliary input jack. Next to this is a line output for feeding amplifiers, and a headphone socket that could be better-positioned. Also visible are the bass driver – which is shared between the two stereo channels – and a bass-reflex port.

ROBERTS STREAM 94i £200



OUTSTANDING - amongst the best

VALUE - keenly priced

VERDICT

If you're using a kitchen FM/AM tranny that's on its last legs, the Stream 94i will revolutionise how you listen to radio.

FOR

- a remarkably well-balanced sound
- versatile
- looks smart

AGAINST

- rather quiet
- subdued treble and limited stereo separation
- poorly-located headphone socket

Roberts Radio
www.robertsradio.co.uk



01202 911 886
bournemouth store

01592 744 779
glenrothes store

  follow us

web site: www.jordanacoustics.co.uk



The McIntosh MA252 (100wpc) combines the best of vacuum tube and solid state design to create an amp that is both visually and sonically stunning.

NEW

MA252

McIntosh's first Hybrid Integrated Amplifier



RETAIL
£4,500

0%
FINANCE AVAILABLE*

Initial 20% deposit of
£900.00, then £150.00
per month for
24 months*

For further information please call 01202 911 886 or email ask@jordanacoustics.co.uk

Finance is subject to status & conditions.

Mail



LETTER OF THE MONTH PRIZE

Visit our website at www.hi-fiworld.co.uk or send your emails to letters@hi-fiworld.co.uk. Letter of the month wins a pair of Tannoy Mercury 7.2 loudspeakers.

Answers by: **NK** - Noel Keywood; **JM** - Jon Myles; **PR** - Paul Rigby; **MP** - Martin Pipe.



Tannoy Mercury 7.2 loudspeakers

www.tannoy.com

For more advice see Letters from earlier issues at www.hi-fiworld.co.uk/letters

A pair of Tannoy Mercury 7.2 loudspeakers are on their way to **DR. RUSSELL SCEATS**, Letter of the Month winner in our February 2018 issue.

Letter of the Month

ASTRAL TWEAKS

I have been an incorrigible hi-fi fiddler (I do also play the violin!) for over 45 years. Like all enthusiasts I am always striving for that last ounce of realism and my poor system which is largely home built (since I love the challenge and satisfaction of listening to something I've built myself) is constantly under attack from my soldering iron!

My latest project was to build external crossovers for my 14 year old Zingali Overture 3 speakers. I also took the opportunity to replace the horrible internal bell wire with Dueland tin plated fabric insulated cable which I have also used to great effect in interconnects. I also subtly fine tuned the internal damping.

The improvement was far from subtle! Dramatic is the most appropriate word. With my PSE 300B power amps and transformer coupled valve preamp the sound is startlingly real. My Koetsu rosewood signature on the remarkable Audio Origami Uni-arm has never sounded so good and CD sounds spacious and realistic via my Cyrus CDxt and Chord Hugo.

This modification was a bit fiddly but pound for pound the best money I have spent. I would encourage anyone with enough courage and technical



Anthony Parkin's Zingali Overture 3 loudspeakers, with custom built external crossovers out of sight behind.

know how to try this. Also great fun to do! I attach a few photos of the result. Keep up the great work with the magazine.

Best wishes
Anthony Parkin.

Yes, there's nothing quite like a finely fiddled home-built system – you're the master and the system knows it, or it gets attacked! Nice to know your World Audio Design 300B Parallel Single-Ended valve amplifier is earning its keep, but then as a violinist I suspect its suits perfectly.

I continue to feel our in-house Icon Audio Stereo 30SE single-ended is about as good as it gets; there's subtle magic within SEs.

Dueland's tinned copper wires, protected by cotton and oil insulation, certainly sound good (I have no experience here). At World Audio Design we always loved the sound of Jensen paper and oil capacitors; quite different to all else. So your recommendation for its use in interconnects resonates with me and may well encourage others to experiment. **NK**



The impressive home built external crossovers put together by Anthony Parkin.

RETURN OF THE BUG

You kindly helped me with upgrade advice back in the October 2016 issue when I was looking to add an external phono stage to my system. As a result, I saved the pennies and a few months ago, purchased an Icon Audio PS1 MKII and I am very pleased that I did. It has made a significant improvement to my vinyl enjoyment.

The upgrade bug waned for a while and has returned, but in controllable form! In the not too distant future, I would like to upgrade my tone arm and then later, my cartridge, as I believe the Icon Audio has more to deliver. I hope

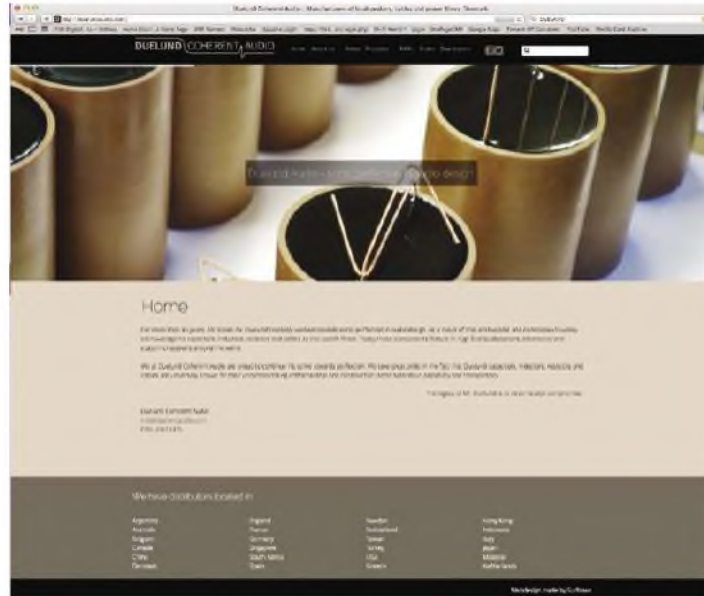

Duellund make "tinned multistrand wire in a cotton and oil dielectricum, recognised as the go-to wire for REAL sound".

to gain between the latter two? This is at the very top of my budget and so the cartridge upgrade would have to wait a while longer. My current arm is an Origin Live Onyx and the cartridge is a Benz Micro Ace SL. My amp is a Yamaha S-A2100 feeding Monitor Audio GX200 speakers. Speaker cable is QED Reference XT400.

My music tastes are varied and range from light jazz/vocal to pop/rock. I am not after subsonic bass as my room has a tendency to boom if I am not careful and would prefer to have it clean and controlled. I also like plenty of detail and solid imagery. Along with SME, other arms on my shortlist are the Rega RB2000, Clearaudio Clarify &

suggestions, but would say it would have to be a moving coil.

With many thanks and kind regards,
Mark Gould

Hi Mark. SME arms are beautifully made and finished, making them a delight to use. If like me you have to regularly change the cartridge (for review purposes) then an SME is just about essential. But in any case I slightly prefer the more svelte sound of a long arm so use a SME 312S out of choice. The shorter SMEs have a slightly faster sound, you could say and a 310 would be an obvious choice if it fits your Gyrodec. I do not know whether this is possible



SME309 arm – beautifully made and finished and wonderful to use.

you can make some suggestions for both arm and cartridge, which I can put on my shortlist.

The turntable I have is a Michell Gyrodec with the HR power supply and my ideal choice of arm would have been an SME IV, but the recent price increase no longer makes it a contender unfortunately. What are the other SME arms like in comparison to the IV, such as the 309 or 310? Is there anything

Satisfy and Origin Live Encounter. Are there others I should consider perhaps?

I know the SME arms are above this level in price and performance and are regarded as natural partners for the Gyrodec. If they are worth the extra, I would be willing to wait a while longer and hope SME prices do not jump again.

As for a suitable cartridge upgrade from the Benz, I am open to



For serious MC listening get an Icon Audio PS3 valve phono stage.

– best to ask Michell. Otherwise an SME309 would seem ideal for you.

Upgrading from a Benz Micro Ace SL is not so easy as you are getting into serious high-end territory where taste is a factor. An Ortofon Windfeld Ti or MC Anna might suit, or a Benz Micro Gullwing, according to budget. My only slight reservation is that high end MCs these days commonly employ boron



The budget Nobsound phono preamp bought by Mike Tartaglia Kershaw. "Clean, detailed and powerful with a huge sound-stage" he says.

rod cantilevers and I don't much like their sound. Impressive perhaps, but rather cold and mechanical as a generalisation. **NK**

CHINESE TUBES

I do love my Monitor Audio Gold 200 speakers with the Prima Luna Dialogue HP valve amp. Ever since I bought the Prima Luna I have wanted to try a valve phono pre amp. Then I spotted this pre-amp on Amazon:

<https://www.amazon.co.uk/Nobsound-Vacuum-Preamplifier-Turntable-Pre-Amp/dp/B07289S6KT/>

I thought it has got to be worth £50 just to have a go. I expected a warm fuzzy valve sound. What I got was clean, detailed and powerful with a huge sound-stage. Valves do seem to bring more 'colour' to individual instruments even when massed together and drums have a real solid thump. Please test this pre amp and see if you agree. I can't believe my ears.

Also, I agree entirely with your review of the Audio Technica AT VM740ML cartridge. It is working well in my Sony PS-HX500 turntable.

Best wishes,
Mike Tartaglia Kershaw

Thanks Mike. Others may be interested in that valve phono stage. We will try and get one in for review. I note it is from Nobaudio/Douk Audio, Guandong, China, and Muffsy hails from the same region too I suspect – see next letter. I'll make no comment on the peculiar names! **NK**

BUILDING MUFFSY

Your op-ed piece on phono preamps in the February 2018 issue piqued my interest.

My story is not exceptional. I resumed my interest in vinyl after a

few years without a deck. I found a decent second-hand Systemdek IIX and connected my old Rega Fono Mini. It all sounded great, but I thought it would sound better with an up-to-date phono preamp.

I bought a Douk Audio T8, which sounded terrible. So, with zero experience of kit building I had a go at a Muffsy Phono Preamp PP-3 <https://www.muffsy.com/>. No-one was more surprised than me that it worked (after some troubleshooting). And it sounds not half bad. Way better than the Douk

Hi John – and the answer is No (and yes). You do not state what cartridge you are using; if an old or worn budget moving magnet (MM) then look at this area first. If you have a tight budget consider a Goldring E3 – it's a great little device.

If you are happy with the cartridge and want a really good phono stage I suggest you consider an Icon Audio PS2 MM valve phono stage. All phono preamps these days use silicon chips, including your Muffsy. I decided to embark on a



Icon Audio PS2 MM all-valve phono stage, silicon chip free! Get it for unique sound quality says Noel, but it isn't "as cheap as chips".

Audio T8 and even somewhat better than the Rega Fono Mini. In fact, the improvement was so great that I'm wondering if this – i.e. phono preamp – is the area that I should concentrate on upgrading next?

The rest of the system is an early Icon Audio 40i and Monitor Audio Silver Si loudspeakers. I have a large, hollow listening room that I'm slowly damping down.

Any recommendations?

Regards
John Beverley

fully discrete design to get away from the problems of chips, notably non-linear silicon-etched capacitors and resistors that have known problems, and high (open-loop) distortion that results.

Unfortunately – nowadays – chips are so attractive everyone uses them, making phono preamps sound much alike. However, by using valves the Icon Audio skirts all this entirely – and you will hear the difference.

NK

CARTRIDGES AND CABLES

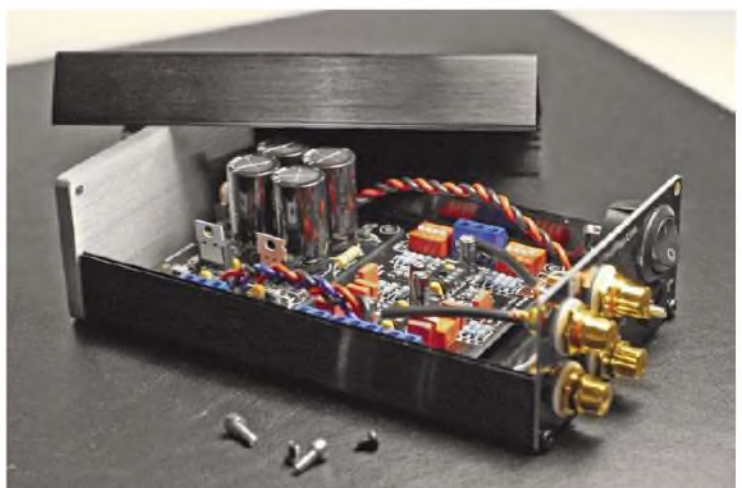

The small Muffsy DIY phono stage kit. "It sounds not half bad" says John Beverley.

That was an interesting review of the upper-end Audio Technica cartridges, and the geometry profiles of styli, in your December 2017 edition. I purchased a 540ML Audio Technica cartridge just weeks after they came out, to replace an Ortofon 2M Blue moving magnet. I was really pleased, indeed astonished, with the transformation in audio quality – much crisper and more realistic percussion on things like timpani, snare drum, piano, and attack on brass instruments. Reverberation was also more apparent and realistic on recordings.

The presentation through a Naim XS2 amp and Dynaudio speakers just sounded more like the real thing. Maybe its the positioning of the magnets in combination with the stylus profile? I was a complete Shibata stylus convert until I tried the Microline stylus. In some respects I even prefer the Microline, but Ortofon's 2M Black with Shibata stylus is still a favourite of mine, and their Quintet moving coil with a Shibata can sound impressive with the right recording on vinyl.

Although I have some remaining playing hours to go, I would consider eventually replacing my 2M Black at some stage for either a 540ML or one of the 700 series Audio Technicas. Just wondered what sort of improvement that might achieve, going from a 540ML to a VM 740ML?

On another separate issue, I wonder if the future of amps will be more an integrated design, as compared with pre/power amps, as the quality of integrated seems to have improved significantly in recent years. I mention this because I have both types on different audio systems. But the pre/power Naim (main) system has various power supplies. By the time it is all connected, if any part or channel fails, it would be a nightmare to determine, without test equipment, which part has failed.

This may not be such an issue for you, because you will have the test equipment presumably, but if I had to send all the preamp, power amp, power supplies, cables, connecting leads, and relevant bits back to the manufacturer or dealer, it would cost a fortune in postage, and each part would need detailed testing to find the fault. And that assumes I can find the boxes up in the loft, to pack them in! An integrated amp is generally one single box, (unless you add a separate power supply as per Naim).

Modern homes are in general more compact than years ago, so the space for all those extra boxes is limited. Then there is all that additional cabling, and



Naim amplifiers like Naim's SuperNait 2 are highly developed and electronically sophisticated Class A/B amplifiers with a smooth powerful sound.

connectors, each connector providing a potential, weak link in the audio chain.

I appreciate that a good pre/power amp combination can be fabulous, if set up correctly, but, apart from the cost, the physical size, and maintenance implications do make me think carefully if I would ever go that route again.

When I considered my purchase years ago, I listened and compared it to the Naim Supernait, (version 1). The pre power gave a better account on audio definition, so that is why I purchased it. However, there is now a version 2 Supernait, with very good reviews, and many other competitors amps out there, with improved components and designs, all in a single box.

Less hassle to return to the dealer when it goes wrong, less packaging, less postage costs, quicker turnaround probably to identify faults, and possibly easier to to sell second-hand due

to a wider market of second-hand purchasers. Probably more sustainable also, using less resources to produce a similar result.

It is surprising how much power output can be obtained from a modern integrated amp, in a single box, 150 watts per channel or even more is no longer that unusual, with big toroidal transformers. The old argument, that used to force purchasers with insensitive speakers onto big pre/power combinations, due to lack o output power on integrated amps, no longer applies.

In reviews of equipment, I believe it time that reviewers at least commented on the comparisons between choice of pre/power amps v integrated, also the reliability of equipment, maintenance implications of having lots of separate boxes linked together, and how much real audio difference there is likely to be between modern integrated and pre/power combinations, for the average purchaser.

**Ron Koorm
Harrow**

Hi Ron. I cannot say what change you might experience when moving from a 540ML upward to the new metal-bodied 700 Series cartridges from Audio Technica. I suspect it would be small however.

Good point about pre/power amps, especially the tangle of cables they impose.

On the issue of power I can assure you that 50 Watts is plenty enough for most people; I measure the power we use when playing in the office, and our McIntosh MC152 has power meters that are a constant reminder (very useful when reviewing). Average playing level is just a few Watts, with peaks occasionally swinging up to 10-20Watts. Certainly, a twist of the



Your local VHF/FM transmitter sends out a Mono (L+R) and Stereo difference (L-R) signal so as to be compatible with mono radios.

volume control to very loud can move peaks to 50 Watts or so, but you must go insanely loud to get past this. Naim's smaller integrations are very well developed Class A/Bs and smooth in their sound; few come close. Nowadays Class D gives high power with low distortion, if sheer power is what you want. **NK**

SOUND OF THE SIXTIES

Listening to Radio 2's Sound of the Sixties on a mono portable radio it is immediately apparent that on stereo tracks we are only hearing one channel – an over-loud rhythm track with a ghostly vocal echo. The BBC say this is because my mono radio can only access one half of the stereo signal. A mono portable radio would not have a stereo decoder so what is happening? My suggestion that on artistic merit they should be playing the mono mix any way went right over their heads.

**Robert Springthorpe
Oxford**

Hi Robert. It is not true that a VHF/FM mono radio plays just one channel of a stereo signal, it plays the sum of both channels (L+R), because stereo VHF/FM comprises mono plus stereo content (on a sub-carrier) specifically to be compatible with mono radios. It should play stereo correctly as-is, unless the music is discrete left and right – for example vocals at right and instruments at left – as per early Beatles. This would only occur with the odd song though, not all programme. **NK**

STATIC ATTRACTION

Thank you for publishing my query in your November issue. I should have been more clear on cable I used. Just to update you, I have been using Chord Epic speaker cables and various interconnects from Chord ranging from Anthem to Signature series.

Although happy with these, I have used the opportunity while in the US to try others and now have my system wired with Morrow Audio cables: interesting difference and burn in seems to be very challenging! I have also purchased a new rack from Mapleshade Audio which not only looks super has improved how system sounds.

Anyway, my main system now consists of aforementioned VPI, Ortofon, Devialet but coupled with Martin Logan Classic ESL 9 'speakers – your fault partially as your review reminded me of experience hearing electrostatics when a child at a show in Brighton. Anyway, went and heard the speakers here in



Martin Logan Classic ESL 9 hybrid electrostatic loudspeakers. "I heard the speakers here in New York and let us say I am \$6500 worse off" says John Speight.

New York and let us say I am \$6500 worse off.

I also saw a letter in your recent publication over room size and placement. May I ask that you consider bringing back the idea of reviewing systems, not just components. It would help us incompetent listeners on setting up and subsequently upgrading our systems. I know that with effort my system would sound a lot better, but I need help.

By the way Noel, it is challenging as to what I can listen via this system so now listen to poor recordings via MacBook using dragonfly red plugged into Stax electrostatic headphones.

*Kind regards
John Speight*

Hi John – oh, so you bought Classic ESL 9s! That is interesting. You should tell us all more about this. They are one of the most dramatic electrostatics I have heard to date, but as you use Stax headphones I guess you made the transition from box to panel some time ago. **NK**

QUAD DISMISSED?

Noel Keywood's words are always honest and illuminating but how disappointing, in his glowing appraisal of Martin Logan's ESL9, to read his dismissal of the Quad Electrostatic 57 speakers.

Weak bass? If you listen to Massive Attack instead of Ron Carter, perhaps.

Cant go very loud? Well, loud enough to disturb the neighbours where I live.

Insensitive? I drive mine with a 15 watts valve amp.

Looks? Art Deco and surely less obtrusive than the 5 ft high Martin Logans.

Having produced music all my life and listened to many high-end studio monitors, the Quads still do it for me every time. I'm afraid Noel, I'll have to go with the opinion of Ken Kessler 'from the other side' with this one.

*Regards,
Ray Singer*

Hi Ray. Yes, alright – how could I ever deride a Quad ESL-57 and end up

in heaven! The One Thing revamped Quad ESL-57 offers one of the purest sounds I have ever heard; they are totally captivating. Quads are also the first electrostatic I ever heard, albeit in Braun clothing and accompanied by occasional sparks. After returning them to a friend and going back to box loudspeakers I saw the light – one that has never dimmed. The Quads then are nothing other than a remarkable loudspeaker, even today, and of course they remain in production I must mention, at QuadMusik Wiedegarbe (Germany).

On specifics, I too have heard ESL-57s produce Reggae bass with remarkable clarity and speed, but that was in a room that very specifically suited them: it was narrow at around 9ft allowing the panels to abut the side walls – just as Peter Walker said they should be placed if possible, since this extends panel area, lessening cancellation and thus strengthening bass.

The bass panels resonate at 90Hz and bass falls away fast below this frequency so you get bass, but it isn't deep. A room no longer than 14ft and preferably shorter has enough 'gain' around 50Hz to sustain apparent bass, so these 'speakers usefully suit smaller UK living rooms – conversely they get lost in bigger rooms.

Revamped ESL-57s and '63s have protection circuits (high voltage breakdown diodes in the secondary) to prevent them going too loud, so as to avoid internal arcing. But they're loud enough for modern day use.

ESL-57s are very insensitive at around 82dB from one Watt input but since you cannot play loud in any case 40 Watts is sufficient. I would call 15 Watts with '57s gentle!

I moved on to the open Martin Logan XStat panel after removing the outer sock and protection grille of my ESL-63s, to realise how much fine detail they suppress. With the technically advanced and very cleverly engineered XStat panel you get to hear the film with nothing in the way – and what revelation!

The Martin Logan's are hybrids whose panel reaches down to 400Hz so they don't match the Quads for sheer coherence and fidelity below this frequency because you are back to the box problem. So I perfectly understand and sympathise with you; Quad ESL-57s remain an awesome loudspeaker – so long as you don't live in a castle and want to play the Sex Pistols at a level to wake Sid.

NK

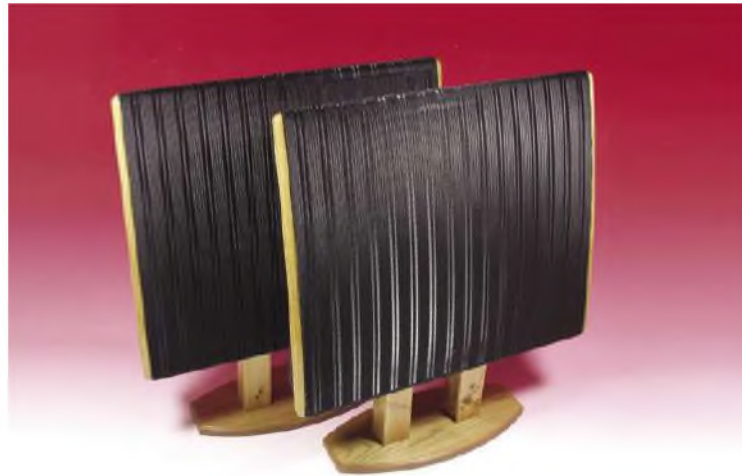

The first commercial full-range electrostatic loudspeaker, the renowned Quad ESL-57, released in 1957. It's still going strong today; our picture shows a One Thing Audio restored and updated version. "The Quads still do it for me every time" says Ray Singer.

VISITING CONCORDE

Hi Noel. We met at the Bristol Hi-Fi show earlier this year, 2017. I was the chap who worked at Rolls Royce and spoke to you about the old British Aircraft Corporation (BAC, now BAE) facility in Filton, Bristol. We talked about Concorde that was built there.

I mentioned at the time that a museum was being built to house Concorde, which until fairly recently, had been left to rot on the side of the old runway. I thought you may be interested to know that the museum has now been completed, and was opened to the public a few weeks ago.

I thought the museum was purely to house Concorde and nothing else. However, a guy who worked on Concorde during the 1960s visited recently, and commented it was a fantastic place to visit and the old hanger was stuffed to the gills with anything and everything related to BAC and R-R heritage, right back to the very beginnings of both companies. The cost is £15 per person, however, ex employee's can get

a discount, plus you can purchase a 'season' ticket, should you feel you would like to return again. See you at the next Hi-Fi Show in Bristol 2018.

Very Best Regards,
Steve V Allen

Hi Steve. Thanks for the update and info. I will certainly go; I lived on that airfield for one year, as a student apprentice in Barnwell Hall. An amazing experience – especially when Britain's nuclear equipped Vulcans landed for a splash-and-dash. This museum will be fascinating for anyone interested in visiting the home of Concorde, likely many Hi-Fi World readers. The location is Filton, on the north side of Bristol, close to the M4 – it is easy to reach. **NK**

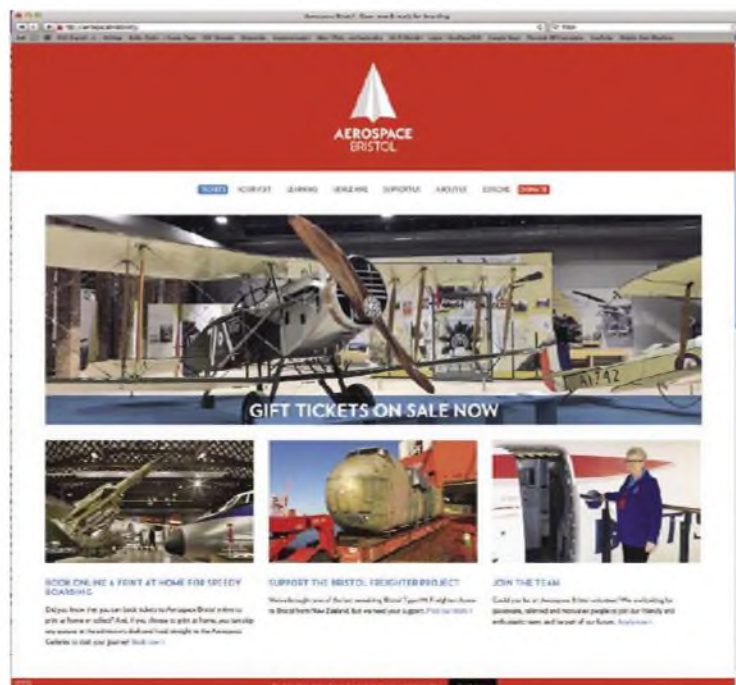

The recently opened Concorde museum in Filton, Bristol.



Your music. Your speaker. Your choice.

Introducing Mu-so Qb by Naim. The compact wireless music system designed by our specialist audio engineers in England. Offering versatile features and 300 watts of power, Mu-so Qb has to be heard to be believed. Why compromise?



Pretty Poly!

Chord's new Poly module turns its Mojo DAC into a streaming device. Jon Myles finds the combination works wonderfully.

Chord certainly hit the mark with the Mojo - a DAC/headphone amplifier that turns smartphone into a high-resolution player, and can also be used in a hi-fi system for improved analogue-to-digital conversion. The one thing Mojo lacked was any form of streaming capability.

Not any more, though. Chord's dedicated Poly module brings DLNA, Airplay and Bluetooth streaming to the Mojo, as well as containing a microSD card slot so music can be loaded into it as well.

Costing £500, Poly is designed to work exclusively with the Mojo - slotting into its digital connections to form one complete unit which is not much larger than the palm of your hand. In typical Chord fashion it feels



The Poly's connectors slide into Mojo's digital inputs to provide its streaming functions.

extremely robust.

After connection Mojo works as usual - complete with the colour-coded buttons to signal incoming sample rate (red for 44.1kHz, blue for 192kHz etc). The Poly itself contains just two small indicator lights to denote Mojo pairing, battery life and set-up status.

I found Poly easy to pair with an iPhone 7 via Bluetooth but connecting to a home DLNA server via wi-fi required a little more time. First you have to use the supplied pin to press and hold a P-status button (similar to ones on a smartphone for ejecting the SIM card) which makes

the Poly's network discoverable and able to be connected to.

Unfortunately Chord as yet do not have a dedicated app for the Poly (although I'm told one is in the offing shortly) so a third party one such as Plex, 8 Player or MyAudioStream is needed. Once I'd negotiated this the connection was strong and I was able to stream files from a NAS drive straight into the Mojo/Poly combination.

SOUND QUALITY

As it is purely a streaming plug-in the Poly shouldn't add or subtract from the Mojo's already impressive sound quality - and it doesn't.

Listening through a set of Noble Audio K10 in-ear monitors the detail and crystal-clear quality of the Mojo shone through. The drum and bass/jazz marriage of Tim Hagans' 'Animation/Imagination' (24/96) had an expansive, full-bodied sound with instruments placed exactly in the correct space. The trumpet was bright without being harsh while bass had punch, but it wasn't so dominant as to overwhelm other instruments.

This was via the streaming option from my home network. I next loaded some high-resolution tracks onto a microSD card for use when out and about. The same level of clarity was evident, the likes of The Pogues' 'Fiesta' having infectious energy, while Sinead O'Connor's lilting 'Peggy Gordon' came over with a haunting



Mojo and Poly both use a matching aluminium case and similar design to provide a seamless fit when paired together.



quality. On the latter the Chords revealed every catch in the singer's breath, as well as the delicate echo surrounding each verse.

As a final test I plugged the Mojo/Poly into a Devialet Expert 220 Pro amplifier via a 3.5mm to twin RCAs lead in place of my usual Naim NDX streamer. While the Naim had the edge in terms overall soundstage and physicality the Chords were on a par when it came to rhythmic thrust and resolving power. Considering the Mojo and Poly are battery-powered while the Naim has a full-fledged linear mains supply that's no mean feat.

All of which puts into focus just how clever this combination is. For a combined cost of around £900 you get a high-quality DAC and streaming module that can operate in a full-blown system and also be slipped into a pocket for use with headphones when outside. Intelligent stuff indeed.

CONCLUSION

For Mojo users who want extra functionality Poly is a natural choice.

CHORD POLY £500



OUTSTANDING - amongst the best.

VERDICT

A compact unit that retains the sound quality of the superb Mojo DAC but adds streaming capability.

FOR

- complete streaming features
- compact
- clean, open sound

AGAINST

- no dedicated app (as yet)

Chord Electronics
+44 (0)1622 721444
www.chordelectronics.co.uk

The new 800 Series Diamond
didn't get better by chance.
It got better by change.
868 changes to be precise.

Bowers & Wilkins

bowers-wilkins.com



The Clear choice

Can't afford Focal's Utopia headphones? Now there's an alternative. Martin Pipe tries the Clear for size.

When I heard the Utopia, from French audio specialist Focal, I was stunned by the incredible standard of reproduction they delivered. Unsurprisingly, the Utopia won Hi-Fi World's 'best headphones' award last year – but they cost £3,500.

But there's a *garçon nouveau* dans la gamme – the Clear. Pitched between the 'entry level' Elear (£900) and the Utopia, the Clear sells for £1,500. It is a circumaural open-back design; at 450g, it's almost as heavy. The Clear's patented M-shaped domes are fabricated from an aluminium/magnesium material with physical properties that get close to those of the more esoteric rare-earth metal.

The voice-coils are wound from copper. Each has a 55 Ohm impedance, making them compatible with most equipment. Hold these 'phones up to the light, and you can see Focal's high-tech transducers suspended in the cups – which rest gently on your ears, thanks to removable 20mm memory-foam cushions covered with a perforated microfibre fabric. The clickstop-adjustable headband that covers the solid aluminium yoke is fashioned from a mixture of microfibre and soft leather.

They're comfortable to wear for long periods, look fantastic and are beautifully-made. In short, they exude quality – as one has every right to expect, given that not-insignificant price-tag. In the Clear box you get a 3m balanced cable terminated in a 4-pin XLR plug, a 3m unbalanced interconnect with 6.3mm plug and – for portable practicality – a 1.2m

lead that sports a 3.5mm plug. All plug into the base of each cup, courtesy of a 3.5mm mono plug. A 6.3mm adaptor is provided for the shorter lead, and your luxury purchase is rounded off with an elegant carrying-case.

PERFORMANCE

And the sound? Simply breathtaking. I partnered these objects of desire with my trusty FiiO X3 personal as well as Prism Callia and Chord Hugo TT DACs digitally-driven by a Cambridge CXN fed with hi-res and CD-derived material. The Clear eked out every last ounce of music from all three of their unbalanced headphone amplifiers – yes, even those of the modest X3. The Clear's lack of audible colouration contributes to an overall impression of neutrality. No exaggerated bass or treble tizz here – just a deep, articulate low-end, a naturally-communicative midband and an open, detailed top.

It's amazing what the Clear can do for music. Spinning Heaven 17's *Let's All Make A Bomb* (Penthouse and Pavement, FLAC CD rip), the textures of each contribution to the electronic rhythms were definable with an ease that simply eludes lesser headphones.

With another electronic classic from the '80s, Depeche Mode's *Photographic* (Speak and Spell, 24/96 FLAC), it was easy to follow a lower-pitched counter melody that tends to be lost in the mix.

Switching to supremely-talented Irish singer/songwriter Eleanor McEvoy's latest release – an

exceptionally well-recorded contemporary rendering of Thomas Moore's music and poetry (CD FLAC rip) – I found the same successful balance between musicality and analytics.

In McEvoy's version of 'Though Humble The Banquet', the brass was endowed with a living presence – while her centre-stage vocal crackled with intimacy.

They're revealing – I could pick out the hum at the end of the B52s' *Throw That Beat In The Garbage Can* – but this somehow doesn't impair enjoyment of the music, which becomes dangerously-addictive!

With orchestral material (a FLAC stream-capture of the National Youth Orchestra of Great Britain, playing Stravinsky's *Rite of Spring* during last year's Proms season) I was treated to a lucid and three-dimensional soundscape in which no tonal texture or dynamic twist was spared.

Yes, these 'phones are – like the Utopia – reference-class. The Clear boasts practically all of the more expensive model's staggering performance, but with valuable accessories that increase its versatility. If you can afford to spend £1,500 on a pair of headphones, you won't be disappointed.



FOCAL CLEAR £1,500



OUTSTANDING - amongst the best

VERDICT

The Clear is well-built, looks good and produces a sound that is to all intents and purposes beyond criticism. A world-class headphone.

FOR

- supplied with three different cables
- accurate, transparent
- incredibly musical

AGAINST

- heavy

Focal
www.focal.com



exposure



exposure

Exposure Electronics Limited
Unit 18, Winston Business Centre, 43 Chartwell Road
Lancing, West Sussex, BN15 8TU, United Kingdom

www.exposurehifi.com

Super Nova!

Novafidelity's X35 offers digital and analogue replay, storage and streaming in one box. Jon Myles finds it a perfect proposition.



The face of home hi-fi has changed markedly over the past few years. Once the traditional combination of CD player/record deck, amplifier and loudspeakers reigned supreme. But now, for an increasing number of people, the all-in-one unit is the go-to component for music replay.

Not only do they provide a CD player and amplification in one box but also provide other features like internal storage, streaming capability for accessing NAS drives and high-resolution files on a computer as well as subscription services such as Tidal and Spotify, a DAC for connecting external sources plus, in the case of some, the ability to digitise your existing vinyl collection for easy playback.

In short, they are like the Swiss Army knife of hi-fi. One of the first companies to offer all of the above functionality in a single box was

Cocktail Audio with the X30 which came out some four years ago (see Hi-Fi World December 2014 issue). Since then the company has constantly refined its product range - as well as renaming itself Novafidelity - and among its latest offerings is the new X35.

It looks identical to the previous X30 - consisting of a unit the size of a standard CD player housed in a metal chassis with a machined 13mm thick aluminium front panel. The fascia is dominated by a 7-inch TFT colour screen that displays album artwork and information such as track sample rate, as well as being the access point for the various set-up menus. Two large rotary controls to the left and right provide for volume control and OK/pause/scroll, while a small set of buttons allow the selection of various functions.

Inside, though, the X35 takes a huge step forward from its

predecessor. A linear power supply based around a toroidal transformer drives two Class D amplifier modules providing some 100 Watts per channel of power. Also, Novafidelity have fitted the well-regarded ESS ES9018K2M Sabre Reference DAC to handle digital duties - providing support for PCM files up to 32bit/384kHz (24bit/192kHz for Wav and Flac) as well as DSD 64/128/256.

Connectivity is via USB, AES/EBU, XLR, optical and coaxial digital inputs, as well as unbalanced analogue RCAs. There's also an MM phono input for vinyl playback or recording. Add to this analogue, digital and pre-amp outputs as well as a DAB+/FM tuner section and it is fair to say the X35 can connect to just about anything with the exception of Bluetooth.

Control of the unit is via the



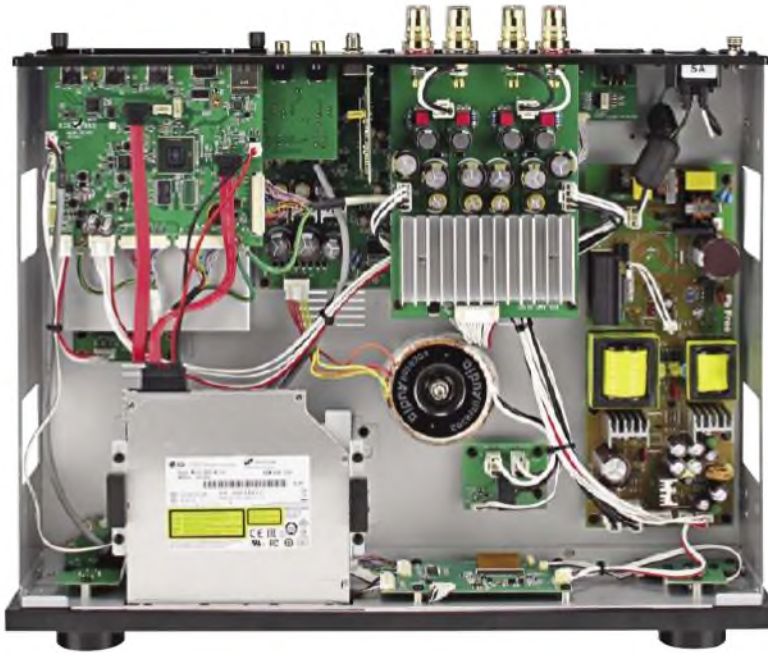

The Novafidelity uses Class D amplification allied to a linear power supply - hence its good measured performance.

supplied, button-heavy remote – or more conveniently Novafidelity’s dedicated Novatron Music X app for iOS and Android.

For music storage either HDD or solid-state drives can be fitted into a customised slide-out draw on the rear (up to 8Tb accepted). You can do this yourself or ask the dealer

to fit it. As standard (with no storage) the X35 costs £1695 while a 2Tb HDD equipped model is £1825.

The unit can be used either wired or wirelessly - but for the latter you’ll need Novafidelity’s optional £35 dongle (why they don’t pack this in with a machine at this price I don’t know).

“The X35 brought out a big soundstage from a pair of Acoustic Energy AE109 floorstanders. Here the sheer power of the organ assailed my ears with presence and a sense of grandeur”

SOUND QUALITY

Class D operation is still looked on with suspicion in some hi-fi circles, but when implemented well with a quality power supply its power and detail levels are a persuasive combination.

Which is what I heard from the X35 after loading standard CDs (average rip time around 2 minutes) plus some high-resolution files to the internal storage.

Jimi Hendrix’s guitar on ‘Hey Joe’ had bite but was not unduly harsh or piercing – and the track was pushed along with a good tempo. Moving on to a more expansive recording - Bach’s ‘Toccatà’ - the X35 brought out a big soundstage from a pair of budget Acoustic Energy AE109 floorstanders. Here the sheer power of the organ assailed my ears with presence and a sense of grandeur.

In terms of absolute sound depth it was a little wanting compared to the best separates - lacking that extra ounce of authority you need to hear this work at its best.

But the ability to switch between Bach and Hendrix at the push of



A slide-out draw at the rear allows buyers to specify either hard disk or SSD storage.



The back panel has USB, AES/ EBU, XLR, optical and coaxial digital ins as well as unbalanced analogue RCAs. There’s also an MM phonoinput for vinyl playback or recording.



Album artwork is clear and crisp.

a button made up for that. On an extended listening session I found myself listening to an eclectic mix of music from various sources - Tidal's streaming music, my own files on the home network and those I put on the X35's internal drive. The big selling point of the device is that it makes all this very easy.

The pre-out function also means that it can be paired with existing systems and act as a purely storage/digital front-end. That's true versatility for you.

So, I tried the Novafidelity connected to a McIntosh MC152 power amp using the former as the

digital front-end and the latter as the amplification. This proved a rather potent combination.

Connected to a pair of Sonus faber's new Olympica I standmounts the McIntosh's powerful yet velvet-like sound gave 'Mr Brightside' by The Killers an enthralling

presentation. I was hearing a stadium-like sound - this was big, powerful and utterly enjoyable.

But the Novafidelity's digital section was not sacrificing anything in terms of detail. That quality came through in Messiaen's 'Quartet For The End Of Time' in a 24bit/97kHz recording where the air, space and overall presence of the instruments had everything I wanted.

CONCLUSION

Feature-packed, solid-sounding and able to slot into an existing system to provide a great digital front-end. The Novafidelity X35 has it all.



The front panel also allows users to drill down through the various menus, access stored music and change settings.

MEASURED PERFORMANCE

Power output of the Nova Fidelity X35 amplifier measured 112 Watts into 8 Ohms and 203 Watts into 4 Ohms – big power figures.

The X35 uses Class D power amplifiers fed from a linear supply. Distortion was very low for Class D, measuring 0.01% at 1kHz and 0.05% at 10kHz, both 1 Watt output. At near full output the figure was just 0.1%.

A peculiar feature of the X35 was its frequency response, via analogue Line and Phono inputs, treble rolling down early to give a warm sound with Normal EQ selected. This could only be corrected by selecting Custom EQ and lifting treble a little with the top three slide controls. All other EQs (Rock, Pop, Classical etc) massively altered response so the X35 appears tilted toward such tailored responses. The Phono stage has a warp filter below 30Hz that introduces strong attenuation, measuring -20dB at 5Hz.

Line and Phono (MM only) input sensitivities were low at 1V and 8mV respectively. Low gain results in low output noise (-95dB), but the Class D amplifiers were in truth a little noisy,

this degrading dynamic range via all three digital inputs to 108dB, where the ESS ES9018 Sabre32 series DAC used internally is capable of 120dB+, hence Nova Fidelity quote dynamic range via the Pre-out sockets and we measured 118dB here.

Unlike the analogue inputs, the digital input exhibited flat frequency response with Normal EQ, reaching up to 58kHz (-1dB) with a 192kHz sample rate input. So the analogue inputs will sound warm but the digital inputs tonally balanced.

The X35 has heavily tailored analogue response characteristics; even Normal wasn't normal but 'warm'. Digital lacks this. Dynamic range is compromised by small amounts of noise in the output amplifiers, a not uncommon problem. The X35 measured well but it is a little idiosyncratic. **NK**

Power (8 Ohms)	112W
Frequency response	20Hz-8kHz
Distortion (10k, 1W, 4 Ohms)	0.05%
Sensitivity	1V
Noise	-95dB
Damping factor	60

FREQUENCY RESPONSE

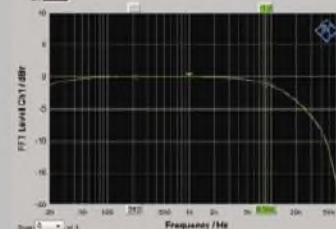

DISTORTION

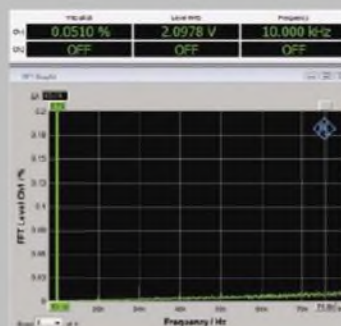

NOVAFIDELITY X35 £1695 (£1825 WITH 2TB STORAGE)



OUTSTANDING - amongst the best

VALUE - keenly priced

VERDICT

A do-it-all package that is hard to beat - offering digital, vinyl and streaming playback in one box.

FOR

- range of functions
- punchy but detailed amplification
- storage options
- ease of use

AGAINST

- nothing

Nu Nu Distribution
020 3544 2338
www.nunudistribution.co.uk

FOCAL | KANTA N° 2

Kanta inaugurates a new vision of the Premium loudspeaker. Completely dedicated to performance, for the first time it combines a Flax sandwich cone speaker driver with a legendary Beryllium tweeter. It delivers a precise, detailed sound that brims with warmth and musicality. With its incredible style and its broad range of finishes, Kanta delights the eyes as much as the ears...

Performance meets style

Visit focal.com to discover more.

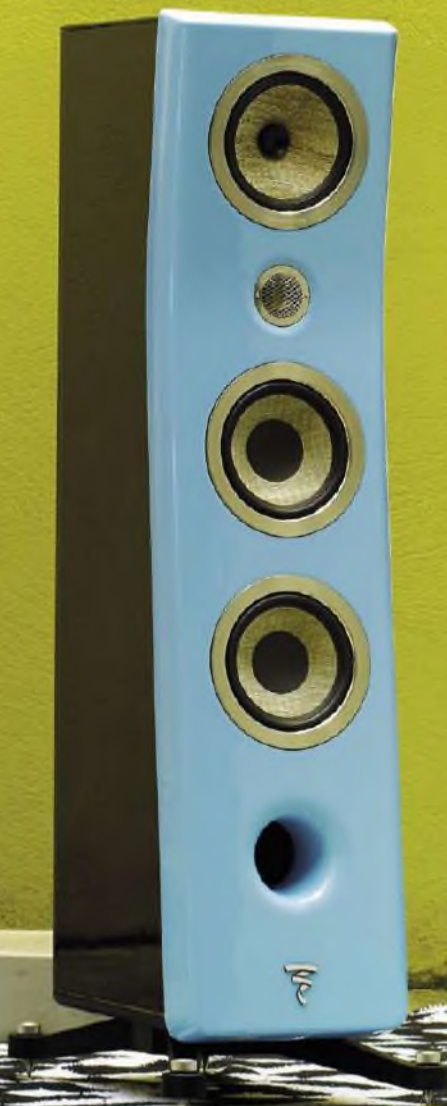



WIN

DUAL'S SUPERB MTR 75 USB TURNTABLE WORTH £250! WE HAVE TWO TO GIVE AWAY IN THIS MONTH'S COMPETITION!

Here's your chance to win the superb Dual MTR USB turntable we reviewed in our April 2017 issue. Read the review excerpt below and answer the questions.

"This is a two speed (33rpm, 45rpm) fully automatic turntable that comes as a complete plug-and-play package. It has an on-board phono preamplifier, making an external phono stage unnecessary, and it has the now-obligatory USB digital output that turns the analogue sound

to digital so it can be recorded on a computer. This is almost unbelievable ability at £250.

The player is very light at 3.9kgs. It is also low profile at 122mm high, with a well finished tinted acrylic, hinged dust cover. The plinth is 372mm (14 1/2in) deep and a 14in wall shelf is needed for enough rear clearance for the dust cover to open. Width is 435mm.

I took a very close look at the turntable's mechanisms and they were all well made. The auto system would trigger at the end of an LP, to lift the arm, with tracking

force right down to 1gm – and the cartridge wasn't even disturbed. The arm bearings were free of slack and moved freely in both planes. And the auto system worked flawlessly.

Press the Start button on the front of the plinth and the MTR-75 does the rest, placing arm onto LP then lifting it off at the end, returning it to the rest. It was uncanny to see all this again, working so smoothly and quietly. It is nothing short of fantastic".

For a chance to win this great prize, just answer the four easy questions at right. Send your entries on a postcard only, by 13th March 2018 to:

**March 2018 Competition,
Hi-Fi World magazine,
Studio 204,
Buspace Studio,
Conlan Street,
Notting Hill,
London W10 5AP**

RULES AND CONDITIONS OF ENTRY

- ONLY ONE ENTRY PER HOUSEHOLD
- MULTIPLE ENTRIES WILL BE AUTOMATICALLY DISQUALIFIED
- PURCHASE OF THE MAGAZINE IS NOT A PRE-CONDITION OF ENTRY
- NO CORRESPONDENCE WILL BE ENTERED INTO
- THE EDITOR'S DECISION IS FINAL
- NO EMPLOYEES OF AUDIO WEB PUBLISHING LIMITED, OR OF ANY COMPANIES ASSOCIATED WITH THE PRODUCTION OR DISTRIBUTION OF THE PRIZES, MAY ENTER

QUESTIONS

[1] What speeds are available -

- [a] 16 & 78 rpm
- [b] 33 & 45rpm
- [c] variable rpm
- [d] digitally stepped rpm

[2] Is the phono preamp -

- [a] off-board
- [b] unavailable
- [c] on-board
- [d] an optional extra

[3] Is the weight -

- [a] 9.3kgs
- [b] 22lbs
- [c] 8ounces
- [d] 3.9kgs

[4] The auto system triggered at -

- [a] the end of an LP
- [b] the start of an LP
- [c] indiscriminately
- [d] never

entries will be accepted on a postcard only

**DECEMBER 2017 WINNER: TANNOY MERCURY 7.4 LOUDSPEAKERS
Mr. Philip Cadman of Dudley, West Midlands**



WORLD STANDARDS

Your guide to the best products we've heard that are currently on sale in the UK...

TURNTABLES

AVID INGENIUM £800
Great bass response and upper midrange detail allied to clarity makes this a must-hear at its price-point.



CLEARAUDIO INNOVATION £6400
Expensive, but offers great results from a finely honed and beautifully finished belt drive turntable, with servo control from the platter to keep a grip on tempo like few others. Can be fitted with a Clearaudio tangential arm, or any conventional design. Awesome.



INSPIRE MONARCH £4,350
A rebuilt from the ground up Technics Direct Drive, having blistering pace and dynamics allied with smoothness, sophistication and purity of tone. A true reference.



LINN LP12SE £3,600
The UK's most iconic turntable, the legendary Sondek goes from strength to strength. New Keel sub-chassis and Radical DC motor add precision and grip to one of the world's most musical disc spinners. Expensive though.

MICHELL GYRO DEC £1700
Wonderful styling coupled with great build and finish make this turntable a delight for friends and family. It has an attractive clear acrylic dust cover, and you can mount just about any arm. A current design standard.



PRO-JECT ESSENTIAL DIGITAL £300
A budget turntable that turns in a great analogue performance, but also has a hi-res digital output. Send 24/96 across your lounge via optical cable to a DAC and get great audio quality. Or record LP to your laptop.



REGA RP3 £550
The first of the super-quality Regas, little compromised by price and featuring Rega's outstanding RB303 tonearm, suitable for MM and MC cartridges. A standard at the price point.

TIMESTEP EVO £2100
The famous Technics SL-1210 MkII Direct Drive but with improved plinth, isolation, main bearing and power supply, plus an SME arm (add £1500). DD convenience, rock steady pitch and fab sound at a great price. Our in-house reference.



TONEARMS

ORIGIN LIVE ENCOUNTER MK3C £1,745
Origin Live combines carbon fibre and ebony to marvellous effect in its new 12-inch arm. Creamy and rich in presentation, the Encounter delves deep into the mix for a satisfying listen.

HADCOCK GH-242 EXPORT £810
Consummately musical, lyrical sounding tonearm, but needs the right turntable.

ORIGIN LIVE ONYX £450
Easy, smooth, creamy nature that reminds you why you're listening to vinyl in the first place. Essential audition at the price.



REGA RB303 £300
A one piece tapered casting makes this arm's structure almost unrivalled. Great dynamics and superb imaging, for MM and MC. Reference quality for peanuts.

SME 312S £1,600
Twelve inch magnesium alloy tapered arm tube plus SME V bearings. An insightful yet smooth and relaxed sound. Superlative build completes the package. Our Editor's steed.



SME 309 £1500
A one-piece tapered 9in arm finished like a camera and slick to use. Superlative SME quality and sound at affordable price.

SME V £3000
Offers rapid fire timing and a sense of precision, plus rock solid dynamics. Top dollar for deep pockets.

CARTRIDGES

AUDIO TECHNICA AT-OC9 MLIII MC £420
A fine sounding MC with strong bass and super fine treble from a great stylus – yet inexpensive.



AUDIO TECHNICA AT-F3/III MC £150
Great value entry level moving coil with detail and grip you just can't get from similarly priced moving magnets.

BENZ MICRO ACE SL MC £595
Smooth, lucid and full-bodied, award-winning hand-made cartridge from Switzerland.

BENZ MICRO WOOD SL MC £945
Highly finessed Swiss moving coil that plays music with riflebolt precision.

DENON DL-103 £180
A popular and much loved budget MC with big bass, smooth treble and deep sound stage. Fantastic value.



LYRA TITAN I MC £3,500
Breathtaking speed and dynamics from LP, helped by diamond coated, boron rod cantilever.



ORTOFON 2M MONO SE MM £80
A mono cartridge purposed for The Beatles in Mono microgroove LPs. Fitted with a top quality Shibata tip. Fab for the four.



ORTOFON 2M BLACK MM £400
As good as it gets from MM. Fabulous detail and insight from a Shibata stylus, good bass and excellent tracking.

ORTOFON CADENZA BRONZE MC £1,400
A mid-price MC with a slightly livelier presentation than the super smooth Cadenza Black. High-end sound at midband price – great value.



ORTOFON CADENZA BLACK MC £1,800
Ultra smooth and dimensional moving coil with bass and punch aplenty. Lovely stylus.

ORTOFON A95 MC £3,750
Fast and extremely detailed, this is an MC cartridge that sets standards.

REGA CARBON MM £35
Budget price for a competent cartridge with a fairly unflappable nature. Ideal for beginners.



GOLDRING 1012GX MM £250
A glorious sounding cartridge with solid bass and strong dynamic punch, plus excellent treble from its Fritz Geiger stylus. Fun and affordable.



SHURE M97XE £80
Big warm sound, but great tracking and bullet proof stylus protection from damped guard. A survivor.

VAN DEN HUL DDT-II SPECIAL MC £995
Long-established cartridge from Holland with an open and dynamic sound.

PHONO PREAMPS

CAMBRIDGE AUDIO 651P £200
Clean, concise sound from MM and MC cartridges at a very low price. A real bargain.

ICON AUDIO PS3 MKII £2,500
All valve MM phono stage with MC transformer option, graced by big, spacious and relaxed sound.



LUXMAN EQ-500 PHONOSTAGE £4,495
A fully-equipped phonostage from Japanese manufacturer Luxman that offers comprehensive cartridge matching allied to superb sound.



LEEMA ACOUSTICS ELEMENTS ULTRA £1,199
Smooth and detailed sound with the ability to accommodate most modern cartridges. Exceptional value for money.



PRO-JECT TUBE BOX DS £425
Compact MM and MC phonostage with valve output circuit and a big sound.



QUAD QC24P £995
MM and MC, oodles of gain, a volume control – and valves! Looks superb and sounds even better: smooth, atmospheric and big bass.

TIMESTEP T-01MC £995
New, minimalist phonostage that sonically punches well above its weight.

PREAMPLIFIERS

ICON AUDIO LA-4 MKIII £1,400
Uses early 6SN7 triodes for liquid sound. Has plenty of gain and a remote control into the bargain.



MF AUDIO CLASSIC SILVER £4,500
One of the best preamplifiers we've heard at any price, this transformer-coupled marvel does very little wrong. It's powerful, clean and open, yet delicate. Its sound is unmatched at or near the price.

MING DA MD7-SE £1,520
A valve preamplifier with an open, effortless sound and a big soundstage. It has plenty of gain so will accept any source and drive any power amp. A real beauty.



INTEGRATED AMPLIFIERS

ARIAND PRO845SE £1,499
Pure single-ended valve magic. Low-powered but immediately gorgeous, easy-going yet forcefully dynamic at the same time.



AUDIO RESEARCH VSI60 £3,500
Power house sound with enormous pace and punch from traditional U.S. muscle master Audio Research. Breathtaking, but expensive.



CAMBRIDGE AUDIO AZUR 651A £350
Dual-mono construction and meaty toroidal power supply combine to produce a solid and sharp sound with sonics far beyond its price point.

CREEK EVOLUTION 100A £1,500
Superb build and smooth confident sound make this powerful amplifier a benchmark.



CYRUS 8DAC £1,400
Trademark shoebox-sized Cyrus integrated now offering 88Watts per channel, plus DAC. Svelte delivery from a dainty case that fits in anywhere – and isn't Class D!

EXPOSURE 1010 £495
Entry-level integrated from Exposure has excellent upper mid-performance with an almost valve-like sound.



ICON AUDIO STEREO 60 MKIII £2,800
Excellent tube integrated with plenty of power and an expansive soundstage, plus KT150 tube option and bias meter for easy adjustment.



NAIM NAIT 5Si £925
Naim's famed entry-level integrated amplifier is updated to si status. Demos Naim's superbly muscular sound at entry level.

SUGDEN A21SE £2,480
Class A amp with fantastic sound quality producing hard, sculpted images, deep detail and tight bass. Just don't expect disco-like sound levels!



POWER AMPLIFIERS

AUDIO RESEARCH VS175 £7,498
Powerful, fast valve sound that makes everything else look weak at times. Needs careful matching but well worth the effort.

AUDIO RESEARCH VS115 £5,000
Oodles of power with enormous punch. Rafael Todes said it provided "shock and awe" while retaining incredible smoothness and texture.

ICON AUDIO MB845 MKII £7,600
With 120W from big 845 valves right down to low frequencies, this power amplifier has massive dynamics and bass swing, yet is easy on the ear.



ICON AUDIO MB81PP £15,000
Big Russian transmitter valves deliver 200W from these massive monoblock amplifiers. Frightening in every sense.

MCINTOSH MC-152 £4,995
Stunningly insightful sound with enormous bass punch from a uniquely designed transistor amp. Amazing audio, a league up, if expensive.



QUAD ELITE QMP MONOBLOCKS £2400 PR
The proverbial iron fist in a velvet glove. Plenty of power but delivered with an assured and confident nature. Smooth on top and easy on the ear but can rock out when needed.

QUAD II-EIGHTY MONOBLOCKS £6,000 PR
Powerful and expansive sound from modern design monoblocks that also look lovely. Superb – used by us as a reference.



LOUDSPEAKER FLOORSTANDER

B&W 803 D3 £12,500
B&W's updated statement floorstanders deliver depth and definition with breathtaking speed and authority, aided by a diamond coated tweeter. Expensive – but enormously impressive.

CASTLE AVON V £1,600
A big floorstander at a modest price that suits the average room. Refined ribbon treble and deep bass give it a great delivery.



EMINENT TECHNOLOGY LFT-8B £2,500
Excellent U.S. planar magnetic loudspeaker at bargain price. Utterly superb - a must hear.

EPOS K2 £1,000
A fun sound that is tidy all round and very engaging, with solid bass. Music as you hope it to be.

FOCAL ARIA 926 £1,400
Simple, clean, neutral sound – easy going but well engineered and affordable.

MARTIN LOGAN SUMMIT X £16,698
Matches Martin Logan's XStat electrostatic panel to a powerful subwoofer to provide extended, powerful bass. Dramatic sonic purity. Awesome – all but unmatched.

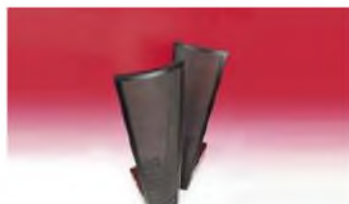

MARTIN LOGAN ELECTROMOTION £2,500
Martin Logan's budget baby XStat hybrid electrostatic. Fits into any lounge to give electrostatic levels of clarity and imaging.



QUADRAL CHROMIUM STYLE 8 £1,700
A supremely smooth yet open sounding loudspeaker. Clean and detailed treble from a fine ribbon tweeter. Accurate yet informative and enjoyable. Pure class.

QUADRAL ORKAN VIII AKTIVS £6,200
Active loudspeaker with tight, powerful bass, perfect accuracy and detailed treble from a ribbon tweeter.



Q ACOUSTICS 2050i £480
A large floorstander at a budget price. Offers high sensitivity and big sound and has very few flaws for the price.

SPENDOR SP100 R2 £6,495
Retro looks but a sound that's hard to match. Spendor's 12" bass unit provides massive low-end grunt with a room-filling sound.



SPENDOR A3 £1,300
Fine little floorstander with a smooth, natural midband and even tonal balance. Ideal for smaller rooms.

TANNOY DEFINITION DC10 Ti £6,000
Enormous power with great projection. Glorious subsonics too. Need little power to go very loud and have superb finish into the bargain.



TANNOY KENSINGTON £9,950
Big but not overpowering, punchy modern sound from classic cabinetry. Need little power to go very loud and suit a traditional home, or castle.



LOUDSPEAKERS STANDMOUNT

ACOUSTIC ENERGY NED 1 V2 £225
Civilised sounding speaker with fast and tuneful bass.

ACOUSTIC ENERGY AE1 CLASSIC £845
Brilliantly successful remake of an iconic design; not flawless, but surely one of the most musical loudspeakers ever made.



ELAC BS243 £1,000
More transparent and spacious than they've a right to be at this price, these refined mid-price standmounters represent top value.



EMINENT TECHNOLOGY LFT-16A £1,200
U.S. planar magnetic bookshelf loudspeaker with unrivalled mid-band and treble. Hear it before all else.

WHARFEDALE DIAMOND 220 £200
Builds on the success of previous Diamond ranges with better bass, more detail and a greater sense of scale.



KEF LS50 £800
Supremely musical mini-monitors which sound much bigger than they look.



MARTIN LOGAN MOTION 35 £1,300
Folded Air-Motion tweeter gives a taste of Martin Logan's electrostatic sound in a standmount. Different from the standard mini-monitor and all the better for it.



PMC TWENTY.21 £1,575
Transmission line loaded standmount with a big box sound from a compact cabinet. Punches well above its weight



Q ACOUSTICS 2020i £165
Great little bargain-priced stand-mounts with a friendly, fun yet surprisingly refined sound. Hard to better for a pair of starter loudspeakers.

WHARFEDALE DENTON £500
A beguiling mixture of retro looks with modern, high-technology drive units. The Denton has an easy-going, big-hearted sound with a touch of trad warmth that should appeal to many.



HEADPHONE AMPLIFIERS

CREEK OBH11 £150
Designed specifically for low to medium impedance (30 Ohm – 300 Ohm) headphones the little Creek has a marvelously well-judged sound.

CHORD MOJO £399
Class leading portable DAC and headphone amp with ability beyond all else. Big, open spacious sound.



EPIPHANY EHP-02 £99
PP3 battery-powered portable gives great sound quality at an almost giveaway price. Happy with the output from an iPod or CD player, the little epiphany is a true bargain.



ICON AUDIO HP8 MKII £650
The HP8 MKII valve-based headphone amplifier brings the spacious sound of valves to headphones. And it matches 'em all.



FIDELITY AUDIO HPA 100 £350
Great little headphone amplifier with a lively yet refined and open sound.

MUSIC FIRST PHONE BOX £276
Brings a big stage, plenty of detail and rich, deep colours to the sonic spectrum.



OPPO HA-2 £250
Remarkable performance and sound from ESS Sabre32 DAC in a slim portable package.



CD PLAYERS

AUDIOLAB 8200CDQ £949
Inspired CD player and DAC with price-performance ratio like no other. Capable of matching designs costing much more.



CANOR CD2+ £3,100
Musically coherent and tuneful valve-driven CD player from Slovakia. Lovely liquid sound.



CAMBRIDGE AUDIO AZUR 651C £410
Snappy modern presentation from this budget CD player. Cracking audiophile entry point for any digital fan.

CHORD RED REFERENCE MKIII £16,000
A unique and massive engineering exercise that could well be the best CD player available. Chord's Pulse Array DAC technology produces a musical experience like few others. A true reference player



ESOTERIC K-03 £9,495
Superb high-end silver disc spinner that is beyond criticism. Devoid of its own character but has a flawless presentation.



EXPOSURE 101 £395
Detailed player with fine sense of timing should be an automatic entry on any demo list at this price.

ELECTROCOMPANIET EMP-1/S £4,650

Epic in scale, lavish in tone and exuberant in its musicality - this is a memorable SACD spinner. Quirky in operation and modest in finish, though.



OPPO BDP-105D £1200

Universal player and DAC that makes CD and Blu-ray (+DVD) sound deep, spacious and full bodied. Reference quality that's affordable.



REGA APOLLO-R £550

Rega comes up with a fine CD player again. Tremendous detail and an easy, unforced sound at all times. Few bells and whistles but made up for by its superb sonic ability.



ROKSAN KANDY K2 £900

A charmingly musical performer at the price - this is a surprisingly sophisticated CD player for the money.



TUNERS

CAMBRIDGE AUDIO AZUR 651T £299

Value-packed AM/FM/DAB and DAB+ ready tuner. Precise and detailed with excellent resolution of spoken word.



CREEK DESTINY 2 £550

Creek's tuner expertise shines through in the Destiny 2. This AM/FM receiver is wonderfully three-dimensional and smooth.



MAGNUM DYNALAB MD-90T £1,900

Exceptionally able, but commensurately priced, audiophile tuner that cannot fail to charm.



DACS

AUDIOLAB M-DAC £600

Excellent sound from ESS Sabre32 DAC and impressive flexibility with a unique range of filter options make this a stand-out product. Low price is the icing on the cake.



AUDIOLAB Q-DAC £250

Stripped-down version of Audiolab's M-DAC loses some features but retains much of the sound, making it a veritable bargain.

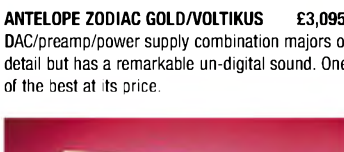

ANTELOPE ZODIAC GOLD/VOLTIKUS £3,095

DAC/preamp/power supply combination majors on detail but has a remarkable un-digital sound. One of the best at its price.



CHORD 2QUTE HD £990

Superb build quality and exceptional sound from this compact unit. Boasts the ability to handle DSD direct via USB and has an exceptional soundstage. One of the best DACs you can buy.



DCS DEBUSSY £8,000

DCS's bespoke 'Ring DAC' circuit gives a beautifully-fluid, almost analogue sound that encourages long listening sessions. Not cheap but worth every penny.

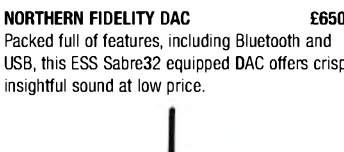

NORTHERN FIDELITY DAC £650

Packed full of features, including Bluetooth and USB, this ESS Sabre32 equipped DAC offers crisp, insightful sound at low price.



METRUM OCTAVE £729

Unique two-box digital-to-analogue converter with great sound at a great price. Cuts upper treble, though.



NAIM DAC £2,400

Superb high-end digital converter with a probing, punchy and forensically-detailed sound.



TEAC UD-501 £699

Feature-packed DAC with benefit of DSD playback. Superb sound means little to touch it at the price.



RESONESSENCE INVICTA MIRUS £4,499

One of the most highly spec'd DACs available, with a smooth yet enthralling presentation. Few approach it.



NETWORK PLAYERS

CHORD DSX100 £7,500

Chord's proprietary DAC circuit shines in their top-of-the-range streamer. Hear-through clarity with a sound rich in detail, dynamics and soundstage.



CAMBRIDGE AUDIO NP30 £399

Budget offering from Cambridge offers a great introduction to network streaming.

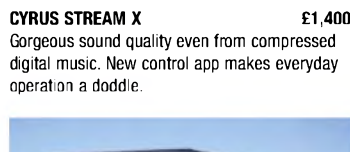

CYRUS STREAM X £1,400

Gorgeous sound quality even from compressed digital music. New control app makes everyday operation a doddle.



CONVERT TECHNOLOGIES PLATO £2999.00

A network player with amplifier that does it all, including turn LP to hi-resolution digital, and add cover artwork from the 'net.



NAIM NDX £2,995

Clean, incisive and very detailed sound with Naim's traditional pace and timing make this one of the best network music players around.

NAIM ND5XS £2,175

Great sound quality with traditional Naim heft. A wonderful DAC with full 24/192 handling. Only the display could be better.

NAIM NAC-N172 XS £1,650
A pre-amp/DAC/streamer package provides a taught, rock-solid presentation with a tonally rich midband and a superior sense of rhythm.



PRO-JECT STREAM BOX RS £1,095
Unusual valve-based streamer/preamp with variety of inputs and a lovely liquid sound. Not the most detailed but compensates with sheer musical verve.

QUAD PLATINUM DMP £2,500
Combined CD/network player has all the usual Quad elements but with added zest and detail that brings life to everything you care to play.



DIGITAL SOURCES

ASTELL&KERN AK100 MKII £569
Portable high-definition digital player with superb sound quality. Punchy and fast.



FiiO X3 £150
Fabulous value player with nice easy sound and full range of abilities. Small and light. For newbies.

LOTOD PAW GOLD £1,500
Reference quality sound; it's like carrying your hi-fi in your pocket. Equivalently large too, but stunning headphone quality



NAIM HDX £4,405
Interesting one-box network-enabled hard-disk music system that gives superb sonics together with impressive ease of use.

NAIM UNILITE £1,995
A 50W amplifier with traditional Naim heft, a CD player and vhf/fm radio, plus network input and Bluetooth make this a great all-in-one.



PORTABLE SPEAKERS

BAYAN SOUNDBOOK £149.99
Superb design and great sound make for one of the best portable Bluetooth speaker/radios on the market. Not the cheapest – but worth every penny.



IRIVER IBA-50 £69
Big, warm sound with plenty of volume and clean at high levels. Muscular sound compared to many rivals.

CABLES

BLACK RHODIUM TWIST £71/3M
Twisted to fight off radio frequency, the Black Rhodium speaker cable is easy on the ear with a fine sense of clarity and focus. A remarkable performer at the price.



MAINS CABLES R US NO.27 £95
Offers a sprightly pace with a precise nature. Fast performance enhance frequencies and beautifully etched detail.



CHORD SIGNATURE REFERENCE £900
Majors on timing, detail and openness. Capable of getting the best from most systems and a recommended upgrade.



TELLURIUM Q BLACK 280/3M
A deep, dark, velvety performer that's nevertheless highly musical, it represents excellent value as mid-price cables go.

TELLURIUM Q SILVER DIAMOND £804/M
An open, natural and transparent sound that is difficult to beat, from these great loudspeaker cables.



HEADPHONES

AUDEZE LCD-3 £1,725
A planar magnetic 'phone that offers monitor quality. Strong sound with silky, dark quality that others struggle to match.



B&W P3 £170
Beautifully presented headphones from the loudspeaker specialists. Feed them a good quality source signal and they reward with excellent sound.

JAYS V-JAYS £49
Wonderful little budget over-ear portable 'phones with a clean, clear sound to beat the best of the rest at the price.



NOBLE K10 INC. FITTING £1,279
Custom fit in-ear phones with 10 drivers deliver a sound that is out of this world. Personal and perfect.



OPPO PM-1 £950
Planar magnetic phones with a warm, easy but big bodied sound that draws you in. Need a lot of drive, but deliver superb bass.



SENNHEISER HD700 £599
Tremendously fast with a strong, focussed, lower-frequency range and a firm bass punch.



YAMAHA HPH-MT220 £150
Purposed for indoor monitoring yet light and comfortable enough to be used on the move. Excellent sound quality marred only by a slight warmth to vocals.



Stereo 845pp
 "King of Triodes" ST845pp 50wpch £6,999 Worlds first 845 PP integrated amplifier



Stereo 60 MKIIIm **hi-fi+**
 ST60 IIIm with KT150 valves 80wpch, 50w Triode Outstanding performance £3,299



Stereo 40 MKIIIm
 ST40 IIIm True "Hi End" Amplifier, Triode 25w, UL 45w many features from £2,099



Stereo 25 MKII
 Simplified ST40 30wpch UL, HQ Headphone socket, "Easy Bias" From £1,199 (EL34)



Hi Fi World "Best Valve Amplifier"
Stereo 30se
 Stereo 30se KT150 Valves Pure Class A 18w Triode, 28w UL £2,199



PS1 MKII MM/MC
 Our extraordinarily good pure valve phono stage only £1,199 MM or £1,449 MC/MM



PS3 MKII MC/MM Phono Preamp
 100% Pure Valve Pure valve Phono Preamplifier £2,599



HP8 MKII Only £849
 Pure Triode With Output Transformers matching 8-600 Ohms



New 15" Horn speaker now on demonstration

Up to 20% off B grade speakers with minor cabinet blemishes
 MFV3 std. in dark rosewood finish.
 MFV3 super in Cherry or Walnut wood veneer
 Subject to availability ring or email for more info

Icon Audio have a valve amplifier to suit all purposes. From 15 watts per channel to 80w integrated or 16w to 250w mono blocks. Immerse yourself in our warm easy listening detailed sound. David Shaw has been making innovative highly regarded amplifiers for 15 years which are all leaders in their class, some like the unique ST845 or HP8 have no equal, and others like the ST60 and ST40 are "outstanding" in performance and value for money. All our amplifiers are handmade, "point to point" with our own hand wound transformers in our own factory and finished in Leicester. Built to last and be easily serviced.

Various upgrades are available including capacitors and valves. As a UK company we offer rapid economical service on all our products both old and new. Come for a listen at our Leicester showroom or order from one of our appointed dealers. For more information see our website, ring or email us, or ask for our latest brochure printed on real paper!

Buy direct from us or through one of dealers or worldwide distributors
 UK only prices including 20% VAT and mainland delivery. Some models show upgraded valves. E80E

Diamond Life

Italian cable specialist HiDiamond's entry-level interconnects offer high-end sound at a reasonable price, says Jon Myles.



The role of good interconnects in a hi-fi system is often overlooked. Perhaps it's because they are shorter than loudspeaker cables and usually hidden out of sight between components. But their importance cannot be overstated. They are the first link in the signal chain – carrying the all important musical information from source to amplifier.

If they're introducing smear, artificial tonality or simply restricting tonality then there's nothing the amp can do to correct it. So choosing the best set for you is vital.

Which brings us to HiDiamond – an Italian company which has been specialising in cables for the past 17 years. The Diamond 1 is its entry-level RCA interconnect priced at £60 for a 1 metre length.

Taking it out of the box, 'entry-level' were not the first words that sprang to mind. It's a chunky beautifully-finished cable with a thick braided external jacket housing the 4VRC copper/graphite conductors – which have been baked four times at different temperatures, something HiDiamond says helps retain signal integrity.

These cables are terminated with sturdy locking connectors which, once tightened, provide a firm grip on the sockets.

SOUND QUALITY

I used the HiDiamonds with an Oppo UDP-205 universal disc player connected to a variety of amplifiers from a muscular McIntosh MC152 to Creek Evolution 100A and then an Icon Audio Stereo 30SE valve integrated.

What came over was an open, honest sound with plenty of detail so the individual characteristics of each amplifier shone through.

The punchy, powerful nature of the McIntosh was evident on David Bowie's 'Diamond Dogs' with the guitars sounding raw and full-bodied. The Diamond 1s were free of dynamic compression with an excellent sense of instrumental separation.

Playing the same track through the Icon Audio revealed a silkier sound – no less detailed but with a smoother, more organic flavour. What I was hearing was the inherent nature of these two very different amplifiers which is exactly what a quality interconnect should be doing.

What was consistent no matter what amplifier was attached was the pace and timing of the music. With Keith Jarrett's live 'Sleeper' LP the rhythmic dexterity of his piano playing had a pleasingly propulsive quality with no blurring of the notes in the faster passages. Everything was clean and clear, Jan Garbarek's saxophone coming over as bright and tonally rich – without the thin and edgy sound that some cheaper interconnects can impart.

This openness does mean the HiDiamonds won't flatter poor recordings but the upside is that they will make the most of good ones, bringing out transient information and micro-dynamics that others might mask.

CONCLUSION

The Diamond 1s are everything a good interconnect should be. They allow the music to flow unimpeded across the entire frequency spectrum with a sense of natural ease. They are good enough to be paired with high-priced electronics but will also bring benefits to mid-priced systems. If you are looking to improve on what you already have I'd recommend an audition.

**HIDIAMOND
DIAMOND 1S £60
(1 METRE PAIR)**



£

OUTSTANDING - amongst the best

VALUE - keenly priced

VERDICT

A high-end sounding interconnect at a reasonable price. Natural, open with no artificial character they allow music to breath as it should.

FOR

- organic sound
- revealing
- detailed
- price

AGAINST

- won't flatter poor recordings

Elite Audio Ltd
+44 (0)1334 570 666
www.eliteaudiouk.com

ortofon

accuracy in sound



Quintet

Since 1948 Ortofon have introduced nearly 100 different moving coil pick-up cartridges to the hi-fi market. Their latest models in this long and proud heritage are the Quintet Series.

All Quintet cartridges use the same ABS thermoplastic bodies and neodymium magnets, but each model in the range has its own sonic expression that reflects its status. From the well-rounded **Quintet Red**, through the smooth **Quintet Blue** and spacious yet dynamic **Quintet Bronze**, up to the pure audio excellence of the **Quintet Black S**; this series offers something for every discerning listener at a very attractive price.

The Quintet Series also includes a true-mono cartridge, for accurate reproduction of older mono recordings.



Distributed by Henley Audio
T: +44 (0)1235 511 166 | E: sales@henleyaudio.co.uk | W: www.henleyaudio.co.uk

HI-FI WORLD

NOW AVAILABLE
ON THE APP STORE

App Store > Entertainment > audio web publishing ltd

Hi-Fi World

audio web publishing ltd >

Details Ratings and Reviews Related

Screenshots

TOP IN-APP PURCHASES

1. Hi-Fi World Dec 2015 £3.99
2. Hi-Fi World Subscription £8.99
3. Hi-Fi World August 2015 £3.99
4. Hi-Fi World September 2015 £3.99
5. Hi-Fi World June 2015 £3.99
6. Hi-Fi World May 2015 £3.99
7. Hi-Fi World December 2015 £3.00
8. Hi-Fi World February 2015 £3.99
9. Hi-Fi World November 2015 £3.99
10. Hi-Fi World December 2014 £3.99

LINKS

Privacy Policy

© 2014 Hi-Fi World

Description

Hi-Fi World brings you the best hi-fi...from around the world!

- We listen and measure products in depth, at our London offices.
- Expert opinion from a team of renowned writers, musicians and engineers.
- International standard measurements using Rehe & Schwarz test equipment...

Information

Developer: audio web publishing ltd
 Category: Entertainment
 Updated: 7 Dec. 2014
 Version: 1.0
 Size: 9 MB
 Rating: Rated 4+
 Family Sharing: Yes
 Compatibility: Requires iOS 5.0 or later. Compatible with iPhone, iPad, and iPod touch.
 Languages: English

DOWNLOAD OUR APP ON APPLE AND ANDROID
 DOWNLOAD FROM iTUNES OR GOOGLE PLAY

iPad, iPhone, iPod, Tablets **OUT NOW!**

THE IDEAL ANTIDOTE

VISIT OUR WEBSITE: www.hi-fiworld.co.uk

**A SUBSCRIPTION TO HI-FI WORLD
MAKES THE PERFECT GIFT FOR
YOUR NEAREST AND DEAREST.**

SAVE

...up to

26%

Subscribe today and you will get a special discounted rate giving a **saving of 15% to 26%** off the cover price. That's an amazing **£3.83 - £3.33 per issue including postage.**



So don't delay, take out a subscription today!

FOR BACK ISSUES ENQUIRIES PLEASE CALL

01442 820580

OVERSEAS SUBSCRIPTIONS IF YOU LIVE OUTSIDE THE UK,
PLEASE CALL FOR OUR LATEST PRICES

+44 (0) 1442 820580

**SO WHAT ARE YOU WAITING FOR? CALL NOW!!!
SUBSCRIPTION HOTLINE 01442 820 580**

Lines open Mon-Fri 9.00-5.00 or (weekend answering service available)

FOR OUR
ON-LINE MAGAZINE
GO TO WWW.HI-FIWORLD.CO.UK

email:
hifiworld@webscribe.co.uk

TO WINTER BLUES

WHY SUBSCRIBE TO HI-FI WORLD?

- 12 issues a year delivered straight to your door.
- Be first to grab a bargain in our "Free Reader Classified Ads" section.
- Run by dedicated hi-fi engineers and enthusiasts.
- Subscribers receive a minimum 10% Discount annually.
- Hi-Fi World has become famous for its informative reviews and radical kit designs.
- **PLUS!** Subscribe by Direct Debit and receive a 16.5% discount on a yearly subscription (UK only).

Instruction to your Bank or Building Society to pay by Direct Debit



Please fill in this form and send to:

Originator's Identification Number

Hi-Fi World, Subscriptions Department Unit 4 College Road, Business Park, College Road North, Aston Clinton HP22 3EZ

4	2	7	0	4	9
---	---	---	---	---	---

Name and full Postal Address of your Bank/Building Society

To: The Manager	Bank/Building Society
Address	
Postcode	

Name(s) of Account Holder(s)

--

Branch Sort Code

--	--	--	--	--	--

Bank/Building Society Account Number

--	--	--	--	--	--	--	--	--	--	--	--

Reference

HF

Instruction to your Bank or Building Society

Please pay Webscribe Ltd Direct Debits from the account in this instruction subject to the safeguards assured by the Direct Debit Guarantee. I understand that this instruction may remain with Webscribe Ltd and, if so, details will be passed electronically to my Bank/Building Society.

Signature(s)
Date

Bank and Building Societies may not accept Direct Debits Instructions for some types of accounts
The guarantee should be detached and retained by the Payer

The Direct Debit Guarantee

- This Guarantee is offered by all banks and building societies that accept instructions to pay Direct Debits
- If there are any changes to the amount, date or frequency of your Direct Debit Webscribe Ltd will notify you 10 working days in advance of your account being debited or as otherwise agreed. If you request Webscribe Ltd to collect a payment confirmation of the amount and date will be given to you at the time of the request
- If an error is made in the payment of your Direct Debit by Webscribe Ltd or your bank or building society you are entitled to a full and immediate refund of the amount paid from your bank or building society
- If you receive a refund you are not entitled to you must pay it back when Webscribe Ltd asks you to
- You can cancel a Direct Debit at any time by simply contacting your bank or building society. Written confirmation may be required. Please also notify us.



I would like a years subscription to Hi-Fi World and receive a discount off the cover price (I have read and accept the terms and conditions).

I would like to pay for my 12 issues by:

6 monthly Direct Debit: Pay £22.00 every 6 months saving 19% off the yearly subscription rate of £54.00

Annual Direct Debit: Pay £40.00 every 12 months saving 26% off the yearly subscription rate of £54.00

Annual cheque/credit card: Pay £46.00 saving 15% off the yearly subscription rate of £54.00

Cheques made payable to Audio Web Publishing Ltd.

Your Details

Title _____ Forename _____

Surname _____

Address _____

Post Code _____

Daytime Tel: _____

Email: _____

Please debit my VISA MASTER MAESTRO AMEX (SWITCH)

Security No: (last three digits printed on the signature strip)

--	--	--	--	--	--	--	--	--	--	--	--	--	--	--	--	--	--	--	--

Valid from Date: ____/____/____ Expiry Date: ____/____/____

Switch card issue No:

Cardholder Signature: _____

Outside UK:-

EUROPE Airmail **£50.00**

OVERSEAS Airmail **£70.00**



Send this form to:

Hi-Fi World, Subscriptions Department Unit 4 College Road, Business Park, College Road North, Aston Clinton HP22 5EZ

Portable power

Noel Keywood finds ATC's new HDA-DP10 portable high-resolution player offers remarkable value for money.

Here's a small and simple budget portable digital player available for £200 or so, yet one graced with some classy electronics and a commensurately impressive measured performance. The little ATC HDA-DP10 had a few foibles that jumped at me as I'll explain, but I still came away liking its simplicity and

its sound.

This player is small and easily pocketable; at 144gms it will strain a shirt pocket perhaps, unlike the Astell&Kern AK100's 122gms, but perhaps not if you wear lumberjack shirts. At 53mm wide, 118mm high and 17mm deep it will certainly fit most pockets, providing high-quality sound to headphones whilst on the move. The case is CNC machined from a solid billet, making it strong and rigid.

Now that CD players have all but left the planet little portables like this can also act as a substitute, playing ripped CD files and hi-res for better sound quality into a standard hi-fi – another aspect I'll look at.

The HDA-DP10 uses a modern, high-quality digital-to-analogue converter (DAC) chip from Asahi Kasei Microdevices of Japan, the AK4490, a unit I have heard give very smooth sound. No surprise then that this player handles standard digital (PCM) up to 24/192, plus basic DSD 64 (but not 128 I found). Most PCM variants are supported, including FLAC, Ogg, Ape, and Apple's aiff, m4a and ALAC as well as MP3 and AAC of course.

The chip specs promise more than this: PCM up to 768kHz and DSD128 but ATC do not claim such figures, likely due to insufficient power within its Ingenic audio processor; it simply ignored DSD128 I had loaded onto a card.

As often with budget players there is no internal memory; music is stored on microSD cards (extra), two slots are fitted with each addressing 128GB maximum. Bear in mind that DSD tracks can run to hundreds of Megabytes.

The bottom face of

the player carries a 3.5mm stereo headphone socket and a small low/high volume slide switch sitting next to it – but this changes volume little I found.

Also on the bottom face is a 3.5mm Line output for connection to a hi-fi and within it an optical digital output for connection to an external DAC. You need an adaptor for this but one is supplied. The Line output is fixed level; the volume control has no influence. It seems to come before the headphone output drive stage since it has slightly higher dynamic range (see Measured Performance). This output can be connected direct into the CD or Line input of any amplifier, just like a CD player, using a 3.5mm-phonon adaptor lead (not supplied). Whilst acting as a tethered player like this the unit can be run from a 5V USB power supply, but not from a computer since the computer takes charge of it for music transfer purposes.

On that note I loaded the player direct from a Mac running Sierra (10.12.4) without problem and had no trouble with a PC running Windows 8 – but the operating leaflet says 8 and 10 may be 'imperfect'. MicroSD cards can be loaded direct from a computer by mounting them on a small USB adaptor however, should this be a problem.

Initially, I had to reset the player a few times when it locked up and the screen went blank, but this problem cleared and did not return – peculiar. Re-set is achieved by the paper-clip-into-a-tiny-hole method! Our review sample was running V1.11 firmware and checking to see if this needed to be updated, I found no firmware update available on the ATC website. However, the unit is a re-styled xDuo X-10 it appears, for which firmware is available, but V1.1 when I looked (Jan 18) so it appears outdated.

The method of operation was simple enough, a spin wheel being used to scroll down lists, its central button making a selection. You





The bottom face carries headphone and Line stereo 3.5mm output jacks, with optical digital in the latter. There are two card sockets – and note the small re-set hole at top right.

don't get a touch screen and the screen's active area is 30mm x 40mm – which is small so the graphics and typeface are tiny but clear, bright and sharp I found. There's no equaliser or pre-set EQs, but there is a Sharp/Slow digital filter option. There is no Bluetooth. The internal 2400mAh battery takes 4 hours to charge and provides 9 hours playing time, ATC say.

SOUND QUALITY

Like other recent AKM DACs in their Verita Series (with Velvet Sound they say), the one in this player gave more or less what AKM claim – a velvety sound.

The longer I listened, the more I took to the HDA-DP10. It didn't jump out at me initially with tub-thumping bass or ringing treble; it is quite a gentle sounding player yet wonderfully lush and civilised, with great midrange insight.

The Isley Brothers 'Summer Breeze' (CD, 16/44.1) had their harmonised vocals presented with easy clarity centre stage where this track, and the distorted guitar, often sound challenging.

Similarly with the Eagles 'Somebody' (CD, 16/44.1) which is compressed upward to sound loud and can be a tad coarse – but not on this player. The classic line-up of drums, solid repetitive bass line and Glen Frey's centre-stage vocals with his 'nasty' inflexions came over with a silkiness and ease I don't so often hear – but with plenty of drive and dynamism so the song powered along.

Things moved up a gear with David Bowie singing 'Suffragette City' (DSD 64 .dff) and this was when I started to appreciate the slickness of this player's sound, feedback guitar and hammered keyboards washing through my Philips Fidelio XI phones with the air, space and grandiosity

that DSD can have through a good system.

Running The Doors 'Light My Fire' (DSD 64 .dsf) further revealed the ability of this player to keep cool and composed even when asked to present a fairly massive performance, something it didn't fluff at all. The drum kit was well and truly assaulted in one ear whilst the long and 1970s indulgent Hammond organ solo wound on in the other, Jim Morrison eventually jumping in centre-stage with his powerful vocals – wonderful stuff. It was conveyed with grip, civility yet power and drive. I ended up using Slow filter by the way, but there wasn't much between it and Sharp.

Connecting digitally into a mains powered Audiolab M-DAC brought better definition and punch to bass, as usual, this being a common limitation with battery powered players. Otherwise, the HDA-DP10 gave a very good account of itself, with

similar smoothness but slightly muted dynamic contrasts. An accompanying DAC must have a 192kHz optical digital input however (many don't) – and you don't get DSD via this route.

CONCLUSION

The HDA-DP10 is very well made and has a simple operating interface. It turns on within seconds and has a clear bright display, if a small one. With a useful array of facilities and outputs it can act as a hi-res player in a hi-fi system, running from USB power, or as a portable. Playing most music files including DSD64, it provided a silky smooth and insightful sound that is up with the best, making this an impressive little player.



The top face has on/off and microUSB input/charge only.

MEASURED PERFORMANCE

The HDA-DP10 returned a high dynamic range value of 118dB from its Line output under measurement, close to some of the best players currently available – most of which use a bigger battery to drive current-hungry high-end chips.

With a fixed output of 1.65V from its Line socket the DP10 can be used

as a 'CD player' when hooked into a hi-fi, but with 15dB greater dynamic range when playing hi-res (24bit) files. When playing CD rips you get CD performance of course.

The headphone amplifier delivers twice as much output as Line, measuring 3V – a very high value more than enough to drive all headphones. Dynamic range measured a tad less at 116dB, and distortion was minimal at 0.03% – excellent values for a budget player. Switching to low output reduced level little, from 3V down to 2.4V (commonly 0.3V-0.6V to avoid hearing damage).

Frequency response (Sharp Roll Off) measured flat to 80kHz with 192kHz sample rate hi-res digital, again up with the best players. Selecting Slow Roll Off this fell to 50kHz – not an easily audible change.

The HDA-DP10 measured very well all round by any standard and was especially impressive at its price. **NK**

FREQUENCY RESPONSE

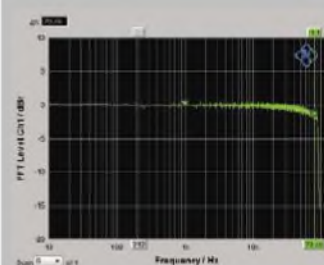

DISTORTION

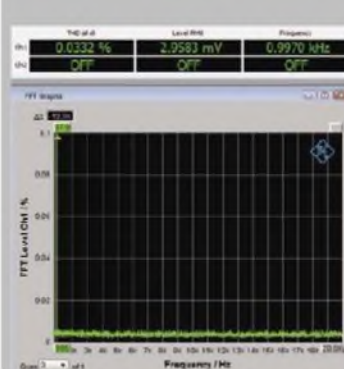

Frequency response	4Hz- 80kHz
Distortion (24bit, -60dB)	0.03%
Separation	95dB
Dynamic range	118dB
Noise	-115dB
Output	3V

ATC HDA-DP10 £200



OUTSTANDING - amongst the best

VALUE - keenly priced

VERDICT

Excellent sound from a small, easy to use player that works as a portable or a tethered player within a hi-fi system. Impressive, especially at the price.

FOR

- smooth sound
- small and light
- easy to use

AGAINST

- small screen
- outputs at bottom
- no EQ

ATC
www.atc-hifi.com
+44 (0) 7985 768 460

Generous Part Exchange available, please contact us for more information.

0% Interest Free Credit On All SOTM Products

S O t M

Ultimate High Performance Audio



SOTM tx-USBUltra USB Hub and Regenerator
RRP: £990

"I am going to have to admit that the SOTM tx-USBUltra Signal Regenerator has permanently spoiled me when I elect to listen to USB audio. I have never heard this level of improvement from any other USB enhancement device and now find it to be a necessary component for my overall enjoyment of music." - **Stephen Plaskin, Audiostream**



SOTM SMS-200Ultra Network Player
RRP: £1,200

"Those of you that own other quality power supplies will find the SMS-200 highly versatile in application given its wide input voltage range. I am happy to report that the audio possibilities available to the computer audiophile have never been better." - **Steve Plaskin, Audiostream**



SOTM SMS-200 Mini Network Player
RRP: £389

"I feel that the SMS-200 has raised the performance bar of what is possible from a mini network player. When combined with the mBPS-d2s, one can expect engaging musical performances with midrange reproduction that is topnotch." - **Steve Plaskin, Audiostream**



SOTM Ultra Bundle
RRP: £2,740
Special Offer: £2,329

Save 15% off the total price of SOTM's three latest "ultra" products.



SOTM SPS-500 Power Supply
RRP: £550

The SPS-500 is an audio power supply designed specifically for high performance audio. It is built to eliminate noise generated by powered devices as well as to simply remove noise coming from an AC power source.

The combination of the SMS-200Ultra, SPS-500 Power Supply and the tx-USB Ultra USB Hub and Regenerator is perfect for any computer audiophile.



web: eliteaudiouk.com

e-mail: info@eliteaudiouk.com

tel: 01334 570 666



Italian craftsmanship allied to a sophisticated sound make the new Sonus faber Olympica 1s a very desirable loudspeaker, finds Jon Myles.

Fabulous Fabers

National stereotypes are a dangerous thing – but somehow they are hard to avoid with the likes of Sonus faber. Their range of loudspeakers are handsome, hand-crafted items that simply ooze Italian style and elegance.

Even the names, Il Cremonese, Guarneri etc, evoke the country's rich heritage of making fine, immensely covetable instruments – often with prices to match.

Recently, though, the company has been pushing into new markets, aiming to bring its loudspeaker-making talents to hi-fi enthusiasts

who cannot quite stretch their budget to the likes of the company's flagship models.

It started with its Venere range which, while still designed and engineered at Sonus faber's Italian base in Vicenza, are put together in China to keep production costs down.



A novel grille composed of strings is a distinctive feature - as is the asymmetrical cabinet shape.

Now comes the new Olympica range comprising two floorstanders, a centre 'speaker and the standmount Olympica I on review here. These are Sonus faber's middle range – standing above the Veneres and below the Homage Tradition series with all production taking place in Italy.

As you'd expect from Sonus faber the Olympicas are a striking-looking loudspeaker, the lyre-shaped cabinet being constructed from walnut wood allied to a sculpted, leather-covered front baffle. It's also asymmetrical with one side being slightly deeper than the other. There's two reasons for this – first the shape



The large 29mm silk dome tweeter uses a wave guide for optimal sound dispersion.

helps reduce internal resonances and secondly it accommodates Sonus faber's new bass reflex system. This consists of a full range vertical slot at the rear which is covered by a stainless steel foil with precisely positioned perforations to manage airflow.

As well as this innovative shaping the 'speakers also feature an unusual grille. Instead of the traditional fabric type employed by most manufacturers Sonus faber has designed one consisting of a series of strings which means you can still see the outline of the drive units when it's attached.

Those drivers are also all new, the mid/bass being a 150mm unit made from cellulose pulp and other natural fibres while the 29mm tweeter is Sonus faber's proprietary silk DAD (Damped Apex Dome) which has been developed from the one used in the £79000 high-end Aida model.

Despite all this craftsmanship the Olympicas come in at £4998 per pair plus another £898 for the optional matching stands. While you can use your own stands the dedicated ones are recommended as the 'speakers bolt onto them and provide a slight backward tilt to time align the drivers.

Put all this together and in the style stakes the Olympica Is undoubtedly show a clean pair of heels to the more mundane box-type models. If I had a wife she'd no doubt approve.

SOUND QUALITY

Possibly because of the names it appends to many of its products plus its Italian heritage (despite being part of America's Fine Sounds Group which counts McIntosh and Wadia amongst its other holdings), Sonus faber loudspeakers are often perceived as mainly purposed for classical and opera replay. These Olympicas put the lie to that.

Yes, they are deliciously rich and smooth with the San Francisco Symphony's rendition of Beethoven's 'Symphony No 9' (24bit/96kHz) – violins especially having a lifelike presence – but they can also belt it out with more hard-charging material. With Nirvana's 'Nevermind' album Dave Grohl's drumming sounded thunderous but was whip-crack fast with no obvious overhang. Kurt Cobain's hoarse, growling vocals were

intelligible and laced with emotion.

On the end of our muscular McIntosh MC152 power amplifier the Olympicas also threw out a wide, expansive soundstage, punching images with height and depth well out into the room.

While these 'speakers are not strictly 'handed', the slanted reflex port positioned on one side of the rear means you can use it facing inwards or out. In truth there's not a great deal of difference but I did find having it facing towards the side walls brought better stereo imaging and slightly deeper bass.

And while there might not be sub-sonics on offer due to the size of the cabinet, the Olympicas do unearth a good deal of low frequency information. Listening to the opening



The rear of the Olympica 1s feature Sonus faber's new bass reflex port which extends down the whole of one side and is covered by a stainless steel foil.

of 'Debaser' by the Pixies I was struck by just how big and bouncy the bass sounded.

Sometimes that quality can come at the expense of detail and refinement but the Olympicas are not short on either of these attributes. On Bruce Springsteen's sparse, atmospheric 'Racing In The Street' the opening piano was clipped and precise and the subsequent two restrained drum beats with one simple bass note wonderfully evocative. As the pace gathered



Twin 'speaker binding posts at the rear allow for bi-wiring if required.

toward the end the 'speakers handled the change of tempo with aplomb so I could just sit back and allow the music to wash over me. It was a sophisticated, natural presentation with a sense of ease about it.

And that just about sums up these loudspeakers. If you want a striking design allied to sumptuous sound then take a listen - I have a feeling they'll seduce you.

CONCLUSION

The Olympica 1s look good but, more importantly, sound even better. They have a free-flowing, musical nature which makes them a joy to listen to.

"They are deliciously rich and smooth with the San Francisco Symphony's rendition of Beethoven's 'Symphony No 9' (24bit/96kHz) – violins especially having a lifelike presence – but they can also belt it out with more hard-charging material."



The (optional) matching stands are tilted to time align the drivers. The loudspeakers also bolt on for maximum stability.

MEASURED PERFORMANCE

For a smallish stand mounter the Olympica 1 produced unusually flat and extended bass, right down to 60Hz, as our analysis shows. The low end is very well controlled, the port providing support at 55Hz where it is quite sharply tuned. Below this frequency bass cuts off, but this is to be expected in a cabinet of the size.

Overall, the Olympica 1 delivers very good bass quality under measurement and will sound well balanced, tuneful and quite lively.

Sensitivity was good at 86dB Sound Pressure Level from one nominal Watt (2.8V) of input so 40W-60W will be more than enough to play very loud.

Above the bass region the speaker has a smooth midrange suggesting low

colouration. With no dip in the 2kHz-4kHz crossover region detail will be strong and the presentation forthright.

The tweeter also has relatively even output, a stepped and gated sine wave analysis (not shown) revealed. This is a tonally accurate loudspeaker then with no undue treble emphasis.

A 4 Ohm bass unit gives the impedance curve 4 Ohm minima, but reactive components lift the overall value to 7 Ohms, our analysis showing the usual residual peaks around the port dip at 55Hz, plus a steady rise to 3kHz due to voice coil and crossover inductances.

The Olympica 1 is a well engineered stand mounter that's accurate in tonal balance and has extended bass for a small cabinet. NK

FREQUENCY RESPONSE

Green - driver output
Red - port output



IMPEDANCE

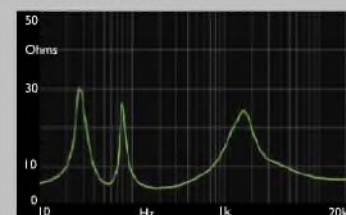

SONUS FABER OLYMPICA 1
£4998 (OPTIONAL STANDS £898)



OUTSTANDING - amongst the best

VERDICT

The Sonus faber Olympica 1s marry style with sound quality. Rich and detailed but able to step up to the mark and pound out a tune when needed.

FOR

- large soundstage
- stereo imaging
- detail
- striking looks

AGAINST

- nothing to speak of

Sonus Faber
www.sonusfaber.com



CHRIS DIFFORD

Chris To The Mill
Demon

Better known perhaps as a member of the band Squeeze and that band's

principle lyricist (there's a new Squeeze album 'The Knowledge' and an autobiography from the man on the way, incidentally), Difford has now presented all three of his solo albums on vinyl. The trio of LPs are presented in a sturdy slipcase. Of these only the first album 'I Didn't Get Where I Am' (2003) has appeared briefly on wax before. 'The Last Temptation of Chris' (2008) and 'Cashmere If You Can' (2011; you can see that puns are a favourite part of his humour toolbox, can't you?) appear on vinyl for the first time.

The solo Difford is a lot different from the Squeeze Difford. Of course, Difford sings on these LPs and he does very little of that in Squeeze.

Also Difford doesn't have to be pop on his solo work so there's a strangely attractive smoothness

about his tunes, a more grown-up feeling to them.

'I Didn't...' provides a warming, balladic-themed LP that will surprise and delight many Squeeze fans open-minded enough to allow Difford space to grow as an artist. 'Last Temptation' is sardonic, witty and dry with it while 'Cashmere...' combines all of that with a beautifully rhythmic quality that is honest in tone as well as being straight as a die in terms of delivery.

The mastering is well behaved with no brightness or harshness in the mids or treble. The LPs are never 'loud' in a mastering sense which aids listening fatigue issues although I would have liked the final sound to have opened up a touch.

A tad more air and space would have been welcome. I'm nit-picking, though, this is a solid mastering performance for a top quality trio of albums. If you are new to Difford's solo work you are in for a treat.

AUDIOPHILE VINYL



YES

Topographic Drama
Rhino

During their 2016 tour Yes played the 1980 album 'Drama' in its

entirety. It was the first time they'd ever done such a thing. More than that, the band also played sides one and four from the 1973 double-album 'Tales From Topographic Oceans'. Startling because these are arguably the two most contentious LPs in the band's entry discography. The first because Trevor Horn was on vocals for the former original album and nearly ripped his voice to shreds trying to emulate lead vocalist Jon Anderson while the latter LP was the symbol of prog excess that forged punk. And now both were being played on stage!

This new triple-LP features live performances from twelve dates recorded on the same tour in February 2017 by the current Yes line-up: Steve Howe (guitars), Alan White (drums), Geoff Downes (keyboards), Billy Sherwood (bass),

Jon Davison (vocals, replacing Jon Anderson) and additional drummer for this tour Jay Schellen.

With the addition of 'And You And I' from 1972's 'Close To The Edge' and 'Heart Of The Sunrise' from 1971's 'Fragile', the elaborate gatefold package also arrives with a full size, 6-page booklet.

Mastering reveals the give-away spacious auditorium feel but that music has been mastered remarkably quietly, prompting a gain boost which further opens up the detail and midrange insight which is both smooth and very pleasant to the ear.

There are a few irritations. The audience gives a standing ovation when anyone so much as lifts an eyebrow while Davison is a pleasant but weak vocalist – he's no Jon Anderson. He's too meek in his delivery. This lack of emotional uplift and punch harms the songs, and gives the music a tribute band feel making Davison sound like a young Aled Jones.

Argentinean born Schiffrin (85) penned the 'Mission Impossible' theme, the music for the films 'Cool Hand Luke', 'Enter The Dragon', 'Magnum Force', 'The Eagle Has Landed' and more. The only time I spoke with Schiffrin it was brief but provides an insight into this nicely mastered LP.

He was one of the most versatile composers on the scene – and he wanted me to know it. Schiffrin was adamant, he hated any suggestion of procedure, any accusation of soundtrack by rote, any hint that a template may be involved. He was an artist and he'd tear your throat out if you said otherwise. This happened to be my first mistake, incidentally.

"I studied music!" Schiffrin snapped and spluttered through a half ingested sandwich. "I don't want to sound like a snob or arrogant but you really should study classical music, get yourself

The Rite of Spring by Stravinsky". Blood filled his cheeks. He discarded the sandwich. "I have a technique, yes. I have influences but I have my own personality. I write a soundtrack from the beginning to the end, in one unified way. I don't do films that fit my style, I adapt my style to films. I like the challenge. I am a chameleon! I am sorry to disappoint you. You are not going to be able to pin me down because I am a chameleon".

That word again. Then we both counted to 10.

I tried to talk about 'Bullitt', starring Steve McQueen. 'Bullitt' and the music, according to Schiffrin, depended on suspense, "I didn't write any music for the chase," Schiffrin recollected. "I told the director Peter Yates it's not necessary to have music here. You'll have more freedom to use sound effects".

Suffice to say this album sounds superbly evocative and reveals the true talent of the man.



LALO SCHIFFRIN

Bullitt Speakers Corner

AUDIOPHILE VINYL

Based on Adrian Sherwood's reggae/dub label, this group was formed by drummer Style Scott and Sherwood created the band with a rotating cast of characters that ranged from Prince Far I, Lee "Scratch" Perry and U-Roy to more contemporary figures such as Jah Wobble. The label has released two albums from the band's discography.

'One Way System' includes Eskimo Fox, Crucial, Lizard, Vin Gordon, Crocodile, Bonjo and more wonderfully named characters while the music itself plays with both reggae and dub but flirts with avant grade textures that send the rhythms into different directions while playing with space. 'Socca' is a great example of this, with its sparse and sharp drum beats.

'Tunes from the Missing Channel' (1983) includes Wobble

alongside jazz star Steve Beresford Public Image Limited's Keith Levine, Doctor Pablo, Martin Frederix, Ashanti Roy, Bis Sherman plus Scott himself.

The music itself gives no quarter in terms of commercialism despite the fact that this LP could very well be termed as such.

In mastering terms, the vinyl has been produced with a fine tonal balance that pushes the detail in the upper mids without actually becoming bright. Hence, keyboards and guitars have a crisp precision

The vocal excerpts sometimes do cross the line with a slight pinching in the upper mids but the effects are not excessive and the effect might be due to the rather emphasised nature of the vocals in the first place.

A welcome pair of LPs that push dub experimentation, breaking new rhythmic ground.



DUB SYNDICATE

Tunes from the Missing Channel/ One Way System On U-Sound

CELEBRATING QUICKSTEP

HI-FI WORLD'S BEST LOUDSPEAKER CABLE AWARD 2016

Capture the Excitement, Emotion and Drama of your Music



Hi-Fi World Best Loudspeaker Cable Award 2016 *

The **exclusive technology** of our very best cables can now be enjoyed by a much larger audience!

EXCLUSIVE FEATURES

- Balanced Sound ✓
- Musically Entertaining ✓
- Stunning Clarity ✓
- Sharp Definition ✓
- Authentic Imaging ✓
- Excellent Timing ✓
- Effortlessly Open ✓

Read the reviews in full at www.blackrhodium.co.uk to discover how these reviewers describe the outstanding Quickstep sound quality.

"Quicksteps were surprisingly balanced in tonal terms while the design offered a naturalistic reflection of the music that was entertaining and extremely natural in its approach."

Paul Rigby- theaudiophileman.com

* *"They get out of the way of the signal that few others do at this price and allow you to hear the music unsullied and in all its glory."*

Jon Myles, Hi-Fi World

"For sound per pound this is an excellent choice for the audiophile offering a detailed soundstage with exceptional speed, and a sound that was very open and effortless."

Janine Elliot, Hi-Fi Pig



Go buy your own Quickstep Cable NOW at your nearest Black Rhodium Dealer or via www.blackrhodium.co.uk

Hear QUICKSTEP at these dealers

- Nintronics 01707 320 788 | Peak Hi-Fi 01226 761 832 | AUDIO-PHILIA 07518 151 516
 Analogue Seduction 01733 350 878 | Audio T Swansea 01792 474 608 | DoGood Audio 01515 253 845
 Ian Harrison 01283 702 875 | Homesound 01316 621 327 | MCRU 01484 540 561 | Planalogue 01865 693 032

"DAB could likely be cranked up progressively to offer better sound quality"



Noel Keywood

There are lots of riddles and logical anomalies around – such as the one I mentioned in Letters this month. Wireless, that good old-fashioned invention

from long ago, surely was a giant leap forward for mankind. Instead of ungainly vessels like Brunel's Great Eastern trying to lay Gutta Percha wrapped cables across the Atlantic, a clever fellow called Guglielmo Marconi managed to achieve the same end without any wires at all.

Surely, sending invisible signals through the air, through outer space, through walls and over hills and mountains, with no visible means of carriage or propulsion has got to be the finest magic trick the human race has ever pulled out of the hat. Curious that we now have blase acceptance of our ability to manipulate something – electromagnetic radiation – that I'm still not sure we understand.

What a seemingly strange anomaly then that cables are becoming ever more important to us as they criss-cross the planet in a vast spider's web called the internet, and cables are now rendering Marconi's waves obsolete.

VHF/FM radio was the final Swan Song of 'wireless' as a way of transmitting entertainment from a single location – studio or live venue – to homes all over Britain without any need for wires. We all think it's fabo because it does its job very well, reaching most parts of the UK. Those bits it doesn't reach being occupied by sheep who are not too bothered about the issue.

The bit I really like about VHF/FM is peculiarly oblique to the history of broadcasting and its technology though. You have to go to what I find a totally fascinating website <http://tx.mb21.co.uk/info/> and navigate to Main Gallery (top

of the home page) to literally see what I mean. Or go to Wallpaper to benefit from it.

The whole idea of VHF/FM was to capitalise upon Marconi's vision of powerful transmitters that covered large areas: this is the idea of big broadcasting if you like. These big transmitters sit in far away places – and mb21 shows you them. It shows and says much more though.

There are no end of – for me – intriguing articles about the 'construction of stayed masts' for example (<http://tx.mb21.co.uk/features/construction/index.shtml>), accompanied by informative pictures. And many of these pictures hint at why VHF/FM is almost heroic in conception and scale – and why therefore it is being phased out!

Yes, we are talking massive masts on distant windswept hill tops with fantastic names like North Hessary Tor, Wenvoe, Holme Moss, Blaen-Plwyf, Skriaig and endless others that derive from some of the UK's lesser used languages, perhaps even Nordic. I get the feeling many were originally named by the Vikings!

The oblique attraction here you'll see best in the Wallpaper gallery: fabulous shots of radio transmitters no less! Look before you laugh though. There are some visually arresting pictures of snow covered hills lit by a cold wintery sun, iridescent moons set against dark skies picking out ghostly aerial structures, and naturally the more straightforward daytime stuff, shot by the less brave, showing gorgeous scenes lit by bright sunlight. It's all very evocative and you'll see straight away that big transmitters atop hills in remote locations are a problem.

Those big aerials were expensive to construct and need ongoing maintenance. They also need a stout electrical supply as the

transmitters turn out thousands of Watts. This supply must be routed out to such remote locations, across fields, valleys and up mountain sides. All this is the practical reality of VHF/FM and – guess what – DAB offers a complete alternative.

DAB transmitters are far less powerful, so smaller and more robust. There are many more of them, but each is cheaper to install and run. Moreover, with DAB you transmit close to your local human audience, not to sheep who lack trannies.

DAB is a far more efficient way of emitting radio waves to an audience and it was purposed at outset to reach cars without fading or mutual interference between transmitters, something Marconi wasn't able to factor in since in his time horses were the thing – and they don't listen to radio either.

So you could say VHF/FM was always best at reaching those who don't listen and are not interested – they're too busy munching. The pictures on mb21 show clearly the cost of doing this and why broadcasters and Governments are happy if VHF/FM fades away. It's as much to do with money as it is technology or sound quality.

DAB could likely be cranked up progressively to offer better sound quality, but then for seemingly mysterious reasons I might say, wireless has since been sidelined by the very thing it was trying to replace – wire. The internet now offers 20,000 radio stations, no aerial needed. It isn't wire any more but ultra-fine glass optical cable that takes up no space but carries vast amounts of data, because of its frequency of operation – light. So if Guglielmo had used an Aldis lamp instead of a spark transmitter he might have had more enduring success! ●



quadral 

AURUM RODAN 9

RRP £4,999.00

For your nearest dealer call 0203 5442338
More fantastic products from NuNu Distribution Limited
www.nunudistribution.co.uk

NuNu Distribution Ltd



"It takes a very special band or artist to retain the creative hunger"



Paul Rigby

I've just finished watching a documentary on Apple. Actually, no let me rephrase that. It was a documentary on the people who used Apple products, specifically the computers. Not really the phones or its iPods. It's called MacHeads and it's not a new production. It was originally released somewhere around 2009. A slightly uneven film, it did well when it focused on the people and their passion for the hardware.

It also looked at how Apple needed its core user-base in the early days, especially when it was struggling. It appeared at computer shows and actively included the Mac users in discussion for the future.

It was interesting to see physical user groups grow and flourish, doing their thing, meeting in unlikely places, ideas were discussed, friends were made, projects undertaken, home-brew programs were created and the like.

Then Apple grew, became super-rich and, well, the users could now 'take a walk'. Well, of course, the company has never said that but that's how MacHeads in the film felt.

The early days of Mac fandom were the best, they said. The shine was still on it. It was exciting. Anything seemed possible. Everyone was in it together. There was a coherent aim and direction for the Mac movement. Then?

It's a familiar story. I watched another documentary about the history of bulletin boards and its user base. Same thing there. Early days were the best. Later on, the dedicated users were left behind by the internet.

Music is exactly the same. The early days of any music movement (i.e. the mods, punk, etc.) were the best. For a short time, there was passion and life and enthusiasm

and broad horizons lay head. Then? A stale atmosphere fell upon the genre as a whole and, well, the new people ruined it didn't they? As the 'new people' tend to do. And the bands lost touch, as they tend to do too.

I've been listening to 'C88', a 3CD box set from Cherry Red (www.cherryred.co.uk) that looks at the music from the late 80s from new bands, struggling bands, bands that reached out to their fans and did so from struggling, small indie labels who did the 'right thing' and they did it 'for the fans'. Until money took over to either swallow them up (e.g. Creation) or kill them off altogether (e.g. Sarah).

You'll find groups like The Stone Roses, Pale Saints, The Mock Turtles, The Pooh Sticks, The Man From Delmonte and Bridewell Taxis as proof of that.

What this collection set provides is a box of innocence, wide-eyed and open to hurt. And it's lovely to see.

"Deep Purple and The Who were the most dangerous bands in the mid-seventies" said ex-Deep Purple vocalist Glenn Hughes. A time of excess, "Even the roadies had roadies," he once said. "It was beyond Spinal Tap".

He himself said that sex, drugs and rock'n'roll killed the version of the Deep Purple band that he was in. This is when the innocence and that early passion dies.

And why the expanded Hughes box set for the 2003 album 'Songs in the Key of Rock' (Purple Records) exists at all. He undertook his solo work because, when any music project begins – in this case Deep Purple – the end is already on the way.

Just listen to the included song, 'Higher Places (Song for Bonzo)' as proof. This was a track dedicated to

Hughes's dear friend, the late Led Zeppelin drummer John Bonham. Killed by rock, you might say.

This is why early albums from new groups are often the best. The Beatles is a great example of this. In the beginning they were full of life, wide-eyed and bushy-tailed, replete with energy, everything was new, they couldn't do enough for you or anyone else, they wanted to get ahead but wanted to do it while having fun!

It's ironic that, later in the sixties, while the group itself was becoming ever more stale and jaded, it's own Apple label of independent artists was filling with that same wide-eyed innocence.

Deep Purple repeated the same history with its own label Purple Records which featured fizzing independent artists such as Carol Hunter, Buddy Bohn, Yvonne Elliman and more. You can hear the energy and passion oozing from these artists on 'Purple People Vol. 1' (Purple Records).

I remember Bill Bruford (drummer for Yes and King Crimson), in his self-titled autobiography saying something similar about his brief appearance in the prog-rock outfit Genesis. Phil Collins, in those days, was a real laugh, apparently. Then he found solo fame later on. Then he reportedly became all too serious. Maybe it's the weight of life and its experiences.

It takes a very special band or artist to not only retain the creative hunger but also to produce it with energy while searching for the next goal.

There are not too many examples that I can think of. Frank Zappa perhaps? King Crimson, mentioned above, maybe? Can you name a few? I'd be fascinated to hear your contributions. ●

THE VINYL REVOLUTION



The EVO and the new EVOke now you have a choice !

The new **EVOke** has world beating performance and right now we have the unit reviewed in this issue and a brand new one for sale. Performance figures are comparable with the world's most expensive turntables and the ability to fit any arm or cartridge mean you can have the **EVOke** that you want.

The **EVO** was used by Hi-Fi World to evaluate the Beatles In Mono records and is now used as their reference. The **EVO** comes fitted with the legendary SME 309 tonearm loved by so many and a cartridge of your choice.

We have worked with direct drive turntables and moving coil cartridges for 35 years. We can supply completely new units with 6 year guarantees, used ones with 5 year guarantees, or we can convert your own.

Stereo, Mono & 78 rpm Artisan Noriyuki Miyajima has been making phono cartridges in Japan for more than three decades. Only recently discovered by American and European audiophiles, they have since received rave reviews all over the world and deservedly so.

Every Miyajima cartridge is handcrafted in-house by a dedicated full-time team of six based in Fukuoka. The cartridge bodies are individually precision-milled from rare and exotic hardwoods including ebony, rosewood and African blackwood (mpingo). These dense natural materials lend a vibrant and natural tonality to the sound.

Miyajima - Benz LPS - Denon DL103 - DL-102 mono - Audio Technica AT33 & OC9
SME Turntables & Tonearms - Oyaide - Furutech - Klipsch - 78rpm - SL1200 Mods

Tax free best prices for World wide mail order by Fed Ex

Sound Hi Fi Dartmouth Devon 01803 833366 www.SoundHiFi.com



SCHITT
.EU.COM

Sieveking
sound



electromod
the sound connection



SYNERGISTIC
RESEARCH
NEVER COMPROMISE

MrSpeakers

“Hi-fi is perhaps undergoing one of its biggest transformations since the early 1980s”



Jon Myles

It's often said there's rarely anything new in the world of home hi-fi. In essence the basics have remained the same since the invention of the audio amplifier in the early 1900s. You take a small electrical signal, amplify it and then feed the signal to a loudspeaker that converts it into sound.

Although 'speakers have improved over the years with designers embracing ever more exotic materials for drive units and cabinets, as well as computer-aided design, most still use Rice-Kellogg drive units 1924. Amplifiers have evolved from the early pure Class A models to Class A/B and now Class D operation.

Through all this the basic system set-up has remained the same; source-amplifier-loudspeakers. The only major change has been in the first link of the chain with vinyl giving way to CD and the silver disc now gradually being replaced by digital files stored on hard disks or solid state drives.

There's no reason to think this configuration will change any time soon (after all, over the past 100 years no-one has found a different way of reproducing music). But while reviewing the Novafidelity X35 featured in this issue it occurred to me that home hi-fi is perhaps undergoing one of its biggest transformations since the introduction of the CD in the early 1980s.

It comes with the rise of the single-box, do-it-all components which are becoming increasingly popular. At one time this sort of product would have been an anathema to a hi-fi enthusiast. Wisdom held that the more components you packed into a single chassis the greater the chance of interference between them

– especially regarding the low-level signal going into the pre-amp and the larger voltage and current within the power section.

A true high-end system consisted of separate pre and power amps., while the mid and budget market was dominated by integrated amplifiers. The thought of packing internet connectivity, Bluetooth, radio, streaming and even vinyl phono stages into a single box would seem absurd – at least as far as sound quality was concerned.

But things have moved on in the past few years, helped by greater understanding of how to pack more functionality into a limited space without sacrificing sound quality. Technicians at Naim, for example, will tell you that their work on producing bespoke sound systems for the Bentley range of luxury cars gave them valuable insights into how to engineer audio circuits to work best in a noisy environment (and they don't get much more electrically noisy than a high-performance motor vehicle). This knowledge fed down to the latest Uniti range of all-in-one components.

In the case of the Novafidelity X35 the functionality contained in a case no bigger than a standard CD player is of a scale undreamt of less than a decade ago.

Could its sound be bettered by a dedicated standalone player and amplifier of around the same price? Definitely – but the X35 also offers streaming, the ability to digitise vinyl, high-resolution playback, storage as well as DAB+/FM and internet radio. And the only audio leads you'll need are those to connect a pair of loudspeakers – while the unit takes up less space than a set of separate components on a hi-fi rack.

This latter point is important – and one of the reasons the

one-box solution seems to be gaining traction in the marketplace. While many of us enjoy mixing and matching components, experimenting with different interconnects and cables and tweaking our systems to sound just-so, the majority of consumers don't. They want something clean, simple and easy-to-operate which takes up as little space as possible yet still sounds good (and, ideally, will not be obsolete within five years as it cannot handle the latest digital formats).

Take into account also that the average living space in most British cities is becoming smaller and smaller due to the astronomically high cost of housing, the appeal of these do-it-all single component systems becomes evident.

It's not surprising then that even high-end manufacturers have cottoned on to this demand as they seek to attract new buyers who might not traditionally have been part of their core market.

Even Germany's iconic Burmester have come out with their own take on the concept with the Phase 3 which incorporates a CD player/streamer/server/DAC with a 120 Watt amplifier mounted on its own stand and complete with matching loudspeakers. Perhaps it's more than just coincidence that Burmester, like Naim, has gained valuable expertise by fitting sound systems into luxury cars from the likes of Mercedes-Benz and Porsche.

The big plus side to all of this activity is that these new components are enticing a fresh wave of buyers into the hi-fi market who previously may have been put off by the seeming complexity of multiple-box systems. That, in the long-term, can only be good for the hi-fi industry and the future of our hobby. ●

Over 170 brands booked
with more to come!

SOUND & VISION

THE BRISTOL SHOW

23rd – 25th February 2018. 10 a.m. – 5 p.m. every day at the Bristol Marriott City Centre Hotel



**SAVE TIME
& MONEY
Buy Your
Tickets
Online***

www.bristolshow.co.uk

ADMISSION

Adults

£12.50 on the door
£11 online*

Students & Seniors (over 65)

£11 on the door
£9.50 online*

Multiple day tickets
available online only

Accompanied Children
Under 16 FREE

*online booking fee applies

audio T

BRANDS INCLUDE: +Audio, Acoustic Energy, Air Audio, Albedo, Anatech Distribution, Apollo Hi-Fi, Arcam, Armour Home Electronics, Art Vinyl, Astell & Kern, Astin Trew, Atacama Audio, ATC, ATI Amplifiers, Atlas Cables, Auden Distribution, Audeze, Audio Analogue, Audio Detail, Audio Note, Audio Pinnacle, Audio Technica, Audioengine, Audiolab, AudioQuest, AV Tech Solutions, AVM, AVTech Media, Big Red Sales, Bluesound, Bowers & Wilkins, Bryston, Buffalo Technology, Canton, Cary Audio, CH Precision, Chord Company, Chord Electronics, Chord Mojo, Creaktiv, Creek Audio, Custom Design, Cyrus, Dali, Decent Audio, Diamond Vinyl, discOverY, Diverse Vinyl, Dual, Dynaudio, ELAC, Elipson, Epos, Exertis, Exposure, Focal, Funk Firm, Fyne Audio, Gekko Cables, Glanz, Gold Note, Graham Audio, Harbeth Audio, Hegel, Henley Audio, Hi-Fi World, Hi-Fi+, HIFICRITIC, hORNS, IAG, iFi Audio, Innuos, Jamo, JL Audio, Karma AV, KEF, Keith Monks, Kennerton, Klipsch, Knosti, Kog Audio, Kordz, Kudos Audio, Leema Acoustics, Lehmann, Loewe, Lumin, Malvern Audio Research, Markaudio-Sota, MCRU, Melco Audio, Meze, MGY OÜ, Michell Engineering, Ming Da, Mission, Mitchell & Johnson, Miyajima, Mobile Fidelity, Monitor Audio, Musical Fidelity, Nagaoka, Naim Audio, Naim Label, Neat Acoustics, Nordost, Novafidelity, NuForce, NuNu Distribution, Okki Nokki, Onkyo, Opera Loudspeakers, Ophidian Audio, Optoma, Origin Live, Ortofon, Piega, Pioneer, Planalogue, PMC, Prism Sound, Pristine Vinyl, Pro-Ject, ProAc, Puritan Audio Laboratories, Q Acoustics, Q-Up, QED, quadral, Quadraspire, Questyle, Rega, REL Acoustics, Revo, RHA, Rohde & Schwarz, Roksan, Roon, Ruark Audio, Russell K, Scansonic, SCV Distribution, Select Audio, Sennheiser, Sonoro, Sony, Sota Acoustics, Sound Foundations, Spendor Audio, SweetVinyl, T+A, TAD, Tangent, Teac, Technics, Tellurium Q, The Vinyl Adventure, Timestep, Tonar International, Totem Acoustic, Townshend Audio, Unison Research, van den Hul, Vinyls Best, Vivac, Vivid Audio, Vogel's, Von Gaylor Audio, Wharfedale, Wilson Benesch, XTZ Sound and many more...

**HI-FI, STREAMING, HOME CINEMA,
PROJECTORS, VINYL, HEADPHONES
- THEY ARE ALL AT BRISTOL!**

Witness the launch of dozens of new products, with many brought directly from the Consumer Electronics Show in Las Vegas, at the UK's largest and longest running Hi-Fi Show - now celebrating its 31st year!

- ▶ Experience the latest in home hi-fi and speak directly to the journalists, the manufacturers and the designers!
- ▶ Visit the What Hi-Fi? magazine stand for a demonstration and answers to all your questions

**£10,000 OF HI-FI
TO BE WON IN THE WHAT HI-FI?
SHOW COMPETITION**

- ▶ Exclusive Deals & Special Offers: pick up a fantastic Show bargain... with great deals on most purchases!
- ▶ FREE HEADPHONES for students
- ▶ Enjoy Cabot Circus shopping and entertainment area with easy parking right next to the hotel

GETTING TO THE SHOW

BY TRAIN: Temple Meads Station is a short distance from the Marriott.

BY CAR: From the M4 take J19 (M32 - Bristol). Follow signs for City Centre and RAC signs to the Show. For those using satellite navigation systems the hotel post code is BS1 3AD. Easy local parking in Cabot Circus car park and Broadmead and Bond Street NCPs.



www.bristolshow.co.uk

For the latest news and a full list of brands exhibiting please visit our website

Organised by

In association with



audio T

WHAT HI-FI?

"The UK's DAB+ stations leave much to be desired in terms of sonics"



Martin Pipe

Digital radio has been UK reality since September 1995, when the BBC began radiating DAB (Digital Audio Broadcasting) signals from four 1kW transmitters around London. But the DAB story goes back even further. It began development in 1981 – a year before CD's launch! – at Munich's Institut für Rundfunktechnik. An early DAB prototype was demonstrated to delegates at a Geneva conference in 1985, and three years later experimental transmissions started in Germany.

Norway adopted DAB as a digital terrestrial-radio platform like Germany, the UK and many others. Made redundant, its FM transmitters were finally shut down at the end of 2017.

German FM transmitters are living on borrowed time too. In 2013 Willi Steul, director of Deutschlandradio, estimated a switchoff date "sometime between 2020 and 2025".

The UK will be looking to end FM as soon as "50% or more" of radio listening is digital. This will trigger a government review, which should lead to a definite switchover timetable. The process of turning off analogue won't start before 2020, though.

We're already sailing close to that magic number; in a recent Radio 4 'You and Yours' broadcast, Ford Ennals – trade-body Digital Radio UK's CEO – revealed that "about 49% of all listening is digital...in the first half of 2018, we'll see it get to 50%. People are choosing to listen digitally".

Apparently, 51% of 'You and Yours' listening is currently via a digital platform; perhaps tactfully, no mention of Radio 3 was made.

A goodly proportion of listeners to the revered arts and classical network remain loyal to FM, as they believe it's audibly-superior to the DAB simulcast. "The government", Ennals explained in his slot, "has been massively-supportive of digital radio." Which brings me to the press-release I received from the Department for Digital, Culture, Media and Sport earlier this year.

It explained that "commercial and community radio stations will be helped to go digital", under plans announced by the-then Digital Minister Matt Hancock. This is perhaps just as well, as the infrastructure is a lot more involved than 'old-tech' FM and beyond the budgets of small broadcasters. In his statement Hancock acknowledged the importance of local radio as "much-loved and vitally important, as a source of objective and in-touch local news". It is hoped that "new licensing arrangements will be in place by the end of the year". An 8-week consultation to determine a "licensing process appropriate for small scale DAB radio multiplexes" ended on February 28th. DAB's emphasis is on 'choice' rather than sound quality.

Another press-release that arrived at much the same time as the DCMS one came from Roberts, whose Stream 94i I review elsewhere in this magazine. "What are the benefits of DAB versus FM?", it asks. "There are many more stations broadcast via DAB than FM, so listeners can enjoy a whole range of stations that are unavailable via FM." It then mentions Internet radio – available on Roberts radios like the Stream 94i – which provides "access to around 20,000 global stations you cannot get on FM".

The BBC streams some of its networks online and these

– especially the higher-bitrate AAC ones – can sound better than FM, never mind DAB! A viable mobile alternative, as broadband coverage improves?

Topping the BBC streaming league though is the lossless (FLAC) experiment that Radio 3 listeners could enjoy via their computers over the entire 2017 Proms season – enticingly the network's entire output, rather than individual Proms concerts, was available. I asked a BBC spokesman if there was any chance this service could be made permanent, especially after FM ends. I was told that the BBC is "reviewing last year's experiments and conducting further tests, but no decisions have yet been made regarding the future".

And the BBC's position on FM's fate? "Digital radio switchover is a matter for Government. We have made our position clear that any switchover must be listener-led".

I've already made a partial switchover. At my local Cash Converters, I paid £3 for a Pure Highway gadget designed to add DAB to in-car audio systems. It worked, and I was able to lash it up to my vehicle's Sony head-unit. Interestingly, Pure future-proofed the Highway with a DAB+ upgrade. The process was far more complex than it needed to be, with codes that had to be entered.

The UK's DAB+ stations leave much to be desired in terms of sonics, if my experience is anything to go by. But at least my car is now DAB-readied – unlike the vast majority of vehicles currently on British roads. It's not the same as having a dedicated DAB head unit, and reception isn't yet as reliable as FM. But I'm happy to get 6 Music – for much of the time! – whilst driving. ●

Introducing – the NEW award-winning
AT2-2100 Integrated Amplifier from *ASTIntrew*.



“A powerful transistor-based amplifier with an almost valve-like sound which makes for a thoroughly musical experience.”



OUTSTANDING - amongst the best
Hi-Fi World, Feb 2018 Issue

Available Finishes



web
www.astintrew.co.uk

ASTIntrew®

email
info@astintrew.co.uk

Enjoy the Music.com®

Enjoy the Music.com is the Internet's leading information site for high fidelity audio equipment and consumer electronics since 1995. Being affiliated with many prominent publications plus offering its own *Review Magazine* and over 200 show reports online, *Enjoy the Music.com* is official media partners with AXPONA, Los Angeles Audio Show, and RMAF plus Internet partners with *The Absolute Sound*, *Australian Hi-Fi*, *hi-fi+*, *Hi-Fi World*, *HIFICRITIC*, *HiFi Media*, *NOVO*, *Sound Practices* and *VALVE* magazine.

LAAS
LOS ANGELES AUDIO SHOW

**ROCKY MOUNTAIN
INTERNATIONAL
AUDIO FEST**

AXPONA
AUDIO EXPO NORTH AMERICA



"There is some great second-hand stuff out there that, with a little care and attention, produces stunning sound"



Dave Tutt

You know how sometimes you hear a tune and it just does something in your brain – and it won't go away? It doesn't have to be a new song or anything particularly great, it just gets stuck there. I am sure many families with kids, especially young girls, have been given the ear worm of tunes from Disney and, specifically, Frozen's 'Let It Go' – complete with dancing and actions. It's a great song to be honest. Then the post Christmas film of Oliver dumped a few others into the loop.

I hate hits from shows and musicals, Sting's 'The Last Ship' – which has some great tunes in it – being one of the few exceptions. I can take just about anything but being infected with one of these is, well, horrible! The internet provides an alternative name for this phenomenon: INMI or Involuntary Musical Imagery. It is as good a name as anyone could come up with. I've got the music INMI!

A few months ago I decided to dig out my copy of Godley & Creme's 'Consequences', a tape I made when the album first came out – one that I pirated, as it proved almost impossible to find in the shops. The guy who lent it to me had been into London to buy his LP but only had a cassette machine in his car so I made two copies at the time, on TDK SA tape, one for each of us.

My TDK SA tape is still in pretty good condition, given that it's 40 years old – if the original release date is to be believed. All the same, I need to find a copy on vinyl that's in good nick; I want the original.

Discogs.com provided an answer to this desire – at a cost. There was but one copy in the UK – on cassette which of course seemed a bit

stupid for me to buy. The rest were scattered across Europe, America or the Far East, with the most expensive in China at over £370 plus delivery: my wife would probably have divorced me if I purchased it!

I am as yet still without a mint copy of the triple LP but am working on it. But I need a turntable to play it on and my own, sadly, has a failed arm cable in the left channel, so I have a delicate 'thread and terminate' job coming up soon. But that's another, if related issue.

Back to the ear worms. Another track appeared which plagued me from the moment it was played on Radio 2. It's called 'Go!' By M83. I have played it 10 – well, maybe 20 – times a day from the CD that I received at Christmas, but as yet I don't actually remember it. It is so strange but is, to my ears, totally addictive – a different type of ear worm!

Another recent purchase has several ear worms embedded in it. The culprit this time is Pat Benetar and the album 'Tropico'. It is one of her less well-known albums but two tracks, 'Suburban King' and 'Painted Desert', both have been rattling around my empty brain this month. I purchased the album on black plastic when it came out in around 1985, but running a new copy on CD brought back all those memories of hearing it for the first time on my then-new Thorens TD160, pre its extensive modifications.

This was one of the first albums I played after the modifications, and 'Suburban King' is not only great but gets more irritatingly addictive when you play it on a modded turntable.

Whilst on Discogs I also found two other LPs I wanted – and for just £2 each. One was a copy of Quarterflash's 'Back Into Blue'

and the other Gallagher and Lyle's 'Breakaway'. Fortunately, no ear worms on these, so I'm not as yet desperate to play them. This gives me hope that some sanity is returning – at least in terms of 'tunes in the head' are concerned.

Ear worms are made worse by good sounding products and some old ones aggravate the malady. I have just worked on a Leak Stereo 70 amplifier, a Leak 2300 tuner and a Thorens TD150 turntable, all of which are quite nice, if not antique pieces of hi-fi. None of them pass a FAT certification test as their mains cables are so poor. What surprised me though was the sound of the transistor Stereo 70. Not exactly classic as in earlier valve units, but given its age – from around 1968 – not that bad. New phono sockets helped the poor connections and a clean up of the switches and pots was also of benefit.

The best though was the great sound from the tuner. I think we have all got used to digital-type tuners but the warmth and clarity of this one was great. Just a mains switch that was jammed to be replaced here. The DIN output socket would have to go if it were mine.

Usually tuners arrive with far more wrong with them, requiring repairs especially to corroded variable capacitors and drive bands, and usually cures for the AM section even if it's never used. This one, straight out of the box, was a matter of some lubrication around the tuning and away we go.

I would recommend a trawl through the piles of hi-fi scrap at Boot Fairs or eBay as there's some great second-hand stuff out there that, with a little care and attention, produces stunning sound! Trouble is the ear worms get worse. ●

+44 (0)7759 105 932
dave_london@hotmail.com
www.tutt-technology.co.uk

HI-FI WORLD

NOW AVAILABLE
ON THE APP STORE

App Store > Entertainment > audio web publishing ltd

Hi-Fi World

audio web publishing ltd >

Details Ratings and Reviews Related

Screenshots

HI-FI WORLD

Offers In-App Purchases

This app is designed for both iPhone and iPad

Rating: 3.4

TOP IN-APP PURCHASES

1. Hi-Fi World Dec 2015 £3.99
2. Hi-Fi World Subscription £8.99
3. Hi-Fi World August 2015 £3.99
4. Hi-Fi World September 2015 £3.99
5. Hi-Fi World June 2015 £3.99
6. Hi-Fi World May 2015 £3.99
7. Hi-Fi World December 2015 £3.00
8. Hi-Fi World February 2015 £3.99
9. Hi-Fi World November 2015 £3.99
10. Hi-Fi World December 2014 £3.99

LINKS

Privacy Policy

© 2014 Hi-Fi World

DESCRIPTION

Hi-Fi World brings you the best hi-fi...from around the world!

- We listen and measure products in depth, at our London offices.
- Expert opinion from a team of renowned writers, musicians and engineers.
- International standard measurements using Rehe & Schwarz test equipment...

Information

Developer: audio web publishing ltd
Category: Entertainment
Updated: 7 Dec. 2014
Version: 1.0
Size: 9 MB
Rating: Rated 4+
Family Sharing: Yes
Compatibility: Requires iOS 5.0 or later. Compatible with iPhone, iPad, and iPod touch.
Language(s): English

CONTENTS

Page	Product	Price
39	MONITOR 100 FULL RANGE FLAME	£1,299
56	PC HI-FI SYSTEMS INCLUDING DAP	£1,299
59	SOLO FOCUS SPARK 1 LOUDESPEAKERS	£1,299
17	NEW RECORDS	£1,299
13	LEMMING 2.000 CD PLAYER	£1,299

MARCH 2018
VOLUME 28 NO 1

TABLES

- 11. MONITOR 100 DIGITAL CASSETTE
- 12. MONITOR 100 DIGITAL CASSETTE
- 13. MONITOR 100 DIGITAL CASSETTE

FEATURES

- 14. MONITOR 100
- 15. MONITOR 100
- 16. MONITOR 100

LOUDESPEAKERS

- 17. MONITOR 100 LOUDESPEAKERS
- 18. MONITOR 100 LOUDESPEAKERS
- 19. MONITOR 100 LOUDESPEAKERS

DIGITAL

- 20. MONITOR 100 CD PLAYER
- 21. MONITOR 100 CD PLAYER
- 22. MONITOR 100 CD PLAYER

COMPETITION

- 23. MONITOR 100
- 24. MONITOR 100
- 25. MONITOR 100

ACUSTIC ENERGY AE109
loudespeakers

7 PAGES OF LETTERS - THE BEST WIND A PAIR OF
LANNOY MERCURY 7.2 LOUDESPEAKERS (UK ONLY)

DOWNLOAD OUR APP ON APPLE AND ANDROID
DOWNLOAD FROM iTUNES OR GOOGLE PLAY

iPad, iPhone, iPod, Tablets **OUT NOW!**

FRI 23rd TO SUN 25th FEB 2018

**SOUND
& VISION**
THE BRISTOL SHOW

See us at **BRISTOL!**



... at the Bristol Sound & Vision Show 2018
Stand 4A in the Bristol Suite, ground floor.

23RD - 25TH February 2018
10.00am - 5.00pm everyday

There is now just one chilly month to go before the UK's most popular hi-fi show is upon us once again in Bristol, from Friday 23rd February through to Sunday 25th February 2018, from 10am to 5pm. And we will be there as always, on Stand 4A in the Bristol Suite on the ground floor.

Come and see us with your questions, stories and systems – or just for a friendly chat.

This is always a popular and busy show, packed with UK manufacturers – so don't miss it. See you there!

For Show details including ticket prices, click on www.bristolshow.co.uk. It is held at the Marriott City Centre hotel, 2 Lower Castle Street, Old Market, Bristol, England BS1 3AD.



Friday 23rd - Sunday 25th February 2018

Where?

Marriott City Centre Hotel,
Lower Castle Street,
Bristol, BS1 3AD

How much?

ON THE DOOR

ONE DAY TICKET

Adult One Day Tickets: £12.50
Students/Senior Citizens (over 65): £11

Accompanied Children under 16 FREE

ONLINE* ONLY TICKET SALES

Adults - £11 Students/Senior Citizens (over 65): £9.50

TWO DAY TICKETS

Adults: £20
Students/Senior Citizens (over 65): £17

THREE DAY TICKETS

Adults: £30
Students/Senior Citizens (over 65): £25.50

*Online booking fee applies.

Opening times

10.00 a.m. - 5.00 p.m. every day

BRISTOL SOUND & VISION SHOW

See you There!

We do not sell these products. It is for your information only.

WORLD CLASSICS

Here is our list of the great and good from audio's glorious past, products that have earned their place in hi-fi history. You'll also see some oddities which aren't classic as such, but are great used buys. The year of introduction is given, alongside the original UK launch price.

TURNTABLES

EAT FORTE 2009 £12,500
Lavishly finished two box, two motor turntable with gorgeous Ikeda 407 tonearm bundled. Exceptionally stable and unfussy performer with a relaxed but highly enjoyable gait



FUNK FIRM VECTOR II 2009 £860
Innovative engineering gives a nimble, pacy and musical sound that's one of the best at the price.

REGA P2 2008 £300
Excellent value for money engineering, easy set up and fine sound.

MCINTOSH MT10 2008 £8,995
Big, expensive, controversially styled and glows more than some might consider necessary, but an astonishingly good performer.

REGA P3-24 2008 £405
Seminal affordable audiophile deck with fine bundled tonearm. Tweakable, and really sings with optional £150 outboard power supply.

ACOUSTIC SOLID ONE 2007 £4,050
Huge turntable, both in terms of sheer mass and sonic dynamics. Fit up to three arms and enjoy, just don't damage your back moving it...

AVID VOLVERE SEQUEL 2007 £4,600
Stylish high end vinyl spinner with industrial strength build quality and a sound to match. Sound is edge-of-the-seat stuff.

MICHELL GYRODEC SE 2005 £1,115
Design icon with superlative build. Sound is beautifully smooth, effortless and exceptionally expansive.

MARANTZ TT-15S1 2005 £1,299
Cracking all in one deck/arm/cartridge combination, this must surely be the best sound'plug and play package at this price point.

MICHELL TECNODEC 2003 £579
Superb introduction to Michell turntables - on a budget. Top quality build and elegant design mean it's still the class of the mid-price field.



MICHELL ORBE 1995 £2,500
The top Michell disc spinner remains a superbly capable all rounder with powerful, spacious sound that's delicate and beguiling

SME MODEL 10A 1995 £4,700
Exquisitely engineered deck and SME V tonearm combo that's an extremely accomplished performer with classical music.

LINN AXIS 1987 £253
Cut-price version of the Sondek with LXV arm. Elegant and decently performing package. Later version with Akito tonearm better.

TECHNICS SL-P1200 1987 £800
CD version of the Technics SL-1200 turntable. Massively built to withstand the rigours of 'pr' use and laden with facilities - a great eighties icon.

ROKSAN XERXES 1984 £550
Super tight and clean sound, with excellent transients. Less musical than the Sondek, but more neutral. Sagging plinth top-plates make them a dubious used buy.

DUAL CS505 1982 £75
Simple high quality engineering and a respectable low mass tonearm made for a brilliant budget buy. Polished, smooth and slightly bland sound.

MICHELL GYRODEC 1981 £599
Thanks to its stunning visuals, this bold design wasn't accorded the respect it deserved. Clean, solid and architectural sound.

TOWNSHEND ROCK 1979 £ N/A
Novel machine has extremely clean and fluid sound. Substantially modified through the years, and capable of superb results even today.

MARANTZ TT1000 1978 £ N/A
Beautiful seventies high end belt drive with sweet and clean sound. Rare in Europe, but big in Japan.



REGA PLANAR 3 1978 £79
Brilliantly simple but clean and musical performer, complete with Acos-derived S-shaped tonearm. 1983 saw the arrival of the RB300, which added detail at the expense of warmth. Superb budget buy.

SONY PS-B80 1978 £800
First outing for Sony's impressive 'Biotracer' electronic tonearm. Built like a tank with a clean and tidy sound, albeit lacking involvement. Scarily complicated and with no spares support - buy with caution!

TRIO LD-7D 1978 £600
The best 'all-in-one' turntable package ever made. Clean, powerful and three-dimensional sound, ultimately limited by the tonearm.

ADC ACCUTRAC 4000 1976 £300
Bonkers 1970s direct drive that uses an infra red beam to allow track selection and programming. More of a visual and operational delight than a sonic stunner.

PIONEER PLC-590 1976 £600
Sturdy and competent motor unit that performs well with a wide range of tonearms. Check very thoroughly before buying due to electronic complexity and use of some now-obsolete ICs.

PIONEER PL12D 1973 £36
When vinyl was the leading source, this bought new standards of noise performance and stability to the class, plus a low friction S-shaped tonearm. Later PL112D was off the pace compared to rivals.



TECHNICS SP10 1973 £400
Seminal Japanese engineering. Sonics depend on plinths, but a well mounted SP10/II will give any modern a hard time, especially in respect of bass power and midband accuracy.

LINN SONDEK LP12 1973 £86
For many, the Brit superdeck; constant mods meant that early ones sound warmer and more lyrical than modern versions. Recent 'SE' mods have brought it into the 21st century, albeit at a price.

ARISTON RD11S 1972 £94
Modern evolution of Thorens' original belt drive paradigm. Scotland's original super-deck was warm and musical, albeit soft. Still capable of fine results today.

GOLDRING Lenco GL75 1970 £15.6S
Simple, well engineered motor unit with soft, sweet sound and reasonable tonearm. Good spares and servicing support even today.

GARRARD 301/401 1953 £19
Tremendously strong and articulate with only a veiled treble to let it down.



THORENS TD124 1959 £ N/A
The template for virtually every 1970s 'superdeck', this iconic design was the only real competition for Garrard's 301. It was sweeter and more lyrical, yet lighter and less impactful in the bass

TONEARMS

REGA RB251 2009 £136
Capable way past its price point, the new 3-point mount version of the classic RB250 serves up a taut and detailed sound. A little lean for some tastes, but responds well to rewiring and counter-weight modification.

HELIUS OMEGA 2008 £1,595
Stylish and solid lump of arm with fabulous build quality, that turns in a dynamic and weighty performance.

AUDIO ORIGAMI PU7 2007 £1,300
The classic Srynix PU3 updated to spectacular effect. Hand made to order, with any mass, length and colour you care for. Fit, finish and sound truly impressive.



GRAHAM PHANTOM 2006 £3,160
Sonically stunning arm with magnificent bass dexterity and soundstaging. Build quality up to SME standards, which is really saying something!

TRI-PLANAR PRECISION 2006 £3,600
Immaculate build, exquisite design and one of the most naturally musical and lucid sounds around.

MICHELL TECNOARM A 2003 £442
Clever reworking of the Rega theme, using blasting, drilling and rewiring!

SME 309 1989 £767
Mid-price SME comes complete with cost-cut aluminium armtube and detachable headshell. Tight, neutral sound with good tonality, but lacks the IV's pace and precision.

NAIM ARO 1987 £1,425
Charismatic unipivot is poor at frequency extremes but sublime in the midband; truly emotive and insightful.

SME SERIES V 1987 £2,390
Vice-like bass with incredible weight, ultra clear midband and treble astound, although some don't like its matter of factness!

NAIM ARO 1986 £875
Truly endearing and charismatic performer - wonderfully engaging mid-band makes up for softened frequency extremes.



ALPHASON HR100S 1981 £150
First class arm, practically up to present-day standards. Buy carefully, though, as there is no service available now. Totally under priced when new, exceptional.

SME SERIES III 1979 £113
Clever variable mass design complete with Titanium Nitride tube tried to be all things to all men, and failed. Charming nonetheless, with a warm and inoffensive sound.

TECHNICS EPA-501 1979 £ N/A
Popular partner for late seventies Technics motor units. Nice build and Titanium Nitride tube can't compensate for middling sound.

LINN ITTOK LVII 1978 £253
Japanese design to Linn specs made for a musical, rhythmic sound with real dynamics. The final LVIII version worth seeking out.

AUDIO TECHNICA AT 1120 1978 £75
Fine finish can't compensate for this ultra low mass arm's limited sonics - a good starter arm if you've only got a few quid to spend.

HADCOCK GH228 1976 £46
Evergreen unipivot with lovely sweet, fluid sound. Excellent service backup.

ACOS LUSTRE GST-1 1975 £46
The archetypal S-shaped seventies arm; good, propulsive and involving sound in its day, but ragged and undynamic now.

SME 3009 1959 £18
Once state of the art, but long since bettered. Musical enough, but weak at frequency extremes and veiled in the midband. Legendary serviceability and stunning build has made it a cult, used prices unjustifiably high.

PHONO STAGES

CREEK OBH-8 SE 1996 £180
Punchy, rhythmic character with oodles of detail makes this a great budget audiophile classic. Partner with a Goldring G1042 for an unbeatable budget combination.

MICHELL ISO 1988 £ N/A
This Tom Evans-designed black box started the trend for high performance offboard phono stages. Charismatic, musical and punchy - if lacking in finesse.



LINN LINNK 1984 £149
Naim-designed MC phono stage built to partner the original Naim NAIT - yes, really! Fine sound, although off the pace these days.

INTEGRATED AMPLIFIERS

NAIM NAIT XS 2009 £1,250
With much of the sound of the Supernait at half the price, this is powerful, articulate and smooth beyond class expectations.

MUSICAL FIDELITY PRIMO 2009 £7,900
Seriously expensive, but one listen explains why. Wonderfully exuberant sound that can only come from a top quality tube design.

SUGDEN A21A S2 2008 £1,469
Crystalline clarity, dizzying speed and forensic detailing. Power limited so needs sensitive speakers.

CREEK OBH-22 2008 £350
Brilliant value budget passive, with remote control, mute and input switching, plus an easy, a neutral sound.

CAMBRIDGE 840A V2 2007 £750
Version 2 addresses version 1's weaknesses to turn in a mightily accomplished performance, offering power, finesse and detail.

SUGDEN IA4 2007 £3,650
Goodly amount of Class A power, icy clarity and a breathtakingly fast, musical sound make this one of the very best super-integrateds.

NUFORCE P-9 2007 £2,200
Impressive two box preamp with superb resolution and an engaging sound.

MELODY PURE BLACK 101D 2007 £3,295
The clarity and openness of valves plus firm grip and fine detail make this a preamplifier masterclass.

AUDIOLAB 8000S 2006 £400
In another life, this sold for three times the price, making it a stand-out bargain now. Very clean, powerful and tidy sound.

MCINTOSH MA6800 1995 £3735
Effortlessly sweet, strong and powerful with semi-styling to match.

DELTEC 1987 £1900
Fast, dry and with excellent transients, this first DPA integrated is the real deal for eighties obsessives. Ridiculously punchy 80W per channel from a tiny, half-size box. Radical, cool and more than a little strange.

EXPOSURE VII/VIII 1985 £625
Seminal pre-power, offering most of what Naim amps did with just that little bit extra smoothness. Lean, punchy and musical.



AUDIOLAB 8000A 1985 £495
Smooth integrated with clean MM/MC phono stage and huge feature count. Extremely reliable, too. Post '93 versions a top used buy.

VTL MINIMAL/50W MONOBLOCK 1985 £1,300
Rugged, professional build and finish allied to a lively and punchy sound (albeit with limited power) make them an excellent used buy.

MUSICAL FIDELITY A1 1985 £350
Beguiling Class A integrated with exquisite styling. Questionable reliability.

MISSION CYRUS 2 1984 £299
Classic 1980s minimalism combines arresting styling with clean, open, lively sound. Further upgrade-able with PSX power supply.



NAIM NAIT 1984 £350
Superb rhythms and dynamics make it truly musical, but tonally monochromatic. Fine phono stage, very low power.

CREEK CAS4040 1983 £150
More musical than any budget amp before it; CAS4140 loses tone controls, gains grip

MYST TMA3 1983 £300
Madcap eighties minimalism, but a strong and tight performer all the same.

ROTEL RA-820BX 1983 £139
Lively and clean budget integrated that arguably started the move to minimalism.

NAD 3020 1979 £69
Brilliantly smooth, sweet and punchy at the price and even has a better phono stage than you'd expect. The archetypal budget super-amp.

ROGERS A75 1978 £220
Lots of sensible facilities, a goodly power output and nice sound in one box. The later A75II and A100 versions offered improved sonics and were seriously sweet.

A&R A60 1977 £115
Sweet and musical feature-packed integrated; the Audiolab 8000A remains a classic.



SUGDEN C51/P51 1976 £130
Soft sounding early Sugden combo with a plethora of facilities and filters. A sweet and endearing performer but lacking in power and poor load driving ability.

SUGDEN A21 1969 £ N/A
Class A transistor integrated with an eminently likeable smoothness and musicality. Limited inputs via DIN sockets.

ROGERS CADET III 1965 £34
Sweet sounding valve integrated, uses ECL86 output valves, even has a half useable phono stage, sweet, warm a good introduction to valves

CHAPMAN 305 1960 £40
Smooth pre/power combo with a sweet and open sound. Not quite up to Leak/Quad standards but considerably cheaper secondhand.

POWER AMPLIFIERS

ELECTROCOMPANET NEMO 2009 £4,995 (EACH)

Norwegian power station as cool as a glacier tonally, yet impresses with sheer physicality and fleetness of foot. 600W per channel.

NUFORCE REFERENCE 9SE V2 2006 £1,750
Brilliant value for money monoblocks with massive power and super-clean, three dimensional sound.

QUAD II-80 2005 £6,000 PER PAIR

Quad's best ever power amplifier. Dramatic performer with silky but dark tonality, blistering dynamics, serious power and compellingly musical sound.



QUAD 909 2001 £900
Current-dumper has a smooth and expansive character with enough wallop to drive most loads. Not the most musical, but superb value all the same.

NAIM NAP 500 2000 £17,950
Flagship amplifier will drive just about any speaker with ease. Factor in the company's trademark pace, rhythm and timing and it all adds up to one effortlessly musical package.

MARANTZ MODEL 9 1997 £8000
Authentic reproduction monoblocks still more than cut the sonic mustard. Highly expensive and highly sought after.

MICHELL ALECTO 1997 £1989
Crisp, clean and beautifully controlled with gorgeous styling. Partnered with the £1650 Orca this sounds delicious!



MUSICAL FIDELITY XA200 1996 £1000
200W of sweet smooth transistor stomp in a grooved tube! Under-rated oddity.

PIONEER M-73 1988 £1,200
Monster stomp from this seminal Japanese power amplifier, complete with switchable Class A and Class B operation. Clean, open and assured sounding, albeit a tad behind the pace on high speed dance music. Rosewood side cheeks and black brushed aluminium completes the experience.

KRELL KMA100 II 1987 £5,750
Monoblock version of the giant KSA-100 is one of the seminal 80s transistor power amplifiers. Massive wallop allied to clean and open Class A sound makes this one of the best amplifiers of its type.

RADFORD STA25 RENAISSANCE 1986 £977
This reworking of Radford's original late sixties design was possessed of a wonderfully rich, old school valve sound with enough power (25W) and lots of subtlety.

QUAD 405 1978 £115
The first of the current dumpers is a capable design with smooth, effortless power and a decently musical sound. 606 and 707 continue the theme with greater detail and incision.

HH ELECTRONICS TPA-50D AMPLIFIERS 1973 £110
Simple design with easily available components, solid build quality and fine sound make for a surprisingly overlooked bargain

LECSO AP1 1973 £ N/A
Madcap cylindrical styling alluded to its 'tower of power' pretensions, but it wasn't. Poor build, but decently clean sounding when working.

QUAD 303 1968 £55
Bullet proof build, but woolly sound. Off the pace, but endearing nonetheless. Some pipe smoking slipper wearers swear by them!

LEAK STEREO 20 1958 £31
Excellent workaday classic valve amplifier with decent power and drive. Surprisingly modern sounding if rebuilt sympathetically. Irrepressibly musical and fluid.



LEAK STEREO 60 1958 £N/A
Leak's biggest valve power amp offers 35 Watts per channel and more low end welly than the smaller Stereo 20. Despite concerns over reliability rarity value means high price.

QUAD II 1952 £22
The all-time classic valve amplifier, with a deliciously fluid and lyrical voice. In other respects though, it sounds hopelessly dated. Low power and hard to partner properly



LEAK POINT ONE, TL10, TL12.1, TL12 PLUS 1949 £28
Early classics that are getting expensive. Overhauling is de rigueur before use, using original parts if possible. Surprisingly crisp and musical. Deeply impressive in fine fettle.

PRE AMPLIFIERS

AUDIOLAB 8000C 1991 £499
Tonally grey but fine phono input and great facilities make it an excellent general purpose tool.



CROFT MICRO 1986 £150
Budget valve pre-amp with exceptionally transparent performance.

CONRAD JOHNSON MOTIV MC-8 1986 £2,500
Minimalist FET-based preamplifier is brilliantly neutral and smooth with a spry, light balance in the mould of Sugden. Something of a curio, but worthwhile nonetheless

AUDIO RESEARCH SP-8 1982 £1,400
Beautifully designed and built high end tube pre-amplifier with deliciously sweet and smooth sound. Not the last word in incision or grip.

LINN LK-1 1986 £499
A brave attempt to bring remote controlled user-friendliness to hair-shirt audiophile hi-fi. Didn't quite work, but not bad for under £100.

NAIM NAC 32.5 1978 £ N/A
Classic high end pre. Brilliantly fast and incisive sound that's a joy with vinyl but a tad forward for digital.

LECSO AC-1 1973 £ N/A
Amazing styling courtesy of Allan Boothroyd can't disguise its rather cloudy sound, but a design classic nonetheless

QUAD 33 1968 £43
Better than the 22, but Quad's first tranny pre isn't outstanding. Responds well to tweaking/ rebuilding though...



LEAK POINT ONE STEREO 1958 £ N/A
Good for their time, but way off the pace these days. Use of EF86 pentode valve for high gain rules out ultra performance. Not the highest-fi!

QUAD 22 1958 £25
The partner to the much vaunted Quad II mono-blocks - cloudy and vague sound means it's for anacrophiles only.

LOUDSPEAKERS

WHARFEDALE DIAMOND 10.3 2010 £290
Great small standmounters for audiophiles on a budget; dry punchy sound with impressive sound-staging at the price.



YAMAHA SOAVO 1.1 2009 £3,000
Musical, transparent with impressive dynamics and cohesion. Excellent build and finish.

USHER BE-10 2009 £10,500
Clever high end moving coil design with immense speed and dizzying clarity allied to epic punch. Needs the best ancillaries to fly, though...



SPENDOR A5 2009 £1,695
Multi-talented floorstanders with generous scale and punch and Spendor's classic mid-range detail. Deliver a sound that thoroughly engages whatever you care to play.

MONITOR AUDIO PL100 2008 £2,300
The flagship 'Platinum' series standmounter has a lovely warm and delicate sound with superlative treble.



MARTIN LOGAN SOURCE 2008 £1,600
Brilliant entry level electrostatics, giving a taste of loudspeaker esoterica for the price of most moving coil boxes. Tremendous clarity, evenness and delicacy, although not the world's most powerful sound.

PMC OB11 2008 £2,950
Cleverly updated floorstanders give scale and solidity in slim and well finished package.

ISOPHON GALILEO 2007 £2,100
Big standmounters that really grip the music and offer quite startling dynamics and grip.

ONE THING AUDIO ESL57 2007 £1,450
One Thing Audio's modifications keep the good old ESL57 at the very top of the game.

MOWGAN AUDIO MABON 2007 £3,995
Massively capable loudspeakers that offer dynamics, scale and clarity in an elegantly simple package. Wide range of finishes, too.

B&O BEOLAB 9 2007 £5,000
Technically impressive and visually striking loudspeakers with sound quality that more than matches their looks.



ISOPHON CASSIANO 2007 £12,900
Drive units featuring exotic materials allied to superlative build quality result in an immensely capable loudspeaker. Not an easy load to drive, however.

B&W 686 2007 £299
Baby standmounters offer a sophisticated and mature performance that belies both their dimensions and price tag.

QUAD ESL-2905 2006 £5,995
The old 989 with all the bugs taken out, this gives a brilliantly neutral and open sound like only a top electrostatic can; still not a natural rock loudspeaker, though.

B&W 801D 2006 £10,500
In many respects, the ultimate studio monitor; dazzling clarity and speed with commanding scale and dynamics.



REVOLVER CYGNIS 2006 £5,999
Revolver pull out all the stops and show what they can do with this magnificent flagship loudspeaker. A superb monitor that is like a mini B&W 801D in many ways.

USHER BE-718 2007 £1,600
Beryllium tweeters work superbly, allied to a fast and punchy bass driver. The result is subtle, smooth and emotive.

USHER S-520 2006 £350
Astoundingly capable budget standmounters that offer detail and dynamics well beyond their price and dimensions.

ACOUSTIC ENERGY AE1 CLASSIC 2006 £845
Brilliantly successful remake of an iconic design; not flawless, but surely one of the most musical loudspeakers ever made.



MISSION X-SPACE 1999 £499
The first mass production sub and sat system using NXT panels is a sure-fire future classic - not flawless, but a tantalisingly unboxy sound nevertheless!

MISSION 752 1995 £495
Cracking Henry Azima-designed floorstanders combined HDA drive units and metal dome tweeters with surprisingly warm results. Benign load characteristics makes them great for valves.

TANNOY WESTMINSTER 1985 £4500
Folded horn monsters which sound good if you have the space. Not the last word in tautness but can drive large rooms and image like few others.



CELESTION SL6 1984 £350
Smallish two way design complete with aluminium dome tweeter and plastic mid-bass unit set the blueprint for nineteen eighties loudspeakers. Very open and clean sounding, albeit coarse at high frequencies and limp in the bass. Speakers would never be the same again...

HEYBROOK HB1 1982 £130
Peter Comeau-designed standmounters with an amazingly lyrical yet decently refined sound. Good enough to partner with very high end ancillaries, yet great with budget kit too. A classic.



QUAD ESL63 1980 £1200
An update of the ESL57, with stiffer cabinets. Until the 989, the best of the Quad electrostatics.

MISSION 770 1980 £375
Back in its day, it was an innovative product and one of the first of the polypropylene designs. Warm, smooth, clean and powerful sound.

ACOUSTIC RESEARCH AR18S 1978 £125
Yank designed, British built loudspeaker became a budget staple for many rock fans, thanks to the great speed from the paper drivers, although finesse was most definitely not their forte...

YAMAHA NS1000 1977 £532
High tech Beryllium midband and tweeter domes and brutish 12" woofers in massive sealed mirror image cabs equals stunning transients, speed and wallop allied to superb transparency and ultra low distortion. Partner carefully!



JR 149 1977 £120
Cylindrical speaker was ignored for decades but now back in fashion! Based on classic KEF T27/B110 combo as seen in the BBC LS3/5a. Doesn't play loud, needs a powerful transistor amplifier, but has clarity and imaging.

KEF R105 1977 £785
Three way Bextrene-based floorstander gave a truly wideband listen and massive (500W) power handling. A very neutral, spacious and polite sounding design, but rhythmically well off the pace.

CLASSICS

SPENDOR BC1 1976 £240

Celestion HF1300 tweeter meets bespoke Spendor Bextrene mid-bass unit. The result is a beautifully warm yet focussed sound. A little bass bloom necessitates careful low-stand mounting.



IMF TLS80 1976 £550

Warm and powerful 1970s behemoth with transmission loading and a mixture of KEF and Celestion drive units. Impressively physical wideband sound but rhythms not a forte

HH ELECTRONICS TPA-50D AMPLIFIERS

1973 £110

Simple design with easily available components, solid build quality and fine sound make for a surprisingly overlooked bargain. Not exactly stylish, however.

BBC LS3/5A 1972 £88

Extremely low colouration design is amazing in some respects – articulation, stage depth, clarity – and useless in others (both frequency extremes). Came in wide variety of guises from various manufacturers building it under licence.

LEAK SANDWICH 1961 £39

Warm sounding infinite baffle that, with a reasonably powerful amplifier can sound quite satisfying.

QUAD ESL57 1956 £45

Wonderfully open and neutral sound puts box loudspeakers to shame. Properly serviced they give superb midband performance, although frequency extremes less impressive. Ideally, use in stacked pairs or with subwoofers and supertweeters

SYSTEMS

MERIDIAN SOOLOOS 2.1 2010 £6,990

Crisp styling, bright, colourful touchscreen, plus excellent search facilities. This is one hard disk music system with a difference. Best partnered to Meridian active loudspeakers



NAIM UNITIQUE 2010 £995

Great little half width one-box system with truly impressive sound allied to a wealth of source options

ARCAM SOLO MINI 2008 £650

Half the size and two-thirds the price of a full-sized Solo, the Mini gives very little away in terms of performance to its bigger brother

MERIDIAN F80 2007 £1,500

Fantastically built and versatile DVD/CD/DAB/FM/AM unit, designed in conjunction with Ferrari. Ignore nay-sayers who sneer that it isn't a 'proper' hi-fi product. Just listen.

SHANLING MC-30 2007 £650

Quite possibly the cutest all-in-one around with fine performance from the CD player, tuner and MP3 player input. Very low power, though.



AURA NOTE PREMIER 2007 £1,500

Lovely shiny CD/tuner/amplifier with fine sound quality and dynamic abilities.



MARANTZ 'LEGEND' 2007 £22,000

The combination of SA-7S1 disc player, SC-7S2 preamp and MA-9S2 monoblocks delivers jaw-dropping performance.

ARCAM SOLO NEO 2006 £1,100

Excellent all-in-one system, with a warm, smooth and balanced sound to match the features and style.

PEACHTREE AUDIO IDECCO £1,000

Excellent sounding iPod dock, impressive DAC and fine amplifier section make this an excellent one box style system.



TUNERS

ARCAM FMJ T32 2009 £600

Excellent hybrid FM/DAB+ tuner with a smooth, engaging sound. Factor in its fine build and it's a super value package



MAGNUM DYNALAB MD-100T 2006 £1,895

One of the best ways to hear FM that we know; superbly open and musical sound in a quirky but characterful package

MYRYAD MXT4000 2005 £1,000

Sumptuous sound and top-notch build quality make for a tempting AM/FM package. Warm and richly detailed on good-quality music broadcasts

NAIM NAT03 1993 £595

The warm, atmospheric sound is further proof of Naim's proficiency with tuners.

CREEK CAS3140 1985 £199

Excellent detail, separation and dynamics - brilliantly musical at the price. T40 continued the theme...

QUAD FM4 1983 £240

Supreme ergonomics allied to a pleasingly lyrical sound with plenty of sweetness and detail made this one of the best tuners around upon its launch



NAD 4040 1979 £79

Tremendously smooth and natural sound allied to low prices and good availability make this budget analogue esoterica.

MARANTZ ST-8 1978 £353

Marantz's finest radio moment. Warm, organic sound plus an oscilloscope for checking the signal strength and multipath.

YAMAHA CT7000 1977 £444

Combines sleek ergonomics, high sensitivity and an explicit, detailed sound.

SONY ST-5950 1977 £222

One of the first Dolby FM-equipped tuners, a format that came to nought. Still, it was Sony's most expensive tuner to date, and boasted good sound quality with brilliant ergonomics.



ROGERS T75 1977 £125

Superb mid-price British audiophile design, complete with understated black fascia. Smooth and sweet with fine dimensionality.

SANSUI TU-9900 1976 £300

A flagship Japanese tuner. It boasts superlative RF performance and an extremely smooth and lucid sound.



TECHNICS ST-8080 1976 £180

Superb FM stage makes for a clean and smooth listen

REVOX B760 1975 £520

The Revox offers superlative measured performance although the sound isn't quite as staggering as the numbers. Fine nonetheless, and surely the most durable tuner here?

SEQUERRA MODEL 1 1973 £1300

Possibly the ultimate FM tuner. Massive in terms of technology, size and features dedicated to extracting every ounce of performance from radio, including impressive multi-purpose oscilloscope display

LEAK TROUGHLINE 1956 £25

Series I an interesting ornament but limited to 88-100MHz only. II and III are arguably the best-sounding tuners ever. Adaptation for stereo easy via phono multiplex socket. Deliciously lucid with true dimensionality

HEADPHONE AMPLIFIERS

GRAHAM SLEE NOVO 2009 £255
Dynamic headphone amplifier with a great sense of timing. Crisp, clear treble and warm midrange gives an involving sound.



MUSICAL FIDELITY X-CAN V8 2008 £350
Open and explicitly detailed sound plus serious bass wallop. A great partner for most mid-to-high end headphones.

CD PLAYER/RECORDERS

MUSICAL FIDELITY TRIVISTA 2002 £4000
When playing SACDs, the sweetest, most lucid and lyrical digital disc spinner we've heard. Old school stereo, pure DSD design. CD sound is up in the £1000 class, too! Future classic.

MARANTZ SA-1 2000 £5,000
The greatest argument for SACD. This sublime Ken Ishiwata design is utterly musically convincing with both CD and SACD, beating most audiophile CD spinners hands down.



SONY MDS-JE555ES 2000 £900
The best sounding MD deck ever, thanks to awesome build and heroic ATRAC-DSP Type R coding.

PIONEER PDR-555RW 1999 £480
For a moment, this was the CD recorder to have. Clean and detailed.

MARANTZ DR-17 1999 £1100
Probably the best sounding CD recorder made; built like a brick with a true audiophile sound and HDCD compatibility.



CAMBRIDGE AUDIO CD4SE 1998 £200
A touch soft in the treble and tonally light, but outstanding in every other respect.

SONY TCD-8 DATMAN 1996 £599
Super clean sound makes this an amazing portable, but fragile.

LINN KARIK III 1995 £1775
The final Karik was a gem. Superb transport gives a brilliantly tight, grippy dynamic sound, albeit tonally dry.

NAIM CDS 1990 £ N/A
Classic Philips 16x4 chipset with serious attention to power supplies equals grin-inducing sonics

MARANTZ CD73 1983 £700
A riot of gold brushed aluminium and LEDs, this distinctive machine squeezed every last ounce from its 14x4 DAC -super musical



MERIDIAN 207 1988 £995
Beautifully-built two-box with pre-amp stage. Very musical although not as refined as modern Bitstream gear. No digital output.

SONY CDP-R1/DAS-R1 1987 £3,000
Sony's first two boxer was right first time. Tonally lean, but probably the most detailed and architectural sounding machine of the eighties.

CAMBRIDGE AUDIO CD1 1986 £1500
Inspired Stan Curtis redesign of Philips CD104, complete with switchable digital filter. Lean but tight and musical performer.



MERIDIAN MCD 1984 £600
The first British 'audiophile' machine was a sweeter, more detailed Philips CD100. 14x4 never sounded so good, until the MCD Pro arrived a year later.

SONY CDP-701ES 1984 £890
Sony's first bespoke audiophile machine used a 16x2 DAC to provide a clinically incisive sound; supreme build quality allied to the pure unadulterated luxury of a paperbook-sized remote control.

YAMAHA CD-X1 1983 £340
Nicely built 16x2 machine with a very sharp and detailed sound; sometimes too much so. Excellent ergonomics, unlike almost every other rival of the time.

SONY CDP-101 1982 £800
The first Japanese CD spinner was powerful and involving. Brilliant transport more than compensated for 16x2 DAC, and you even got remote control!



ANALOGUE RECORDERS

AIWA XD-009 1989 £600
Aiwa's Nak beater didn't, but it wasn't half bad nonetheless. Massive spec even included a 16x4 DAC!

NAKAMICHI CR-7E 1987 £800
The very best sounding Nakamichi ever - but lacks the visual drama of a Dragon.



SONY WM-D6C 1985 £290
Single capstan transport on a par with a Swiss watch, single rec/replay head better than most Naks. Result: sublime.

PIONEER CTF-950 1978 £400
Not up to modern standards sonically, but a great symbol of the cassette deck art nonetheless.

YAMAHA TC-800GL 1977 £179
Early classic with ski-slope styling. Middling sonics by modern standards, but cool nonetheless!

SONY TC-377 1972 £N/A
A competitor to the Akai 4000D open reel machine, the Sony offered better sound quality and is still no slouch by modern standards

REVOX A77 1968 £145
The first domestic open reel that the pros used at home. Superbly made, but sonically off the pace these days.

COMPACT DISC TRANSPORTS

ESOTERIC P0 1997 £8,000
The best CD drive bar none. Brilliantly incisive, ridiculously over engineered.

TEAC VRDS-T1 1994 £600
Warm and expansive sound made this a mid price hit. Well built, with a slick mech.

KENWOOD 9010 1986 £600
The first discrete Jap transport was beautifully done and responds well to re-clocking.

DACS

DCS ELGAR 1997 £8500
Extremely open and natural performer, albeit extremely pricey - superb.

DPA LITTLE BIT 3 1996 £299
Rich, clean, rhythmic and punchy sound transforms budget CD players.

CAMBRIDGE AUDIO DAC MAGIC 1995 £99
Good value upgrade for budget CD players with extensive facilities and detailed sonics.

PINK TRIANGLE DACAPO 1993 £ N/A
Exquisite; the warmest and most lyrical 16bit digital audio we have ever heard.

QED DIGIT 1991 £90
Budget bitstream performer with tweaks aplenty. Positron PSU upgrade makes it smooth, but now past it.

CABLES

MISSING LINK CRYO REFERENCE 2008 £495/0.5M
High end' interconnects, with deliciously smooth, open and subtle sound without a hint of edge.

TECHLINK WIRES XS 2007 £20
Highly accomplished interconnects at an absurdly low price. Stunning value for money.

VDH ULTIMATE THE FIRST 2004 £250
Carbon interconnects that help you forget the electronics and concentrate on the music. Miraculous transparency. Tight and tuneful bass mixed with air and space.



WIREWORLD OASIS 5 2003 £99/M
Excellent mid-price design with a very neutral, silky and self-effacing sound. Superb value for money.

TCI CONSTRICTOR 13A-6 BLOCK 2003 £120
Top quality 'affordable' mains outlet block, with fine build and good sonics. Well worth the extra over standard high street specials, which sound coarse and two-dimensional by comparison.

Radio gaze

In light of his Roberts 'smart radio' review, Martin Pipe examines the Psion WaveFinder – an early (and to this day unique) DAB radio-cum-lightshow

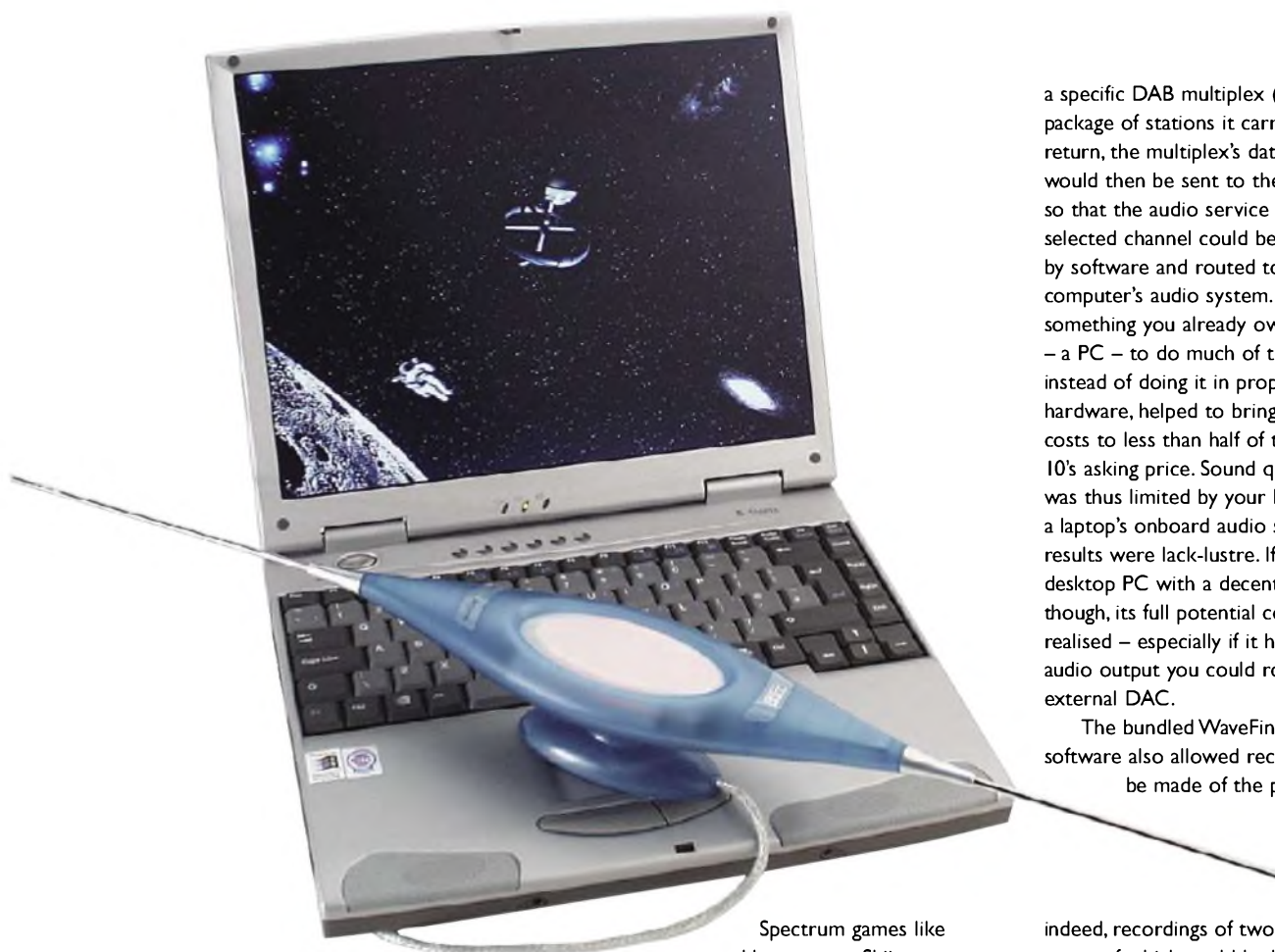

a specific DAB multiplex (and the package of stations it carries). In return, the multiplex's data stream would then be sent to the PC so that the audio service of the selected channel could be decoded by software and routed to the computer's audio system. Using something you already owned – a PC – to do much of the work, instead of doing it in proprietary hardware, helped to bring down costs to less than half of the Alpha 10's asking price. Sound quality was thus limited by your PC; with a laptop's onboard audio system results were lack-lustre. If you had a desktop PC with a decent soundcard, though, its full potential could be realised – especially if it had a digital audio output you could route to an external DAC.

The bundled WaveFinder software also allowed recordings to be made of the programme;

Spectrum games like Horace goes Skiing.

Digital radio has been available to British listeners for over two decades. In September 1995, the BBC began radiating DAB signals in central London from a network of five transmitters. However, few people could receive these transmissions (Radios 1 to 4 FM, and 5 Live) as the first commercial DAB product – Arcam's Alpha 10 'Digital Radio Tuner' – didn't surface until 1998. But at £800 a pop, it was hardly going to bring DAB to a wider audience. Hopes were therefore high for the October 2000 launch of the £300 WaveFinder from Psion plc, a London-based company famous for its electronic organisers, palmtop computers and – for those with even longer memories – Sinclair

The WaveFinder relied on an IBM-compatible personal-computer to do the donkey work. It resembles a dipole receiving aerial – 68cm long, from tip to tip – with an ungainly central bulge that glows in a range of different colours! Yes, this is the first (and last?) radio to put on a light-show. Positioned wherever the best reception could be obtained, it connects to your PC via a USB port. Said bulge contains the DAB tuner/demodulator and USB interface circuitry – functionality buried in a screened slab of complex surface-mount electronics. The power requirements of this went beyond what a USB port could provide, and so Psion supplied a 'wall-wart' that plugged into the side of the USB plug.

Via USB, the bundled Windows software told the tuner to select

indeed, recordings of two services – one of which could be listened to – carried by the same multiplex could be made simultaneously to your hard disk. Again, way ahead of the curve! You could record in DAB's native mp2 (MPEG-I, Layer 2) codec, or transcode into the MP3.

The resulting files could be played by software like Winamp – or even decoded into PCM, sample-rate converted from DAB's 48kHz to 44.1kHz and burnt onto CD-Rs for playback in-car – and of course on hi-fi systems! Yes, you could listen to 'time-shifted' DAB broadcasts via the audiophile DAC of a high-end CD player.

Radio had never sounded so good; at the time, all BBC stations were carried at a bitrate of 192kbps, and minimal audio processing (compression and limiting) was applied.

Psion's software-based approach was interesting, as in theory bugs could be 'squashed' and new features added. The greater computing power available to a PC also made for a more intuitive user interface (radio stations selected by buttons with the relevant logo) and easy 'wizard' based installation, as well as recording.

As a mere 'receiver unit', the WaveFinder hardware would be more resilient to changes; indeed, from the outset it could tune into Band L (UHF, 1452-1492 MHz) as well as the Band III (VHF, 174-240 MHz) channels that carry all UK DAB services.

However, the WaveFinder was beset by problems. First of all, it's insensitive – at a time when DAB coverage was fairly limited to start off with. You might get some – or none – of the multiplexes. And even if you could bring them in, reception might be erratic with audible 'pops' and gurgles.

Secondly, the software (initially Windows 98) is rather buggy and consumes resources to the extent that listening to DAB radio stations slowed down contemporary computers so much you couldn't do much else with them! This was certainly true of the 1998-vintage 233MHz Toshiba Pentium MMX laptop I originally used it with back in 2000 – and revisited for the purpose of this article. Psion subsequently upped its 'minimum hardware requirements' to reflect 'real world' conditions. Later software revisions threw up incompatibility issues with the then-new Windows XP, especially in relation to USB drivers.

Although the last version of XP (SP3) is supposed to be compatible, I couldn't get it to work with WaveFinder. It's also disappointing that Psion never supported MacOS – visually, the device is quite a good match for a turn-of-the-millennium iMac!

A final problem is that the nominally 10-volt wall-wart supplied with the WaveFinder is unregulated. It wasn't uncommon for a mains surge to 'kill' the unit's internal power-supply circuitry. Some repair technicians became quite adept at dealing with faulty WaveFinders. To reduce the chance of this happening to mine, I switched to a regulated 300mA supply (Uniross UNI303R, 12V output and centre-positive polarity settings) from Maplin. If you come across a WaveFinder in working

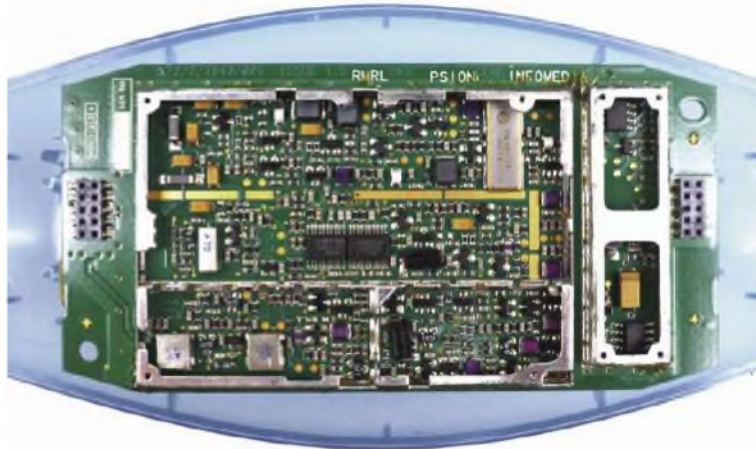

The WaveFinder's electronics were complex. Over 400 surface-mounted components are crammed onto the board. It's difficult to see how Psion could have made money from the Wavefinder, after its retail price had been reduced from £300 to £50.

condition, I'd advise doing the same.

Back in 2000, I had a lot of trouble getting the WaveFinder to give reliable results; in the end, I switched to a Videologic DRX-601 DAB tuner. This was introduced in 2001, i.e. not long after the WaveFinder, for the same £300, and became popular with hi-fi enthusiasts who couldn't afford the Arcam. I fed my DRX-601 from an external Antiference DAB roof aerial, and reception was (and continues to be) excellent. Admittedly you can do the same with the WaveFinder to improve reception – it has a subminiature coaxial aerial connector on its rear – but the software problems and dependence on my PC meant the no-nonsense Videologic won the day, even when the WaveFinder's recording facility was factored in.

Then came the 2002 launch of new BBC services like 6Music and Radio 7 (which, in 2011, would be rebranded Radio 4 Extra). These, together with portable DAB sets and more commercial stations, stimulated public interest in DAB. Videologic changed its name to Pure and introduced affordable portables. Pure, a prominent DAB-radio market player, is still with us; in contrast, Psion pulled out of DAB and stopped supporting the WaveFinder in 2004. Not even Dixons PC bundle-deals or reducing the price to £50 in December 2000 could save the day; I can imagine that customers who had paid full price for their WaveFinders a few months earlier were not impressed...

My WaveFinder still works, and with the aerial placed near a window it's able to reliably-receive all of the

multiplexes available in my South Essex location; this wasn't the case back in 2000! The LEDs still slowly pulse in a sequence of colours, and either distract or provide a talking point according to your mood or point of view.

As WaveFinder is no longer supported, the drivers (development of which was stopped in 2004) are no longer officially available. However, the contents of the installation CD-ROM are available here: <http://bit.ly/2qXDKOc>. And to the poster I offer my sincerest thanks, as my disc had long since disappeared; without the drivers, a computer peripheral is junk. I can confirm that the drivers work with Windows 98 Second Edition, but as noted earlier I had no joy with Windows XP SP3; some have reported better luck. The 'unofficial' download presumably contains later drivers, as icons for BBC Radio 7 are provided (the associated Radioscape button tunes in 4 Extra). There is however unofficial support for Linux here: <http://bit.ly/2FCdHiQ>

As it stands, newer stations broadcasting in the newer DAB+ format are incompatible with this unit as the Radioscape software cannot decode streams encoded in its HE-AAC v2 codec. DAB+ stations are found during a search and appear on the lists, but selecting them yields no audio.

Putting aside its lack of support for the increasing number of DAB+ services, the WaveFinder may still be of interest to hi-fi enthusiasts with vintage PCs. Theoretically at least, it's the best-sounding DAB radio out there as it relies on your existing audio hardware.

vinyl section

contents

MARCH 2018

www.hi-fiworld.co.uk

NEWS 84

All the latest and greatest vinyl releases for you, from the pen of Paul Rigby.

SGT. PEPPER'S LONELY HEARTS CLUB BOX SET REVIEW 87

Paul Rigby on a new box set of The Beatles' classic album.

BLUE HORIZON SHELIVING 91

Looking for the ideal rack for your turntable? This might just be it, says Paul Rigby.

TOTAL STATE MACHINE BOOK REVIEW 93

Test Dept mixed music with politics – Paul Rigby delves into the band's history told in this new book.



news

MUSIC ON VINYL

Don't the staff of this company ever sleep? Lots more from Music on Vinyl (www.musiconvinyl.com).

First up is Ten Years After's 'A Sting in the Tale' on gold vinyl. This is the band's admirable 'come back' album released in 2017.

Prog fans should be aware of Quiet World's worthy yet flawed concept piece, 'The Road' (1970). It has a Moody Blues-esque feel about it but Genesis fans will be excited by the inclusion of a young Steve Hackett on guitars.

Classic rock-influenced, indie rockers, Blind Melon's 'Soup' (1995) offer a suite of dark tones on LP, their final release before the death of their lead singer.

Fusion drummer, Billy Cobham's 1974 release, 'Crosswinds', was his second LP as a leader. A decent album featuring the likes of George Duke and John Abercrombie.

From 1971, UK outfit Pluto's self-titled LP, original released on the Pye imprint, Dawn with plenty of experience – there's even a Joe Meek connection in there, for example. It features classic 70s hard rock and is well worth seeking out.

Also look out for John Hiatt 'Collected', a compilation over two discs; Herbie Hancock's 'Sunlight' (1978); Odetta's 'Odetta Sings' limited to just 750 copies on gold vinyl; 'Livin' Blues' – Dutch music's 'Golden Years' of the sixties and seventies; plus from 1969, blues guitarist, Freddie King's 'My Feeling for the Blues'.



RHINO RECORDS

From Rhino is The Velvet Underground's 'Loaded' (1970), the band's first Atlantic release. Reed carries the LP but it's the band's first successful commercial outing.

From Aretha Franklin a...different take. 'A Brand New Me' has 12 hits backed by the Philharmonic orchestra. Soul with added lush.

Blues-Based rock from The Faces with 'Ooh La La' (1973), their last album. Band tensions were not evident, though. It's a corker of an LP. Ronnie Lane is the master songwriter here. Arrives with a replica of the original sleeve.

Also look out for The Doors' 'Strange Days'. Why? Because this one's in mono, from the original mono master tapes. Don't forget - play it with a mono cartridge! 0.7mil tipped too!



WARNERS BLACK FRIDAY

A host of goodies from Warners includes two Black Friday, Record Store Day releases. Son Volt's country-folk outing, 'Straightaways' (1997) deserves time and attention to draw out its treasures.

The other Black Friday LP is Pantera man, Dimebag Darrell's 'The Hitz', the five audio tracks from the CD/DVD pack, 'Dimevision 2': the first time they've appeared on vinyl.



SIRE SELECTION

From the Sire label include The Replacements' 'For Sale: Live at Maxwell's 1986' (2017) recorded, says the sleeve, in front of "more than 30 people", which is pretty good going, I'm sure you'll agree. This is the band on a good night over two discs. Essential for the fans.

Also look out for Barenaked Ladies' 'Gordon' full of entertaining harmonies, fun, frolics and great melodies and the first appearance on 180gm vinyl.



SPEAKERS CORNER

Two jazz pieces for you from this German-based audiophile label includes The Jazz Workshop's 'Four Brass One Tenor'. Released in 1956 this was actually an Al Cohn LP under Victor's Jazz Workshop series. Also included were Freddie Green (guitar), Dick Katz on piano, Buddy Jones on bass and Osie Johnson on drums. Manny Albam added arrangements. Trumpets were the aim of this game. They included Thad Jones, Nick Travis, Joe Newman, Jo Wilder and Bernie Glow plus Phil Sunkel. A rhythmic jazz LP with smooth arrangements.

Next is Miles Davis 'In Berlin' (1965). A live recording with the Berlin Philharmonic, it's his first recording with Wayne Shorter on tenor sax plus Herbie Hancock (piano), Ron Carter on bass and Tony Williams on drums. This LP shows how 'together' the band are along with a sense of space and freedom.



VINILISSIMO

Two from this Spanish reissue label (www.munster-records.com) includes The Village Callers 'Live' (1968). Combing jazz, soul and R&B with Latin overtones, this East Los Angeles band was heavily sampled by later hip hop outfits such as The Beastie Boys. The album itself is thick with rhythmic layering, riding under a strong organ vibe and wholly funky vocals.

PRETTY EN ROSE

Pretty En Rose's 'Original Soundtrack' is taken from Angelique Bosio's film about the life of Fifi Chachnil, a key part of the Parisian fashion scene.

Produced by Ross Blake (rossblake.bandcamp.com) it combines ethereal pop with a loungecore sensibility plus a slightly woozy and dreamy orchestral structure.



...AND FINALLY

Scottish folk-pop outfit, The Just Joans' 'You Might Be Smiling Now...' ([Fika, www.fikarecordings.com](http://www.fikarecordings.com)) Homespun tales from everyday people. No gloss, no pretensions.

Kjetil Mulelid Trio's 'Not Nearly Enough To Buy A House' (Rune Grammofon, <http://www.runegrammofon.com>). Quiet, sometimes complex jazz but driving and insistent and offering an attractive musicality. The melodies draw you in.

Prog, "sludge" and horror from Upcdownc, 'I, Awake' (upcdownc.bandcamp.com) combines almost ambient reflective synth and effects work with hard-edged guitar and rock explosions in a post metal instrumental framework.





sounddeck By SDS

Order online at sounddeck.co.uk

Sounddeck PM £90

The perfect way to enhance your turntable including Linn or Technics. Available in 295mm, 292mm or 285mm sizes Sounddeck PM uses an aluminium laminate which converts vibrational energy into negligible amounts of heat which lets the stylus process information in the grooves without interference from feedback and rumble. While the stylus is collecting vibrations and sending them up to the cartridge it is also forcing vibrations back into the record, these are collected and recycled through the system creating secondary noise which has to be processed by the system. The Sounddeck PM absorbs this noise so the system can process pure music without all the background mush - resulting in a cleaner sound.



Sounddeck DP Damping Puck £115

Available in polished stainless steel 745Grams or aluminium 262grams
The Sounddeck DPS damping puck is machined from two pieces of stainless steel bonded together with a layer of polymer. It sits firmly over the top of a turntable's spindle - holding the vinyl securely to the platter to extract a larger soundstage, firmer bass and extra detail.



Sounddeck DF £48 (set of 4)

Available in 75mm Squares or 80mm Circles
Sounddeck damping feet are 3mm thick vibration absorbing steel pads which isolate speakers, amps, turntables and components from vibration and feedback. They prevent speakers from driving the floorboards or shelving which enables them to operate in a vibration free environment resulting in a cleaner sound. They are also supplied with soft neoprene pads to prevent marking shelves or floors.



Visit sounddeck.co.uk for information and links to hifi reviews.

"The Best Tonearm I've heard" HI FI WORLD



Be Well Informed Choosing Your Arm

Perfect 10 award "The most addictive product I've heard" AUDIO 10 (USA)

"For me Origin Live in the analogue sector is the discovery of the year! ..."
IMAGE HI FI (Germany)

"The biggest improvement I've made in 25 years of listening to music and lots of exchanges of hi-fi stuff! ...breathtaking, big new level! It's like coming to Nirvana".
OWNER COMMENT: FERDINAND ROEHRIG

Tonearm of the Year Award HI FI WORLD

Most wanted component award STEREO TIMES (USA)

Best sound at the show award KLANGBILDER (Vienna)

Multi-Award winning Origin Live arms embody advanced design which enable even lower arms in the range to outperform highly regarded brands costing over 5 times as much.

You may be skeptical, so we offer a 3 week money back guarantee should you be anything but delighted.

To start enjoying an entirely new level of performance see website below.

Email: originlive@originlive.com

Website: www.originlive.com

Phone: +44(0)2380 578877



Sgt. Pepper's Lonely Hearts Club Band Anniversary Edition



Featuring remixes, rarities, hi-res digital audio and more, Paul Rigby reviews this new 'Super Deluxe' version.

The original album was a final culmination and refining of a musical revolution. And make no mistake about it, The Beatles were responsible for a complete and wide-ranging revolution in music in terms of creation and produc-

tion. After this LP, the rest of the world looked on and saw what was possible. It seems understandable, therefore, that this LP should be the subject of a lavish, CD/Digital-based box set.

The album itself is newly mixed by Giles Martin and Sam Okell in

stereo and 5.1 surround audio (not remastered, you understand, actually remixed) from the original four-track master tapes and expanded with early takes from the studio sessions, including no fewer than thirty-four previously unreleased recordings. You'll find a 24bit/96kHz version of

Dial A Dealer Directory

directory of Hi-Fi Dealers throughout the UK and Ireland.

divine audio

AnalogueWorks
Croft Acoustics
Graham Slee
KLE Innovations
London
Lounge Audio
Meridian
Rogue Audio
Trenner & Friedl

www.divineaudio.co.uk
01536 762211 tim@divineaudio.co.uk

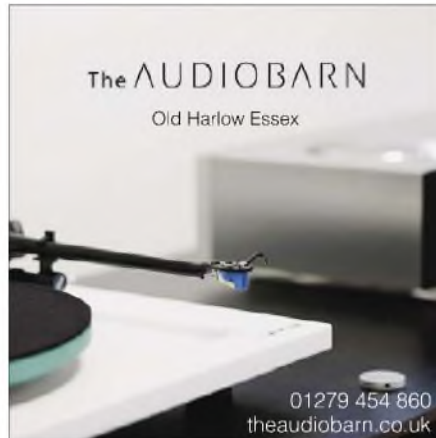

TO ADVERTISE HERE
PLEASE CALL
JOANNA HOLMES ON
+44 (0) 7958 602347
OR EMAIL:
joanna@hi-fiworld.co.uk

9 High Street, Hampton Wick,
Kingston upon Thames, Surrey KT1 4DA
Open: Tuesday - Saturday 10am - 6pm
0208 943 3530

Infidelity

MUSIC & CINEMA SYSTEMS

NAIM, LINN, REGA, ARCAM, B&W 800 SERIES, PMC, FOCAL,
DYNAVECTOR, KUDOS, VELODYNE, STAX, LYRA, OPPO,
TANGERINE AUDIO, TELLURIUM Q.

SEE AND HEAR THE VERY BEST

CEDIA MEMBER

clarity

TO ADVERTISE HERE
PLEASE CALL
JOANNA HOLMES ON
+44 (0) 7958 602347
OR EMAIL:
joanna@hi-fiworld.co.uk

Billy Vee

SOUND SYSTEMS

London Linn & naim Specialist

CALL SALES: (020) 8318 5755 or 8852 1321 - 248 Lea High Road, London, SE13 5PL
Web: - www.billyvee.co.uk email: sales@billyvee.co.uk Full delivery and installation services.



Full Naim Uniti & Classic series available



Full Linn DS range on demonstration

Trade in your CD Player & claim up to £1000 against a new digital Streaming player - offering you easier access to your music and better sound quality

Please call in or visit billyvee.co.uk for full details of this and other great new performance enhancing promotions



TO ADVERTISE HERE
PLEASE CALL JOANNA HOLMES ON
+44 (0) 7958 602347
OR EMAIL:
joanna@hi-fiworld.co.uk

the stereo album plus a mono CD version of the same, 4K standard promotional films for 'Strawberry Fields Forever', 'Penny Lane' and 'A Day In The Life' plus 'The Making of Sgt. Pepper', a restored, previously unreleased documentary film (broadcast in 1992).

Also included are posters and a 144-page hardcover book packed with new interviews and rare images. The entire box is contained in a lenticular 3D collage slip cover.

So how does it sound? I grabbed the original stereo album from this box set and compared it with the version found in the 2009 stereo CD box set. I chose 'With a Little Help From My Friends'. The remix centralised the vocals far more than the 2009 version giving Starr a more important and controlling role in the song. The addition of further reverb increased the perceived soundstage too. Much was made of McCartney's new found bass lines in the 2009 version but, after the novelty had worn a tad, I found that bass guitar over-bearing. The remix corrected this, retaining the bass whilst easing it into the mix as a partner to the rest of the instruments. The same could be said for the tambourine which took on festive bell proportions at times in the 2009 version. Here, the balance was much improved.

I then moved to a complex piece, George Harrison's 'Within You Without You' and it appeared that Martin and Okell had benefitted from improved studio kit here because there was a real improvement in terms of noise on this track. Despite a measure of compression being evident, it was less harsh in presentation while being open and spacious in terms of the midrange. Harrison's vocal was a great improvement, being softer but also more direct and persuasive in his tone.

I then turned to the mono CD version of 'Sgt. Pepper' and selected 'Lucy in the Sky With Diamonds' and its unique psychedelic mono mix from the recently released 'In Mono' set with - unlike its Stereo sister - reduced inherent compression.

Again, the new edition was the winner here. Not only were the

mids smoother and more accessible to the ear but the vocal moved away from the backing instruments a touch which helped the emotive delivery.

As for those instruments? The rather hollow sound of the drums on the earlier edition had now gone to be replaced by a more complex and intricately organic rendition. Finally, the enhanced clarity of the psychedelic swirling effects increased the 'out there' atmosphere of the arrangement.

Finally, 'When I'm 64' is a beautifully delicate arrangement. If you listen carefully, there's lots going on with heaps of subtle instrumental interjections and moments to draw the ear.

The new box set's track was a little odd because, at the standard volume I used throughout the test, the music was too 'full on'. Bass was a forced and balance was out of kilter. I had to knock the gain down two clicks to return the box set version to an acceptable volume which made me question the levels on this track. Once reduced in gain, though, the new version revealed how the subtle aspects of the song were eased towards the ear: cymbals, the rather shy piano and even the bit at the end where McCartney is clearly smiling as he's singing, all were now more recognisable.



The album itself is newly mixed by Giles Martin and Sam Okell.

CONCLUSION

This is a magnificent set but possibly not for the reasons that were initially envisaged. The book is great, the posters a nice addition, the bonus studio session work lovely to have and the videos and surround sound a useful addition. For me, though, what stands out here are the original albums in stereo and mono. Why? Because they offer you the best versions of this album currently available on the market. They provide sensible and logical mixes. Finally, 'Sgt. Pepper' sounds 'right'. Both of the new versions blow the official box set versions away. Simple as that.

Which means? Martin and Okell have - yes 'have' - to work on a completely new set of Beatles remasters based on these new mixes at some point in the future. I'm sorry but having heard the possibilities in this box set, it has to happen. I would strongly suggest to Apple that they push out 24bit/192kHz versions of all of the albums with CD versions of the same in the same presentation box, if necessary.

Then - I know there will be howls of protests at this - both men need to look at vinyl for the same reasons. I know, I know, the "What... again?" brigade will protest but I, for one, am in the 'yearning' process, already. After hearing this box set, you will be too.

HEATHCOTE AUDIO

web-www.heathcoteaudio.co.uk/e-mail-heathcoteaudio@aol.com

**WE URGENTLY REQUIRE YOUR SURPLUS EQUIPMENT FRIENDLY
PROFESSIONAL SERVICE PLEASE PHONE GEORGE ON 07860-511111**

VALVES

ROGUE AUDIO APOLLO DARK MONO'S FEW HOURS DEM	MINT/BOXED	£10450
ROGUE AUDIO HYDRA FEW HOURS DEM USE	MINT/BOXED	£2100
ROGUE AUDIO RP-5 LIGHT DEM USE	MINT/BOXED	£2450
ROGUE AUDIO TRITON NEW/DISPLAY	MINT/BOXED	£695
ROGUE AUDIO 66 MAGNUM REMOTE CONTROL PRE	EX DEM	£695
QUAD II-EIGHTY MONO'S FEW HOURS USE (6K?)	MINT/BOXED	£3750
MELODY M88Q KT88 MONOBLOCKS	MINT/BOXED	£2150
NEW AUDIO FRONTIERS 300B SUPREME POWER AMP (13K NEW) ONE OWNER LOW HOURS FANTASTIC AMP	MINT/BOXED	£4995
ANTIQUE SOUNDLABS AQ-9 845 MONOBLOCKS	DEM	£2850
MATTISSE REFERENCE 2 BOX PRE AMP (64 STEP ATT.)	ONE OWNER	£3450
PAPWORTH M-100 MONOBLOCKS ONE OWNER LOW USE	MINT/BOXED	£1995
ART AUDIO INTEGRA INTEGRATED 1 OWNER	EXCLT	£1195
LECTOR ZOE REMOTE PRE AMP 1 OWNER	MINT/BOXED	£995
JOLIDA JD801A KT88 INT ONE OWNER FROM NEW	VGC/BOXED	£650
ANTIQUE SOUNDLABS LH-01 PRE-AMP H/PHONE AMP	EX DEM	£349
MULLARD 5-20 EL-34 MONOBLOCKS	EXCLT	£650
AUDIO INNOVATIONS 1000 SILVER PASSIVE PRE-AMP	EXC	£599

SOLID STATE

BYSTON B100-SST INTEGRATED 1 OWNER FROM NEW	EXCLT	£995
XTZ CLASS A-100 D3 C/W DAC & PHONO STAGE 1 OWNER FROM NEW	MINT/BOXED	£449
MERIDIAN 502 (MC PHONO BOARD) & MSR 1 OWNER FROM NEW	MINT BOXED	£895
MERIDIAN 501 PRE AMP & MSR	MINT/BOXED	£325
NAKAMICHI PA7E STASIS POWER AMP ONE OWNER FROM NEW	EXCLT	£1350
NAKAMICHI CASSE PRE AMP ONE OWNER FROM NEW	EXCLT	£450
DENON PMA 2010 INTEGRATED ONE OWNER FROM NEW	MINT/BOXED	£1250
PASS LABS X-2 PRE AMP ONE OWNER FROM NEW	EXCLT	£1295
H-CAT P-12B PRE AMP (£2500?) DEM USE ONLY	EXCLT	£1250
CONSONANCE A-100 LINEAR AMP ONE OWNER	MINT/BOXED	£650
PRIMARE I-121 INTEGRATED ONE OWNER FROM NEW	MINT/BOXED	£595
AUDIO INNOVATIONS 1000 SILVER PRE-AMP	EXC	£599
PS AUDIO GCA 100 X 5 POWER AMP 1 OWNER (4.5K?)	XCLT/BOXED	£1795
ADVANTAGE i200 REMOTE INTEGRATED (SUPERB AMP)	EXCLT	£895
MUSICAL FIDELITY A3CR POWER AMP 1 OWNER	MINT/BOXED	£495
JOHN SHEARNE 2.5 INTEGRATED AMP	1 OWNER	£375
JOHN SHEARNE 3.5 POWER AMP	1 OWNER	£375
TRIO L-05 MONOBLOCKS (RARE)	EXCLT	£795
TRIO L-01 PREAMP C/W PHONO STAGE	EXCLT	£495
DPA 50S PRE AMP	VGC/BOXED	£495
DPA 50S POWER AMP	DEM/BOXED	£750
DPA 50S 3 BOX PRE AMP (PRE/PSU/PHONO STAGE)	EXCLT	£750
DPA 50S SINGLE BOX PRE AMP	GC	£395
DPA ENLIGHTENMENT PRE	NOS	£395
SONY F542E INTEGRATED	MINT/BOXED	£99
SONY N-220 POWER AMP	VGC	£169

LOUDSPEAKERS

WILMSLOW AUDIO PRESTIGE FACTORY BUILT GRANITE PLINTHS	EXCLT	£1750
PMC TWENTY/23 FLOORSTANDERS 1 OWNER FROM NEW	MINT/BOXED	£1250
PMC TWENTY/24 FLOORSTANDERS 1 OWNER FROM NEW	MINT/BOXED	£1950
PMC TLE-1 POWERED SUB 1 OWNER FROM NEW	MINT/BOXED	£1050
AURUM CANTUS GRAND SUPREME £10,000 +	DEM/CRATED	£5450
ART ALNICO-8 (£10,000) ONE OWNER FEW HOURS USE	MINT/BOXED	£4995
FAB AUDIO FAB-1S ONLY PAIR IN UK (7.5K PLUS)	fab	33995
MBL 300E FLOORSTANDERS PIANO BLACK (10K)	EXCLT	£2750
MERIDIAN M2 ACTIVES & STANDS 1 OWNER FROM NEW	EXCLT/BOXED	£795
NHT 3.3 FLOORSTANDERS (SEE STEREOHILE REVIEW!!)	EXCLT	£1395
KLIPSCH CORNER HORNS (BIRDS EYE MAPLE)	FANTASTIC!	£3995
SONICS BY JOACHIM GERHARD (AUDIO PHYSICS) AMERIGO (5K?)	DEM/BOXED	£1850
MARTIN LOGAN DECENT SUBWOOFER	GC	£1250
ACOUSTIC AUDIO FUNDAMENTAL K2 1 OWNER (£25K NEW)	MINT/CRATED	£6995
B&W 801 MATRIX SERIES 2 WALNUT 1 OWNER	EXCLT	£2250
MARTEN MILES CHERRY (8K+ ONE OWNER)	EXCLT	£2995
BOLZANO VILLETTRI BV3003 & BV SUB. FANTASTIC!	SALE!	£2795
PODIUM 1s PANELS VERY LOW USE (£6000? NEW)	1 OWNER	£1595
ART AUDIO PRECISION MONITOR (PIANO BLACK 6K+)	DEM+1	£1795
AUDIOSTATIC ES-100 ELECTROSTATICS	EXCLT	£1195
ALR JORDAN CLASSIC 2 (BIRCH VENEER £800+)	NEW/BOXED	£450
AURUM CANTUS MUSIC GODDESS (£2500)	DISPLAY	£1195

VINYL

ACOUSTIC SOLID 1/ORIGIN LIVE ARM/EXTRA'S	EXCLT	£3495
CLEARAUDIO MASTER REFERENCE/MASTER TQ-1/ETC	DUE IN	£9950
CLEARAUDIO UNIFY 12 INCH TONEARM FEW HOURS USE ONLY	MINT/BOXED	£1250
LUXMAN PD-444 TURNTABLE 1 OWNER COLLECTORS DREAM	EXCLT	£2450
PROJECT 12 INCH CARBON FIBRE ARM (EX DISPLAY)	BOXED	£395
PROJECT 9CC CARBON FIBRE ARM (EX DISPLAY)	BOXED	£295
AUDIO INNOVATIONS DELTA INERTIA TONEARM N.O.S	N.O.S	£695

GARRARD 401 WITH ACCOUSTAND SKELETAL PLINTH	EXCLT	£950
NOTTS ANALOGUE MENTOR & HEAVY KIT	EXCLT	£1750
DENON DP-1200 SPECIAL EDITION (INC.ARM/CART.)	RARE	£495
ODESSY RP1 .XG ARM 1 OWNER COMPLETE COLLECTORS CONDITION	EXCLT	£1450
NOTTS ANALOGUE MENTOR ARM	DIS/DEM	£495
GRAHAM ENGINEERING ROBIN TONEARM (UNUSED?)	MINT/BOXED	£450
PROJECT 12 INCH CARBON ARM 2 WEIGHTS DIS/DEM/UNUSED?	MINT/BOXED	£395
PROJECT 9 INCH CARBON ARM 2 WEIGHTS DIS/DEM/UNUSED?	MINT/BOXED	£325
HADCOCK GH-242SE UNIPIVOT TONEARM	EXCLT/BOXED	£475
VERTEX AQ SILVER SOLFONN TONEARM LEAD	DIS/DEM	£795
MICHELL ISO PHONO STAGE & HERA PSU	EXCLT	£349
AUDIO INNOVATIONS 1000 MC STEP UP	MINT/BOXED	£475
VAN DEN HUL MC D 501 SILVER HYBRID TONEARM CABLE (SME V ETC)	EXCLT	£225
OKKI NOKKI RECORD CLEANING MACHINE 1 OWNER	BOXED	£249
THORENS TD160 SUPER	VGC	£225
VOYD VALDI AND HUGE PSU 1 OWNER FROM NEW	PLEASE	RING

DIGITAL

DENON DCD 2010AE SACD/CD PLAYER ONE OWNER	MINT/BOXED	£995
LINDEMANN 680 EXCLT BOXED	PLEASE	RING
TECHNICS SLP-S7 REMASTER CD PLAYER ONE OWNER	EXCLT/BOXED	£295
TECHNICS SLP-1200 AND REMOTE CONTROL PRIVATELY OWNED	EXCLT	£695
MUSICAL FIDELITY KW DM25 DAC (SUPERB)	MINT/BOXED	£895
INCA TECH KATANA	VGC	£395
THETA DATA UNIVERSAL TRANSPORT 1 OWNER	EXCLT/BOXED	£495
THETA CARMEN CD/DVD TRANSPORT 1 OWNER	EXCLT/BOXED	£695
THETA DS-PRO GEN III COAX AES/EBU/AT&T RCA/BAL.OUT 1 OWNER	EXCLT/BOXED	£750
PINK TRIANGLE ORDINAL (GETTING RARE)	GC	£349
PIONEER CLD-D925 LASER DISC/CD 1 OWNER LOW USE	MINT/BOXED	£299
LARGE NO.OF MINT LASER DISCS	PLEASE	RING

TUNERS/MISC.

NAKAMICHI/ST7E TUNER ONE OWNER FROM NEW	EXCLT	£349
OKKI NOKKI RECORD CLEANING MACHINE 1 OWNER	BOXED	£249
JORMA SUPER POWER/BYBEE POWER CORDS 1.5 METRE 2 OFF	EACH	£595
BEN DUNCAN PURE POWER 1KW P-100 POWER TRANSFORMER 1 OWNER	EXCLT	£375
MUSICAL FIDELITY X-CANS V3	MINT/BOXED	£195
BLACK RHODIUM 1.2 METRE POWER CORDS	NOS	£99
TEAC V-5000 REMOTE CASSETTE DECK 1 OWNER	EXCLT/BOXED	£195
LARGE NO. OF POWER CORDS FROM RUSS ANDREWS/TC/COINCIDENT/ VAN DEN HUL/CHORD /RINGMAT/PS AUDIO/BLACK RHODIUM ETC	PLEASE	RING

INTERCONNECT

VAN DEN HUL MC D 501 SILVER HYBRID TONEARM CABLE (SME V ETC)	EXCLT	£195
TOWNSEND DCT RCA 1 METRE PAIR	DIS/DEM	£250
HOVLAND PINCUS G3 2 METRE PAIR XLR	DIS/DEM	£275
ABBEY ROAD REFERENCE 1.5 METRE PAIR EICHMAN PLUGS	DIS DEM	£375
ABBEY ROAD REFERENCE 1.5 METRE PAIR EICHMAN PLUGS	DIS DEM	£375
ABBEY ROAD REFERENCE 1 METRE PAIR EICHMAN PLUGS	DIS/DEM	£345
ABBEY ROAD INTERCONNECT 1 METRE RCA PAIR	DIS/DEM	£199
MADRIGAL CZ GEL 1 METRE XLR PAIR	DIS/DEM	£249
AVID SCT STANDARD BLUE 1 METRE RCA	NEW/BOXED	£249
CHORD INDIGO 1 METRE RCA 2 PAIRS BELIEVED UNUSED MINT	EACH PAIR	£399
MANY MORE INTERCONNECT CABLES IN STOCK AND ON WEB SITE		

LOUDSPEAKER CABLE

ABBEY ROAD REFERENCE 5 METRE PAIR	DIS/DEM	£599
HOVLAND NINE LINE 4 METRE BI-WIRE PAIR	DIS DEM	£450
HOVLAND NINE LINE 2.5 METRE BI WIRE PAIR	DIS/DEM	£350A
GOERTZ M12 VERACITY SILVER SPADES 7.5 METRE PAIR BOXED	DIS DEM	£450
TRANSPARENT MUSIC WAVE BI WIRE 7.5 PAIR!!	VGC	£575
MIT MH-750 8 METRE PAIR!!	EXCLT	£1195
BLACK RHOD. POLAR. NINJA DCT ++2.9M, PAIR (£1500.00)	DEM	£650
XLO 5.2 SIGNATURE-1 4FT PAIR	DEM	£450
XLO REF.2.5 METRE PAIR (SPADES)	EXCLT	£350
MANY MORE LOUDSPEAKER CABLES IN STOCK AND ON WEB SITE		

CLEARANCE ITEMS

TECHNICS A-800 MK2 REMOTE INTEGRATED	VGC	£99
TECHNICS ST-GT650 TUNER	VGC	£69
TECHNICS ST-550 TUNER	VGC	£49
JVC 1010 K2 DIGITAL REMOTE DIGITAL AMP	GC	£175
SONY SY-SE500 TUNER	GC	£30
DENONPMA 900V INTEGRATED AMP	GC	£99
PIONEER PDS-702 LEGATO LINK CD PLAYER	VGC	£99
MICROMEGA STAGE 2	MINTY	£149
SANSUI SC-2110 CASSETTE DECK	GC	£75
REVOX A-77	RING	£175
ROTEL RB-950BX AM/FM TUNER	EXCLT	£99
ROTEL RT-870L LW/MW/FM STEREO	EXCLT	£75

Rack no Roll

A vinyl support system that also aims to remove noise from the hi-fi chain, Paul Rigby reviews Blue Horizon's Professional Rack System.

Arguably, the best shelving mount for any turntable is a wall shelf as it is isolated from unstable flooring. Sometimes, wall shelves are not a possible option, though. Hence, any alternative turntable shelving system has to be stable and must remove invasive noise.

The Professional Rack System (PRS) hopes to do that very thing. It features a bespoke triple layer bamboo laminate, with the grain running in opposing directions and the central lamination running vertically. The idea here is to prevent standing waves forming.

The PRS rack modules can be configured into many shapes and sizes: single height: 600 x 450 x 30mm, and double height 1140 x 450 x 30mm. In addition, when funds allow, you can upgrade the basic system by adding component shelves and steel spike isolation between tiers as well as the accompanying Sanctum isolating platforms. If you already own a rack, you can add the Sanctum isolation shelves under individual audio electronics.

A cable management system keeps loose wire under control and allows signal and power cable to be kept separated too.

On my Avid Acutus turntable I played David Gray's album, 'White Ladder' and the track 'Please Forgive Me', recorded at a relatively low volume and featuring voice, piano and acoustic guitar but also, in parts, a dynamic and high-energy series of percussive beats adding to the sonic

variety.

Ordinarily, at high volumes and during crescendos, Gray's voice could sound a little pinched in the upper mids leading to listening fatigue. Using the PRS, that threat was lowered considerably.

Adding the Sanctum platform to the shelf, noise dropped further, adding a slight reverb shimmer to the lead vocal for the first time



and a deep, bass echo effect to the drums. In fact, the bass of the drums dominated the rear of the central stereo image. The contrast between that and the light synth runs were markedly greater.

I then added the upgraded, top-of-the-range spiked parts to the legs, separating the single, long leg look into sections, separated by those spikes to give the system a separate tiered effect. I played ex-Genesis man Anthony Phillips' 'Sides' and the track 'Um & Aargh'. The result? The soundstage was enormous! The amount of air and space infused throughout all dimensions was significant in the overall sonic improvement.

Playing the finger picking guitar of Leo Kottke and



'Morning is the Long Way Home' from 'Ice Water', the guitar was no longer a chaotic mess of strings but an instrument where the strings flew in precise formation, adding a beguiling lyricism. Meanwhile Kottke's Johnny Cash-like vocal offered a bass clarity that provided a strong central focus to the pacy rhythms of the track.

CONCLUSION

For each upgrade, the sound enhancements were quite startling in terms of the decrease in noise, increased accuracy and clarity afforded to the music. The improvements are not subtle, by any means, showing just how important is the tackling of the many flavours of noise. A top quality shelving system is critical in that endeavour. The PRS shelving system is certainly that.

TYPICAL PRICES:

Three shelf rack, bamboo: £1,605
 Three shelf rack, bamboo with Sanctum equipment support shelves: £2,352
 Three shelf rack, available in bamboo with Sanctum equipment support shelves & spike isolation: £2,742

(A new 30mm, matt finish MDF shelf version, £990. Also available in Cherry, Walnut or Maple, prices on application.)

BLUE HORIZON PROFESSIONAL RACK SYSTEM



OUTSTANDING - amongst the best.

VERDICT

Simple to put together, sturdy and easy to use, the PRS shelving offers a valuable sonic upgrade.

FOR

- simple assembly
- build quality
- lowers noise
- adds clarity

AGAINST

- nothing

Blue Horizon
 +44 (0)118 981 4238
www.soundfoundations.co.uk

HI-FI WORLD

NOW AVAILABLE
ON THE APP STORE

The screenshot displays the Hi-Fi World app interface. At the top, there's a navigation bar with options like Music, Films, TV Programmes, App Store, Books, Podcasts, and iTunes U. Below this, the app is identified as 'Hi-Fi World' by 'audio web publishing ltd'. The main content area features a large image of the magazine cover for March 2014, Volume 28, No. 1. The cover highlights 'ACOUSTIC ENERGY AE109 loudspeakers' and includes a 'FREE READER CLASSIFIED ADS IN THIS ISSUE!' banner. To the right of the cover is a 'contents' page listing various articles and their page numbers, such as 'LOUDSPEAKERS', 'DIGITAL', 'VINYL', and 'HIFI NEWS'. Below the magazine preview, there's a 'Description' section stating that the app brings the best hi-fi news from around the world, and an 'Information' section providing details like the developer (audio web publishing ltd), category (Entertainment), and version (1.0).

**DOWNLOAD OUR APP ON APPLE AND ANDROID
DOWNLOAD FROM iTUNES OR GOOGLE PLAY**

iPad, iPhone, iPod, Tablets OUT NOW!

Total State Machine

Paul Rigby delves into an intriguing book on the history of Test Dept - a band which mixes music with politics.

Total State Machine
Authors: Graham Cunnington, Angus Farquhar & Paul Jamrozy
Price: £40

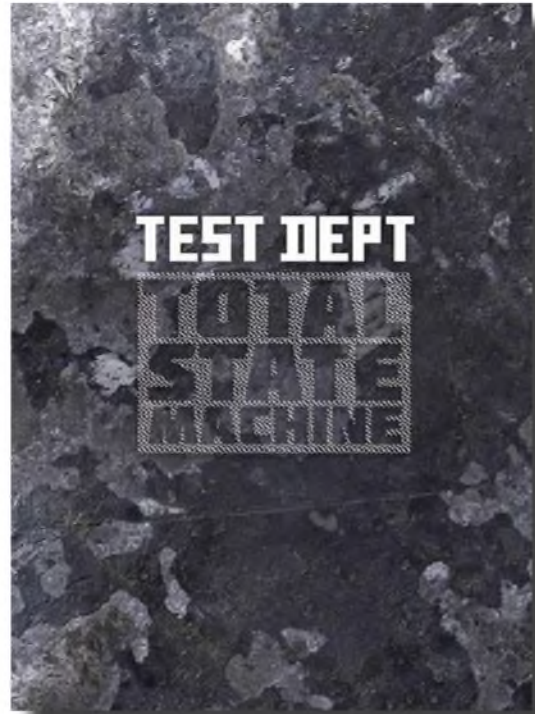

Formed in 1982 in London, an industrial/electronic outfit while playing large multimedia events at obscure venues, Test Dept met politics head on: apartheid, neo-Nazism and Britain's Criminal Justice Act were just three areas that they targeted, for example.

This sumptuous book combines text, photographs of memorabilia and photo-art while telling the full story of the band through reviews, live concert reports and images, historical notes and more.

As a unit, Test Dept appear to be a UK version of Slovenia's Laibach (with whom they have collaborated) in their use of art, symbolism and the decision to play at unusual venues while also keen to use all forms of media to get a message across.

This book is intriguing because it not only talks about the band but also our changing society. This is not just a book about a band, it's a piece of social history.

Test Dept have been active in activism, as it were, and all are detailed here. They played in front of Polish workers at the time of the political Communist upheavals in the 80s, tried and failed to perform in Czechoslovakia because of fears of an official backlash, caused ructions in Hungary and had a file opened on them in East Germany by the Stasi,

the then national security police.

And then there's been the confrontations with the UK police during gigs in support of the likes of the News International print workers at The Siege of Wapping in London.

It's sometimes difficult to reconcile a band who engage with both political activism and their own, inherent, commercial interests. Personally, I applaud any artist who uses their art to open the eyes of the public. I wish there were more people who engaged with life as directly as Test Dept.

If you were to be cynical, you could accuse Test Dept, like others of their ilk, of exploiting tragedies for their own commercial ends. Exploiting the oppressed but from a different direction.

But, you know, it was ever thus. It's a bit like John Lennon extolling the Working Class Hero and then retiring to his Rolls Royce to disappear to his mansion or penthouse suite.

There will always be an uneasy element to our musical heroes (unless you're someone like Muddy Waters or Woody Guthrie, I suppose. Hell, even George Formby has more working class hero street cred than John Lennon, when you come to think about it).

So bear this in mind when you read this book. The blurb likes to

insinuate that Test Dept were a missing link to the riots, the urban outcry and the Thatcher backlash of the 80s and 90s.

The frame of the book gives them almost an inflated sense of revolutionary importance, as if they were almost one step ahead of MI6. I would suggest that line is taken more by the publishers than by the band itself.

See Test Dept as ordinary people...jobbing artists who draw your eye to what's important, who point a finger at the important issues, who shout at you to stop ignoring the pain and the hurt that's going on all around us and to stop being so bloody smug, comfortable and apathetic. It's a good message. It's a very good book.

The additional hardback copy of the book is limited to 250 copies and comes with a set of extra items including two posters.

You also get a DVD of archive Test Dept film and video and a live recording produced on CD with unique cover art.

These items will only be available with this edition of the book. Price is £80 from www.pc-press.co.uk.

IAN HARRISON HI-FI SALE!

HI-FI AT DISCOUNT PRICES. FREE NATIONWIDE DELIVERY

Email: ian.harrison@mercian.myzen.co.uk

SPECIAL OFFERS!! NEW YEAR SALE! UP TO 40% OFF!!

CARTRIDGES UP TO 30% OFF PHONO STAGES UP TO 25% OFF TURNTABLES & TONEARMS UP TO 25% OFF CABLES UP TO 40% OFF

VAN DEN HUL MC10S £825, ORTOFON CADENZA BLUE £950,
AUDIO TECHNICA AT-ART7 £765, AT-ART9 £715, AT33SA £545, ATF7 £135

TONEARMS

AMG
CARTRIDGE MAN
GRAHAM
HELIUS
MICHELL
MOERCH
MOTH
ORIGIN LIVE
ORTOFON
PRO-JECT
REED
REGA
ROKSAN
SUMIKO

HEADPHONE AMPS

CREEK
FIDELITY AUDIO
GRAHAM SLEE
ICON AUDIO
LEHMANN
PRO-JECT
SUGDEN

AMPLIFIERS

CREEK
EAR/YOSHINO
ICON AUDIO
SUGDEN
TOM EVANS
VALVET

ACCESSORIES

DIGITAL STYLUS GAUGES, RECORD CLEANING MACHINES, CLEANERS, AUDIO CASSETTES

CARTRIDGES

AIR TIGHT
AUDIO TECHNICA
BENZ MICRO
CARTRIDGE MAN
DECCA LONDON
EMT
GOLDRING
GRADO
HANA
IKEDA
KOETSU
MY SONIC
NAGAOKA
ORTOFON
SOUND SMITH
TECHDAS
VAN DEN HUL
ZYX

SPEAKERS

ACAPPELLA
CABASSE
EPOS
HARBETH
ICON AUDIO
OPERA AUDIO
Q. ACOUSTICS
TAYLOR ACOUSTICS

CD PLAYERS

CREEK
EAR/YOSHINO
ICON AUDIO
SUGDEN

PHONO STAGES

EAR YOSHINO
GRAHAM SLEE
ICON AUDIO
LEHMANN
MUSICAL
SURROUNDINGS
PARASOUND
PRO-JECT
PURE SOUND
ROTHWELL
TOM EVANS
TRICHORD
WHEAT AUDIO

CABLES

BLACK RHODIUM
IXOS
KUBALA-SOSNA
PEERLESS
PRO-JECT
QED
SUPRA
TRANSPARENT
WIREWORLD
ZENSATI

RECORD CLEANING

PROJECT
MOTH

WIRELESS

BLUESOUND

TURNTABLES

ACOUSTIC SIGNATURE
ACOUSTIC SOLID
AMAZON AUDIO
INSPIRE
LUXMAN
MICHELL
MUSIC HALL
PRO-JECT
REED
ROKSAN
SRM TECH
T+A
THORENS

HI-FI FURNITURE

ALPHASON
ATACAMA
CUSTOM DESIGN
HI-FI RACKS
MUMARI
MUSIC TOOLS
NORSTONE
QUADRASPIRE
SOUNDSTYLE
TRACK AUDIO

HEADPHONES

AUDIO TECHNICA
BEYER
ERGO
GRADO
PSB
SENNHEISER

* PHONE FOR TERMS. PLEASE PHONE TO CONFIRM PRICE & AVAILABILITY PRIOR TO ORDERING. ALL GOODS ARE BRAND NEW & BOXED WITH FULL U.K. GUARANTEES. NO EX. DEM OR EX DISPLAY GOODS. NO GREY IMPORTS. GOODS ARE NOT SUPPLIED ON APPROVAL. SORRY, NO GENERAL CATALOGUES. PLEASE PHONE OR WRITE FOR SPECIFIC REVIEWS, BROCHURES OR PRICES. SUPPLIER OF HI-FI PRODUCTS & ACCESSORIES SINCE 1986 MAIL ORDER ONLY FROM: IAN HARRISON, 7 MILL HILL, REPTON, DERBY, DE65 6GQ. **TEL: 01283 702875. 9am - 9pm INCLUDING SUNDAYS.**

studio **AV**

SEE, HEAR AND FEEL
THE DIFFERENCE

HI-FI | DEMO LOUNGE | ELITE BRANDS
EXCEPTIONAL PERFORMANCE

Come and see us in the
T+A room at the
Hi-Fi Show Live
in Windsor on
21-22 October.

Coming Up:
11th November
T+A & Melco event at
studioAV. Call or email
to register your interest



WWW.STUDIOAV.CO.UK

01753 863300 sales@studioav.co.uk

rock hifi

...Stands for excellence



Cosmic Black

White Quartz

Star Galaxy

Granite is the ideal material for a loudspeaker stand. Heavyweight, stable and luxurious-looking you will find no better foundation for your sound. All stands are hand-made in Wales from local material.

For sizes, colours and bespoke editions contact:

E: martin@rockhifisupport.co.uk T: 01267 236110 M: 07930523854

criterion audio



Criterion Audio is a premium hi-fi dealer in Cambridge. From vinyl and valves to the latest in streaming and headphones, we can help you find the perfect audio system to suit your budget and needs. Call us on 01223 233730 to arrange a demo.

Criterion House, Oakington Road, Cambridge CB3 0QH
www.criterionaudio.com info@criterionaudio.com

free reader Classifieds

TERMS AND CONDITIONS: Only one advert per reader. No Trade adverts. This section is strictly for readers selling secondhand hi-fi equipment only. Maximum length per advert is 30 words, Adverts over 30 words will not be accepted. Telephone numbers and E-mail addresses are treated as one word. Model numbers are treated as one word i.e. Quad 303 = two words. Email your advert to: classifieds@hi-fiworld.co.uk or fill in the form on page 97 and post it to Hi-Fi World Free Readers Ads, Studio 204, Buspace Studio, Conlan Street, Notting Hill, London W10 5AP. Sorry, we cannot accept adverts over the telephone. The Publisher reserves the right to judge submissions.

WELL TEMPERED Classic turntable, £1500. Audio Research SP8 (Mullards) £1200. Edison Twelve (Mullards) £550. Rehdeko RK125's, Domo stands £1800 (part exchange RK115's. Leak Troughline mono, mint. Reasonable offers. Tel: 0113 255 9475

FREE FOR Collection: Large number of Hi-Fi magazines. QED DiscMaster MM phono stage, battery/mains, £40. Quad 405/2 power amplifier, £250. Bang & Olufsen DVD1 DVD player, £40. Tel: 01708 457 691

SUGDEN MASTERCLASS power amplifier, preamp, CD player. Isotek PowerBlock. All boxed. Stand. Connects. Quality floorstanding speakers. All as new. £12,000 plus new. £1000. Tel: 01772 685 972 or 07599 556 853 (Preston, Lancs)

JVC KD-720 cassette deck, good working order, £25. Marantz PM7001 amplifier, boxed, £150. Marantz ST7001 DAB/FM tuner, boxed, £125. B&W AS2 Subwoofer, boxed, £125. Free Hi-Fi magazines, collect. Tel: 01708 457 691

McINTOSH MC500 monoblocks. McIntosh C2300 tube pre-amp. McIntosh MCD500 SACD/CD. Talon Firebird speaker, Diamond Tweeters. To sell as complete system. £15,000 ono Tel: 020 7700 5010

QUAD 606 Power Amplifier £595. Quad 66 Preamplifier with control panel £385 Both boxed, manuals, cables, mint, light domestic use Tel: 07415652983 Dereham, Norfolk

HI FI ENTHUSIAST. Requires a reprint or copy of the Sugden audio tuner DTFM. Can anyone in the hi fi arena help to track one of these manuals Sugden Audio no longer available on their database Many thanks. Keith. 07919061178. keijab@googlemail.com

WANTED IN perfect condition murphy A894SR radiogram cash waiting within reason ps this model only from 1970/71. Tel: 07543454828

M J ACOUSTICS reference 100 mk2 subwoofer immaculate Black. Remote control 4 user presets Amplifier power 120 Watts Cost £600 Sell £275 Telephone 01243528010

PMC TWENTY.21 speakers immaculate Oak ATL Advanced Transmission line Stunning sound quality for size Cost £1485 Sell £795 Telephone 01243528010 West Sussex

NAIM NAT 02 Stereo FM tuner. Immaculate. Boxed. Receipt. Can Post UK. Pictures available. I bought this item in 2012 and it has remained boxed and unused since because I moved and do not have anywhere to fit an aerial for it. Offers. E midlands. 07783 327 689, spinkray.rs@gmail.com

JBL L-88, speakers, walnut, recently serviced (receipt). Thorens TD125 MK2. SME 3009 S2 Improved arm, both Very good condition. Contact for pics, can demo, collection only. Offers invited. Email: garyrobinson20@btinternet.com or Tel: 07564688217 Essex

CANADIAN GUTWIRE Synchrony 3 metre length speaker cables. Superb - totally new condition. £700. (Synchrony Interconnects available separately). Email: stephen.adolphus@gmail.com. Tel: 07787 574784.

SOUND ORGANISATION silver metal Hi-Fi/AV rack on castors, WDH 90x40x62cm with three tinted glass shelves, £60. Collection only. Email for photos to: travida172@gmail.com, or phone Ken, 01323 500174 (Eastbourne)

EDWARDS AUDIO TTISE turntable red. No arm. Cut for Jelco arm. Purchased Oct. 17. Boxed excellent condition. £165 ono. Gary 0794 1331670 Tonbridge collection

QUAD ESL57 speakers bronze. One Thing Standard Service. Good condition and sound. Boxes. £250 ono. Cash and collect. Near Witney, Oxon. Email: keithtoft@gmail.com 01993 882353.

REVOX A77 service manual £30, Leak Delta 30 £10, HFW KLS 1 to 11 (pt1) articles £10. All plus p&p. Contact Tom at info@oakfieldonline.com HFW03 in mail subject please.

SPEAKER STANDS White Marble bespoke. Built by a monumental mason. 470mm high 355mm deep 270mm wide. 27.4 Kg. £5. Collect. E Midlands. Pictures available. Changed speakers to a smaller model 07783 327 689 or Email: spinkray.rs@gmail.com

AUDIO PHYSIC Cardeas Plus walnut. 10yr. Warranty 9mth old £22,500 Boxes Manual Castor Spikes 46.9" 12" 23.4" 55kG 300W 4 Ohm 25 - 40k £10,000 + Carriage Tel: 01661 823606 Email: grant.darras@gmail.com

'STENTORIAN' WHITELEY Electrical Radio Co. Ltd., upright mahogany cabinet (29x19x19ins). For Leak TL series valve amps., preamp, "Troughline" tuner and Garrard or BSR deck. Collectors item. Good condition. £55 01242 582169 john.marino@btinternet.com

NAIM FLATCAP. Great condition. Little used. Serial no. 123416. £90. 07785 724849. (South Oxfordshire).

SONUS FABER Concerto loudspeakers & stands (VGC boxed) £750; Klipsch KG4.5 loudspeakers VGC £250; Pair Leak TL10 amps for restoration £500 dougalhare63@gmail.com 01584 831861 (Shropshire)

WELL TEMPERED Classic turntable, £1500. Audio Research SP8 (Mullards) £1200. Edison Twelve (Mullards) £550. Rehdeko RK125's, Domo stands £1800 (part exchange RK115's. Leak Troughline mono, mint. Reasonable offers. Tel: 0113 255 9475

PROJECT RPM 5 Carbon Red turntable. Project Ds phono stage Ortofon 2m Bronze cartridge £1400 For £950 New Record Clean System £50. Tel: 01661 823606 Email: grant.darras@gmail.com

NEXT MONTH

APRIL 2018 ISSUE



QUADRAL RODAN 9 LOUDSPEAKERS

The new Rodan 9 loudspeakers from Quadral, Germany, offer high-end quality in a compact floorstanding package. At top sits an aluminium ribbon tweeter for smooth but incisive and detailed highs. Below is an Altima midrange unit, with composite aluminium/titanium/magnesium membrane cone for a clear mid-range, and below are twin Altima bass units. Here's a modern high technology loudspeaker that we'll be reviewing, with revealing measurement, in our next great April 2018 issue. Don't miss it.

Also, we hope to bring you –
ELECTROCOMPANIET EC1 6DX AMP/STREAMER
UNICO 90 AMPLIFIER
JAMO D54 BLUETOOTH 'SPEAKERS
ATLAS ELEMENT SUPERIOR INTERCONNECT
LONGDOG AUDIO P6 MONOBLOCK AMP X2
SOTM SMS-200 ULTRA MINI NETWORK PLAYER
PRIMA LUNA DIALOGUE PREMIUM HP POWER AMPLIFIER
PRIMA LUNA DIALOGUE PREMIUM PRE AMPLIFIER
...and much more.

This is a selection of what we hope to bring you, not a complete list. We regret that due to a wide range of issues, we cannot guarantee that all products listed above will appear.

**PICK UP THE APRIL 2018 ISSUE OF HI-FI WORLD ON SALE FEBRUARY 28TH 2018,
OR SUBSCRIBE AND GET IT DELIVERED TO YOUR DOOR: SEE PAGE 54**

FREE READER CLASSIFIED ADS ORDER FORM

STOP PRESS

ADVERTISERS INDEX

Absolute Sounds	OBC
AstinTrew	72
Audio T	70
B&W	36
Billy Vee	88
Black Rhodium	64
Criterion Audio	94
Devialet	IBC
Divine Audio	88
Electromod	68
Elite Audio	58
EnjoyTheMusic.com	72
Exposure	38
Focal	42
Heathcote Audio	90
Henley Designs	22,52
Ian Harrison	94
Icon Audio	50
Infidelity	88
Jordan Acoustics	26,27
Malvern Audio	16
MarkAudio	14
Naim	34
NuNu Distribution	66
Origin Live	86
PMC	18
Rock Hi-Fi	94
SCV Distribution	12
Select Audio	20
Sound Damped Steel	86
Sound Hi-Fi	68
Spendor	24
Studio AV	94
Tellurium Q	6
The Audio Barn	88
The Chord Company	IFC

TERMS AND CONDITIONS: Only one advert per reader. Maximum length per advert is 30 words, Adverts over 30 words will not be accepted. No Trade Adverts. This section is strictly for readers selling secondhand hi-fi equipment only. Telephone numbers and E-mail addresses are treated as one word. Model numbers are treated as one word i.e. Quad 303 = two words. Sorry, we cannot accept adverts over the telephone. The Publisher reserves the right to judge submissions.

You can email your advert to us at: classifieds@hi-fiworld.co.uk or write or type your advertisement copy in block capitals with one word per box and post it to us at:

Hi-Fi World Free Readers Ads,
Studio 204,
Buspace Studio,
Conlan Street,
London W10 5AP

We cannot accept adverts over the telephone

1	2
3	4
5	6
7	8
9	10
11	12
13	14
15	16
17	18
19	20
21	22
23	24
25	26
27	28
29	30

Name: _____

Address: _____

Post Code: _____

Daytime Tel: _____

FREE READER CLASSIFIED ADVERTS COPY DEADLINES

APRIL 2018 - 6TH FEBRUARY

MAY 2018 - 6TH MARCH

THE EAGLES

HOTEL CALIFORNIA

1976



"It's a nailed-on classic LP, taking the band away from the country flavours of yore and towards the rock genre as the sound grew in size and power"

There are plenty of hated famous bands out there. Sometimes I wonder if some people hate the success. Then again, maybe it's the constant replays of certain songs that build up, over time, as a sort of resentment from some. It's happened to The Beatles, U2, Oasis and other successful acts. Then again, maybe that's the compliment. When a band gets to the stage that it's seeped so far into the public consciousness that certain music fans just can't take yet another replay of those famous songs.. maybe that's when you've really made it.

The Eagles has been in this position a lot. Criticism has been aimed at them saying that they are not rough around the edges as many people think they should be - but that there's an almost offensive slick aura about them.

"Critics lose their leverage all of a sudden when something gets mass acceptance" said band member Glenn Frey in 1992. "They're no longer arbiters of taste". Maybe the success and the negative connotations got to the band, though, because they began to fall apart after this LP hit the shelves.

Which is a shame because it's a nailed-on classic LP, taking the band away from the country flavours of yore and more towards the rock genre as the sound grew in size and power with Don Henley involved in a more active part of the proceedings both in terms of writing as well as singing.

The LP itself touched on the darker side of life at that time including success and excess as well as flat out despair regarding American life in general.

Oh and that famous dual guitar solo on the title track? Don Henley talked to Rolling Stone about that one and revealed, "Don (Felder) and Joe (Walsh) sat down and worked on those solos for days. Then [producer] Bill Szymczyk and I did some editing on those solos. Then they relearned the parts after we edited them together. They'll be pissed at me for saying this [laughs] but that wasn't them just sitting down and spontaneously playing it in one take. That was weeks of work to get there".

But what was the song about? Glenn Frey had this to say to NBC, "All of our songs were cinematic, but we wanted to open up with [a

montage] It was just one shot to the next - a picture of a guy on the highway, a picture of the hotel, the guy walks in, the door opens, strange people. We take this guy and make him like a character in *The Magus*, where every time he walks through a door, there's a new version of reality. We decided to create something strange, just to see if we could do it. And then a lot was read into it - a lot more than probably exists. I think we achieved perfect ambiguity".

Fans of this album might be interested to know that there is a luxury boxed edition of it now out as a digital collection on CD and Blu-ray. 'Hotel California: 40th Anniversary Deluxe Edition' contains two CDs plus one Blu-ray Audio disc that includes remastered sound and ten previously unreleased live recordings, as well as hi-res stereo and 5.1 mixes.

Presented in an 11" x 11" hardbound book, the set also features rare and unseen photos from the era, a replica tour book and an 11" x 22" poster. Both a 2CD Expanded Edition and single CD will also be available, along with digital download and streaming versions.

The ten live tracks (which Henley has been reported to like a lot because of their "gritty" nature) were recorded during the band's three-night stand at the Los Angeles Forum in October 1976.

The concert recordings – which were recorded about a month before the album came out – feature one of the first ever live performances of 'Hotel California' and 'New Kid In Town' along with other Eagles classics including 'Already Gone', 'Take It To the Limit' and 'Witchy Woman'.

The Blu-ray Audio disc that accompanies 'Hotel California: 40th Anniversary Deluxe Edition' features the 5.1 Surround Sound mix originally released on DVD-A in 2001 along with a hi-resolution, 24bit/192kHz stereo mix.

The CD mastering from this set is excellent. It is detailed and shows admirable insight for a silver disc. Hence, subtle sounds such as the previously shy secondary percussion is easily picked out by the ear.

Overall it is a classic album that bears listening to again and again to enjoy its full value. **PR**

E X P E R T **PRO**

AUDIOPHILE EVOLUTIVE SYSTEM

1000 **PRO**

BEST MEASURED PERFORMANCES
AT ALL POWER LEVELS



0.00025% · 1000W · 6Ω
THD+N (harmonic distortion + noise)

0.0001% · 10W · 6Ω
THD (harmonic distortion)

0.001Ω
Output impedance

133 dB
Signal-to-noise ratio

Inventors of the world's best amplification technology - ADH® - we are constantly working towards the ultimate perfection: zero distortion. In this passionate quest, we thoroughly reviewed the electronics of our systems to develop the new Expert Pro line.

DEVIALET

INGÉNIERIE ACOUSTIQUE DE FRANCE

"...delivers the clearest sound with finest detail imaginable."

- Noel Keywood - HiFi World - July 2016

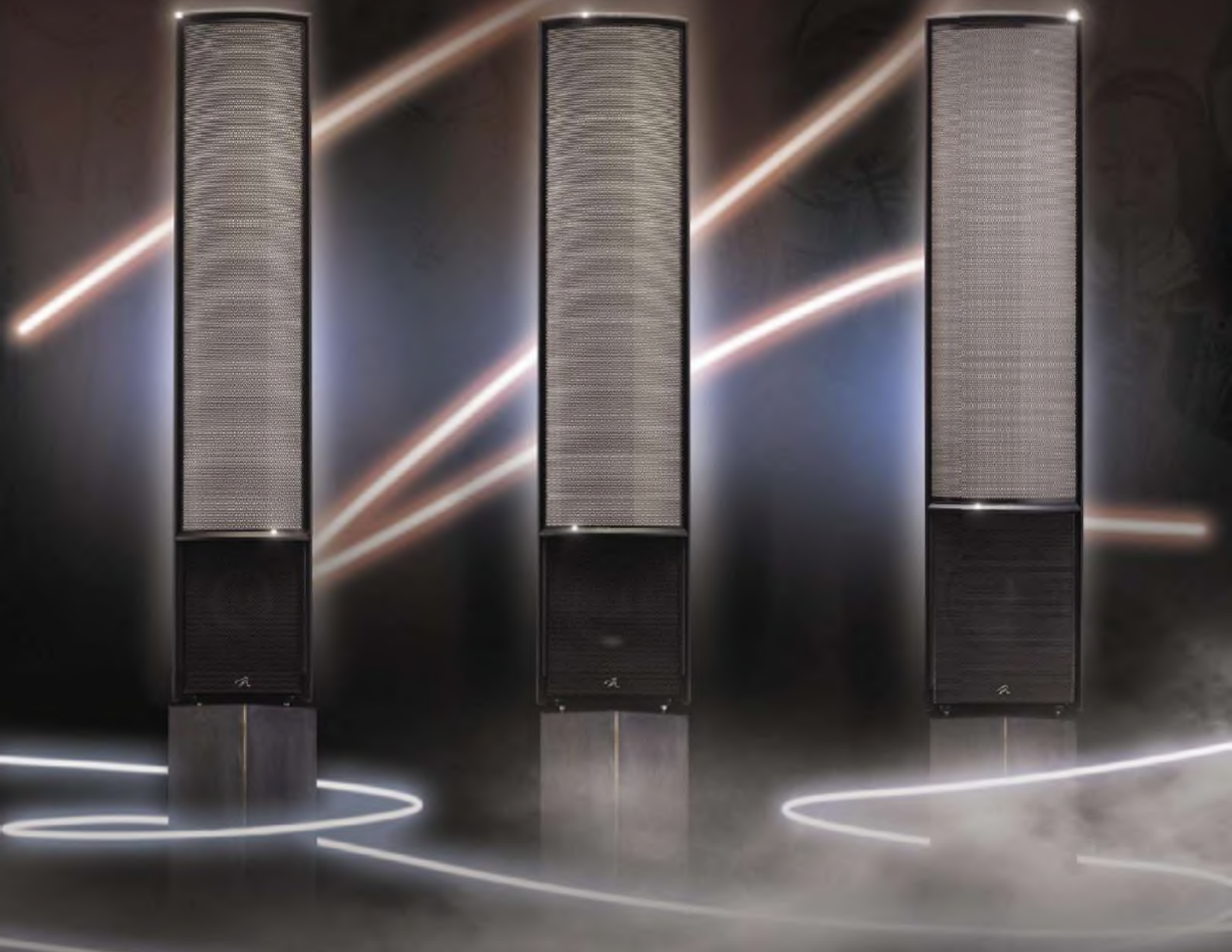

IMPRESSION. EXPRESSION. RENAISSANCE.

THE NEW MASTERPIECE SERIES FROM MARTIN LOGAN

 **absolute sounds** Ltd.

International Distributors & Consultants of Specialised Hi-End Audio & Video Systems

58 Durham Road, London, SW20 0TW T: +44 (0)20 89 71 39 09

W: www.absolutesounds.com E: info@absolutesounds.com

For Your Nearest Dealer Please Visit The [Absolute Sounds](http://www.absolutesounds.com) Website

