

HI-FI WORLD

JULY 2017

UK £4.50

www.hi-fiworld.co.uk

FREE READER CLASSIFIED ADS IN THIS ISSUE!



QUADRAL RUBIN *EXCLUSIVE!*
loudspeakers



MELCO N1A MK2 *EXCLUSIVE!*
music storage drive



OPPO HA-2 SE
headphone amplifier



ROHDE & SCHWARZ
MEASUREMENT

McINTOSH MP1100

phonostage

COMPETITION
WIN A PAIR OF
QUADRAL CHROMIUM
STYLE 8
LOUDSPEAKERS
WORTH £1750!
(UK ONLY)





POLK SIGNATURE S15 BOOKSHELF LOUDSPEAKER *EXCLUSIVE!*
YAMAHA WXAD-10 MUSIC STREAMER
iFi iOne Nano Bluetooth USB DAC
DIGITAL STREAMING FEATURE

JULY 2017

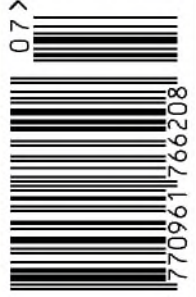

07 >

9 770961 766208

7 PAGES OF LETTERS - THE BEST WINS A PAIR OF QUADRAL ARGENTUM 520 LOUDSPEAKERS! (UK ONLY)





"If you have a good system and want to give it a boost these may just be the most cost-effective way to do that"

Chord Shawline Range
Hi-Fi World October 2016



"The Shawlines are really top-class interconnects... Give them an audition and hear for yourself"

OUR VERDICT
★★★★★

Chord Shawline Analogue
Hi-Fi Choice July 2016

THE CHORD COMPANY
Shawline
ANALOGUE
THE CHORD COMPANY
Shawline
ANALOGUE

chord.c

ch

Connect with us

Designed and hand built in England by music lovers since 1985. Enjoyed by music lovers all over the world.

The Chord Company Ltd, Millsway Centre,
Amesbury SP4 7RX, UK

To get more information and find your nearest retailer, please call us on:
+44 (0)1980 625700 or visit:

www.chord.co.uk

THE
CHORDTM
COMPANY



welcome

EDITOR

Noel Keywood
e-mail: editorial@hi-fiworld.co.uk

DESIGN EDITOR

Faiza Chunara
tel: +44 (0) 20 8206 6018
e-mail: adproduction@hi-fiworld.co.uk

PRODUCTION EDITOR

David Noble
tel: +44 (0) 20 8206 6019
e-mail: classfieds@hi-fiworld.co.uk

SALES MANAGER

Louise Palfrey
mob: +44 (0) 7917 047 548
e-mail: louise@hi-fiworld.co.uk

ADVERTISING EXECUTIVE

Joanna Holmes
mob: +44 (0) 7958 602347
e-mail: joanna@hi-fiworld.co.uk

PUBLISHER

Noel Keywood
e-mail: publisher@hi-fiworld.co.uk

FREE READERS CLASSIFIEDS

tel: +44 (0) 20 8 206 6019
e-mail: classfieds@hi-fiworld.co.uk

SUBSCRIPTIONS

tel: +44 (0) 1442 820 580
fax: +44 (0) 1442 827 912
e-mail: hifiworld@webscribe.co.uk

PHOTOGRAPHY

David Noble
tel: +44 (0) 20 8206 6019

WRITERS

Paul Rigby, Jon Myles, Martin Pipe



From 2003 and Martin Pipe's look at an early streamer – Yamaha's MCX-1000 on p51 – we move on to streaming today in 2017 and – well – Yamaha again with the WXAD-10 reviewed on p63. We aren't trying to promote Yamaha over others here, so much as show how far and how fast this whole streaming thing has come in the last 14 years.

And as streaming gets ever more popular the competition for your pound heats up: I've just received a press release for the first hi-res streaming service: from French music provider Qobuz.

To date, Tidal has been the provider of choice for those who want to listen to full CD quality files over the internet. They run at a higher data rate (1.4Mbps) than those from most streaming services, who use lossy – as in loss of quality – compressed files, Tidal potentially offering better quality, if not by much. The reason is old 16bit digital (CD) had limited resolution in the first place; distortion and noise lurk in the background.

You have to go to 24bit to eradicate these evils – and even lossy compressed 24bit (AIFF) is better than 16bit I have found. Qobuz are now offering 24bit files losslessly compressed by FLAC (free lossless audio codec) for streaming. Until now you had to download to get hi-res digital sound; now you can stream it with all the benefits of having access to a vast library of songs. At this point I don't know whether the higher data rates of hi-res digital will cause problems on slow networks, especially wi-fi links; hopefully we will be able to tell you more soon.

If you know little about the benefits of streaming services and streaming itself, we explain all in our feature this month on p54 – in simple, jargon free terms. It's difficult to simplify a complex subject – and digital is getting ever more complex – but I believe beginners will have no difficulty with our carefully written piece.

Over in a parallel world LPs keep spinning, to produce the pure analogue sound that hi-res tries to replicate. And what a world. McIntosh recently released their MP1100 tube equipped hybrid phono stage that pulls out all the stops in terms of complexity. Don't miss our review on p83.

I hope you enjoy our in-depth coverage in this issue of high fidelity's breathtaking technologies. The world doesn't stop.

Noel Keywood
Editor



hi-fi world

Audio Web Publishing
Studio 204,
Buspace Studio,
Conlan Street,
London W10 5AP
www.hi-fiworld.co.uk

verdicts

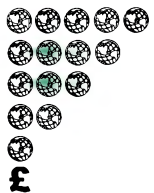

OUTSTANDING

EXCELLENT

GOOD

MEDIOCRE

POOR

VALUE

amongst the best
extremely capable
worth auditioning
unremarkable
flawed
keenly priced

ELECTRONIC MAGAZINE

Go to our website www.hi-fiworld.co.uk to buy an electronic version of this magazine, individual issues, back issues or a subscription.

testing (see www.hi-fiworld.co.uk for full explanations of all our tests)

To ensure the upmost accuracy in our product reviews, *Hi-Fi World* has extremely comprehensive in-house test facilities, and our test equipment - from big names like Rohde & Schwarz and Hewlett Packard - is amongst the most advanced in the world.

Loudspeakers are measured using a calibrated Bruel & Kjaer microphone feeding a Clio-based computer

analyser, using pulsed and gated sinewaves, in a large room to eliminate the room's influence. Pickup arm vibration is measured with a Bruel & Kjaer accelerometer.

No other UK hi-fi magazine has in-house testing, and none has access to such advanced tests across all types of equipment. That's why you can depend on *Hi-Fi World* reviews.

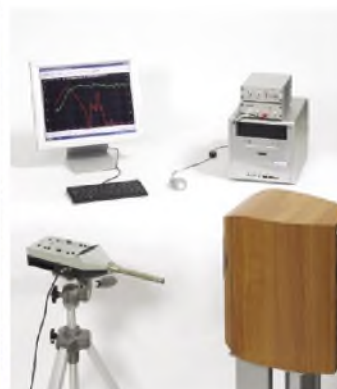

Distributed by Comag Specialist, Tavistock Road, West Drayton, Tavistock Works, UB7 7QX Tel +44 (0) 1895 433662

Printed by Precision Colour Printing Halesfield 1, Stirchley, Telford TF7 4QQ, United Kingdom Tel: +44 (0) 1952 585585

Our Agents in Malaysia Millennium Hi-Fi & AV Simon Chang Showroom & office, 500-1-3 First Floor Wisma Indah (Shen Court), Jalan Tun Razak 50400 Kuala Lumpur, Malaysia
Tel: 603 9283 8171 Fax: 603 9281 3762 e-mail: info@millennium-audio.com

All unsolicited submissions and goods are at the owner's risk. We accept no responsibility for such submissions, nor do we undertake to return them.
No material may be reproduced from this magazine without the publisher's written permission. © Audio Web Publishing Ltd

contents



22

MELCO N1A MK2 NETWORK MUSIC STORAGE DEVICE



15

OPPO HA-2 SE HEADPHONE AMPLIFIER



63

YAMAHA WXAD-10 STREAMER



39

POLK SIGNATURE S1 BOOKSHELF SPEAKER

LOUDSPEAKERS

QUADRAL RUBIN LOUDSPEAKERS 11
Budget floorstanders from Quadral of Germany: Jon Myles listens.

POLK SIGNATURE S15 BOOKSHELF LOUDSPEAKER 39
A new bookshelf speaker from the US reviewed by Jon Myles.

DIGITAL

MELCO N1A MK2 NETWORK MUSIC STORAGE DRIVE 22
Stream from a drive with a difference, like expert Jon Myles.

iFi iONE NANO BLUETOOTH USB/DAC 19
A small desktop DAC impresses Jon Myles.

YAMAHA WXAD-10 STREAMER ADAPTER 63
A budget streamer that everyone can afford, says Jon Myles.

AMPLIFICATION

OPPO HA-2 SE HEADPHONE AMPLIFIER 15
Top quality headphone sound on the move, by Noel Keywood.



83

McINTOSH MP1100 PHONO STAGE

JULY 2017

VOLUME 27 : NO. 5

FEATURES

54 STREAMING FEATURE

Noel Keywood and Jon Myles provide a jargon free guide to streaming.

SOUNDBITES

43 MIXX AUDIO S3 WIRELESS BLUETOOTH SPEAKER AND ALARMCLOCK/RUSS ANDREWS MAINS PURIFIER

Paul Rigby listens to some novel accessories.

91 SLATE SOLID AUDIO SLATE PLATTER MAT/ AIRBOURNE CORK & RUBBER MAT

Noel Keywood and Paul Rigby check out vinyl upgrades.

OLDE WORLDE

51 YAMAHA MCX-1000 MUSIC SERVER

Martin Pipe looks back at streaming in 2003.

VINYL

80 NEWS

All the latest and greatest vinyl releases for you, from the pen of Paul Rigby.

83 McINTOSH MP1100 PHONO STAGE

An exotic phono stage reviewed by Noel Keywood.

89 AUDIOPHILE BOOK

Paul Rigby reads Sgt Peppers, covering the Beatle's classic album.



HEADPHONES

93 NOBLE AUDIO SAGE EARBUDS

Jon Myles listens to hi-tech in-ear phones.

REGULARS

7 NEWS

Words from the world...

21 COMPETITION

Your chance to win a pair of Quadral Chromium Style 8 loudspeakers worth £1750

28 MAIL

Seven pages of your views, wonderful as always...

36 SUBSCRIPTIONS

Ensure your copy every month and save money too!

44 WORLD STANDARDS

Updated guide to the latest and greatest hi-fi hardware on sale

60 AUDIOPHILE CD

Paul Rigby rounds up the latest audiophile CD releases.

74 WORLD CLASSICS

Brilliant designs that have stood the test of time...

67,69,71,73 OPINION

The team get to grips with matters music, hi-fi and life!

90 DIAL-A-DEALER

A comprehensive guide to UK hi-fi retailers

95 CLASSIFIEDS

Second-hand bargains.

96 NEXT MONTH

What we hope to bring you in the next sizzling issue...

97 ADVERTISERS' INDEX

98 CLASSIC CUTS

Bill Wyman's Monkey Grip, 1974, spun by Paul Rigby.

Bowers & Wilkins

Designed for listening

The new CM Series loudspeakers are undoubtedly beautiful, capable of gracing any room with their clean lines and high-quality finishes. But as with all Bowers & Wilkins loudspeakers form must follow function, and thanks to our Decoupled Double Domes and tweeter-on-top technology you won't believe how beautiful your music can sound.

bowers-wilkins.com



Decoupled Double Dome tweeter



email:news@hi-fiworld.co.uk

news

DCS VIVALDI ONE

Digital music experts dCS have announced a limited edition music player to mark their 30th anniversary.

Hi-Fi World was given a sneak preview of the product at the company's Cambridgeshire headquarters recently, ahead of its official launch at the Munich High-End Show.

Named the Vivaldi One it features a CD/SACD transport alongside network streaming facilities to allow music to be played from network attached storage devices or on-line services such as Tidal and Spotify. Apple AirPlay is also built in.

Inside is the latest iteration of dCS's Ring DAC – effectively a digital signal processing computer – which runs PCM up to 24bit/384kHz as well as DSD64 and 128. The DAC is driven by custom-designed software running on Field Programmable Gate Array (FPGA) chips. Designed and hand-built in Britain, the Vivaldi One is limited to 250 pieces and costs £55000 in standard anodised black and silver but other luxury finishes are available – including 24k gold! During our visit to dCS HQ the Vivaldi One was partnered with a pair of Wilson Audio loudspeakers for a listening session – and, not surprisingly, the sound was exceptionally clear and detailed with superb resolution both from CD and streamed high-resolution files. We hope to bring you more soon.



ASTELL&KERN KANN

Based upon the AKM AK4490 DAC, the new Kann supports native DSD playback up to DSD256 with PCM audio playback up to 32bit/382kHz. Its built-in amp offers a normal/high gain switch while the unit is able to offer the lowest output impedance of any Astell&Kern portable high-res audio player: single-ended 3.5mm at 0.65 Ohms plus balanced out 2.5mm at 1.3 Ohms.

With a USB Type-C included for charging and data transfer plus a micro USB for USB audio out and USB DAC, the chassis also holds a dedicated Line Out (2.5mm balanced and 3.5mm single-ended). Storage is handled with 64GB internal flash memory plus support for a micro SD card up to 256GB and full size SD card support up to 512GB. Other features include aptX HD Bluetooth codec support and a touch screen spanning 102mm with a WVGA 800 x 480 resolution. The battery, a 6,200mAh 3.7V Li-Polymer, will last up to fifteen hours. Price is \$999.

For more information go to www.unlimited.com or call 020 8200 8282



SONUS FABER HOMAGE TRADITION

Sonus faber has unveiled its new range of Homage Tradition loudspeakers. The UK launch took place at London's KJ West One hi-fi store in association with exclusive distributor Absolute Sounds. The company says the range has been designed to incorporate the best of Italian design with improvements to sound quality developed after extensive research.

The Tradition series includes two of Sonus faber's Homage loudspeakers - the Guarneri standmount and Amati floorstander – plus a new Serafino model which is a 3.5 way floorstander. They feature design and components trickled down from Sonus faber's flagship Aida, Lilium and II Cremonese models. All the 'speakers feature distinctive lute-shaped cabinets said to help control internal resonances, plus a new bass reflex system named Stealth Ultraflex. This employs an extruded aluminium back panel which acts as the vent while controlling the speed of the airflow to reduce turbulence and hence distortion. The Guarneri also has a pair of dedicated stands constructed from carbon fibre. The largest of the range – the Amati – boasts a 28mm silk-dome tweeter, 150mm mid-range driver and a pair of 220mm woofers each having its own port and chamber. The Serafino has similar mid and treble units but slightly smaller woofers.

Priced at £23500 for the Amati, £18000 for the Serafino and £13600 for the Guarneri (including stands) the new range is available now. For more information go to www.sonusfaber.com



TRI-ART TURNTABLES IN BAMBOO!

The lowest cost of these bamboo designs is the two-speed, belt-driven, Sprout TA-0.5 turntable with levelling legs, featuring a 24-pole synchronous AC motor with bronze collar bearing with steel ball bearing and an aluminium sub platter with steel shaft.

The attached 9", three-ply bamboo laminate arm is soaked in hemp oil and sealed in beeswax.

It arrives with VTA and azimuth adjustments plus a bronze with brass collar spike and synthetic, high viscosity grease bearing with Cardas Wire 33 AWG and a micro bubble level.

A built-in MM phono amp, with by-pass switch, amplifies the included Audio Technica AT95E. Prices are \$995 or \$650 without the phono amp (all prices as US dollars).

The Pebbles two-speed, belt-driven TA-1 turntable also has a bamboo platter with levelling legs plus a 24-pole synchronous AC motor. Offered with a 9" arm for \$1,295 or without for \$995, it weighs in at 5kg.

The Pebbles tonearm is a 9" (\$350) or 12" (\$450) model, three ply bamboo laminate. It's 12mm thick, soaked in hemp oil and sealed in beeswax with VTA and azimuth adjustments plus bronze with brass collar spike and synthetic, high viscosity grease bearing, anti-skating mechanism, Cardas Wire 33 AWG, silver plated cartridge clips and a bamboo mount.

Finally, the dual speed, dual plinth, belt-driven, 10kg Bam Bam turntable is a dual motor model featuring a bamboo platter with copper inlay and bronze ingot insets and levelling legs. It can handle both the 9" and 12" arms variety and is priced at \$2,500 with a 9" arm or \$1,925 without.

To learn more, click www.triartaudio.com



SYMPHONICA FOR IPHONE & ANDROID

Constructed from "environmentally friendly" woods, Symphonica has announced the forthcoming release of a wooden horn speaker for a selection of smartphones.

It needs no electricity yet boosts the volume from your phone speaker. Symphonica also, "...enhances the sound, adding the body and warmth that you've been missing," said the company.

Supporting the iPhone 5/5S/5C/SE, 6/6 Plus/6S/6S Plus, 7/7 Plus/Red Special Edition and Samsung Galaxy S6/S6 Edge, S7/S7 Edge, S8/S8+ with others to follow, the company is also offering wood smartphone cases, docking stands and a rechargeable bluetooth remote control you can use with your phone, tablet or computer.

To learn more, click www.symphonicasound.com



NOBLE AUDIO LIGHTNING TO 2-PIN IEM

Noble Audio has launched a new Lightning-to-two-pin IEM cable designed to connect the latest Apple iOS devices with all current and legacy Noble products.

The new Lightning cable is compatible with all current models in the Noble range and is also backwards-compatible with all products since the Californian company's inception, including its custom-fit models (CIEMs).

The cable also uses Noble Audio's new ear-hooks which keep the cable positioned behind the ear when in use. The new ear-hooks are pre-formed.

The new Lightning cable is available now priced at £60 for a 1.2m length. It is available direct from www.nobleaudio.com and in the UK from www.audiosanctuary.co.uk or call 020 8942 9124

AVID REFERENCE SUBWOOFER

Weighing in at 140kg and offering 120W of power with an aluminium construction, the new Avid subwoofer includes a pair of 305mm drive units plus DSP room correction. You can make adjustments to the DSP Room correction from the comfort of your listening chair using the iPhone Wi-Fi remote control app. There's also PC-based GUI software that enables full access to the DSP functions including a built-in Auto Room EQ function and microphone for room calibration. The price is £20,000.

To learn more, click www.avidhifi.com or call 01480 869 900



CANEVER AUDIO ZEROUNO PLUS

The ZeroUno Plus pre-amp/DAC offers four digital inputs, two pairs of RCA input connectors and two pairs of analogue output connectors; it is based upon a Sabre DAC chip.

The unit holds six separate power transformers, while an ES9018S Sabre is included, using proprietary firmware.

All incoming analog/DAC signals are amplified by an inter-stage Lundahl transformer. A Cirrus Logic CS 3308 chip is included, controlled by proprietary firmware while a valve output stage is based upon the 6SN7GT.

You can assign a displayable label to each input: Tape, Phono Or Tuner, Line 1, Line 2, Aux 1 and Aux 2.

Finally, the aluminium chassis has been coated with several layers of metallic paint and two layers of transparent acryl. For more information click www.canever.eu or call 039335 708 2807



AIR AUDIO BALANCED MAINS POWER SUPPLY

A 2kVA balanced transformer with multi-taps for 220, 230, 240, 250VAC voltage inputs. The power is supplied by a large, low impedance balanced output, earthed centre-tapped secondary. The transformer core is run at reduced flux density, is impregnated with varnish and the centre 'hole' resin filled to reduce mechanical buzz.

This configuration produces an output voltage consisting of a symmetrical pair of identical but out-of-phase voltages that bring a reduced noise floor. Measuring 230 x 330mm, the unit weighs in at 16kg. Price is £1,400.

To learn more, click www.airaudio.co.uk

or call 01491 629629



NAIM'S POWER-LINE LITE

The Power-Line Lite mains plug features a thermoset resin case carrying floating pins that align to provide an enhanced contact area with the socket connections.

The stripped cable ends are secured by profiled clamp screws and the cable is both decoupled and clamped. The Power-Line Lite cable itself is custom manufactured.

Completing the Power-Line Lite is an IEC inlet plug that continues many of the decoupling and electrical continuity themes of the mains plug. Price is £95.

To learn more, click www.naimaudio.com or call 01722 426 600

AMENDMENTS

The Lindemann Musicbook USB DAC/Headphone amplifier reviewed in Hi-Fi World June 2017 issue should have received five globes – and not the four stated.

In the same issue - the price of the Isotek Evo 3 Mosaic mains regeneration unit is £7950 and not as stated.

HYM RELEASES THE SEED

The unit features a turntable, amplifier, speakers plus digital additions for streaming and more.

"The system utilises a set of patented tri-point shock absorber filters that... keeps the turntable steady, balancing the tonearm and maintaining a consistent sound performance," said the company.

It provides 70W of power along with Wi-Fi and Bluetooth facilities for streaming. A featured 3.5mm Aux socket is accompanied by RCA/SPDIF line out. A dust cover can be bought as an add-on.

Price? It was \$735 but there's currently a sale on which reduces that to \$435!

To learn more click www.seed.hym-originals.com



SME

MODEL 15

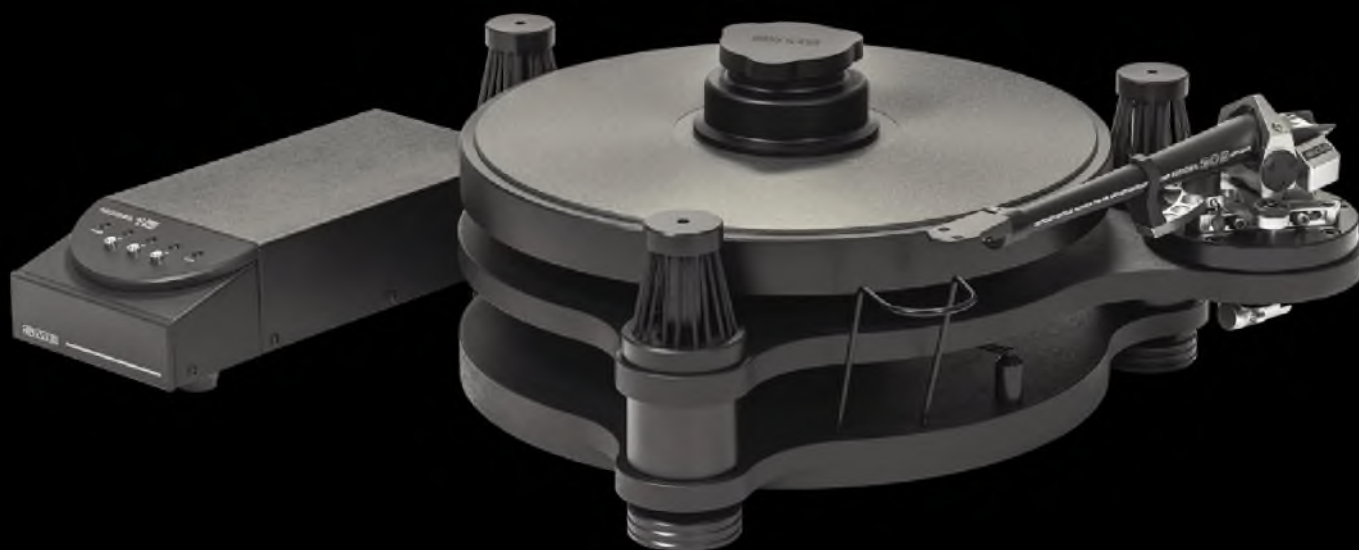

Experience a New Dimension in Sound

The Model 15 could be described as "the ultimate in recovery vehicles", allowing the cartridge to retrieve the last nth of recorded material whether digital or analogue, from the vinyl disc and thus approaches the ultimate in perfection.

Receiving its inspiration from the superb Model 10 precision turntable the Model 15 seeks to emulate the excellence of our Models 20/3 & 30/2 turntable whilst retaining the more compact footprint preferred by many of our enthusiasts.

The Model 15 has been designed with the same attention to detail combined with simplicity of operation that has come to be expected from all SME products. Its superb performance together with laid back styling make it a glamorous addition to your sound system that will astound and amaze listeners for many years to come.

SME Limited

Mill Road
Steyning
West Sussex
BN44 3GY

T +44(0) 1903 814321
F +44(0) 1903 814269
E enquiries@sme-audio.com
www.sme-audio.com

*Audio
Lounge*
LONDON

Call for a demo

Audio Lounge
138 Wigmore Street
London W1U 3SG
020 7487 4080
www.audiolounge.co.uk

Realistic Rubins

Quadral's new Rubin floorstanders sound powerful and detailed, says Jon Myles.



A fair number of Quadral loudspeakers have passed through Hi-Fi World's listening room over the past few years - and almost all have been greeted with glowing praise by those who have heard them.

The German manufacturer has forged an enviable reputation for producing well-engineered 'speakers with a consistent sound at realistic prices.

And while Quadral may not have the same brand recognition as B&W, KEF, Wharfedale and others on these shores, it is a major player across Europe.

No surprise, then, that I unboxed the latest model from the company with a sense of anticipation. The Rubin is a relatively large floorstander costing £1100 and standing just under 3.5 feet high - exact dimensions being 100.6mm x 20.84mm x 34.5mm (H/W/D).

The Rubin is a true three-way model with a pair of 135mm titanium-coated polypropylene woofers working together, before handing over to a matching 135mm midrange driver. Above the latter is Quadral's proprietary aluminium dome tweeter which sits in an in-house designed wave guide and is claimed to extend up to 46kHz.

The cabinet is finished in either high gloss black or white and features rounded sides which curve towards the back to reduce internal standing waves, while the rear panel features one set of loudspeaker binding posts.

Weighing in at 17.8kg the Rubins are handsome-looking with the grilles off - four drive units give them a purposeful demeanour. They do, though, require a substantial run-in to make the titanium-coated mid and woofer truly come alive. I gave them a thorough 72 hours of non-stop use before settling down to critical listening.

SOUND QUALITY

Starting out I connected the Rubins to a Creek 100A Evolution integrated amplifier which - at a price of £1500 - would seem a natural match.

Tellurium Q®

10 products of the year and most wanted components
in just 2 years by preserving relative phase relationships in a signal



Introducing our new Black II Speaker Cable

"Tellurium Q have surpassed themselves here. It is often said that all cables colour the sound of a system to some extent, but the Silver Diamonds do it to a lesser extent than any other product I've heard so far."

John Myles, *HiFi World*

"If you're looking for a major jump in your system's performance, I'd suggest buying a pair of these instead of considering a hardware upgrade. Before you write this advice off to cable delusion, expectation bias, or the recent Mercury retrograde phase, please take note: I have never said this in TONE's 11-year history"

Jeff Dorgay, *Tone Audio*

"Well, I have just stumbled upon a speaker cable that I'm very tempted to put in a class of its own"

Mono & Stereo



facebook.com/telluriumq

telluriumq.com

+44 (0)1458 251 997

== TQ ==

It did not take too long to pin down these loudspeakers' essential quality; they major on detail with an emphasis on the leading edge of notes through the midband and treble.

On Miles Davis's 'In A Silent Way' Tony Williams' double-time cymbal work was almost glacial in its presentation - a shimmering presence hanging in just the right space behind the maestro's improvised trumpet lines.

There was a feeling the Quadral Rubins were working hard to bring the most out of this recording. Chick Corea's spiralling solo on his Fender Rhodes piano was a highlight, having both tempo and definition through the Rubins, coming across as gorgeously clear.

Bass was excellent even with some of the most testing tracks I could find. The lower registers of James Blake's 'Limit To Your Love' pinned me to my seat, being both forceful and physically imposing. The separation between the bass and vocals in the frequency range was superb, giving a crisp rendition of the track. Sitting back I heard everything about the production; forensic detail was on offer.

With 'Dreams' by The Cranberries there was the same hear-through quality, the ringing guitar line sounding pristine.

But switching to something a little more muscular with Bruce Springsteen's 'Born In The USA' and I couldn't help feeling the Quadral Rubins were a tad too clinical in combination with the Creek 100A.

A move to Icon Audio's Stereo 30SE valve amplifier made the difference. This brought extra warmth to the mid-bass and gave a more relaxed presentation. The detail was still there but the combination worked better overall with a richer and essentially deeper soundstage.

John Medeski's Hammond organ on 'End Of The World Party' had body and punch to it but never sounded too forward in the mix.



Behind it the drums and bass backing came over as a perfect foundation, allowing the keyboard lines to weave their magic.

The same went for Charles Mingus's 'Mingus Ah Um' where the Icon Audio brought an extra degree of resonance to the walking bass lines with, to my ears, a greater presence.

That said, the beauty of these Quadral Rubins is that they are so fast, open and natural that the character of the matching amplifier becomes the important factor. They will not hide faults - but they will give you a thrilling experience.

CONCLUSION

The rear of the Quadral Rubins has one set of binding posts plus a large reflex port - but bass output is even and accurate.



Quadral's aluminium dome tweeter and wave guide give good high-frequency response.

If you value precision and detail then the Quadral Rubins will be right up your street. They are excellent in this respect. However, if you prefer a little more warmth to the presentation then careful amplifier matching is recommended. Fortunately, the high sensitivity means they work well with the likes of Icon Audio's Stereo 30SE valve integrated which makes an ideal combination.

MEASURED PERFORMANCE

The Quadral Rubin was enormously sensitive, delivering 91dB sound pressure level (SPL) from one nominal Watt of input (2.8V). This can be achieved by engineering in "loose bass" - but not in this case. The Rubin has very flat and even bass output, and it is well damped too, our red port trace shows (and the Impedance trace). What all this means is that the Rubin will go very loud from little power and a 30 Watt amplifier will suffice for very

high volume, while 10-20Watts would still give high enough volume for most listeners.

However, contributing to this sensitivity is the fact that from 20Hz up to 800Hz this is a 4 Ohm loudspeaker and should be treated as such; it draws current. It does have an input capacitor however, that causes impedance to rise below 20Hz, acting as a high pass filter that lessens cone flap with LP and speeds bass.

Frequency response measured reasonably flat at 30 degrees off axis, our analysis shows; the speakers should be pointed straight down a room, not at listeners. There is some small plateau emphasis of high frequencies, enough to add a bright patina to the sound; this is not a warm sounding speaker by any means. Treble is smooth however and detail will be strong.

Bass runs down to 50Hz before rolling down quickly below this frequency. There is a small amount of peaking around 60Hz (+2dB) to add to 'speed'. Port output (red trace) was wide and flat; it applies broad acoustic damping to the bass units. Port output extends down to 25Hz.

The Rubin will sound light and bright, highly detailed, a tad forward and fast, in essence. Bass should be tight and clean; it won't be heavy. **NK**

FREQUENCY RESPONSE

Green - driver output
Red - port output



IMPEDANCE

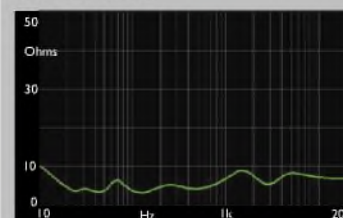

QUADRAL RUBIN £1100



EXCELLENT - extremely capable.

VERDICT

A powerful loudspeaker whose sense of detail is hard to match at the price. Lacks warmth but careful amplifier matching can make it sing.

FOR

- detail
- neutrality
- sensitivity

AGAINST

- lack of warmth

Nu Nu Distribution
+ 44 (0) 203 5442338
www.nunudistribution.co.uk



Pro-Ject
AUDIO SYSTEMS



VC-S CLEANER

The VC-S cleaner from Pro-Ject Audio Systems is the most effective and efficient way of keeping your vinyl records clean, without breaking the bank.

Designed to penetrate and remove deep-set dirt within the record groove, the VC-S makes use of a two-stage, semi-manual process; incorporating a vinyl cleaning stage and a powerful vacuum stage. The result is a marked improvement in sound quality and equipment life.

Supplied with all the necessary accessories to get cleaning straight away, the VC-S makes use of a fast dual-direction motor, a powerful vacuum and a built-in waste water cavity. The integral fixing clamp protects the record label from getting wet, and the supplied Wash-IT cleaning solution is environmentally safe and very effective with any type of record.

An optional dust cover and 7" record adapter kit are also available.

AVAILABLE NOW FOR £349.00 (SRP)



Distributed by Henley Designs Ltd.

T: +44 (0)1235 511 166 | E: sales@henleydesigns.co.uk | W: www.henleydesigns.co.uk

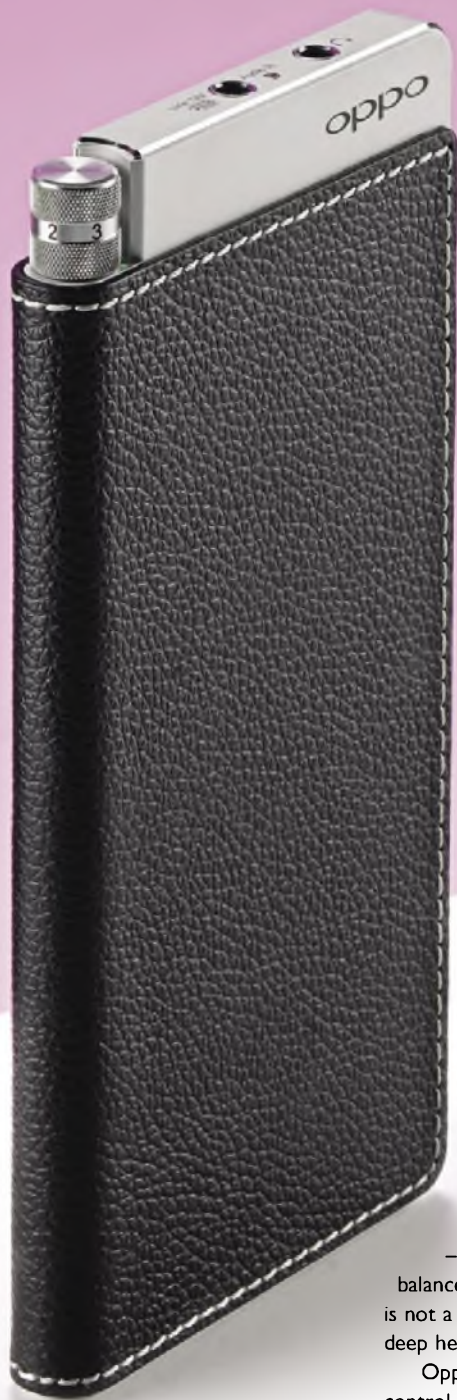

Pure Power

Oppo's new HA-2SE headphone amplifier/DAC can transform the sound of a portable device, says Noel Keywood.

solid if not overly heavy 178gms on our scales and measures 137mm high, 68mm wide and just 12mm deep – almost as large as an iPhone 6S. So it will fit a trouser pocket but not a shirt top pocket. Build quality and finish were superb.

Needless to say, there are many little extras that embellish the cake. In addition to the iPhone USB A socket input (marked A) there is a micro-USB socket for connection to a computer (B) and an analogue input (C), a slide switch selecting between them. There is no S/PDIF digital input, however

– a disappointment – and no balanced headphone output which is not a disappointment, except for deep headphone geeks.

Oppo fit a nice rotary volume control complete with on/off switch – just like a radiogram! There's a High/Low volume switch, Bass boost switch and battery check/power bank mode select button. A Line output socket (no volume control) can feed a hi-fi amplifier or active loudspeakers direct.

A set of short connecting leads are supplied: Apple Lightning to USB A for iPhones etc, micro-USB to micro-USB for Android phones (e.g. Samsung) and 3.5mm stereo jack – so the headphone output of a player can be connected. In this case the HA-2SE acts as an amplifier with volume control alone.

Oppo supply a fast charger that will charge the internal 3000mAh battery in 90 minutes (1.5 hours) or the unit charges from a computer's

USB outlet, from the 5V d.c. line that is intrinsic to USB. Play time is 7 hours via the digital inputs or 13 hours via the analogue input.

The ESS chip accepts PCM up to 384kHz sample rate and also quad rate DSD. You can only play DSD from a device with a player like Pure Sound or Audirvana that sends DSD over USB; forget playing DSD from an iPhone.

As always, PCs need a driver to be loaded and Macs do not. With a Mac the Audio/Midi utility can be set at sample rates up to 384kHz but it's best to stick to 96kHz to keep file sizes and data rate down, higher sample rates offering little obvious benefit I find. Macs don't play a file at its native sample rate; they re-sample rate to that set by the user.

I encountered one little niggle: connecting to a USB hub caused the battery lights to fall to minimum after a minute or so and computer connection to be lost; the Oppo was demanding too much charge current from the hub, invoking protection. Connecting direct to the Mac overcame this.

SOUND QUALITY

In a word: extraordinary. Even with low-res files of various sorts on my iPhone (m4As, AACs etc) the difference this amplifier made was both obvious and startling. With the Central Band of the Royal Air Force playing 'The Battle of Britain (March)' theme tune, that I had dismissed quality wise, I suddenly discovered a very large and powerful sounding live band where the massed horns blared with a sense of scale and power.

There was air and space around the musicians, where before it was just a flat sounding, MP3 quality film sound track – or so I thought. The HA-2SE

The HA-2SE is a high quality, portable Digital-to-Analogue Convertor (DAC) and headphone amplifier combined. Instead of listening to your iPhone (for example) through its internal DAC and headphone amp, connect it digitally through its charging lead to the HA-2SE and you get music piped through to the hi-fi industry's top DAC chip, the ESS ES9028 Q2M – a recent update on the 9018 and purposed for portables, hence the SE.

That's the basic idea then. Since this means carrying it together with a phone size, weight and pocketability are important. It weighed a

Connect your home to a deeper music experience

mu-so



Channelling forty years of audio engineering, we present Mu-so. A range of compact, yet commanding wireless music systems, that will unleash you music wherever it's stored, in breathtaking quality. Advanced connectivity includes AirPlay, Bluetooth®, Spotify Connect®, TIDAL, iRadio and multiroom streaming.

naimaudio.com



Go Deeper

Experience at John Lewis, selected Apple stores and our network of specialist audio retailers.



AirPlay is a trademark of Apple Inc.



Headphone and Line output at top, together with a cylindrical volume control incorporating on/off switch. The side has green battery status lights, Hi output and Bass+ (boost).

brought it to life.

Next up (somehow!) was 'Darkness Growing On Me' where Justin Hawkin's power chords and wailing vocals hit me between the eyes with visceral power – just how it should be. It was like turning the Philips Fidelio XI headphones into Tannoy Westminster: everything had force and might. I transferred a range of 24/48 music files to the iPhone, that play unrestricted through the HA-2SE (see boxout) and got not only full high-res quality but perfect

smooth, with very fine upper treble. Even a messy Eagles CD track, 'Somebody'

– compressed upward to sound loud – came over as relatively clean, composed and well sorted; Glen Frey's voice was firm and strident centre stage whilst the Hammond organ lent an atmospheric presence from above and behind.

On the same theme, old and messy digital such as Gerry Rafferty's 'Time's Caught Up On You' was re-presented sounding smooth and composed, a function of the new Sabre chip that processes old digital to clean it (jitter removal, bit error reduction etc).

CONCLUSION

The HA-2SE is a headphone amplifier with massive advantage, courtesy of its use of the latest ESS digital convertor chip, plus excellent

headphone amplifiers. With a powerful and expansive sound that seemingly teases more than I could have imagined from all files played, from compressed to hi-res, it's a pocketable DAC with a difference. You can also use it to feed a hi-fi system.

HI-RES ON A MOBILE PHONE

Decent sound quality from a mobile phone? It is possible, and here's how in Apple's somewhat contorted music environment, with Android also covered. I used measurement (Rhode&Schwarz UPV spectrum analyser) to assess performance, not guesswork or manufacturer's data.

The iPhone 6S was running latest iOS 10.3.1 and this accepts 24/48 maximum (Android accepts 24/192). All the same, it will play 24bit files, crucial for lowering noise and distortion, increasing dynamic range.

Taking advantage of this on the iPhone is not straightforward. Firstly, iTunes will not import FLAC or DSD. Digital music files must be converted to 24/48 PCM with a programme like XLD beforehand. Then iTunes must be set to import using the Apple Lossless Encoder (go to iTunes at top left, then General, then Preferences and Import settings linked to 'When a CD is inserted'), so it doesn't compress and limit quality. This builds a hi-res file the iPhone will accept when you transfer from Mac to iPhone using iTunes.

Playing 24/48 test files generated like this, on an iPhone 6S through the Oppo HA-2SE, gave full hi-res quality, with 114dB dynamic range (CD is 102dB) and low 0.03% distortion (CD 0.2%), plus half-sample rate bandwidth of 22kHz.

Via the iPhone's headphone output the figures were 104dB dynamic range and 0.1% distortion, so the Oppo provides large improvement over the iPhone's internal digital convertor and headphone amp.



Input selector switch at left, 'phone charge lead input (USB A) and computer input (micro-USB).

hi-fi quality from the new ESS Sabre chip and headphone amps.

To generalise: what is on offer here is superb low level silence where fine sounds can be picked out with ease, giving a feeling a great insight and subtlety, plus massive dynamic scale and fulsome low end bass power. What you don't get is digital hardness, glare or brightness.

The Sabre series DACs sound smoother and even warmer than lesser (earlier) breeds; not everyone takes to this, especially those playing Rock who want hard cymbal crashes and 'fast' transients, after suffering hearing loss from attending too many Rock concerts methinks. The sheer dynamic power of the Oppo should make up for this though: think of it as sitting in the bass bins. Android based phones (e.g. Samsung) can play 24/96 files and better so they are less restricted than the iPhone.

Hooked up to a MacBook Pro I could run any sample rate up to 384kHz and DSD (Pure Sound or Audirvana) and sound quality was little different to 24bit from the iPhone – again massive dynamics, a big but easy sound that is chocolate

MEASURED PERFORMANCE

Frequency response of the Oppo HA-2SE digital section, with a 192kHz sample rate input, measured flat to

91kHz before a slow roll off to 96kHz, our analysis shows. This is an extended response and about the highest practically possible.

FREQUENCY RESPONSE

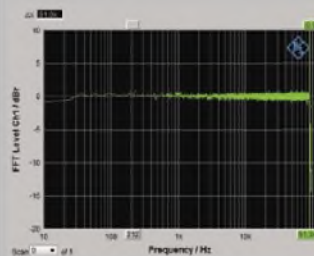

Output from the headphone socket was high at 2.8V (H gain), and still loud at 0.87V at Low setting (L gain). Dynamic range was good for a battery driven portable at 114dB, if not up to mains powered DACs.

DISTORTION

THD (all)	Level (dB)	Frequency
0.0446 %	2.8335 mV	997.00 Hz
OFF	OFF	OFF

Distortion measured 0.002% at full output (0dB) and 0.035% at -60dB with 24bit, and 0.22% with 16bit – good figures. Our distortion analysis shows some small amount of second harmonic distortion.

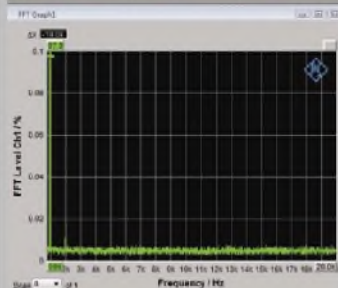

The analogue input stage has x2.5 gain (8dB) with maximum of 1.12V_{in}/2.8V out.

The Oppo HA-2SE measured well in all areas. **NK**

Frequency response	4Hz-91Hz
Separation	91dB
Noise	-113dB
Distortion	0.035%
Dynamic range (24bit)	114dB
Output (hphone)	2.8V

OPPO HA-2 SE £289



OUTSTANDING - amongst the best

VERDICT

Fantastic sound quality from a small battery powered headphone amplifier that can also drive a hi-fi system.

FOR

- sound quality
- multiple inputs
- Line out

AGAINST

- no S/PDIF digital input
- incompatible with low current USB hubs

Oppo
+ 44 (0)345 060 9395
www.oppodigital.co.uk

M-DAC **MINI**



Bluetooth
aptX



iOS
Compatible



Android
Compatible



PC & Mac
Compatible



Battery
Supported



USB-A & Micro USB
Connections



Coaxial / Optical
Inputs & Outputs



RCA Analogue
Outputs



6.3mm Headphone
Output



ESS 9018K2M DAC



Up to 32bit / 384kHz
Resolution



DSD 256
Compatible

IAG House, 13/14 Glebe Road, Huntingdon, Cambridgeshire, PE29 7DL, UK
Tel: +44 (0)1480 452561 Fax: +44 (0)1480 413403 www.audiolab.co.uk

audiolab

iFi hi-fi

Jon Myles connects iFi's slim Nano iOne DAC to his computer - and loves what he hears.

In these days of all-singing, all-dancing components (amplifiers with DACs and Bluetooth, CD players with network capabilities etc), there's something refreshing about iFi's Nano range.

A series of small, slim boxes, they are engineered to do a specific job in the replay chain - be it a regenerated USB power supply, headphone amplifier or, as in the case of the Nano iOne here, an off-board DAC.

If you've not come across iFi before it's a relatively new company but an offshoot of Abingdon Music Research (AMR) - well-known for its amplifiers and CD players. Indeed, iFi makes much of the fact that some of the technology is trickled down from AMR's top-line products.

Its products, though, are aimed firmly at the computer audio and home entertainment generation and so the iOne's marketing highlights the fact that it can be hooked up to a Google Chromecast, 4K television, Apple TV, Xbox and Playstation to improve sound, as well as being used with a smartphone, tablet or computer.

The circuit is built around a Burr-Brown multi-bit DAC which supports PCM up to 24bit/192kHz, DSD up to 12.4MHz and DXD to 384kHz. There's also aptX and AAC Bluetooth capability incorporated (a small button on the front facilitates pairing).

Housed in an aluminium case measuring 25.5mm x 64mm x 100mm (H/W/D) and tipping our scales at 122g, inputs consist of a combined S/PDIF coaxial/optical and one USB 3.0 (which also doubles as the power supply) housed on the rear, alongside a single pair of RCA outs. The front contains two toggle switches - one for input selection the other for the digital filter. The latter has two settings - one for listening which is minimum phase and a standard one which is recommended for taking measurements.

Finally, a circular window on the front displays different colours to indicate the incoming source file type and its resolution - so you'll get red for standard CD, cyan for 24bit/192, blue for DSD64 etc.

SOUND QUALITY

Connecting the iFi to a MacBook Air with a selection of high-resolution tracks, there was a clean and open sound on offer. Vocals were particularly well highlighted. A 24/96 rip of Diana Krall's 'Live In Paris' showcased her distinctive inflections and smoky jazz voicings.

Behind her, the band was presented with good detail alongside nice separation between the instruments. Rhythmically the iFi was taut, with a good sense of tempo but without pushing the music at you - instead allowing it to flow naturally.

With Joy Division's 'She's Lost Control' (24/192) the opening

electronic percussion notes hit hard and also emerge from a silent background - a testament to how well the iFi eliminates the inherent noise from computer sources.

Flicking the front rocker switch to BT (for Bluetooth) then pairing and relaying music via an iPhone, the iFi's presentation remained similar - and actually is one of the best I've heard via this method. Jan Garbarek's 'In Search Of Dreams' was virtually indistinguishable from the same track relayed via CD. Every note and key



The rear of the unit has RCA outs plus SPDIF and USB inputs.

change on the saxophone was there, with a broad swell to the sound.

The only downside is that bass is not the most fulsome. There's a lightness of touch to it which means some dance and dub tracks didn't power through quite as I'd like. But that's a minor point compared to how well the iFi performs in all other areas - especially at just £199.

CONCLUSION

Small and versatile - the iFi Nano iOne is an excellent DAC.



IFI NANO IONE £199



EXCELLENT - extremely capable.

VERDICT

A compact DAC which has the ability to improve the sound from computer-based music files.

FOR

- crisp sound
- inputs
- price

AGAINST

- slight lack of bass

Select Audio
+44 (0)1900 601954
www.selectaudio.co.uk

 FOCAL®



FOCAL | ELEAR

With a sophisticated design, Elear headphones create a personal and passionate listening experience. Inspired by Utopia, these open high-fidelity Focal headphones feature an aluminum/magnesium tweeter that will take you to the heart of the music. The leather headband and aluminum yoke offer ideal comfort.

Contact your local Focal retailer
to experience: www.focal.com



L I S T E N B E Y O N D

WIN A PAIR OF QUADRAL CHROMIUM STYLE 8 SUPERB LOUDSPEAKERS WORTH £1750 IN THIS MONTH'S GREAT GIVEAWAY!



Here's your chance to win the impressive Quadral Chromium Style 8 loudspeakers we reviewed in our March 2016 issue. Read the review excerpt below and answer the questions.

"In mainland Europe Quadral has an enviable reputation for producing exceptionally well-engineered and clean-sounding loudspeakers that can go head-to-head with the best at their respective price points.

The Quadral catalogue is extensive and one step up from the Rhodium series of 'speakers comes the larger Chromium range – with bigger cabinets and drive units, plus – in the case of the Chromium Style 8 – a ribbon tweeter for extended high frequencies.

Measuring 100.6cm x 20.85cm x 34.35cm (H/W/D), this is a true three-way loudspeaker, bass duties being handled by a pair of 180mm titanium-coated drivers. They work with a 155mm midrange unit of similar construction and the aforementioned aluminium ribbon tweeter – said to extend upward to

55kHz.

The cabinet itself has a deep gloss finish (black or white available) with gently curved side walls to minimise internal standing waves; a discrete Quadral logo is etched on top. At the back is a single pair of 'speaker binding posts (so no bi-wiring), above which sits the rear-firing reflex port.

The cabinet sits on an integral base plate, decoupled by spacers to provide a rigid foundation.

The Chromium 8s impressed me with their coherence and seamlessly integrated soundstage. These are 'speakers that major on a natural, unforced rendition of the music".

For a chance to win this great prize, just answer the four easy questions at right. Send your entries on a postcard only, by 11th July 2017 to:

**July 2017 Competition,
Hi-Fi World magazine,
Studio 204,
Buspace Studio,
Conlan Street,
Notting Hill,
London W10 5AP**

QUESTIONS

[1] For extended high frequencies it has -

- [a] dome tweeter
- [b] cone tweeter
- [c] ribbon tweeter
- [d] planar tweeter

[2] Bass duties are handled by -

- [a] titanium-coated drivers
- [b] paper cone drivers
- [c] steel cone drivers
- [d] plastic drivers

[3] What is etched at top -

- [a] set up instructions
- [b] power handling
- [c] date of manufacture
- [d] Quadral logo

[4] The cabinet sits on -

- [a] integral base plate
- [b] wooden cones
- [c] air cushion
- [d] brass legs

RULES AND CONDITIONS OF ENTRY

- ONLY ONE ENTRY PER HOUSEHOLD
- MULTIPLE ENTRIES WILL BE AUTOMATICALLY DISQUALIFIED
- PURCHASE OF THE MAGAZINE IS NOT A PRE-CONDITION OF ENTRY

- NO CORRESPONDENCE WILL BE ENTERED INTO
- THE EDITOR'S DECISION IS FINAL
- NO EMPLOYEES OF AUDIO WEB PUBLISHING LIMITED, OR OF ANY COMPANIES ASSOCIATED WITH THE PRODUCTION OR DISTRIBUTION OF THE PRIZES, MAY ENTER

entries will be accepted on a postcard only

**APRIL 2017 WINNER: Q ACOUSTICS 3050 LOUDSPEAKER
Mr. Kevin Dowell of Coalville**

Here To Serve

Melco's award-winning N1A hi-fi network music storage device has been upgraded to Mk2 status - Jon Myles likes what he hears.

In these days of digital downloads, CD rips, digitised copies of vinyl collections and music held on USB sticks (of which I have more than is particularly sensible), the problem of where to store all this music is becoming more important.

Yes, you can collect them all and transfer to a network attached storage (NAS) device to be relayed via a streaming device to your system. But good as this is, the majority of NAS drives (especially those costing around the £100 mark) are not strictly hi-fi – built instead to house all sorts of things including movies, pictures, PDFs and just about any other digital file you can think of.

So enter Melco, producers of high-quality storage devices specifically designed to store and replay music to your system via a network player/streamer/DAC. I reviewed the

original entry-level N1A model two years ago (Hi-Fi World, March 2015 issue) and was impressed by its detail, resolution and flexibility.

Now the company has updated the unit to Mk2 status with a number of significant upgrades all aimed at improving what was already impressive sound quality.

First off, storage capacity has been increased with two 3TB Western Digital Blue hard drive disks on board – which can be used for 6TB of total storage or mirrored in a Raid array where one drive acts as a back-up so in the case of failure your music files are not lost.

Other improvements

include the addition of native DSD support, improvements to front panel OLED display, a dedicated capacitor bank for the power supply to help reduce noise, as well as upgraded circuit boards and wiring. Melco has also partnered with developer SongKong to offer its music tagging service to buyers (see separate panel for more details).

Housed in a standard-sized case, apart from the display window the front panel also includes a USB 3.0 port for importing files, as well as

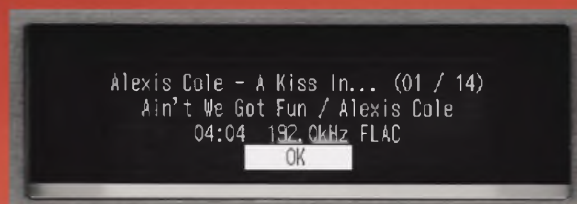

The Melco's display can show song titles plus artist and sample rate of the file.



four buttons to control playback. There's no dedicated app for smartphones or tablet devices at present but the likes of PlugPlayer will do the job is so desired.

All the outputs are situated on the rear for output in digital form either via a dedicated USB port to a DAC or an ethernet connection to a network player. A separate ethernet connection allows the Melco to be connected to a network router, switch or hub. Three other USB ports allow importing music from external USB storage, adding additional storage devices should that 6TB capacity not be enough and adding a back-up device if you require (something I'd definitely recommend if you don't use the Melco's Raid facility).

The pre-installed media server means there's no need to involve a computer in the playback process unless you absolutely want to. Also - for those who are still wary of having a hi-fi component sharing the same network as their computers - the Melco can be switched to Direct mode meaning it simply acts as a music library.

Set-up was easy and simple, the Melco outputting music to our Oppo BDP-105D Universal player within a matter of minutes from unboxing. Importing a variety of high-resolution tracks from the front panel USB connection was also quick and painless, navigating a menu tree

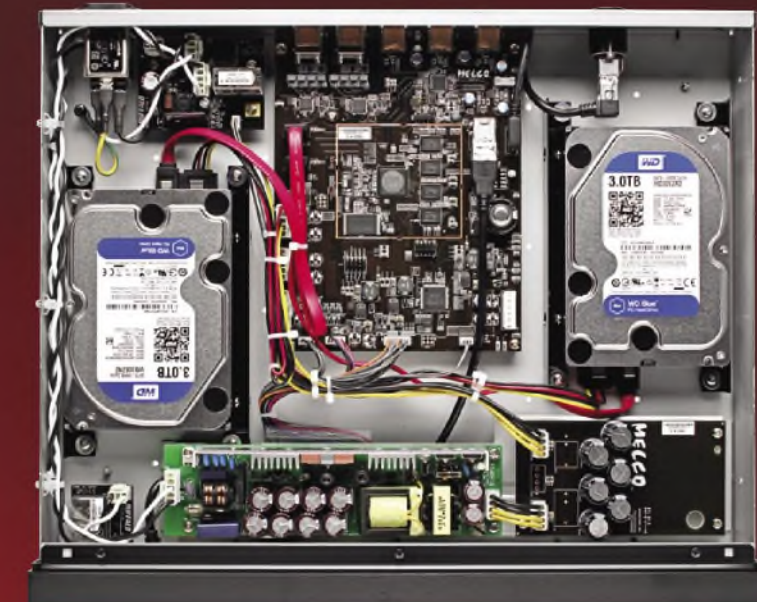

The new Melco N1A Mk2 includes two 3TB Western Digital hard disks. Other upgrades include a dedicated capacitor bank for the power supply (bottom left).

possessing smooth responsiveness to all actions.

SOUND QUALITY

The original Melco N1A was probably the best network attached music library I'd heard – definitely a step-change in quality from any ordinary NAS drive.

This upgraded model adds functionality and improves on the sound quality in subtle ways. The internal changes have brought a greater element of detail to the

sound - allowing an extra insight into recordings. It's crisp, refined and ultimately extremely smooth.

With The Allegri Quartet's

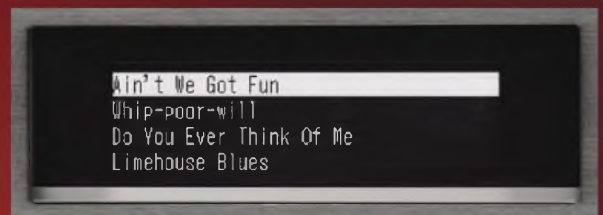

Individual track lists can be displayed on the front panel.





HI-FI WORLD
"Amplifier of the Year"

Hi-Fi Choice
RECOMMENDED



Stereo 845pp

"King of Triodes" ST845pp 50wpch £6,495 Worlds first 845 PP integrated amplifier

hi-finews
OUTSTANDING
PRODUCT

HI-FI WORLD



Stereo 60 MKIII **hi-fi+**

ST60 III with KT150 valves 80wpch, 50w Triode Outstanding performance £3,299

HI-FI WORLD

hi-finews
HIGHLY
COMMENDED

Hi-Fi Choice
RECOMMENDED



Stereo 40 MKIII

ST40 III True "Hi End" Amplifier, Triode 25w, UL 45w many features from £1,899

HI-FI WORLD

designed by David Shaw



Stereo 25 MKII

Simplified ST40 30wpch UL, HQ Headphone socket, "Easy Bias" From £1,099 (EL34)

HI-FI WORLD



Hi Fi World
"Best Valve
Amplifier"
Stereo 30se

Stereo 30se KT150 Valves Pure Class A 18w Triode, 28w UL £1,999

HI-FI WORLD

hi-finews
HIGHLY
COMMENDED



PS1 MKII MM/MC

Our extraordinarily good pure valve phono stage only £1,099 MM or £1299 MC/MM

Innovative Designs
From Icon Audio

Hi-Fi Choice
RECOMMENDED

HI-FI WORLD

HI-FI WORLD



PS3 MKII MC/MM Phono Preamp

100% Pure Valve Pure valve Phono Preamplifier £2,499



HP8 MKII Only £749

Pure Triode With Output Transformers matching 8-600 Ohms



New 15" Horn speaker now on demonstration

See our range of speakers specially
designed for valve amplifiers

Icon Audio have a valve amplifier to suit all purposes. From 15 watts per channel to 80w integrated or 16w to 250w mono blocks. Immerse yourself in our warm easy listening detailed sound. David Shaw has been making innovative highly regarded amplifiers for 15 years which are all leaders in their class. Some like the unique ST845 or HP8 have no equal, and others like the ST60 and ST40 are "outstanding" in performance and value for money. All our amplifiers are handmade, "point to point" with our own hand wound transformers in our own factory and finished in Leicester. Built to last and be easily serviced.

Various upgrades are available including capacitors and valves. As a UK company we offer rapid economical service on all our products both old and new. Come for a listen at our Leicester showroom or order from one of our appointed dealers. For more information see our website, ring or email us, or ask for our latest brochure printed on real paper!

Buy direct from us or through one of dealers or worldwide distributors

UK only prices including 20% VAT and mainland delivery. Some models show upgraded valves. E&OE

SONGKONG FOR MELCO

SongKong for Melco is a powerful software tool designed to make tagging digital music files with metadata (song, album, composer, artist etc) as well as adding album artwork as easy as possible.

Anyone who has thousands of files stored will know how difficult it is to keep this consistent.

Basically, the programme takes samples of each song and then uses these to match it to an on-line database using information from MusicBrainz and Discogs – downloading and filling in all the relevant information automatically. It will even look for duplicate songs in a library and give the option to delete them if wanted.

Special attention has also been paid to Classical music – with SongKong capturing information such as composer, conductor, performers and even Movement numbers where appropriate.

The programme produces a list of all updated files – while users can also individually edit the metadata if required.

SongKong works on both Mac and PC and costs £40 when bought with a Melco device. For more information visit www.jthink.net/songkong.

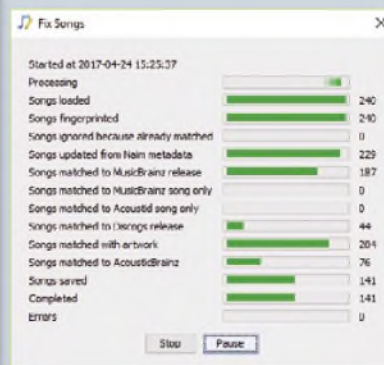
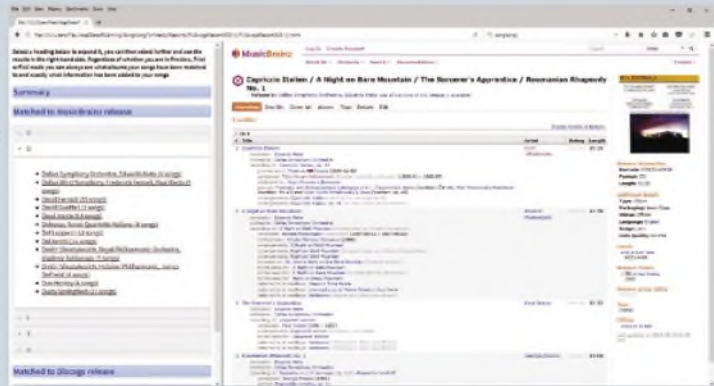

SongKong will create metadata for all albums (see left) and also allow you to examine all music files stored on the Melco.

'String Quartet's By Alec Roth' the Melco managed to strip away any semblance of digital nastiness, letting the syncopated string parts flow with a natural ease.

The changes in the rhythmic interplay between the strings was more lifelike and focussed than ever.

Acoustic instruments especially had more body, Charles Mingus's double bass coming over as big, bold and bouncy while Keith Jarrett's piano on 'The Kohn Concert' (24/96) was vividly resonant. His mutterings as he pound the keys in the more



The rear panel of the Melco has dedicated RJ45 sockets for attaching to a home network and player, as well as a USB out (far left) for connecting to an external DAC. In the centre are the USB sockets for importing music, adding additional storage or backing up files.

up-tempo parts of this recording were also easier to decipher, no longer being just background noise.

It's not just acoustic instruments that benefit, though The swelling synthesiser parts on New Order's 'Age Of Consent' expanded majestically above Peter Hook's bass lines, flooding into the room from our Martin Logan ESL-X hybrid

electrostatic loudspeakers.

There was a similar sense of scale and outright resolution no matter what music I played – one that you won't get from other storage devices.

As such the new Melco N1A MK2 is probably the best way to store your digital files in one easy place. Admittedly, at £2099 the Melco is a fair bit dearer than most NAS drives you can buy – but it justifies its price in terms of sound and performance.

CONCLUSION

The new Melco improves on what was already a fine product with easier operation and improved sound quality. A great product gets better then.

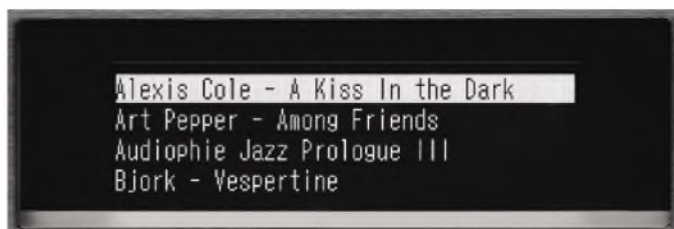

Choose your albums from the front panel of the Melco. Just press play to cue all selections.

MELCO N1A MK2 £2099



OUTSTANDING - amongst the best.

VERDICT

A powerful, audiophile network music server which really does get the best out high-resolution stored digital music files. Sets the standard at this price level.

FOR

- large storage
- easy operation
- clean, powerful sound

AGAINST

- nothing at the price

Kog Audio
+44 (0)24 7722 0650
www.kogaudio.com



**Jordan
Acoustics**

01202 911 886
bournemouth store

01592 744 779
glenrothes store

follow us

web site: www.jordanacoustics.co.uk



MCINTOSH
MP1100

new

2-CHANNEL VALVE PHONO PREAMPLIFIER

Utilizing four 12AX7A valves, with 2 valves used per channel in a fully balanced configuration - it is McIntosh's very first fully balanced valves phono stage. The MP1100 will give vinyl lovers a new level of musical enjoyment and exhilaration. It's filled to the brim with everything you need to not only play new records or pressings from the early days of vinyl, but it will also get every last musical note and nuance out of them - including some you may have never heard before.

MP1100

VALVE PHONO PREAMPLIFIER

£11,000

(valves included)

Finance Example*

Initial 20% deposit of £2,200, then £293.33 per month for 30 months

*Finance is subject to status & conditions.

MCINTOSH
MT10 & MT5

PRECISION TURNTABLES

Every McIntosh MT10 & MT5 Precision Turntable is factory adjusted for perfect playback. With custom arm and MC cartridge included, tracking force, anti-skate force, cartridge overhang and arm height are all preset for maximum performance. All you have to do is place your favourite record on the platter.



MT10

PRECISION TURNTABLE

£13,700

(inc arm & mc cartridge)

Finance Example*

Initial 20% deposit of £2,740, then £365.33 per month for 30 months

*Finance is subject to status & conditions.



MT5

PRECISION TURNTABLE

£9,000

(inc arm & mc cartridge)

Finance Example*

Initial 20% deposit of £1,800, then £240.00 per month for 30 months

*Finance is subject to status & conditions.

SPENDOR D9

LOUDSPEAKERS, FLOORSTANDING

The NEW Spendor D9 is an elegant, modern, full-size, 3-way, 4-driver, floor-standing loudspeaker. It music with exceptional resolution and a vibrant realism that conventional loudspeakers cannot match. It delivers low frequencies with breath-taking power, scale and authority. It is easy to place in real-world listening rooms, very efficient, and compatible with all good amplifiers. With a tall slim enclosure and smart modern finishes the Spendor D9 is entirely at home in any living environment. The D9 incorporates all the engineering innovation developed for the 3-way Spendor D7 loudspeaker, but the new D9 is far more than just a big D7...

£6,495/pair
(standard finishes)

£7,495/pair
(premium finishes)

Finance Examples*

£1,299 initial 20%
deposit then £173.20
per month for 30 months

*Finance is subject to status & conditions.

£1,499 initial 20%
deposit then £199.87
per month for 30 months

*Finance is subject to status & conditions.



MARANTZ 10 SERIES

FROM KEN ISHIWATA

Introducing the NEW 10 Series Reference from the UK's most successful Marantz Legendary retailer - Jordan Acoustics



PM-10

INTEGRATED AMPLIFIER

£6,999

(black or champagne finish)

Finance Example*

Initial 20% deposit of
£1,399.80, then £186.64
per month for 30 months

*Finance is subject to status & conditions.

SA-10

SUPER AUDIO CD PLAYER

£5,999

(black or champagne finish)

Finance Example*

Initial 20% deposit of
£1,199.80, then £159.97
per month for 30 months

*Finance is subject to status & conditions.



LETTER OF THE MONTH PRIZE

Mail



Visit our website at www.hi-fiworld.co.uk or send your emails to letters@hi-fiworld.co.uk. Letter of the month wins a pair of Quadral Argentum 520 loudspeakers.

Answers by: **NK** - Noel Keywood; **JM** - Jon Myles; **PR** - Paul Rigby; **MP** - Martin Pipe.

QUADRAL ARGENTUM 520

<http://www.quadral.com/en/loudspeaker/argentum-520>

For more advice see Letters from earlier issues at www.hi-fiworld.co.uk/letters

A QUADRAL BREEZE 2 portable powered loudspeaker is on it's way to Tony Williams, Letter of the Month winner in our June 2017 issue.

Letter of the Month

MAINS AND CABLING

Over the last few issues you have been discussing the merits of an assortment of mains treatments in both articles and readers letters. You also regularly feature reviews on a plethora of cables of all types and prices including specialist mains cables. This has prompted me to write in and seek advice and guidance on the whole subject of tweaks of this kind which I have been inclined to do for some time now. My system consists of an SME Model 15 turntable with an SME IV tonearm. An Ortofon Cadenza Black cartridge feeding an Icon Audio PS3 phono stage, then into a Musical Fidelity AS integrated amp, which has benefited greatly from their fine tuning service. Speakers are the CM-10 floor standers.

Cabling consists of a Black Rhodium interconnect (£100.00) and Kimber speaker cable. I also have an assortment of inexpensive after market mains cables, maximum cost £50.00. Finally, when I had my property rewired some years ago I asked the electrician to provide a dedicated spur for each of the 13 amp sockets feeding the system. I'm not entirely sure why other than the fact that I once read about it in a hi-fi mag!



The PS Audio PS5 mains regenerator has 1200VA capacity, so it will handle 1000 Watts of power draw – more than enough for all hi-fis. It also has a distortion meter and oscilloscope so you can see the waveform, plus adjustable output voltage.

As you can see I am fortunate in owning a pretty decent vinyl based system and am keen to maximise its potential. As things stand, the performance I get is very good. However, I feel that there is a degree of veiling and some compression along with greater transparency that is waiting to be revealed. Bass could also be a little tighter and better defined. Like many audiophiles I am also aware of the significant variations of performance from day to day and at various times. Sometimes it really rocks and other times everything sounds somewhat muffled and sucked in. Curious.

The question is – what to do about

it? Do I treat the mains? If so what? A mains conditioner? A Balanced mains unit? A unit to produce a perfect sine wave? New mains cables? Etc..

What about connecting cables? New interconnects? New speaker cables? How much to spend? Which brands? I like a well balanced sound. Smooth, clean and open with transparency and detail plus some satisfying bite as long as it doesn't stray into brightness or brittleness.

The problem is that the whole subject is a hi-fi minefield I have a budget of £2000/£3000 The last thing anyone wants to do is to waste this kind of money on what I would call folly purchases, resulting in either no

improvement or one that is so small as to be insignificant and certainly not worth the money spent. Any advice in pointing me in the right direction would be gratefully received.

Finally, I would like to thank Noel for his past reviews on Ortofon cartridges and Icon Audio products. I have bought their products as a direct result and have never been disappointed. No pressure then!
Regards

Clive Kerr

Hi Clive. That's a lovely system and I am glad you are happy with my recommendations.

To be truthful I do not yet know enough about this whole mains thingy to make similarly confident recommendations, even though I have tried out many filters and have a huge mains balancing transformer hidden in the corner of my lounge, supplying the hi-fi.

There is little information around about mains condition, because testing the mains is dangerous; people don't like to go close. For mains measurement I now use a large E/I step-down transformer that has just about no distortion in itself (when unloaded). This is a simple yet effective approach and shows that in North West London the mains comes in with flattened wave tops and 3-4% distortion. Very interestingly, Ming-Da report exactly the same condition in Malvern, Worcestershire, so I suspect some form of voltage regulation is causing this, likely UK wide. This gives me some confidence in saying that my experience will be the same as others, which is important



The distorted (3%) mains waveform in North West London. Note flat tops and triangulation.

to it being applicable to others – a problem with making recommendations about mains conditioning equipment, especially across national boundaries.

This distortion produces a

spectrum of harmonics that reach up to 1kHz, the audio mid-band – not nice. Only a mains regenerator can cure this; mains filters and balanced mains supplies will have an affect, but a lesser one. This brings some focus to the issue.

Needless to say, a regenerator is expensive, especially as it needs to meet 500-1000 Watts of power demand if a power amplifier is to be supported – desirable. They

amps., not switch-mode supplies. This approach makes for a bulky and expensive unit, but one that uses an internal, frequency locked 50Hz source from a stable crystal reference (from a synthesiser chip) – necessary for turntables using synchronous motors.

So there are two approaches to regenerators: expensive and inexpensive, for hi-fis and computers respectively. From all this you



The IsoTek Evo 3 Mosaic 150 Watt mains regenerator supply we use to keep the sound clean and sweet. Price is £7950

commonly exist as uninterrupted power supplies (UPS) for computers. To date, I have only measured two purposed for hi-fidelity, including the superb IsoTek Evo3 Mosaic.

What's the difference? Distortion. The IsoTek produced less than 0.1% distortion for much of the time and it even has an accurate distortion readout. Whether UPS power supplies for computers such as the Power Inspired AG1500 (see next letter) can match this I do not know yet as we have not tested one. Power Inspired appear to use a switch-mode approach that may generate more noise and distortion than the 'linear' approach of a hi-fi power amp. driving a reversed mains transformer, say Class D Icepower boards driving a 40V:230V step-up transformer (I'm designing this in my head!).

Looking at the big heatsinks inside the IsoTek and Longdog Audio regenerators I have tested to date suggests they both use linear power

can see there is a hierarchy of effectiveness: filters, balancers with filters, computer regenerator / UPS, hi-fi regenerator. Filters cut out hash and noise, balanced transformers reduce distorted earth currents, regenerators do the lot (almost – see Nick Gorham's reply).

For hi-fi use I would suggest a noise and distortion figure (THD) is necessary within the unit's spec – and you won't find this with most UPS equipment. In absence of such, expect the worst, especially from a switch-mode unit that may produce a lot of hash, but of course you could attenuate this with a mains filter on the output (it almost gets silly!).

So what is available? Balanced and filtered supplies are available from Airlink Transformers who have a wide range well below £1000 from which readers report fine results. They are rated in reactive power (VA or Volt-Amperes) for which the not-especially reactive load of a hi-fi

system (unlike a motor for example) that may need a few hundred Watts at most can be supplied by 500-1000VA easily. You need to study manufacturers specs of mains current draw to find out how much each hi-fi unit is drawing from the mains (mains power in Watts).

In the following letter Mark Sheard asks if we have tested the interesting Power Inspired AG1500. This appears to be a switch-mode design and is spec'd at less than 3% distortion, but that is still a long way from the IsoTek's 0.1%. We have requested a review sample. Then there are the PS Audio units, from the USA and available from MCRU; these are expensive like the IsoTek, but less so.

At under £1000 you will likely have to buy and hope. At over £1000 you may want to ask whether a home demo is possible, as PS Audio offer in the States. Everyone reports a happy experience though and I was almost shocked at how much the IsoTek improved our main in-house review system. It became smoother sounding with less coarseness, our Martin Logan ESL-X hybrid electrostatics became better integrated (weird!) and an air of sweetness of tone appeared. I won't say dynamics were improved, but the power amp wasn't included because it drew too much power.

That is as much as I can offer on the subject at present. It is a massive and obscure one about which everyone suffers some confusion. I hope we can continue testing such supplies in future to provide you and all readers with more objective info.

NK

Nick Gorham, Longdog Audio and designer of the LDA Garrard 401 mains regeneration unit, replies.

Hi Clive, Noel kindly asked me to add a little in response to your question. It seems to me that given your report that sometimes the system "really rocks", that the problem (as you suspect) is down to the mains.

As Noel has said, distortion on the mains is a major problem, and one that it seems is getting worse. One solution would be to switch to using a fully regenerated supply which, given your budget, would be possible with something like the PS Audio P3. However,



A mains regenerated power supply from Longdog Audio, purposed for turntables, including the Garrard 401.

I will make another cheaper suggestion which would be to try one of the DC blocker solutions that MCRU make up using LDA technology, starting at £250 with <https://www.mains-cables-r-us.co.uk/mains-products/1128-mcru-in-line-dc-blocker.html>.

The effect of DC or asymmetrical loads on the mains supply is one of the chief sources of distortion, and by causing the transformers in your equipment to saturate, the distortion and noise is generated right inside your equipment. It may not seem to be logical, but one of the places people are using the blockers is putting them in front of mains regenerators. At the front of most regenerators is a large toroidal transformer, and saturation of that transformer will create a spray of distortion harmonics that will only make the regenerator's life that much harder. When I started looking into this some years ago, I did some investigation (you know measurement and science, that stuff that we are not meant to do in hi-fi), and the details of what I found can be seen here <http://www.mains-cables-r-us.co>.

uk/sitefiles/15/2/2/152201/Excelsior_White_Paper.PDF.

Isolation and balancing transformers can also be very beneficial, but as most of them are also toroidal based, they are just as susceptible to the effects of asymmetric mains.

Given your set-up, I think the problem is most likely in the transformer in the power amp. The phono stage will probably (not sure, not taken one apart) have a EI transformer which will be less affected by asymmetry in the supply. Though, as Noel found when he tried the LDA Quartz regenerator, the effect of the supply into turntables can't be ignored. I don't however, have any direct experience of using a regenerator with your particular turntable, so I can't say for certain if there are gains to be made there, though I would be happy to send you one of the quartz regenerators to try as I would like to know if it did.

Nick Gorham, Longdog Audio.

MAINS REGENERATION

I've been thinking about clean power for my hi-fi for a long time now, having



Is the UK manufactured Power Inspired AG 1500 mains regenerator the bargain it appears, asks Mark Sheard? We hope to get one in for review.



"Moving coil cartridges aren't quite as pricey as I'd thought" says Daniel Portillo. "Will my Yamaha A-S1100 integrated amplifier do a decent job" with them?"

just read the review of the Isotek Evo3 it's only raised my interest. But the cost is prohibitive. I've been looking on line to see what is out there and the Power Inspired AG 1500 has my interest. What I would like to know is have Hi-Fi World heard of or reviewed Power Inspired products? At well under a thousand pounds for 1500 watts, I hope you will have a look or maybe a review sometime in the future. Thank you for such a good monthly read.

Regards

Mark Sheard

Hi Mark. Thanks for the info. I have contacted Power Inspired and a review is being organised. The £650 AG 1500 does indeed look very promising and since there is a distortion spec perhaps it will give



Power Inspired AG 1500 is a UPS that works from mains (160V-290V) or battery (internal or external), so it even offers battery based mains supply. Distortion is quoted as less than 3%. "I hope you will have a look" says Mark Sheard.

low distortion, eliminating mains clipping. Because our mains measures 3% distortion (THD) and the AG 1500 spec says <3% (less than 3%) what degree of benefit it provides is uncertain.

NK

MAGNETS OR COILS?

I recently scratched the long-held itch of owning a vintage turntable when I took delivery of a Kenwood KP-1100 imported from Japan (I believe the equivalent model in the West was the KD-990). From what I've been able to ascertain, it has a pretty nice tonearm and one deserving of something of slightly higher calibre than the old Shure M44G moving magnet cartridge that was supplied with it.

Until recently, I'd only ever considered MM cartridges in the belief that MC were 1/ really expensive, 2/ had non-replaceable styli and 3/ required expensive separate phono stages/SUT to do them justice (and I'm not really inclined to consider the expense of said additional kit right now!).

However, from looking around MC carts aren't quite as pricey as I'd thought and it has been suggested that the in-built phono stage in my Yamaha A-S1100 integrated amplifier is likely to be able to do a decent job with MC carts (although you may disagree with this?!)

System-wise, in addition to the aforementioned integrated amplifier I am currently running a set of XTZ 99.25 standmount speakers. The room has wooden floors (with a rug and soft furniture) so I'd be looking to avoid anything that leans toward the bright side.

So, given my prospective budget of £300-£400, what would you consider to be a good match for my (medium mass?) tonearm? Do I stick with magnets or coils?

Thanks,

**Daniel Portillo
Cardiff**

Hi Daniel. With an amplifier as good and well equipped for moving coil (MC) cartridges as your Yamaha A-S1100 you have the world of MCs in front of you. I think you are aiming a bit low considering budget MCs. For what you want to spend, you are right on the limit between the best moving magnet (MM) cartridges and moving coils (MC). The undisputed champion of MMs is Ortofon's 2M Black, worlds away from the Shure M44G!

Good budget MCs are available from Hana of Japan – see our review in the January 2016 issue – and from Denon (DL-103) and Audio Technica. They do not have user-replaceable styli, but are good and inexpensive. If you damage the cantilever, a common approach is to offer a paid-for replacement. Look at the support details on the internet or ask your dealer, before you buy.

I like the sophistication of the Shibata stylus of Ortofon's 2M Black MM. Dave Cawley of Timestep however recommends the Denon DL-110 – and Audio Technica's AT OC9 ML-III is another great MC cartridge at an affordable price with firm, powerful bass I can say from experience. The Benz Micro Ace is also a favourite with many. The warmest balance is offered by Ortofon's Quintet Black, or the Cadenza Black if you can afford it. You should move to coils if you feel happy about the total cost, including possible stylus replacement. Otherwise get a 2M Black. I won't let anyone near my Ortofon Cadenza Bronze, even though it is now older than the cat. **NK**

DIGITAL WORRIES

I expect you can only imagine my surprise and delight to find a reply to my letter Letter of the month for April. I want to congratulate you on a successful diagnosis and a problem duly solved. This took a little longer than you might



An Elac Discovery 101 connected by ethernet cable, instead of the mains: “harshness and a noise has gone” says Paul Goodwin.

expect, hence my delayed reply.

The good news is that you do appear to have solved the problem and an unexpected improvement in sound quality as a bonus. To recap, I was having trouble with my streamer unable to maintain a reliable and permanent connection with my digital library on a NAS drive. You were correct in speculating that the internet through the mains appears to have been the problem. I removed the connection through the mains and established a long cable trailing through the house – a solution originally discounted as such a length of cable would normally be frowned upon in audio terms. Apparently this is not an issue with digital internet type cable – a cat6 Network cable as it is called.

In the same issue (April 2017) you had information about streaming services. I at the same time was considering the Tidal HiFi service so decided to take the plunge. I then spent the trial month subscribing then unsubscribing as my connection continued its unreliability. Sometimes I had both libraries (NAS and Tidal), sometimes only one – but no real logic as to which one. Taking out the “internet through the mains” brought an immediate improvement in the connection and sound quality with the Tidal service. Fantastic, but would this be replicated by the NAS library that is mostly CDs ripped to flac. I waited and hoped it would be so.

It took about ten days for the streamer to eventually find the library on the NAS, I surprised myself with my patience on this, shying away from the usual round of reboots and updates. My patience has been rewarded – just a few days ago the library was discovered, the connection has remained, the Tidal subscription renewed, and the bonus is the sound quality is superb, from both the NAS and Tidal.

The “internet through the mains” connection seemed to have put a

harshness and a noise that I can now detect, because it has gone, if that makes sense. The stereo image and sound stage is much more solid and detailed. There is a musicality that the Elac Discovery 101 streamer provides I truly did not expect from digital.

In my original letter I neglected to name my local hi-fi dealer Doug Brady Hi Fi in Warrington who is nothing but helpful and approachable in all of this. Indeed they too made the same suggestion of the connection.

Kind regards

Paul Goodwin
Liverpool

That’s good to hear Paul – and thanks for writing in again so other readers can benefit from your experiences.

With 10/100 ethernet the usual quoted maximum length of cable is 100metres or 300ft, cat6 being the best you can get. Don’t coil the cable or lead it around large metal objects

like water tanks. Keep the cable as short as possible. Cable impedance will cause loss of signal strength and capacitance exacerbates jitter through time domain indeterminacy at zero crossings. This will degrade sound quality.

I worry slightly about the ten-day time lag in your streamer seeing your NAS library – but hey ho, it’s digital isn’t it. **NK**

REVOX REEL

I’m a reader of your magazine and realise a strange kind of Revox bashing whenever you or your readers write about open reel decks. Under “Olde Worlde” you can’t resist to discredit Revox A77 and B77 machines as being outperformed by Japanese open reels. And your readers complain regularly about a lack of reliability and unavailable spare parts for those decks. Very strange!

As a matter of fact I know many people that use quite old Revox decks since many years without any problems – even audio engineers. On top, at least here on the continent, it’s not a problem to find a professional repair shop and almost every spare part. Some companies produce new, improved parts and tune Revox decks to get an even better performance.

I own a refurbished Revox B77 MkII HS and its sound quality with Master Tapes is simply outstanding. My deck is upgraded with a digital counter and an electronic pause function. I know some of the Japanese decks, most of them were made for home use only and their mechanics are quite simple. On top, they



“The cost of maintaining an A700 is, for most people, beyond what they want to pay” says Dave Tutt.



The Garrard Zero 100SB MkII, with its complex parallel tracking arm that eliminated tracking error distortion.

aren't service friendly at all, many cable looms and few plug-in boards.

Revox machines are based on professional Studer decks that were created for daily use in studios and at broadcasters. I recommend "Revox Online" (www.revox-online.de) for everyone who wants to refurbish or upgrade a Revox deck, or looks for spare parts. They even offer restored Revox products! This shop is located in East Frisia, not so far away from the British shore... So, what's the problem with Revox open reel decks?

Cheers,

Guido Puttkammer
Germany

Hi Guido. I have to say that there are, as with all manufacturers, good machines and bad machines – as well as the odd machine that should never have left the factory.

My worst ever experience has been with the Revox A700 series which to my mind is just a bad design in its electronic layout and the components used, as well as some aspects of its mechanical design. Perhaps it is a little unfair, but having had to change every integrated circuit and capacitor in one due to outright failure, or noise or intermittent issues, you have to understand that this sort of thing is extremely expensive to do from a commercial standpoint and something I have never had to do on any other machine from any other manufacturer.

My third A700 arrived only last week with the same set of issues. Since the heads have about the same life as an average cassette deck, the cost of maintaining an A700 is, for most people, beyond what they want to pay.

Although many prefer the sound of

a Revox, which to my mind brings back the Quad 303/33 era of electronics, I prefer the sound of an Akai GX600D (my own machine) to the others that I have, including a Studer PR99 Mk2 varispeed and various multi-track machines, as well as the Teacs and Pioneer machines that come through the workshop door. There are Japanese machines that are hard work to repair with rusted bearings and failed clutch and motor systems, but this is the same for all old equipment.

On specific points, plug in boards are of no advantage, especially on older equipment. Gold flashing is no guarantee of a good connection. Much as it may seem a good idea I find that it is just as likely to be a source of problems as a great boon to servicing. The A700 is full of them along with poor switching arrangements that means you have to replace entire printed circuit boards if you need to change a switch.

Simple mechanics are of no detriment to the function of a machine. A Ferrari may be a complicated beast but a Ford takes you down the road just the same and it is likely to run without you spending thousands to keep it moving every couple of months. If there is no tape snatching and the mechanism is smooth with good speed stability a simple mechanism is cheaper to build and maintain. The Japanese have been experts in simplifying for a long time. Think of the first VHS video machines and how they became significantly cheaper to build with less rubber belts and parts that wore out.

Mechanical issues occur across all tape machines, no matter who makes them. Many of these machines – be they semi pro or home use – had a design life of around 10 years of

average use. Beyond that there are some which are unlikely to make it any further and as most are now over 25 years old, purchasing one and maintaining it, as well as funding the tape for it, is a dubious exercise unless you have vast amounts of cash.

I often wonder what people do with a tape deck now anyway. Would you invest in one just to copy vinyl or CDs? Unless you do live recordings they are pretty much a recording studio toy that is no longer something the majority would consider in their listening room. They are not spouse friendly items. Most that I have repaired have hardly been used since the service, just sitting gathering dust.

So your Revox for your purposes is probably great. I have had A77 machines here that were fine. Not actually to my taste though and as I have not had to repair my Akai since it was purchased in 1974 or so I have to say that for longevity it wins hands down!

Best wishes

Dave Tutt
www.tutt-technology.co.uk

CHINESE LOSS LEADERS

Noel Keywood's column about the Chinese production system should start alarm bells ringing, if they aren't already. Immediately, I thought of the British motorcycle industry burying its collective head in the sand and sticking with the parallel twin design pioneered in the 50s (I believe), when along came the Japanese and showed them how it should be done – with disastrous consequences!

OK, so the UK hi-fi industry is in rude health, with innovation, value and sound quality all being happily fulfilled,

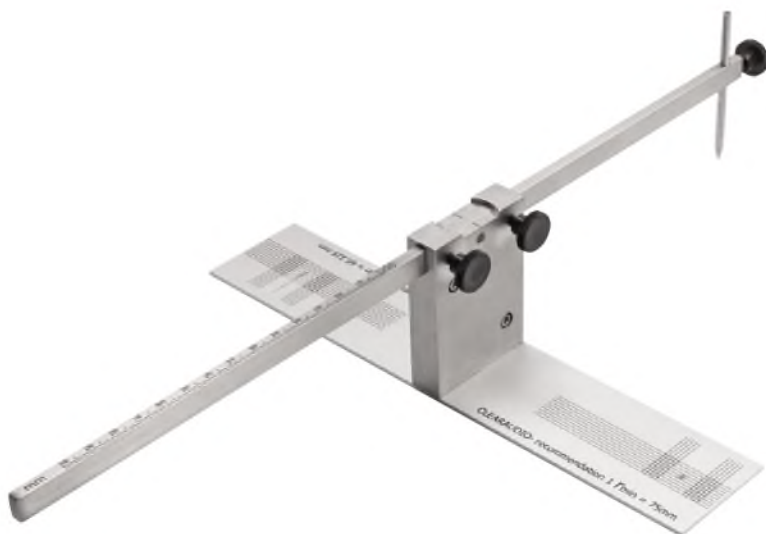

“I gave up on paper/card protractors a while ago, preferring to use my Clearaudio alignment gauge” says Mike Bickley.

but hopefully they are taking note of developments – especially sold-below-cost kit as loss leaders, grabbing market share and forcing manufacturers to drop prices, effectively threatening (even throttling) development, quality and financial stability in an effort to compete, and possible bankruptcy if they fail.

You mention Garrard, who were based about six miles away from my very house, but they lost out – and, surprisingly, haven’t risen phoenix-like from the ashes, like some other much-loved British names (I’d love to see a Zero 100SB Mk III). Still, hopefully it is not too late.

OK, so me buying a FiiO DAP (OK, I admit it, two of the things; an X1 and an X3 2nd gen) is just encouraging them, but they are great players at an even better price, and bought this sort of device into someone of my limited means’ price range, and may lead on to better things one day...

Still, forewarned is forearmed, as someone great once said, so hopefully the message is being heeded and understood. What is the response (if any) you’ve had from the industry on this?

Yours sincerely
John Malcolm

Hi John. British hi-fi companies get on with it in the global market place. Chinese competition is a fact of commercial life, as Japanese competition once was – and still is. As you say today’s high-resolution digital portable players are a technological marvel we can all enjoy because of low price – and they come out of Korea and China, with Sony and Pioneer of Japan also contributing. Germany, USA and UK do not figure, except with models built in the Far East.

Chord Electronics of the UK get close with the Mojo portable DAC, both designed and manufactured in the UK, but it lacks the ability to play on-board files out of memory. Otherwise, Mojo has a performance that exceeds portables, because of its unique DAC. Even the Oppo HA-2SE I review in this issue cannot match its figures.

Motorcycles, like cars, show that all is not lost. Germany makes cars that Far East manufacturers find hard to beat. And Triumph that you mention have motorcycles, like the new Street Triple, that are hard to keep up with. **NK**

TURNTABLE SET UP

I read Noel’s turntable set up article in the June 2017 issue with interest. On the subject of tracking error alignment, I gave up on paper/card protractors a while ago, preferring to use my

Clearaudio alignment gauge – see <http://clearaudio.de/en/accessories/turntable-accessories.php#Top>. This is expensive but worth it I feel. You have to have access to the tonearm’s pivot point to use it.

Another accessory for arm height, VTA and cartridge azimuth is supplied by Russ Andrews – see <http://www.russandrews.com/groovetech-gt-2-mkii-alignment-gauge>. Both these items take away any guesswork involved in setting up a turntable.

Mark Gaudet’s letter in the June 17 issue has raised a few points. Firstly, the most critical setting which usually isn’t set correctly is overhang or tracking alignment. In my opinion this can only be achieved using something like the Clearaudio alignment gauge. Once you have the stylus tip sitting on the cross wires on the protractor, there is no room for error using this procedure – it is right or wrong

On some cartridges, the cantilever is at a slight angle to the body of the cartridge, so if you are using the body of the cartridge to align the cantilever, this explains what you are hearing. With something like the Clearaudio gauge you are aligning the stylus, not the cartridge body. Because the gauge is linked to the pivot of the tonearm, errors are minimised.

Mike Bickley.

Hi Mike. Good point about some cantilevers being angled relative to the body – you have experience here! It suggests the generator is misaligned. However, outward bias force will correct this to some extent if it is an angle to the right and could even be deliberate on the manufacturer’s part. **NK**

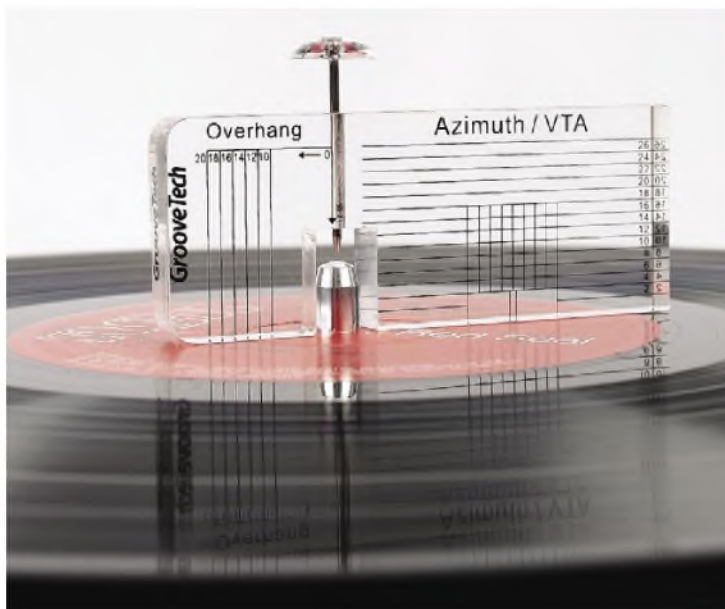

Russ Andrews Groovetech GT2 MkII alignment gauge.

HI-FI WORLD

NOW AVAILABLE
ON THE APP STORE

App Store > Entertainment > audio web publishing ltd

Hi-Fi World

audio web publishing ltd >

Details Ratings and Reviews Related

Screenshots iPhone iPad

HI-FI WORLD

Get

Offers In-App Purchases

This app is designed for both iPhone and iPad

Rating: 4+

TOP IN-APP PURCHASES

1. Hi-Fi World Dec 2015 £3.99
2. Hi-Fi World Subscription £8.99
3. Hi-Fi World August 2015 £3.99
4. Hi-Fi World September 2015 £3.99
5. Hi-Fi World June 2015 £3.99
6. Hi-Fi World May 2015 £3.99
7. Hi-Fi World December 2015 £3.99
8. Hi-Fi World February 2015 £3.99
9. Hi-Fi World November 2015 £3.99
10. Hi-Fi World December 2014 £3.99

LINKS

Privacy Policy

© 2014 Hi-Fi World

Description

Hi-Fi World brings you the best hi-fi... from around the world!

- We listen and measure products in depth, at our London offices.
- Expert opinion from a team of renowned writers, musicians and engineers.
- International standard measurements using Rohde & Schwarz test equipment.

Information

Developer audio web publishing ltd
Category Entertainment
Updated 7 Dec. 2014
Version 1.0
Size 9 MB
Rating Rated 4+
Family Sharing Yes
Compatibility Requires iOS 5.0 or later. Compatible with iPhone, iPad, and iPod touch.
Languages English

DOWNLOAD OUR APP ON APPLE AND ANDROID
DOWNLOAD FROM iTUNES OR GOOGLE PLAY

iPad, iPhone, iPod, Tablets **OUT NOW!**

PUT A SPRING IN YOUR

VISIT OUR WEBSITE: www.hi-fiworld.co.uk

**A SUBSCRIPTION TO HI-FI WORLD
MAKES THE PERFECT GIFT FOR
YOUR NEAREST AND DEAREST.**

SAVE

...up to

26%

Subscribe today and you will get a special discounted rate giving a **saving of 15% to 26%** off the cover price. That's an amazing **£3.83 - £3.33 per issue including postage.**



So don't delay, take out a subscription today!

FOR BACK ISSUES ENQUIRIES PLEASE CALL

01442 820580

OVERSEAS SUBSCRIPTIONS IF YOU LIVE OUTSIDE THE UK,
PLEASE CALL FOR OUR LATEST PRICES

+44 (0) 1442 820580

**SO WHAT ARE YOU WAITING FOR? CALL NOW!!!
SUBSCRIPTION HOTLINE 01442 820 580**

Lines open Mon-Fri 9.00-5.00 or (weekend answering service available)

FOR OUR
ON-LINE MAGAZINE
GO TO WWW.HI-FIWORLD.CO.UK

email:
hifiworld@webscribe.co.uk

STEP WITH THIS GREAT OFFER

WHY SUBSCRIBE TO HI-FI WORLD?

- 12 issues a year delivered straight to your door.
- Be first to grab a bargain in our "Free Reader Classified Ads" section.
- Run by dedicated hi-fi engineers and enthusiasts.
- Subscribers receive a minimum 10% Discount annually.
- Hi-Fi World has become famous for its informative reviews and radical kit designs.
- **PLUS!** Subscribe by Direct Debit and receive a 16.5% discount on a yearly subscription (UK only).

Instruction to your Bank or Building Society to pay by Direct Debit



Please fill in this form and send to:

Hi-Fi World, Subscriptions Department Unit 4 College Road, Business Park, College Road North, Aston Clinton HP22 5EZ

Originator's Identification Number

4	2	7	0	4	9
---	---	---	---	---	---

Name and full Postal Address of your Bank/Building Society

To: The Manager	Bank/Building Society
Address	
Postcode	

Name(s) of Account Holder(s)

--

Branch Sort Code

--	--	--

Bank/Building Society Account Number

--	--	--	--	--	--	--	--

Reference

HF

Instruction to your Bank or Building Society

Please pay Webscribe Ltd Direct Debits from the account in this Instruction subject to the safeguards assured by the Direct Debit Guarantee. I understand that this instruction may remain with Webscribe Ltd and, if so, details will be passed electronically to my Bank/Building Society.

Signature(s)
Date

Bank and Building Societies may not accept Direct Debits Instructions for some types of accounts
The guarantee should be detached and retained by the Payer

The Direct Debit Guarantee



- This Guarantee is offered by all banks and building societies that accept instructions to pay Direct Debits
- If there are any changes to the amount, date or frequency of your Direct Debit Webscribe Ltd will notify you 10 working days in advance of your account being debited or as otherwise agreed. If you request Webscribe Ltd to collect a payment, confirmation of the amount and date will be given to you at the time of the request
- If an error is made in the payment of your Direct Debit by Webscribe Ltd or your bank or building society you are entitled to a full and immediate refund of the amount paid from your bank or building society
- If you receive a refund you are not entitled to, you must pay it back when Webscribe Ltd asks you to
- You can cancel a Direct Debit at any time by simply contacting your bank or building society. Written confirmation may be required. Please also notify us.

TERMS & CONDITIONS: You will receive 12 issues per year. Minimum subscription term is 12 months. Prices include P&P and are correct at the time of going to press. All prices are quoted in sterling. Offer available for UK subscribers, only. For enquiries relating to overseas pricing call + 44 (0) 1442 820 580.

I would like a years subscription to Hi-Fi World and receive a discount off the cover price (I have read and accept the terms and conditions).

I would like to pay for my 12 issues by:

6 monthly Direct Debit: Pay £22.00 every 6 months saving 19% off the yearly subscription rate of £54.00

Annual Direct Debit: Pay £40.00 every 12 months saving 26% off the yearly subscription rate of £54.00

Annual cheque/credit card: Pay £46.00 saving 15% off the yearly subscription rate of £54.00

Cheques made payable to Audio Web Publishing Ltd.

Your Details

Title _____ Forename _____

Surname _____

Address _____

Post Code _____

Daytime Tel: _____

Email: _____

Please debit my VISA MASTER MAESTRO AMEX (SWITCH)

Security No: (last three digits printed on the signature strip)

--	--	--	--	--	--	--	--	--	--	--	--	--	--	--	--	--	--

Valid from Date: ____/____/____ Expiry Date: ____/____/____

Switch card issue No:

Cardholder Signature: _____

Outside UK:-

EUROPE Airmail **£50.00**

OVERSEAS Airmail **£70.00**



Send this form to:

Hi-Fi World, Subscriptions Department Unit 4 College Road, Business Park, College Road North, Aston Clinton HP22 5EZ

ortofon

accuracy in sound

CADENZA

The Cadenza Series represents another example of Ortofon's constant push toward technological perfection. By taking key design characteristics from previous market leaders, such as the MC Jubilee and the Kontrapunkt Series, Ortofon have developed Cadenza to elevate any decent Hi-Fi system to a whole new level.

The range consists of five different models, including a Mono version, but they all adhere to Ortofon's core principles of accurate information retrieval and phenomenal sound performance.



ortofon



Distributed by Henley Designs Ltd.

T: +44 (0)1235 511 166 | E: sales@henleydesigns.co.uk | W: www.henleydesigns.co.uk

Signature Sound

America's Polk Audio takes on the British budget loudspeaker market with its new Signature S15. Jon Myles finds it a true contender.

Polk Audio may not be among the best-known hi-fi brands in the UK – but the company is something of a powerhouse in its native America with a reputation for building excellent sounding loudspeakers at down-to-earth prices. Founded in 1972, Polk has an extensive research and design facility in Baltimore in Maryland and holds a number of patents on its various cabinet, crossover and driver technologies.

Now its looking to make a mark this side of the Atlantic with the

launch of its new Signature series. The extensive range consists of three floorstanders, two centre channels, a small satellite surround unit and a pair of standmounts – the smallest of which is the S15 on review here.

As that list implies the Signature line-up is positioned to be used for hi-fi as well as a full home theatre set-up – which is much more popular in the US than here – and Polk's literature makes much of the fact that the S15s are ideal for using as a rear channel pair in a home 5.1 system.

But don't let that put you off

their talents when used in a straight two-channel system for they have a lot to offer (see Sound Quality later).

Design-wise they are a traditional compact two-way standmount measuring 12"x 7.5" x 10.25" (H/W/D) and weighing in at 5.9kg per 'speaker. The cabinet itself has nicely rounded edges at both top and bottom and is stiffly braced internally to eliminate unwanted vibration.

The custom-made drivers consist of a 1" Terylene domed tweeter allied to a 2.52" mica-reinforced polypropylene mid-bass unit with butyl rubber surround. These are





STELLAR SOUND

Discover the 5-star Tucana II Anniversary Edition amplifier and the new Quasar streaming amplifier with DAC and Bluetooth, available now.



fixed to a baffle which is bolted onto the front fascia for added rigidity.

Around the rear are a single pair of 'speaker binding posts and the reflex port - although you may find it hard to spot the latter at first. This is because of what Polk describes as its proprietary Power Port technology. In essence it's a shaped metal plate positioned an inch away from the port's opening and extending from the top of the cabinet to just above the 'speaker terminals. This deflects the port's output to either side in an effort to achieve greater dispersion into the listening area.

Polk says this eliminates turbulence and distortion for bigger low-end impact claiming it offers 3dB more bass response output than a traditional port. One other advantage is that it means the S15s can be used closer to a rear wall without adversely affecting the sound.

SOUND QUALITY

At £300 a pair the Polks face considerable competition from established British brands such as Tannoy, Monitor Audio and Wharfedale as well as their US counterpart JBL.

Connected to a Creek Evolution 100A integrated amplifier via Tellurium Q's new Black II 'speaker cable, the Signature S15s had a fast, punchy sonic signature that was musical and fun, with an emphasis on clean treble and powerful bass.

With the electronic percussion of Safri Duo's 'Samb-Adagio' the sound was much bigger than I expected from such a relatively small set of loudspeakers. Mid-bass response was pleasantly tight without being boomy or flabby at any point, so the track raced along – just as it should. There was an element of warmth on evidence probably down to the Power Point technology, but it didn't translate into a muddy sound.

Higher up, the Polks have crisp treble which – while not as extended as a ribbon tweeter – gave vocals excellent definition. Beth Gibbons' plaintive singing on Portishead's Dummy was pin-sharp, while the Polks made me fully aware of her distinctive phrasing.

The tweeter also projects well and has a fast quality to it, so the complicated fretwork on Antonio Forcione's 'Tears Of Joy' had both bite and definition. The subtle double bass which drives the rhythm along also had plenty of space around it. This track has significant dynamic shifts – switching



The Polk loudspeakers use a plate on the back for controlling bass output from the port. It's unusual but works well.



from loud and forceful to slow and quiet in a second – and the Signature 15s kept pace with the changes without missing a beat.

I've heard this track through 'speakers costing around £500 that failed to convey the atmosphere of the piece as well as the Polks.

Admittedly, the Polks don't extract every last ounce of detail on some recordings - some of the electronic effects on Jamie XX's 'In Colour' sounding a little recessed - but for a £300 set of loudspeakers they do an outstanding job and you have to pay a good deal more to

better them. Their main attribute is making music sound fun while retaining a sense of detail and authority.

CONCLUSION

Polk may not have the highest of profiles in the UK but on the evidence of the Signature S15s that deserves to change. They produce good bass from a small cabinet and match this with a well-judged midband and treble. Pair them with a decent budget amplifier and you will have the basis of a cracking system whatever genre of music you like to listen to.

MEASURED PERFORMANCE

Frequency response of the Polk Signature S15 measured reasonably flat at 25 degrees off axis, our analysis shows; the speakers should be pointed straight down a room, not at listeners. There is a small plateau lift in output above

3kHz, due to accentuated output from the tweeter. This will add a sheen to the sound; the Signature S15 will not sound warm. Output from the tweeter peaks toward 10kHz and detail will be strong, but there may be some sharpness at times from CD or MP3.

FREQUENCY RESPONSE

Green - driver output

Red - port output



Sensitivity was typical for a small stand mounter, measuring 87dB from one nominal Watt of input (2.8V). Measured impedance (with pink noise) was 6 Ohms but the bass unit is a 4 Ohm unit, like most, to keep voltage sensitivity up.

Our impedance trace shows bass damping imposed by the port as a 'dip' around 65Hz with residual peaks either side, and these apart the load is resistive. This is a common port damping behaviour, showing the port is fairly narrow tuned – a characteristic reflected in the symmetrical acoustic peaking in seen in our red port trace. This result gives lively sounding bass, if not as even a sound as broader damping.

IMPEDANCE

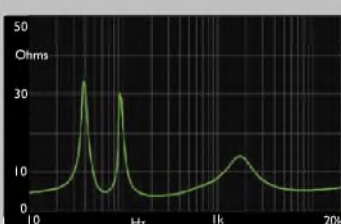

The Polk S2 measures well in all areas, but it will sound a little bright. **NK**

POLK SIGNATURE S15 £300



OUTSTANDING - amongst the best.

VERDICT

A well-rounded budget loudspeaker with an infectious sound that never fails to please.

FOR

- good bass
- clean treble
- easy placement

AGAINST

- nothing at the price

Polk Audio
www.polkaudio.com



exposure



exposure

Exposure Electronics Limited

Unit 18, Winston Business Centre, 43 Chartwell Road
Lancing, West Sussex, BN15 8TU, United Kingdom

www.exposurehifi.com



MIXX AUDIO S3 WIRELESS BLUETOOTH SPEAKER & DIGITAL ALARM CLOCK £40

A portable, lightweight wireless speaker, digital clock with alarm or phone charger. Available in pink and black, with anti-slip base and dual 3W speaker, the S3 features two alarm settings. It also offers a 3.5mm Aux port to connect non-Bluetooth devices.

The built in microphone allows for hands-free calls. Bluetooth 4.0 connects to smartphones, laptops or tablets within 10m, supported by a rechargeable battery with up to

seven hours music playback time. A back up battery option retains clock time and alarm.

It is best utilised in a small space as a near-field 'speaker, due to its low power amplifier and small chassis.

I played Paul McCartney's 'Get Yourself Another Fool' on MP3. For the price (and the format), I was pleasantly surprised at the open, relaxed and airy nature of the sound.

Upper midrange detail was actually aided by turning the chassis side on to point the speaker directly at you.

The Aux port proved to

be sonically unforgiving, though. Connecting my Astell&Kern AK120 player and playing Bob Marley's 'I Shot The Sheriff' at 24bit/96kHz and the inevitable lack of bass highlighted a strident midrange output. Here, the Mixx was best listened to just away from 'head on' to reduce this tonal spotlight towards brighter upper mids.

I returned to Bluetooth, connecting to my MacBook via Bluetooth and played Sonny Rollins' 'St Thomas' via Audirvana+ at 24bit/96kHz. Here, although bass was merely suggested, midrange offered excellent balanced upper mid and treble detail from the small 'lifestyle' chassis while the lower midrange/upper bass added enough balance throughout the soundstage to provide a useful tonal contrast. Best heard as a streaming speaker, the Mixx offers a pleasant and smooth, but forward sonic output.

PR

[www.mixx-audio.com]

SOUNDBITES



POWERPURIFIER CLASSIC MAINS PURIFICATION £329

A mains purification product with a difference, three areas of mains contamination are targeted: spikes and surges, mains noise and Wi-Fi interference. Offering a single chassis with a removable casing, inside are a range of colour-coded sockets to house separate, plug-in, colour-matched, boxed modules.

The modules include the UltraPurifier which is fitted as standard to the PowerPurifier and promises mains noise reduction.

The other standard module is



the SuperClamp for spike and surge protection.

You can purchase extra modules. The first is the MegaClamp (£180, an upgrade for the SuperClamp) which offers enhanced spike and surge reduction. The ClarityMains (£114 each) is a mains conditioner utilising Coherence Technology. Up to four of these modules can be fitted to the PowerPurifier. Finally, Mains Zapperators (£142) are mains conditioners that deal with very high frequency noise from wireless computer networks. You will need to add your own mains cable.

I used a default kettle cable and hardware store power block as a reference. Adding a single ClarityMains module opened up the soundstage, infusing it with space and air, enlarging the stage itself. Upping the number of modules to four, the vocal presentation exhibited more detail with greater depth in the soundstage while midrange smearing of the upper mids was reduced to reveal subtle synth runs for the first time, while bass no longer bloomed.

Plugging in the Mains Zapperator, I was impressed by the smoothness of the vocals and an organic presentation, without mechanical falsity about the percussion when all of the modules were in place.

The Purifier won't solve all of your noise issues but no one-box system can. It does, though, remain an important first step and, for many, will be revelatory in terms of sonic improvement. **PR**

[01539 797300

www.russandrews.com]



WORLD STANDARDS

Your guide to the best products we've heard that are currently on sale in the UK...

TURNTABLES

AVID INGENIUM £800
Great bass response and upper midrange detail allied to clarity makes this a must-hear at its price-point.



CLEARAUDIO INNOVATION £6400
Expensive, but offers great results from a finely honed and beautifully finished belt drive turntable, with servo control from the platter to keep a grip on tempo like few others. Can be fitted with a Clearaudio tangential arm, or any conventional design. Awesome.



INSPIRE MONARCH £4,350
A rebuilt from the ground up Technics Direct Drive, having blistering pace and dynamics allied with smoothness, sophistication and purity of tone. A true reference.



LINN LP12SE £3,600
The UK's most iconic turntable, the legendary Svindek goes from strength to strength. New Keel sub-chassis and Radical DC motor add precision and grip to one of the world's most musical disc spinners. Expensive though.

MICHELL GYRO DEC £1700
Wonderful styling coupled with great build and finish make this turntable a delight for friends and family. It has an attractive clear acrylic dust cover, and you can mount just about any arm. A current design standard.



PRO-JECT ESSENTIAL DIGITAL £300
A budget turntable that turns in a great analogue performance, but also has a hi-res digital output. Send 24/96 across your lounge via optical cable to a DAC and get great audio quality. Or record LP to your laptop.



REGA RP3 £550
The first of the super-quality Regas, little compromised by price and featuring Rega's outstanding RB303 tonearm, suitable for MM and MC cartridges. A standard at the price point.

TIMESTEP EVO £2100
The famous Technics SL-1210 MkII Direct Drive but with improved plinth, isolation, main bearing and power supply, plus an SME arm (add £1500). DD convenience, rock steady pitch and fab sound at a great price. Our in-house reference.



TONEARMS

ORIGIN LIVE ENCOUNTER MK3C £1,745
Origin Live combines carbon fibre and ebony to marvellous effect in its new 12-inch arm. Creamy and rich in presentation, the Encounter delves deep into the mix for a satisfying listen.

HADCOCK GH-242 EXPORT £810
Consummately musical, lyrical sounding tonearm, but needs the right turntable.

ORIGIN LIVE ONYX £450
Easy, smooth, creamy nature that reminds you why you're listening to vinyl in the first place. Essential audition at the price.



REGA RB303 £300
A one piece tapered casting makes this arm's structure almost unrivalled. Great dynamics and superb imaging, for MM and MC. Reference quality for peanuts.

SME 312S £1,600
Twelve inch magnesium alloy tapered arm tube plus SME V bearings. An insightful yet smooth and relaxed sound. Superlative build completes the package. Our Editor's steed.



SME 309 £1500
A one-piece tapered 9in arm finished like a camera and slick to use. Superlative SME quality and sound at affordable price.

SME V £3000
Offers rapid fire timing and a sense of precision, plus rock solid dynamics. Top dollar for deep pockets.

CARTRIDGES

AUDIO TECHNICA AT-OC9 MLIII MC £420
A fine sounding MC with strong bass and super fine treble from a great stylus – yet inexpensive.



AUDIO TECHNICA AT-F3/III MC £150
Great value entry level moving coil with detail and grip you just can't get from similarly priced moving magnets.

BENZ MICRO ACE SL MC £595
Smooth, lucid and full-bodied, award-winning, hand-made cartridge from Switzerland.

BENZ MICRO WOOD SL MC £945
Highly finessed Swiss moving coil that plays music with rifle-precision.

DENON DL-103 £180
A popular and much loved budget MC with big bass, smooth treble and deep sound stage. Fantastic value.



LYRA TITAN I MC £3,500
Breathtaking speed and dynamics from LP, helped by diamond coated, boron rod cantilever.



ORTOFON 2M MONO SE MM £80
A mono cartridge purposed for The Beatles in Mono microgroove LPs. Fitted with a top quality Shibata tip. Fab for the four.



ORTOFON 2M BLACK MM £400
As good as it gets from MM. Fabulous detail and insight from a Shibata stylus, good bass and excellent tracking.

ORTOFON CADENZA BRONZE MC £1,400
A mid-price MC with a slightly livelier presentation than the super smooth Cadenza Black. High-end sound at midband price – great value.



ORTOFON CADENZA BLACK MC £1,800
Ultra smooth and dimensional moving coil with bass and punch aplenty. Lovely stylus

ORTOFON A95 MC £3,750
Fast and extremely detailed, this is an MC cartridge that sets standards

REGA CARBON MM £35
Budget price for a competent cartridge with a fairly unflappable nature. Ideal for beginners.



GOLDRING 1012GX MM £250
A glorious sounding cartridge with solid bass and strong dynamic punch, plus excellent treble from its Fritz Geiger stylus. Fun and affordable.



SHURE M97XE £80
Big warm sound, but great tracking and bullet proof stylus protection from damped guard. A survivor.

VAN DEN HUL DDT-II SPECIAL MC £995
Long-established cartridge from Holland with an open and dynamic sound.

PHONO PREAMPS
CAMBRIDGE AUDIO 651P £200
Clean, concise sound from MM and MC cartridges at a very low price. A real bargain.

ICON AUDIO PS3 MKII £2,500
All valve MM phono stage with MC transformer option, graced by big, spacious and relaxed sound.



IFI IPHONO £350
Multi EQ phonostage from British manufacturer that punches well above its weight. Substantial bass and open midhand.



LEEMA ACOUSTICS ELEMENTS ULTRA £1,199
Smooth and detailed sound with the ability to accommodate most modern cartridges. Exceptional value for money



PRO-JECT TUBE BOX DS £425
Compact MM and MC phonostage with valve output circuit and a big sound.



QUAD QC24P £995
MM and MC, oodles of gain, a volume control – and valves! Looks superb and sounds even better: smooth, atmospheric and big bass.

TIMESTEP T-01MC £995
New, minimalist phonostage that sonically punches well above its weight.

PREAMPLIFIERS
ICON AUDIO LA-4 MKIII £1,400
Uses early 6SN7 triodes for liquid sound. Has plenty of gain and a remote control into the bargain.



MF AUDIO CLASSIC SILVER £4,500
One of the best preamplifiers we've heard at any price, this transformer-coupled marvel does very little wrong. It's powerful, clean and open, yet delicate. Its sound is unmatched at or near the price.

MING DA MD7-SE £1,520
A valve preamplifier with an open, effortless sound and a big soundstage. It has plenty of gain so will accept any source and drive any power amp. A real beauty.



INTEGRATED AMPLIFIERS
ARIANO PRO845SE £1,499
Pure single-ended valve magic. Low-powered but immediately gorgeous, easy-going yet forcefully dynamic at the same time.



AUDIO RESEARCH VS160 £3,500
Power house sound with enormous pace and punch from traditional U.S. muscle master Audio Research. Breathtaking, but expensive.



CAMBRIDGE AUDIO AZUR 651A £350
Dual-mono construction and meaty toroidal power supply combine to produce a solid and sharp sound with sonics far beyond its price point

CREEK EVOLUTION 100A £1,500
Superb build and smooth confident sound make this powerful amplifier a benchmark



CYRUS 8DAC £1,400
Trademark shoebox-sized Cyrus integrated now offering 88Watts per channel, plus DAC. Svelte delivery from a dainty case that fits in anywhere – and isn't Class D!

EXPOSURE 1010 £495
Entry-level integrated from Exposure has excellent upper mid-performance with an almost valve-like sound.



ICON AUDIO STEREO 60 MKIII £2,800
Excellent tube integrated with plenty of power and an expansive soundstage, plus KT150 tube option and bias meter for easy adjustment.



NAIM NAIT 5Si £925
Naim's fabled entry-level integrated amplifier is updated to si status. Demos Naim's superbly muscular sound at entry level.

SUGDEN A21SE £2,480
Class A amp with fantastic sound quality producing hard, sculpted images, deep detail and tight bass. Just don't expect disco-like sound levels!



POWER AMPLIFIERS

AUDIO RESEARCH VS175 £7,498
Powerful, fast valve sound that makes everything else look weak at times. Needs careful matching but well worth the effort.

AUDIO RESEARCH VS115 £5,000
Oodles of power with enormous punch. Rafael Todes said it provided "shock and awe" while retaining incredible smoothness and texture.

ICON AUDIO MB845 MKII £7,600
With 120W from big 845 valves right down to low frequencies, this power amplifier has massive dynamics and bass swing, yet is easy on the ear.



ICON AUDIO MB81PP £15,000
Big Russian transmitter valves deliver 200W from these massive monoblock amplifiers. Frightening in every sense.

MCINTOSH MC-152 £4,995
Stunningly insightful sound with enormous bass punch from a uniquely designed transistor amp. Amazing audio, a league up, if expensive.



QUAD ELITE QMP MONOBLOCKS £2400 PR
The proverbial iron fist in a velvet glove. Plenty of power but delivered with an assured and confident nature. Smooth on top and easy on the ear but can rock out when needed.

QUAD II-EIGHTY MONOBLOCKS £6,000 PR
Powerful and expansive sound from modern design monoblocks that also look lovely. Superb – used by us as a reference.



LOUDSPEAKER FLOORSTANDER

B&W 803 D3 £12,500
B&W's updated statement floorstanders deliver depth and definition with breathtaking speed and authority, aided by a diamond coated tweeter. Expensive – but enormously impressive.

CASTLE AVON V £1,600
A big floorstander at a modest price that suits the average room. Refined ribbon treble and deep bass give it a great delivery.



EMINENT TECHNOLOGY LFT-8B £2,500
Excellent U.S. planar magnetic loudspeaker at bargain price. Utterly superb - a must hear.

EPOS K2 £1,000
A fun sound that is tidy all round and very engaging, with solid bass. Music as you hope it to be.

FOCAL ARIA 926 £1,400
Simple, clean, neutral sound – easy going but well engineered and affordable.

MARTIN LOGAN SUMMIT X £16,698
Matches Martin Logan's XStat electrostatic panel to a powerful subwoofer to provide extended, powerful bass. Dramatic sonic purity. Awesome – all but unmatched.



MARTIN LOGAN ELECTROMOTION £2,500
Martin Logan's budget baby XStat hybrid electrostatic. Fits into any lounge to give electrostatic levels of clarity and imaging.



QUADRAL CHROMIUM STYLE 8 £1,700
A supremely smooth yet open sounding loudspeaker. Clean and detailed treble from a fine ribbon tweeter. Accurate yet informative and enjoyable. Pure class.

QUADRAL ORKAN VIII AKTIVS £6,200
Active loudspeaker with tight, powerful bass, perfect accuracy and detailed treble from a ribbon tweeter.



Q ACOUSTICS 2050i £480
A large floorstander at a budget price. Offers high sensitivity and big sound and has very few flaws for the price.

SPENDOR SP100 R2 £6,495
Retro looks but a sound that's hard to match. Sendor's 12" bass unit provides massive low-end grunt with a room-filling sound.



SPENDOR A3 £1,300
Fine little floorstander with a smooth, natural midband and even tonal balance. Ideal for smaller rooms.

TANNOY DEFINITION DC10 TI £6,000
Enormous power with great projection. Glorious subsonics too. Need little power to go very loud and have superb finish into the bargain.



TANNOY KENSINGTON £9,950
Big but not overpowering, punchy modern sound from classic cabinetry. Need little power to go very loud and suit a traditional home, or castle.



LOUDSPEAKERS STANDMOUNT

ACOUSTIC ENERGY NEO 1 V2 £225
Civilised sounding speaker with fast and tuneful bass.

ACOUSTIC ENERGY AE1 CLASSIC £845
Brilliantly successful remake of an iconic design; not flawless, but surely one of the most musical loudspeakers ever made.



ELAC BS243 £1,000
More transparent and spacious than they've a right to be at this price, these refined mid-price standmounters represent top value.



EMINENT TECHNOLOGY LFT-16A £1,200
U.S. planar magnetic bookshelf loudspeaker with unrivalled mid-band and treble. Hear it before all else.

WHARFEDALE DIAMOND 220 £200
Builds on the success of previous Diamond ranges with better bass, more detail and a greater sense of scale.



KEF LS50 £800
Supremely musical mini-monitors which sound much bigger than they look.



MARTIN LOGAN MOTION 35 £1,300
Folded Air-Motion tweeter gives a taste of Martin Logan's electrostatic sound in a standmount. Different from the standard mini-monitor and all the better for it.



PMC TWENTY.21 £1,575
Transmission line loaded standmount with a big box sound from a compact cabinet. Punches well above its weight



Q ACOUSTICS 2020i £165
Great little bargain-priced stand-mounts with a friendly, fun yet surprisingly refined sound. Hard to better for a pair of starter loudspeakers.

WHARFEDALE DENTON £500
A beguiling mixture of retro looks with modern, high-technology drive units. The Denton has an easy-going, big-hearted sound with a touch of trad warmth that should appeal to many.



HEADPHONE AMPLIFIERS
CREEK OBH11 £150
Designed specifically for low to medium impedance (30 Ohm – 300 Ohm) headphones the little Creek has a marvelously well-judged sound.

CHORD MOJO £399
Class leading portable DAC and headphone amp with ability beyond all else. Big, open spacious sound.



EPIPHANY EHP-02 £99
PP3 battery-powered portable gives great sound quality at an almost giveaway price. Happy with the output from an iPod or CD player, the little epiphany is a true bargain.



ICON AUDIO HP8 MKII £650
The HP8 MKII valve-based headphone amplifier brings the spacious sound of valves to headphones. And it matches 'em all.



FIDELITY AUDIO HPA 100 £350
Great little headphone amplifier with a lively yet refined and open sound.

MUSIC FIRST PHONE BOX £276
Brings a big stage, plenty of detail and rich, deep colours to the sonic spectrum.



OPPO HA-2 £250
Remarkable performance and sound from ESS Sabre32 DAC in a slim portable package.



CD PLAYERS
AUDIOLAB 8200CD £949
Inspired CD player and DAC with price-performance ratio like no other. Capable of matching designs costing much more.



CANOR CD2+ £3,100
Musically coherent and tuneful valve-driven CD player from Slovakia. Lovely liquid sound.



CAMBRIDGE AUDIO AZUR 651C £410
Snappy modern presentation from this budget CD player. Cracking audiophile entry point for any digital fan.

CHORD RED REFERENCE MKIII £16,000
A unique and massive engineering exercise that could well be the best CD player available. Chord's Pulse Array DAC technology produces a musical experience like few others. A true reference player.



ESOTERIC K-03 £9,495
Superb high-end silver disc spinner that is beyond criticism. Devoid of its own character but has a flawless presentation.



EXPOSURE 101 £395
Detailed player with fine sense of timing should be an automatic entry on any demo list at this price.

ELECTROCOMPANET EMP-1/S £4,650
Epic in scale, lavish in tone and exuberant in its musicality - this is a memorable SACD spinner. Quirky in operation and modest in finish, though.



OPPO BDP-105D £1200
Universal player and DAC that makes CD and Blu-ray (+DVD) sound deep, spacious and full bodied. Reference quality that's affordable.



REGA APOLLO-R £550
Rega comes up with a fine CD player again. Tremendous detail and an easy, unforced sound at all times. Few bells and whistles but made up for by its superb sonic ability.

ROKSAN KANDY K2 £900
A charmingly musical performer at the price - this is a surprisingly sophisticated CD player for the money.



TUNERS
CAMBRIDGE AUDIO AZUR 651T £299
Value-packed AM/FM/DAB and DAB+ ready tuner. Precise and detailed with excellent resolution of spoken word.



CREEK DESTINY 2 £550
Creek's tuner expertise shines through in the Destiny 2. This AM/FM receiver is wonderfully three-dimensional and smooth.



MAGNUM DYNALAB MD-90T £1,900
Exceptionally able, but commensurately priced, audiophile tuner that cannot fail to charm.



DACS
AUDIOLAB M-DAC £600
Excellent sound from ESS Sabre32 DAC and impressive flexibility with a unique range of filter options make this a stand-out product. Low price is the icing on the cake.



AUDIOLAB Q-DAC £250
Stripped-down version of Audiolab's M-DAC loses some features but retains much of the sound, making it a veritable bargain.

ANTELOPE ZODIAC GOLD/VOLTIKUS £3,095
DAC/preamp/power supply combination majors on detail but has a remarkable un-digital sound. One of the best at its price.



CHORD 2QUTE HD £990
Superb build quality and exceptional sound from this compact unit. Boasts the ability to handle DSD direct via USB and has an exceptional soundstage. One of the best DACs you can buy.



DCS DEBUSSY £8,000
DCS's bespoke 'Ring DAC' circuit gives a beautifully-fluid, almost analogue sound that encourages long listening sessions. Not cheap but worth every penny.

NORTHERN FIDELITY DAC £650
Packed full of features, including Bluetooth and USB, this ESS Sabre32 equipped DAC offers crisp, insightful sound at low price.



METRUM OCTAVE £729
Unique two-box digital-to-analogue converter with great sound at a great price. Cuts upper treble, though.

NAIM DAC £2,400
Superb high-end digital converter with a probing, punchy and forensically-detailed sound.



TEAC UD-501 £699
Feature-packed DAC with benefit of DSD playback. Superb sound means little to touch it at the price.



RESONESSENCE INVICTA MIRUS £4,499
One of the most highly spec'd DACs available, with a smooth yet enthralling presentation. Few approach it.



NETWORK PLAYERS

CHORD DSX100 £7,500
Chord's proprietary DAC circuit shines in their top-of-the-range streamer. Hear-through clarity with a sound rich in detail, dynamics and soundstage.



CAMBRIDGE AUDIO NP30 £399
Budget offering from Cambridge offers a great introduction to network streaming.

CYRUS STREAM X £1,400
Gorgeous sound quality even from compressed digital music. New control app makes everyday operation a doddle.



CONVERT TECHNOLOGIES PLATO £2999.00
A network player with amplifier that does it all, including turn LP to hi-resolution digital, and add cover artwork from the 'net.



NAIM NDX £2,995
Clean, incisive and very detailed sound with Naim's traditional pace and timing make this one of the best network music players around.

NAIM ND5XS £2,175
Great sound quality with traditional Naim heft. A wonderful DAC with full 24/192 handling. Only the display could be better.

NAIM NAC-N172 XS £1,650
A pre-amp/DAC/streamer package provides a taught, rock-solid presentation with a tonally rich midband and a superior sense of rhythm.



PRO-JECT STREAM BOX RS £1,095
Unusual valve-based streamer/preamp with variety of inputs and a lovely liquid sound. Not the most detailed but compensates with sheer musical verve.

QUAD PLATINUM DMP £2,500
Combined CD/network player has all the usual Quad elements but with added zest and detail that brings life to everything you care to play.



DIGITAL SOURCES

ASTELL&KERN AK100 MKII £569
Portable high-definition digital player with superb sound quality. Punchy and fast.



FiiO X3 £150
Fabulous value player with nice easy sound and full range of abilities. Small and light. For newbies

LOTOTO PAW GOLD £1,500
Reference quality sound; it's like carrying your hi-fi in your pocket. Equivalently large too, but stunning headphone quality



NAIM HDX £4,405
Interesting one-box network-enabled hard-disk music system that gives superb sonics together with impressive ease of use.

NAIM UNITILITE £1,995
A 50W amplifier with traditional Naim heft, a CD player and vhf/fm radio, plus network input and Bluetooth make this a great all-in-one.



PORTABLE SPEAKERS

BAYAN SOUNDBOOK £149.99
Superb design and great sound make for one of the best portable Bluetooth speaker/radios on the market. Not the cheapest – but worth every penny.



IRIVER IBA-50 £69
Big, warm sound with plenty of volume and clean at high levels. Muscular sound compared to many rivals.

CABLES

BLACK RHODIUM TWIST £71/3M
Twisted to fight off radio frequency, the Black Rhodium speaker cable is easy on the ear with a fine sense of clarity and focus. A remarkable performer at the price.



MAINS CABLES R US NO.27 £95
Offers a sprightly pace with a precise nature. Fast performance enhance frequencies and beautifully etched detail.



CHORD SIGNATURE REFERENCE £900
Majors on timing, detail and openness. Capable of getting the best from most systems and a recommended upgrade



TELLURIUM Q BLACK 280/3M
A deep, dark, velvety performer that's nevertheless highly musical, it represents excellent value as mid-price cables go.

TELLURIUM Q SILVER DIAMOND £804/M
An open, natural and transparent sound that is difficult to beat, from these great loudspeaker cables.



HEADPHONES

AUDEZE LCD-3 £1,725
A planar magnetic 'phone that offers monitor quality. Strong sound with silky, dark quality that others struggle to match.



B&W P3 £170
Beautifully presented headphones from the loudspeaker specialists. Feed them a good quality source signal and they reward with excellent sound.

JAYS V-JAYS £49
Wonderful little budget over-ear portable 'phones with a clean, clear sound to beat the best of the rest at the price.



NOBLE K10 INC. FITTING £1,279
Custom fit in-ear phones with 10 drivers deliver a sound that is out of this world. Personal and perfect.



OPPO PM-1 £950
Planar magnetic phones with a warm, easy but big bodied sound that draws you in. Need a lot of drive, but deliver superb bass.



SENNHEISER HD700 £599
Tremendously fast with a strong, focussed, lower-frequency range and a firm bass punch.



YAMAHA HPH-MT220 £150
Purposeful for indoor monitoring yet light and comfortable enough to be used on the move. Excellent sound quality marred only by a slight warmth to vocals.



BRODMANN

ACOUSTICS



Vienna has always been one of the most beautiful cities in the world. It's stunning continental architecture, numerous parks, and world-renowned arts and cultural institutions have enchanted guests for centuries. Could there be a more suitable place for the company headquarters of The Joseph Brodmann Group?

The name of Joseph Brodmann is a driving force behind our uniqueness and our high expectation towards quality. In 18th century Vienna, he earned widespread acclaim for excellence in piano making and in furthering the development of piano soundboards. Among the friends and customers of the Brodmann house were Ludwig van Beethoven and Carl Maria von Weber. Ignaz Bösendorfer learned the high art of piano making from him and became Brodmann's most famous pupil. By 1828, his manufacturing process was considered one of the most innovative and modern of its time.

Designed by Hans Deutsch is many years of experience and ideal of perfection are evident in all the Joseph Brodmann speakers.

The stunning range from the FS to the JB205 their sound is as amazing as the finish on the cabinets. The in and on wall speakers can have the finish of your dreams be this to match your wall or a picture you admire.



I'll be your server tonight!

Martin Pipe examines Yamaha's MCX-1000 music server and proprietary MusicCast technology – cutting edge stuff in 2003.



Yamaha entered the home music-server market in late 2003. Marketed as the 'MusicCast' system, Yamaha's proposition could be installed at home by the purchaser. It was built around the MCX-1000 ripper / server / player / CD-recorder, a significant and weighty chunk of hardware available at a low price second hand – and what I'm looking at here.

A key MusicCast benefit was an ability to stream music to remote MCX-A10 clients wirelessly; it was one of the earliest home-entertainment products to make use of Wi-Fi, which freed users from the need to route wires (audio or Ethernet) around the home.

One MCX-1000 can support up to five wireless clients (seven,

with wired Ethernet) simultaneously. With two clients, though, the system cost around £2,800 when released – it was still very much a 'luxury' product. Yamaha never licensed its proprietary MusicCast technology to third-parties, and regrettably the only clients you can use with the MCX-1000 are MCX-A10s.

The MCX-1000 as examined here has a 80GB IDE hard-drive, which equated to somewhere between 100 and 150 CDs held in 'no-loss' PCM form (FLAC was embryonic back then). 'Ripping' CDs is an easy process, which can be kicked-off by a front-panel 'auto-store' button or the unit's menu system. This is simultaneously-available on the front-panel fluorescent display, and a video output that allows you to view a

more informative and attractive 'colour' version on your TV.

A Gracenote CDDB database stored on the hard-drive identifies the CD you've inserted, and from it the track and album names are derived. Sensibly, you can also configure the unit to access CDDB online so that newer releases can be recognised. What if your CD isn't in the database, and thus cannot be identified? The MCX-1000 lets you add the track/album information of an 'unknown' CD manually. To make the process less laborious, Yamaha makes provision for a computer keyboard (an older type with the obsolete PS/2 connector – no USB ports here!). My own unit came without a remote handset (and the MCX codes for the brilliant 'Sure' Android app didn't work), and so

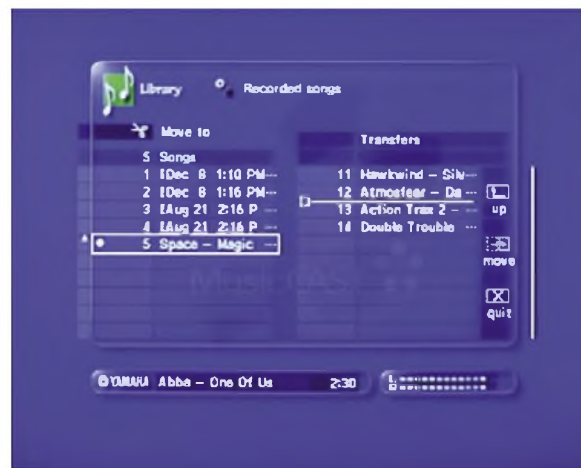

A 'screen-shot' of the MCX-1000's video output. Recordings from external non-CD 'line' sources have to be moved to the library, in order to make them visible to MusicCast clients or the CD transfer function. To make this process less laborious, Yamaha made provision for a computer keyboard to be attached

'Ripping' CDs to the hard drive is a very easy process that occurs much faster than 'real-time', the MCX-1000's simple but effective onscreen display keeping you informed of progress.

I was pleased to discover that the keyboard can also be used to drive the MCX-1000.

After one disc has copied, you're asked if you want to copy another one; note that you can also listen to CDs via the machine, just as with a regular CD player. If capacity is more important than sound quality, music can be compressed in one of three MP3 bit-rates – 160, 192 or 320kbps. Compression takes place in the background, and by default both MP3 and PCM versions are stored. You can then delete the PCM version, but doing so means you won't be able to copy/move the track to a custom audio CD-R or CD-RW with the MCX-1000's disc-burning capability (the unit's optical drive is a software-modified Yamaha CD burner – these

were highly-regarded computer-peripherals at the time).

Yamaha estimated that the 80GB hard-drive could accommodate as many as 1,000 CDs in MP3 form, encoded at the bottom 160kbps rate. Thanks to the lower bit-rates associated with MP3, the full complement of clients (seven, with 160kbps) could be served at the same time. In contrast, use PCM – which shifts data at 1.4Mbps – and only one wireless client can be used. Note that CD-ROMs containing MP3 files can be played, but not copied to the MCX-1000's storage.

When the CD-ripping process is complete, you'll find your music – along with any added previously – in the 'library'. This can be sorted by artist, genre or album; if you're in an adventurous mood or have time to spare, a complete list of all songs in the library can be displayed in alphabetical order. Bookmarks, random playback, 'gapless' discs and playlists are all accommodated, but there's no 'word-search' to help you track down a specific song quickly – something that would have been great for creating 'mood' playlists! Selecting music with a MCX-A10 client works along identical lines.

Internet radio, far from mainstream in 2003, is not supported by server or client. What you do get, though, is the ability to record from external sources – optical/coaxial digital or analogue line input – to the hard-drive in CD-standard 44.1kHz 16-bit form. And there's a timer facility, too, which facilitated

timeshifting of radio programmes in the pre 'catch-up' era (the MCX-2000 follow-up went one step further, building in a FM tuner!). The relevant technology employed is, I'm sure, identical to what you'd find inside one of Yamaha's contemporary CD recorders. Only here, it's going to a hard-drive rather than to CD. Recordings can, however, be copied from the hard-drive to CD-R/CD-RW.

Recording-level adjustment is automatic, or manual with a front-panel knob (that's for analogue – levels from digital sources are set on-screen). Bargraph-type meters are displayed on your TV, and their 'delayed' response is a bit of a hindrance when it comes to level-setting. If you're recording an album in one go, there's an auto track-marking function that presumably works by detecting the silence between tracks. You can't adjust its sensitivity, though, and it didn't work at all during the process of recording an LP from a turntable, connected to the line-input via a phono stage.

Thankfully, tracks can be manually-defined as you record. It's a shame that you don't even get basic audio-editing facilities. Even with 2003 technology, you should have been able to display a waveform on your TV/monitor and split tracks, trim off superfluous material and even carry out operations like click/noise reduction (possibly overnight, in an offline process). Recordings made from external inputs can, with the keyboard, be titled. They're buried



A full set of domestic-standard analogue and digital inputs and outputs, ensuring that the MCX-1000 can be interfaced to most if not all hi-fi systems.

To display menus on a standard-definition TV, composite and S-video outputs are provided.



Here we can see the video connections and 10-100Mbps Ethernet port. The rectangular 'lump' next to the latter is a PCMCIA card that provides the IEEE802.11b Wi-Fi connectivity. A screw-in panel provides access to the 80GB FATA hard drive, which can be replaced by one of at least 250GB in capacity for larger music collections. Courtesy of some corporate nonsense, the hard-drive is deliberately 'mated' to the unit it's fitted to. As a result you cannot take your drive and install it in another MCX-1000. This must have been particularly infuriating if your MCX-1000 happened to fail within guarantee. You would have to rip all those CDs again...

in a separate section of the menu system (external inputs/recorded songs) although they can be moved to a new folder/album in the library for ease of access - and client playback.

The CD-recording capabilities are alas fettered by SCMS (Serial Copy Management System) limitations – you can't, for example, transfer a DAT copy of a CD to the MCX-1000 via its digital input - and Yamaha's apparent decision to kowtow to the music industry. For a start, Yamaha insists you use 'audio-use' CD-Rs and CD-RWs. Horrendously-overpriced relative to their 'data' equivalents fifteen years ago, they're practically-unobtainable nowadays; my solution is to continually 'recycle' a CD-RW, copying its newly-recorded contents to a CD-R with a PC (or ripping the disc with Exact Audio Copy, subsequently converting the WAV file into FLAC for portable playback) before the CD-RW is erased for subsequent recording.

But it gets much worse! You can only move tracks – not merely copy - from the library. As a result, albums in your library could be depleted of key tracks! Infuriatingly, it applies to all digital material – recordings from external sources, as well as CD rips. Yet the MCX-1000 will allow you to duplicate commercial CDs, using the hard-drive as temporary storage!

As a get-around, Yamaha includes an 'analogue copy' mode that works

by converting the desired audio into analogue, and back to digital again! The process has to occur in 'real-time', whereas digital copying can take place at high speed. It works surprisingly-well, insofar that deterioration isn't as bad as one would expect.

I note in passing that the MCX-1000 contains a pair of AKM AK4528 'audio codecs'. Each chip contains an ADC as well as a DAC, and both sections are capable of working at 24-bit/96kHz. Chances are that, within the MCX-1000's electronic walled-garden, 16 bits are the order of the day. An unusual CD-recording mode, inherited from the optical drive specified by the manufacturer, is 'Advanced AudioMASTER'. This Yamaha-exclusive lengthens the pits burnt during recording to the maximum allowed by Red/Orange Book CD standards. The capacity of a 74-minute CD-R is reduced to 63 minutes, but Yamaha claims jitter-related benefits. In my experience, the resulting discs read better on some players.

As a hard-drive jukebox, the MCX-1000 is fairly-powerful and friendly in use. And the sound quality it delivers is more than acceptable – I would judge the sonics to be comparable with a mid-priced major-manufacturer CD player of the time. There's plenty of 'body' and dynamic potential, while rhythmic timing and detail emerge intact. Recording

also fares well overall, although coarseness can be evident – in my view, though, the results better the 16-bit converters of many modern of today's USB turntables.

The headphone output is pretty awful. When partnered with Oppo PM3s, mine broke into instability at high levels! Sure, the MCX-1000 is ultimately going to be hamstrung by CD's technical limitations – but even these days, most music listening involves CDs or CD-quality sources.

It may look like standard FATA fare, but the optical drive inside the MCX-1000 is a custom job. You can't replace it with an off-the-shelf model – even a Yamaha one. And the usefulness of the MCX-1000 is somewhat reduced without it! Hard-drive storage capacity isn't the problem it could be, as a CD-ROM upgrade disc from Yamaha allows you to replace it with one of up to 250GB in size. During the upgrade, the new drive is connected in place of the optical unit so that your existing library can be moved across (a time-consuming process that Yamaha calls 'data forwarding'). The proviso is that the new drive must have an obsolete FATA/IDE interface. These are much more difficult to source than today's SATA hardware. Some enthusiasts have reported success with FATA-to-SATA converters and larger drives.

But is it worth all that hassle today? Probably not! You can use Exact Audio Copy to rip CDs with a computer, copying the resulting files to a NAS - from where they can be streamed to a networked streamer like Cambridge's CXN. Recent streamers will also play hi-res material, and tune into Internet radio stations.

To capture and edit analogue sources, a USB analogue-to-digital converter and Audacity can be pressed into service. No proprietary standards, or infuriating music-industry corporate nonsense to scupper the enjoyment of a music collection that might have cost you thousands of pounds over the years.

The MCX-1000 is thus now little more than an interesting conversation piece, unless you have a specific use for it. Mine is currently connected to a 1974-vintage Pioneer QX-949 quadrasonic receiver via a Denon DTS decoder, for fingertip access to a library of 1970s-era surround-sound music. Yup, old-tech digital meets positively-antediluvian analogue!

Streaming: What is it? Why do it?



In response to readers' queries, Noel Keywood and Jon Myles explain the ins and outs of streaming music to your hi-fi – without the jargon!

Last month we published a reader's letter (June 2017 issue, p28) complaining about our feature on streaming music to your hi-fi. Network issues surrounding streaming we did not explain, because they were not the subject matter, but all the same if you don't understand what a network is and can do – and of course network terminology – then you won't be streaming anytime soon. Here's a look at a simple network, what it does and how you

stream over it, download over it and fume at it.

WHAT IS A NETWORK?

What is a network? This is one foggy issue rarely explained. You buy a computer, then ask BT, Virgin, Sky or whoever to install "the internet". A man arrives sometime or other (!), fits a box, strings a wire to your computer and – bingo – you have the internet. You also now have a network, even though it doesn't appear that way and nobody says so.

See our diagram of a basic budget PC hooked up to a box from your internet provider (commonly B.T.).

The crucial point here is that the box offers more than just internet connection for your PC (or Mac). It allows other items in the house access to both the internet and your computer, because they are both connected to it; it's a hub in effect, as our diagram shows.

The box and your computer form a small network that expands as other items (clients) connect

into it through this hub. As a quick aside, you can ask your computer to access the box "client list" to see what is connected – important when trouble-shooting any problems.

At the back of the box you will find a row of ethernet sockets provide access to your 'network', via an ethernet cable. When you plug an item in, it is handed an IP address so it can be recognised. Items on the network can identify each other over ethernet cables, using these IP addresses. Once connected in they can bi-directionally communicate.

simple. It is a way of getting music stored on a computer – distant or in your home - played through your hi-fi system. A box known as a 'streamer' organises this by talking to the other computers (shaking their hands and things like that). The streamer then becomes a source much like a CD player or turntable. It differs from them in not obtaining music from a disc, black or silver, but from other computers, by streaming from them

Streaming takes place in real time: when your computer asks the distant one to send, the distant one

arises. A streamer doesn't store music – but neither does a CD player or turntable. All three just enable the playback of music. With the latter two it's via CDs or LPs while with a streamer it is from digital files stored on a computer hard drive – somewhere. This can be your PC or Mac, a Network Attached Storage drive (NAS) under the stairs, in the loft or wherever, or someone else's computer outside the home and attached to the internet.

That 'someone else' will charge you to listen though, being a music



Additionally, hidden inside the box is a radio aerial and this provides another two-way link to your network, via a very high frequency (and data rate) digital 'wi-fi' radio link. Think of wi-fi as an invisible ethernet cable – that's all it is.

WHAT IS STREAMING?

Now let's get back to streaming and what is going on here. It can sound complicated because of the terminology – but is essentially

does so as a continuous stream and you listen at the other end whilst it is doing so. This is very different to downloading.

Buy a streamer, plug it into your pre-amp or integrated amplifier via its RCA outputs and you have the ability to access any music stored digitally in your household, or outside the household via the internet.

WHERE IS THE MUSIC?

This is where the confusion often

provider somewhere out on the internet (Qobuz in France, for example). All these computers are interconnected by wires, even across the Atlantic. Your home network, often termed LAN (local area network), connects into this external network (WAN or Wide Area Network) in effect.

HARDWARE

What is a NAS? A Network Attached Storage device is a small



Cambridge's CXN is a superb streamer for its price – and enables you to access services such as Spotify.

box containing a hard drive like a computer that plugs into your hub via an ethernet cable (see set-up explained). They contain a hard disk like a computer but have one function – which is storage of your music files. The streamer sees these files via your home network and plays them back through your system.

DOWNLOADING

With downloading, music is transferred from a distant computer to your computer in one go, as a single file. It is then played from your home computer, or storage device like a NAS. You then have control in effect after paying for it, so you can play as many times as you like. It is still played from your computer or NAS through the streamer, via

your home network (LAN). Under these circumstances the streamer talks to your devices, that you own and control, instead of talking to an external device that you don't own or control. Obviously, you do have to buy the downloads first.

Take a look at the likes of Blue Coast Music (bluecoastmusic.com) or HD Tracks (hdtracks.com) and you'll find a wealth of music to buy for download to your computer. The advantage is that many are available in resolutions that beat that of CD or streaming, offering better sound quality.

STREAMERS TO BUY

So what streamer to buy? There are multiple options available – but consider them in terms of the



A Western Digital 3TB MyCloud NAS drive will allow you to store music and stream it to your hi-fi.



Yamaha's WXAD-10 is a cost-effective way of adding streaming to an existing hi-fi system.

facilities you are looking for. For example, the Cambridge Audio CXN (£800) will add streaming to your system in an easy package, but it will not store music – for that you'll need to save the files on a computer or NAS drive.

At the cheaper end of the spectrum there's something like Yamaha's new WXAD-10 (see review this issue) – a compact box that plugs into your integrated amplifier or pre-amp to enable streaming of music

from devices elsewhere. At just £149 it's ideal for anyone looking to try streaming without spending a fortune.

However, without complicating things too much, there are also products available that will allow you to stream, plus store music on them as they have hard drives built-in – just as in a computer. One of the best is the Plato Lite from Convert Technologies (formerly Entotem) for £2250. This comes with 1Tb worth of in-built storage so you can save music to it instead of a computer, but it will also access music stored on your network.

The Cambridge, Plato and Yamaha will all also allow you to access subscription services such as Tidal, Spotify and Qobuz where music is streamed to them from the internet for a monthly fee.

There's also the likes of Naim's NAC-N272 – seen in our headshot for this article – which is a preamplifier and streamer combined.

These are just some of many products on offer for those looking to stream music – there's no end of alternatives available.

If you are looking to enter the world of streaming music then a visit to a dealer should be your next port of call to see what's available to suit you and your budget.

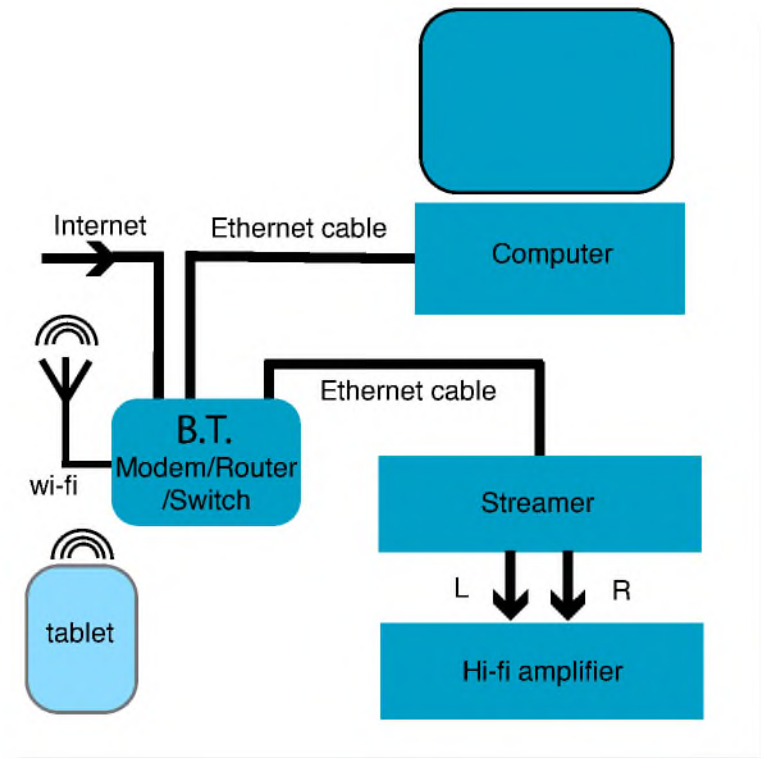

Our diagram makes clear how a B.T. internet box (modem/router/switch) and computer form the basis of a network. A streamer is connected to the B.T. box using an ethernet cable. It then feeds music to the hi-fi in the same way a CD player does so – it becomes a music source. Note that a tablet gets in on the act via wi-fi, using an app to act as an intelligent remote control. Bad news if your kids just stole the iPad though.

This is not a PC and a B.T. internet box – it is a network! Plug a streamer into one of the yellow ethernet sockets and a NAS drive (optional) into another, and you are ready to go. Well, when you get it all set up, which is where the fun begins.

Avoid sending ethernet over the mains at all costs, to avoid endless problems and poor sound quality.

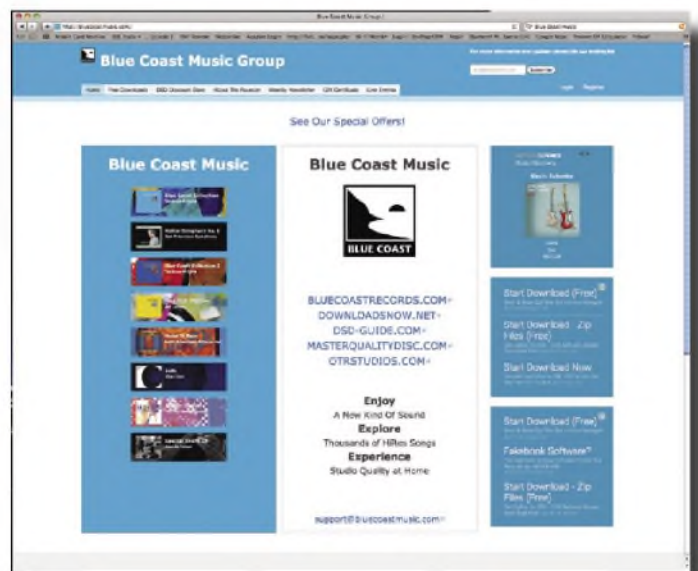

For high-resolution downloads to make the most of streaming, check out Blue Coast Music in California.



SCANSONIC

AUDIO ANALOGUE
soundpleasure

DECENTAUDIO.CO.UK



TEL: 05602 054669
EMAIL: INFO@DECENTAUDIO.CO.UK

AUDIO ANALOGUE - KRONOS AUDIO - MAGNEPAN - RIVA AUDIO - SCA



Transfiguration

KRONOS
TIME FOR MUSIC™



DECENT AUDIO
SOUND DISTRIBUTION

ANSONIC - TRANSFIGURATION - USHER - VAN DEN HUL - VELA AUDIO



JETHRO TULL

Songs from the Wood
Chrysalis

Bands sometimes talk of a project that was truly 'together'. That is, everyone pulls in the same direction, ideas flow, everyone is happy. That was Tull on 1977's 'Songs From the Wood'. It was also an honest-to-goodness album of original songs as opposed to the recently familiar interpretations from another project: a play or somesuch.

'Songs' was also a pleasing album. Pleasing in terms of being aesthetically charming, that is, while the folk-centric core of the project provided a sense of cultural purity (in its best sense) that added a simplicity and sensitivity that was most appealing.

Here, the combination of delicate folk (along with a range of beautiful harmonies) and raucous rock provided an essence of what the band was. The songs, 'Hunting Girl' and 'Velvet Green' almost seem to epitomise the content.

The new edition of the album

is a joy for fans. Mastering is forceful, not bright, yet levels are pushed. Presented in a hardbook format, the first disc of the set contains the Steven Wilson remix of the original studio album plus the previously unreleased 'Old Aces Die Hard' and 'Working John, Working Joe'. CDs two and three in the box form 22 live tracks, remixed to stereo by Jakko Jakszyk and jiggled into a single set from the 'Songs From The Wood Tour' via Boston and Landover of that year.

DVD 1 contains 5.1 DTS, AC3 Dolby Digital Stereo Surround and 24bit/96kHz LPCM stereo versions of the Steven Wilson remix and rarities.

The final disc includes video from the Maryland concert mixed to 16bit/48kHz stereo LPCM and 5.1 DTS, AC3 Dolby Digital surround by Jakko Jakszyk.

A 96-page book includes words from Martin Webb, Ian Anderson and assistant engineer Trevor White.

AUDIOPHILE CD



THE BYRDS

Live at the Fillmore, February 1969
Floating World

This disc represents an interesting time for The Byrds. Only a year before, original band members Roger McGuinn and Chris Hillman had seen a mini-exodus of other original band members and the introduction of Gram Parsons and Kevin Kelly. 'Sweetheart of the Rodeo' was a divisive LP, it moved away from the trademark jangly guitars towards full-on country music to form country-rock. The classic Byrds sound had gone. Parsons then left six months after he'd been largely responsible for the genre change. Worse, Chris Hillman left just two to three months before this live gig.

McGuinn was and still is a very likeable character in musical terms, though. He's created many gems and his guitar playing was most appealing and so fans persisted and hung on for the ride.

Which is where this album comes in. It was recorded by Columbia at an early show and

includes McGuinn plus Clarence White (guitars), John York (bass) and Gene Parsons (drums).

Mastering cannot be perfect: this is a live concert. That said, the overall nature of the sound is on the bright side as treble is slightly pinched, upper-mids are rushed and compressed, while bass blooms. The overall arrangement is nicely balanced to provide focus on the McGuinn vocals and supporting band and in that order, while the audience never dominates. Instrumental separation is good and the soundstage is relatively wide which helps the air and space during the presentation.

The general sound here is country rock with songs emanating from 'Sweetheart' plus the 'Dr. Byrds & Mr Hyde' LP while the classic hits are touched upon as a three-song medley. You'll also find a few covers. It's a fine, although not outstanding, concert, but fans will find it a fascinating snapshot of the band's ongoing evolution.

A critical influence on all guitar-toting artists interested in both blues and rock. You ask Eric Clapton. There would be no Eric without Albert King. At least, not in the form he became. Same with Stevie Ray Vaughan. Part of the reason for that has been King's unique take on the guitar. Another reason is that his left-handed 'upside down' style has never sounded like B.B. King...unlike the majority of the rest of the blues-rock guitar fraternity.

What you've got here is a batch of cuts from his time at Parrot – a gig secured after Willie Dixon helped King to get an audition. That initial audition session produced the title track from this CD collection.

From there, in 1959, King joined Bobbin Records and adopted a form of jump blues. You'll find plenty of songs here from that period including 'Don't Throw Your Love On Me So Strong'.

The song was issued as a single that reached No. 14 in the R&B charts.

This collection also focuses on five previously unissued tracks from Parrot, plus another five from Bobbin including 'Little Boy Blue' from the former and 'California' from the latter.

Mastering on such vintage material is expected to be difficult because of the often inherent compression present but this CD is surprisingly demur in those terms. The title track, for example, is a little strident in its presentation but not too hard on the ears.

By the time we get to 'Blues at Sunrise', track eight, the 'tone', as it were, continues in fine form – which aids the King vocals and prevents his delivery being shattered by overly bright guitar crescendos, adding a welcome tonal balance to the general sonics.

As the CD progresses, the music quality improves further. A fine reissue.

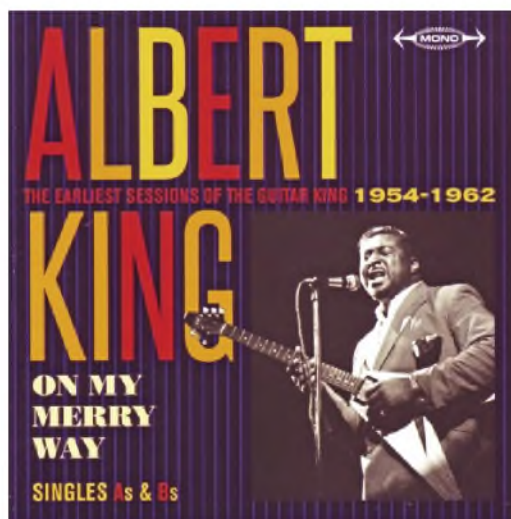

ALBERT KING

On My Merry Way: The Earliest Sessions of the Guitar King 1954-1962
Jasmine

AUDIOPHILE CD

A post-punk band from Watford with other flavours such as a smattering of folk and even a little bit of psychedelia to add a certain frisson to the final sound. Formed in 1980, the band featured the voice of Garçe Allard, Cliff Silver on bass, the guitar of Tristan Garel-Funk (who would found the Snake Corps with Nigel Pollard), drums from that man Pollard and keyboardist/sax via David Wood.

In 1981, the band recorded two discs for their own Last Movement label then recorded a John Peel session, signed with Midnight Music and released the debut album 'Epic Garden Music', arguably their best LP which included both single and EP releases plus a host other additional tracks that emphasised the group's tight, clean sound.

The band would split on two occasions but reform every time and produce albums upon

reforming. This box set covers the band's entire career, in commercially released terms, and includes five CDs as the group moved towards a rather introspective and/or meditative jangly guitar indie presentation along with slightly more ambitious and experimental song arrangements later in the 90s and Noughties.

In mastering terms, the music levels have been boosted to rather sharp levels. I would guess that this has a lot to do with either original digital recording with poor ADCs or compression applied to an analogue recording. It's not horribly aggressive but the compression is evident on the Singles first disc and the first album from 1982, especially. Get to 1990 and the track 'It's Snowing' and the dynamic reach is far more expansive and expressive with a far more relaxed presentation.

This is a wonderful box set from a long neglected group.



SAD LOVERS AND GIANTS

Where the Light Shines Through - 1981-2017
Cherry Red

CELEBRATING QUICKSTEP

HI-FI WORLD'S BEST LOUDSPEAKER CABLE AWARD 2016

Capture the Excitement, Emotion and Drama of your Music

Exclusive connectors
GN1 'Straight Line Contact'
Loudspeaker Plugs



Hi-Fi World Best
Loudspeaker
Cable Award 2016 *

The **exclusive technology** of our very best cables can now be enjoyed by a much larger audience!

EXCLUSIVE FEATURES

- Balanced Sound ✓
- Musically Entertaining ✓
- Stunning Clarity ✓
- Sharp Definition ✓
- Authentic Imaging ✓
- Excellent Timing ✓
- Effortlessly Open ✓

Read the reviews in full at www.blackrhodium.co.uk to discover how these reviewers describe the outstanding Quickstep sound quality.

"Quicksteps were surprisingly balanced in tonal terms while the design offered a naturalistic reflection of the music that was entertaining and extremely natural in its approach."

Paul Rigby- theaudiophileman.com

* *"They get out of the way of the signal that few others do at this price and allow you to hear the music unsullied and in all its glory."*

Jon Myles, Hi-Fi World

"For sound per pound this is an excellent choice for the audiophile offering a detailed soundstage with exceptional speed, and a sound that was very open and effortless."

Janine Elliot, Hi-Fi Pig



Go buy your own Quickstep Cable NOW at your nearest Black Rhodium Dealer or via www.blackrhodium.co.uk

Hear QUICKSTEP at these dealers

- Nintronics 01707 320 788 | Peak Hi-Fi 01226 761 832 | AUDIO-PHILIA 07518 151 516
 Analogue Seduction 01733 350 878 | Audio T Swansea 01792 474 608 | DoGood Audio 01515 253 845
 Ian Harrison 01283 702 875 | Homesound 01316 621 327 | MCRU 01484 540 561 | Planalogue 01865 693 032

Go With The Flow

Want to bring high-resolution streaming to your existing hi-fi system at a bargain price? Yamaha's WXAD-10 could be just the thing. Jon Myles explains.

Though sceptics are still out there, streaming music to the hi-fi is becoming a first choice for many enthusiasts. It's fast and convenient, with benefits CD and vinyl just can't offer (the playback of high-resolution files for one, the addition of music subscription services for another).

But what if you've already got a system that's been fettled over the years to sound just how you like it – yet still want to add streaming capability to it – without breaking the bank?

Enter the new Yamaha WXAD-10 wireless streaming adapter. It aims to do just that for the sensible price of £150. It also has one other trick up

its sleeve – but more of that later.

First of all though – exactly what is it? Essentially it's a small box that plugs into your existing components (integrated amplifier, pre-amp etc) via either a single set of analogue RCA outs or a 3.5mm headphone socket. Once connected, music can be streamed to it in many ways, for playback through the system.

The streaming options are comprehensive. There's Bluetooth and Apple AirPlay for sending music directly from a mobile 'phone, tablet or computer, DLNA compatibility for accessing digital files on a network attached storage (NAS) drive, support for subscription music services such as Tidal, Spotify, Deezer, Napster and Qobuz, as well as access

to the thousands of internet radio stations now available.

The WXAD-10 can be used either wired to your network router via an ethernet cable – which I'd recommend – or wirelessly if cable connection isn't possible.

Inside, the circuitry is built around a Burr-Brown PCM5121 DAC that can process digital file sizes of up to 24bit/192kHz, alongside Yamaha's in-house designed network module that contains a high-precision, low-jitter clock which is said to optimise the quality of streamed audio by reducing jitter. All popular formats are supported, including FLAC, WAV, AIFF, ALAC, MP3 and AAC. The only thing missing is DSD – but that's no real surprise at the price.



BLACK | BEAUTY



Evocative styling
Contemporary features

Enjoy the warm, clear sound of valve amplification from all your audio devices with the new v40 from Blue Aura.

blueaura.co.uk

v 40

Blackline



Control of the device is provided by a free Yamaha app for iOS and Android mobile phones and tablets.

Take it out of the packaging and the WXAD-10 seems a little unremarkable - measuring a compact 45mm x 130mm x 106mm (H/W/D) and weighing a decidedly light 226g. But that size means it can easily sit next to your existing hi-fi - and while it may look a little utilitarian in its matte grey finish that's not much of an issue - it's the functionality that counts here.

And on that point there's one other feature incorporated within the WXAD-10 - Yamaha's MusicCast system. This means any of the company's MusicCast-equipped range of components (amplifiers, wireless speakers, soundbars, AV receivers etc) can be linked together to create a full multi-room music



An on-off switch and button to pair the unit with the dedicated phone app are situated underneath the unit.

system throughout the house in a similar fashion to the Sonos range of products.

SET-UP

As befits what is essentially an add-on device, set-up is quick and simple. A small button on the underside pairs the WXAD-10 to the MusicCast controller app on your mobile device. Let it have your network password and the job's done.

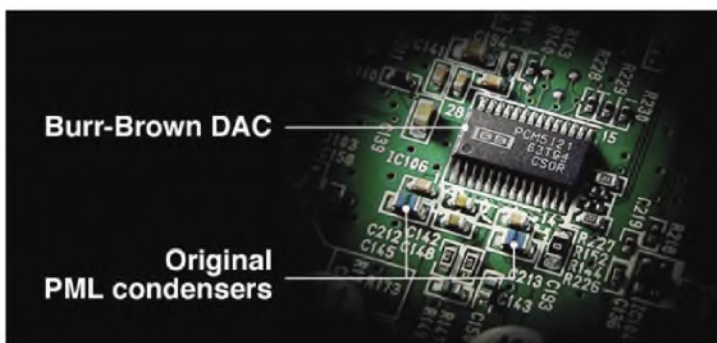

Burr-Brown DAC

Original PML condensers

It took just a few seconds for the Yamaha to discover my NAS drive and index the albums including cover artwork. The connection remained stable throughout the review period even when streaming 24bit/96kHz material wirelessly.

Another button on the underside is used for Bluetooth pairing - and once again this was achieved in less than a minute on both an Android tablet and Apple iPhone.

The MusicCast application is one of the best available in terms of ease of use, with a nice interface. It will even allow you to control the volume on the 3.5mm output jack, although not for the RCA connections so direct connection to a power amplifier is out.

SOUND QUALITY

Having connected the Yamaha to my resident Naim Supernait 2 integrated amplifier driving Neat's potent Iota Alpha 2 loudspeakers, I started off by streaming The Clash's 'London Calling' in 24bit/192kHz format from my NAS drive.

The presentation was rhythmically strong with a nice punchy quality to Paul Simonon's opening bass line. With the volume turned up there was a forceful smack to the drums while the metronomic guitar line rolled along with ample definition.

Playing the same track from the NAS but from a CD rip reveals the WXAD-10 has more than enough resolution to reveal the extra quality of the 24/292kHz version. There was extra depth to the sound and a richer, more organic presentation.

With Philip Glass's 'Heroes Symphony' (Bournemouth Symphony Orchestra) the Yamaha did a good job of placing the various instruments in their own space - casting a wide and high soundstage from the little Iota loudspeakers.

Switching to subscription music services with Tidal and its £19.99 a month lossless offering



The internal circuitry of the WXAD-10 is neatly laid out and features a Burr-Brown PCM5121 DAC chip.



The rear has a single pair of RCA outlets, plus an ethernet port for wired connection (recommended). The USBs are for service and power (right).

(16bit/44.1kHz), Leonard Cohen's vocals on 'You Want It Darker' were dark and resonant. Detail was good enough to allow me to hear his intake of breath before various lines. The quiet intensity of the sparse organ, bass and percussion backing was pitched just right, with good tonality.

For comparison I then tried the Cohen track on CD via a Naim player. Not surprisingly the latter won out in terms of absolute resolution as well as better timing and a more lifelike feel. But switching back to the Tidal version through the Yamaha still proved an enjoyable listen and one I could certainly live with.

That's why the WXAD-10 is so impressive. For just £150 you get a little box that can connect to existing systems and bring the benefits of high-resolution streaming from NAS drives as well as opening up the world of subscription music services. The MusicCast feature allows you the option of adding multi-room music in the future if so desired.

CONCLUSION

For anyone considering adding streaming functionality to their system but worried about the cost or complexity, the WXAD-10 could be just the thing. It's simple to set-up and use, sounds excellent and costs just £150. Highly recommended.

YAMAHA WXAD-10 STREAMING ADAPTER £149.99



OUTSTANDING - amongst the best.

VALUE - keenly priced.

VERDICT
Adds streaming from NAS drives or subscription music services to traditional hi-fi set-ups at a bargain price. Sounds good too.

FOR
- ease of use
- excellent sound
- price
- MusicCast facility

AGAINST
- No DSD

Yamaha
www.uk.yamaha.com

HI-FI WORLD

NOW AVAILABLE
ON THE APP STORE

App Store > Entertainment > audio web publishing ltd

Hi-Fi World

audio web publishing ltd >

Details Ratings and Reviews Related

Screenshots iPhone iPad

HI-FI WORLD

Get

Offers In-App Purchases

This app is designed for both iPhone and iPad

Rating: 4+

TOP IN-APP PURCHASES

1. Hi-Fi World Dec 2015 £3.99
2. Hi-Fi World Subscription £8.99
3. Hi-Fi World August 2015 £3.99
4. Hi-Fi World September 2015 £3.99
5. Hi-Fi World June 2015 £3.99
6. Hi-Fi World May 2015 £3.99
7. Hi-Fi World December 2015 £3.99
8. Hi-Fi World February 2015 £3.99
9. Hi-Fi World November 2015 £3.99
10. Hi-Fi World December 2014 £3.99

LINKS

Privacy Policy

© 2014 Hi-Fi World

Description

Hi-Fi World brings you the best hi-fi... from around the world!

- We listen and measure products in depth, at our London offices.
- Expert opinion from a team of renowned writers, musicians and engineers.
- International standard measurements using Rohde & Schwarz test equipment.

Information

Developer: audio web publishing ltd
Category: Entertainment
Updated: 7 Dec. 2014
Version: 1.0
Size: 9 MB
Rating: Rated 4+
Family Sharing: Yes
Compatibility: Requires iOS 5.0 or later. Compatible with iPhone, iPad, and iPod touch.
Languages: English

Contents

VINYL NEWS AND REVIEWS SECTION SEE PAGE 80

HI-FI WORLD

JULY 2017 £4.50 www.hifiworld.co.uk

FREE READER CLASSIFIED ADS IN THIS ISSUE!

McINTOSH MP1100
phonostage

22 HIGH-END ANALOGUE HEADPHONE AMPLIFIER

15 5.1 SURROUND HEADPHONE AMPLIFIER

63 REMASTERED CD REPRODUCER

39 FULLY FEATURED 5.1 SURROUND RECEIVER

83 MULTICHANNEL PROLOGIC

JULY 2017
VOLUME 27 NO 5

FEATURES

- STREAMING FEATURE
- THE HISTORY OF HI-FI
- THE HISTORY OF HI-FI

SOUND BITES

- MARK RICHARDS: PHONO STAGE, PHONO STAGE AND PHONO STAGE
- ANDREW DICKSON: PHONO STAGE
- ANDREW DICKSON: PHONO STAGE

OLDE WORLDE

- MARK RICHARDS: PHONO STAGE
- ANDREW DICKSON: PHONO STAGE

VINYL

- MARK RICHARDS: PHONO STAGE
- ANDREW DICKSON: PHONO STAGE

REGULARS

- MARK RICHARDS: PHONO STAGE
- ANDREW DICKSON: PHONO STAGE

**DOWNLOAD OUR APP ON APPLE AND ANDROID
DOWNLOAD FROM iTUNES OR GOOGLE PLAY
iPad, iPhone, iPod, Tablets OUT NOW!**

"You see what I mean by the confusions that can arise from 'streaming'"



Noel Keywood

How can we explain streaming in this magazine when we don't know what it means? That's an issue that arose when discussing our feature on streaming this month. Jon Myles had one take on what it means and I had another. This made me even more aware of just how jargon laden and ad hoc digital can be – and why it is so confusing.

We came at streaming from different angles: Jon is an avid streamer whereas I see it all in basic engineering terms, a block diagram in my head.

Let's try one definition: you stream within a system, when your streamer reads music from a Network Attached Storage (NAS) drive for example, and you stream from commercial streaming services like Tidal or Spotify.

If I say, from this model, it is playing and listening to digital music on the fly, or in real time, then it equally includes a CD player – and that is not considered to be a streaming device.

Is streaming then, playing digital music from a source distant to the hi-fi system, and in real time? The streamer reads music from a NAS drive far away from the hi-fi, or from a computer also likely to be far away. But if the NAS drive is sitting on the floor just behind the hi-fi and has only music on it, then this definition breaks down. And what about a CD transport streaming to an external DAC like an Audiolab M-DAC+? It is no different to a NAS drive streaming to a streamer, is it?

Semantic life gets more difficult when the streamer has a storage drive on board. Who did that? For it immediately raises even more confusions – now the streamer stores music and you and I, reading the product's spec. may well assume it is able to store all music passing through – for play another day.

Not so. On-line streaming services go to great lengths to ensure you cannot store and replay what you have paid for to hear. Continued listening means paying a monthly subscription – as once you might have tossed a coin at a travelling minstrel to induce him to play again.

You see what I mean by the confusions that can arise from 'streaming'.

Streaming at home is quite different from streaming into your hi-fi system from sources outside the home, unless your mate has an on-line server dishing up music for free.

The issue here is that a streamer and streaming are different. A streamer is a device that talks to distant computers, asking them to send music so you can listen to it through your hi-fi.

"No it doesn't", said Jon: a NAS drive is not a computer. Oh shoot! Trying to define streaming through a streamer is impossible.

I did actually disagree with him here. A NAS drive isn't a computer as we know it but it has on-board computing power to exert control and management. It can be addressed via an ethernet link and music then obtained from it. It will show up in a list of attached devices.

But we can still ask: is it a computer or is it a mechanical transport like a CD transport, since there is a rotating disc inside on which music is stored? But then, there might not be a rotating disc inside, just solid-state memory.

Whichever way you go with this attempt to pin down what a streamer and streaming are, a definitive answer remains elusive.

My preferred definition remains that a streamer, as a device, polls outside computers, asking them to deliver music to it. You may or may not have to pay – this is sort-of a different issue. If you want to pay

to listen then the streamer will be purposed to access these services in the easiest way possible.

To baffle us all even further a streamer that can do all this may or may not have a digital-to-analogue converter on-board. Those that do (most) can feed an amplifier direct – convenient. Those that do not (e.g. Auralic) feed an external DAC. This allows a very high quality DAC to be used. Quality will be better than that from units with an internal DAC chip. So we are trading quality for convenience here, as well as cost since a streamer without a DAC inside should be less expensive.

So I will return to my favoured definition of a streamer: it is a box that polls outside computers for music. It sends that music to your hi-fi. Don't mention NAS drives.

If you visualise a streamer like this it becomes fairly easy to understand what it does and how to cope with it. Since it polls outside computers it must be connected to them – and it is, but here again we run into complexity. For speed and reliability it's best connected into your home network through ethernet cables, but it can alternatively communicate and send music over wi-fi or it can do it over the mains using a mains link.

It talks to computers outside the house over ordinary copper telephone cables, usually owned by BT. So a streamer polls outside computers over the internet via creaky copper cables, or a NAS drive or home computer (PC or Mac) over your home network through ethernet cables. It can extract music from any of them. That's the mechanics of it all, giving you an easy visual idea of what is going on here without jargon. I suspect we will be arguing about all this for some time to come, all the same! Digital is nothing if not confusing. ●

THE VINYL REVOLUTION



The EVO and the new EVOke now you have a choice !

The new EVOke has world beating performance and right now we have the unit reviewed in this issue and a brand new one for sale. Performance figures are comparable with the world's most expensive turntables and the ability to fit any arm or cartridge mean you can have the EVOke that you want.

The EVO was used by Hi-Fi World to evaluate the Beatles In Mono records and is now used as their reference. The EVO comes fitted with the legendary SME 309 tonearm loved by so many and a cartridge of your choice.

We have worked with direct drive turntables and moving coil cartridges for 35 years. We can supply completely new units with 6 year guarantees, used ones with 5 year guarantees, or we can convert your own

Stereo, Mono & 78 rpm Artisan Noriyuki Miyajima has been making phono cartridges in Japan for more than three decades. Only recently discovered by American and European audiophiles, they have since received rave reviews all over the world and deservedly so.

Every Miyajima cartridge is handcrafted in-house by a dedicated full-time team of six based in Fukuoka. The cartridge bodies are individually precision-milled from rare and exotic hardwoods including ebony, rosewood and African blackwood (mpingo). These dense natural materials lend a vibrant and natural tonality to the sound.

Miyajima - Benz LPS - Denon DL103 - DL-102 mono - Audio Technica AT33 & OC9
SME Turntables & Tonearms - Oyaide - Furutech - Klipsch - 78rpm - SL1200 Mods

Tax free best prices for World wide mail order by Fed Ex

Sound Hi Fi Dartmouth Devon 01803 833366 www.SoundHiFi.com



hear the music . . . not the equipment

- WDKT88 32 watts per channel ultralinear push pull stereo amplifier. Single input power amp or integrated with multi-input relay switching
- WDKELB4 15 watts per channel ultralinear push pull stereo amplifier. Single input power amp or integrated with multi-input relay switching
- WDPhono3 All triode passive equalization valve phono-stage. Dual input option. MC step-up transformers available. Requires WDPSU3 power supply
- WDPRe3 Transformer coupled single ended valve pre-amplifier. Low output impedance. Multi-inputs utilizing relay switching. Requires WDPSU3 power supply
- WDPSU3 High performance choke power supply
- WDHD35 Transformer coupled single ended valve headphone amplifier. Multiple settings for headphone impedance matching



Kits and Components for the Audiophile Community

07972 055492 sales@world-designs.co.uk

www.world-designs.co.uk

"Every creative artist should be described as intolerable at one time"



Paul Rigby

There are certain social mores that exist in our life that keep us buttoned down. A suite of disciplines and rules and strictures that govern behaviour that range from being polite in conversation, manners at the dinner table, saying please and thank-you and so on.

Such rules and disciplines allow you to interact with society and stop you getting into trouble.

Many of them, however, also restrain, restrict and contain our natural inner passions, thoughts, ideas and that 'creative' side.

What do I mean by that? Think back to school. Most of us were products of our parents and, in some ways although not all of course, reflected images of them too. Yet childhood 'imperfections' emerged via looks/image, speech or how you did this or that. These were the things that set us apart at school. Made us different. Some of those triggered adverse comments from our peers. Names were called and almost all children have a horror of being different or of standing out.

Ironically, these imperfections can be clues to greatness. The triggers for childhood name calling being the reflected seeds for later talents. Irony upon irony, it's often the kids who always fitted in, were never different, were never picked on, had an easy ride... These kids often ended up being bland, boring, predictable adult drones of society.

It's the 'weirdoes' that win in the end. 'Win' in terms of self-fulfilment, that is. The musicians, the artists, the photographers, the actors, the mathematicians, the scientists, the inventors and the [cough] hi-fi journalists. These people spend a long time 'unlearning' many of those childhood social mores, to be better able to perform in their chosen

discipline.

Music is full of such people, of course. The little bundle of energy called Wreckless Eric signed to the Stiff record label in punk's heyday, is a good example. Eric never had a massive pop hit but this clever cockney rock'n'roller knew a melodic hook when he saw it (witness the song, 'Whole Wide World' which has been covered by everyone from Elvis Costello to The Monkees). Eric had an innocence and playful wistfulness about him. Even Eric's drunken stage antics exuded more charm than threat. You can hear more on three new vinyl album reissues just released by Demon: 'Wreckless Eric' (1978), 'The Wonderful World of...', and 'Big Smash' (1980).

Dr John is another eccentric but arguably in a far more voodoo direction, as his New Orleans blues and boogie pianistic roots will testify. Combining an eclectic approach to music and the genres within, Dr John's insistence to integrate his cultural roots in the form of ceremonial-type events in full Mardi Gras costume have not only raised eyebrows but also set him apart from the pack, attracting a host of celebrity stars to his albums while also triggering untold guest spots on other LPs. People love the man's quirks and his gravelly voice (see 'Mac Rebennack: Good Times in New Orleans 1858-1962', Soul Jam).

Bobby Hatfield, one half of The Righteous Brothers, was not eccentric or on any sort of edge but the producer of their version of 'Unchained Melody' that made his act a legend, Phil Spector was and, no doubt, still is.

Said Hatfield of Spector, "He was real easy to work with but he was a little odd. I know he shot a gun off in the studio a couple of times... [The murder of actress Lana Clarkson in 2003] was a horrible thing to have

happened but it wasn't a real shock".

Wall of Sound creator and producer of 'Be My Baby' by the Ronettes owned quirks, yes, but they knew no bounds and were dangerous to boot.

His associated bi-polar mental issues resulted in an uncontrolled personality. As he admitted to the Telegraph in 2002, "Trust me, you don't want my life". Check out 'The Other Brother: A Solo Anthology 1965-1970' on Ace.

A Mexican band leader, pianist and film/TV composer, Esquivel was wholly ignored for many years until this figure – who looks like he just escaped from an episode of Gerry Anderson's 'Thunderbirds' – was recognised as a genius, creating loungecore-jazz-latin arrangements in the 50s, now known as 'Space Age Bachelor Pad Music', way before it became recently popular.

Known for his mind-bending stereo experiments (he recorded for RCA's 'Stereo Action' series), hi-fi writers hated him. This is a sixties report from USA's High Fidelity magazine, "I have to draw the line somewhere and for me Esquivel oversteps it in his complete disregard for musical taste and tonal attractiveness. There is plenty of sonic sensationalism here, both in the frantically fancy arrangements and the spectacularly stereoisitic recording but almost without exception the crude effects cancel each other out. The sounds emanating from an electronic organ and a zu-zu-ing chorus, the nauseous glissandos on various instruments and the squalling brasses are, for the most part, intolerable". (Check out 'Esquivel and His Orchestra: Strings Aflame', Jackpot)

Every creative artist should be described as "intolerable" at one time in their life. It's a sort of right of passage. ●

BoxIT

by *creaktiv*



The BoxIt range is perfect for giving you the sound quality you are looking for from your equipment whilst aesthetically looking great and hiding all those cables away from sight.

Units can be put together in combinations to accommodate your system. Available in a variety of colours to match your decor, shelf or with a drop flap the BoxIt can be wall mounted or stand alone the choice is yours.



"Together Lynch and Badalamenti created the most influential soundtrack ever written"



Jon Myles

For those of us of a certain age the return of *Twin Peaks* to our TV screens is, to say the least, a momentous occasion. The original series was not just a cult classic, it redefined what the murder mystery could be – as far removed from the genteel village fete stories of the likes of *Murder She Wrote* or *Midsomer Murders* as it was possible to get.

Here instead, director David Lynch and co-writer Mark Frost created a seemingly ordinary American town – the *Twin Peaks* of the title (population 51,201) – peopled with a dark, festering underbelly of eccentric characters and held in the grip of bizarre happenings all centred around the killing of High School student Laura Palmer and the search for the culprit.

Whether the new series will cause as much interest and excitement as the original remains to be seen as its influence has seeped into so many other programmes nowadays that is hard to see it having the same influence.

But one thing that is often overlooked in explaining *Twin Peaks*' appeal is that of the music that soundtracked the series. Lynch is famous for paying obsessive attention to the scores for his work – and for *Twin Peaks* he turned to composer Angela Badalamenti who he'd previously collaborated with on his breakthrough film *Blue Velvet*.

Together Lynch and Badalamenti created what has been described as the most influential soundtrack ever written. And the story goes that it all happened without Badalamenti even seeing a script – mainly because Lynch hadn't written one yet.

Instead Lynch described the opening of the story and his vision

for the series while Badalamenti sat at his piano and picked out some notes. It was the beginning of what became 'Laura Palmer's Theme' – two brooding, evocative chords that repeat slowly over and over again while an orchestra slowly swells in the background.

Since then the theme tune has appeared in popular music time and again, such is its influence. It's been used by the KLF and Bastille while Moby sampled it for his hit single *Go* and it can be heard popping up on no end of dance tracks.

Julee Cruise found fame with a vocal version of the song – 'Falling' – and credits Badalamenti and Lynch with establishing her distinctive vocal style. Even Paul McCartney fell under the soundtrack's spell – inviting Badalamenti to the famous Abbey Road studios in West London to work with him.

It was a powerful example of how music and pictures can work together to create an eerie, disturbing atmosphere and nowadays no TV drama is complete without serious attention being paid to its soundtrack.

And while remarking on the importance of music to TV and films it would be remiss not to mention the influence of another famous director; Jonathan Demme who sadly passed away recently.

A fervent Punk and New Wave fan before he achieved Hollywood fame, Demme actually directed the video for New Order's 'The Perfect Kiss' single. Unlike any other New Order video, it was a single, stark shot of the band performing the song in their rehearsal room. It could not have been more true to the spirit of Factory Records if the director had been born in Manchester instead of actually

Baldwin in New York.

Rumour has it, actually, that Demme had been planning to film some dramatic shots of drummer Stephen Morris pounding the skins behind his kit – but had to abandon the plan after discovering the percussion track was all electronically programmed.

But Demme incorporated his love of music – and especially that deemed a little left-field by others – into some of his best-known work. The soundtrack for his debut feature *Caged Heat* was written by Velvet Underground legend John Cale. It's a pretty awful film – the promotional material has the tagline 'White Hot Desires Melting Cold Prison Steel' – but the soundtrack has its moments.

And when Demme really hit big with *The Silence Of The Lambs*, which group's song should pop up in the final confrontation scene? None other than the famously confrontational *The Fall* with 'Hip Priest'.

This was obviously a man with a deep knowledge of music and a David Lynch-like ability to understand how a soundtrack can enhance the power of the pictures you are seeing on screen. Perhaps it's no surprise, then, that Jonathan Demme also made one of the best rock movies ever – *Stop Making Sense* which features a Talking Heads concert and is about as close to being actually there as you can get. It's also the first movie to be made using entirely digital audio techniques – and this was back in 1984.

So, the connection between music, TV and films can be a potent one in the right hands. But it was that original *Twin Peaks* that really set the benchmark for the synthesis of the two. Let's hope the new series can match it. I'll be watching (and listening) closely. ●



Distributed exclusively in the UK by SCV Distribution
Please call for information on becoming an authorised
dealer, or to find your nearest dealer on **03301 222500**

www.scvdistribution.co.uk



"The moral? Things fail so always back-up your data"



Martin Pipe

Do you have any CD-R or DVD-R media? If so, dig it out immediately! There's a possibility it might now be unreadable – but act now and you might save some of the contents. Back-ups of 128kbps MP3 files ripped years ago, for an early personal music player of limited-capacity, are one thing. You still have the original CDs, right?

But what about irreplaceable photos, archived documents or audio CDs you recorded with a 'stand-alone' unit? As hi-fi enthusiasts, it's taken for granted that we can still enjoy cassettes or open-reel tapes recorded 40-50 years ago as long as they were kept away from heat, humidity and magnetic fields.

Admittedly, batches of open-reel tape suffered from something called 'sticky shed syndrome' (SSS). During manufacture, a chemical compound known as the 'binder' is used to attach the magnetic coating to the plastic film (the 'tape' proper).

SSS-plagued tapes employed an unstable binder that was 'hygroscopic' – it could absorb atmospheric moisture over time and break down. Attempt to play such tape, and the coating containing your precious music will be deposited around the tape path!

You can 'bake' affected media in an accurately-controllable oven; the moisture evaporates, and the 'dried out' tape may be stable long enough for its contents to be transferred to digital. But there's no guarantee the treatment will work. One shudders to think of all the priceless album master-tapes that have been lost forever.

But home-use cassettes were affected by SSS, and their long-time durability has lulled us into a false sense of security. Then digital recording on optical media came

along. For the first time, we could make our own 'one-off' CDs! Optical is unaffected by stray magnetism and, being contactless, won't wear out. Marketing departments seized on these benefits, reassuring us that discs would retain their contents for decades.

The reality is rather different. I was often sent 'preview' software products on CD-R. One 650MB Sony disc, stored in its jewel box as per manufacturer-recommendations, became completely-useless within a decade of being sent to me in 1997. The dye and coating on the disc surface had 'rotted' away. Its data was irretrievable.

The coating of CD-Rs, especially those used in harsh environments like cars, can be scratched or flake off. If this occurs near the hub, the CD-R's table of contents (and thus the disc) will no longer be playable.

And DVD-Rs? Although data-density is higher, the precious information-carrying 'layer' is sandwiched between two polycarbonate discs. It's theoretically less-vulnerable than a CD-R. Naturally, the seal between the constituent discs needs to be airtight or you'll get 'CD-rot' type failures. Millions of these discs were sold globally, for data and consumer use (DVD recorders were popular VCR-replacements).

Recently, I tried playing video recorded onto TDK-branded DVD-R media with a Panasonic machine about 8 years ago. The disc, a dark-blue 16x DVD-R labelled 'TDK DVD-R 1-16x 4.7GB DATA/VIDEO', is clean. Carefully-stored away from direct sunlight and temperature extremes, it showed no scratches, thumb-prints, dust or other signs of deterioration. Yet it wouldn't play.

I then came across another such DVD-R I burnt around the same time, but on this occasion with my

PC's Samsung DVD burner (at 4x). It would have been verified after writing, and the fact I still have it suggests a 'pass'! Yet, like the previous one, it refused to read.

I bought around 100 of these TDK discs in different batches between 2008 and 2010. Further checking reveals that only half even attempt to play. Cheapo 2003-vintage 'no-brand' discs have a better success rate! I quickly started backing up the 'playable' discs with the free Roadkill Unstoppable Copier. Transfer errors were frequently-encountered, and so data has been lost forever.

But I subsequently discovered that they're not 'genuine' TDK. Imation (which used to be Scotch/3M) took over TDK's media division in 2007, but was allowed to continue using TDK branding. I don't recall being informed by the packaging that TDK products were no longer 'true' Japanese TDK.

Imation pulled out of the market in 2015, shedding many jobs in the process. It then renamed itself 'Glassbridge Enterprises' and shifted focus to 'investment' and 'asset management'. Financialisation, it would seem, is more lucrative than manufacturing!

An Imation representative told me that "media sold under the TDK brand met or exceeded standards". And warranties? "Consumer products were typically covered from one to two years from the date of original purchase," he said. A far cry from the 'true' TDK's 'lifetime warranties'...

Imation wouldn't explain where its so-called 'TDK' media came from, or how quality-control was maintained. I offered to send offending discs to Imation/Glassbridge so they could determine the reasons for failure – an offer that was ignored. I doubt they have the interest. So the moral? Things fail so always back-up your data.. ●

We do not sell these products. It is for your information only.

WORLD CLASSICS

Here is our list of the great and good from audio's glorious past, products that have earned their place in hi-fi history. You'll also see some oddities which aren't classic as such, but are great used buys. The year of introduction is given, alongside the original UK launch price.

TURNTABLES

EAT FORTE 2009 £12,500
Lavishly finished two box, two motor turntable with gorgeous Ikeda 407 tonearm bundled. Exceptionally stable and unfussy performer with a relaxed but highly enjoyable gait.



FUNK FIRM VECTOR II 2009 £860
Innovative engineering gives a nimble, pacey and musical sound that's one of the best at the price.

REGA P2 2008 £300
Excellent value for money engineering, easy set up and fine sound.

MCINTOSH MT10 2008 £8,995
Big, expensive, controversially styled and glows more than some might consider necessary, but an astonishingly good performer.

REGA P3-24 2008 £405
Seminal affordable audiophile deck with fine bundled tonearm. Tweakable, and really sings with optional £150 outboard power supply.

ACOUSTIC SOLID ONE 2007 £4,050
Huge turntable, both in terms of sheer mass and sonic dynamics. Fit up to three arms and enjoy, just don't damage your back moving it...

AVID VOLVERE SEQUEL 2007 £4,600
Stylish high end vinyl spinner with industrial strength build quality and a sound to match. Sound is edge-of-the-seat stuff.

MICHELL GYRODEC SE 2005 £1,115
Design icon with superlative build. Sound is beautifully smooth, effortless and exceptionally expansive.

MARANTZ TT-15S1 2005 £1,299
Cracking all in one deck/arm/cartridge combination, this must surely be the best sound* plug and play package at this price point.

MICHELL TECNODEC 2003 £579
Superb introduction to Michell turntables - on a budget. Top quality build and elegant design mean it's still the class of the mid-price field.



MICHELL ORBE 1995 £2,500
The top Michell disc spinner remains a superbly capable all rounder with powerful, spacious sound that's delicate and beguiling.

SME MODEL 10A 1995 £4,700
Exquisitely engineered deck and SME V tonearm combo that's an extremely accomplished performer with classical music.

LINN AXIS 1987 £253
Cut-price version of the Sondek with LVX arm. Elegant and decently performing package. Later version with Akito tonearm better.

TECHNICS SL-P1200 1987 £800
CD version of the Technics SL-1200 turntable. Massively built to withstand the rigours of 'pr' use and laden with facilities - a great eighties icon.

ROKSAN XERXES 1984 £550
Super tight and clean sound, with excellent transients. Less musical than the Sondek, but more neutral. Sagging plinth top-plates make them a dubious used buy.

DUAL CS505 1982 £75
Simple high quality engineering and a respectable low mass tonearm made for a brilliant budget buy. Polished, smooth and slightly bland sound.

MICHELL GYRODEC 1981 £599
Thanks to its stunning visuals, this bold design wasn't accorded the respect it deserved. Clean, solid and architectural sound.

TOWNSHEND ROCK 1979 £ N/A
Novel machine has extremely clean and fluid sound. Substantially modified through the years, and capable of superb results even today.

MARANTZ TT1000 1978 £ N/A
Beautiful seventies high end belt drive with sweet and clean sound. Rare in Europe, but big in Japan.



REGA PLANAR 3 1978 £79
Brilliantly simple but clean and musical performer, complete with Acus-derived S-shaped tonearm. 1983 saw the arrival of the RB300, which added detail at the expense of warmth. Superb budget buy.

SONY PS-B80 1978 £800
First outing for Sony's impressive 'Biotracer' electronic tonearm. Built like a tank with a clean and tidy sound, albeit lacking involvement. Scarily complicated and with no spares support - buy with caution!

TRIO LO-7D 1978 £600
The best 'all-in-one' turntable package ever made. Clean, powerful and three-dimensional sound, ultimately limited by the tonearm.

ADC ACCUTRAC 4000 1976 £300
Bonkers 1970s direct drive that uses an infra red beam to allow track selection and programming. More of a visual and operational delight than a sonic stunner.

PIONEER PLC-590 1976 £600
Sturdy and competent motor unit that performs well with a wide range of tonearms. Check very thoroughly before buying due to electronic complexity and use of some now-obsolete ICs.

PIONEER PL12D 1973 £36
When vinyl was the leading source, this bought new standards of noise performance and stability to the class, plus a low friction S-shaped tonearm. Later PL112D was off the pace compared to rivals.



TECHNICS SP10 1973 £400
Seminal Japanese engineering. Sonics depend on plinths, but a well mounted SP10/II will give any modern a hard time, especially in respect of bass power and midband accuracy.

LINN SONDEK LP12 1973 £86
For many, the Brit superdeck; constant mods meant that early ones sound warmer and more lyrical than modern versions. Recent 'SE' mods have brought it into the 21st century, albeit at a price.

ARISTON RD11S 1972 £94
Modern evolution of Thorens' original belt drive paradigm, Scotland's original super-deck was warm and musical, albeit soft. Still capable of fine results today.

GULDRING LENCU GL75 1970 £15.65
Simple, well engineered motor unit with soft, sweet sound and reasonable tonearm. Good spares and servicing support even today.

GARRARD 301/401 1953 £19
Tremendously strong and articulate with only a veiled treble to let it down.



THORENS TD124 1959 £ N/A
The template for virtually every 1970s 'superdeck', this iconic design was the only real competition for Garrard's 301. It was sweeter and more lyrical, yet lighter and less impactful in the bass.

TONEARMS

REGA RB251 2009 £136
Capable way past its price point, the new 3-point mount version of the classic RB250 serves up a taut and detailed sound. A little lean for some tastes, but responds well to rewiring and counter-weight modification.

HELIUS OMEGA 2008 £1,595
Stylish and solid lump of arm with fabulous build quality, that turns in a dynamic and weighty performance.

AUDIO ORIGAMI PU7 2007 £1,300
The classic Syninx PU3 updated to spectacular effect. Hand made to order, with any mass, length and colour you care for. Fit, finish and sound truly impressive.



GRAHAM PHANTOM 2006 £3,160
Sonically stunning arm with magnificent bass dexterity and soundstaging. Build quality up to SME standards, which is really saying something!

TRI-PLANAR PRECISION 2006 £3,600
Immaculate build, exquisite design and one of the most naturally musical and lucid sounds around.

MICHELL TECNOARM A 2003 £442
Clever reworking of the Rega theme, using blasting, drilling and rewiring!

SME 309 1989 £767
Mid-price SME comes complete with cost-cut aluminium armtube and detachable headshell. Tight, neutral sound with good tonality, but lacks the IV's pace and precision.

NAIM ARO 1987 £1,425
Charismatic unipivot is poor at frequency extremes but sublime in the midband; truly emotive and insightful.

SME SERIES V 1987 £2,390
Vice-like bass with incredible weight, ultra clear midband and treble astound, although some don't like its matter of factness!

NAIM ARO 1986 £875
Truly endearing and charismatic performer - wonderfully engaging mid-band makes up for softened frequency extremes.



ALPHASON HR100S 1981 £150
First class arm, practically up to present-day standards. Buy carefully, though, as there is no service available now. Totally under priced when new, exceptional.

SME SERIES III 1979 £113
Clever variable mass design complete with Titanium Nitride tube tried to be all things to all men, and failed. Charming nonetheless, with a warm and inoffensive sound.

TECHNICS EPA-501 1979 £ N/A
Popular partner for late seventies Technics motor units. Nice build and Titanium Nitride tube can't compensate for middling sound.

LINN ITTOK LVII 1978 £253
Japanese design to Linn specs made for a muscular, rhythmic sound with real dynamics. The final LVIII version worth seeking out.

AUDIO TECHNICA AT 1120 1978 £75
Fine finish can't compensate for this ultra low mass arm's limited sonics - a good starter arm if you've only got a few quid to spend.

HADCOCK GH228 1976 £46
Evergreen unipivot with lovely sweet, fluid sound. Excellent service backup.

ACOS LUSTRE GST-1 1975 £46
The archetypal S-shaped seventies arm; good, propulsive and involving sound in its day, but ragged and undynamic now.

SME 3009 1959 £18
Once state of the art, but long since bettered. Musical enough, but weak at frequency extremes and veiled in the midband. Legendary serviceability and stunning build has made it a cult, used prices unjustifiably high.

PHONO STAGES

CREEK OBH-8 SE 1996 £180
Punchy, rhythmic character with oodles of detail makes this a great budget audiophile classic. Partner with a Goldring G1042 for an unbeatable budget combination.

MICHELL ISO 1988 £ N/A
This Tom Evans-designed black box started the trend for high performance offboard phono stages. Charismatic, musical and punchy - if lacking in finesse.



LINN LINNK 1984 £149
Naim-designed MC phono stage built to partner the original Naim NAIT - yes, really! Fine sound, although off the pace these days.

INTEGRATED AMPLIFIERS

NAIM NAIT XS 2009 £1,250
With much of the sound of the Supernait at half the price, this is powerful, articulate and smooth beyond class expectations.

MUSICAL FIDELITY PRIMO 2009 £7,900
Seriously expensive, but one listen explains why. Wonderfully exuberant sound that can only come from a top quality tube design.

SUGDEN A21A S2 2008 £1,469
Crystalline clarity, dizzying speed and forensic detailing. Power limited so needs sensitive speakers.

CREEK OBH-22 2008 £350
Brilliant value budget passive, with remote control, mute and input switching, plus an easy, a neutral sound.

CAMBRIDGE 840A V2 2007 £750
Version 2 addresses version 1's weaknesses to turn in a mightily accomplished performance, offering power, finesse and detail.

SUGDEN IA4 2007 £3,650
Goody amount of Class A power, icy clarity and a breathtakingly fast, musical sound make this one of the very best super-integrateds.

NUFORCE P-9 2007 £2,200
Impressive two box preamp with superb resolution and an engaging sound.

MELODY PURE BLACK 101D 2007 £3,295
The clarity and openness of valves plus firm grip and fine detail make this a preamplifier masterclass.

AUDIOLAB 8000S 2006 £400
In another life, this sold for three times the price, making it a stand-out bargain now. Very clean, powerful and tidy sound.

MCINTOSH MA6800 1995 £3735
Effortlessly sweet, strong and powerful with semi-styling to match.

DELTEC 1987 £1900
Fast, dry and with excellent transients, this first DPA integrated is the real deal for eighties obsessives. Ridiculously punchy 80W per channel from a tiny, half-size box. Radical, cool and more than a little strange.

EXPOSURE VII/VIII 1985 £625
Seminal pre-power, offering most of what Naim amps did with just that little bit extra smoothness. Lean, punchy and musical.



AUDIOLAB 8000A 1985 £495
Smooth integrated with clean MM/MC phono stage and huge feature count. Extremely reliable, too. Post '93 versions a top used buy.

VTL MINIMAL/50W MONOBLOCK 1985 £1,300
Rugged, professional build and finish allied to a lively and punchy sound (albeit with limited power) make them an excellent used buy.

MUSICAL FIDELITY A1 1985 £350
Beguiling Class A integrated with exquisite styling. Questionable reliability.

MISSION CYRUS 2 1984 £299
Classic 1980s minimalism combines arresting styling with clean, open, lively sound. Further upgradeable with PSX power supply.



NAIM NAIT 1984 £350
Superb rhythms and dynamics make it truly musical, but tonally monochromatic. Fine phono stage, very low power.

CREEK CAS404U 1983 £150
More musical than any budget amp before it; CAS414U loses tone controls, gains grip.

MYST TMA3 1983 £300
Madcap eighties minimalism, but a strong and tight performer all the same.

ROTEL RA-820BX 1983 £139
Lively and clean budget integrated that arguably started the move to minimalism.

NAD 3020 1979 £69
Brilliantly smooth, sweet and punchy at the price and even has a better phono stage than you'd expect. The archetypal budget super-amp.

ROGERS A75 1978 £220
Lots of sensible facilities, a goodly power output and nice sound in one box. The later A75II and A100 versions offered improved sonics and were seriously sweet.

A&R A60 1977 £115
Sweet and musical feature-packed integrated; the Audiobab 8000A remains a classic.



SUGDEN C51/P51 1976 £130
Soft sounding early Sugden combo with a plethora of facilities and filters. A sweet and endearing performer but lacking in power and poor load driving ability.

SUGDEN A21 1969 £ N/A
Class A transistor integrated with an eminently likeable smoothness and musicality. Limited inputs via DIN sockets.

ROGERS CADET III 1965 £34
Sweet sounding valve integrated, uses ECL86 output valves, even has a half useable phono stage, sweet, warm a good introduction to valves.

CHAPMAN 305 1960 £40
Smooth pre/power combo with a sweet and open sound. Not quite up to Leak/Quad standards but considerably cheaper secondhand.

POWER AMPLIFIERS

ELECTROCOMPANIET NEMO 2009 £4,995 (EACH)

Norwegian power station as cool as a glacier tonally, yet impresses with sheer physicality and fleetness of foot. 600W per channel.

NUFORCE REFERENCE 9SE V2 2006 £1,750
Brilliant value for money monoblocks with massive power and super-clean, three dimensional sound.

QUAD II-80 2005 £6,000 PER PAIR

Quad's best ever power amplifier. Dramatic performer with silky but dark tonality, blistering dynamics, serious power and compellingly musical sound.



QUAD 909 2001 £900
Current-dumper has a smooth and expansive character with enough wallop to drive most loads. Not the most musical, but superb value all the same.

NAIM NAP 500 2000 £17,950
Flagship amplifier will drive just about any speaker with ease. Factor in the company's trademark pace, rhythm and timing and it all adds up to one effortlessly musical package.

MARANTZ MODEL 9 1997 £8000
Authentic reproduction monoblocks still more than cut the sonic mustard. Highly expensive and highly sought after.

MICHELL ALECTO 1997 £1989
Crisp, clean and beautifully controlled with gorgeous styling. Partnered with the £1650 Orca this sounds delicious!



MUSICAL FIDELITY XA200 1996 £1000
200W of sweet smooth transistor stomp in a grooved tube! Under-rated oddity.

PIONEER M-73 1988 £1,200
Monster stomp from this seminal Japanese power amplifier, complete with switchable Class A and Class B operation. Clean, open and assured sounding, albeit a tad behind the pace on high speed dance music. Rosewood side cheeks and black brushed aluminium completes the experience.

KRELL KMA100 II 1987 £5,750
Monoblock version of the giant KSA-100 is one of the seminal 80s transistor power amplifiers. Massive wallop allied to clean and open Class A sound makes this one of the best amplifiers of its type.

RADFORD STA25 RENAISSANCE 1986 £977
This reworking of Radford's original late sixties design was possessed of a wonderfully rich, old school valve sound with enough power (25W) and lots of subtlety.

QUAD 405 1978 £115
The first of the current dumpers is a capable design with smooth, effortless power and a decently musical sound. 606 and 707 continue the theme with greater detail and incisiveness.

HH ELECTRONICS TPA-50D AMPLIFIERS 1973 £110
Simple design with easily available components, solid build quality and fine sound make for a surprisingly overlooked bargain.

LECSUN AP1 1973 £ N/A
Madcap cylindrical styling alluded to its "tower of power" pretensions, but it wasn't. Poor build, but decently clean sounding when working.

QUAD 303 1968 £55
Bullet proof build, but woolly sound. Off the pace, but endearing nonetheless. Some pipe smoking slipper wearers swear by them!

LEAK STEREO 20 1958 £31
Excellent workaday classic valve amplifier with decent power and drive. Surprisingly modern sounding if rebuilt sympathetically. Irrepressibly musical and fluid.



LEAK STEREO 60 1958 £N/A
Leak's biggest valve power amp offers 35 Watts per channel and more low end welly than the smaller Stereo 20. Despite concerns over reliability rarity value means high price.

QUAD II 1952 £22
The all-time classic valve amplifier, with a deliciously fluid and lyrical voice. In other respects though, it sounds hopelessly dated. Low power and hard to partner properly.



LEAK POINT ONE, TL10, TL12.1, TL12 PLUS 1949 £28
Early classics that are getting expensive. Overhauling is de rigueur before use, using original parts if possible. Surprisingly crisp and musical. Deeply impressive in fine fettle.

PRE AMPLIFIERS

AUDIOLAB 8000C 1991 £499
Tonally grey but fine phono input and great facilities make it an excellent general purpose tool.



CROFT MICRO 1986 £150
Budget valve pre-amp with exceptionally transparent performance.

CONRAD JOHNSON MOTIV MC-8 1986 £2,500
Minimalist FET-based preamplifier is brilliantly neutral and smooth with a spry, light balance in the mould of Sugden. Something of a curio, but worthwhile nonetheless.

AUDIO RESEARCH SP-8 1982 £1,400
Beautifully designed and built high end tube pre-amplifier with deliciously sweet and smooth sound. Not the last word in incision or grip.

LINN LK-1 1986 £499
A brave attempt to bring remote controlled user-friendliness to hair-shirt audiophile hi-fi. Didn't quite work, but not bad for under £100.

NAIM NAC 32.5 1978 £ N/A
Classic high end pre. Brilliantly fast and incisive sound that's a joy with vinyl! but a tad forward for digital.

LECSUN AC-1 1973 £ N/A
Amazing styling courtesy of Allan Boothroyd can't disguise its rather cloudy sound, but a design classic nonetheless.

QUAD 33 1968 £43
Better than the 22, but Quad's first tranny pre isn't outstanding. Responds well to tweaking/rebuilding though...



LEAK POINT ONE STEREO 1958 £ N/A
Good for their time, but way off the pace these days. Use of EF86 pentode valve for high gain rules out ultra performance. Not the highest-fi!

QUAD 22 1958 £25
The partner to the much vaunted Quad II mono-blocks - cloudy and vague sound means it's for anacrophiles only.

LOUDSPEAKERS

WHARFEDALE DIAMOND 10.3 2010 £290
Great small standmounters for audiophiles on a budget; dry punchy sound with impressive sound-staging at the price.



YAMAHA SOAVO 1.1 2009 £3,000
Musical, transparent with impressive dynamics and cohesion. Excellent build and finish.

USHER BE-10 2009 £10,500
Clever high end moving coil design with immense speed and dizzying clarity allied to epic punch. Needs the best ancillaries to fly, though...



SPENDOR A5 2009 £1,695
Multi-talented floorstanders with generous scale and punch and Spendor's classic mid-range detail. Deliver a sound that thoroughly engages whatever you care to play.

MONITOR AUDIO PL100 2008 £2,300
The flagship 'Platinum' series standmounter has a lovely warm and delicate sound with superlative treble.



MARTIN LOGAN SOURCE 2008 £1,600
Brilliant entry level electrostatics, giving a taste of loudspeaker esoterica for the price of most moving coil boxes. Tremendous clarity, evenness and delicacy, although not the world's most powerful sound.

PMC OB11 2008 £2,950
Cleverly updated floorstanders give scale and solidity in slim and well finished package.

ISOPHON GALILEO 2007 £2,100
Big standmounters that really grip the music and offer quite startling dynamics and grip.

ONE THING AUDIO ESL57 2007 £1,450
One Thing Audio's modifications keep the good old ESL57 at the very top of the game.

MOWGAN AUDIO MABON 2007 £3,995
Massively capable loudspeakers that offer dynamics, scale and clarity in an elegantly simple package. Wide range of finishes, too.

B&O BEOLAB 9 2007 £5,000
Technically impressive and visually striking loudspeakers with sound quality that more than matches their looks.



ISOPHON CASSIANO 2007 £12,900
Drive units featuring exotic materials allied to superlative build quality result in an immensely capable loudspeaker. Not an easy load to drive, however.

B&W 686 2007 £299
Baby standmounters offer a sophisticated and mature performance that belies both their dimensions and price tag.

QUAD ESL-2905 2006 £5,995
The old 989 with all the bugs taken out, this gives a brilliantly neutral and open sound like only a top electrostatic can; still not a natural rock loudspeaker, though

B&W 801D 2006 £10,500
In many respects, the ultimate studio monitor; dazzling clarity and speed with commanding scale and dynamics



REVOLVER CYGNIS 2006 £5,999
Revolver pull out all the stops and show what they can do with this magnificent flagship loudspeaker. A superb monitor that is like a mini B&W 801D in many ways.

USHER BE-718 2007 £1,600
Beryllium tweeters work superbly, allied to a fast and punchy Bass driver. The result is subtle, smooth and emotive.

USHER S-520 2006 £350
Astoundingly capable budget standmounters that offer detail and dynamics well beyond their price and dimensions.

ACOUSTIC ENERGY AE1 CLASSIC 2006 £845
Brilliantly successful remake of an iconic design; not flawless, but surely one of the most musical loudspeakers ever made.



MISSION X-SPACE 1999 £499
The first mass production sub and sat system using NXT panels is a sure-fire future classic - not flawless, but a tantalisingly unboxy sound nevertheless!

MISSION 752 1995 £495
Cracking Henry Azima-designed floorstanders combined HDA drive units and metal dome tweeters with surprisingly warm results. Benign load characteristics makes them great for valves.

TANNOY WESTMINSTER 1985 £4500
Folded horn monsters which sound good if you have the space. Not the last word in tautness but can drive large rooms and image like few others.



CELESTION SL6 1984 £350
Smallish two way design complete with aluminium dome tweeter and plastic mid-bass unit set the blueprint for nineteen eighties loudspeakers. Very open and clean sounding, albeit course at high frequencies and limp in the bass. Speakers would never be the same again...

HEYBROOK HB1 1982 £130
Peter Comeau-designed standmounters with an amazingly lyrical yet decently refined sound. Good enough to partner with very high end ancillaries, yet great with budget kit too. A classic



QUAD ESL63 1980 £1200
An update of the ESL57, with stiffer cabinets. Until the 989, the best of the Quad electrostatics.

MISSION 770 1980 £375
Back in its day, it was an innovative product and one of the first of the polypropylene designs. Warm, smooth, clean and powerful sound.

ACOUSTIC RESEARCH AR18S 1978 £125
Yank designed, British built loudspeaker became a budget staple for many rock fans, thanks to the great speed from the paper drivers, although finesse was most definitely not their forte...

YAMAHA NS1000 1977 £532
High tech Beryllium midband and tweeter comes and brutish 12" woofers in massive sealed mirror image cabinets equals stunning transients, speed and wallop allied to superb transparency and ultra low distortion. Partner carefully!



JR 149 1977 £120
Cylindrical speaker was ignored for decades but now back in fashion! Based on classic KEF T27/ B110 combo as seen in the BBC LS3/5a. Doesn't play loud, needs a powerful transistor amplifier, but has clarity and imaging.

KEF R105 1977 £785
Three way Bextreme-based floorstander gave a truly wideband listen and massive (500W) power handling. A very neutral, spacious and polite sounding design, but rhythmically well off the pace.

SPENDOR BC1 1976 £240
 Celestion HF1300 tweeter meets bespoke Spendor Bextrene mid-bass unit. The result is a beautifully warm yet focussed sound. A little bass bloom necessitates careful low-stand mounting.

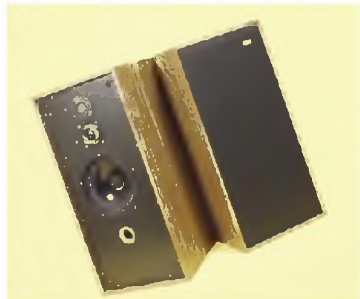

IMF TLS80 1976 £550
 Warm and powerful 1970s behemoth with transmission loading and a mixture of KEF and Celestion drive units. Impressively physical wideband sound but rhythms not a forte.

HH ELECTRONICS TPA-50D AMPLIFIERS 1973 £110
 Simple design with easily available components, solid build quality and fine sound make for a surprisingly overlooked bargain. Not exactly stylish, however.

BBC LS3/5A 1972 £88
 Extremely low colouration design is amazing in some respects – articulation, stage depth, clarity – and useless in others (both frequency extremes). Came in wide variety of guises from various manufacturers building it under licence

LEAK SANDWICH 1961 £39 EACH
 Warm sounding infinite baffle that, with a reasonably powerful amplifier can sound quite satisfying.

QUAD ESL57 1956 £45 EACH
 Wonderfully open and neutral sound puts box loudspeakers to shame. Properly serviced they give superb midband performance, although frequency extremes less impressive. Ideally, use in stacked pairs or with subwoofers and supertweeters

SYSTEMS

MERIDIAN SOOLOOS 2.1 2010 £6,990
 Crisp styling, bright, colourful touchscreen, plus excellent search facilities. This is one hard disk music system with a difference. Best partnered to Meridian active loudspeakers.



NAIM UNITIQUITE 2010 £995
 Great little half width one-box system with truly impressive sound allied to a wealth of source options

ARCAM SOLO MINI 2008 £650
 Half the size and two-thirds the price of a full-sized Solo, the Mini gives very little away in terms of performance to its bigger brother.

MERIDIAN F80 2007 £1,500
 Fantastically built and versatile DVD/CD/DAB/FM/AM unit, designed in conjunction with Ferrari. Ignore nay-sayers who sneer that it isn't a 'proper' hi-fi product. Just listen.

SHANLING MC-30 2007 £650
 Quite possibly the cutest all-in-one around with fine performance from the CD player, tuner and MP3 player input. Very low power, though.



AURA NOTE PREMIER 2007 £1,500
 Lovely shiny CD/tuner/amplifier with fine sound quality and dynamic abilities



MARANTZ 'LEGEND' 2007 £22,000
 The combination of SA-7S1 disc player, SC-7S2 preamp and MA-9S2 monoblocks delivers jaw-dropping performance

ARCAM SOLO NEO 2006 £1,100
 Excellent all-in-one system, with a warm, smooth and balanced sound to match the features and style.

PEACHTREE AUDIO IDECCO £1,000
 Excellent sounding iPod dock, impressive DAC and fine amplifier section make this an excellent one box style system.



TUNERS

ARCAM FMJ T32 2009 £600
 Excellent hybrid FM/DAB+ tuner with a smooth, engaging sound. Factor in its fine build and it's a super value package



MAGNUM DYNALAB MD-100T 2006 £1,895
 One of the best ways to hear FM that we know; superbly open and musical sound in a quirky but characterful package.

MYRYAD MXT4000 2005 £1,000
 Sumptuous sound and top-notch build quality make for a tempting AM/FM package. Warm and richly detailed on good-quality music broadcasts.

NAIM NAT03 1993 £595
 The warm, atmospheric sound is further proof of Naim's proficiency with tuners.

CREEK CAS3140 1985 £199
 Excellent detail, separation and dynamics - brilliantly musical at the price. T40 continued the theme...

QUAD FM4 1983 £240
 Supreme ergonomics allied to a pleasingly lyrical sound with plenty of sweetness and detail made this one of the best tuners around upon its launch



NAD 4040 1979 £79
 Tremendously smooth and natural sound allied to low prices and good availability make this budget analogue esoterica

MARANTZ ST-8 1978 £353
 Marantz's finest radio moment. Warm, organic sound plus an oscilloscope for checking the signal strength and multipath

YAMAHA CT7000 1977 £444
 Combines sleek ergonomics, high sensitivity and an explicit, detailed sound

SONY ST-5950 1977 £222
 One of the first Dolby FM-equipped tuners, a format that came to nought. Still, it was Sony's most expensive tuner to date, and boasted good sound quality with brilliant ergonomics



ROGERS T75 1977 £125
 Superb mid-price British audiophile design, complete with understated black fascia. Smooth and sweet with fine dimensionality

SANSUI TU-9900 1976 £300
 A flagship Japanese tuner. It boasts superlative RF performance and an extremely smooth and lucid sound



TECHNICS ST-8080 1976 £180
 Superb FM stage makes for a clean and smooth listen.

REVOX B760 1975 £520
 The Revox offers superlative measured performance although the sound isn't quite as staggering as the numbers. Fine nonetheless, and surely the most durable tuner here?

SEQUERRA MODEL 1 1973 £1300
 Possibly the ultimate FM tuner. Massive in terms of technology, size and features dedicated to extracting every ounce of performance from radio, including impressive multi-purpose oscilloscope display.

LEAK TROUGHLINE 1956 £25
 Series I an interesting ornament but limited to 88-100MHz only. II and III are arguably the best-sounding tuners ever. Adaptation for stereo easy via phono multiplex socket. Deliciously lucid with true dimensionality.

HEADPHONE AMPLIFIERS

GRAHAM SLEE NOVO 2009 £255
Dynamic headphone amplifier with a great sense of timing. Crisp, clear treble and warm midrange gives an involving sound.



MUSICAL FIDELITY X-CAN V8 2008 £350
Open and explicitly detailed sound plus serious bass wallop. A great partner for most mid-to-high end headphones.

CD PLAYER/RECORDERS

MUSICAL FIDELITY TRIVISTA 2002 £4000
When playing SACDs, the sweetest, most lucid and lyrical digital disc spinner we've heard. Old school stereo, pure DSD design. CD sound is up in the £1000 class, too! Future classic.

MARANTZ SA-1 2000 £5,000
The greatest argument for SACD. This sublime Ken Ishiwata design is utterly musically convincing with both CD and SACD, beating most audiophile CD spinners hands down.



SONY MDS-JE555ES 2000 £900
The best sounding MD deck ever, thanks to awesome build and heroic ATRAC-DSP Type R coding.

PIONEER PDR-555RW 1999 £480
For a moment, this was the CD recorder to have. Clean and detailed.

MARANTZ DR-17 1999 £1100
Probably the best sounding CD recorder made; built like a brick with a true audiophile sound and HDCD compatibility.



CAMBRIDGE AUDIO CD4SE 1998 £200
A touch soft in the treble and tonally light, but outstanding in every other respect.

SONY TCD-8 DATMAN 1996 £599
Super clean sound makes this an amazing portable, but fragile.

LINN KARIK III 1995 £1775
The final Karik was a gem. Superb transport gives a brilliantly tight, grippy dynamic sound, albeit tonally dry.

NAIM CDS 1990 £ N/A
Classic Philips 16x4 chipset with serious attention to power supplies equals grin-inducing sonics.

MARANTZ CD73 1983 £700
A riot of gold brushed aluminium and LEDs, this distinctive machine squeezed every last ounce from its 14x4 DAC -super musical



MERIDIAN 207 1988 £995
Beautifully-built two-box with pre-amp stage. Very musical although not as refined as modern Bitstream gear. No digital output.

SONY CDP-R1/DAS-R1 1987 £3,000
Sony's first two boxer was right first time. Tonally lean, but probably the most detailed and architectural sounding machine of the eighties.

CAMBRIDGE AUDIO CD1 1986 £1500
Inspired Stan Curtis redesign of Philips CD104, complete with switchable digital filter. Lean but tight and musical performer.



MERIDIAN MCD 1984 £600
The first British 'audiophile' machine was a sweeter, more detailed Philips CD100 14x4 never sounded so good, until the MCD Pro arrived a year later.

SONY CDP-701ES 1984 £890
Sony's first bespoke audiophile machine used a 16x2 DAC to provide a clinically incisive sound; supreme build quality allied to the pure unadulterated luxury of a paperbook-sized remote control.

YAMAHA CD-X1 1983 £340
Nicely built 16x2 machine with a very sharp and detailed sound; sometimes too much so. Excellent ergonomics, unlike almost every other rival of the time.

SONY CDP-101 1982 £800
The first Japanese CD spinner was powerful and involving. Brilliant transport more than compensated for 16x2 DAC, and you even got remote control!



ANALOGUE RECORDERS

AIWA XD-009 1989 £600
Aiwa's Nak beater didn't, but it wasn't half bad nonetheless. Massive spec even included a 16x4 DAC!

NAKAMICHI CR-7E 1987 £800
The very best sounding Nakamichi ever - but lacks the visual drama of a Dragon.



SONY WM-U6C 1985 £290
Single capstan transport on a par with a Swiss watch, single rec/replay head better than most Naks. Result: sublime.

PIONEER CTF-950 1978 £400
Not up to modern standards sonically, but a great symbol of the cassette deck art nonetheless.

YAMAHA TC-800GL 1977 £179
Early classic with ski-slope styling. Middling sonics by modern standards, but cool nonetheless!

SONY TC-377 1972 £N/A
A competitor to the Akai 4000D open reel machine, the Sony offered better sound quality and is still no slouch by modern standards.

REVOX A77 1968 £145
The first domestic open reel that the pros used at home. Superbly made, but sonically off the pace these days.

COMPACT DISC TRANSPORTS

ESOTERIC P0 1997 £8,000
The best CD drive bar none. Brilliantly incisive, ridiculously over engineered.

TEAC VRDS-T1 1994 £600
Warm and expansive sound made this a mid price hit. Well built, with a slick mech.

KENWOOD 9010 1986 £600
The first discrete Jap transport was beautifully done and responds well to re-clocking.

DACs

DCS ELGAR 1997 £8500
Extremely open and natural performer, albeit extremely pricey - superb.

DPA LITTLE BIT 3 1996 £299
Rich, clean, rhythmic and punchy sound transforms budget CD players.

CAMBRIDGE AUDIO DAC MAGIC 1995 £99
Good value upgrade for budget CD players with extensive facilities and detailed sonics.

PINK TRIANGLE DACAPO 1993 £ N/A
Exquisite; the warmest and most lyrical 16bit digital audio we have ever heard.

QED DIGIT 1991 £90
Budget bitstream performer with tweaks aplenty. Positron PSU upgrade makes it smooth, but now past it.

CABLES

MISSING LINK CRYO REFERENCE 2008 £495/0.5M
High end' interconnects, with deliciously smooth, open and subtle sound without a hint of edge.

TECHLINK WIRES XS 2007 £20
Highly accomplished interconnects at an absurdly low price. Stunning value for money.

VDH ULTIMATE THE FIRST 2004 £250
Carbon interconnects that help you forget the electronics and concentrate on the music. Miraculous transparency. Tight and tuneful bass mixed with air and space.



WIREWORLD OASIS 5 2003 £99/M
Excellent mid-price design with a very neutral, silky and self-effacing sound. Superb value for money.

TGI CONSTRICTOR 13A-6 BLOCK 2003 £120
Top quality 'affordable' mains outlet block, with fine build and good sonics. Well worth the extra over standard high street specials, which sound coarse and two-dimensional by comparison.

vinyl section

contents

JULY 2017

www.hi-fiworld.co.uk

McINTOSH MP1100 PHONO STAGE 83
An exotic phono stage reviewed by Noel Keywood.

AUDIOPHILE BOOK 89
Paul Rigby reads Sgt Peppers, covering the Beatle's classic album.

SLATE SOLID AUDIO SLATE PLATTER MAT / AIRBOURNE CORK & RUBBER MAT 91
Noel Keywood and Paul Rigby check out vinyl upgrades.

SUNDAZED DAZES

Three from the US-based outfit (www.sundazed.com). Donovan's 'Barabajagal' (1968) folk rock backed by Jeff Beck, Big Jim Sullivan and John Paul Jones. Inventive and sparkling, includes the single, 'Atlantis'.



'The Soul of Wand Records', a compilation featuring Florence Greenberg's cult label production, featuring Nella Dodds, The Charts, Maxine Brown and more.

Imprint, Modern Harmonic's 'Folk Songs for the 21st Century' via Sheldon Allman (the singing voice of TV's talking horse, 'Mr Ed'). This rocking/country/easy atomic concept album (i.e. 'Radioactive Mama', 'Crawl Out Through the Fallout', etc) is very silly but very 'fun'.

news

DAMAGED MINDS

"I gotta fever! And the only prescription is more cowbell!" Has the band seen the sketch within USA's Saturday Night Live? From Damaged Goods (damagedgoods.co.uk) is Cowbell's new release, 'Haunted Heart', a casually sneering, retro, fifties smear.

Two Billy Childish vehicles include Thee Knights of Trashes' 'Thee Milkshakes' (1984) and The Millshakes' Revenge! 'The Legendary Missing 9th Album' (1987). Both combine primitive garage rock with raw melodies and both ape aggressive early 60s beat releases.



PURE PLEASURE

From UK audiophile outfit, Pure Pleasure (www.purepleasurerecords.com) comes Laura Nyro's 'Christmas and the Beads of Sweat' (1970). Superb song-writing divided into two sides. The first backed by Muscle Shoals session men, the flip by New York heavies Duane Allman and Alice Coltrane. A social reflection from Vietnam downwards.

Also look out for a pair of jazz classics: The Modern Jazz Quartet's stunning 'Pyramid' (1960), full of passion and invention plus Duke Ellington's debut vinyl LP, 'Masterpieces by Ellington' featuring 'uncut concert arrangements'. Including 'Mood Indigo', 'Solitude' and more, this is a stone cold classic of a jazz LP that includes the classic band line-up (Hodges, Greer, Brown et al).



ROCK TRIO

A double album from Demon (www.demonmusicgroup.com), 'Indie Anthems' is a vinyl-only compilation including Suede's 'Trash', Radiohead's 'Just', Embrace's 'Ashes', The Stone Roses' 'Fools Gold' and many more.

Alt.rock/hard rock outfit, Tess of the Circle's limited-edition vinyl edition of 'Amplify'. 'Anniversary Edition' based on the 2016 release is a 300-copy, hand numbered copy featuring a signed letter from vocalist, Tess Jones.

Finally, Maypole's self-titled LP is a reissue of the 1971 debut (Vinilissimo; munster-records.com). Initially released when their label, Colossus, was about to fold, this 'lost' psych/hard rock album deserves lots of attention.



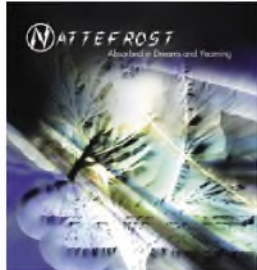

SIREENA SIRENS

Nattefrost's 'Absorbed in Dreams and Yearning' (2005; www.sireena.de) is a synth-based instrumental with samples on coloured vinyl and coloured by Tangerine Dream influences.

The Electric Family's 'Terra Circus' is their first LP in ten years. Contemporary German rock that is high on ambition fades into derivative blandness.

THE DEAD DAISIES

A rocking supergroup featuring a rotating line-up currently includes Doug Aldrich (Whitesnake/Dio), Marco Mendoza (Thin Lizzy), John Corabi on guitar (Mötley Crüe), Brian Tichy on drums with guitarist Dave Lowy. Even guitarist, Slash, has guested at one point. Those into 70s-era rock will have a fun time.

This 'Live & Louder' box set features recordings from the 2016 UK & European Tour. Includes two vinyl discs, one CD, 7" single, DVD plus patch, poster, photocard and sticker.



...AND FINALLY

From International Photographic (internationalphonographinc.com) is avant-jazz reedman, Julius Hemphill's 1972 recording, 'Dogon A.D.' Features David Sanborn, Tim Berne, Bakida Carroll, Abdul Wadud and Philip Wilson. A nicely mastered, historic LP.

Part of an ongoing reissue programme, Flying Saucer Attack's (Domino, dominorecordsco.com) 1994 self-titled noise-based drone electronica was and is an incredible feedback fest.

Jen Gloeckner's new self-titled LP has an ambient/trip-hop feel with Gloeckner's naturally pinched/compressed delivery contrasting with the laconic beats.

Morrissey & Marshall's 'We Rise' (CJA, www.morrisseyandmarshall.com) provides notable rock/pop harmonies with a pleasing psychedelic varnish that sometimes falls into the irritatingly dramatic.

Tuxedo's 'Tuxedo II' (Stones Throw; www.stonesthrow.com) offers attractive R&B/funk. Well constructed, solidly played, professional arrangements but there's too much B-material here. Hire a song-writer, guys.

Tom Hickox's 'Monsters from the Deep' (Family Tree, tomhickoxmusic.com) offers a unique smooth, baritone delivery. Quirky, edgy, with an intriguing rhythmic sensibility. Worthy of attention.

From Deeznuts, 'Binge & Purgatory' (Century Media; www.centurymedia.com). Hardcore punk/metalcore from Australia rock hard but retains a cutting, clean delivery which never blurs the message.

Crewdson's 'Toys' (Slowfoot, slowfoot.co.uk) aka Hugh Jones features a range of home-made instruments has a sort of electronica fusion with jazz structures. Innovative.

Vlad Dobrovolski's 'The Drums of the Fore and Aft' (Kota, kotaarecords.com) utilised modular and analogue synths for this soundscape production. An LP of contemplation and meditation.

Post War Glamour Girls' 'Swan Songs' (Hide and Seek, www.hideandseekrecords.com) offers solid indie vibes with lots of chat. The LP features enough lyrics for a 10LP box set. An album or a novel?

Finally, 'Heirlooms & Hearsay' from Roxanne de Bastion (Nomad, www.roxannedebastion.com) offers a 'little girl' delivery and bendy words with a simple clarity. Does she wear shoes she she sings? That's what I want to know. If she does, then she shouldn't.

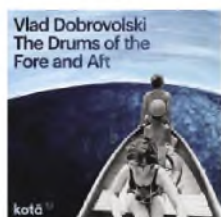

HI-FI WORLD

NOW AVAILABLE
ON THE APP STORE

App Store > Entertainment > audio web publishing ltd

Hi-Fi World

audio web publishing ltd >

Details Ratings and Reviews Related

Screenshots iPhone iPad

HI-FI WORLD

Get

Offers In-App Purchases

This app is designed for both iPhone and iPad

Rating: 4+

TOP IN-APP PURCHASES

1. Hi-Fi World Dec 2015 £3.99
2. Hi-Fi World Subscription £8.99
3. Hi-Fi World August 2015 £3.99
4. Hi-Fi World September 2015 £3.99
5. Hi-Fi World June 2015 £3.99
6. Hi-Fi World May 2015 £3.99
7. Hi-Fi World December 2015 £3.99
8. Hi-Fi World February 2015 £3.99
9. Hi-Fi World November 2015 £3.99
10. Hi-Fi World December 2014 £3.99

LINKS

Privacy Policy

© 2014 Hi-Fi World

Description

Hi-Fi World brings you the best hi-fi... from around the world!

- We listen and measure products in depth, at our London offices.
- Expert opinion from a team of renowned writers, musicians and engineers.
- International standard measurements using Rohde & Schwarz test equipment.

Information

Developer audio web publishing ltd
Category Entertainment
Updated 7 Dec. 2014
Version 1.0
Size 9 MB
Rating Rated 4+
Family Sharing Yes
Compatibility Requires iOS 5.0 or later. Compatible with iPhone, iPad, and iPod touch.
Languages English

Contents

VINYL NEWS AND REVIEWS SECTION SEE PAGE 80

HI-FI WORLD

JULY 2017 £4.50 www.hifiworld.co.uk

FREE READER CLASSIFIED ADS IN THIS ISSUE!

McINTOSH MP1100
phono stage

22 WOODBURNER/METRAK MP1100/1100T

15 OPTO-MUSIC HEADPHONE AMPLIFIER

63 REGENERATED ELECTROPOWER

39 FULLY AUTOMATIC RECORDING MACHINE

83 MULTITRACKED PROTOTYPING

JULY 2017
VOLUME 27 NO 5

FEATURES

- STREAMING FEATURE

SOUNDBITES

OLDE WORLDE

VINYL

CLASSIFIEDS

ADVERTISERS INDEX

CLASSIC CUTS

DOWNLOAD OUR APP ON APPLE AND ANDROID
DOWNLOAD FROM iTUNES OR GOOGLE PLAY
iPad, iPhone, iPod, Tablets OUT NOW!

Sweet dream

McIntosh have released a new phono stage where the old and new sit alongside each other in complex combination. Noel Keywood looks closely.

Phono stages: I dream about them, but I never had a dream like this. The new MPI 100 phono stage from McIntosh (New York) is quite unlike anything that would pop into my head in the middle of the night, but McIntosh do a lot of things differently – and also very well. Their new MPI 100 phono stage, priced at a considerable £10,900, is both fascinating and impressive.

Like the lovely Luxman EQ500 (£4495) I tested in our March 2017 issue, and like our in-house Icon

Audio PS3 phono stage, the MPI 100 uses valves, something I will talk more about later, and it caters for MM and MC cartridges. There are no fewer than three turntable inputs with each configured differently – let's say one for dad the audiophile, one for daughter the DJ and one for grandad's 78s. To cope with all this the MPI 100 has pre-programmable 'configurations'.

I didn't mention grandad gratuitously, because McIntosh are also dialling into music history here by incorporating compatibility with LPs that pre-date what we know and

use today: RIAA equalisation. The MPI 100 has alternative equalisations used by earlier commercial disc formats, these being LP by Columbia, AES (Audio Engineering Society) and NAB (National Association of Broadcasters), as well as grandad's 78s.

The U.S. has musical history that it wants to retrospectively appreciate and the MPI 100 facilitates this through its multiple equalisation curves.

The turntable inputs are through phono sockets (unbalanced). However, input No3 also has a



balanced XLR socket. Running fully balanced greatly reduces hum and noise of all forms; its preferable to all else both in theory and in practice I have found.

In addition to three turntable inputs, there are two Line inputs; Line 1 is through phono sockets (unbalanced) and Line 2 through XLR balanced) sockets. Using phono or XLR in-to-out there is no gain; phono input to XLR out gives x2 gain; XLR in to phono out gives x0.5. Line in does go to Digital out as well.

Unbalanced phono socket outputs and balanced XLR outputs are fitted, measurement showing the latter give twice the output of the former, effectively doubling quoted gain values.

Surprisingly, there are digital outputs too, so you can rip LPs to digital files. Appropriately, McIntosh fit a high resolution 24/192 Analogue-to-Digital convertor. Both USB and S/PDIF digital are available, the latter via phono-socket electrical and TOSLINK optical connectors, as is common.

A disappointment was lack of an on-board volume control, so the MPI 100 must be used with a pre-amplifier, increasing system complexity and cost – even though it has enough gain to drive a power amplifier direct. It does however, have a remote control that allows cartridge loadings and gains to be adjusted from the listening position.

Size wise, this is a substantial unit, designed to fit a 19in rack – which hi-fi racks all are. It is therefore 18in wide (457mm), 445mm deep and 152mm high. Weight is high at



12AX7 (ECC83) double-triodes are used as amplifiers in fully balanced circuitry. These have a 10,000 hour life and are cheap to replace should it be necessary (unlikely).

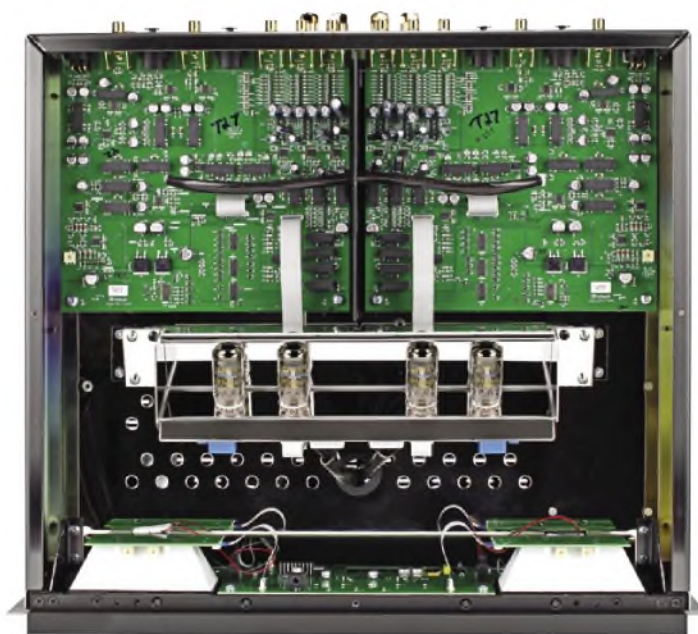

This is a massively complex phono stage complete with micro-processor controlled switching via relays, seen as oblong black objects on the board. Much of the board uses miniature surface-mount (SMD) parts and it is robotically manufactured.

12kgs, with plenty of heavy sheet steel used in the case work; the top cover was unusual heavy I found. The bottom of the case is stainless steel and carries power supplies, and a digital section, effectively shielding these components from the sensitive analogue stages above. Build quality and finish are very good, and as always we have the company's particular styling, with blue display readouts, blue illuminated output meters and big rotary knobs.

Curiously sited on top of the cabinet in a window lie the valves, four 12AX7 double-triodes. Since you can't do all the MPI 100 does with just four 12AX7s there had to be unmentioned transistors inside and indeed I found numerous N5532 low noise audio chips clustered around the phono inputs, on a large, robotically produced circuit board bristling with miniature surface mount (SMD) parts, accompanied by an army of sealed relays. They contribute substantially to a stable and reliable product, in this case switching all the many options the unit possesses. The valves it would seem are used in intermediate stages, since dedicated silicon chip input and output stages cost less and perform better.

IN USE

Switching on, the McIntosh pauses whilst the valves warm up, LEDs beneath them glowing orange. When ready to go their colour changes

to green. For those that dislike valve lighting, the display can be switched off. Mains power consumption is 50 Watts; we ran the unit from an Isotek Evo3 150 Watt mains regenerator. There was no switch on noise, such as clicks or thumps.

There are five gain settings: 40dB and 46dB are for high and low output MMs; 52dB (x400) is for high output MCs, whilst 58dB and 64dB

are for conventional and very low output MCs respectively. Technically, it's best to use lowest gain possible and turn volume up, by the way, because this lessens the likelihood of overload, but the MPI 100 has a clip warning indicator to warn of this if the unit is mis-set, and the meters provide similar warning. I used 58dB for an Ortofon A95 MC cartridge and 40dB for Ortofon 2M Black MM.

Input impedance can be set at 25, 50, 100, 400 and 1k Ohms for MCs and 47k for MMs. MCs (moving coils) should be set according to the cartridge manufacturer's instructions, most being designed for 100 Ohms, but MMs (moving magnets) need a 47k load.

Input capacitance loading can



also be set from 50pF up to 400pF in 50pF steps, but this is for MMs only, affecting frequency response.

Ideally, a turntable should be run balanced. This requires a minor re-wire to balanced cables and XLR connectors, one per channel. Because few balanced-input phono stages exist and even fewer of them have fully balanced internal circuitry (quite easy using chips) this is a rarely encountered option. Balanced working cancels distortion, noise and interaction with distorted earth currents. So McIntosh's option to do this on the MPI 100 inevitably caught my eye. It's good that at last a mainstream manufacturer bothers to do this on a serious phono stage, especially when it has obviously been designed with historical archiving in mind (see our Boxooout).

Valve phono stages (with input transformers) sound better: smoother, more spacious and organic in quality. However, valves are too noisy to be used with MC cartridges unless input transformers are used. McIntosh have elected not to go down this path, producing a hybrid design in the MPI 100 that has transistors to prevent noise being an issue. Again, I suspect that the historical suggestion made by valves (tubes) – authenticity being the key



What look like gold amplifier output terminals on the lower case-work are in fact earth terminals for turntables – up to three can be connected. At lower right sit the digital outputs.

word here – has something to do with valves appearing in a window. Bear in mind here McIntosh also make tube amplifiers – and they always have done, so the company has a long and strong connection with tubes.

In addition to NAB, AES, RIAA and LP equalisation curves (see downloadable handbook on 'net) there are rumble and scratch filters to help clean up old recordings.

And finally the digital bit. Apple Macintosh computers (as they call them) do not need drivers (as per usual) whilst PCs do (as per usual). You need a music editing programme

to record LP and here McIntosh mention Vinyl Studio by Alpinesoft, but the free Audacity programme is very popular and also very suitable.

SOUND QUALITY

I used the MPI 100 with a Timestep Evo modified Technics SL-1210 Mk2 turntable, SME309 arm and Ortofon MC-95 moving coil cartridge. Output was taken balanced to a Music First Audio magnetic preamplifier and thence to our in-house McIntosh MC152 power amplifier driving Martin Logan ESL-X hybrid electrostatic loudspeakers. I also used direct connection via the unbalanced output to our Icon Audio Stereo30 SE single-ended valve amplifier that has a volume control for an alternative approach. The McIntosh MC152 is transistor and gives intense insight and detail, as well as great bass grip. The Icon Audio Stereo30 SE is super-smooth, easy and spacious.

On the MPI 100 McIntosh have fitted a microprocessor to control all the switching, avoiding bangs and thumps. I found I could switch gains etc on the fly as a result; no need to switch off or turn volume down. The A-95 cartridge needed 58dB gain as it has quite strong output. With this set there was absolutely no hiss or hum in the loudspeakers, even with my ear pressed against the stators.

Spinning Mark Knopfler's True Love Will Never Fade, from Kill to Get Crimson (180gm) – a test track I use a lot and know well – the MPI 100 showed immediately the sort of character I expected. It has a dry and revealing quality, yet it also has a nicely involving resolution of instrumental and vocal textures, rather than the hard, bleached quality common to unbalanced, silicon chip phono stages. There was a sense of spaciousness around Mark Knopfler's



The four 12AX7s sit in their own compartment at top, visible through a window in the top cover. An LED sits under each, lighting orange at warm up and green when running.

voice and his guitar chimed out strongly, embellished with firmly etched and obvious fine treble. This is a phono stage with good projection and the presence of valves helps here. I noticed bass was a both tight and clean, but not emphasised or overly fulsome as can be the case with valves. The presence of a warp filter is largely responsible for the unit's composure and lack of bass wallow. When the background bass line kicked in half way through True Love Will Never Fade it took a nicely solid form I could follow easily. The McIntosh seemed to have it all on this track, shown by the sense of control, the structure and order of CD, whilst at the same time adding better resolution of timbral content accompanied by stronger projection of instruments and vocals. "Projective" is the word that came to mind when listening to Mozart's Symphony No25, on an excellent Decca LP re-mastered and re-released on 180gm vinyl by Pro-Ject. Violins fairly jumped from the XStat electrostatic panels of our Martin Logans, with a bright sheen overlaying a strong sense of animation from the instruments and the musicians

behind them of course.

These were the dominant sonic properties of the unit and they remained across a wide range of LPs played. Curious to explain that a phono stage can bring life to a performance, but there it is. The MP1100 is not backward in coming forward, as they say, and you get a nice big dose of "life" courtesy of the valves. It brought both clarity and excitement to LP, all in well ordered fashion.

CONCLUSION

In essence, this is a phono stage that has it all, except for a volume control. It matches any cartridge, will run three turntables at once, can be adjusted on the fly using remote control and it even has bright blue

ARCHIVING TO DIGITAL

The early disc equalisation curves this preamplifier has on-board puts it into different territory to most else – at least in domestic audio. "A serious archivist needs at least 60 options" Dave Cawley of Timestep told me, before he headed off to an ARSC (Association for Recorded Sound Collections) conference in San Antonio, Texas, to chair meetings. "But for the amateur at home it's a good start".

America's Library of Congress demands high transcription standards before accepting materials to its archives – and no MP3! Nowadays it asks for digital recordings of LP to be made without EQ for historical storage, and also with EQ so as to have a immediately playable file, technically correct or not. As Dave Cawley explained to me, every recording company had its own EQ in the early days of recorded music and technical details have been lost, so EQs are commonly matched to recordings subjectively, through listening tests. Hence the need for unequalised references, in case the match was incorrect.

The MP1100 offers a basic set of five EQ curves for – well – budding archivists. It even has a 78rpm curve for grandad. It is more than a hi-fi phono stage.

output meters to warn of overload if mis-set. Add in a 24/192 high resolution digital output so LPs can be digitally archived or turned into files for phone or portable player and you have it all. Just add in a great sound, compatibility with rare historical recordings and even an option to run fully balanced, input to output and you start to see what is on offer and why it is so priced. My dreams never got so far but others could manage better by listening to the new MP1100. It has the lot.

MEASURED PERFORMANCE

Gain values of 40dB (x100) up to 64dB (x1585) are quoted and were met; for example with maximum gain of 64dB, 1mV in gave 1660mV output – very high gain and enough for a low output MC cartridge. That was unbalanced input to output (phono sockets). The balanced XLR output gave double the output of unbalanced, offering a massive x3160 gain maximum.

Overload was set by a 10V output limit from unbalanced and 19V from balanced, so the MP1100 manages well in this respect also. The output meters show maximum well before actual output overload occurs, being calibrated for digital overload.

Equalisation (RIAA) accuracy was absolutely correct, as our frequency response analysis shows. Low frequency gain (Rumble filter off) was curtailed below 14Hz, giving a measured frequency response of 14Hz–20kHz. There is -8dB attenuation at 5Hz to warps.

The Rumble filter is drastic, rolling off gain sharply below 53Hz (-1dB point) and this will lighten bass.

Distortion (1mV in, 64dB gain) measured 0.2%, with third and fifth harmonics suggesting it was not from the valves.

Equivalent input noise (what you actually hear) was minimum at the highest gain setting of 64dB (x1500), measuring an unusually low 0.04µV, a level at which hiss will be inaudible. At 58dB (x800) the figure was 0.05µV, at 52dB (x400) 0.08µV, at 46dB (x200)

0.15µV and at 40dB (x100) 0.28µV. A value of 0.1µV is very quiet and anything lower excellent, so the MP1100 is exceptional in this area. The 40dB figure is noisy but purposed for high output MMs that are noisier (thermal noise).

The CLIP display and the meters indicated maximum early: both are linked to digital overload, not overload in the analogue amplifiers, to maximise dynamic range. The MP1100 ADC (via Aux input) was not linear for 24bit, measuring 0.4% distortion at -60dB, where 0.1% or better is expected. Bandwidth was good, frequency response measuring flat across the audio band, and the optical output delivered a 192kHz sample rate signal where many do not.

For a complex and large phono stage with so many switched options the MP1100 measured well. The digital section needs a better ADC however.

NK

Frequency response 14Hz- 20kHz

Distortion 0.2%
Separation 78dB
Gain x100 – x1500
Overload 10V, 19V out
Noise (e.i.n., 64dB gain) 0.04µV

FREQUENCY RESPONSE

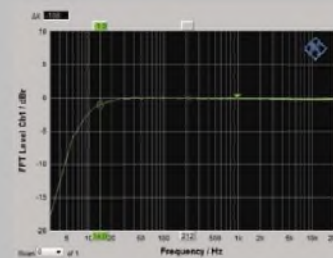

DISTORTION

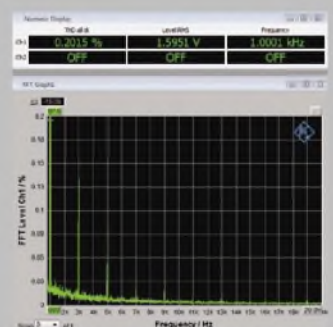

MCINTOSH MP1100 £10900



OUTSTANDING - amongst the best

VERDICT

A top quality phono stage with massive versatility and a great sound. Expensive but worth it.

FOR

- clear, projective sound
- no hiss or hum
- fully balanced all through
- digital output
- matches all cartridges

AGAINST

- size
- top viewing window
- no volume control

Jordan Acoustics
 +44 (0)1592 744779
 www.jordanacoustics.co.uk

HEATHCOTE AUDIO

web-www.heathcoteaudio.co.uk/e-mail-heathcoteaudio@aol.com

WE URGENTLY REQUIRE YOUR SURPLUS EQUIPMENT FRIENDLY PROFESSIONAL SERVICE PLEASE PHONE GEORGE ON 07860-511111

LOUDSPEAKERS

MBL 300E FLOORSTANDERS PIANO BLACK	EXCLT	£3450
MERIDIAN M2 & DEDICATED STANDS 1 OWNER FROM NEW	EXCLT/BOXED	DUE
SYSTEM AUDIO SA-1750 FLOORSTANDERS	EXCLT	£475
PMC TWENTY/24 FLOORSTANDERS & TLE-1 POWERED SUB		
ONE OWNER FROM NEW (£6250) UNMARKED AS NEW CONDITION	MINT/BOXED	£2995
AURUM CANTUS MUSIC GODDESS (£2500)	DEM/NEW	£1295
NHT 3.3 FLOORSTANDERS	EXCLT	£1395
KLIPSCH CORNER HORNS (BIRDS EYE MAPLE)	FANTASTIC!	£3995
SONICS AMERIGO HI END LOUDSPEAKERS (5K?) DEM USE ONLY	DEM/BOXED	£1850
MARTIN LOGAN DECENT SUBWOOFER	GC	£1250
ACOUSTIC AUDIO FUNDAMENTAL K2 1 OWNER (£25K NEW)	MINT/CRATED	£6995
B&W 801 MATRIX SERIES 2 WALNUT 1 OWNER	EXCLT	£2250
AURUM CANTUS GRAND SUPREME £10,000 +	DEM/CRATED	£5750
ART ALNICO-8 6 (£10,000) DEM USE	MINT/BOXED	£5250
MARTEN MILES CHERRY (8K+ ONE OWNER)	EXCLT	£2995
BOLZANO VILLETTRI BV3003 & BV SUB FANTASTIC!	SALE!	£2595
PODIUM 1s PANELS VERY LOW USE (£6000? NEW)	1 OWNER	£1795
ART AUDIO PRECISION MONITOR (PIANO BLACK 6K+)	DEM+1	£1795
HALLES TRANSCENDENCE 5 (SUPERB £6K?)	EXCLT/BOXED	£1750
AUDIOSTATIC ES-100 ELECTROSTICS	EXCLT	£1250
AURUM CANTUS LEISURE 3 SE (SINGLE SPEAKER)	EXCLT	£175
ALR JORDAN CLASSIC 2 (BIRCH VENEER £800+)	NEW/BOXED	£475
MISSION CYRUS CLS70 ICONIC STANDMOUNTS	EXCLT	£325
POLK RTI-A1 MONITORS (FEW HOURS USE)	MINT/BOXED	£295
WILMSLOW AUDIO PRESTIGE	RING	
THEIL CS 1.5 ONE OWNER FROM NEW	VGC/BOXED	£495
MONITOR AUDIO MA-12 SMALL STUDIO'S	GC	£295

DIGITAL

MERIDIAN 507.24 CD PLAYER ONE OWNER FROM NEW	EXCLT/BOXED	£595
DENON DCD 2010AE SACD/CD PLAYER ONE OWNER	MINT/BOXED	£995
TECHNICS SLP-S7 REMASTER CD PLAYER ONE OWNER	EXCLT/BOXED	£295
TECHNICS SLP-1200 AND REMOTE CONTROL PRIVATELY OWNED	EXCLT	£695
MUSICAL FIDELITY KW DM25 DAC (SUPERB)	MINT/BOXED	£895
MICROMEGA STAGE-2	EXCLT	£199
INCA TECH KATANA	VGC	£395
TRICHORD DIGITAL TURNTABLE	EXCLT	£395
THETA CARMEN CD/DVD TRANSPORT 1 OWNER	EXCLT/BOXED	£695
THETA DS-PRO GEN III COAX AES/EBU/AT&T RCA/BAL OUT 1 OWNER	EXCLT/BOXED	£695
PINK TRIANGLE ORDINAL (GETTING RARE)	GC	£349
PIONEER CLD-D925 LASER DISC/CD 1 OWNER LOW USE	MINT/BOXED	£349
LARGE NO OF MINT LASER DISCS	PLEASE	RING

VINYL

MICHELL ORBE/QC PSU/REGA ARM ONE OWNER BOXED	DUE IN	TBA
ACOUSTIC SOLID 1/REGA ARM/EXTRA'S	EXCLT	£3250
CLEARAUDIO MASTER REFERENCE/MASTER TQ-1/ETC	DUE IN	TBA
CLEARAUDIO UNIFY 12 INCH TONEARM FEW HOURS USE ONLY	MINT/BOXED	£1250
LUXMAN PD-444 TURNTABLE 1 OWNER COLLECTORS DREAM	EXCLT	£2500
AUDIO INNOVATIONS DELTA INERTIA TONEARM N.O.S	N.O.S	£750
GARRARD 401 WITH ACCOUSTAND SKELETAL PLINTH	EXCLT	£950
NOITS ANALOGUE MENTOR & HEAVY KIT	EXCLT	£1750
VOYD VALDI HUGE PSU ONE OWNER FROM NEW	GC	£695
TRIO KD-550 CORIAN BASE	VGC	£550
DP-1200 SPECIAL EDITION (INC ARM/CART)	RARE	£495
THOMENS TD-160S AUC ARM SHURE CART. EXCELLENT CONDITION	EXCLT	£375
ODDESSY RP1-XG ARM 1 OWNER COMPLETE COLLECTORS CONDITION	EXCLT	£1450
ORIGIN LIVE SILVER TONEARM	EXCLT	£395
NOITS ANALOGUE MENTOR ARM	DIS/DEM	£495
GRAHAM ENGINEERING ROBIN TONEARM (UNUSED?)	MINT/BOXED	£450
PROJECT 12 INCH CARBON ARM 2 WEIGHTS DIS/DEM	MINT/BOXED	£395
PROJECT 9 INCH CARBON ARM 2 WEIGHTS DIS/DEM	MINT/BOXED	£325
HADDOCK GH-242SE UNIPIVOT TONEARM	EXCLT/BOXED	£475
ORIGIN LIVE GOLD PLATED TONEARM	DEMNEW	£395
GARRARD 501 MISSING LINK PHONO STAGE MM/MC	EXCLT/DEM	£450
GRAHAM SLEE ERA GOLD (BLACK)	EXCLT	£275
VERTEX AQ SILVER SOLFONN TONEARM LEAD	DIS/DEM	£795
VAN DEN HUL MCD 501 SIL HYBRID TONEARM CABLE	EXCLT	£199
TOM EVANS MICRO GROOVE & PSU	EXCLT	£375
MICHELL ISU PHONO STAGE & HERA PSU	EXCLT	£349
AUDIO INNOVATIONS 1000 MC STEP UP	MINT/BOXED	£495
CARTRIDGE MAN DIGITAL STYLUS GAUGE	DEM	£165
VAN DEN HUL MC D 501 SILVER HYBRID TONEARM CABLE (SME V ETC)	EXCLT	£225
OKKI NOKKI RECORD CLEANING MACHINE 1 OWNER	BOXED	£275

SOLID STATE

MERIDIAN 502 (MC PHONO BOARD) & MSR 1 OWNER FROM NEW	EXCLT BOXED	£795
MERIDIAN 501 PRE AMP & MSR	MINT/BOXED	£325
NAKAMICHI PA7E/CASSE/STYE ONE OWNER FROM NEW	EXCLT	£1850
DENON PMA 2010 INTEGRATED ONE OWNER FROM NEW	MINT/BOXED	£1250
PASS LABS X-2 PRE AMP ONE OWNER FROM NEW	EXCLT	£1295
PASS LABS ALEPH PRE AMP	EXCLT	£1195
H-CAT P-12B PRE AMP (£2500?) DEM USE ONLY	EXCLT	£1295
CONSONANCE A-100 LINEAR AMP ONE OWNER	MINT/BOXED	£695
PRIMAHE I-121 INTEGRATED ONE OWNER FROM NEW	MINT/BOXED	£595

AUDIO INNOVATIONS 1000 SILVER PRE-AMP	EXC	£599
PS AUDIO GCA 100 X 5 POWER AMP 1 OWNER	EXCLT/BOXED	£1795
ADVANTAGE i200 REMOTE INTEGRATED (SUPERB AMP)	EXCLT	£895
MUSICAL FIDELITY A3CR POWER AMP 1 OWNER	MINT/BOXED	£495
JOHN SHEARNE 2 5 INTEGRATED AMP	1 OWNER	£375
JOHN SHEARNE 3 5 POWER AMP	1 OWNER	£375
ALCHEMIST KRACKEN II & LARGE OPTIONAL PSU	EXCLT	£395
TRIO L-05 MONOBLOCKS (RARE)	EXCLT	£795
TRIO L-01 PREAMP C/W PHONO STAGE	EXCLT	£495
SONY LA SCALA MIDI SEPERATES (VARIOUS)	EXCLT	RING

VALVE

ROGUE AUDIO 66 MAGNUM REMOTE CONTROL PRE	EX.DEM	£695
QUAD II-EIGHTY MONO'S LOW FEW HOURS USE (6K?)	MINT/BOXED	£3750
MELODY M880 KT88 MONOBLOCKS	MINT/BOXED	£2150
NEW AUDIO FRONTIERS 300B SUPREME POWER AMP		
(13K WNO) ONE OWNER LOW HOURS FANTASTIC AMP	MINT/BOXED	£4995
ANTIQUE SOUNDLABS AQ-9 845 MONOBLOCKS	DEM	£2850
MATTISSE REFERENCE 2 BOX PRE AMP (64 STEP ATT.)	ONE OWNER	£3450
PAPWORTH M-100 MONOBLOCKS ONE OWNER	MINT/BOXED	£1995
ART AUDIO INTEGRA INTEGRATED 1 OWNER	EXCLT	£1195
LECTOR ZOE REMOTE PRE AMP 1 OWNER	MINT/BOXED	£995
JOLIDA JD801A KT88 INT ONE OWNER FROM NEW	EXCLT/BOXED	£695
ANTIQUE SOUNDLABS LH-01 PRE-AMP H/PHONE AMP	EX.DEM	£375
MULLARD 5 20 EL-34 MONOBLOCKS	EXCLT	£595
AUDIO INNOVATIONS 1000 SILVER PRE-AMP	EXC	£599

TUNERS/STANDS/MISC.

SONY TC-377 REEL TO REEL ONE OWNER FROM NEW	EXCLT/BOXED	DUE
JORMA SUPER POWER/BYBEE POWER CORDS 1.5 METRE 2 OFF	EACH	£595
SONY LA SCALA PRE AMP/TUNER /CD PLAYER/TAPE DECK	EXCLT	RING
OKKI NOKKI RECORD CLEANING MACHINE 1 OWNER	BOXED	£275
AUDIOLAB 800DT TUNER 1 OWNER FROM NEW	EXCLT/BOXED	£295
SONY ST 5950 SD CLASSIC 70s TUNER	GC	£200
MARANTZ LAYLA ALL IN ONE AMP/CD/TUNER/CLOCK	EXCLT	£275
BEN DUNCAN PURE POWER 1KW P-100 POWER TRANSFORMER 1 OWNER	EXCLT	£375
TECHNICS ST-GT650 TUNER	VGC	£125
TECHNICS ST-GT550 TUNER	VGC	£99
ROTEL RB-950BX AM/FM TUNER	EXCLT	£125
ROTEL RT-870L LW/MW/FM STEREO	EXCLT	£99
MUSICAL FIDELITY X-CANS V3	MINT/BOXED	£195
BLACK RHODIUM 1.2 METRE POWER CORDS	NOS	£99
LARGE NO OF POWER CORDS FROM RUSS ANDREWS/TCI/COINCIDENT/ VAN DEN HUL/CHORD /RINGMAT/PS AUDIO/BLACK RHODIUM ETC	PLEASE	RING

INTERCONNECT

JORMA NO.1 INTERCONNECT ONE OWNER BOXED	DUE IN	RING
VAN DEN HUL MC D 501 SILVER HYBRID TONEARM CABLE (SME V ETC)	EXCLT	£225
TOWNSEND DCT RCA 1 METRE PAIR	DIS/DEM	£250
GUTWIRE CHIME 1 METRE RCA MINT/BOXED (2 PAIRS AVAILABLE)	DIS/DEM	TBA
GUTWIRE BASIC INTERCONNECT 2 METRE RCA PAIR	DIS/DEM	TBA
HOVLAND PINCUS G3 2 METRE PAIR XLR	DIS/DEM	£275
ABBEY ROAD REFERENCE 1 5 METRE PAIR EICHMAN PLUGS	DIS DEM	£375
ABBEY ROAD REFERENCE 1 5 METRE PAIR EICHMAN PLUGS	DIS DEM	£375
ABBEY ROAD REFERENCE 1 METRE PAIR EICHMAN PLUGS	DIS/DEM	£345
ABBEY ROAD INTERCONNECT 1 METRE RCA PAIR	DIS/DEM	£199
GOERTZ PURL SILVER 1 METRE RCA PAIR BOXED	DIS/DEM	£225
GOERTZ PURL SILVER 1 METRE RCA PAIR BOXED	DIS/DEM	£225
GOERTZ PURL COPPER 1 METRE RCA PAIR BOXED	DIS/DEM	£175
MADRIGAL CZ GEL 1 METRE XLR PAIR	DIS/DEM	£249
AVID SCT STANDARD BLUE 1 METRE RCA	NEW/BOXED	£249
KIMBER SELECT 1020 0.5 METRE RCA	MINT/BOXED	£295
KIMBER SILVER STREAK 1 METRE ULTRA PLATE RCA PAIR	DIS/DEM	£175
TRANSPARENT MUSIC LINK + 1 METRE XLR PAIR	DUE	£275
DISCOVERY ESSENCE 1 METRE RCA (2 PAIRS PRICED EACH))	DIS/DEM	£295
CHORD INDIGO 1 METRE XLR PAIR MINT	DIS/DEM	£450
CHORD INDIGO 1 METRE 3 PIN DIN MINT	DIS/DEM	£395
CHORD INDIGO 1 METRE DIN TO RCA PAIR	DIS/DEM	£395
CHORD INDIGO 1 METRE DIN TO RCA PAIR	DIS/DEM	£395
MANY MORE INTERCONNECT CABLES IN STOCK AND ON WEB SITE		

LOUDSPEAKER CABLE

JORMA NO.1 CABLE 1 ONE OWNER BOXED	DUE IN	RING
CHORD CO EPIC SUPER TWIN BIWIRE 14.5 METRE PAIR!!	EXCLT	RING
GUTWIRE CHIME 10FT PAIR MINT/BOXED	DIS/DEM	£1750
ABBEY ROAD REFERENCE 5 METRE PAIR	DIS/DEM	£599
HOVLAND NINE LINE 4 METRE BI-WIRE PAIR	DIS DEM	£450
HOVLAND NINE LINE 2 5 METRE BI WIRE PAIR	DIS/DEM	£350
GOERTZ MT2 VERACITY SILVER SPADES BOXED	DIS DEM	£450
VAN DEN HUL ORIGINAL INTEGRATION 5 METRE PAIR	DIS/DEM	£450
TRANSPARENT MUSIC WAVE BI WIRE 7 5 PAIR!!	VGC	£575
MIL MH-750 8 METRE PAIR!!	EXCLT	£1195
BLACK RHOD POLAR NINJA DCT ++2 9M. PAIR	DEM	£650
XLO 5 2 SIGNATURE 1 4FT PAIR	DEM	£495
XLO REF 2 5 METRE PAIR (SPADES)	EXCLT	£375
CHORD CO SIGNATURE 0 8 METRE JUMPEHS	MINT	£275
MANY MORE LOUDSPEAKER CABLES IN STOCK AND ON WEB SITE		

Sgt Pepper Tales

In the latest of his on-going series on music-related books, Paul Rigby looks at a celebration of The Beatles' classic Sgt Pepper album.

SGT. PEPPER AT FIFTY

The Mood, The Look, The Sound, The Legacy of The Beatles' Great Masterpiece
Mike McInnerney, Bill DeMain & Gillian G. Gaar
Omnibus

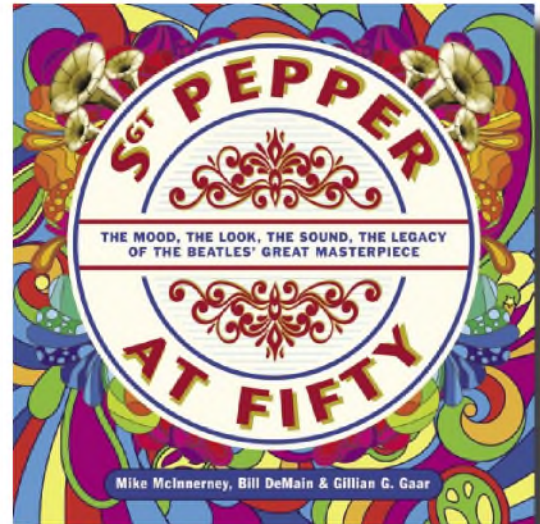

Don't be fooled into thinking that this book will hit the ground running in terms of the album and the band. You really do need to judge this book

by its cover and read carefully.

When the book title talks about 'The Mood', then that refers to the culture of the times. It means a look at the people surrounding the album: poets, fashion models, writers and the like. That is, the nature of the 'scene'.

In this first section of the book, the authors attempt to find context for the album, they want to give you a sense of where and why the album actually emerged.

For some, this information will be old hat and rather 'ho hum'. Experienced 60s readers will be familiar with much of what is said here, although those who might have taken a more cursory view on the times will find much that is new.

For example, coverage of the Human Be-In in January of 1967, the Rolling Stones drug arrests and the like. There are plenty of very interesting photographs of people, publications and posters to provide a fascinating suite of visual furniture, though.

When we get to The Look, the

editorial begins to dovetail a tad with intriguing pieces on the image surrounding the album. For example, The Beatles themselves adopted a singular identity for this album. A piece on facial hair proves intriguing. Before the band adopted facial hair there were only two types of people who wore 'mustaches', according to the band's hairdresser Leslie Cavendish – "spivs and old men" – whereas George Harrison thought that they represented something rather more spiritual: "Moustaches were part of the synchronicity and the collective consciousness of the time". Whatever you say, George.

The image of The Beatles of the Sgt Pepper period was important, symbolically. It broke the connection with the Beatlemania period, once and for all.

It's at this stage of the book that discussion is broached of the cover design. At this point we have a full and detailed investigation of just who is present on the cover.

The montage, as you know, features a host of individuals, many unknown to many of us, others 'of their time'.

For example, who remembers H.C. Westermann, the American satirical artist? Or Richard Merkin, a painter and professional dandy?

The fascinating section also lists the miscellaneous extra props that populate the cover including the portable TV that belonged to John Lennon, apparently, the velvet snake and the garden gnome (which I know was seen at auction around 5-10 years ago, fetching a pretty penny).

At this point, sleeve artist Peter Blake is focused upon (again, with plenty of top quality images) plus a fascinating section on the chap who designed the Sgt Pepper drumhead, seen on the sleeve, Joe Ephgrave (a real person, despite the rumours stating otherwise).

Discussion of the music itself is wide-ranging and detailed, including information on the 'missing' singles: Penny Lane and Strawberry Fields, Paul's compositions on his Magic Piano (a specially painted upright) plus lots of intricate detail on the structures, arrangements and the differences between the mono and stereo versions of the album.

From a slow start, the book builds and progresses – ending on the aftermath of the project that brings the LP up to present day – and builds in detail and intensity.

This book is a marvellous literary version of the Beatles magnum opus heard on the Sgt Pepper LP, 'A Day in The Life'.

Dial A Dealer Directory

directory of Hi-Fi Dealers throughout the UK and Ireland.

The Right Note
Music in the home



Digital: Aurender, Bel Canto, CEC, dCS, Gamut, VertexAQ.
Vinyl: Aesthetics, Graham, Spiral Groove, Transfiguration.
Tuners: Magnum Dynalab.
Amplifiers: Aesthetix, Bel Canto, CAT, Gamut, Storm Audio, Vitus, VTL.
Loudspeakers: Avalon, Gamut, Kaiser Acoustics (Chiara & Vivace), NEAT, Totem, Velodyne (subs).
Cables: Chord Co., DNM, Nordost, Siltech, Tellurium, VertexAQ, Mains Aletheia, Vertex AQ.
Supports: Arcici, Black Ravioli, Hi-Fi Racks, LeadingEdge, Stands Unique, Vertex AQ.
Room acoustics: LeadingEdge

Music in the Home
Tel: +44 (0)1225 874728
Web: www.rightnote.co.uk

sound cinergy
specialists in home entertainment

37 high street, Aldridge, WS9 8NL
Tel: 01922 457926
www.soundcinergy.co.uk
email: clive@soundcinergy.co.uk

Black Rhodium, Chord Co, Exposure, Heed, Kudos, Lehmann, Linn, Marantz, Michell, Monitor Audio, Naim, Neat, Nordost, Okki Nokki, Ortofon, Project, Rega, Roksan.

Check our website for ex dem and secondhand bargains. Ample car parking.
Tuesday - Saturday 10.00am - 5.30pm

Peak HiFi

For all your Hi-Fi requirements

www.peakhifi.co.uk

Martin Logan • Ortofon • Unison Research
Oracle Audio • SME • Thorens • Classic Turntable Co.
Project Audio • SMD Acoustics • Dynavector • Jelco
Koetsu • Sugden Audio • Lehmann Audio • PMC

sales@peakhifi.co.uk
Tel: 01226 761832 Mob: 07801 821791

Available 9am - 9pm 7 Days a Week

Vinyl Records Wanted
Top Prices Paid for Rock, Pop, Folk, Metal, Indie, World, Classical, also 7" & 12" singles, Cassettes & Mini-Discs too!

Hi-Fi Equipment Wanted
Turntables, Amplifiers, Speakers
Mini-Disc Players, 10" Reel-to-Reels
Nakamichi Cassette Decks

To discuss, call Mike
01522 722815

mike@vinylsimple.co.uk

divine audio

AnalogueWorks
Croft Acoustics
Graham Slee
KLE Innovations
London
Lounge Audio
Meridian
Rogue Audio
Trenner & Friedl

www.divineaudio.co.uk
01536 762211 tim@divineaudio.co.uk

ADVERTISE HERE IN OUR
NEW DIAL A DEALER
DIRECTORY!
PLEASE CALL JOANNA
HOLMES ON
+44 (0) 7958 602347
OR EMAIL:
joanna@hi-fiworld.co.uk

amp3

sales@advancedmp3players.co.uk
0343 289 6880
www.advancedmp3players.co.uk

Introducing the Cayin N3 Digital Audio Player

- + Supports all common digital formats up to 24 bit/192kHz and DSD up to 11.2Mhz (DSD256)
- + USB DAC Mode
- + Support for 256GB Micro SD cards
- + Available in Black or Cyan
- + RRP £149.99



**SAVE 10% OFF ALL ORDERS WWW.AMP3.CO.UK
USE CODE HIFIWORLD @ CHECKOUT**

ADVERTISE HERE IN OUR
NEW DIAL A DEALER
DIRECTORY!
PLEASE CALL JOANNA
HOLMES ON
+44 (0) 7958 602347
OR EMAIL:
joanna@hi-fiworld.co.uk

HI-FI WORLD

VINYL, NEWS AND REVIEWS SECTION PAGE 80

FREE READER CLASSIFIED ADS IN THIS ISSUE

McINTOSH MP1100

TO ADVERTISE HERE
PLEASE CALL JOANNA HOLMES ON
+44 (0) 7958 602347
OR EMAIL:
joanna@hi-fiworld.co.uk



AIRBORNE CORK & RUBBER MAT €25

A low cost replacement mat for your turntable, the Airborne is constructed from antistatic cork and rubber granules. Spanning 29.5 cm, 3mm thick and weighing in at 155g, it has been created via

sustainable Portuguese forest management techniques.

I placed it on my Origin Live Sovereign turntable and played The Bee Gees LP, 'Odessa'.

I was impressed by the Airborne's sense of discipline in the upper frequencies.

For the price, the control of the upper mids was admirable as the lead vocal, always in danger of smearing over the top of the soundstage, was held in check with a focus that allowed the strummed acoustic guitar to be fully visible. The low noise qualities of the mat also allowed those instruments on the edges of the soundstage to produce enhanced detail: the bank of strings, the banjo plucking and more all exhibited enhanced focus and clarity.

Moving to the jazz vocal and the bass notes of vocalist, Earl Coleman

fronting the Billy Taylor orchestra on the track, People. Again, the element of focus added an enhancement to the entire soundstage – almost like giving the focus ring on a camera lens a tweak to bring it into focus. Hence, the vocal delivery was given a new, almost granite edge to the bass notes, adding texture to the Coleman voice. The piano, on the left channel, offered a commendably precise presentation that added character, whilst the bass, on the left channel, was no longer a tone cloud of lower frequencies.

Percussion, meanwhile, was allowed to be fragile and delicate and noticeable without being smothered and hidden by associated frequencies.

A great value for money, easy to implement upgrade for any turntable that adds a measure of clarity and precision, providing improvement across the sonic palette. **PR**

[Tel 0208 969 9822
mail@honestjans.com]

SOUNDBITES



SLATE AUDIO GARRARD 401 MAT £140

This is a very heavy, pure slate 7.5mm thick mat, that came in well above the 400gm limit of my chemical scales; I would guess it weighs around 1kg. As such it is in a different league

to most mats, because its own mass opposes force from the stylus tip above, rather than the turntable platter. In effect it takes over this task.

Just as well in some ways, with the 401 platter. Yes, it is heavy and rigid – but so much so it rings like a bell, as I was reminded when removing the Slate mat; as I walked away the platter was still at it! Garrard's 401 platter is a gorgeously rigid and heavy die casting, but it is more than a little lively.

The result of this is a well understood mid-band greyness of tone quality wise, as well as some slight zing in the uppers (original mat on).

Considering the dead weight of the Slate mat and its inert nature, I was not surprised to be hit by wonderfully clean and clear leading edge transients from it, that enhanced both the dynamics of the Garrard and its sense of speed. The greyness was gone and instead a new clarity prevailed. I loved it.

By adding to platter mass the big Slate mat increases rotational inertia and lessens ability of groove tracing to introduce dynamic wow. So you get the Garrard's fabled sense of unstoppable speed in full, where with others a certain warmth can be introduced that, whilst curing the platter's ring, also deadens the pace a tad.

I was particularly intrigued by how the Slate enhanced higher midrange frequencies, bringing strength and resonance to the cowbell in Robin Trower's 'Lady Love', for example, expanding its sonorous force. The Slate had a habit of teasing out the dynamic contrasts and timbral content of instruments, painting them against a clean backdrop.

This is a fascinatingly different platter mat for the Garrard 401 – one well worth hearing. Recommended. **NK**

[01507 534251
sales@slateage.com]

IAN HARRISON HI-FI SALE!

HIFI AT DISCOUNT PRICES. FREE NATIONWIDE DELIVERY
Email: ian.harrison@mercian.myzen.co.uk

SPEND £2000 OR MORE ON ANY TURNTABLE, TONEARM OR TURNTABLE AND ARM AND GET A £500 CARTRIDGE FREE!

SPECIAL OFFERS!! SALE! UP TO 40% OFF!!

VAN DEN HUL MC10 SPECIAL £875, VAN DEN HUL MC1 SPECIAL £1000,
AUDIO TECHNICA AT-ART7 £800, AT-ART9 £725, AT33SA £545, AT33PTG/II £375

TONEARMS

AMG
CARTRIDGE MAN
GRAHAM
HELIUS
MICHELL
MOERCH
MOTH
ORIGIN LIVE
ORTOFON
PRO-JECT
REED
REGA

HEADPHONE AMPS

CREEK
FIDELITY AUDIO
GRAHAM SLEE
LEHMANN
PRO-JECT
SUGDEN

AMPLIFIERS

CREEK
EAR/YOSHINO
ICON AUDIO
SUGDEN
TOM EVANS

ACCESSORIES

DIGITAL STYLUS GAUGES, RECORD CLEANING MACHINES, CLEANERS, AUDIO CASSETTES

CARTRIDGES

AIR TIGHT
AUDIO TECHNICA
BENZ MICRO
CARTRIDGE MAN
DECCA LONDON
GOLDRING
GRADO
KOETSU
ORIGIN LIVE
ORTOFON
SOUNDSMITH
TECHDAS
VAN DEN HUL
ZYX

SPEAKERS

ACAPELLA
CABASSE
EPOS
HARBETH
ICON AUDIO
Q. ACOUSTICS

CD PLAYERS

CREEK
EAR/YOSHINO
ICON AUDIO
SUGDEN

PHONOSTAGES

EAR YOSHINO
GRAHAM SLEE
ICON AUDIO
LEHMANN
MUSICAL
SURROUNDINGS
PARASOUND
PRO-JECT
PURE SOUND
ROTHWELL
TOM EVANS
TRICHORD
WHEST AUDIO

CABLES

BLACK RHODIUM
IXOS
KUGALA-SOSNA
PEERLESS
PRO-JECT
QED
SUPRA
TRANSPARENT
WIREWORLD

RECORD CLEANING

PROJECT
MOTH

TURNTABLES

AMAZON AUDIO
AUDIO TECHNICA
INSPIRE
MICHELL
MUSIC HALL
PRO-JECT
SRM TECH
THORENS

HIFI FURNITURE

ALPHASON
ATACAMA
CUSTOM DESIGN
HI FI RACKS
MUNARI
MUSIC TOOLS
NORSTONE
QUADRASPHIRE
SOUNDSTYLE
TRACK AUDIO

HEADPHONES

AUDIO TECHNICA
BEYER
ERGO
GRADO
PSB
SENNHEISER

* PHONE FOR TERMS. PLEASE PHONE TO CONFIRM PRICE & AVAILABILITY PRIOR TO ORDERING. ALL GOODS ARE BRAND NEW & BOXED WITH FULL U.K. GUARANTEES. NO EX. DEM OR EX DISPLAY GOODS. NO GREY IMPORTS. GOODS ARE NOT SUPPLIED ON APPROVAL. SORRY, NO GENERAL CATALOGUES. PLEASE PHONE OR WRITE FOR SPECIFIC REVIEWS, BROCHURES OR PRICES. SUPPLIER OF HIFI PRODUCTS & ACCESSORIES SINCE 1986 MAIL ORDER ONLY FROM: IAN HARRISON, 7 MILL HILL, REPTON, DERBY, DE65 6GQ. TEL: 01283 702875. 9am - 9pm INCLUDING SUNDAYS.

studio **AV**

STUDIO AV WITH ABSOLUTE SOUNDS PRESENT MAGICO LOUDSPEAKERS

SATURDAY 24TH JUNE 2017



SEE, HEAR AND FEEL THE DIFFERENCE

Experience Magico loudspeakers up close and personal at studioAV's demonstration lounge in Chobham

Call or email to register your interest

01753 863300 sales@studioav.co.uk
www.studioav.co.uk

hi-fi+
Highly recommended!

HI-FI WORLD
Highly recommended!



PRISTINE VINYL
Serious about Vinyl



VIVAC RCS

"The Vivac Record Cleaning System is one of the best upgrades a vinyl-lover can make."

Clean the record, **release the sound**

Contact us today or visit our website to find out why.
www.pristinevinyl.com t: +44 (0) 1837 871288

criterion audio



Criterion Audio is a premium hi-fi dealer in Cambridge. From vinyl and valves to the latest in streaming and headphones, we can help you find the perfect audio system to suit your budget and needs. Call us on 01223 233730 to arrange a demo.

Criterion House, Oakington Road, Cambridge CB3 0QH
www.criterionaudio.com info@criterionaudio.com

Green Day

Earphone specialist Noble Audio has replaced its popular Savant model with the new Sage in-ears. Jon Myles plugs them in and listens.

Specialist earphone manufacturer Noble Audio has been rolling out a number of new models recently – a process it started last year with the introduction of the £1699 Kaiser Encore which was a direct replacement for the flagship 10-driver-per-side K10.

Now comes the £549 Sage which replaces the popular Savant but introduces some important updates. Chief amongst them is the use of new, custom-built balanced armature drivers. There are two per side, with one dedicated to bass and the other handling the midband and higher frequencies. Noble says the vented bass-port of the low-frequency driver has been repositioned and its aperture increased for extra low-end extension.

The earpieces themselves are constructed from injection-moulded ABS plastic with a precision-machined green aluminium faceplate featuring the Noble crown logo.

They come packed with a generous 12 pairs of eartips (four

types in three different sizes) as well as a hard carrying case, earwax removal and cleaning tool as well as a velvet pouch. The detachable cable has industry standard two-pin connectors so can be upgraded if required and uses silver-plated copper wires.

Like all the Noble earphones I've used the fit was extremely comfortable once the correct eartips were selected with no discomfort even during long listening sessions.

SOUND QUALITY

The original Savants were characterised by a smooth midband and treble and accurate – if not overly powerful – bass. These new Sages don't deviate far from this but, crucially, add a little more extension to the treble while bringing extra low-end drive.

Paired with a FiiO X5 high-resolution digital audio player the pounding bass on 'Phat Planet' from Leftfield's 'Rhythm and Stealth' (24bit/96kHz) had body and weight, without becoming overly dominant or sounding artificially enhanced. Instead, it was nicely textured and melodic.

High notes were clean and clear: Ornette Coleman's saxophone on the live 'Sound Grammar' sparkled, his every key change laid out starkly against the backing musicians.

Extremely impressive was the coherence between the various frequencies. As in a good loudspeaker, there was no sense that two drivers are at work, so seamlessly did they integrate – while also doing a sterling job of separating instruments and presenting them in their own space,

something single-driver models can struggle to do.

Listening to John Coltrane's free-form 'Ascension' the Noble in-ears cut through the dense collection of instruments, allowing me to focus on the individual musicians and hear how they weave their complex melodic lines around each other.

With something lighter, as in Cowboy Junkies' 'Blue Moon', the Sages captured the atmosphere and ambience of the disused church where this piece was recorded, bringing out the emotion within Margo Timmins' voice.

In fact, these Noble Sage earphones turn in an impressive performance no matter what type of music you choose. They've been balanced for a natural sound but have improved bass on their predecessors, plus a top-end that is crystal clear and extended enough to bring out extra detail in even familiar recordings.

For some £549 may seem a lot to pay for a pair of in-ear headphones, but paired with a quality digital audio player they justify the price.

CONCLUSION

Noble's new, improved balanced armature drivers and redesigned housings make the Sage in-ears an impressive set of 'phones. Bass is deep yet controlled while high frequencies are crystal clear. Worth hearing.



NOBLE AUDIO SAGE £549



OUTSTANDING - amongst the best.

VERDICT

Dual driver 'phones that get to the heart of the music with a presentation that has extended frequency extremes allied to a smooth midband.

FOR

- deep, controlled bass
- sparkling treble
- excellent build quality
- comfort

AGAINST

- not cheap

Noble Audio
+1 (805) 886-5255
www.nobleaudio.co.uk

Enjoy the Music.com®

Enjoy the Music.com is the Internet's leading information site for high fidelity audio equipment and consumer electronics since 1995. Being affiliated with many prominent publications plus offering its own *Review Magazine* and over 200 show reports online, *Enjoy the Music.com* is official media partners with AXPONA, Los Angeles Audio Show, and RMAF plus Internet partners with *The Absolute Sound*, *Australian Hi-Fi*, *hi-fi+*, *Hi-Fi World*, *HIFICRITIC*, *HiFi Media*, *NOVO*, *Sound Practices* and *VALVE* magazine.

LAAS
LOS ANGELES AUDIO SHOW

**ROCKY MOUNTAIN
INTERNATIONAL
AUDIO FEST**

AXPONA
AUDIO EXPO NORTH AMERICA



Billy Vee
SOUND • SYSTEMS

London Linn & naim Specialist

CALL SALES: (020) 8318 5755 or 8852 1321 - 248 Lee High Road, London, SE13 5PL
Web: - www.billyvee.co.uk email: sales@billyvee.co.uk Full delivery and installation services.



Full Naim Uniti & Classic series available



Full Linn DS range on demonstration

Trade in your CD Player & claim up to £1000 against a new digital Streaming player - offering you easier access to your music and better sound quality

Please call in or visit billyvee.co.uk for full details of this and other great new performance enhancing promotions



Peak HiFi

DEMONSTRATIONS

Available by appointment 7 days a week

PART EXCHANGE WELCOME



Audio Desk • Bryston • Classic Turntable Company • Dynavector • Goldring • Jelco • Koetsu • Lehmann Audio • Martin Logan • Oracle Audio • Ortofon
Peak Turntable Company • PMC • Pro-ject • QED • Quadral • Roksan • Rothwell Audio • SMD Acoustics • SME • Stirling Broadcast • Sugden Audio

www.peakhifi.co.uk

Tel: 01226 761832

Mob: 07801 821791

sales@peakhifi.co.uk

free reader Classifieds

TERMS AND CONDITIONS: Only one advert per reader. No Trade adverts. This section is strictly for readers selling secondhand hi-fi equipment only. Maximum length per advert is 30 words. Adverts over 30 words will not be accepted. Telephone numbers and E-mail addresses are treated as one word. Model numbers are treated as one word i.e. Quad 303 = two words. Email your advert to; classifieds@hi-fiworld.co.uk or fill in the form on page 97 and post it to Hi-Fi World Free Readers Ads, Studio 204, Buspace Studio, Conlan Street, Notting Hill, London W10 5AP. Sorry, we cannot accept adverts over the telephone. The Publisher reserves the right to judge submissions.

CAMBRIDGE AUDIO CXC CD transport, £160. Yamaha AS501 amp, digital inputs, £100. Marantz CD 6005 CD player, £100. Marantz PM 6006 amp, £160. £240 for both units. Tel: 01625 433 996

ARCAM DIVA AVR 100, very good condition, boxed with manual, £150. Arcam Diva DV88 DVD/CD player, very good condition, £150 plus P&P. Tel: Graham 07815 295 227 (Durham)

AUDIO ANALOGUE Crescendo, boxed, remote, music rooms demo model, valve like sound, £295 B&W 686, boxed, excellent condition, £95. £350 for both. Tel: 07716 139 026

YOSHINO EAR 834L pre amp, £600. Unison Research Unico hybrid integrated amplifier, £600. All excellent condition. Tel: 020 7263 5702 after 7pm. 07505 057 414 anytime.

ELECTROCOMPANET EC 48 pre amplifier, very good condition, boxes and manuals, £1200. Isotek mainline mains filters, very good condition, £90. Two available. Tel: Stuart 07555 263 931 (Northamptonshire)

GARRARD 401 Steel Plate Motorboard. I have a 7mm thick steel plate, cut out for a Garrard 401/SME 9" tonearm. It is approx. 440mm square. Needs a clean & a respray. Great starting point for a non resonant plinth system. This item is free to a Garrard home. This is a pick up only from Birmingham area. Contact Mike Bickley Email: michael.bickley@hotmail.co.uk

NEAT MOTIVE I Floorstanders Loudspeakers Cherrywood excellent speakers/sound £450 Tel: Evan 07957384795 (London)

MUSICAL FIDELITY A3.2 RDS tuner £175 Absolutely spotless, remote, original box. Smoke and pet free home. Kept covered and clean. Beautiful. Mike (Cheshire) Email: imeldayates@hotmail.com 07500804700

RUSS ANDREWS Crystal 24/ Kimber 12TC speaker cable, 1m pair with kimber banana plugs with super burn in and deep cryogenic treatments applied RRP £450 - £195 Tel: 01902 884694 Email: jukey39@yahoo.co.uk

YAMAHA A-S501 amplifier, mint condition, boxed. Dali Zensor 1 loudspeakers, mint, boxed. Hi-Fi News magazines, first 4 1/2 years, June 1956 to Jan 1961. Tel: 0114 237 8731

TWO AUDAX 15cm bass/midrange speaker drivers, £40. Chord Chorus 2 interconnects, 0.5m, RCA ends, cost £180, sell £50. All in original boxes. Tel: 01527 579 938

MUSICAL FIDELITY ENCORE 225 streamer. Too complicated for pensioner. 6 weeks old, £3500 ono Vienna Acoustics Baby Grand speakers, Symphony Edition, slight damage to front corner, £1500 ono. Tel: John 07415 649 912 (Birmingham)

I HAVE over 40 original drivers from Bowers & Wilkins (including DM604), Mission, PMC and Dynaudio. Please Email me on fatlizzy@gmail.com for full list.

WORLD AUDIO WD25T EX Loudspeakers, Millennium tweeters, professionally finished cabinets, detachable grills £475 AVI Lab Series CD player and Integrated Amp £500 each. £850 together. Can demo Buyer collects. 01827 706569

ICON-AUDIO PS3 upgrade tubes. Electro-Harmonix gold pin 4x6922 (E88CC), 1x6SN7. Bought Feb '17 £180, selling for £120 plus postage. Noticeably improved mid and treble over standard JJ branded items. 20 hrs use. Genuine reason for sale. Tel: 07873228770, Email: grant-h74@hotmail.co.uk

CANADIAN GUTWIRE Synchrony 3 metre length speaker cables. Superb, totally new condition. £700. (Synchrony Interconnects available separately). Email: stephen.adolphus@gmail.com Tel: 07787 574784.

DENON AH D600 headphones (£300), vgc. £160. Musical Fidelity M1 HPAP headphone amplifier in black, as new, £195. Trichord Diablo (serial no. 0104-4185) MM/MC phonostage in silver, vgc, £315. Philips Fidelio X1 headphones (£270), barely used £95. All in original packaging. Tel/text Richard on (07772) 711432 /01494 269889 (Bucks) or Email richard.schofield@kcl.ac.uk

SONUS FABER Concerto loudspeakers and stands £950 Triangle Zerious 202 loudspeakers £400. Klipsch KG4.5 loudspeakers £450 Unison Research S2K single-ended valve integrated amp £900 dougalthare63@gmail.com 07588660643 (Shropshire)

MUSICAL FIDELITY X-RAY 24 Bit CD Player, original iconic edition. Immaculate, transparent sound, remote, manual, no box. £350 ono + carriage, Kent. Email: rowe.ja@pg.com Tel: 07879 430721

PMC 20/22 speakers, oak finish, as new. Offers in excess of £1000. Naim NAC AS cable (8 metres) Offers over £100 John - Portsmouth, Hants - mobile 07971 353769

NAIM NAT 02 immaculate. Boxed. Serviced by Naim in past. £600 ono Can Post UK. This tuner rarely comes up for sale. A sought-after product. Speaker Stands White Marble bespoke x. Built by a monumental mason. 470mm high 355mm deep 270mm wide. 27.4 Kg. Offers. Pictures available. Changed speakers to a smaller model. Pictures available. 01159 877 567, 07783 327 689, Email: spinkray.rs@gmail.com

HARBETH P3ESR speakers reluctantly available for sale. They are finished in Maple wood and are in superb condition - as new! Priced at £850 (£700 less than brand new!) buyer to collect. Call Jeff on +44 (0)7910913525, based in Dorset.

YAMAHA RX-A1010 Aventure AV receiver, black, £300 (£1000). REL Quake sub-woofer £100 (£300). Eclipse TD 307's (5) AV speakers, £200 (£700). All mint, boxed. Tel: Graham 07815 295 227 (Durham)

QED DISCMASTER phonostage, boxed, £40. Yamaha MDX 793 Minidisc, £55. Wharfedale Diamond speakers, Mk1, £40. Garrard Stylus Balance, mint, boxed, £25. Carbon Fibre record brush, sealed package, £6. Tel: 01708 457 691

CAMBRIDGE AUDIO CXC CD transport, £160. Yamaha AS501 amp, digital inputs, £100. Marantz CD 6005 CD player, £100. Marantz PM 6006 amp, £160. £240 for both units. Tel: 01625 433 996

YOSHINO EAR 834L pre-amp, £600. Unison Research Unico hybrid integrated amplifier, £600. All excellent condition. Tel: 020 7263 5702 after 7pm 07505 057 414 anytime

NEXT MONTH

AUGUST 2017 ISSUE

Technics recently released a budget version of their latest SL-1200 G Direct Drive turntable, the SL-1210 GR. Timestep have immediately released an upgrade, fitted with external linear power supply, Michell TecnoArm and Denon DL-110 cartridge – the Timestep EVO SL-1210GR. Don't miss our in-depth view in the next issue.

Also, we hope to bring you –
NAD M50.2 DIGITAL MUSIC PLAYER/NAD M32 DIRECT DIGITAL AMPLIFIER
MING-DA CAMPANA INTEGRATED AMPLIFIER
TANNOY MERCURY 7.4 SPEAKERS
LENCO L90 WOODEN TURNTABLE
QUADRAL MERIN LOUDSPEAKERS
FOCAL UTOPIA HEADPHONES
...and much more.



This is a selection of what we hope to bring you, not a complete list. We regret that due to a wide range of issues, we cannot guarantee that all products listed above will appear.

**PICK UP THE AUGUST 2017 ISSUE OF HI-FI WORLD ON SALE JUNE 30TH 2017,
OR SUBSCRIBE AND GET IT DELIVERED TO YOUR DOOR: SEE PAGE 36**

ADVERTISERS INDEX

2nd Hand Hi-Fi 84
 Absolute Sounds OBC
 B&W 6
 Billy Vee 94
 Black Rhodium 62
 Blue Aura 64
 Criterion Audio 94
 Decent Audio 58,59
 Divine Audio 90
 Enjoy The Music.Com 94
 Exposure 42
 Focal 20
 Heathcote Audio 88
 Henley Designs 14,38
 IAG 18
 Ian Harrison 92
 Icon Audio 24
 Jordan Acoustics 26,27
 Leema Acoustics 40
 Naim 16
 Nu Nu Distribution 50,70
 Peak Hi-Fi 90,94
 Pristine Vinyl 68
 SCV Distribution 72
 Select Audio IBC
 SME 10
 Sound Cinergy 90
 Sound Hi-Fi 68
 Studio AV 92
 Tellurium Q 12
 The Chord Company IFC
 The Right Note 90
 Vinyl Simple 90
 World Design 68

FREE READER CLASSIFIED ADS ORDER FORM

STOP PRESS

TERMS AND CONDITIONS: Only one advert per reader. Maximum length per advert is 30 words, Adverts over 30 words will not be accepted. No Trade Adverts. This section is strictly for readers selling secondhand hi-fi equipment only. Telephone numbers and E-mail addresses are treated as one word. Model numbers are treated as one word i.e. Quad 303 = two words. Sorry, we cannot accept adverts over the telephone. The Publisher reserves the right to judge submissions.

You can email your advert to us at: classifieds@hi-fiworld.co.uk or write or type your advertisement copy in block capitals with one word per box and post it to us at:

Hi-Fi World Free Readers Ads,
 Studio 204,
 Buspace Studio,
 Conlan Street,
 London W10 5AP

We cannot accept adverts over the telephone

1	2
3	4
5	6
7	8
9	10
11	12
13	14
15	16
17	18
19	20
21	22
23	24
25	26
27	28
29	30

Name: _____
 Address: _____

 Post Code: _____
 Daytime Tel: _____

FREE READER CLASSIFIED ADVERTS COPY DEADLINES

AUGUST 2017 - 8TH JUNE

SEPTEMBER 2017 - 6TH JULY

BILL WYMAN

MONKEY GRIP

1974



"Arguably the greatest solo Rolling Stones album that has ever existed"

Bill Wyman – William Perks to his mother – replaced future Pretty Things member Dick Taylor as Rolling Stones band member in 1962. Wyman became the oldest member of the Stones. Charlie Watts would join the Stones soon after and a classic rhythm section was born. Well before he left the band in 1993, Wyman was 'alone' when he decided to create his debut solo record.

He commented to Bob Harris just before the album was released in 1974 "There was a difficulty in finding the time to do it. I didn't want to make it a long recording or take a long time over it. I [had] never sung and I never wrote anything more than average songs until a year ago when I thought, right, now I'm going to try to write some good songs".

Wyman wrote the album at his home in France, initially producing forty songs which were whittled down to twenty. "I gave them to a few people and got comments" said Wyman. "It was difficult because there was no-one to bounce ideas from. Most people write in duos, one guy writes the music, another writes the lyrics and they move things backwards and forwards. I had nobody. I was afraid that they might be a bit too corny...too rude...anything".

The creation of this LP was intriguing because it revealed the same sort of fears, worries and insecurities that many other inexperienced musicians also felt and still feel, when launching into their first major project.

"I selected the songs and put them down on this terrible little cassette player I had – not a Revox or anything sophisticated. I overdubbed a rhythm guitar on there (which I can't play) and a piano (which I can't play) and a bass (which I can, sorta, muffle about on) and then I tried to sing. I got to rehearse and sing when my old lady went shopping. I was totally alone and worried about anyone hearing me. Eventually, I got about 16 songs together which I thought were worth working on. I couldn't go into a studio and play it to somebody I had to [hand over the cassette] and say, right, here they are and hope they didn't laugh".

Some might be surprised by that swathe of insecurity from a 'mighty' member of one of the

biggest bands on the planet.

Wyman wanted to work with other named musicians on this album to offer solid backing support.

"I phoned up Dallas Taylor and Joe Lala from Manassas and asked them because I felt very easy [with them]. Then I got very uptight and phoned Dr John...trembling...I didn't know what he was like. I asked if he had any days free. He came in on two day sessions. Leon Russell – who I really like as a piano player in the style that I try to play bass in – he did a couple of sessions.

I tried a few people who were not available: Ry Cooder, Roy Buchanan, people like that. Then there were other people that the guys in the sessions recommended such as Danny Kottchmar (who has worked with Neil Young, James Taylor, etc). Well, I'd never heard of him then. Just a name. But when he came, he fitted into every single thing that we did. The atmosphere was beautiful".

Wyman purposefully avoided any Stones links while colleagues advised Wyman to bring in arrangers and producers to help, "...but I thought :That's not the way. That's passing it over to somebody else". I thought: "I'm going to do this one...me, you know? And, if it's a failure, then [it will be on my] conscience".

The result? Arguably the greatest solo Rolling Stones album that has ever existed. Yes, the star-studded backing band takes care of instrumental duties but Wyman surprised by the quality of his song-writing.

There's nothing incredible in terms of songs but they are both solid and appealing while his singing is filled with pleasure and humour. Wyman is almost gleeful – the album obviously introduced a sense of freedom and relaxation into his life.

His loose-limbed, relaxing presentation only added to the groove-filled musical content.

You can find a vinyl version of this album within a new and nicely mastered box set from Demon. Called 'White Lightning' - The Solo Box', it features all four solo albums including 'Stone Alone' (1976), 'Bill Wyman' (1982) and 'Stuff' (1992), which appeared, originally, in Japan only.

PR

Come Together
The Beatles
FLAC 192 kHz 24 Bit

4/5

4:16

LUMIN

LUMIN

THE
AUDIOPHILE
NETWORK
MUSIC | PLAYER
FAMILY

S1/A1/T1/D1

NOW | WITH | NATIVE
TIDAL | SUPPORT



selectaudio[®]

Distributors of exquisite audio equipment
Tel +44 (0)1900 601954

WWW.LUMINMUSIC.COM

THE SUBLIME COLLECTION



"the Audio Research Reference Phono 3 is one of those rare devices that gets closer to 'best' than most. Highly recommended."

Alan Sircom / HiFi+ / Reference Phono 3

With their new sublime collection Audio Research brings us closer to the music than ever before.

With the new Reference 6, they have devised a control centre that marries the sonic glories of the company's founding models of over 40 years ago with the cutting-edge performance and operation genius of the post-digital era. Configurable to

"... 'masterpiece' doesn't come close to describing what ARC hath wrought."

Ken Kessler / HiFi News / Reference 6

the user's needs, it provides sound quality that is unrivalled in transparency, warmth and authenticity.

Joining it is the Reference PH3, a phono stage that celebrates the sensational return of vinyl to the public consciousness. Which just might explain why the Reference 6 and Reference PH3 sing in such perfect harmony.

 **absolute sounds ltd.**

International Distributors & Consultants of Specialised Hi-End Audio & Video Systems

58 Durham Road, London, SW20 0TW T: +44 (0)20 89 71 39 09

W: www.absolutesounds.com E: info@absolutesounds.com

For Your Nearest Dealer Please Visit [The Absolute Sounds Website](http://TheAbsoluteSoundsWebsite)

audio research
HIGH DEFINITION®