

# HI-FI WORLD

MAY 2009

UK £3.80

www.hi-fiworld.co.uk

FREE READER CLASSIFIED ADS IN THIS ISSUE!

**EAT FORTE** *EXCLUSIVE!*  
turntable



**COMPETITION**  
WIN AN  
MIT Z-POWERBAR  
WORTH £1,600!

**CYRUS CD XT SE**  
CD transport

**AUDIO RESEARCH DAC7**  
digital to analogue convertor



**SIMAUDIO MOON i3.3**  
integrated amplifier

MAY 2009

05 >



9 770961 766161

*EXCLUSIVE!*

ORIGIN LIVE CONQUEROR TONEARM <  
BUDGET AMPLIFIER SUPERTEST <  
OLDE WORLDE: MARANTZ CD94 <  
DR FEICKERT TWIN TURNTABLE <  
EPOS ELS8 LOUDSPEAKERS <

*exposure*



Those who appreciate good sound will prefer the tighter "S."

## New 3010S series:

Tighter bottom-end, livelier sound, more drive...same price

### CD player £1200

- Brand-new "CD solution" – custom-made transport mechanism, servo units and control mechanisms
- Twin Burr-Brown PCM 1704 mono DACs and a discrete output stage
- Low jitter clock and a large toroidal transformer with separate windings for the transport mechanism and audio stages.

### Integrated Amplifier £1000

- Larger power supply
- 110 watts RMS (as compared to 100W for the previous model)
- 6 line inputs, bi-wiring and bi-amping compatible
- Option to fit a MC or MM phono cartridge
- Remote control

### Power Amplifier £800

- Larger power supply
- 110 watts RMS (as compared to 100W for the previous model)
- Capable of driving sophisticated speaker systems, in bi-amping mode or monoblock mode
- Clean and extended low frequency response



**WE ARE THE UK'S FASTEST GROWING AUDIO TITLE!!!**

**welcome**

**EDITOR**

David Price  
tel/fax: +44 (0) 1275 371 386  
e-mail: editorial@hi-fiworld.co.uk

**DESIGN EDITOR**

Faiza Chunara  
tel: +44 (0) 20 7625 3129  
e-mail: adproduction@hi-fiworld.co.uk

**PRODUCTION EDITOR**

David Noble  
tel: +44 (0) 20 7625 3134  
e-mail: classifieds@hi-fiworld.co.uk

**ADVERTISING SALES EXECUTIVE**

Marina Nik  
tel: +44 (0) 20 372 6018  
Mob: +44 (0) 7917 047 546  
email: advertising@hi-fiworld.co.uk

**ADVERTISING DIRECTOR**

Debi Silver  
tel: +44 (0) 1723 500 435  
mob: +44 (0) 7966 84 35 36  
e-mail: debisilver@hi-fiworld.co.uk

**ACCOUNTS**

tel: +44 (0) 20 8841 8892  
fax: +44 (0) 20 8841 9144  
e-mail: accounts@hi-fiworld.co.uk

**PUBLISHER**

Noel Keywood  
e-mail: publisher@hi-fiworld.co.uk

**FREE READERS CLASSIFIEDS**

tel: +44 (0) 20 7625 3134  
e-mail: classifieds@hi-fiworld.co.uk

**SUBSCRIPTIONS**

tel: +44 (0) 1442 879097  
fax: +44 (0) 1442 872279  
e-mail: hifiworld@webscribe.co.uk

**PHOTOGRAPHY**

David Noble  
tel: +44 (0) 20 7625 3134

**WRITERS**

Tony Bolton, Patrick Cleasby, Peter Comeau, Steven Green, Andrew Harrison, Paul Rigby, Adam Smith.

**hi-fi world**

SUITE G4, ARGO HOUSE  
KILBURN PARK ROAD  
LONDON NW6 5LF  
[www.hi-fiworld.co.uk](http://www.hi-fiworld.co.uk)

**verdicts**

- ● ● ● ● OUTSTANDING
- ● ● ● EXCELLENT
- ● ● GOOD
- ● ● ● ● MEDIOCRE
- ● POOR
- £ VALUE



I've always been a bit suspicious about received wisdom, and the current credit crunch shows why. All those great and good men of the US Treasury, Bank of England and every other major financial authority *didn't* – they assure us – see the big bust coming, and carried on regardless, safe in the knowledge that the worst could never happen...

Well, the same generally agreed consensus in hi-fi has been for a long time that vinyl is dead. Or at least it's alive but only just – a pesky irritation prolonged by the audio equivalent of real ale drinkers wearing woolly sweaters that their aunties made for them for their fiftieth birthdays...

Unfortunately, one look at the facts doesn't quite bear this out. Fascinating market research data from GfK shows the market for vinyl hardware is moving towards ever higher prices. In short, it's the monied, focused, know-what-they-want audiophiles who are buying high end record players, not men with dogs on string leads, roll-ups dangling out of their mouths...

The penny has finally dropped that the simple process of dragging a lump of carbon through a vinyl groove rotating thirty three and one third times every minute actually yields *superior* sound to high resolution digital audio - and of course its low resolution 'eighties throwback' cousin Compact Disc! As a result, more people are going 'back to black' and spending serious money on the process too – witness the rise in vinyl hardware sales value reported by GfK earlier this year [see p89].

Euro Audio Team are well aware of this, and have just launched one of the most amazing turntables I've heard [p10]. It's around £12,500, so my order will have to wait at least until the end of the month, but I'd be surprised if there isn't a strong worldwide demand for such an exotic, no-holds-barred high end analogue product.

Meanwhile though, back in the real hi-fi world, we'll continue to show you how get the best 'toys for the black stuff' on a sensible budget. And if you're not analogue-included, the good news is that digital is getting better than ever too – even at the affordable end. Read on to find out how – and enjoy this month's issue of *Hi-Fi World!*

**David Price, editor**

**testing**

To ensure the upmost accuracy in our product reviews, *Hi-Fi World* has extremely comprehensive in-house test facilities, and our test equipment - from big names like Rohde & Schwarz and Hewlett Packard - is amongst the most advanced in the world.

Loudspeakers are measured using a calibrated Bruel & Kjaer microphone feeding a Clio-based computer

analyser, using pulsed and gated sinewaves, in a large room to eliminate the room's influence. Pickup arm vibration is measured with a Bruel & Kjaer accelerometer.

No other UK hi-fi magazine has in-house testing, and none has access to such advanced tests across all types of equipment. That's why you can depend on *Hi-Fi World* reviews.



**ELECTRONIC MAGAZINE**

Go to our website [www.hi-fiworld.co.uk](http://www.hi-fiworld.co.uk) to buy an electronic version of this magazine, individual issues or a subscription. At present we do not offer back issues, but hope to soon.

Distributed by Seymour Distribution Ltd 86 Newman Street London, W1T 3EX Tel: +44 (0) 20 7396 8000 Printed by St.Ives, Plymouth Tel: +44 (0) 1752 345 411

Our Agents in Malaysia Millennium Hi-Fi & AV Simon Chang Showroom & office, 500-1-3 First Floor Wisma Indah (Shen Court), Jalan Tun Razak 50400 Kuala Lumpur, Malaysia  
Tel: 603 9283 8171 Fax: 603 9281 3762 e-mail: [info@millennium-audio.com](mailto:info@millennium-audio.com)

All unsolicited submissions and goods are at the owner's risk. We accept no responsibility for such submissions, nor do we undertake to return them.  
No material may be reproduced from this magazine without the publisher's written permission. © Audio Publishing Ltd

# 15

Audiolab 8000S - best value in our affordable amplifier supertest.



# 28

Cyrus CD Xt SE - superb, reasonably priced CD transport.



# 36

Simaudio Moon i3.3 - excellent do-it-all high end integrated amplifier



# 42

Audio Research DAC7 - top notch computer-capable DAC!



# 10

EAT Fone - one of the world's best turntables!



# 40

Bang & Olufsen Beosound 5 - stylish computer audio from Denmark.



## AMPLIFIERS SUPERTEST 15

Paul Rigby rounds up seven sub-£500 amplifiers from Audiolab, Cambridge Audio, Icon Audio, Marantz, Pioneer, Pro-Ject and Rotel...

## SIMAUDIO MOON I3.3 36

Andrew Harrison auditions an impressive new Canadian integrated amplifier...

## DIGITAL CYRUS CD XT SE 28

David Price tries out Cyrus's super new 'Servo Evolution' CD transport.

## GRIMM AUDIO CCI 32

This intriguing new CD player master clock unit is reviewed by Tony Bolton.

## AUDIO RESEARCH DAC7 42

Andrew Harrison is beguiled by this high end American digital-to-analogue convertor.

## LOUDSPEAKERS EPOS ELS8 26

Adam Smith auditions these new affordable standmounters.

## ORBITSOUND T12 35

Patrick Cleasby auditions an expansive sounding iPod sound system.

## SYSTEMS

## BANG & OLUFSEN BEOSOUND 5 40

This striking new hard disk-based music system gets the treatment from Tony Bolton.

## TEAC REFERENCE 380 58

Paul Rigby reviews a smart new style system.

## FEATURES POWER PLUS 67

Andrew Harrison spends some time with the Naim HDX hard disk music player, now augmented with an XPS power supply...

## SHOWTIME 80

David Price and Adam Smith go sleuthing around at the Bristol Sound and Vision show!

## SHOWTIME USA 112

Roving reporter Robert Kelly gives his highlights from the Las Vegas Consumer Electronics Show 2009.

## OLDE WORLDE MARANTZ CD94 61

Haden Boardman tells the story of this classic multibit player, and all its myriad variations!

## VINYL VINYL NEWS 98

Paul Rigby with all the latest black plastic releases...

## EAT FORTE 10

David Price is smitten by this seminal new high end turntable.

## DR FEICKERT TWIN 100

Adam Smith gets back trouble manhandling this mighty new turntable package...

## ORIGIN LIVE CONQUEROR 3C 107

David Price auditions the new carbon hybrid tubed version of OL's penultimate tonearm.

## DIY DESIGNING LOUDSPEAKERS 68

Peter Comeau puts the finishing touches to WD25A EX.



## 7 NEWS

Words from the front...

## 87, 105 SOUNDBITES

Tony Bolton tries Ringmat's Spike Stoppers and David Price spins up the Rubato copper mat, then Tony Bolton auditions SRM Tech's Turntable Tune-up Kit and Roksan's Digital Stylus Balance.

## 45 MAIL

Nine pages of your views and queries.

## 64 SUBSCRIPTIONS

Ensure your copy every month and save money too!

## 73 WORLD CLASSICS

Our favourite vintage hi-fi separates.

## 79 COMPETITION

Your chance to win MIT's Z-Powerbar mains conditioner worth £1,600!

## 84 AUDIOPHILE VINYL

Paul Rigby rounds up the latest audiophile releases.

## 89, 91, 93, 95, 97 OPINION

The team get to grips with matters music, hi-fi and life!

## 120 DIAL-A-DEALER

A comprehensive guide to UK hi-fi retailers.

## 123 FREE READERS CLASSIFIEDS

Three pages of second-hand bargains.

## 128 NEXT MONTH

What we hope to bring you in the next issue.

## 129 ADVERTISERS' INDEX

## 130 CLASSIC CUTS

Paul Rigby reviews Steve Kuhn's 'Life's Backward Glances: Solo And Quartet', on ECM.

# Melody

[www.melodyvalvehifi.com](http://www.melodyvalvehifi.com)  
[info@melodyvalvehifi.com](mailto:info@melodyvalvehifi.com)



1688 Signature

*Stereo Preamp*

For more information visit our website: [www.melodyvalvehifi.com.au](http://www.melodyvalvehifi.com.au)  
or email us at: [info@melodyvalvehifi.com.au](mailto:info@melodyvalvehifi.com.au)

World Radio History





news@hi-fiworld.co.uk

# news



## UBER STATEMENT!

Sendor's new ST ("Statement") loudspeaker is described as, "a distinctive and innovative high performance loudspeaker for discerning individuals". Impressively styled with a slim jet black piano lacquer cabinet, Sendor says the ST conceals a wealth of new engineering and innovation. A so-called 2.5 way system, it sports a new 18cm Kevlar composite polymer loaded low frequency driver and a new 18cm polymer cone bass-mid driver specifically for the ST. A new 29mm wide-surround tweeter, with bi-elliptical acoustic lens technology, is also fitted – running via a refined crossover network with high grade electrical components, super linear 630V low-loss dielectric capacitors and WBT Next-Gen terminals. The Sendor ST uses multilayer laminated inlays which are bonded into the front baffle with a set of thin dynamic damping layers to create a remarkably rigid and acoustically silent structure, the company says. Sendor also claims a new approach to low-frequency engineering with minimum damping of the active acoustic volume, and a 4th generation Sendor linear-flow port "for deep articulate bass, in almost any listening room".

Absolute mechanical stability is essential for correct sound, so the base of each ST carries a set of four machined steel stabiliser discs which are rigidly attached deep into the core structure of the cabinet. These contribute to the neat appearance and stability of the slim cabinets without recourse to outriggers or plinth extensions. Each loudspeaker is supplied with three acoustically engineered disc grilles. Sendor will offer a special service for customers wishing to specify custom inlay materials and finishes, and can liaise directly with designers, architects and artists to ensure that even the most complex projects become reality, they say. Inlay materials can include natural veneer, metal laminate, leather, fabric and lacquer. The selection of inlays available at launch includes exotic ebony, zebrano and aluminium. The new ST retails from £5,500 per pair in the UK. For more information, call +44(0)1323 843474 or click on [www.sendoraudio.com](http://www.sendoraudio.com).

## ALL TOGETHER NOW

Here's something that will put the cat amongst the purist pigeons – Naim's brand new £2,000 NaimUniti 'all in one' music system. "This will deliver the customary Naim sound quality and emotional connection to music to a new generation of customers as well as existing ones", the company says. The NaimUniti is said to be the first all-in-one audio player to offer CD, FM/DAB, Internet Radio, MP3/iPod, Digital Audio Music Streams and USB sources. The Internet Radio player offers the listener thousands of stations, and also key is NaimUniti's digital audio music streaming capabilities via UPnP networked devices. With its onboard DAC, NaimUniti becomes a versatile audio source hub, able to interface with digital audio sources. There's a front panel USB port for playback of music stored on memory sticks, while the unit will take over control and display content stored on most MP3 players connected via its front panel USB port.

The CD player's swing drawer and transport suspension are as used on the CDX2, as is the magnetic disc clamp; a low inertia, resonance-controlling device that ensures both rigid coupling and mild damping without adding to the task of the drive servo mechanism by increasing rotational inertia. It's also the first Naim player to utilise the new, more rigid, beam-strength mounting of the swing drawer on the front panel supported by the base.

There's also an FM/DAB tuner, with presets transparent to source so preset one can be FM, DAB or Internet Radio, for example. The optional n-Link, Naim's custom designed iPod connector, cable allows the NaimUniti user to connect and charge their iPod through the dedicated rear panel iPod input. Connecting an iPod to NaimUniti via the n-Link also enables iPod control and display of music content via the NaimUniti front panel. There's a 50W amplifier, a 3.5mm headphone socket and 3 pairs of RCA phono inputs, 5 digital inputs and even a DIN! Vital statistics are 87x432x314mm and 11.3kg. For more information, click on [www.naimaudio.co.uk](http://www.naimaudio.co.uk).



## WEEKENDERS

Northern Ireland-based retailer Kronos Audio Visual are running a series of Musical weekends throughout 2009, starting on the 20th and 21st March. The events will run on both Fridays and Saturdays and will be based at their shop at 8-9 Scotch Street Centre, Dungannon, Co. Tyrone. Among the manufacturers and distributors already confirmed are Focal/JM Lab including the Utopia speaker range, Metropolis Music (BAT, Boulder, Hovland, Coda, Eben, Lumley, Vitus, etc.), Symmetry (Ayre, Esoteric, Grand Prix Audio, System Audio, Lyra, etc.), Dali loudspeakers including the Helikon range, Atlas Cables, Moon Electronics including the Reference range, Electrocompaniet including their new speaker range and much more. There will also be prize draws and other special events. Sessions will run mornings, evening and afternoons but as places are limited please contact Kronos Audio Visual to book a place either by telephone 02887753606 or email [david@kronosav.co.uk](mailto:david@kronosav.co.uk). Information is also available on their website [www.kronosav.co.uk](http://www.kronosav.co.uk).

## PRIMO MOVER

Musical Fidelity's new £7,999 Primo pure Class A triode fully balanced preamplifier is said to be the result of twelve years of intense research and development. The preamp uses 14 selected ECC81 valves. Distortion, across the band from 10Hz to 50kHz, is claimed to be around 0.01% regardless of the volume control setting, and with a flat frequency response of 10Hz to 50kHz +0.5dB, the Primo is said to be capable of driving any amplifier with any reasonable length of cable in a totally linear way. Both the balanced and single-ended output stages have two pairs of output tubes in parallel, to ensure completely linear performance, and there's a separate fully regulated HT and heater circuit for both channels in the power supply. The Primo's tube life should be around 10,000 hours, claims Musical Fidelity. The front panel is machined from solid milspec aluminium billet, and its badges are made from medical grade stainless steel. The top and sides are machined from solid and finished to the highest standard.

Matching this is a brand new fully balanced, dual mono power amplifier boasting no less than 1kW per channel. Limited to fifty pieces, the massive Titan punches out up to 4kW into 2 Ohms. A sizeable external PSU ensures that there is no interaction between the Titan's twin 3kW mains transformers and the delicate signal circuitry. The Titan is housed in two identically-sized, superbly finished boxes. Distortion is less than 0.01% from 10Hz to 50kHz, the company claims, and the noise figure is said to be 126dB down. At £19,999 the Titan is not cheap, but is "the best amp we know how to make", says Musical Fidelity. For more information, contact Antony Michaelson at Musical Fidelity on +44(0)20 8900 2866 or click on [www.musicalfidelity.com](http://www.musicalfidelity.com).



Musical Fidelity Primo



Musical Fidelity Titan



## MINI ME

Yamaha's new highly compact M-430 micro system offers high quality sonic performance matched by a wide range of features and functionality at a highly competitive price, the company says. It packs 25W output via CD, MP3 and WMA playback, and also functions as an AM/FM and DAB radio, and there's an integrated iPod dock located atop the main unit. Providing full iPod functionality the M-430 allows you to browse all the iPod's menus through the display via the remote control. The system also offers subwoofer and digital optical outputs and phono outputs and inputs. For more information, click on [www.yamaha.co.uk](http://www.yamaha.co.uk)

## DARK SIDE OF THE TUNES

As part of its "ongoing mission to wake the rock and pop world up to high resolution music downloads", Linn Records have added Pink Floyd to their roster of artists available to download at the original CD quality. London 1966-1967 is the earliest Pink Floyd recording available commercially, and contains two lost tracks: a longer version of 'Interstellar Overdrive' and 'Nick's Boogie'. These tracks were originally recorded for Peter Lorrimer Whitehead's film 'Tonight Let's All Make Love In London', on January 11 and 12, 1967. Other recently-added artists for download include Thin Lizzy, The Sensational Alex Harvey Band and Caravan. Linn Records also offer 'studio master' downloads, at 24bit resolution giving significantly better sound than CD. UK band The Aliens have committed to the hi-res format, with band member John Maclean saying that Linn's website "would encourage people to get some quality control back into their musical lives." For more details, click on [www.linnrecords.com](http://www.linnrecords.com).



## RADIO ACTIVE

One of the few hi-fi manufacturers to take FM seriously anymore is Densen, who have their new third generation of B-800 FM tuner out now. Whilst the previous incarnation was upgraded with RDS, the new generation has improved performance in several areas. The front end is a completely new design, which is hand calibrated before each unit leaves the Densen factory. Further to that the user can calibrate the front end in two steps, to match it perfectly for various signal levels. Internally the front end is electrically isolated to avoid high frequency interference with the delicate audio circuits. The power supply contains a custom-made transformer with Densen's own capacitors with a total capacity of 20,000uF (rather unusual for a tuner), and there's now the option of upgrading with Densen's DNRG external power supply. There's also a slot for a forthcoming DAB module, currently unavailable because Densen head honcho Thomas Sillesen "simply thinks DAB sounds to poor" at the moment! There are several features designed to aid tuning, such as variable muting and DX/local adjustment and gain level on the front end input, the latter being adjustable via the bundled remote control. The analogue audio stages are Class A stages with no feedback at all. For more information, click on [www.densen.com](http://www.densen.com).





## HI, DEFINITION

Described as "Tannoy's most important new loudspeaker release for quite a while", the Definition range is of pure two-channel music speakers aimed at the mid-to-higher end audio market. The three-strong line-up is said to "incorporate a wealth of high-tech features, innovative materials and cutting edge processes". With roots tracing back to Tannoy's original Definition series launched in 1993, they all sport the latest evolution of Tannoy's proven 8in (200mm) and 10in (250mm) Dual Concentric drivers, reinforced by auxiliary bass drivers in the floorstanding models. The Wideband tweeter is an ultra-rigid titanium dome driven by a pure neodymium magnet assembly, itself rigidly coupled to the rear the acoustic cavity. By positioning the tweeter at the centre of the advanced multi-fibre low-frequency cone, the result is true point-source articulation. The substantial ported cabinets are constructed from the finest grade birch plywood, sourced from cooler, slower-growing regions to further improve the acoustic properties of the laminate. The cabinet's trapezoid shape and complex parabolic curves are precisely engineered to minimise resonances and internal reflections.

Each driver is coupled to the cabinet with a unique bracing mechanism. The new crossover features high end components with low loss laminated core inductors and superior polypropylene capacitors that are acoustically damped using Tannoy DMT material. Once fully assembled, the entire crossover is super-cooled to -190 degrees Celsius and thawed over a set period of time using a proprietary Deep Cryogenic Treatment (DCT) process. This permanently reduces internal stresses in the microstructure of the crossover's components, joints and conductors, leading to further improved signal transfer and greater resolution of fine detail. High-purity silver-plated OFC wiring is used exclusively throughout and the terminal block features substantial electro-plated brass speaker binding posts from WBT. Available in deep-lustre black, or lacquered real wood veneers in cherry or dark walnut, each Definition cabinet is hand-finished to the highest standards. Rich, articulate and expressive in sound; elegant, contemporary and organic in style, Definition defines the art of sound. Prices range from £2,499 for the Definition DC6 to £3,999 for the DC8 and £4,999 for the Definition DC10T. For more details, click on [www.tannoy.co.uk](http://www.tannoy.co.uk) or call +44 (0) 1236 420199.



## RE-CYCLE

These times are surely right for Cowon iAudio's digital audio player repair service. It offers a repair service for all Cowon iAudio products, whether they have been bought from Advanced MP3 Players or not. Once they have received the player, it is examined by experienced technicians and an accurate quote is produced. The price quoted is the price you pay, there are no hidden charges or additional costs. For more information, call +44(0) 131 273 4387 or click on [www.advancedmp3players.co.uk](http://www.advancedmp3players.co.uk).

## SUPER SONIC

Chord Company's SuperScreen mains cable delivers wonderful value for money at £65 for a one metre cable, it's claimed. Chord has chosen a moulded mains plug, but special attention to detail with the internal wiring layout means this outperformed some "audiophile looking" screwed on plugs, the company says. The new Chord SuperScreen mains cable has been built using the same design principles as the Company's award-winning Carnival SilverScreen speaker cable, with the same contra-rotated overlapped dual foil shields, and borrows heavily from the configurations used throughout Chord's range of products in that the high frequency effective, heavy gauge foil shields are left fully floating. Chord have long been aware of the need to minimize resonances and vibration within interconnects and speaker cables. Mains cables are no exception and the carefully directionalised high quality multi-stranded copper conductors are surrounded by a dense but flexible PVC insulation. The contra-rotated dual foil shields are surrounded by another layer of vibration damping translucent insulation as used on the company's Epic and Carnival SilverScreen speaker cables. The result is "dramatic improvements to the contrast, clarity and detail levels", with prices starting at £65. For details, call +44 (0)1980 625700 or click on [www.chord.co.uk](http://www.chord.co.uk).



## EGG HEAD

Five years ago, we first saw the Eclipse TD712z, the flagship of the TD range which made something of a name for itself in pro-audio circles as a high end near field studio monitor. The new Mk2 version, costing £5,000 per pair, is a subtle but serious revision, with a number of improvements whilst retaining the same distinctive design values. Described as a "high-end Time Domain speaker with integrated stand", its makers Fujitsu-Ten have added a more powerful motor system for the single drive unit, a new ultra-efficient high-power magnet structure, redesigned damping system for the driver surround, high-density zinc internal components, a new design of coupling to the integrated stand and a cabinet sporting a 50% larger internal volume. The single driver crossoverless design, with a "completely integrated non-resonant structure", vertical angle adjustment of the head, knife-edge wing stand, spiked energy earth path from head to stand to floor and steel, zinc, aluminium and ABS composite construction is retained. For more details call +44(0) 20 7328 4499 or click on [www.eclipse-td.net](http://www.eclipse-td.net)

## SPOTTED!

A dangerous moment at the Bristol Sound and Vision show, as PR supremo Rob Follis – widely believed to be the world's greatest living consumer of Apple Computer products – came across *Hi-Fi World's* very own Tony Bolton, a man who proudly boasts that he was running in mono until his mid-twenties. The audio equivalent of matter and anti-matter meeting, fortunately no one was harmed - although the look on Rob's face was initially steelier than one of Tony's gramophone needles!



# (B)EAT This!

**Hitherto known for their bespoke premium priced audio tubes, Euro Audio Team have just launched a brand new high end turntable featuring an Ikeda tonearm, no less! David Price gets into the groove...**

**J**ozefína Krahulcová, CEO of Euro Audio Team (E.A.T.) is a redoubtable character. Bubbling with enthusiasm for this, her company's first (but not last, I am assured) high end turntable, she exudes confidence despite the time not being quite right for the launch of such an esoteric, luxury product. "I am a big fan of vinyl - it's the best way to listen to music," she tells me, "and I've got a very nice classical music collection. I wasn't happy about the turntables on the market, so I decided to do this..."

Ebullient she may be, because the new E.A.T. Forte isn't just another derivative design – another 'me too' premium priced product there to have a presence in the market. It shows some interesting thinking – certainly in its unique combination

featuring a separate motor unit, massive platter and string belt drive, it actually reminds me very much of Marantz's fabled TT-1800, their late high end design that never was – and also certain top Micros of that period. Whilst the outward appearance may ring bells, so to speak, the inside engineering is quite different. The plinth is a metal filled, MDF box of backbreaking weight, with beautiful gloss lacquered wood veneer. Debates rage hard on online forums about the merits of this, but suffice to say that just as the sprung subchassis approach works best when the springs are as unintrusive as possible (à la Avid), so the high mass approach works better the higher the mass is – and the Forte is certainly heavy...

"this massive machine gets the best out of your vinyl without you or it having to try very hard..."

of clever techniques used by various other designs – and the reappearance of a seminal tonearm from a past master of the art – Ikeda.

Costing £12,400 (in piano black or Zebrano finish, add £500 for premium Makassar), it is a fixed subchassis "mass design", in the tradition of the great nineteen seventies direct drives. Indeed,

The platter is the next most noticeable thing, largely on account of its huge 400mm diameter. It weighs 19.9kg, and is a two part affair with the inner section of the platter made from soft alloy, and the outer part made of a harder material. As you might expect, the main bearing (in the Forte's case inverted with a ceramic ball mating to a Teflon cup)

needed to handle this sort of weight and resultant pressure is vast, but it is given a helping hand by magnetism no less – with the bottom half of the platter incorporating neodymium magnets to lower the pressure on the bearing. This 'semi magnetically suspended design' is an elegant working compromise, but tweekers won't be delighted to learn that the bearing pressure is not easily adjusted and is best left to the factory setting. Finally, the platter comes with sorbothane damping, and the mat is made from recycled vinyl records; a massy record clamp is supplied.

Interestingly, the Forte is a twin motor design, the designers choosing to specify two low torque AC motors generating 2,700Kj of torque via twin pulleys and long diamond cut string belts. This is coupled with an active speed controller, and located in a separate enclosure which is made of sandwiched metal and MDF. This has two speeds, switchable by a push button, and there's a digital display offering stepped speed increase or decrease (if you so wish). One particular fun feature is the way this speed display counts its way up to 33.333RPM (or 45RPM) when you







switch on, steadily climbing to normal operating speed.

As you might expect, Technics SL1200-style 0-33.333 RPM in half a second starts are not available from a turntable with a platter that weighs more than most turntables. But this is of course to miss the point; the designers of the Forte assert that the higher the torque to the motor, the more intrusive it can be. By using twin motors, only gently connected to the platter which itself is so heavy it resists the short-term, momentary dynamic wow imposed by the stylus, the idea is that the motors spin the platter up to speed in a reasonable time and momentum does the rest. The motors then don't engage with the playback loop directly, that 20kg platter acting as a filter to speed variations. The twin motors seem to

work as twin turbochargers on car engines, supplying unstressed lazy torque rather than delivering needlessly (and possibly intrusively) high amounts. Regular readers will know I personally am a big fan of direct drives, but I do find E.A.T.'s approach interesting and very thorough. They have obviously designed the Forte well aware of the vagaries of belt drives, and all the problems it imposes, and would contend – I am sure – that it ain't what you do, it's the way that you do it! This is reflected in remarkably fine speed

stability [see MEASURED PERFORMANCE].

I find the deck itself a paragon of simplicity; it really is the sort of turntable you buy if you're not into fiddling. Once located (which given its size and mass is easier said than done), you – ermm – just switch it on and off and that's your lot. No suspension springs to twiddle, no fine speed to set, no intricate assembly of umpteen bits from a kit before it works. Essentially, the EAT Forte is a plug and play turntable – but for millionaires! It is, of course, immaculately finished,

and whilst I may prefer functional, machine-like looks of the Avid Acutus or the arresting geometric grace of the Michell GyroDec, I can see that it is an attractive thing to have in your house – providing you've got one big enough, of course...

Another key part of the Forte is of course the tonearm. Although notionally badged as an EAT product, Jozefína makes no bones about the fact that it is designed and manufactured by Ikeda. Indeed it is a chrome finished Ikeda IT407 12" design, mounted on a sorbothane damped heavy metal base. If you're not a Japanese hi-fi nut, you might be shrugging and saying so what – so think of it as being a bit like Lexus getting Bristol to supply engines for their top limousine [see ARMS AND THE MAN]. More remarkable is that Osamu Ikeda was reputed to be in semi retirement, and extremely unlikely to ever make any tonearm for anybody ever again...

Originally launched in 2006, the 12" IT407 is a fairly high mass dynamically balanced design that traces its lineage all the way back to Fidelity Research days. Precision radial ball bearings are used along with a thread linked, weighted bias compensator and there's a locking counterweight at one end of J-shaped polished arm tube, and a detachable headshell at the other. The build quality and finish of this arm is equal to the SME Series V, which really needs no more explanation – but suffice to say it is absolutely exquisite to hand cue, feeling as silky as the top SME in use. My only gripe would be the slightly fiddly arm rest lock, which isn't the best ever devised, even if it does the job.

Once again, the debates around tonearms are manifold; everyone 'in the know' has their favourite, and just to make life interesting, they rarely agree. The Ikeda arm brings no innovation, no fancy tonearm materials, no special damping systems or clever 'active counterweights'; rather it's an utterly conservative high mass design that relies on impeccable and consistent construction to achieve its sonic goals. Put a decent moving coil in (in my case a van den Hul Frog), dial in the tracking force, bias and vertical tracking angle (all very easy and elegantly done) and you're off!

### SOUND QUALITY

Having just spent a long and most enjoyable period with Avid's Acutus, and of course my own Sony TT-S8000 (a late seventies Japanese direct drive that makes most moderns look like Fisher-Price playthings), it was a

sobering experience to see the E.A.T. Forte in my equipment rack, let alone hear it. It is massive; bigger I would say than two Technics SL1200s in a row. The sound is concomitantly large, as imposing as the deck's physical bulk. I was fascinated, as in my system I haven't come across anything quite like it...

First then, a little bit of perspective. I found the Avid Acutus (at a mere £3,000 less if you fit it with the SME Series V tonearm that it so obviously wants) to be a breathtaking vinyl replay tool – masses of energy, vast amounts of detail and tremendous energy that had me perching on the edge of my seat. Put on some power pop like Simple Minds, or heavy electronica like The Prodigy and it was time to fasten your seatbelt for – as they say – the ride of your life.

Immense and cowering as the Forte may be sonically, it is not like the Avid. It is an altogether less intense experience. Don't take this to be in any way disparaging, as actually it is more versatile. Slip on some John Coltrane and you can sip a snifter of Scotch, light up a Silk Cut and tap your toes just as the Right Honourable Ken Clarke would his Hush Puppies. You can relax into the music, think about next weekend's visit to the in-laws or what colour you're going to paint the front door when the weather gets better. With the Avid, you'd have the vagaries of the recording etched into your cranium, and may well be thinking, "a great piece of music, but this early sixties cross-paired mic recording isn't ideal". Back to the E.A.T. though, and you'd be bathing in the languid, luxuriant sounds of Johnny Hartman singing, 'Lush Life', sitting up straight totally transfixed with your heart up where your Adam's Apple should be. My point is simple; the Forte takes you into the music as far as you want to go, yet demands nothing from you.

On the very surface of things, it is less detailed than the Avid. It doesn't put a magic marker under every attack transient, underlining when the note starts, and yet it is no less fast and no more unstable – indeed it seems even more speed-stable than the Acutus, which is really saying something. I found with Yes's 'Owner of a Lonely Heart', my reference Sony only just nosed ahead in the leading edge of the bass guitar stakes. The TT-S8000 is utterly exceptional in this respect, and a little ahead of the Avid, whereas the E.A.T. was, figuratively speaking, just millimetres behind its back bumper. But whilst the lithe direct drive with its light platter and clever quartz lock

speed control servo system could just about inch ahead on leading notes, it lacked the E.A.T.'s immense stability. It was as solid as the proverbial lump of granite sticking out of the briny. The scale, the epic expanse of its soundstage and the utter unflappability of its performance beat the Sony into a cocked hat.

Peter Gabriel's 'Solsbury Hill' was another case in point. Brilliant of course as the song is, it's a slightly murky mid-seventies analogue recording and one that doesn't flatter a turntable of any size, price or weight. I found the Forte was able to unpeel the song, rather like an onion skin, giving me great insight into every layer of the production, yet without sounding in any way forced or strained. I remember the Avid doing this too, albeit

with more drama and seemingly more detail, although I still found the E.A.T.'s presentation more naturally 'right' on an instinctive level. Its dynamics were formidable, and yet less explicit. With such innate power, it was able to deliver the contrasts in a more effortless way, like a slumbering giant waking up to brush away an irritation without bothering to raise an eyelid. Again, by contrast, the Sony seemed a tad breathless – which is not something you ever say about it in less illustrious company...

Tonally, the Forte was superb. Its bass is immense, unflappable and without fault – save for being *fractionally* slower to switch on than the Sony. Alternatively, it may be right and the Sony is simply a little 'nervous' with the leading edges, etching them artificially hard in a characteristically direct drive way? The E.A.T. is also sumptuous in the best tradition of vinyl; cue up The Who's 'Won't Get Fooled Again' from an original seventies pressing of 'Who's Next' and you really know that's a valve bass guitar amp being used. It's the sort of bass that doesn't need to make any apologies – there's no issue with the recording, or the rest of the replay equipment, it's just there like the elephant in the room.

Yet it doesn't overpower, or slur

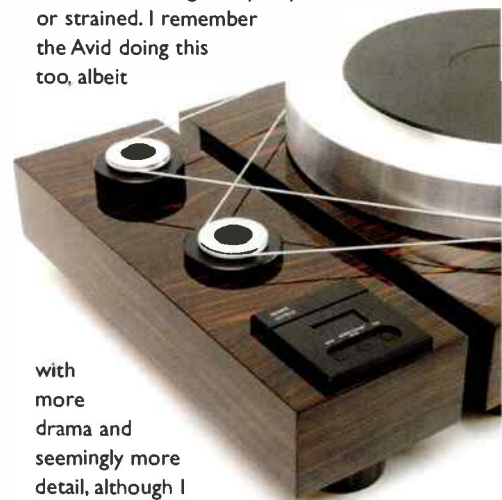



notes, or dominate the mix in any way; put on some nineteen sixties freakbeat from Ice (the most famous band to come out of my own Sussex University, which isn't saying much) and yes, sure enough, you can tell it's recorded in someone's bathroom in Brighton. Cue up 4hero's 'Escape That' however, and you're into low frequencies the like of which you rarely hear outside of Wembley Arena. Powerful as the E.A.T is below the stairs, let's just say it's not gratuitous.

Across the midband, you have a massively expansive sound. It makes the Sony – and to a less extent the Avid – seem rather stuck between the speakers. Yet instruments are not quite as accurately located as with the Acutus, which if it were a policeman would be a Miami-based member of CSI. The E.A.T. isn't imprecise, it's just big enough in its soundstaging for you not to have to ask questions; "the guitar's over there, the lead vocal is over there, okay, fair enough!" Nor is the midband quite as icily clear as the Acutus or the Sony, but it's actually no less detailed or informative, it's just the way it presents the information is altogether more relaxed. Now, I have a sneaking suspicion that the Ikeda arm is at least partly behind this state of affairs. It's so redolent of all those hours I used to spend languishing in Japanese hi-fi shops in and around Tokyo, listening to that country's high end fare. Think massively polished, with easy information retrieval that would never even think of throwing it at you. Yes, it's an ever so slightly 'hi-fi' sound, but a gorgeous one – and mates brilliantly to the E.A.T.'s mellow, moody, subtle sound.

As befits a turntable of this immense speed stability, the treble is a joy. It is slick and easy, beautifully polished and wonderfully atmospheric – yet sharp and incisive in a way that never dominates. Miles Davis's 'Kind of Blue' was majestic; smooth, vast in stage and deliciously, naturally musical, and with a wonderfully natural top end. If

ever there was a turntable/arm combination to flatter a cartridge's natural treble ability, this is it. Once again, my reference players both turned in a superficially slightly more detailed rendition, but it wasn't in any way more informative. Rather, it was if the brightness control had just been turned up a bit. The Avid was brilliant, pushing you right up close to the cymbals, the Sony had wonderful 'snap', whereas the E.A.T. took a gentle step back from the hi-hats, giving a less 'in your face' rendition that was – all said and done – a tad easier and more satisfying to listen to.

## CONCLUSION

At this level, you're not going to get a bad turntable, so the question then is – *what kind of good one do you want?* As with fine wines, great watches, top restaurants and seven star hotels, at this price you're buying something that suits you like the best bespoke tailored suit. And so whom would the E.A.T. Forte suit? Well, the standard fitment of the Ikeda arm means this is far more like a turntable package than most decks at this price, which come sans tonearm, requiring you to make this big decision. The Forte is a case of 'add cartridge and go'; it even requires relatively little set up as it is not a skeletal design which demands various layers be bolted on to various others.

What it gives then is brilliant sound out of a (very big) box, with a superb fitted arm that sings with almost any highmass moving coil cartridge. It presents a relaxed, easy, nonchalant sort of sound, but one that is nevertheless immensely satisfying. The best thing is that it's very devoid of character, or obvious strengths or weaknesses for that matter. Simply put, it's a massive machine that gets the best out of your vinyl without you – or it – having to try very hard. At nearly £13,000, it seems you can afford not to!

## ARMS AND THE MAN

In 1964, the former factory manager of Japanese tonearm specialist Grace decided to start his own business. At the age of thirty five, Osamu Ikeda formed Fidelity Research Kabushiki Kaisha and by the mid nineteen seventies his company was making world-class tonearms and pickup cartridges. Ikeda was no copyist, taking out several international patents and finessing his designs like few others. Indeed, so respected was he in Japan that his products were even used by the Imperial Family. The late nineteen seventies were the glory days for Fidelity Research, with the FR64 series of tonearms his strongest product, being a superlative device at a time when there was a relatively paucity of competition.

After the demise of Fidelity Research, the great man came back with Ikeda Sound Laboratories Company. An altogether smaller and specialist affair, he designed, built and inspected every product by hand. It was a chance for yet more innovation, not least the world's first MC cartridge without a cantilever. The new IT345 and IT407 tonearms were launched in autumn 2006; coming in twelve and sixteen inch versions respectively. E.A.T. use a specially modified, gloss finished version of the former.

## VERDICT

Don't be fooled by its conservative looks, this is a brilliantly conceived, superbly engineered vinyl spinner. A memorable - seminal even - high end product.

## E.A.T

FORTE/IKEDA 12" £12,400

Absolute Sounds

+44(0)208971 3909

www.euroaudioteam.com

## FOR

- supreme musical ease
- unerring speed stability
- flawless engineering
- excellent fitted tonearm

## AGAINST

- size
- weight

## MEASURED PERFORMANCE

The EAT Forte carries an Ikeda IT407 12in (307mm) arm with detachable headshell. This is a solid affair made from various metals Ikeda say, rolled not diecast. The arm feels solid and 'dead' in the hand and indeed it measures like that too. For a long, tubular arm it is surprisingly free of a main arm tube mode, expected around 200Hz or lower. In this region there is no sign of vibration, although a small bump at 120Hz could possibly be due to primary flexure. Otherwise, the IT407 is a very 'quiet' arm all the way up to 3kHz and should give excellent bass quality and fine sound staging as a result, as well as a pure midband. Above 3kHz, as accelerations rise, the headshell becomes as active as most, so here the Ikeda is less distinguished. Also, 12in arms roughly halve the tracing distortion generated by a 9in arm and usually sound smoother and silkier as a result, although often not as 'fast'.

The EAT Forte turntable produced some amazing results. It was just 0.1% slow, a negligible amount and low speed drift below 1Hz was lower than usual too, resulting in a very low unweighted Wow and Flutter value of 0.072%. This suggests the EAT

Forte will have much the same grip on pace as a Direct Drive. Weighted wow and flutter was low too, as is to be expected, measuring 0.061%.

An unusual combo this may be in appearance, but it is a good deal more sophisticated under the skin than one might imagine. It's a great pairing. NK

## ARM VIBRATION

Arm vibration behaviour

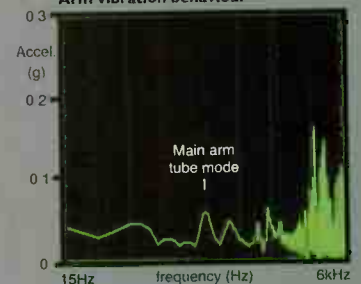

## SPEED STABILITY

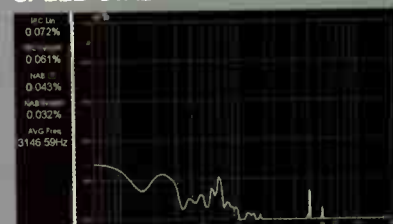

*"...a significant breakthrough in high performance audio."*  
**The Absolute Sound, U.S.A.**

*"...performance that lifts them above the competition."*  
**Hi-Fi News, U.K.**

*"...hits the sweet spot head on"*  
**Stereophile, U.S.A.**

*"Black Velvet...a big 5 stars"*  
**Sound & Vision, Greece**

*"...OUT-OF-THIS-WORLD GOOD."*  
**Tone audio, U.S.A**

*"FIRST CLASS.."*  
**Audio Review, Italy**

*"...from the first few notes, (you're) hooked.n"*  
**Hi-Fi+, U.K.**

*"...what I heard blew me away."*  
**The Audiophile Voice, U.S.A.**

*"A little champ of price/quality ratio: available at an affordable price, especially for atube amplifier of more-than-usual power.."*  
**Audio Review, Italy**

*"PrimaLuna ProLogue One is now my'affiliate reference amplifier'. With apologies to various British and Italian geniuses, this amplifier has to my ears no equals at its retail price."*  
**Hi-Fi News, U.K.**

*"A refreshing change from the transistor competition with a captivating presentation. Excellent finish and build quality makes for a package strong on value."*  
**Hi-Fi World, U.K.**



**Prologue1** 35 Watts Stereo Integrated Amplifier with EL34



**Prologue2** 40 Watts Stereo Integrated Amplifier with KT88



**Prologue3** Dual Mono Valve Preamplifier



**Prologue4** 35 Watts Stereo Integrated Amplifier with EL34



**Prologue5** 35 Watts Stereo Amplifier with EL34



**Prologue6** 70 Watts Stereo Amplifier with EL34



**Prologue7** 70 Watts Stereo Amplifier with KT88



**Prologue8** Valve CD Player



**Dialogue1** 36 Watts Stereo Integrated Amplifier with EL34



**Dialogue2** 36 Watts Stereo Integrated Amplifier with KT88

## PrimaLuna

Music is a universal pleasure that should not be denied to anybody. So, too, the beauty of music reproduced by valves. To make available to a wider audience the seductive, silky sound of the vacuum tube, PrimaLuna has developed a range of all-valve amplifiers with the construction, power and sonic performance of high-end electronics, but with one unique, inimitable feature: prices that can only be described as 'entry level'!

Since the arrival last year of PrimaLuna's first model, the ProLogue One, the audio community has been unable to contain its joy nor reign in its praise, because PrimaLuna has revolutionized the whole concept of 'affordable audio.' Commencing with a pair of integrated amplifiers with prices more typical of mundane, solid-state products, PrimaLuna has shown other manufacturers that compromises in fit and finish, styling and facilities are unnecessary.

And PrimaLuna has shown the music lover that 'high end' performance and pride of ownership can be made available to aficionados on a budget. But don't take our word for it. Audition your preferred ProLogue or the newly-launched Dialogue models at the PISTOL Music dealer of your choice. And prepare your wallet for a pleasant surprise!





# Power Struggle

**Paul Rigby wonders if decent sounding integrated amplification is available to those on a more modest budget, as he tries seven of the best affordable amps from Marantz, Audiolab, Pro-ject, Rotel, Icon Audio, Cambridge Audio and Pioneer...**

**A** funny thing happened in hi-fi a few years ago. Right in the middle of the boom times, a range of manufacturers started bringing out entry level two channel separates. This meant that for the first time in a long time, the likes of Pioneer could sell you an affordable integrated amplifier. Various rivals responded, and suddenly it's all go in the sub-£500 sector!

This increased competition has had largely positive results, as the sheer quality of many of today's affordable hi-fi components can fair take your breath away. Going back to Pioneer and think of their late eighties designs such as the A300, and £300 would buy you a think pressed steel case, a crude fascia and a plastic volume knob. The A-A9-J – its 'real terms' price successor, is on another level in the facilities, fit and finish stakes. Likewise, Audiolab is now selling the 8000S for £300 where once it was three times the price. Now built in Shenzhen rather than Huntingdon of course, it's nevertheless just as well made if not better. We can also see giant leaps made by the likes of Marantz and Cambridge Audio, and of course the introduction of a valve amplifier on to the market for £500 – something many thought would never happen! Quality has come to this sector, and whilst the term 'budget' may have been used pejoratively in the past when describing low cost amplifiers, it need not be now.

This test looks at seven circa £500 amplifiers - differing in size, technology and, above all, their price. But does it follow that one amp priced at £550 will automatically be streets ahead of a model rated at £270? Read on to find out...

"whilst the term 'budget' may have been used pejoratively in the past, it need not be now"...

## T-3E CONTENDERS

Marantz PM6002	£270	p16
Audiolab 8000S	£300	p17
Pro-ject Pre/Power Box	£320	p18
Rotel RA-06	£500	p19
Icon Audio Stereo 25	£500	p20
Cambridge Azur 740A	£500	p21
Pioneer A-A9-J	£550	p23

## REFERENCE SYSTEM

Avid Acutus/ SME IV/Benz Glider cartridge  
 Icon PS3 phono stage  
 Naim CD5 CD player  
 Spondor S3/5R loudspeakers  
 Chord Anthem 2 interconnects  
 Chord Epic Twin loudspeaker cables  
 Atacama HMS 1 loudspeaker stands  
 Atacama Equinox XLPro SE hi-fi rack





## MARANTZ PM6002 £270

**D**espite being a goodly amount under £300, this is only Marantz's third cheapest integrated two channel stereo amplifier in their range – so they obviously take the budget end of the separates hi-fi market seriously. It comes powered by the company's proprietary Linear Drive Power Supply (LDPS), and Marantz claim the PM6002 can tackle just about any speaker you care to throw at it. The extruded heatsink acts both as a heat dissipater and as a mechanical isolator, and the amplifier is fitted with a sturdy anodised case (measuring 120x440x350mm, weighing 7kg) available in silver or black. Full dual-mono construction is used to keep the signal path as pure as possible by isolating each channel. Six inputs populate the rear including a moving magnet connection for vinyl fans plus a pre-out for further expansion. Two sets of speakers can be attached via gold plated connectors.

At the front, along with a headphone socket and a comprehensive Record Selector, the Marantz supports tone controls but, for the audiophile, it also includes a Source Direct button to bypass the tone controls and improve the sound. In aesthetic terms, the PM6002 is pleasing to the eye. Many rivals bombard you with a light show, which is why the PM6002's single, tiny red LED to indicate the current source is such a relief.

### SOUND QUALITY

Spinning the Carol Kidd CD 'Dreamsville', the first impressions of the track, 'A Nightingale Sang In Berkeley

Square', were of an amplifier with a warmish presentation, slightly veiled up top, with a detailed midband and a weighty yet imprecise bass – especially right at the very bottom end. Although a broad warmth tends to cover the upper midrange and treble, removing any excess glare (and indeed some of the sparkle), vocals can sound a little coloured. However, Kidd's voice does present all its essential characteristics through this amplifier, in a generally enjoyable manner. Rock appeared rather more forgiving. On playing Can's 'Monster Movie', 'You Doo Right' is a drum-heavy track, and the warm and weighty rendition was very palatable and, despite transients being a little indistinct, midrange detail was admirable when pushed.

Playing vinyl improved matters still. This higher resolution source

with a naturally mellow presentation evened out the vocals on Kate Bush's 'π' from 'Aerial', providing the ear with a sweeter sound that allowed the bass to flow more naturally, whilst retaining midband detail. Rock, on vinyl, finally woke the PM6002 from its slumbers via Yes's 'The Yes Album' and 'Yours Is No Disgrace'. The genre's inherent liveliness suited the PM6002's nature while masking its drawbacks, with a combination of musical force and warmth. Testing other rock LPs, I can confirm that the Marantz revels in wind-milling guitar strums, twirling drum sticks and spandex trousers, relying more on passion than outright finesse. Users looking for transparency and detail across the spectrum won't be natural allies of the Marantz, but it still offers a fine, fulsome and bouncy sound given its very modest price tag.

### MEASURED PERFORMANCE

The PM6002 delivers 55 Watts into 8 Ohms and 90 Watts into 4 Ohms. A damping factor of 26 is enough to exert good apparent control over bass cones.

Distortion levels were low, measuring 0.014% in the midband (1 Watt/4 Ohm), level rising to 0.1% near full output. Results were good at high frequencies too, our analysis showing just a small amount of second harmonic exists, and this remained consistent with output power and load.

The phono stage has a small +0.75dB bass lift at 35Hz and +0.3dB at high frequencies to add a little extra liveliness. Noise was very low, sensitivity normal at 3mV and overload high.

The tone controls were fairly conventional, providing 10dB of lift and cut at spectrum extremes.

The PM6002 has particularly stable and benign distortion behaviour. NK

Power	55 Watts
Frequency response	3Hz-54kHz
Separation	75dB
Noise	-94dB
Distortion	0.006%
Sensitivity	200mV
Damping factor	26
Disc	
Frequency response	13Hz-43kHz
Separation	60dB
Noise (e.i.n.)	0.24uV / -81dB
Distortion	0.008%
Sensitivity/O.L.	3mV/123mV

### DISTORTION

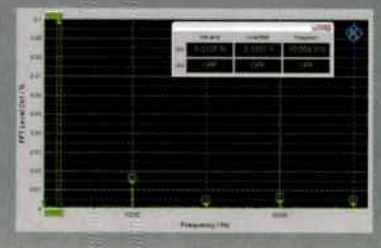

### VERDICT ●●●£

Warm sound with plenty of passion makes for a fine entry-level integrated.

**MARANTZ PM6002 £270**

Marantz

☎ + 44 (0)1753 680868

www.marantz.com

### FOR

- value
- musicality
- ease of use

### AGAINST

- soft bass
- veiled treble



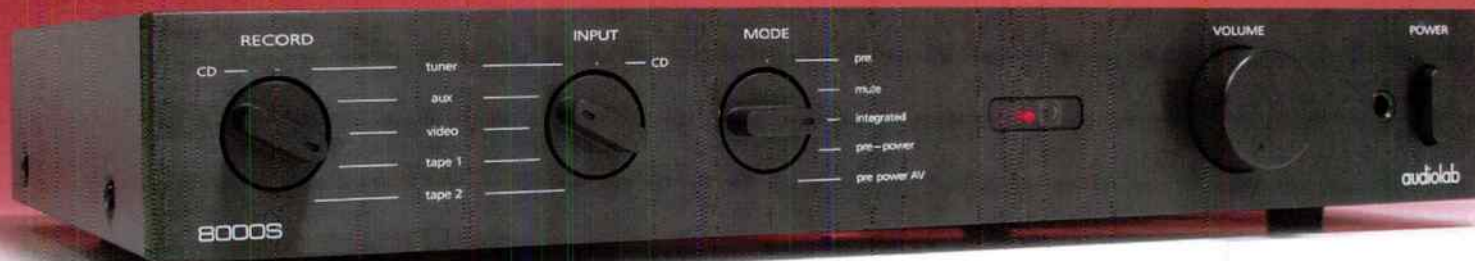

## AUDIOLAB 8000S £300

**B**ased on the classic 8000a integrated, this latest modern incarnation is a very versatile beast – at least in its source and speaker switching potential, as the front panel avoids the clutter of tone controls, *et al.* The 'S' arrives with a gamut of line inputs populating the rear: six sets of inputs, in fact, including three tape loops. One should note however, that although one set of outputs are labelled as Video, you will be able to utilise them as a spare set of inputs for other purposes. This amplifier can even act as a preamplifier with bi-amping options, or serve as a separate pre-power amp which will be useful to AV enthusiasts who might wish to add an AV processor. Inside the silver (or black) box, Audiolab has employed extensive heatsinking over several components for durability and reliable operation at high levels over extended periods. The chassis is slim (74x445x335mm) whilst the amplifier weighs in at 8kg.

The visual design is intriguing, offering a retro styling that, apart from the torpedo-shaped on/off switch and large volume knob, is based on three clunky-looking switches that gave me the feeling of running through the launch sequence in a nineteen sixties cold war missile silo! There's something strangely satisfyingly about the 'clunk' that the selector switches make on this amplifier - it's a nice thing to use and to live with.

### SOUND QUALITY

Despite its small £30 price premium over the Marantz, the Audiolab 8000S proved considerably more capable. First, Carol Kidd's vocalisations were considerably more airy

whilst her backing band sounded far less claustrophobic than via the Marantz PM6002. There was also a much wider soundstage that allowed the music to breathe. Treble offered a welcome sense of delicacy on cymbals while mid tones on piano were very clean. Rock performed equally well. Via Can, bass was crisp and detailed with good lower frequencies that never become muddled or confused. Each instrument was picked out with alacrity. That's not to say that the 8000S was clinical in any way but it certainly had a much improved focus over the Marantz.

Turning to vinyl and Kate Bush proved rather more civilised and controlled. Again, both upper mid and treble enjoyed a measure of focus and detail, but there was possibly a little less musicality on this softer track – an interesting point which does highlight the cheaper Marantz's greatest redeeming feature - its musicality. The Yes track was far

more interesting with a very clean and dynamic sound that offered tremendous clarity considering this amplifier's modest position in life. Despite the rather raucous rock arrangement, the 8000S retained its ability to identify each instrument successfully. Also, as space was added to each, the bass guitar, for example, had more room to manoeuvre.

Due to the welcome clarity, vocal harmonies were also more of a delight and offered the choice of listening to a well presented whole or picking out each voice as you pleased. The 8000S has suffered from criticism of a lifting upper-midrange. However, I'd warrant that this wayward element merely confirms that you should be careful in matching this amp with your chosen speakers. The civilised Spondors proved an ideal choice. This is a brightly lit and entertaining performer alright, but providing you match accordingly, you will be impressed.

### MEASURED PERFORMANCE

The Audiolab is a band limited design with a high frequency limit of 31kHz (-1dB). This usually gives a slightly darker palor to treble, but keeps it clean and easy; Naim's also band limit heavily. Power output measured 72 Watts into 8 Ohms and 121 Watts into 4 Ohms, enough for high volume in most situations. With a high damping factor of 58 the 8000S should have the firm bass traditionally associated with Audiolab amplifiers.

The distortion pattern remained very constant, mostly second and third harmonic, both in the midband and at high frequencies, with changing load and power levels. This suggests the amplifier will not be tinged by distortion changing in a manner uncorrelated to the music, always a good sign. An input sensitivity of 320mV is useful, if insufficient for low gain external phono stages, and the Audiolab has neither

phono stage nor tone controls onboard.

The 8000S is an uncomplicated design that measures well in all areas and appears able to continue the Audiolab tradition. NK

Power	72 Watts
Frequency response	2Hz-31kHz
Separation	87dB
Noise (indirect/direct)	-104dB
Distortion	0.014%
Sensitivity	320mV
Damping factor	58

### DISTORTION

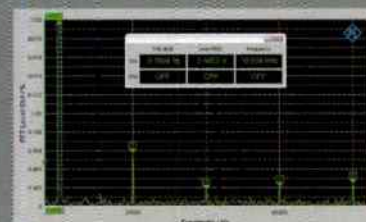

### VERDICT

Compact in form with a crisp and dynamic presentation, it offers excellent value for money.

**AUDIOLAB 8000S £300**

Audiolab  
+44(0)845 458 0011  
www.audiolab.co.uk

### FOR

- detail
- bass response
- dynamic

### AGAINST

- well lit upper midband





## PRO-JECT PRE/POWER BOX £320

**T**his is the only two box preamp-power amplifier combination in this test, and the only Class D design. This explains the miniature dimensions (38x103x103mm) of course, as Class D produces negligible heat – hence no need for bulky heatsinks. The boxes arrive with a wooden sleeve. You stack one box on top of another and then slide both cases into the 'sleeve' which, on the face of it, provides a neat and tidy finish - until you start plugging the leads into the rear of both. Then it begins to look like a Spider Crab – a small box dominated by a range of thick cables that sprout everywhere and threaten to lift the amplifiers clean off the ground all on their own! However, if you can tidy the mess, the Project boxes will provide you with a great set-up that will be ideal for those short of space. Weight is just 630g and 670g for the Pre and Power Boxes respectively – not quite Krell territory then!

### SOUND QUALITY

It was immediately apparent that the Pro-Jects were struggling to drive the Spondors, volume had to be pumped up high and sibilance and minor distortion began to dominate. This prompted a change to a more sensitive speaker, the John Blue JB4 which, whilst helping the volume, revealed the Project's lack of inherent bass and treble detail. All that was left was a fairly innocuous sounding midrange in my system. So I

returned to the Spondors but moved rooms, setting up the Pro-Jects in a much smaller office and used the Spondors as near-field monitors. Lowering the original volume cleared any distortion, allowed the small room to alleviate the lack of bass and the civilised Spondors to create the rest. Things took a big turn for the better...

Still, even working within their envelope, the wee Pro-Ject amps are not designed for rock. Both Can on CD and Yes on vinyl suffered from a light bass, whilst the Hammond organ on the Yes album sounded rather anaemic - and yet there were highlights, even here. Can's Irmin Schmidt's keyboard work was

picked out more effectively here than on either the Marantz or the Audiolab, whilst both Yes' vocal detail and the upper mid response over both keyboard and guitars was admirable. What remained was an amplifier that delivered a subtle yet tantalising sound. Underpowered it may be but the Pro-Ject is capable of real delicacy. The Kate Bush track allowed these amps to spring to life, extracting new and exciting nuances in Bush's vocal work whilst keyboards where lifted from the backing track for the first time whilst vinyl warmth enhanced the bass. This is a real Curate's Egg then - a low-powered contender for fine jazz, classical and acoustic works.

### MEASURED PERFORMANCE

The Project Amp Box is a 'digital' amplifier (Class D analogue switching amplifier in fact) with the usual traits/weaknesses, albeit well controlled. Bandwidth contracts as load decreases, flat from 3Hz-20kHz (-1dB) into 8 Ohms, but limited to 14kHz into 4 Ohms due to reactance in the necessary series output inductors. These also limit damping factor to 14: but that is the same as a Naim and no drawback in itself. Power measured 30 Watts, as claimed, into 4 Ohms, and 20 Watts into 8 Ohms.

Distortion level was low in the midband at 0.04%, but harmonics stretched beyond 20kHz. Distortion level increased considerably at higher frequencies, at 6kHz measuring 0.3% or more (1W, 4 Ohms) with extended harmonics. This will be audible, likely giving treble a brittle edge.

Input sensitivity was very low at 2.2V, or 770mV with Pre Box, with its

gain of 2.86. A d.c. offset of 10V exists on all loudspeaker terminals too. Noise was low. The Amp Box puts up a fair performance as Class D amps go and should sound interesting! NK

Power	30 Watts
Frequency response	3Hz-14kHz
Separation	85dB
Noise	-122dB
Distortion	0.2%
Sensitivity	2.2V
Damping factor	14

### DISTORTION



### VERDICT ●●●●£

Compact in stature, these lyrical amps are great for small rooms as part of a near-field speaker set-up, but otherwise limited in appeal.

**PRO-JECT**  
**PRE/POWER BOX £320**  
 Henley Designs  
 ☎+44 (0)1235 511166  
 www.henleydesigns.co.uk

### FOR

- subtle detail
- delicate upper midrange

### AGAINST

- under powered
- careful speaker matching
- bass light





## ROTEL RA-06 £500

**H**ere's what Rotel do best – a very neat but conservatively styled, fine sounding traditional stereo amplifier that's designed to handle just about any budget loudspeaker that you care to throw at it, and offer upgradeability for the future. It is designed with separate pre and power modules within the single chassis, and there's short signal path routing to minimise the length of the signal pathway, to prevent as much audio degradation as possible. In addition, the circuit board layout is symmetrical to enhance the duality of both channels, the company says. The RA-06 features six inputs including a phono stage that can handle a moving magnet cartridge, a set of tape connections for the Luddites amongst us (including myself, I hasten to add) and a 'media player' socket which arrives as a 3.5mm input situated on the front of the chassis. The rear also features two sets of speaker terminals.

Despite being one of the most expensive amplifiers in the group, this Rotel seems to be aimed at less specialist, more general buyers because like the Marantz, it sports sound-degrading but eminently practical tone controls. Still, the company has ensured that there's a 'defeat' button to keep the audiophiles happy in this instance, thankfully. A 3.5mm headphone socket is fitted to the front fascia, and a remote control is supplied, which although well made is a little cluttered. The overall design is not exactly minimalist but the front fascia of the chassis, which measures 100x440x350mm, does provide a classy, brushed aluminium feel and a sense of professionalism that imbues

confidence. It's a nice thing to use and to own.

### SOUND QUALITY

Spinning Carol Kidd, the Rotel certainly showed pronounced bass, but it wasn't the most controlled in the lower regions. This was contrasted by an effective level of mid detail, doubtless helped by an obvious midrange lift. Together this made for a big, vibrant and lively sound, although somewhat lacking in nuance. Indeed, the soundstage seemed a little 'thick', the listener tending to feel that each instrumentalist was sitting on the knee of another, but still there was energy and exuberance there that I really liked. The Rotel sounded desperate to give more, more, more, and this need to please was largely fulfilled with Can's 'Yoo Doo Right', which retained all its own inherent energy, the Rotel proving largely sympathetic with Malcolm Mooney's emotional vocals. Again, however, this

track was visceral: drums offered power, not tonality and guitars offered guts, not clarity.

Moving to vinyl and Kate Bush, and I got a more balanced and enjoyable sound, while still retaining those weighty lower and upper bass regions. Overall, treble and upper midrange didn't supply the clarity of the Pro-Ject, but Kate Bush's 'π' was certainly fun. This new found musicality was maintained on the Yes track, in which the Rotel had a rollicking good time and showed its preference for meaty subject matter, allowing its sufficiently weighty bass and lifted midrange to make the party swing and be damned with treble and upper mid finesse.

The Rotel struck me as a amplifier with a whole heap of passion, oodles of guts and full-on emotion but little in the way of subtlety. It's an amplifier for seat-of-the-pants music fans whose hearts rule their heads.

### MEASURED PERFORMANCE

The RA-06 produces 90 Watts into 8 Ohms and 144 Watts into 4 Ohms so it is powerful enough to drive insensitive loudspeakers in large rooms.

Distortion levels were low even at high frequencies and the RA-06 will not change its sound much according to conditions of use, a valuable property. With wide bandwidth and high damping factor the RA-06 should have the usual punchy, controlled and open sound of Rotel amplifiers. Tonal correction usefully applies gentle correction at spectrum extremes to trim the balance rather than grossly alter it.

An MM phono stage has accurate equalisation but lacks a warp filter. Hiss was very low at 0.3uV (equivalent input noise).

The RA-06 is a tidily engineered amplifier that measures well. NK

Power 90 Watts

Frequency response	5Hz-166kHz
Separation	66dB
Noise	-100dB
Distortion	0.015%
Sensitivity	200mV
Damping factor	48

Disc	
Frequency response	16Hz-60kHz
Separation	64dB
Noise (e.i.n.)	0.3uV / -75dB
Distortion	0.02%
Sensitivity/O.L.	3mV/166mV

### DISTORTION

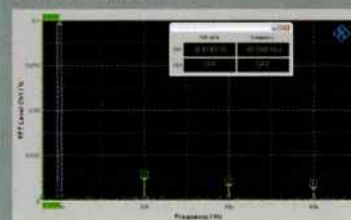

### VERDICT

Punchy sounding amplifier that, whilst lacking the finer musical points, wears its heart on its sleeve.

**ROTEL RA-06** £500  
**ROTEL UK**  
 ☎ +44 (0) 1903 221 500  
[www.bowers-wilkins.co.uk](http://www.bowers-wilkins.co.uk)

### FOR

- gutsy sound
- musicality
- fine build quality

### AGAINST

- lacks finesse
- lower bass control



## ICON AUDIO STEREO 25 £500

**T**his is the only member of the group to feature thermionic tubes instead of transistors. It sports hand-made, point-to-point construction featuring a Class A, triode

front-end based on EL34 valves. Icon Audio is keen to see its amplifier as a platform to work from rather than as the final solution, although we tested the 'basic' version here. For example, the Stereo 25 is capable of including 6L6, EL34, 6CA7, KT66, KT88 or 6550 valves. In addition, Icon offers a range of customisation options that includes a 15W RMS triode output stage, an automatic HT relay to protect cold valves at switch on and extend valve life and the inclusion of copper foil in paper and oil capacitors. Of course, each upgrade adds to the basic cost of the amplifier and prices for each can be found direct from the company. A safety cover is included as part of the package. Some child-less users won't bother fitting it, preferring the pleasant glow of the valves to soothe them.

As supplied, the basic model measures 215x320x310mm and weighs in at a hefty 15kg. It also boasts some nice engineering touches as standard, including Teflon insulated silver audio cable and gold plated input and loudspeaker terminals. The only potential problem with the Icon is its limitation to just three line inputs which would demand that your system be restrained

to the essentials. This will be of no great concern to many users but should be considered by others who populate their system with more esoteric additions.

### SOUND QUALITY

Beginning with a slice of swing jazz from Carol Kidd's 'Berkeley Square', the Icon gave the best vocal rendition in the test so far, even topping the Audiolab. You could almost hear Kidd's vocal chords tensing and flexing as she moved the notes around her throat. Frequencies enjoyed a full dynamic range and, although lacking lower bass frequencies of the Audiolab, bass was still fully formed with tuneful upper registers. Mids, despite a touch of stress when attempting to tackle the most complex rhythmic passages,

were both detailed and musical in nature. Admirable instrumental separation aided the room given to each, which meant that, for example, cymbals ticked away delicately alongside a lazy double bass without any sense of muddle.

Can lacked the force and passion of the Rotel and the absence of lower bass removed a certain structure from the music. Instead, the Icon relied on its excellent midrange detail to give the drums character and soul to Michael Mooney's voice whilst each instrument maintained an unfettered clarity. Moving to vinyl and Kate Bush, the Icon was allowed to run free, smiling its head off and revelling in the higher resolution source. Yes, lower bass was still light but you could almost forgive it because of the tuneful, detailed and unhurried upper mid and treble. Also, on Yes's 'Yours Is No Disgrace', each instrument showed a wonderful tonality. The Icon may not have exhibited the same level of pizzazz as the Rotel but its excellent instrumental separation and clarity aided transparency whilst the broad sound stage helped to envelope you in the performance.

### MEASURED PERFORMANCE

The Icon Audio Stereo 25 produces 25 Watts only if a high 3% distortion figure is used. The amplifier distorts progressively by slewing, almost certainly due to its budget output transformers, behaviour that produces third order distortion. This adds a glassy edge to the sound and a sense of incisiveness some associate with 'speed'.

However, at low powers the Stereo 25 is distortion-free, so its sound is very power dependant. Bias on our sample measured 6.6V against 7V recommended and I found 8V gave slightly better linearity so the amplifier was run at this bias voltage.

Sensitivity was high at 210mV and hum very low at 0.5mV. Noise (hiss) was also low. A damping factor of 4 is reasonable and bass distortion kept in check providing 5 Watts or so is drawn. Frequency response was wide and flat within the audio band.

The Stereo 25 has limitations;

it lacks the low levels of distortion that better output transformers bring. However, used conservatively with sensitive loudspeakers it should sound clean and open. NK

Power	25 Watts
Frequency response	6Hz-32kHz
Separation	76dB
Noise	-98dB
Distortion	0.12%
Sensitivity	210mV
Damping factor	4

### DISTORTION



### VERDICT ●●●●£

Valve fans will love the transparent nature of the top end, and expect the lack of rumbling bass. An excellent value integrated if matched carefully.

**ICON AUDIO**  
**STEREO 25** £500  
 Icon Audio  
 ☎ +44 (0) 116 244 0593  
 www.iconAudio.com

### FOR

- sweet treble
- midrange insight
- expansive soundstage

### AGAINST

- low power





## CAMBRIDGE AZUR 740A £500

**B**ack to a conventional solid-stater with the 740A, after our quick 'walk on the wide side' with the Icon! This is a neat looking, feature packed integrated available in silver and black finishes. It's very flexible too - with its fixed input mode, the 740A can also be used as a power amplifier. Also, RJ45 sockets allow the connection of active speakers or connection to a multi-room system. An impressive seven inputs will allow you to attach just about anything around the back.

The 740A's wish to be all things to all men does lead to a rather schizophrenic form factor. Prime culprit is the multi-mode display interface where multiple commands can be initiated by adjacently placed physical buttons. For hi-fi use, I feel this interface is too complex - and it's beginning to feel old fashioned in our iPhone touting world - if you're going to have a large display working in this manner, make it a touch screen. Otherwise, what's wrong with rotary selectors and a smaller chassis? The volume pictorial indicator, which is centrally placed on the same illuminated display, is a flowery affair and similarly excessive. Actually, I feel that the interface is aimed more at the multi-room user. Within such an environment, the display makes more sense. The remote however, is aimed at neither. Despite being well made, its interface is a tad confusing offering only a numeric push-key system to select each input. What's wrong with labeling inputs with the most popular connections: CD, Tuner, etc? The Azur's measurements are pretty standard at 115x430x350mm plus 10.7kg in weight.

### SOUND QUALITY

After walking away from the box, grumbling about the design, I was shocked to experience what the Cambridge could actually do in action via the Spondors. Listening to Carol Kidd, the vocals were, if anything, richer and slightly sweeter than the Icon! Kidd's tones wrapped you up like a big cuddly dressing gown. The 740A, above all else and over all genres and formats, showed a tremendous sense of ease. Imagine Hendrix playing a guitar. He would seem to say, "Hey, this is easy - look, I can even play it behind my back... or with my teeth!" That was the Cambridge 740A. Yes, the Audiolab's deep bass was there, as was its detail but the 740A achieved the same highs with less effort. This had a great effect on piano. You could almost feel the pianist's relaxed hands, smoothly tracking the scale...

The 740A's lower bass control helped provide an effective drum

pulse on the Can track whilst the upper mids featured a deep sense of emotion. For example, Mooney's vocals were riveting and scoured by a sense of passion. Meanwhile, the guitar's upper mid and treble frequencies wailed along, effectively connecting the two for the first time as a single entity. Vinyl replay enhanced the 740A's musicality and dynamic range. Kate Bush's now almost maternal vocal rendition showed excellent variation, hovering above the organic acoustic guitar. Yet the thump of the lower bass regularly grounded the performance. Similarly, Yes maintained both clarity and musicality. Chris Squire's unique bass runs were given extra motion, as was Tony Kaye's Hammond organ. I particularly enjoyed discovering new midrange details for the first time such as Jon Anderson's understated vocal modulations. A very impressive product then - if only it wasn't quite so fiddly.

### MEASURED PERFORMANCE

The Cambridge Audio Azur 740A has a massive toroidal mains transformer that allows it to deliver no less than 112 Watts into 8 Ohms and 182 Watts into 4 Ohms, so it has some serious grunt for its size. With a damping factor of 35 the Azur should have a solid blow to its bass delivery.

Distortion levels were very low all round, at low and high power outputs right across the audio band. A figure of just 0.0003% was achieved in the midband and our high frequency analysis at 1 Watt, 10kHz into 4 Ohms clearly shows distortion being flagged up as a low 0.0014%; full scale is just 0.01% here on the Rohde & Schwarz UPV analyser, so the 740A will lack edginess. With very wide bandwidth, doubtless due to copious feedback, the Azur will sound bright and clear, lacking the darker pallor of band limited designs. Input sensitivity was low at 470mV so any external phono stage will

need high gain of at least x200 (+46dB) for MM cartridges.

The Azur 740 is powerful, low distortion and wideband so will likely have a clean and powerful sound. NK

Power	112watts
Frequency response	6Hz-163kHz
Separation	76dB
Noise	-105dB
Distortion	0.001%
Sensitivity	470mV
Damping factor	35

### DISTORTION

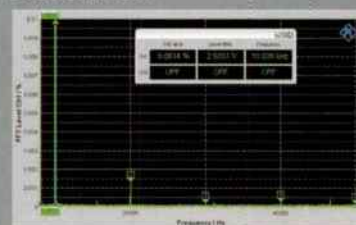

### VERDICT

Unusually revealing, it offers a sumptuous performance of class leading proportions.

**CAMBRIDGE**  
**AZUR 740A** £500  
**CAMBRIDGE AUDIO**  
 ☎ +44 (0) 845 900 1230  
[www.cambridgeaudio.com](http://www.cambridgeaudio.com)

### FOR

- lush sound
- bass control
- transparency

### AGAINST

- ergonomics

# emillé

*just for your musical bliss*



KI-40L  
STEREO INTEGRATED AMPLIFIER

Distributed in the UK by Angelsound Audio  
[www.angelsoundaudio.co.uk](http://www.angelsoundaudio.co.uk)  
Tel:01923 352479

**- Dealers**

Midlands  
Mayflower Sounds  
Tel:01923 524266

Surrey/Hampshire  
Blade Audio  
Tel : 01302 711528

West Sussex  
Heatherdale Audio  
Tel:01903 872288

Northern Ireland  
Kronos Audio Visual  
Tel : 02887 753606

Emillé Labs  
[www.emillelabs.com](http://www.emillelabs.com)  
Tel:+82 55 382 7373 Fax:+82 55 383 7375



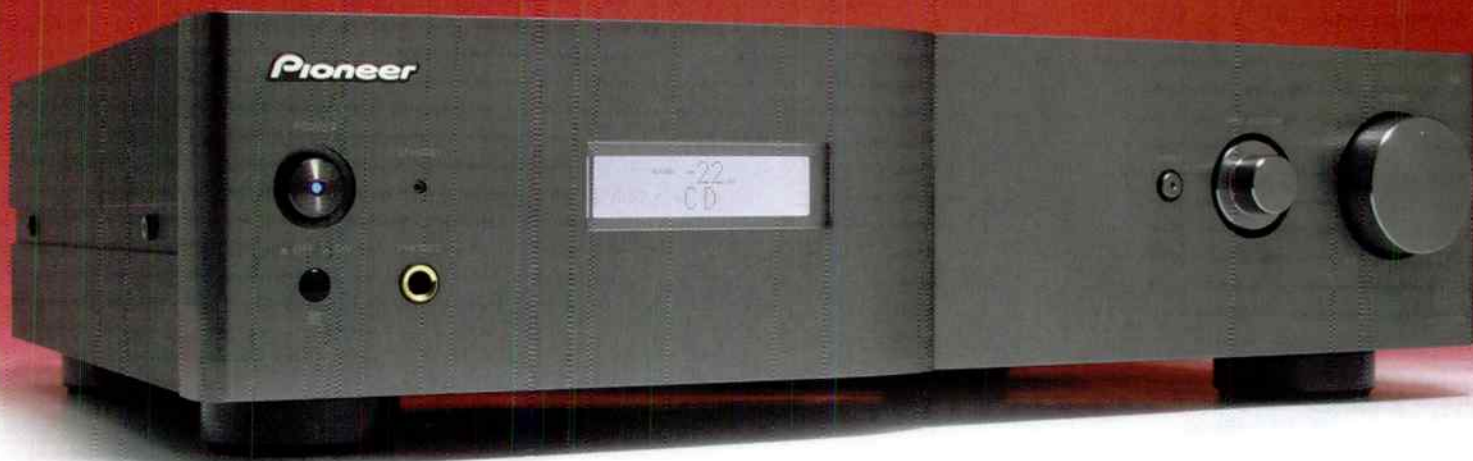

## PIONEER A-A9-J £550

**T**his amplifier oozes build quality, and has a unique 'step' that dominates the frontal area of the chassis – there, says the company, to break up sound waves bouncing back towards the case. The A-A9-J, weighing in at a sturdy 11.5kg and measuring 113x420x369mm, shows great attention to detail. For example, the chassis incorporates a particularly sturdy outer case including a rigid under-base with a stabilising plate and aluminium side panels. It also features an integrated Class AB dual mono symmetrical heart which is said to operate in pure Class A mode at low power, but then smoothly switch over to Class B when the power kicks in. This system is backed by twin toroidal transformers. After all of that, it's such a shame that the associated, plastic, remote control feels cheap and rather nasty...

Five inputs include a tape loop whilst vinyl fans will be happy to see a built-in phono amp that can support both moving magnet and moving coil. Digital fans will be happy to see a USB port – although it is situated at the rear. In conjunction with the USB port, the A-A9-J also features something called a Sound Enhancer which attempts to replace missing frequencies on a 'best guess' basis to improve the quality of MP3 tracks. Despite the amplifier, available in charcoal grey, offering tone controls, a Direct button allows you to bypass the lot to provide a more direct signal pathway. Other controls include a Pre-out, a control socket for other Pioneer products plus a front mounted headphone socket.

### SOUND QUALITY

Within Carol Kidd's swing jazz vocal, the Pioneer showed itself to be a brightly lit amplifier, although not a harsh one. There's a definite midrange lift that sometimes threatens to break out into more brighter tones. In fact, if the Spondors were not keeping the Pioneer on a controlled leash, then the amplifier may have proved harder to get along with. Yet, with the midrange lift comes a beneficial tonal clarity and enhanced transparency. If nothing else, the Pioneer's personality has to be carefully taken into consideration when choosing matching speakers – and the Spondors are of course an excellent choice. The same pronounced midrange effect could be heard with Can but, due to the group's high energy presentation, the clear yet slightly strident sound was magnified.

Moving to vinyl calmed the brighter tendencies a touch. Kate Bush's 'π' may have revealed a lack of lower bass control but it did show the Pioneer's great power. Yes, there was still a slight lifting of the vocal compared to the Cambridge and the A-A9-J didn't have the same delicate interplay of vocals and instruments of the Cambridge either, but what it did provide was a more visceral performance that reminds me of the Rotel. Also, despite the upper mid and treble being slightly shouty at times, you could hear the rasping of fingers strumming acoustic guitars and how the drums were bouncy and full of vigour. Playing Yes, on the other hand, pinned me to my seat with the sheer force of the Pioneer's, foot-tapping, performance. A full-on amplifier: what it lacks in subtlety, it makes up for in energy and detail.

### MEASURED PERFORMANCE

The Pioneer produces a modest 60 Watts into 8 Ohms and 80 Watts into 4 Ohms.

The amplifier's distortion pattern was consistent at all power levels, with low order second and third harmonics dominant; our analysis shows this pattern and with 0.03% at 10kHz the Pioneer is clean.

Channel separation was low at 30dB and noise high at -87dB when operating out of Direct Mode, poor results. Even distortion was a trifle higher, so the A-A9-J must be used with Direct selected but this cuts out a good set of tone controls that nicely trim spectrum extremes.

The phono stage has full gain down to 5Hz so record warps will produce cone flap. Otherwise, equalisation was accurate and noise low.

The Pioneer A-A9-J produces a good set of results in Direct mode. NK

Power	60 Watts
Frequency response	2Hz-130kHz
Separation	101dB
Noise (indirect/direct)	-87/102dB
Distortion	0.03%
Sensitivity	180mV
Damping factor	44
Disc	
Frequency response	5Hz-33kHz
Separation	62dB
Noise	-81dB
Distortion	0.04%
Sensitivity /O.L.	2.6mV/54mV

### DISTORTION

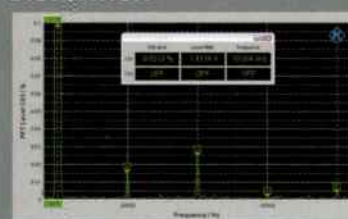

### VERDICT ●●●●

A transparent yet powerful amplifier, but demands careful matching to the right speaker for best results.

**PIONEER A-A9-J £550**

Pioneer

+ 44 (0)1753 789789

[www.pioneer.co.uk](http://www.pioneer.co.uk)

### FOR

- clarity and incision
- aesthetics and ergonomics
- features

### AGAINST

- brightly lit sound

## PEERLESS

QBD76  
D to A converter



**C**ould we produce a Digital-to-Analogue converter better than the award-winning DAC64? Yes. Taking performance to a totally different level with advanced features unavailable until now, the Chord QBD76 is in a class of its own.

Designed using latest generation FPGAs with 1.25 million gates, this 5th generation pulse array DAC is truly state of the art. Its new pulse array, 8th order noise shaping and 2608 times over sampling, plus new digital phase lock loop and highly accurate 115 MHz clock, mean that data-related jitter is removed - giving just 3 pico seconds of random clock jitter. Ergonomically, the microcontroller and display gives a clear indication of status, configuration and even frequency. Additionally, the new USB input enables connection to a personal computer so that music can be streamed directly. Uniquely, we have even included a high quality Bluetooth input allowing direct audio streaming from your mobile phone, PDA or laptop.

**CHORD**

Chord Electronics Limited

for more information  
T 01622 721444

E [sales@chordelectronics.co.uk](mailto:sales@chordelectronics.co.uk)  
W [www.chordelectronics.co.uk](http://www.chordelectronics.co.uk)

Hi Fi World Award Winner  
World Radio History



**T**his was a fascinating group test for more than one reason. Firstly, considering the low price and thus the low budget that each company had to play with in development and component choice, it was interesting to see and hear the differences within each amplifier. Not just in sound quality but in design and implementation. It was also quite obvious that, just because an amplifier is priced towards the lower end, it doesn't mean that the sound becomes homogenised. Each amplifier under test here was aimed at a particular market and a particular type of listener. I believe that, because of the steady and consistent increase in component quality, this sector has not only matured but the extra refinement seen on some models should be wholeheartedly applauded.

The Marantz PM6002 offered all the features you could expect, put together with care and attention. Relatively understated and not too flashy, the sound proved to be just the reverse. A real wolf in sheep's clothing, the Marantz when pushed both in volume and with high energy music, proved to be forthright and confident - even if it was a tad lacking in the music's finer details. A sterling job all the same - it's a good package at the price.

The Pro-Ject Pre/Power Box is a specialist amplifier requiring careful siting. Small in stature, this combo is ideal for use in a small flat or attic room where its excellent upper mid detail retrieval can work to its full capacity without it running out of puff. Its lack of bass response and power will necessitate careful speaker

matching, however.

The Rotel RA-06, like the Marantz, seemed civilised on the outside with a smooth and silky brushed aluminium finish. However, when music was pushed through it, the 'O6 became almost psychotic in its lust for energy, noise and a general wish to have a bloody good time. This is an amp that is capable of drinking you under the table and telling dirty jokes to your mother-in-law! Elegance and grace it has not - there's no metallic sheen to its cymbals and you

"the Cambridge 740A will delight anyone who is sensible enough to demo one..."

can't hear the thumb fall from one acoustic string to another, but what it does give you is its very heart and soul. It makes your foot tap so much that people will suspect that you have St Vitus Dance!

If the Rotel is an exuberant stage performer, then the Pioneer A-A9-J is your dentist. There's a measure of clinical transparency with this amplifier that makes you admire it but also, like most drill wielding types, makes you a little wary too. Especially when they try to uncover too much and they dig so deep they cause pain. That's what you have to be careful with when using the A-A9-J. Speaker matching is more important here than most. With the right match, the Pioneer can show you aspects of music that will amaze and astound you. Some might find the presentation a mite too clinical but others will enjoy the truth it beholds.

Icon's Audio Stereo 25 was unique in this test in offering a whole gang of valves. It also, arguably, offered the most natural sound of the entire test. There was so much air and space floating around the music when the Icon played that I had the urge to close all the doors and put my coat on. The soundstage for the Icon was large which encouraged the musicians to spread about a bit. The lack of lower bass however, is a valve trait but ideal if your neighbours are close by or live underneath you as well as

to the sides. Still - you'll have to run it with very efficient speakers.

The best value amplifier in this test, by far, was the Audiolab 8000S. Beautifully compact, in its slimline casing, the 8000S gives you just about everything you will need for a budget amplifier and, if it wasn't for its slight lack of fluidity when playing low-key jazz over vinyl, I may have been convinced to give it the top award.

However, that has to go to the Cambridge Azur 740A which, despite its horrible interface, walked away as the winner because it, well, sounded the best and, after all, that's what it's all about. That gentle combination of richness and mid detail, air and fragility in the treble regions along with solid bass power when required was an irresistible combination that will delight anyone who is sensible enough to demo one. A worthy winner.



**Audiolab 8000S - best value for money.**



**Cambridge Audio Azur 740A - best all round performer.**



Adam Smith spends some time in front of Epos's new ELS8 standmount loudspeakers...

# Straight Eight

**T**he market for neat and affordable compact loudspeakers is, and always has been, a buoyant one. Whether the end user is a student putting together their first system, a hi-fi enthusiast wanting some quality sounds in a second room in the house, or a surround sound aficionado looking for high quality rear channel loudspeakers, the budget standmounter will always have a place.

The latest challenger in this sector comes from a well known name – Epos. This company can trace its history back to 1983 and the original designs by Robin Marshall, but it has continued to flourish in recent years, turning out a variety of models that have combined fine performance with sensible prices. The ELS8 is the new arrival, designed to replace the well regarded ELS3, but improving on its smaller forebear in relevant places.

What this means in practice is a neat and well made compact loudspeaker, tipping the scales at 5.7kg and measuring 310x180x215mm. This is slightly larger than the ELS3, which Epos says gives better low end performance from the 5 1/4in (150mm) bass driver, featuring an injection moulded polypropylene cone and rubber surround. I note that Epos have added a bead of glue around the inner 'corner' of the surround roll to strengthen it and minimise the risk of any dips in the response due to cone breakup. This is an unusual move with a rubber surround, only usually being necessary with foam types, and it suggests the rubber is thin, which keeps moving mass low, helping sensitivity.

Above this is a 25mm magnesium alloy dome tweeter, developed specifically for the ELS8 and featuring a neodymium magnet and fine mesh protective cover for minimal sonic

intrusion. The cabinet is neatly styled and available in a choice of light maple or black vinyl finishes. A pair of grilles on injection moulded plastic supports that follow the contour of the baffle are provided, and Epos recommend that the ELS8s are used on a pair of stands 50-60cm high, such as their own ST35 types, positioned not less than 8in (20cm) from a rear wall.

## SOUND QUALITY

Appropriately positioned atop my Atacama Nexus 6 stands and suitably run in, I sat back to take a listen to the ELS8s, wondering what my initial reaction might be – all too often I find that the first bars of a track played through an affordable loudspeaker can be a make or break moment. It so happened that my first choice track featured a female vocalist, and I have to say that I was very pleasantly surprised by the voice sat in front of me, offering fine scale



and parked nicely between the loudspeakers.

The midband of the ELS8s proved an area of success. Not only were vocal performances well balanced, nicely judged and blessed with just the right amount of air and space, but instruments turned out to be just as well rendered. Acoustic items had a good sense of accuracy and electronic items came through with the right amount of detail to make it clear whether an original analogue synthesiser was playing, or one of those new fangled digital things. Atmospherics were well judged and the Eposes set up a convincing wall of sound across the front of my room, albeit a fairly compact one.

At the bottom end, the ELS8s continued to fare well. Their low end, although obviously not digging the real depths, offered a good sense of punch and impact and I never found them becoming confused or tangled by a complex tune. One concern that did arise however, was that it did not take too much provocation for the bass drivers to signal the fact that they were reaching the limits of their travel. A Jazzanova drum and bass track I often spin to check handling of low bass and fast rhythms had the ELS8s sounding uncomfortable at what was quite a moderate volume [pardon? Ed.] Fair enough, I suppose, as these aren't designed for big rooms – but still headbangers need not apply...

Across the upper bass and lower midrange, the slight lift in output visible on the frequency response graph added body to performances and, once more, left no stone unturned in the quest to bring all the necessary information from the disc or record being spun. Bass guitars were lithe and well balanced, and the ELS8s gave a fine rendition of Charlie Haden's acoustic bass on 'The Private Collection'. I could also not help but be pleased by the ELS8s sense of neutrality – they never seemed to favour any particular type of music over another, turning a genuinely consistent performance as I wandered through rock, jazz, classical, ambient and some heavy metal for good measure.

All good then, except for the feeling that something was not quite gelling for me. In the treble, the ELS8s have something of a curious balance to my ears. Whilst the sharp rise in output towards 20kHz meant there was no sense of dullness or muddle, the broad but subtle 'trough' in

the frequency response below this [see MEASURED PERFORMANCE] meant that high frequency detail was slightly lacking. Cymbals were missing out on the precision that such items are usually blessed with. The leading edges of strikes were blunted and delicately tapped hi-hats wandered off into the background of the music to become an indistinct event. There also seemed to be a peculiar underlying sense of 'hiss' whenever a percussive instrument was hit, tapped or brushed at times.

Still, my main problem is that the ELS8s sound a tad emotionally sterile compared to rivals such as the Usher S-520s. Whilst no one would expect a £250 standmounter to give the most emotive performance in the world, the fact remains that some of those classic models I mentioned earlier certainly never failed to engage, no matter what their other shortcomings may have been. Listening to the ELS8s I did not find myself as immersed in the performance as I'd have liked.

**CONCLUSION**

To my ears, the Epos ELS8s are something of a mixed bag. On a purely technical level, they have many impressive qualities, namely a well detailed and nicely atmospheric midrange, good low end impact for their size and a fine level of low and mid frequency detail. However their treble has a certain lack of detail and I found them musically uncommunicative. In this hotly contested area of the market, it is possible to find designs such as the B&W 686 and Acoustic Energy Aegis Neo I which offer just as much of a 'correct' performance, but also grip on an emotional level and draw you into the music. Personally I think this is the sign of a top budget loudspeaker and, for me, the Epos ELS8s fall a little short of the best.



**NOEL SAYS**

With a good past reputation I was keen to hear these latest Epos 'speakers. I found their treble quite distinct and at times sharp edged due to the top end peak, which was surprisingly obvious. The mid was very clear and the balance quite a full one overall, albeit tinged by some boxiness. As Adam says the ELS8s do have a slightly cold quality about them that's a little unengaging. But they are certainly quite fast and punchy though, and I feel this is the sort of box that will divide opinion strongly, so some may rate them higher. I waver between three and four globes! NK

**VERDICT**

Neatly engineered and neutral sounding, the ELS8s are steady performers, but lack engagement on an emotional level.

**EPOS ELS8** £250  
**Epos Acoustics**  
 +44(0)1442 260146  
 www.epos-acoustics.com

**FOR**  
 - clean and solid midrange  
 - good rhythmicity

**AGAINST**  
 - indistinct treble  
 - emotionally unfulfilling  
 - limited loudness

**MEASURED PERFORMANCE**

The ELS8 has a distinctive two part response shape with a smooth plateau of output from 120Hz up to 1.5kHz and, above that, another smooth plateau up to 9kHz that is a few dB down. This is unlike most modern loudspeakers and suggests a fairly easy going sound with good body to it, although no edginess. A roll down above 9kHz should keep treble from sharpness, although a supersonic lift above 18kHz may be detectable at times, with material possessing energy at that frequency.

Short and long term decay spectra showing drive units and cabinet respectively were very clean, suggesting low colouration. Although the port outputs cabinet noise it is rear facing and loses it backwards. Distortion measured less than 0.2% above 100Hz, a good result. Bass distortion was low from the drive unit, no more than 2% down to 20Hz. The port hovered around 4% below 50Hz, again low, so the '8 will have clean bass.

Bass output rolls down slowly to 70Hz then steeply below that. This is a slightly over damped response suitable for near wall use. The port peaks at 38Hz and being +9dB above forward output may well give low bass presence. Often, loudspeakers like this need amps with some shove to get them sounding lively, but they give fast sounding bass. A high overall

impedance of 8.3 Ohms helps toward a low sensitivity figure of 82dB and this again militates for power, at least 60 Watts being a likely figure. The load is very reactive too so amps may react quite differently to it.

The ELS8 is very nicely engineered and should give a svelte sound that is both easy, natural yet tight and punchy, but it needs a powerful amplifier. NK

**FREQUENCY RESPONSE**

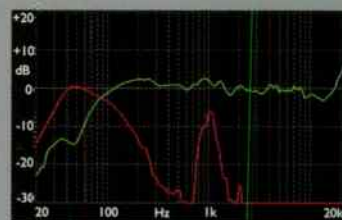

Green - driver output  
 Red - port output

**IMPEDANCE**

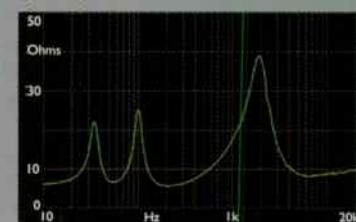

# Servo Charged

**Following the success of its CD8 SE CD player, Cyrus has extended its 'Servo Evolution' mechanism platform to a CD transport - the CD Xt SE. David Price listens in...**



**"O**ur project has been a massive undertaking for a specialist like Cyrus but we now have a unique and valuable platform on which to build better CD players", said Cyrus's Peter Bartlett, just before the CD8 SE was launched late last year. And true enough, so the company's stand-alone CD Xt transport has duly got the Servo Evolution treatment...

Whilst I rate the 8SE very highly – it's certainly one of the most convincing silver disc spinners under £1,500 – finding out about Cyrus's Servo Evolution project immediately had me wondering about the implications of putting the new mechanism into a separate transport. Why? Because what the world needs now, in my opinion at least, is a great compact, affordable transport.

Regular readers will know I am a huge fan of Esoteric's silver disc transport design prowess – their optical disc readers are impeccably engineered, stable and serviceable. Feeding something like a high end Chord QBD76 they are breathtaking, and good enough to make me rethink my latent anti-Red Book tendencies. But you can expect to pay many thousands for such a thing, taking them out of the real world. The Cyrus CD Xt SE however, costs just £950 and – if the transport section of the CD8 SE was (is) anything to go by – has the potential to offer almost as much performance at a

fraction of the price. Well, that was my theory, any way...

I've been a supporter of these new generation of Cyrus silver disc spinners for the simple reason that they are not merely reheated generic mechanisms bought in from outside, stuck in a pretty box and given an ambitious price tag. Cyrus actually spent over one hundred thousand pounds they say, developing this from the ground up. As such, you're not going to get another piece of 'cut and shut' engineering; it's been designed to work for real time reading of Red Book CDs, and most certainly was not a DVD-ROM drive in another life!

Peter Bartlett takes up the story. "The brief was to make the best CD platform possible. Our goal was to overcome our dependence on the mass produced OEM CD drive kits all hi-fi manufacturers have used since CD was invented. We know this to be the most limiting factor in player performance and so wanted to develop our own 'made for high-end audio' CD engine. This enormously complex project is beyond the financial and technical abilities of most hi-fi specialists and of limited value for large producers. However Cyrus has a uniquely qualified engineering team who have the experience and skills to develop optical drive systems."

He adds that, "realistically, all engineering is a compromise and OEM CD kits will be designed for the biggest customers, never the specialist hi-fi industry. It is likely

that OEM kits have been engineered for in-car or low cost boom box markets. Obviously these kits will be engineered with a very wide production tolerance and for use in a variety of challenging environments and not for highest quality audio. The new SE platform is quite different because it is specifically engineered to retrieve data from an audio CD with the fewest errors. It is engineered to provide the ideal data output for hi-fi and because Cyrus controls the whole electro mechanical servo system and we have engineered the SE system to provide much better quality audio than has been possible with conventional drives".

The SE package calls for a carefully specified front disc loader (no wobbly plastic tray is used), a specific laser, bespoke motors and most importantly, the software that controls them. Written in house, this is designed to eke out every possible bit of data, rather than designed to be stable under movement (i.e. for in-car use) or to have super-fast access (i.e. budget mass market machines). The servo software is the bit that controls the loader, laser, sled and motors that position the light beam – and the key to the mechanism's efficacy. The result is twenty percent fewer read errors than the Philips based CDM 12 mech used in the old CD Xt (and many other transports and players), Cyrus says.

The idea is that because the system reads 'right first time', less error correction is called for, and missing information doesn't have to





be re-read as much as conventional OEM transports, causing less servo action and thus lower drain on the player's power supply. "Power supply ripple is very low compared to normal players", Bartlett claims. Also, a precision quartz reference anti-jitter circuit keeps the datastream from the mech in check, as our measurements show [see MEASURED PERFORMANCE].

Servo Evolution mechanism aside, the CD Xt SE is a standard Cyrus 'shoe box', which is no bad thing. Made from beautifully diecast magnesium alloy, it measures 78x215x360mm and weighs 3.5kg. Round the back is the Cyrus MC-BUS System bus connector, plus the familiar Cyrus PSX-R power supply upgrade option socket and a single coaxial digital output. A crisp LC display sits in the middle of the front fascia, with switchable green backlighting. Disc operation is smooth and silent, and track access fast – unlike so many ROM-based CD mechanisms. Some people have reported trouble reading discs, but I have had no such problems either with the CD8 SE or this Xt SE transport-only variant, so this is something of a mystery to me. Overall, I found it a joy to use, apart from perhaps the slightly fiddly buttons...

### SOUND QUALITY

Allied to the excellent Stello SA100 Signature DAC, I found the Cyrus transport to be all I had hoped for.

Having done extensive comparisons with my own £5,000 Sony CDP-R1 transport and the CD8 SE last autumn, I was aware that the SE mech was capable of holding its own in exalted company – and as I'd hoped, the transport version was better still...

First things first. The Cyrus SE transport does *not* give what so many love about high end Japanese transports such as the Sony – namely a bass that sounds like it is hewn from the rocks just off Crackington Haven beach, that switches on and off like an LED light. This is the one area that justifies you spending your tens of thousands of pounds on an Esoteric P-01. Compared to such high end delights, you'll find the CD Xt SE's low end just a little softer and lighter, but that's only to be expected considering the price differential.

However, in most other respects, the Xt is not far off – which is to say that it sports a tuneful low end, a wide open treble and in-between is a highly expansive, even and detailed midband that flows in a wonderfully

most modern high end transports sound like the audio equivalent of a heavy fog, that is saying something – the Sony is forensic in extremis, and the Cyrus is only a little less intricate.

For example, Empire of the Sun's 'Walking on a Dream' may be a fine modern pop song, but it is not state of the recording art; the usual gripe about compression applies, and there's a lot of grit to the song's tonal balance too. On lesser transports, including the similarly priced Stello CD-T100, this hard upper mid takes over the song, and makes the whole track strident and almost unlistenable. The high end Sony transport pulls back from this, accentuating the bass and pushing those hard vocals back in the mix slightly, but still they remain acerbic. The Cyrus lightened the bass off a touch compared to the Sony, but almost pushed 'beyond' that steel to reveal the track's catchy rhythms. In a way, I would say that whereas the Stello was destructive and the Sony deconstructive, the Cyrus was reconstructive! In this sense,

"what the world needs now, in my opinion at least, is a great compact, affordable CD transport..."

organic way. Indeed, compared to my reference Sony, it is actually more tuneful – which is really saying something – if a little less precise. And given that the CDP-R1 makes

it reminds me of the classic Linn LP12 turntable – the Cyrus's innate musicality always accentuates the positive, and doesn't suffer from analysis paralysis, when the whole

# isoTek®

www.isoteksystems.com

## The best sub-£300 mains conditioning product on the market

*"Excellent value for money...  
A great real-world product that's  
useful and inexpensively  
upgrades your system"*

HI-FI WORLD

*"We would not hesitate to  
suggest the Sirius as an  
effective upgrade for  
any system"*

HI-FI CHOICE



IsoTek Sirius featured with Supreme power cable



IsoTek is committed to the creation of truly cutting edge designs through the development of unique proprietary technologies. Every product is designed and developed in the England and hand assembled in their factory in Hampshire.

Only the finest quality components are used, and many of these are uniquely developed and built to 'Ministry Of Defence' specifications.

IsoTek has consistently established a class leading reputation, a fact that has been proved by numerous reviews throughout the world and over 25 industry awards.

For your free brochure, or to locate your nearest dealer please call Sound Fowndations on 01276 501 392.

## Sound Fowndations

Tel: 01276 501 392 • Mob: 07789 307 619

E-Mail: sales@soundfowndations.co.uk • www.soundfowndations.co.uk

www.isoteksystems.com



song is spoiled as the player obsesses on telling you how bad the recording is. It is euphonic, but only in the way that it lets you into the music, rather than tripping over its tail trying to give you the detail.

This in no way means the Cyrus is a big fluffy cloud of a machine – by the standards of the transport in almost any £2,000 CD player for example, it is amazingly intricately detailed, yet frames all this information together in a particularly musical way. I found 4hero's 'Morning Child' (a far better quality recording than Empire of the Sun) to be bristling with air and space. The CD XT SE once again unlocked a whole extra layer of the recording compared to the Stello, as if you were no longer on the outside looking in. I was taken aback by the tonal richness of the cor anglais, the delicacy of the singer Carina Anderson's voice and the power of the percussion was a joy. By contrast, the Stello sounded like it was being paid by the hour on minimum wage rates. The Sony was majestic too, giving an even more dimensional sound with a stronger and more insistent bass, yet even though it was superior in 'hi-fi' terms, I am not sure if I enjoyed the song any more; in fact I think the Cyrus might have just swung it.

Steely Dan's 'Aja' showcased this transport's expansive sound; it is very wide left to right, with very accurately located instruments within the soundstage. Again, in absolute terms the CD Xt SE lacks just a touch of front to back space; rather like my Michell GyroDec turntable it tends to hang instruments near the plane of the speakers or just in front, but doesn't drop back too far from that. Again, this is a recurring theme with CD players, and you don't really lose this until large amounts of money are lavished. The Sony delivered a better proportioned soundstage with a good deal more, but the addition of a PSX-R power supply to the Cyrus brought the gap down a fair way. Indeed, the PSX-R has a very positive effect, but in a subtle way.

This external DC Power supply plugs into the back of the CD Xt SE transport, and allows it to tap into a large reserve of highly regulated DC energy. It provides a completely separate power feed for the high current demands of the transport's mechanism



Only basic optical and coaxial digital outputs on the back; bottom right is the socket for the optional PSX-R external power supply.

drive motors, meaning the PSX-R effectively removes the dynamically changing load of the motors from the internal power transformer. The most obvious improvement is soundstaging, but there's also a stronger and firmer bass, an even smoother treble and sharper midband focus. It was a subtle improvement, but all the same very worthwhile considering the £500 price premium.

By the standards of other similarly priced transports, the Cyrus CD Xt SE had a wonderfully open and sweet treble, but in outright cost-no-object terms it was just a little diffuse and imprecise. Again, this was made all the better with the PSX-R, which added insight and ambience which I really helped me enjoy my Deutsche Grammophon disc of a 1972 recording of Vivaldi's 'Four Seasons'. PSX-R or not though, the string tone was superb and the recording flowed beautifully – making classical music actually rather enjoyable from digital disc, when I normally find the reverse is true.

**CONCLUSION**

It would be easy for me to celebrate the Cyrus CD Xt SE's brilliance by comparing it just to another highly capable price rival such as the Stello, but

so good is this transport that I had to put it against one of the best machines I've heard – the Sony CDP-R1 which would be retailing now (were it still available) at ten times its price. In this context, the Xt SE came over as a little light and soft in the bass, a touch opaque across the high treble and lacking slightly in depth perspective – yet it was actually more fun to listen to and more musically cohesive. Adding a PSX-R power supply effected subtle improvements across the board, taking it closer still to the Sony without sacrificing that lovely musicality.

As such – either with or without the PSX-R – this new £950 transport represents brilliant value for money. It gives a close-to-high end performance at a price nowhere near the best modern silver disc transports. It's another great product from Cyrus, and I would suggest a possible future cult machine, offering as it does a slice of the digital high life on an everyday budget.

**REFERENCE SYSTEM:**  
 Sony CDP-R1 CD transport  
 Stello CD-T100 CD transport  
 Stello SA100 Signature DAC  
 MF Audio Silver Passive Preamplifier  
 World Audio K5881 power amplifier (modified)  
 Yamaha NS1000M loudspeakers

**MEASURED PERFORMANCE**

The Cyrus transport outputs digital via a conventional S/PDIF link, through both optical and electrical connectors. Signal related jitter in the digital stream can be seen in our analysis where the residual from a 1kHz -60dB tone can be seen with a level of 45pS at 1kHz and other related components remain below 10pS or so. The jitter residual from the -60dB tone is about as low as it gets, so the Cyrus transport is as clean as can be reasonably expected. Random jitter from hum and clock noise etc., was very low, lower than 5pS on peaks. Checks were made of sample rate and to ensure linearity wasn't compromised by factors such as noise. Bandwidth extended to 21kHz a sweep into our

Rohde & Schwarz UPV digital analyser showed, fixed tones (shown) giving a perfectly flat result as expected, with distortion measuring 0.019% - as low as it gets. So the Cyrus CD Xt SE gives a fine set of results as a transport and works very well. NK

**JITTER**

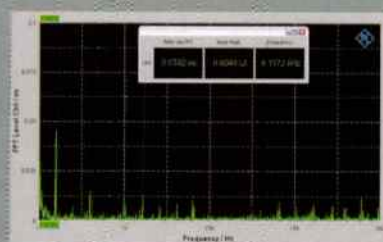

**VERDICT**

Brilliant value audiophile CD transport with high end sound at an affordable price! Surely a future classic.

**CYRUS CD XT SE £950**  
 Cyrus Audio Ltd  
 +44 (0) 1480 435577  
 www.cyrus.co.uk

- FOR**
- super fluid, musical sound
  - tuneful bass
  - insightful midband
  - design, build, upgradeability

- AGAINST**
- nothing at price

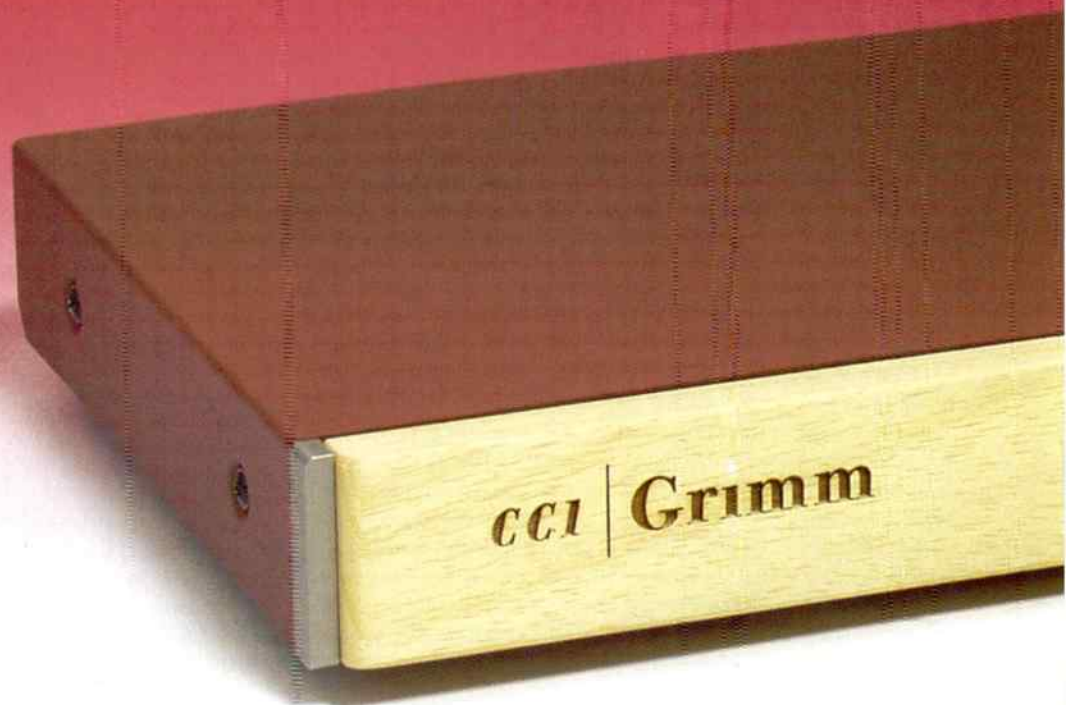

# Clock Wise

**Separate, standalone master clock units are popular with Japanese high end digital audiophiles, but few such products have made it to Europe. However, Grimm Audio's CC1 looks set to change that, thinks Tony Bolton...**

**A** Compact Disc player's master clock is key to unlocking its performance potential. Responsible for ensuring accurate digital processing, although a good one doesn't guarantee it will sound great, a bad one means it can never even sound good. The trouble is that different machines come with different clocks, and some are not as good as others. To this end, companies such as Trichord and Audiocom have stepped in to offer aftermarket modifications to CD players, replacing their standard chips with altogether more highly specified designs, often with great success.

Recently, and especially at the high end, some CD (and SACD) players have come fitted with bespoke external clock sockets. Whilst they come with a decent clock as standard (of course), the option of fitting a better external digital clock is there to users should they so wish. This has become something of a custom of high end Japanese audiophiles who recognise how important clocking is, knowing that timing fluctuations (i.e. jitter) damage sonic performance, causing

an opaque and often hard sound.

The professional heritage of the CC1 clock unit is clear to see, with its standard rack-mount size of 434x220x55mm, but you are not presented with an uncompromisingly industrial looking piece of equipment. The fascia is grained and polished wood, with small chrome plated buttons, discreetly placed beside each logo for source and sampling rate selector. At the back are 16 BNC sockets, divided into two groups. Dip switches control the behaviour of the relevant group altering impedance and mute options. BNCs 11 to 16 can also be adjusted through 180 degrees to correct phase anomalies. There are also two XLR sockets marked AES 3 in and out. These are intended for connection to studio master clocks. It's unlikely that any domestic user is going to need more than a couple of these sockets, since most digital equipment has no facility for connecting to an external clock, but players from Esoteric and dCS,

amongst others can make use of this, as well as some digital loudspeakers.

## SOUND QUALITY

I started my listening using the onboard clock on the Marantz SA-7 and was very impressed with the sound emanating from the Chario Ursa Major loudspeakers. It was detailed, well defined, and smoothly presented. Imaging was amongst the best I have encountered from a digital source, not quite achieving the holographic qualities that I would expect from an equivalently priced vinyl player, but very impressive all the same.

Engaging the Grimm Clock was easy. Just plug the BNC lead into an output from the Grimm and plug the other end into the player. In this case, selection of internal or external clock is controlled by a button on the front of the SA-7. After pressing it, there was a pause in the music while the Marantz locked onto the signal, then the music continued to flow.







The first difference that I noticed was the alteration on texture of sounds. Everything seemed deeper and more detailed. Playing Saint-Saens Organ Symphony on SACD with Ormandy conducting the Philadelphia Orchestra, and Michael Murray at the organ took me by surprise. This piece has fairly complex instrumentation, with pianos joining the organ and orchestra at certain points in the last movement. A lot of players can get a little lost in this, leaving the listener with a jangly, almost 'pub-piano' sound overlaid across the rest of the instruments. The SA-7 on its own gave a good rendition of this, but the addition of the Grimm Clock improved the focus and definition to the point that I was sure I was listening to a pair of good quality grand pianos, not the cheap upright alternative. Other major improvements to the sound were a greater sense of background ambience, and a superior feeling of the space in which the performance took place. Linked to this was a far greater sense of the scale of music.

Artur Pizarro's solo piano, playing Beethoven's 'Pathetique Sonata' displayed the different shades of tonality that this instrument is capable of. The decay of notes hung in the air, drifting to silence, whilst the hard struck chords had a resonance and impact that outstripped the already good performance of the SA-7 in this area. Using the right hand

button on the Grimm to multiply the base sampling rate by 1, 2 or 4 times produced further increases in resolution, stereo separation noticeably benefitting from this. I found that I was focusing more on the music than the equipment, something that rarely happens when I listen to digital. I felt that the whole spectrum of the sound improved with the CCI connected. Timing was tighter, imaging more focused, and definition improved, making for a more musically coherent experience.

At £1999.95 this is not cheap, but there is an obvious improvement in reproduction when it is used. If your player is equipped with suitable connections to allow the connection of an external clock, then I would certainly recommend investigating the option. I doubt that

"I was focusing more on the music than the equipment, something that rarely happens when I listen to digital..."



The Grimm is designed to work with CD players that have a master clock input, such as this Marantz SA-7.

you will be disappointed with the result.

### MEASURED PERFORMANCE

The Grimm clock was fed heavily pre-jittered digital test signals from our Rohde & Schwarz digital generator, via its AES balanced input. It proved able to handle 5nS of broadband jitter - a grossly jittered signal - and eliminate jitter completely. Shown in our analysis is a more realistic 200pS of jitter at 1kHz fed into the Grimm clock (green trace). Output of the clock in the yellow trace shows the jitter element has been completely eliminated, showing that relocking via AES is effective. It's random jitter output is as low as

possible too, so this unit does its job well. NK

### JITTER SPECTRUM

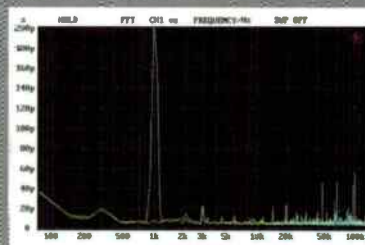

### VERDICT

Excellent, if highly specialised, product for high end digiphiles that can return real performance gains.

**GRIMM AUDIO CC1** £1,999.95  
**Sound Hi Fi**  
 +44(0)1803 833366  
[www.soundhifi.com](http://www.soundhifi.com)

**FOR**  
 - sound quality gains  
 - technical efficacy

**AGAINST**  
 - only some CD players can benefit from it

# enjoy yourself



**2008 Award Winner**

## Pioneer

**PDPLX5090** 

**BDPLX71**   
Including free QED HDMI lead

**Please call for the latest Prices**  
Includes free delivery

## Monitor Audio

**Platinum Ex Dem Please call**



EX DEM Gold Silver and Bronze also available.

## Monitor Audio

**New Radius HD Range**  
All models in stock  
Call for latest prices.



## AV Receivers

**SAVINGS**

  
**Yamaha RXV1900 £849**

  
**Denon AVR2809 £799**

  
**Marantz SR6003 £699**

  
**Pioneer VSXLX51 £695**

  
**Onkyo TXSR876 £649**

## ARCAM solo mini special pack



**Please call for special price.**

Purchase the Arcam Solo mini, Arcam Muso Loudspeakers and the Arcam rdock at our special price.  
Price including free next day delivery

**2008 Award Winner**

## Yamaha

**CD S700 £299** 

**A-S700 £399** 

Price includes free delivery.

**Check our website for the latest 2009 savings**

Linn, Arcam, Marantz, B&O, Bose, Chord Electronics, InFocus, JVC, Monitor Audio, Mordaunt Short, Pioneer, RE, Roksan, Sim2, Tannoy, Teac, Tivoli, Velodyne, Yamaha. Plus many more



6 Abbey Street, Carlisle, Cumbria. CA3 8TX  
Telephone 01228 546756  
[www.petertyson.co.uk](http://www.petertyson.co.uk)  
Email [sales@petertyson.co.uk](mailto:sales@petertyson.co.uk)  
Open Monday-Saturday 9am-5.30pm



153 Kenton Road, Gosforth, Newcastle. NE3 4NQ  
Telephone 0191 2857179.  
[www.newcastlehifi.co.uk](http://www.newcastlehifi.co.uk)  
Email [mark@newcastlehifi.co.uk](mailto:mark@newcastlehifi.co.uk)  
Open Monday-Saturday 10am-5.30pm



# Bar Extension

Despite the demise of the iPod Hi-Fi, the range of iPod dock music centres makes for an incredibly crowded field. Orbitsound have several offerings, of which the T12 is the flagship. Patrick Cleasby asks if it can match the big beasts of Bose and B&W...

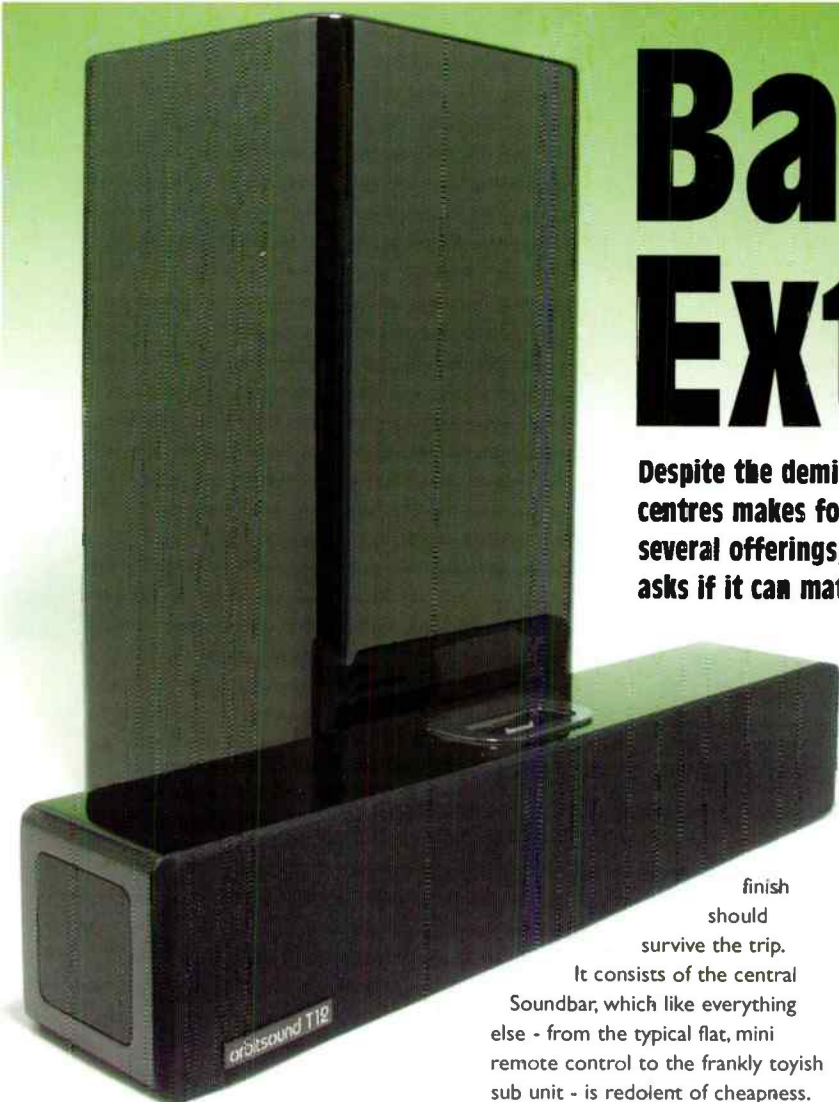

finish should survive the trip.

It consists of the central Soundbar, which like everything else - from the typical flat, mini remote control to the frankly toyish sub unit - is redolent of cheapness. A laptop-type mains transformer is supplied, plugging into the rear of the Soundbar, which has a simple on/off rocker switch. The sub is passive and therefore not powered. Somewhat ridiculously, the cabling for the sub is frail, cheap speaker cable, with soldered bare ends which drop off at the merest provocation.

Obviously, the primary function of the T12 is intended to be iPod docking, and thankfully the indentation for the dock connector on the top of the Soundbar, accepts the standard iPod adapter as supplied by Apple nicely. The supplied remote performs basic iPod control functions, but if you use the controls on the iPod itself it is not necessary to have the remote in hand as there is a rear mounted rotary volume control.

The interesting second possible usage, as suggested by press photography for the T12, is to route one other analogue source into the Soundbar, most obviously a television. For this usage you will need the remote control, as input switching is not possible on the unit itself. Bizarrely there is no provision for a digital input, and despite the promise of the 'Stereo Wide' Airsound system (which reminds one of the ghetto blasters of the eighties), there is no capability of processing any such new-fangled delights as surround audio.

From the Bose Sounddock to the B&W Zeppelin via the late, unlamented iPod Hi-Fi, there has been a stream of supposedly genre-busting arrivals on the Apple music scene, with much tat being available to snare the unsuspecting punter too...

Orbitsound's top of the range offering, the T12, does have some claim to being unique however, as it touts their 'Airsound' technology as the ideal way to get a decent stereo separation from one of these single point sources, using ingeniously side mounted speakers [see [www.orbitsound.net](http://www.orbitsound.net)].

The T12 is a pairing of a piano black 'Soundbar', with the distinctive 'Airsound' speakers at either end of the cuboid unit, with a similarly finished sub unit. At the time of launch it was priced at a dangerously daring Bose/B&W competitive £350, but has now dropped to a more reasonable £250, sometimes appearing to be offered at £200 on the web.

The package is slightly too large to wrestle home on the bus, so take the car if you're going to buy one. The parts are all robustly boxed in separate internal compartments, so the reasonably attractive piano black

The one remaining 'back of the box' widget is the Airsound switching itself - a three-way switch moves between off, on and wide. This takes us on to listening. Due to the TV usage suggestibility, my first pass was to hook up the analogue outs of a Sony LCD TV and watch '24' via the T12 with Airsound 'On'. The experience was a pleasant one, with voices being clear and audible, and the overall presentation being well balanced and nicely expansive (in Stereo mode at least; I found the 'Wide' position spatially unconvincing).

There was one exception however, as the subwoofer does not develop a convincingly sub-like bottom end, and the bass it does produce sounds light, ill-defined and echo-ridden, and does not blend well with the more hi-fidelity sounds emanating from the Soundbar. This finding was only reinforced once I moved on to iPod listening using a 160GB 6G iPod in the dock. The energetic Tears For Fears B-side 'New Star', which is normally an emphatically tight pop song, sounded a tad flabby in the bottom end as the TV listening had suggested it would do. Compared to the likes of the tighter, tauter B&W Zeppelin or even the Kicker ik500, this makes the T12 an unconvincing proposition for serious music listening.

## CONCLUSION

The Orbitsound T12 Soundbar looks the part underneath a similarly styled TV such as a Samsung, and does a nice job of improving lacklustre TV sound. But any push towards music TV or musical iPod listening will highlight the diffuse and soft bass from what is a poor passive sub unit with insufficient crossover tuning or flexibility. Worth investigating if TV is your primary intended use, but make sure you get a proper demonstration.

## VERDICT ●●●£

An interesting design with an attractive, expansive sound but suffers from poor subwoofer integration.

**ORBITSOUND T12 £250**

Orbitsound

+44(0)8456 521 219

[www.orbitsound.com](http://www.orbitsound.com)

## FOR

- smart looking
- simple operation
- TV application
- iPod integration

## AGAINST

- questionable build
- subwoofer integration



# Interstellar

**Simaudio's Moon i3.3 is a great sounding and versatile integrated amplifier, says Andrew Harrison...**

**P**erhaps now more than ever, an expensive hi-fi acquisition has to work hard to justify its position. Not only do we have so many more domestic distractions competing for our disposable income, but the wherewithal to invest in quality audio may be reduced as we tighten our belts to weather the financial squall.

Some purveyors of fine audio hardware, such as Simaudio of Quebec, are responding to the worldwide downturn by designing more affordable, higher value products. There are cheaper entry-level products planned for this year by the Canadian company in the shape of the .5 Series; but Simaudio has already lowered the entry price to its high-end production line with the Moon 3.3 Series, launched late last year.

In the case of the Moon i3.3 integrated amplifier here, Simaudio can be seen to be incorporating some useful and important facilities into the box. As a starting point, the Moon i3.3 is a traditional 100W integrated line amplifier, housed in a relatively modest full-width chassis, with remote control of source and volume and a large digital display to

give some feedback of its operation. But to the core amplifier can be added three upgrades, either at time of purchase or later as funds or needs expand: a balanced XLR line-level input, a combined moving-magnet/moving-coil phono stage and a digital-to-analogue converter.

The base model already includes five line-level inputs – four traditional RCA inputs through the rear panel, plus another input from the front via a 3.5mm mini-jack. The latter is a concession to modern playback needs, giving easy access for connecting a portable music player such as an iPod.

The DAC option is especially interesting as it makes the Moon i3.3 a one-stop solution for incorporating several digital audio sources into your system with the minimum of fuss. Four separate digital inputs are available – two S/PDIF on coaxial phono, one on Toslink optical, and a USB digital audio input. With the help of that DAC board option it's a cinch to make the amplifier a centralised hub for listening to the sound of, say, a CD transport, DVD player or DAB radio, a games console, a TV set-top box, and a desktop or laptop computer.

In contrast to some of Simaudio's

more established models, such as the Moon Evolution Series, or even the eye-catching 5.3 series units, which all make use of weighty alloy case architectures, the new 3.3 range takes a rather conventional looking outward design in slimmer lightweight boxes. Presently there are two models, a CD player – the Moon CD3.3 – featuring an extra external digital input; and this Moon i3.3 100W integrated amplifier.

The Moon i3.3 is reasonably purist in its options, leaving out such fripperies as balance, tone and input level matching, although on the front panel can be found a useful array of controls nonetheless. Most important is the right-sided volume knob, in this case in charge of a real potentiometer behind the fascia rather than a rotary encoder. Adjacent to this is the 'MP In' input for MP3 player, and a 1/4in headphone jack. To switch input, there are two Input buttons labelled '<' and '>', allowing you to cycle through available inputs – which will vary of course depending on which of the three add-ons you may have installed inside. Our review sample was fully loaded, giving an impressive total of ten inputs when you include the front iPod access.

Contrary to the promise of





the user manual, I couldn't get any numerical indication of volume setting on the big red LED display. This was especially disappointing as the marker notch on the volume knob of the black-finish amp tested (also available in natural metal silver) proved difficult to see from across a room. So in effect, volume changes had no visual feedback when turning by remote control.

What the big red digits can tell you is the sample frequency of digital bitstreams fed in via the onboard DAC. The card is specified as capable of handling the usual PCM formats of 16-to-24bit audio, at sample frequencies from 32kHz up to 192kHz, thanks to a Burr-Brown PCM1793 integrated DAC/digital filter chip. In practice it will be seeing 16/44.1 from CD-sourced music, up to 24/96 from computer audio. You'll be lucky to find anything that can output digital beyond 24bit 96kHz resolution on a single digital cable.

Turning to the amplifier's back panel we have an orthodox layout of RCA phono sockets for line inputs, plus two pairs of phonos for audio output. One is fixed-level for sending analogue audio to a tape recorder, the other variable and proportional to the amp's volume setting. The obvious application for this facility is for bi-amping. Nearby SimLink jack sockets are not so much for finding Darwin's missing link as syncing control of Simaudio separates. With a cable linking a Simaudio CD player and amp for instance, pressing play on the CD player automatically switches the amp to its CD input. Nothing revolutionary here, but a potentially useful aid for the system in a family setting.

Speaker connections are made to heavy-duty WBT style clear plastic

"smooth, controlled and unflustered, it's a high end contender packed into more modest clothing..."

shrouded terminals. These will happily take a single pair of 4mm plugs through the centre but you'll have to be more careful if you intend to bi-wire with a second set of plugs at the amp end. You can unscrew the terminals and insert plugs vertically but – on the amp's right side at least – your speaker leads will foul with the 'CD' and 'AI' input phonos.

Overall construction is relatively lightweight, but the case feels stiff and well-braced, thanks to the extruded side heatsink panels. These take care of waste heat from the power amp's output bipolar transistors (two pairs a side) and associated semiconductors thermally bonded inside. The amp is said to be biased into Class A for its first 5 Watts of power but in use the amp barely got warm at moderate listening levels. Worryingly, one of the amplifier's feet had become detached on receipt and could not be refastened due to a stripped thread, but this was the only blot on an otherwise well-crafted chassis, showing excellent standards of fit and finish.

The inside of the amp is dominated by a huge toroidal transformer, almost 140mm (5.5in) in diameter. There's one motherboard PCB that stretches to each corner of the chassis, and in our case the three daughter cards fulfilling the needs of XLR in, phono amplification and digital conversion. The phono stage can be configured with

jumpers, switching it from MM to MC gain, 100 Ohm to 47k Ohm input impedance, and optional 100pF capacitance.

### SOUND QUALITY

Given an amplifier of 'modest' power – which is one way to look at anything below 100W per channel – any testing would normally be carried out on some easy-drive loudspeakers, since my reference choice of B&W 802D often present an onerous load for mainstream integrations. No such problem for the Moon i3.3 though, as I was pleasantly surprised to discover in a try-out post the usual running-in period. In fact not only did the Moon take in its stride the driving of sub-4 Ohm speakers up to and beyond usual comfort levels, it showed the canny knack of remaining tight, tuneful and distress-free.

Back at normal levels, the Moon





# Space Age

Tony Bolton logs in to Bang & Olufsen's new BeoSound 5 hard disk-based music system...

**F**ounded in 1925, Bang and Olufsen have been making beautifully designed products since before the second World War. Whilst the technology has radically changed, the company's ergonomic ethos remains, even in the days of wireless network equipped audio. Given the complexity of such products, the challenge is to make the latest B&O designs as easy to use as past ones, which worked in a more direct way with physical media (i.e. CD and cassette).

That's precisely what this high end system has to do – and B&O take an interesting approach. It comprises two separate packages, the BeoSound 5 Head Unit and the BeoMaster 5 Socket Unit. The former consists of a screen mounted on a substantial column which has controls for the on-screen display. Total dimensions are 310x190x80mm, with the screen having overall dimensions of 260 x 220mm. Styling is of course minimalist, and the absence of ornamentation gives the screen and its milled aluminium support a business like look that would compliment either a Bauhaus glass and chrome coffee table or the control desk of the latest incarnation of the USS Enterprise...

The support contains three controls. The bottom one is a milled edged volume knob (visual display

of volume level appears at the right edge of the screen and follows the curvature of the screen as the volume setting increases). Above this, set into a recess is a lever that operates the main selection mode, allowing source choice and methods of selecting music, more of which later. The top control is, again, a milled edged knob that acts as a scroll wheel for part of the display. All controls are nicely weighted, with a reassuring solidity to the touch. Inside the circle formed by this last knob, lies a black horizontal bar marked '<', '>' and 'GO'. These three controls, combined with the aforementioned trio, are all that are needed to access either Net Radio, or the 1,000 or so CDs worth of music that B&O claim can be stored on the 500Gb hard drive inside the BeoMaster 5...

Just as you'd expect from this marque, I found the display very clear. The previously mentioned middle lever moves a pointer on screen, which selects either source (Net Radio or stored music) or way of choosing music. This can be cued up using the cover, artist, album, track title or a favourites list (which can come in four colours to differentiate between different users or types of list) to access the required music. Having selected some music, it can then be played as a complete album, a single track or in various forms of

playlist. The BeoSound 5 has a search capability called 'MOTS' (More Of The Same) where, having analysed the music currently being played, it will then search its memory for similar music, selecting it by a mixture of rhythm, and musical style. This can create playlists that can involve some rather unusual musical connections but which hang cohesively together!

Once the method of accessing the music is chosen, the right-hand side of the display shows the tracks listed on an album, or the titles by the same artist, depending upon the selection area chosen. Pressing the '<' button, expands the information available from just the album title to full track listing. Having made a choice you press 'GO' and the music starts. The usual pause, forward and reverse facilities are accessed via the 'GO-bar'. Alterations to the presentation of the sound can be made by moving the main pointer to the Mode option. Here you can make adjustments to the balance, treble, bass, or for late night/low volume listening there is a Loudness option.

The Mode setting also allows access to the Internet to download music or to access Net Radio. Again the technology allows the user to browse stations by genre, language, country or station name. Favourites can be stored in 'coloured' lists that hold up to 99 station presets. These coloured lists allow different users



to maintain their own selections without interfering with others choices, or allowing the single user to create different selection lists for different moods and occasions. This works well, being intuitive and easier to get the hang of that they are to explain in print! Accessing the 'Clean-up' setting in the Mode menu allows deletion of tracks and stations from the memory. Accessing the music in the first place requires an Internet connection from your computer. Both Macs and PCs are compatible.

The BeoSound 5 is intended to be a freestanding unit that can be mounted on a dedicated, rather elegant looking column, or placed on a suitable surface for use. I found it quite convenient to have it sitting on the coffee table in front of me. This did mean that there were three wires trailing across the room to the BeoMaster 5 Socket Unit, but in a proper installation the B&O installer would route all of this out of sight.

The BeoMaster 5 is required to provide the storage and processing power for the unit. It is a black box measuring 100x380x260mm and weighs 4.7kg. Its 500GB hard drive can hold a myriad of albums as already mentioned, as well as storing the Net Radio stations and holding your photographs ready for display on a suitable screen such as the BeoVision range. At the back are a range of sockets including an RJ45 Ethernet socket for the Internet, various video and sound options including Component and Composite video and a pair of stereo audio analogue outputs. Media storage can be in either lossless storage such as WMA files, or as MP3 files. WAV and AAC formats are also supported – this gives it a useful advantage over Linn DS systems which don't field AAC (which is of course iTunes' native codec), meaning you can play back all your DRM-free iTunes tracks. Artwork can be kept as JPEG, BMP, GIF or TIFF files. Software updates will automatically be provided.

The final parts of the chain in any audio system are the amplifier and loudspeakers. Here B&O have combined the two in the BeoLab 3 active loudspeakers. These little solid aluminium cubes measure a mere 162 x 135 x 223mm and weigh 2.55kg. This compact design is possible because of B&O's respected ICEpower amplifiers. These good sounding Class D modules produce 125 Watts at full power. Each cabinet contains two, one for treble and one for the bass. The latter can also be tuned to the room, using B&O's Adaptive Bass Control technology. This consists of three settings for placement of

the unit in corners, against walls or freestanding in a room.

I experimented with all three positions, placing the speakers on both stands and a coffee table in the process. The system is effective in controlling the relative amount of bass output. Using the freestanding setting when the speaker was placed in a corner resulted in a very overblown bass sound. Adjusted properly it should satisfy most users, fine alterations to the bass output can of course be made via the on board tone controls. Those wanting deeper bass have the option of buying the similarly styled BeoLab 2 subwoofer unit, which uses the same amplification module, and is designed to compliment the BeoLab 3s. A range of five colour finishes – black, dark grey, red, blue and white – allow the speakers to blend in with, or be contrasted against your home décor, and the flexibility of the positioning should ensure domestic harmony.

## SOUND QUALITY

Scrolling through the range of music on the hard drive, I settled down to listen to Nigel Kennedy's recording of Vivaldi's 'Four Seasons'. The presentation of the sound suited the smooth and sleek look of the equipment. With the tone controls set at the default flat position and the speakers on stands away from the walls, I was pleasantly surprised at the level of bass output. For such small cabinets, the sound was pleasingly rich and full-bodied. Although adding the subwoofer would no doubt take the bass response to new depths, I did not feel that it was essential by any means in my room.

Moving up the frequency range and I appreciated the B&O's characteristic cleanliness and tidiness. There's little in the way of grain on strings across the midband, while instruments are well located in space with convincing projection from these relatively small loudspeakers. Still however, I felt that there was a certain level of incision missing. Kennedy's violin lacked the tonal patina of string being vibrated by the coarse edge of a bow; instead I was presented with a rounded and inoffensive presentation of the instrument. This is typically B&O – it's a very pleasant, smooth and sophisticated sound, if a little standoffish – and likely just what the general public would regard as "hi-fi"...

Further scrolling located the Dubliners singing 'Dirty Old Town'. Here again, the rawness of the voices seemed a little brushed over – those Guinness lubricated tonsils seemed to be awash with Earl Grey

tea instead. For me this took away some of the character of the sound, but left a pleasant, if rather glossed over, version to digest. Again, I doubt most B&O buyers would regard this as disappointing, but by separates hi-fi standards at this price it wasn't incisive enough.

Continuing through various playlists using the (optional extra) remote control, I tried Blur's single 'Charmless Man'. The beat of the track came across well, showcasing the speakers' real grip and rhythmic bounce, and there was no shortage of power too, for a product of this type. Better still, they remained in control as the volume was pushed higher, but again I felt the upper mid (and vocals in particular) had a slightly opaque quality. I would have preferred, to use the modern BBC vernacular, a more "edgy" sound. Still, it certainly wasn't an unpleasant listen – and this I suspect is all that's needed for a product of this type.

## CONCLUSION

It's always difficult to review a product like this in these pages, as our readers' buying criteria are necessarily a little different to those of the designers. So, let's be clear that on its own terms this is a stunning product. Beautiful to use and indeed to behold, it is designed to look and work like no other, and makes most high end network music-equipped AV receivers or 'Squeezebox' type products look horribly clunky. What car makers call the 'surprise and delight' factor is very high with this BeoSound 5 package – you are constantly thrilled by all its lovely little ergonomic touches. In sonic terms too, it is no slouch – possessing a smooth, clean and silky sound that works nicely, and uniformly, across all types of music.

However, *Hi-Fi World* readers, better suited to subtle combinations of separates from a number of manufacturers, may well be disappointed with the sonics. They are not bad, it's just that any combination of components under a couple of thousand pounds should comfortably exceed what this big Bang and Olufsen can do. If you want the cool sophistication of the styling and the fuss-free convenience of having all your music stored in the one place, rather than spread across feet of shelving, then this could be just what you are looking for. But remember, the sound has been tuned to the same unobtrusive qualities as the styling.

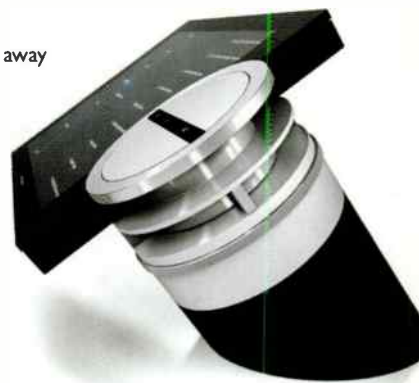

## VERDICT

The height of minimalist sophistication with superb ergonomics, but this new B&O system ultimately fails to seduce sonically.

## BANG & OLUFSEN

BEOSOUND 5	£2,121.50
BEOMASTER 5	£1,905.55
BEOLAB 3	£2,673.75
BEO 4	£189.75

Bang and Olufsen UK Ltd.

+44 (0)118 969 2288

[www.bang-olufsen.com](http://www.bang-olufsen.com)

## FOR

- breathtaking styling
- superlative ergonomics
- clever packaging
- build and finish

## AGAINST

- unengaging sonics
- price

# DAC to the Future

Andrew Harrison finds more than just battleship build quality to like in Audio Research's new DAC7 - it's a crossover digital-to-analogue convertor that looks like a valve preamp but has more in common with the iPod generation...



**T**here's something strangely comforting about a hi-fi product with grab handles on the front. But in truth, the Audio Research DAC7's aren't terribly useful, as it only weighs 5.2kg - this is no retro amplifier, but rather a modern day solid-state digital to analogue converter built for the PC age. The company has focused first on getting the best from its USB digital audio input - and then added the more familiar digital interfaces like RCA and Toslink S/PDIF to widen the unit's scope. And it's as well that it did, since those S/PDIF inputs do work so very well!

In the centre of the trademark thick aluminium fascia is a black-backed window containing various LEDs to show which of five inputs is active. We're spoilt for choice here, with each of the principal industry-standard connectors represented: RCA phono, BNC, XLR and Toslink optical - plus the less typical USB port. Four lights illuminate to show power on, polarity inversion, digital lock and mute. In the smaller dark window below are push buttons labelled Power, Invert, Mute, and Input; the latter cycling between aforementioned available inputs.

Only lacking here is some kind of indication of the incoming digital audio sample frequency. When playing from a computer in particular, it's useful to have ready reference to the incoming datastream format, in order to ensure that a Mac or Windows PC isn't inadvertently doing any on-the-fly sample-rate conversion. When playing CD-ripped music, for example, it's sometimes easy for the computer to get reset to 48kHz sample-frequency output, with subtle but debilitating results on audio quality. A front panel indicator could prevent the error by explicitly showing data frequency.

On the rear panel are all the necessary connectors, chassis mounted with enough space between them to allow for chunky cables. In the case of the USB input, it uses a Type B port, as found on most PC printers.

Look inside the DAC7 and you find two small frame transformers - one each for digital and analogue sections - used in the power supply on one side, with a large part of the circuit board dedicated to smoothing and voltage regulation on the other. A bank of six high-temperature specification electrolytics on top are supplemented with lower-value Rel Cap bypass capacitors on the PCB's underside. The circuit board itself is a real heavyweight type with thick conductive tracks, itself supported from the chassis baseplate on sturdy support pillars. In one corner, just behind the various digital input socketry, is the unit's digital section. This features some surface-mount components such as the converter's core DAC chip, a Burr-Brown PCM1792. This hybrid chip - using multibit and delta-sigma conversion techniques - is a 24bit, 192kHz-capable converter utilising eight-times oversampling and an integrated digital filter.

The rest of the large circuit board, however, more closely resembles a valve amplifier, with circuit tracks so wide and so well-spaced from each other, it could almost be using point-to-point wiring on a tag strip. Solder joints alone betray the hand-crafted nature of construction, with generous amounts of shiny metal showing at every junction of component with circuit board. The centre of the board is dominated by a large and mostly discrete solid-state output stage. This is laid out in an almost mirror-like symmetrical fashion for the

stereo left and right channels, and provides passive I/V (current-to-voltage) conversion. This recovers the required analogue voltage output that will ultimately drive a connected pre- or integrated amplifier. The notable addition to the fully discrete output stage is a pair of low-noise J-FET opamps right at the end of each channel, allowing a direct-coupled output through the unit's balanced XLR and unbalanced RCA phono connectors.

You can switch between inputs from the comfort of your armchair with a supplied infrared remote control, as well as invert polarity of the output, mute the sound, or put the DAC7 into standby. So far, so conventional for any hi-fi DAC that offers remote control. But more surprising are the triangular buttons arranged in the compass ordinal points and marked skip left and right, play/pause and stop. When playing music through the USB input from a computer, these buttons actually control playback from a program on the PC. So with music playing from iTunes, for example, those navigation controls allow you to start play, pause and skip using Audio Research's own remote handset. And if you're watching a video from Apple QuickTime, it will likewise give control over playback.

## SOUND QUALITY

Smooth and sonorous are just two words that leap to mind upon hearing the DAC7 in action. Audio Research has engineered a free-flowing, natural sound using the more established technology of an oversampling converter chip. It's not an instant razzle-dazzle sound that pulls you in, but a stable, confident portrayal of music that can seduce the ear. The key here is the manner in which the DAC7 simply lets the music reveal its





natural pace.

An easy way to illustrate the DAC's mastery of musical structure is with some challenging grand piano recital. Mitsuko Uchida plays Debussy's *Études* with accomplished grace, despite the technical challenge of sequencer-like staccato runs. In 'Pour les Huit Doigts', there's a shocking and seemingly unrelenting run of notes right from the start to the end of the brief composition. Playing from CD on a dCS Verdi via an AES balanced line, the DAC7 made sense of the rippling finger storm, highlighting the lower resonances of the instrument in a brief left-hand stretch toward the bass notes. As a brief point of comparison, the Chord DAC64 is similarly adept, perhaps bringing out more gravitas at the low end, at the expense of reduced upper smoothness.

The Audio Research could stand its ground against costlier designs too, losing out on the ineffable silkiness of the dCS Delius – but likewise making good sense of a complex north African acoustic *mêlée* lead by Rabih Abou-Khalil on the stringed oud. From his remarkable 1992 album *Tarab* and the stand-out track 'Bushmen in the Desert', the Lebanese oud player sits centre back while hand percussion builds up at front left and right stereo positions. The rhythms are complex, defying normal Western counting, but a section in what approaches 5/4 time proves a challenging trial for good hi-fi reproduction, but the DAC7 sailed through the piece, keeping the smoke-tinged tension and atmosphere all the way.

In tonal terms, the Audio Research DAC7 has a somewhat mellow tone, smooth at the top,

splendidly open right through the midband, and controlled down to the bass. It loses out on the final word of bass extension, subjectively speaking, missing out on some low-frequency effect highlights on some tests discs; yet it gets most of everything else so tangibly right, it almost feels rude to point it out. And compared to DACs that process the digits with upsampling, the stereo representation is a tad more constrained in its width.

From 'Pictures at an Exhibition' with Riccardo Muti at the helm of the Philadelphia Orchestra, there's a more mono-focused rendering with strings sited centre-left and woodwinds centre-right. Dynamics are truly first class, hinting at the range of an in-the-room orchestra, and instrumental positioning is beautifully stable. To return to the term 'sonorous', it's the colouring of the piece's all-important brass and horns that truly impressed. Close harmonies between these instruments are played with such believable realism, they make many playings of this work appear like detuned raspberries!

Music played through the USB input, on the whole, kept the faith too. The stereo precision was there, where many a USB DAC gets a little nebulous and vague, although the top end

could sometimes lose out on the treble grace as found through AES balanced, for instance. Audio Research has excelled itself in getting the USB working so very well.

## CONCLUSION

More than just an accomplished hi-fi digital converter: the superb new Audio Research DAC7 bridges the gap between PC and music system by allowing high end sound reproduction from both traditional and computer-based sources.

## VERDICT

⊕⊕⊕⊕⊕ £  
A high end sound featuring great sonority from both computer and disc material, through a wide variety of inputs.

## AUDIO RESEARCH MODEL DAC7

£2,998

Absolute Sounds

+44(0)20 8971 3909

www.audioresearch.com

## FOR

- natural undigital sound
- emotionally inviting
- rock-solid stereo imaging
- great build

## AGAINST

- no sample freq. display
- 16/48 via USB only

## MEASURED PERFORMANCE

Our high resolution frequency response sweep with the digital generator of our Rohde & Schwarz UPV analyser clearly shows that high frequency output rolls down slightly above 10kHz, a popular way of ensuring CD doesn't sound bright or glassy. The trace readout shows the upper -1dB point is 21kHz all the same, much like other players. At the other end of the spectrum the DAC7 reached down to 4Hz.

Linearity was up with the best, although peak level of 0dB distortion was a little high at 0.02%. More consequential are lower level figures, from -6dB down to -60dB and over this range the DAC7 measured well, our -60dB analysis showing the usual sea of quantisation noise with harmonics picked out by markers, and which measured 0.23% in all. The noise is intrinsic to digital quantisation on the Philips test disc by the way, not generated by DAC7. The UPV gives a dramatic visual presentation of the phenomenon.

EIAJ Dynamic range was a high 112dB, as expected from the excellent linearity figure, and output high too, measuring 2.7V.

The DAC7 measures well all round. It should give an easy sound. NK

Frequency response (-1dB)	4Hz - 21kHz
CD	
Distortion (%)	
0dB	0.02
-6dB	0.005
-60dB	0.23
-80dB	4.2
Separation (1kHz)	109dB
Noise (IEC A)	-100dB
Dynamic range	112dB
Output	2.7V

## FREQUENCY RESPONSE

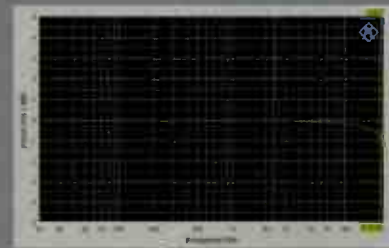

## DISTORTION

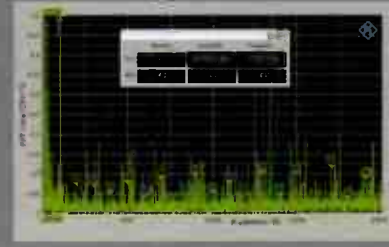

**SPECIAL INTRODUCTORY OFFER!!!!**

# **HI-FI WORLD ELECTRONIC EDITION**

**VISIT OUR WEBSITE: [www.hi-fiworld.co.uk](http://www.hi-fiworld.co.uk)**

**Queries to - [esubs@hi-fiworld.co.uk](mailto:esubs@hi-fiworld.co.uk)**

**Subscribe to our  
eco-friendly e-edition of  
Hi-Fi World and receive a  
50% discount!!!**

- **Receive your issue a week before on-sale dates.**
- **Be the first to grab a bargain in our Free Reader Classified Ads.**
- **In-house lab. tests to AES and IEC standards**
- **Run by dedicated hi-fi engineers & enthusiasts.**
- **No missed issues, or postal delays.**
- **Access your issues from anywhere in the World.**
- **PC and Mac friendly.**
- **Eco-friendly.**

**Subscribe today and receive 12 issues for  
£20 – that's an amazing £1.90 per issue!**

**check out our free trial issue**

**VISIT OUR WEBSITE:  
[www.hi-fiworld.co.uk](http://www.hi-fiworld.co.uk) and select  
"ELECTRONIC EDITION"**

**To purchase your e-edition click here**

Pay in Sterling, US Dollars or Euros. Non-sterling prices vary according to exchange rate.  
**Cards accepted:** Visa, Maestro (Switch), Mastercard, Solo and Delta.





# mail



## LETTER OF THE MONTH PRIZE



KEF iQ30 LOUDSPEAKERS

Visit our website at [www.hi-fiworld.co.uk](http://www.hi-fiworld.co.uk) or send your emails to [letters@hi-fiworld.co.uk](mailto:letters@hi-fiworld.co.uk). Letter of the month wins a pair of KEF iQ30 loudspeakers and one years FREE subscription to Hi-Fi World.

A pair of KEF iQ30 loudspeakers is on their way to **JEREMY S. RIDSDILL**, Letter of the Month winner in our APRIL 2009 issue.

## Letter of the Month

### RUSH RELEASE

It was interesting to see you devoting so much print to the vexed issue of poor sounding CDs in your December issue (in your letters section and Adam Smith's column). So the poor mastering of Metallica's 'Death Magnetic' album has caused a bit of a stir, resulting in 13,000 fans petitioning for a remaster job to be carried out...

This is not the first time this has happened. When Canadian prog-rockers Rush released 'Vapor Trails' (2002), it was met with the same furore due to its abysmal sound quality. Having been a huge fan since the late 1970s I was shocked on first listen at how 'heavy' this album sounded. However, I have since come to understand that my initial perception that the band had lurched towards a more 'industrial' sound, was mostly due to the fact that the mastering job had completely destroyed the dynamics of the recording - worse still the level of distortion (limiting) rendered it almost unlistenable.

Having listened to Rush for years, I had been accustomed to a band who always seemed to take a meticulous approach to recording/producing music - in fact their albums have always been a great way to assess my hi-fi system's abilities as I have added/upgraded over the years due to the wonderful complexity of the playing and the wide dynamic range of their material.

Such was the anger of fans at the time (many of whom are musicians, recording industry insiders and/or audiophiles), that large numbers voiced their disappointment on many of the online, fan-based forums. An in-depth article on this particular piece of 'audio vandalism' can be found at [www.prorec.com/Articles/tabid/1109/EntryID/2471/Default.aspx](http://www.prorec.com/Articles/tabid/1109/EntryID/2471/Default.aspx)

I believe a petition was formed

**Turn Me Up!™**  
Bringing Dynamics Back To Music

HOME ABOUT US JOIN / GET CERTIFIED PRESS / MEDIA CONTACT

Turn Me Up!™ is a non-profit music industry organization campaigning to give artists back the choice to release more dynamic records. To be clear, it's not our goal to discourage loud records; they are, of course, a valid choice for many artists. We simply want to make the choice for a more dynamic record an option for artists.

Today, artists generally feel they have to master their records to be as loud as everybody else's. This certainly works for many artists. However, there are many other artists who feel their music would be better served by a more dynamic record, but who don't feel like that option is available to them.

This all comes down to the moment a consumer hears a record, and the fear that if the record is more dynamic, the consumer won't know to just turn up the volume. This is an understandable concern, and one Turn Me Up! is working to resolve.

Go to [www.turnmeup.org](http://www.turnmeup.org) to find out how compressing music during mastering, to make it 'louder', destroys dynamics, generates distortion and ruins sound quality.

with a view to persuading the record company to remaster the CD. At this point in time this has come to nothing and we fans are left with a collection of excellent songs that have been 'butchered' in an attempt to make the album as 'loud as possible'. At least there has been an admission from guitarist, Alex Lifeson, that the album was mastered 'too hot'. My guess is that the record company were none too keen to release a remastered version just a few years after the release of the original as this would be an admission of their 'error'. Alternatively, the situation may not be rectifiable by remastering. Interestingly this album was also issued on double vinyl LP but I have yet to listen to a copy to see if it is audibly superior (long since deleted).

I am looking forward to hearing

how Adam got on with his intention to return his Metallica CD to the shop for a refund on the grounds of poor sound quality (I suspect he will be one of only a very few who would take such action - the rest, probably Hi-Fi World readers!). I am afraid to say that we (audiophiles) must consider ourselves to be a minority group and, as such, can have little influence on these things - I wish it were different!

**David Leach**

I don't think complaint in this case is misplaced. Compression ruins sound quality and artistic intent in my view, something that has been very lucidly explained by many industry professionals. It seems to be only a small body of mastering engineers/producers that hang onto the very

Xanda



# Some of the best ideas seem to happen almost by accident...

Just look at the founding of Leema Acoustics. Ex-BBC film sound engineers Mallory Nicholls and Lee Taylor, created the compact Xen loudspeaker as a research project and then made it commercially available to professional sound studios.

The Lee and Mallory partnership showed off their new speaker gem at the 1998 Bristol Hi-Fi Show. There, they found a welcoming response from discerning listeners.

This early success spawned a range of loudspeakers, from bookshelf to full-range floor standing models, but Leema Acoustics was soon to build on its reputation for outstanding acoustic design, with a successful range of audio electronics.

Critically lauded CD players and amplifiers became part of the Leema Acoustics range.

Last year, the original Constellation Range was supplemented by the more affordable, but no less high-quality, Spectrum Range, including the Pulse integrated amplifier and the Stream CD player both based on their more upmarket counterparts.





simple view that grungy is best. One reason is that studios invest large sums in latest recording and editing equipment and destroying sound quality makes a nonsense of their investment. So grungy and distorted isn't an easy sell anywhere.

The more people complain and explain (i.e. just turn it up) the more the message will get through. I'm sure most artists would rather their work was heard and appreciated for what it is, than have their efforts destroyed at the last hurdle by a mastering engineer with all sliders set to Max.  
**NK**

I'm a big Rush fan too, and so I think you make some very astutely observed points. As the band's own Geddy Lee once sang, "one likes to believe in the freedom of music, but glittering prizes and endless compromises shatter the illusion of integrity". This was back in 1980 ('The Spirit of Radio') but eerily prescient not just about the music industry in general (and mastering in particular), but about his own band's recording future! I think too many mastering engineers have been taking Nigel Tufnel's description of his special guitar amp in 'Spinal Tap' too literally:

"NT: What we do is, if we need that extra push over the cliff, you know what we do?

Interviewer: Put it up to eleven?  
Nigel Tufnel: Eleven. Exactly. One louder." **DP**

### ADDICT

I have been an addict from the early seventies and can still remember the magic of being allowed to listen to Holst's Planet suite on my Dad's Garrard Zero 100 (now one of my modest turntable collection - Garrard 401, Lenco GL75) - I even traded the first one hundred issues of 2000AD for my first turntable!

In terms of my own system I have evolved from a true 'Flat Earther' to the present set up of a Michell Orbe SE, Origin Live Silver Mk2, Van den Hul Frog, PS Audio GCPH phono amp, Shanling CD-T100C using cryo treated Bendix 6385s, Pioneer DV 717 (to play DAD 24/96 discs) Electrocompaniet ECI 1 or ECI 4, Martin Logan SL3 speakers with custom made sound absorbing panels. All of this is wired together with various silver wiring including the rarely reviewed Albedo range and housed on two Quadraspire racks in an almost dedicated listening room - I share it with my son's train set!

I enjoy listening to LP more than CD and I guess my collection reflects this - I had to smile at Adam's recent reorganising of his LPs, his maximum number



**Emille Labs KPE-2AS is one of the sweetest and most finely detailed phono stages ever. OK, it's expensive at £2990, but they don't come better.**

of LPs of one artist being 15! (Don't you have more turntables than that?) - I think my Sinatra LPs probably number about 150...

My question regards the next allocation of funds and is specifically aimed at David's knowledge of my turntable, arm and cartridge combination. I was a little disappointed in the PS Audio GCPH phono amp - it didn't live up to all the hype in another magazine (yes I know I should have listened to it first). I was tempted by the ease of adjustment and the mono button. I would like to purchase a phono amp that would be a significant step up from the GCPH and would like to know what, in your opinion would be a good match for my current set up. The 'usual suspects' would, I suppose, include the more expensive EAR offerings, Whest Audio, Icon Audio PS3, Audio Research PH5, Noteworthy Audio Pho Note. I'm sure you know many more besides.

**Rob Radcliffe.**

Hi Rob. Sorry to say, I don't know of phono amplifiers to recommend other than those we recommend! But David might.

Whilst a wide variety of designs have hit the market recently only a few stand out and in my opinion - sorry to bore regular readers! - only a good valve design will do. Most solid state designs rely on low noise integrated circuits and at a fundamental design level are not especially clever. Valve designs get down to the nitty gritty by not parcelling off gain to an anonymous 'gain block', a clever idea that isn't very clever when it comes to high quality audio. That whittles options down considerably to the "usual suspects" I recommend from Icon Audio, Quad, Eastern Electric, plus the expensive but delightful Emille Labs KPE-2AS. These are all thermionic. David insists solid-state designs have merit too (!) and will likely add a few names onto this shortlist, including ANT Audio and Naim I suspect. **NK**

Well, funny you should say that Noel, but - ermm - I'd recommend you listen to ANT Audio and Naim! First - your turntable is superb. It's not often said these days, as the Orbe is getting on for fifteen years old, but I still think it is one of the very best at or near the price. It does most things very well and some almost peerlessly - specifically its tonal accuracy and massive left to right soundstage. It demands a serious arm - and you have rightly fitted an Origin Live Silver. This is superb, but still I feel a weak point in the chain - and I'm loathe to recommend an expensive phono stage until you upgrade to something like an Origin Live Encounter or Audio Origami PU7. So, maybe if you keep this in mind, we'll get to phono stages...

The vdH Frog is a beautiful cartridge (sonically, if not aesthetically), and on the sweet, warm, soft side - unlike, for example, an Ortofon MC Windfeld. Whilst an Icon Audio PS3 would work brilliantly, it too is ever so slightly on the 'gentle' side of the street, and so your turntable might usefully benefit from the extra 'snap' from the A.N.T. Audio Kora 3T Ltd. This phono stage has a great deal of the scale and delicacy of the Icon, but a fractionally tighter, tauter bass and a tad more rhythmic drive. There's not much in it, but in terms of synergy it could prove the better choice. The Naim Stageline of course takes you further down this path - being massively taut and super detailed, but I suspect with a vdH Frog you're after a more beguiling sound. **DP**

### SWEET AS KANDY

I have a Roksan Kandy L111 amp, Arcam CD73 CD player, Pioneer DVLX50 used for Super Audio discs (SACDs) and associated tuner, MiniDisc and cassette units. I also use a Project Perspex turntable with Goldring 1042 cartridge. Current speakers are Monitor Audio Silver 6 which are four years



Having successfully entered two sectors of the market, Leema Acoustics has now released its biggest and best statement to date in the form of the **Reference Series**.

The word Reference conjures certain expectations. Not least the use of fine quality materials, seamless build quality and innovative, even groundbreaking design. None of these new products disappoint.

## Pre nuptials

Starting with the Pyxis pre-amplifier, the Leema family shape is already in evidence. The 8mm-thick aluminium billet front panel presents two large control knobs. On the left, volume, on the right, input source or record output. When the corresponding row of blue LED's are lit, the input source is indicated. Press the button, and the LED's change to red, indicating the record feed. This can be output via the traditional tape-out sockets, the on board USB interface or the S/PDIF outputs.

Returning to Source mode, we're afforded the choice of onboard or external phono stage, CD, Tuner, Aux/MP3 or Analogue tape inputs. If you need to feed a direct digital source into the unit, there's again either S/PDIF or USB inputs to choose from, making use of the Pyxis' onboard DACs.

## room for control

A closer examination of the controls reveals two buttons located just below the volume dial. The left is marked Setup, and pressing this once alters the function of the volume control to that of a bass equalisation control. Pressing it a further three times allows the function to cycle through treble, balance, and finally, input gain. With the exception of balance, each of these settings is individually stored for each input.

These facilities allow differences in relative loudness and tone between, say, a CD player and a radio tuner to be eliminated.

The other button is labeled Mute which very quickly fades the volume to zero.

Pressing it again fades back up to the previous listening level.

Visit: [www.leema-acoustics.com](http://www.leema-acoustics.com)  
Phone: +44 (0)1938 811900  
Email: [info@leema-acoustics.com](mailto:info@leema-acoustics.com)

In the middle of the fascia are four more buttons. The first is labelled EQ and allows the user to switch the EQ circuit in and out for easy comparison.

Occasionally a source will be fed into the Pyxis that benefits from overall phase inversion. The Invert button reverses the absolute phase of the signal.

The next button is labeled Mono. Pressing this results in both channels being summed together, useful for Mono recordings and internet radio

The fourth and final button is labeled AV Direct. This comes into its own when using a dedicated external multi-channel processor, equipped with it's own volume control.

The Standby button, located at the far right of the fascia, switches the unit on and off. This Standby control also serves to power up any other Leema unit connected via LIPS.

## More than Lip service

LIPS stands for "Leema Intelligent Protocol System". LIPS 1 is standard throughout the Constellation and Spectrum ranges and allows the units to communicate intelligently.

For example, switching on the CD player will power up the connected amplifier, select it's CD input and set the volume.

LIPS 2 is connected via XLR-5 connectors to control reference series amplifiers, such as the Altair. This allows volume control to be carried out at the power amplifier end, which means the audio signal level in the inter connect can be held at a high level to minimise induced noise.

# Pyxis

## Reference pre-amplifier

'the most advanced stereo pre-amplifier currently available'





old. These are connected with DNM stereo speaker cable and the CD and SACD are connected with DNM stereo interconnect cables.

I would like to spend about £800-£900 on new speakers, preferably floorstanding. My room is approx 13' x 14' and one corner of this room is taken up by an under-the-stairs cupboard which means that the room is odd shaped. I would like to get speakers which have less 'boom' and better imagery and smoother treble. I did listen to the Epos M22i units which were connected to an Arcam A38 amp, but the sound was nothing special. Would the Kandy make these speakers sparkle?

I did once own a pair of KEF Q35 speakers which imaged superbly because they had one driver. Are there any such speakers which are within my price range? I did consider the B&W 684. Interests are classical to jazz via opera and film soundtracks and stage shows. No Pop! Your help please - you did help me choose the Kandy almost two years ago and I have not been disappointed with it.

**Cliff Millward.**

Hi Cliff. This is an easy one - the KEF iQ50 is a compact floorstander meant for smaller rooms, possessing a dry, well damped bass end that should minimise the inevitable room boom you'll suffer in a 13ft x 14ft (4.4m x 4.6m) space. Alternatively, you may find the iQ30 standmounter easier to accommodate. Both use the single coaxial Uni-Q drive unit with tweeter located inside the woofer cone that, as you say, gives stable and focussed imaging. A pair of iQ50s will not strain a piggy bank either, costing around £450. **NK**

### MISSING IN ACTION!

I know that magazines have editorial deadlines that can cause articles to be missed, etc., but just recently, I feel as though the magazine has, accidentally, been teasing me (and possibly other readers as well) a little, so I hope you'll offer help by the letters section instead...

In the October issue, in your reply to Colin's letter, you mentioned that in the November issue you'd be assembling a system around the front end of Cyrus XT SE and PSX-R. As this is the transport I'm thinking of buying to replace my Micromega Duo CD2.1, when the November issue arrived I opened it with eager anticipation but was upset as I couldn't find a system with the Cyrus front end.

You'll imagine my pleasure, then, when I noticed in the 'Next Month' articles in the January issue that you were planning to test this very same transport in the February issue, so again



**KEF iQ50, a compact floorstander designed for small-ish rooms.**

I opened the magazine eagerly when it arrived, and was again upset to find that there's no test in the magazine.

As I mentioned earlier, the current front end for my system is a Micromega Duo CD2.1 CD transport. This feeds in to a Musical Fidelity Tri Vista DAC that then feeds Musical Fidelity A3/A300 pre/power amps. The interconnects are unbranded, while the speaker cable is Supra Ply, although in the future I aim to replace all these with Townshend Isolda DCT.

Currently, the speakers I'm using are Totem Audio Arros, although I only bought these to replace a pair of Audiostatic Wings when I moved house (the cottage I moved to isn't big enough for the Audiostatics!).

In time, when we move to a larger house, the Audiostatics will come back in to use, and when commenting on my thoughts and making suggestions about equipment, I'd like you to consider these speakers rather than the Arros. Although the Arros are good, they're not in the same league as the Audiostatics!

There is absolutely nothing wrong with the Micromega transport except it is a top loader, and as space is a constraint and I also want to install a turntable in my system, I need to find a front loading CD transport. Following your comments about the Cyrus CD8 SE and CD XT SE, my thoughts centre around the Cyrus CD XT SE and wonder how you think it would compare to the Micromega?

I currently have a very detailed, open and natural sounding system and this is what I want to maintain, while listening predominantly to classical music (mainly organ, orchestral and vocal) although there is some occasional jazz,

rock and pop music played.

As well as my CD transport, I have a few questions about vinyl replay, as this is something that I want to reintroduce to my system. I currently have a Thorens TD160 with a Slate modified RB300 arm and a cartridge of unknown make (although it may be a Linn MM). The sound is not particularly good; the soundstage is quite narrow and the sound as a whole isn't brilliant, lacking defined bass and treble. I'm thinking a new cartridge is what's needed and suspect that an Ortofon 2M Black would be a good choice. Would you agree or make alternative suggestions?

Following on from this, the last part of my missive concerns a very large stroke of good fortune that I've recently been the recipient of. I've been given for nothing (yes, given!, yes, nothing!) a Garrard 401. Since then, I've been reading many internet forums and articles to discern what to do with the deck, and my thoughts are of taking it to Loricraft for a full refurbishment, then making a plinth of 18mm Birch ply (I've already bought a set of plans for the cut out off the world's most famous internet auction site), putting a 12in Scheu Analog Cantus tonearm on it and installing the Ortofon 2M Black from the Thorens deck. In time, I'd like to upgrade this to an Kontrapunkt B cartridge, but that may have to wait a while. Would you consider this a good way to go with the 401, and do you have any comments about my plans?

Lastly, would you consider the phono stage on the MF A3 preamp to be good enough to use, or would you recommend a separate phono stage, and if so, which one?

**Phil Cowling**

Hi Phil - sorry for being such a tease. I can assure you I don't just sit down and pluck kit out of thin air that we flag up in our 'next issue' page - it's a result of extensive consultation with manufacturers. Unfortunately, some of them are a little optimistic in what they promise - as all manner of things conspire to delay the kit reaching us, such as machining problems, component supply issues, and so on. Most of the time, we review what we say we're going to - but sometimes we get caught out, due to "circumstances beyond our control", and that is of course when you get miffed and moan at me! The problem is that if I was deliberately more suspicious of the claims about kit arrival and review timing in general, then page 128 would be a convenient blank page on which you could write your shopping lists, or keep a record of friends' phone numbers, or you could even rip it out of the mag and use it

# Altair for power



Using fully balanced signal connections enables the Altair monoblocks to be located a considerable distance from the Pyxis – up to 500m away if required.

These massive 45kg cubes feature heatsinks running down both sides. The back panels have both XLR and RCA inputs, as well as LIPS connectors. WBT NextGen are used for the loudspeaker binding posts.

Each Altair includes two sets of speaker terminals because, although it's described as a monoblock, each chassis comprises two amplification modules. While unbalanced connectors may be used, all of the internal circuitry is based on a fully balanced topology, as is that of the Pyxis.

The power amplifier's input section contains a long-tail pair of ZTX 753 transistors. From here the signal runs into a current mirror using ZTX 653 transistors. This ensures optimum balance in the input stage for vanishingly low distortion. After this comes a Darlington driver stage using Sanken transistors, leading to six pairs of Toshiba output devices per module.

All of this combines to produce a substantial power rating of 550W/ch into 8 ohm, with the ability to deliver up to a 2kW peak into a 2 ohm load. Short-term current delivery is an incredible 100A. Other figures are equally impressive: the signal-to-noise ratio is specified at 135dB and the frequency response encompassing a 5Hz to 100kHz bandwidth.

Needless to say, it requires a very special pair of loudspeakers to handle such prodigious electrical muscle, and Leema has developed the Xanda floorstander to fulfill this task.



Xanda  
insane  
sounds

For a unit that is capable of dealing with the maximum output of an Altair amplifier in full song, the Xanda is more compact than you would initially think. Standing a mere 1160mm high on its RDC cone feet, and leaving a footprint of only 380mm wide by 480mm deep, this is a room-friendly design that will fit into most living rooms comfortably.

Xanda can be supplied in any automotive paint colour. This allows matching with even the most outlandish decor. Whether conventional or metallic finishes are chosen, the final result gleams and shimmers in a piano-gloss finish.

The wide section at the bottom houses a 250mm aluminium long throw driver, with a column of five drivers above. Four of these are the familiar 100mm polypropylene units found in other Leema speakers. These are configured as two bass/mid units and two mid rangers. In between all these sits a 30mm soft-dome silk tweeter, ferrofluid cooled.

Internal components include hand-wound, air-cored coils and polypropylene caps in high power areas. The two pairs of binding posts are gold/copper WBT NextGen.

Connection of all of this complex sounding equipment is a cinch, thanks to the LIPS systems. After switching on, a few seconds is required for the protection circuitry, and the soft start function in the Altairs to operate. This is required because of the high inrush current on power up which, without a staged switch-on procedure, would trip most mains circuit protectors.

## Insane sounds

Firing up the Antila CD player with Radiohead's triple-platinum selling 1997 album *OK Computer*, and the second track – the hit single 'Paranoid Android' – filled the room. The opening guitar and shaken percussion were soon joined by the emotion-ridden tones of vocalist Thom Yorke. Over the next six minutes he explores the album's recurring themes of insanity and violence. From such a seemingly gentle start the song builds and builds, then abruptly changes gear with a harmonised vocal backing to Yorke's increasingly intense vocalisations; and then into a classic rock section with modern electronic effects. The end is sudden, almost as though a plug has been pulled.

The sound that flows out of the Xanda speakers would delight the band and come close to the experience that they would have had in the recording studio at St Catherine's Court, Bath. The acoustic of the 15th-century manor house is obvious through this system. Little hints of background details and the unusual decay of notes immediately tell you that you are listening to music being played through a very special ensemble of equipment indeed.





**The Scheu Analogue 12in Cantus arm - eccentric, but works well we found.**

to leave a note for the milkman!

As you'll have noticed from my review of the Cyrus CD XT SE this month, I really rate the new Cyrus 'SE' mech, and so would happily recommend it as a replacement to your old Philips CDM-based Micromega transport. You'll find a good deal more detail and focus, and yet no less musicality. It should be a dream team when partnered with your very capable Musical Fidelity DAC. The other key point is of course that Cyrus will support the SE mech for a very long time into the future, so there's no spares availability issues to deal with - something you cannot say with most transports, especially those using Philips or Sony derived mechanisms! **DP**

Cyrus have put a lot into their new CD transport and measurement of digital jitter through the digital section of our Rohde & Schwarz UPL analyser shows they have achieved great results, with negligible random and signal related jitter. Cyrus also say they have reduced read errors and data correction significantly too. With its small profile and unusual front slot loading, Mac Mini style, the Cyrus is quite a device that David eulogises over, so you won't go wrong here.

The Ortofon 2M Black is one of the best MM cartridges available, but then it is a very recent design with a high price tag of around £450. I doubt you'd be disappointed by this one either; it is a very clear top choice.

Pickup arms are starting to multiply like bunny rabbits on a carrot farm. Reawakening interest in vinyl is the reason, of course, the only problem it brings being widening choice, especially with an item that's very prone to mystic reverence as a pickup arm. I had some fascinating conversations with loudspeaker designer Karl Heinz Fink at the 2009 Bristol Show about this where he

confirmed our own findings that some designs that look the part and have a good reputation really don't work so well. He uses laser interferometry to see what an arm is doing, whilst we have been using a Bruel & Kjaer accelerometer to look at vibrational modes. The Scheu Analogue 12in Cantus is an arm easy to dismiss as worryingly eccentric - well, to a conservative engineer like me! - yet measurement and use showed us it works astonishingly well (see our September 08 issue). But others have been devouring carrots too and 12in arms are increasing very rapidly in number as a result. I have just measured the very conventional looking Ikeda IT407 arm fitted to the EAT Forte turntable reviewed in this issue and was surprised at how well it performed, giving results similar to the Cantus. It seems the IT407 is soon to be replaced by a new model so you may be able to get one for the price of a new SME 312 or 312S.

Bear in mind that 12in arms demand a very big plinth, and if this plinth is to house a Garrard then it needs to be sturdy: think block-house construction and dimensions. Mine sits on a big slab of marble on a very strong but low table, to avoid rocking motion. The all up weight is prodigious so isn't something to be moved around on a whim.

Whilst a 12in arm on a Garrard is one solution, I'm not sure it is the only one. Long 12in arms are super



**A miniature Bruel & Kjaer 4517 accelerometer attached to the headshell measures an arm's vibrational modes.**

smooth sounding and very svelte, but perhaps a little laconic for some. At this level sound quality preferences become a matter of taste I feel, so try to listen to what is available if at all possible.

Needless to say we are all suitably impressed - or is that depressed? - by a Garrard 401 as a freebie! No reason not to build a decent plinth perhaps, and keep your fingers crossed your freebie doesn't rumble. If it does, then it will need

to be fixed by Loricraft or Dr Martin Bastin, whom you can call at 01584 823446. He does not have email or a website. Of course, Martin also offers the plinth I have used and enjoyed for so long. Have fun - it will all be worth it in the end. **NK**

**FROG IN THE LOFT**

*In 2006 I had finally got enough funds to give my 401 the Martin Bastin treatment only to have my Micromega CD player die on me! Having already got a great turntable in my Orbe SE, Origin Live Silver Mk2, Van den Hul Frog I decided the funds had to go on a new CD player. So, reluctantly, away into the loft went the 401. Gone but not forgotten!*

*I have no woodworking skills to speak of so I have eyed jealously the works of art some of you guys house your 301/401s in. Then during one listening session I caught sight of an old Ikea Lack table in a corner of the room - the one you guys used to recommend as a cheap turntable support. Basically I cut down the Ikea Lack table to fit directly on top of my Quadraspire table and turned it into a plinth. The legs of the plinth Blu Tack directly to the tops of the metal legs of the Quadraspire giving mechanical energy an easy path away from the deck. The plinth is so light it stores little if any energy. I know this flies in the face of the usual approach of mass, mass and more mass but frankly the results speak for themselves - my Orbe has seen no action since the 401 was put in place. Do I get the prize for the cheapest ever plinth for a 401?*

*I'm now enjoying the fruits of many years of collecting bits - the 'as new' Shure V15xMR cartridge I've had in a drawer for over five years, the cork composite mat I bought from Loricraft at the Chesterfield Hi-Fi show even more years ago, the RB250 I bought in a clearance sale for £25 and had rewired by Incognito then put in the loft. Oh the joy of a project coming together! All I need now is a cover and, oh yes, what about that bearing upgrade Adam reviewed. STOP! This was meant to be cheap. Anyway, if someone as inept as I can get their 401 up and running it may encourage others to give it a go!*

**Rob Radcliffe**

Sounds like a fun front end Rob. But a Frog in the loft? Surely not! Or perhaps your roof leaks like mine, in which case it will feel at home. **NK**

**INTO THE DITCH**

*Having spent many happy years in the diligent pursuit of ever better sound, in the utterly mistaken belief that the music source was capable of infinite exploitation, I've changed kit quite a bit. Lately I've ditched all of my CDs and*



## The persuader

There are some systems that give the listener clinically precise imaging and spatiality, but may fail to deliver the subtleties of the change from intimate close-miked vocals at the beginning of this song, to the anthemesque ending. The Leema Reference system provides both, by the bucket load, along with a persuasive drive to the slow and measured beat of the music.

The USB outputs allow archiving to computer from all sources, including vinyl. Playing Pink Floyd's *The Dark Side of the Moon* on a Clearaudio Master Reference turntable shows the speakers ability to dig deeply into the bass regions. The album features a very deep pulsing 'heartbeat'. Through most systems this is only apparent at the beginning and the end. The fact that this pulse runs all of the way through the record is obvious when played through the Leema Reference system.



## Agena again

If your main sources are digitally based and you only have a modest record collection then the onboard phono stage option will be sufficient for most needs. If vinyl is your primary source then Leema have come to your rescue with the Agena Reference phono-stage.

Once again this blends with other Leema components and like all Leema electronics is available in either satin black or natural silver anodised finishes.

Agena is superbly specified with three inputs, two unbalanced using RCA phono plugs, and one XLR-equipped balanced input option. Each input has two headshell settings, allowing the use of up to six different cartridges. This may seem overspecified, but some high-end turntables – such as the reference Clearaudio deck – can readily be fitted with up to three tonearms. This allows the user to fit both stereo and mono cartridges, and perhaps a cheaper unit to allow other family members to play records without risk to a very expensive item.

Selection is made through the user configurable interface. Moving coil and moving magnet inputs are catered for, with independent adjustments for sensitivity, resistance and capacitance. Outputs are through either RCA phono, XLR or alternatively, via the onboard A-to-D converter, again through USB or S/PDIF.



## Sounds of the Seventies

Turning to Pink Floyd again, this time through the Agena phono stage, is a true revelation in just how much information top-quality equipment such as the Clearaudio Goldfinger cartridge and the Graham Phantom B44 tonearm can extract from the groove. Feeding this high-resolution source into an equally transparent-sounding set of electronics is an astounding experience. You are transported to the control room in Abbey Road Studios, and are suddenly surrounded by people sporting long hair and flares as 1973 pours out of the speakers into the listening room.

From the operatic pretensions of 'Great Gig In The Sky' to the opening ringing and clatter of cash registers in 'Money' and the harmonious ramblings of 'Brain Damage', you are listening to a convincing performance of the music, now, not a second-hand reproduction of that moment nearly four decades ago.

This vividness applies across the musical world. Play Bach organ works, or Miles Davis exploring his trumpet's sonic extremities, and this awesomely specified powerhouse of a system responds effortlessly. You find yourself listening in one of the world's great cathedrals, or in a small smoky club in New York. Put on Fairport Convention's LP *Full House*, jump to the track 'Sloth', and you are sitting in front of the band. The vocals of Thompson, Nicol, Swarbrick and Pegg hang in the air, supported, in particular, by Richard Thompson's beautiful guitar playing. The whole effect is nothing short of mesmerising.

Now this sort of excellence may not come cheaply. The Agena phono-stage is £2935 with the Pyxis pre-amplifier costing £3925. The Altair power amplifiers cost £8325 each, and allow £8495 for a pair of Xanda loudspeakers. For the performance on offer the price is moderate. Rival components struggle to come close to the Leema Reference's ability to set a holographic, almost physical image in front of the listener. Neither would they have the same level of agility in the bass department. While it's not impossible to find powerful amplifiers that can produce a big sound they will often sacrifice speed and the dexterity to stop and start deep notes accurately. This 'overhang' blurs the timing, draining the energy from the rhythm.

There are no such problems here. The Altairs and Xanda loudspeakers have a bass agility comparable to, in automotive terms, a Bugatti Veyron, or, that other Top Gear favourite, the Pagani Zonda. Combining this with the system's seductive musical fluidity, and a seemingly endless, seamless, fuss-free power delivery proves a winning combination.

Leema Acoustics has excelled itself in producing a reference system that lives up to its name and justifies its price tag in the most convincing way possible. It is nothing short of a reference benchmark for reproduced music.

[www.leema-acoustics.com](http://www.leema-acoustics.com)

World Radio History

sound investment



vinyl and moved wholesale to computer based music, stored in lossless FLAC format. Oh the convenience - but I do miss those little rituals of having to turn



**Van den Hul Frog moving coil cartridge - happy in a damp loft?**

the record over - really I do!

Anyway, now that I'm discovering the delights of high definition music downloads from the likes of Linn, Chesky and others, I'm trying to figure out how to get those, and other sources, played back through my stereo (no multichannel extravaganzas here - t'other half would kill me on the spot).

My Squeezebox (played into the DAC of my Lyngdorf TDAi2200) can manage 24/48 resolution - if I want more I'll have to invest in a Transporter or Linn. But how can I get music from Blu-ray, or HD TV into my digital-only input amplifier? I was bitterly disappointed to find that my £3,000 Pioneer plasma only had analogue audio outputs aside from HDMI. My PVR is feeding the amp via its optical audio output. Similarly my Sony PS3 (the cheapest way to get Blu-ray capability at the time) also uses an optical output as I've no HDMI inputs on the amp.

So my understanding is that the only way to get Blu-ray audio (heaven knows how many flavours that comes in) is via HDMI connection. Any other audio output from it will have be downsampled to 48/16 resolution over S/PDIF. And as far as I can tell, the only way to get an amp with HDMI inputs is to buy a multichannel receiver (which I don't want).

Have I got this right? Have we been led down the garden path of ever

changing platforms again? Is the fear of pirating ruining the show for the rest of us law-abiding citizens?

What I would love from you guys is a clear explanation of how people like me can get the highest quality source through a normal stereo set-up. A future article, please?

In the meantime the scarcity of optical inputs on my Lyngdorf means I have to employ optical S/PDIF converters. These little cigarette packet sized confections do the job, but with each having a separate mains supply, that means six extra boxes and three more mains leads to tuck away somewhere. What I need is a multi-way converter - one that accepts, say, 3 or 4 optical inputs, provides one or more S/PDIF outputs, and ideally switches to the driving source automatically. Is there such a beast? It's all so sad - really makes me want to ditch the lot and just play my new Cowon S9 which seems to do it all, albeit in miniature!

**Anon**

Yes, you're right, it's a big shambles and a stereo amp with HDMI input has yet to appear. One solution is to use an AV preamp like the new Onkyo PR-SC886 and run it in stereo by telling it no Centre or Surround loudspeakers exist, whereupon it will mix down to stereo. You can then take in multichannel high definition audio from Blu-ray and feed it out as stereo, to a valve power amp if you like, to end up with high resolution digital fed through a trad. stereo hi-fi. Okay, it's a hybrid system with solid-state front end containing more video processing than the Dreamworks Studio, but Onkyo provide an Off switch (Pure Audio) for all this! It is the only way I know to channel high resolution audio from Blu-ray using an HDMI link between player and amplifier (preamp in this case). Although S/PDIF is able to carry 24/192 stereo, I find from tests, and sometimes does from DVD players, I would not like to guarantee high resolution stereo from a Blu-

ray player would be channelled out through this link as it was not designed for such work and no standards exist. **NK**

**PIONEER PL-707**

Your recent debates on older direct drive decks prompted me to drop you a line. I have recently inherited from a relative, a Pioneer PL-707 turntable which is in fantastic condition, although no manual came with it, but there are other means of obtaining copies, I think.

My questions relate around the cartridge and cables. It still has the original cartridge, a Pioneer PC-6mc. Looking closely, the stylus appears slightly off centre, so probably a change would be required, but which would be suitable? Would it be worth trying to find the same cartridge or changing for a more modern MC? Not having the instructions at the moment doesn't help as I am unsure of adjusting VTA if it's an alternative cartridge.

Do you think it would be worth changing the captive mains lead and captive interconnect too? Anything else you could suggest to prolong the life of this turntable would be helpful as I know spares are almost non-existent. I would be running this through a Trichord phono stage going to a Mark Levinson 383 integrated to Diapason Adamantes (bit leftfield but it works for me).

I also have a Michell Odyssey turntable with Lyra Dorian so it will be interesting to run a back to back comparison of these two pieces of kit to see how they compare, although I think David's money would be on the Michell (rightly so).

My other sources are Nakamichi 670zx cassette deck, which is still working well and almost new tapes are still easy to find from Oxfam, etc.

Digital source is a Consonance CD120 player, which I was considering upgrading - any suggestions? These are all connected by JPS Labs cables which I picked up second-hand too (a bargain if you can find them) and are very good, although you never see any reviews of these. Musical tastes are varied from Soul to movie soundtracks!

**Raymond Hodge**

The PL-707 is an interesting design with a good arm. It should have a tidy performance. The PC-6MC is a high output type and would come nowhere near a Lyra Dorian. I'd suggest you consider a Dynavector DV-20XL or Audio Technica AT OC9 MLII, both moving coils. Alternatively, for a real cheapie just fit a Goldring 1022GX MM cartridge to get up and running. **NK**

Yes Raymond - I'd take the Michell Odyssey to be honest! The PL-

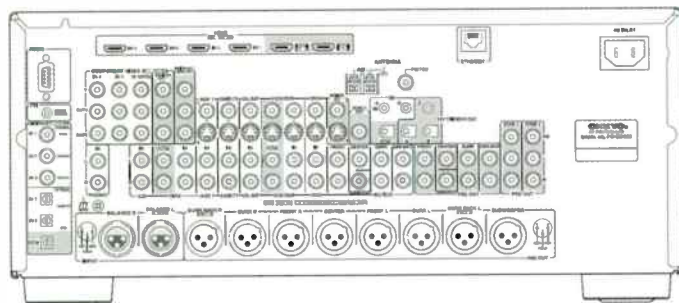

**Rear of the new Onkyo PR-SC886 AV preamp., with HDMI inputs at top and surround outputs at right (phono) and along the bottom (XLR) - a way to feed high resolution Blu-ray to a hi-fi.**

707 is a worthy design alright, but Pioneer's real class began to appear a generation later with the PL600X (the quartz-locked variant with independently sprung subchassis) and its high end brother the parallel tracking PL-L1000. At this point, I'd like to pipe up and say how alarming I think it is that Hi-Fi World seems to have started some form of Direct Drive mania, where everything that's thus aspired to now seems to be held in particularly high regard. I've seen people misquoting me on eBay, saying I recommend their cheapo, bottom of the range Technics DDs because I've praised the SLI200. So



**Pioneer PL-707 turntable - could be better says David. Fit it with a Lyra Dorian.**

remember - it ain't what you do, it's the way that you do it. The SLI200 happens to be a brilliantly well implemented mid-price example of the breed, but believe me there was an awful lot of dross, some of which is now being claimed to be amazing by its cynical sellers! All mass market DDs, Technics and a few others notwithstanding, were bright, hard and unsophisticated sounding devices, not too dissimilar in sound to those coarse 16bit, 2 times oversampling first generation Japanese CD players. Buyers beware... **DP**

### IN FOCUS

*Have you noticed that in some ways hi-fi has a lot in common with photography? The magazines which cater for these subjects start with news of the latest products, which focus (no pun intended) on price and specification. How important these are is a matter of conjecture...*

*Then come extensive equipment reviews. I find these helpful, and like to read and re-read them. Some I'll keep for reference. Even if I can't afford the equipment under review, I can still appreciate good craftsmanship and I enjoy reading the technical details. I like something to get my teeth into. Lots of words. A postage stamp size summary*

*is not satisfying. And like most people I suppose, I can dream.*

*Certainly it's good to have reviews you can trust, but they should be part of the buying and selecting process, not the whole. I'm amazed that people can buy equipment they've never seen/handled or heard simply on the basis of a good review. The internet has much to answer for in that respect. (I will dismiss internet user reviews as not worth looking at.)*

*So I do think they should be kept in perspective. One downside is they can make you worry about things you never knew you had to worry about. Bear in mind too that reviews often find fault with very expensive gear. Just to let you*

*know that what you may be tempted to buy can be bettered. No matter how satisfied you are today, soon you'll want to upgrade. And that's the thing about technology - There's Always Something Better Round the Corner!*

*However, let's not lose sight of the fact that in the main reviews of hi-fi and photography equipment are informative and useful. But there is a large difference. If I see the latest photographic equipment reviewed and I think it's worth a look, within a couple of months it's likely to be in high street camera shops. And where I live I have a choice of national chain stores and independents.*

*Not so in the hi-fi world. For a start hi-fi shops are not so prevalent, certainly on the high street. When you do find a shop with 'Hi-Fi' in its title, the chances are you'll find a shop full of flat-screen televisions and A/V gear. Oh, and you may find a mini system tucked away in a corner. Latest gear? No chance.*

*It's very frustrating and I believe the hi-fi dealers lose out by not having so many outlets for their products. Then I had a thought. With so many town centre shops closed down and empty now, surely some enterprising hi-fi dealer could take advantage and put hi-fi back in the high street?*

**Melvyn Dover.**

Internet reviews can be wildly variable and often very misleading. I have just read a long review of the Ortofon 2M Blue that described it's sound as "warm like a Shure". Huh? Historically they're miles apart; measure them and they're miles apart; listen to them and they're still miles apart! Yet other reviews can be very perceptive - it's difficult to tell bad from good.

Unfortunately, one of the reasons shops are emptying are due to high business rents and rates, combined with increasingly difficult access caused by traffic and parking restrictions. Something would have to change here before traders return, hi-fi outlets being as challenged by these costs and restrictions as any other operation. Heavens, if M&S are forced to abandon Torquay centre because parking difficulties limit custom at their food store, according to the Sunday Times, then there's little hope for others.

Cameras and hi-fi are often linked, although whilst camera technology steadily improves, hi-fi finds itself in an altogether different and more fragmented world, inhabited by slow moving digital technology and a revival of 'old' analogue. As much as I'd like to again see Medium Format pictures as lovely as those that came from our Mamiya cameras, after once wrestling with a Mamiya 6MF on the floor of a Kuala Lumpur hotel at a hi-fi show, trying to change its roll film, I think I'll be sticking with the convenience of digital.

The reverse situation exists with hi-fi. Today's AV receivers are so complicated they are virtually unusable and, as much as I love my Macs I have no intention of letting a fickle computer come between me and music. So the simplicity of LP it is! **NK**

It's fair to say that hi-fi retail in the UK is troubled, and this is for a number of reasons. As Noel states, there are practical issues preventing people getting to high streets now - mad one way systems, so-called 'traffic calming' blocking up back access roads and frenzied parking attendants impede access, as does the 'Congestion Charge' in London. Then there are the countless online reviews, written with much confidence, a catchy sub-plot ("the magazines don't want you to know just how good this is", etc.) and little in the way of actual knowledge or understanding. Then there are the forum posters obsessing on dealers in a negative way, calling them "stealers" and all trying to bypass



them by encouraging their friends to buy stuff about which there is a particular 'vibe' that week. Then there are the dealers themselves, struggling to make any money these days because of falling margins due to internet selling. It's a very sad time and my heart goes out to the good ones.

I've said this and I'll say it again - I wouldn't be into hi-fi at all had it not been for a visit to a great, now-defunct dealer in Oxford. They had no hard sell, but a lot of hard knowledge and experience. I do hope that if business prices drop (and rents/rates come down), that some new ones open up - and do what they do best - give customers a chance to make their own minds up in a congenial and unpressurised environment. Meanwhile guys - don't just 'give up' and buy online without hearing for yourself. Make a pilgrimage to a good dealer - even it means a long, hard drive. You'll really find it worthwhile - the amount of nearly brand new kit on eBay shows how buying online blind (by which I mean 'deaf') is a complete waste of money. **DP**



**How to keep people away from shops - charge 'em!**

### SPEAKER CHOICE

I need some expert advice on choosing a pair of new (reasonably priced) speakers to suit a budget system I bought nearly thirty years ago. Because the system is so old, all I seem to get from the dealers down here in Oz are suggestions to replace the whole lot - but as far as I'm concerned it still sounds excellent and has plenty of mileage left.

What's left of the system is a Rega Planar 3 with A&R P77 cartridge and a A&R A60 amp. The original speakers I had were Mordaunt Shorts, but they met with a tragic accident recently and are no longer with us. Any ideas?

**James**



**Usher S-520 loudspeaker, a budget favourite of ours.**

I'd suggest you buy a Goldring 1012GX to replace the A&R P77 which has likely seen better days. This will give you a very good turntable setup at a bargain price. For loudspeakers I suggest KEF iQ30s or Usher S-520s, the latter possibly costing less down under. The resulting system should sound very nice indeed. You certainly don't have to throw everything away, but you will notice improvement if you upgrade judiciously. **NK**

Quite right - go for the KEFs for a sharp modern sound, the Ushers for a smooth and balanced even sound, and consider the Q Acoustics 1050i floorstanders if you want a 'retro' sound that's big and full and enveloping. Any of these, plus the cartridge change (you could always go for the full monty and get a Goldring 1042 cartridge if you want the true spiritual successor to your P77) and some good speaker cables from Black Rhodium (the Tango being a personal favourite) - will give great rewards. **DP**

### S-EXPRESS

As a result of your excellent write-up of the Jelco SA-750D in the February 2009 issue of Hi-Fi World I am considering its purchase for use in a Garrard 401 installation. However, the Sound Hi-Fi RRP has since increased to £449 and at this price point I would be grateful to know whether, in your opinion, it would still justify an 'outstanding' (5-globe) verdict or be reduced to 4-globe status ('excellent').

I would also welcome your opinion as to both its technical suitability with the Garrard 401 turntable as well as any comments concerning the aesthetic appeal of such a combination in view of the grey toned finish of both products.

**Rod Hird.**

Rod, as far as I am concerned, the SA-750D is well worth the asking price of £449 and still merits a firm five globe recommendation.

It is a shame that the price has had to increase as a result of the good old pound crashing through the monetary floor, but given the performance of the arm I would still recommend it strongly.

If that isn't enough to convince you, then you might also like to know that in a mad moment of 'reviewer puts his money where his mouth is' I actually bought the review SA-750D from Sound Hi-Fi (luckily, before the price increase!) and have every intention of mounting it on a Garrard 401 myself. I have not actually auditioned the combination of the two yet, as my 401 was bought as a restoration job and is in a bit of a state at the moment, but given the smooth, fluid and insightful nature of the arm combined with the dynamic ebullience of the 401, I have a sneaking suspicion they will work quite well together, as well as looking rather smart. I shall report back once work is complete! **AS**

### POWER STRUGGLE

I live in Far North Queensland Australia and I look forward every month to your excellent publication. However I was a bit surprised to read your review on the Musical Fidelity A1 Class A amplifier. In the review you said the A1 was a full Class A amp, with 32 Watts per channel. Sorry guys, but this is just not true, as the A1 runs in Class A only for the first few Watts (which Musical Fidelity don't like to admit, but it is true), then switches to conventional class AB. The first indication of this is that the power consumption of the amp rises as the volume is turned up, which does not happen on a true Class A amp.

Secondly, it does not use anywhere near enough power for its output of 32 Watts to be running in pure Class A mode. I have built a number of Class A amps from scratch and also a kit amp which was really efficient for its 15 Watts per channel and it consumes 100W continuously. The better of my other amps runs at 46W per channel into 8 ohms and consumes half a kW



**Musical Fidelity A1 - not full Class A says reader Chris Allman. We liked it all the same.**

continuously! Power consumption and not enough heatsinks aside, no true Class A changes its power consumption with volume as the A1 does. It may well be Class A for a few Watts, but not up to its 32W per channel quoted. I don't have the data to hand, but I remember the A1's power consumption to vary with volume between 100W to about 170W for full volume. I am sure it is a really good amp as you said, but not a true Class A.

**Chris Allman**

Fair enough Chris. You are absolutely right about Class A drawing full mains power all of the time; they actually get (slightly) cooler when used, power being sent to the loudspeaker. We did not test mains current draw of the A1 and cannot comment on how much output is available in Class A operation, but assumed it is a large proportion as so much heat is generated from the high quiescent bias current, the Class A bit. It runs very hot! **NK**

**CURRY FAVOURITE**

I bought my first hi-fi around 1995 from Currys, yes, so predictable seemed the obvious path. I did alright mind you, it was a Kenwood KA-3020se amp/ DP-3080Mk2 CD and matching tuner KT-2080, and also some Tannoy Mercury Mk2s which I didn't realise were so good till I read your review regarding transparency on some Target stands. I enjoyed these for many years

then recently got back into hi-fi which I thoroughly enjoy and have spent my time experimenting with various pieces then passing them on.

My point is you really don't have to spend much to get some serious hi-fi. I bought a Technics SU-V500 at a charity auction for £2(!) then swapped this for a Musical Fidelity A1 which I spotted a chap using for music on a fairground ride! Then I picked up a Marantz CD6000OSE KI Signature for next to nothing and just recently obtained a pair of Yamaha NS-670 sailboat speakers from Oxfam for £15! They give my Tannoy DC2s at £650 a good contest.

For analogue I picked up a Thorens TD160 at a jumble sale for £2! But the

tuner ST-4950. Incidentally, would this be as good as the ST-5950 because it makes my Denon TU-260 seem inferior.

Also, do you know where I could get dust caps for some Robin Marshall R552s (£5!) as they sound very light sounding with no bass. Is this correct?

**Robert**

You're right Robert - there are lots of bargains to be had in 'grunge hi-fi'! Can't help you with the Monitor Audio dustcaps, but the Sony ST-4950 is virtually the same tuner as its more expensive 5950 bigger brother, save the useless and still-born Dolby FM facility. **DP**

**SOURCE ODYSSEY**

I am having a real problem in choosing a new phono stage to replace the WAD Phono 2. My system comprises a Dynavector 20X/H; SME IV tonearm; Michell GyroDec; WAD Phono 2; Audionote M3 Line stage preamp; WAD 300B PP Monoblocks; Audionote ANI/J speakers. Based on your reviews I've arrived at two lists of possibles, one using valves and the other solid state.



**Sony ST-5950 tuner, a real beauty.**

biggest disappointment was recently missing a full Sony system from late 1970s comprising TA-5650, PS-4000, cassette deck of similar stature and nineties CD player, but I did get the

All of these, bar one, have been highly recommended in the magazine and I would appreciate some guidance on how to choose between them.

The main valve contenders are:



**HOUSE OF LINN**  
Europe's Leading Linn Specialist.  
Do the tune-dem.

Owned and Run by Former Linn Staff  
[www.houseoflinn.com](http://www.houseoflinn.com) ▲ [info@houseoflinn.com](mailto:info@houseoflinn.com) ▲ +44 (0)161 766 4837

**The listening experience at house of linn is so good demonstrations last for hours.... Discover how we make music sound real in your home.**

Independently owned and operated by former Linn staff to give you the best Linn experience from **Komri to Classik.**

Call or email for appointment or advice. Visit our website for news and events.

Demonstration, Sales, Installation, Upgrades, Aftercare for all Linn Hi-Fi Components & Systems.

Room: **komri**



Icon Audio PS3; PhoNote; Minimax; Audionote M2 RIAA; or WD Phono 3. But I also wondered about a Naim Superline (+ HiCap), Naim Stageline (+ HiCap), Whest PS.30R; Emille Labs KPE-2AS; or Anatek. Although my system is currently all valve and music mainly acoustic, would a high quality solid-state stage fit well feeding the valves, rather than a step-up transformer and valve combination?

Also, how much difference does the step-up transformer make – Audionote have about eight different ones ranging from £400 to about £9,000 – am I likely to hear the difference? I'm also not clear about how much synergy there needs to be between a phono stage and the cartridge. For example, do some stages work really well with certain cartridges but are awful with others? Should I think in terms of cartridge-arm-phonostage-turntable as four parts of the same object that must integrate together?

I have the SME IV and GyroDec – therefore should I be thinking of replacing both cartridge and phono stage? I have about £4,000 to spend. I would appreciate your guidance on how to think this through.

**Ted**

Oh dear Ted – stop worrying! I suppose I should encourage you to spend, spend, spend just to keep U.K. PLC afloat, but I can't bring myself to be so cruel! In a nutshell, you already have a notionally ideal setup I feel and just need to tweak or tune it perhaps. I strongly advise you not to replace the popular transformer/valve front end with transistors as this is a retrograde step, and for no good reason. By all means get a WAD Phono 3 and tweak it with boutique components, including top notch valves - perhaps New Old Stock, known as NOS. Alternatively, if you don't want to tweak, get an Emille Labs KPE-2AS, which is a cut above most.

I can't comment on the Audionote transformers because I have not heard them, but I doubt they'd be anything less than impressive. You could well upgrade the Dynavector DV20X/H however. A Lyra Dorian might suit I suspect. **NK**

I can't say I am a fan of your loudspeakers, but given that your equipment list is very impressive and shows real subtlety of taste, I suspect you had your reasons for choosing them! Each unto their own! Anyway - Noel's right inasmuch as you're not far off vinyl nirvana already, but there are a few things I'd point out. First - the GyroDec is a joyous thing to own, but the Michell Orbe sounds



**World Design Phono 3, a great sound from LP and easy to tweak.**

considerably better - and your system is good enough to showcase this. So - sell the Gyro, buy an Orbe SE (and ask if Michell can do you a silver one to match your SME Series IV)! Then get yourself an Ortofon Kontrapunkt B if you like a balanced sound, or a Lyra Dorian if you want a very peppy one - both are superb moving coils and way better than your Dynavector, but differ in presentation so make sure you've thought about it carefully. I would then go for an Icon Audio PS3, which would suit either way and make for a sublime vinyl front end. **DP**

### MUSIC OF THE SPHERE...

Goodness me, a double edged attack from both DP and NK in January's Letters on the poor little Denon DL103. Now I am not saying the '103 is my favourite cartridge, but I do have quite a lot of respect for it, and feel the urgent need to defend the little fella.

Okay, the problems: spherical stylus. Surely there is a bit more to it than that, such as polish and finish, actual size of the stylus tip, and how it is mounted to the cantilever? All of which are exemplary in case of the DL103.

Tracking weight; I admit 2.3 grams plus sounds scary, but again actual stylus size and quality is far more relevant. And the Denon scores very high there.

I think these two so called 'problems' are a bit talked up (deluded?) and are not really an issue. What does let the Denon down are a resonant plastic body and the real thorn in its side is its need for a high mass arm.

On paper it is not such a low compliance cartridge, it weighs 8.5 grams, but the realities are that it needs the high mass of something like an early (non improved) SME, and really feels at home in the 3012 version, as it does in old and crusty high mass arms such as the Audio Technica broadcast arms; AT-1503 and ATP-12, Fidelity Research FR64, etc...

Without the 'mass' behind it, a DL103 is flat, dry and frankly boring to listen to. With the 'mass' the Denon cartridge takes on a weight and authority that challenges even the mighty (now let's get Noel seriously upset!) Ortofon SPU.

Putting a DL103 in something like a stock Rega would be dreadful. In its homeland this cartridge is the choice, along with my beloved SPU (now let's get NK seriously upset!). Nigel's combination of SME 3012 and DL103 is a de facto choice for a lot of audiophiles across the globe.

Technology wise, well, we would never use a pre WWII directly heated triode in an amplifier, or a 60 year old plus idler wheel drive system on a turntable would we? How about valves in a tuner? No never!! Especially now we have 'perfection' with all this digital stuff.

Having pulled many cartridges apart (due to my incredibly nosey nature) the Denon is incredibly 'modern' despite its 1960s underpinnings. The real balance is cost; one hundred of your English pounds buys one. Frankly, for that it is more than a bit of a bargain; over half a million have been sold! There are more refined styli and cartridges knocking about, but not at this kind of price. I admit, I own about seven different versions, but the DL103 remains a sub £100 bargain.

**Anon**

Your last observation is spot on "the DL103 remains a sub £100 bargain". Anything above, it becomes challenged by more modern designs. It's an internet special that's fun for the impecunious, or the addicted. Seven different versions? That's worse than bigamy, known as septgamy I suspect (but readers will correct me on this I feel!). **NK**

I hope you avid Denonites love your families as much as you love your little hundred quid sphericals! **DP**



**TEAC makes great claims for its Reference 380 mini system, and Paul Rigby finds himself duly charmed...**

# Black Magic?

**F**or those who might recoil at the sight of a bulbous and Dalek-like valve amplifier ruining the delicate lines of their living room, then a mini system might be the answer [are there really such people on Earth? Ed]. They're neat, visually appealing, integrated, easy to set-up and use. The downside has often been that, to achieve these highlights, at a low price point, sound quality has been made to suffer...

Arriving as a three-box set, the

TEAC's intention is to buck that trend. Consisting of a A-H380 stereo amplifier, a PD-H380 CD player and a T-H380DNT tuner which handles FM/AM, DAB and Internet radio, both the CD player and tuner measure 215x93x305mm (HxWxD) and weigh 2.3kg and 2.8kg respectively. The amplifier is chunky at 215x110x312mm and weighs a sturdy 4.2kg to boot.

Starting with the 45W (across 6 Ohms) amp, which arrives with a well made remote, featuring a six-input selector, mini-headphone socket and

tone controls, what surprised me was the dual-mono internal construction that duplicates the circuitry for each channel, speaker binding posts as opposed to spring-loaded wire connectors and a rear-mounted, 18-pin, connector for an optional TEAC iPod dock [pictured]. The CD player features a decent one-bit DAC, and there are nice little touches too such as the rubber dust cover for the front-mounted USB port. The tuner, including a fold-away Wi-Fi aerial, features a Frontier Silicon Venice 6



DAB/Internet radio chip, which will be familiar to Pure users.

**SOUND QUALITY**

Replacing the bell wire interconnects with a set of Chord Anthem 2s improved the sound dramatically, so I kept these for the duration of the review – even though I appreciate that typical users would retain the stock cables, or if possible upgrade to something more affordable like QED 79 strand. I also used a range of loudspeakers, including John Blue JB4s (£625) and Spendor S3/5Rs (£725) on

output, easily delineating between both WAV and 320kbps MP3 output.

Moving onto the FM radio, I was surprised how good the performance was, with a refined and authoritative display via Radio 3 and an upfront and dynamic portrayal from both Radios 2 and 4. The only downside was the intrusive hiss from all but the strongest station signals. DAB, with a roof mounted aerial, sounded confident. Planet Rock was lively, often punchy.

The Internet radio was easy to set up even with my PC router being

vocals were handled with aplomb.

Finally, if you can, grab the optional iPod dock. A heavy duty item complete with a Video Out socket. Yes, the iPod output is not as convincing as CD but, for an extra £25 users of the polycarbonate peril will find it very worthwhile.

**CONCLUSION**

A good value package, the TEAC Reference 380 is reasonably priced, packed to the gills with features and actually sounds excellent for what it is. The only problem is that it rewards spending an equivalent amount on loudspeakers and cables, so suddenly the fuss-free 'one stop solution' nature of the package is lost - well, at least if you're an inveterate tweeker like me, and just can't seem to get enough!

"reasonably priced, packed with features and actually sounds excellent for what it is..."

Atacama HMS I stands.

The TEAC's little CD player may not have the broad soundstage, resolution or intensity of a more expensive separates system but, depressing the amplifier's Tone Dir button to bypass the tone controls (which immediately triggered a sense of extra dynamism and air) and hooking up a pair of the JB4s proved an excellent match for jazz recordings. Via Carol Kidd's 'How Long Has This Been Going On?' (Linn), there was admirable midrange sparkle with vivid acoustic guitar.

The TEAC, armed with the Spendor's warm, civilised tones, managed to easily tame chart-based, peak limited CDs and, while spinning Can's 'Yoo Doo Right' via Monster Movie (Mute), showed full, tight bass for the price plus control over the full volume range. They were equally adept at handling the USB port

on the other side of the house. The station list was grouped by country and musical genre and play was relatively responsive with fine quality from 128kbps streams and up. However, I would have like to have seen a larger display screen. The current model is a bit cramped. You are also able to play tracks directly from a computer via the Wi-Fi network. For the price, the phono stage was a delight and hugely entertaining. Yes, 'The Yes Album', via the Spendors offered pleasantly shimmering cymbals whilst complex



**VERDICT** ●●●●●

Packed with features, the well engineered Teac offers both value for money and an impressive performance across all sources.

**TEAC REFERENCE 380** £499

**TEAC UK**  
 ☎ +44 (0) 845 130 2511  
 www.teac.com

**FOR**

- overall sound quality
- wireless connectivity
- build quality
- value

**AGAINST**

- restricted Internet display

**MEASURED PERFORMANCE**

The Teac A-H380 amplifier produces a useful 50 Watts per channel into 8 Ohms and 72 Watts into 4 Ohms, so it will run loud, if not to disco levels, much depending upon loudspeaker sensitivity as usual. Distortion was kept to a low level even at high frequencies and was primarily second harmonic in nature, an encouraging result that suggests the amplifier will have an easy quality to its sound. The MM phono stage has very low hiss, accurate equalisation and an interesting warp filter that boosts deep bass a little (+0.6dB at 30Hz) but suppresses warps around 5Hz by -8dB to reduce loudspeaker cone flap.

Frequency response of the CD player rolled off gently at high frequencies, measuring -1dB down at a low 15kHz, enough to give an easier sound than most, without the usual brightness. It will not sound overtly warm or dull however. Unfortunately, distortion on one channel measured a high 2.8% at -60dB, whilst the other measured a more normal 0.37%. Jitter was very low from the digital output so an external DAC would benefit performance.

The VHF/FM tuner rolls off early at high frequencies, measuring -1dB at 3kHz - enough to soften its delivery. Distortion was low at 0.18% at 50% modulation and hiss was very low at -72dB with a 0.85mV aerial signal, or higher. A pilot tone filter suppresses 19kHz mpX. Sensitivity was good, 38uV needed from the aerial for 50dB hiss on Stereo.

The Teac H380 provides good results in most areas. It has been tailored to sound smooth and inoffensive, rather than bright and edgy. NK

Power	50 Watts
Frequency response (Direct)	8Hz-34kHz
Separation	86dB
Noise (A/D, Direct)	-94dB

Distortion	0.02%
Sensitivity	200mV
Damping factor	30
<b>CD/DVD/SACD</b>	
Frequency response	5Hz-15kHz
Separation	98dB
Noise	-123dB
Distortion (-60dB)	2.8%
<b>Disc (LP)</b>	
Frequency response	14Hz-40kHz
Separation	78dB
Noise	-82dB
Distortion	0.02%
Sensitivity	3mV
Overload	110mV
<b>VHF TUNER</b>	
Frequency response	15Hz-3kHz
Stereo separation	50dB
Distortion (50% mod.)	0.18%
Hiss (CCIR)	-72dB
Signal for minimum hiss	850uV
Sensitivity (stereo)	38uV

**VHF/FM FREQUENCY RESPONSE**

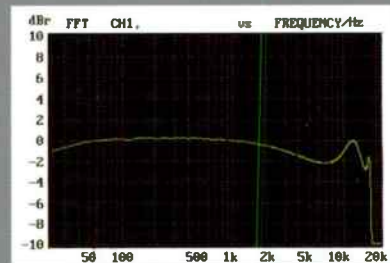

**AMPLIFIER DISTORTION**

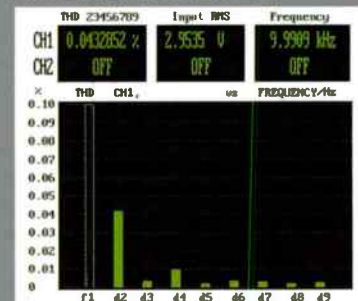



# MOON CD3.3/i3.3

Classic styling, class leading performance.

Multi-award winning CD players, phono stages, integrated, pre and power amplifiers from Canada's finest – Moon Electronics.

DISTRIBUTED IN THE UK BY RENAISSANCE AUDIO – [WWW.RENAISSANCEAUDIO.CO.UK](http://WWW.RENAISSANCEAUDIO.CO.UK)



CHESHIRE  
DOUG BRADY HI-FI  
01925 828009

CO TYRONE  
KRONOS AV  
0288 7753606

DEVON  
AUDIO DESTINATION  
01884 243584

EDINBURGH  
LCLD & CLEAR  
013 555 3963

ESSEX  
RAYLEIGH HI FI  
01268 779752

GLASGOW  
LOJY & CLEAR  
0141 221 0221

GLOUCESTERSHIRE  
CERITECH AUDIO  
0844 7365719

LONDON  
O'BRIEN HI FI  
0208 9460331

## AWARD WINNING RINGMAT PRODUCTS

Ringmat is the world's leading supplier of products that are truly designed to improve sound and picture quality in hi-fi and home cinema systems.

All Ringmat products are of unique design and tackle distortion problems in a manner that is quite different from all other attempts. We do not just create products if satisfactory solutions are already available.

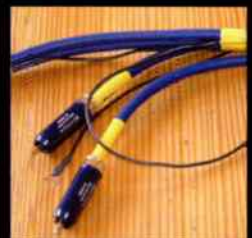

RINGMAT and RINGMAT SUPPORT SYSTEM  
Use this modular system on every flat turntable platter



STATMAT CDi BLUE  
Use a Statmat for playing all CDs and DVDs, other than with multi-disc players



Statmat CDi Blue  
Ultimate Guide to Home Cinema 2004

VIVACITY AR ANTI-RESONANCE PLATFORMS  
Use VIVACITY AR Platforms under all equipment to free the sound, and pictures, from resonance and vibration based distortion

RINGMAT FEET, DOMES AND SPIKE STOPPERS  
Use these Ringmat products for the most effective means of isolating your hi-fi and home cinema equipment

RINGMAT MAINS LEADS, INTERCONNECT, TONEARM and SPEAKER CABLES  
Use Ringmat cables for the cleanest transfer of signals, from power source to speakers

RINGMAT DEVELOPMENTS PO BOX 200 BRENTWOOD ESSEX CM15 9FB  
++44(0) 1277 290 210 [WWW.RINGMAT.COM](http://WWW.RINGMAT.COM)



# Sweet Sixteen



Haden Boardman reassesses the classic nineteen eighties Japanese-built Philips and Marantz multibit CD players...

It has not escaped my notice that demand for the classic late nineteen eighties Japanese designed Marantz CD94 CD player seems to be on the rise, with prices for what is now a twenty two year old-plus machine going through the roof. So, with that in mind, we thought the CD94 and its variants warranted closer investigation...

Sold in the UK from 1988, both the Philips CD960 (Marantz's then parent company) and the CD94 share the same basic architecture and design. This includes the classic Philips TDA1451 dual multibit digital to analogue converter, the SAA7220 over sampling filter, tuned CDM1 swing arm mechanism, massive power supply and diecast aluminium chassis with 10kg weight.

Cosmetics and ergonomics differed totally. The Marantz unit originally sold at £800, the Philips at £700. Stylewise, the wooden end cheeks of the Marantz win the style war in my opinion, while the control panel of the Philips is much better thought out. The only real electrical

difference between the two concerns the DAC chip; in the CD94 you find the first use of the "A" version of the TDA1451, which the Philips misses out on. Other than that they are near identical, although the Marantz does look much more than one hundred pounds worth of extra money!

A short time after the launch of the main machines, a separate digital to analogue converter box was launched by both brands (spot

the rare matching DAT recorder!) Using the same diecast chassis; with a similar sized power supply (just to supply the DAC!) both the Marantz CDA94 and Philips DAC960 used a new S1 version of the TDA1451A chip, the so-called Single Crown version. Both the A and the S1 offer more refinement than the standard TDA1451. These DAC boxes also offered variable output and balanced XLR output. Cosmetics again differed, but internally I can see no differences.

Based on the same double box chassis was of course the classic Limited Edition Marantz CD12 (and the not-sold-in-the-UK Philips LHH-1000 version, identical except finished in moon silver rather than champagne gold). It had a superior power supply, more copper shielding internally, better op-amps, better capacitors, zinc side cheeks and vitally, the top of the line selected Double Crown TDA1451A S2 DACs - but the same old circuit...

to a CD94/II in a single box CD12 style enclosure. And to complete the set, the CD99, a transport only, half a CD12!

By 1990, Philips had launched the so-called DAC7 bitstream DA converters, which offered a totally different sound from the previous TDA1541 (and its predecessor the 14bit TDA1540). Also, the Dutch giant was one of the first to feel the nineties recession, and it was the end for high-end machines, even the classic metal swing arm mechanism disappeared.

Marantz in Japan did develop the TDA1451 concept further though; there was the Special D Limited DAC which sold only in Japan (1996, with no matching transport) and one we did get to see here, the CD7 (1999), both using a similar circuit based around a balanced output and a pair of Double Crown TDA1451A chips. (I must confess, having done a lot of listening to various D-A convertor

"what marks the machine out is the way it is built, the attention to detail, the tweaks and the overall performance achieved..."

A CD94/II was launched at the end of the decade, which used a pair of TDA1451A Single Crown DAC chips in a balanced configuration, with completely new audio output section (surprisingly not offering balanced audio outputs). In Japan a version of the CD94 was launched in gold rather than black, called simply CD94 Limited; I suspect this machine also used the Single Crown DAC chip. Not often seen in the UK is the CD95, which is electrically identical

chips, I have yet to find anything that can beat either the TDA1541A or the Burr Brown PCM63K. I remain unconvinced about Bitstream, the similar PWM (MASH) or the Sony Linear variant.) The most common machine in the UK is the CD94, followed by the CD960 and CD94/II.

In terms of technology, there was nothing remarkable about the circuit or the design. In fact the capacitor-coupled output stage of the Mk I machines can be traced back to

innovative scandinavian loudspeakers



Ranger model

 symmetry

T: 01727 865488

e: [info@symmetry-systems.co.uk](mailto:info@symmetry-systems.co.uk)

w: [www.symmetry-systems.co.uk](http://www.symmetry-systems.co.uk)

**f·cross**  
rigidity redefined

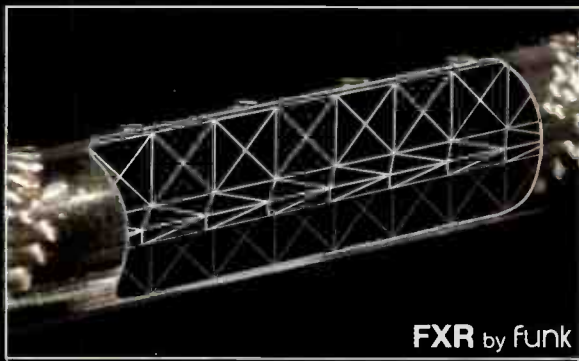

FXR by funk



**the FUNK firm**

[www.thefunkfirm.co.uk](http://www.thefunkfirm.co.uk)



the original Philips CD100 of 1983! What marks the machine out is the way it is built, the care and attention to detail, the tweaks, and the overall performance achieved.

In use these machines are smooth, slick and simply beautiful. The diecast CDM1 is enclosed in a special Japanese designed draw mechanism which operates promptly and smoothly. The machine is quiet in operation (although all CDM mechanisms do make a bit of a chirping noise it does have to be said), but track access is not as fast as some competitors. The quality of the anodised enclosure and the general fit and finish, are simply superb.

**SOUND QUALITY**

So just how does a classic CD94 stack up today? Well I have to be honest - straight up, the CD94 was a mild disappointment. Compared to the CD12, the machine sounded flat. Despite a very similar circuit, the '12 was in a different league. This should come as no surprise, as the '12 was two and half times the price back in the day, but somehow I expected the CD94 to be very much at a similar game, given the very similar architecture.

Comparing the machine to a shiny new Cyrus CD8SE was a bit like comparing chalk and cheese. The Cyrus threw detail at you in comparison to the vintage Marantz. Playing ABBA's 'The Day Before You Came' showed the older machine to have a rock-solid three dimensional image that the newer Cyrus machine missed out on completely, while the bottom end extended further down the frequency range. On midrange and treble detail and definition the Cyrus won convincingly though, both machines offering a totally difference perspective on the sound, with Agnetha's voice changing character to a larger extent than one might have expected. Long term listening favoured the more laid back Marantz, but I did keep longing for a little more detail!

The MkI CD94 and CD960 can still hold their heads up high. Comparing these units to a Technics SL-P1200, and a Sony CDP502ES from the same era was a shock. The Sony was wiped out by all, it simply did not compare, the Technics was just pushed into third place. (Of note is that a year later Sony actually used the TDA1541 on the '502 replacement, the CDP555ES.)

Hooking up the CDA94 DAC to the rear of a CD94 seems to make little difference. There is a lift in detail, but it is tiny given the expense. Too many similarities between the two.

Common to all Philips/Marantz machines offering variable output, this is quite poor, best avoided. Similar to the CD12, the balanced output is not as hot as the fixed level phono output, as it sources the signal from the single ended output, you are listening to an extra chip and transformers for no real reason.

Both the Mk I CD94/CDA94 could benefit from further DIY modifications. Decent quality mains leads have a huge effect, as does fitting a clock and matching power supply. Biggest upgrades can be had from replacing the entire audio output; frankly the chips fitted are poor, and the entire audio circuitry lets the rest of the machine down badly.

The Mk II '94/CD95 tackles the audio output problem head on. A sub-board is fitted on to which are the two TDA1541A SI DAC chips, operated in a balanced push-pull mode to eliminate any errors in the conversion process. Sadly the audio signal is stuffed through half a dozen chips, and similar to the Mk I machine, a capacitor-coupled output stage. There is a clear stepped and significant improvement to the Mk II, it sounds wider, deeper and more detailed than the Mk I. Again, compared to a more modern machine there is an apparent lack of detail; but the detail is there this time; but the darker tonal balance does mask this to some degree.

These machines are pretty bullet-proof, but oh, did I mention the belts? The slick, smooth loading mechanism uses a selection of 'no longer available' rubber! Similar sized units are available from parts supplier CPC, but the thickness of the belts is not quite right, and with these new belts fitted, the operation of the loading mechanism does become a tad sloppy. (Rumour has it the original belts where actually from Panasonic, an avenue I am currently investigating; more to follow!) A good cleaning of the loading mechanism, fresh (light) oil can usually keep the mechanism loading correctly, even with the original belts. The CDM1 lasers seem to last for ever, you are more likely to find a servo drive fault to the disc spin motor than anything else.

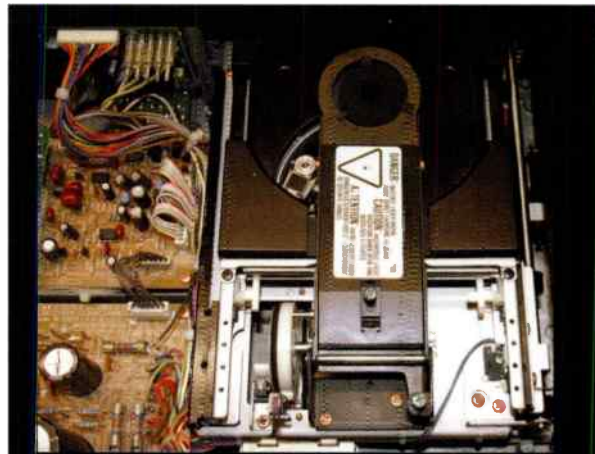

Diecast CDM1 mechanism common to all; note the troublesome loader belt to the left...



Substantial power supply and twin Single Crown DAC board of CD94/II.

**CONCLUSION**

These classic machines are beautiful to behold. They use what is considered one of the best CD pick-up mechanisms ever made, the CDM1. The DAC chips are established classics, especially the Crown S1s fitted to the CD94MkII, CD95 and the CDA94/DAC960. Value wise, it is hard to stick a price tag on these units. Demand clearly outstrips supply, especially for a clean CD94/II. Value for money is not high, especially compared to the throwaway prices the lesser Euro models from the same era sell for, but most Euro models also have throwaway build. A good clean example of our 'Made in Japan' machine should carry on performing fault-free for many a year; but these machines are fast getting on for a quarter of a century old, with practically no parts back up, so buy with caution...



# THE IDEAL ANTIDOTE

VISIT OUR WEBSITE: [www.hi-fiworld.co.uk](http://www.hi-fiworld.co.uk)

## UK SUBSCRIPTION SAVE UP TO



# 12.5%

**SAVE UP TO 12.5%** off the cover price when you subscribe to Hi-Fi World. That's an amazing £3.33 per issue, including postage.



FOR BACK ISSUES ENQUIRIES PLEASE CALL

**01442 879097**

OVERSEAS SUBSCRIPTIONS IF YOU LIVE OUTSIDE THE UK,  
PLEASE CALL FOR OUR LATEST PRICES

**+44 (0) 1442 879097**

**SO WHAT ARE YOU WAITING FOR? CALL NOW!!!**

**SUBSCRIPTION HOTLINE 01442 879097**

Lines open Mon-Fri 9.00-5.00 or (weekend answering service available)

FOR OUR  
ON-LINE MAGAZINE  
SEE P120

email:  
[hifiworld@webscribe.co.uk](mailto:hifiworld@webscribe.co.uk)

Fax No:  
01442 872279



# TO WINTER BLUES!

## WHY SUBSCRIBE TO HI-FI WORLD?

- 12 issues a year delivered straight to your door.
- Be first to grab a bargain in our "Free Reader Classified Ads" section.
- Run by dedicated hi-fi engineers and enthusiasts.
- Subscribers receive a minimum 10% Discount annually.
- Hi-Fi World has become famous for its informative reviews and radical kit designs.
- **PLUS!** Subscribe by Direct Debit and receive a 12.5% discount (UK only).

### Instruction to your Bank or Building Society to pay by Direct Debit



Please fill in this form and send to:  
Hi-Fi World, Webscribe Ltd, PO Box  
464, Berkhamsted, Herts., HP4 2UR

Originator's Identification Number

4	2	7	0	4	9
---	---	---	---	---	---

#### Name and full Postal Address of your Bank/Building Society

To: The Manager Bank/Building Society

Address

Postcode

Name(s) of Account Holder(s)

Branch Sort Code

Bank/Building Society Account Number

Reference

HF

#### Instruction to your Bank or Building Society

Please pay Webscribe Ltd Direct Debits from the account in this Instruction subject to the safeguards assured by the Direct Debit Guarantee. I understand that this instruction may remain with Webscribe Ltd and, if so, details will be passed electronically to my Bank/Building Society.

Signature(s)

Date

Bank and Building Societies may not accept Direct Debits Instructions for some types of accounts

**The guarantee should be detached and retained by the Payer**

#### The Direct Debit Guarantee

- This Guarantee is offered by all Banks and Building Societies that take part in the Direct Debit scheme. The efficiency and security of the Scheme is monitored and protected by your own bank or Building Society
- If the amounts paid or the payments dates change Webscribe Ltd will notify you 10 working days in advance of your account being debited or as otherwise agreed
- If an error is made by Webscribe Ltd or your Bank or Building Society, you are guaranteed a full and immediately refund from your branch of the amount paid
- You can cancel a Direct Debit at any time by writing to your Bank or Building Society. Please send a copy of your letter to us.



I would like a years subscription to Hi-Fi World and receive a discount off the cover price (I have read and accept the terms and conditions).

I would like to pay for my 12 issues by:

6 monthly Direct Debit: Pay £19.95 every 6 months saving 12.5% off the yearly subscription rate of £45.60

Annual Direct Debit: Pay £39.90 every 12 months saving 12.5% off the yearly subscription rate of £45.60

Annual cheque/credit card: Pay £41.04 saving 10% off the yearly subscription rate of £45.60

**Cheques made payable to Audio Publishing Ltd.**

#### Your Details

Title \_\_\_\_\_ Forename \_\_\_\_\_

Surname \_\_\_\_\_

Address \_\_\_\_\_

Post Code \_\_\_\_\_

Daytime Tel: \_\_\_\_\_

Email: \_\_\_\_\_

Please debit my  VISA  MASTER  MAESTRO  AMEX (SWITCH)

Security No:    (last three digits printed on the signature strip)

Valid from Date: \_\_\_\_/\_\_\_\_/\_\_\_\_ Expiry Date: \_\_\_\_/\_\_\_\_/\_\_\_\_

Switch card issue No:

Cardholder Signature: \_\_\_\_\_

#### Outside UK:-

**EUROPE** Airmail **£50.00**

**OVERSEAS** Airmail **£70.00**



## Send this form to:

Hi-Fi World, Subscriptions Department PO Box 464, Berkhamsted, Hertfordshire, HP4 2UR.



## SALE LIST

### Huge Reductions on new & used Linn Equipment

Product	Finish	List Price	Condition	Sale Price
Majik 140 (Floor-Standing Speakers)		£1,475.00	D excellent	£795.00
Unidisc 2.1		£4,730.00	D excellent	£1,995.00
C6100 6 channel power amp (aktiv boards option)		£2,420.00	D excellent	£1,295.00
Classik Music	Black	£995.00		£547.25
Classik Music (new style)	Silver	£1,250.00	mint as new	£795.00
Katan	Maple	£750.00	cosmetic damage t to tweeter grill	£295.00
Katan	Cherry	£750.00	new boxed	£525.00
Trikan	Maple	£570.00	dem good	£290.00
Sizmik 120 sub woofer	cherry	£1,200.00	good,some marks	£495.00
Komponent 120 sub woofer	Grey	£575.00		£295.00
Komponent 104 (pair)	Graphite	£390.00	D good	£235.00
Akurate 242	Rosenut	£6,040.00	D, Good some marks on cabinets	£2,999.00
Complete set of 10 mono 242 Aktiv Cards		£950.00		£570.00

### ARCAM

CD36	Silver	£1,450.00	D v. good	£749.00
T51 FM tuner	Silver		D v. good	£69.00
T61 FM tuner	Silver		D v. good	£79.00
MS250 400gb music server	Black	£3,000.00	D as new	1395.00

### ARCAM AV

AVR300	black	£1,300.00	D v. good	£295.00
Arcam FMJ DV139 upscaling dvd/cd	Black	£1,850.00	D & new boxed	£995.00
Arcam AVR 280	Silver	£1,250.00	D good	£395.00
Arcam FMJ AVP9 Processor	black	£3,750.00	D good	£1,695.00
Arcam FMJ P7 power amp	black	£2,900.00	D good	£1,589.50
Arcam AVP700 processor	silver	£1,450.00	D v good	£895.00
Arcam P1000 7 channel amp	silver	£1,700.00	D v good	£995.00
Arcam DV135 dvd/cd	silver	£900.00	D v good	£295.00

### CYRUS

CD 8X (silver)	Silver	£1,000.00	D v.good	£499.00
CD XT (Silver)	Silver	£800.00	D v.good	£399.00
Discmaster 8.(silver)	Silver	£800.00	D v.good	£399.00

### KRELL & AUDIO RESEARCH

Audio Research SP16 pre amp	Silver	£2,249.00	D v.good	£1,395.00
Audio Research WS 55 valve power amp	Silver	£2,499.00	D good	
			some marks	£1,495.00
Krell Showcase Processor	Silver	£4,495.00	D good	£2,395.00
Krell Showcase 5 channel power amp	Silver	£4,999.00	D good	£2,795.00
Krell Showcase DVD	Silver	£3,698.00	D good	£1,995.00

### MARTIN LOGAN

Martin Logan Summit	cherry	£9,000.00	1 yr Excellent	£3,995.00
Martin Logan Summit Electrostatic speakers	cherry	£9,000.00	D v.good	£4,495.00
Cinema Centre Speakers	Black		used	£200.00

### AV COMPONENTS & MISCELLANEOUS

Denon AVR2106 Receiver	Silver	£450.00	D. Good	£200.00
Denon AVR2807 Receiver	Silver	£799.00	D. Good	£479.00
Denon AVR 2106 Reciever	Silver	£450.00	D. Good	£259.00
Denon S-301 AV system	Silver	£1,250.00	new boxed	£789.00
Denon S-101 AV system	Silver	£850.00	D. Good	£495.00
Denon DVD 2910 dvd with hdmi/scaling	black	£600.00	D. Good	£249.00
Pioneer LX01 AV system inc spks,hd recorder	black	£1,699.00	D,vgc almost unused	£995.00
Pioneer LX 70 Blu-Ray		£995.00	D. Good	£395.00
Pioneer DV868 DV hdmi		£795.00	new boxed	£295.00
Acoustic Energy Aelite 3 speakers	cherry	£749.00	dem good, some marks	£299.00
Acoustic Energy AE120 floor standing speakers	black	£450.00	dem good	£150.00
Acoustic AE73DS		£350.00	new boxed	£229.00
Monitor Audio S5 light oak	light oak	£450.00	dem good	£200.00
Mission 773 floor standing spks	light oak		dem good	
			some marks	£150.00
Mission 78 DS rear effects dipole spks	blk/Lwood	dem good		£100.00

D = EX Demo

HiFi, Multi-Room and Home Cinema with full Design & Planning service

161 OLD BROMPTON ROAD LONDON SW5 0LJ

TEL: 020- 7244 7750/59 FAX: 020 - 7370 0192

[www.thelisteningrooms.com](http://www.thelisteningrooms.com)

E-mail: [john@thelisteningrooms.com](mailto:john@thelisteningrooms.com) Mon-Sat 10-6pm



BRITISH DESIGN AND ENGINEERING AT ITS BEST

After 35 years, Michell is still a family run business with a team of dedicated and proud craftsmen, producing quality turntables and accessories



Orbe SE

The Michell flagship for music lovers who are not prepared to compromise

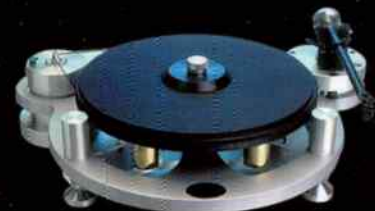

Gyro SE

The classic Michell turntable, refined over many years of development to its current level of performance.



TecnoDec

Entry level turntable incorporating features from the classic Gyro

  
MICHELL ENGINEERING

J A Michell Engineering Ltd  
2 Theobald Street, Borehamwood,  
Hertfordshire, England, WD6 4SE

Telephone: 020-8953 0771

Fax: 020-8207 4688

[michell-engineering.co.uk](http://michell-engineering.co.uk)



Andrew Harrison spends time getting to know Naim's HDX hard disk-based music player, now augmented with a Naim XPS power supply...



# Power Plus

**B**ack in November's issue of Hi-Fi World, editor DP reviewed Naim Audio's controversial new computer audio jukebox, the HDX, and loved it - but not everyone agreed. Web forums have been full of naysayers, bemoaning the fact that two of the company's central tenets have been broken, namely thou shalt not include a digital output, and thou must beware of switch-mode power supplies. For Naim based its HDX music server on a Windows PC, replete with micro-processors, switch-mode power supply and digital outputs...

Of course considerable attention paid to sort out the rough edges of PC sound, so much so that I won't be giving too much away to state my feelings after a month of living with the HDX. It fully deserves its place as one of the finest sounding music servers on the market today.

Using any Windows PC as a music server is relatively trivial these days. Even clunky old Media Player will let you import as much digital music as you've got disk space for. The real trick behind turning a PC into a domestic music source like the HDX is threefold - to maintain easy jukebox functionality without a monitor, mouse and keyboard; to keep the acoustic noise of a creaky Windows box from intruding on the listening experience; and to sidestep all the computer processing grunge that will reduce your lossless music's quality to the level of internet radio.

Naim has worked hard to push the envelope of PC sound, using a trusted PC motherboard of industrial pedigree to sidestep the pain of having to respecify a new version in the fast-moving churn of IT

parts. The Seagate 3.5in hard disks - two of them, 400GB each, the second a mirror of the first for automatic backups - were chosen for their promised long-life and low noise output. And the all-important soundcard has been developed in-house by Naim to ensure it performs as a pedigree audiophile component.

To fly the HDX, all without having to see its underlying Microsoft Windows XP Embedded foundation, you navigate its imported CD library from the front touchscreen panel, or control it remotely using another PC loaded with a DeskTop Client (DTC) program, based on software from DigiFi. That touchscreen will do the trick, but I found it distinctly unsnappy, and far removed from the tactile navigability we expect of, say, an iPhone. It gets the job done, but lacks *élan*. So, tired of fiddling with the small screen, I turned to DTC. This has its own problems, starting with installation glitches on Windows XP, a lack of official support for Vista 64bit, and a layout that was last thought cutting edge with Windows 95. In a modern world of interactive graphics, the Naim DTC interface has all the allure of an Excel spreadsheet...

Importing CDs is seamless after disc insertion, with track info and cover art often coming over a (wired-only) network connection from AMG's online database. But woe betide you if your albums aren't English language, as there's a chance you'll get random characters in place of readable texts. Track names at least can be painstakingly edited in Windows.

The HDX is one of the quietest Windows boxes I've used, but isn't silent due to the quiet whirr emanating from its blend of two hard disks and a cooling fan. Naim told me they continually evaluate new hardware technologies, so there remains the chance the HDX will later take advantage of modern near-silent storage.

As a one-box solution, the stock HDX has a silky smooth way with

music, shelving off the last vestiges of the glassiness of CD audio to create an inspiring three-dimensional sphere of sound. There's little coming from the speakers to suggest this is digital at all, let alone from a PC. Some may worry that a computer plugged into the system will degrade your system's sound, but I heard no such degradation in a non-Naim vinyl-fronted setup.

Like most Naim Audio components, you can expand the sound possibilities further with an external power supply. I tried an XPS unit, and it didn't take long to find that adding £2,690 to the £4,405 of the HDX brings tangible, expensive, unmissable benefits. A solo classical guitar playing favourites such as 'Cavatina' from Xuefei Yang, for instance, simply hangs in space detached from the material world of metal and plastic hardware. Classical crescendos have more space to breathe and envelop you on the safety of your sofa. Acoustic recordings found added layers and intertwining melodies, as I heard with Gergiev conducting a Shostakovich 8 symphony. You'll also hear a tightening of bass timing and of stereo precision, making the unaccompanied HDX appear almost fluffy in comparison.

So the interface can be clumsy, the software slightly buggy, and the hardware some way off silent running. Yes, make no mistake this is a Windows PC at heart with familiar foibles. Yet the Naim HDX has patently been refined to stand proud on the grounds of its unimpeachable musical quality, which remains beguiling and entrancing. And the addition of the XPS power supply takes it to an even higher level, sounding even less 'hi-fi' and more musical - natural in an organic way. At over £7,000 the 'full fat' HDX is a very expensive thing to own, but if you're after an upgradeable, expandable and unforgettable 'computer audio' experience, this is a standout product.



NAIM HDX	£4,405
NAIM XPS	£2,690
Naim Audio	
☎ +44 (0)1722 426600	
www.naim-audio.com	

# Designing Loudspeakers

## WD25A EX – the final crossover by Peter Comeau

In the March issue I introduced a 'top-of-the-range' version of WD25 called the EX, the design of which was prompted by a re-visit by an owner of the original Dynaco A25 on

which the WD25 was based.

If you haven't read the previous write-ups on WD25 and the Dynaco A25, suffice it to say that the Aperiodic concept introduced in the '70s by the Scandinavian Dynaco range has never, to my knowledge, been successfully re-incorporated in a commercial loudspeaker. The WD25 is an attempt to recover the performance of this classic design using up-to-date materials and sound quality.

Initially the sonic character of the WD25A, the stand-mount that 'copies' the concept of the Dynaco A25, was brought as close as I could remember to that of the original. Our memory of sound, however, is not without failings and, you have to remember, back in the '70s I was using vinyl as a primary source and without the advances in turntable performance that we have today – not to mention Compact Disc!

As such I was delighted to hear from one Hi-Fi World reader who still had a pair of Dynaco A25 in everyday use and would I like to hear them? You bet I would! So a couple of years ago our reader arrived, with Dynacos under each arm, for a sonic shoot-out.

In the comparison that followed, while I was delighted by how close I had got to the performance of the originals, Mr Dynaco owner was not so pleased. In particular he preferred the warmth and full blooded bass of the originals, whilst the more revealing midband of the WD25A did not impress him.

So we agreed to disagree and, perhaps, meet again once I'd brought



the desired elements of warmth and bass power into the equation.

### EX – ONE STEP CLOSER

In fact it was to be eighteen months before I got round to having another 'go'. By this time I'd used the SEAS Millenium treble unit in a couple of speakers, one a rejig of Noel Keywood's KLS3 Gold, successfully replacing the Audax pressurised Gold Dome unit.

The Millenium had impressed me, as well as others, so much so that I wondered whether it had a place in WD25. Of particular interest was the way it managed to reveal all the treble and midrange detail required while not sounding 'bright' or 'forward' in the way many modern treble units have to do.

So it sounded right up Mr Dynaco's street in that I could bring

back the warmth of the bass without compromising on treble detailing.

The basic crossover design was outlined in the March issue but, at that point, I had little idea how much work was left to be done. Accordingly a date was set for a revisit of the Dynaco A25s and, this time, Mr Dynaco owner was happy to leave them with me for a day and a half to aid analysis of the comparison.

On first listen it was clear, once again, that I was close, but not close enough. The first step was to bring up the bass power by reducing midrange level. A small increase in coil inductance in series with the bass unit, from 0.68mH to 0.76mH, was enough.

However this, naturally enough, left the treble over-exposed and the crossover audibly obvious, so it was back to the crossover drawing board



to see what could be done.

Increasing the treble attenuation a touch, with 1 Ohm from the input to the crossover circuit itself, and 0.68 Ohm in series with the treble unit, put the treble level in the right area. But this also altered both the crossover point and its phase relationship with the bass unit crossover where the increase in inductance actually lowered the crossover frequency.

With the comparison with Dynaco A25 now firmly lodged in my memory the process of tweaking and adjusting went into full swing. I thought it best to re-establish the crossover point and investigate the acoustic slopes of the crossover as a result.

Using LspCAD v6 I am able to feed the measurements of the drive units in the cabinet into a 'virtual' crossover to see its effect before listening to the result. The acoustic crossover slope that I've found successful, time and time again, is what I like to call a 3rd order Linkwitz characteristic. In theory there is no such thing, the Linkwitz-Riley topology pertaining to even order filters only, but the characteristics of a Linkwitz filter, namely a -6dB crossover point and 'perfect' phase integration between the low and high pass sections, can still be simulated in LspCAD.

So, working to this 'quasi-Linkwitz' 3rd order slope we see an acoustic response from the drive units that looks like Figure 1 (having found the ideal crossover point for these drivers to be 2kHz). The

for example has a gradually decreasing output beyond 1.5kHz which approximates to a first order slope. Add this to our second order electrical crossover and we get a third order acoustic filter. As the meerkat says "Simples"!

## LISTEN AGAIN

LspCAD is a great tool, but only when you use its results to feed into your own listening process. The technique is

to use LspCAD to predict the measured results, then listen, make adjustments, feed these back into

LspCAD, adjust to match the target slopes, listen again and so on.

This is a process of iteration. Sometimes the results come quickly, sometimes it takes days or weeks to achieve the 'perfect' performance.

In this case the results were good, very good, with high quality source material. But that's not everything. Good quality recordings can often fool you into believing that the speaker is 'perfect', but I find that a few poorer quality discs, what I call my 'problem' CDs, highlight errors that may otherwise not show up.

These 'problem' discs can be relatively modern recordings, such as Tears For Fears 'The Seeds Of Love'

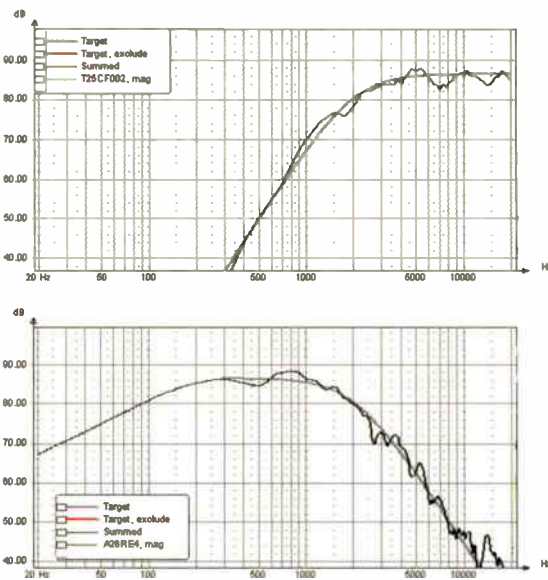

**Figure 1. Acoustic slopes of LF and HF drive units and crossover aligned to quasi-Linkwitz 3rd order targets. Crossover frequency 2kHz**

question of balance between bass and treble. If the treble output is a tad too high the speakers will sound bright and detailed but overbearing and ear-rippingly harsh on these early recordings. Similarly a touch too much bass and the music slows to a crawl, percussion sounds heavy and bloated and the early recordings come across as coloured and wooden.

Then there is the midrange. One way of overcoming the compressed, mono mixed, squeezed-through-a-tube vocals of the 'difficult' recordings is to recess the midrange a little producing that apparently spacious 'depth' so beloved of audiophiles.

This may clean up the sound of difficult records and make them sound warmer but the overall effect is to push vocals too far into the background leaving them swamped by the rest of the band. Clearly that isn't right, either, it's just an acoustic trick.

What is needed is good projection of the midband without making it forward. I won't deny it, it's a difficult juggling act, but it can be achieved with judicious balancing of all three elements so that the speaker sounds seamless across the audio band. When that point is reached you lose the bass-midrange-treble conflict and start listening to the music instead of the speaker.

In this case the initial listening results indicated some harshness in the treble crossover region which was ameliorated by 'softening' the turnover of the filter by increasing the series resistance of the treble coil. Traces of treble excess on sibilance and stringed instruments led me to turn to adjustment of the bass section to bring the upper midrange

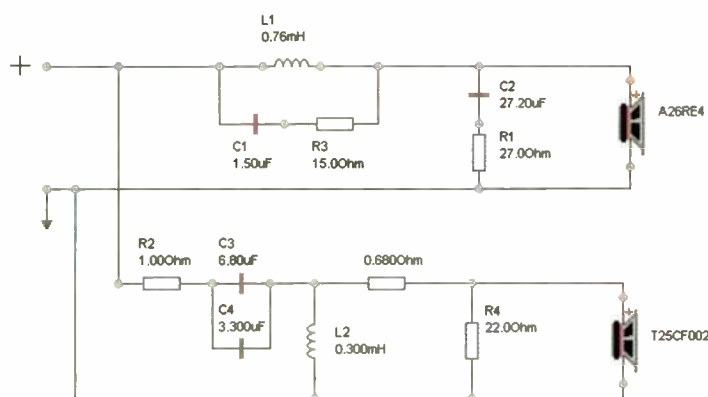

**Figure 2. Crossover to achieve quasi-Linkwitz 3rd order slopes as shown in Figure 1.**

circuit for this crossover is shown in Figure 2.

Now you may be a little puzzled as to why the electrical crossover looks remarkably like a second order if these are third order slopes. The answer lies in the way the electrical crossover works with the natural roll-off of the drivers. The bass unit,

or older master tapes transcribed to CD like The Rolling Stones 'Forty Licks'. The latter should be a fascinating trip through rock and roll music and recording techniques from the '60s onwards, even though the early singles are definitely 'lo-fi' they should still be listenable.

Largely it comes back to this



## WDKEL84 Valve Amplifier Kit

*"The quality that can be gleaned from this amp is a fine introduction to the joys of the valve sound"*

The WDKEL84 features a pair of EL84 valves in Push Pull configuration per channel, providing two channels each 18 Watts into an 8 Ohm load. Available as a 5 input integrated amplifier with ALPS volume control.

**WDKEL84 kit £499**

**WDKEL84 built and tested £649**



## WD88VA Valve Amplifier Kit

*"The result is an amplifier that combines majesty, transparency and rhythmic boogie factor with the ability to swing and sing on all types of music"*

Often described as a 'sweet sounding' valve, our particular implementation of the KT88 makes sure that it is driven to its ultimate performance. Available as a 35W stereo power amplifier with single input volume control, or as a relay switched integrated with five inputs.

**WD88VA kit £989**

**WD88VA built and tested £1289**



## WDHD3S Headphone Valve Amplifier Kit

*"WDHD3S is a single-ended design with the power pentode wired up in triode configuration for added purity and is as quiet as a mouse"*

A beautifully simple stereo headphone amplifier design using Mullard ECL83 valves. It works directly from any source. The circuit uses twin high specification E/I output transformers that can be switched to drive any headphones between 16 to 300 Ohms.

**WDHD3S kit £398**

**WDHD3S built and tested £528**



## WD25A Standmount Speaker Kit

*"The one aspect that stands out is the easy ability to resolve instruments and voices ... bass quality and definition is a revelation"*

The aperiodic enclosure offers the bass clarity and definition of a larger closed box, together with the efficiency and easy amplifier load necessary for users of valve amplifiers. Available with SEAS STD soft dome treble unit, or high performance SEAS Millennium treble unit.

**Cabinet kit (pair) £349**

**WD25A STD kit (pair) £269**

**WD25A EX kit (pair) £699**



## WD25T Floorstanding Speaker Kit

*"The WD25T always sounds crisp and taut, but can 'rumble' menacingly giving impressive physicality reminiscent of far larger boxes. Imaging is superb, the midband is also special; it's very open with masses of detail about the condition of the recording"*

Cunningly arranged as an aperiodic enclosure leading to a lower sealed compartment, the WD25T combines the optimum damping of aperiodic loading with the bass extension of a large closed box. Available with STD soft dome or high performance Excel treble units.

Both the WD25 kits are based around a SEAS 26cm (10") paper cone bass unit with an efficiency of 89dB for 1W. The crossover has been developed for an easy drive 6 - 8 Ohm load making the system ideal for all types of amplifiers.

**Cabinet kit (pair) £549**

**WD25Tv2 STD kit (pair) £329**

**WD25Tv2 XL kit (pair) £499**



*All our kits are complete with pictorial easy-to-follow instructions.  
All parts are included - all you need is a screwdriver and soldering iron.*

[www.world-designs.co.uk](http://www.world-designs.co.uk)  
Tel: 01832 293320





Figure 3. Measured results from WD25A EX showing acoustic crossover and response on treble unit axis.

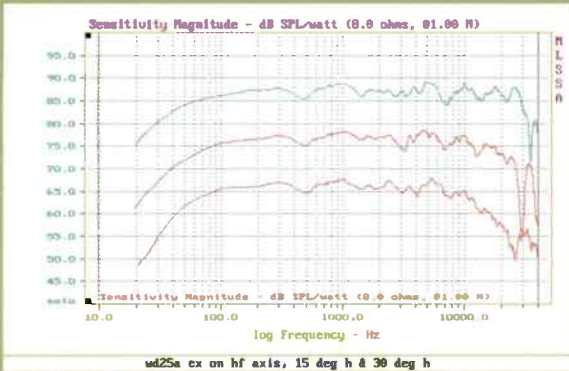

Figure 4. Family of responses of WD25A EX at 1m. Blue - on axis with treble unit, Red - 15 degrees horizontal and 30 degrees horizontal. Note close correlation of sonic character and even power distribution in room right up to 10kHz.

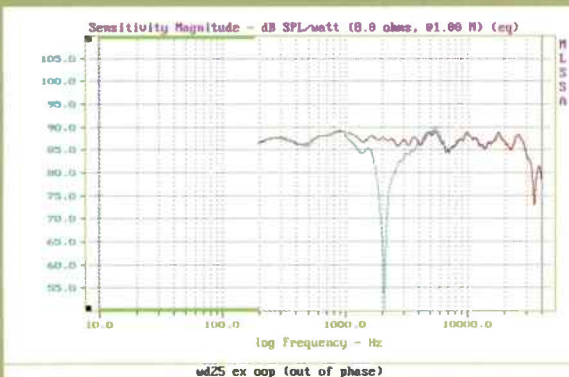

Figure 5. Response with drive units In Phase (red) and Out Of Phase (blue). Deep notch for OOP response shows accurate phase integration throughout the crossover.

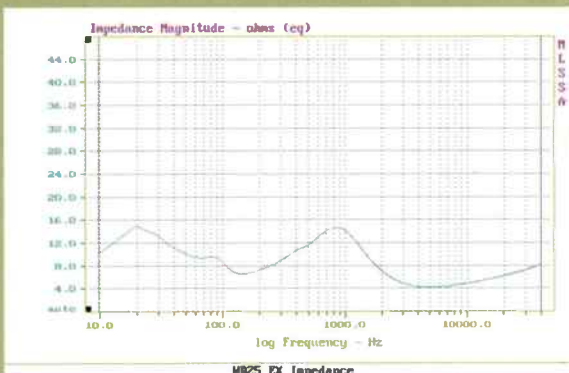

Figure 6. 'Easy drive' impedance of WD25EX. Overall an 8 Ohm load with no abrupt phase changes. Minimum impedance of 4 Ohms in the treble region will not cause amplifiers any problems.

output of the bass unit into line with the treble.

After extensive listening I ended up significantly reducing the capacitance across the bass unit which, as well as increasing midband output, had the unexpected bonus of subjectively boosting the bass power too, probably as a result of the component choice open to me with the new, preferred, value.

## COMPONENT SELECTION

Once the actual values of the crossover have been worked through it's time to consider component selection. Coils are a no-brainer. We use the best quality ferrite core for the bass because of its low resistance and an air core for the treble for low distortion.

Incidentally if we were also to use an air core for the bass section the coil resistance, in series with the bass unit, would jump from 0.2 Ohms to 0.8 Ohms with a corresponding loss of sensitivity of 1dB and a reduction in amplifier damping factor. Having listened to both types of coil the problems outweigh the benefits when using an air coil for bass with this design.

Of more interest is the capacitor performance. Clearly superior quality polypropylene capacitors are de rigueur for the treble section, but what about the bass? In the past

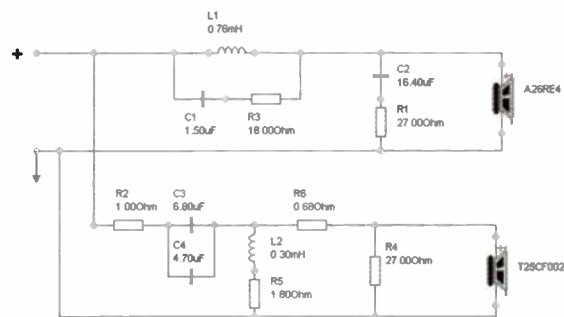

Figure 7. Final schematic crossover of WD25A EX derived from listening tests.

we've used a reversible electrolytic bypassed with a polypropylene at 10% of the value of the electrolytic, and this does work well. An electrolytic on its own produces a level of cardboard and wooden colouration through the midrange simply because its resistance does not change linearly with frequency so the capacitor losses at high frequencies disturb the crossover dynamically.

With the level of musical transparency produced by the WD25A EX, however, even a bypassed electrolytic in the bass section did not perform as well as using all-polypropylene capacitors here. Luckily the lower value of capacitance required by this crossover does allow us to use polyprops without too much of a space issue - a pair of SONIQS 8.2uF proved ideal.

The final crossover circuit is shown below. It proved an exhausting and, at times, frustrating achievement but, I have to say, well worth it in the end. A similar prototype crossover for the WD25T floorstanders was demonstrated at the Bristol show to great acclaim, so we have the proof this combination of drive units is the best WD25 yet.

But what about Mr Dynaco owner - what does he think of the WD25A EX? Reader, he bought a pair.

## WD Phono3S Valve Phonoamplifier Kit

*"The real star of the show for me, however, is the Phono3 as it is particularly astonishing in its abilities, especially at its modest price."*

### Passive RIAA EQ

Based around a triple gain stage of ECC83 valves, this phono preamplifier utilises passive RIAA equalisation (zero feedback) for the finest sonic performance from any turntable. A separate power supply removes all sources of hum and noise from the Phono3S case for optimum clarity of sound.

### MM and MC inputs

WDPhono3S offers you two inputs, selected on the front panel, for MM and MC cartridges. MC inputs feature high performance step-up transformers for the lowest noise, clearest output from any cartridge. Each input has individual impedance matching to obtain the best sound from the cartridge of your choice. In addition you can select the subsonic filter characteristic to give the optimum results from your turntable, arm and cartridge.



*Kits come complete with pictorial instructions for easy assembly.*

*WDPhono3S kit £399*

*WDPSU3 power supply £229*

*WDPhono3S and PSU3*

*built and tested £853*

## WDPRE3 Valve Preamplifier kit

*"So there we have it, a pre-amplifier capable of driving any load and maintaining its linearity no matter what cables or partnering equipment you prefer to use."*

### The Active Preamp principle

This 5 input line level preamp is essentially an SE triode power amplifier in concept. WDPRE3 uses an ECC82 double triode arranged as input voltage amplifier and power output amplifier stages, the latter driving oversize 20:1 output transformers.

### Active vs Passive

Many enthusiasts assume that a 'passive' control unit (essentially just a volume control and switching system in a box) is the ideal 'preamplifier'. However this assumption takes no account of the interface between the source and the power amplifier, let alone the effects of partnering cables. The WDPRE3 effectively isolates the source from the power amplifier and provides the correct terminating impedance to optimise the musical performance.



*WDPRE3 requires the WDPSU3 power supply (shown above)*

*WDPRE3 kit £369*

*WDPRE3 XL kit £399*

*WDPRE3 Built and tested £495*



# WORLD CLASSICS

## DIGITAL

### CAMBRIDGE AUDIO CDI 1986 £1500

Inspired Stan Curtis redesign of Philips CD104, complete with switchable digital filter. Lean but tight and musical performer.

### CAMBRIDGE AUDIO CD4SE 1998 £200

A touch soft in the treble and tonally light, but outstanding in every other respect.

### LINN KARIK III 1995 £1775

The final Karik was a gem. Superb transport gives a brilliantly tight, grippy dynamic sound, albeit tonally dry.

### MARANTZ CD73 1983 £700

A riot of gold brushed aluminium and LEDs, this distinctive machine squeezed every last ounce from its 14x4 DAC -super musical



### MARANTZ SA-1 2000 £5,000

The greatest argument for SACD. This sublime Ken Ishiwata design is utterly musically convincing with both CD and SACD, beating most audiophile CD spinners hands down.



### MERIDIAN 207 1988 £995

Beautifully-built two-box with pre-amp stage. Very musical although not as refined as modern Bitstream gear. No digital output.

### MUSICAL FIDELITY TRIVISTA 2002 £4000

When playing SACDs, the sweetest, most lucid and lyrical digital disc spinner we've heard. Old school stereo, pure DSD design. CD sound is up in the £1000 class, too! Future classic.

### MERIDIAN MCD 1984 £600

The first British 'audiophile' machine was a sweeter, more detailed Philips CD100. 14x4 never sounded so good, until the MCD Pro arrived a year later.



### NAIM CDS 1990 £ N/A

Classic Philips 16x4 chipset with serious attention to power supplies equals grin-inducing sonics.



### SONY CDP-101 1982 £800

The first Japanese CD spinner was powerful and involving. Brilliant transport more than compensated for 16x2 DAC, and you even got remote control!

### SONY CDP-R1/DAS-R1 1987 £3,000

Sony's first two boxer was right first time. Tonally lean, but probably the most detailed and architectural sounding machine of the eighties.



### SONY CDP-701ES 1984 £890

Sony's first ever bespoke high end audiophile machine used a 16x2 DAC to provide a clinically incisive sound; supreme build quality allied to the pure unadulterated luxury of a paperbook-sized remote control.

### TECHNICS SL-PI200 1987 £800

CD version of the Technics SL-1200 turntable. Massively built to withstand the rigours of 'pro' use and laden with facilities - a great eighties icon. Sonically, it's pure fun, with hefty bass that can still show weedy modern players a thing or two!

### YAMAHA CD-X1 1983 £340

Nicely built 16x2 machine with a very sharp and detailed sound; sometimes too much so. Excellent ergonomics, unlike almost every other rival of the time.

## COMPACT DISC TRANSPORTS

### TEAC VRDS-T1 1994 £600

Warm and expansive sound made this a mid price hit. Well built, with a slick mech.



In this heavily revised section, you'll find the great and the good from audio's glorious past. Most are seminal designs which have earned their place in hi-fi history, but you'll also see some oddities which aren't classic as such, but are great used buys. The year of introduction is given, alongside the original UK launch price. Think we've overlooked something? Then write in and let us know!

### ESOTERIC P0 1997 £8,000

The best CD drive bar none; TEAC's Tokyo boys pushed the boat out in style. Brilliantly incisive, ridiculously over engineered.

### KENWOOD 9010 1986 £600

The first discrete Jap transport was beautifully done and responds well to re-clocking even today.

## DACs

### CAMBRIDGE AUDIO

### DACMAGIC 1995 £99

Good value upgrade for budget CD players with extensive facilities and detailed sonics.



### DCS ELGAR 1997 £8500

Extremely open and natural performer, albeit extremely pricey - superb.



### DPA LITTLE BIT 3 1996 £299

Rich, clean, rhythmic and punchy sound transforms budget CD players.



### PINK TRIANGLE DACAPO 1993 £ N/A

Exquisite; the warmest and most lyrical 16bit digital audio we have ever heard. Clever plug-in digital filter modules really worked!



### QED DIGIT 1991 £90

Budget bitstream performer with tweaks aplenty. Positron PSU upgrade makes it smooth, but now past it.

**TURNTABLES**

**ARISTON RDI1S 1972 £94**  
Modern evolution of Thorens' original belt drive paradigm, Scotland's original super-deck was warm and musical, albeit soft. Still capable of fine results today.

**ADC ACCUTRAC 4000 1976 £300**  
Bonkers 1970s direct drive that uses an infra red beam to allow track selection and programming. More of a visual and operational delight than a sonic stunner.

**PIONEER PL12D 1973 £36**  
The beginning of the end for the British turntable industry. When vinyl was the leading source, this bought new standards of noise performance and stability to the class, plus a low friction S-shaped tonearm. Later PL112D was off the pace compared to rivals



**PIONEER PLC-590 1976 £600**  
Sturdy and competent motor unit that performs well with a wide range of tonearms. Check very thoroughly before buying due to electronic complexity and use of some now-obsolete ICs.

**DUAL CS505 1982 £75**  
Simple high quality engineering and a respectable low mass tonearm made for a brilliant budget buy. Polished, smooth and slightly bland sound.

**GOLDRING Lenco GL75 1970 £15.65**  
Simple, well engineered motor unit with soft, sweet sound and reasonable tonearm. Good spares and servicing support even today from specialists. Eminently tweakable. Similar 88 and 99 motor units are budget 301/TD124 rivals.

**LINN AXIS 1987 £253**  
Simplified cut-price version of the Sondek complete with LVX arm. Elegant and decently performing mid-price package. Later version with Akito tonearm better.

**LINN SONDEK LPI2 1973 £86**  
For many, the Brit superdeck; constant mods meant that early ones sound warmer and more lyrical than modern versions. Recent 'SE' mods have brought it into the 21st century, albeit at a price..



**MARANTZ TT1000 1978 £ N/A**  
Beautiful seventies high end belt drive with sweet and clean sound. Rare in Europe, but big in Japan.



**MICHELL GYRODEC 1981 £599**  
Thanks to its stunning visuals, this bold design wasn't accorded the respect it deserved until recently. Early examples sound cold and mechanical, but now right on the pace. Clean, solid and architectural sound.

**TECHNICS SP10 1973 £400**  
Seminal Japanese engineering. Sonics depend on plinths, but a well mounted SP10/II will give any modern a hard time, especially in respect of bass power and midband accuracy.

**REGA PLANAR 3 1978 £79**  
Brilliantly simple but clean and musical performer, complete with Acos-derived S-shaped tonearm. 1983 saw the arrival of the RB300, which added detail at the expense of warmth. Superb budget buy.

**GARRARD 301/401 1953 £19**  
Heavy metal - tremendously strong and articulate with only a veiled treble to let it down. In many respects, better than the seventies 'superdecks' that succeeded it.



**ROKSAN XERXES 1984 £550**  
Supposedly the first to 'better' the LPI2. Super tight and clean sound, with excellent transients. Less musical than the Sondek, but more neutral. Sagging plinth top-plates make them a dubious used buy.

**SONY PS-B80 1978 £800**  
First outing for Sony's impressive 'Biotracer' electronic tonearm. Built like a tank with a clean and tidy sound, albeit lacking involvement. Scarily complicated and with no spares support - buy with caution!

**THORENS TD124 1959 £ N/A**  
The template for virtually every 1970s 'superdeck', this iconic design was the only real competition for Garrard's 301. It was sweeter and more lyrical, yet lighter and less impactful in the bass.



**TOWNSHEND ROCK 1979 £ N/A**  
The product of academic research by the Cranfield Institute, this novel machine has an extremely clean and fluid sound. Substantially modified through the years, and capable of superb results even today.

**TRIO LO-7D 1978 £600**  
The best 'all-in-one' turntable package ever made, Trio/Kenwood threw their 'engineering best practice' book at this one with startling results. Clean, powerful and three-dimensional sound, ultimately limited by the tonearm.

**TONEARMS**  
**ACOS LUSTRE GST-1 1975 £46**  
The archetypal S-shaped seventies arm; good, propulsive and involving sound in its day, but ragged and undynamic now.

**AUDIO TECHNICA AT 1120 1978 £75**  
Fine finish can't compensate for this ultra low mass arm's limited sonics - a good starter arm if you've only got a few quid to spend.

**ALPHASON HR100S 1981 £150**  
First class arm, practically up to present-day standards. Buy carefully, though, as there is no service available now. Totally under priced when new, exceptional.



**SME 3009 1959 £18**  
Once state of the art, but long since bettered. Musical enough, but weak at frequency extremes and veiled in the midband. Legendary serviceability and stunning build has made it a cult, used prices unjustifiably high.

**GRACE G707 1974 £58**  
This early Japanese example of the tonearm art has a smooth, lyrical sound. Imported by Linn, fitted to early LPI2s. Sonically way off the pace now, though.

**REGA RB300 1983 £88**  
Inspired budget esoterica. Detailed, tight, neutral sound but tonally grey sounding in absolute terms. Responds well to tweaking, and its cheaper RB250 brother better still.



**SME SERIES III 1979 £113**  
Clever variable mass design complete with Titanium Nitride tube tried to be all things to all men, and failed. Charming nonetheless, with a warm and inoffensive sound.

**HADCOCK GH228 1976 £46**  
Evergreen unipivot with lovely sweet, fluid sound. Excellent service backup.



**LINN ITTOK LVII 1978 £253**  
Arguably the first 'superarm'; Japanese design to Linn specs made for a muscular, rhythmic sound with real dynamics. Now off the pace, but the final LVIII version worth seeking out.

**NAIM ARO 1986 £875**  
Truly endearing and charismatic performer - wonderfully engaging mid-band makes up for softened frequency extremes.





**TECHNICS EPA-501 1979 £ N/A**  
Popular partner for late seventies Technics motor units. Nice build and Titanium Nitride tube can't compensate for middling sound.

**INTEGRATED AMPLIFIERS/COMBOS**

**DELTEC 1987 £1900**  
Fast, dry and with excellent transients, this first DPA integrated is the real deal for eighties obsessives. Ridiculously punchy 80W per channel from a tiny, half-size box. Radical, cool and more than a little strange.

**ROGERS A75 1978 £220**  
The prototypical Audiolab 8000a – lots of sensible facilities, a goodly power output and nice sound in one box. The later A75II and A100 versions offered improved sonics and were seriously sweet and open to listen to.

**EXPOSURE VII/VIII 1985 £625**  
Seminal mid-eighties Exposure pre-power, offering most of what rival Naim amps did with just that little bit extra smoothness and sweetness. Still, it's by no means 'sweet' by today's standards, being lean, punchy, musical. It's also possessed of that quintessentially eighties look – frumpy black steel boxes with rough silk screened logos!



**SUGDEN CS1/P51 1976 £130**  
Soft sounding early Sugden combo with a plethora of facilities and filters, complete with seventies-tastic DIN socketry. A sweet and endearing performer as you'd expect, but lacking in power and poor load driving ability, so partner carefully.

**VTL MINIMAL/50W MONOBLOCK 1985 £1,300**  
Vacuum Tube Logic was one of the Europe's biggest tube names in the eighties, and it shows. Rugged, professional build and finish allied to a lively and punchy sound (albeit with limited power) make them an excellent used buy.

**A&R A60 1977 £115**  
Sweet and musical feature-packed integrated; the Audiolab 8000A used its blueprint to great effect.



**CREEK CAS4040 1983 £150**  
More musical than any budget amp before it; CAS4140 loses tone controls, gains grip.

**AUDIOLAB 8000A 1985 £495**  
Smooth integrated with clean MM/MC phono stage and huge feature count. Extremely reliable, too. Post '93 versions a top used buy.



**MCINTOSH MA6800 1995 £3735**  
Effortlessly sweet, strong and powerful with seminal styling to match.

**SUGDEN A21 1969 £ N/A**  
Class A transistor integrated with an eminently likeable smoothness and musicality. Limited inputs via DIN sockets.

**MISSION CYRUS 2 1984 £299**  
Classic eighties minimalism combines arresting styling with clean, open, lively sound. Further upgradeable with PSX power supply.



**MUSICAL FIDELITY A1 1985 £350**  
Beguiling Class A integrated with exquisite styling. Questionable reliability.



**NAIM NAIT 1984 £350**  
Superb rhythms and dynamics make it truly musical, but tonally monochromatic. Fine phono stage, very low power.

**NAD 3020 1979 £69**  
Brilliantly smooth, sweet and punchy at the price and even has a better phono stage than you'd expect. The archetypal budget super-amp.



**MYST TMA3 1983 £300**  
Madcap eighties minimalism, but a strong and tight performer all the same.

**ROGERS CADET III 1965 £34**  
Sweet sounding valve integrated, uses ECL86 output valves, even has a half useable phono stage, sweet, warm a good introduction to valves



**ROTEL RA-820BX 1983 £139**  
Lively and clean budget integrated that arguably started the move to minimalism.

**CHAPMAN 305 1960 £40**  
Smooth pre/power combo with a sweet and open sound. Not quite up to Leak/Quad standards but considerably cheaper second-hand.

**PREAMPLIFIERS**

**AUDIOLAB 8000C 1991 £499**  
Tonally grey but fine phono input and great facilities make it an excellent general purpose tool.

**AUDIO RESEARCH SP-8 1982£1,400**  
Beautifully designed and built high end tube preamplifier with deliciously sweet and smooth sound. Not the last word in incision or grip, but that didn't matter to those who aspired to it.

**CONRAD JOHNSON MOTIV MC-8 1986 £2,500**  
Minimalist FET-based preamplifier from the Yank valve specialists is brilliantly neutral and smooth with a spry, light balance in the mould of Sugden high end stuff. Something of a curio, but worthwhile nonetheless.

**CROFT MICRO 1986 £150**  
Budget valve pre-amp with exceptionally transparent performance.

**LEAK POINT ONE STEREO 1958 £ N/A**  
Good for their time, but way off the pace these days. Use of EF86 pentode valve for high gain rules out ultra performance. Not the highest-fi!

**LINN LK-1 1986 £499**  
A brave attempt by the Glasgow boys to bring remote controlled user-friendliness to hair-shirt audiophile hi-fi. Didn't quite work, but not half bad for under £100.

**NAIM NAC32.5 1978 £ N/A**  
The Salisbury company came of age with this, their classic high end pre. Brilliantly fast and incisive sound that's a joy with vinyl but a tad forward for digital.

**LECSON AC-1 1973 £ N/A**  
Amazing styling courtesy of Allan Boothroyd can't disguise its rather cloudy sound, but a design classic nonetheless.



**QUAD 22 1958 £25**  
The partner to the much vaunted Quad II monoblocks - cloudy and vague sound means it's for anacrophiles only.

**QUAD 33 1968 £43**  
Better than the 22, but Quad's first tranny pre isn't outstanding. Responds well to tweaking/ rebuilding though...

**POWER AMPLIFIERS**

**HH ELECTRONICS TPA-50D AMPLIFIERS 1973 £110**  
Simple design with easily available components, solid build quality and fine sound make for a surprisingly overlooked bargain. Not exactly stylish, however.

**LEAK STEREO 60 1958 £N/A**  
Leak's biggest valve power amp offers 35 Watts per channel and more low end welly than the smaller Stereo 20. Despite concerns over reliability their rarity means high prices are the order of the day.

**LEAK STEREO 20 1958 £31**

Excellent workaday classic valve amplifier with decent power and drive. Surprisingly modern sounding if rebuilt sympathetically. Irrepressibly musical and fluid.



**LECSON API 1973 £ N/A**

Madcap cylindrical styling alluded to its 'tower of power' pretensions, but it wasn't. Poor build, but decently clean sounding when working.

**MARANTZ MODEL 9 1997 £8000**

Authentic reproduction monoblocks still more than cut the sonic mustard. Highly expensive and highly sought after.

**MICHELL ALECTO 1997 £1989**

Crisp, clean and beautifully controlled with gorgeous styling. Partnered with the £1650 Orca this sounds delicious!

**LEAK POINT ONE, TL10, TL12.1 1949 £28**

Early classics that are getting expensive. Overhauling is de rigueur before use, using original parts if possible. Surprisingly crisp and musical sound, that's far more modern than Quad IIs. Deeply impressive when in fine fettle.



**MUSICAL FIDELITY XA200 1996 £1000PR**

200W of sweet smooth transistor stomp in a grooved tube! Under-rated oddity.



**QUAD II 1952 £22**

The all-time classic valve amplifier, with a deliciously fluid and lyrical voice. In other respects though, it sounds hopelessly dated. Low power and hard to partner properly



**QUAD 405 1978 £115**

The first of the current dumpers is a capable design with smooth, effortless power and a decently musical sound. 606 and 707 continue the theme with greater detail and incision.

**QUAD 303 1968 £55**

Bullet proof build, but woolly sound. Off the pace, but endearing nonetheless. Some pipe smoking slipper wearers swear by them!

**RADFORD STA25 RENAISSANCE 1986 £977**

At the time, very possibly the least cool amplifier on the planet – and we're not talking heat dissipation here. This reworking of Radford's original late sixties design was possessed of a wonderfully rich, old school valve sound with enough power (25W) and lots of subtlety.



**KRELL KMA100 II 1987 £5,750**

Ludicrous monoblock version of the giant KSA-100 is one of the seminal eighties transistor power amplifiers. Massive wallop allied to a very clean and open Class A sound makes this one of the best amplifiers of its type, ever.

**PIONEER M-73 1988 £1,200**

Monster stomp from this seminal Japanese power amplifier, complete with switchable Class A and Class B operation. Clean, open and assured sounding, albeit a tad behind the pace on high speed dance music. Rosewood side cheeks and black brushed aluminium completes the eighties-tastic experience.



**PHONO STAGES CREEK OBH-8 SE 1996 £180**

Punchy, rhythmic character with oodles of detail makes this a great budget audiophile classic. Partner with a Goldring G1042 for an unbeatable budget combination.



**LINN LINNK 1984 £149**

Naim-designed MC phono stage built to partner the original Naim NAIT - yes, really! Fine sound, although off the pace these days.

**MICHELL ISO 1988 £ N/A**

This Tom Evans-designed black box started the trend for high performance offboard phono stages. Charismatic, musical and punchy - if lacking in finesse.

**TUNERS MARANTZ ST-8 1978 £353**

Marantz's finest radio moment. Warm, organic sound plus an oscilloscope for checking the signal strength and multipath.



**CREEK CAS3140 1985 £199**

Excellent detail, separation and dynamics - brilliantly musical at the price. T40 continued the theme...

**NAD 4040 1979 £79**

Tremendously smooth and natural sound allied to low prices and good availability make this budget analogue esoterica. Needs a good antenna to work properly, however.

**NAIM NAT03 1993 £595**

The warm, atmospheric sound is further proof of Naim's proficiency with tuners.

**PIONEER TX-9500 1976 £295**

Another of the serious classic solid-staters. Boasts the usual high end Jap package of fine sound, brilliant sensitivity and superb build.

**LEAK TROUGHLINE 1956 £25**

Series I an interesting ornament but limited to 88-100MHz only. II and III are arguably the best-sounding tuners ever. Adaptation for stereo easy via phono multiplex socket. Fed by a modern outboard decoder they're deliciously lucid with true dimensionality.



**YAMAHA CT7000 1977 £444**

Reputedly the best of the classic Jap analogues, this combines sleek ergonomics, high sensitivity and an explicit, detailed sound.

**QUAD FM4 1983 £240**

Supreme ergonomics and styling allied to a pleasingly lyrical sound with plenty of sweetness and detail made this one of the best tuners around upon its launch.



**REVOX B760 1975 £520**

More of a semi-pro machine than a domestic bit of kit, the Revox offers superlative measured performance although the sound isn't quite as staggering as the numbers. Fine nonetheless, and surely the most durable tuner here?

**NAD 4140 1995 £199**

Brilliant affordable digital tuner has a smooth, detailed musical sound plus sensible real-world facilities.

**ROGERS T75 1977 £125**

Superb mid-price British audiophile design, complete with understated black fascia. Fine sound in the true Rogers mould – smooth and sweet with fine dimensionality.

**SANSUI TU-9900 1976 £300**

A flagship Japanese tuner designed to steal sales from the likes of Accuphase and Revox, it boasts superlative RF performance and an extremely smooth and lucid sound, along with very fine build and finish.



**SONY ST-5950 1977 £222**

One of the first Dolby FM-equipped tuners, a format that came to nought. Still, it was Sony's most expensive tuner to date, and boasted a very good sound quality allied to brilliant ergonomics.

**SEQUERRA MODEL 1 1973 £1300**

Possibly the ultimate FM tuner. Massive in terms of technology, size and features dedicated to extracting every ounce of performance from radio, including impressive multi-purpose oscilloscope display.



**TECHNICS ST-8080 1976 £180**

National Panasonic's specialist hi-fi brand was a big hitter back then, and this is no exception. Superb FM stage makes for a very clean and smooth listen with lots of detail and depth.



**ANALOGUE RECORDERS**

**YAMAHA TC-800GL 1977 £179**

Early classic with ski-slope styling courtesy of Mario Bellini. Middling sonics by modern standards, but cool nonetheless!



**AIWA XD-009 1989 £600**

Aiwa's Nak beater didn't, but it wasn't half bad nonetheless. Massive spec even included a 16x4 DAC!

**NAKAMICHI CR-7E 1987 £800**

The very best sounding Nakamichi ever - but lacks the visual drama of a Dragon.



**PIONEER CTF-950 1978 £400**

Not up to modern standards sonically, but a great symbol of the cassette deck art nonetheless.



**REVOX A77 1968 £145**

The first domestic open reel that the pros used at home. Superbly made, but sonically off the pace these days. B77 better, but couldn't match the Japanese.



**SONY WM-D6C 1985 £290**

Single capstan transport on a par with a Swiss watch, single rec/replay head better than most Naks. Result: sublime.



**SONY TC-377 1972 £N/A**

A competitor to the Akai 4000D open reel machine, the Sony offered better sound quality and is still no slouch by modern standards

**DIGITAL RECORDERS**

**SONY MDS-JE555ES 2000 £900**

The best sounding MD deck ever, thanks to awesome build and heroic ATRAC-DSP Type R coding.



**PIONEER PDR-555RW 1999 £480**

For a moment, this was the CD recorder to have. Clean and detailed.

**MARANTZ DR-17 1999 £1100**

Probably the best sounding CD recorder made; built like a brick outhouse with a true audiophile sound and HDCD compatibility.



**KENWOOD DM-9090 1997 £500**

Serious and sophisticated sound thanks to well implemented ATRAC 4.5; surprisingly musical MD recorder.

**SONY TCD-8 DATMAN 1996 £599**

Super clean sound makes this an amazing portable, but fragile.

**LOUDSPEAKERS**

**ACOUSTIC RESEARCH**

**ARI8S 1978 £125**

Yank designed, British built loudspeaker became a budget staple for many rock fans, thanks to the great speed from the paper drivers, although finesse was most definitely not their forte...

**BBC LS3/5A 1972 £88**

Extremely low colouration design is amazing in some respects - articulation, stage depth, clarity - and useless in others (both frequency extremes). Came in wide variety of guises from various manufacturers building it under licence. Partner with Rogers AB1 subwoofers for an extra two octaves of bass!

**HH ELECTRONICS TPA-50D**

**AMPLIFIERS 1973 £110**

Simple design with easily available components, solid build quality and fine sound make for a surprisingly overlooked bargain. Not exactly stylish, however.



**LOWTHER PM6A 1957 £18 EACH**

This seminal full-range driver is still manufactured. High sensitivity, as fitted to many classic horn designs.

**TANNOY WESTMINSTER 1985 £4500**

Folded horn monsters which certainly sound good if you have the space. Not the last word in tautness but can drive large rooms and image like few others.

**JR 149 1977 £120**

Infamous cylindrical speaker that was ignored for decades but now back in fashion! Based on classic KEF T27 / B110 combo as seen in the BBC LS3/5a. Doesn't play loud, needs a powerful transistor amplifier, but rewards with fine clarity and imaging.



**SPENDOR BCI 1976 £240**

Celestion HF1300 tweeter meets bespoke Spendor Bextrene mid-bass unit - and the result is a beautifully warm yet well focussed sound. A little bass bloom necessitates careful low-stand mounting, but these prove that the seventies did have some fine designs after all!

**QUAD ESL57 1956 £45 EACH**

Wonderfully open and neutral sound puts box loudspeakers to shame. Properly serviced they give superb midband performance, although frequency extremes less impressive. Ideally, use in stacked pairs or with subwoofers and supertweeters.



## CLASSICS

### KEF R105 1977 £785

Three way Bextrene-based floorstander (complete with castors!) gave a truly wide-band listen and massive (500W) power handling. A very neutral, spacious and polite sounding design, but rhythmically well off the pace. The quintessential nineteen seventies loudspeaker.

### IMF TLS80 1976 £550

Warm and powerful nineteen seventies behemoth with transmission loading and a mixture of KEF and Celestion drive units. Impressively physical wideband sound but rhythms aren't its forte.

### MAGNEPLANAR SMGA 198X £800

Technological loudspeaker with genuinely musical abilities; fast, smooth, open, dry.



### MISSION 770 1980 £375

Back in its day, it was an innovative product and one of the first of the polypropylene designs. Warm, smooth, clean and powerful sound.



### MISSION 752 1995 £495

Cracking Henry Azima-designed floorstanders combined HDA drive units and metal dome tweeters with surprisingly warm results. Benign load characteristics makes them great for valves.

### HEYBROOK HBI 1982 £130

Peter Comeau-designed standmounters with an amazingly lyrical yet decently refined sound. Good enough to partner with very high end ancillaries, yet great with budget kit too. A classic.

### CELESTION SL6 1984 £350

Smallish two way design complete with aluminium dome tweeter and plastic mid-bass unit set the blueprint for nineteen eighties loudspeakers. Very open and clean sounding, albeit course at high frequencies and limp in the bass. Speakers would never be the same again...



### LEAK SANDWICH 1961 £39 EACH

Warm sounding infinite baffle that, with a reasonably powerful amplifier can sound quite satisfying.



### QUAD ESL63 1980 £1200

An update of the ESL57, with stiffer cabinets. Until the 989, the best of the Quad electro-statics.



### YAMAHA NS1000 1977 £532

High tech Beryllium midband and tweeter domes and brutish 12" woofers in massive sealed mirror image cabs equals stunning transients, speed and wallop allied to superb transparency and ultra low distortion. Partner carefully!



### MISSION X-SPACE 1999 £499

The first mass production sub and sat system using NXT panels is a sure-fire future classic - not flawless, but a tantalisingly unboxy sound nevertheless!



**To advertise in this space  
please call 020 7372 6018  
or email:  
advertising@hi-fiworld.co.uk**



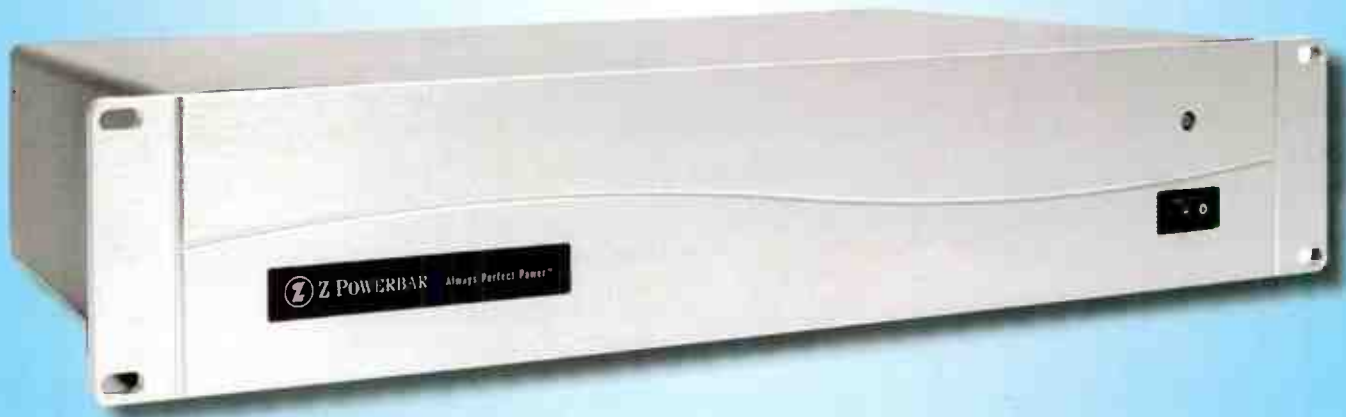

## WIN AN MIT Z-POWERBAR MAINS CONDITIONER WORTH £1,600 IN THIS MONTH'S GREAT GIVEAWAY!

**H**ere's your chance to win a superb MIT Z-Powerbar, as reviewed by Adam Smith in April 2009's *Hi-Fi World*. Here's what he said...

"As most audiophiles know, the importance of a good mains supply can never be underestimated. Any noise or rubbish coming up the mains lead will have a direct effect on what passes down the loudspeaker cables, and the result is unlikely to be beneficial. Having been converted to the benefits of mains conditioning back in 2007, I was intrigued to know what benefits this might bring. The MIT Z-Powerbar boasts six mains outlet sockets that will run a total of

1,800W. One is permanently live, four are switched and one incorporates additional isolation, designed specifically for digital equipment. All these sockets share the same technology internally however, namely "multiple patented, parallel tuned filters operating over the widest bandwidth, engineered to remove noise from your AC power line" according to MIT. This means that the Z-Powerbar works by stabilising, filtering and optimising the incoming signal using a parallel circuit configuration, rather than the more common series type.

Plugged in and warmed up, I was pleased to note that the MIT is absolutely silent. When the music played, the MIT convincingly leapt

ahead of cheaper units, things being more effortless and unstressed, as if the amplifier was working less hard to achieve the same results. The dynamic headroom appeared to have increased, and everything I played grew in both stature and authority. In the midband, singers and instruments were more vivid within the soundstage, bass lines gained better focus and I was strongly reminded of my recent times with the Roksan Kandy K2 amplifier, as its uncanny background silences suddenly appeared to have been effectively transplanted into my own setup. Overall, I was quite taken aback at the changes the Z-Powerbar made to my system, as the unit is very effective at what it does. Cheap it certainly isn't however, so this is recommended for high end systems, of course."

For a chance to win this great bit of kit, just answer the following four easy questions. Send your entries on a postcard only by 30th April 2009 to: **May 2009 Competition, Hi-Fi World magazine, Unit G4, Argo House, The Park Business Centre, Kilburn Park Road, London NW6 5LF.**

### RULES AND CONDITIONS OF ENTRY

- ONLY ONE ENTRY PER HOUSEHOLD
- MULTIPLE ENTRIES WILL BE AUTOMATICALLY DISQUALIFIED
- PURCHASE OF THE MAGAZINE IS NOT A PRE-CONDITION OF ENTRY
- NO CORRESPONDENCE WILL BE ENTERED INTO
- THE EDITOR'S DECISION IS FINAL
- NO EMPLOYEES OF AUDIO PUBLISHING LIMITED, OR OF ANY COMPANIES ASSOCIATED WITH THE PRODUCTION OR DISTRIBUTION OF THE PRIZES, MAY ENTER

### QUESTIONS

**[1] How many mains outlets does the MIT have?**

- [a] 2
- [b] 4
- [c] 6
- [d] 8

**[2] How much power will it run in total?**

- [a] 1,600W
- [b] 1,700W
- [c] 1,800W
- [d] 1,900W

**[3] What type of filters does it use?**

- [a] double sprocketed, double boosted
- [b] single layer, finely honed
- [c] multiple patented, parallel tuned
- [d] quadruple damped, triple polished

**[4] Adam was quite what, at the changes?**

- [a] "profoundly inspired"
- [b] "roundly impressed"
- [d] "taken aback"
- [c] "pleasantly surprised"

May Competition  
Hi-Fi World Magazine  
Unit G4 Argo House  
The Park Business Centre  
Kilburn Park Rd.  
London NW6 5LF

**entries will be accepted on a postcard only**

**FEBRUARY 2009 CHORD COMPANY CABLE BUNDLE & ARCAM FMJ A18 INTEGRATED AMPLIFIER WINNER: Mr. Ian Hancox of Walsall**

# Show Time!

**Audiophile super sleuths David Price and Adam Smith crept around the Bristol Sound and Vision show at the end of February to bring you all that's hot!**



## MICHELL

*Interesting times for the Borehamwood based vinyl specialist, as I heard – off the record, you understand - that the company is planning a significant new product launch in the coming months! Whilst I was sworn to secrecy on the details, I can say that Michell fans will be very pleasantly surprised. On the record, so to speak, the company had a small but significant new development – a new Rega-style three point fixing system with very natty VTA adjuster, which makes the decks compatible with the latest generation RB301 tonearms. As usual, the Orbe SE was on demonstration, and sounding sublime via Sugden amplifiers and ProAc loudspeakers. DP*

## CABASSE

*Coherent Systems were demonstrating a very musical system consisting of Oracle CD player, Belles amplification and the reintroduction of Cabasse loudspeakers into the UK. The pretty iQ2 satellites, with their tri-axial drive unit sounded far more spacious than their looks might suggest, and were well integrated with their matching subwoofer to give a highly cohesive performance. AS*



## ADAM

*At the show for the second year running, Adam Audio used both surround sound and two channel demos from a music server and Linn DS digital music player. They switched between the HM series monitors in new wood finishes, the brand new 'Pencil' columns from the Classic range and their new in-wall items, fitted in a purpose-built demo wall. Best of all though, every few hours they woke the rest of the hotel up with a blast of the mighty Tensor Betas – not all visitors may have seen them, but I bet most heard them! AS*



## LEEMA

*Leema Acoustics were demonstrating their new reference series items, and the Agena phono stage, Pyxis preamplifier, huge Altair IV monoblocks and Xanda loudspeakers turned in one of*

*the best sounds at the show. Naturally the choice of Garrard 501/SME V/Lyra Argo turntable helped immensely but the new Leemas looked and sounded superb. Not too sure about the white paintjob on the 'speakers though... AS*

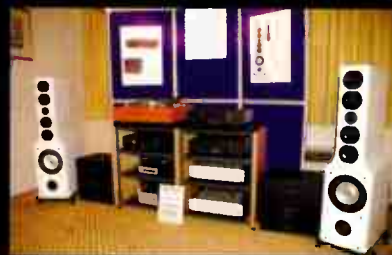

## TOTEM

*Joelit, distributors for Totem Acoustic amongst others, unveiled the rather intriguingly named beChocolate high end all-in-one radio/CD/digital music system, running into Totem Hawk loudspeakers. The sound from this was highly impressive, being punchy, fast and detailed and the unit itself is stylish and available in a wide variety of vivid colours. I was also rather taken by the amusingly named 'Chocolate Bar' remote control, although I think they missed a trick in not making it look like a bar of Dairy Milk... AS*







**MONITOR AUDIO**  
 Being a huge fan of MA's PL100 ribbon tweeter-equipped standmounting loudspeaker, and liking its bigger brother PL300 floorstander very much (but also knowing how difficult it is to get it to work well), I was interested to hear it in show conditions – and the result was most encouraging. But I wonder when they are going to announce a mid-sized PL200, which would be perfect for crowded UK living rooms...? DP



**WATERFALL**  
 Waterfall loudspeakers were showing their new flagship Niagara loudspeakers, bearing glass cabinets, a tweeter loaded by a unique glass horn, and a price tag of £25,000. Their sound was rich and highly enjoyable, although I am resisting the temptation to use the word 'transparent' [thanks – Ed.]. Look out for a review soon! AS



**CYRUS**  
 Following the great success of its Servo Evolution CD players, the Huntingdon small box specialist was showing its new XP series amplifiers using the preamp section of the DAC XP and a new power supply system, plus five digital inputs including USB. The idea is to make the amps a 'digital hub' for a number of inputs, including TV and computers, with surprisingly good sound. The company hasn't given up on Compact Disc though, with the CD8 SE clearly a league above compressed audio via a PC! DP

**YAMAHA**  
 In addition to their regular home cinema room, running an 11.2 configuration this year no less, Yamaha were demming the newly upgraded Soavo 1.1 loudspeakers in a bespoke two channel stereo room – and very impressive it sounded too when driven by the company's new range of CD/AS 1000 and 2000 series separates. The new entry level 700 series went down well too... DP



**ARCAM**  
 British specialist Arcam put on a fine show as usual, but the bit of kit that got my eyebrow twitching was the mysteriously entitled 'FMJ Blu-Ray Player'. An impressive but discrete looking box, it wasn't plugged in to anything so I was unable to assess its performance, but judging by Arcam's past form with DVD players it should be very good. I then tapped it on the top of the casing, to make sure it wasn't made of wood, and can confirm that it sounded like it was made of metal and full of electronic components, so I'd guess it will be on the market in a matter of months! DP



**MARTIN LOGAN**  
 Another key new product I saw at the Bristol Show was the Martin Logan Spire loudspeakers in the Absolute Sounds room. Part of the latest electrostatic hybrid range, they sport the new generation of panels – as seen and heard first on the stunning CLX – and sounded divine, despite the usual adverse show conditions. Fast, transparent and delicate



beyond the capabilities of box loudspeakers via Krell Evolution series electronics, they also integrated nicely with the moving coil bass units. Another key product of 2009, methinks... DP

**PMC**  
 Professional speaker-meisters PMC unveiled their new PB1i floorstanders, complete with twin 6.5in bass drivers, newly developed for the model. Driven by new Bryston SST2 amplification, they proved to be solid and dynamic performers, with plenty of well extended, clean bass. AS



Tel: +44 (0)1435 867 438

www.metropolis-music.co.uk

metropolis music

*a very special range of products that cater ...*

"I walked out convinced the **Anat Signature II** loudspeaker may be the "World's Most Accurate" as YG's advertising campaign boldly claims. The **Anat Signature II** is one of the fastest, cleanest and most accurate sounding loudspeaker I've heard whether in a show or home. Outstanding performance!"

*Stereo Times Editor, Clement Perry  
(model shown below)*



■ 1 shown: anat reference II professional



Every item from the Metropolis Music portfolio has been selected for its extreme sonic performance and beautiful aesthetic quality.

This symbiosis of design, build and sound is what gives a Metropolis Music product its individuality. Each is a personal statement of both the designer and constructor and you.

We know that everyone has their own idea of what sounds 'right', which is why within our varied range of handpicked products there is a product for everyone.

Contact Metropolis Music for details of your nearest specialist dealer.

For latest product information, product reviews and full price list please visit the MM website.

[www.metropolis-music.co.uk](http://www.metropolis-music.co.uk)



■ 2 shown: 1021

#### MM BRANDS SHOWN:

1. YG Acoustics
2. Boulder
3. Acoustic System
4. Mastersound
5. Hovland
6. Ayon Audio
7. Hansen Audio
8. Lumley
9. Furutech
10. Vitus Audio
11. Copulare
12. Coda
13. LSU
14. Nakamichi Niro
15. EBEN
16. Tenor Audio

#### MM BRANDS NOT SHOWN:

- Ascendo
- BAT
- Canor
- Exemplar Audio
- Kharm
- LSA Audio
- Music Tools
- Soundlab



■ 3 shown: various



■ 4 shown: (new) reference 845



■ 5 shown: stratos



■ 6 shown: (new) cd2



■ 7 shown: the emperor



■ 8 shown: stratosphere



■ 9 shown: power cable



■ 10 shown: ss-101



■ 11 shown: zonal serie a



■ 12 shown: csi



■ 13 shown: (new) levitation support unit



■ 14 shown: (new) nakamichi nero sss



■ 15 shown: eben c1

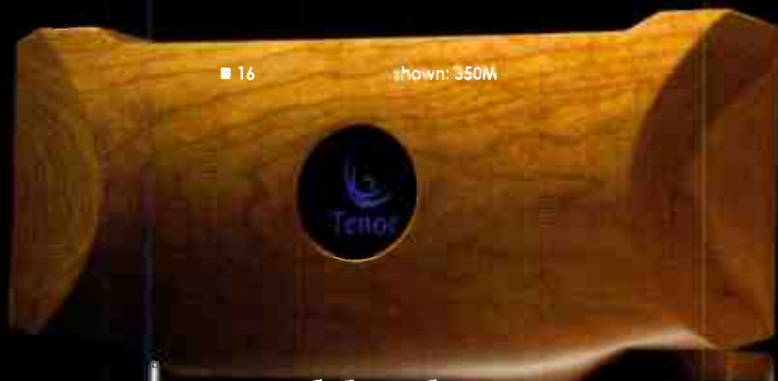

■ 16 shown: 350M

...for all music tastes and budgets



**MARIANNE FAITHFUL**  
*Easy Come Easy Go: 18 Songs For Music Lovers Naive*

In some respects, this album could be used to tour schools. "This," you would say, frowning and shaking your head in a sombre manner, "is what happens when you devote your life to the practice of hedonism." For while Emmylou Harris's latest release drifts down from the angelic heavens, spreading spiritual peace amongst us all, Faithfull clammers up from the pits of hell, her bloodied fingers grasping at every nook and rock outcrop, her dirtied hands appearing, flailing and flapping, grasping, from the abyss, slapping onto the cool ground and lifting her body weight from the hole of damnation...

This whopping eighteen-track double album is packed with covers from wildly varying sources: Dolly Parton to Black Rebel Motorcycle Club and from Duke Ellington to the Decemberists. Names are further

dropped with her collaborators who include Nick Cave, Jarvis Cocker, Kate and Anna McGarrigle.

Time and experience have both battered Faithfull's voice and limited its range to a demotic, rasping croak. So there are elements of the one trick pony when songs are interpreted along interesting pathways: The Decemberists' 'The Crane Wife', for example, with the assistance of Nick Cave is a *tour de force* whilst the duet with Anthony (from Anthony and the Johnsons) on Smokey Robinson's 'Ohh Baby Baby' is a snooze.

Her voice is perfect for defiance, anger and the rallying cry to ride out, not for gentle delicacies that require a deftness of touch. Yet, her acting experience does help in providing a grand dame approach to one or two potentially dodgy tracks, enabling her to successfully navigate through some potentially choppy waters. All in all, this album is an experience and, on that basis alone, should receive a deserved recommendation.

**MIGHTY SUPERFUNK**  
*Rare 45s and Undiscovered Masters 1967-1978 Volume 6 BGP*

Arriving as a double album squeezed into a single album sleeve, this is an excellent compilation of twenty funk rarities. Compiled by Dean Rudland, the content features a range of new discoveries including master tapes for a proposed single that never made a formal release, 'Groovy Baby' from Kim Tamanga on the Current label, a part of the Cotique Records label. Another previously unreleased track includes 'He Say She Say' (Sylvia) by the mysterious Chet Ivey. In fact mystery follows many of the artists on this album. It's quite enlightening just how many struggling artists were around during the late sixties and early seventies. Artists who managed to taste a limited measure of success before quickly fading away into obscurity again.

Take Eleanor Rigby, for example. Not the famous Beatles track, this was

**i hear loving**

does your record collection mean something to you? of course it does. give it the respect it deserves and stop scratching around. enter the realm of mint condition, sealed, rare & collectable records. vinyl to die for, if you will. although we'd rather you didn't. if you know your porky prime cuts from your nimbus supercuts visit **991.com** today and make a real sonic investment

<http://991.com/audiophile>





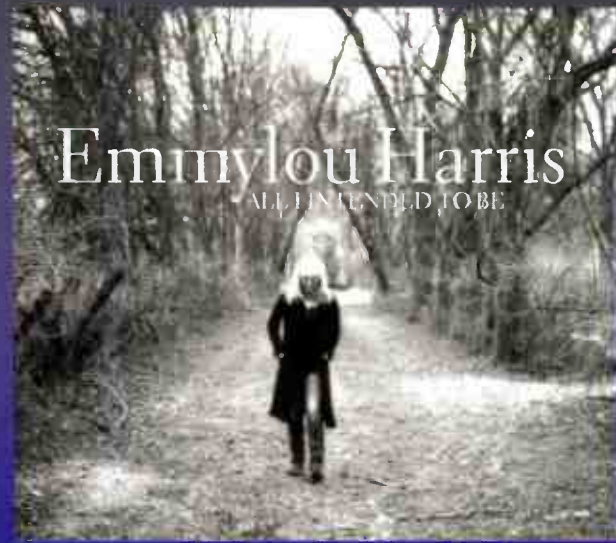

a lady who sang a cracking rendition of the funk staple, 'Queen Of Losers'. Whether Rigby was her real name is doubtful but nothing else is known of her. Other singers struggled to cope with the limited exposure they were getting. For example, Mary Alice McCall, who was a regular singer in church and is represented here with 'I'm Moving Home', on the Cle An Thair label in 1971, was scared stiff of the studio and was very nervous when she recorded this song. Although you can't tell that she has problems when you hear it here.

There are a couple of cross-genre artists here too. Take Jamo Thomas, known as Mr Jamo in the Northern Soul genre where he has a dedicated following, who released this mad funk release, the excellently titled 'Shake What You Brought With You'. Recorded in 1970 on the SSS International label, he tends to scream a lot over the backing track. All in all, a treasure trove of funk!

### THE MAGIC MIXTURE *This Is* Sunbeam Records

Originally released in 1968 on the Saga label, this British-born psychedelic rock outfit is – or at least should be – known in both music and high fidelity circles. For music lovers, it provides a true rarity for early British rock fans, this was the band's only album release, that is probably best known for the, well, daft 'Motorbike Song' which is more of a novelty track but is sung with real energy from a band who were

obviously having a fine old time. For audiophile users, the album also holds interest because the band features, on organ, one Stan Curtis, the founder-director of Cambridge Audio and Mission and former Chairman of both Wharfedale and Quad. The boy done good, then. Back in the late-sixties, however, Curtis was roaming London playing in a variety of rock clubs but how on earth he and the rest of The Magic Mixture found themselves on the classically oriented Saga label is anyone's guess. The label was making forays into 'pop' but Magic Mixture was the only rock outfit to appear there.

To be fair, this is not an album to stir the loins. It's not a classic. However, fans of both Jimi Hendrix and Cream should check it out. Okay, the band don't rise to the genius levels of either artist but there's certainly enough flavour here to spark interest. I haven't had the opportunity to compare this reissue with the original but reports say that this 180gm copy is a little heavier in the bass. There's a good focus to the Mixture's output that will provide any rock fan with an enjoyable listen. Not bad when you consider that the band recorded the entire album in a single day...

### EMMYLOU HARRIS *All I Intended To Be* Nonesuch

This new release from Harris is intriguing because, despite her last two albums containing largely original work penned by her own fair hand, this album is stuffed full of songs from

other writers. However, this is a long intended foray into the works of others, a collection of favourite songs which Harris has wanted to tackle for, in some cases, twenty five years. Some might call it a lack of focus whilst others will point to her adaptability as an artist, but hardworking Harris does try to pack in a lot of varied activities.

More than that, her natural creativity picks up associates in the same way that a wet finger collects the crumbs from a plate of food. Here, collaborators such as Dolly Parton, Vince Gill and Kate & Anna McGarrigle congregate. The style of the new album is interesting too as it links back to some of her earliest works. "It encompasses all the different hats I've worn - songwriting, doing covers, working with so many great people," Harris said. "In a sense, it was a return to a sound that's been with me throughout my career."

In addition, this album sees the return of her ex-husband, Brian Ahern, as the producer. A role he performed on eleven of her previous albums during the seventies and eighties. So, what we have here is that country music foundation and not the more experimental direction seen by Harris' Daniel Lanois collaborations. There is nothing staid about this album, however. Each song whether they be the few self-penned tracks included here or the majority of the songs written by others, are all superbly presented by Harris who owns every single one. Is this woman capable of producing a pop album? Not yet she ain't!

**Small can be wonderful. We are thrilled with the sound of this Bel Canto, Gamut, Velodyne and VertexAQ system.**

## Compact super system!

**Do** you suffer from the perennial problem that the hifi system is not welcome in the living room? What if a neat, superb system could be combined, **WITHOUT PENALTY**, with home theatre for the family?

Here is a system that is **COMPACT, AFFORDABLE AND STUNNING** yet gives scale, power and fine detail, better than a big'un.

A problem with big systems – big speakers and powerful amplifiers – is that with more power even **MORE VIBRATION** feeds back and dilutes the upgrade you've paid for!

**VERTEX AQ** mains filters and vibration-absorbing platforms and cables make amazing improvements to every system, no exceptions.

**BEL CANTO's** half-size components are neat and unobtrusive but amaze people with high-end performance. Their CD2 and DAC3 each have built-in volume controls and can drive power amps directly – no preamp – for finer detail. Amps could be the M1000 Ref monoblocks.

**GAMUT's** L3 speakers follow their philosophy: equipment designed to match the way humans hear sound – in the *time domain*. It's surprisingly rare but satisfyingly obvious when you hear how musical they sound.

The **VELODYNE** sub-woofer self-calibrates to the room and underpins the L3s to give a full-range, big-scale sound without driving the room into resonance.

Customers say we make some of the **BEST SOUNDS** in our studio they have ever heard, so you know we can do the same in your home. Our advice takes account of your best components and guides you where change is needed, in stages you can afford.

You **AVOID EXPENSIVE MISTAKES**, enjoy music and save money in the long run.

**JUST LISTEN AND YOU'LL KNOW**

**CD:** ACCUSTIC ARTS, BEL CANTO, GAMUT, RESOLUTION AUDIO, STELLO, WADIA.

**VINYL:** AESTHETICS, CLEARAUDIO, DNM, GRAHAM, THE GROOVE, LEHMANN, MICHELL, SUMIKO BLUE POINT SPECIAL, TRANSGURATION. **TUNERS:** MAGNUM DYNALAB.

**AMPLIFIERS:** BEL CANTO, CAT, DNM, GAMUT, HALCRO, HOVLAND, SONNETEER, STELLO. **LOUDSPEAKERS:** AUDIO PHYSIC, DALI, ETHOS, GAMUT, NEAT, TOTEM.

**CABLES:** ARGENTO, CHORD Co., DNM, KUBALA SOSNA, NORDOST, SILTECH, VERTEXAQ

**MAINS** Vertex AQ. **SUPPORTS:** ARCICI, STANDS UNIQUE, VERTEX AQ

Hear this system in Room 22 at the London hifi show 28/29 March

The  
Right  
Note

Music in the home



BATH

01225 874728

or lo-call

0845 230 7570

STAMFORD  
AUDIO

FROM A NEW LABEL FORMED BY  
THE SPECIALISTS IN AUDIOPHILE  
180 AND 200g VINYL....

NEW RELEASE



Limited to 500 hand numbered copies  
First time on Vinyl with 4 tracks featuring Sandy Denny on vocals.

**FIRST VINYL PRESSING ANYWHERE!!**

Sandy Denny, Jerry Dcnahue, Gerry Conway, Trevor Lucas and Pat Donaldson

The long-awaited restoration of tracks to form the aborted 2nd album by this folk-rock supergroup! On 180g vinyl in superb gatefold sleeve with unseen photos not in CD booklet!



Tel: 0845 603 5781 [www.stamfordaudio.co.uk](http://www.stamfordaudio.co.uk)

## Music First Audio

Our award winning pre-amplifier lets you hear your music the way it was recorded:

uncoloured,

unsullied,

unsurpassed



"The most musical pre-amplifier available..."

Andrew Harrison - Hi Fi News



[www.mfaudio.co.uk](http://www.mfaudio.co.uk) : : Puffing Music First 01424 858260





### RINGMAT SPIKE STOPPERS £43 (FOR 4)

Over the years I have tried most available isolation materials underneath my hi-fi equipment, ranging from the commercially available options through bubble wrap and squash balls. So it was with some interest that I unwrapped the Ringmat Spike Stoppers. These cork cones come in two sizes - the small (42mm diameter, 19mm high) type have a load bearing capability of up to

29kg in sets of either three or four. In my case, I used two sets of four to test them underneath my Kelly KT3 loudspeakers, which currently sit atop a pair of two inch tall polished black granite plinths, the spikes resting in little metal pucks Blu-tak'd to the plinth to stop them moving. Installation of the Spike Stoppers was easy, resting the spike inside the hole drilled in the top of the Spike Stopper. One of the Stoppers had a blue speckled finish - this is a

synthetic rubber binder mixed into the cork - and this is meant to be placed underneath the spike bearing the least weight.

From the opening bars of the Guilini/ Philharmonia Orchestra's recording of Rossini's 'L'Italiana in Algeri' I noticed positive changes to the sound of my system. I found improvements in every aspect of the music, from its timing through the darkest reaches of the back of an extended sound stage. The music had greater authority and presence, as well as precision and ease. It seemed to flow better, sounding subtly but significantly more natural and as such made me want to listen longer. As such I would certainly recommend trying the Ringmat Spike Stoppers in your system; the improvement garnered by them is impressive, especially considering the reasonable price. **TB**

[Contact: +44(0)1277 200210,  
[www.ringmat.com](http://www.ringmat.com)]

# soundbites

### RUBATO COPPER MAT £249.95

It is very difficult to assess turntable mats, because it is not the mat you're listening to, but the combination of the mat and the turntable platter itself. As such, the key is to talk in terms of the effect the mat has - and that's pretty much how mat design has progressed; effectively by trial and error. We've seen a range of cork (Ringmat) and acrylic type (Origin Live, Funk Firm) aftermarket mats appear over the years, and for their specific applications they are very good - generally with British belt drive turntables with fairly high mass 'masak' platters. But there's been little for fans of classic Japanese direct drives, with clanky lighter weight platters, such as the Technics SP10 and SL1200, until this high mass copper item arrived recently. Japanese vinyl anoraks will know about Micro Seiki's famed CU-180 copper mat, which was a strong seller in Far East markets in the nineteen seventies - and this closely resembles it. Whilst the Micro could be covered with an additional felt mat, this one is supplied 'naked', however.

Despite the welcome flywheel

effect, its heavy, thick copper composition can upset some decks. For example, the Sony TT-S8000 I first tried didn't like it - it upset the magnetic speed sensing system causing the quartz lock to misbehave. A Technics SL1200, which doesn't use a 'tape head' speed sensor mounted by the inner lip of the platter, worked fine and locked on speed. On a lesser JVC direct drive which didn't use a 'tape head' but had a weaker motor, the mass of the mat stopped the quartz lock working. So we're talking only big, powerful direct drives with no magnetic speed sensing (which precludes Sonys or Denons), then.

Properly installed, the results are very impressive - the noise floor drops, and a tremendous sense of rhythmic ease is imparted. That slightly brittle, 'chrome plated' upper midband that SP10s give disappears, and there's a solidity and tonal rightness that was hitherto lacking. On modern belt drives, it is less convincing, slowing down a Michell GyroDec (because of the weight) and bringing the

springs a little too low for comfort. Here I found a SDS Isoplatmat, which is about 30% lighter (but still a fair weight) worked better - as it did on a Technics SL1200. This mat is very promising then, providing you have the right turntable for it. I would be interested in a lighter weight version of this mat, possibly with an optional thin sorbothane or vinyl layer on top - this would make it a far more universal upgrade. It works superbly now, but only on some turntables. **DP**  
[Contact: +44 (0) 1822 612449,  
[www.puresound.info](http://www.puresound.info)]





...with 0% finance\*

\*subject to status/conditions

0%\*



**System 1**

McIntosh MXA-60 - £5,500 (This reference-quality 60th Anniversary system features a high-performance 75wpc amp, state-of-the-art CD/SACD/MP3 player, vacuum tube preamplifier, as well as an AM/FM/RDS Tuner and speaker system with 2 way bass reflex.)

Please call for finance details\*

0%\*



**System 2**

McIntosh MCD 301 CD Player - £4,795  
 McIntosh MA-6600 Integrated Amp - £6,695  
 ART Deco 8 Signature Speakers - £10,000

Deposit: £2,150\*  
 Pay £537.22 for 36 months\*

0%\*



**System 3**

McIntosh MCD-500 CD Player - £7,195  
 McIntosh MA-7000 Integrated Amp - £8,195  
 ART Deco 20 Signature Speakers - £20,000

Deposit: £3,600\*  
 Pay £885.05 for 36 months\*

0%\*



**(NEW) McIntosh MCD500**

0% Deal\*: Dep: £995 + £172.22 for 36 months

0%\*



**McIntosh MA7000**

0% Deal\*: Dep: £995 + £200 for 36 months

0%\*



**McIntosh C2300**

0% Deal\*: Dep: £695 + £166.66 for 36 months

Above are just examples. All McIntosh Products are available with 0% finance\*

# shadow audio

SPECIALIST HI-FI FOR THE TRUE MUSIC LOVER IN YOU

T: 0844 800 0073 or 74 | www.shadowaudio.co.uk



"Hi-Fi World has many readers looking to upgrade even now, even when times are tough..."



## David Price

If you were a new hi-fi manufacturer, where would you start? Well, just as the leader of the opposition is wont to say when answering questions on how he would get us out of the mess the government has made of the British economy, you "wouldn't start from here"!

Well, me too, as it happens. I'd certainly rather I launched the good ship "PriFi" (or whatever silly name I came up with) during calmer economic waters, so to speak. Ideally, you'd be wanting to make CD players in around 1984, wouldn't you? Or maybe I'd take direct drive turntables in 1975, or DVD players circa 1998. As for DAB tuners or DCC machines – errr, no thanks!

In 2009 (yes, that's us!), the bitter chill that is the UK retail sector is sending mixed messages. I'm still a little puzzled by what's going on – after all, despite the news that we're now over the two million unemployed mark for the first time in a decade, I'd dare to suggest that some people have almost never had it so good. Notwithstanding the 20% drop in the value of their houses – which was always nothing but a chimera anyway – there are a lot of people still in work, paying less for their mortgages, petrol and shopping bills. What an odd recession it is!

So – in theory then – some people, despite the constant doom-laden commentary we get from BBC News 24, Radio 5 Live, etc. – are actually quite a lot better off than they were a year ago (of course, I realise that savers and those who have just lost their jobs aren't part of this!). So how then does this translate to hi-fi sales?

Well, having access to GfK market research data paints a fascinating picture – and tells me

precisely what I should be doing as an aspiring captain of the hi-fi industry with my notional new "Pri-Fi" products. The figures – year on year and ending the last week of December 2008 – show a lot of doom and gloom, but read between the lines and you can see some quite interesting, and counter intuitive, things going on...

Okay – the bad news first. Total hi-fi separates sales by volume are down 12%. Ouch – but less than perhaps one might have feared with the spectre of banks collapsing, here there and everywhere? The biggest sales drop is with tuners, down 19%, and turntables, down 16% (but hold these in your mind, as we're coming back). Save a prayer too for amplifiers (-11%), hi-fi CD players (-8%) and loudspeakers (-16%). In fact, it's only AV receivers – the dreaded scourge of the Hi-Fi World reader, and Noel who has to test the wretched things (and finds they never quite work right) – that are growing at +16% sales by volume year on year...

Okay, it's not exactly a rosy picture for us turntable using stereo-types, then is it? Well actually there's more – and this is where life gets interesting. The sales-by-value figure tells a different story – take turntables for example. Whilst the number sold has dropped by 16%, the retail value has increased by 9%. This means – as any economics student knows – that the number of units is down, but the average unit cost is up. How to do this? Well, go up-market! That's precisely what's happened. The UK turntable market has died in the cheapo 'USB turntable' type area, and blossomed in the £15,000 EAT Forte area. People are buying fewer record decks, but spending a lot more on them. This means the high end is thriving (well, sort of), while the

entry-level market is on its knees...

The pattern is repeated with other products too – albeit nowhere near as marked as with vinyl; Tuners have dropped 19% by volume but only 10% by value (fewer units sold, but much more expensive), loudspeakers have dropped by 16% but only 4% by value (a more pronounced move to high end designs). CD players have dropped 8% by volume by nothing by value (so CD buyers are moving up-market too). It's only with amplifiers that the value of the market has dropped more than the volume (-13% and -11% respectively – which says amplifiers are selling less, and those that are selling are cheaper).

This is a fascinating insight into what is going on – and what is going on is that although the hi-fi market is shrinking, those who have stuck around are spending ever more on individual purchases. In short, in the midst of this recession, the audiophiles are busy upgrading just like they always did, while the casual impulse buyers ("oh why not, I'll just load up my credit card") are running away.

So, if I was a new manufacturer (and before the internet forum chatterboxes get all hot under the collar, no I am not!), then I would pay great interest in market data from GfK ([www.gfk.com](http://www.gfk.com)) – its data is surely worth its weight in gold. Or, alternatively, I would look at the Hi-Fi World letters section – where we have page after page of readers looking to upgrade even now, when times are tough. I think it's fair to say that fair weather friends (and buyers) come and go, but hi-fi is so important to some of us that we'll never shake off upgraditis – or resist spending serious money if we're sure it brings a commensurate improvement. ●

# // the singularly most addicting piece of gear I have ever heard"

10 AUDIO REVIEW

"A new benchmark for musical communication" STEREOTIMES

"One of the truly special products I've reviewed in the past 18 years" STEREOPHILE

Winner of Stereo Times magazine Most wanted component of 2005 award

"The best tonearm I've heard" HI FI WORLD



Your cartridge can deliver vastly improved results if coupled with a high grade arm. Great tonearms of the past were recognised for what they contributed but we would suggest it's time to upgrade. Massive performance improvements are now possible, so why not advance your system to a new level? After all, a significant tonearm upgrade offers many times the improvements of those given by cartridge upgrades, and last a lot longer. Our multi-award winning arms are offered with a no risk, money back guarantee should you be anything other than delighted.

### Tonearm Models

Enterprise  
Conqueror  
Illustrious  
Encounter  
Silver  
OLI

2005 World Awards

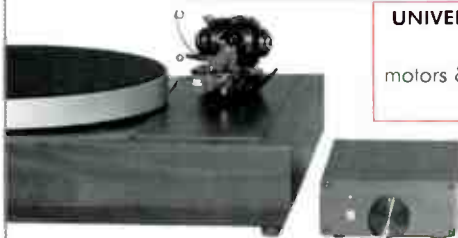

### UNIVERSAL MOTOR UPGRADE

Upgrades & replaces motors & power supplies for ALL belt drive turntables

### "The single most important upgrade you can ever make to any record deck concerns the motor

drive...nothing can prepare you for the shock of going DC. In a word, gobsmacking." COMMON GROUND MAGAZINE

"It's value is nothing short of tremendous." LISTENER MAGAZINE

"The LP12 remains a classic ...but ...upgrade kits by Origin Live can bring a vast improvement to it's performance" HI FI NEWS

**UNIVERSAL TURNTABLE MOTOR KIT** - No one would blame you for being sceptical of an easy to fit, inexpensive dc motor upgrade. Especially one that improves on the best of other power supplies costing over 4 times as much or your money back. It is simply impossible to imagine the level of improvement attained by eliminating the motor vibration that your stylus amplifies over 8,000 times! Our DC motor kit offers massive improvements to all versions of Linn Lingo / Valhalla, Rega, Systemdeck, Roksan, Rock etc. The kits consist of a drop in replacement high grade DC motor and off-board 2 speed control box. Why not order now? - see web site or phone.

Standard dc Motor Kit - £250

Advanced dc Motor Kit - £339

Ultra dc Motor Kit - £570

Upgrade Transformer - £175

Upgrade DC 200 motor - £129 with kit

ORIGIN LIVE

Tel/Fax: +44 02380 578877

E-mail: [originlive@originlive.com](mailto:originlive@originlive.com)

[www.originlive.com](http://www.originlive.com)

## PARTS CONNEXION

The Authority on Hi-Fi DIY

### DIY Parts & Components

pcX stocks the largest selection of DIY products for the discerning audio hobbyist, in all of North America!

### Upgrade Mods & Repairs

pcX has developed a world-wide reputation for best high performance and high quality upgrades and repairs. In a variety of areas, we are your one-stop source for the most polished audio components available.

### Accessories

PEARL Tube Coolers, EAT Cool Dampers, Duende Chatura Tube Rings, HiFi Tuning Silver Fuses, Furutech NanoLiquid, Walker Audio SST, Vibrapod Isolators, Caig De-Oxit, Bybee Quantum Purifiers etc.

### New & NOS Tubes

pcX has in-stock stocks of ALL currently manufactured NEW tube brands as well as a vast array of NOS offerings.

Sales: [www.partsconnexion.com](http://www.partsconnexion.com) Inquiries: [info@partsconnexion.com](mailto:info@partsconnexion.com)  
order@partsconnexion.com 905-681-9602  
905-631-5777 Visa, MasterCard, Amex, PayPal, Money Order & Bank Draft  
5109 Harvester Rd, Unit B2, Burlington, Ontario, Canada L7L 5Y4

# ISOKINETIK



### ISOkinetik Audio Enhancement

Rega special. Take your Rega turntable to a higher level of perfection - transform your standard Rega to a deck which will compete with decks priced over £2,000.

### ISOsub Rega sub platter upgrade.

Precision machined 3 piece construction, aluminium hub, hardened ground steel axle, stainless steel spindle, 3 brass contacts provide further isolation. Added stability reduces wow and flutter.

### ISOTone Rega tonearm rewire kit.

Must-have upgrade for Rega RB: 250, 300, 600, 900, 2501, 301 also Moth and Rega based derivative arms. Single length of silver plated high purity copper from clips to phono's. Kit complete with cartridge clips and silver solder - fitting service available.



Dealer and distributor enquiries welcome. For a full range of upgrades and accessories, interconnects or speaker cables please email [info@isokinetik.co.uk](mailto:info@isokinetik.co.uk) or call 0208 241 8890 [www.isokinetik.co.uk](http://www.isokinetik.co.uk)



"have you ever considered the problems of restoring audio for a DVD production?"



## paul rigby

**W**e're all familiar here at *Hi-Fi World*, with the notion of restoring music for release on both vinyl and CD. However, have you ever considered the problems of restoring audio for a DVD production? Not only is the audio source often much worse than that aimed at vinyl and CD, but then there's the question of syncing with the video...

North Shore Entertainment ([www.nsefilms.com](http://www.nsefilms.com)), which has produced its own DVDs featuring the likes of Frank Sinatra and Dean Martin, is also responsible for a number of productions for Audio Fidelity ([www.audiofidelity.net](http://www.audiofidelity.net)). I intend to return to the subject of Audio Fidelity, which represents the re-emergence of that great audiophile company, DCC, under a new name and the production of new vinyl and 24k gold CD releases which will be reviewed in future issues. The company is currently releasing a range of DVDs, one of which is called 'Back In The Day: Live At Hurrahs'.

'Hurrahs was part of the centre of the punk/new wave scene in New York in the late seventies. A whole host of bands that emerged out of that movement were discovered at the Hurrahs club: Lene Lovich, The Go-Gos (featuring Belinda Carlisle) and more. "During those years, someone was filming the acts on three-quarter inch video which is notoriously bad quality," said North Shore Entertainment boss, Marino Amaruso. "We took that video and upgraded the sound and the video and put together a whole collection of live work spanning sixty minutes. A sort of fly-on-the-wall video. It was fun for me to do because I remember seeing these bands at the time."

The source material was

purchased from a Long Island company called Historic Films who retain thousands of hours of archival material in storage. "Three-quarter inch tape is not very sharp to begin with – it's also an oxide-based material so, over the years, as this stuff was not stored properly, the oxide dried up and flaked off. When you watch it now, you get all kinds of white spots and banding," said Amaruso.

The audio restoration reflected the quality of the original recording: a camera mike or soundboard. There was a dramatic aural difference between the two. "With a camera mike, the music suffers by having no bass at all, it's all midrange. So what you do, is pick up any bass or various parts and individually turn that up a little bit to give it 'bottom' whilst also removing a lot of the hiss. It's not that you're playing God with a person's song but you're actually making it sound better."

But what is a soundboard recording? When a band arrives at a club and does their sound-check, the live sound is mixed just like a record: the bass is set at a certain level, the guitars, drum mikes and so on. A soundboard recording means that the recording device, a camera in this case, is physically plugged into it. This provides an 'even' sound. "Without the sound-board, if you had a camera and were filming next to the bass player, for example, the camera mike would be swamped by bass, with vocals in the distance," said Amaruso.

In theory the soundboard mix should be wonderful but, "you're talking about a club whereby, if you stood too long in one spot, your feet would stick to the floor and every band that came in used the board which wasn't great to begin with – from the Acme company, maybe. It was better than the camera, though."

The result is excellent, benefitting from some considered and time consuming restoration. A time capsule sound source that every punk and new wave fan will love.

Valuable archive material pops up from the most unlikely places. Often, TV archives provide the source for many a gem. Discovery Records ([www.discovery-records.com](http://www.discovery-records.com)) is currently selling, for example, a range of fascinating DVDs focusing on that great jazz composer and arranger, Bill Evans. We have seen nine DVD collections, none of which are familiar, and all are essential to the dedicated Evans fan and all benefit from rescued TV archive material. The sound is not wonderful but the rarity factor prevents any undue criticism.

'Live in Oslo 1966' (Impro Jazz), for example, combines a recording in Norway of Evans playing with local musicians and, for the second part, a trio performance from a short-lived New Jersey, USA, TV show that also includes an interview with Bill. The 'Trio: Umbria 1978/Hamburg 1972' performance via Jazz Shorts is fascinating as it includes a series of rehearsals plus discussions relating to a later show with alto sax man, Herb Geller – the only known collaboration between the two. Other DVDs include 'The Rome Concert 1979' (Impro Jazz), 'But Beautiful' (Modern Jazz), 'The Universal Mind Of Bill Evans' (Eforfilms), 'The 1965 London Concerts' (Impro Jazz), 'Waltz For Debby' (Salt Peanuts), 'European Nights' (Impro Jazz) and 'In Europe' (Jazz Music Performances).

The fact that DVDs like these utilise material from a range of unusual and diverse sources leads you to wonder just what else is out there? I await new releases from both Audio Fidelity and Discovery Records with interest. ●

# Walrus

11 New Quebec St, London W1



*i'm back by popular demand...  
so get down to walrus NOW!*

british design and manufacture  
plus superb sound. croft is back!



croft micro 25 + series 7 \*\*\*\*\*



solidtech radius stand



pure sound A30



michell gyro se



kibri naima



brinkmann la grange



nottingham analogue space 294



shanling MC-3000 dock/tuner/cd



stax SR-2050 II basic system



solidtech rack of silence stand



benz micro glider



lyra skala



stax SR-007 omega system 2 \*\*\*\*\*

- a2t
- acoustic signature
- acoustic solid
- acuhorn
- aesthetix
- air tight
- amazon
- amity
- amplifon
- amr
- apollo furniture
- aura
- basis
- benz micro
- black rhodium
- bocchino
- brinkmann
- cartridge man
- cawsey
- clearaudio
- consonance
- croft acoustics
- decca london
- duevel
- dynavector
- ear yoshino
- emt
- funk firm
- gershman acoustics
- goldring
- graham (tonearms)
- graham slee
- hadcock
- harmonix
- heco
- heed audio
- horning
- hyperion
- incognito
- isolda
- jadis
- john blue
- kibri
- koetsu
- luxman
- lyra
- lyra connoisseur
- mcintosh
- melody
- michell engineering
- mit cables
- morch
- musical fidelity
- nordost
- nottingham analogue
- origin live
- ortofon
- pro-ject
- pure sound
- rcm
- rega
- reimyo
- ringmat
- roksan
- shun mook
- shanling
- sme
- solid tech
- something solid
- stax
- stello
- stirling broadcast
- sumiko
- tannoy
- tom evans
- townshend audio
- transfiguration
- trichord
- usher
- van den hul
- xindak



**\* Please ask about our ex-demo stock; many items are virtually as new but with large reductions.**

We deliver by Business Post 24hr service (subject to stock availability), and internationally by DHL, TNT or UPS.  
Major credit/debit cards accepted, even known to take cash on occasions!  
Please visit our website for product, technical and ordering info.

tel: 020 7724 7224 fax: 020 7724 4347 contact@walrus.co.uk [www.walrus.co.uk](http://www.walrus.co.uk)



"the end result of being first with DAB is that we'll have the worst digital radio system in the world for decades!"



## steven green

**A**t the end of January, Communications Minister Lord Carter published the Digital Britain interim report, which outlined the government's thinking on various digital issues facing the UK. The proposal that has made the most headlines is that there should be a universal service obligation for broadband, where every household in the UK must have access to broadband at a speed of at least 2 Mbps. This will be welcome news for those who currently have very slow broadband, although in mine and in many other people's opinions, this doesn't go far enough...

However, the Digital Britain report also laid out the government's views on digital radio, which I'll cover in the rest of this column. As expected, the government supported the Digital Radio Working Group's (DRWG – made up of representatives from the BBC, commercial radio and the DAB receiver manufacturers) recommendations that the UK should push ahead with DAB, and that Internet radio shouldn't figure in the long-term plans. However, the Digital Britain report *did* stop just short of what the DRWG had hoped for, because the report said that the government would commit to making DAB "a primary distribution mechanism for radio", whereas the DRWG wanted DAB to be "the" main digital radio platform. The section about digital radio in the Digital Britain report only consisted of proposals to make DAB the main digital radio platform though, and Internet radio wasn't mentioned at all, so in reality the government does actually support everything the DRWG proposed.

A damning but enlightening quote emerged recently on this subject in a report sent by the commercial radio industry to Lord Carter prior to

the publication of the Digital Britain report. In the report, the commercial radio industry said that it would only "forge ahead with DAB" if "the government, Ofcom and the BBC" made a "commitment not to pursue alternative technologies to DAB". Or in other words, if the Digital Britain report proposed that Internet radio should figure in the long-term plans for digital radio (the BBC is more biased towards DAB than anyone, so they hardly need to be convinced to pursue DAB alone), the commercial radio industry would refuse to invest the money and effort needed to make the push towards FM switch-off, which would leave the government's digital radio plans in tatters. Clearly the threat worked. Then again, Lord Carter has always been a DAB supporter anyway, because when he was the chief executive of NTL he bought a 33% stake of Digital One, the national commercial DAB multiplex operator, so it was very predictable that he would back DAB in the Digital Britain report...

One galling aspect about the decision to press ahead with DAB/DAB+ is that it's yet another example of short-term decision making, which is precisely what landed us in the current mess we're in. The government set up the DRWG in 2007 because DAB sales had been very poor and the commercial radio groups had been whingeing about the costs of transmitting both analogue and digital, and FM switch-off being a distant prospect. So the decision to try and accelerate the move to DAB was simply the government trying to appease the commercial radio broadcasters.

A decision to press ahead like this shouldn't be based on short-term issues, because if analogue radio systems are anything to go by, we'll probably be using DAB/DAB+ for the next few decades – the

broadcasters would view switching to a different and better system as being unnecessary effort and expense. And although DAB+ may be a significant improvement upon DAB, it is still limited by the fact that it uses the old DAB system's 1980s-style transmission scheme, so DAB+ is still very inefficient by modern-day mobile broadcasting system standards. For example, the forthcoming DVB-H2 mobile broadcasting system is about three times more efficient than DAB+, which means that it would have three times the capacity of an equivalent DAB+ system. This makes the transmission costs for each station far lower, so the broadcasters would be much more likely to use higher bit rate levels in order to provide high audio quality.

The UK is one of the only countries in the world to have made any progress with digital radio up to now, because the vast majority of countries have shown little or no interest in it. These other countries are now free to choose systems such as DVB-H2, or they could go with mobile Internet-based broadcasting standards such as eMBMS, which would allow live radio to be combined with on-demand content, providing listeners with a far better service than we'll be getting in the UK. And that's the irony, because the government's plan when it first came into office was that the UK would be the leading nation for digital broadcasting, and yet the end result of being first has been that we'll have the worst digital radio system in the world for decades! Not content with the damage it's already done, the government now supports the blatantly anti-consumer, protectionist recommendations made by the broadcasters in the DRWG report. I used to vote Labour, but now I'll be glad to see the back of this bunch of buffoons. ●

# The all-new M-series from ROKSAN



High performance hi-fi separates  
that will make your heart sing



To find out more about the M-Series of high performance hi-fi separates  
from Roksan, and where you can buy them  
visit: [www.henleydesigns.co.uk](http://www.henleydesigns.co.uk)



[www.henleydesigns.co.uk](http://www.henleydesigns.co.uk), 01235 511166

#### ROKSAN CENTRES OF EXCELLENCE

Midland Hi-Fi Studio, Wolverhampton • Audio Merchants, Glasgow • Sound Cinergy, Aldridge • HG Rapkin, Northampton  
Home Media, Maidstone • Kronos Hi Fi, Dungannon • Merlin Music, Melrose • Sevenoaks Sound & Vision, Yeovil  
Sevenoaks Sound & Vision, Southgate • Sevenoaks Sound & Vision, Holborn • Technosound Systems Ltd., Dunstable  
Hi Fi Sound, Darlington • Unilet Sound & Vision, New Malden • Videotech, Huddersfield • Zouch Audio, Asby-De-La-Zouch

World Radio History



"the vinyl revival has led to a blossoming of extravagant engineering confections - I love it!"



## noel keyword

Using to a top vinyl playing system is a privileged experience. It's all analogue, the engineering is ingenious and, as often as not, the styling is visually intriguing too. Unlike most other modern day products turntables are an art form. And now the revival of vinyl has led to a blossoming of extravagant engineering confections - I love it!

It was subbing this issue that brought it home to me. Adam's simple yet telling observation that at the recent Wigwam show visitors to his room were most impressed by his Garrard 301 (see his column on p97) reminded me that the 301 is a visually intriguing machine, highly styled, in a particularly strong nineteen fifties idiom. It is visually arresting; think of Mallard perhaps, not the same as surrounding steam locomotives but evocatively styled and redolent of its period. So Garrard's excellent 301, a studio workhorse in its time, resonates with us visually today. It combines effective engineering with distinctive design and old products like this have set a trend in hi-fi, one with an on-off history that is nowadays coming back on.

Let's say the Garrard 301, released in 1954, was to hi-fi what a 1950s Cadillac was to automobiles, a style icon that also performed its function well. It was followed by the smart if less ostentatious 401 I use, and then Garrard were overwhelmed by Japanese mediocrity.

Mediocrity? Well, not in engineering terms of course, for they managed to convince us all that fine engineering would provide a better tomorrow, and in many senses it has done that, but one devalued by a manufacturing ethic that demands rapid product churn and obsolescence just to maintain sales. Bear in mind that Adam's Garrard

and the many 301s still in use today will have been doing its job faithfully and competently for fifty years and you get some idea of the different ethos. My 401 has been in constant use for a mere twenty summers or so and I have never even contemplated the possibility of it dying on me, as there's little to go wrong or wear out. So it won't be heading toward landfill any time in the future, and no matter what its initial cost, final ownership cost will be minimal.

Contrast this sort of design to our two Pioneer PLC-590 Direct Drive workhorses. Both ground to a halt after a few years of use and had to be repaired. One throws a wobbly every now and then, speeding up and slowing down, showing just how fickle such complicated designs can be. I love their control ergonomics, solid cast alloy plinth and stable arm platform but there is no chance either would replace my Garrard 401.

In their time, 301s and 401s were natty studio workhorses. This was when LP was king and digital a far off dream - of perfection, no less!

How it has all changed. Digital audio has all but ground to an embarrassing halt, in a flurry of dead end technologies and formats. Worse, none were ever packaged in a way that has any visual appeal of the sort we see in the past with turntables, and we are seeing again as new, ever more extravagant designs appear. There are some honourable exceptions, notably Chord Electronics DACs and Apple's iPod, but had Steve Jobs not returned to Apple I suspect the design standard in this field would be lead by the Zune - and if you've never heard of that, it just proves my point about how totally anodyne and forgettable modern technology has become in contrast to the analogue turntable.

It would be nice if Blu-ray had upped design standards, because

although yet another 'silver disc' it is a formidable one. But Blu-ray players are as subject to design churn as anything that went before, Samsung bringing out new models so fast, for example, we were not able to secure the interim BD-P1550 before the latest BD-P2500 was announced. Short wavelength blue lasers and vast digital storage capacity they may have, but style wise, forget it.

I'd say that Garrard's early efforts contributed strongly to the turntable being seen as a style item. What Garrard helped start was expanded upon by Transcriptors with their fantastic Reference and then furthered by John Michell, almost alone with his stunning range of decks, until recently.

Now the world has fallen back in love with the analogue turntable, its styling is enjoying a real creative boost. Interesting designs are coming from the USA and Italy our CES Show report highlights, from Eastern Europe in the form of the EAT you can read about in this issue, and from Germany too, where they have a fascination with LP.

I feel we have some way to go with the pickup arm though. Designers are groping their way ahead here, most of them not really certain what is and what is not important. There's a lot said about them, but not so much is really known. There's plenty of scope for the use of interesting materials and structures and surely we are going to see a lot more happening here in future.

In the meantime, as ever more music is released on LP and as modern digital formats fumble and stumble to provide a player with any visual appeal, I think we can sit back and enjoy the wonder of using something that sounds great, lasts almost for ever and looks fabulous as well. ●

# Cymbiosis

## Linn Products

*Sondek LP12 specialist  
setup, upgrades, rebuilds  
25+ years experience with international reputation*

## Naim Audio

*500 series stockist  
always available for demonstration  
including DBL Loudspeakers*

**Arcam • Atacama  
Chord Company • Denon  
Dynavector • KEF  
Kudos • Neat Acoustics  
Quadraspire • Rega Research  
Spendor & more...**

*We are hi-fi specialists, so please call us for  
advice, recommendations and demonstrations*

*We always carry a selection of quality used hi-fi  
check our website for more details*

6 Hotel Street, Leicester, LE1 5AW

Tel: 0116 262 3754

e-mail: [shop@cymbiosis.com](mailto:shop@cymbiosis.com)

[www.cymbiosis.com](http://www.cymbiosis.com)

## IMPACT AUDIO

For The Best In Audio Components

LOUDSPEAKER KITS - DRIVE UNITS - ACCESSORIES.



Mini 12



Finiton Sat / Sub



Conia



T-100



K-Power



A-series



VISATON



Speaker



Speaker

Send for free catalogue:

Tel: 01270 883243 Fax: 01270 882241

[info@impactaudio.co.uk](mailto:info@impactaudio.co.uk)

[www.impactaudio.co.uk](http://www.impactaudio.co.uk)

Radway Green - Crewe - Cheshire - CW2 5PR

**VISATON**  
GERMANY

Demonstration by  
appointment

whest audio ltd  
[www.whestaudio.co.uk](http://www.whestaudio.co.uk)



'the bar has been raised yet again'

tel +44 (0) 20 8978 7047



"by all accounts, the day was a roaring success and both forum members and public alike enjoyed it..."



## adam smith

**W**ell, it's all over, and despite a severe case of exhaustion and a sore back from humping for too much large and heavy equipment around, I cannot help but feel a sense of satisfaction. What am I talking about? Well, the big Hi-Fi Wigwam 'bake-off' at Scalford Hall on March 1st, of course!

For those of you who didn't see my mention of it last month, the idea was simple – take around fifty members of a successful online hi-fi forum and get them to bring their systems along to a central location in England for the public to come and have a listen to, as well as each member to have a wander round and compare notes. For me, this meant hiring a van, a three hour drive, a night in a Premier inn followed by an alarm call at silly o'clock in the morning, ten hours on my feet entertaining the public, packing it all up again and a three hour drive home! A week later I still don't think I've caught up with my missed sleep but it was all well worth it.

By all accounts, the day was a roaring success and both forum members and public alike appear to have had a very enjoyable time. The atmosphere was friendly, affable and there were no undignified scenes or tensions – just a bunch of enthusiasts (or "nerds" as my dear wife put it...) getting together, playing some music, genially showing off and generally having a bit of a laugh. The day was hectic and I know I was not the only exhibitor who had a crowded room all day – sadly my co-host had to pull out at the last minute, meaning I hosted my room on my own, and the first chance I had for a 'bathroom break' was actually 3pm. Given that the show opened at 10:30, I took this as a good, if slightly uncomfortable,

sign! Top tip – always make sure you have a 'room buddy' at such events, or a 'porta-potty'...

As a result of being on my own, I sadly only had a chance to hear a handful of other systems and equally was unable to run round with the camera to put together a 'show highlights' report. However, on reading the show guide, I was amazed by the sheer variety of equipment and system configurations on offer. In one room you'd find a computer audio setup feeding valve amplifiers, in the next were some homemade open baffle loudspeakers, further down the corridor were some huge Tannoys neighbouring a simple but affordable setup fronted by a classic turntable. The gear came in all ages, shapes, sizes and prices and, by all accounts, some very fine noises were to be heard.

From a personal perspective, I was more than happy with the sounds that my own system was making in my room and I was delighted by the number of positive comments I received. Interestingly the two main attention-grabbers were my Garrard 301 turntable and Ferrograph loudspeakers, the latter seemingly well liked, even if more than one "ugly" comment was passed! Quite a few people also seemed keen to hear a well fettled 301 in action, but I was quite surprised at just how many enthusiasts had never even seen one before in the flesh – I suppose when one virtually lives and breathes such items, it can be all too easy to forget how rare and exotic they can appear to many who have not experienced them. Ultimately, my Marantz CD player was well liked, but most of the time it didn't get a look-in – everyone wanted to hear the Garrard. Most amusing was one forum member voting the Garrard "prettiest sight of the day"; I am truly flattered as, much

as I love the deck, even I wouldn't exactly describe it such!

As mentioned, one of the ideas behind the event in the first place was for the show naysayers to show what they felt they could do and I did half wonder if, after the success of the event, there would be an element of smug sneering at the trade for their shows but, interestingly, the reverse was true. Generally, I think it was felt that manufacturers and dealers have a much harder time at exhibitions, having to bring much more equipment, plus keep smiling and demonstrate it for two or even three days at a time. There is also the simple fact that if a distributor sells loudspeakers X and amplifier Y that he will inevitably have to demonstrate them together and, even if the two are individually good items, they may simply not synergistically gel together, resulting in a sound that is far from what the units are capable of on their own. All in all, I think a new level of respect was garnered for the trade in general, and the efforts they go to at such shows.

Finally, I feel a few honourable mentions should be made. Firstly all forum members extend our grateful thanks to Wigwam owner James Palmer, and Chester Group for getting the whole thing off the ground, and also to the latter for having the bravery to see if such an event would be a success. We are also indebted to Scalford Hall for hosting the event, and the staff were friendly and helpful, if a little bemused by the whole thing! Although attendance numbers have yet to be officially confirmed, the suggestion is that the show exceeded the minimum footfall that Chester Group were hoping for, in order to make the whole thing financially viable. We are all certainly hoping this is true, as we're all raring to go again next year! ●

# vinyl section

## contents

MAY 2009

[www.hi-fiworld.co.uk](http://www.hi-fiworld.co.uk)

### DR FEICKERT TWIN 100

Adam Smith gets back trouble manhandling this mighty new turntable package...

### SOUNDBITES 105

Tony Bolton tries SRM Tech's Turntable Tune-up Kit and Roksan's Digital Stylus Balance.

### ORIGIN LIVE CONQUEROR 3C 107

David Price auditions the new carbon hybrid tubed version of OL's penultimate tonearm.

## ROCK IN THE MIX

A wide variety of rock issues have hit the market of late. The following gives you just a flavour. From Deep Purple, the classic 'Stormbringer' (EMI) was the 1974 follow-up release to 'Burn' and featured David Coverdale, Glenn Hughes, Jon Lord, Ritchie Blackmore and Ian Paice. Newly remastered by vinyl stalwart Peter Mew at Abbey Road, the album appears with a bonus disc of remixes and rarities. In contrast, and injecting a slice of country into the rock, Nashville Pussy's 'From Hell To Texas' (SPV) also appears via gatefold whilst the music, has been three years in the making, is heavier and dirtier than their earlier works. Finally, The Damned's punk oriented 'Black Album' (Devils Jukebox, [www.lamf.biz](http://www.lamf.biz)) is restricted to just 666 copies and includes a bonus 12" disc of unreleased tracks.

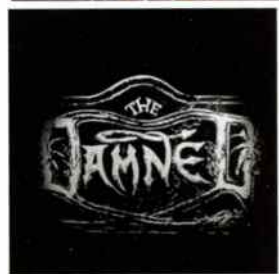

## news

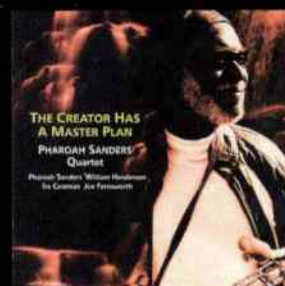
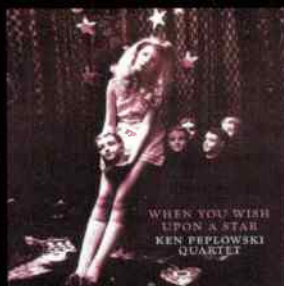

## VENUS FROM JAPAN

Currently offering a range of both neglected and relatively obscure jazz releases on high quality Japanese pressings via the chin-scratchingly intriguing, 'Hyper Magnum Sound' process, Venus issue their LPs on 200gm vinyl, thick card covers and a plastic outer bag with an attractive obi-strip down the left-hand side. Latest titles include: Harold Mabern's 'Misty', Ken Peplowski Quartet's 'When You Wish Upon A Star', Nicki Parrott's 'Moon River', Eric Alexander Quartet's 'My Favourite Things' and the Pharaoh Sanders Quartet's 'The Creator Has A Masterplan'. Contact: [www.discovery-records.com](http://www.discovery-records.com).

## SUAN

A highly collectable album – one original example was recorded as being sold for almost \$2,000 on eBay, and that was a couple of years ago. Armando's Piazza's psych folk-rock release, 'Suan', from 1972, on the obscure Beautiful Butterfly label, has always been hailed as a worthy listen. Now the Greek reissue label, Missing Vinyl, is offering a reissue on 180gm vinyl from, amazingly for such an obscurity, the original master tapes! "We took the music from the master tapes provided by the band. The final album was mastered in Italy," commented MD, Nick Youkoutis. Contact: [www.veamusic.com](http://www.veamusic.com).





## WYATT A GO-GO

Robert Wyatt's catalogue, on the Domino label, has enjoyed a recent airing via CD. Now, the whole lot has also been seen on vinyl – and about time too. The album releases include 'Rock Bottom' (his debut, released in 1974), 'Ruth Is Stranger Than Richard' (the 1975 release that featured Brian Eno), 'Theatre Royal Drury Lane 1974' (a rare live gig, introduced by John Peel), 'Nothing Can Stop Us' (a great mix of political comment and the superb ballad, Chic's 'At Last (I Am Free)'), 'Old Rotten Hat' (a 1985 release), 'Dondestan' (featuring sparse works, from 1991), 'Shleep' (packed with talented support including Phil Manzanera and Paul Weller), 'Cuckooland' (including plenty of experimental forays) and 'Comicopera' (a work in three parts, released in 2007). All are only available for a limited period.

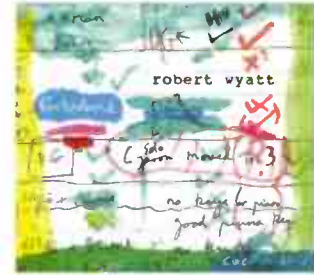

## WHOLE HEAP OF JAZZ

A wealth of new jazz has appeared this month, ranging from 140gm to 180gm vinyl weight. The obscure Lee Morgan Septet (180gm, Jazz Beat) release from 1957, 'Dizzy Atmosphere', features sometime members of Dizzy Gillespie's band; Art Pepper's '+Eleven' (140gm, Disconforme) is a brilliant, 1959 release playing Marty Paich arrangements; Sonny Rollins' 'The Bridge' (140gm, Disconforme) is an absolute classic from 1962, three years after Rollins' supposed retirement; Miles Davis '+19' (180gm, Jazz Track) is an excellent collaborative piece with Gil Evans, proving that the, at the time, unfashionable big band sound could push boundaries. Errol Garner's 'Concert By The Sea' (180gm, Jazz Beat) was his finest hour, full of verve and drive. Finally, Zoot Sims' 'Stretching Out' (180gm, Wax Train) is another rarity in the cool jazz category.

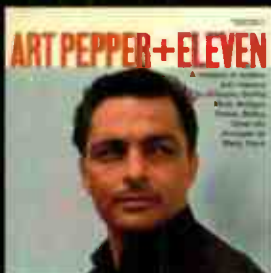

## DARK WAS THE NIGHT

Just released on the 4AD label, is a three disc compilation, within a gatefold sleeve, featuring a range of classic underground artists such as Yo La Tengo, Grizzly Bear, Kronos Quartet, Blonde Redhead and The New Pornographers. There's also a selection of interesting duets featuring the likes of Dirty Projectors and Talking Heads' front man, David Byrne. The latter's take on a Byrne composition. Knotty Pine has, in fact, just been released as a single.



## DELTA SPIRIT

Mixing both rock and soul into one unlikely mix, US-based Delta Spirit, on Rounder Records, provide a sort of Rolling Stones for the noughties feel with their new release, 'Ode To Sunshine'. Out of California, this five piece outfit have been honing this debut release over many months gigging - and it shows: each song is tight and well executed. With elements of preachy Dylan-esque lyrics and foot-tapping melodies, this is an intriguing album that's well worth a punt.

# Doctor Doctor!

**Adam Smith risks life and limbs manhandling the mighty Dr Feickert Twin turntable...**

**T**here are one or two people out there who are rather surprised to discover that the way hi-fi equipment is designed, and consequently how it looks, is not actually an accident. It is largely true that form follows function, and the appearance and structure of a finalised component will largely reflect the particular ethos that its designer follows.

This is especially true in the case of turntables, but sometimes it takes a little investigation to reveal the particular train of thought that the designer has followed. Of course this is not always the case – one look at a Townshend Rock R7 will quickly reveal that designer Max Townshend is a fan of isolation and damping, thanks to the novel bellows sprung feet and the traditional damping trough. However, for the first time in my life I have come across a turntable where the designer's ethos became immediately apparent before I had even opened the box. You see, Dr. Christian Feickert follows the "high mass concept as the main design rule", and I realised this was the case when it took two of us to move the box containing the Twin turntable - make no mistake about it, at over 32kg in weight, this is one deck you do not want to be transporting too often!

Dr. Christian actually has a background in physics and mathematics, plus a doctorate in physical chemistry, but it was in the mid nineteen nineties that he turned his attention to sound reproduction, specifically attempting to investigate why digital reproduction equipment of the time sounded "bad compared to analogue gear". This in turn led to his full-time involvement in

vinyl replay, becoming international distributor for his friend Thomas Scheu's company, Scheu Analog. After Thomas's untimely death in 2004, Christian helped his widow Ulla to maintain the company's position, before leaving to pursue his own designs, in the form of Dr. Feickert Analogue.

The Twin is the first black plastic player from the company, and rumour has it that a Single and Triple will be following in due course; I suspect that a forklift truck at the very least will be required to move the latter when it arrives. The name Twin stems from the fact that the deck's base consists of two cylinders of black painted ply, sandwiched between two hefty steel discs. As can be seen, two steel bars protrude from the ply discs, which support the three layer ply armboard at the rear. This is a nice touch, as aligning the arm simply involves undoing three screws

and sliding the whole platform along the rails – in this way the deck can be easily adjusted to accept nine, ten or twelve inch arms. Furthermore, optional longer rails that stick out of the front are available, which allow a second arm to be fitted at the front of the deck.

This construction sits on a further lacquered ply baseboard, into which three feet are fitted – felt covered on their bases and adjustable for levelling the whole unit – and the whole thing results in what Dr. Feickert calls a MARC, or Mechanical Anti-Resonant Circuit. The platter matches the colour of the black ply layers and is a matt coated acrylic item, although a matt coated poly-oxo platter is available for a further £250, or a similar item with brass inserts for £490. Interestingly, the platter spins on an inverted grease bearing which is preloaded at the factory and needs checking once a year.

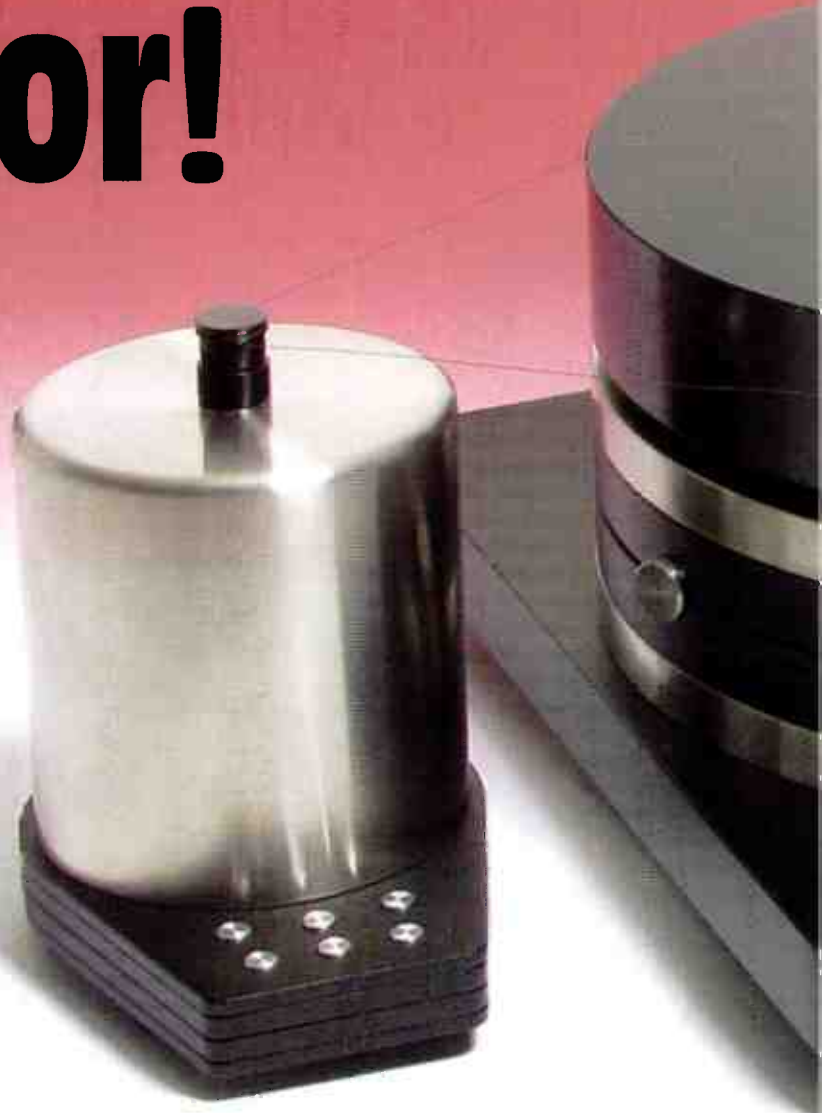





Drive to the Twin is provided from an impressive motor pod containing a purpose-designed Papst DC unit, run by a proprietary electronic controller circuit, developed by Dr. Feickert himself. This allows speeds of 33, 45 and 78rpm as standard, plus a good range of speed adjustment using two up/down buttons. Even more handy is that any new speed setting you dial in can be stored for that speed change button, and then altered again at a later date if you so desire. The standard drive method is by string; a method I am rapidly becoming a fan of, although the motor pulley is also set up to accept a belt should you prefer this method. Dr. Feickert provides two Kevlar drive strings, fortunately pre-tied, as I have found in the past that I lack the small fingers and long nails for carrying this operation out successfully on a DIY basis! Unfortunately, whilst

the motor proved easily adjustable for accurate speed, and pleasingly torquy for swift startup, it was also disappointingly noisy in operation, being clearly audible across my listening room in between tracks...

Our review sample Twin came with Dr. Feickert's new DFA-105 arm – a ten and a half inch design based on the Jelco SA250 and manufactured to Dr. Feickert's specifications. This is available on its own for £855, or for £780 as packaged with a Twin. Regular readers will know I am a fan of Jelco arms and the DFA-105 does not disappoint in build terms. Equally, the chrome and black finish is superb and matches well with the turntable although, as this is available in various shades, including dark blue and burgundy, I don't know whether there is a matching coloured DFA-105 for each! Also available is the DFA-90 arm, based on the straight, nine inch Jelco SA250-ST, or the deck

can be provided with armboards cut for the arm of your choice. Setup of the deck is simple, and I had it up and running in around forty minutes, the included Dr. Feickert alignment gauge helping here. Then it was time to find the Deep Heat for my back and cue up a record...





**REVOLVER**

HIGH QUALITY LOUDSPEAKERS

'We think it deserves our Maximum Mojo Award and Serious consideration for our Loudspeaker of the Year' StereoMojo

'Their big-hearted nature presented music with staggering levels of dynamics and presence' Hi-Fi World Magazine



**Cygnis**

Designed and made in the United Kingdom

Hi-Fi World Award 'Best Loudspeaker'

Phone: +44 (0)87 0047 0047 Email: info@revolveraudio.co.uk

Website: www.revolveraudio.co.uk

**GRANITE SPEAKERS!**

- Only UK manufacturer
- Gives your home that look of class!
- Unbelievably crisp sound!
- Hand made cabinets.
- Bespoke manufacture available
- sensibly priced!



ENVIROSOUND | Tel 0844 8000133

**Got CD's?**

The Brennan JB7 is a new kind of CD player that holds up to 2,500 CDs. You can find and play a specific track or album from your armchair in seconds. Or play your entire music collection with one click. JB7 is the size of a large book and is simple to use. There is nothing else like it.

Top buys of 2008

"compact and ultra-simple...the JB7 shows superb clarity of thought and engineering"

GRAMOPHONE - January 2009

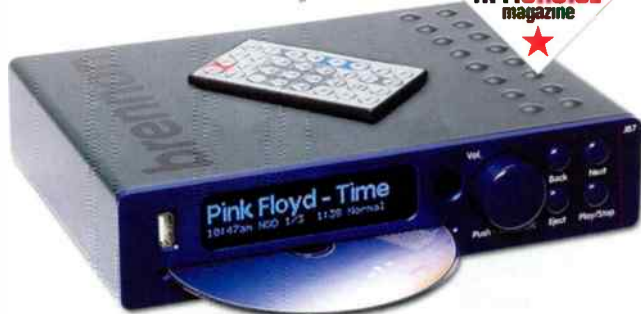

**www.3ga.org.uk**  
or call 01638 615117



rainbow warrior

limited edition Rega P3 in even more colours

- > rega research
- sim2
- stax
- sumiko
- trichord
- well tempered



hi-fi for grown-ups

ipswich (01473) 655171  
www.signals.uk.com



"like a big, unstressed V8 engine, it offers a sense of unruffled composure that most belt drive decks can only dream of..."

**SOUND QUALITY**

If you think that the size and weight of the Twin suggests that it is going to offer a similarly big sound, then you'd be right. This is a deck that positively fills the room with a capacious, firm and flowing performance. The low end is like a big, unstressed V8 engine, offering a sense of ease and unruffled composure that most belt drive decks can only dream of. Although lacking the sheer thunder of a Garrard or the pinpoint snappy timing of a high end direct drive, this is pretty much as good as it gets when rubber bands (or in this case, bits of string!) are involved. Spinning Deacon Blue's 'When Will You (Make My Phone Ring)?' had the song romping along merrily, the Twin pulling the bass line from the track with impressive dexterity. Equally, Ricky Ross's vocals hung behind the loudspeakers with a grandeur and scale that suggests a truly well designed spinner.

With my Audio Technica AT-OC9MLII bolted into the DFA-105 arm's headshell, the deck proved more than able to dig deeply into the heart of music to pull out fine details. A track entitled 'Brighton Pier' tucked away on a Jenny Jones twelve inch single and featuring simple spoken word verses underpinned by a firm bass guitar and gentle percussion (and a few seagulls) was magnificent; the Twin setting up a real depth of sonic field and pushing the rear wall of my listening room out of the way with ease. Equally, a rather old recording of the Syd Lawrence orchestra playing Glenn Miller that appeared in my record collection was an absolute delight – the Twin adding warmth and atmosphere to the band, and capturing the lead clarinet

with precision and tunefulness. I had actually only intended to give 'In the Mood' a quick spin but I ended up enjoying a whole side of the album - a real guilty pleasure.

Across the top end, the Dr. Feickert combo proved to be equally relaxed and assured. It imbued cymbals and percussion with fine spatiality and a pleasingly atmospheric decay, but without ever making the result hard or harsh. In some ways however, this did prove to be something of a mixed bag, slightly lessening the impact of faster and crisper recordings. A 45rpm twelve inch single of Chris Rea's 'Ace of Hearts' seemed to be a little lacking in pace through the Twin and DFA-105, as did the solid backing hi-hat that carries Tift Merrit's 'Still Pretending'. I know very well that the Jelco-based arms are smooth and liquid performers and I wondered if the DFA-105 was just holding the Twin back a fraction too much. Consequently it was time for the toolkit to reappear and I bolted my Alphason HR100S, fresh from an Audio Origami service, onto the armboard...

This was more like it – things definitely picked up a gear and the Twin started to move from its rather languid sonic posture to sit up and take interest in rhythmical proceedings. Tift Merrit's hi-hat suddenly snapped into focus and Chris Rea seemed

to have almost speeded up slightly. Ultimately, the Alphason was a premium arm in its day and, although the DFA-105 is clearly a highly competent performer, it proved to me that the Twin is more than capable of coping with something truly high end on its armboard and that such a device really does show what it is capable of.

As the weeks wore on, I found myself enjoying the Dr. Feickert Twin greatly, and working through my record collection to see what it made of the gems contained therein.

**CONCLUSION**

The Dr. Feickert Twin is a superbly constructed and massive deck that is a pleasure to use and listen to. Given the wide range of arms that it can accept as standard, the build quality that suggests it will run for years without a hiccup and the fine, expansive sound that it turns in, it would be foolish not to give it a recommendation – even if your osteopath might beg to differ.

**REFERENCE SYSTEM**

- Garrard 301 turntable
- Alphason HR-100S arm (Cardas wired)
- Audio Technica AT-OC9MLII cartridge
- Anatek MC1 phono stage
- Naim SuperNait amplifier
- Ferrograph S1 loudspeakers (modified)

**VERDICT**

Massive in stature and sound, the Twin is a competent, versatile and highly musical performer.

**DR. FEICKERT TWIN/DFA-105** £4,495/£780  
 Angelsound Audio  
 ☎ +44(0)1923 352479  
 www.angelsoundaudio.co.uk

- FOR**
- big, relaxed sound
  - fine midrange spatiality
  - superb build quality
  - versatile drive system

- AGAINST**
- laid back with DFA-105 arm

**MEASURED PERFORMANCE**

The DFA-105 arm fitted to our review turntable - a Jelco SA-250 it seems - has a lively sounding arm tube when tapped and unsurprisingly it suffers a very pronounced main tube resonant mode at 250Hz, seen as a huge peak in our vibration analysis made with a lightweight Bruel & Kjaer accelerometer. This will affect image stability and low end dynamics, and it may add some colouration too. As modern arms go the standard SA-250 isn't very clever, yet its straight tube cousin, the SA-250ST, is a very different animal with a damped tube that is free from flexural resonance. Above 3kHz, as accelerations increase, the headshell gets lively, like most. The turntable would be better equipped with a Jelco SA-250ST I feel.

Thread slippage due to insufficient tension made the made the turntable run slow initially. Moving the motor slightly to raise tension cured this and speed was steady and sufficiently accurate at 0.4% slow "out of the box", but adjustable to zero error. Basic speed was stable and fairly drift free, resulting in a low unweighted wow figure of 0.133%. Wow was well

suppressed at 0.106% (weighted) and there was no flutter, so the turntable exhibits good speed stability.

The turntable is a heavily engineered beast that works well. The arm fitted to our sample wasn't ideal and better is needed. NK

**ARM VIBRATION**

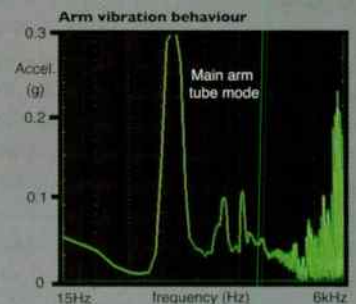

**SPEED STABILITY**



# RETRO REPRODUCTION

QUALITY HIGH FIDELITY & VINTAGE

## AMPLIFIERS

Arcam A80 integrated amp	£295
Art Audio vinyl one with volume control	
MM MC £1700 new	£795
Albany pre amp with phono	£395
Audio Analogue Puccini special addition	£345
Audio Innovation Classic 25 EL34 integrated amp last edition of the style range	£495
Audio Research M300 MKII monoblocks boxed	£2295
Audio Research SP14 pre amplifier	£995
AMR 77 Titanium finish flightcased x dem	£195
Avondale output PSU	£195
Bel Canto valve pre amp remote control SEP2 upgraded to SEP3	£895
Caim 4808 integrated amp 100 watts	£645
Concordant exultant valve pre amp with phono stage	£495
Carry CAD 301 SE power amp with western electric 300b	£1195
Croft EL34 integrated amp with phonostage	£495
Cyrus 2	£135
E.A.R. 890 power amp	£2250
E.A.R. valve pre amp 802 with phonostage	£795
Edison 12 valve power amp	£295
Gammali D200 MKIII as new boxed	£295
Graaf GM70 phonostage	£1195
Hovland EL34 power amp	EPOA
Hovland valve pre with phono	EPOA
Korato renaissance mono blocs 30W class A	£995
Krell KSP7B pre amp	£595
Leema Tucana boxed mint warranty	£1695
Leak 12+ mono blocs restored	£495
Leak TL60	EPOA
Leak TL12+ rare hammered paint finish 1961	EPOA
Linn Klassik silver 1 yr warranty	£595
Linn LK100	£225
Linn Aktive amp module	£95
LFD PAO (SE serial number 124) Conran	
face plate power amp silver wired x dem	£495
Marantz 4240 quadradial receiver	£195
Melody Astro Black 40	£995
MicroMega Integrated amp	£195
Musical Fidelity MA100 power amps (x2) 195	£195
Mendian 551 integrated amp boxed	£295
Mission pre power logo styled case serviced	£795
Naim 32.5 serial no. 28479 pre amp with phono stage	£125
Naim NAC92 serial 165888	£1175
Naim 42.5 pre amp	£395
Naim 90.3 power amp boxed	£225
Naim 250 NAP 250 serial 37071	£1745
Naim HiCap	£445
Naim HiCap chrome bumper style serial 37345	£395
Naim NAC32.5 serial 37033	£95
Nakamichi PA7E power amp Nelson Pass 200w	£995
PS Audio IV pre amp with separate PSU	£195
Quad 2 mono blocs mint original valves	£195
Quad 303 power amp	£195
Quad 405 power amp boxed	£195
Rega Mira integrated amp remote boxed mint	£350
Rofel RA-01 integrated amp	£245
Rofel RB-03 power amp	£245
Rofel RB970 BX power amp	£145
Sony N8000 ES five channel power amp	£495
Sugden A21 SE 1 yr old as new	£1345
Sugden Amp Master Transimpedance power amp	£295
Sonneteer Campian integrated amp	£345

## SPEAKERS

Acoustic Energy AE1 6 months old	£495
Acoustic Energy AE1 stands	£195
ATC SCM35 floorstander	£895
AVI Active Pro 9 speakers Rosewood finish x dem	£795
Apogee Centaurus Slant 6 ribbon hybrid speaker new £3000 boxed	£895
Castle Howard 2 Oak finish	£495
Celestion DL4	£395
Beaumont Virtuoso reference lowther	£95
B&W DM4	£245
Cyrus CLS50	£245
Nydaudio Audiance 40	£295
EPOS classic speaker with open frame stands	£550
Gale 40 (chrome ends drivers replaced boxed	£395
Gamma floor standing speaker new £5000	£795
JBL TL-6K floor standing speakers as new	£195
JBL century 100s	£345
Linn Sarah black finish with stands	£1995
Lumley Lampros 300 MKII speakers new £5000	£495
KEF Reference 1s black finish	£95
KEF Celest 3	£95
Leema floorstanding speakers rosewood finish £2000 new	£895
Leema sub ex-dem	£495
Leema Zen speakers ex-dem	£795
Linn Kan with stands MK1	£225
Linn Kellidh Rosewood KU stone bases	£295

Linn bank custom mannar stands	£225
Martin Logan Aerius	£1195
Mission 75 rosewood	£175
Mission 750 limited edition anniversary	£195
Mission 775s boxed	£345
Mono Pulse 32A 8 months old ex dem.	£495
Nagoka Swan high efficiency speaker cult item	£195
Neat Ultimatum MFS 1 red velvet finish with stands new £3000 now	£2195
Neat MS7 2 years old new £7500	£295
ProAc Future point 5 special yew finish	£1745
Quad ESL 988 Electrostatic speakers	£1995
Quad ESL 63 serviced	£995
Revolver R33	£345
Rugark Equinox last edition	£195
Reference 3A royal virtuoso with matching stands	£2495
Senanton early 60s corner speaker pair	£375
Tannoy Dimension 10 £5000 new 1 year old	£2495
Tannoy 15" 385HPD recently serviced by	£495
Wembley Loudspeakers	£195
Wharfedale V3 omni directional speakers	£95
Technics SB-F1 MKII honey comb disc speakers	£95

## TURNTABLES

Audio Technica OC9 re-issue cartridge	£195
Garrard 401 mint condition	£395
LFD Musical phono stage	£345
Linn Axis Turntable with Linn Arm	£295
Linn Basic Turntable with basic tone arm	£225
Michell Gyrodec SE with Rega arm 4 mths old	EPOA
Michell TechnoArm wing loom	£95
Michell Hydraulic Transcripser	from
Michell Focus 1 with Michell arm	£345
Nottingham analogue horizon SE with rega arm	£495
Rega P5 with P700 tone arm	£195
Rega RB300 with Incognito re-wire	£175
Roksan Xerxes Rega Arm boxed mint cond.	£195
Roksan Radius acrylic finish with Nima arm	£295
SME 10 with tonearm with V	£3295
SME 3009 tonearm series II improved with phonoplugs boxed	£225
System Deck Transcription turntable with 774 arm as reviewed by Hi-Fi World	£295
System Deck electronic	£245
Tannoy Eclipse	£75
Technics SL150 direct drive SME cut-out	£125
Technics SL1200 MKII	£295
Technics SL D3 direct drive turntable	£595
Thera Mies balanced option	£95
Thorens TD16 MKII	£95
Thorens TD124 MKII mint condition with superb plinth	EPOA
Thorens Turntable TD160 with tonearm	£195
Thorens 125 MKII Turntable	£195
Trichord Dmo phonostage 6mths old	£295
Wilson Benesch Full Circle with 0.5 Act Tonearm	£1295

## CD PLAYERS, DACs

Audio Analogue Paganini 24bit	£375
AMR CD 77 Titanium finish flightcased x dem	EPOA
CYC 3300R CD player	£375
CEC DAD 3 QZ4	£395
Cyrs PSXR	£295
DCS Purcell upsampler factory serviced	£995
DPA little bit 7350 DAC	£95
Lera DL2 CD player boxed as new	£1795
Exposure 2010 CD player	£295
Leema Antlia CD	EPOA
Lector CDP TTL CD player Top Loader 2 boxed	£1295
Musical Fidelity XDAC V3	£245
NAD 525 BEE	£195
Naim CD3 boxed as new	£195
Naim CDI 16 bit	£495
Primare CD20	£295
Quad 77 bus CD player	£295
Quad 99 CDP CD player	£495
Quad 99 CDP2 CD player 10mths old	£645
Rega Planet Transcripser & DAC	£445
Roksan Kandy III DVD player	£295
Sony CDP X-B920E	£125
Sony SCD 777ES top loading SACD player boxed	£895

## MISCELLANEOUS

PS Audio statement biwire speaker cable boxed as new	£795
PS Audio statement 3 mtr XLR interconnect	£375
Teac X3 open reel	£245
Naim Nail 01 with power supply	£245
boxed mint serviced	£895
Nakamichi RX-505E auto reverse cassette deck	£295

## DUE IN...

Leak Vanslope/point 1 stereo pre amp various	
Reference 3A DiCapo Royal Virtuoso	
Russ Andrew Quad 33 303 upgrade	
Quad 2 pre valve & radio various	
Naim Headline 2	
Naim CD player with PSU	
Naim NAPSC	

GENEROUS PART-EX. ON ALL EQUIPMENT, NEW OR USED. WILL BUY GOOD QUALITY EQUIPMENT AS ABOVE. NEXT DAY MAIL ORDER & UPLIFT FACILITIES

Opening times: 10.30 - 5.30 Tues. to Sat.  
28a Haddington Place, Edinburgh EH7 4AF  
Tel/Fax: 0131 558 9989  
Email: retro.reproduction@virgin.net  
Website: www.retroreproduction.co.uk

# BIGEARSAUDIO

website: [www.bigearsaudio.org.uk](http://www.bigearsaudio.org.uk) updated daily

DISTRIBUTORS OF TANNOY PRESTIGE LOUDSPEAKERS TRADE-IN WELCOME!!

## VALVE AMPS

AUDIO VALVE BALDUR 70 MONOBLOCKS [£4500]	£2250
ROGUE ATLAS VALVE/TUBE POWER AMPLIFIER	
KT77/EL34 [£1360]	£850
CONSONANCE REFERENCE M800 SE VALVE POWER AMPLIFIERS [£2250]	£1250
ALMARRO A318B INTEGRATED AMPLIFIER [£2250]	£1950
CONRAD JOHNSON PV10AL VACUUM TUBE PREAMPLIFIERS	£450
ROGERS HG88	£275
OTL 6AS7G OUTPUT TRANSFORMER-LESS INTEGRATED AMPLIFIER	£575
LECTOR VFI-70L	£675
TYPE 45 VALVE POWER AMPLIFIER	£550
PAPWORTH M100'S	£1250
HEART RHYTHM 300B SET VALVE AMPLIFIER	£775
CROFT VITA PRE-AMP, AS NEW	£750
CROFT SC. EL84 PARALLEL SE, [£1250]	£850
CR DEVELOPMENTS ROMULUS 5881	£1250

## CD PLAYERS

EPOS M12.2'S, AS NEW	£325
TANNOY 3LZ'S 10 GOLDS MINT	£850
CALIFORNIA AUDIO LABS TEMPEST II CD PLAYER TEMPEST 2	£1250
INCA DESIGN KATANA CD/HOOD PLAYER, BOXED AS NEW [£950]	£575
SHEARNE PHASE 7 ANNIVERSARY CD PLAYER [£1500]	£950
CYRUS C07 CD PLAYER - SILVER	£425
NAD CS411, RUSS ANDREWS DAMPER + POWER UPGRADE,	£275
REGA PLANET CD PLAYER	£625
LECTOR CDP0-5T	£525
MICROMEGA CD132 CD PLAYER [£950?]	£425
MERIDIAN 563 DAC, MINT,	£275
SONY PLAYSTATION 1 CD CONVERSIONS AMAZING	£350
MICROMEGA STAGE3 CD,	£2400
LECTOR CDP-TT, TOP LOADER	£525
ROKSAN KANDI CD AS NEW, BOXED	£1000
LECTOR CDP-06T VALVE CD PLAYER	£850
NAIM CDS1	£495
MARANTZ CD17 MKII [£850]	

## SPEAKERS

JOHNBLUE M8'S, ASTONISHING, SINGLE DRIVER	£1325
ZINGALI OVERTURE, AS NEW, BOXED [£3750]	£1750
TANNOY CHATSWORTHS 12" GOLDS	£330
USHER S-520'S	£1250
KEF 107 REFERENCE SPEAKERS	
SPENDOR BC1A LOUDSPEAKERS WITH BUILT-IN AMPLIFIERS, MINT	£775
B & W SPEAKERS PS, ROSEWOOD	£395
AURUM CANTATAS LEISURE 2SE'S [£899]	£525
Q-ACOUSTICS 1020 SPEAKERS+STANDS	£150
SONUS FABER GRAND PIANO LOUDSPEAKERS	£625
VANDERSTEEN AUDIO MODEL TWO [£4000]	£950
B&W 602.5 S3 SPEAKERS	£850
NAIM CREO'S IN CHERRY BEAUTIFUL, BOXED	£275
ACOUSTIC ENERGY ELITE 2'S, BOXED, AS NEW, [£449]	£575
REVOLVER R33'S, BOXED, AS NEW,	£325
MORDAUNT SHORT SYSTEM 442 FLAGSHIP SPEAKERS	£475

## TURNTABLES/ACCESSORIES

TRANSCRIPTOR [CLOCKWORK ORANGE] TURNTABLE,	£850
ORIGINAL AND BEAUTIFUL,	£325
LINN BASIC+ARM	£425
TRICHORD DINO, 2 BOX, EXT PSU, MINT,	£650
MUSICAL SURROUNDS PHONOEMA PHONO-STAGE	£575
LYRA CARTRIDGES	£375
PROJECT DEBUT III, [£210]	P.O.A
QUADRASPIRE 3 TIER STAND	£125
THE ISOLATOR-UNBELIEVABLE RESULTS!!	£315
ALL GRAHAM SLEE PHONO STAGES	£85
OKKI NOKKI RECORD CLEANING MACHINE	£275

chrisbircley@btinternet.com  
01736 740421  
07947 678256

# High End Cable

visit [www.highendcable.co.uk](http://www.highendcable.co.uk)  
For the best prices telephone Dave Jackson on 01775 761880

Argento Audio | Analysis Plus | Audience | Chord Company | Ecosse | Furutech  
Hovland | IsoTek | Nordost | MIT | Oehlbach | Purist Audio Design | Quantum | STAX  
Stereovox | Synergistic Research | Townshend | van den Hul | Vovox | Wyrewizard

## NORDOST



To many the Worlds finest and which other cable makers aspire to with the ODIN being the master of them all. We offer excellent trade in facilities to upgrade you through the full Nordost range.

## stereovox

Highest quality, superbly made cables from Chris Sommovigo the much acclaimed cable designer. Stereovox offer two distinct ranges the Reference and Studio. Visit this website for links to reviews, which rate this brand one of the best anywhere. Currently in Stereophile's top 500 products. Prices for interconnects start at less than £200.00

## quantum



Probably the biggest upgrade you can offer your Hi-Fi system. Qx2 | Qx4 | Power Cords

## audience



Another leader in expert cable design with the AU24e a performance upgrade on the renowned AU24. Two models in the adeptResponse conditioners are now available in the UK

## FURUTECH

High performance cables and power accessories



STAX The best in the World

## Vovox



Townshend Audio

## CHORD

## ECOSSE





### SRM TECH TURNTABLE TUNE-UP KIT £37.95

This consists of a two point cartridge alignment protractor made of laminated plastic, six pairs of different lengths of non-magnetic stainless steel M2.5 machine bolts, and two pairs of M2 bolts along with matching nuts and washers. A combination spanner and Allen Key are also provided. Another bag contains cotton pads and buds, and a pipe cleaner. A third bag houses four bottles of coloured fluids. The fluid pack consists of Stylus Cleaning Fluid (blue), Contact-Z Contact Cleaner (clear), Belt and Drive System Cleaner (yellow) and a murky dark grey gloop labeled Ultimate Turntable Bearing Oil. This oil is actually loaded with graphite and Molybdenum Disulfide (car geeks will recognise this as being the magic ingredient of Moly slip gearbox treatment!), whereas the other three all use

Isopropyl Alcohol.

I started the overhaul process with the drive belt, inner platter and motor pulley of my ageing Linn Sondek LP12 turntable, using a cotton pad and the yellow fluid. It certainly shifted some dirt, the pad going a satisfyingly dark colour. A quick listen revealed a small but noticeable drop in surface noise and a little more snap to the music. Next I removed both parts of the platter, and using the buds as per the instructions removed the old oil from the main bearing. I then dripped in enough oil to cover the ball at the bottom of the bearing shaft, and coated the shaft of the inner platter with a thin layer as well. It took about fifteen minutes and three good spins before it was fully settled back down. This time the difference was obvious. The music sounded too fast!

I checked with a strobe and found that the platter RPM had indeed increased a small but noticeable amount above 33.333RPM. My Sondek uses an Origin Live DC motor and power supply, the latter having little trim pots which can be set to any speed, so having readjusted things and found the music sounding more expansive and spacious, instruments better lit with pinpoint accuracy and an inky darkness between notes.

Next I dipped the supplied brush

into the Stylus Cleaner and drew it gently from the back of the stylus, forward, a few times, then allowed a couple of minutes for any residual liquid to evaporate. This resulted in a sharpening of the tonal textures and a further reduction in the presence of any remaining surface noise to the point of near non-existence. Lastly I opened the clear liquid, labeled Contact-Z and using a combination of the pipe cleaner to reach inside the plugs and sockets, and the cotton pads for the rest, I gave the connections from arm leads to speaker terminals a good wipe down. Again the music gained a layer of freshness and vitality, rather akin to cleaning your windows and letting the first rays of spring sun inside unimpeded.

The results of all this tinkering has been a Sondek restored to full health and the excuse to sit down and play yet more records, just to hear how good they're sounding now. Although the £38 or so might seem expensive for a collection of cleaning fluids, the sonic improvement this particular combination of items yields is far in excess of this. Never underestimate the importance of routine maintenance to your vinyl replay system – this kit shows why.

TB

[Contact: +44(0) 1234 741 152, [www.britishaudio.co.uk](http://www.britishaudio.co.uk)]

# soundbites

### ROKSAN DIGITAL STYLUS BALANCE £60

Stylus tracking force must be accurately set to get the optimum sound, and if it's a long way out, can actually damage the record groove and the cartridge's suspension. Manufacturers normally supply an optimum operating range (i.e. 1.5-1.9g), along with a recommended figure which has normally come about after extensive listening and measurements. Of course, you can set your tracking force by ear, but generally the closer to the manufacturer's recommended figure you are, the better the cartridge sounds – surprisingly, just a tenth of a gram off this can be like 'night and day'.

That's why *Hi-Fi World* recommends the use of an accurate

tracking force gauge. Ortofon do a cheap 'weighing scales' type design for under £10, but it is not completely accurate – good though as it is as a general guide. Roksan's new Digital Stylus Balance is an altogether superior device, although so it should be at £60. Still, remember that other companies ask up to three times as much as this for rival products, so it's actually very good value.

Although not a thing of beauty like The Cartridge Man's £225 Digital Stylus Force Gauge, the Roksan nevertheless feels well made. It reads up to 5g, with accuracy to three decimal places from its four digit backlit LC display (with auto power-off after 120 seconds). It comes with a small chromed 5g calibration weight

and two replacement batteries. Neat, effective and accurate (it matched our Technics SH-50PI reference gauge closely), this is a great affordable high end stylus balance. TB  
[Contact: +44(0) 1235 511 166, [www.henleydesigns.co.uk](http://www.henleydesigns.co.uk)]



Web [classiquesounds.co.uk](http://classiquesounds.co.uk)

# Classique Sounds

Specialist Supplier of Vintage Audio

61 Aylestone Drive  
Aylestone,  
Leicester, Le28qe



Tel 0116 2835821  
Local rate 0845 1235137  
Mobil 07815 188040

Leak Stereo 20 full rebuild using Paper in oil caps £299.00  
Conversion of Leak valve pre to passive including Silver wired/soldered/10odium plugs £299.00

**wanted class 'c and modern hifi eqpt.**  
**FOR SALE PRE/POWER AMPLIFIERS**

XTC POW2 power amplifier. 150W. Bxd. £1299	£ 649	XTC PR1-1 remote line pre amp. Superb. £1250.	£ 599
Truly stunning original pair Quad II valve power amplifiers with GBC valves. Boxed. An investment at only.....	£ 299	Studen A48 & T48 tuner in wooden sleeve.	£ 299
Beautiful condition 100% original Quad 22 pre amp	£ 99	Moth Series 30 passive pre amp. Stan Curtis design.	£ 349
Moth Series 30 passive pre amp. Stan Curtis design.	£ 219	Cambridge Audio C70 pre amp. MM&MC. Boxed.	£ 249
Quad 44 pre amplifier. Excellent cond with manual.	£ 699	Arcam Alpha 9 integrated with remote & MM/MC	£ 59
Musical Fidelity A1 Class A amplifier. Ex condition.	£ 899	Nad 302 integrated amplifier.	£ 899
Croft series V1 valve power amplifier. Good cond.	£ 179	Leak Stereo 50. Bronze. Rebuilt with PIO caps. Rare	£ 199
Orange Audio valve pre amp with MM/MC. Boxed.	£ 99	Meridian 201 pre amp. Boxed. Ex condition.	£ 299
Harmon Kardon integrated valve amp. 110V. V rare	£ 149	Audio Innovations Series 800C tube pre amp/phono	£ 349
Sony TA-F44ES int amplifier. Awesome build. Bxd	£ 119	Pair Mullard 5-10 valve power amps. 100% original	£ 179
Nad 7011 stereo receiver. 2X 25W with phono	£ 795	Arcam Alpha 8 pre. amplifier. Ex condition.	£ 999
Pair Leak TL12+ amplifiers. Croft rebuilt. Bronze.	EPOA	Pair Marantz MA5's. Class A. 110V. Awesome.	£ 799
Quad II amps. Many in stock. Prices/condition varies		Leak Stereo 20 rebuilt with quality paper in oils.	£ 895
Unison Research Mystery One line level pre amplifier. Stunning	£ 449	condition with box/book. Serviced. Cost £1700	£ 195
Arcam Alpha 10 int amp. Bxd. remote & mint. £799	£ 549	Quad 4051. Excellent condition.	£ 229
Pinnius 21001 Class A/B int line amp. Boxed. 100W	£ 375	Quad 34 pre amp. Ex cond. Brown 5 pin din version.	£ 169
Nakamichi CAS pre-amplifier. Ex cond. Cost £750	£ 399	Scott stereo master 260 American integrated amp. £169	£ 225
CP235 pre amplifier with remote and book.	£ 399	Musical Fidelity A1 class A integrated amp. As new.	£ 249
Arcam Alpha 10 amplifier. Super condition. Remote	£ 159	Rogers cadet III integrated amplifier. Ex condition.	£ 1964
Musical Fidelity "The Pre amp". Ex cond & boxed.		Van der Lee. single ended int valve amp. C1964.	£ 425
Leak. Varislope point 1 pre amp. Converted to Passive	£ 149	Wilslow Audio Mercury B power amp. Ltd edition	£ 595
Musical Fidelity B200 int amplifier. 60W class A/B	£ 125	Leak. Varislope pre amplifier. Ex condition.	£ 149
Quad 303 power amplifiers from .....	£ 69	Pair Musical Fidelity MA65 class A monoblocks.	£ 149
Rotel RA-920AX integrated amplifier. Ex condition.	£ 99	Meridian Linear MC phono stage/pre-amp. Boxed.	£ 149
Rotel RA-840 BX int amplifier with MM & MC	£ 299	Musical Fidelity Pre 8 pre amplifier. Chrome front.	£ 149
Musical Fidelity A100 pure class A integrated 50W			

**TURNABLES/CD PLAYERS**

AR. Acoustic Research CD06 CD player. Very rare.	£ 149	Linn Sondek LP12. Valhalla/Akito. Super condition.	£ 699
SME 3009 Series II arm. Early split weight version.	£ 349	SME 3009 Series II imp. Boxed/manual. As new.	£ 299
EAR R34PMM & MC valve phono pre amp. Boxed	£ 549	Meridian 206 CD player & remote. Fair condition.	£ 119
Sony MDSJH9200 mini disc player/rem. Mint & Bxd.	£ 129	SME 3009 series II improved/non improved from...	£ 275
ST12 305S with SME mount. Black finish.	£ 129	Marantz CD73 CD player. © 1984. Nice condition.	£ 195
Thorens TD150 MkII arm. Boxed/manual. No lid.	£ 79	Cambridge Audio CD5 CD player with remote.	£ 299
Ariston R100 turntable. Ready to fit SME tone arm	£ 149	Arcam Alpha 9 CD player. Bxd. rem & mint. £799	£ 299
Arcam Alpha 7SE CD player. Award winner.	£ 159	Systemdek transcription turntable. The original.	£ 299
Arcam Diva CD92 CD player. Nice condition.	£ 399	Exposure 2010 CD player. Super condition manual.	£ 275
Nad 504 CD player. In excellent condition. No display	£ 49	Cambridge Audio CD5. Black finish. Boxed/remote	£ 59
Rotel RP830 turntable with AI cartridge. No lid.	£ 49	Sony CDP-911E CD player/remote/book. Cost £300	£ 119
Rotel 965 BX CD player. Tweakers dream machine.	£ 149	Rotel R65 BX CD player. Superb condition.	£ 99
Project 1.2 with cartridge. Ex condition & boxed.	£ 119	Nad CS41i Cd player. Mint & boxed	£ 199

**SPEAKERS**

Blueprint point one floorstanders. Rear firing super tweeter. Valve friendly. Cost £1100. Made in UK. Awesome.	£ 349	Sonab O44 omnidirectional speakers. Rare	£ 149
B&W CDM7SE floorstanders. Mint/bxd. Red ash.	£ 549	Pair Quad ESL57's. Bronze. Superb working order	£ 99
Q&W ESL63's. Just serviced. Excellent cond. Black.	£ 1099	Acoustat Spectra II hybrid electrostatic speakers. Built in conventional bass unit. Similar to Martin Logan. Boxed	£ 699
Acoustat Spectra II hybrid electrostatic speakers. Built in conventional bass unit. Similar to Martin Logan. Boxed	£ 699	Cisle Sevens in excellent condition.	£ 249
Cisle Sevens in excellent condition.	£ 249	Rogers LS1. Black finish and in nice condition.	£ 49
Wharfedale Diamond 9.1. Ex condition & boxed	£ 129	Kef Q35 floorstanders in black. Good condition.	£ 125
Pair Quad ESL57 speakers. Fully reconditioned including 2 new Otec treble panels. Awesome sound & dynamics.	£ 1150	George stands for EL563 speakers	£ 239
Quad ESL57 speakers. All fully serviced with full 3 months warranty. Hear what ESL57s should sound like. From Kef Coda 7. Black finish. Boxed & mint.	£ 99	Rotel RT 840 tuner. LWM/WFM. Missing button.	£ 39
Apogee Acoustic Centaurus studio monitor speakers. Ribbon tweeters. Bi wireable. Stand mounters. Awesome.	£ 499	Rotel 850 stereo tuner.	£ 29
Celestion Little one speakers in white. Boxed. £99	£ 49	Nakamichi CR1E cassette deck.	£ 129
		Denon TU260L stereo tuner	£ 29
		Nad 602 cassette deck. Boved with instructions.	£ 39
		Nad 412 tuner. Mint/boxed/booklet/original receipt.	£ 89
		Bulgian plugs for Quad II amplifier. Brand new. Each	£ 99
		Quad FM1 Valve tuners. Various prices from only	EPOA

**OTHER ITEMS**

Revox B77. 3.75 to 7.5 IPS. Lovely condition.	£ 299	Arcam Diva T61 tuner in black. AM/FM. RDS	£ 89
Sony TC K6115 3 head cassette deck. Dolby S.	£ 69	Quad Multiplex FM decoder for FM1. Needs service	£ 20
Linn Basik LVX tone arm. Black. Ex condition.	£ 99	Linn LP12 arm/board for Linn arm. Ex condition.	£ 20
Yamaha YSP 800 5.1 speakers with digital amps.	£ 299	Quad FM3 tuner in excellent condition. From...	£ 99
Revox G36 valve reel to reel player. 3.75 and 7.5 IPS. Needs to be mounted in box/cabinet. Nice original cond.	£ 799	Pro-tone 0.22uf paper in oil capacitors. 500V. 10%	£ 89
Pro-tone 0.22uf paper in oil capacitors. 500V. 10%	£ 599	Marshall ECC83 12AX7 specially selected valves.	£ 600
Top quality paper in oil capacitors 0.1 and 0.22uf	£ 15	99.99% pure silver wire 0.5mm. Price per metre.	£ 59
99.99% pure silver wire. 1.0mm. Price per metre.	£ 99	Sony TCKB820 Cassette deck. Mint. Bxd. Cost £150	£ 239
Quad Alpha 8 tuner. Mint & bxd. remote. Cost £249	£ 239	George stands for EL563 speakers	£ 39
Rupert stands for Quad ESL57	£ 79	Rotel RT 840 tuner. LWM/WFM. Missing button.	£ 29
Chord mains lead 1.5M. Well reviewed. Cost £140.	£ 119	Rotel 850 stereo tuner.	£ 129
Sony ST-5700ES FM-AM Stereo tuner. Cost £299	£ 129	Nakamichi CR1E cassette deck	£ 29
Chord Chorus1 interconnect. 1.5M. Cost £300	£ 129	Denon TU260L stereo tuner	£ 39
Nakamichi BX125 cassette deck.	£ 29	Nad 602 cassette deck. Boved with instructions.	£ 89
Denon DRR-M10 half width Cassette deck. Silver	£ 79	Nad 412 tuner. Mint/boxed/booklet/original receipt.	£ 99
Nad 402 stereo tuner. Excellent cond. Great sound	£ 650	Bulgian plugs for Quad II amplifier. Brand new. Each	£ 95
Russian EL84 tubes. Superb quality. Price each.	£ 95	Quad FM1 Valve tuners. Various prices from only	
Musical Fidelity T1 FM tuner. Award winner. £200			

**QUAD ESL57 & ELS63 PANELS/SERVICING ETC**

New One Thing Audio "Widget". All round improvement for 57's & a kinder load for amp £79 per full rebuild of 57s including latest Otec treble panels for only £1190.00  
We sell serviced Quad ESL57 speakers from only £1200.00pr. Why spend £4000+?  
**ESL57 SPEAKERS STANDARD SERVICE £680. PR**  
Price includes 2 completely rebuilt treble panels etc. Ring for further info.  
Classique Sounds servicing restores the Quads to a position where they can hold their head high. Jon Marks. **HIFI WORLD**. April 1999. UK servicing facilities available.

# Analogue Seduction

where music is our passion



Analogue Seduction are dedicated towards two channel Hi-Fi, specialising in vinyl replay.

As well as our on-line shop we have dedicated demonstration retail facilities based in Peterborough, Cambridgeshire and we can offer our customers home demonstrations.

We stock the finest in amplification, analogue, digital replay and speakers. We also specialise in a cable termination and cable burn in service.

Please visit our website [www.analogueseduction.net](http://www.analogueseduction.net) to browse or purchase products that are not easily available elsewhere.

New vinyl records now stocked

Tel: +44 (0)1733 344768

**MANTRA AUDIO** Specialist Suppliers of Audio Accessories  
[www.mantra-audio.co.uk](http://www.mantra-audio.co.uk)  
ORDER SECURELY @ <https://shop.mantra-audio.co.uk>  
SEE WEBSITE FOR MONTHLY OFFERS & FULL PRODUCT RANGE  
ITEMS EX STOCK DELIVERY BY RETURN OTHERWISE 3 -10 DAYS

CARTRIDGE SELECTION	STYLUS	HEADPHONE SELECTION	
<b>Goldring</b>		<b>Grado</b>	Prestige SR-60 £90
Elektra £41	£28	Prestige SR-80 £108	
1012 GX £155	£88	Prestige SR-325i £315	
1042 £195	£135	<b>Goldring</b>	DR 50 £35
2100 £83	£52	DR 100 £45	
2200 £98	£62	DR 150 £70	
2400 £165	£135		
2500 £195	£155	<b>HI FI ACCESSORIES</b>	
Eroica LX/H £200	£176 EX N/A	ARTAccessories USB Phono Plus PreAmp	£85
Elite £325	£259 EX N/A	analogue-digital computer interface	
<b>Audio Technica</b>		MiltyPro Super Exstastic Brush	£14
AT 95 E £32	£20	Shure SFG2 Stylus Force Gauge	£24
AT 440 MLa £129	£94	<b>REPLACEMENT STYLI</b>	
AT OC9 ML II £425	£400 EX	Swiss Quality Diamond Styli	
<b>Denon</b>		ADC XLM Mk III	£17
DL 103 £117	£105 EX N/A	Akai AN 5, AN 60	£13
DL 103R £261	£235 EX N/A	AN2, AN 70	£15
DL 110 £81	£73 EX N/A	Aiwa AN11	£13
DL 160 £108	£97 EX N/A	Dual DN 145 E, DN 165 E	£17
DL 304 £342	£308 EX N/A	JVC DT 55, DT 60	£13
<b>Grado</b>		National EPS 24 CS, P 30 D, P 33 D	£13
Prestige Black £52	£36	Ortofon FF15/WMS20 EII, OMS/10/10/20	£17
Prestige Gold £130	£93	Pioneer PN 210/220/240	£13
<b>Lyra</b>		Shure N75C, N75-6, SC35C	£13
Dorian £495	£395 EX N/A	N75ED/EJ T2 N75-3, N95ED/EJ	£17
Argo £849	£675 EX N/A	N 97 HE, VN 35 HE	£27
<b>Shure</b>		Sony ND 142/155 G, CM234	£13
M 97 XE £98	£58	ND 143/150/200 G	£15
Sumiko		Stanton D 681 EEE	£21
Blue Point Special £229	£195 EX		

\*\*\*Over 500 Styli Types Stocked\*\*\*  
EOE prices may vary without notice

**EX - Exchange price same make moving coil cartridge**

Order direct online or Tel/Fax (01757) 288652

MANTRA AUDIO (HFW), Town End House, Skipwith, Selby, North Yorkshire YO8 5SQ



# Carbon-ated!

There are few better developed tonearms than those from Origin Live, all of which benefit from constant evolution. It was recently the turn of the high end Conqueror to receive a new carbon hybrid armtube and upgraded wiring. David Price listens in the new 3c...

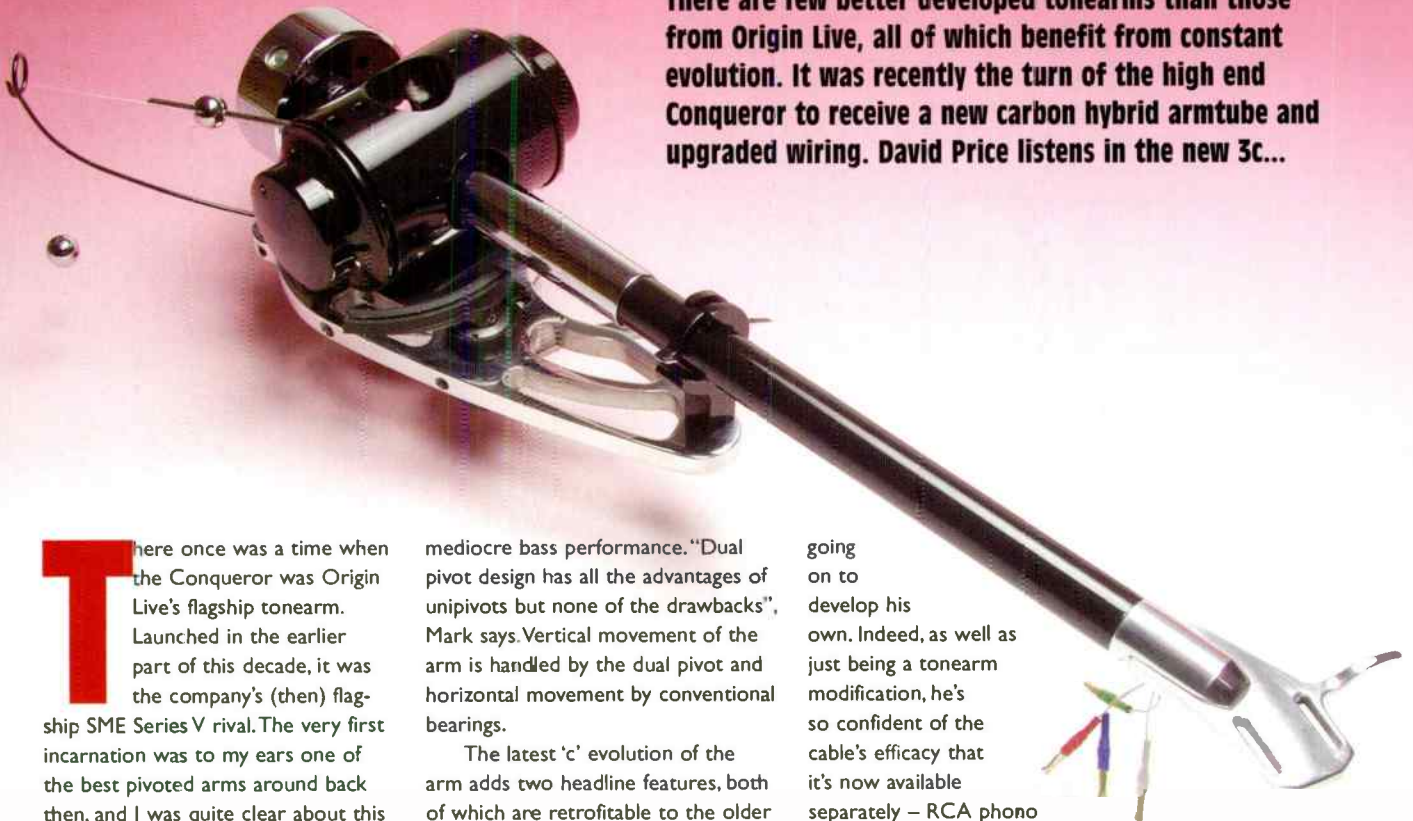

**T**here once was a time when the Conqueror was Origin Live's flagship tonearm. Launched in the earlier part of this decade, it was the company's (then) flagship SME Series V rival. The very first incarnation was to my ears one of the best pivoted arms around back then, and I was quite clear about this because it took up extended residency on my beloved Michell Orbe turntable, which had hitherto been using an SMEV and before that a Linn Ekos. Although the SME was stunning in so many ways, on the Orbe at least, it wasn't endearing. The Conqueror – a natural price rival – proved eminently more listenable, but only very slightly less able in outright terms...

Well, unlike the SME, the Origin Live has gone through a number of evolutions since then – the result being an arm that looks quite similar and is of the same vital statistics, but with virtually no parts common to that first Conqueror. The first significant point on the evolutionary path was the fitment of a new armtube to the second generation arm, in a polished "metal" finish (OL's Mark Baker is very bashful about what materials he uses, having had – he claims – a number of people copying his designs over the years). The third generation arm sported the company's 'Dual pivot' arms – and for me is where this arm you see before you starts, genetically. The unusual dual pivot bearing on the horizontal axle was designed to give many unipivot characteristics – low friction and high decoupling which give excellent definition and transparency – but to escape their

mediocre bass performance. "Dual pivot design has all the advantages of unipivots but none of the drawbacks", Mark says. Vertical movement of the arm is handled by the dual pivot and horizontal movement by conventional bearings.

The latest 'c' evolution of the arm adds two headline features, both of which are retrofitable to the older Conqueror 3, but not before that. First, the carbon hybrid armtube (a £600 mod) does a lot to damp down the liveliness of the previous tube. Although arm tube resonance is not the beginning and end of a tonearm's performance, it is nevertheless a significant contributing factor. This is why various manufacturers over the years, from SME to Technics, have experimented with everything from magnesium to titanium nitride in an effort to make a well damped but very stiff tube. Origin Live's solution is to mix a shell of carbon, which Mark Baker says has "very good" damping materials, with "metal" (which he won't specify). The latter is stiffer than carbon but rings, whereas the former is soft but self damped. Together, the two should counteract the other's weaknesses, making for a strong but quiet tube – or so the theory goes...

The other big tweak is the cable, which costs £380 to retrofit (actually to all Origin Live arms of any vintage, not just this, either by direct hard wiring or via a 5-pin DIN plug) but of course comes standard on the new Conqueror 3c. The Laminar Flow 2 external arm cable comes as a direct result of Mark Baker having experimented with umpteen different commercial cable types – and then

going on to develop his own. Indeed, as well as just being a tonearm modification, he's so confident of the cable's efficacy that it's now available separately – RCA phono or XLR fittings are offered. A fully balanced design, it uses a combination of six dielectric insulators to ensure an even response across the audible frequency range. Great care has been taken to optimise key electrical characteristics such as impedance, inductance and capacitance, says Baker. Experimentation with silver and silver plated strands was conducted but high purity copper was ultimately selected for its more natural tonal balance. To protect against RF interference the cable has a 95% nickel plated copper braid shield with an attached earth lead.

The Conqueror is a chunky and robust tonearm – reminding me in many ways of a Zeta (by its physical presence, not its design details). Never have I seen such a high standard of fit and finish on a Conqueror – it is certainly a lot less 'agricultural' looking than earlier incarnations. It maintains the traditional 'round' 24mm Rega mounting, weighs a total of 820g and has an effective mass of 14.5g – on the higher side of average. The effective length is 240mm, and the arm calls for a maximum armboard thickness of 27mm. As ever with the big Origin Lives, I found it easy to set up (the supplied instructions are now excellent), although it remains second

# WHEN ONLY THE BEST WILL DO

## New Spendor SA1

The most musical and revealing small loudspeaker ever created by Spendor.

This tiny 2-way infinite baffle design presents sound in a remarkably clear and cohesive manner, it is simply captivating.

Finished in a choice of gorgeous; Hi-Gloss Zebrano, Jet Black Piano Lacquer or Satin Wenge, the Spendor SA1s will complement any room.



### SPENDOR

### HEAR THE SA1

AT THE SEVENOAKS STORES MARKED ●

<b>Aberdeen</b> 01224 252797	<b>Manchester</b> 0161 831 7969
<b>Bedford</b> 01234 272779	<b>Norwich</b> ● 01603 767605
<b>Brighton - Hove</b> ● 01273 733338	<b>Nottingham</b> ● 0115 911 2121
<b>Bristol</b> ● 0117 974 3727	<b>Oxford</b> 01865 241773
<b>Bromley</b> ● 020 8290 1988	<b>Peterborough</b> 01733 897697
<b>Cambridge</b> 01223 304770	<b>Plymouth</b> ● 01752 226011
<b>Chelsea</b> 020 7352 9466	<b>Poole</b> ● 01202 671677
<b>Cheltenham</b> 01242 241171	<b>Reading</b> ● 0118 959 7768
<b>Epsom</b> 01372 720720	<b>Sevenoaks</b> ● 01732 459555
<b>Exeter</b> ● 01392 218895	<b>Sheffield</b> ● 0114 255 5861
<b>Glasgow</b> 0141 332 9655	<b>Southampton</b> ● 023 8033 7770
<b>Guildford</b> ● 01483 536666	<b>Southgate</b> 020 8886 2777
<b>Holborn</b> ● 020 7837 7540	<b>Swindon</b> 01793 610992
<b>Kingston</b> ● 020 8547 0717	<b>Tunbridge Wells</b> ● 01892 531543
<b>Leeds - Wetherby</b> 01937 586886	<b>Watford</b> 01923 213533
<b>Lincoln</b> ● 01522 527397	<b>Weybridge</b> 01932 828525
<b>Loughton</b> 020 8532 0770	<b>Witham - Essex</b> ● 01376 501733
<b>Maidstone</b> ● 01622 686366	<b>Yeovil</b> 01935 700078

NEW Dublin 01 495 3062

### Features:

- New 22m wide-surround extended-range tweeter
- New 15cm long-throw Spendor bass-mid drive unit
- New short signal path gold-plated crossover, meticulously refined using hi-grade electrical components
- Optional, stylish, stable, non-resonant stands
- The world's finest WBT binding posts



JULY 2008

Visit [www.SSAV.com](http://www.SSAV.com) today!

# SEVENOAKS

SOUND & VISION

the experts in home entertainment



to the SME Series V, as does every other arm I've tried, in its sheer ease of mounting and operation.

## SOUND QUALITY

I think the secret's out by now that I am a fan of Origin Live arms. Some rivals sometimes sound more musical (certain unipivots I could mention), others are grippier (well you know who), but in my view OL arms strive to give the best of both worlds. Obviously, there are those who disagree, or who simply regard it as compromise – and that's fair enough – but I'd say I've yet to hear few 'real world' tonearms as nice as the latest Conqueror 3c.

Cue up an old copy of Human League's 'Dare', and you can hear why this arm has won many friends over the years. It imposes a little of its character on the music, and in the latest carbon hybrid guise, adds - or subtracts - even less. Leading edges are sharp but not artificially edgy, whereas the notes themselves are rendered so evenly and delicately. Those full fat Korg analogue synthesisers in 'Sound of the Crowd' were dripping with harmonics, while singer Phil Oakey's deadpan voice sounding unusually 'fruity' and even slightly less out of tune than normal. Hi hats

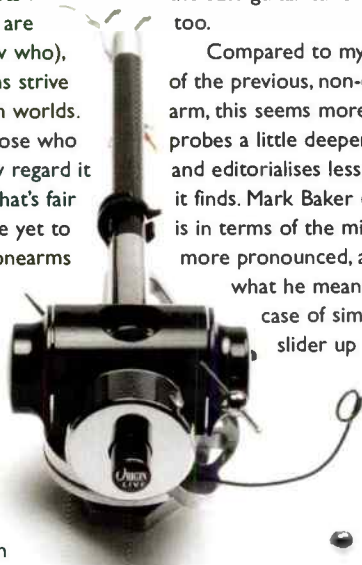

this fact. Once again, it loved the recording's innate softness and warmth, and penetrated deep into the 'pores' of the recording. The guitar work was revealed as beautifully syncopated, the vocal harmonies wonderfully done, the percussion tight and committed and the bass guitar tuneful and soulful too.

Compared to my recollections of the previous, non-carbon tubed arm, this seems more insightful. It probes a little deeper into the record and editorialises less about what it finds. Mark Baker describes this in terms of the mid-band being more pronounced, and I know

what he means, but it's not a case of simply turning the slider up – it's the quality more than the quantity that's increased. 4hero's 'Morning Child' showed a more subtle, less muddled recorded

acoustic – with a slightly brighter light shone on the midband, but it remains very smooth and actually suited some cartridges (the vdH Frog) and turntables (the GyroDec, which is slightly on the warm side anyway). Of course, I can't account for the changes; it's obviously a combination of both armtube and cable, but they're there all the same – and it pushes this arm quite a way

“a wonderfully easy, open and even sound that has the uncanny ability to pull you in to the music...”

– of the Roland Dr. Rhythm variety you understand – were crisp and explicitly conveyed, yet not sharp or tiring as they sometimes can be funnily enough – and I was surprised by this too. It was open, clean, matter of fact, full of beans and a joy to behold – my mind was immediately taken from thoughts about pressing quality, recording techniques and the like. It just let the flavour flood out...

Moving to the altogether different America's 'Horse with No Name', and the new Origin Live arm tapped another seam of musical enjoyment. Although the 'Homecoming' album was considerably 'lower fi' than 'Dare', unlike so many tonearms I could mention – especially the SME Series V – the Conqueror didn't remind you of

ahead of the last one.

Bass is *certainly* tauter than before, although it is not quite as sumptuous (read: coloured), making the low frequency regions sound altogether more SME-like, but still it has the immense grip that the SME V lacks, along with that last few percent of flare flapping power. New Atlantic's 'I Know' (12" Love Decade remix) showed the new Conqueror still to be generous in its low end, giving a whole extra level of commitment to this classic rave track's Roland TB303-driven bottom end. Up into the midband, and the piano pads were wonderful to behold – vast in scale and located with great precision in an otherwise fairly muddy mix. The heavy sequenced disco beats of The Ones' 'Flawless' showed dizzying

attack in the bass, along with a sense of complete ease – the cartridge sounding as snug as a bug in a rug.

Feed this tonearm with a well recorded slice of the black stuff and it is supreme, once again reminding me how much difference an extra £2,000 or so can make (compared to the £600 OL Silver). It's a lot of money, but it was a lot of improvement too – I found the stage depth of 'So What' to be quite remarkable. The SME V wanted to tie everything in a neat package in a quite confined studio, whereas the Conqueror seemed happy to let the boundaries dissolve and the loudspeakers disappear, whilst remaining almost as accurate placing images within the soundstage.

Okay, so I can report faster transients, greater detail and an even better sense of the recorded acoustic, along with the Conqueror's traditional strengths of musical ease and fun, but another key attribute of this arm is its tonal accuracy. Sadly, many turntables are simply too coloured to show this, but put it on a platform like a Michell and you can hear the ringing harmonics of acoustic instruments in all their glory. Kate Bush's 'Feel It' was a case in point; her piano work captured on analogue tape at Abbey Road in the late nineteen seventies is an experience to remember via a pickup arm like the Origin Live. Always tonally highly adept, I feel the new 'c' package has made the arm better still – bringing the recording, warts and all, blinking into the sunlight. It's the stuff of vinyl legend!

## CONCLUSION

Tonearms are very personal things – like watches or even camera lenses I suppose – but for me the Origin Live Conqueror 3c is an exceptional example of the breed. It builds on a very accomplished design and takes it – probably – about as far as it can go. The result is a wonderfully easy, open and even sound that has the uncanny ability to pull you in to the music, rather than tell you how good or bad it is in microscopic detail. It's certainly a significant advance on the previous incarnations of this, which themselves were lovely devices to listen with. As such, it comes strongly recommended for those wanting the ultimate 'real world' tonearm; it's expensive but justifiably so.

### REFERENCE SYSTEM

Michell GyroDec turntable  
Sony TT-S8000 turntable  
SME Series V tonearm  
Origin Live Silver tonearm  
vdH Frog cartridge  
Ortofon MC Windfeld cartridge  
Icon Audio PS3 phono stage  
Sugden IM4 integrated amplifier  
Yamaha NS1000M loudspeakers

### VERDICT

Tangible advance on its already accomplished forebear, this is a brilliant all round pickup arm with a relaxed yet confident and enjoyable sound.

**ORIGIN LIVE**  
**CONQUEROR 3C** £2,650  
Origin Live  
☎ +44(0)2380 578877  
www.originlive.com

**FOR**  
- superb tonal rendering  
- excellent rhythmic flow  
- musical ease

**AGAINST**  
- nothing



**Heatherdale**  
audio limited



202 Findon Road, Worthing, WEST Sussex, BN14 0EJ  
Tel. 01903-872288 or (after hours) 07860 660001 Fax. 01903-872234  
e-mail: heatherdale@hifi-stereo.com //www.hifi-stereo.com

**SPEAKERS**

JM Labs Mezzo Utopias Superb/boxed	£2800
Monitor Audio GS-60 speakers mint/boxed	£995
KEF IQ-5 speakers mint/boxed	£195
B&W VM-1 centre speaker mint/boxed	£75
Sonus Faber Concerto Grand Piano speakers, superb/boxed	£795
Celestion A3 speakers, superb but no boxes hence only	£1195
Tannoy ST-100 super tweeters superb/boxed (£1200) only	£495
B&W DM 1800 speakers with stands	£150
Acoustic Zen Adagio Centre speaker with stand (new)	£1625
Hales Transcendence 5 speakers	£2895
Dynaudio Audience 7 speakers with stands	£395

**TURNTABLES, CARTRIDGES & TONEARMS**

Dynavector 507 MK2 arm (£2995) only	£2295
-------------------------------------	-------

**AMPLIFIERS**

Almarr 318B (new)	£2250
TRI TRV-M300SE amplifier (new)	£4495
Meridian 551 integrated amp	£595
Roksan Caspian remote controlled int' amp	£495
Goldmund SRM-250 monoblocks, ex demo. (£6590) only	£4995

**PRE-AMPS;**

Mark Levinson ML-40 processor/pre amp cost new over £30,000 offer for	£9995
Proceed PAV pre-amp	£495

**CD PLAYERS & TRANSPORTS**

Meridian GO-7 CD player, mint/boxed	£895
CEC TLOX belt drive transport AS NEW only	£8995
CEC TL-1N transport with DA-1N DAC, AS NEW only	£8500
Denon DVD3910 multi-format player with HDMI	£295

Panasonic DMREZ-25 DVD recorder HDMI-1080P	£99
Meridian 508 CD player	£795
Tri CD player New	£1895
Goldmund Eidos CD/SACD Player ex demo mint/boxed/full warranty (£3195) only	£2495

**MISCELLANEOUS**

Denon TU-1800 DAB/FM/AM tuner mint/boxed	£150
Selection of NEW Madrigal CZ	
Gel balanced interconnect @ 30% discount.	
Selection OYAIDE plugs and power strips	POA
Sony AM/FM ST-SE370 Tuner	£75
Technics ST-610L Tuner (FM/MW/LW)	£65
Winds ALM-01 Stylus Gage (New)	£425
Sony ST-SE570 Tuner	£60

**Main dealer for Esoteric**

ALL USED CARTRIDGES ARE CHECKED UNDER A MICROSCOPE BEFORE BEING OFFERED FOR SALE.

VISA - SWITCH - MASTER CARD - AMEX - DINERS CLUB WELCOME.  
WE TAKE PART EXCHANGE ON NEW & USED STOCK and buy in for cash

**Sound Hi Fi**



Focal 705TE



Jelco SA-750D



Avid, SME & other turntables

**marantz**

**PREMIUM**

because music matters



Avid, SME, Shelter cartridges, AT-OC9, Clearaudio, Jelco, Hadcock, SL-1200 mods  
Denon cartridges, The Cartridge Man, Marantz, Focal, Whest Audio, A.N.T, Puresound, Transfiguration, 78rpm

All demonstrated in a relaxing setting with river views! Very high part exchanges & mail order.

**Sound Hi Fi Dartmouth Devon 01803 833366 web www.SoundHiFi.com**

**plug 'n' play 'n' smile**



**kudos**  
www.kudosaudio.com

0845 4586698 for details...



**One Decent Wallshelf**

Thoroughly Recommended - David Price, Hi-Fi World Jan 06  
featuring:  
steel frame with multipoint fixing  
upto 25mm thick 1/2 metre acrylic isolation platform  
tuning pack for system matching  
available:  
hdw - £129  
odw (pictured) - £249  
odwt (2 shelf) - £349  
all in either silver or black

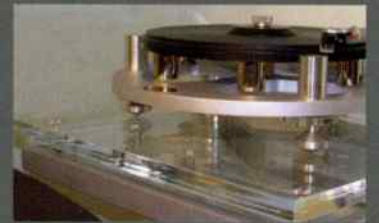

**The Decentscale 2**

SIMPLY THE BEST SUB £100 SCALE THERE IS ....



Wallshelves, Isolation Platforms, Digital Tracking Force Scales, Cables

**Decent Audio 0845 6019390**



# HEATHCOTE AUDIO

TEL: 07860 511111 WEB SITE [www.heathcoteaudio.co.uk](http://www.heathcoteaudio.co.uk)

E-MAIL [heathcoteaudio@aol.com](mailto:heathcoteaudio@aol.com)

AGENTS FOR LAVARDIN. MUSIC FIRST. AURUM CANTUS.

BLACK RHODIUM AND MUCH MORE.

EQUIPMENT URGENTLY REQUIRED FOR IMMEDIATE

PURCHASE!! PLEASE PHONE GEORGE NOW!!

ALL MAJOR CREDIT DEBIT CARDS ACCEPTED

## VINYL

EAR 509 MONOBLOCKS 25th ANNIVERSARY ED. (RARE LITTLE USE)  
COUNTERPOINT SA-5000A LEGENDARY PRE/PHONO STAGE (2 BOX)  
TUBE TECHNOLOGY SYNERGY INT.AMP  
BALANCED AUDIO TECH. BAT VK-60 POWER AMP (E6K?)  
ROGUE AUDIO 88 POWER AMP  
MUSIC FIRST SILVER PRE AMP (E3K?)  
ROGUE AUDIO 66 MAGNUM REMOTE PREAMP  
ANTIQUE SOUND LABS 'THE WAVE' MONOBLOCKS  
AURUM REF. BATTERY POWERED PRE AMP & PHONO (E2500)  
ANTIQUE SOUND LABS AD1001 KT88 INTEGRATED EXCLT  
ANTIQUE SOUND LABS AD1000D? TWIN 945 MONOBLOCKS (E5000)  
ANTIQUE SOUND LABS L101 PRE AMP/HEADPHONE AMP  
UNISON RESEARCH FEATHER PRE/3S POWER  
AUDIO RESEARCH SP-9 C/W PHONO STAGE (RARE BLACK)  
SME SERIES 10 TONEARM AND DAMPING TROUGH  
CONRAD JOHNSON PV-5 PRE AMP C/W PHONO STAGE

## VINYL

PROJECT RPM 9X/CARBON ARM/GOLDRING 1022GX (E1300)  
CLEARAUDIO EVOLUTION & TANGENT PARALLEL ARM  
ORACLE DELPHI/TURBO PSU  
QUASAR SKELETON /SEPARATE MOTOR & PSU/HELIUS ARM  
VOYO VALDI/SEPARATE PSU  
ROGUE AUDIO STEALTH PHONO STAGE (E800)  
MUS.FID.XLPS V3 PHONO STAGE  
NWA TWO BOX PHONO STAGE  
BILL BEARD MM/MC PHONO STAGE  
McCORMACK MINI PHONO DRIVE (MM/MC E600?)  
BILL BEARD BATTERY STEP UP  
MUSIC FIRST SILVER STEP UP (E3000?)  
SME SERIES 10 TONEARM AND DAMPING TROUGH  
THORNS TD 160 SUPER WORKS BUT SCRUFFY

## SOLID STATE

LAVARDIN 6/2 PRE AMP & 2 MAP MONOBLOCKS . (13600+ NOW)  
DK DESIGN VS 1 SIGNATURE MKII INTEGRATED  
PLINIUS SE-300 (E3K+ NOW)  
PASS LABS ALEPH P PRE AMP  
PASS LAB ALEPH O MONOBLOCKS  
McCORMACK RLD-1 REMOTE PRE & DNA-125 POWER AMPS (4.5K)  
XTC PRE 1 (REMOTE) P/W 1 POWER AMP (E3000+)  
KRELL KAV 3000 INTEGRATED AMP  
CONRAD JOHNSON PF-1 PRE AMP+ PHONO STAGE  
CONRAD JOHNSON PFR REMOTE PRE (E3K?)  
CONRAD JOHNSON MP 2500A POWER AMP  
TECHNICS A-901 MKII INTEGRATED  
MARANTZ MA-700 MONOBLOCKS  
MUSIC FIRST SILVER PRE AMP (E3K?)  
ALCHEMIST FORSETTI 2 BOX PRE RCA/XLR  
H-CAT 12-B PRE WITH WTC CONTROL (E2800)  
H-CAT P-12A PRE AMP (E2500?)  
ROTEL RB-8708X STEREO/MONO AMP  
ADVANTAGE 1200 INTEGRATED AMP  
ROKSAN S-1 PRE AMP NO PSU

## DIGITAL

KRELL MDC-1 TRANSPORT/SBP-64 DAC/PSU (E15K?)  
ACCUHASE DP-90 TRANSPORT (E8000?)  
MARANTZ SA-7001 KI SIG (LITTLE USED)  
AUDIO ANALOGUE PAGANNINI (NEW MECH)  
ORACLE S-2000 TRANSPORT (E5800?)  
EINSTEIN THE CD PLAYER  
CHORD 1500E DAC/DIGITAL PRE AMP (E6800)  
RESOLUTION AUDIO CESCIUM TRANSPORT(RARE)  
UNISON RESEARCH UNICO (E1750) NEW MECH  
INCA TECH KATANA CD PLAYER (LITTLE USED)  
PIONEER 905 PRECISION  
SONY SCD 8940 DS SACD/CD PLAYER  
SONY MDS 920 MINIDISC PLAYER  
THETA DATA UNIVERSAL CD/LD PLAYER (RARE!)  
THETA PRO GEN III DAC GLASS & BALANCED OPTONS  
TRICHORD DIGITAL TURNTABLE  
PIONEER CLD 2950 CD/LD PLAYER  
PERPETUAL TECH. P1A/P3A/MODULAR PSU MODRIGHT SIG.2  
PERPETUAL TECH. P3A 24/96 UPSAMPLING DAC  
MODRIGHT SIGNATURE-2 (SUPERB)  
MICROMECA CLASSIC SOLO XLR/RCA (NEW MECH)  
DENON 2800 MKII GOLD (HDCD)  
THETA CARMEN CD/DVD TRANSPORT  
THETA DATA II TRANSPORT (SILVER) AES/RCA ETC  
THETA DATA TRANSPORT (BLACK NO REM.)  
SONY SMDS J8920 MINIDISC PLAYER  
Z-SYSTEMS UPSAMPLER (E1500)

## TUNER/TAPE/MISC

MAGNUM DUAL AB FT-11 ANALOGUE TUNER  
SONY 77ES DAB/AM/FM REMOTE CONTROL TUNER  
AVI REF.7 BAND TUNER  
HITACHI FT 5500 MKII  
QUAD 33 TUNER  
SONY SMDS JB 920 MINIDISC PLAYER

MINT/BOXED £3750  
SERVICE/BOXED £1995  
EXCLT £2999  
EXCLT/BOXED £2450  
EXCLT £795  
EX.DEM £2290  
MINT/BOXED £795  
EX.DEM £300  
NOS £895  
EXCLT £795  
EXCLT £2750  
MINT/BOXED £295  
EXCLT/BOXED £1295  
MINT/BOXED £895  
VGC £595

MINT/BOXED £650  
MINT/BOXED £1495  
EXCLT £2195  
EXCLT £1495  
LOVELY £475  
EX.DEM £395  
EXCLT £225  
EXCLT £295  
EXCLT £375  
EX.DEM £349  
VGC £199  
DEM £1750  
VGC £195  
COMPLETE £75

DEM/BOXED £5495  
DEM/BOXED £2450  
DEM/BOXED £2750  
EXCLT £1150  
EXCLT/CRAVED £2500  
MINT/BOXED £2250  
MINT/BOXED £1495  
VGC £395  
VGC £599  
MINT/BOXED £995  
MINT/BOXED £1795  
EXCLT £1199  
NOS £495  
DEM £2250  
MINT/BOXED £495  
DEM £1750  
DEM £1250  
EXCLT £175  
EXCLT/BOXED £795  
EXCLT £295

EXCLT £2450  
EXCLT £2450  
MINT/BOXED £475  
MINT/BOXED £395  
NEW/DIS £3795  
EXCLT £1275  
SALE! £2500  
EXCLT/BOXED £795  
SALE! £750  
EXCLT £399  
MINT/BOXED £199  
EXCLT £199  
EXCLT £199  
EXCLT/BOXED £395  
EXCLT/BOXED £795  
EXCLT £395  
EXCLT/BOXED £249  
LAST SET.BNIB £1895

BRAND NEW £795  
SALE! £695  
SALE! £275  
MINT/BOXED £1250  
MINT/BOXED £750  
VGC £395  
VGC £99  
MINT/BOXED £399

VGC £495  
VGC/BOXED £245  
EXCLT £375  
VGC £149  
GC £89  
VGC £99

TICE POWER BLOCK  
MVL CO/MO ENHANCER (ULTRA RARE)  
REVOX 677 7.5 IPS.  
QUANTITY OF TAPE AND METAL SPOOLS

## LOUDSPEAKERS

EGGLESTONWORKS ROSA  
MARTIN OSBAN CLARITY  
SNELL TYPE C MK IV AMERICAN OAK  
LINN KANS AND DEDICATED STANDS (LATE MODELS)  
REFERENCE 3A VEENA (SUPERB E3000)  
AURUM REF. 3A VEENA (SUPERB E3000)  
QUAD 980 ELECTROSTATICS  
MARTEN MILES II CHERRY (8K+ NEW)  
FAB AUDIO MODEL-ONE (RETAIL E7500)  
BKS 128 RIBBON HYBRID (STAR GRANITE E2800)  
AUDIO NOTE AFD-3 SILVER FINISH POSTS  
T&A TMR-100 TRANSMISSION LINE LOUDSPEAKERS  
B&W DM602 MKII  
MORDANT SHORT 914 FLOORSTANDERS  
CELESTION F-80 FLOORSTANDERS  
B&W 904 MATRIX EXCELLENT LOUDSPEAKERS  
THEL CS 2.2 LOUDSPEAKERS  
CELESTION A-2 SANTOS R/W/BD (E15/1600?)  
ALL R. JORDAN WOT 5 FLOORSTANDERS (E2500)  
CURA CA-30 FLOORSTANDERS (MAPLE)  
PROAC STUDIO 150  
CASTLE HOWARD S2 ROSEWOOD  
ATO 208X & TARGET 72 STANDS  
HARPER QUARTETO (E4000)  
MIRAGE M1BI BIPOLAR GIANTS (E6500)  
REGA XEL (ROSEWOOD E1250)  
AURUM CANTUS V3M GLOSS BLACK (E1700)  
AURUM CANTUS SUPREME (AWESOME! E10,000)  
AURUM CANTUS VOLLA (RETAIL E2500)  
AURUM CANTUS MUSIC GODDESS E2500  
KEF B139 TWO DFF NEW OLD STOCK  
KEF B110 RECONDITIONED PAIR OFF

## INTERCONNECT CABLE

RENAISSANCE SILVER CABLE 2 METRE BALANCED  
RENAISSANCE SILVER CABLE 2 METRE RCA  
RENAISSANCE SIGNATURE SILVER CABLE 1 METRE RCA  
DPA SLINK 1 METRE BALANCED  
BLACK RHODIUM ORATORIO 1 METRE BALANCED (E800)  
BLACK RHODIUM ORATORIO 2 METRE BALANCED (E1000)  
NIRVANA DIGITAL COAX 4FT SILVERBI  
NIRVANA 631 1MTR BALANCED  
MUSIC FIRST SILVER CABLE 1 METRE RCA(E600?)  
ATLAS ELECTRA 2 METRE BALANCED  
XLO SIGNATURE TYPE 1.1 RCA  
AUDIOQUEST DIAMOND 0.8 METRE  
BLACK RHODIUM CONCERTO 1 METRE RCA(E180)  
XLO PRO 1METRE AND 0.5 M ETR RCA (SIX OFF)  
BLACK RHODIUM SYMPHONY 1 METRE RCA  
QUANTITY OF ITALIAN ART AUDIO CABLE 3 INTERCONNECTS 1M/1.5M/2M  
AND 4 LENGTHS OF 3 METRE LOUDSPEAKER CABLE

## LOUDSPEAKER CABLE

NIRVANA SL-323 1 METRE PAIR  
XLO SIGNATURE 2 TYPE 5.2 4FT PAIR  
OED GENESIS SILVER SPIRAL 3 METRE PAIR  
OED XT-400 4 METRE PAIR AIR LOC TERMINATED  
NORDOST SPL 3 M ETR BI-WIRE (E3000?)  
BLACK RHODIUM PINE NINJA DCT +++ (E1500)  
XLO REF.2.5 METRE PAIR  
DPA BLACK SLINK (E100 PER M.) 4.5 METRE PAIR WBT LOCKING PLUGS  
SONORAM PLATEAU 4 METRE+ PAIR (HI END USA HEAVY COPPER CABLE)  
MIT MH-750 BI WIRE 3 METRE PAIR  
TRANSPARENT SUPER BI CABLE 10 FT PAIR  
PS AUDIO X-STREAM 3 METRE PAIR (VERY HEAVY!)  
DIAMOND HI SILVER 3 METRE PAIR  
BLACK RHODIUM S-300 BI WIRE 7 METRE BI WIRE PAIR(E560)  
BLACK RHODIUM S-300 BI WIRE 5 METRE BI WIRE PAIR(E400)  
BLACK RHODIUM S-300 BI WIRE 4 METRE PAIR (E240)  
AUDIOQUEST INDIGO

## STANDS

ASH DESIGN COSMIC CLASSIC 5 ROSEWOOD  
FINITE ELEMENT PADDOE 35E555 2 TIER TABLE  
SOUNDSTYLE ST-100  
SOUNDSTYLE ST-100  
SOUNDSTYLE ST 90 MIDI SIZE  
SOUNDSTYLE LOUDSPEAKER STANDS  
TARGET R-2 LEAD FILLED  
ELEMENTAL AUDIO LOUDSPEAKER STANDS (E2K?)

## MAINS CABLES/BLOCKS/CONDITIONERS ETC

TICE MAINS POWER BLOCK  
XLO REFERENCE SERIES POWER CORD 1 METRE X 2  
XLO REFERENCE SERIES POWER CORD 2 METRE  
TARA LABS RSC AIR-2 8FT POWER CORDS (SHUKO)  
TARA LABS POWER CORD (GREEN) 2 METRE  
BLACK RHODIUM SUPER MAINS POWER CORDS  
BLACK RHODIUM POWER CORD RHOIUM PLATED EASYGRIP PLUG  
ISOTEK POWER CORD

GC £349  
MINT/BOXED £399  
VGC £299  
PLEASE RING

EXCLT £2750  
EXCLT £1695  
EXCLT £1995  
EXCLT £399  
EX.DEM £1595  
NEW/DIS £1995  
MINT/BOXED £2750  
EXCLT £2750  
EX.DEM £4750  
MINT/BOXED £1995  
GC £395  
VGC £495  
EXCLT £249  
EXCLT £195  
BOXED AS NEW £149  
VGC £695  
BOXED £695  
BRAND NEW £995  
EXCLT £1195  
MINT £995  
EXCLT £695  
EXCLT/BOXED £695  
MINT/BOXED £1795  
DEM £2250  
EXCLT RING £395  
EX.DEM £395  
EX.DEM £395  
EX.DEM £795  
EX.DEM £6995  
BRAND NEW £1750  
EX.DISPLAY £1750  
NEW £175  
NOS £195  
£120

EXCLT £595  
EXCLT £450  
EXCLT £450  
VGC £149  
VGC £299  
EXCLT £450  
EX.DEM £249  
EX.DEM £249  
BRAND NEW £375  
BOXED/AS NEW £375  
BOXED AS NEW £249  
NEW £149  
NEW £95  
EACH 95/65  
NEW £100

DEM/BOXED £450  
DEM £495  
EXCLT £149  
EXCLT £149  
EXCLT £695  
DEM £795  
EXCLT £325  
EXCLT £395  
EXCLT £560  
EXCLT £595  
EXCLT £995  
EXCLT £500  
EX.DEM £400  
NEW £300  
NEW £170  
NEW £140  
CHEAP

EXCLT £195  
EXCLT £360  
DEM £195  
DEM £195  
DEM £195  
DEM £550  
NOS £175  
BOXED £895

BOXED £349  
EACH £120  
EXCLT £149  
BRAND NEW £225  
EXCLT £65  
BRAND NEW £65  
BRAND NEW £95  
£65



## Specialist Audio Retail and Installation

We are a small evolving company offering a uniquely high level of personal service by helping you choose a system performance that best meets your needs. From initial consultation and demonstration through to installation and finally sales aftercare, we are committed to your long term musical satisfaction. Comfortable audition rooms, part exchange, low cost finance options.

Linn Elite, NaimNet, B&W 800 series dealer. - Stand alone or expandable multi-room solutions.

248 Lee High Road, Lewisham, London, SE13 5PL ☎ (020) 8318 5755 - 8852 1321

10am - 6:30pm. Mon - Sat (Closed Thurs) 🌐 [billyvee.co.uk](http://billyvee.co.uk) ✉ [sales@billyvee.co.uk](mailto:sales@billyvee.co.uk)

- The very best audio systems
- Installed in your home
- For your lasting enjoyment



**Billy Vee**  
SOUND • SYSTEMS



# Exceptional Value from *icon Audio* of Leicester

Real Hi End Hi Fi to suit all pockets!

designed by David Shaw 

## New Speaker MFV 3 "Made For Valves"

**Release the full quality  
of your valve amplifier!**

Virtually all modern speakers are designed for transistor amplifiers. This means that they often don't "hit the mark" when using valves. Our MFV 3 was designed and tested exclusively using valves, using our experience of making a wide range of Push-Pull and Single Ended valve amplifiers. An ideal partner to tubes, you will hear rich deep bass, wonderful lucid mid-range and smooth transparent treble. We use custom designed doped woven fibre bass/midrange cones with long life neoprene roll surrounds, superb silk dome tweeter, and simple high quality crossover, and long fibre MDF cabinets. Matched veneers, with a choice of dark walnut or light cherry finishes. Fully Bi-wireable, complete with plinth, spikes (and cover) we are confident that the MFV 3 will delight your ears on a wide range of music. Full leaflet on [iconaudio.com](http://iconaudio.com) or ask for a leaflet by post.

Only £979.00 per pair



## 100w Mono-Blocks

**"A FINE  
INTRODUCTION  
TO THE  
WORLD  
OF SERIOUS  
TUBE POWER"  
Hi Fi World  
April 2008**



MB 90

**Powerful, Beautiful, and Versatile!** KT88/6550 or KT90

Smooth, precise and powerful. Without any harshness. Massive 100w headroom means you can comfortably drive speakers normally out of reach of most valve amps. Hand wired "Point to Point". Hand wound transformers. Will exceed the performance of many other brands **Check our specification:** Incredible 100 watts (28.3v @ 8Ω). New all valve design by David Shaw. Low & high sensitivity means **Can be passive or pre-amp driven.** Triode driver stage using excellent 6SN7/6SL7 valves. Silver audio cable. **Switchable to 50w Triode output.** Choke PSU.. Beautiful stainless steel and Plexiglas cover included. Vital warm-up/Standby facility.

From £1,799 pair complete (Various upgrades available)

# KingSound

Full range of these amazing electrostatic speakers  
Now in stock! Full info on: [www.kingsaudio.com.hk](http://www.kingsaudio.com.hk)  
UK Price list on our website. Leaflet on request.

Common Features: Designs by David Shaw. Hand built 'Point to Point' wiring. Designed and finished in Leicester UK. No printed circuit board. ALPS Volume control. Gold plated terminals. Audiophile components. Silver Teflon audio cable. Steel & alloy plate construction. Soft start. Unique HT delay. Comprehensive manual Inc DIY valve change info.

Find out more: website at [www.iconaudio.com](http://www.iconaudio.com) or ask for an illustrated Leaflet. Available through good dealers or direct from us

Phone 0116 2440593 email [sales@iconaudio.com](mailto:sales@iconaudio.com) *icon Audio* 351 Aylestone Road Leicester LE2 8TA (U.K.)

\*Conditions apply

Prices correct with 15% VAT at time of going to press but subject to change. E & O E

Visa, MasterCard and debit cards accepted

## Fabulous New MB 845s!

"Amongst the best amplifiers I have ever heard...Awesome dynamics and power! High Drama. Superb Value" N Keywood H F W



These extraordinary mono blocks are not for girls! They are big, brutal and uncompromising. At 90+90 watts of pure triode magic they were designed to go into sonic territory inaccessible by 300Bs or KT88s. The 1931 RCA huge power triode is still without equal, partnered with the superb 1941 6SN7/6SL7s using only 3 stages. Inspired by the QUAD IIs! They are the answer to anyone jaded by their present system. *Audition them!*

From £2499.00 per pair

## A Serious 30w Valve Amplifier for Only £499.00!

Based on our award winning £900 Stereo 40. "Entry level" does not have to mean low power or quality! Inspired by "Leak". Hand crafted "Point to Point" wiring. Versatile: can use 6L6, EL34, KT66 or KT88s. Beautiful stainless steel and Plexiglas cover included. Limited offer of free EL34 upgrade worth £100



## Mini Hi Fi & Headphone Amplifier

A true ALL VALVE hi fi amplifier only 12"x 4"  
Designed and finished in Leicester UK.  
5+5w SE with separate transformer winding for best headphone performance. 8-600 Ω  
All Class "A" Single Ended design uses EL84 & ECC83 valves. Study or bedroom  
Only £399.00 complete



## PS 3 All Valve Phono Stage

"Our Fave Affordable High End Phono Stage" N.K. Hi Fi World. Awarded 5 "Globes"

Only a pure valve design can get the best from vinyl. All triode. No feedback. Passive RIAA. Custom British MC TX option. A supercharged PS1 with the best possible Power supply. Valve rectified & regulated for definition and smoothness  
14kg. Upgrades available

From only £1399.00 complete (Inc MC TX)



## LA4 Line pre-amp

"...big beautifully controlled sound...imaging very detailed...distortion an all time low of 0.0009%... excellent reliability" Hi Fi News July 2006

Valve rectification 2x EZ81  
Twin choke smoothing.  
All triode design 3x 6SN7  
Remote control included  
Four inputs plus tape loop  
High & low level outputs  
Will match any power amp

From only £699.00 complete



**We Only  
Make 100%  
Pure Valve  
Amplification**



# SEVENOAKS

SOUND & VISION

the experts in home entertainment



Stores Nationwide



Demonstration Rooms



Expert Impartial Advice



Unrivalled Product Range

When you buy from Sevenoaks you are buying from one of the biggest, longest established and most trusted Hi-Fi / Home Cinema retailers in the UK.

We have been making home entertainment come alive for customers for more than 35 years now. With a national network of stores and a hard-won reputation for outstanding customer service we are confident that we can do the same for you.

Ultimately, our stated aim is quite simple... to offer a total home entertainment solution, no matter what the customer's need.

**The philosophy behind Sevenoaks Sound & Vision is simple, customer-focused and hasn't changed since the day the company started. When you shop at Sevenoaks we guarantee you:-**

- Superb customer service, including after-sales care and attention to detail.
- An unrivalled product range, with every leading manufacturer in stock and impartial advice on offer.
- Knowledgeable staff that are highly trained, dedicated to customer service and have a genuine passion for home entertainment.
- Demonstration facilities in every store, offering pleasant and comfortable surroundings to test high-performance products in a home-like environment.
- Competitive prices across the whole range of products stocked.
- Leading edge expertise in bespoke design and installation with Cedia qualified staff in many stores.

Purchase **ANY** Arcam, Cyrus, Marantz or Roksan hi-fi amplifier at RRP or **ANY** Yamaha, Onkyo, Denon or Pioneer AV receiver/amplifier at RRP and **CLAIM** up to

# 30% OFF

the RRP of the loudspeakers of your choice\*

\* Max RRP of loudspeakers: £1500. Subject to availability. Most, but not all, brands included. Offer valid until 08/04/2009. Not in conjunction with any other offer (NICWAOO). Participating stores only. E&OE.

**Don't need loudspeakers?** There are great deals on Hi-Fi and AV amplifiers and receivers purchased on their own too! Visit [www.SSAV.com](http://www.SSAV.com) for more offers

## BRANDS STOCKED INCLUDE\*

Acoustic Energy  
Arcam  
Artcooustic  
Atacama  
Audiolab  
B&W

Beyer Dynamic  
Chord Company  
Chord Electronics  
Cyrus  
Da-Lite  
Denon

Draper  
Escent  
Goldring  
Grado  
In Focus  
IxoS

KEF  
Linn  
Loewe  
Logitech  
Marantz  
Meridian

Michell  
Monitor Audio  
Musical Fidelity  
Nevo  
Onkyo  
Optimum

Optoma  
Panasonic  
Pioneer  
Pixel Magic  
PMC  
Primare

Project  
Q Acoustics  
QED  
Quad  
Quadraspire  
REL

Roksan  
Rotel  
Samsung  
Sennheiser  
Sharp  
Sim2

Sonos  
Sony  
Sound Org  
Sound Style  
SpeakerCraft  
Spectral

Spendor  
Stewart Screens  
Teac  
Toshiba  
Van Den Hul  
Yamaha

\* Some brands/products are not available at all stores - please confirm before travelling

news, the latest offers and more at [www.SSAV.com](http://www.SSAV.com)

World Radio History



## Home Cinema & Hi-Fi

From a straightforward high definition flatscreen TV to a 1080p projector, from a DVD Recorder to a complete Blu-ray based solution, we can offer every conceivable flavour of Home Cinema and Hi-Fi.

Choosing components/systems that will fit together correctly in your home is no easy task but our expert experienced staff do it day in day out so it is help.

And with demonstration rooms in every store, you're positively encouraged to bring in your favourite discs or hook up your MP3 player to give a system a thorough workout before you buy.



### LCD & PLASMA SCREENS



These new screens from Pioneer are 1080p HD ready and feature KURO technology for the deepest blacks

#### Pioneer G9 KURO Series Plasma TVs

New 40, 50 inch models Full 1080p HD ready



#### Samsung Series 6 'Rose Black' LCD TVs

32, 37, 40, 46 and 52 inch full 1080p HD ready models



#### Panasonic VIERA PZ81

Panasonic's new PZ81 full 1080p HD ready Plasma TV, and the first to include an integrated inbuilt HD tuner.

### DLP PROJECTORS

Want a bigger picture? Then a full 1080p projector and screen could be the answer

#### Sim2 Grand Cinema HT380

This award winning projector has to be seen to be believed!



#### InFocus IN80, IN81, IN82 & IN83

For an unforgettable experience, fire up an InFocus projector and start playing Blu movies, TV and games

### HOME CINEMA SEPARATES

Onkyo's award winning range includes the top TX-5500 and TX-SR106 AV receivers and the award winning DV-SP400 DVD player



#### Yamaha

The DSP-AM933E AV amplifier features full support for HD audio formats ensuring maximum enjoyment of all high definition sources. Also available is the award winning DSP-AX763 and the flagship DSP-711 at selected stores.



#### Denon

The range includes the award winning Denon DVD1940 DVD player and outstanding AV amplifiers and receivers including the new AVR-1909 and AVC-111

### BLU-RAY DISC PLAYERS

#### Panasonic DMP-BD35

Conforming to BD profile 1.0 this player delivers outstanding picture and sound quality



#### Pioneer BDP-LX71

View film exactly as the filmmakers intended in breathtaking 1080p resolution at 24 frames per second with Pioneer's new BDP-LX71



#### Denon DVD-2500BT

For faithful transmission of full HD video and HD audio signals bringing out the full quality of film



### HI-FI SEPARATES

#### Pro-Ject Turntables

Pro-Ject's excellent range includes the multi award-winning Debut turntable. Debut USB - ideal for converting your favourite tracks to your iPod and Debut colour - available in finishes to suit any decor.



#### Genie 2

The new Genie 2 is an ideal choice for vinyl lovers on a budget



#### Roksan Kandy K2

Roksan replaces its hugely successful Kandy series with the new Kandy K2 amplifier and matching CD player.

#### Marantz CD6002 & PM6002

The award winning CD and amplifier from Marantz gives true high end performance and represents outstanding value for money



#### Cyrus

For an entire quality of sound that is rare at any price. Cyrus and their remarkable Evolver CD player - CD6 SE, CD8 SE & CDX t SE



#### Arcam FMJ Series

Combining sleek design, flexible connectivity and a level of reproduction far beyond that of budget separates systems

### LOUDSPEAKERS

#### B&W 600 Series

The fourth generation of the 600 series features new drive units, crossovers and a whole new design



#### B&W MiniTheatre MT30

Award winning 5.1 speaker system available in silver, black or white



#### Dali Lektor 1

These speakers deliver remarkable performance from compact enclosures



#### Monitor Audio

With a choice of sizes and finishes, there's a Monitor Audio speaker to complement any system. Ranges include Bronze BR, Silver RS, Gold Signature, new Radius R1C and the flagship Platinum



#### Radius HD

A new decor matching range of ultra compact sub/sat speakers replacing the highly acclaimed Radius



#### Q Acoustics 1010i 5.1

Smart styling complements the Q Acoustics award-winning performance



#### KEF KHT3005SE

Award winning 5.1 speaker package available in high gloss black or silver



#### Spendor A5 and A6

The A5 offers exceptional performance in relation to its compact dimensions. New drive units ensure clear and natural mid-range and beautifully open treble. The A6 utilises technology developed whilst developing the TT loudspeaker with its asymmetrically sculptured tweeter faceplate and refined 18cm bass/mid driver.





ALL-IN-ONE SYSTEMS

**Denon D-M37DAB**

Denon's micro systems are back. This award-winning model, available in silver or black, features a CD player capable of reading MP3 and WMA discs, a DAB tuner, 30W amplifier and optional SC-M37 speakers.



**Arcam Solo Mini**

Award-winning integrated CD, Radio and Amplifier with iPod control via optional iLead/iDock.



**WHAT HI-FI? AWARDS 2008**  
SILVER PRIZES  
BEST CD PLAYER  
ARCAM SOLO MINI

**Teac Reference Series 380**

This new three component system's strong feature set includes DAB/EAB+ and WIFI Internet Radio, MP3 playback from CD or via a front-mounted USB socket, an optional iPod dock, high-quality circuitry, tone and balance controls and CD Direct function.



**B&W Zeppelin**

This award-winning iPod docking station ticks all the boxes: it's beautiful, solid as a rock and sounds amazing!



**WHAT HI-FI? AWARDS 2008**  
SILVER PRIZES  
BEST IPOD DOCKING STATION  
B&W ZEPPELIN

Essential Accessories

At Sevenoaks, accessories are not an afterthought. Our staff can demonstrate the difference the right accessories can make to your listening and viewing experience.

ACCESSORIES INCLUDE: SOUNDSTYLE GRADO QED



MULTI-ROOM AUDIO

**Logitech Squeezebox Duet**

With Squeezebox™ Duet, you can listen to the music you love in any room of your home. This smart, wireless player delivers your entire music collection to your stereo. The controller then makes it easy to browse, select and play.



**Sonos**

This multi-room digital music system lets you play your favourite tunes all over the house – and control them from the palm of your hand. You can even play different songs in different rooms.



**WHAT HI-FI? AWARDS 2008**  
PRODUCT OF THE YEAR  
DIGITAL MUSIC PLAYER & ACCESSORIES  
SONOS

SPECIAL OFFERS

HERE ARE JUST A FEW OF THIS MONTH'S SPECIAL OFFERS. VISIT [www.SSAV.com](http://www.SSAV.com) FOR MORE OFFERS AND OUR LATEST PRICES!



**SAVE £5**  
GREAT PERFORMANCE & VALUE FOR MONEY

**MARANTZ**  
CD6002 CD PLAYER (SILVER)  
PM6002 AMPLIFIER (SILVER)

**MONITOR AUDIO**  
BRONZE BR1 SPEAKERS

**£549**

CD6002 & PM6002 also available in black at extra cost. For our latest prices visit [www.SSAV.com](http://www.SSAV.com)

CHANGE SPEAKERS TO DALI LEKTOR 1 £649



**ONKYO DV-SP406**  
DVD PLAYER

**YAMAHA DSP-AX763**  
AV AMPLIFIER

**KEF KHT1005.2**  
AV SPEAKER PACKAGE

**£699**

CHANGE SPEAKERS TO Q ACOUSTICS 1010i £879

**PIONEER PDP-LX5090**

50" PLASMA TV

**£1599** **SAVE £5**

when purchased together with other AV components worth at least £2500

Price on its own - Visit [www.SSAV.com](http://www.SSAV.com)

**DENON DVD-2500BT**  
BLU-RAY DISC TRANSPORT

**£669** **£699**

(SILVER) (BLACK)

**SAVE £5**

**PANASONIC DMP-BD35**  
BLU-RAY DISC PLAYER

**£189**

OR LESS! - Visit [www.SSAV.com](http://www.SSAV.com)

**SAVE £5**

**PIONEER BDP-51FD**  
BLU-RAY DISC PLAYER

**£349**

OR LESS! - Visit [www.SSAV.com](http://www.SSAV.com)

**SAVE £5**

**DENON AVR-1909**  
AV RECEIVER

**KEF KHT2005.3** AV SPEAKERS  
**£949**

**SAVE £5**

**ONKYO TX-SR606**  
AV RECEIVER

**KEF KHT3005E** AV SPEAKERS  
**£1199**

**SAVE £5**

**YAMAHA DSP-AX763**  
AV AMPLIFIER  
**B&W 685 THEATRE** AV SPEAKERS  
**£1349**

**SAVE £5**

**ARCAM SOLO MINI**  
CD/DAB SYSTEM  
**MONITOR AUDIO BRONZE BR1**  
SPEAKERS WORTH £180 **FREE**

**£749**

**SAVE £5**

**DENON D-M37** CD/DAB SYSTEM  
**MONITOR AUDIO BRONZE BR1** SPEAKERS  
**£349**

OR LESS! - Visit [www.SSAV.com](http://www.SSAV.com)

**SAVE £5**

BEAT THE PRICE INCREASES!

As many products are imported and the pound has weakened again, we are experiencing the biggest price increases in living memory - typically 10-30%!

Buy now while many products are still at pre-increase prices - delay and you'll miss a bargain. For our latest prices visit [www.SSAV.com](http://www.SSAV.com)



Stores Nationwide

All Sevenoaks stores stock a wide range of products, have comfortable demonstration rooms, provide first-class customer service and can deliver and install your purchase.



Custom Installation

Stores with Cedia qualified staff can also provide a bespoke design and installation service. They have unrivalled expertise in all areas of home automation and can demonstrate a wide range of installation options.



Mail Order 0800 587 9909

Can't get to one of our nationwide stores? Why not call our Mail Order Hotline? We have great products\*, great prices and good old-fashioned service.

And if you're not sure what product is right for you, just ask one of our dedicated sales advisors for expert advice.



\*Subject to availability. Due to restrictions, some products/brands are not available via mail order. We only accept payment via Credit/Debit Card or Bank Transfer. Goods will only be delivered to the registered card holder's address. Other restrictions may apply - please ask at time of purchase. SSAV adheres to The Distance Selling Regulations 2000. Full terms and conditions available at [www.SSAV.com](http://www.SSAV.com)

Website

Can't find what you're looking for? Visit the Sevenoaks website where you'll find news, special offers, information, a comprehensive product range, massive savings on end-of-line clearance product, a free monthly competition and more.

[www.SSAV.com](http://www.SSAV.com)

**Aberdeen**  
01224 252797

**Bedford**  
01234 272779

**Brighton** Home  
01273 733338

**Bristol**  
01177 974 3727

**Bromley**  
020 8290 1988

**Cambridge**  
01223 304770

**Chelsea**  
020 7352 9466

**Cheltenham**  
01242 241171

**Epsom**  
01372 720720

**Exeter**  
01392 218895

**Glasgow**  
0141 332 9655

**Guildford**  
01483 536666

**Holborn**  
020 7837 7540

**Kingston**  
020 8547 0717

**Leeds** Wetherby  
01937 586886

**Lincoln**  
01522 527397

**Loughton**  
020 8532 0770

**Maldstone**  
01622 686366

**Manchester**  
0161 831 7969

**Norwich**  
01603 767605

**Nottingham**  
0115 911 2121

**Oxford**  
01865 241773

**Peterborough**  
01733 897697

**Plymouth**  
01752 226011

**Pool**  
01202 671677

**Reading**  
0118 959 7768

**Sevenoaks**  
01732 459555

**Sheffield**  
0114 255 5861

**Southampton**  
023 8033 7770

**Southgate**  
020 8886 2777

**Swindon**  
01793 610992

**Tunbridge Wells**  
01892 531543

**Watford**  
01923 213533

**Weybridge**  
01932 828525

**Witham** Essex  
01376 501733

**Yeovil**  
01935 700078

IRELAND

**Dublin**  
01 495 2020  
Unit 3a Grange Road  
Retail Centre, Grange Road,  
Rathfarnham, Dublin 16

PRICING MAY VARY FROM THE UK

**PLEASE NOTE**  
Some brands/products are not available at all stores.

Special/added value offers are not in conjunction with any other offer (NICWAOO). ADVERT VALID UNTIL 08/04/2009, E.O.E.



**IAN HARRISON HI-FI** TEL: 01283 702875

HIFI AT DISCOUNT PRICES. FREE NATIONWIDE DELIVERY

**SALE!**

**TRADE IN YOUR OLD MOVING COIL CARTRIDGE & SAVE UP TO 60% OFF THE RRP.**

MICHELL ORBE	£POA	SUMIKO BPS EVO III	£195
MICHEL ORBE SE	£POA	STAX 3050 MKII	£750
MICHELL GYRO SE	£POA	WHEST AUDIO PS30R	£POA
MICHELL TECNOARM A	£POA	WHEST AUDIO 2	£POA
MICHELL GYRODEC	£POA	TRICHORD DIABLO	£599
MICHELL TECNODEC	£POA	TRICHORD DINO MK2	£279
MOTH TONEARMS	£POA	TRICHORD D300	£POA
MOTH RECORD CLEANERS	£POA	GRADO GS1000	£800
ERGO HEADPHONES	£POA	GRADO RS1	£605
KOETSU CARTRIDGES	£POA	CLEARAUDIO CARTRIDGES	£POA
GRADO CARTRIDGES	£POA	CLEARAUDIO TURNTABLES	£POA
DENON CARTRIDGES	£POA	BEYER HEADPHONES	£POA
DENON HEADPHONES	£POA	EAR/YOSHINO	£POA
AUDIO TECHNICA CARTRIDGES	£POA	CLEARAUDIO CONCERTO	£800
AUDIO TECHNICA HEADPHONES	£POA	BENZ MICRO	£POA
HARBETH SPEAKERS	£POA	TOM EVANS GROOVE X	£1700
ORTOFON 2M BLACK	£POA	EPOS M12i	£POA
TRANSFIGURATION CARTRIDGES	£POA	CREEK DESTINY AMPLIFIER	£POA
SENNHEISER	£POA	CREEK DESTINY CD PLAYER	£POA
GOLDRING G1042	£POA		

**I ALSO SUPPLY:**

VAN DEN HUL, ZYX, CARTRIDGE MAN, SUMIKO, ORTOFON, RESON, SME, GRAHAM, MOTH, HADCOCK, THORENS, EAR/YOSHINO, ACOUSTIC SOLID, HEED, GRAHAM SLEE, PURE SOUND, AESTHETIX, ACCUSTIC ARTS, NAD, SONY, NU FORCE, SUGDEN, HALCRO, C.A.T. GAMUT, GRAAF, MONRIO, AUDIO ANALOGUE, PATHOS ACOUSTICS, UNISON RESEARCH, OPERA, TRIANGLE, FINAL, HARBETH, USHER AUDIO, DIAPASON, TANNOY, AUROUSAL, ERGO, STAX, AKG, BLACK RHODIUM, TRANSPARENT, QED, IXOS, HI DIAMOND, SUPRA, WIREWORLD, KEMP ELEKTRONICS, JUAL, B.C.D. CUSTOM DESIGN, OPTIMUM, ASH DESIGN, APOLLO, ALPHASON, B.D.I.

**PLEASE PHONE TO CONFIRM PRICE & AVAILABILITY PRIOR TO ORDERING. ALL GOODS ARE BRAND NEW & BOXED WITH FULL U.K. GUARANTEES. NO EX. DEM OR EX DISPLAY GOODS. NO GREY IMPORTS. GOODS ARE NOT SUPPLIED ON APPROVAL. SORRY, NO GENERAL CATALOGUES. PLEASE PHONE OR WRITE FOR SPECIFIC REVIEWS, BROCHURES OR PRICES. SUPPLIER OF HIFI PRODUCTS & ACCESSORIES SINCE 1986 MAIL ORDER ONLY FROM: IAN HARRISON, 7 MILL HILL, REPTON, DERBY, DE65 6GQ. TEL: 01283 702875. 9am - 9pm INCLUDING SUNDAYS.**



**Anatek Research**

The award winning  
Phonostage!



**Anatek-Research**

Sussex  
England

Tel : 01273 261 229

[www.anatek-research.co.uk](http://www.anatek-research.co.uk)

**audioJSrepairs**

audio consultancy

...the repair and upgrade service  
for the hifi enthusiast!

25 years of musical fidelity experience  
"we are the specialists"

JS audio repairs can repair and service all brands of  
audio equipment new old and vintage.

We have over 25 years of musical fidelity experience.  
If you have any musical fidelity equipment new or old and  
would like to get the best performance and sound,  
we wont just fine tune or tweak your equipment...!  
We offer a full upgrade service .....

James Cartwright  
Tiv-Vista 21 DAC, Meridian 200 C D transport, RMA VP-7 headphone amp

"John has repaired a diverse range of hi-fi gear for me over the past 17 months, including an aged but lovely sounding Meridian CD transport from 1991. Everything that I have sent him has been dealt with promptly with no fuss. John is also an absolute gem to deal with and will happily discuss prospective repairs on the phone. Such professionalism is a rare and wonderful thing in the UK today... Top marks John!"  
Testimonial from Website.

**[www.jsaudiorepairs.co.uk](http://www.jsaudiorepairs.co.uk)**

info@jsaudiorepairs.co.uk  
0208 405 9043

**MUSONIC STYLI**

REPLACEMENT STYLUS REQUIRED?



CONTACT THE PEOPLE  
WITH OVER 50 YEARS  
EXPERIENCE



MANUFACTURERS AND  
SUPPLIERS OF MORE THAN  
1,000 MODELS



PICKUP CARTRIDGES  
AUDIO ACCESSORIES



MAIN UK SUPPLIER OF  
NAGAOKA CARTRIDGES  
AND STYLI



**MUSONIC (UK) LIMITED**

271B WENTA BUSINESS CENTRE  
COLNE WAY  
WATFORD  
HERTFORDSHIRE WD24 7ND

Tel: 020 8950 5151  
Fax: 020 8950 5391  
e-mail: sales@musonic.co.uk

For info and to buy online visit: [www.musonic.co.uk](http://www.musonic.co.uk)





# DIAL A DEALER

This is a comprehensive directory of Hi-Fi Dealers throughout the UK and Ireland.

## BERKSHIRE

### LORICRAFT AUDIO

Loricraft Audio is now open for visitors but please call to arrange for a visit. You can buy all our products directly from us or through your local dealer. Our internet shop site can take direct orders for our turntables and accessories! Loricraft Audio, The Piggery, Mile End Farm, Wantage Road Lambourn, Berkshire, RG17 8UE Office Phone/Fax : +44(0) 1488-72267 EMAIL :terry@garrard501.com website:http://garrard501.com

## BRISTOL & BATH

### THE RIGHT NOTE

Tel : 01225 874728. Happy with your system? Wonder why there's so much for sale secondhand? Avoid the frustration and expense of "upgrade-itis", never quite "there". With infinite patience we'll help you plan longer term. Brands selection : Accoustic Arts, Audio Physic, Aesthetix, Bel Canto, CAT, Chord Co, Clearaudio, Esoteric, Gamut, Graham, Halcro, Magnum Dynalab, Sumiko, VertexAQ, Wadia.

### V'AUDIO HI FI CONSULTANTS

36 Druid Hill, Stoke Bishop, Bristol. BS9 1EJ. Tel: 0117 968 6005. ATC, AVI, Nola, ALR Jordan, Audio Analogue, Avid, Black Rhodium, Electrocompaniet, Edge amps/cd, Harman Kardon, Infinity, Jamo, Lyra, Origin live, Opera, ortofon, PS Audio, Michelle, REL, SME, Sugden, Townshend. Specialist in Video Projects by SIM2, Infocus, Sanyo, Power Plan. Screens by Stewart, smx and da-lite. Demos by appointment only. Home trial facilities.

## CHESHIRE

### ACOUSTICA

17 Hoole Rd, Chester CH2 3NH. www.acoustica.co.uk. Tel 01244 344227. HiFi & Home Cinema from Amphion, Arcam, ART, Ayre, B&W Nautilus, Classe, Focal, JM Lab, Monitor Audio, Naim Audio, Primare, Rega, REL, Rotel, Spondor, Sugden, Thiel, Wadia. We offer full demonstration facilities, interest free credit, delivery & install systems throughout Cheshire, Merseyside & North Wales. Tuesday to Saturday 10.00 to 5.30.

## ACTON GATE AUDIO

www.acton-gate-audio.co.uk  
4 Ruabon Road, Wrexham, LL13 7PB, (01978) 364500  
Arcam, Atlas, Audiolab, Croft, Denon, Grado, JM Labs, KEF, Michell, Monitor Audio, Musical Fidelity, NAD, Ortofon, Opera, Onkyo, Pro-ject, QED, Quad, Rel, Roksan, Sugden, Sennheiser, Unison, van-den-Hul, Wharfedale, Yamaha.  
Tuesday - Saturday 9.00 - 17.00  
email: info@acton-gate.com

## ORPHEUS AUDIO

Demonstrating: acoustic signature, Basis, Benz, Rcm, Whest, Consonance, Shanling, Luxman, Acoustic Masterpiece, Ear, Sumiko, Acoustic zen, Monopulse, Wlm, Dueve, Sound Mechanics racks and accessories, Brilliance, Albedo, Almarro. Demonstrations by appointment, home trials, no problem. Check website for winter bargains.  
Tel: 0161 4281539  
www.orpheusaudio.co.uk

## DOUG BRADY HI FI KINGSWAY

Studios, Kingsway North, Warrington, WA1 3 NU Tel 01925828009 Fax 01925 825773. Visa Mastercard, 2 dem rooms, home trial, Agencies include : Arcam, AV1, Chord, Copland, Exposure, Krell, Lyra, Michell, Meridian, Musical Fidelity, Monitor Audio, Naim, ProAc, Roksan, SME, Stax, Isotek, Kudos, Sonus Faber, Spondor, Ortofon, Prima Luna, Quad, Avid, Moon, Nordost, Wilson Benesch, and many more.

## CORNWALL

### BIGEARS AUDIO

To find a system that will allow you to hear the music instead of the equipment phone Bigears Audio, here you will find an interesting array of new and good quality used equipment! my intention is to have satisfied customers whatever their audio preferences. Naim dealer for the South West. chrisbirchley@btinternet.com. Tel: 01736-740421

## ESSEX

### ROCOCO SYSTEMS & DESIGN

Essex/London Linn Specialist  
Tel: 01371856407 - 02074541234  
www.rococosystems.com  
We have over 30 years in entertainment solutions, We can give you expert advice on your Linn Hi-Fi, Multi-room AV and Home

Cinema systems. P/EX, ex-demo and used Linn available, Demos by appointment. Home Demos welcome. Authorised dealers for Arcam, AMX, Artcoustic, Chord, Infocus Linn, Loewe, Lutron, Kaleidescape, Marantz, Nevo, Opus, Phillips Pronto, Runko, Systemline, Speakercraft Sonos Sim2

## GLOUCESTERSHIRE

### CERITECH AUDIO

Coleford, Gloucestershire. Tel: 0844 736 5719. Email: info@ceritech.co.uk. www.ceritech-audio.com.  
We provide bespoke Hi-Fi and AV services to customers throughout Gloucestershire, Monmouthshire, Herefordshire and surrounding areas. We offer honest and expert advice, and professional demonstrations of an enviable range of top brand products. Authorised Agents for Abbey Road, DALI, Leema Acoustics, Moon, Naim Audio, Neat Acoustics, ProAc, Roksan and others.

## LANCASHIRE

### HOUSE OF LINN MANCHESTER

Telephone: 0161 766 4837  
Email: info@houseoflinn.com  
www.houseoflinn.com  
The Linn specialists. Independently owned by former Linn staff. Straightforward, professional expertise with demonstration, sales, installation and support for the Linn range of components and systems. The listening experience is so good that demonstrations can last for hours. Discover how we make music sound real in your home! Appointments only.

## LEICESTERSHIRE

### ZOUCH AUDIO

The Old Coach House, Off South St, Ashby de la Zouch, Leicestershire, LE65 1BQ. Tel : 01530 414128 Email : mike@zouchaudio.co.uk Specialist Audio Equipment from Audia, Audica, Apollo, Ayon, Black Rhodium, Boulder, Chord Electronics, DALI, Edgar, Fatman, Graham Slee, Isotek, LSA, Marantz, Mission, Monopulse, Musical Fidelity, NAD, Nordost, Ortofon, Project, Q Acoustics, QED, Quad, Roksan, Spectral, System Fidelity, Tom Evans, Usher, Vitus. Over 30 years experience and 4 demonstration rooms.



# DIAL A DEALER

This is a comprehensive directory of Hi-Fi Dealers throughout the UK and Ireland.

## LONDON

### THE CARTRIDGE MAN LTD

88 Southbridge road, Croydon  
 CR0 1AF Telephone: 020 8688 6565  
 Website: [www.thecartridgeman.com](http://www.thecartridgeman.com)  
 email address: [thecartridgeman@talktalk.net](mailto:thecartridgeman@talktalk.net)  
 UK Distributor: Hiaudio Distribution  
 Makers of the prize-winning range of MusicMaker cartridges and other desirable audio accessories. We also have a cartridge refurbishing service and rebuild classic valve equipment to the highest standards. "It doesn't have to cost an arm and a leg - but there is no such thing as a free lunch, either."

### MY AUDIO DESIGN

35 Whitehall, London, SW1A 2BX  
 Tel: 020 7839 8880 / 07782 137 868 E-mail: [sales@madengland.com](mailto:sales@madengland.com)  
 Website: [www.madengland.com](http://www.madengland.com) E-Shop: [www.shop.madengland.com](http://www.shop.madengland.com)  
 We offer MAD, Benchmark Media, SONOS, WBT, Trichord Research, ATC, FatmanTube, Project, Lehmann, Ortofon, Vandenhul, QED, NAD, Goldring, Grado, Focal, Musical Fidelity, Ex-demo & second hand gears. Custom Installation, Servicing, Custom Design. Appointment Only. Short walk from Embankment, Charing-X & Westminster Tube.

## MANCHESTER

### AUDIO COUNSEL

26 High St Cheadle SK8 1AL  
[www.audio-counsel.co.uk](http://www.audio-counsel.co.uk)  
 TEL 0161-491-6090  
 e mail [dave@audiocounsel.co.uk](mailto:dave@audiocounsel.co.uk)  
 Hi Fi and Home Cinema from , B&W Densen, Dynavector Cartridges Emm Labs, Hutter, Isobue, In Focus, Naim, Neat Acoustics Pioneer, Piega, Quadraspire, Rega, Revolver, Rotel, Shahinian, Totem, Well Tempered Turntables, Zu Loudspeakers. Quality Hi Fi is not plug and play. We deliver and install all systems. 0% Finance available. Tuesday to Saturday 10.00am to 5.30pm Thursday till 8pm

## MIDLANDS (WEST)

### SOUND CINERGY

37 high street, aldridge, WS9 8NL  
 01922 457926  
[www.soundcinergy.co.uk](http://www.soundcinergy.co.uk)  
[cive@soundcinergy.co.uk](mailto:cive@soundcinergy.co.uk)  
 Quality hifi and home cinema from black rhodium, chord co, creek, epos. exposure, linn, marantz, monitor audio, mordaunt short, nad, okki nokki, ortofon, project, rel, roksan, themescene, trichord, vdH. Check our website for ex dem and secondhand bargains. free car parking. tues - sat 10 -5.30

## NORFOLK

### BASICALLY SOUND & VISION

Calveley Court, Southburgh Road,  
 Reymerston, Norfolk NR9 4QD  
 Tel : 01362 820800  
 Email : [enquiries@basicallysound.co.uk](mailto:enquiries@basicallysound.co.uk)  
 Web : [www.basicallysound.co.uk](http://www.basicallysound.co.uk)  
 We offer Naim, Rega, PMC, Bryston, PS Audio, Arcam, Wilson Benesch, Isobue, Dynavector and others. Turntable Workshop & Multi-Room Solutions. Relaxing out of town location, 2 demonstration rooms & free parking. Home demos welcome. Opening Hours Mon - Sat 9:30 - 7:30 but please call in advance on Mon, Tues & Weds.

## SOMERSET

### ALTERNATIVE AUDIO,

Alternative Audio,  
 Taunton, Somerset, Tel: 01984 624242  
 Email: [peter@alternativeaudio.co.uk](mailto:peter@alternativeaudio.co.uk)  
[www.alternativeaudio.co.uk](http://www.alternativeaudio.co.uk)  
 We specialise in valve amplification and vinyl replay with the accent on high quality musical enjoyment, demonstration by appointment. Ex-Dem and used equipment for sale. Almarro, Art Audio, Border Patrol, EAR/Yoshino, Graham Engineering, Experience Filtration, Lector, LFD Audio, Lyra, Music First Audio, Nottingham Analogue Studio, Quadraspire, Shun Mook, SME, Vandersteen Audio, Wave Mechanic.

## YORKSHIRE

### THE AUDIO ROOM

2 George Street, Hedon, Hull, HU12 8JH.  
 01482 891375. [www.theaudiroom.co.uk](http://www.theaudiroom.co.uk)  
 Authorised agents for Ayre, Arcam, Bowers and Wilkins inc 800series, Classe, Cyrus, Densen, Dynaudio, Dynavector, Grado, Hutter, Isobue, Isotek, Linn, Lyra, Mark Levinson, Meridian, Naim, Nordost, Proac, Quadraspire, Rega, Rotel, Stax, Stereovox and others. 0% finance available, free parking, 3 demonstration suites, friendly and quality staff and advice, mail order service.

### AUDIO REPUBLIC

78 Otley Road, Leeds O1132177294  
[www.audio-republic.co.uk](http://www.audio-republic.co.uk)  
 For the best in quality hifi in West Yorkshire, representing Naim Audio, Rega, Sugden, Audio Research, VPI, Krell, Copland, Sonus Faber, Arcam, Nottingham Analogue, Roksan, Hutter, Martin Logan, Proac, PMC, M&K, Finite Elements, SME, Cardas, Kudos Loudspeakers and others. Open Tuesday-Saturday 9.30am to 5.30pm

## FANTHORPES HI-FI, TV & CUSTOM INSTALLATION SPECIALISTS

HEPWORTH ARCADE, SILVER STREET,  
 HULL, HU1 1JU  
 Established over 60 years  
 TEL: 01482 223096  
 Web: [www.fanthorpes.co.uk](http://www.fanthorpes.co.uk)  
 Email: [shop@fanthorpes.co.uk](mailto:shop@fanthorpes.co.uk)  
 Part exchange welcome. High-end Second Hand Equipment. Multi-room installations. Demonstration by appointment. Home trials welcome. Interest free credit available. Experienced staff. We stock Arcam, Dali, Denon, Dynaudio, Exposure, Kef, Loewe, Onkyo, Primare, Roksan and much more

## IRELAND

### STONE-PEARLS RECORDS "REVOLUTIONARY OLD"

Tel: 353-87-942-7618  
 Email: [info@tonepearls.com](mailto:info@tonepearls.com)  
[www.tonepearls.com](http://www.tonepearls.com)  
 New audiophile LP/vinyl records using the revolutionary new Tone-Pearls and pure analogue techniques. Live recording, unedited, unprocessed, pure analogue recording and cutting, 180g virgin vinyl pressing. New LP released: Piano Music in a Church of West Ireland, Classics of Chopin and Debussy and more...

## NORTHERN IRELAND

### KRONOS AUDIO VISUAL

Dungannon. N.Ireland. Tel 02887753606  
 E mail [david@kronosav.co.uk](mailto:david@kronosav.co.uk)  
 Web [www.kronosav.co.uk](http://www.kronosav.co.uk)  
 Brands include Ayon, Atlas, BAT, Bel Canto, Boulder, Carat, Clearaudio, Consonance, Dali, Electrocompaniet, Kef, Leema, Lyra, Marantz, MF, Michell, Moon, Music First, Oracle, Pathos, Project, Pure Sound, Roksan, Ref 3A, Shanling, SA, Triangle, Unison, Yamaha and much more. Demos by Appointment. Home Demos welcome.

To advertise in this  
 space please call

020 7372 6018

or email:

[advertising@hi-fiworld.co.uk](mailto:advertising@hi-fiworld.co.uk)





# FREE READER CLASSIFIEDS

**TERMS AND CONDITIONS:** Only one advert per reader. No Trade adverts. This section is strictly for readers selling secondhand hi-fi equipment only. Maximum length per advert is 30 words, Adverts over 30 words will not be accepted. Telephone numbers and E-mail addresses are treated as one word. Model numbers are treated as one word i.e. Quad 303 = two words. Email your advert to; [classifieds@hi-fiworld.co.uk](mailto:classifieds@hi-fiworld.co.uk) or fill in the form on page 129 and post it to Hi-Fi World Free Readers Ads, Suite G4, Argo House, Kilburn Park Road, London NW6 5LF. Sorry, we cannot accept adverts over the telephone. The Publisher reserves the right to judge submissions.

**INAUGURAL AI Audio Event.** Stalls selling vintage and modern hi-fi equipment at The Settlement, Nevells Road, Letchworth, Herts on Sunday June 21st 2009 from 10am-4pm. Admission 10am/£10 12noon/£5. Contact Vaughan Warren 07725029954

**WANTED: PERHAPS** you are upgrading your system! Wanted good quality record deck/turntable, Garrard or Thorens, tone arm and cartridge, valve amplifier and speakers from 1960's onwards. Tel: 01726 812966

**CREEK OBH-21** headphone amplifier, hardly used. Asking £110. Isotek Gemini 4-way mains filter. Excellent condition. Asking £110. Call Chris on 07864 102 846

**KEITH MONKS** Sweep arm, unused, £20. Sony Professional Walkman, needs attention, offers. Nakamichi RX202E auto reverse cassette £130. Denon AVP AI POA T2 POA T3 AV pre powers £1800 (£4900). Tel: 01708 457 691

**WANTED: B&O SPI2(E)** cartridge and 1/2 mounting bracket. B&O ST/L pickup arm. Audio Technica AT1005 MkII pickup arm. Micro (Sieki) MA101 MkII pickup arm. Colton X50 viewer. Colton Magna Lift. Transcriptors stylus brush. Please quote price and postage to: Mr J.R. Parr, 94A Imperial Avenue, Shirley, Southampton, SO15 8PX Hampshire. Tel: 02380 772 895 & messaging.

**AVO VALVE** tester CT160. Comes with valve data manual. Good working order. £250. Tel: 07946 522 644

**SUPER SYSTEM:** Denon 2800, Denon TU260L II, Marantz PM66SE K.I. Signature, Kef Cherry floorstanders C3's (£1680) only £550. Quad 99 pre £499. Classe CAP151 amp (£2000) £995. EAR 8L6 £1790. Wanted: IMF, Sub, DAC. Tel: 01206 510 392 or 07765 264 381

**NAIM AUDIO** CDI CD player, 102 pre amplifier, NAP 250 power amplifier, 72 pre amplifier. All items olive green. Naim Audio 32.5 pre amp with phono boards. Croft Epoch special valve pre-amplifier. Lector Zoe valve pre amplifier. Cabbase 100 watt monoblock amplifier. Erra TD2 CD player, voted best CD player 2007 Hi-Fi Plus. Naim Audio late 2002 82 pre amplifier with two Hi-Caps. Please phone for prices. Tel: 020 8524 2181

**LINN LK I**, Linn LK280 amps, boxed. Linn Sarah's with stands. Quad tuner. Arcam Alpha disc player. Sony 730ES cassette player. All hardly used and immaculate. Tel: Alan 01494 763 042

**FOR SALE: SUGDEN** Masterclass pre-amplifier £875. Isotek Orion mains filter £175. B&W DM605.2 speakers with integral 130watt sub-woofer £200. (Buyer to collect speakers). Tel: Peter 01642 559 078

**QED DIGIT DAC** £65. Turntable spiked floor stand £30. Pioneer Slimline DV350 silver + remote £50. Sony DVPNS705V + remote £120 (£450). Aiwa cassette deck ADF450 £65. Quad 99 pre-amp + remote, boxed £499. AE Evo 3's £225. Can send. Tel: 01206 510 392 or 07765 264 381

**WANTED: YAMAHA CDR-1500** digital audio recorder. Original box, operating instructions, black colour only, including accessories. Little used please. Tel: Peter 0794 184 2605

**ARISTON RDII** with Origin Live D.C. engine and modified, rewired Rega 250, £200. Systemdek II Dunlop no arm £80. Nordost BlueHeaven bi-wired 4m pair £250. Tel: 07961 858 708 (Maidstone)

**CAMBRIDGE AUDIO R50W** monitor loudspeakers, 3 way system using Kef speakers. Weight 98lbs. Old but in good condition. £150. Tel: 020 8688 6397

**MILLER AND KRIESEL V-125** active 12" sub, £220. Tannoy Oxford (no grilles) £100. Michell Argo pre-amp £200. Exposure Super 8 power amp £200. Rose RV 23s valve amp MM-MC £350. All excellent condition. Tel: 01722 334 694

**AKAI FM/AM/MPX** stereo tuner AT-580 with operators manual. Akai stereo cassette deck CS-34D Dolby system. Free to a good home on collection. Tel: 01503 230 785 (Cornwall)

**AUDIO ANALOGUE** Puccini Special Edition integrated amplifier. Original 1997 model owned from new. Perfect condition. Modified by Audiocom. £450. Tel: Mike 01323 645 317

**TANNOY DUAL** Concentric 3LZ 10" Monitor Golds. Mint condition. Offers over £600. Sansui 1001 SP 3 way speakers. Tone controls. Tri-amp. £150. Both plus carriage. Demonstration phone Derreck 01455 220 214 (Coventry)

**FOR PERFECTIONISTS.** Really good powerful sound. Hearing is believing. Quicksilver all valve monoblocks, upgraded by Croft with Precision components, modified with new Mullard EL34's plus spare valves. Demonstrated. Tel: 07951 553 091 (London)

**PROJECT DEBUT III** turntable, black, mint condition, boxed, £50. Sony floorstanders, 4-way, beech laminate, yellow drivers, on spikes, very good condition, £40. Tel: 01332 758 907

**PURE DRX 701ES** tuner, mint, manual, boxed, £80 ono. Audio Note AZ-2 speakers, floorstanders. No box. Very good condition. £150 ono. Buyer collects. Tel: 07941 174804 after 6pm (Berkshire)

**MARK LEVINSON 38.S** pre-amp, new (£6500), now £1450 ono. Mint condition. XLO Signature speakers cable 1.8 metre new (£1800), now £500 ono. Very good condition. Tel: Tony 07868 714 812 (London S.E.)

**NAIM ALLAE** loudspeakers in American rosewood. Bought November 2008. Perfect condition. £1900. No offers. Tel: 01743 363 116

**PAIR HACKER** speakers, teak surround on stands 20" x 13". Mint condition. £100 ono. Buyer to collect please. Phone Terry 07939 394380 (S.Yorks) Buyer to collect.

**FOCAL PROFILE 908** stand-mount speakers. As new (£1400) £650. Plus classic Exposure amps looking for a good home, inc. Six, Seven, Eight, Seventeen and Four. Offers. Tel: 01285 644 418

## A new lease of life for your Musical Fidelity amp, CD or DAC.

To upgrade your hi-fi without losing a penny in part exchanges, book in for a factory tune up from Musical Fidelity. We carry out an exhaustive list of upgrades that gives well-used gear a new lease of life and means your favourite gear can perform as never before.

We can tune up everything we have made since 1985, except the SACD player, and our upgrades come with a one-year Musical Fidelity warranty. Please note: *nobody else* is authorised to tweak our amps.

With a tune up, you pay only for the upgrade in performance, instead of losing on a part exchange.

To find out more, phone us on 020 8900 2866 or visit [musicalfidelity.com](http://musicalfidelity.com), where you can download a Booking Form today.

**MUSICAL FIDELITY**

**audioXpress... It Just Sounds Better**

## Your Favorite Audio – One New Magazine!

- PROJECTS
- REVIEWS
- THE NEWEST TECHNOLOGIES
- AUDIO CLASSROOM
- and Much More!

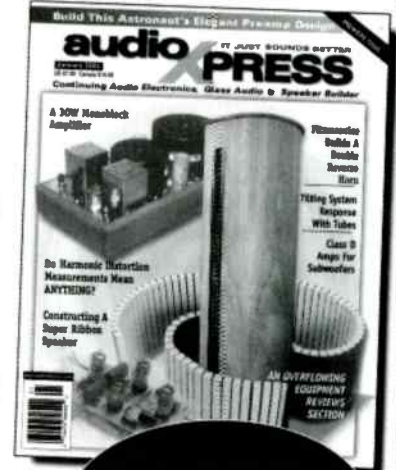

Subscribe To This  
Great Monthly  
Publication Today!

**Only \$59.95 US  
for 12 Issues!**

audioXpress • PO Box 876 • Peterborough, NH  
03458-0876 USA • Phone: 603-924-9464  
Fax: 603-924-9467 • E-mail: [custserv@audioXpress.com](mailto:custserv@audioXpress.com)

ORDER  
ONLINE AT: **[www.audioXpress.com](http://www.audioXpress.com)**

# You don't know what you're missing

– until you try a van den Hul  
cable in your hi-fi system

van den Hul cables provide a signal path  
for your music that will deliver it  
accurately and as completely  
as possible

To find out more about the full range of  
interconnects, a/v, HDMI and speaker cables  
from van den Hul, and where you can buy  
them visit: [www.henleydesigns.co.uk](http://www.henleydesigns.co.uk)

van den Hul



[www.henleydesigns.co.uk](http://www.henleydesigns.co.uk)





B&W DM 705 speakers, beech. Current model. Immaculate, boxed, £450. FS700 dedicated filled stands, £95. Tel: 01202 730 449 (Poole, Dorset)

OPERA SECONDA speakers (cherry) £750. Unison Research Hybrid valve equipment: Secondo 120w/ch integrated amplifier £780. Unico FM/RDS/AM tuner £475. All below 1/2 price. Chord Rumour 4 bi-wire speaker cable 2 x 9m £180 (£430). Tel: 023 8073 8935

QUAD 33 control unit, 303 amplifier, Sony ST-80F tuner, Leak 600 speakers, Manantz CD42 player, Sony TC-13JSD cassette recorder, Thorens TD160 deck. Reasonable offers considered. Tel: 0113 273 5799 (Leeds)

OLIVE GREEN Naim 250 amplifier, olive green Naim CDI CD player, olive green Naim 72 pre amplifier, olive green Naim 102 pre amplifier, Naim 32.5 pre amplifier, Croft Epoch special valve pre-amplifier, Lector (Italian) valve pre amplifier, Lector (Italian) valve CD player. Two box top loader. Erra CD player, black, rated very highly, Cardas interconnect lead. 1mtr long. Please phone for prices. Sensible offers considered. Tel: 020 8524 2181

KIMBER SELECT KS-1021 (-11dB) attenuation, 1m, mint, boxed, £250. Graham Slee Solo headphone amplifier with P.S.U., mint, boxed, (£600+) £280. grado RA-1 battery headphone amplifier (£350) £200. Tel: Val 01908 661 094

B&W 686 speakers, 2 weeks old. Cost £270. Accept £220. Tel: 07716 139 026

BANG & OLUFSEN Beogram 6002 £149. Beomaster 6000 £149. Beocord 8002 £99. If sold together £350. Plus Roksan Caspian Mk1 CD £299 plus Sony STR DB930 Surround Sound Receiver £199. Tel: 01270 619 387

REVOX A77 tape recorder 7 1/2 and 15 ips. Wow and Flutter 0.04%. 10 inch NAB reels. Frequency 30Hz to 20kHz. A fine system. £220. Tel: 01753 586 660 (Windsor)

PINK TRIANGLE Little Pink Thing GTi If anyone is breaking an LPT GTi for spares, please could they get in touch: cmoorhouse14@btinternet.com or 07967 339986. Thanks

JEFF ROWLAND Model 3 mono amps £1200. Celestion 66 studio monitor £225. Castle Harlech black ash £275. Jeff Rowland Coherence One preamp MkII £1100. B&W DM6 £150. Tel: 01255 421 589

NAIM NAC 12n pre-amp 1970's vintage in working order. best offer secures jonfitzgerald167@hotmail.com

NAIM AUDIO NAP 180 power amplifier, 2000 model, £475. Also available Naim Audio Flatcap plus snaic, 2001 model, £200. Both in mint condition, original boxes, packaging. Contact David 07736 280018.

SONUS FABER Minima Amators/ Stands £750. Audion 300BPSE triode monoblocks £1450. Kuzma Stabi SD/Stogi S/vdHul Frog £1500. Art Audio Vinyl One, mm/mc £950 Tel : 01453 544354.

ARCAM A85 integrated, remote, manual, excellent condition. £320. Technics SL-1200 MK II excellent condition, very little use with spare stanton cartridges in silver cased transport box. £180. 07747664742

FOR SALE all reasonable offers considered:-Morel MDT32 tweeters, flange modified. Hart TCI test cassette. L-pad attenuators. Speaker spike set. Scanspeak flow resist vents. Dual CS5000 headshell. Tel 07779 199 392.

WANTED: TOP quality Hi Fi separates and complete systems, Naim, Linn, Cyrus, Meridian, Arcam etc, fast, friendly response and willing to travel/pay cash Please call me on 0781 5892458

MERIDIAN 207 with pre, no remote, good condition £195. Ultimate cables balanced xlr inters 450 mm long £100. E-mail alan.g@talktalk.net. 01395275698

NAD 533 turntable with nad 250 arm modified origin stub and electra cartridge, as new £125...ortophon a76 stepup for mc good £80 alan.g@talktalk.net

FOR SALE Rotel RCD 1070 (CD Player) Superb sound, outstanding quality. Hardly used. Boxed. £70. 07941 471561

CELESTION A3 floor standing loud speaker, mint condition and boxed. Free delivery. £850.00. Tel: 01953 888130 (Norfolk).

TEAC TUNER TR450 - Immaculate condition. Hardly used due to house move. As new. Price to include postage if needed. £35 Tel Andy 07970 078653.

YAMAHA TAPE Deck KX580SE. Superb very little used tape deck. Dolby b/c/s. NRHX. Absolute mint condition £40 to inc. Postage. Tel Andy 07970078653.

QUAD 33/303/FM3 + wooden rack £200.00. Nachamichi 680ZX cassette deck £150.00. Pioneer PD 6700 compact disc player £50.00. A&R Cambridge T21 FM Tuner £30.00. QED phono/phono lead £5.00. IXOS 104 OFC phono/phono lead £10.00. Telephone 01228 544376

ATC SCMI I speakers £425. Naim CD5i £375. Naim Nait5i £375. e-mail: frank8ush@ntlworld.com or Tel: Frank 02920 419226. (South Wales).

PASSLAB 1.5 Aleph P Audionote ANS6II Transfomer Altec 604 Altec 417 Audionote io Ortofon MC3000II Cello Cartridges Trio KT815 TimDe Decoder Rolling Stone Box Set MFSL Ariston RDII Turntable 07944909209 stevehifiman@hotmail.co.uk

QUAD ESL63 speakers; one owner from new: fully serviced by Quad; Excellent condition; brown grilles; natural wood finish; separate stands; original cartons/packing £1200 ono: 90add@tiscali.co.uk 01595-880-419

WILSON BENESCH infrasonic generator and torus amplifier mint condition £3,400 NAIM nap 300 power amp £3,500 nac 252 with supercap £4,600 all mint condition boxes can demo Tel 02380470107 7 lesliestubbs@tiscali.co.uk

GARRARD 401, SME plinth, superb condition with lid and 3009 arm £550 Thorens TD135 plinth, lid arm. Thorens TD 150, arm but no lid Offers. Loads more Hi-Fi send for list. 01548 560913 mikeh7@tiscali.co.uk

WILSON BENESCH torus infrasonic generator and amplifier mint condition £3,400 NAIM nap 300 power amp £3,500 nac 252 with supercap £4,600 all mint condition boxes can demo Tel 02380470107 lesliestubbs@tiscali.co.uk

BRYSTON 4BSST power amplifier, black, no handles, 5 years old, mint, boxed, 300 watts / channel but capable of fine detail and great nuance. £1400 ovno. Phone 0121 744 2486, or rdsmith@tiscali.co.uk

FOR SALE. Exposure CD player £125.00. 2M pair Chord Odyssey 4 bi-wire speaker cable. £100.00. 2M pair Chord Odyssey 2 single wire speaker cable. £50.00. Tel (01483) 728657 before 9 pm. Ask for Dave. (Surrey).

ROTEL CD player inc remote / instructions £40. Excellent condition. Telephone Bill, Tiverton, Devon, 01884-829597

ARCAM A90 amplifier black with phono. Over £1000 when new. 2 years old. Immaculate. Boxed with instructions. Selling due to upgrade. £400. Tel. 01623-757443 (Notts.)

PINK TRIANGLE Tarrantella/ RB300/1042, hardly used, upgraded to MK 2 guise, £600 davidprior@email.com 07894 836653

MUSICAL FIDELITY A5 CD Player as new mint condition low usage upgrading to SACD (£1,500) £800 no offers 01268 415 017 Essex

OPPO DV980H DVD player, euro model, streams SACD and DVD-Audio by HDMI to Onkyo etc. Great HFW review. 2 months old. £145 ono. 07826 902109 or vaughst@gmail.com

QUAD ESL57 speakers. One very early original condition, other fitted with new quad eht block (2006). Both working but require attention. New boxed genuine Quad metal grille. £225 01842 812895.

QUAD 34 pre amp brown five din version serviced by quad nov 2008 £110. Quad FM 4 tuner brown five din. £110 both boxed. Gary 07508254462

GARRARD 401 Transcription turntable, 1970's, serial No 07108, with manual and original inspection report. Excellent condition and working order, all original, little used, stored since 1988. £300 Tel 01525405290 Bedfordshire

ROGERS LS6a/2 speakers, black finish. Virtually new. Excellent condition. Unwanted gift. £30. Located Maidenhead. Collect only. 07971 303640.

<sup>NEW</sup> The Moscode 402Au Tube Hybrid Amplifier

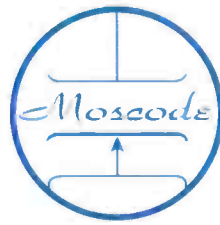
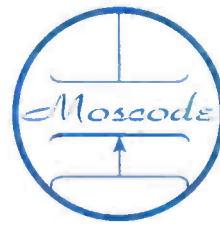
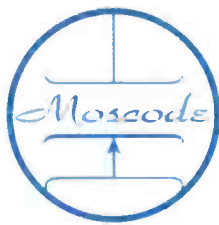
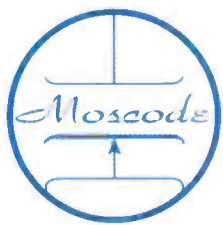

On permanent demonstration at Mayflower Sounds  
Tel. 01302 711 528      www.mayflowersounds.co.uk  
(M) 07931 524 266      mayflowersounds@fsmail.net



Precision engineering

A passion for the music

# Ortofon Cartridges

at last you will  
find all the music  
in your vinyl

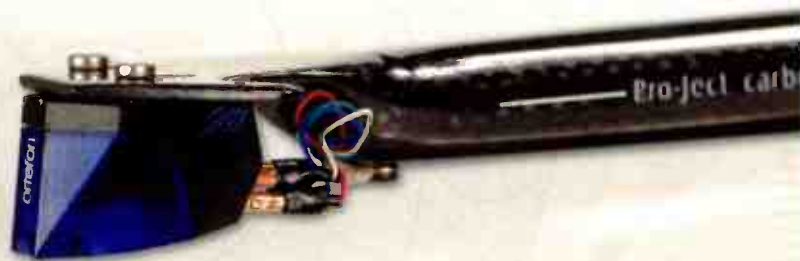

**ortofon**  
accuracy in sound



www.henleydesigns.co.uk

To find out more about the full range of  
hi-fi cartridges from Ortofon, and  
where you can buy them visit:  
[www.henleydesigns.co.uk](http://www.henleydesigns.co.uk)



MARANTZ CD63 SE CD player good condition - but needs a little TLC. boxed with manual £75.00 o.n.o PIONEER MJ - D707 mini disc player recorder hardly used , in good working order with manual £100.00 o.n.o. Tel: 01353 749057 mobile 07930 159930 anytime. No timewasters/scams please

WANTED FAULTY or non working Quad 34 preamps. Quad 33 preamp panels or scrap unit. decoder panel for Quad fm2. Quad 405-2 panels. Contact Mike 01758 613790.

MUSICAL FIDELITY TRI-VISTOR 300, Integrated Amplifier, Two-Box Design, 350watts 8ohm, 600watts 40hm, serviced by MF and new valves fitted, Boxed, Mint, £1350:00 07859388167

WANTED ONE or two AVI 2000 series monobloc amps or AVI 2000 series stereo power amp in good condition nsongs@talktalk.net 0117 9737363

FOR SALE Spondor S5E Speakers. Maple. Excellent Condition. As New. Boxed. £600 o.v.n.o. York, North Yorkshire. Tel: Geoff on 01904 658178 (Could Possibly Deliver Within Reason).

SONY STR-DB1070 100Wx5 receiver, 16kg so local delivery preferred (West Lancs), £100. Nakamichi DVD10s high quality DVD and CD replay, £120. Both as new with remote and manual. 01704 840646

ARCAM ALPHA 8 analogue tuner. Box/handbook/never-used Arcam multi-remote/dipole aerial. Good, quality sounding tuner. Used carefully. Almost mint. Retailled circa £250. (£90 Offers Includes P&P). klugheit.123@gmail.com.

FOR SALE : Origin Live Illustrious Mk.2 Tonearm . 1st stepped-tube version , plain mounting pillar .Superb performer, excellent condition , original wooden box etc . Ring for details . £950 ovno . Mark 01745 815212/588284

STAX SRM-006T Headphone Energiser, exc condition, valve classA design, boxes, manual. £300 ono. ATC-SCM 10 passive monitors + stands, boxes. £280 ono. 01372 729569 (surrey).

SUPERNAIT FOR sale. Just over 1 year old, boxed and in as new conditions as little used. £1750 ono. Contact Andrew on 0207 252 8122 or 07791529128

MISSION 70 speakers, £40 Linn Valhalla Board £50 Linn AC Motor, £40 RB300 arm £50 Van den Hul c122 speaker cable. 2x3mt length, £20 07788821996 or 01502 565406 (Lowestoft)

SPEAKERS. BOWERS & Wilkins, CM2. Rosewood. Absolutely as new. £195 pr. ono Pivotelli brackets for same £25 Collect from near Junc.9 M5 or negotiate delivery. Tel: Anne 01684 275399

MORDAUNT SHORT Performance 6 floorstanding speakers in silver. Editor's choice HFC. As new condition. Little over 14 months old. Inspection welcome. Were £3500, £2099 ono. enquiries: cjumb@hotmail.com

AUDIO NOTE E/Lexus Signature speakers with external crossovers. Lovely apple veneer. Immaculate. Lead-filled AN stands. £4,500 ono. See - www.stereophile.com/standloudspeakers/506an Hampshire. 01730 825493. jeremy2@waitrose.com

QUAD 33/303/FM3 + wooden rack £200.00 Nachamichi 680ZX cassette deck £150.00 Pioneer PD 6700 compact disc player £50.00 A&R Cambridge T21 FM Tuner £30.00 QED phono/phono lead £5.00 IXOS 104 OFC phono/phono lead £10.00 Telephone 01228 544376

GARRARD 401, SME plinth, superb condition with lid and 3009 arm £550 Thorens TDI35 plinth, lid arm. Thorens TD 150, arm but no lid Offers. Loads more Hi-Fi send for list. 01548 560913 mikeh7@tiscali.co.uk

LEAK TL25 plus amps, Mullard Valves, new caps etc £750 ono a pair Leak 20-75 speakers, unique black surrounds, £750 ono. a pair All in pristine condition. Loads more items send for list. 01548 560913 or E-mail mikeh7@tiscali.co.uk

REVEL ULTIMA Salon, 10/10 condition, 4 years old, box manual, located Venice Italy info and pics bebo60@tim.it €11.900 + Shipping.

CREEK P43R remote volume control pre-amp. Box and manual. Excellent condition. £150. 01889 575655 (Staffordshire)

STANDS UNIQUE Midi Tower, base shelf + turntable shelf + three standard shelves, excellent condition, packaging and instructions, will accept £95 including post and packaging to a UK mainland address or buyer collects (South London). Inquiries to aasm\_1@yahoo.co.uk

VINYL LP'S Wanted Rock : Folk : Jazz: Soul : Reggae : Blues Punk : Indie Must be in Excellent condition www.tantrel.com tantrel@gmail.com 0845 0941997

INAUGURAL AI Audio Event. Stalls selling vintage and modern hi-fi equipment at The Settlement, Nevells Road, Letchworth, Herts on Sunday June 21st 2009 from 10am-4pm. Admission 10am/£10 12noon/£5. Contact Vaughan Warren 07725029954

WANTED: PERHAPS you are upgrading your system! Wanted good quality record deck/turntable, Garrard or Thorens, tone arm and cartridge, valve amplifier and speakers from 1960's onwards. Tel: 01726 812966

CLASSIC CONTACTS

When a classic goes 'poof' your troubles have just started, but there may be a good ending. Replacing failing parts can improve the sound, so here is a short listing of all those companies who specialise in getting a classic up and running again after its deposited a small ring of soot on your ceiling!

GT AUDIO

(Graham Tricker, Bucks) Leak Troughline specialists. Also Quad and most classic tuners, radios and amplifiers restored, repaired. Tel: 01895 833099 Mob: 07960 962579 www.gtaudio.com

TECHNICAL AND GENERAL

(East Sussex) Turntable parts - wide range of spares and accessories, plus arms and cartridges. Tel: 01892 654534

CARTRIDGE MAN

(Len Gregory, London) Specialist cartridge re-tipping service and repairs. High quality special cartridges. Tel: 020 8688 6565 Email: thecartridgeman@talktalk.net www.thecartridgeman.com

AUDIOLAB

(Phil Pimblott, Leeds) Renovation, repair and restoration. Specialist in valve hi-fi, radio transmitters, cinema amps, kit building. Tel: 0113 244 0378 www.audiolabs.co.uk

QUAD ELECTROACOUSTICS

(Cams) Quad's service department, able to repair almost all Quad products, from the very first. Tel: 0845 4580011 www.quad-hifi.co.uk

ARKLESS ELECTRONICS

(Northumberland) Specialist in repairs, restoration and modifications to all amplifiers, valve or solid state, ancient and modern. Tel: 01670 829891 Email: arklesselectronics@btinternet.com

SOWTER TRANSFORMERS

(Brian Sowter, Ipswich) Large range of audio transformers for valve amps, cartridges, line drive, interstage plus all associated services. Tel: 01473 252794 www.sowter.co.uk

WEMBLEY LOUDSPEAKER

(Paul MacCallam, London) Comprehensive loudspeaker servicing. Tel: 020 8 743 4567 Email: paul@wembleyloudspeaker.co.uk www.wembleyloudspeaker.com

EXPERT STYLUS COMPANY

(Wyndham Hodgson, Surrey) Stylus replacement service for all types of cartridge. Including precise profiling for 78s Tel: 01372 276604 Email: w.hodgson@btclick.com

ONE THING

(Coventry) Specialist in electrostatic panel manufacture and repair. Can refurbish ESL 57s and 63s as well as Leak Troughlines and Quad IIs. Email: one.thing@ntworld.com www.onethingaudio.com

CLASSIC NAKAMICHI

(Paul Wilkins, Worthing, West Sussex). Restore, Repair & Service Nakamichi Cassette Decks. Tel: 01903 695695 Email: paul@bowersandwilkins.co.uk www.bowersandwilkins.co.uk

HADEN BOARDMAN

Repair, service & modifications; classic & modern. Collection available. Redundant / faulty equipment purchased, selected new equipment available. Tel 01942 790600 www.audioclassics.co.uk

Dr MARTIN BASTIN

(Shropshire) Garrard 301/401 restoration, renovation and service. Special plinths; rumble cures, etc. Tel: 01584 823446

D.K. LOUDSPEAKER SERVICE

(Dave Smith, Hornchurch, Essex) Re-cone of hi-fi loudspeakers, high quality loudspeaker systems, P.A., power loudspeakers. Tel/Fax: 01708 447 344

LOCKWOOD AUDIO

(London) Tannoy loudspeaker parts, restoration and repair. Also Epos and TDL loudspeakers. Tel: 020 8 864 8008 www.lockwoodaudio.co.uk

LORICRAFT AUDIO

(Terry O'Sullivan, Bucks) Garrard 301/401 and their own 501 repair, spares and service. Tel: 01488 72267 www.garrard501.com

REVOX

(Brian Reeves, Cheshire) Revox tape recorder spares, service and repair. Accessories also available. Tel: 0161 499 2349 Email: brian@revoxservice.co.uk www.revofreeuk.com

CLASSIQUE SOUNDS

(Paul Greenfield, Leicester) ESL-57s restored, rebuilt, fully renovated or improved. Leak, Quad valves amps etc. Tel: 0845 123 5137/ Mob: 0116 2835821 Email: classique\_sounds@yahoo.co.uk www.flashbacksales.co.uk/classique

OCTAVE AUDIO WOODWORKING

(Bristol) Unit 2, 16 Midland Street, St Phillips, Bristol. Tel: 0117 925 6015 www.octave-aw.co.uk

# NEXT MONTH

As April showers give way to the darling buds of May, so the new hi-fi season blossoms – and Hi-Fi World is there to bring you all that's good in the garden. Our usual mix of brand new blooms and hardy perennials are featured, with highlights including the high end Electrocompaniet EMC-1UP CD player and Kudos C30 loudspeakers, plus Puresound's affordable A30 valve integrated and AudioSmile's brand new Kensai mini monitors. Factor in a six-way vinyl spinner supertest and a host of other delights, and there's much to see in the June edition! Here's just some of what we hope to bring you:



**TURNTABLE SUPERTEST: AVID DIVA II, FUNK FIRM SAFFIRE JNR, PRO-JECT 6 PERSPEX [pictured], SCHEU ANALOGUE CELLO, THORENS TD700, TOWNSHEND ROCK 7**

**PURESOUND A30 VALVE INTEGRATED AMPLIFIER  
ELECTROCOMPANIET EMC-1UP CD PLAYER  
MUSICAL FIDELITY PRIMO PREAMPLIFIER  
SONY WALKMAN ANNIVERSARY FEATURE  
VAN DEN HUL CANARY MC CARTRIDGE  
OLDE WORLDE: MICHELL FOCUS ONE  
AUDIOSMILE KENSAI LOUDSPEAKERS  
KUDOS AUDIO C30 LOUDSPEAKERS  
SIMAUDIO MOON CD.5 CD PLAYER  
ADAM AUDIO A5 LOUDSPEAKERS  
DENON AVR-2908 A/V RECEIVER  
NAIM UNITI CD MUSIC SYSTEM  
TANNOY DC8T LOUDSPEAKERS  
DENSEN B-800 FM TUNER  
DEVILSOUND USB DAC**

**PICK UP THE JUNE 2009 ISSUE OF *HI-FI WORLD* ON SALE APRIL 30TH, OR  
SUBSCRIBE AND GET IT DELIVERED TO YOUR DOOR: p64**



## ADVERTISERS INDEX

2nd Hand Hi-Fi	119
3GA	102
Absolute Sounds	14
Analogue Seduction	106
Anatek Research	118
Audio Emotions	38
AudioXpress	124
Big Ears	104
Billy Vee	111
Chord Electronics	24
Classique Sounds	106
Cymbiosis	96
Decent Hi-Fi	110
Eil.com	84
Electrocompaniet	BC
Emille Labs	22
Envirosound	102
Exposure	IFC
Heathcote Audio	111
Heatherdale Audio	110
Henley Designs	94,124,126
Hi-Fi Sound	119
High End Cable	104
House of Linn	56
Ian Harrison	118
Icon Audio	114
Impact Audio	96
Iso Kinetic	90
JS Audio Repairs	118
Kudos	110
Leema Acoustics	46,48,50,52
Mantra Audio	106
Melody	6
Metropolis	82,83
Michell Engineering	66
Midland Audio Exchange	122
Music First Audio	86
Musical Fidelity	124
Musonic	118
Newcastle Hi-Fi	34
Origin Live	90
Parts Connexion	90
Renaissance Audio	60
Retro Reproduction	104
Revolver	102
Ringmat Developments	60
Rochester Hi-Fi	126
Sevenoaks	108,115,116,117
Shadow Audio Cons.	88
Signals	102
Sound Foundations	30
Sound Hi-Fi	110
Stamford Audio	86
Symmetry	62
The Funk Firm	62
The Listening Rooms	66
The Right Note	86
Turntable World	119
Usher	IBC
Walrus Systems	92
Whest Audio	96

# FREE READER CLASSIFIED ADS ORDER FORM

## STOP PRESS

**TERMS AND CONDITIONS:** Only one advert per reader. Maximum length per advert is 30 words, Adverts over 30 words will not be accepted. No Trade Adverts. This section is strictly for readers selling secondhand hi-fi equipment only. Telephone numbers and E-mail addresses are treated as one word. Model numbers are treated as one word i.e. Quad 303 = two words. Sorry, we cannot accept adverts over the telephone. The Publisher reserves the right to judge submissions.

You can email your advert to us at: [classifieds@hi-fiworld.co.uk](mailto:classifieds@hi-fiworld.co.uk)  
or write or type your advertisement copy in block capitals with one word per box and post it to us at:

**Hi-Fi World Free Readers Ads,**  
Unit G4, Argo House, Kilburn Park Road,  
London, NW6 5LF.

### WE WILL ACCEPT PHOTOCOPIES OF THIS FORM

1	2
3	4
5	6
7	8
9	10
11	12
13	14
15	16
17	18
19	20
21	22
23	24
25	26
27	28
29	30

Name: \_\_\_\_\_

Address: \_\_\_\_\_

Post Code: \_\_\_\_\_

Daytime Tel: \_\_\_\_\_

### FREE READER CLASSIFIED ADVERTS COPY DEADLINES

JUNE 2009 - 7TH APRIL

JULY 2009 - 5TH MAY



ELECTROCOMPANIET

If music really matters...



EMC 1 UP  
Reference CD player

*"That sound can simply be classified as right, with an integrity and musicality that makes almost every disc equally enjoyable."*

Gramophone

Audio Destination - Tiverton - 018 84 24 35 84  
The Audio Works - Cheshire - 016 14 28 78 87  
Linton Audio - Gateshead - 019 14 77 41 67  
Sounds of Music - East Sussex - 014 35 86 52 12  
Kronos Audio Visual - Northern Ireland - 028 87 75 36 06  
Kevin Galloway Audio - Ayrshire, Scotland - 015 63 57 41 85

Midland Audio X-Change - Belbroughton - 015 62 73 11 00  
Rowles Music Limited - Sussex - 019 03 53 00 05  
Unilet Sound & Vision - Surrey - 020 89 42 95 67  
Home Media Limited - Kent - 016 22 67 67 03  
V Audio - Bristol - 011 79 68 60 05

Service Centre  
NSS Ltd, London - Tel: 020 88 93 58 35

Made in Norway  
[www.electrocompaniet.no](http://www.electrocompaniet.no)