

# Hi-Fi WORLD

NO.41 DECEMBER 1998

SUPPLEMENT

## PHONING HOME

New HD83  
all-valve  
headphone  
amplifier



## ASSEMBLY LINE

Assemblage's ST-40  
valve power amp

BOOK REVIEW:  
Testing Loudspeakers  
by Joseph D'Appolito

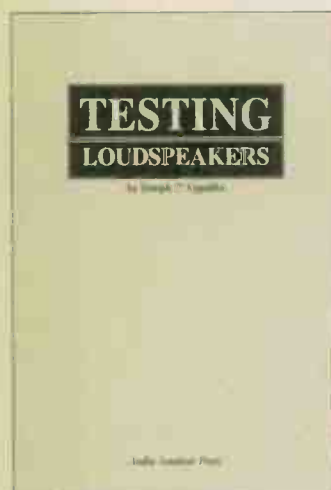

# FREE D.I.Y. SUPPLEMENT No.41

If you love music  
you'll love our  
**Loudspeaker Upgrade Handbook**

Order your copy  
**Russ Andrews Direct 0800 373467**

---

If you really love music  
you'll love

**TORLYTE**

'Phone for our Torlyte Brochure  
**Russ Andrews Direct 0800 373467**

---

If you really, really love music  
you'll love

 **KIMBER KABLE**

'Phone for our Lifestyle Brochure  
**Russ Andrews Direct 0800 373467**



**Russ Andrews Accessories Ltd**, Edge Bank House, Skelsmergh, Kendal, Cumbria, LA8 9AS  
Tel: 01539 823247 Fax: 01539 823317

# D.I.Y. Supplement

## Contents

All rights to the designs are reserved by World Audio Design Ltd. They are published for single use by private individuals. They are not to be used for commercial gain without prior permission from World Audio Design Ltd.  
Audio Publishing Ltd and World Audio Design Ltd accept no responsibility for accident or injury arising from the construction or use of any of the designs published.  
All of the projects in this supplement have gone through rigorous listening and test procedures. The performance and specification of these projects can only be guaranteed on kits bought directly from World Audio Design Ltd.

### **KIT NEWS**

Up-to-date dispatches from the cutting-edge of home-made hi-fi.

5

### **WORLD AUDIO DESIGN HD83 HEADPHONE AMPLIFIER**

The latest kit offering from World Towers is this high-grade, single-ended valve headphone amp. And to get can-lovers into the mood, we'll also be knocking money off Sennheiser headphones when you buy the two together.

7

### **DIY STEPPED ATTENUATOR**

Our electro-boffins take you (literally) step-by-step through the construction of a top-notch attenuator.

13

### **ASSEMBLAGE ST40 VALVE POWER AMP**

Leo Lam arms himself with a soldering iron, pulls out his ear plugs and puts this Canadian power amp kit through its paces.

16

### **BOOK REVIEW:**

### **TESTING LOUDSPEAKERS**

by Joseph D'Appolito.

23

### **DIY LETTERS**

Problems? Let your fellow readers and our own men in white coats sort them out.

25



# Watford Valves

7 DAYS A WEEK 9AM - 9PM THE AUDIOPHILES CHOICE  
All output valves multi-tested and precisely matched  
Full no quibble guarantee. Expert advice on all valve amps

PRE-AMP VALVES			OUTPUT VALVES		
		£			£
ECC81	Brimar	4.50	EL34WXT	Sovtek	6.00
ECC82	RFT	3.50	EL34	Svetlana	8.50
ECC83	Philips	6.00	E34L	Tesla	8.50
ECC83	GE	7.00	EL84	Sovtek	2.50
ECC83	Brimar	10.00	EL84M	Sovtek	5.00
ECC84	RFT	4.50	EL84	Tesla	6.00
ECC85	RFT	4.50	EL84	Philips	12.00
ECC88	Tesla	6.00	EL84	Mullard	15.00
E182CC	Amprex	12.00	EL519	EI	12.00
E188CC	Phil-SQ-Gold	16.00	KT66	GEC	80.00
ECL85	Siemens	7.00	KT88	Tesla	25.00
ECL86	Tungstram	4.00	300B	Sovtek	65.00
EF86	Siemens	7.00	5881	Sovtek	4.90
EL86	Siemens	7.00	6L6WXT	Sovtek	8.00
EZ81	Tesla	6.00	6L6GC	GE	17.00
6SL7GT	Sylvania	6.00	6550A	GE	24.00
6SN7WGTA	Philips	8.00	6550C	Svetlana	16.00
GZ34	Harma	6.00	6650WE	Sovtek	16.00
GZ37	Mullard	9.00	7581A	Philips	20.00



## G.E.C. KT66

We are pleased to be able to offer this rare original classic tube. sought after for its rich detailed sound and bass clarity this is an opportunity not to be missed by serious Audiophiles seeking perfection from their Quads. Available matched at £80.00 each.

### MORE AUDIO SPECIALS 50PCS 100PCS

		50PCS	100PCS
12AT7WC	Philips	3.60	2.75
12AU7WA	R.T.	3.80	2.95
5814A	Philips	2.95	2.40
6922	Philips	2.95	2.50
6SL7WGT	Philips	4.00	3.50

WATFORD VALVES 3 RYALL CLOSE,  
BRICKET WOOD, ST ALBANS, HERTS AL2 3TS

Fast mail order/next day delivery/World Wide shipping  
1000's more valves stocked. Prices exclude VAT and carriage.



01923 893270

Fax: 01923 679207



## TECHNICAL & GENERAL

SOME NECESSITIES - FROM THE ORIGINAL CLASSIC TURNTABLE SPECIALISTS

			P&P
<b>CONNOISSEUR</b>			
	BD1/2 Drive Belt	£10.55	£1.85
	BD1/2 Motor Suspension kit	£13.95	£2.45
	SAU.2 Headshell	£16.75	£2.55
	SAU.2 Connecting Lead	£15.95	£3.55
<b>GARRARD Standard Models</b>			
	Wired arm tubes	from £12.75	£2.50
	Cartridge carriers (sliders)	£10.55	£1.85
	Idler wheels	£9.85	£2.25
<b>301/401 Transcription models</b>			
Original	Thrust pad assembly	£10.85	£2.25
Original	Idler tension spring	£2.95	£1.85
Original	Brake pad	£2.20	£1.85
Xeroxcopy	Owners Manual 301 incl. full size mounting template	£8.85	£1.85
	401 " " " "	£6.70	£1.85
Replacement	301 control knobs On-Off/Speed select	pair £20.25	£2.55
Replacement	301 suppressor unit	£5.65	£2.25
Replacement	301 motor pulley (-2%), (-1%), (Std), (+1%)	each £15.65	£2.25
Replacement	301 Chrome plated mounting bolts	set £6.60	£2.25
Recommended	Lubrication set - early 301 or 301/401 (specify)	£5.60	£1.85
<b>GOLDRING/LENCO</b>			
	Idler wheel (lock-nut or clip fixing)	£19.95	£2.85
	Arm pivot bearings with instructions	£8.55	£1.85
	Spindle/Main bearing assembly complete	£24.85	£3.85
	Headshells	from £21.95	£2.55
	Instruction books	from £4.20	£1.85
<b>THORENS</b>			
<b>TD.124 series</b>			
	Idler wheel original	£27.50	£2.85
	Idler wheel our redesigned replacement	£15.35	£2.55
	Drive belt	£15.25	£1.85
	Chassis spring suspension (replaces 'mushrooms')	£15.85	£2.55
<b>TD.150/160</b>			
	Drive Belt	£10.55	£1.85
	Suspension springs (-1%), (Std), (+1%)	set £12.85	£2.55
	Suspension bushes (set of 3)	£12.50	£2.55
	Armboards for most models	from £16.90	£2.55
CECIL WATTS	Dustbugs/Parastats/Spares - incl. Preener wicks		

Cartridges and styli for 78s and Mono LPs in addition to current Stereo LPs

TECHNICAL & GENERAL  
PO BOX 53, CROWBOROUGH, EAST SUSSEX, TN6 2BY  
TELEPHONE: (01892) 654 534

## BK ELECTRONICS 50 WATT STUDIO Loudspeaker Amplifier Panel. PP50



- FEATURES:-**
- \* 50W R.M.S. into 8 ohm
  - \* 775mV I/P for rated O/P
  - \* Toroidal Transformer
  - \* Short Circuit Protection
  - \* D.C. Speaker Protection
  - \* Balanced I/P (readily unbalanced)
  - \* Link through XLR sockets for daisy chaining more than one Speaker
  - \* Indented gain control
  - \* I.E.C. fused mains inlet
  - \* Compatible with HiFi Amps CD Players, Studio Mixers and Computers etc.

The PP50 Studio Loudspeaker Amplifier is designed to meet the exacting demands of the professional market but has the quality of sound reproduction normally associated with Highend Audio. Although having a small footprint, it has a full 50W R.M.S. output that makes a useful addition to an existing loudspeaker cabinet or custom made loudspeaker enclosures. The panel is designed to fit flush through a cutout approximately 170mm x 150mm in the rear of a Loudspeaker cabinet. Individual artwork available for OEM users.

**SPECIFICATION: \*Power 50W R.M.S. @ 8 ohms \*B/W 20-25KHz -1dB \*Damping Factor >200 \*Distortion 0.05% \*S/N A Weighted >100dB \*Supply 230V. A.C. 50-60Hz \*Weight 1.4Kg \*Size H205 W165 D85mm**

The above item may be ordered by post, fax, e-mail or phone and payment is welcome by cheque or credit card. **PRICE: £59.00 + £5.00 P&P incl VAT**

**B.K.ELECTRONICS**  
UNIT 1 COMET WAY  
SOUTHEND-ON-SEA  
ESSEX SS2 6TR

Web: <http://www.bkelec.com>  
E-mail: [Sales@bkelec.com](mailto:Sales@bkelec.com)

TEL: 01702-527572  
FAX: 01702-420243



# KIT NEWS

## CROSSOVER TALK

Audio-Links have jumped on the active crossover bandwagon with their new offering which they claim to be "a true reference for other active crossovers". The analogue phase-linear unit is available for two-way, three-way and subwoofer/satellite systems. Adjustments can be made to the phase and frequency response, time lag, equalisation and driver sensitivity. Bandwidth is from 10Hz-450kHz with 0.0002% distortion and 110dB S/N noise ratio.

**Audio-Links**  
7 Fairmont Crescent,  
Scunthorpe,  
North Lincs.  
DN16 1EL  
Tel: 01724 870432

## RESTORATION COMEDY?

For those whose interest in old equipment goes beyond purely audio, Newnes have published an informative volume, *Electronic Classics - Restoration and Repair*, by Andrew Emmerson. Lest anyone should pick it up expecting a sort of compendium of Haden's columns over the last few years, *Electronic Classics* steers severely away from high-fidelity and instead concentrates its gaze on wireless sets, telephones and television sets from the point of view of the hobbyist/restorer.

Although the book contains helpful and indeed ethical hints for the would-be small business, the main thrust of the argument is towards restoration as a

pastime and as a 'heritage saver' to boot. Andrew Emmerson has not ducked any of the main worries like 'Applying Wrinkle Paint' and 'Removing Odours'. Many of these techniques can also be used on the equipment itself.

head-scratching over something that "Joe would know".

If you saw the original Quatermass or can remember London's telephone EXChange names, this book will provide both a comfortable browse and 1001 tips you probably didn't know you didn't know.

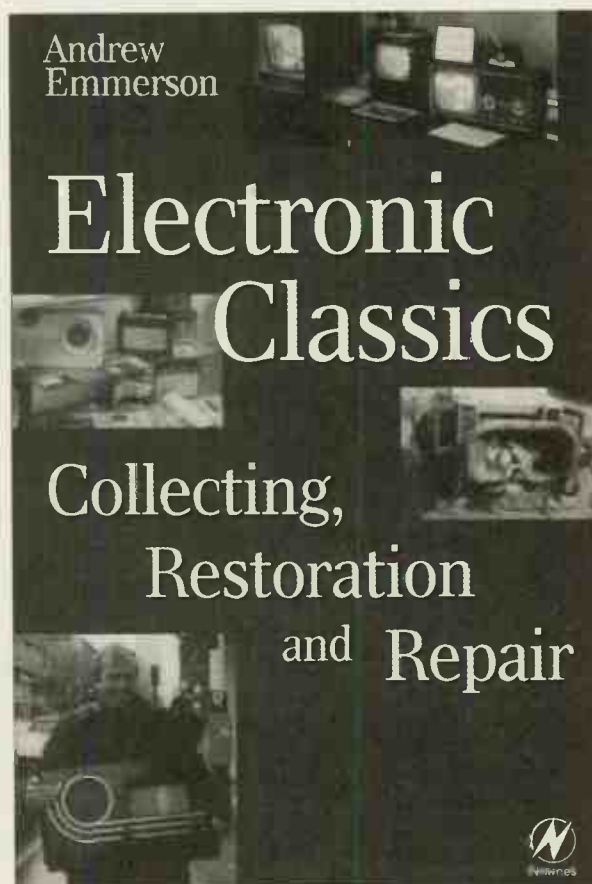

**Electronic Classics by Andrew Emmerson**  
Newnes  
PO Box 382,  
Oxford  
OX2 8RU  
Tel: 01865 314301

## 'ARKEN A BIT

A nice bit of news for all fuddle fingers and 'haven't done anything since I dropped solder on the cat' types: Arkless Electronics is a new concern which is offering repairs and modifications to 'good-quality British, European and American analogue hi-fi equipment'.

In addition to these standard services, Jez Arkless, late of Alchemist, is prepared to 'update' vintage equipment to more modern specifications in the interests of improved sound, if appropriate, and can also build prototypes to your order, or to his own designs. In addition, a get-you-going service

for kits is also on offer for the faint-hearted.

**Arkless Electronics**  
1 Radford Close,  
Stockton-on-Tees  
TS19 9LN  
Tel: 01642 860881

The book has a clearly written and mind-bogglingly comprehensive reference section enabling wiring colour-codes to be unscrambled and out-dated raw materials to be identified and sourced (maybe). As a big bonus, a list of clubs dedicated to elderly electronic gear is included which could save weeks of



Ω

Billington Gold

Ω

Long known as specialists in rare tube brands, Billington Export provides a line of premium-grade valves to fill the increasing demand for hard-to-find tubes! BILLINGTON GOLD features specially tested valves selected for long life, low microphony and low noise. Versions with gold plated pins are available. BILLINGTON GOLD brand comes from a variety of countries around the world. We have carefully chosen the best manufacturer for each type, with an emphasis on the highest audio quality and product reliability. We stock one million valves including: BRIMAR, GE USA, GEC UK, MAZDA, MULLARD, RCA, RUSSIAN/SOVTEK/SVELTANA, SYLVANIA, TESLA, THERMIONIC, TUNGSRAM and other rare brands, as well as sockets and CRTs.

BILLINGTON GOLD

RARE BRANDS

2A3	17.25	33A-101K	5.40	13E1 STC UK	120.00	ECC86 Mullard	5.93
6L6GC	9.50	300B Tesla	105.00	85A2 Mullard	4.50	ECP80/6BL8	0.75
6L6GT	6.45	3C24EEV	27.00	350B Chinese	14.25	ECL82 Tungstram	3.30
6SL7GT	4.50	3B28 RCA	14.70	807 Ceramic	30.00	ECL85/805	1.49
12AX7	5.55	4250A/QB35750 Philips	72.00	807 USA	6.75	ECL86	2.85
50CA10	22.50	7591A replacement	39.00	1625 USA	3.95	EF39/CV1053	1.65
274B	12.00	5Y3GT	3.90	6587WB Philips	5.93	EF95/CV4010 Mullard	1.95
300B/VA300B	(Pair) 126.00	6AH4GT USA	7.50	5751GE	6.00	EF184 RFT	0.99
Gold Colour Box		6AS7G Russian	2.93	5814AECG/Philips	0.99	EL34 Tesla Blue	12.00
807	9.95	6AU5GT GE USA	3.75	6028	0.79	EL34 Tesla JJ	8.10
811A	9.00	6AU8A USA	0.75	6463 GE USA	2.40	EL38	13.32
813	24.00	6BE6/5915 ECG Philips	0.90	A2293/CV4079	4.43	ECL86 Russian	1.49
845	33.00	6BH6 RCA	2.48	C3m Siemens	15.30	EL90 Brimar	2.70
4300B	66.00	6C33CB Russian	19.50	CV4062/E2134	5.25	EZ80 Brimar	6.00
5881	8.00	6J4/CV5311	1.80	DA42 GEC	28.50	F2A Siemens	120.00
6550B/B3	12.00	6Q7G/CV587 STC UK	3.60	DG7-32 Mullard	21.00	F2A11 Siemens	120.00
E81CC	5.70	6S07	3.00	E80CC Mullard	45.00	KT88 Chinese Unbranded	12.50
E81CC-01	9.50	6U8A RCA	1.43	E80F Philips	18.00	PCL82 Tungstram	2.15
E82CC	5.70	6V6 RCA Black Metal	15.00	E80L Philips	31.50	PCL86 (ECL86) Russian	0.53
E82CC-01	8.50	6V6GT MWT	6.00	E88CC Tesla Gold Pin	8.85	PT4D Ferranti	22.50
E83CC-01	8.50	12A U7WA RTC France	7.88	EC92 RFT	2.70	QOV03/20A GEC	5.25
E88CC	8.00	12A U7WA Cifte France	7.88	ECC81/CV4024 Mullard UK	7.50	S11E12/CV4060	43.50
ECC81	5.70	12E1 STC TTT UK	16.50	ECC82 Sylvania	15.00	Z2b	27.00
ECC82	5.70	12S G7	1.65	ECC83 Yugoslavian	4.05		
ECC83	5.55						
ECC88	5.25						
EF86	9.90						
EL34	7.50						
EL84	4.80						
GZ34	8.40						
KT66	9.50						
KT88 Special							
GEC replica	22.50						
KT88	18.50						
TT21 Chinese	27.00						

WHOLESALE SECTION

6AL5/EB91 Mullard, government box	100 pieces @ £ 75.00 [£0.75 each]*
9002 RCA USA audio triode	100 pieces @ £ 60.00 [£0.60 each]*
E180CC/7062 Mullard UK box anode GVT	100 pieces @ £280.00 [£2.80 each]*
EF37A Mullard UK Grey	50 pieces @ £125.00 [£2.50 each]*
EF86 Russian, identical to Sveltana EF86 but no logo	50 pieces @ £210.00 [£4.20 each]*
EL34 Chinese tested - guaranteed	50 pieces @ £175.00 [£3.50 each]*
C3M Siemens, government box	20 pieces @ £150.00 [£7.50 each]*

RARE SOCKETS

47E [for 4212E]	37.50	PO5 [for Aa, Ba]	11.70
4B4/B5B [for PX4]	3.98	Octal and B9A sockets IN STOCK...POA	
45DA [for DA10E]	15.00	Side contact for AZ1 [CT8]	10.43

For orders over £600.00 please deduct 33%. (Does NOT apply to items marked \*)

BILLINGTON EXPORT LTD IE GILLMANS INDUSTRIAL ESTATE

BILLINGHURST SUSSEX RH14 9EZ

TEL: (0)1403 784961 FAX: (0)1403 783519 email: billingtonexportltd@btinternet.com

VISITORS BY APPOINTMENT ONLY PLEASE

AMERICAN EXPRESS, MASTER-CARD, VISA, accepted.

MINIMUM ORDER: UK £50 + VAT + Carriage. Export £100.00 [US \$150.00] + Carriage.  
3,000 OTHER TYPES OF VALVES IN STOCK! PLEASE INQUIRE FOR ANY TYPE NOT LISTED.



CRICKLEWOOD ELECTRONICS

ANSAR SUPERSOUND Audio Polypropylene 400VDC±5%

The secret's in the metallised film!

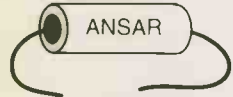

Manufactured specifically for high end audio, these polypropylene capacitors offer exceptional value for money as they use a specially imported high purity metallised polypropylene film, ensuring smooth, detailed and transparent sound quality and extremely low distortion, whether they are placed directly in the signal path such as in crossovers or for decoupling etc. Ideal for replacing old, stale and leaky capacitors.

Part No	Value	Price
CW100N	CAP PROPYL 100nF	£1.25
CW150N	CAP PROPYL 150nF	£1.25
CW220N	CAP PROPYL 220nF	£1.25
CW330N	CAP PROPYL 330nF	£1.25
CW470N	CAP PROPYL 470nF	£1.25
CW680N	CAP PROPYL 680nF	£1.25
CW100U	CAP PROPYL 1µF	£1.25
CW150U	CAP PROPYL 1.5µF	£1.50
CW220U	CAP PROPYL 2.2µF	£1.50
CW330U	CAP PROPYL 3.3µF	£1.85
CW470U	CAP PROPYL 4.7µF	£2.00
CW680U	CAP PROPYL 6.8µF	£2.50
CW100N	CAP PROPYL 100µF	£3.50
CW150	CAP PROPYL 150µF	£4.50
CW220	CAP PROPYL 220µF	£6.50
CW500	CAP PROPYL 500µF	£9.95
CW1000	CAP PROPYL 1000µF	£20.00

Low voltage capacitors are extensively used in amps & preamps (especially in tone control, bass & treble etc.) By changing to polypropylene you can enjoy an enhanced lighter - brighter sound especially in the treble and mid bass range, and a transparent lower bass improvement. Close tolerance & high stability ensure that both channels can be very closely matched.

Part No	Value	Voltage	Price
CP47P	CAP PROPYL 47pF	250V	£0.35
CP100P	CAP PROPYL 100pF	250V	£0.35
CP150P	CAP PROPYL 150pF	250V	£0.35
CP220P	CAP PROPYL 220pF	250V	£0.35
CP330P	CAP PROPYL 330pF	250V	£0.35
CP470P	CAP PROPYL 470pF	250V	£0.35

Low Impedance High Temperature (105°C) Radial Electrolytics ± 5%

Superior electrolytics at affordable prices. The low impedance end resistance maximises signal purity, whilst the superior temperature characteristics allow the capacitor to remain very stable under the most varying conditions.

Part No	Value	Voltage	Price
1H50	LO 2 HI TEMP 1µF	50V	£0.25
2U2H50	LO 2 HI TEMP 2.2µF	50V	£0.25
4U7H63	LO 2 HI TEMP 4.7µF	63V	£0.25
10H63	LO 2 HI TEMP 10µF	63V	£0.25
22H63	LO 2 HI TEMP 22µF	63V	£0.30
47H63	LO 2 HI TEMP 47µF	63V	£0.35
100H63	LO 2 HI TEMP 100µF	63V	£0.50
220H50	LO 2 HI TEMP 220µF	50V	£0.75
470H63	LO 2 HI TEMP 470µF	63V	£1.25
1000H35	LO 2 HI TEMP 1000µF	35V	£1.50
2200H50	LO 2 HI TEMP 2200µF	50V	£2.25
4700H25	LO 2 HI TEMP 4700µF	25V	£2.50

Trobo Solder Lug Reservoir Capacitor 10,000µF 80V

Choosing the right electrolytic for power supply use is very important in keeping down hum whilst allowing maximum current flow for good transient & bass response. Elna capacitors are respected the World over for their exceptional audio attributes.

Part No 1000080 CAL Elna1000µF/80V £11.00

Monacor Air Cored Inductors.



A range of professional air cored inductors for 8Ω or 4Ω crossovers/filters for use up to 300W. 1.2mm enamelled copper wire wound on air spaced plastic bobbins.

Monacor Ferrite Inductors



A range of professional high efficiency ferrite cored inductors with very low ohmic losses for 8Ω or 4Ω crossovers or filters for use up to 400W. 1.4mm enamelled copper wire (1.3mm on F1000) wound on plastic bobbin.

Part No	Specification	Price
F220	2.2mH 0.15Ω 400W	£6.50
F330	3.3mH 0.20Ω 330W	£9.50
F470	4.7mH 0.25Ω 140W	£11.00
F680	6.8mH 0.35Ω 120W	£12.00
F1000	10mH 0.45Ω 100W	£13.50

High Quality Valves

Part No	Description	Price
6550C	OUTPUT VALVE	£26.00
6L6GT	OUTPUT VALVE	£4.50
6SN7GT	OUTPUT VALVE	£4.50
6V6GT	OUTPUT VALVE	£3.95
ECC81	TRIODE	£4.50
ECC82	TRIODE	£4.50
ECC83	TRIODE	£4.50
EF86	LOW NOISE PENTODE	£9.90
EL34	OUTPUT VALVE	£8.50
EL84	OUTPUT VALVE	£3.50
GZ34	RECTIFIER	£6.50
KT88	OUTPUT VALVE	£20.00

Valve Holders - High quality valve bases. Chassis mounting with screw fittings.

Part No	Description	Price
B9AC	B9A VALVE HOLDER CERAMIC	£1.50
CC	SCREENING CAN	£2.25
OCTC	OCTAL VALVE HOLDER CERAMIC	£2.00
OCTP	OCTAL VALVE HOLDER PHENOL	£1.50

Fully Gold Plated Phono (RCA) Plugs with spring coil cable grip.



Part No	Description	Price
PPG5A2	PAIR GOLD PLUGS for up to 5mm CABLE	£1.50 pair
PPG8A2	PAIR GOLD PLUGS for up to 8mm CABLE	£1.50 pair

Very High Quality Phono (RCA) Plugs



Very high quality satin grey metal with heavy gold plated connections. Top collet cable grip & PTFE insulators. Very low noise.

Part No	Description	Price
PPG6H2	GOLD PTFE PLUGS for up to 6mm CABLE	£3.50 pair
PPG8H2	GOLD PTFE PLUGS for up to 8mm CABLE	£3.50 pair

Extra High Quality Gold Plated Phono Oxygen Free (RCA) Leads (pairs).



Available in 2 colours & 3 lengths. Highly flexible oxy-

gen free cable with extra moulded-in control / grounding wire.

Part No	Length/Colour	Price
LPP1QG	0.8 Metres/Green	£5.50
LPP1QV	0.8 Metres/Violet	£5.50
LPP2QG	1.5 Metres/Green	£6.50
LPP2QV	1.5 Metres/Violet	£6.50
LPP5QG	5 Metres/Green	£11.00
LPP5QV	5 Metres/Violet	£11.00

Bass Reflex Tuning Ports



A range of adjustable plastic ports for use in various sizes of loudspeaker cabinets. d= diameter L=adjustable length (mm)

Part No	Dimensions	Price
R35	d=35L=110-210	£2.50
R50	d=50L=150-280	£3.00
R70	d=70L=128-245	£3.50
R100	d=110L=160-322	£5.50
R85	d=85 angled 45° for narrow cabinets L=210-310	£6.50

Superior Monacor hi-fi speaker cabinet design book with many interesting new designs £6.00 (no VAT) + £1.00 P&P

High Quality Components at the right price. Please add £2.00 carriage + VAT to all orders. Credit Card phone orders accepted.

Cricklewood Electronics Ltd, 40 & 42 Cricklewood Broadway, London NW2 3ET. Tel: 0181 452 0161 Fax: 0181 208 1441

# BOTTLES AND CANS

If loudspeakers don't light your fire try HD83, the new World Audio Design single-ended valve headphone amplifier.

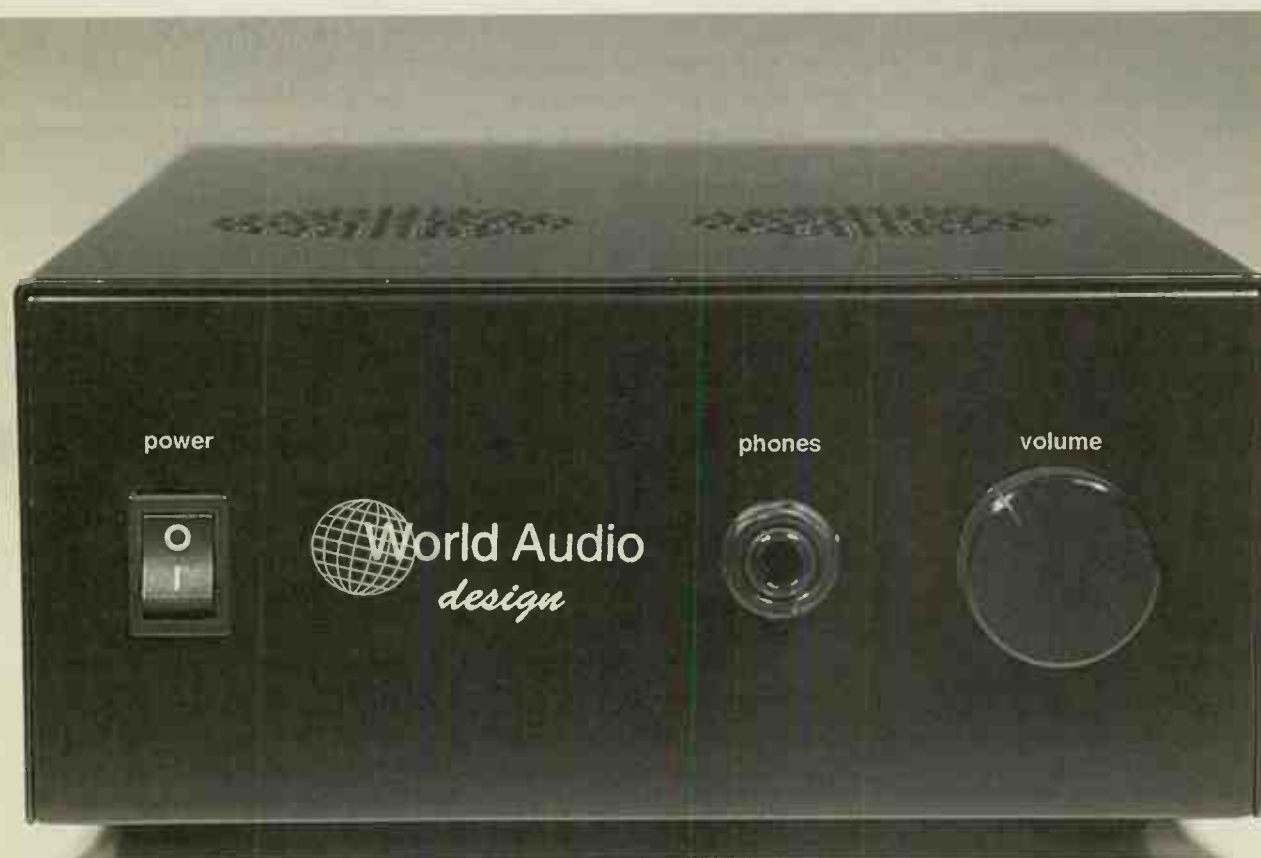

## INTRODUCTION

by Noel Keywood

You asked for it - a valve headphone amplifier that is. Headphones potentially offer superb sound quality, but they also reveal the limitations of the solid-state amplifiers which drive them. Our valve headphone amp eliminates solid-state intrusion by working direct from any source, or from an amplifier's Tape Out or Pre-amp Out sockets.

It goes without saying that headphones obviate problems with room acoustics and also make a lot of sense to those families who don't like dad's Black Sabbath albums, nor his penchant for large loudspeakers.

For those headphone enthusiasts out

there and for those hi-fi family men who, like myself, lack the benefits of a dedicated hi-fi room and are thus forever in search of a few musical moments, may I introduce to you our latest kit, the HD83 valve headphone amplifier. This little beastie was born out of World Audio Design's desire to create something slightly different, something which numerous readers have been requesting.

## ON THE OUTSIDE...

The HD83 is housed in a 'U'-style steel chassis 180mm (w) by 300mm (l) by 80mm (h), finished in black powder coat with a white, screen-printed logo and labelling. Unlike our heavy-duty power amps, the valves are housed internally.

You need have no worries about overheating, though, as each valve is haloed by perforations in the chassis top.

On the rear panel you'll find a pair of phono sockets for left and right channel inputs and an IEC mains socket. Round the front are located the On/Off switch, a 1/4in. jack socket for your headphones and a volume knob.

## ... ON THE INSIDE PT1

by Nick Lucas

The HD83 utilises a pair of ECL83s, thermionic old timers which are currently not under production. However, they're not that expensive and their numbers are relatively plentiful (we have recently acquired a large stock of them). The



valve's B9A base is the same as the famous ECC81/82/83 family. We found that the Mullard original was the best performer.

The HD83 circuit is an elegant design which our engineer Gary Devon will elaborate on later. Suffice to say it's single-ended and comes with a very beefy power supply consisting of a toroidal mains transformer and large amounts of smoothing capacitance to keep any ripple voltage on the high tension line to an absolute minimum.

For the heater supply we decided on split windings to feed AC rather than DC to the filaments. Rest assured you will find the HD83 as quiet as a mouse.

The output stage utilises E and I core transformers of a very high quality. Gary spent many hours getting their specification spot-on, and they're not

The HD83 circuit is extraordinarily simple, with only one amplification stage ahead of the pentode. In our application this pentode section is connected as a triode, its screen grid hooked up to the anode via a 100ohm resistor. Since the extra power of the straight pentode was unnecessary for the HD83, we opted for the sonic purity of a triode instead. This mode of operation still pushes out around 1watt, which gives enormous headroom on 'phones.

The input is built on the triode section of the ECL83. There's little out of the ordinary here, apart from the feedback arrangement which uses a bass compensation scheme. Overall feedback is increased with decreasing frequency by virtue of capacitors C4 and C7 in the triode's cathode, which yields taut, solid bass.

inductance which can actually be put to good use filtering RF, thereby stopping it from entering the amp's feedback loop. In a similar way to the essential inductor on the output of solid-state amps, it also helps maintain stability with reactive (especially capacitive) loads.

The power supply is very straightforward, with solid-state rectifiers, capacitor input filters and RC decoupling.

## A LOAD OFF YOUR MIND

Depending on which way you wire up the four secondaries, you can match the HD83 up to pretty much any headphone. The four impedance options are 16ohms-50ohms, 50ohms-125ohms, 125ohms-250ohms and over 300ohms. Where your headphones straddle the border between two ranges, try both and stick with the best sounding.



cheap. In fact, most of the cost of the HD83 goes on these little beauties, which holds true to the idea that the most important part of any normal valve amplifier is the output transformers.

## ON THE INSIDE PT2

by Gary Devon

The HD83 has a pair of ECL83 triode/output pentode valves, one per channel. In each envelope is a signal triode and a small power pentode, partnered for reasons of economy - you only needed one valve plus a PSU to make an amplifier (mono of course!) The triode/output pentode combination was very popular in TV sets, radios and record players (like the Dansette) in the Fifties and Sixties.

The output transformer and the derivation of overall feedback are a little different from the norm. A special third winding is incorporated into the output transformer to permit the various connections which are possible with the four separate secondary windings. The four combinations of these windings make it possible to match headphones whose impedances vary from 16ohms to over 300ohms. If the feedback were taken directly from the secondary, this would mean changing feedback components with each new pair of 'phones. The third winding avoids this.

The coupling of the third winding to the secondaries is very good but not perfect. This shows itself as a leakage

## POLISHED PERFORMER

To give you an idea of what the HD83 is capable of, driving a 30ohm load 30mV input gave 180mv output, 17Hz-20kHz (-1dB). The output transformers were correctly matched. Usually power rating of headphones is around 200mW so the HD83 has plenty of headroom. For full performance analysis see the main magazine measurement pages.

## BITS AND PIECES

The kit basically contains everything in the parts list. All components are supplied in their own individually-labelled, sealable bags to avoid them being lost or misplaced. The hardware (including the Alps Blue volume potentiometer) mounts straight onto



# HD83 headphone amplifier

## SIGNAL CIRCUIT (ONE CHANNEL)

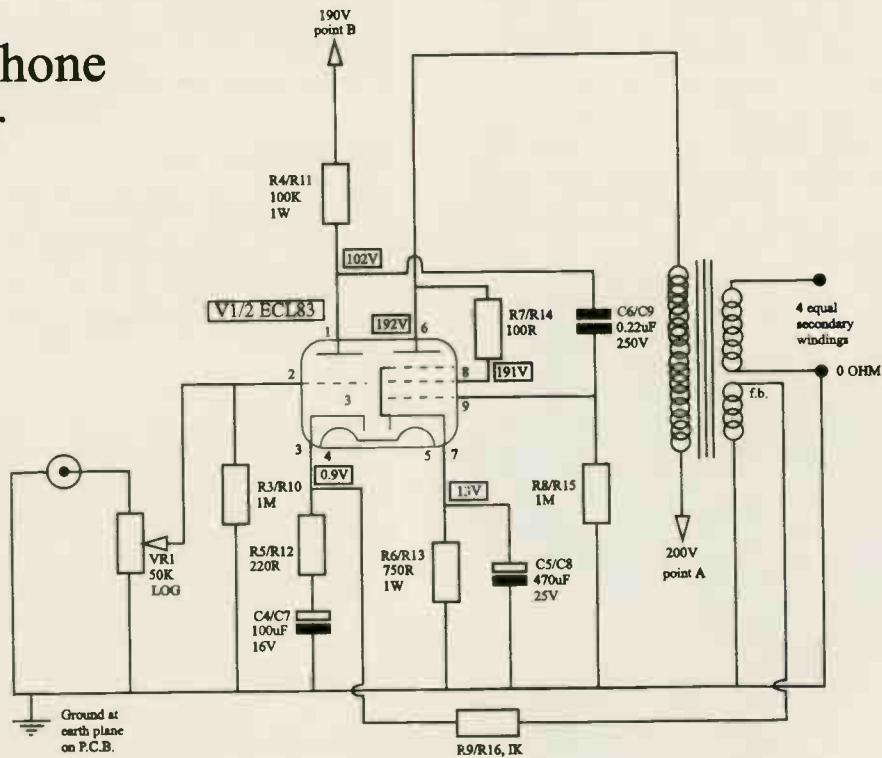

## POWER SUPPLY UNIT

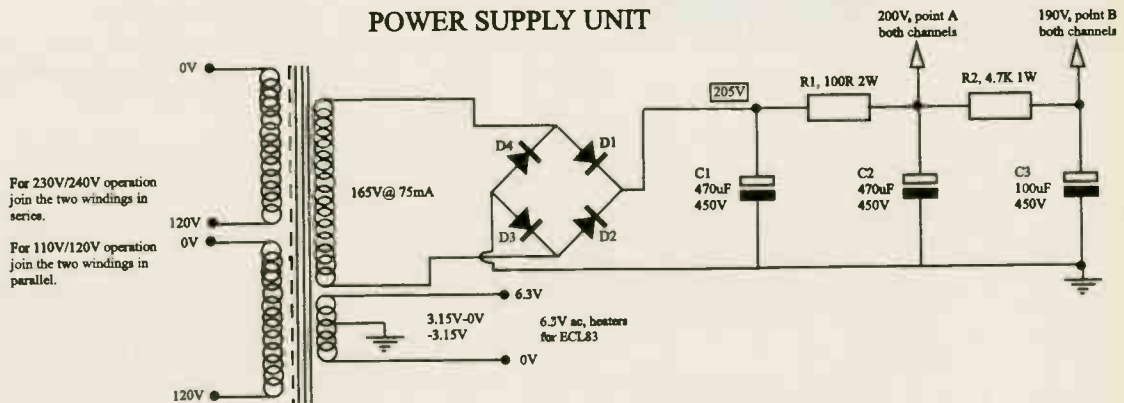

## VALVE PIN LAYOUT

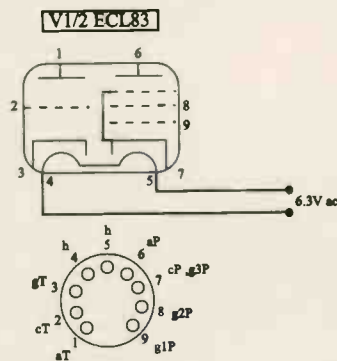

Views are from underneath valve or valve holder  
h = heater hct = heater centre tap c = cathode a = anode nc = no connection T = triode P = pentode

# Audio Note Kit Amplifiers - Power-Amp Kit

## The Audio Note Kit One (illustrated)

Based around the justly famous 300B directly heated triode, we see this kit as the introduction to *real* Audio Amplification, as it covers all the important aspects of design necessary, Single Ended, No-Feedback, Class A, Directly Heated Triode, to become a member of this exclusive club of amplifiers.

**Kit One** has one 300B per channel running at 420 volts with 75mA current giving 8-9 watts of the cleanest power you will ever hear, the input stage consists of a 6SN7GT with a 5687 double triode driver stage running in SRPP. The power supply is capacitor-choke-capacitor configuration with a 5U4G HT rectifier, the 300B's have a DC filament supply for hum-free operation whilst the other valves are AC heated. Component quality is similar to our Level 2 finished products, **Audio Note** paper in oil signal capacitors, Beyschlag 1 watt 1% metal film resistors, good quality electrolytics (*sorry NO Black Gates!*) and a simple, attractive stereo chassis in black paintwork. We have several component and cosmetic upgrades available for **Kit One**, please ask for details.

*The Kit One has recently been awarded the title "The Greatest Audio Bargain of the Twentieth Century" by Dick Olsher (ex-Stereophile) In a review on the Internet - this is just one of many rave reviews, copies of which we can supply on request.*

Price: £799 incl. VAT, which includes ALL parts & valves (yes, also the 2 x 300B's needed) but not postage packing which to UK customers is £12.00.

KIT ONE ORDER CODE: AN-KIT-001

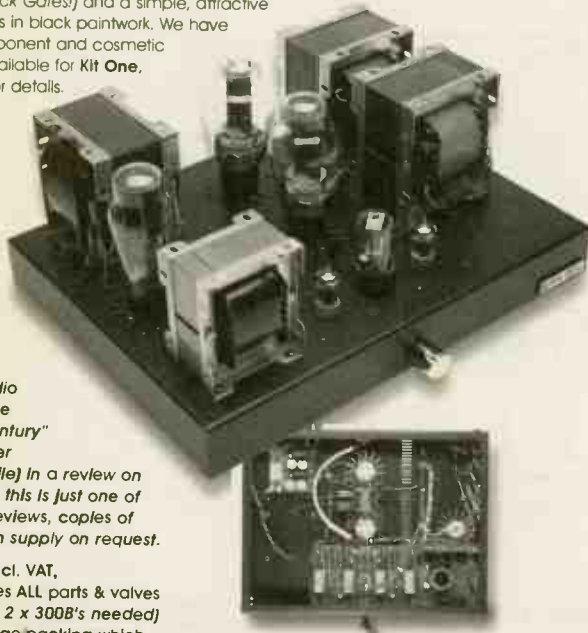

## The Audio Note Kit Two

**Kit Two** features a single 6550 tetrode running in Single-Ended mode, yielding some 12 watts of pure Class A. With a valve rectified HT for the output stage, stereo chassis, and 6SN7GT input and 12AX7/ECC83 SRPP driver stage, componentry and chassis as Kit One.

**Kit Two costs £599 incl. VAT, includes valves, but not postage/packing.**

KIT TWO ORDER CODE: AN-KIT-002

## The Audio Note Kit Three

**Kit Three** features 2 x 300B's per channel running in single-ended parallel yielding 16/17 watts in pure Class A. This kit is on two mono chassis with valve rectified HT supplies, no signal feedback, it uses a 6SN7GT double triode as input valve and a pair of 5687 double triodes running in SRPP as drivers. The **Kit Three** is essentially a mono version of the Kit One with double the power, the same component choices and on two chassis' instead of one.

**The Kit Three costs £1,550 incl. VAT but excluding delivery.**

KIT THREE ORDER CODE: AN-KIT-003

## The Audio Note Kit Four

The **Kit Four** is really our introduction to valve amplifier kit building, the circuit and power supply being mounted on a single printed circuit board. The high-quality push-pull output and mains transformers are all mounted in a small aluminium chassis covering everything so nobody will be able to see that you have succumbed to the lure of the valve amplifier which is sweeping the world. The circuit consists of two 6V6GT tetrodes running in Push-Pull class A, yielding about 10 watts, driven by a 6SN7GT and a 12AX7/ECC83 input stage. Easy to build, even for the beginner. Visually **Kit Four** matches the **Audio Note** Pre-amplifier shown here but with a single chrome-plated volume control. As with all **Audio Note** kits everything (*except solder*) is included.

**The Kit Four costs: £279 incl. VAT but not delivery.**

KIT FOUR ORDER CODE: AN-KIT-004

## Audio Note Driver, Interstage & Pre-Amplifier Output Transformers

Here is a product group that you do not see advertised every day! As usual we start small with the intention to grow quickly.

## Audio Note Paper In Oil Signal Capacitors

These handmade signal capacitors are sonically superior to any of the plastic or other paper types we have come across. If you have never experienced the difference that a really good paper / oil capacitor can make in a valve amplifier, then you really should try.

## Audio Note Paper In Oil Tin Foil Signal Capacitors

The tin foil is better than alu-foil for most applications, we recommend you try them.

## Audio Note Paper In Oil Copper & Silver Foil Signal Capacitors

These copperfoil paper signal capacitors are considerably better than both the standard offerings and the tin foils. To start with there will be a few values / voltages of each available and we shall expand as fast as we can to cover all the popular values.

## Audio Note Acid & Chloride Free Silver Solder

The best solder available, used in all our amplifiers from OT0 to the mighty GAKU-ON.

## Audio Note Cables & Wires

**Audio Note** manufacture a range of high quality copper and silver coax, speaker and wiring cables, which, depending on the overall price of the project, will do justice to any hi-fi system, regardless of price. Please call for prices and details.

## Audio Note High Quality Stepped Attenuators & Switches

These handmade attenuators and switches are manufactured by a friend of Mr Kondo of **Audio Note**. They are the best you can buy.

## Audio Note High Quality Valve Bases

All of our valve bases are of the highest possible quality materials. Ceramic, Teflon and gold and silver plated. If you want the best look no further - they are the ultimate!

## Audio Note Resistors

**Audio Note** endeavour to stock the entire E12 range of all the different makes of resistor, since most are used in our products stock is generally available within four weeks.

BEYSCHLAG - HOLCO - SHINKOH Tantalum Film Resistors

AUDIO NOTE 1/2 Watt Tantalum Resistors

AUDIO NOTE 1 Watt Tantalum Resistors

AUDIO NOTE 2 Watt 1% Tantalum Resistors

AUDIO NOTE Precision Carbon Film Resistors

ALLEN BRADLEY 1 Watt 5% Carbon Film Resistors

**Audio Note** is happy to provide a wide range of complete kits, output and mains transformers, chokes, paper in oil, aluminium, tin, copper or silver foil signal capacitors, Black Gate, Cerafine or standard electrolytic capacitors, tantalum, carbon and metal film resistors, silver wires, interstage and driver transformers, switches, balance controls, potentiometers, attenuators, chassis's and fittings for the quality oriented DIY'er, whether you are a beginner or hardened experimenter, male or female, we have the best (and not always most expensive) parts for most projects.

## Audio Note Loudspeaker Drivers & Kits

We shall be offering the speaker drivers that we use in our own loudspeakers for general sale from now on. You can buy the drivers individually or together with matched and tested cross-overs, cabinet drawings and reflex ports.

## Audio Note Circuits, Valvedata & Basic Technical Information

If you would like some suggestions which to base a future project around, then we shall be happy to provide you with a circuit pack containing good circuits like ONGAKU, KEGON/KASSAI, NEIRO, GAKU-ON plus several other power amplifier circuits and the M7Tube & M10 pre-amplifiers, which are the best sounding pre-amplifier circuits we have come across.

## Audio Note Quality Output Transformers

We are in the process of building up four separate ranges of **Audio Note** output transformers. In order to offer the best possible outputs at different pricepoints, they will fall into four categories.

**Economy range** Selected to ensure quality audio in a price efficient package.

**Mid-price range** Top quality with specially selected components.

**High Quality range** Double C-core outputs for single-ended circuits exclusively.

**Super High Quality range** All-silver wired outputs of the best possible quality.

**Audio Note** offer a design, prototyping and production service, where we can supply for almost any requirement. Please telephone for details.

## Audio Note Mains Transformers

Available for most popular designs. We shall continue to expand the range as opportunities become available.

# Components & Valves

## Pre-Amp Kit

### The Audio Note Pre-Amplifier Kit (illustrated)

A complete kit loosely based on the **Audio Note M7Tube** pre-amplifier circuit is now available. The moving-magnet compatible phono stage consists of a cascode input, with passive RIAA equalisation and anode-follower output using the 12AX7/ECC83. Line buffer/amplification for the four line inputs consists of an ECC82 configured in parallel anode-follower mode. For the power supply a valve rectifier and choke-input filtering are employed. All circuitry is housed in a non-magnetic aluminium chassis giving the very best sound quality.

Both phono and line stages are built on 'track-less' pcbs allowing easy construction but with the sonic benefits of hard-wiring.

The standard-quality version of the pre-amp kit includes Roederstein polyester film capacitors, Beyschlag 1 watt 1% metal film resistors, Noble open-frame style potentiometers and all pcbs, valves, wire etc. Various component upgrades are available, details upon request.

**Cost of The Pre-Amplifier Kit is: £299 Incl. VAT but not delivery.**



### Audio Note Black Gate Electron Transfer, High Performance, Graphite Foil Capacitors

**Audio Note** is currently the sole source in Europe that holds any significant range of values in stock, we use literally 1000's in production, as we were the first company to realise the tremendous benefits that Black Gate capacitors offer, and we are to date the only high-end audio company in the world to incorporate Black Gate capacitors consistently in our finished products.

There are very few audio parts that promise a guaranteed improvement when replacing practically any other part, but this is what the BLACK GATE capacitors actually do. Exchanging any electrolytic capacitor anywhere in the circuit of an amplifier or in the crossover of a speaker will greatly improve sound quality. We are working on some guidelines as to where, how and which types of Black Gates to use in different circuits, the first such technical guideline is available now and is called "Improving your CD-Player" and can be obtained by sending a stamped addressed envelope to us requesting this leaflet. All AUDIO NOTE Level 2 Signature products use Black Gate Electron Transfer in critical signal / power supply junctions.

### Audio Note Cerafine Powdered Ceramic Electrolytic Capacitors

We have at long last secured a reliable source for these fine power supply filter capacitors, a must in any single-ended project. The Cerafines really cover many of the Black Gates values and where the prices for the BG's are prohibitive the Cerafine is a fine sounding alternative. We have increased the range of Cerafines we stock quite recently, and strongly recommend all the Cerafines as a far superior replacement or substitute for ordinary electrolytics, and at the prices offered that should be within most budgets. All power supply Cerafines are supplied with a capacitor clamp and are upright mounting.

### Audio Note Potentiometers

The best available from a sound quality / price viewpoint, made by Noble in Japan, utilising high quality conductive plastic film. However a better alternative is the KO-ON volume controls which are used in pre-amplifiers like the M7 Tube, M7Line, and in a mono version on the input in the NEIRO, KASSAI, KEISON and GAKU-ON, these are very good sounding pots by any standard.

**Audio Note** also carry large quantities of STANDARD TYPE SWITCHES, STANDARD ELECTROLYTIC CAPACITORS (good quality industrial types), RCA, BNC, BANANA, PLUGS, RCA SOCKETS, SPEAKER & GROUND TERMINALS & LOUDSPEAKER SPADES.

### Audio Note Moving Coil, CD Line & Input Matching Transformers

**Audio Note** now offer moving coil, CD and input matching transformers for general sale. Common to all of these small signal transformers is that they come in a mumetal screening can with a threaded spindle with a nut for mounting.

## Valves

### The Audio Note AV300BSL (illustrated)

**Audio Note** has very limited stocks available of the AV300BSL and AV32BSL.

AV300BSL - 50 watt dissipation for about 12 watts class A, single ended configuration.

AV32BSL - 65 watt dissipation for about 18 watts class A, single ended configuration.

These super linear output tubes are widely regarded as the best amplification devices available.

Previously offered with a 2 year warranty at \$250 and \$300 respectively.

They are now available without warranty for the unbelievably low prices of \$50 and \$75 each.

Offer subject to availability on a first come first served basis.

Prices are exclusive of VAT.



### Audio Note Selected Audio Valves

Our valves are selected from the best available sources and are tested to the same stringent standards that we apply in the production of our own amplifiers. They fall into two categories, standard production items and rare, mostly NOS (New Old Stock) valves which are no longer in production. We have compiled a special list of the NOS items, which is available against a stamped self addressed envelope, if you live outside the UK, send US \$2. You should be aware that the valves on this list are NOT cheap, but we have stock of original GE, RCA and United Electronics 211, both standard versions and reinforced anode type for the US airforce, 845 Westinghouse, VT25/10/10Y, VT62/801A, WE300B, STC4300A, Mullard GZ34/CV1377, Tungsol 5U4G (best sounding 5U4G we have ever heard!), Chatham 5R4WGY and many others.

### Audio Note Recommended Magazines

#### Listener

Review based music & hi-fi magazine that contains some of the best considered & well written articles in print. A very good read £4 per copy.

#### The Audio Adventure

Glossy, well produced publication that provides a good alternative to the established magazines. Not afraid to be controversial. £4 per copy.

A full list of available issues on request.

FOUNDING SPONSOR

masterprize

Call us today for more information.

Ask for a full components catalogue or see our web page.

Audio Note

Music's Finest Conductor

Audio Note (UK) Ltd, Unit C, Peacock Industrial Estate  
Lyon Close, 125-127 Davigdor Road, Hove, East Sussex BN3 1SG

Tel: +44 (0)1273 220511 Fax: +44 (0)1273 731498

Web: [www.audionote.co.uk](http://www.audionote.co.uk)



the chassis. The components supplied include carbon-film resistors, large Trobo electrolytics and Philips polypropylene signal capacitors. All of these, as well as the valve bases, sit on a double-sided PCB 160mm by 160mm by 1.6mm. We have deliberately left plenty of space on the board to allow all you tweekers out there to fit specialist, larger-than-life upgrade components.

Internal wiring as supplied is PTFE-sheathed, silver-plated copper for the HT lines, copper multi-strand for the mains and single-screened for the signal paths. Build time is 6hrs-15hrs depending on ability. If you do encounter any problems, you can call our help-line. And if the worst comes to the worst, for a nominal fee we will get your HD83 up and running.

As far as ease of assembly goes, the HD83 is on a par with KEL34, meaning it's not too tough. As long as your soldering technique is fine, you have a basic understanding of electronics (and the precautions to take when dealing with HT)

and you can use a multimeter, there should be no problems.

## THE HUNT FOR HEADPHONES

As a complete package to get you up and running, we are offering discounts on the price of any of Sennheiser's headphones if you buy them from us at the same time. For example, the HD565s retail for £149.95. When bought with the kit, they would cost £10 less. For further information on the Sennheiser range and the discounts available, please do not hesitate to contact us on tel: 0171 221 0691. For the purpose of this review, we used the HD490s, HD500s, HD565s and HD580s.

## SOUND QUALITY by Jon Marks

I had expected there to be just a little hiss or possibly hum with the volume on the HD83 all the way down, but even listening for it I had trouble finding any. Thus

satisfied, I set Musical Fidelity's X-Ray CD player a-spinning with John Lee Hooker's Boom Boom. With Sennheiser's HD565s and HD580s warming my lugs, what emerged showed the output transformers weren't sully the signal. If you're accustomed to the overtly soft bass and rolled-off treble served up by sub-standard valve designs, you'll find the HD83 refreshingly different. Bass is punchy and controlled without becoming artificial, while treble has the crispness of the best solid-state with the tonal purity, delicacy and speed associated with valves.

Select a sparse track such as Hooker's 'Bad Like Jesse James' or Eric Bibb's 'Saucer And Cup', and you'll be rewarded with holographic clarity and vocals completely free from grain - the sound just blossoms unrestricted from the earpieces. The HD83 rocks as well, its upper-bass smack on percussion driving tunes along with relentless energy.

## HD83 PARTS LIST

Component type	Description	Quantity	HARDWARE	
<b>RESISTORS</b>			Chassis	1
R1	100ohms 2W	1	PCB	1
R2	4.7kohms 1W	1	Mains transformer	1
R3	1Mohm 0.66W	1	Output transformer	2
R4	100kohms 1W	1	B9A valve base	2
R5	220ohms 0.66W	1	Fuse holder	1
R6	750ohms 1W	1	Fuse cover	1
R7	100ohms 0.66W	1	Fuse	1
R8	1Mohm 0.66W	1	Mains switch	1
R9	1kohm 0.66W	1	Mains lead	1
R10	1Mohm 0.66W	1	Feet	4
R11	100kohms 1W	1	1/4in. jack socket	1
R12	220ohms 0.66W	1	Red phono socket, gold-plated	1
R13	750ohms 1W	1	Black phono socket, gold-plated	1
R14	100ohms 0.66W	1	Black knob	1
R15	1Mohm 0.66W	1	Wire, nuts & bolts.	
R16	1kohm 0.66W	1		
VR1	Alps 50kohm dual log pot	1		
<b>CAPACITORS</b>				
C1	470uF 450V	1		
C2	470uF 450V	1		
C3	100uF 450V	1		
C4	100uF 16V	1		
C5	470uF 25V	1		
C6	0.22uF 250V	1		
C7	100uF 16V	1		
C8	470uF 25V	1		
C9	0.22uF 250V	1		
<b>DIODES &amp; VALVES</b>				
D1-D4	BYV96D	4		
V1/V2	ECL83 Mullard	2		

## HOW TO ORDER HD83

HD83 is available from Hi-Fi World:

HD83 (UK inc VAT & P+P)	£175
HD83 (Overseas excluding carriage)	£150
HD83 PCB only (UK inc VAT & P+P)	£35
HD83 PCB only (Overseas excluding carriage)	£29
HD83 transformer set (UK inc VAT & P+P)	£105
HD83 transformer set (Overseas excluding carriage)	£90

All the above come with a full set of instructions.

**PLEASE BE AWARE THAT THE HD83 WILL ONLY BE AVAILABLE FROM THE 16TH NOVEMBER 1998. TO ENSURE PRE-CHRISTMAS DELIVERY, SEND YOUR ORDERS IN EARLY.**

Call Nick Lucas on 0171 221 0691

(9am-5pm, Monday to Friday) for more information.

E-mail: wad@hi-fiworld.co.uk

For overseas freight charges, please call, fax or e-mail.

# STEPPING OUT

When it comes to controlling volume, potentiometers often fail to make the grade. Richard White investigates one alternative with a budget stepped attenuator.

Back in 1935, when Wharfedale brought out a stepped attenuator for their range of extension 'speakers, works engineer Mr Broadley chose the values by knocking 10 nails into a piece of wood and experimenting with various lengths of resistance wire between them. This approach owed nothing to mathematics but did ensure that the degrees of attenuation sounded right, having been chosen literally by ear.

Nowadays, attenuators are all the rage again, but unless you can afford an expensive pot or are lucky enough to have the odd 24-position switch lying around, amateurs are still stuck with cheap carbon-track pots and the damage they wreak on the sound. Well, fear not! Help may be at hand with our stepped attenuator on a shoestring.

## POT PROBLEMS

What makes life hard for designers of normal pots is that, in order to get an output infinitely variable between no signal and maximum, you need a disc coated in conductive material with wiper contacts.

Most basic pots rely on low-grade carbon as the coating, which results in a hard, confused sound worsened by poor channel matching. The contact between disc and wiper is also generally not great, and as anyone who has an amp whose volume control has started 'crackling' will know, long-term reliability is an optional extra.

It is possible to produce potentiometers with higher-grade materials and much closer tolerances, but these aren't inexpensive. Cue the stepped attenuator.

Rather than running wipers over a conductive disc, a stepped attenuator is built up from resistors soldered to a multi-way switch. This means volume can't be altered in a single, smooth sweep, but instead changes in discrete steps, a small penalty to pay for some very important advantages. The resistors which go into the attenuator can be selected for maximum sound quality; channel balance, which has its greatest affect on imaging precision, is also vastly superior; and switch contacts will withstand thousands of rotations and still sound better than wipers on a disc.

## 12 STEPS TO NIRVANA

We had to begin by deciding the minimum number of steps which would give reasonable utility without breaking the bank. Having decided that 12 (including an Off position) would be workable, we



A decent standard pot as fitted to Panasonic's SU-C1000 pre-amp.

plumped for the Maka Switch system which has silver-plated contacts on removable wafers and is relatively robust under soldering stresses. To avoid make/break thumps, we used a pair of the make-before-break versions (Maplin order code FH52G - £2.50 each) which fits the robust matching shaft assembly (FH46A - £3.47).

Before reaching for your iron, there's the matter of appropriate resistor values to be settled. Part of this work has already been done by whoever designed your equipment: if the original is a 100kohm pot, then the sum of all the attenuator's resistors in series ought to be 100kohms too. The mathematics behind the actual values is as follows:

$$X = -20 \times \log \frac{R_y}{R_x + R_y}$$

This equation gives an answer in decibels below 0dB.

As followers in the footsteps of Newton or indeed Theile and Small will immediately descry, this formula is one of those wretched 'can't get at the bit you want', where it is easiest to hazard a guess at the right value, check it by the formula and then guess again if you were out.

## CALCULATOR CRAZY

Here's an example of working out a particular resistor value. We decided that we wanted one of our steps to give 26dB of attenuation. A rough guess involved 92kohms for  $R_x$  and 8kohms for  $R_y$  to give our required total of 100kohms. Applying the formula  $R_y$  over  $R_x + R_y$  gives 8kohms over 100kohms, or .08. Common log of .08 is -1.0970; multiplying this by -20 gives

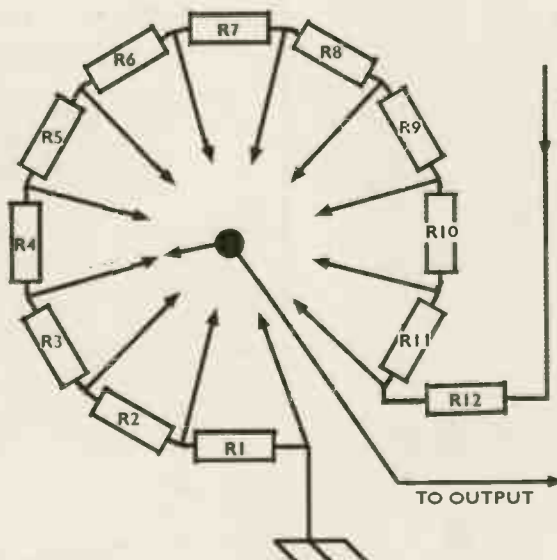

Arranging the resistors on the switch is simplicity itself.

# Falcon Acoustics Ltd

Falcon Electronics, Basically Sound

NEW:-Big Air Core Inductors - 1.25mm wire

DRIVE UNITS: by FOCAL & Seas, and a pick of the best from other manufacturers.  
100+ CROSSOVER NETWORKS: - Active & Passive, Components, Accessories, COMPONENTS

SOLENE Polypropylene capacitors. 0.1mFd. to 100mFd.

Polyester and Polycarbonate Film Capacitors. 0.1mFd. to 10mFd.

ALCAP Reversible Electrolytic Capacitors (Non-Polar); 50v, 100v & Low Loss. 2mfd. to 600mFd.

FALCON Custom-wound Inductors.

FERRITE:- Standard, High Power, Super Power, Super Super Power + AIRCORED 0.56 - 1.25mm wire

TAPPED INDUCTORS:- 0-10mH in 1mH steps & 0-1mH in 0.1mH steps

AUDIO AMATEUR PUBLICATIONS

NEW: Valves for Audio Frequency Amplifiers from Philips Technical Library plus lots in P/L.

Back year sets of Speaker Builder, Audio Amateur & Glass Audio, plus the Audio Anthology Set.

Altogether 50+ books and 50+ Audio Amateurs magazine year sets. 1997 sets available.

COMPUTER PROGRAMS

Large selection of Programs available from the very comprehensive Liberty AudioSuite test

program via AIRR, LoudSpeaker Ver.6, BassBox 5.1, to the basic Bullock/White Box response.

Also the IMP FFT Test Kit, the Mitey Mic Kit and Mic/Preamp kit for Audiosuite or AIRR

See us at the CHESTERFIELD HI-FI SHOW 21 -22 November 98

## FOCAL®

'State of the Art' Kit Designs

B300	8.5litre	2 way Compact,	88.5 dB/watt system;	-3dB. point of 60Hz.
B400	18litre	2 way Compact,	90.5 dB/watt system;	-3dB. point of 55Hz.
C500	30litre	2 way Column,	89.5 dB/watt system;	-3dB. point of 45Hz.
C600	52litre	2 way Column,	91.0 dB/watt system;	-3dB. point of 42Hz.
C700	53litre	3 way Column,	89.5 dB/watt system;	-3dB. point of 38Hz.
C800	83litre	3 way Column,	90.2 dB/watt system;	-3dB. point of 35Hz.

A comprehensive range of Focal kits from an even wider range of High-Tech Loudspeaker units

SUPPLIERS TO THE TRADE SINCE 1972

Send for our FREE price list PL27: Just send a large S.A.E. (38p stamp) or US\$2 bill overseas.  
Europe US\$1 bill or 3 International Reply Coupons (IRC) to:- (Dept HFW) Tabor House,  
Norwich Road, MULBARTON, Norwich, Norfolk. NR14 8JT Tel (01508) 578272

## LOUDSPEAKER and ROOM MEASUREMENT PACKAGES

**LIBERTY AUDIOSUITE v 3** visit <http://www.libinst.com>

Loudspeaker (and Electronic) Measurement System with

\* **HIGHEST CAPABILITY**  
Now with Multitone distortion measurements (IMD) using up to 4 simultaneous test stimulus frequencies, plus many new added functions

\* **STRAIGHTFORWARD OPERATION**  
With built-in, expanded, EASY SCRIPTS

\* **DOWN TO EARTH PRICE** **£696.00 plus VAT**  
Plus £15 next day delivery

**ETF4** (WINDOWS95/NT) visit <http://www.etfacoustic.com>

Room Measurement and Analysis System

\* **ROOM ACOUSTIC MEASUREMENTS**  
presented in simple graphical form, easy to understand

\* **DESIGN ROUTINES for HELMHOLTZ RESONATORS and QRD DIFFUSERS** for you to correct room acoustic problems

\* uses your existing soundcard, and an omni mic **£ 80.00 plus VAT**

**LspCADv3** visit <http://hem1.passagen.se/ijdata>

Combined Room / Loudspeaker Box / Crossover program

\* imports data from LAUD, LEAP and MLLSA **£68.00 plus VAT**

Tony Seaford at MARTON MUSIC  
Phone 01282-773198 or Fax 01282-776413  
e-mail 106505.251@compuserve.com

## Arcadia Valve Amplifiers



### New Line Level Pre-Amplifiers

Two Models Available.

6 line inputs, 10dB of gain, zero feedback  
finest quality components, musical results

Model 1 £995, Model 2 £1995

"There's none of the wispy airiness and soft, slow bass that one associates with the breed - just consistently fine tone, edge-of-your-seat dynamics and effortlessness."

Jason Kennedy on the Model 1 in Hi-Fi Choice  
Sept '97

OEM, TRADE AND RETAIL ENQUIRIES WELCOME

P.O. Box 21, Bramhall, Cheshire SK7 2FF

Tel/Fax: +44 (0)161 4390727

EMAIL: SJS@AUDIOPHILE.COM

HTTP://WWW.NETFORWARD.COM/AUDIOPHILE/SJS

SJS Electroacoustics  
HAND WOUND INTERSTAGE, OUTPUT AND MAINS TRANSFORMERS FOR VALVE AMPS



SERVICE  
FOR  
ENTHUSIASTS

High quality Push-Pull or single ended  
Output, Mains, Chokes, Interstage, Input and  
Cartridge Transformers



Choose from our catalogue or specify a custom design at no extra charge. Range of package options: full or half shrouded or open frame. Encapsulation, as illustrated for our popular size "P+" for output or mains. All transformers built to order by our craftsmen. Usually 3-4 weeks delivery. Free technical support for all our products (Phone, Fax or internet). Free catalogue. Visa, Mastercard, JCB etc.

E A Sowter Ltd  
PO Box 36 IPSWICH  
IP1 2EI England  
Tel: (+44) (0) 1473 252794  
Fax: (+44) (0) 1473 236188

E-Mail: sales@sowter.co.uk  
techsupport@sowter.co.uk  
Catalogue and overseas  
agents on our Website:  
<http://www.sowter.co.uk>



21.94dB attenuation, which is close but no cigar. The answer is to try another approximation and see if that works. (The correct answer is  $R_y =$  roughly 5kohms)

A Handy Hint For Puzzled People is that when the ratio of  $R_y:R_x+R_y = 1:1000$ , then the attenuation is 60dB. Similarly, a 1:100 ratio gives 40dB, 1:10 gives 20dB and so forth. This does not help much with the values in between, but it does prevent some of the more obvious errors along the way.

### CLIMBING THE LADDER

Given that -60dB is a reasonable level for the first 'live' switch position (one above Off), and that our network in this case needs to be 100kohms total, this makes the first resistor 100ohms.

For the next step, we chose an attenuation of about 54dB which, with a bit of testing by the formula, came out to 200ohms total. 100ohms is already accounted for in the previous step, so our second resistor is also 100ohms. Next step (about 50dB) turned out to need a total of around 350ohms. With the 200ohms of the first two resistors, the third resistor's value is therefore 150ohms.

Carrying on through with this admittedly laborious process eventually yielded the results below:

Resistor	Value	Total	Attenuation
R1	100ohms	100ohms	-60dB
R2	100ohms	200ohms	-53.9dB
R3	150ohms	350ohms	-49.1dB
R4	240ohms	590ohms	-44.6dB
R5	300ohms	890ohms	-40.9dB
R6	620ohms	1510ohms	-36.4dB
R7	820ohms	2k3	-32.7dB
R8	1k	3k3	-29.6dB
R9	2k2	5k5	-25.2dB
R10	4k7	10k2	-19.8dB
R11	15k	25k	-12dB
R12	75k	100k	

As you can see from the diagram, R12 is permanently in circuit because we decided that the final 20% of an audiophile's knob (the loud end) is practically never used. If you think differently, it's simple enough to calculate your own table of values to take account of this, either by omitting R12 or reducing its value. It will, however, be necessary to recalculate all the other values with this in mind. Avoid making any startling leaps. As a guide, a change of 1dB can just about be heard; 3dB (100% louder) sounds like about +25% and so on. We chose to use steps between 3dB and 5dB - a smaller increment would be preferable but then you will need a much more complex and dearer switch.

### TUNING TIME

Once the 'let's build an attenuator' bug has really bitten, and you find yourself filling backs of envelopes with experimental ratios, you can always opt for smaller steps around your usual listening levels. For domestic harmony (needing to answer the telephone, etc) it is handy to have an Off position whatever wild and wonderful custom sequences you develop. It's true that this throws away a valuable switch position, but that reflection will not be much comfort in the divorce-court/padded-cell/mortuary to which an un-silenceable system might lead!

It's not always possible to buy a single resistor which is spot on the calculated value, but near enough is generally good enough in this instance.

### READY, STEADY, BUILD!

The Maka Switch wafers we used have 10 of their tags on the front and the last two on the back. Assembly is quite straightforward as long as you make sure that the resistor which joins tags 10 and 11 doesn't short on the longer wiper tags (I used a bit of spare insulation to prevent this).

And do remember to connect both wipers (back and front), otherwise you'll get a noisy open circuit somewhere along the line. By the same token, it's well worth while checking the 'chain' of resistors with your multi-meter to ensure that there are no dry joints.

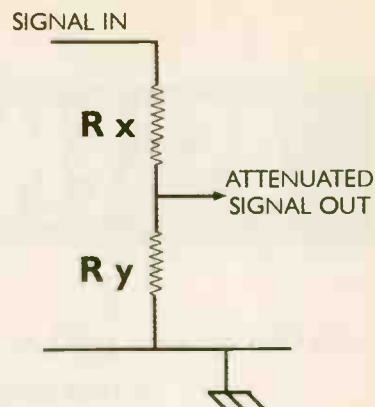

Rx and Ry form a potential divider.

### SOUND QUALITY

Now for the acid test; was that permanent blob of solder on the dining table worth it? I connected our prototype between a Creek CD43 CD player and a TAG McLaren P60 power amp. With the attenuator in the Off position, I set the CD spinning before (moment of truth!) moving up to the first step.

I was pleased to find the resistor values gave a comfortably quiet initial volume level. I was even happier with how crystal clear the music was. Compared with a standard carbon pot, this home-made attenuator delivered crisp, open and balanced sound at its -60dB setting. In addition, the usual bass-droop experienced at low levels was much less marked.

Gradually notching up, I found that the coarse steps we had been obliged to use still produced an ear-friendly progression of loudness and, to return to the *raison d'être* for the whole exercise, the sound quality was streets ahead of a standard pot. Imaging was solid and three-dimensional, tonal colour realistic (if a touch bright with 1% metal-film resistors) and sound staging spacious. The difference over a basic pot was like swapping passive 'speakers for actives - the sound lost a lot of its imprecision and flabbiness, gaining massively in aspects such as dynamics, tunefulness and impact. Considering this simple DIY construction cost less than £10, 'bargain' is definitely the word.

For further experiments, you could have hours of fun trying out different resistor types; given the very positive results with standard .6watt metal films, it would seem the world is indeed your very tweakable oyster!

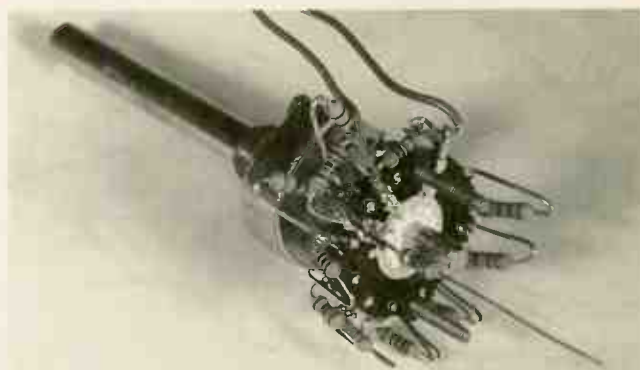

The finished article in all its attenuator glory.

# ASSEMBLAGE ASSEMBLED

In the second part of the Assemblage kit amplifier trials, we look at the ST-40 power amplifier. Leo Lam carried out the construction.



**B**ack in August 1998, I put solder to iron over Assemblage's L-1 hybrid line-level pre-amp which went down a treat at World Towers. This unassuming black box is only half the story though; after all, you won't get very far trying to drive loudspeakers from a pre. Step forward the matching ST-40 power amplifier.

I have a feeling TPC are out to spoil their customers since it's becoming easy to take the high quality of the components in their kits for granted. The ST-40 comes with all the well-known

brands: Multicaps, Kimber Caps (and hook-up wire), Wima and Holco. Even the four EL34s supplied bear the 'WXT' suffix, applied to arguably the most advanced and best-sounding iterations of these valves to date. And as none of the ST-40's bottle line-up is ex-production, the amp is unlikely to present a service nightmare.

## VACUUM IS CLEANER

In terms of active devices, the power is more traditional than the

pre, which has a JFET input stage - there are no solid-state components in the signal path of the ST-40. FETs and BJTs are employed solely for regulating the power supply.

Assemblage claim an output of 40watts into 8ohms, achieved with two pairs of EL34 pentodes running in push-pull. Half an ECC83 acts as the input buffer, leaving an ECC82 as the driver stage. Nipping power-supply nasties in the bud is heavy regulation for the input section. Further seasoning a tempting recipe are output transformers custom made to The Parts Connections' specification by Hammond in Canada, which include three taps for 4ohm, 8ohm and 16ohm loads. Any alterations in this area have to be effected under the bonnet as only one pair of 'speaker terminals is provided.

As usual with Assemblage kits the ST-40 is very reasonably priced at US\$699 in standard form and US\$925 for the upgraded Signature kit (the 'bolt-on' upgrade kit is available separately at US\$249).

### ON YOUR MARKS...

The ST-40 was packaged in a similar way to the L-1, with the transformers ready-mounted on the casing to avoid breakage and all the components in their own clearly-labelled plastic bags (don't tell Greenpeace!) The assembly procedure is the same as for the L-1 too: if the manual tells you to install capacitor C1, track down the bag carrying that label and simply solder the component into the position clearly marked on the circuit board.

As is customary with Assemblage's offerings, the ST-40 arrives with very detailed and helpful instructions illustrated with photographs and diagrams. I must stress, however, that the majority of the instructions for the ST-40 are text-only, and it is a good idea to have a careful read before starting.

### TOOLING UP

To construct the amp you will need the following tools: a soldering iron; Philips screwdrivers (sizes 0 and 1); a 1/2in. spanner; a 3/8in. combination spanner; a pair of needle-nose pliers; a wire-stripper (be kind to your fingers, do NOT use hobby knives); a 1/16in. Allen key; a ruler for some rough measurements; and a multi-meter for some high-voltage measurements and the final biasing adjustment. I always find that a bit of Blu-Tac and a desoldering gun are handy to have around as well.

Before I detail some of the building steps, a serious word of warning. The ST-40 contains voltages as high as 500VDC, which is definitely lethal. For this reason, the ST-40 is not for beginners. Furthermore, extreme care must be exercised during construction. Above all, take your time: this is easily TPC's most demanding kit, so don't ruin yours by rushing it!

### STEP BY STEP

To minimise the chances of damaging them and incidentally to make life a lot easier, the transformers should be unbolted before any assembly is done. I reckon these contribute to about 90% of the weight of the whole amplifier, so do your back a favour. They are easily removed by undoing the nuts and stand-offs holding them in place.

Next, a number of stands-offs can be mounted on the top side of the circuit board (clearly explained as 'the side without the silk-screened prints'). Three B9A sockets can then be soldered to the same side of the PCB, followed by the octal sockets which sit on the previously-fitted stand-offs. The orientation of these

octals is important; the 'keyhole' must be aligned with the printed outline. Since these sockets will later protrude through the main chassis, get the alignment spot-on before soldering them in. Once you've done that, though, the topside of the PCB is complete.

### PCB ASSEMBLY

All the remaining parts are installed on the underside of the board, where their component numbers are clearly printed. Populating the PCB here is pretty much identical to the method involved in the L-1: all the components have their 'reference designator' (part number, I suppose), eg R1, C12, etc. Find the bag with the right resistor or capacitor and solder them into the location marked on the PCB. As a good habit, check the value on the list and instal the parts with their values showing, to facilitate error checking later. It may be a little more time-consuming but it pays off every time.

Some of the ST-40's resistors and diodes get hot during use - these are marked and should be raised by a quarter-inch for better ventilation. Other components are not marked on the board at all and you'll find directions in the literature like, "not labelled, but located directly below/above Rxxx". Don't despair; these descriptions are all very obvious when the kit is actually in front of you.

Once the passive components (resistors, potentiometers, diodes and capacitors in that order) had been dealt with, it was time for the semiconductors. To avoid contamination by static, always earth yourself before handling these and do not underestimate the importance of the isolation pad between a device and its heatsink. Neglecting either of these precautions can cause an instant breakdown, rendering the part completely useless. With the semiconductors in place, the main circuit board is complete.

### POWER SUPPLY BOARD

A small PCB houses the power supply and this is mounted to one side of the main chassis. Onto this go the passive components, fuse clips and power switch. The sole brain taxer here is checking the polarity of the large electrolytic capacitors, as ever clearly marked on the board. The consequences of incorrect connection could be explosive!

### THE MAIN CHASSIS

Now the PCBs are finished, the remaining hardware can be mounted (things like the bias test-point jacks, the IEC mains socket, 'speaker binding posts, RCA inputs and the chassis earth lugs). There is quite a lot of hard-wiring in this project, so it is important to keep cabling tidy to avoid mistakes.

The three transformers are then hoisted into place, followed by the main PCB. After that, the input AC voltage should be selected by soldering the indicated wires to the IEC socket.

Connecting the power transformer secondary windings proved much more irksome. There are six wires with different colours (can people with colour blindness tell orange from red? Let's hope so!) coming out of the transformer and they must be soldered to the correct (close-tolerance) holes. The bias test-point jacks were then hooked up to the PCB with jumpers saved from the resistor leads.

More wiring follows for the output transformers and the input stage. The only irreducible requirement here is patience. There are seven sets of hook-up wires to strip and solder, and therefore seven chances of coming adrift. Make sure you study the



# Rothwell

## THE ULTIMATE VOLUME CONTROL

12 way  
coarse control

custom made  
switches with  
silver plated  
contacts

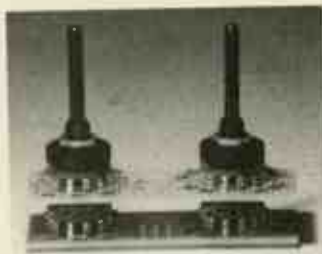

12 way fine  
control (with  
steps of less than  
1dB)

low noise, high  
quality metal film  
resistors (1%  
tolerance 50ppm  
tempco)

The Rothwell Stepped Attenuator is truly the ultimate volume control. Two 12 way dual gang (stereo) devices are used, one for coarse control, the other for fine. The combination gives 132 volume settings with steps of less than 1dB, and channel balance better than 0.1dB. No pot can come close to the performance of this unit. The sound quality of the attenuator can be staggering when compared to a pot. The expensive "audiophile" pots using plastic film or cement tracks pale in comparison. Space, imaging and sheer detail are unsurpassed. This unit may look like an overkill solution to the problem of poor pots, but hearing it proves that it is justified.

This high performance volume control is available as a 10K unit (ideal for passive pre amps), or as a 100K unit (ideal for valve pre amps).

The cost is £79. inc. VAT and p&p, and each attenuator comes with a free copy of "The Pre Amp Constructor's Guide". The Guide contains invaluable advice for the would-be constructor, along with 6 different circuits for use in valve pre amps.

To order one of these superb volume controls, simply send a cheque for £79. Please state 10K or 100K when ordering. "The Pre Amp Constructor's Guide", (free with each attenuator) is available separately for £3.50.

**Rothwell Electronics, 60 Pennington Road,  
Great Lever, Bolton,  
BL3 3BR  
Tel/fax 01204 654614**

## ACTIVE CROSSOVER MODULES

- A true reference for other active crossovers.
- Individually calibrated in our workshop for your loudspeaker. Analogue phase linear.
- Square wave output unmatched by any other available crossover.
- User adjustment of phase and frequency response, time lag, equalisation, driver sensitivity. - Instructions supplied.
- More accurate than the best loudspeaker computer software.
- Built using audiophile components.
- Fully alterable for future loudspeakers.
- Available for 2 way, 3 way, satellite and subwoofer systems.
- Specifications: <0.0002% Distortion.  
>110dB S/N Ratio.  
<0.5uS Rise Time.  
0Hz to 450kHz Bandwidth.

## AUDIO LINKS

7 Fairmont Crescent, Scunthorpe,  
North Lincolnshire DN16 1EL  
TEL/FAX (+44) 01724 - 870432

# LANGREX SUPPLIES LTD

DISTRIBUTORS OF ELECTRONIC VALVES, TUBES AND SEMI-CONDUCTORS AND I.C.S.

1 MAYO ROAD • CROYDON • SURREY CR0 2QP

24 HOURS EXPRESS MAIL ORDER SERVICE ON STOCK ITEMS

E MAIL LANGREX@AOL.COM

PHONE

0181 684 1166

FAX

0181 684 3056

A selection of our stocks of New Original Valves / Tubes.  
Many other brands available.

STANDARD TYPES			SPECIAL QUALITY TYPES			AMERICAN TYPES			OTHER TYPES		
ECC88	BRIMAR	4.50	A2900/CV6091	GEC	17.50	6L6GC	GE	15.00	ECC81	RFT	3.00
ECC88	MULLARD	6.00	E88CC/CV2492	BRIMAR	4.50	6L6WGB	SYL	10.00	ECC82	RFT	3.50
ECH81	MULLARD	3.00	E88CC/CV2492	MULLARD	8.50	12AX7WA	SYLVANIA	6.00	ECC83	RFT	5.00
ECL82	MULLARD	5.00	ECC81/CV4024	MULLARD	6.00	12BY7A	GE	7.00	EF86	USSR	5.00
ECL86	SIEMENS	5.00	ECC81/M8162	MULLARD	7.50	5687WB	ECG	6.00	EL84	USSR	2.25
EL36	MULLARD	5.00	ECC81/6201	MULLARD	8.50	6072A	GE	6.00	EL34G	SOVTEK	6.00
EL84	RCA	5.00	ECC82/CV4003	MULLARD	6.00	6146B	GE	15.00	E34L	TESLA	8.00
EZ81	MULLARD	3.50	ECC82/M8136	MULLARD	7.50	6336A	RCA	35.00	6SL7GT	USA	5.00
EZ80	MULLARD	3.50	ECC83/CV4004	MULLARD	7.50	6550A	JAN GE	25.00	6SN7GT	USA	5.00
GZ33/37	MULLARD	6.00	ECC83/M8137	BRIMAR	6.50	7027A	GE	25.00			
5Z4G	BRIMAR	5.00		MULLARD	15.00	7581A	SYL	15.00			
6V6GT	BRIMAR	4.25									
12E1	STC	10.00									
13E1	STC	85.00									
807	HYTRON	7.50									
811A	RCA	25.00									
6080	MULLARD	10.00									

THESE ARE A SELECTION FROM OUR STOCK OF OVER 6000 TYPES. PLEASE CALL OR FAX FOR AN IMMEDIATE QUOTATION ON ANY TYPES NOT LISTED. WE ARE ONE OF THE LARGEST DISTRIBUTORS OF VALVES IN THE UK.

SAME DAY DESPATCH VISA/ACCESS ACCEPTABLE. OBSOLETE TYPES A SPECIALITY.

CREDIT CARD MIN ORDER £10.00.

OPEN TO CALLERS MON.-FRI. 9AM - 4PM. CLOSED SATURDAY

U.K. P&P 1-3 VALVES £2.00, 4-6 VALVES £3.00 ADD 17.5% VAT TO TOTAL INC P+P. O'SEAS P & P PLEASE ENQUIRE



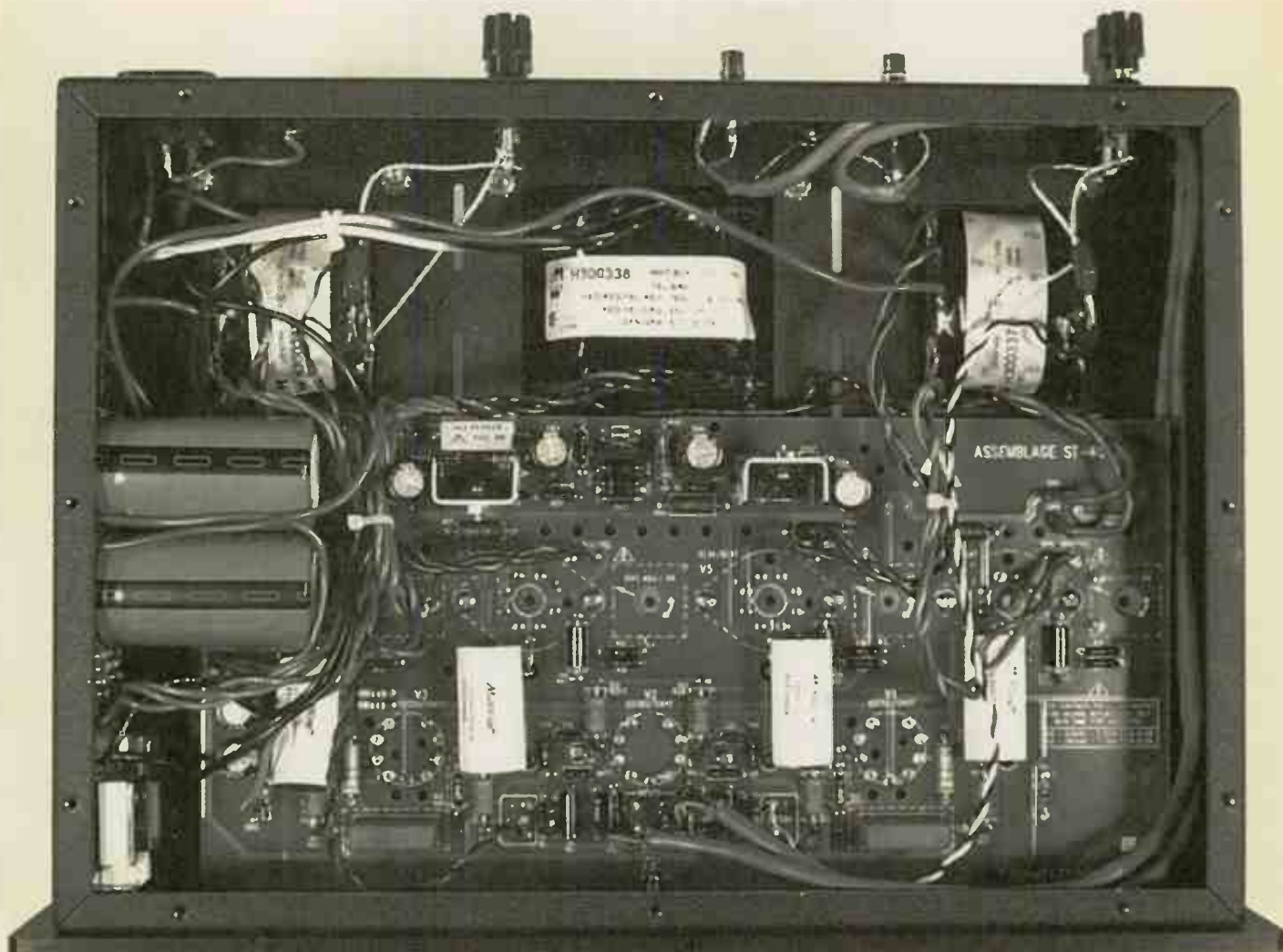

Inside the ST-40. Here you can see the amplifier's innards after the upgrade components (which we'll cover in more detail in a forthcoming Supplement) have been fitted. The PCB has plenty of space for larger parts which makes assembly easy.

instructions very carefully; if you are running out of concentration or patience, leave it. Have a cup of tea and try again when you're feeling sharper. Remember, high voltages are involved; don't let them get involved with you!

After the transformers' wiring and some little pieces of hardware like the feet, the power supply board can be installed. Again, plenty of wiring links it to the main PCB and the IEC socket, so be absolutely sure all the cables are placed correctly. Some will be carrying over 500V to the main PCB. Once this is done, basically that's it!

### THE BEGINNING OF THE END

After putting the buttons and fascia in place, the rest is down to checking and adjustment. Insert the fuse and the input valves (not the EL34s); double-check all the wiring and components. All present and correct? Good! Now you can place the amplifier upside down and turn the power on. The valves and the face-plate LED should start to glow. The HT for the input valves should be around 525VDC on pins 3 and 4, and -70V on pin 5. If these are alright, turn off the unit and wait at least five minutes to allow the capacitors to discharge before you work on it again.

### FIVE MINUTES LATER...

Now the bottom cover of the ST-40 can be attached and the

EL34s plugged into their sockets. The biasing potentiometers should be set to their highest rating to minimise the biasing current. Turn on the amplifier with your loudspeakers connected and adjust the bias voltage to 0.4V with respect to ground.

For the first few hours the bias is likely to drift, so TPC advise checking it every 15 minutes until things stabilize. After that, adjustments should be minimal. That's all there is to it! Fortunately, mine worked first time so I started the running-in, which took about a week. The whole kit had taken one evening (about five hours) to build, start-to-finish, non-stop.

### SOUND OFF!

The ST-40 was hooked up to the rest of my Assemblage system: the L-1 (still in standard form) fed by the DAC-2, which was in turn fed by Teac's T-1 transport. Through a short run of Kimber 8TC 'speaker cable, I tried out ProAc's Studio 150s, Heybrook's Heylettes and the current-hungry Seas Mini Monitors, all on the 8ohm tap. A Musical Fidelity Nu-Vista was sometimes employed to exploit further the virtues of the ST-40. It may be a little unfair, but since the Power 35 from Unison Research was the only other EL34 push-pull power amplifier I had to hand, I pressed it into service for comparison.

I was pleasantly surprised to find the ST-40 driving the



# The Chesterfield Hi-Fi Show

November 21/22 1998  
at

Ringwood Hall, Chesterfield, Derbyshire

(on A619, 4 miles west of J30, M1)

10am to 6pm

Britain's brightest hi-fi and audio show takes place at its favourite venue again.  
Don't miss the special Show Offers.

You'll find a good relaxed atmosphere, heaps of good music (to hear and buy), good food and drink, a country hotel setting, loads of vinyl (new and second-hand), used, vintage and new equipment, Collectors' Corner, Audio Society stands, Components, kits and spares, books, cables, some of the nicest people in the business, no aggressive pressing crowds, probably the best sounding hi-fi in the UK and much much more.

£5.00 entry includes FREE parking and a wealth of aural and visual delights

For more information contact: 01246 207240

(24-hour computerised Voice Information Service and Faxback Service)

Organised by: Avondale Audio and The Chesterfield Hi-Fi Show Ltd. PO Box 50, Chesterfield S40 4YU

## SPEAKER KITS FROM IPL ACOUSTICS

Over a 9 year period I.P.L. ACOUSTICS have developed a range of high quality speaker kits, using the best units from SEAS, MOREL, AUDAX, and I.P.L. and have produced a comprehensive range of speakers which will compete with the most expensive of commercial designs.

All speakers have biwired crossover kits containing high quality components and terminals.

S5TL  
TRANSMISSION LINE



PLUS KIT .....£382.00  
TOTAL KIT .....£506.00

FIVE TRANS-  
MISSION LINE  
KITS

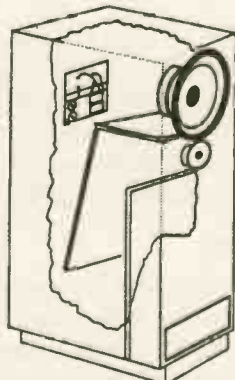

TRANSMISSION LINE  
PLUS KITS .....£177.00 -  
.....£382.00

M3TL  
TRANSMISSION LINE



PLUS KITS .....£177.00  
TOTAL KIT .....£241.80

A2 H.D.A.  
AEROGEL KIT



PLUS KIT .....£187.50  
TOTAL KIT .....£259.00

S3TLM METAL  
TRANSMISSION LINE



PLUS KIT .....£233.00  
TOTAL KIT .....£311.50

PRE-VENEERED CABINET KITS NOW AVAILABLE. Carriage charge extra on all kits.

If you would like further details please send large SAE with 36p stamp for PAGE SPEAKER BUILDING CATALOGUE, comprising VALUABLE ADVICE on DESIGNING, BUILDING, and TESTING speakers and full technical specifications including response curves of eight kits drive units and details of SPECIALIST CABLES and ACCESSORIES KITS FOR A V USE NOW AVAILABLE.

I.P.L. Acoustics, 2 Laverton Road, Westbury, Wiltshire, BA13 3RS. Tel: 01373 823333



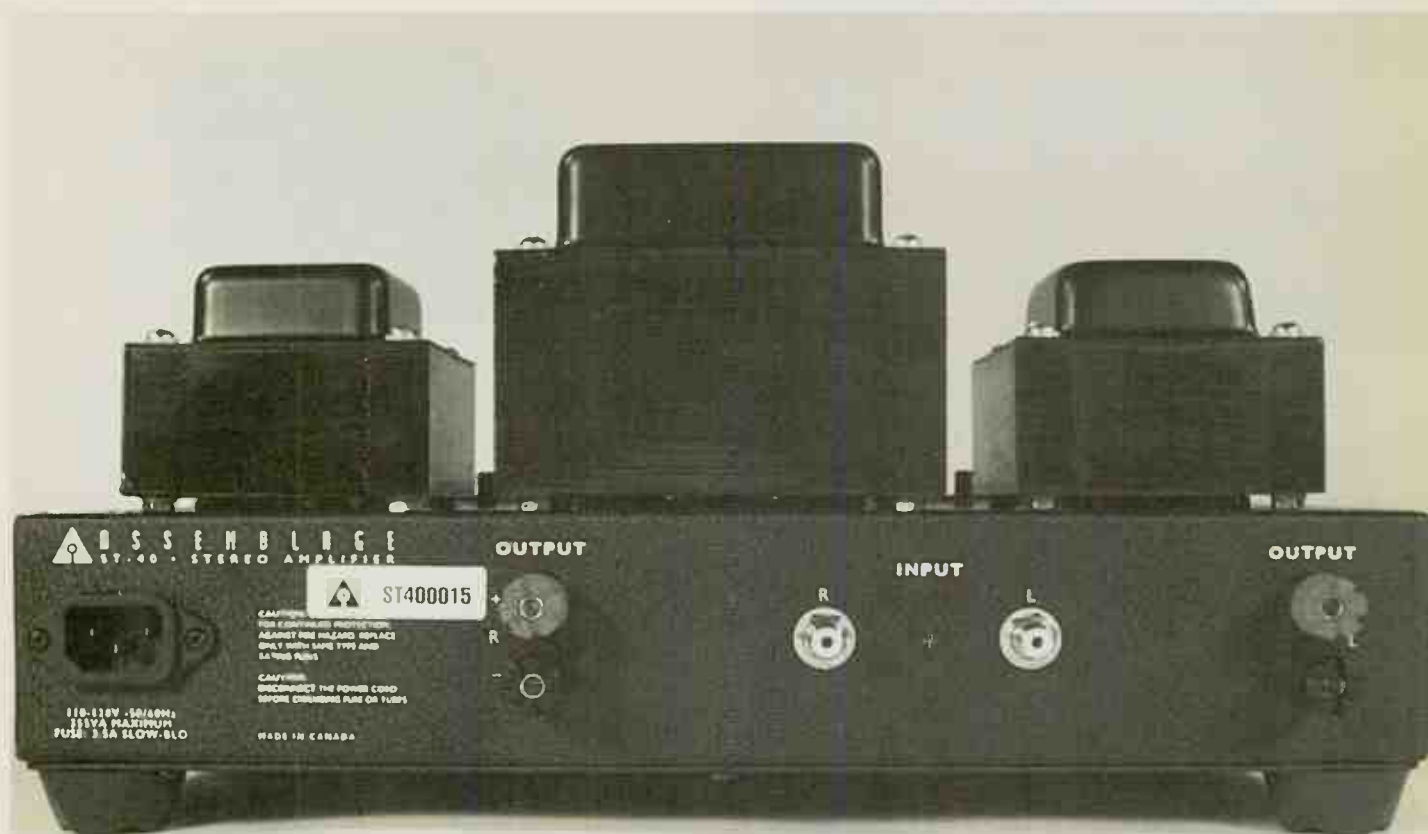

The ST-40's rear panel is uncluttered. The transformers are tapped for different loudspeaker impedances, but only one set of terminals is provided. Swapping loads necessitates removing the bottom-plate for a little rewiring

ProAcs with great control and composure. The 150s, with their three Seas drivers, are not the easiest of loads for valve power amplifiers, yet the Assemblage put up a decent fight. Midrange was lush and warm whilst retaining the harmonic content of the instruments being played. Treble was soft and delicate but tended towards the warm side rather than being overly enthusiastic. The ST-40 is obviously all about calm and stability. The most commendable characteristic was its bass; very extended, even more so than the Unison Research. It was as if the depth was limited only by the loudspeakers and not the amplifier.

The ST-40 had a winning way with Classical pieces. There was a complete lack of sharpness and grain, which can mar the most commendably dynamic performances. The only downside was a general lack of transparency which was slightly disappointing considering the super-high parts quality inside. With the Power 35, it was possible to appreciate

every string of a guitar and every single pix of a violin's cato. Unfortunately, the Assemblage wasn't able to pull these together convincingly and as a result the finer points of the dynamics were restricted. But, and it's a big BUT, do note that this was the standard un-tweaked kit; there is an upgrade still to come!

Considering its cost, this amp is a real over-achiever and certainly good value for money. Of course the rate at which you supply your own labour to yourself is up to you!

### OOPS!

There was one hiccup in an otherwise vice-free spell with the Assemblage. While it was back at World Towers to sit for its portrait, the general impression of its performance was poor. The ST-40 was hooked up via its 4ohm taps driving the Jamo Concert 8s. E-mail was exchanged and the fault discovered.

Glenn, Assemblage's cheerful Product Manager and incidentally the ST-40's

designer, discovered that the output transformer varied from specification and that the feedback network was not optimised for 4ohm operation. However, since 8ohm performance was claimed to be unaffected, this review was done solely with the amplifier configured for that load.

According to Glenn, new transformers have been ordered and a feedback network optimised for 4ohm operation is being finalised. Existing customers can call The Parts Connection who will gladly replace the output transformers free of charge. The feedback network for 4ohm working will also be provided. Once again, though, the manufacturing problem with the transformers did not affect the amplifier's 8ohm performance whatsoever.

(In the L-1 review of August 1998, the price of the kit was omitted. The standard L-1 should cost US\$599, the Signature kit (with upgrade parts) US\$875 and the upgrade kit bought on its own US\$299)●

## AN ANSWER.....

From the U.K.'s Premier Valve-equipment Repair/Restoration Centre...  
to the question we're most-oft asked:

"What exactly do you do?". Well, we.....

**Repair, Restore, Re-calibrate, Re-align:-**

Tape recorders by *Revox, Akai, Tascam, Teac* (up to 1");

Valve - amps., pre-amps., tuners, cinema amps.,  
theatre-organ amps., industrial/p.a. amps. from *Radford, Quad, Leak,*  
*Kalee, Clarke & Smith, Compton, Parmeko, RCA, Altbass etc.;*

Valve - Communications Receivers and Transmitters  
(to 30MHz/2kW/6" tall) by *KW, Marconi, Labgear, Eddystone,*  
*Redifon, RCA, Tiger:* and so on.

We will....

Build that Kit for you or

Re-build it if you've had a go but it's gone pear-shaped.

We will....

Custom-build for you a published Classic design.

Design something special (a 250-watt AB2 high-level modulator, Sir?  
No problem!!) and build the prototype.

All this,

as well as being an Authorised Service Centre for such respected  
names of the Digital Era as *Denon, Pioneer, Kenwood, Yamaha.*

\*\*\*\*\*

Overall, some pretty comprehensive facilities....and it will take only  
a few minutes of your life plus a few pence from your pocket to call/fax  
and discuss your requirements: **0113 244 0378.** Or write!

We are:-

### AUDIO LABORATORIES (LEEDS)

3 Kildare Terrace Industrial Estate,  
Leeds LS12 1DB, England.

VA

## Audiophile Sound • Professional Finish • Affordable

Our aim at Riverside Audio is to enable the home constructor to  
build valve amplifiers which combine true audiophile sound quality  
with the professional finish of high-end products at an affordable price.



The Riverside 4040 is an integrated amplifier featuring dual mono  
construction, five line level inputs and both 4 and 8  $\Omega$  outputs. The  
chassis is hand polished stainless steel and includes a matt black  
valve cover. The amplifier delivers 40 Wrms per channel at less than  
0.1% distortion. Kit £625, fully built £725.

The Riverside P2 moving magnet phono amplifier is designed to  
partner the Riverside 4040 for those who enjoy the vinyl sound. High  
accuracy equalization is provided for a moving magnet input to a gen-  
erous line-level output. Kit £225, fully built £275.

Contact Riverside Audio for further information and pricing. Most  
parts are available separately - even down to individual components.  
Riverside Audio can also design special audio mains and output trans-  
formers.

Riverside Audio, 18 Riverside, Cambridge CB5 8HL  
Telephone (01223) 512253 Facsimile (01223) 572629  
Internet—<http://www.riverside-audio.demon.co.uk/>



## Vacuum Tubes for Audio Are Back!

*Glass Audio* brings together  
yesterday's tube with today's  
improved components, voltage control,  
and the exciting new Soviet tubes,  
to make smooth sound in your  
livingroom possible again!

# YES!

Please send my first issue of *Glass Audio*. I'll pay just \$45.00 for six issues  
(1 year); \$80.00 for 12 issues (2 years) of the best information on tubes to be found  
anywhere. I understand that my satisfaction is guaranteed!

Name \_\_\_\_\_

Street & Number \_\_\_\_\_

City \_\_\_\_\_ Postal Code \_\_\_\_\_

Country \_\_\_\_\_

REMIT IN US \$ DRAWN ON A US BANK ONLY. PRICE GOOD THROUGH DECEMBER 31, 1995.

We Accept MC/VISA.

## Glass Audio

PO Box 176, Dept. HFWS, Peterborough, NH 03458-0176 USA  
Phone: (603) 924-9464 or FAX 24 hours a day (603) 924-9467

# TESTING LOUDSPEAKERS

By Joseph D'Appolito

Reviewed by Noel Keywood.

**T**esting Loudspeakers tries to work from the basics right up to the Fast Fourier Transform in an attempt to cater for enthusiasts as well as beginners. In my view, the book is theoretical enough to make it suitable mainly for students and engineers. It works with theoretical models and the maths developed to describe and predict their behaviour. Providing the models are accurate, this is fine; otherwise this way of seeing things is not especially useful.

Concepts like displacement, velocity and acceleration response come in early, and the driver impedance curve, which Gilbert Briggs noted tells all, is up for discussion by p14 in a 174-page book. Moving at this pace means Testing Loudspeakers is a relatively dense read. It is also thorough, so fairly obscure subjects such as the behaviour of an air spring and the notion of Vas are discussed succinctly.

D'Appolito goes on in this chapter to discuss three different methods of driver impedance measurement, together with their drawbacks - definitely a valuable exercise. Less appealing is his writing style, which was obviously learned at the very rigid "I will now present" school of composition, with infuriating "it is therefore obvious that" when it usually isn't and cannot be either.

The third chapter, covering impedance measurement of entire loudspeakers, is relatively brief. It lists the measurement methods and equations necessary for deriving all the parameters needed to conform to common alignments listed in the Loudspeaker Designer's Cookbook.

Impedance testing and equation derivation deals with the electrical input of the loudspeaker. Chapter 4 moves to the acoustical side of things, talking about the various near-field and far-field options, their benefits and drawbacks.

Having tried all the old ways of measuring loudspeakers myself, including 30ft. towers and high brick walls (both disastrously useless), real anechoic chambers (GEC Hirst Research) and many different domestic lash-ups, I warmed to the author's pragmatic view

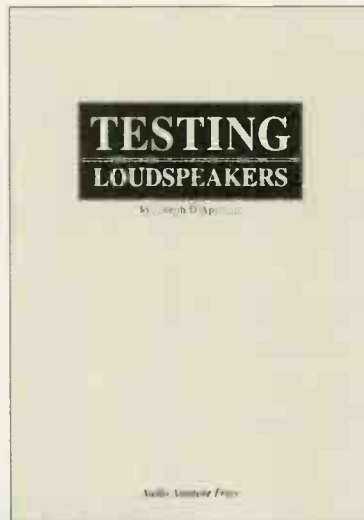

that you can get useful data by intelligent testing with modern equipment in a reasonably-sized space. This gives results, I have found, that are close to those from an anechoic chamber, at considerably less cost.

Elucidating the differences between white noise and pink noise, their power spectrums and why one is used with a constant-bandwidth analyser and the other a constant-percentage bandwidth analyser is the acid test for clarity of thought and exposition. This book doesn't pass it well. I didn't feel the explanation was either simple or comprehensible enough, nor that clarity was the author's forte in, say, the way it was with M.G. Scroggie. But then Scroggie was probably the best technical author ever, with a deeper understanding of resonant systems and the role of reactance than most.

The next chapter, No5, concerns the acoustical testing of entire loudspeakers rather than drive units. It runs through driver 'integration', near-field and far-field measurement, polar responses and subwoofer power response.

Again, the information contained herein is wide-ranging and useful, and raises the pertinent point that this is difficult territory if you don't enjoy the luxury of an anechoic chamber. A little less theory and more pragmatism is needed, perhaps. What is a loudspeaker's

frequency response, for example? Since it differs wherever you put the microphone, can there be one response? This sort of thing needs consideration and discussion.

Finally, we have 'The Big One': the Fast Fourier Transform. Even D'Appolito, quick to dive into equations as apparent explanations for things, acknowledges that gaining an intuitive understanding of this is important but difficult.

Furthermore, explanations of the FFT, aliasing, window periods versus the low-frequency limit et al are uncommon.

The best I have seen (by Hewlett-Packard) used a three-dimensional graph with time, frequency and amplitude axes showing how sine waves might behave in time and how they can be represented by 'lines' on an FFT screen. Then the sine waves can be graphically added, Scroggie-style, to show how many sine waves can form a complex signal, and vice-versa.

All I can say about this chapter is that I don't feel the explanations were especially lucid. They were again thorough, however, and tackle difficult issues like phase, time and group delay.

The last chapter gets to grips with actual testing using a personal-computer-based measurement system. This is important because MLSSA in particular is popular amongst loudspeaker manufacturers and is something of an industry standard. With its practical approach, this final chapter will appeal to many experimenters, who these days will almost certainly approach the subject with a PC-based FFT and measuring mic.

In my view Testing Loudspeakers is about the theory behind measurement. Since measurement is a dangerous business waiting to trip up the unwary, it is a vital precaution to understand the theory first, even if only in outline. For comprehensive coverage of theory, this book is first-class. For uniqueness it also scores; I know of no other texts like this. For clarity of exposition it is mediocre; expect to read any one explanation many times. As I said, this publication is more for students and engineers who must bone up on theory. If it is for beginners, then my heart goes out to them.

TESTING  
LOUDSPEAKERS  
BY  
JOE D'APPOLITO  
available from our  
World Library  
see p50 for  
order form  
Book code 1580  
Cost 24.95GBP  
+ 2.50BP UK p+p  
paper back



# Colomor (Electronics) Ltd

Unit 5 Huffwood Trading Estate, Brookers Road, Billingshurst, West Sussex RH14 9RZ Tel: 0(44)1 403 786 559

Fax: 0(44)1 403 786 560 E MAIL - sales@colomordemon.co.uk

## VALVES SPECIAL OFFER

	£p each	£p each
803 USA	50.00	ES91 1.00
807 CERAMIC BASE	20.00	EF95 1.00
807 USA	5.00	PCL86 4.5V, HTR, ECL86 0.50
808 POA		£35 / 100; £250 / 1000
813 RCA	35.00	PT15 MARCONI 35.00
1625 USA	3.50	PX4 POA
6CH6 Bnmar	2.50	PX25 POA
DA100 POA		VT4C211, GE, USED, TESTED & GUARANTEED 45.00
DG7-32 MULLARD	10.00	B4 BASES 1.00
ES5L/8233 AMPREX	16.00	B5 BASES 1.50
E80F	5.00	
E180CC	2.50	
EB91 6 AL5	.70	
ECC88 MULLARD / FOREIGN	2.00	
ECC803 TELEFUNKEN	18.00	
EF37A MULLARD, GREY	2.50	
EF39 CV1053	1.25	

PLEASE SEND LARGE  
1st CLASS STAMPED  
SAE FOR OUR  
FREE VALVE CATALOGUE.

## TRANSFORMERS, CHOKES & BLOCK CAPACITORS

Oil filled block capacitors by TTC Dublier 5uf, 1uf, 2uf, 4uf all at 600V £6.00 ea.	500mA 6.3V 300mA 4V 500mA £40.00	5H, 400mA £38.78 ea; 7.5H, 250mA £30.00ea
Buf, 600V; 5uf, 1KV; 1uf, 1KV; 2uf, 800V; 4uf, 1KV £8.00 ea.	Primary 115-250-440V Secondary 640-0-640V 160mA 330-0-330 225mA £50.00	10H, 75mA £23.50 ea; 10H, 170mA £33.00ea 20H, 50mA £30.00ea
Buf, 800V £10.00 ea.	New Mains Isolation Transformers 250V, 50Hz, 1to 13kvA, 13A fused Class F, 13A Skt & Plug £95.00 ea.	10H, 70mA Resin Filled £20.00 ea. 10H, 75mA Varnished £10.00
Oil filled Transformer, Gardeners	Oil filled Chokes by Parmeko/ Gardeners 2.5H, 220mA; 2.5H, 350mA; 4.5H, 150 mA; 4.5H, 220mA; 4.5H, 280mA; 5H, 110mA; 5H, 200mA; 5H, 250mA; all at £30.00 ea.	.6H, 300mA Gardeners, varnished, £8.00 5H, 100mA Oil, Parmeko, £15.00 15H, 25mA, Gardeners, varnished, £6.00ea 20H, 75mA, Oil Parmeko, £30.00ea.
Primary 110 250V Secondary 400-0-400 75mA 6.3V 5A 6.3V 2.5A 6.3V		

## OTHER VALVES £p each

ECC81	2.15	5R4GA	6.15
ECC81	6.00	5R4GY	5.80
ECC82	2.50	5U4G	4.95
ECC82	7.25	5U4G	6.00
ECC82	8.00	5Z3GT	3.60
ECC82	10.00	5Z4GT	1.90
ECC82	12.50	6B4G	6.00
ECC83	3.35	6B4G	28.95
ECC83	9.50	6B4G	35.00
ECC85	2.30	6BH6	2.60
ECC85	6.00	6FQ7	9.45
ECC88	2.00	6L6G	30.00
ECC88	4.95	6L6	9.80
ECC88	10.00	6L6G	6.40
ECC88	10.00	6L6 GC	14.90
E88CC	10.00	6L6 GT/C	2.50
E88CC/01	16.95	6L6 WGA	12.00
E88CC/01 MULLARD	1.60	6L6 WGB	12.00
ECH81	3.50	6SL 7GT	2.35
ECL82	4.50	6SL 7GT	8.00
EF86	11.00	6SN7GT	36.0
EF86	12.75	6SN7GT	8.00
EL33	6.00	6V6 GT	5.10
EL34	6.15	6X4	2.00
EL34B	27.45	6X4 WA	3.30
EL37	2.15	12BY7	8.45
EL84	5.10	12BY7A	8.45
EL84	1.90	13E1	7.60
EZ80	6.00	85A2	2.20
EZ81	6.00	6072A	7.45
GZ33	13.00	6146	13.85
GZ34	3.50	6336A	49.00
GZ34	15.00	6550A	9.55
GZ37	7.00	6550A	24.14
KT66	52.00	6550A	32.00
KT88	17.85	6550-B2	12.75
VT4C	12.00		

VAT @17.5% TO BE ADDED TO ALL UK & EEC VATABLE ORDERS  
P&P UK 1-3 valves £1.95 4-6 £3.00 7-10 valves £4.55  
Other countries please apply for tariff.  
Payment by Cheques, PO's, Banker's Draft  
sent to address above. Please

## WIRE & INSULATION

introduce **DESKADEL** Products

731/733 Ormskirk Road • Pemberton  
Wigan • Lancashire • England • WN5 8AT  
TEL/FAX: 44 - 1 - 942 887171



DRAAD & ISOLATIE  
HI & ISOLATION  
DRAHT & ISOLATION

The DESKADEL range of HI-Fi interconnect, speaker cables, hook-up wires and tone arm wires are precision manufactured featuring PURE SILVER conductors insulated with PTFE in a variety of designs to suit all applications. Using only the finest materials and the latest manufacturing techniques we aim to provide a selection of quality products for superb natural sound reproduction on a scale previously unheard.

INTERNATIONAL TRADE ENQUIRIES WELCOME

## DISTRIBUTORS:

Switzerland  
**ARBELOS**  
Tel/Fax: 41-613616466

UK  
**AUDIO SYNTHESIS**  
Tel: 44-1-159224138  
Fax: 44-1-159229701

Holland  
**ANALOGUE AUDIO PRODUCTS**  
Tel/Fax: 31-30-6044342

Belgium  
**DESKADEL INT BVBA**  
Tel: 32-3-8892231  
Fax: 32-38609181



# DIY

---

# Letters

## SUFFERING FROM BIAS

I need your help and expertise. I would like some pointers on how to check the bias settings on an amp running EL34 tubes. What does one need to perform such actions and how do you do it (I own a Jadis Orchestra valve amp). It's an ultra-linear, push-pull design running two 12AX7s and four EL34s. I opened up the amp and took a quick look at one channel.

The pins were as follows:

- 1) Pins 1 and 8 of the EL34s are connected to each other and a fuse rated at 314mA/250V before it's grounded.
- 2) Pin 2 and 7 are for the heater.
- 3) Pin 3 is connected to a 5kohm resistor at the output transformer.
- 4) Pin 4 is connected to a 460kohm resistor at the output transformer.
- 5) Pins 5 and 6 are connected to a small, adjustable potentiometer that reads "22kohm 734M". One of its legs is grounded. Any help on this matter is much appreciated.

Mr Kamarudin

To check the DC bias settings of your amplifier you'll need a good multi-meter to measure the operating current of each valve. As I am not familiar with the details of the Jadis Orchestra you will also have to measure the HT voltage supplying the EL34s in order to calculate the dissipation

of each valve, which should really remain below 25watts for the sake of longevity.

Before doing anything to the amp bear in mind that, if you make a bad mistake you could give yourself a potentially lethal

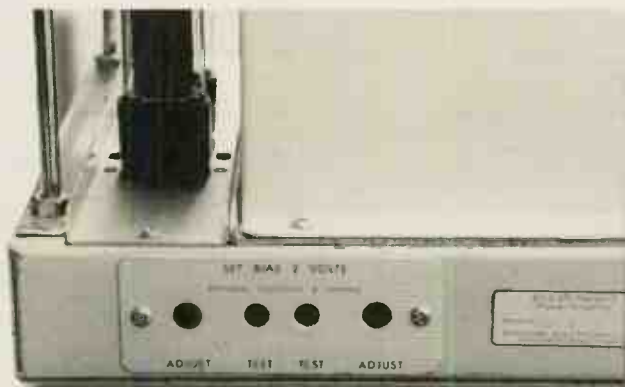

Unlike the Jadis, biasing the output valves on Radford's STA25 valve power amp is easy thanks to potentiometers mounted on the rear panel.

electric shock and/or damage the amp. You have to weigh up the pros and cons of getting an engineer to do it for you against the possibility of something nasty happening. A new output transformer from Jadis will not be cheap.

The fuses are connected between the cathodes of the EL34s and ground. You can measure the DC cathode current here (cathode current is screen grid current plus anode current). To save switching the amp on and off, take out all of the fuses and connect 1ohm resistors across each fuse holder (you can use blown fuses with a 1ohm resistor soldered between the end caps). 1ohm will give a voltage reading of

1mV per mA.

With the amp on and warmed up, measure the anode voltage at pin 3 of one of the EL34s. This will be similar for all of them. Next measure the voltage across the 1ohm resistors for each valve. The total power dissipation will be the HT voltage you measured multiplied by the current in each valve. This should be about 25watts, and all of the EL34s should be the same. Jadis may have decided upon a specific operating current, though, and this may differ from the 25watts dissipation current - you should check with them. The potentiometers look like the bias current adjusters.

After you've finished your adjustments, switch the amp off, replace all the fuses and put the cover back on. If you are not sure about any of the above, it may be better to get an engineer to set the amp up for you, and at the same time show you how it's done. GD

## II TO TANGO

Would you please give me details on ways of making the Quad II amplifier more sensitive, perhaps by changing the EF86s for something else. Also, what type of capacitor and resistors would give improved sound quality, especially on voices?

Michael Lavin



# KIT & COMPONENT SUPPLIERS

## LOUDSPEAKER KIT SUPPLIERS

**Wilmslow Audio, 50 Main Street, Broughton Astley, Leicestershire LE9 6RO**  
Tel: (01455) 286603  
Fax: (01455) 286605

UK distributors of Drive Units from ATC, COLES, DYNAUDIO, KEF, MOREL, PEERLESS, RCL, SEAS, SCANSPEAK AND VOLT. Comprehensive range of high quality crossover components, acoustic damping products, connectors and veneers. Over 20 different D.I.Y. loudspeaker kits on demonstration, including ATC 50 & 100.

**Audio Note (UK Ltd)**  
Unit C, Peacock Ind. Est.  
125-127 Davigdor Road  
Hove, East Sussex BN13 1SG  
Tel: 01273 220511  
Fax: 01273 731298

Suppliers of a large amount of components for the Audiophile Kit builder. Valve amplification data and vintage circuits also available. See the double page spread in the back section of the main issue for extra & more detailed information.

**Avondale Audio,**  
The Hollis, Avondale Road  
Chesterfield S40 4TF  
Tel: 01246 200096  
Fax: 01246 207240

Audio Engineers; upgrades, Improvements & servicing to both static and moving parts of the hi-fi chain. (amps as well as turntables). Also bespoke range of own equipment and an extensive range of parts & components available.

**European Precision Mouldings Ltd**  
Highwyh, Sawbridgeworth,  
Herts, CM21 0JS  
Tel: 01279 600428  
Fax: 01279 723846

Manufacturers of the Red Scorpion range of loudspeaker terminals and binding posts.

**Falcon DIY Speakers**  
Falcon Acoustics Ltd., Tabor House,  
Norwich Road, Mulbarton,  
Norfolk NR14 8JT.  
Tel: 01508 578272

UK distributors of FOCAL drive units & Kits, plus SOLEN (SCR - Chateauroux) polypropylene capacitors and the largest specialist Audio inductor manufacturer in the UK. Stocking Audio Amateur Publications and Audio Computer Software. Comprehensive range of D.I.Y. Speaker kits, Parts, Accessories and Books. Please send large SAE (38p) for free price list. "Everything but the wood"

**IPL Acoustics, 2 Laverton Road, Westbury, Wiltshire BA13 3RS.**  
Tel: 01373 823333

IPL supply a range of eight speaker kits using drive units from SEAS, Morel, Audax, Visaton etc. including four transmission lines to suit all room sizes. We also supply a full range of drive units, capacitors, and cabinet accessories as well as silver plated P.T.F.E. insulated cables.

**South Coast Speakers Ltd**  
326 Portwood Road,  
Southampton, Hampshire.  
Tel: 01703 559312

UK suppliers for High-Quality Driver Units from: SEAS VOLT VISION SCAN-SPEAK also MOREL RCL & many more. Accessories/Components all of the Highest Quality inc. ProAudio MKT Capacitors, Inductors wound to order for any values. Many DIY Kits always on demonstration in our comfortable listening area. Custom design services & friendly advice!

## VALVE AND OUPUT TRANSFORMER SUPPLIERS

**Wilson Valves, 28 Banks Avenue, Golcar, Huddersfield, West Yorks HD7 4LZ.**  
Tel: 01484 654650  
Fax: 01484 655699

E-mail: wilsonvalves@surflink.co.uk  
We stock over 2,500 different types of valves, N.O.S. and New. Please send a S.A.E. for full list. No charge for matching. Most major credit cards accepted.

**Chelmer Valve Company**  
130 New London Road,  
Chelmsford, Essex CM2 0RG.  
Tel: 01245 265865 Fax: 01245 490064.  
Supplier of premium range of audio valves, other valves and components also available. (Please see our main advertisement in this supplement).

**Billington Export Ltd.**  
1E Gillmans Trading Estate,  
Billingshurst,  
West Sussex RH14 9EZ  
Tel: 01403 784961  
Fax: 01403 783519

Billington Export Ltd. holds large stocks of audio valves including many obsolete brands such as Mullard, GEC, Brimar etc. as well as Sovtek, Thermionic Gold Brand and the recently introduced Billington Gold range. Also Cathode Ray Tubes (eg. used in Marantz tuner IOB). 50 page catalogue available, tel or fax for a quotation. Minimum order £50.00 UK, £100 export

**Langrex Supplies Ltd**  
1 Mayo Road, Croydon,  
Surrey CR0 2QP  
Tel: 0181 684 1166  
Fax: 0181 684 3056

One of the largest distributors of electronic valves, tubes and semi-conductors in the UK by original UK and USA manufacturers. Obsolete types are a speciality. Telephone or fax for an immediate quotation.

**Watford Valves**  
3 Ryall Close, Bricket Wood,  
St. Albans, Herts AL2 3TS  
Tel: 01923 893270  
Fax: 01923 679207

Specialist in new old stock and current production valves. Sole UK distributor of the Harma Diamond range selected for their superior performance. Huge range held, stockists of Mullard, GE, Phillips, National, Brimar, Sylvania, Telefunken, RCA, MOV and many more. All valves are new boxed and guaranteed. For free price list and specialist advice call or fax Derek Rocco, Watford Valves.

**PM Components**  
Springhead Enterprise Park,  
Springhead Road, Gravesend,  
Kent DA11 3HD  
Tel: 0474 560521

P.M. Components Ltd are the specialist component company for High End Audio enthusiasts. We have a design and manufacturing base for audio valves and associated products and have a capability to produce custom tubes for major manufacturers. Our 70 page catalogue is available at £2.50 including U.K. postage. P.M. Components are major stockists for Golden Dragon, Mullard, GEC and Teonex valves and have a vast archive of vintage tubes gathered from every manufacturer in the world.

**Woodside Sound Engineering.**  
Arfryn, Llanboidy, Whitland. SA34 0EY  
Tel: 01994 448271 Fax: 01994 448665

E-Mail: woodside@arfryn.demon.co.uk  
As well as producing transformers for our own products, we can now offer an expanding range of audio transformers for new ventures and Renovations. We can wind transformers for most RADFORD amplifiers to original specification. Contact us with your requirements or a list of standard items is available on request.

## CLASSIC TURNTABLES

**Technical & General**  
P.O. Box 53, Crowborough,  
East Sussex TN6 2BY.  
Tel: 01892 65 45 34.

The original specialist source of spares, replacements and expertise for the classic turntables. Years of actual experience and comprehensive range of parts (originals and re-manufactures), manuals, ancillaries, No dubious 'improvements' - no harmful 'modifications'. Our specialities: Connoisseur; Garrard; Goldring; Lenco; S.M.E.; Thorens; Watts; Ortofon; Shure; Cartridges and styli for 78s, Mono LPs, Stereo LPs.

## COMPONENT SUPPLIERS

**PY Tubes, 108 Abbey Street, Accrington, Lancs BB5 1EE.** Tel: 01254 872500. Fax: 01254 872166. Large range of electronic and TV components, satellite and aerial equipment. Call today for efficient service.

**Audio-Links**  
7 Fairmont Crescent, Scunthorpe,  
North Lincolnshire DN16 1EL  
Tel/Fax: 01724 870432

Large range of specialist audiophile components for solid state and valve enthusiasts. Mail order and a friendly service. Monday to Saturday, 9am - 6pm. 30 Page Catalogue - £2.00.

**AudioCom (UK),**  
Unit 6, Tindle Enterprise Centre  
Warren Street, Tenby  
Pembrokeshire, SA70 7JY  
Tel: 01834 842803  
Fax: 01834 842804

E-Mail: audocom@connect-Wales.co.uk  
AudioCom are suppliers of Premium Grade components, including: ALPS, BHC, AEROVOX, Burr Brown, Caddock, Danish Audio Connect, DNM Design, T-Network & Slit Foil electrolytics, Elna, Elma, I.T. Electronics Air Core and Corobar® 99.99%OFC Inductors, Linear Technology, MIT Multicaps, Nichicon, MUSE premium grade electrolytics, 99.99% Pure Silver Wire, Sanyo OS-CON, Sfernice, Suflex, Vishay... plus many more products at very competitive prices. Our 1998 Audiophile Parts Catalogue available on request.

**I.T. Electronics (Germany)**  
AudioCom (UK),  
Unit 6, Tindle Enterprise Centre  
Warren Street, Tenby  
Pembrokeshire, SA70 7JY  
Tel: 01834 842803  
Fax: 01834 842804

E-Mail: audocom@connect-Wales.co.uk  
I.T. Electronics are manufacturers of audiograde components and accessories. Product range includes polypropylene capacitors, high power resistors, air core, RCA split-pin lockable phono's, interconnects, drive units, over 40 loudspeaker kits. A selection of components are now held in stock, and available by mail order from AudioCom (see our ad for brochure). Alternatively send for I.T. Electronics 245 page handbook, priced £2.50. (German language only)

**Hart Electronic Kits Ltd**  
Penylan Mill, Oswestry,  
Shropshire SY10 9AF  
24 Hr sales/enquiries Tel: 01691 652894  
A range of Audiophile kits for 80 watt Power Amplifiers, Tuners, Pre-Amps and Moving Coil/Moving Magnet RIAA Pickup Preamps. All kits are fully engineered, with our thirty years design experience, for easy constructions from circuits by John Lindsey Hood, the most respected designer in the field. Send for lists.

**AP Electronics**  
20 Derwent Centre, Clarke Street,  
Derby, DE1 2BUT

Check out the AP ELECTRONICS catalogue. It's free with every order of over £40.00 or can be purchased for a £4.95 cheque payable to 'AUDIOKITS'. Over 80 pages include pre and power amplifier kits, high grade audiophile resistors, capacitors and semiconductors, audio and mains cables, gold and rhodium plated connectors and COMPONENT NOTES on using high grade parts. A quarterly newsletter 'AP PERFORMANCE AUDIO' has been recently launched and your first issue is free.

**Cambridge Scientific Supplies**  
12 Willow Walk,  
Cambridge CB1 1LA.  
Tel: 01223 811 716  
Fax: 01223 501 833

Specialist wire products for the knowledgeable audiophile including: Silver wire (>99.99% purity, stress free) unique quadruple PTFE insulated Silver wire, Silver loaded solder, PTFE sleeving and Nylon braid sleeving, premium Gold plated connectors and plugs. Custom assembly available. Call Peter Bullock for a catalogue and application note.

**Russ Andrews Accessories Ltd**  
Edge Bank House, Skelmersgh,  
Kendal, Cumbria, LA8 9AS  
Tel: 01539 823247  
Fax: 01539 823317

Orderline: 0800 373467 (UK)  
World leading supplier of the highest quality premium grade components. Loudspeaker Upgrade Handbook available. Sole UK distributor of Kimber Cable. NEW Audio Lifestyle Brochure available containing new ranges of accessories.  
To receive your copy just mail, phone or fax the address above.

**Rothwell Electronics**  
60 Pennington Road  
Great Lever  
Bolton  
BL3 3BR

Tel/Fax 01204 654614  
Rothwell Electronics manufactures and supplies stepped attenuators for the DIY audio market, as well as finished valve amplifiers. The attenuators have 132 settings, channel balance better than 0.1dB, and cost just £79 inc. VAT and postage. Call for free brochure.

**V.R.R.**  
30 Melbourne Avenue,  
Worthing, BN12 4RT.  
Tel: 01903 501158

Vintage Radio Restoration  
Bespoke output transformers for most valves, push-pull and single ended. Components and circuits provided to construct high quality valve amplifiers. Mains transformers "C" core ideal for pre-amps. Call for spec.

**Kopperae**  
PO Box 6884, Dundee, DD5 1YB  
Tel: 07970 - 654356

E-mail: wkopp@taynet.co.uk  
Kopperae manufacture unique anti-resonance and anti-interference hi-fi accessories that dramatically cut transistor harshness and background noise. These products include the highly effective anti-RF, anti-resonance CD Roof: an attractive medite-copper-damping pad slab that sits on TOP of your CD player. For the DIY enthusiast, we have the Cu Pad, a copper backed self-adhesive damping pad that can be used in a variety of applications, including cutting panel vibrations and lining chassis. We also supply plain 0.6mm sheet copper. Build chip, transformer and DAC shields, or clad casings, and get the significant benefits that RF shielding brings. ALL products are available custom sized.  
Contact us now for a free brochure

## RESTORATION

**Audio Laboratories (Leeds)**  
3, Kildare Terrace, Whitehall Road,  
Leeds, LS12 1DB  
Tel: 0113 244 0378

Have your pet hi-fi project professionally done. With over 20 years experience in factory-grade kitbuilds and overhauls, to both valve and solidstate equipment, our good reputation stems from meticulous engineering coupled with superb measurement facilities.

## VINTAGE DIY

**Loricraft Audio**  
4 Big Lane, Goose Green,  
Lambourn, Berks RG16 7SQ.  
Tel: 01488 72267

Specialist restoration of 301's and 401's using genuine spares and re-manufactured parts to original pristine standards in our newly built workshops designed primarily for these purposes.

**Classique Sounds**  
Classique House  
61 Aylestone Drive  
Aylestone, Leicester, LE2 8QE  
Tel/Fax: 0116 2835821

Mobile: 0802 213740  
Suppliers of quality vintage/valve hifi equipment including Leak, Quad, Radford, Rogers, Lowther, Tannoy, Garrard, Thorens etc. Rebuild service available with 12 months guarantee. Also suppliers of heavy plinths for Garrard 301/401/124, from £175.00. As well as power supplies. Repairs to Quad Electrostatic ESL57 Treble/Base panels. EHT units and dust covers also available. Translucent 99.99% pure silver interconnect cable. Terminated from £59.99 .5m. Guaranteed better than existing cable, regardless of price. Quality modern Hifi also available. Wanted all your vintage hifi equipment

## WELDING

**N.Clark Welding & Fabrications**  
14 Redhills Road  
Easton Industrial Estate  
Southwoodham Ferrers  
Essex CM3 5UP  
Tel: 01245 323336

Precision welding and sheet metal work TIG/MIG welding, CNE Punch and Press Milling and Turning Fine Limit and General Engineering Prototype work and batch work undertaken.



Because the Quad has an overall feedback loop, changing the input valves will not greatly affect the sensitivity. One way to increase sensitivity would be to reduce the overall feedback by modifying the feedback components (which are a 470ohm resistor from the output transformer which is connected to a 100ohm to ground). Try changing the 470ohm to 910ohm and the 100ohm to 91ohm. This mod will increase the sensitivity by 5dB to 6dB. However, reducing the feedback will lower the damping factor and increase distortion, although this is unlikely to cause problems in everyday use.

For modifying your amp, please bear in mind that there are metal-film resistors and metal-film resistors, carbon films and carbon films, polypropylene caps and so on. Some cheapo resistors may be OK in a washing machine, but you should treat your amp with flowers and chocolates if you want it to give you the best sounds. Of course, you could buy roses or pick some - it depends on your budget. You have the usual selection of electrolytic caps - Black Gates, Cerafines, etc - but money is the biggest decision maker here.

For soulful vocals like Nat King Cole, try to use a quality carbon film like Allen Bradley (if you can get them). On the other hand, if you want to look down Nat's neck and see what he had for dinner, go for Vishay bulk foils.

For coupling caps, a good polypropylene from, say, MIT is fine, but to be outrageous you could try Sprague Vitamin Q or AudioNote paper in oils. I would recommend you seek out some quality valves as well. If you can, get GEC 2729s for the input to replace the EF86s; otherwise opt for the regular Mullard. You could sample the new KT66R from Golden Dragon as well - it's the spitting image of the GEC original and sounds good too. If you've still got decent working KT66s and EF86s then it's probably best to leave them in. GD

## MORE POWER TO THE SPEAKERS

I have been reading your various articles about going active and have decided that it is the next step for me. My system includes a Marantz CD-63SE CD player, NAD 402 tuner, Rega Planar 2 turntable, Arcam Alpha 9 integrated and 9P power amps and B&W DM602 loudspeakers. What active crossover would you suggest? I feel that the car equipment from Maplins et al is probably not up to

the same standard as my amps.

I also want to change my 'speaker cable to tighten up the bass. I am currently using CableTalk Talk 3. My budget for all of this is about £500, excluding any extra interconnects. Many thanks.

**Tony Kelt**  
tony.kelt@cro.gb.landisgyr.com

The starting point for any attempt to go active is to pin down your loudspeakers' crossover point and whether the filter slopes are 6dB/octave, 12dB/octave, etc. The tweeter and mid/bass on the DM602 meet at 3kHz, with both halves of the crossover acting at 6dB/octave according to B&W. Apart from any sonic considerations, Maplin's DR66 would be unlikely to work in this case as it has 12dB/octave slopes.

Once you've tracked down the information above, it's time to search out an active crossover. AudioLinks (tel: 01724 870432) offer kit and ready-made devices tailored specifically to match your own loudspeakers. These come in flavours to suit two and three-way systems as well as satellite/sub combinations. On top of being analogue phase linear, phase, frequency response, time-lag and output level are all user-adjustable. Another crossover company worth contacting is Immortal Coils (tel: 01480 497730).

Once the new crossover is happily ensconced in your system it's time to search out some 'speaker cable. Keep the amps as close to the enclosures as possible to minimise the cable's impact on sound quality. Pentacone (tel: 01924 445039)



B&W's DM602 loudspeakers are prime candidates for a switch to active operation.

offer a 3m individually-terminated set of their Standard loudspeaker cables for £150 - you'll need two runs for a two-way active set-up. JM

## SPEEDING THE BASS

I built a set of electrostatic 'speakers about a year ago and have been highly impressed by their clarity (though their power demand makes a 185watt amp look under-powered! A suitable valve amp would be an interesting design in large-scale heating). The bass is claimed to go down to 35Hz but methinks that a little



The Quad II valve power amplifier is one classic which can benefit from appropriate component upgrades.

low. Strictly non-scientific measurement (my ears) indicates 45Hz is where the frequency response goes into a nose dive.

A friend mentioned that some clever person in England had designed a bass system for electrostatics that consists of non-baffled, paper-cone drivers arranged in a push-pull configuration. It was supposed to be able to keep up with the main 'speakers dynamically. Normal subwoofers are slow and generally consist of more distortion (admittedly low-frequency) than sound. Have you heard of the design? I prefer to build my own hi-fi gear where possible.

**Brett Russell**  
brussell@southcom.com.au

*Have we heard of the design? Yes, indeed; it was concocted by Celestion and called the SL6000. The two earthshaking subs (one per channel) each had a pair of 12in. high-power PA drivers. Because of the cancellation at lower frequencies inherent in a dipole arrangement, they required large amounts of bass boost and were ferociously power hungry. Still, if you*

*could supply the current, they would oblige by going below 10Hz without booming, blurring or slowing transients. Unfortunately, they're no longer made. Fortunately, it's possible to get close to their performance with a dipole subwoofer we constructed back in April 1996's Supplement.*

*Run from an active crossover based on that used with the SL6000s, our subs had a single 13in. cone to the left and right in order to keep costs down. This meant bass had to be rolled off below 30Hz to reduce distortion and improve power handling, but the benefits of going without boxes (speed, lack of coloration and great articulation) remained 100% intact. If you're interested in a spot of sub DIY, we stock the Audax woofers (PR330MO). JM*

## THE LOW-DOWN

I see that in the November issue you explained how to convert 'speakers to active operation with Maplin's DR66 active crossover. In a similar low-cost context, readers may be interested to know that Maplin's CJ07H active car-stereo subwoofer filter can be used at

home as well. It needs a power supply of between 9VDC and 16VDC. Maplin have a regulated, 12VDC, 500mA mains adapter (JC92A) at £11.50 which is suitable.

My subwoofer uses the Maplin crossover, a post-upgrade spare amplifier (which I am sure many of you have in the loft or a second system) and an easily-built, bass-reflex 'speaker with a 10in. Audax driver. Assuming you already have a spare amp, the entire project could cost as little as £120.

There is a choice of crossover frequencies - 50Hz, 90Hz or 180Hz with 12dB/octave slopes. And, since it has been created for in-car audiophiles, there is 12dB of bass boost or cut centred on 45Hz, 80Hz or 120Hz. Input level potentiometers allow you to balance subwoofer levels with your main system.

Hooking the crossover up is very simple - just take a stereo signal from your integrated amp's Tape Out socket to the Maplin. The crossover is fully stereo but the two subwoofer outputs can be mono'd with a phono-to-phono 'Y' adaptor to the sub's amplifier. This then drives the

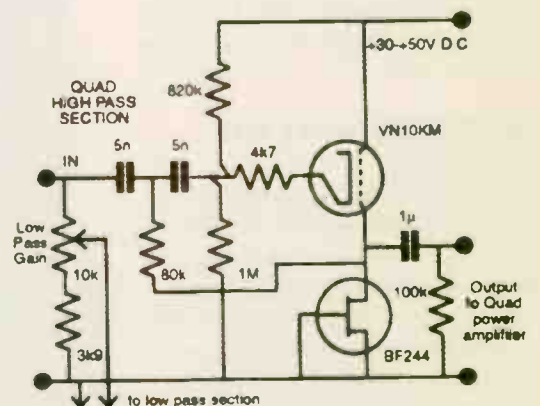
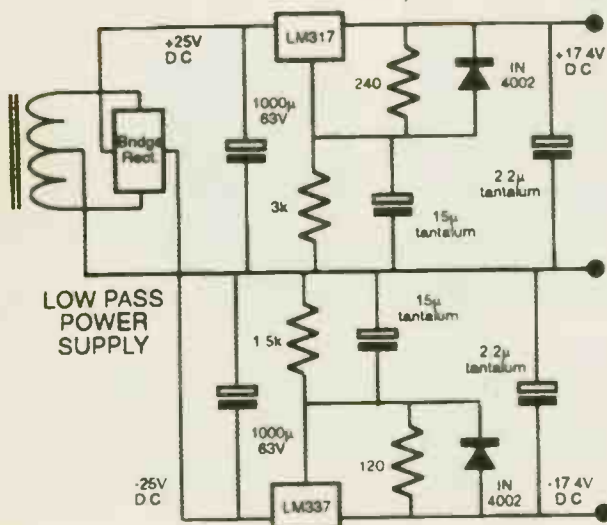
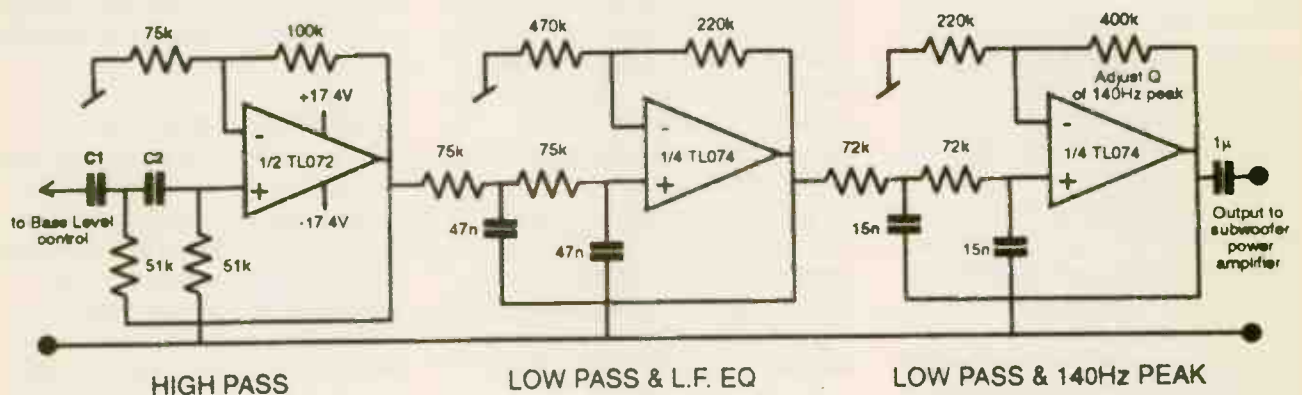

C1 and C2 in the crossover circuitry above are both 0.1µF. This rolls off lower bass output below 30Hz to increase power handling.

## ALL 25 MM MDF

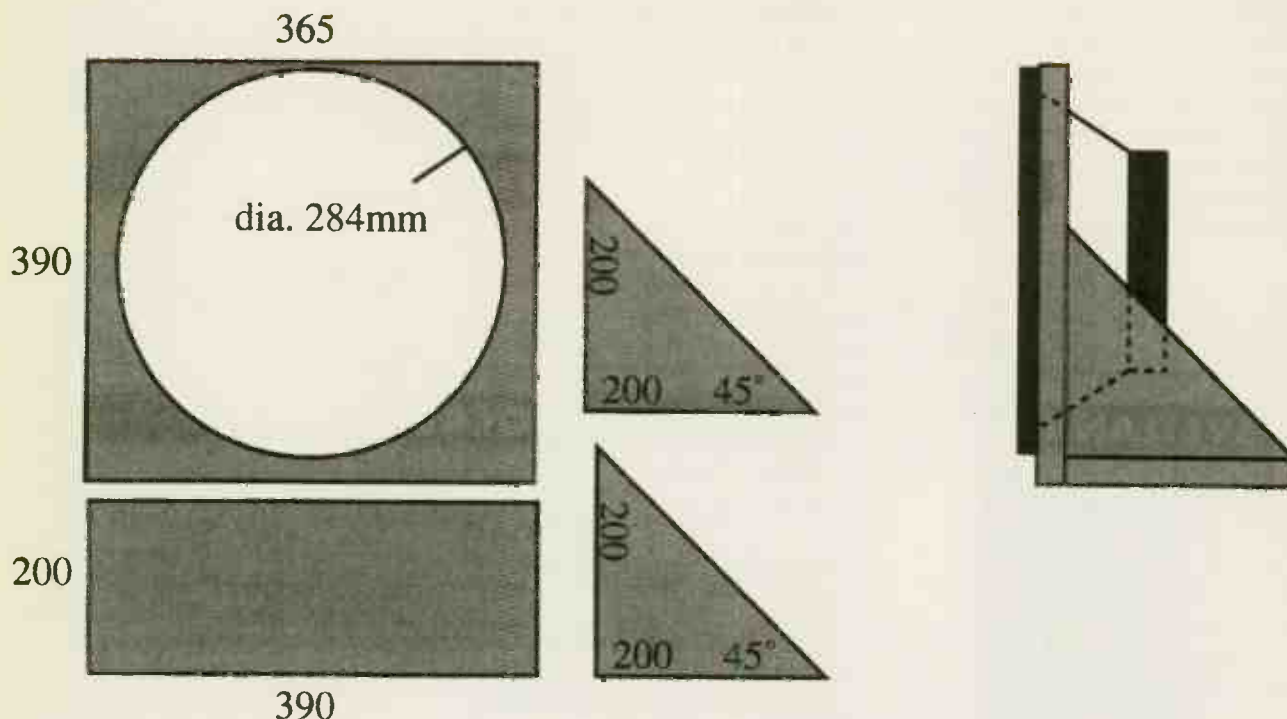

Cabinets don't come much simpler than those for the dipole subwoofers. Bolting the bases of the frames to paving slabs helps though.

subwoofer driver through a single channel; an 8ohm, 10watt resistor across the unused 'speaker terminals provides a load to avoid damage to the amp's redundant channel. Of course you can run a stereo pair of subwoofers if you like, but you will have to build, pay for and house two bass units instead of one.

Speaker design is probably the difficult part. I chose a 10in. Audax paper-cone driver that is some years old and was bought for about £20 (the current version of this driver can be bought through Hi-Fi World for £55). This is fixed to a 70-litre box, ported and tuned to about 30Hz with a 50mm long, 48mm diameter tube.

I used 18mm chipboard for the box with dimensions of 62cms by 38cms by 38cms. I have avoided the cost and complexity of cabinet finish by covering the box with a table cloth! To finish it off I bought a 60cm MDF ready-cut circular table top and screwed it to the box.

The box proportions are not too important at subwoofer frequencies, but robustness and freedom from rattles and buzzes are. At the moment I use a very light filling of fibreglass loft insulation. I have not had the chance to put in any cross-bracing yet, but this is something else I want to try.

After all this, how does it sound? Comments, of course, are made in the

context of my own system, and as you have probably realised this follows a 'best result at lowest cost' philosophy. My main source is an Aiwa XC-700 CD player. Vinyl junkies may like to know that I use a Connoisseur BD1 turntable with an SME 3009 S2 and an ageing AKG P8E.

I have converted a much-loved Musical Fidelity B200 integrated into a passive pre-amp with an active MM/MC stage, and this feeds a Rotel RB-971 power amplifier. The main 'speakers are Magneplanar SMGAs.

Like all panels the SMGAs are dipoles and adding a conventional box subwoofer may turn out to be unsatisfactory. Sound coming from the rear of a panel is 180degrees out of phase with that coming from the front, and this could produce difficulties matching the subwoofer to the main speakers. In practice, I haven't experienced this. The results are a delight. The Maggies give excellent image height and depth and the extra subwoofer octave adds that final dimension. When listening at a real concert there is a weight to string basses that rarely comes across with hi-fi, and I don't merely mean volume levels; there's a 'body' and substance to a row of basses that is hard to reproduce. The Maggies are pretty good at this anyway and the subwoofer fills in the missing details.

It would be uncharitable to be negative about a £30 component, so I won't be; nothing in this world is perfect, let alone budget hi-fi. Limitations are there in the form of some softness to the sound. Higher-cost drivers, better amps and more sophisticated crossovers would improve matters, but we're talking tens of pounds here, not hundreds.

The next step with the Maplin crossover is to use it to drive a pair of stereo subwoofers. If you already have a spare amp then that has to be the sensible next step. I haven't the room for two subwoofers, but if anyone tries it I'd be very interested in hearing about it.

Derek Rumble  
drumble@ordsvy.gov.uk

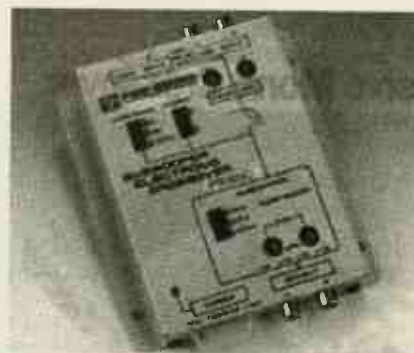

Maplin's £30 CJ07H subwoofer crossover is another weapon in the DIYer's active arsenal.



## TRANSPORT POLICY

I am considering upgrading my CD source and have a couple of questions.

I have a Denon DCD-825. Two, possibly three hardware upgrades seem like good value for money, the first a clock upgrade, the second the power supply capacitors. This second suggestion comes from AudioNote, who mention some rather expensive Black Gates.



Elna's SILMIC capacitors rely on silk fibres and Oxygen-Free Copper in their construction for superior sound.

Personally, I was thinking of the Elna SILMIC capacitors from AudioCom as this would be far more cost effective. Finally I could look at adding a new digital output board.

Do you think the CD player is actually up to these upgrades, or should I look at buying a second-hand transport (like a Teac T-1) and then go for the upgrades?

As the Denon's analogue stage seems rather limited, I would also want to add an off-board DAC. I am interested in building the Assemblage DAC-2 but if the transport with the above modifications is not up to it, I was going to buy a Flying Calf or similar. Which do you think is more appropriate?

Ian Bashford  
ian\_bashford@compuserve.com

*Unmodified, the T-1 is an excellent transport. I would be surprised to find that a heavily-tweaked budget one-box player could out-perform it. Leo Lam, one of our erstwhile contributors, married a T-1 to Assemblage's DAC-2 and discovered the two sounded as if they'd been made for each other. The Flying Calf would work with the Teac too (it even gelled with our P-30 here at World Towers!)*

*Ken Ishiwata has peppered a number of his previous creations with SILMICs, which is no small recommendation. We are currently investigating some of these caps in CD players and amps, and hope to publish our findings in a Supplement early next year. JM*

## SPINNING INTO CONTROL

I wonder if you would mind helping me with the future direction of my turntable. I bought a second-hand Systemdek IIX with an SME 3009 and worn-out Decca London about eight months ago to replace a cheap and nasty deck that I had been using up until then. Obviously this was a vast improvement, although the cartridge had to go. My dealer suggested a Goldring 1042. This was duly fitted. Wow! Just what I wanted - punchy and controlled and so much more fun than CD!

My question is of a non-specific type; I wonder if you can give me some pointers as to the things I could do to take the sound even further. I have already removed the thin board underneath the deck and replaced the SME interconnects

with some from IXOS. I am not averse to DIY (I am an electrical engineer), but I would also appreciate some pointers to new equipment to give me a long-term upgrade path. The rest of the system includes an Audiolab 8000A and a pair of Kef Q55s.

Mike Cable  
mikeyc9@hotmail.com

*One prime modificational move would be to add Systemdek's own electronic power supply. The company (whose spares are now being handled by AudioNote) used to produce an acrylic platter upgrade as well. If you can track down a local precision machine shop, they should be able to turn up a disc about 20mm thick and roughly 300mm in diameter without too much difficulty. Some Blu-Tack and bituminous damping panels on the sub-platter would be pretty effective too, although you don't want to go mad and over-stretch the suspension springs.*

*Looking further ahead, when the Goldring has traced its last groove, replace it with a DNM Mica or Recca moving magnet. The Q55s can be a bit enthusiastic in the bass, so they'd probably appreciate standing on a paving slab spiked to the floor (if you can get the idea past the domestic authorities!) And a second amplifier for bi-amping would make a lot of sense - another 8000A would be the simplest option. JM*



An electronic power supply like the one fitted to Systemdek's IIX900 would mark a major step forward for your own turntable.

## Supplement Advertiser's Index

Audiolinks	18	Glass Audio	22	Sowter Transformers	14
Audiolab Leeds	22	IPL Acoustic	20	Technical & General	4
Audionote	10, 11	Kit & Components	26	Watford Valves	4
Billington Export	6	Langrex Supplies	18	Wire & Insulation	24
BK Electronics	4	Marton Music	14		
Cricklewood	6	Riverside Audio	22	Russ Andrews	IFC
Colomor Electronics	24	Rothwell	18	PM Components	IBC
Falcon Acoustics	14	SJS Electroacoustics	14	Chelmer Valves	BC



# Golden Dragon

Precision Audio Tubes

*Please enquire for any tube not listed. We have an inventory of over 2,500 different types in stock.*

#### Golden Dragon High Quality Pre-amplifier Tubes

12AT7A/E81CC/ECC81	£ 6.95
12AU7A/E82CC/ECC82	£ 6.95
12AX7A/E83CC/ECC83	£ 6.95
12BH7A	£ 9.95
6DJ8/E88CC/ECC88	£10.95
6SN7GT/ECC33	£ 8.95

KT66R	£69.95 pr
KT88R	£69.95 pr
6550WA	£67.95 pr

#### Golden Dragon Special Quality Pre-amplifier Tubes

E81CC-01	Gold Pins Low Microphony Low Noise	£10.50
E82CC-01	Gold Pins Low Microphony Low Noise	£10.50
E83CC-01	Gold Pins Low Microphony Low Noise	NEW £ 9.50
E88CC-01	Gold Pins Low Microphony Low Noise	£14.50

#### Golden Dragon Triodes

	Singles	Per matched pair	Per matched quad
2A3 4 pin	£22.50	£50.00	£100.00
2A3 Octal	£22.50	£50.00	£100.00
211	£28.50	£60.00	£120.00
811A	£11.50	£25.00	£50.00
845	£36.50	£75.00	£150.00
805	£36.50	£75.00	£150.00

#### Golden Dragon T300B Range

300B Super	£79.00	£160.00	£320.00
4.300B	£84.00	£170.00	£340.00
4.300B LX Super	£124.00	£250.00	£500.00

#### Golden Dragon Power Tubes

	Matched Pair	Matched Quad	Matched Octet
EL34 Super	£25.00	£50.00	£100.00
EL34M	£25.00	£50.00	£100.00
E84L (special quality EL84)	£12.50	£25.00	£50.00
EL156 Octal	£75.00	£150.00	£300.00
6L6WGB	£25.00	£50.00	£100.00
KT66	£25.95	£52.00	£104.00
KT66 Super	£65.00	£130.00	£300.00
KT88	£57.95	£116.00	£232.00
KT88 Special (Gold plated)	£67.95	£136.00	£272.00
KT90	£65.00	£130.00	£260.00
KT90LX	£75.00	£150.00	£300.00
350B	£29.95	£60.00	£120.00
6L6GC	£19.95	£40.00	£80.00
6550A	£42.95	£86.00	£172.00
6550A Special (Gold plated)	£64.95	£130.00	£260.00
50CA10	£84.95	£170.00	£340.00
807	£25.00	£50.00	£100.00

We have a vast range of tubes available from manufactures all over the world including rare and vintage types. an 80 page booklet of valves available is updated monthly and can be provided at a cost of £2.50 per copy U.K. £4.00/\$7.00 rest of world or you may telephone our Sales Desk for a prompt quotation.

Prices exclude VAT and Carriage. Please add carriage charge of £2.50 for UK orders and VAT at 17.5%

**P.M. COMPONENTS LTD.,** Springhead Enterprise park, Springhead Road, Gravesend, Kent DA11 8HD  
Sales Desk 01474 560521 Fax 01474 333762

# The Valve. Golden Dragon



## Simply, The Best.

For more information contact:

PM Components, Unit B3, Springhead Enterprise Park  
Gravesend, Kent. DA11 8HD

01474 560521, fax 333762, e-mail: 101650,2424@Compuserve.com

PRICE VALIDITY TO END NOV 1998 - ASK ABOUT ANY TYPES NOT ON THIS LIST



# CHELMER VALVE COMPANY

## for High Quality Audio Tubes

Everybody in the tube business knows that the justly famous Brand names of yesteryear like BRIMAR, GEC, MULLARD, RCA & TELEFUNKEN Etc. Etc. are scarce and often very expensive.

Although we supply all major brands when available (and have many in stock) our policy is to offer a range of tubes, mostly of current manufacture, the best we can find from factories around the world, which we process specially to suit audio applications. The result - CVC PREMIUM BRAND.

Our special processing includes selection for LOW NOISE, HUM & MICROPHONY and controlled BURN-IN on all power tubes to improve STABILITY and select out tubes with weaknesses Etc.

### A selection of CVC PREMIUM Audio Tubes

PRE-AMP TUBES	POWER TUBES	POWER TUBES	SOCKETS ETC.
ECC81	5.00	EL34G	7.50
ECC82	5.00	EL34 (TESLA)	8.00
ECC83	5.00	EL34 (Large Dia.)	8.50
ECC85	6.00	EL84/6BQ5	4.70
ECC88	5.00	EL509/519	13.00
ECF82	5.00	E84L/7189A	6.50
ECL82	5.00	KT66	9.50
ECL86	5.00	KT77	12.00
EF86	5.50	KT88 (Standard)	12.50
E80F Gold Pin	10.00	KT88 (Gold Special)	21.00
E81CC Gold Pin	6.80	KT88 (GL Type)	30.00
E82CC Gold Pin	8.00	PL509/519	9.00
E83CC Gold Pin	7.50	2A3 (4 or 8 Pin)	14.50
E88CC Gold Pin	8.00	211	22.00
6EU7	6.00	300B	50.00
6SL7GT	4.50	6C33C-B	27.00
5SN7GT	4.50	6L6GC	6.50
6922	5.20	6L6WGC/5881	8.00
7025	6.50	6V6GT	5.00
		6080	11.50
		6146B	10.50
		(continued)	
		6336A	46.00
		6550A	11.00
		6550WA or WB	13.50
		7581A	11.00
		807	9.00
		811A	11.00
		812A	34.00
		845	30.00
		<b>RECTIFIER TUBES</b>	
		EZ80	4.00
		EZ81	4.50
		GZ32	11.00
		GZ33	9.50
		GZ34	6.50
		GZ37	7.50
		5U4G	5.00
		5V4GT	4.50
		5Y3GT	4.00
		5Z4GT	4.50
		B9A (Chassis or PCB)	1.60
		B9A (Ch or PCB) G/Plated	3.00
		Octal (Ch. or PCB)	1.80
		Octal (Ch. or PCB) G/Plated	4.20
		4 Pin (For 2A3, 300B etc.)	3.30
		4 Pin (For 2A3, 300B etc) G/Plated	5.00
		4 Pin Jumbo (For 211 etc.)	11.00
		4 Pin Jumbo (For 211 etc.) Gold Plated	15.00
		5 Pin (For 807)	3.00
		7 Pin (For 6C33C-B)	4.50
		9 Pin (For EL, PL509, Ch. or PCB)	5.00
		Screening Can (For ECC83 etc.)	2.00
		Anode Connector (For 807 etc.)	1.50
		Anode Connector (For EL509 etc.)	1.70
		Retainer (For 6L6WGC etc.)	2.00

### and a few "Other Brands" (inc. Scarce types)

5R4GY FIVRE	7.00	6B4G / SYLVANIA	7.00	6SN7GT BRIMAR	10.00	13E1 STC	110.00
5R4WGY CHATHAM USA	10.00	6BW6 BRIMAR	5.00	12AT7WA MULLARD	5.00	805 CETRON	50.00
5U4GB RCA or GE	12.00	6BX7 GT SYLVANIA	8.50	12AY7 GE-SYLVANIA	7.75	5842A GEC	15.00
5Y3WGT SYLVANIA	5.00	6CG7/6FQ7 SYLVANIA	7.50	12AZ7 GE	7.50	6080W TUNGSTOL	12.50
6AS7G RCA or SEIMENS	12.00	6CL6 RCA or GE	5.00	12BH7A GE or RCA	13.00	6550A GE	22.00
6AU6WC SYLVANIA	3.50	6CW4 RCA	11.00	12BY7A GE	9.00	6146B GE	17.00
		6SL7GT STC	8.50	12E1 STC	12.50		

ALL PRICES IN U.K. POUNDS £

Please note carriage charge extra + VAT (EEC Only) - When ordering state if matching required (add £1.00 per tube).

Payment by CREDIT CARD (ACCESS, VISA, MASTERCARD) or BANKERS DRAFT, TRANSFER or CHEQUE (UK ONLY).

FAX or POST your ORDER - We shall send PROFORMA INVOICE if necessary.

**Valve Amplifiers sound better still fitted with CVC PREMIUM Valves!**

Chelmer Valve Company, 130 New London Road,  
Chelmsford, Essex CM2 0RG. England.

☎ 44 (0)1245 355296 Fax: 44 (0)1245 490064