

Hi-Fi WORLD SUPPLEMENT

No. 11 NOVEMBER 1994

LETTERS AND Q&A

**TRACTRIX HORN
THEORY EXPLAINED**

**WE TEST A BUDGET
NOISE METER**

**BUILD THIS
COMPACT
CARBON FIBRE
DRIVE UNIT
LOUDSPEAKER**

**WE BUILD AND TEST
MAPLIN'S £200 VALVE AMP**

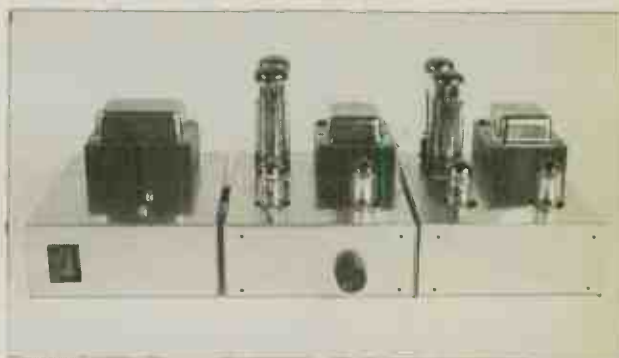

FREE D.I.Y. SUPPLEMENT No. 11

**HI-FI YOU
CAN'T
AFFORD
not to listen to**

EQUIPMENT BY ABSOLUTE SOUNDS,
AUDIO INNOVATIONS, SUGDEN,
IMPULSE, MICHELL, ROKSAN,
TRICHORD RESEARCH, VOYD, LYRA,
MICROMEGA, WILSON BENESCH,
ORTOFON, TARGET, KINSHAW.

By appointment only

SERIOUS KITS

061-707 4823

21, ALGERNON ST., MONTON, ECCLES, MANCHESTER, M30 9QA.

A STATE OF THE ART COMPANY

D.I.Y. Supplement

Contents

All rights to the designs are reserved by World Audio Design Ltd. They are published for single use by private individuals. They are not to be used for commercial gain without prior permission from World Audio Design Ltd.
All of the projects in this supplement have gone through rigorous listening and test procedures. The performance and specification of these projects can only be guaranteed on kits bought directly from World Audio Design Ltd.

KIT NEWS

All the news on new kits, components, and anything useful to the DIY hi-fi enthusiast.

5

KLS4 TWO WAY LOUDSPEAKER

Following the floorstanding KLS3 design in last month's supplement, we develop a compact standmounter, but with the advantages of high quality carbon fibre drive units.

6

MAPLIN MILLENNIUM 4-20

Maplin's Millennium 4-20 kit is based on the renowned Mullard 5-20, but is offered at a budget price. We build, test and listen to this modern interpretation.

13

VALLEY AUDIO MODEL 310

An a.c. noise level meter from Valley Audio in the States. We test the Model 310, useful for professional engineers, studios and hobbyists.

20

TRACTRIX HORN THEORY

Andy Grove, after weeks of research, brings you the theory behind Paul Voigt's unique and original Tractrix horn loudspeaker.

24

DIY LETTERS

Practical advice and help for enthusiast's projects. Read about what can be done with a little imagination.

27

AUDIOCAB

"YOU CAN'T JUDGE AN LP BY ITS SLEEVE"

So does it matter what those MDF boxes in your listening room look like as long as they sound grrrrreat? We think it does, and we think you do too.

So is that going to stop you from building your own? Don't let it. Buy your loudspeaker cabinet kit from Audiocab and your eyes will be as pleased as your ears (not to mention your wallet).

Whether prototyping your own loudspeakers or working to a design from Hi-Fi World (such as the excellent KLS3) we will produce a bespoke kit to your specification. No prior woodwork experience is needed to build the kit and achieve a professional result, with biscuit jointing used to ensure perfect alignment of panels. Cabinets are dry assembled and sanded before despatch. Kits are normally supplied in 25mm unfinished MDF ready for you or your local sprayshop to paint or lacquer, but any finish is available and the use of mouldings ensures that the finished article looks like a desirable piece of furniture.

Still not sure about producing the finish you want? O.K. We'll assemble and finish the kit for you to your specification.

Incidentally, a pair of KLS3's will soon be on demonstration by appointment, so if you live within striking distance give me a call.

Now how about a cabinet to hold all your C.D.'s, in the same style as your speakers, maybe hand dragged or sponged to match your decor.

We specialise in the production of cabinetry and do not therefore at present supply drive units or the other components you will need to complete your loudspeakers.

For further details write to David Barfield, AUDIOCAB, 9 Skew Bridge Close, Wootton Bassett, Swindon, Wilts. SN4 7DW or phone him on 0793 848437

Lockwood Audio

Tel: 081-207 4472

Fax: 081-207 5283

WE BUY AND SELL NEW, USED AND VINTAGE
SPEAKERS, DRIVERS, CABINETS, PARTS

SPEAKER REPAIRS
THE

Authorised **TANNOY** Specialist

MAJOR CREDIT CARDS WELCOME
IMPERIAL STUDIOS,
MAXWELL ROAD,
BOREHAMWOOD, HERTS. WD6 1WE



SOWTER TRANSFORMERS

Sowter Transformers have been used by the Professional Audio Market throughout the world for at least the last twenty - five years.

Using modern technology and Computer Aided Design we are now able to offer a complete design and manufacture service.

Our current lists show a range of over 50 output, 70 power transformers and nearly 30 chokes.

E. A. SOWTER LTD

P.O. BOX 36, Ipswich IP1 2EL

Tel: 0473 252794. Fax: 0473 236188 SEND S. A. E. FOR DETAILS.

GT AUDIO

LEAK, QUAD, RADFORD, RESTORATION KITS

You only want to restore your amplifier once, so use the best components available. All mil spec and selected for a maximum sound quality and reliability.

SPECIAL OFFER

LEAK, QUAD POWER SUPPLY ELECTROLYTIC CAPACITORS 500 VOLT WORKING. THESE ARE ONE FOR ONE DIRECT REPLACEMENT WITH THE ORIGINAL CAPACITORS, £20 PER PAIR INCLUDING P&P.

Agents for: Croft, Nottingham Analogue, Posselt, UKD Callas, Monarchy Audio, XLO, Matisse, Groove Tubes, Gold aero, Townsend, Atacama, Clements, Metaxus

TELEPHONE 0895 833099

(DEMONSTRATIONS STRICTLY BY APPOINTMENT ONLY)

sjs electroacoustics

We offer affordable British products designed with the benefit of almost 50 years of experience. Our transformers are hand wound and made from the finest materials. The designs are specified according to their reflected primary impedance, maximum dc standing current and maximum power. Frequency response is typically within 1dB from 20Hz to 40KHz and 4 and 8 ohm secondary taps are provided. The power rating of the OPT should be up to twice the maximum power output of the stage.

Single Ended Output Transformers

type	primary Z	max dc	max power	suggested valve type	price (inc)
se101	2K5	75mA	25W	300B, 2A3	£66.82
se102	3K0	75mA	25W	300B, 2A3	£67.57
se103	3K5	75mA	25W	300B, 2A3	£69.12
se104	3K5/43% UL	80mA	25W	EL34, 300B(omit UL taps)	£67.36
se105	2K6/43% UL	110mA	25W	parallel EL34, 300B	£68.14
se106	10K0	75mA	50W	211	£166.85
se201	1K25	150mA	30W	parallel 2A3/300B	£82.24
se202	1K5	170mA	30W	parallel 2A3/300B	£84.63
se203	1K75	170mA	30W	parallel 300B	£86.95

Also available se OTX for 600Ω.

Push Pull Output Transformers

type	a to a Z	max dc	max P	suggested valve type	price (inc)
pp101	5K0	60mA	15W	2A3	£49.35
pp102	9K0	50mA	15W	EL84	£54.05
pp103	5K0	65mA	30W	2A3	£58.75
pp104	5K6	100mA	25W	EL34	£60.51
pp105	7K0	100mA	30W	EL34	£62.28
pp106	4K0	100mA	30W	EL84	£62.39
pp107	6K0	100mA	50W	845	£72.85
pp201	3K3	80mA	50W	parallel EL84	£79.92
pp202	2K5	120mA	20W	parallel 2A3	£68.15

Also available push-pull OTX for 300B, 5881 and 6080.

All the above can be supplied with ultra linear taps at no extra cost; and fully shrouded, open frame or drop through as required.

Please enquire about any requirements not listed here. A large range of mains transformers and power supply chokes is also available.

We also supply a full range of quality parts including: Black Gates caps, polypropylene power supply caps, Vitamin Q caps, silver wire, resistors, speakers, Alps pots, advice and lots more.....

Export and Trade Enquiries welcome.

For further information and a catalogue send an A4 or A5 SSAE to:

sjs electroacoustics

Ben-Dor, Lumb Carr Rd, Holcombe, Bury, BL8 4NN.

KIT NEWS

the 1st Southern AUDIO Enthusiasts SHOW

NOT THE SOUTHERN AUDIO ENTHUSIASTS SHOW

Lack of support from the audio trade forced organisers to cancel the 1st Southern Audio Enthusiasts Show last month. The show was scheduled to take place over the weekend of 29/30th October at the Master Robert Hotel.

The organisers asked us to print the following statement: "Unfortunately the support from individual companies within the audio industry was insufficient in the time scale required for us to guarantee a satisfactory show for those companies that had committed and the general public. We therefore had no option but to cancel the show."

The organisers, still enthusiastic about the idea, said they hope to revive the show in 1995.

LEICESTER'S CLASSIC

Classique Sounds, a new specialist vintage hi-fi company, have recently started trading in Leicester. They specialise in refurbishing vintage hi-fi equipment and at their launch displayed a range of equipment including Garrard 301/401 turntables and Leak TL12+/TL25+ amplifiers. Classique Sounds offers a restoration service for most vintage hi-fi and can also fit individually crafted plinths and power supply units for Garrard and other vintage turntables.

Classique Sounds
Classique House,
61 Aylestone Drive,
Leicester.
LE2 3QE
Tel: 0533 835821

MAPLIN LAUNCH NEW CATALOGUE

The new 1995 Maplin mail order electronics catalogue is available now from W.H. Smiths, John Menzies, Eason & Son and Maplin stores for £3.95. The new catalogue has been produced in full colour to give potential purchasers a better idea of what the components look like.

Look out for a review of the new catalogue in our December issue Supplement.

Maplin Electronics
P.O. Box 3,
Rayleigh,
Essex.
SS6 8LR
Tel: 0702 552911

NEW BOOKS FROM WILEY

Wiley books have recently announced a range of new and forthcoming electronic and electrical engineering books for professionals, researchers and students. Amongst the new books is The Spice Book which offers a progressive approach to the SPICE electronic circuit simulation package used by many engineers.

John Wiley & Sons
Baffins Lane,
Chichester,
PO19 1UD.
Tel: 0243 829121

MINERAL LOADED CABINETS FROM CANADA

Irving Isenberg, from Toronto in Canada, is about to set up a new company who's first project will be a special new loudspeaker using mineral loaded cabinets. On a visit to the UK, Irving dropped in at the Hi-Fi World offices to give us a sneak preview of his new cabinet structure. The cabinets are incredibly strong and dense, and from what we heard certainly appeared to produce the goods in sonic terms. The new cabinet virtually eliminates any box colouration normally present in conventional wooden cabinets, giving a clear and transparent sound.

We heard the top cabinets optimised as a two-way stand mounter to demonstrate the qualities of the cabinet material. The MAX, as the loudspeaker is to be named, will use this top box with a bass cabinet below. The MAX is still under development, but Irving has suggested that a kit version could be made available, allowing the home constructor to get their hands on state of the art technology.

At present only the tweeter has been selected, a modified Focal inverted dome. The midrange unit will either be from SEAS or an Audax High Definition Aerogel driver. The bass enclosure and driver have yet to be decided on. Look out for this unique new 'speaker in the near future.

The MAX
Irving Isenberg,
46 Dunloe Rd,
Toronto,
Ontario,
Canada.
M5P 2T4
Tel: 416 481 8400

AP ELECTRONICS

To help constructors of World Audio Design products, AP Electronics have prepared component notes for the 300B valve amplifier kit and 36W class A monoblocks. The notes suggest upgrade components such as Vishay and Holco resistors and Kimber cable internal wiring. For those experienced enough to attempt the 300B from a transformer set, A.P. Electronics offer a full component set. They also offer a build, repair and testing service for constructors who experience problems.

Since these notes were prepared without our knowledge or co-operation, Hi-Fi World and World Audio Design cannot comment on their accuracy or usefulness, nor are we responsible for the outcome of any actions based upon them.

Also new from AP Electronics is a kit version of their SonicLink DM30 amplifier. The kit comes complete with mains transformer, circuit board and components, but constructors will have to source casework, volume control and selector switches themselves. It has a MM and MC stage and costs £340.

AP Electronics
Unit 15,
Derwent Business Centre,
Clarke Street,
Derby. DE1 2BU
Tel: 0332 674929

Here's an easy to build loudspeaker that uses high tech carbon fibre cone drive units to give superb sound quality. It's a compact stand mounting design that is in fact a development of our floor standing KLS3. The new speaker described here, KLS4, offers all the clarity and speed of KLS3, but it uses our own stagger-tuned bass system to give unusually deep, tuneful bass for a cabinet of the size. This speaker reaches smoothly down to 40Hz (-3dB), making it capable of reproducing the lowest bass fundamentals, bar the odd 16Hz organ note or two. It can be built for around £150.

Some time ago a top Japanese engineer told us carbon fibre cone loudspeakers were something special. This material is very strong, stiff and light. It has found use in the turbine blades of jet engines and, he confided, it was superb for loudspeakers. But the Japanese arm of his particular company had put units into a speaker that, for other reasons, proved unsuccessful. It all looked too expensive and difficult, apparently, so they went back to well damped plastic cones, which are simple, cheap, easy to work with and controllable. But they are also heavy, store energy and quack.

Offered carbon fibre drivers by Audax we jumped at the opportunity of using them. Light, rigid and consistent cones are easier to accelerate, easier to stop and store less energy, so they'll have less time-delayed colouration. Consistency of surface behaviour (as well as cone profile)

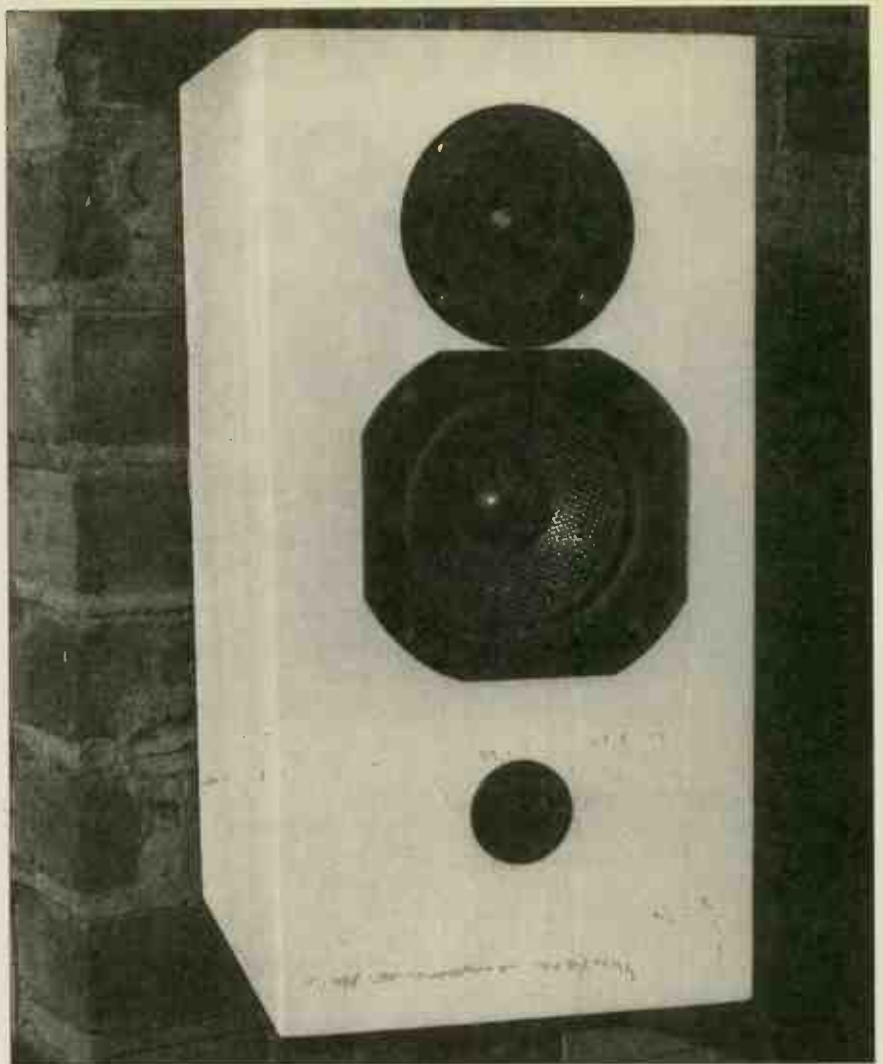

BUILD A COMPACT CARBON-FIBRE CONE LOUDSPEAKER WITH STAGGER-TUNED BASS

Noel Keywood develops a twin-port loudspeaker that gives deep, tuneful bass from a small cabinet.

is the key to a flat, smooth frequency response, a property the open weave of carbon fibre fabric possesses. It is stiffened by a resin that also provides some measure of damping.

Lightness in a cone improves efficiency and, in conjunction with a good magnet, results in high sensitivity. So well engineered carbon fibre cone drive units

should give a fast, clean and clear sound, free from colouration. They should also go loud with little power, making them a perfect match for high quality amplifiers which, by their nature, have low power output. KLS3 showed us that the Audax units provide all these benefits.

It seems like a perfect solution - and it is. By improving the loudspeaker - still a

very imperfect instrument - in this way, greater freedom can be gained in amplifier design. Instead of the madness of insensitive loudspeakers, designed and compromised to dissipate large amounts of heat, being driven by hulking great amplifiers in the home hi-fi can go back to using small, high quality amplifiers of domestically sensible proportions and

sane prices. All of a sudden, heat ceases to be a problem - and every speaker engineer knows how this eliminates a serious constraint.

Dominic enthusiastically designed our first carbon fibre coned loudspeaker - KLS3. It appeared in Supplement No 9, August 1994 issue. I've found this ambitious three-way floorstander gives impressive results. It's very revealing across the midband, giving instruments and voice great body and texture, it is incredibly 'fast' sounding, something a lot of people comment on, bringing a sense of both pace and control to music. And it can be driven easily by all amplifiers, including low power valve amplifiers.

However, the KLS3 speaker is fairly large and, using six drive units in all, costly as well. It produces superb deep bass too, but this only becomes fully apparent in large rooms. For wider domestic use, especially where space is a premium, I felt we should bring out a more compact model as soon as possible, one that was easy to build. If it gives you heart, I built the prototype cabinets from 18mm MDF in around 8hrs all-told, using a handsaw, drill and electric jigsaw (for the driver and port cutouts). Since we're talking about box making here, bear in mind that straight, parallel edges, right angled corners and dimensional accuracy to within less than 1mm are necessary if you want a square box, rather than The House That Jack Built.

Careful marking out and subsequent cutting are the key to success in box building. If you don't want this hassle, try and get a good local wood supplier to do the cutting. We normally use Moss & Co in Hammersmith, London W14 to cut good square MDF (medium density fibreboard) panels for our prototypes, which we then glue together. The veneered cabinets you see in our pictures are, however, from a small, specialist cabinet company and, alone, cost more than mass produced commercial loudspeakers, so this is not a viable solution for DIY; we use it to get cabinets with a professional finish, veneering being a large component of the cost.

HOW THE CABINET WAS DESIGNED

To design a loudspeaker, in outline we use the same method as most major companies, which I will explain briefly. It

isn't too easy for most DIYers to copy I'm afraid to say, mainly because of expense, but also because of technical complexity. But at least an explanation puts you in the picture.

The behaviour of a drive unit in a box can be calculated by using what's known as the Thiele-Small parameters of the drive unit. So useful and valuable has this technique of determining and optimising performance become, that nearly all modern drive units come with a full set of 'Thiele-Small' from their manufacturers. Numerous computer design packages are also available to calculate performance in any given box size (volume). This technique is fast, accurate we've found, and gives a designer a good idea of how

would fit into anyone's home, yet it had to have satisfactory bass output. Ideally, this means a frequency response extending down to 40Hz, -3dB.

A 0.25 cu ft internal-volume enclosure gives a small box that can be configured into bookshelf proportions, but this couldn't be pushed below about 70Hz, -3dB, with a flat response, MacSpeakerz told me.

Moving up to 0.5 cu ft nominal volume gave a compact, stand mounting box and also quite a lot of latitude in bass performance with port tuning, from under-damped (i.e. bass peak) with a 0.5in long port to over-damped (i.e. steadily falling bass) with a 4in long port. The -3dB point in free space (i.e. a notional

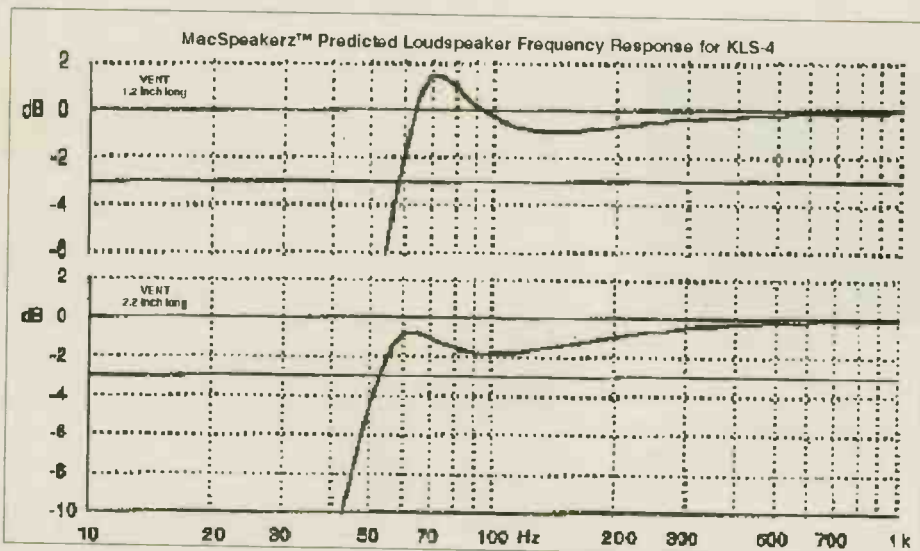

With a 1.2 inch length port bass peaks up around 70Hz

Lengthening the port by just an inch removes the peak and pushes bass deeper.

amenable the final design is to tweaking. In the case of this speaker, the last feature was obviously of some importance.

Before I go any further, just bear in mind one key point here. Box design only optimises bass performance, below about 200Hz. It is strictly about tuning the driver to the box, which only matters at low frequencies. There's far more than just this to consider if a good loudspeaker is to result. I mention this because so many people get box-obsessed, including manufacturers. Ultimately, the best loudspeaker is one that has no box.

Also, what the computer says is right the ear will not necessarily like, but it gets into the right area and success should then arrive after a bit of knowledgeable tweaking.

At higher frequencies we assume that rear radiation from the drive unit is effectively absorbed by the damping on the speaker cabinet walls and is non-existent. Sound quality then becomes more strongly linked to drive unit quality and crossover design.

To optimise the box using Thiele-Small I ran the MacSpeakerz box design programme on the same Macintosh LC computer that I'm typing this article on. I wanted a small-box loudspeaker that

performance that does not take into account beneficial room enhancement of bass) slid down to 50Hz, -3dB, and some useful peaking (only +1dB or so) could be employed, which at 63Hz or so would add useful punch, ensuring good subjective bass speed, without giving one-note bass. Interestingly, a larger box wouldn't work, so MacSpeakerz got me straight into the right area, before lifting the saw.

The theoretical response is shown in the graph and the measured response of the final box followed it perfectly. However, whilst bass quality was very good and amenable to being tuned, it wasn't the best I have heard from a box of the size. Noticing how effectively port length and damping could be adjusted to virtually eliminate the usual twin impedance peaks of a reflex loudspeaker, meaning more bass power would be drawn from the amplifier and bass output raised, I decided to experiment with twin stagger-tuned ports. A very long low frequency port was fitted, running the full height of the cabinet and venting through the bottom panel at rear to clear the speaker stand. A conventional front port was fitted too.

The interactions proved complex, but ►

after lengthy experimental listening tests and measurement (using Fourier analysis of single-shot pulses - necessary for meaningful results from resonant systems) it was apparent that the bottom port aided the front port around 60-80Hz when the front port's length was optimised, giving good subjective bass punch and speed. At lower frequencies, output from the bottom port extended response downward usefully to -3dB at 40Hz and -6dB at 32Hz - very low for such a small cabinet. The result was fast, punchy bass, superb bass depth and - important this - a relatively well damped sound that played bass properly, differentiating notes well, rather than giving an inflated 'boing...boing' sound, not uncommon with reflex speakers.

Bass Response

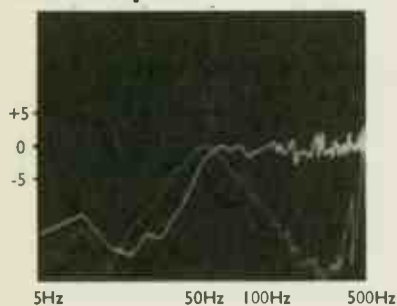

The bottom port adds to the frontal response of the driver to deepen bass.

So much for the box. Before designing the crossover the drive units had to be fully characterised in terms of their near-field frequency response and their electrical load, especially reactance at the crossover frequency. The crossover uses second order filters which give a consistent forward response free from phase problems, satisfactory roll-off rates, reasonable simplicity and a low component count. A slow initial roll-off was engineered into the tweeter's filter to ensure good integration between drive units to allow for some drive unit and component variation, even though these are minor. This gives constructors a better chance of getting a perfect performance without any need for final component adjustment. The crossover frequency is 3700Hz.

Finally, an important warning. Other drive units are very unlikely to work properly in this design and the crossover relates only to the drive units specified. It is not a universal crossover and cannot be used as such, at least for hi-fi purposes. The crossover is carefully matched to the drivers and the bass unit matched to the box. If you experiment with other parts we cannot provide useful advice, since the interactional processes are too complex.

BUILD INSTRUCTIONS

Build the box from 18mm Medium Density Fibreboard (MDF). Each speaker needs six panels, dimensioned as listed under the diagrams. The target internal volume figure is 0.55 cu ft but you don't have to worry unduly about the accuracy of achieving this, since it is a very approximate volume figure lessened slightly by the intrusion into internal space by the drivers, but increased by the effects of internal damping.

You can alter the proportions of the box if you wish, but don't make it too shallow front-to-back, since depth is valuable here to lessen internal reflections off the rear wall and lower the frequency of possible phase cancellation.

With the panels cut they can be glued, using a strong wood glue like Evostick Resin W. I held the box together with 1.5in panel pins, pinning one side panel to top and bottom panels first, then turning the assembly over and pinning the other side panel, all in one operation, with glue applied of course. Having put together this four-sided box, the front can then be pinned on. It adds strength to the structure and ensures squareness. With all this done, the box must be laid front-panel down and more glue spread along all internal panel joints to ensure an airtight seal. Finally, slide the back panel into place and secure it with pins too. You now have a completely sealed box. Set it aside for 24hrs to let the glue dry.

When the glue is dry, mark out the driver, front port, under port and rear terminal panel cutouts, ensuring there's enough room for the under port to pass between one side and the crossover on the terminal panel. Drill starter holes for the jigsaw blade and then jigsaw these cutouts.

Mounting The Drivers

Mark out the fixing holes for drivers and input terminal panel and pilot drill them for coarse-threaded MDF screws. I used the drive units as templates; these fixing holes are not shown in the diagrams. Clearance holes must also be cut for the tweeter lugs and although these are shown they are not dimensioned, to keep the drawing legible. Use the tweeter as a template, handling it with care, since the fabric dome is delicate. Various rear terminal bi-wire panels are available, so this cutout is not dimensioned - use the panel you choose as a template. We use a 4mm/screw terminal type with enough room on it to carry the crossover components.

Having cut the holes, you can now access the box through the large bass/midrange driver cutout for lining purposes, etc.

The most convenient site for the crossover is on the rear terminal panel. The coils and capacitors can be glued into place: use Araldite. When dry, connect up and add wires long enough to reach the driver units out of the box, so they can be soldered up before being screwing in.

The box walls should be lined with thick carpet felt all around the bass/midrange drive unit at least. Use a small roll on top of the rear panel's damping felt, to break up standing waves. The box can be lightly filled with long haired wool, but be sparing with it, since over-damping will remove the ability of the internal air to act as a compliance, removing the reflex action of the cabinet, where the mass of the air in the ports resonates against the compliance of the air in the cabinet. Manufacturers commonly do not stuff reflex 'speakers'. I suggest you use your ears to arrive at a good bass quality, one that is not over-damped sounding. As I said, underdo the damping, rather than over do it, or you'll end up with a dead sounding speaker.

Port Fitting

Now for the ports. These are nominally of 1.5in internal diameter. I used black plastic pipe from a plumber's merchants of 38mm inside diameter. A piece 370mm long is cut with a hacksaw and serves as the low-frequency under-port. It should be an interference fit in the hole cut in the bottom panel, but Araldite can be used to hold it and seal it in.

The front port is cut 100mm long, using the same tubing. It too is pushed home and held with Araldite. If you wish, you can experiment with front port length - a shorter port gives more upper bass, a longer one more lower bass. However, the length is quite critical and has been carefully optimised to give a flat frontal response, with a frequency-offset low-port peak. Shorten the port too much and you'll get a peaky and lumpy sound, lengthen it too much and you'll get a heavy low drone and loss of apparent bass speed. Shortening to 80mm may appeal to many listeners, however. Experiment at home under normal listening conditions, and before you finally Araldite the tubes in of course.

Screw the terminal panel into the rear cutout, lead the driver wires out through the respective front ports and solder them to the drivers. Be very careful with the tweeter since the plastic holding the terminals softens remarkably easily. If you have any fears here, use push-on tags. Note the polarities, positive to positive. Screw the drivers in and you have a loudspeaker.

You can then tweak the crossover for treble level if desired. A value of 3.3Ω gives flattest treble but may sound a little too bright for some, especially with CD. Use 4Ω to soften out treble a little and 5.6Ω to get a little warmth in the sound.

Scale: 1/4 full size

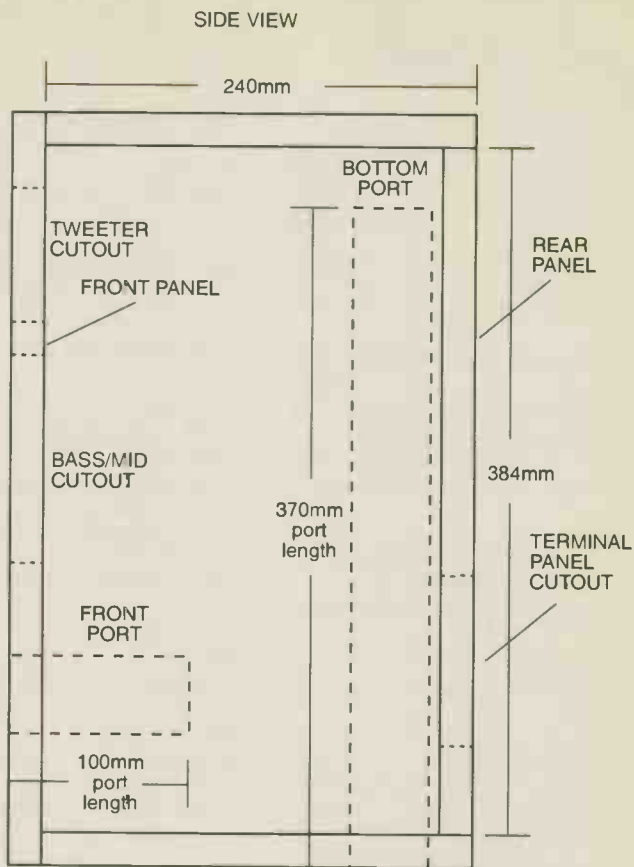
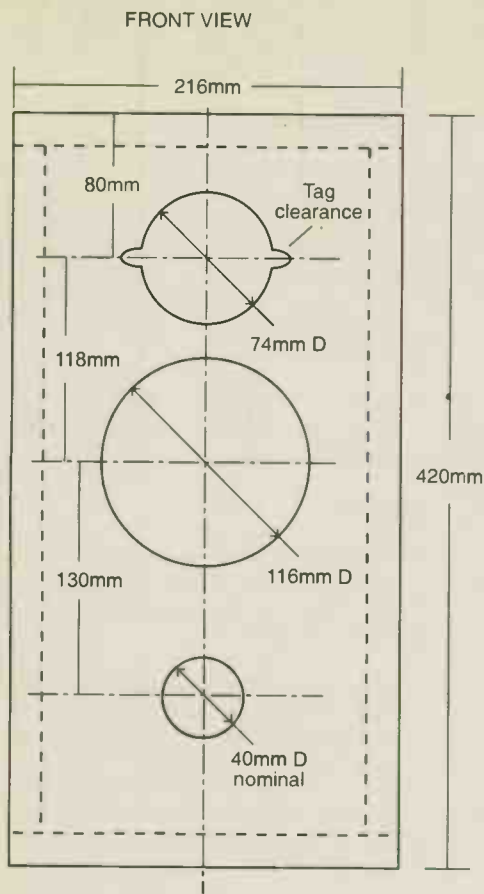

Build from 18mm MDF

Top & bottom panels 240mm deep x 216mm wide

Side panels 240mm deep x 384mm high

Rear panel 180mm wide x 384mm high

Nominal Volume = 15.3litres / 0.54 cu ft

DRIVE UNITS

Bass/Midrange - Audax HM130CO 5.25in Carbon Fibre
Treble - Audax TWO25 MI Fabric dome tweeter

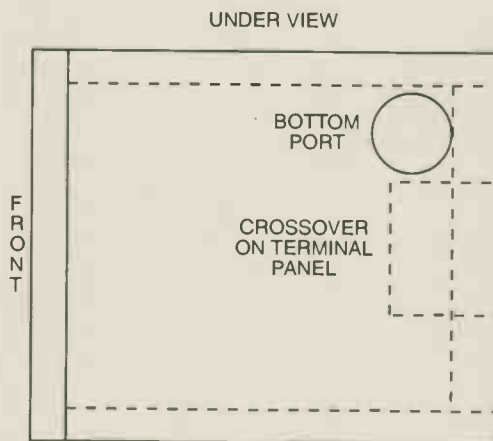
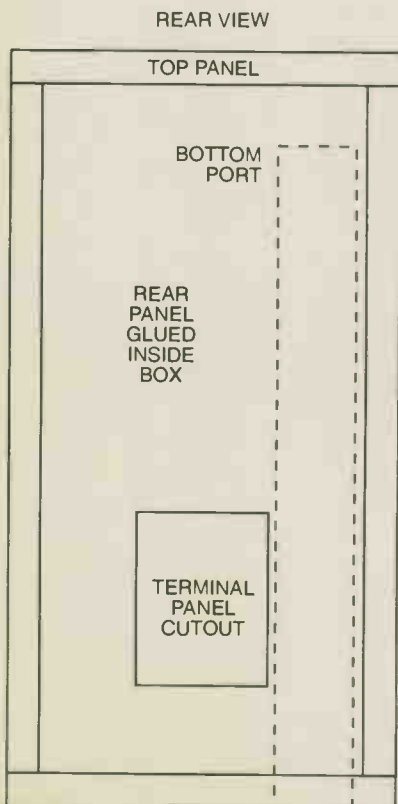

See page 81 in the main issue for drive unit order details.



Golden Dragon

RETAIL PRICE LIST

Golden Dragon Pre-Amplifier Tubes	Singles
6AQ8/ECC85	£6.50
12AT7A/E81CC/ECC81	£6.95
12AU7A/E82CC/ECC82	£6.95
12AX7A/E88CC/ECC83	£6.95
6DJ8/E88CC/ECC88	£10.95
6SN7GT/ECC33	£8.95

Special Quality Golden Dragon Pre-Amplifier Tubes

Special Quality Golden Dragon Pre-Amplifier Tubes	Singles
E81CC-01 Gold Pins Low Microphony Low Noise	£10.50
E82CC-01 Gold Pins Low Microphony Low Noise	£10.50
E83CC-01 Gold Pins Low Microphony Low Noise	£9.50
E88CC-01 Gold Pins Low Microphony Low Noise	£14.50

Golden Dragon Triodes

	Singles	Pairs	Quads
2A3 4PIN	£22.50	£50.00	£100.00
2A3 OCTAL	£22.50	£50.00	£100.00
211	£28.50	£60.00	£120.00
811A	£11.50	£25.00	£50.00
845	£36.50	£75.00	£150.00
805	£36.50	£75.00	£150.00

Golden Dragon 300B Range

	Singles	Pairs	Quads
300B Super	£79.00	£160.00	£320.00
4.300B	£84.00	£170.00	£340.00
4.300B Super	£124.00	£250.00	£500.00

Please enquire of any tube types not listed. We have an inventory of over 2,500 different types in stock.

Golden Dragon Power Tubes

	Pairs	Quads	Octets
EL34/6CA7	£25.00	£50.00	£100.00
EL34L (Laminated EL34)	£29.95	£60.00	£120.00
EL84 (Special Quality EL84)	£12.50	£25.00	£50.00
6L6WGB/5881	£25.00	£50.00	£100.00
KT66	£25.00	£52.00	£104.00
KT88 (New Design)	£57.95	£116.00	£232.00
KT88 Super (Laminated)	£67.95	£136.00	£272.00
*KT88 Special (Gold Plated)	£64.95	£136.00	£272.00
6L6GC	£19.95	£40.00	£80.00
6550A	£42.95	£86.00	£172.00
6550A Special (Gold Plated)	£64.95	£130.00	£260.00
50CA10	£84.95	£170.00	£340.00
807	£25.00	£50.00	£100.00

Ceramic Sockets and Hardware

	Standard	Gold Plated
Locking 4 Pin (300B etc.)	£6.95	£15.00
4 Pin UX4 (300B etc.)	£2.5	£3.50
Jumbo (211 etc.)	£14.50	£25.00
Octal Chassis (EL34 etc.)	£1.25	£3.50
Octal PCB (EL34 etc.)	£1.25	£3.50
B9A Chassis (pre amp)		£2.50
B9A PCB (pre amp)	£0.95	£2.50
Screening Can & Skirt (pre amp)		£8.50
Damping Can (pre amp)		£4.50
Power Valve Retainer (EL34 etc.)		£5.50

High Quality Plastic Sockets and Hardware

B9A Chassis (pre amp)	£1.15
B9A PCB (pre amp)	£0.95
Octal Chassis (EL34 etc.)	£1.25
B7G Chassis (85A2 etc.)	£0.95
B9A Skirted Chassis	
Socket & Can (pre amp)	£1.75
Power Valve Retainer (EL34 etc.)	£1.95

Carriage charge £2.50 on any U.K order. Cash with order or Visa - Mastercard accepted. 24 Hour Answerphone Service.

We have a vast range of tubes available from manufacturers all over the world including rare and vintage types. A 50 page booklet of valves available is updated monthly and can be provided at a cost of £2.50 per copy including U.K postage or you may telephone our Sales Desk for prompt a quotation. VAT at 17.5%.

A selection from our stock of over 2,500 different audio quality valves. Please enquire for items not listed

ECC81	BRIMAR	4.50	LS9B	COSSOR	6.95	6SL7GT	BRIMAR	4.50
ECH81	MULLARD	3.50	M8136	MULLARD	8.50	6SN7GT	BRIMAR	4.50
EC82	GE	4.50	M8162	MULLARD	8.50	6SN7GT	TEONEX	3.50
ECC82	RFT	4.50	M8137	MULLARD	15.00	6SQ7GT	TONEX	4.50
ECL82	TEONEX	3.50	MHLD6	MAZDA	5.50	6V6G	RCA	5.50
ECC83	TEONEX	3.50	OA2WA	TEONEX	3.50	6V6GT	TEONEX	4.50
ECC85	TEONEX	3.50	PCC88	SIEMENS	3.50	6X4	TEONEX	2.50
ECL86	TEONEX	3.50	PL36	MAZDA	3.50	6550A	TEONEX	12.50
ECC88	BRIMAR	4.50	PL504	MAZDA	2.50	12AT6	BRIMAR	2.50
ECC88	GE	5.50	PL509	MAZDA	5.50	12AV6	RCA	2.50
ECC88	TEONEX	4.50	PL519	THORN	5.95	12BA6	WESTINGHOUSE	3.50
EF86	TEONEX	4.50	PY32	MULLARD	2.50	12J5GT	RCA	3.95
EF804S	TELEFUNKEN	25.00	TT100	GEC	65.00	12E1	RCA	3.95
EL32	MULLARD	4.50	U19	GEC	8.50	12E1	STC	15.00
EL85	MULLARD	4.50	UCC85	MULLARD	3.50	13E1	STC	140.00
EL86	MULLARD	4.50	UU5	MAZDA	5.50	13D3	BRIMAR	6.50
EL504	TEONEX	3.50	UU6	MAZDA	6.50	85A2	MULLARD	6.50
EL509	TEONEX	5.50	2X2A	RCA	5.00	1625	RCA	6.50
EL519	TEONEX	5.50	3A/167M	ITT	10.00	5687WA	RCA	6.50
EM84	TEONEX	3.50	5Y3WGTA	SYLVANIA	4.50	5751	RCA	6.50
GZ32	MULLARD	8.50	5V4G	BRIMAR	3.50	5814A	GE	5.50
GZ33	MULLARD	5.50	6AG7	RCA	3.50	5881	USSR	4.95
GZ34	MULLARD	12.50	6A7G	RCA	8.50	6146B	TEONEX	8.50
GZ37	MULLARD	4.50	6BH6	BRIMAR	3.50	6158	BRIMAR	6.50
GZ34	TEONEX	5.50	6C8G	RCA	3.50	6189	SYLVANIA	6.50
KT66	TEONEX	6.00	6DQ6B	PHILIPS	3.50	6201	GE	6.50
KT66	GE	16.50	6K7G	RCA	3.50	6463	UNITED	7.50
						6870	BRIMAR	11.50

EXPORT WELCOME CARRIAGE AT COST

P.M. COMPONENTS LTD., Springhead Enterprise Park, Springhead Road, Gravesend, Kent DA11 8HD, England
Sales Desk Tel: 0474 560521. Fax: 0474 333762

THE CROSSOVER

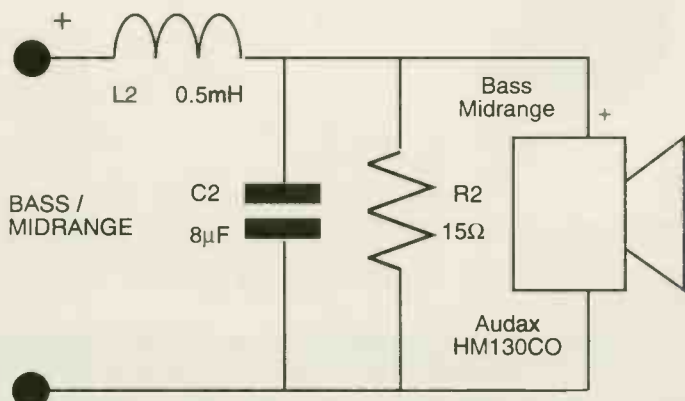
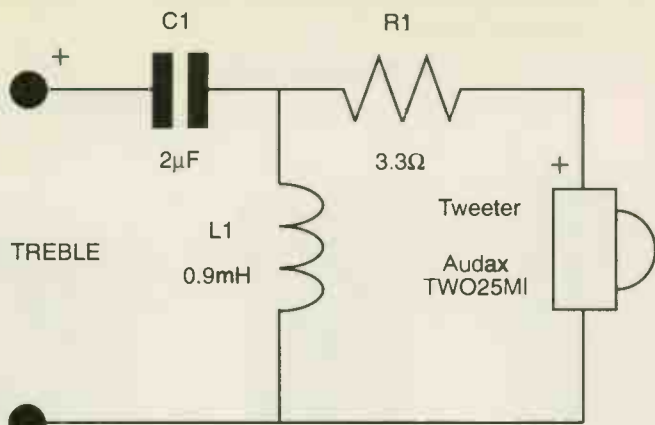

SOUND QUALITY

After experience of the KLS3 'speakers, I was keen to sample their little brothers, the KLS4s.

The 4s use identical components to the 3s with the exception of large bass drivers. A quick look revealed more than the odd port, which indicated a large sound from a small speaker: I was not disappointed. The 4s fair well with any music, not being over biased. Serious bass freaks may not be entirely happy; but they are a smallish speaker.

Billy Idol's Charmed Life album came through strongly, the man's vocals arriving with clarity and atmosphere. My surprise over the depth of sound continued with the 1812 Overture, the piece's finale was frighteningly real.

These 'speakers, however, have no time for poor amplification, but partnered with good equipment, it's hard to fault these 4s. Yes, they are small, but small can be beautiful: don't underestimate these.

Alester Kells

PARTS LIST (per loudspeaker)

DRIVE UNITS

Tweeter Audax TW025MI
Bass/midrange Audax HM130CO

CROSSOVER

R1* 3.3Ω, 5W carbon
R2 15Ω, 3W carbon

C1 2µF, 50V min.
C2 8µF, 50V min.
both capacitors - Solen or Ansar polypropylene

L1 0.9mH air cored
1.2Ω DCR/0.6mm wire
L2 0.5mH air cored
0.3Ω DCR/1mm wire

* R1 3.3Ω - flat response & max treble/5.6Ω min. treble.

HARDWARE

Ports cut from 1 metre of 38mm I.D. tube
Terminals - bi-wire input panels, 4mm skt/screw
Pane Damping - natural carpet felt, 0.5in thick
Internal wadding - long haired wool

MEASURED PERFORMANCE

Our third-octave frequency response analysis shows this speaker has a remarkably flat response from 63Hz up to 20kHz, varying by less than 2dB between these frequency limits. This performance is held over a wide forward angle, so the speaker doesn't change its response off-axis (i.e. there's little lobing, as you'd hope from 2nd order filters). The third octave response, using pink noise in a room, does not show bass performance accurately though. Using a long 32mS impulse, convolved to measure response, showed it extended down to 50Hz (-3dB) in front of the speaker and the port took this down to 40Hz (-3dB).

KLS4 is an easy load, with smaller impedance changes across the audio band than usual, low rates of change showing lack of reactance (i.e. electrical energy storage). Minimum impedance is 5Ω, but the overall nominal value measured out at 9Ω with pink noise. Good valve amplifier matching relies on constancy of impedance and a correct nominal value (i.e. 4 or 8Ω). KLS4 measures out (with pink noise) as just right. Sensitivity measured a respectable 86dB, suggesting use with amplifiers of around 30watts or more. **NK**

Frequency Response

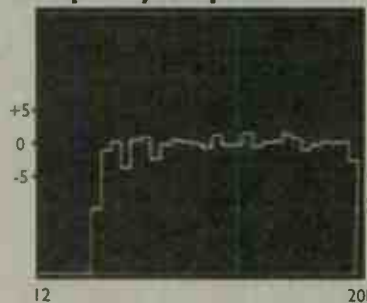

Frequency response is exceptionally flat from 63Hz - 20kHz. This will give KLS4 a balanced sound

Impedance

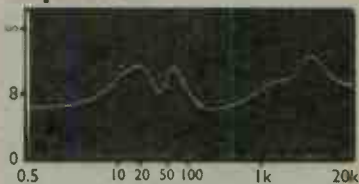

Impedance curve is smooth and high overall at 9Ω making KLS4 an easy load for valve amplifiers.

SPEAKER KITS FROM IPL ACOUSTICS

Over a 5 year period I.P.L. Acoustics have developed a range of high quality speaker kits, using the best units from SEAS, MOREL, AUDAX, VISATON and I.P.L. and have produced a comprehensive range of speakers which will compete with the most expensive of commercial designs. All speakers have BIWIRED crossover kits containing high quality components and terminals.

AS6 PANEL KIT



PLUS KIT.....£262.77
PANEL KIT.....£302.77

FOUR TRANSMISSION LINE KITS

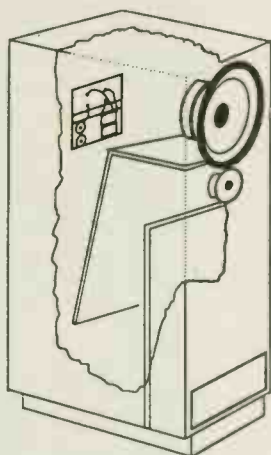

TRANSMISSION LINE
PLUS KIT
£167.00 - £280.00

M3TL



PLUS KITS.....£167.00
TOTAL KIT.....£226.00

A2 RIBBON KIT



PLUS KIT.....£222.00
TOTAL KIT.....£291.00

M2 MINI-MONITOR



PLUS KIT.....£166.00

PRE-VENEERED CABINET NOW AVAILABLE. Carriage charge extra on all kits.

If you would like further details please send £1.50 for **36 PAGE SPEAKER BUILDING CATALOGUE**, comprising **VALUABLE ADVICE** on **DESIGNING, BUILDING** and **TESTING** speakers and full technical specifications including response curves of eight kits, drive units, and details of **SPECIALIST CABLES** and **ACCESSORIES**

I.P.L. Acoustics, 2 Laverton Road, Westbury, Wiltshire, BA13 3RS. Tel: 0373 823333

LANGREX SUPPLIES LTD

DISTRIBUTORS OF ELECTRONIC VALVES, TUBES AND SEMI-CONDUCTORS AND I.C.S.

1 MAYO ROAD • CROYDON • SURREY CR0 2QP

24 HOURS EXPRESS MAIL ORDER SERVICE ON STOCK ITEMS

PHONE
081 684 1166

FAX
081 684 3056

A selection of our stocks of **New Original Mullard - Brimar** audio types made in UK.

STANDARD TYPES

ECC82	6.00
ECC88	6.00
ECC81	3.00
ECL82	3.50
ECL86	3.50
EF86	7.50
EL84	6.00
GZ32	8.50
GZ34	15.00
6SL7GT	4.50
6SN7GT	4.50
6V6GT	4.25

SPECIAL QUALITY TYPES

E88CC - GOLD PIN MULLARD	8.50
ECC81 - M8162 / CV4024 MULLARD	6.50
ECC81 - 6201 / GOLD PIN MULLARD	8.50
ECC82 - M8136 / CV4003 MULLARD	6.50
ECC83 - M8137 / CV4004 BRIMAR	6.50
AMERICAN TYPES GE.	
6L6GC	12.50
6550A	17.50
12AX7A	7.00
7581A	15.00
6146B	15.00

THESE ARE A SELECTION FROM OUR STOCK OF OVER 600 TYPES. PLEASE CALL OR FAX AN IMMEDIATE QUOTATION ON ANY TYPES NOT LISTED. WE ARE ONE OF THE LARGEST DISTRIBUTORS OF VALVES IN THE UK. SAME DAY DESPATCH VISA/ACCESS ACCEPTABLE. OBSOLETE TYPE A SPECIALITY.

OPEN TO CALLERS MON.-FRI. 9AM - 4PM. CLOSED SATURDAY

P&P 1-3 VALVES £1.00, 4-6 VALVES £2.00 7+ £3.00 ADD 17.5% VAT TO TOTAL INC P+P

VISA

Access



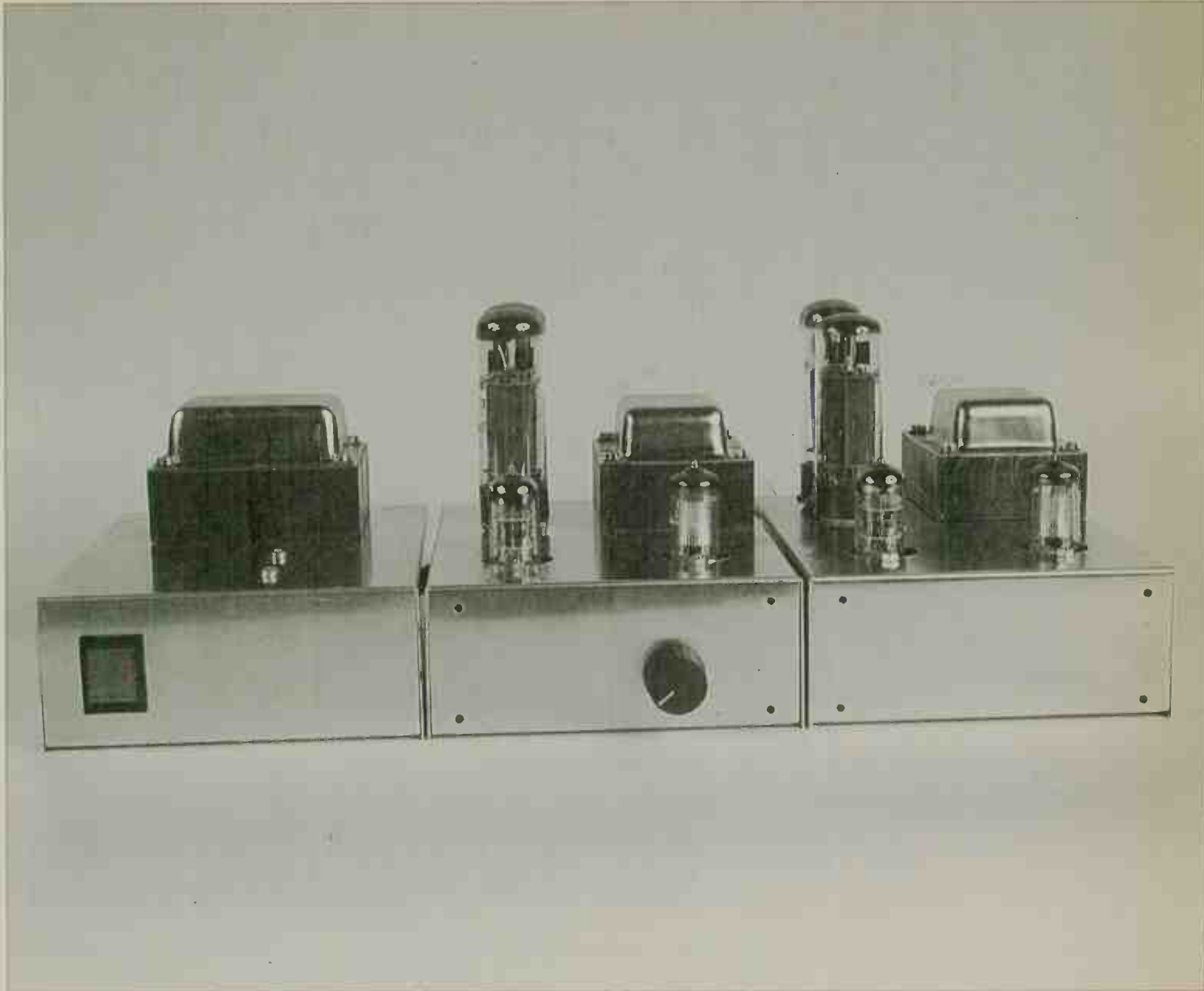

MAPLIN MILLENNIUM 4-20 20 WATT VALVE POWER AMPLIFIER KIT

Nick Lucas builds Maplin's version of the classic Mullard 5-20 amplifier.

The Millennium 4-20 class AB1 twenty watt valve power amplifier kit is a design based upon the popular Mullard 5-20 (hence the similar name). It uses an EF86 driver stage, an ECC83 phase splitter and two EL34

pentodes in push-pull configuration for the output stage, which is the same line up as the original 5-20, but with a solid state rectifier instead of the valve rectifier. We've published the original circuit and Maplin's, so the two can be compared.

Differences are minor, except one of concern, which is the destination of C8 (Mullard - C2). See Measured Performance for our notes on this.

Mike Holmes, the man behind the Millennium, has put together an

WOLLATON A.U.D.I.O

XLO FOR THE HOME CONSTRUCTOR

Whether you are building equipment from scratch, or upgrading existing equipment then XLO wiring will improve the performance. Also available are the XLO chassis mount phono and the XLR connectors, and the speaker binding posts.

Cables and wires.

PRO 100 interconnect	£5.50 per foot
PRO 150 interconnect	£3.00 per foot
PRO 625 speaker cable	£1.25 per foot
PRO PL1000 mains cable	£12.00 per foot
REF PL10 main cable	£25.00 per foot
PRO 16P* Chassis hook up wire	£1.00 per foot
REF 16T* Chassis hook up wire	£10.00 per foot

Connectors

Neutrik gold plated XLR male	£6.00
Neutrik gold plated XLR female	£7.00
XLO pro phono plugs (4 pack)	£25.00
XLO ref phono plugs (4 pack)	£44.00
XLO spade plugs (4 pack)	£13.00
XLO Signature XLR chassis mount (2 pack)	£28.00
XLO Signature XLR chassis mount	£28.00
XLO BNC connectors (2 pack)	£16.00

* Note that the chassis wire is excellent for loudspeakers internal wiring or to replace the jumper connectors used when Bi-wire speakers are used in single wire mode. When using the wire to carry signals of less than 100hz a double run should be used. High quality preamps should be wired with 16T.

WOLLATON AUDIO - TEL/FAX: 0602 284147

SPL 1. Kit £196

11 ltr. Reflex using Morel Drive Units
18mm MDF Flat Pack Cabs, air cored
Ind. SOLON CAPS
"I haven't heard any ready built near field monitor that comes close to these for anything close to the price"

Catalogue of
DRIVE UNITS KITS
available on
request
Loudspeaker design

Recording Musician
"The speakers cost about half the price of a comparable pair"
Daily Telegraph

SPL 2. Satellite Kit £172

3 1/2 litre Enclosure Reflex using Morel magnetically shielded Drive Units
12mm MFD Flat Pack Cabs of highest quality

ATC Kits Active or Passive

ATC Sanctioned Kit 55 and 110 litres
25mm MDF Flat Pack Cabs
ATC 50 55LTR Passive £1850 Active £2895
ATC 100 110LTR Passive £1950 Active £2995

"Rare opportunity to be able to buy a pedigree product for the price of mongrel" Audio Media

Four Dem Rooms • Tuesday to Saturday opening
OVER 30 KITS TO DEM

Wilmslow Audio

DEPT HFW Wellington Close,
Parkgate Trading Estate,
Knutsford, Cheshire WA16 8DX
Tel: 0565 650605 Fax: 0560080



All major Credit Cards accepted



INTRODUCING:-

THERMIONIC GOLD

BRAND VALVES/TUBES

Long known as specialists in rare tube brands, Billington Export introduces a new line of premium-grade valves to fill the increasing demand for hard-to-find tubes! THERMIONIC GOLD features specially tested valves selected for long life, low microphony and low noise. Versions with gold plated pins including E81CC, E82CC, E83CC, E88CC are available as well as grey pin versions of 6L6GC, 12AT7, 12AU7 and others as listed below.

THERMIONIC GOLD brand comes from a variety of countries around the world. We have carefully chosen the best manufacturer for each type, with an emphasis on the highest audio quality, and product reliability.

We also stock one million valves by Brimar, GE USA, GEC UK, Mullard, Russia/Sovtek, Tesla, Tungram and other rare brands as well as sockets and CRTs.

Billington Export Limited

1E Gillmans Trading Estate,
Billingham,
Sussex RH14 9EZ UK
Telephone: (0403) 784961
Fax: (0403) 783519

We can supply sockets for any valve listed in this advertisement. For matched testing please add £2.00 per valve (eg. £8.00 per quartet)

2A3 Thermionic Gold	£15.00	12E1 STC/ITT UK	£15.00	E81CC Thermionic Gold	£5.25	EF86 GEC UK 'CV4085'	£19.50	B7A used for 6C33CB	£3.23
3Amp1A Tungstram	£32.40	13E1 STC UK	£135.00	E81CC-01 Thermionic Gold	£9.50	EF86 Sovtek	£4.50	B7G McMurdo UK Chassis mount skirted	
5c-450A STC UK	£259.35	85A2 Mullard	£5.93	E82CC Thermionic Gold	£4.50	EF804S Telefunken	£27.00		£0.72
5R4GY RCA	£5.93	300B Thermionic Gold	£69.00	E82CC-01 Thermionic Gold	£8.50	EL34 Chinese	£7.00	813 Socket	£15.00
5U4G Sovtek	£4.80	805 USA	£54.00	E83CC-01 Thermionic Gold	£8.50	EL34 Thermionic Gold	£9.95	Octal McMurdo UK	£1.20
5Y3GT RCA	£3.90	300B Silvertune Chinese	£69.00	E88CC Siemens East	£11.55	EL34G Sovtek	£7.00	Octal PCB nylon	£2.70
6A57G Russian	£4.00	807 Valvo Holland	£10.50	E88CC Thermionic Gold	£6.90	EL84 Sovtek	£1.82	Octal PCB, foreign	£1.20
6B4G Russian	£19.50	811A Thermionic Gold	£12.00	ECC81 Mullard UK (CV4024)	£7.50	EL84 Thermionic Gold	£4.00		
6BH6 RCA	£2.48	845 Thermionic Gold	£33.00	ECC81 Thermionic Gold	£5.25	GZ32 Miniwatt France	£8.00	B9A Sockets for ECC83, EL84, EF86 etc.	
6CG7 Penta USA	£6.75	56B7WA Sylvania	£6.45	ECC82 Mullard UK	£9.00	GZ34 Sovtek	£7.95	suitable for preamps	
6L6GC GE	£22.50	5751 RCA	£7.32	ECC82 Thermionic Gold	£4.50	GZ34/SY3GT Sovtek	£4.20	B9A Ceramic, skirted, chassis with	
6L6GC Thermionic Gold	£6.50	58B1/6L6WGC Sovtek	£6.00	ECC83/12AX7WB Sovtek	£3.50	GZ37 Mullard UK	£4.95	screening can, made in China	£1.20
6L6WGC Sovtek Russian	£6.00	6189W GE/RCA	£5.99	ECC83/ECC803S TESLA	£13.13	KT66 Thermionic Gold	£9.50		
6SL7GT STC UK	£6.00	6336A Penta USA	£58.50	ECC83 Thermionic	£5.25	KT88 Thermionic Gold	£18.50	B9A Ceramic, skirted, chassis with	
6SN7GT STC UK	£7.50	6550A GE USA	£33.00	ECC85 Mullard	£5.70	PL519 ECG/Philips	£6.23	screening can, made in Russia	£0.90
6V6GT STC UK	£4.20	6550A Thermionic Gold	£11.50	ECC85/6AQ8 Thermionic Gold	£3.90	Jumbo 4 pin for 211	£11.50	B9A PCB Gold pins	£2.40
6X4W Raytheon USA	£2.50	6550WA Sovtek Russian	£19.95	ECC88 Chinese	£3.90	Jumbo 4 pin gold plated for 211	£24.00		
12AX7 Thermionic Gold	£5.25	CV4003 Mullard UK	£9.00	ECC88 Thermionic Gold	£6.90	UX4 used for 2A3/300B	£2.25	BD9 magnoval chassis mounted for PL519	
12AX7WA Sovtek	£3.50	CV4004 Brimar UK	£7.85	ECC88/6922 ECG Philips	£5.18	UX4 large locking type	£6.00		£2.25
12AX7WB Sovtek	£3.50	CV4024 Mullard UK	£7.50	ECL82 Russian	£1.58	B5 UK	£3.60	Topcap used for 807	£1.20
12BH7A GE Brands	£13.50	DG732 Tungstram Hungary	£32.48	ECL82 East European	£3.23	UX5 McMurdo UK	£2.10	Topcap 12 E1, 5B-254M, PL519	£3.00

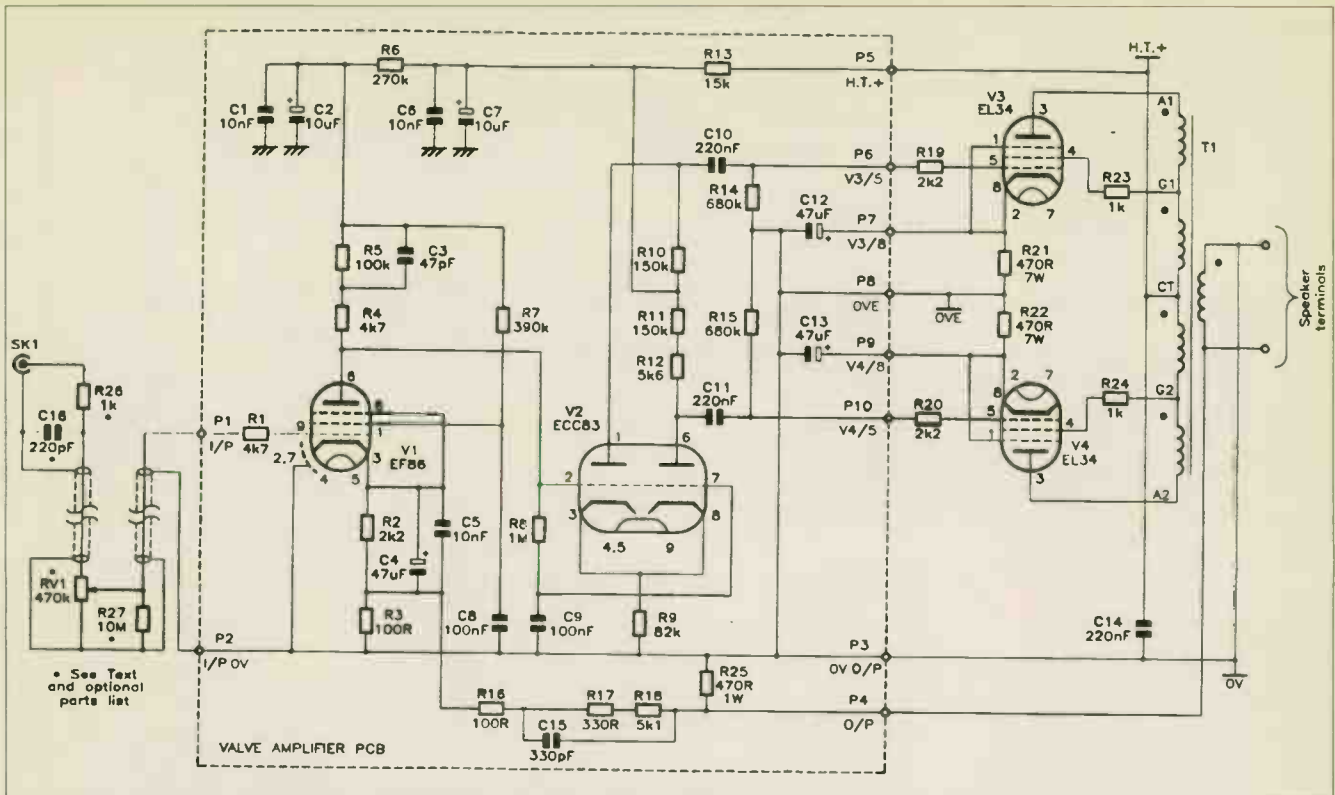

The Millennium 4-20 is based substantially on the Mullard 5-20. Few changes have been made, the most major one being use of a solid state rectifier.

interesting package with an affordable price tag. The kit can be bought and built in three stages, the power supply and each monoblock amplifier kit available separately. This is a nice idea for the constructor with limited funds - the cost can be spread over several weeks.

One of the first things I noticed about

the kit, carrying it from the HFW store to the HFW workshop deep in the heart of Notting Hill, was that my arms were still in their sockets. Being used to big, heavy valve amps this was a pleasant surprise. After opening the boxes, the reason for their lightness became apparent. The chassis are made of aluminium and the

mains transformer is smaller than I would have expected. These are not necessarily bad points: why not produce a light valve amplifier as long as it does not hum badly or suffer transformer melt-down!

THE CHASSIS

Maplin provide an extremely

comprehensive instruction booklet, including a constructor's guide with basic tips and data. As the chassis (there are three of them) are blank, holes must be cut for transformers, valve bases and other hardware. These cut-outs have to be marked up by the constructor. Accuracy is all important here, since if a cut-out is incorrectly positioned parts may not fit.

Using a hand drill, numerous drill bits, a vice for holding the chassis steady while cutting, a coping saw, a reamer and a 30mm diameter circular punch (from Electromail) it took me a couple of hours and a lot of sweat to finish each chassis. The process is relatively straightforward though, and the instructions clear, but I found the cut-out for the mains inlet socket a little on the large side.

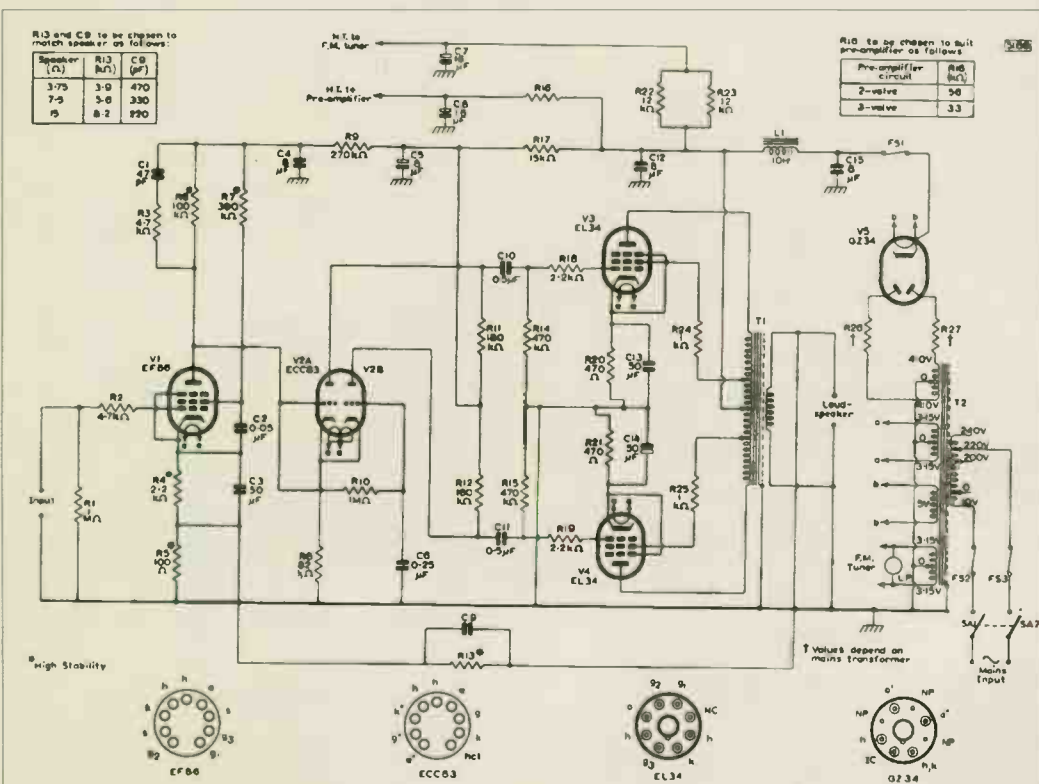

The original Mullard 5-20 design from 1955.

KIT & COMPONENT SUPPLIERS

LOUDSPEAKER KIT SUPPLIERS

Bandor Design & Development Studios
11 Penfold Cottages, Penfold Lane, Holmer Green, Bucks HP15 6XR Tel. (0494) 714058
Bandor Musical Drive Units cover the entire audio spectrum with one 50mm (100Hz - 35K) and one 150mm (20Hz - 8K). One driver covers 2/3 RD of the frequency. Crossovers 150 Hz/8K. Anodised aluminium spun cones. 1.3 grams moving mass gives crisp transients. Good power handling. Robust. 35 YEARS EXPERIENCE.

Tabula Rasa
1 Silkin Dalton Close, Broadfield, Crawley, W Sussex. RH11 9JD
Tel. (0293) 531190

A young company specialising in the distribution of loudspeaker kits, components, accessories, and design measuring equipment from Germany, where the DIY loudspeaker has been well established and very successful for many years.
We handle speaker kits (with or without cabinets), a wide range of drivers, filters, filter components and accessories. Very low cable prices. Loudspeaker designs, measurement systems and high quality filter components also available. 30 day money back guarantee on all speaker kits. Send £2.00 (returnable on purchase of any speaker kit) for our catalogue. Trade enquiries welcome.

Faraday Sound
248 Hall Road, Norwich, NR1 2PW.
Tel. 0603 762967

Loudspeakers in Concrete. Now you can build your own low density concrete cabinet enclosure Faraday FS1, Siren, FS5, FS10 or a design of your own choice. Stunning sound. Simple DIY skills only. Instruction guide for only £3.95. Includes reviews, photo's etc. and at least £5.00 discount off any further products purchased from us e.g. ready made cabinets. Also £25 - £150 off any complete loudspeakers!!

Falcon DIY Speakers
Falcon Electronics, Tabor House, Mulbarton, Norfolk NR14 8JT Tel. 0508 78272

Falcon sell kits, drive units and crossover components and have a large range of books and back issues of kit magazines. Please send large SAE (34p) for free price list.

The Speaker Co.
Unit 9, Waterside Mill, Waterside, Macclesfield, Cheshire. SK11 7HG Tel: 0625 500507

The largest range of speaker drive units and accessories stocked for the speaker builder. Plus a range of speaker kits designed exclusively for The Speaker Company. MLSSA test facility available, phone for an appointment. Our prices can not be beaten.

Audiocab
9 Skew Bridge Close, Wootton Bassett, Swindon, Wiltshire. SN4 7DW. Tel: 0793 848437.

Loudspeaker cabinet kits are the speciality of "AUDIOCAB". Whether you are prototyping your own loudspeakers or working to a design published in Hi-Fi World, including the KLS3, "AUDIOCAB" will produce a bespoke kit to your specification. "Biscuit jointing" is used to ensure perfect alignment of adjacent panels and cabinets are dry assembled and sanded before dispatch. David Barfield, proprietor, says "no prior experience of woodworking will be required to build our kits and achieve a professional finish". Kits will normally be supplied in 25mm unfinished MDF but any finish is available and designs are usually enhanced by the use of mouldings to escape from the normal "square box". Ready built cabinets can also be specified. Professional, trade and retail enquiries are invited.

Wilmslow Audio
Wellington Close, Parkgate Trading Estate, Knutsford, Cheshire WA16 8DX
Tel. 0565 650605 Fax. 0565 650080

Extensive range of drive units and over 30 different designs of self-assembly kit. Two 'ATC' kits now available. Drive units include those from KEF, Dynaudio, Audax, SEAS, Peerless, Scanspeak and Morel. Everything required for the loudspeaker builder and four dem rooms to listen to the kits in built-up form. Two new kits from Morel - one 3 litre, magnetically shielded, one 11 litre book shelf.

PL Acoustics
2 Laverton Road, Westbury, Wilts BA13 BRS
Tel. 0373 823333
IPL supply a range of eight speaker kits using drive units from SEAS, Morel, Audax, Visaton etc. including four transmission lines to suit all room sizes. We also supply a full range of drive units, capacitors, and cabinet accessories as well as silver plated P.T.F.E. insulated cables.

DBS Audio
PO Box 91, Bury St Edmunds, Suffolk IP30 0NF
Tel. 0284 828926
Sole authorised supplier of DBS loudspeaker kits designed by Dave Bemman. The acclaimed DBS6 kit includes Morel tweeters and custom built woofers, plus top quality pre-assembled crossover and components.

VALVE AND OUTPUT TRANSFORMER SUPPLIERS

P.V. Tubes
104 Abbey Street, Accrington, Lancs. BB5 1EE
Tel. 0254 236521/232611 24 hrs a/p
Fax. 0254395361

For all your electronic components. Valves are new in branded boxes and matched pairs are available. Pls call for types and prices. We are closed all day Wednesday.

Vintage Valves,
PO Box 147, Station A, Vancouver B.C. Canada, U6C 2M3. Fax (604) 876 5876.
Dynaco, Sherwood, Scott, The Fisher, McIntosh, Eico, Harmon Karoon, Heath, Altec, Stromberg-Carbon. Many vintage parts and equipment available on request.

Wilson Valves
28 Banks Ave., Golcar, Huddersfield, West Yorks HD7 4LZ. Tel. 0484 654650/420774.
Fax. 0484 655699.

Mail order. Call us to find out more about our extensive range of valves. Over 1,000 different types stocked. S.A.E. for list. (Please mark for Dept. HFW).

Langrex Supplies Ltd
1 Mayo Road, Croydon, Surrey CRO 2QP
Tel. 081 684 1166 or fax. 081 684 3056
One of the largest distributors of electronic valves, tubes and semi-conductors in the UK by original UK and USA manufacturers. Obsolete types are a speciality. Telephone or fax for an immediate quotation.

Billington Export Ltd.
1E Gillmans Trading Est., Billingham, Sussex RH14 9E3
Tel. 0403 784961 or fax. 0403 783 519.
Billington Export Ltd. holds large stocks of audio valves including many obsolete brands such as Mullard, GEC, Brimar etc. as well as Sovtek and Thermionic Gold Brand. Also Cathode Ray Tubes (eg used in Marantz tuner 10B). 40-page catalogue available, tel or fax for a quotation. Minimum order £50.00.

PM Components
Springhead Enterprise Park, Springhead Road, Gravesend, Kent DA11 3HD Tel. 0474 560521
P.M. Components Ltd are the specialist component company for High End Audio enthusiasts. We have a design and manufacturing base for audio valves and associated products and have a capability to produce custom tubes for major manufacturers. Our 70 page catalogue is available at £2.50 including U.K. postage. P.M. Components are major stockists for Golden Dragon, Mullard, GEC and Teonex valves and have a vast archive of vintage tubes gathered from every manufacturer in the world.

Sowter Transformers
EA Sowter Ltd
PO Box 36, Ipswich IP1 2EL
Tel. 0473 219390/252794
Output and mains transformers for GEC KT88 circuits. Can also make any other transformer to order. Send SAE for lists and data.

Chelmer Valve Company 130 New London Road, Chelmsford, Essex CM2 0RG
Tel 0245 265865 Fax. 0245 490064.
Supplier of premium range of audio valves, other valves and components also available. (Please see our ad on inside back cover of this supplement).

RESTORATION

GT Audio 5 Upper Road, Higher Denham, Bucks UB9 5EJ Tel. 0895 833099
Professional repair/restoration of all hi-fi including classic and vintage equipment. Supplier of very high quality electronic components, in particular types which are difficult to source. Original valves available, i.e. Mullard, Brimar, GEC, GE, RCA, Sylvania etc.

COMPONENT SUPPLIERS

Hart Electronic Kits Ltd Penylan Mill, Oswestry, Shropshire SY10 9AF 24 Hr sales/enquiries
Tel. 0691 652892
A range of Audiophile kits for 80 watt Power Amplifiers, Tuners, Pre-Amps and Moving Coil/Moving Magnet RIAA Pickup Preamps. All kits are fully engineered, with our thirty years design experience, for easy constructions from circuits by John Lindsey Hood, the most respected designer in the field. Send for lists.

Audio Components Ltd
Albany Court, Albany Road, Granby Industrial Estate, Weymouth, Dorset, DT4 9TH
Tel. 0305 761017 Fax. 0305 761492
Audio Components supply the Audio Innovations Classic 25 Kit Amplifier. This valve Line Integrated design offers 4 line inputs, a tape loop and 25 watts of Class A power in an elegant, domestically friendly casework. It comes with a comprehensive 40 page instruction manual and a guaranteed fixed price competition service should any difficulties be encountered. Price is £699.

V.R.R.
30 Melbourne Ave, Worthing, BN12 4RT
Tel: 0903 501158
Offers a range of short-lead monoblock valve amplifiers, eg. 60w at £299, output transformers, mains transformers, chokes, valves, cables, circuits, custom design, ready-built stereo valve pre-amps £299, 30 + 30w Class A, power amps £900.

SJS Acoustics
Ben-Dor, Lumb Carr Road, Holcombe, Bury, BL8 4NN.
Suppliers of difficult to find high quality components for valve amplifiers: including Single Ended Output Transformers, Signal and Power Supply Capacitors, PTFE Board and Silver Wire. For full information and a catalogue send an SAE to the above address.

AP Electronics
20 Derwent Centre, Clarke Street, Derby, DE1 2BU
Check out the AP ELECTRONICS 1994 catalogue. It's free with every order of over £40.00 or can be purchased for a £4.95 cheque payable to 'AUDIOKITS'. Over 80 pages include pre and power amplifier kits, high grade audiophile resistors, capacitors and semiconductors, audio and mains cables, gold and rhodium plated connectors and COMPONENT NOTES on using high grade parts. A quarterly newsletter 'AP PERFORMANCE AUDIO' has been recently launched and your first issue is free.

Chelmer Valve Company (pls look under valves)

Electromail
PO Box 33, Corby, Northants NN17 9EL
Tel: 0536 204555
The branch of the well known RS Components trade mail order business that deals with the public. They have a huge range of components and catalogues to match.

Omni Electronics
174 Dalkeith Road, Edinburgh EH16 5DX
Tel. 031 667 2611
A wide range of components aimed at the hobbyist, competitive VAT incl. prices, mail order and a friendly service. Open Mon-Thurs 9.15-6.00, Friday 9.15-5.00 and Sat's 9.30-5.00.

RATA Ltd
Edge Bank House, Skelsmergh, Kendal, Cumbria LA8 9AS Tel. 0539 823247
RATA specialise in supplying high grade audiophile components and cables. They also have a small range of drive units and kit amplifiers.

VINTAGE DIY

Loricraft Audio
4 Big Lane, Goose Green, Lambourn, Berks RG16 7SQ Tel. 0488 72267
Specialist restoration of 301's and 401's using genuine spares and re-manufactured parts to original pristine standards in our newly built workshops designed primarily for these purposes.

CLASSIC TURNTABLES

Technical & General
P.O. Box 53, Crowborough, East Sussex TN6 2BY. Tel. 0892 654534.
The original specialist source of spares, restorations and overhauls for the classic turntables. Years of actual experience and comprehensive range of parts (originals and re-manufactures), manuals, ancillaries, No dubious 'improvements' - no harmful 'modifications'. Our specialities: Connoisseur; Garrard; Goldring; Lenco; SME; Thorens; Watts; Ortofon; Shure;

YOU CAN ADVERTISE IN THIS SECTION FOR ONLY £30. CONTACT AMANDA SWEENEY ON: 071 - 266 0969.

THE POWER SUPPLY

I constructed the power supply unit first. PCB assembly was straight forward, making sure the LCR 68µF capacitor was connected up the correct way round. It has screw-in terminals which I found did not fit the screws supplied. I used M5x8 screws which fitted perfectly, the M4s being too small.

The transformer secondary heater leads are connected to terminal blocks that sit on the PCB. If these are shortened the enamel coating must be scraped off at the connection point to ensure a strong join.

Once built I gave the supply a quick test. There was a little mains transformer mechanical noise at switch on, but this is to be expected because of the chassis thinness. The HT was at 490 volts - about right under no load conditions, and the heater voltage was at 6.4 volts, right again.

THE AMPLIFIER

Now onto the monoblock construction. The PCB assembly is easy enough, but because there are a lot of components. I find it's always wise to fix them to the board with the values facing upwards. This makes it easier to check component value against position if you are unsure later on. Also, I made good use of the parts list and description Maplin provided, which is there to help prevent mistakes. The majority of the resistors are metal film which have a different colour coding to the familiar carbon type, so you will need to refer to the constructor's guide or make use of your multimeter.

I inserted the PCB mounted B9A valve bases first while it was easy to get the soldering iron tip to the pins; the board becomes quite full after the passive components have been mounted. By paying careful attention to the instructions you cannot go far wrong with PSU-pin to PCB-pin, to valve-pin connections.

The amplifiers can either be used as straight monoblocks, or fitted with a potentiometer to give volume control for line level inputs, as I did.

Once completed, I switched on the amplifier with a dummy load (8 Ohms) connected to the speaker terminals and a sine wave input. It worked first time, thankfully, giving a good clean sine wave output on the scope.

I found the Millennium 4-20 kit a very enjoyable build, even if you do have to cut the chassis yourself, which is quite hard work. The kit is packaged professionally and work has gone into the literature. I ran into very few problems - eight out of ten for Maplin, well done. Whether the thin aluminium chassis material and the small size of the mains transformer will cause any troubles will appear in the running test, to be discussed later.

USING THE MILLENNIUM 4-20

Once fully constructed, I found it tricky to move the three separate parts of the

amplifier, joined only by thin interconnecting wires. I would be tempted to screw the three sections together and mount them on a solid wooden base for safety.

From switch on the Millennium 4-20 takes a little time to get going, as the heaters warm up. There is a slight audible hum on both channels which could be suppressed either with larger smoothing capacitors or a π -section choke filter, but the hum wasn't loud enough to annoy.

After half-an-hour of use the power supply was already starting to get warm, reaching a rather high temperature after a couple of hours. Although the transformer and the chassis became hot enough to burn, the transformer didn't show signs of deterioration.

SOUND QUALITY

Listening to the Millennium 4-20 reminded me just how resilient a good valve amplifier circuit can be. That's no slight upon Maplin, who can be congratulated for offering a good DIY kit.

Even a humble kit like this handles

vocals wonderfully, bringing body and texture to images, making them seem fuller and more real than most solid state amplifiers. Maplin's 4-20 is not an especially warm sounding EL34 amplifier either; it has quite a bright, open and 'modern' sound. There was just a hint of 'schhh' in the treble at times, yet more sonority to triangles, and cymbals.

In spite of the small output transformers, the 4-20 had a good bass performance too. I didn't try and push the amplifier too hard, for although valve amps go loud gracefully, they can begin to wallow in the bass. The 4-20 brings you the benefits of valves, with few of the drawbacks. It is excellent value, Mullard's 1955 circuit offering great performance by any standard, even when adapted in this fashion to provide a budget kit. **NK**

Millennium 4-20 £199.50
Maplin Electronics
PO Box 3, Rayleigh,
Essex. SS6 8LR
Tel: 0702 554161

MEASURED PERFORMANCE

The 4-20 gives 20watts per channel over most of the audio band, which surprised me considering the small size of the output transformers. Low frequency output limitations set in below 40Hz due to core saturation, but considering price the performance was very good. Some slewing set in at high outputs and at high frequencies as well, generating third harmonic distortion, but only close to the output limit. Otherwise, the 4-20 delivered plenty of output with low distortion, working well in this respect compared to many commercial designs.

Frequency response was unusually wide, perhaps a little too wide, since in the noise floor there was a small amount of oscillation. High-ish feedback valve amps are best band limited to keep the upper limit to 50kHz or so maximum; the 4-20 reached 73kHz. We notice that Maplin have taken grid 2 of the EF86 input valve to ground through C8 when Mullard - correctly in our view - connected this to the cathode (pin 3), so grid 2 in effect sees no a.c. signal, since the cathode is not fully bypassed. This, and the fact that Mullard's compensation components have been used, which we find can make stability worse, not better, probably account for these minor funnies. All the same, however, there was no high frequency output peak, response rolling off smoothly. This ensured a good square wave response was achieved, free from ringing.

Noise was low at -100dB, as expected from EF86 input valves, which are very quiet devices. Sensitivity was high at 230mV, allowing the amplifier to be used with a passive pre-amplifier. Hum was low enough at 0.5mV on one channel and

1.3mV on the other, output valve balance.

The mains transformer is small and as a result runs very hot. By use of high temperature insulants, transformers can be designed to withstand this, but some owners may be disconcerted. Because transformers are so expensive, some cost savings have necessarily been made here.

The Maplin 4-20 measures very well considering its low price. For the impecunious, it offers a good introduction to the realm of valve amplifiers, outperforming many commercial designs. **NK**

AMPLIFIER

Power	21watts
CD/tuner/aux.	
Frequency response	10Hz-73kHz
Separation	80dB
Noise	-100dB
Hum	0.5/1.3mV
Distortion	0.02%
Sensitivity	230mV
d.c. offset	none

Distortion

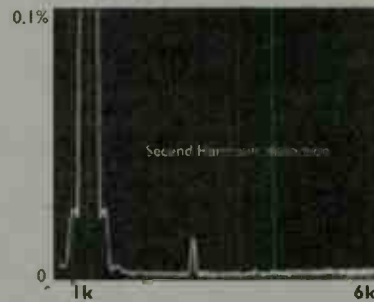

HART

Hart Audio Kits - Your Value for Money Route to Ultimate Hi-Fi

2 Penylan Mill, Oswestry, Shropshire, England SY 10 9AF
phone Oswestry (0691) 652894

Hart Audio Kits and factory assembled units use the very best audiophile components in circuit designs by the renowned John Linsley Hood to give you unbeatable performance and unbelievable value for money. We have always led the field for easy home construction to professional standards, even in the sixties we were using easily assembled printed circuits when Heathkit in America were still using tagboards! Many years of experience and innovation, going back to the early Dinsdale and Bailey classics gives us incomparable design expertise in the needs of the home constructor. The current range of Hart kits is designed to give you the important core components of a system as a matching ensemble of audio excellence.

1100 Series. LH80W "Audio Design" Mosfet Power Amplifier.



Another masterpiece from the drawing board of John Linsley Hood and another opportunity to give a system mega sound performance for only a few hundred pounds cost. A host of advanced features, in the hands of the skilled designer, give this amplifier a performance that really is only equalled, not exceeded, by the 4 or 5 figure price tagged exotica.

As always with a HART kit you have the pleasure of building selected, state of the art equipment, allied to the knowledge that your money has all been spent on quality components, you save all the costs of building and testing, plus the dealers margin on top of these by doing it yourself.

To give an idea of the measures taken to achieve ultimate quality and linearity in this amplifier each of the four output devices is only called upon to work at one NINETY-SIXTH part of its ultimate power rating.

We are proud to offer this latest John Linsley Hood masterpiece, the flagship of our range, which we believe is truly the ultimate design for the perfectionist, combining as it does the best circuit design, the best engineering and the best components, surely the only recipe for REAL sound fidelity. The HART KIT concept also makes it possible to build an amplifier with the facilities YOU want and we offer no less than three variations with options on the basic theme to suit your needs. One of these variations will, we believe, cater for your requirements. Should your requirements change at a later date then upgrades or alteration to a different version are no problem, try doing that to your High St store amplifier!

The Standard version has a passive input selector circuit with Alps Precision Low-noise volume and balance controls, switchable CD, Tuner and Pre-amp inputs and an optional stereo bargraph output level display. The 'Slave' version has stereo power amplifiers and standard power supply. The 'Monobloc' version again has the standard power supply but since it is only driving one power amplifier higher than normal output power is achieved with total channel separation. The slave and monobloc versions enable very sophisticated bi-amping and active crossover systems to be constructed.

K1100 Complete STANDARD Amplifier Kit, two power amplifier channels and one power supply module, direct input passive signal selector stage, Construction Manual and RH11 Reprint.
SPECIAL DISCOUNT PRICE FOR COMPLETE KIT IS ONLY £395.21
A1100 Factory Assembled **£499.21**

K1100S Complete SLAVE Amplifier Kit, as above but without passive input stage.
SPECIAL DISCOUNT PRICE FOR COMPLETE KIT IS ONLY £333.62
A1100SC Factory Assembled **£422.62**

K1100M Complete MONOBLOC Amplifier Kit, consists of all parts for one power amplifier channel and one power supply module and all chassis parts.
SPECIAL DISCOUNT PRICE FOR COMPLETE KIT IS ONLY £261.20
A1100M Factory Assembled **£329.20**

All HART kits are designed for easy home construction to the very highest standards, and can be built by anyone of average manual ability. If you are still not convinced how easy it is to build it yourself with a HART kit you can order the Instruction Manual to read for yourself and we will refund the cost when you buy your kit!

PROBABLY THE LAST VINYL PREAMP YOU EVER BUY.

For those who love the vinyl medium the listening pleasure can only be enhanced by using the very best phono preamplifier available. The Hart range of phono preamps feature a special shunt feedback circuit topology and are designed by John Linsley Hood. This circuit format gives audibly superior sound to the standard series feedback system normally used and gives a performance that will exceed or equal that given by the best of the mega priced offerings. Our range includes units to suit everyone from the occasional user to the serious audiophile. All can be changed to suit moving coil or moving magnet cartridges at the flick of a switch.

K1500 Series. This is an integrated circuit version of the shunt feedback concept, using so little power that it may be run from



batteries. An ideal "first kit" project as it is very simple to put together and no mains voltages are involved.

K1500 Complete Kit With Full Instructions (Battery Powered) **£73.76**
A1500 Factory Assembled **£118.76**

K1450 Features a totally discrete component implementation of the Shunt Feedback concept. Audiophile grade components fitting to an advanced double sided printed circuit board make this a product at the leading edge of technology that you will be proud to own. Nevertheless with our step by step instructions it is very easy and satisfying to assemble. Due to the higher current consumption this unit is powered by our mains driven K1565 Audio Power Supply, itself an advanced piece of technology in a matching case. This supplies the superbly smoothed and stabilised supply lines needed by the preamplifier and features a fully potted Hi-grade toroidal transformer along with a special limited shift earth for hum free operation. Suitable for all moving coil and moving magnet transducers this unit is especially recommended for, and will extract the very best from the modern generation of low output high quality transducers.

K1450/1565X. Complete RIAA Phono preamplifier, Power Supply and power connect cable Kit form **£196.29.**

1450/1565X Factory assembled & tested. **£285.29.**

ALPS PRECISION LOW-NOISE STEREO POTS

Now you can throw out those noisy ill-matched carbon pots and replace with the real hi-fi components only used selectively in the very top flight of World class amplifiers. The improvement in track accuracy and matching really is incredible giving better tonal balance between channels and rock solid image stability.

On the motorised versions the 5v DC drive motor is coupled to the normal control shaft with a friction clutch so that the control can be operated manually or electrically.

Our prices represent such super value for pots of this quality due to large purchases for our own kits.



MANUAL POTENTIOMETERS

2-Gang 100K Lin **£15.67**
2-Gang 10K, 50K or 100K Log **£16.40**
2-Gang 10K Special Balance, zero crosstalk and zero centre loss **£17.48**

MOTORISED POTENTIOMETERS

2-Gang 20K Log Volume Control **£26.20**
2-Gang 10K RD Special Balance, zero crosstalk and less than 10% loss in centre position **£26.98**

PRECISION Triple Purpose TEST CASSETTE TC1DD.

Are you sure your tape recorder is set up to give its best? Our latest triple purpose test cassette checks the three most important tape parameters without test equipment. Ideal when fitting new heads. A professional quality, digitally mastered test tape at a price anyone can afford.
Test Cassette TC1DD Our price only **£10.99.**

DISK-COUNT Classical CD's.

Top quality, Full Digital (DDD) Compact Disks of the great classical favourites. Like everyone else we didn't like the idea of paying silly prices for CD's. After a long search we have now located a source of top quality classical recordings at prices that make you suspect the quality - until you try them! Send for our list of titles.

TECHNICAL BOOKSHELF

Modern Books. Selected to represent the state of the art today.

"THE ART OF LINEAR ELECTRONICS."

J.L.Linsley Hood.
Just Out! Hot Off the Press, the definitive electronics and audio book by the renowned John Linsley Hood. This 300+ page book will give you an unparalleled insight into the workings of all types of valve and solid state audio circuits. Learn how to read circuit diagrams and understand amplifiers and how they are designed to give the best sound. The virtues and vices of passive and active components are examined and there are separate sections covering power supplies and the sources of noise and hum. As one would expect from this writer the history and derivation of audio amplifier circuitry have an entire chapter, as does test and measurement equipment. Copiously illustrated this book is incredible value for the amount of information it contains on the much neglected field of linear, as opposed to digital, electronics. Indeed it must be destined to become the standard reference for all who work, or are interested in, this field.

SPECIAL OFFER. With each book purchased you may request a **FREE** extended index, written by the Author, exclusively from HART. 0-7806-0868-4. **£16.95**

Don't forget most of our kits have reprints of articles by John Linsley Hood that you can purchase separately.

"DIGITAL AUDIO AND COMPACT DISC TECHNOLOGY"

2nd Edition. Boert, Theunissen and Verguit. (SONY Europe)
A thoroughly well written book covering the field of recording media starting with the Phonograph right through to modern professional PCM digital recording systems with particular and extensive coverage on the compact disc. All aspects of the recording and reproduction processes are explained with separate chapters on such things as compact disc encoding and the use of cross interleave Reed-Solomon error correction code (CIRC). This book is of course essential reading for engineers and students involved in the field but its very low prices makes it ideal for the enthusiast of recorded music who wants to know more about the hidden processes going on his CD player.
1992/94 248 Pages. 247 x 190.
0-7506-0614-2 **£17.95**

"THE LOUSPEAKER DESIGN COOKBOOK" Vance Dickason.

(4th Edn.)
All the information you need to build the loudspeaker system you always wanted but could not afford. Easy ways to pick the exact box size, the ideal drivers, and the correct way to load the music to your new super loudspeaker system. Over 140 pages packed with important design data.
1991. 152 Pages.
0-9624-191-7-6 **£22.95**

"THE ART OF SOLDERING"

R. Brewster.
Absolutely essential reading for anyone who ever picks up a soldering iron. Written from knowledge gained in a lifetime in the field, this is the first book ever solely devoted to this essential and neglected skill for all electronic enthusiasts. Covers everything from the correct choice of soldering iron and solder to the correct procedures to follow with many illustrations and practical exercises.
0-85935-324-3. **£3.95**

Postage on Single Books is £1.50 except for The Art Linear Electronics, Digital Audio and Compact Disc Technology and The Loudspeaker Design Cookbook which are £3.50. Two, or more books are only £4.50, any size, any quantity.

Classics from the "Golden Age"

"THE WILLIAMSON AMPLIFIER."

D.T.N. Williamson.
In April 1947, Williamson's power amplifier, using excellent quality push/pull output valves, a special output transformer, and a highly filtered power supply, became an overnight success. The author takes the reader deep into his design considerations, offering practical advice on how to build the units plus concise instructions on setting up the new amp. A cult classic.
1947, Reprinted 1990. 40 Pages.
0-9624-1918-4 **£6.95**

LOUDSPEAKERS; THE WHY AND HOW OF GOOD REPRODUCTION.

G.A. Briggs This easy-to-read classic, last revised in 1949, introduces the reader to concepts such as impedance, phons and decibels, frequency response, reponse curves, volume and watts, resonance and vibration, cabinets and baffles, horns, room acoustics, transients, crossovers, negative feedback, Doppler and phase effects, and much more. A provocative survey of the right questions about sound reproduction.

1949 Reprinted 1990. 88 Pages.
0-9624-1913-3 **£8.95**

Send or phone for your copy of our FREE list of these and many other Kits & Components. Enquires from Overseas customers are equally welcome, but PLEASE send 2 IRCs if you want a list sent surface post, or 5 for Airmail. Ordering is easy. Just write or telephone your requirements to sample the friendly and efficient HART services. Payment by cheque, cash or credit card. A telephoned order with your credit card number will get your order on its way to you THAT DAY. Please add part cost of carriage and insurance as follows: **INLAND Orders up to £20 - £1.50, Order over £20 - £3.50. Express Courier, next working day £10. OVERSEAS - Please see the ordering information with our lists.**

QUALITY
AUDIO KITS

24hrs. SALES LINE
(0691) 652894

ALL PRICES
INCLUDE
UK/EC VAT

HART

"Roll Your own Super Cables"

A tutorial video that blows open the secrets of exotic 'HiEnd' cables, explains a radical new cable theory and shows you:

- * How to make low cost interconnect cables that rival the best at any price (single balanced)
- * How to make the ULTIMATE interconnect still at a sane price (single or balanced)
- * How to make paradigm breaking speaker cables that provide astonishing performance for price
- * What wire to use, what connector, what solder and where to buy it all at acceptable prices
- * All shown step by step, on camera, so you can make them using only normal tools and skills.

A response from one astonished client:

"Should I really be hearing more definition and clarity from these \$25 homegrowns than I get from my \$1000 NBS interconnects?"

Special offer to HiFi World readers:

Roll your own Super cables

VHS HiFi Video (specify NTSC or PAL)

\$49.50 or £34.50 or DM 79.50 inc. postage.

The TubePreamp Cookbook

From 30 years of 'hands on' design, development and professional construction of tube equipment comes this in depth discussion of tube preamp designs and their practical implementation.

- * Classic and exotic circuits
- * Feedback/no feedback concepts
- * Active/passive RIAA options
- * Single ended and balanced/differential designs
- * Power supplies, regulation and regulators
- * The ULTIMATE preamp regulator
- * Component, cable and tube choices
- * Modifications, upgrades, rebuilds and lots lots more

Packed with diagrams, schematics and ideas, it's a gold mine for the advanced constructor or even a professional preamp designer.

Special offer to HiFi World readers:

Vacuum State TubePreamp Cookbook

\$29.50 or £19.50 or DM 44.50 inc. postage.

Ph, Fax or E-Mail Visa/MC (or just post cash)

Fine Print: 14 days money back if not delighted.

VERY SPECIAL OFFER - Video & Cookbook together only \$69.50 or £49.50 or DM 109.50

**Vacuum
State
Electronics**

Allen Wright/Allgäuer

Einsteinstr. 129

81675 Munich, Germany.

Ph/Fax ++49 89 477415

CompuServe 100240,2562

BADGER BOARDS

Printed Circuit Boards

Prototype-Singles-Multiple runs.

Minimum charge £15.00.

Artwork, Plotting from Schematic to final board layout.

Send S.A.E. now for Catalogue of Kits-Boards-Projects available. Many magazine boards produced for individual customers.

**Dept. HFW 87, Blackberry Lane, Four Oaks,
Sutton Coldfield, B74 4JF
Tel: 021 353 9326**

SOWTER
TRANSFORMERS

Sowter Transformers have been used by the Professional Audio Market throughout the world for at least the last twenty - five years.

Using modern technology and Computer Aided Design we are now able to offer a complete design and manufacture service.

Our current lists show a range of over 50 output. 70 power transformers and nearly 30 chokes.

E. A. SOWTER LTD
P.O. BOX 36, Ipswich IP1 2EL
Tel: 0473 252794. Fax: 0473 236188 SEND S. A. E. FOR DETAILS.

**To make the most of
your projects, start with
the right tool.**

**1994
Catalogue**
The Audio Hobbyist's
Definitive Parts Source

Get connected with
the widest selection
of audiophile grade parts.
Send £2.85 along with
your mailing address
and you will receive our
1994 parts catalogue
and a \$10 discount coupon good
on your first order over \$100.

**THE PARTS
CONNECTION**

A DIVISION OF SONIC FRONTIERS INC

2790 Brighton Road, Oakville, Ontario, Canada L6H 5T4
Telephone (905) 829-5858 Facsimile (905) 829-5388

MIT MultiCap • Wonder Cap • Kimber Kap • Solo • Solen • Siemens • Hovland MusiCap
Wima • Holco • Rel-Cap • Draloric • Vishay • Caddock • Mills • Matsushita • TKD • Noble
Cardas • Kimber Kable • Discovery • Audioquest • MIT • ClearAudio • Alps • Bourns • Elma
Shalco Attenuators • Electroswitch • Elna • Nichicon • Gold Aero • RAM • Mallory
Ruby Tubes • Linear Technology • Analog Devices/PMI • Motorola • Edison Price
International Rectifier • MagneQuest • Sonic Frontiers
Pearl • Tube Sockets • WBT • Neutrik • Curcio Audio Engineering • Kits

* or \$5.00 US. for credit card information
** catalogue pricing and discounts
are in US Dollars

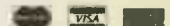



Dedicated hobbyists are, sometime or other, going to wish they had one of these - an audio noise meter. Noise meters are a development of the standard audio level meter with its dB scale, generally having more ranges and - crucially - a selection of switchable noise weighting filters for accurately measuring hiss and hum. But whereas the common and popular audio level meter, meant for measuring sine wave test signals, costs £200-£300, noise meters cost £700-£1500, putting them out of most people's range.

When we came across the Valley People Advantage 310 noise level meter in a U.S. magazine, priced at an unusually low £329, a quick call was made to their Kansas 'phone number. We found their products, mainly aimed at the studio market, were distributed in the U.K. by Hilton Sound. So this meter is available to U.K. hobbyists. But what does it offer and why is it less than half the usual price?

Most surprising is the absence of a range change switch. Normally, these meters have no fewer than sixteen switched ranges covering 10µV to 300V (full scale). The Model 310 has a single push-button instead, giving just two ranges - quite a difference. It sacrifices resolution, direct voltage calibration and a little range for a novel linear dB scale that covers 70dB in one sweep, or 140dB in all, compared with 170dB in an expensive instrument. Savings have been made mainly in the size of the meter movement

VALLEY PEOPLE AUDIO NOISE AND LEVEL METER

Tested by Noel Keywood

and the elimination of the range change switch - both expensive hardware items. The casework is simple too, which also helps contain cost.

The lowest possible reading the 310 can manage is -100dB relative to 0.775V

(8µV), the highest +30dB or 24V and the maximum permissible input voltage is a low 30V. With individual dB calibrations little further apart than the thickness of the meter needle, resolution at scale extremes in particular is limited to a few

dB or so. However, since noise measurement is by its nature an approximate affair, trying to resolve less than a dB is usually academic, so the Valley meter is not really hampered by this. Its bottom-end range limitation will prevent it measuring noise in many digital systems though, including the output from a CD player or DAT machine, for example. We quite often crank our noise meter down to 10µV full scale and end up peering at the needle struggling to get off its end stop at one millionth of a volt, or -120dB, even if this is only to confirm digital zero muting.

Absence of a voltage scale also means that it will usually need to be used in conjunction with a conventional level meter, not as an all-in-one instrument, like most noise meters. Because of its limited scale resolution, the 310 is not suitable for measuring frequency response within 1dB limits, for example.

So much for the downside. What about the upside? Aware that wideband noise measurement is often frustrated by hum, both from external sources and from hum loops caused by a mains powered instrument like this one, the Model 310 has an earthed metal case but a floating ground reference and an isolated, balanced input for measuring balanced sources - something that is rare in many expensive rivals. Personally, I prefer alternative battery operation from rechargeable NiCads since it overcomes all these problems and offers portability, but it remains rare in professional instruments and is not an option with this one. The 310 has the advantage, however, that it can feed external items like a 'scope or sound monitor without being grounded by them.

The literature provided is more a diatribe on the physics of noise, often in the detached first person (if one sums noise one will observe, etc), rather than useful easy guidance for beginners not conversant with noise measurement or, especially, noise weighting filters. It obfuscates even the simple, like the pseudo-DIN Audio Band filter (20Hz/20kHz), making it look obscure and difficult, which is a pity. In contrast, Radford says succinctly that their DIN Audio Band filter "is based on specification DIN 45.500 with 3dB points at 22Hz and 22kHz. DIN also specifies 36dB/octave roll offs but this is considered impracticable." Neither Radford nor Valley People adhere to the standard, but whilst Radford explain why, Valley People circumnavigate it, preferring to make the simple sound complex in a tortuous explanation of little use to anyone attempting to use this meter. Yet they do place the -3dB points at the right frequency and provide very useful 3rd order (-18dB/octave) roll off rates

So, the bottom line is that this meter

does have pseudo-DIN AB, which is a useful filter for general audio band work. The 310 also has IEC A weighting and CCIR/ARM, both of which are also very useful.

Like many, we often use CCIR - a difficult curve to engineer - for hiss level measurement. It is especially useful with tuners due to good 19kHz mpX rejection and it relates well to perceived hiss levels.

As a filter the IEC A curve seems a bit ad-hoc in the usefulness of its curve shape, but it is liked by the Japanese tape companies 'cos it gives lower hiss values than CCIR and it has a few other uses, measuring for compliance to IEC Standards being one of them. The IEC A curve is also used by the EIAJ in CD measurement, so there are uses in this field too.

The hobbyist will find both these filters usefully reject unwanted out-of-band signals as well as allowing measurement to standards. Also included is a general purpose hum reject filter that cuts out all signals below 400Hz.

As if this was not enough, the 310 also offers true RMS, average and peak reading. Not a lot of any use is said in the handbook about the latter, other than it does not meet any standard. Again, the handbook needs attention, rather than the meter I suspect.

As anyone reading the handbook might correctly surmise, the Valley People Advantage Model 310 meter is a little unusual and idiosyncratic, but in the way of such things, also well suited for a particular type of use - studio and professional audio work. However, it's also great value for anyone wanting a good modern noise meter, especially serious hobbyists and small manufacturers. It is well thought out and very well engineered, our measurements showed, even if its display system has some limitations and the handbook has more ●

Model 310 £329
Hilton Sound,
Sutherland Hall, Liverpool Grove,
London. SE17 2HH
Contact: Alan Stewart
Tel: 071 798 0483

400Hz - 20kHz Hum Filter



The 400Hz filter allows weak signals to be measured when hum and its harmonics are present.

CCIR Weighting

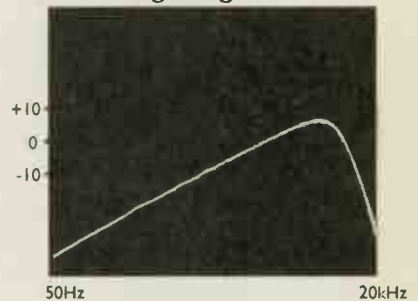

The CCIR weighting curve gives a very good measure of hiss audibility, measurements being unaffected by higher frequency rubbish and hum.

IEC 'A' Weighting

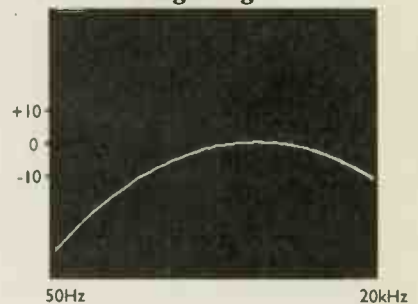

The IEC A weighting curve is centred at 2kHz and relates approximately to noise affecting speech intelligibility.

DIN AB 20Hz-20kHz

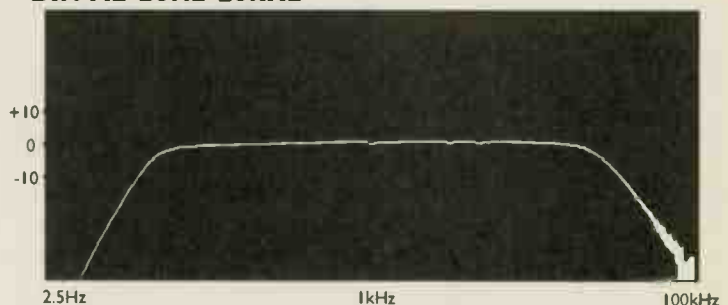

The DIN Audio Band (DIN AB) weighting eliminates all signals outside 22Hz-22kHz limits, but treats all audio signals equally. It's very useful for general audio work.

AP PERFORMANCE AUDIO

THE JOURNAL OF HIGH PERFORMANCE AUDIO CONSTRUCTION

EDITOR:- GRAHAM NALTY M.A. (MECHANICAL & ELECTRICAL SCIENCES-CAMBRIDGE)

ISSUE No 1

SEPTEMBER 1994

Welcome to AP Performance Audio

Welcome to this first issue of AP PERFORMANCE AUDIO.

AP PERFORMANCE AUDIO is unashamedly dedicated to the thousands of customers of AUDIOKITS PRECISION COMPONENTS who have chosen the true high fidelity path of using the best components and materials.

If your SonicLink amplifier gives you greater pleasure from your favourite music and would like to know how and why, AP PERFORMANCE AUDIO is for you.

If you are amazed that SonicLink Mains Cables can make a substantial gain in your listening pleasure, AP PERFORMANCE AUDIO is for you.

If you wonder how SonicLink Interconnect and Loudspeaker Cables can be a cost effective alternative to upgrading, AP PERFORMANCE AUDIO is for you.

But if you enjoy building and modifying hi-fi equipment to get the best sound quality, AP PERFORMANCE AUDIO is especially dedicated to you.

AP PERFORMANCE AUDIO

AP PERFORMANCE AUDIO will be published at about 3 monthly intervals.

AP PERFORMANCE AUDIO will contain the latest news about high performance audio components, new products, cable features, price updates and 'Bargain Bin', latest upgrading techniques for improving your own equipment, new amplifier, preamp and other hi-fi projects to build, and readers' own personal feedback.

AP PERFORMANCE AUDIO will be presented in 'newspaper' format rather than 'magazine' format. Longer articles on projects etc will be preceded and backed up with detailed COMPONENT NOTES which you can order separately.

AP PERFORMANCE AUDIO will be supplied FREE to customers who purchase components of over £100 value during the previous year.

Or you can make certain of getting your copy of AP PERFORMANCE AUDIO, by subscribing to the next 5 issues up to the end of 1995 for only £5.00 (cheques payable to 'AUDIOKITS')

If you like this issue and would like a copy of the next issue sent free, please write to AP PERFORMANCE AUDIO saying what you like most about it and how AP PERFORMANCE AUDIO can be made even better for you in future issues, enclosing a 29p A4 SAE.

THE AP ELECTRONICS XMAS COMPETITION

Over £100 worth of prizes

First Prize SonicLink FIRST MAINS Cable Set 1.25m - Worth £40

Includes Gold Plated 13A Mains Plug

Four Prizes of SonicLink FIRST MAINS STANDARD CABLE SET 1.25m

How to Enter

Write a short letter to AP PERFORMANCE AUDIO describing the improvements to your hi-fi you have enjoyed through building an AUDIOKITS Kit, or upgrading with parts supplied by AP ELECTRONICS, or by using SonicLink cables.

The best five letters will be published in the next AP PERFORMANCE AUDIO.

Prizes will be sent to the writers of the best letters published. Customers fully equipped with SonicLink Mains cables may request a limited selection of alternative prizes of almost equal value.

Tie Break - Increase your chance of winning by giving your own suggestion of the most useful product, part or service which AP ELECTRONICS could offer in the future. All prizes are offered subject to the discretion of AP ELECTRONICS.

MAIN FEATURE - SonicLink FIRST MAINS

SonicLink MAINS cable was introduced in 1989.

SonicLink was the first company to design a hi-fi mains cable. This cable was specifically designed to meet the needs of a mains plug - appliance connection of the highest audio quality, not a loudspeaker cable connected to a mains plug at one end and IEC socket at the other end, unlike some of the "Johnny come lately's".

From the start SonicLink FIRST MAINS was designed as a mains cable. 3 cores of 19 strands of 0.25 mm diameter Silver Plated Copper Wire are insulated to 1000V rms in PTFE and enclosed in a black PTFE sheath. Individual cores are the standard colours for mains cables - Brown, Blue and Green/Yellow.

SonicLink FIRST MAINS was reviewed in Hi-Fi News in their wide ranging cable survey in July 1990. Compared with 4 other cables, SonicLink FIRST MAINS achieved the highest sonic rating, by a substantial margin, of 90%.

In the review it was described as a 'surprising improvement for a Cyrus 2!'

No doubt SonicLink FIRST MAINS is still providing the power to numerous Cyrus 2s, and Cyrus is and Cyrus PSX - Who's for using FIRST MAINS for their Cyrus 3?

Since that review, SonicLink FIRST MAINS has found its way into hundreds, possibly thousands of different homes giving greater pleasure in listening to music wherever it goes. It has even found its way into TV sets where its viewers report improved picture quality following its connection.

More recently, its lead in the market for better sound quality mains cables has been taken over by SUPERMAINS which offers as much improvement over FIRST MAINS as FIRST MAINS offers over the throw away leads provided free with hi-fi equipment.

But FIRST MAINS still remains excellent value as an entry level mains cable for the sceptical, a value for money cable for the person who needs a long run to reach the socket, or even a dedicated spur.

Early in 1994 SonicLink introduced the FIRST MAINS STANDARD Cable sets.

Five of the most popular cable assemblies are now supplied with high quality mains connectors but saving the expensive Gold or Rhodium plating for which SonicLink has become famous. This gives you the chance to purchase a SonicLink FIRST MAINS STANDARD Cable set for only £30 and a 4m x 4 socket STANDARD Extension Set for only £99.

SonicLink STANDARD Cable and Extension sets can be purchased from most SonicLink cable dealers including KAMLA of 251 Tottenham Court Rd, London who keep good stocks. Ring them on 071-323-2747.

LETTERS & COMMENTS To The Editor

"Your Cables are better than any I have heard in the United States".

Jay Bertrand (Bertrand Audio Imports Nashua, H.H. USA)

Phone conversation after testing VIOLET & BLUE Interconnects GREEN Digital Interconnect and CARE MUSIC BiWire Loudspeaker Cables.

NEW COMPONENTS

Vishay VSH Low Cost Bulk Metal Foil Resistors

Low cost version of the popular VSRJ resistor but with a conformal coating. At present stock values are limited for testing, but other values will be added as demand grows - Please let us know your requirements.

Basic specification. 300V 0.3W at 70 Deg C, lead spacing 5.08mm

304-310 1K 1%	£2.00
304-422 22k 1%	£2.50

RUBYCON BLACK GATE CAPACITORS

7 AP ELECTRONICS can now supply 'Black Gate' capacitors for use in low voltage power supplies. Initial customers' reports are very promising.

473-200	22uF 6.3V	£0.55
473-202	100uF 6.3V	£1.00
473-203	220uF 6.3V	£1.25
473-206	2200uF 6.3V	£3.60
473-212	100uF 16V	£1.05

HEXFRED RECTIFIERS

At last a high voltage alternative to Schottky diodes which can also be used for valve circuits. HEXagonal ultra Fast Recovery Epitaxial Diodes incorporate special high voltage epitaxial silicon, a hexagonal cellular structure, planar design and proprietary minority carrier lifetime control process. HEXFREDs are compatible with pin compatible with conventional diodes in TO220 and TO247 packages. HEXFREDs exhibit ultrafast recovery together with ultrasoft recovery, resulting in much lower Radio Frequency Interference. As a result audio circuits will sound quieter.

00-011 HFA08TB60 8A	600V TO220	£5.00
500-021 HFA15PB60 15A	600V TO247	£6.00
00-041 HFA06PB120 6A	1200V TO247	£7.00
500-062 HFA30PA60C 30A	600V TO247	£10.00
Centre Cathode		

COMPONENTS FOR DIGITAL AUDIO

Thanks to recent demand, AP ELECTRONICS can now offer a small but growing range of specialised digital components for building Digital to Analogue converters including parts for the very interesting Elektor design.

Yamaha YM3623	£18.00
Burr-Brown DF1700P	£24.00
Burr-Brown PCM63D-K	£50.00

MAINS CONNECTORS FOR USE ON THE SIDE OF THE UK

AP ELECTRONICS now has a source of very high quality mains plugs and sockets for Continental Europe, Denmark, France/Belgium, India, Israel, Italy, Switzerland, Australia and North America.

Schuko Plugs £9.00 each or £12.50 Rhodium Plated

USA NEMO S-ISP ISA 3 pin plugs £7.50 each

AP ELECTRONICS 1994 CATALOGUE

Second edition is now available - price £4.95 - cheques to AUDIOKITS. Inevitably some suppliers have raised prices just after going to press. A summary of the price increases since the first edition is shown below. Quantity prices have also been changed - please contact the Sales Office.

THANK YOU FOR SELECTING

AP ELECTRONICS

FOR

AUDIO CONNECTORS

ELECTRONIC COMPONENTS

HIGH PERFORMANCE CABLES

AP ELECTRONICS, DERWENT BUSINESS CENTRE, CLARKE STREET, DERBY. DE1 2BU

Reel of Wonder Solder	£90.00
Wonder Solder	£2.50/metre.
Vishay Bulk Foil Resistors	
VSRJ E6 values up to 15K	£6.00
VSRJ All values up to 50K	£8.00
VSRJ 68K, 100K	£10.00
VSRJ values 50K - 250K	£14.00
VHP4 330K, 470K	£18.00
VHP6 560K, 680K, 1M	£35.00
52-145 Alps 50K Log, 10+ price increased to £9.00	

NEW COMPONENT NOTES

AP ELECTRONICS Component Notes enable you to get so much more from building your own special amplifier projects. Packed with advice and ideas gained from Graham Nalty's many years experience of designing amplifiers and auditioning individual high quality parts, AP COMPONENT NOTES can help you source the parts to build your project, identify areas where you can make fantastic improvements to the sound quality at modest cost, and understand the many mysteries that surround the magic of enjoying superbly reproduced music in your home.

The latest COMPONENT NOTES acknowledge the wonderful contribution to Do-It-Yourself audio by Hifi World magazine, covering three excellent products published with the short space of three months.

ACN35 Hifi World Headphone Amplifier	£1.00
ACN36 Hifi World 300B Valve Amplifier	£2.00
ACN37 Hifi Wo Id 36W Solid State Class A Amplifier	£2.00
ACN38 Elektor Integrated Audio Amplifier - Sept 1994	£3.00

NEW AMPLIFIER KIT - DM30

How do you describe a product which you have designed and believe it to be one of the best of all time. Impossible? Every time I play music through the SonicLink DM30, I really feel close to the music and want to listen and listen until I run out of CDs or LPs. I amaze at the incredible definition when I can hear the bass instruments playing their tunes on recordings which other amplifiers can only give a warm background noise.

Now AP ELECTRONICS is able to release all the secrets of the SonicLink DM30 Amplifier. A limited number of kits are now available to constructors to build their own DM30. Kits will be supplied complete with all parts except the case and input switching and control circuitry.

AP ELECTRONICS DM30 Amplifier Kit £340.00

THE BEST POWER AMP KIT YOU CAN BUILD

Calling all constructors of the Virtuoso Power Amp. If you have built the Upgraded Virtuoso Power Amplifier with even better parts of bigger power 6 supplies, you could be enjoying one of the very best power amplifiers ever built from a design in a magazine. If your Virtuoso sounds even better to you than the some of the best manufactured amplifiers you have heard at twice or three times the price, write and tell us.

And if you dare to read ACN34 (price £6), you can share our knowledge of making your Virtuoso sound even better, thank to our continuing research sine the Virtuoso was published in 1988.

WANTED - BEST SELLING AMPLIFIERS

To modify and rebuild for you using parts from the AP ELECTRONICS catalogue and to describe in future issues of AP PERFORMANCE AUDIO so others can enjoy better quality sound. Naim, MF, Pioneer A400, Rotel, Arcam etc

EXY TWO

Do you remember hearing the loudspeakers featured in the SonicLink 'Penta' show last year or at Chesterfield this year. We have just completed an export order of this excellent speakers and now have a very limited number for sale at the barg in price of £750.00 on first come first served. Ring Graham Nalty on 01332-674949 (9-10 am) now to book your pair or be disappointed.

ECLIPSE TURNTABLE

This is the turntable which everyone would like to sell 10 years ago. This is the turntable which is so good that almost every Eclipse turntable sold so far has gone to a former Linn owner. This is the turntable which impressed Graham Nalty so much that it is his only choice for demonstrating SonicLink amplifiers at Hifi shows. Read the impressive review in the August edition of Hifi News. For a demonstration and details of your nearest dealer, contact Graham Nalty on 01332-674929 or Chris Orchard on 0114-268-6095.

100W SINGLE ENDED CLASS A - THE IMPOSSIBLE DREAM

PREVIEW OF NEXT ISSUE OF AP PERFORMANCE AUDIO

Yes your next issue of AP PERFORMANCE AUDIO will present a major feature on Single Ended Class A amplifiers. We will start with a discussion of the best features of published designs such the HFW headphone amplifier and Nelson Pass's Zen in The Audio Amateur.

The AP Single Ended Class A Amplifier will take advantage of all the best features of previous designs. But it will be different. Its mono printed circuit board will have space for all the very best audio parts. There will also be output modules which by connecting in parallel to the main board, and some resistor value changes, will increase the power output.

By using 100V output resistors, 100 watts per channel into 8 ohms can be obtained. This enormous amplifier will have 30 pairs of output transistors per channel and make a better job of heating your room as a 1KW fire!

And NO Negative Feedback if you want to hear if a transistor amplifier can sound better without feedback, or the chance to vary it to the limit.

Also an opportunity to change the outstanding bipolar output transistors for special mosfets which are more linear than the usual mosfets - and sound better too!

AP ELECTRONICS is planning to build a 15 watt prototype using 4 or 6 output resistors per channel which will be powered by a 500 VA transformer!

But anyone crazy enough to have a go at building the prototypes for the 25W, 50W and 100W versions is invited to contact Graham Nalty for further information - and special discounts on parts!

BACK EMF IN LOUDSPEAKER SYSTEMS

All conventional moving coil loudspeaker drive units consist of a mass suspended by a compliant "spider" and/or surround. Just like a weight on the end of a piece of elastic this arrangement can have a tendency to bounce around when excited by any external force. In a conventional loudspeaker this force comes from a reaction between current from a power

However just as electricity passing through the voice coil generates relative movement between the two, so the converse also applies. The voltage thus generated in a loudspeaker voice coil is known as the "Back EMF" (Electromotive Force). In a two way (or more) passive loudspeaker this is naturally divided backwards through the crossover network. Some will reach the low output impedance of the driving amplifier (hence the term damping factor). Unfortunately some will also inevitably



Typical simple 2-way speaker crossover

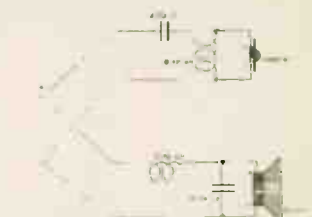

Typical simple 2-way speaker crossover

amplifier passing through a voice coil which cuts through the lines of force of a magnet system.

When the current stops, the moving mass (cone, dome, voice coil, former, adhesives etc) is returned to its rest position by the spring effect of the suspension, its surround and the enclosed air mass of the speaker. Its tendency to overshoot the rest position is controlled by the frictional and electrical "braking" or "damping" whose effects are measured as mechanical and electrical "Q". Choices of these values are compromises reached by designers in pursuing their various design goals for any speaker system.

return to the drive unit terminals, attenuated but as non linear distortions (to which the ear is most sensitive) and phase shifted by the reactive crossover components. Relatively large back EMF from the bass may reach the sensitive treble unit through the crossover, as illustrated in these typical 2-way examples. The earth arrangements are especially critical.

In a future note, I will describe how to overcome some of these, and other eddy current problems with new crossover layouts and BiWiring.

MARK WHEELER

SOUTHERN AUDIO ENTHUSIASTS SHOW

Come along to the Southern Audio Enthusiasts Show on October 29th and 30th to discover how AP ELECTRONICS can help you get the most from your constructional projects. Talk to Graham Nalty about the his plans for the Class A Single Ended Amplifier - he is looking for volunteers to build the higher power versions and may be prepared to offer discounts on your parts. Find out what new parts and projects are in the pipeline.

CABLE TIPS

By the Wire Wizard

Have you ever wondered why some conductors in cable sound better than others? If you carry out extensive research on hifi cable reviews, there seems to be a hierarchy in which Silver cables are amongst the very best. SonicLink HPMC often does better than the equivalent Silver Plated Copper. In the middle area of hifi cables, Silver Plated Copper cables generally do better than plain copper cables. Which explains why SonicLink likes Silver Plated Copper Cables. It also explains why SonicLink has carried out the extensive research which resulted in the introduction the HPMC range. Are there any other 'winners' in conductor materials which offer even better value? Watch this space!

BASEMENT BARGAIN BIN

A small selection of very high quality parts at much reduced prices:

Holco H4 1% 100ppm	1-9 10+
33P2, 56P2, 33P2R, 1K32, 6K81, 8K25, 15K	£0.30 £0.20
35K3, 44K5, 56K2, 68K4, 194K, 206K, 332K	£0.30 £0.20
Bourns 91A Conductive Plastic Pots 1M Log Single	£2.00 Stereo £6.00
Philips 424-7 Polystyrene 1%, 680pF, 750pF 30p each.	
22nF, 33nF 50p each	
15uF 160V Axial Poly F opylene (AUDIOCAP 2)	£5.00
Wima MKS4 10nF 5%, 33nF %5, 220nF %0% 25p each	
BHC ALS20A 1000uF 450V (2 pieces only!)	£45.00 of £70 the pair
LCR 6800uF 35V Tag Ended	£1.75
LCR 10,000uF 40V Tag Ended	£3.00
Panasonic SU Radial 1000uF 50V	£0.50
Philips 108 Long Life axial 4.7uF 63V £0.65, 10uF 63/100V £0.75	
IN4148 diodes £0.50 for 20, £2 for 100.	
Red LEDs £1 for 10.	
IN4002 £1 for 32	
BC214C, BC547C £1 for 12, £5 for 100	
Power Mosfets IRF530 £0.70, RFP12N08 £1.00	
IC Regulators. 7812, 7818, 7905 £0.35, LM317T £0.45, LM337T £0.60	
%" dia Chassis Phono Sockets, red, white, black £0.20. Gold Plated £0.50	

These prices are valid until 1-12-94.

For further bargains, please see the Stocktaking Sale List (Please send A4 29p SAE for FREE copy)

HOTLINE FOR FREE TECHNICAL ADVICE TEL 01332-674929 9-10am MONDAYS-SUNDAYS

ACCESS

VISA

CREDIT CARD TELEPHONE ORDER HOTLINE 01332-674929

(MESSAGES RECORDED WHEN UNATTENDED-PLEASE GIVE FULL DETAILS)

AP ELECTRONICS, DERWENT BUSINESS CENTRE, CLARKE STREET, DERBY. DE1 2BU
TELEPHONE +44-1332-674929 **FAX +44-1332-298836**

TRACTRIX HORN

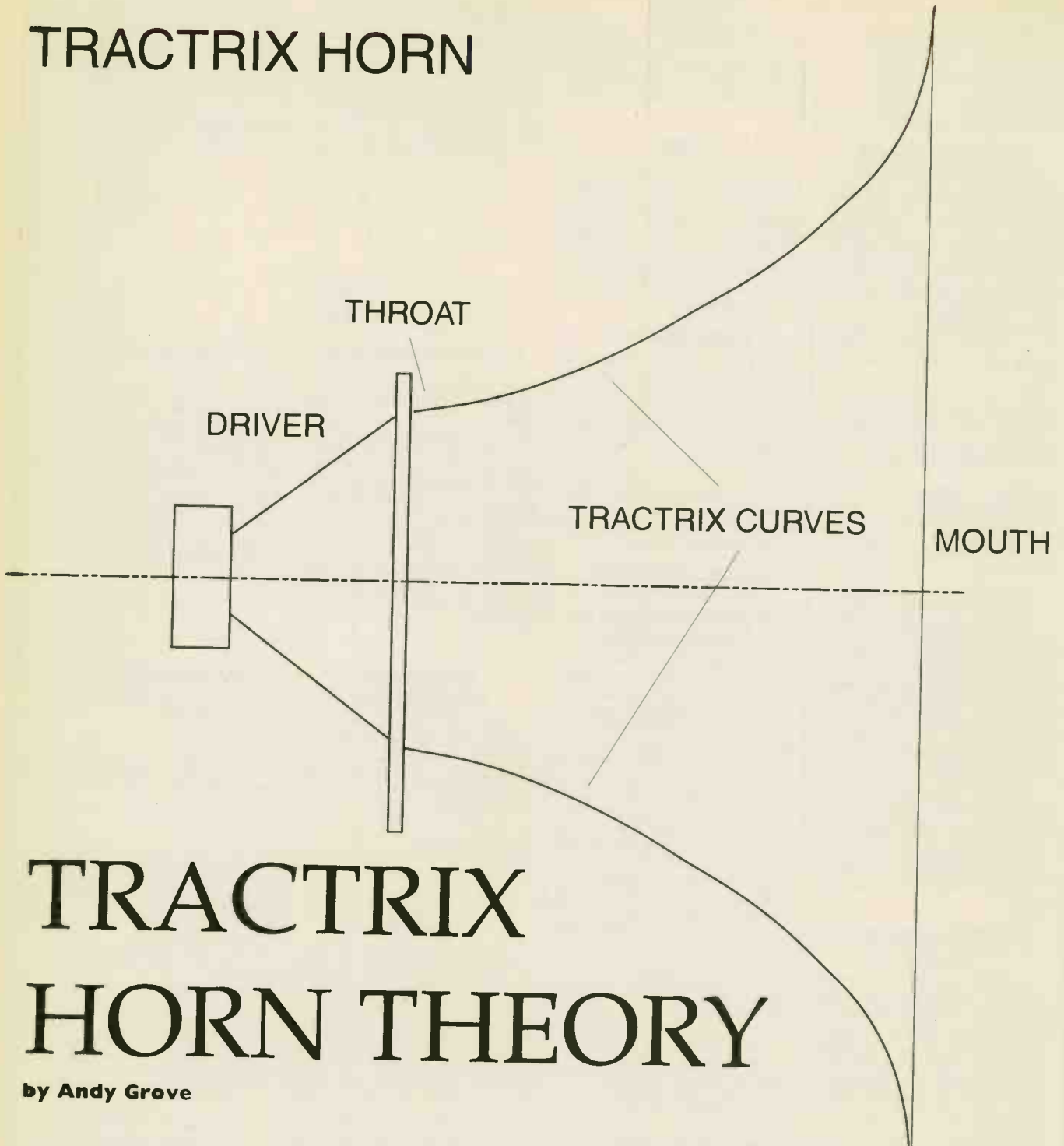

TRACTRIX HORN THEORY

by Andy Grove

How do you design a horn loudspeaker? Answer: with great difficulty. Most horn flares demand heavy mathematics. Only one - arguably the best one - can be designed using simple geometric techniques. All those readers who've demanded we publish a horn design might be interested in the design method explained here.

The sonic properties of horn loudspeakers are well known, awesome dynamics and bass slam, super efficiency (over 110 dB @1W/1m in many cases) and excellent clarity and projection.

There are three main types of horn

used in high quality sound reproduction - the exponential, the hyperbolic or "Hypex", and the Tractrix. These names are mathematical terms which describe the curvature defining the flare of the horn. The exponential flare is the most common. The hyperbolic flare is similar to

the exponential, but gives a slightly more extended bass for a given horn length, at the expense of transient response and colouration. It is, however, the Tractrix horn which has near-legendary status, even though its use seems to be rather more scarce.

The exponential/hyperbolic horns are designed around equations which assume infinite length, a practical design is always a truncated piece of this infinite horn. The low frequency cut-off frequency of all horns is defined by their length, flare rate and mouth area. With the exponential and hyperbolic horns the designer must choose a piece of the infinite horn which gives the performance he needs.

The instant "Zen" appeal of the Tractrix is that it terminates fully (its flare rate becomes asymptotic) in a finite length from the driver, the length and flare rate being a function of the mouth size required for low frequency reproduction. Another distinguishing feature of the Tractrix is that where exponential type horns assume the propagation of a flat wavefront, the Tractrix assumes a more realistic hemispherical wave.

Paul Voigt pioneered using the Tractrix curve for a horn flare. His work was based on the relationship between air pressure and air velocity surrounding a sound source. If the source is emitting a certain frequency (F) and the air pressure and velocity are measured when the source is approached from a distance, it is found that up to a distance equal to a quarter wavelength of F there is a constant relationship between pressure and velocity. Below this distance, the velocity increases at a greater rate than the pressure.

All horns increase efficiency by improving the matching between the

driver and its air load and the Tractrix horn flare does this by causing the air to expand from the driver as if the source is actually behind the driver by at least a quarter wavelength of the low frequency cut-off frequency. This places the driver in the high pressure region rather than the high velocity region, greatly improving impedance matching and thereby efficiency.

A Tractrix curve is a special case of a "curve of pursuit". We see these curves every day in our lives and they have fascinated mathematicians for centuries. Imagine yourself standing in the corner of a big field and to your left, in the adjacent corner, is an angry bull, whilst in front of you is the gate. You just happen to be wearing red and the bull charges. As you run towards the gate the bull will constantly change its direction so that it is always running towards you. The curve the bull traces out is a "curve of pursuit" and if the bull gets his mathematics right, you get a sore bum.

To draw a Tractrix curve suitable for a square horn it is necessary to determine the low frequency (LF.) cut-off frequency first, the formula is -

$$\text{WAVELENGTH} = 340/\text{FREQUENCY} \text{ (metres)}$$

For a cut-off of 40Hz, for example, we get $340/40 = 8.5$ metres

The size of the mouth will be 1/2 of this in free space, or 4.25 metres.

To draw the Tractrix, which forms half of the horn flare, draw a set of axes. The vertical axis should have a length equal to 1/4 of the LF cut-off wavelength (i.e. in our example $8.5/4 = 2.125\text{m}$) as you are only drawing half of the flare, this length we will call L.

Select a small unit step, e.g. 1 cm. The smaller the unit the easier it will be to draw a freehand curve through the points. Mark off a point one unit down from the top of the vertical axis (point B). From that point measure down to the horizontal axis, adjusting the angle of the ruler until the distance from the original point to the horizontal axis is equal to L.

Holding the ruler steady, mark a second point one unit away from point B (point C). Move the ruler to point C and measure down to the axis again, adjusting the angle of the ruler, make another point, and continue this process until you have a reasonable amount of points. The curve can become very long as you need to keep going until you reach the size of the driver. Draw a smooth curve through the points.

The Tractrix you have drawn is one half of the full flare, the other is the mirror image about the horizontal axis. Make four pieces of cardboard cut to the shape of the full flare and you can stick them together to make a cardboard mockup. Fixing the cardboard pieces together requires a 2nd Dan Black Belt in Origami and would be a nightmare in wood or metal, but why not try it?

TRACTRIX CURVE CONSTRUCTION

Tractrix Curve traced through A,B,C,D...
A-a = L, Lengths A-B, C-D, D-E equal (1 unit), also
A-a, B-b, C-c etc. all equal (to L).

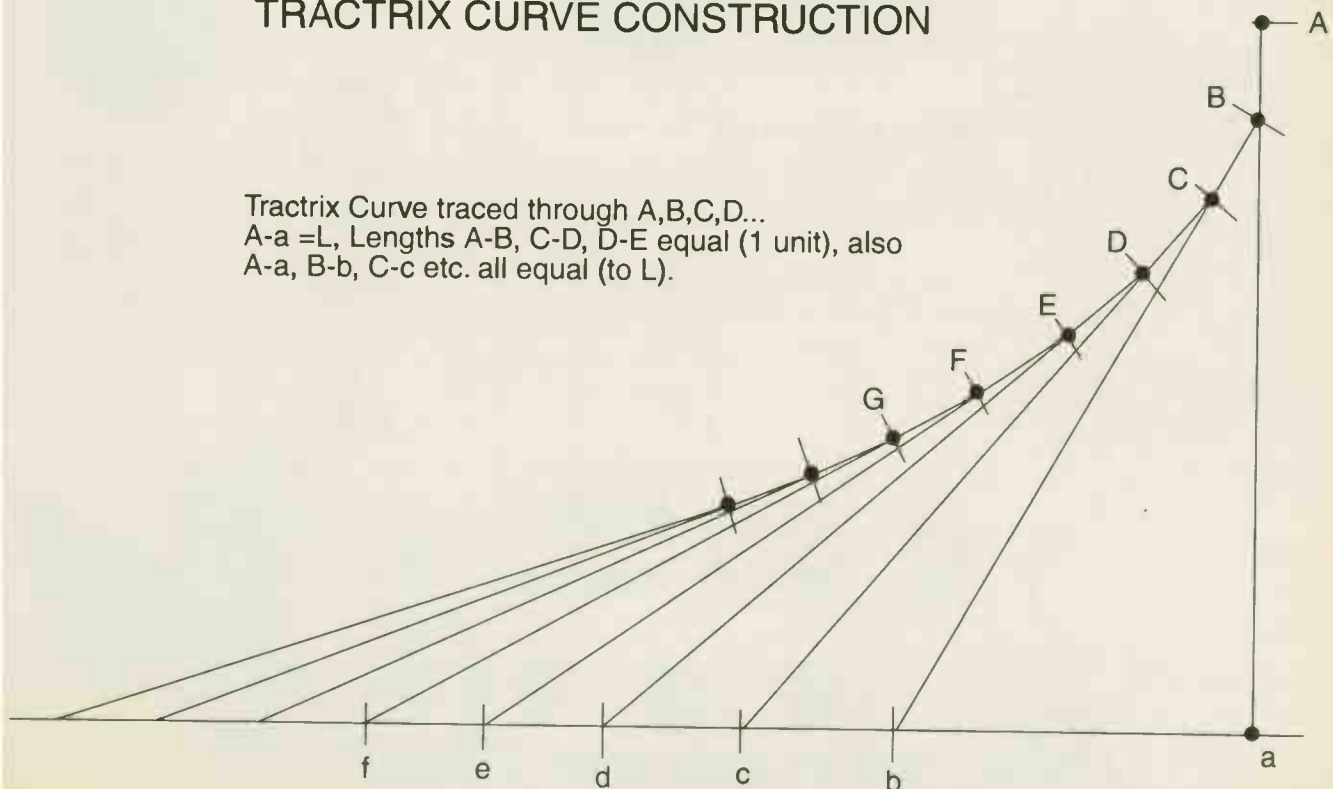

SPEAKER Company

DIY Loudspeaker Design & Construction

Everything you need to build High Quality loudspeakers, be they for High Fidelity reproduction or for Professional P.A applications



Unit 9
Waterside Mill
Waterside Macclesfield
Cheshire SK11 7HG

Tel 0625 500507
Fax 0625 500508

MAIL ORDER

0625 500507

Delivery Charges £4.00
overnight £6.00

Speaker Kits

Jaguar Standard Kit £235^{pr}

This kit contains everything you need to build the speakers except the cabinets.

2 x RCF L5/090 Bass mid drivers, 2 x RCF TWT/E Titanium dome Tweeters, assembled Bi-wired crossovers, 2 x F 469 F Bi-wire connection panels, 1 metre A101 wadding, 6 x FT 57 Fo damping panels, 2 x reflex tubes, 8 x Grill studs, Speaker cloth, Full set of instructions and plans.

Deluxe Kit £315^{pr}

As above but includes cabinet kits machined from 25mm MDF fully rebated for ease of construction.

Tornado Standard Kit £275^{pr}

This kit contains everything you need to build the speakers except the cabinets.

2 x RCF L6/090 Bass mid drivers, 2 x RCF TWT/E Titanium dome Tweeters, assembled Bi-wired crossovers, 2 x F 469 F Bi-wire connection panels, 2.5 metres A101 wadding, 12 x FT 57 Fo damping panels, 4 x reflex tubes, 8 x Grill studs, Speaker cloth, Full set of instructions and plans.

Deluxe Kit £385^{pr}

As above but includes cabinet kits machined from 25 mm MDF fully rebated for ease of construction.

RPD 10 £615^{pr}

10" Precision Devices Bass driver coupled with a 1" compression driver and CD horn with a high quality passive crossover and Deflex panels. This speaker has ultimate speed for precise reproduction of all types of music. Trapezoidal cabinet.

HPD 10 £745^{pr}

As above but with horn loaded cabinet for ultra low bass reproduction which leaves nothing to the imagination. Cabinets come assembled due to the complexity of the design.

101 MONITOR £240^{pr}

This speaker is well known to all. It uses KEF drive units B101 B and T27 A combined in a small infinite baffle cabinet of only 7 Litres with a high quality crossover incorporating electronic protection S-stop. This is one of the best near field monitors available built in 25mm MDF.

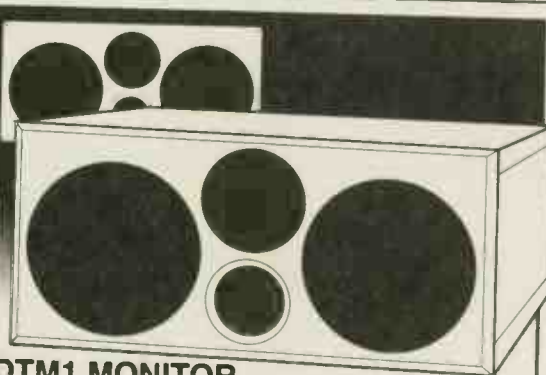

DTM1 MONITOR

This speaker combines the latest of the new technologies from Morel and Spectra Dynamics. Available only as a Deluxe kit and contains everything you will require to build a superb set of monitors.



BOSS MONITOR

A small infinite baffle trapezoidal cabinet with a top mounted MOREL neodymium dome tweeter and 5" bass mid unit. This Speaker has amazing imaging and should be placed close to the wall to achieve optimum results.

Stockists of

- ALTAI • ALTEC LANSING • AUDAX • BAD •
- CELESTION • DESIGN REFERENCE • EMINENCE •
- KEF • MACROM • MOREL • MOTOROLA •
- PRECISION DEVICES • RCF • RCL • SEAS •
- SPECTRA DYNAMICS • VOLT •



PANELS

Deflex panels and Magnapads from Spectra Dynamics are an important feature to some of our kits. These revolutionary products in loudspeaker technology are a vast leap forward over the use of other damping materials and contribute greatly to the delivery.

standard panel £7.95 each

HPD 10



£745
pair

All prices include V.A.T

MasterCard

VISA





D.I.Y. Letters

BUILDING OUR HEADPHONE AMP

I recently constructed the headphone amplifier that was in the recent DIY supplement (August '94) and have been very pleased with the results. Normally when using headphones there is some residual hiss or hum even with a high quality amplifier, and I assume that is primarily because the power amplifier is designed to produce many watts (40-140) where a headphone is only looking for 100s of mW (0.1-0.2W), and the simple series resistor used to reduce the output is not the correct solution. Your amplifier design is totally silent with no signal.

The sound also remains distortion free from volume levels that are just audible, through to the maximum I could comfortably tolerate (yes I do like it loud!).

Building the project on your PCB made construction

very straightforward, all of the other parts were obtained "off the shelf" from my local Maplin Store, including a two tone painted aluminium case.

I would rate the amplifier as a good 'Reference' design since I was able to hear the coloration which is introduced by my pre-amp, which I had always assumed to be transparent. I can also clearly hear differences in off-air broadcast sources, and hiss from open mics and faders (Quad FM4 Tuner). So for anyone who is primarily interested in headphone use I would recommend a simple switch box in front of your amplifier connecting the sources (CD/Radio etc.) as required.

Your readers may also be interested to know that I have found that I prefer the headphone amplifier with the extra phase-shift circuit incorporated, since it does remove the sound from deep

inside the head, to a point just above my eyes and provides a very spatial or "open" sound compared to the normal headphone point source or "boxed in" sound.

Since reading your magazine I have made some changes to my system, replacing my ageing Philips CD104 with the new Marantz CD63. Comparing the two side by side is very interesting, the 104 has more punch to the sound, similar to the effect of a loudness control, but the stereo effect is reduced in that the CD63 seems more capable of producing two totally separate sounds from each speaker simultaneously, while the CD104 seems to switch from one to the other (Ping-Pong). The CD63 has a more natural or flat sounding response.

Keep up the good work, I particularly read with interest your constructional projects,

since my other interest is amateur radio (ham radio) and the fun of building has gone for the majority of enthusiasts who want fully featured transceivers in the size of a car radio or cell phone, and that can only be achieved by buying a Japanese black-box using surface mount technology and custom chips. Although I find the valve revival interesting, I am already committed to my Quad 404-2 so would not tackle some of your major amplifier designs yet.

Please keep the smaller constructional articles flowing, since it is a great pleasure to build something like the headphone amplifier in a weekend, and have immediate success.

**Alan Ralph
Aylesbury,
Bucks.**

PS I now have a waiting list of people at work who would like to hear your headphone amplifier.

COMPATIBILITY PROBLEMS

My Present system consists of the following: Michell Hydraulic Reference turntable, Mayware Formula V silver wired arm, Mayware MC7V cartridge and Arcam A60/HA10 amp. Virtually every component has been replaced in the A60 with the very best available - it sounds great. Speakers are a pair of Heybrook HB1 Mk1 in brand new solid Ash cabinets lined with Deflex Acoustic panels, silver wired and with split crossovers, seated on MAF stands.

My question is that over the past year I've been busy restoring a pair of Leak TL10 amplifiers and would like to use them via the A60's pre-out socket. If there is a sensitivity problem is there anything I could do to the A60? Any advice would be gratefully received.

**P Jones
Rotherham,
S. Yorks.**

The sensitivity of the TL10 is 125mV for full output, which is very sensitive and the output from the A60 is 600mV maximum, so there would not be a sensitivity problem. However, there may be a problem in that the standard A60 did not have a pre-out facility, but there was a special order version known as the A60AP which was modified to provide pre-out. This version can be identified by looking at the back of the amplifier. If you have an A60AP then one of the DIN sockets will be upside down compared to the others. There should also be a metal DIN plug in this socket which would normally be left permanently in place as it provides the link between pre and power inside the amp. The pre-out signal would be taken from here.

On the standard A60 this socket is the same way up as the others and is merely an auxiliary input. It may be necessary for you to get a qualified engineer to modify your amplifier to give the necessary signal, but this should not be a difficult procedure. **AG**

TWEAKITUS COMPULSIVUS

Please find enclosed a couple of items resulting from reading the latest copy of your magazine. I have put them on separate sheets as they relate to separate sections.

I am beginning to think that HFW should carry a statutory Health Warning on the front cover - it is definitely habit-forming.

Until now I have bought the occasional hi-fi magazine to while away the time on the odd train journey - the June issue is the third one I have purchased in a row!

More serious however is the influence your publication has had on my sanity. In the past when buying equipment I have simply selected an item in a magazine which has been given the obligatory nine stars

and described as "Stunning", had the usual brief demo at the local dealer and been happy ever after. Three copies of HFW later I am now - a) dissatisfied with my latest purchase (CD Player) and b) now have contracted a serious case of "Tweakitus Compulsivus". Having started by making up my own Interconnects, (experimenting with various cable types), I am now convinced that I can, with the aid of my trusty soldering iron and my new found knowledge, improve the product of any multi-national giant for minimal outlay. Who needs a massive R&D budget?

More seriously though, those of us who would like to

"tweak" but do not have the necessary knowledge are left a bit frustrated. I accept that it is probably sensible to stick to experimenting with interconnects and "off the shelf" items. However, with items like CD players (my particular obsession) it is tempting to think that replacement of the cheap and nasty mains cable with a decent captive one, adding a switch to inhibit the display, perhaps a bit of cabinet screening/damping material etc. may be both beneficial to sound quality and provide an introduction to a more serious hobby.

The problem is knowing what can be reasonably done

before it is more cost effective to simply "upgrade" via a replacement with an even more costly item! As it is not in manufacturers (or dealers) interest to promote this type of activity, I guess many of us will remain locked into the cycle.

Perhaps you could devote some editorial in your Supplement to offer advice on areas to investigate for cost-effective improvements for those of us who wish to get the most out of our budget equipment.

Keep up the good work - despite the above comments I enjoy your magazine as it provides a balanced viewpoint and interesting

Letter of

BUILDING A VALVE AMP

Many thanks for your magazine, something of a breath of fresh air. Like many others, I am in the throes of building a valve power amplifier and have a few questions for you.

Do you or T de P have any thoughts on the sonic influences of (solid state) regulated power supplies versus chokes? I have developed a regulated H.T. supply followed by a π section filter to attenuate HF and RF noise, using the Plessey polypropylene capacitors mentioned by John Pikes in your June issue, largely to avoid using a large choke, as I have had trouble finding one.

I am also considering using regulated D.C. heater supplies, as the power supplies will be in a separate chassis and this would allow me to avoid having any mains frequency supply to the actual amp. I am aware that the EF86 has a bifilar heater winding and

that push-pull stages will hum cancel, but it's my money, I would like to know whether the heater supply should be tied to ground or allowed to float.

Lastly, I am considering using a batch of "new old stock" 807s that my father in law found in his shed. He says they were commonly used in high quality audio amps in the '50s. Are they still considered a reasonable valve, or would I be better off stumping for a quartet of 5881s?

His finding them in the shed reminds me of when I was a kid in the 60s. My father was a microwave physics researcher and so had a shed full of electronics bits and my favourite game was constructing space stations in the dirt, using the lovely glass bulbs with complicated innards. I especially liked the big bulbous ones with only four pins in the base. Unfortunately they broke rather easily; I sometimes

wonder how many irreplaceable old valves I have ruined!

**Mark Aiden Kelly
East Freemantle,
Western Australia.**

The choke in a power supply can play several roles. In a simple capacitor input Pi (π) network the choke is merely the series filter element in the Pi. A choke input filter is, however, a slightly different story as it eliminates a lot of the problems inherent in nearly all rectification systems. I have had good results with high voltage power supplies using BUZ50A (1000V) MOSFETs but preventing H.F. instability in the regulator circuitry can be a problem, especially if the thing disintegrates in a blue flash before you get a chance to test or adjust it. High voltage Bipolar Junction Transistors (BJTs) are usually pretty dismal in terms of Hfe (current

articles/comments on a wide range of equipment. I'll just have to find somewhere to put the ever growing pile of the things.

Now for my query.

Many years ago a project was started, with the aid of my father on the woodworking side, to build a pair of transmission line speakers. A period of illness on my father's part delayed the assembly, and when he had recovered my situation had changed and I couldn't accommodate them! Nothing has happened for many years.

The result is two almost completed cabinets and a large pile of boxes containing the drive units (8!) and

crossovers.

Reading your magazine has prompted me to consider that maybe "old" doesn't necessarily mean obsolete and thus I am faced with a dilemma. The speakers are the "Hi-Fi Answers" Monitors, based on the Cambridge R50, and they are somewhat large and extremely heavy (even the crossovers are, containing ferrite cored components!)

I have several choices: sell the lot, use some of the components (KEF) to build something else, or complete the project.

Although the latter seems the most sensible it will require time, effort and will cause problems.

My wife does not see hi-fi in quite the same way that I do. The prospect of trying to persuade her that these 4ft high monsters that weigh nearly a hundredweight each are a necessary replacement for the Mission 780s (which have been relegated to wall brackets!) is going to be difficult to say the least.

Do you consider in "modern" terms that these speakers are likely to be able to compete with modern designs in terms of sound quality? I appreciate that they will be capable of wall-shaking bass, but have reservations about the rest of the audio range.

My amp is a much-loved

Cyrus I. Does this provide enough power to drive an older, less efficient design of speaker? Sources vary, but will mainly be Marantz 52IISE CD and Thorens TD150/SME3009 S2/AT95E (in home-made plinth assembly). Music: mainly light rock/female vocal, some classical. Your comments would be appreciated.

Another query - I recently bought the AT95E to replace an elderly Ortofon. I had a bit of difficulty setting up the SME as the recommended tracking weight exceeded the scale on the arm! I did however, using a Hi-Fi Sound test record and a stylus balance achieve a reasonable compromise. This has resulted in a great deal of

The Month

gain) so I have not tried them apart from the ubiquitous MJE340/MJE350 (300V) transistors which work well, but they can be delicate, and there lies the main problem - silicon junctions and high voltages aren't the best of friends.

D.C. heaters are OK, but rectifying low voltages at high currents is a pain due to the 0.7V-1V drop across the rectifier diodes and the ripple on the reservoir capacitor so you need quite a hefty heater winding, large rectifiers and reservoir capacitor (10,000µF or more).

D.C. power for the output valve heaters gets difficult. There must always be a DC path from the heater to the cathode and weird things start to happen if you let the heater supply float; the minimum resistance is usually quoted in the valve manufacturers data.

The 807 is more or less identical to the 6L6 except for the anode cap which

allows higher voltage working (up to 600V), so you should get good results from these valves. The U.S. versions of the Williamson amplifier quite often specified 807s.

Regarding your last point, I cringe at the thought of my teenage exploits with bulbous glass headed, multi-legged aliens (a friend of Dad's valves) and my death ray (air rifle). **AG**

Using D.C. on a heater sets up a fixed potential gradient along it and shortens life by concentrating migration at one part of the filament. We've oft discussed using D.C. for directly heated valves, but invariably they are also expensive (e.g. 300B, 211) so life is consequential and we stick with A.C. With indirectly heated valves though, there's just no point, no matter how much wonga you want to throw around.

Also, our transformer

supplier has pointed out (as have others), the high current pulses generated in the heater winding induce back into the secondary, putting spikes on the H.T. line. It also causes more pulse energy to be radiated electromagnetically too. It sounds like a nest of vipers to me.

Musing on this, it strikes me there are two alternatives. Use D.C., but get a bi-stable flip flop to switch from one polarity to the other every time the amp is switched on. Or use a low frequency A.C. supply, probably based around solid state power circuitry. The frequency would have to be below audibility, but at a rate where the heater did not have time too cool down through the cycle - say 15-25Hz. This supply would have to be free of harmonics too. If you can design an elegant circuit, we'll publish it. Have fun! **NK**



WIN A MAPLIN SOLDERING IRON KIT COMPLETE WITH A LENGTH OF SILVER SOLDER

The writer of the most interesting DIY letter each month will receive a superb Maplin soldering iron, stand, booklet on good soldering practice and a length of high quality silver solder.

Write in to: Hi-Fi World
DIY letters, 64 Castellain
Rd, Maida Vale, London
W9 1EX.

enjoyment "re-discovering" my vinyl collection which had been abandoned in a cupboard for several years! Could you please recommend a suitable "next step up" from the AT95E that will work with the 3009 (designed when "light was right") - no esoterica please, married with limited budget!

**A. R. Webber
Long Ashton,
Bristol.**

PS Another issue on the News stand at the station - here we go again.....

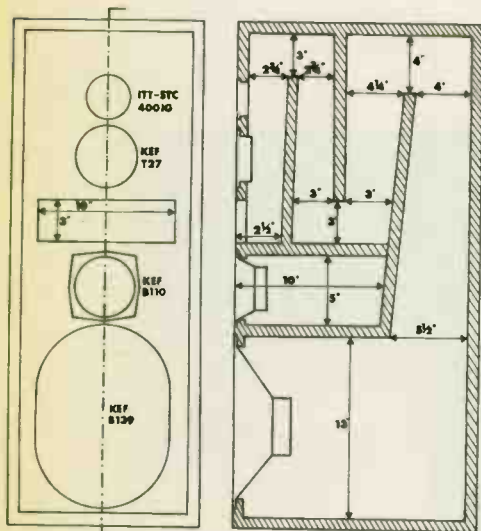

Internal arrangement of the enclosure

SOURCE: From Hi-Fi Answers, now What Hi-Fi.

In answer to your first question, we do plan each issue and supplement carefully to offer a range of articles that will satisfy both the amateur and professional engineer. For example, in the October supplement last month there was an advanced and complex design for a Class A solid state monoblock amplifier, and an article on learning to solder and building your own interconnects. We will be doing more articles aimed at beginners and helping them to understand and learn so that more advanced projects can be tackled. May I suggest that you take a look at the books in the Hi-Fi World library on Page 101 of the main issue. Here you will find

books on all aspects of audio engineering, many of them including practical designs that you can attempt to build.

I have a friend who's built a pair of kit R50s, and Noel was working for Hi-Fi Answers when the design was originally published, and we both agree that they'd be well worth finishing. The drive units were all extremely high quality, KEF B139 bass, B110 midrange, T27 tweeter and STC 4001 super tweeter. To give you an idea, the B139 bass units alone would set you back a hefty £275/pr these days.

When built up these should not only offer excellent bass extension, but smooth and well focused midband and sweet and open treble, such is the quality of the drivers. One area though where you could certainly make improvements on the original design is the crossover. Wilmslow audio offer an updated network design which should give a higher performance. Use modern Solen polypropylene capacitors and air-core inductors wherever possible. If you do decide to go ahead and finish the Hi-Fi Answers Monitors, please take a photo and let us know what you think of the sound - we reckon they'll be pretty awesome.

The R50s had a smooth impedance, but were insensitive. Your Cyrus 1 will drive them, but the R50s would certainly benefit from a more powerful amp. You may be able to exchange your Cyrus 1 for a 2, which offers considerably more power, 50watts, and has the option of outboard PSX power supply increasing power further, to 70watts. It may take some effort, but we think it'll be worth it. **DB**

We scratched around in our

archives and came up with the Hi-Fi Answers that carried this DIY project, dated August 1973, priced at 20p! I remember this particular feature well, since it caused quite a lot of problems at the time, resulted in me being made up from assistant editor to Editor, introduced today's editor of Hi-Fi News, Steve Harris, to hi-fi and showed me then just how popular DIY is, which is why you are reading this supplement 50 million years later (twenty one in fact, but it feels like 50 million!). The story goes thus.

Short of an article at the last moment, the editor of 'Answers grabbed a massive constructional feature by Chris Rogers and slammed it in. I seem to remember he was off to do some boating on the Norfolk Broads at the time and closing the issue took second place in his list of priorities. To this day I harbour a suspicion that our pneumatic secretary had something to do with his haste as well; nautical naughties were probably on the agenda.

Anyway, there was uproar. Every reader seemed to want to build this monster but nobody could figure out how to from a massive jigsaw of parts and an inadequate set of diagrams. The editor was persuaded to take up boating full time and I was asked to take over, which at a young age and with little more than one year in publishing seemed like madness to me, but all the same I wasn't going to argue.

Needing an assistant, I asked an English graduate friend who was working part time as a hospital porter, to help. His name was Steve Harris and he went on to edit What Hi-Fi, Hi-Fi Choice and now Hi-Fi News.

Our first task was to sort out the mess and publish a reprint with all necessary corrections in it. That was quite a task, but more problems were to follow. In

response to an advertisement for this reprint, the 200 or so copies we had ordered fairly flew out of the door. Being naive and enthusiastic, I ordered a few thousand more and, as they went, even more. By this time secretaries from all over the company we being drafted in to cope with the demand and I was advised to stop immediately or likewise consider boating as a full time occupation. It took me twenty years to save up enough pennies to start my own hi-fi magazine and I started publishing DIY supplements just as soon as possible. Old habits never die.

So if you do decide to build these speakers, make sure it is from the Reprint, not from the original article. And no, my memory isn't good enough to recall any useful detail about the project - try contacting the editor of Hi-Fi News! **NK**

A CHOKING PROBLEM

Regarding the 20mH 4A choke in Mr Jones's Class A transistor amplifier (June issue supplement). Is this the correct current rating for such an inductor and if so where can one be purchased? I have tried several companies, but such a rating seems to be excessive.

**W Kenely,
Liverpool.**

This choke should not present a problem to a good manufacturer of chokes and transformers. I would suggest 95 turns of 15 S.W.G. on a 1.5" stack of No 29 Laminations (1" centre leg), an air gap will be needed and this should be a 0.0065" spacer. The laminations should be of 35M6 material.

This will have an inductance well over 20mH at 4A and a DC resistance of about 0.1Ω which should be O.K. for your application. Try Sowter Transformers (address in supplement), they will wind this for you at a reasonable cost. **AG**

Vacuum Tubes For *Audio* Are Back!



Glass Audio brings together yesterday's tube with today's improved components, voltage control, and the exciting new Soviet tubes, to make smooth sound in your livingroom possible again!

Now Published Six Times a Year

YES!

Please send me my first issue of *Glass Audio*. I'll pay just \$45 for one year (6 issues) or \$80 for two years (12 issues) of the best information on tubes to be found anywhere! My satisfaction is guaranteed.

Send me more information about your other publications, *Audio Amateur* and *Speaker Builder*.

Payment Method:

Check or International Money Order

VISA

Mastercard

Remit in US \$, drawn on US bank. • Prices subject to change without notice.

CARD NO.

EXP.

NAME

STREET

CITY

STATE

ZIP

COUNTRY

Glass Audio

PO BOX 176, DEPT. HFWS, Peterborough, NH 03458-0176 USA
Phone: (603) 924-9464 or FAX 24 hours a day (603) 924-9467