

# ***FREE***

with

## ***Everyday Practical Electronics***

# **GETTING THE MOST OUT OF YOUR TEST EQUIPMENT**

- Using Your Analogue Multimeter 2
- Using Your Digital Multimeter 10
- Using Your Oscilloscope 16

by Mike Tooley B.A.



*Wimborne Publishing Ltd*

# USING YOUR ANALOGUE MULTIMETER

Even the most basic analogue multimeter can prove to be invaluable when in the hands of an experienced user. Simple measurements of voltage, current and resistance can provide useful information on the state of almost any circuit. What matters, of course, is the interpretation put on the readings obtained. To get the best from such a simple instrument it is not only necessary to select an appropriate measurement function and range, but also to be aware of the limitations of the instrument and the effect that it might, or might not, have on the circuit under investigation.

The illustration in Fig.1 shows the controls and display provided by a simple analogue multimeter. The range selector allows you to select from a total of twenty ranges and six measurement functions. These functions are:

- d.c. voltage (DC, V)
- d.c. current (DC, mA)
- a.c. voltage (AC, V)
- resistance (OHM)
- continuity test (BUZZ)
- battery check (BAT)

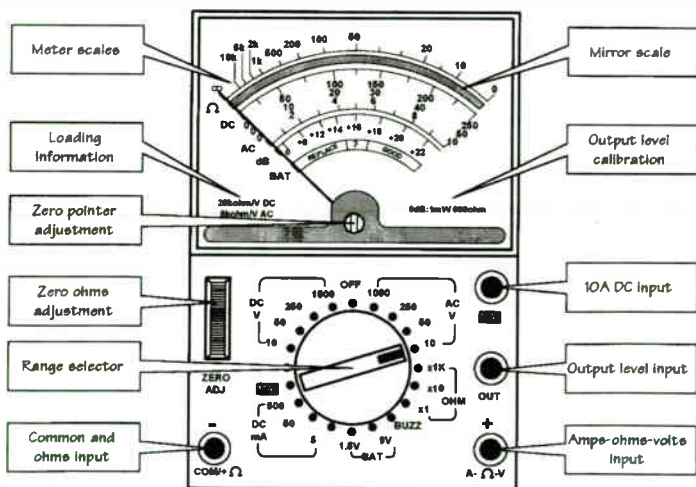

Fig.1. Analogue multimeter display and controls

## D.C. Voltage Measurements

Examples of how to make d.c. voltage measurements are shown in Fig.2 and Fig.3. In both cases, the red and black test leads are connected to the "+" and "-" sockets respectively. In Fig.2, the range selector

is set to DC, V, 50V. The pointer is reading just less than 45 on the range that has 50 as its full-scale indication (note that there are three calibrated voltage scales with maximum indications of 10V, 50V and 250V respectively). The reading indicated is thus 45V, approximately.

In Fig.3, the range selector is set to DC, V, 250V. The pointer is positioned mid-way between the 50 and 100 scale markings and this indicates a voltage reading of 75V.

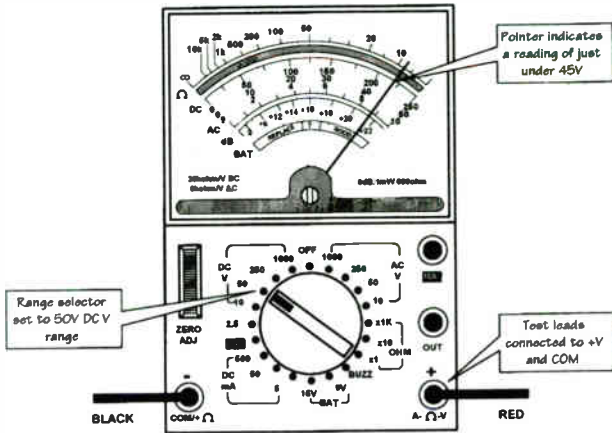

Fig.2. Analogue multimeter set to DC, 50V range

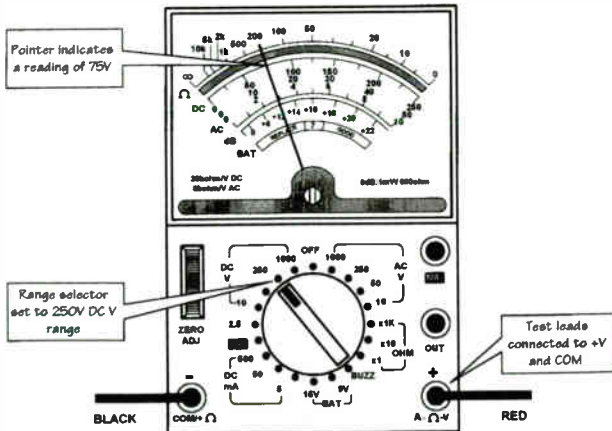

Fig.3. Analogue multimeter set to DC, 250V range

## D.C. Current Measurements

An example of how to make a d.c. current measurement is shown in Fig.4. Once again, the red and black test leads are connected to the “+” and “-” sockets respectively. The range selector is set to DC, 50mA. In Fig.4, the pointer is reading just less than midway between 45 and 50 on the range that has 50 as its full-scale indication. The actual reading indicated is thus slightly less than 47.5mA, or approximately 47mA.

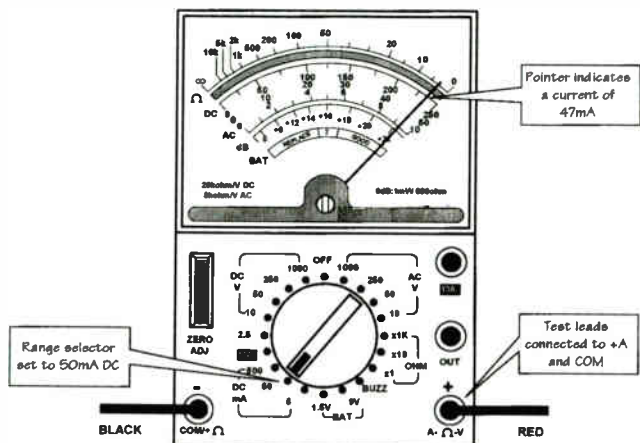

Fig.4. Analogue multimeter set to DC, 50mA range

## D.C. High-Current Measurements

In common with many simple multimeters, both analogue and digital, the high current range (e.g. 10A) is not only selected using the range selector switch but a separate input connection must also be made. The reason for this is simply that the range switch and associated wiring is not designed to carry a high current. Instead, the high-current shunt is terminated separately at its own “10A” socket.

The connections and range selector settings to permit high-current d.c. measurement are shown in Fig.5. The range selector is set to DC, 10A and the red and black test leads are connected to “10A” and “-” respectively. The pointer is reading midway between 8 and 10 on the range that has 10 as its full-scale indication. The actual reading indicated is thus 9A.

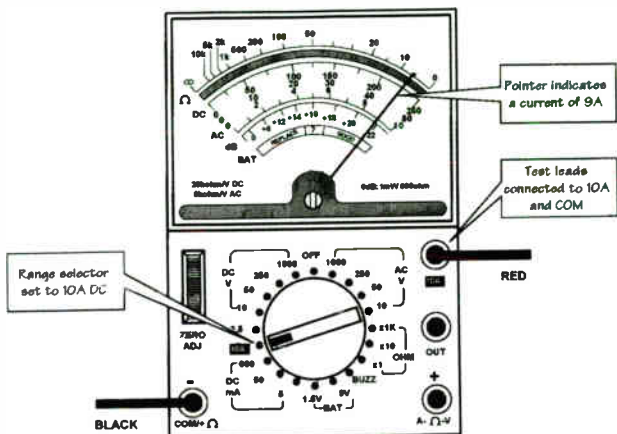

Fig.5. Analogue multimeter set to DC, 10A range

## A.C. Voltage Measurements

An example of how to make a.c. voltage measurements is shown in Fig.6. Once again, the red and black test leads are connected to the “+” and “-” sockets respectively. In Fig.6, the range selector is set to AC, 10V. The pointer is reading midway between 0 and 2 and the indicated reading is 1V, approximately.

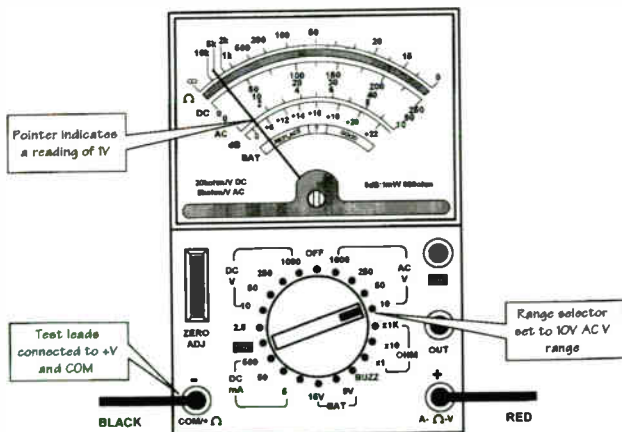

Fig.6. Analogue multimeter set to AC, 10V range

## Output Level Measurements

An example of how to make output level measurements is shown in Fig.7. The red and black test leads are respectively connected to "OUT" and "-" respectively. The range selector is set to AC, 10V (note that the output level facility is based on a.c. voltage measurement).

Output level indications are indicated in decibels (dB) where 0dB (the "reference" level) corresponds to a power level of 1mW in a resistance of 600Ω. The pointer is reading midway between +18 and +20 on the dB scale and the indicated meter reading is thus +19dB, approximately.

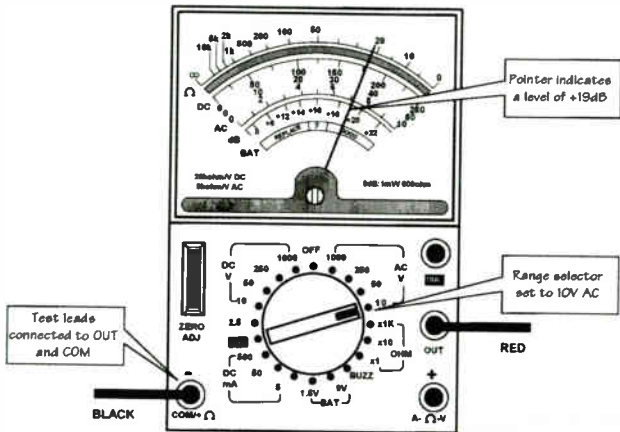

Fig.7. Analogue multimeter set to dB (output level) range

## Resistance Measurements

Examples of how to make resistance measurements are shown in Fig.8 to Fig.10. In all three cases, the red and black test leads are connected to the "+" and "-" sockets respectively. Before making any measurements it is absolutely essential to zero the meter. This is achieved by shorting the test leads together and adjusting the ZERO ADJ control until the meter reads full-scale (i.e., zero on the ohms scale). In Fig.8, the range selector is set to OHM,  $\times 1$ . The pointer is reading mid-way between 0 and 10 and the resistance indicated is approximately 5Ω.

In Fig.9, the range selector is set to OHM,  $\times 10$ . The pointer is reading exactly 30 and the resistance indicated is  $30 \times 10$  or 300Ω. In Fig.10, the range selector is set to OHM,  $\times 1k$ . The pointer is reading exactly 5k and the resistance indicated is  $5k \times 1k$  or 5MΩ.

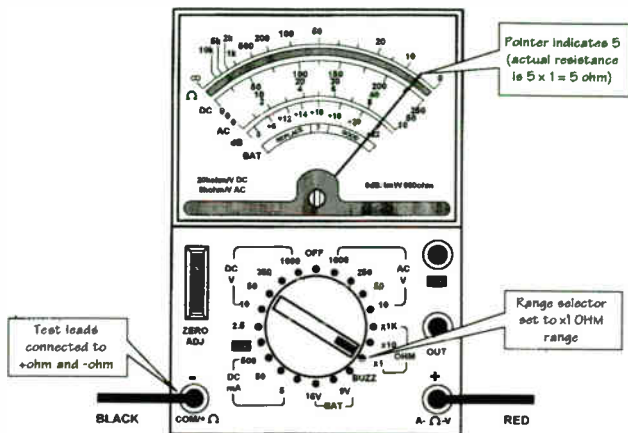

Fig.8. Analogue multimeter set to OHM,  $\times 1$  range

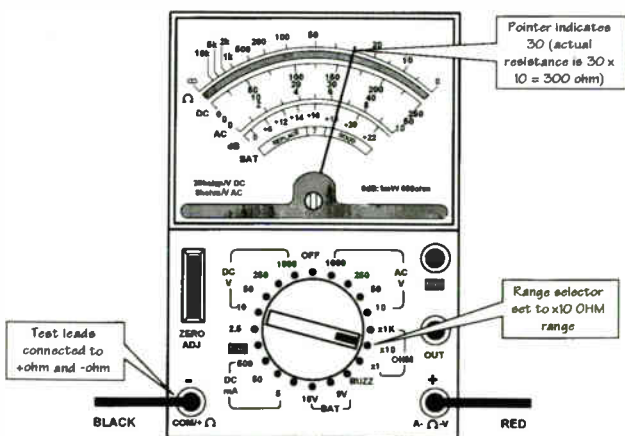

Fig.9. Analogue multimeter set to OHM,  $\times 10$  range

## Continuity Testing

An example of how to make continuity tests is shown in Fig.11. The red and black test leads are connected to the "+" and "-" terminals respectively. The range selector is set to BUZZ. When there is a low-resistance path between the two test probes, an audible buzz will be produced. No meter indication is produced on the continuity range.

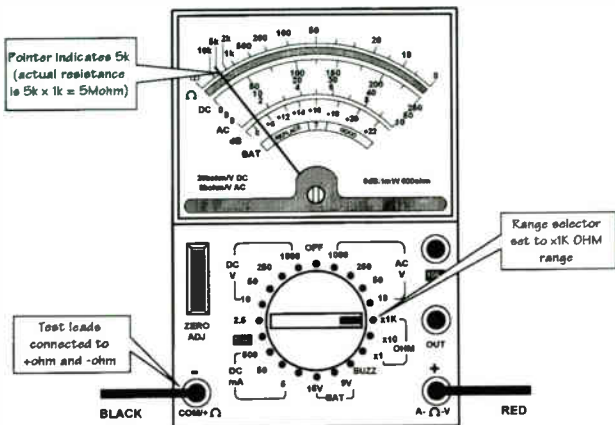

Fig.10. Analogue multimeter set to OHM, x1 range

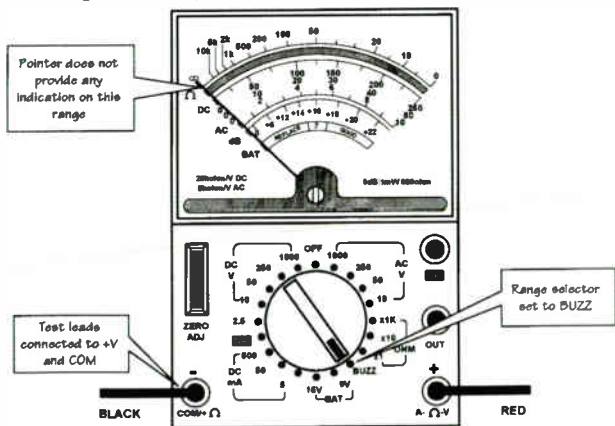

Fig.11. Analogue multimeter set to BUZZ (continuity) range

## Battery Testing

Several analogue multimeters provide a battery testing facility. Fig.12 shows how to carry out a battery test on a 9V battery (e.g., PP3, PP9, etc). It is important to note that a battery test should not merely be a measurement of the battery terminal voltage and ideally such a measurement should be carried out with the battery on-load (i.e., supplying current to a load resistance within the meter). In Fig.12, the range selector is set to BAT, 9V. The indication on the meter shows that the battery is "good" (but will need replacing in the near future).



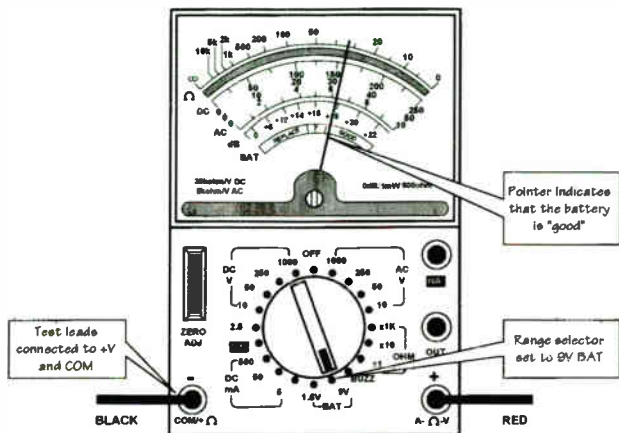

Fig.12. Analogue multimeter set to BAT, 9V (battery test)

## DOs and DON'Ts of Using an Analogue Multimeter

- Ensure that you have selected the correct range and measuring function before attempting to connect the meter into a circuit.
- Ensure that the correct polarity of the probes, where appropriate, is observed before connecting the meter into the circuit.
- Select a higher range than expected and then progressively increase the sensitivity as necessary to obtain a meaningful indication.
- Remember to zero on the ohms range before measuring resistance.
- Switch the meter to the "off" position (if one is available) before attempting to transport the meter.
- Check and, if necessary, replace the internal batteries regularly.
- Use properly insulated test leads and prods.
- Don't rely on voltage readings made on high-impedance circuits (the meter's own internal resistance may have a significant effect on the voltages).
- Don't rely on voltage and current readings made on circuits where high frequency signals may be present, an analogue meter may produce readings that are wildly inaccurate or misleading in such circumstances.
- Don't subject the instrument to excessive mechanical shock or vibration (this can damage the sensitive meter movement).
- Don't attempt to measure resistance in a circuit that has the power applied to it.

# USING YOUR DIGITAL MULTIMETER

Digital multimeters offer a number of significant advantages when compared with their more humble analogue counterparts. The display fitted to a digital multimeter usually consists of a 3½-digit seven-segment display the "½" simply indicates that the first digit is either blank (zero) or 1. Consequently, the maximum indication on the 2V range will be 1.999V and this shows that the instrument is capable of offering a resolution of 1mV on the 2V range. The resolution obtained from a comparable analogue meter would be of the order of 50mV, or so, and thus the digital instrument provides a resolution which is many times greater than its analogue counterpart.

The controls and display provided by a typical simple digital multimeter are shown in Fig.13. The mode switch and range selector allow you to select from a total of twenty ranges and eight measurement functions. These functions are:

- d.c. voltage (DC, V)
- d.c. current (DC, A)
- a.c. voltage (AC, V)
- a.c. current (AC, A)
- resistance (OHM)
- capacitance (CAP)
- continuity test (buzzer)
- transistor current gain ( $h_{FE}$ )

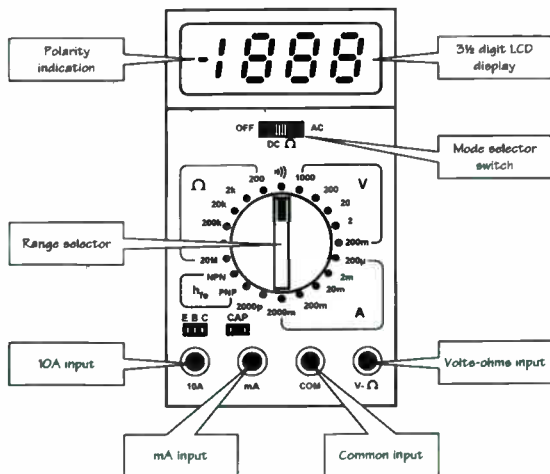
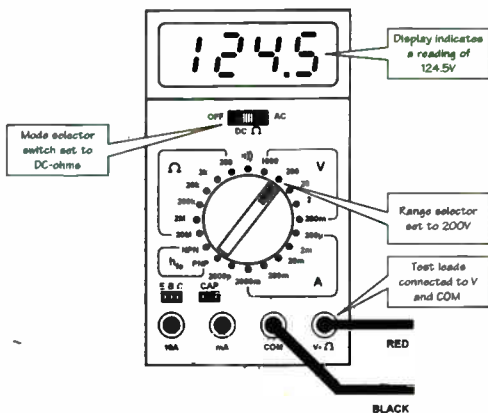

Fig.13. Digital multimeter display and controls

## Voltage Measurements

An example of how to make d.c. voltage measurements is shown in Fig.14. The red and black test leads are connected to the "V-Ω" and "COM" sockets respectively. In Fig.2, the mode switch and

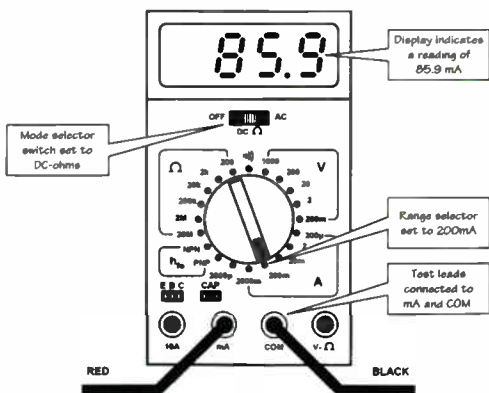

*Fig.14. Digital multimeter set to DC, 200V range*

range selector is set to DC, 200V, and the display indicates a reading of 124.5V.

## D.C. Current Measurements

An example of how to make a d.c. current measurement is shown in Fig.15. Here, the red and black test leads are connected to the "mA" and "COM" sockets respectively. The mode switch and range selectors are set to DC, 200mA, and the display indicates a reading of 85.9mA.



*Fig.15. Digital multimeter set to DC, 200mA range*

## D.C. High-Current Measurements

In common with simple analogue multimeters, the meter uses a shunt which is directly connected to a separate "10A" terminal. Fig.16 shows the connections, mode switch and range selector settings to permit high-current d.c. measurement. The mode switch and range selectors are set to DC, 2000mA (2A) and the red and black test leads are connected to "10A" and "COM" respectively. The display indicates a reading of 2.99A.

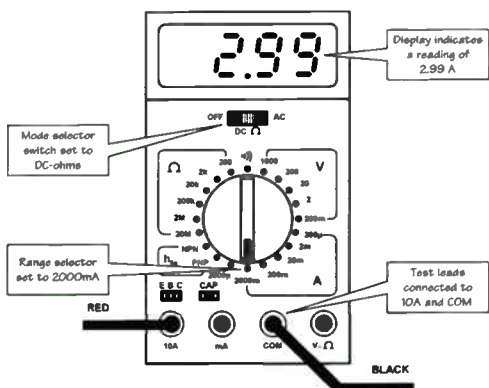

Fig.16. Digital multimeter set to DC, 10A range

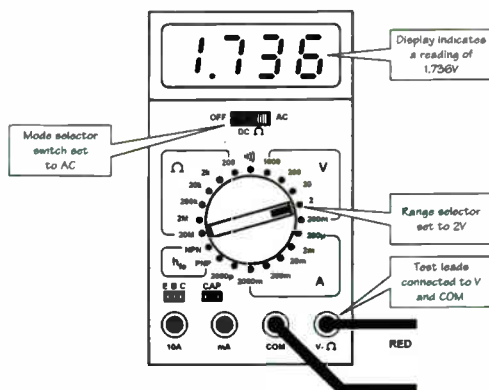

Fig.17. Digital multimeter set to AC, 2V range. For a.c. voltage measurement

## A.C. Voltage Measurements

An example of how to make a.c. voltage measurements is shown in Fig.17. Once again, the red and black test leads are connected to the “V-Ω” and “COM” sockets respectively. In Fig.17, the mode switch and range selectors are set to AC, 2V, and the display indicates a reading of 1.736V.

## Resistance Measurements

An example of how to make resistance measurements is shown in Fig.18. As before, the red and black test leads are connected to “V-Ω” and “COM” respectively. In Fig.18, the mode switch and range selectors are set to OHM, 200Ω, and the meter indicates a reading of 55.8Ω. Note that it is not necessary to “zero” the meter by shorting the test probes together before taking any measurements (as would be the case with an analogue instrument).

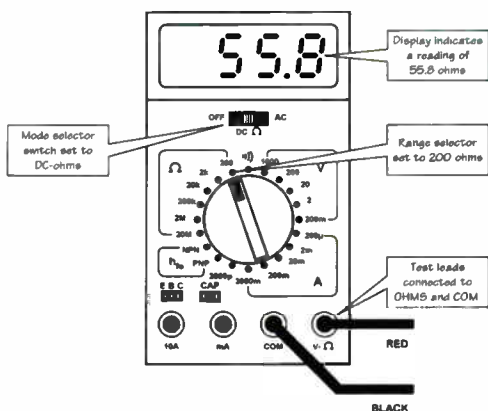

Fig.18. Digital multimeter set to OHM, 200Ω range

## Continuity Testing

An example of how to make continuity (buzzer) tests is shown in Fig.19. The mode switch and range selectors are set to DC, Buzzer (note that this is indicated by means of an icon on the front panel of the instrument) and the red and black test leads are connected to the “V-Ω” and “COM” sockets as usual. When there is a low-resistance path between the two test probes, an audible buzz will be produced. No meter indication is produced (instead, the meter displays an “over-range” indication with the leading digit illuminated).

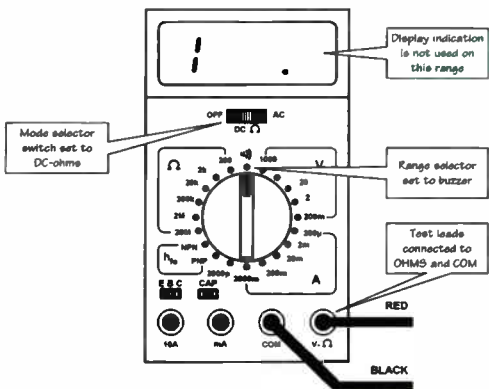

Fig.19. Digital multimeter set to continuity (buzzer) range

## Capacitor Measurements

Many modern digital multimeters incorporate a capacitance measuring facility although this may be limited to just one or two ranges. Fig.20 shows how to carry out a capacitance measurement. The capacitor on test is inserted into the two-way connector marked "CAP" whilst the mode switch and range selector controls are set to DC, 2000p. The display indication shown in Fig.20 corresponds to a capacitance of 329pF.

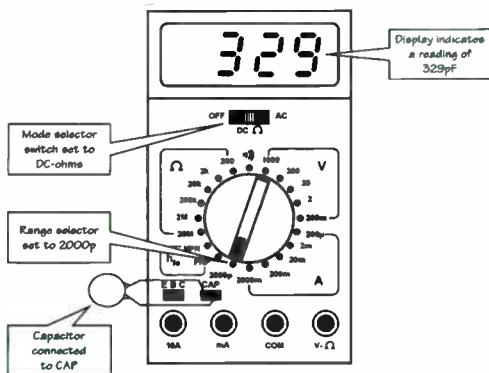

Fig.20. Digital multimeter set to capacitance, 2000pF range

## Transistor Current Gain ( $h_{FE}$ ) Measurements

Many modern digital multimeters also provide some (fairly basic) facilities for checking transistors. Fig.21 shows how to measure the current gain of an *npn* transistor. The transistor is inserted into the three-way connector marked "EBC", taking care to ensure that the emitter lead is connected to "E", the base lead to "B" and the collector lead to "C". The mode switch and range selector controls are set to DC, NPN respectively. The display indication in Fig.21 shows that the device has a current gain of 93 (i.e., for the device in question, the ratio of collector current ( $I_C$ ) to base current ( $I_B$ ) is 93.

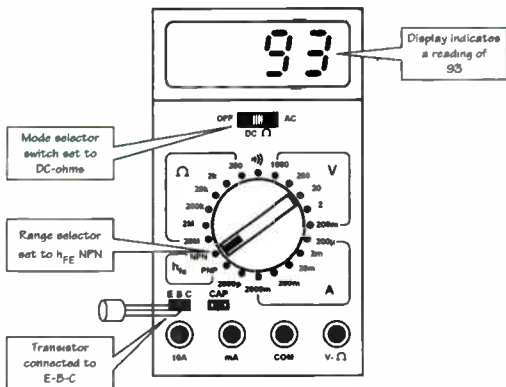

Fig.21. Digital multimeter set to transistor current gain, NPN range

## DOs and DON'Ts of Using a Digital Multimeter

- Ensure that you have selected the correct range and measuring function *before* attempting to connect the meter into a circuit.
- Ensure that the correct polarity of the probes, where appropriate, is observed before connecting the meter into the circuit.
- Select a higher range than expected and then progressively increase the sensitivity as necessary to obtain a meaningful indication.
- Switch the meter to the "off" position in order to conserve battery life when the instrument is not being used.
- Check and, if necessary, replace the internal battery (often a PP3) regularly.
- Use properly insulated test leads and prods.

- Check that a suitably rated fuse is used in conjunction with the current ranges.
- Don't rely on voltage and current readings made on circuits where high frequency signals may be present (as with analogue instruments, digital meters may produce readings that are wildly inaccurate or misleading in such circumstances).
- Don't attempt to measure resistance in a circuit that has the power applied to it.
- Don't rely on measurements made when voltage/current is changing or when a significant amount of a.c. may be present superimposed on a d.c. level.

## USING YOUR OSCILLOSCOPE

Layouts of the controls and display provided by a typical dual-channel oscilloscope are shown in Fig.22 and Fig.23. The majority of the controls identified in Fig.22 are those associated with the position and appearance of the display (e.g. vertical shift, horizontal shift, intensity and focus) whilst those shown in Fig.23 include the vertical gain and attenuator controls.

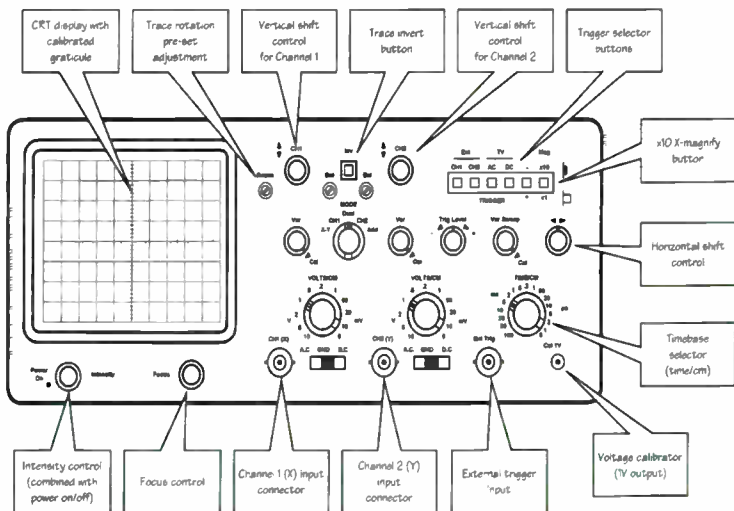

*Fig.22. Front panel controls and display on a typical dual-channel oscilloscope*



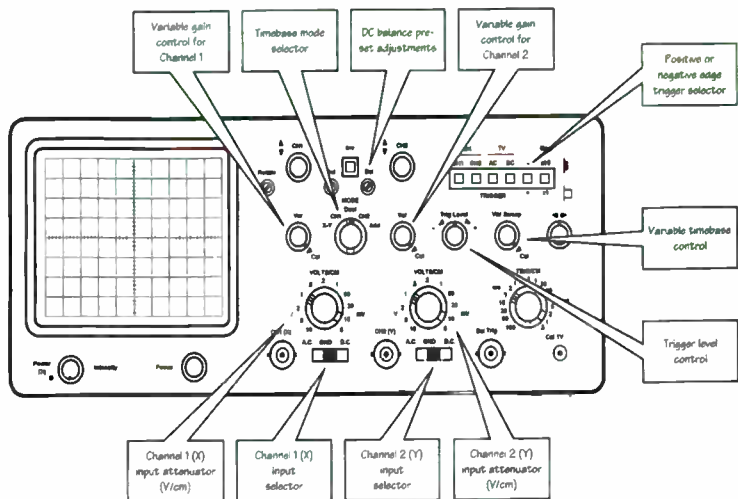

*Fig.23. Front panel controls and display on a typical dual-channel oscilloscope*

The dual-channel oscilloscope has three BNC coaxial input connectors:

- **Channel 1.** This is the primary vertical input but it is also used for the horizontal (X) input when the mode switch is set to the "X-Y" position.
- **Channel 2.** This is the second vertical input which is also used for the vertical input (Y) input when the mode switch is set to the "X-Y" position.
- **External trigger.** This input is only used when the trace is to be locked to an external trigger signal (both "CH1" and "CH2" trigger selector buttons must be pressed on the trigger selector).

In addition, a voltage calibrator test point is provided (marked "Cal 1V" on the front panel. This connector provides an accurate 1V square wave signal which may be used to calibrate the two vertical deflection channels.

## Basic Adjustments

The basic adjustments for single-channel waveform measurements are shown in Fig.24. The sequence of adjustments is as follows:

1. The input signal is applied, via a suitable probe, to the Channel 1 (CH1) input connector.
2. The intensity and focus controls are adjusted for a satisfactory display.

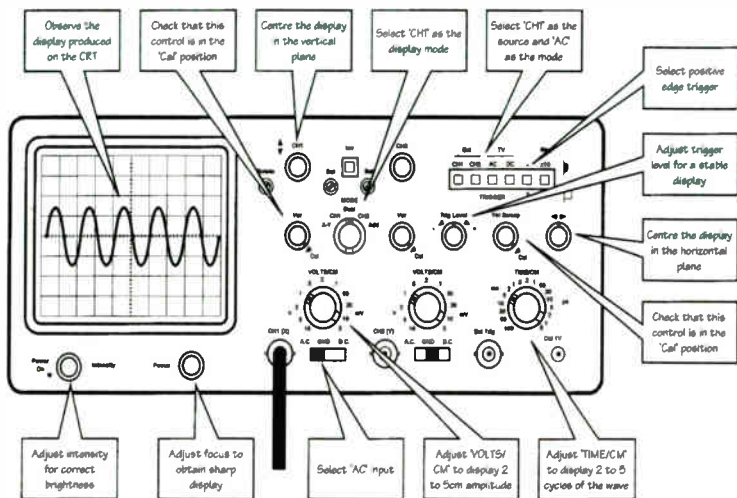

*Fig.24. Basic adjustments for single-channel waveform measurements*

3. The display is centred on the graticule using the vertical and horizontal shift controls.
4. The variable gain (Var) and variable sweep (Var Sweep) controls are set to the calibrate (Cal) positions.
5. The trigger selector (TRIGGER) is set to Channel 1 (CH1).
6. Positive edge trigger is selected, "+" (note that negative edge trigger may also be selected – in practice the sharpest edge of the waveform will produce the most effective triggering).
7. The display mode switch (MODE) is set to Channel 1 (CH1).
8. The Channel 1 input selector is set to "AC".
9. The vertical attenuator (VOLTS/CM) control is adjusted to produce a suitable height display (usually 2cm to 5cm).
10. The trigger level control (Trig Level) is adjusted to obtain a stable (locked) display.
11. The timebase selector (TIME/CM) control is adjusted to produce a suitable number of cycles on the display (usually two to five cycles).

The basic adjustments for dual-channel waveform measurements are shown in Fig.25. The sequence of adjustments is as follows:

1. The first input signal is applied, via a suitable probe, to the Channel 1 (CH1) input connector.
2. The second input signal is applied, via a suitable probe, to the Channel 2 (CH2) input connector.

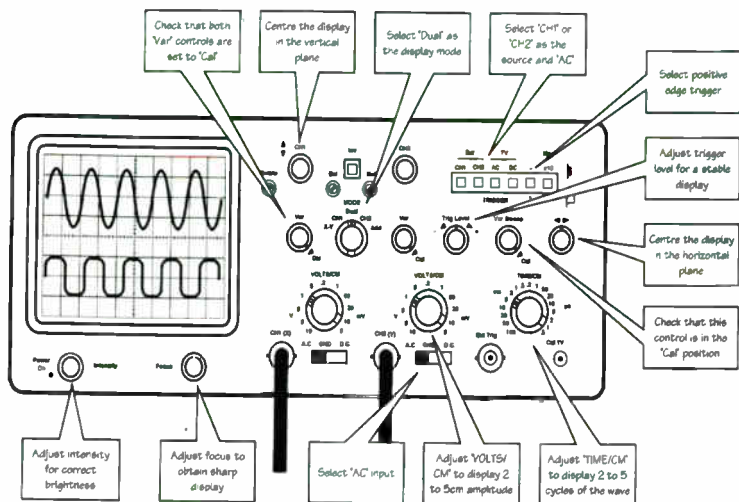
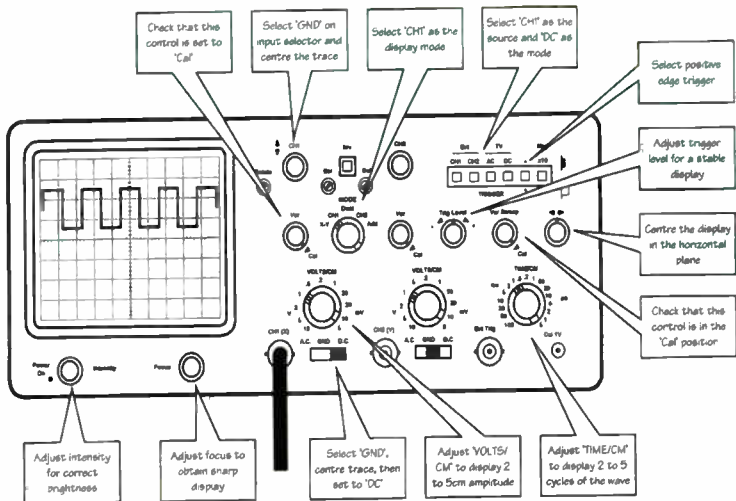

Fig.25. Basic adjustments for dual-channel waveform measurements

3. The intensity and focus controls are adjusted for a satisfactory display.
  4. The displays are centred using the horizontal shift control.
  5. The displays are adjusted (vertically separated into the upper and lower parts of the display) using the two vertical shift controls.
  6. The two variable gain (Var) and variable sweep (Var Sweep) controls are set to the calibrate (Cal) positions.
  7. The trigger selector (TRIGGER) is set to either Channel 1 (CH1), or Channel 2 (CH2), as necessary.
  8. Positive or negative edge triggering is selected as required.
  9. The display mode switch (MODE) is set to dual-channel (Dual).
  10. Both input selectors are set to "AC".
  11. The vertical attenuator (VOLTS/CM) controls are adjusted to produce displays of a suitable height (usually 1cm to 3cm).
  12. The trigger level control (Trig Level) is adjusted to obtain a stable (locked) display.
  13. The timebase selector (TIME/CM) control is adjusted to produce a suitable number of cycles on the display (usually two to five cycles).
- The basic adjustments for measurement of d.c. offset voltages are shown in Fig.26. The sequence of adjustments is as follows:
1. The input signal is applied, via a suitable probe, to the Channel 1 (CH1) input connector.



*Fig.26. Basic adjustments for measurement of DC offset voltages*

2. The intensity and focus controls are adjusted for a satisfactory display.
3. The display is centred on the graticule using the horizontal shift control.
4. The variable gain (Var) and variable sweep (Var Sweep) controls are set to the calibrate (Cal) positions.
5. The trigger selector (TRIGGER) is set to Channel 1 (CH1).
6. Positive edge trigger is selected, "+" (note that negative edge trigger may also be selected – in practice the sharpest edge of the waveform will produce the most effective triggering).
7. The display mode switch (MODE) is set to Channel 1 (CH1).
8. The Channel 1 input selector is set to "GND".
9. The vertical shift control is adjusted so that the trace is exactly aligned with the horizontal axis of the graticule (this line will then correspond to 0V).
10. The Channel 1 input selector is set to "DC"
11. The vertical attenuator (VOLTS/CM) control is adjusted to produce a suitable height display (up to 4cm in height).
12. The trigger level control (Trig Level) is adjusted to obtain a stable (locked) display.
13. The timebase selector (TIME/CM) control is adjusted to produce a suitable number of cycles on the display (usually two to five cycles).

## Waveform Measurements

Examples of some basic waveform measurements using an oscilloscope are shown in Fig.27. In Fig.27a, a square wave is displayed. One complete cycle of this waveform occupies 2cm on the display. Since the timebase range selector (TIME/CM) is set to 1ms/cm, the time for one complete cycle of the waveform is  $2 \times 1\text{ms} = 2\text{ms}$ . The vertical size of the waveform (i.e. its peak-peak value) measures 2cm on the graticule. Since the vertical attenuator (VOLTS/CM) is set to 1V/cm the peak-peak voltage is  $2 \times 1\text{V} = 2\text{V}$ .

A sine wave is shown in Fig.27b. One complete cycle of this waveform occupies 2.5cm on the display. Since the timebase range selector (TIME/CM) is set to 2ms/cm, the time for one complete cycle of the waveform is  $2.5 \times 2\text{ms} = 5\text{ms}$ . The vertical size of the waveform (i.e. its peak-peak value) measures 3cm on the graticule. Since the vertical attenuator (VOLTS/CM) is set to 50mV/cm the peak-peak voltage is  $3 \times 50\text{mV} = 150\text{mV}$ .

An irregular pulse wave is shown in Fig.27c. The display is "low" for 3.4cm measured on the graticule. Since the timebase range selector (TIME/CM) is set to 0.1s/cm, the "low" time shown on the display is  $3.4 \times 0.1\text{s} = 0.34\text{s}$ . Similarly, the period for which the wave next goes "high" is  $1.5 \times 0.1\text{s} = 0.15\text{s}$ . The vertical size of the waveform (i.e. its peak-peak value) measures 4cm on the graticule. Since the vertical attenuator (VOLTS/CM) is set to 1V/cm the peak-peak voltage is  $4 \times 1\text{V} = 4\text{V}$ , equally distributed either side of 0V.

## Pulse Rise and Fall Times

The rise and fall times of a pulse can be easily measured using the techniques previously described (note that this measurement is only valid if the oscilloscope is fitted with a properly compensated probe). Fig.28 shows the parameters of a pulse including:

- Rise time (100% to 900%)
- Faltime (900% to 10%)
- On time (time above 50%)
- Off time (time below 50%)

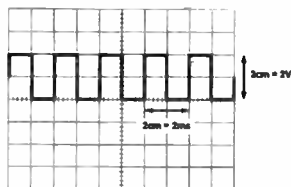

TIME/CM: 1ms/cm  
VOLTS/CM: 1V/cm

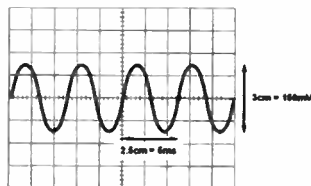

TIME/CM: 2ms/cm  
VOLTS/CM: 60mV/cm

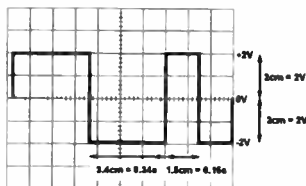

TIME/CM: 0.1s/cm  
VOLTS/CM: 1V/cm

Fig.27. Examples of basic waveform measurements

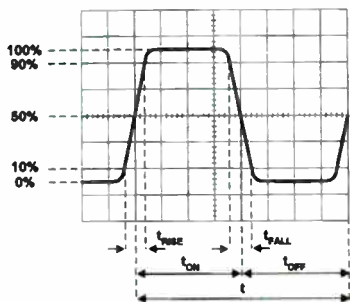

Fig. 28. Pulse parameters (rise-time, fall-time, etc.)

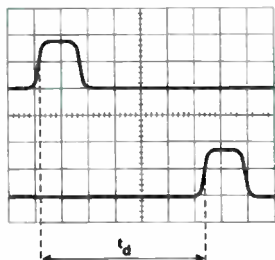

Fig. 29. Measurement of pulse delay using a dual-channel oscilloscope

## Pulse Delay

A dual-channel oscilloscope can be easily used to measure pulse delay (see Fig. 29). Note that this measurement should be performed with the timebase mode switch set to "CHOP" rather than "ALTERNATE" on oscilloscopes that offer an alternate sweep facility.

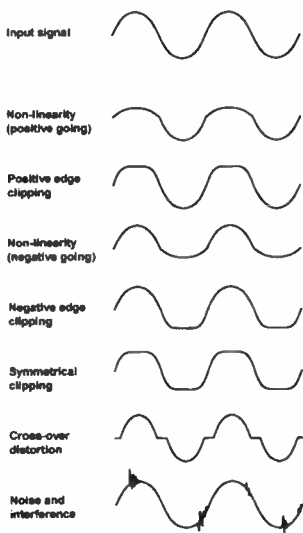

Fig. 30. Sine wave purity performance checks using an oscilloscope

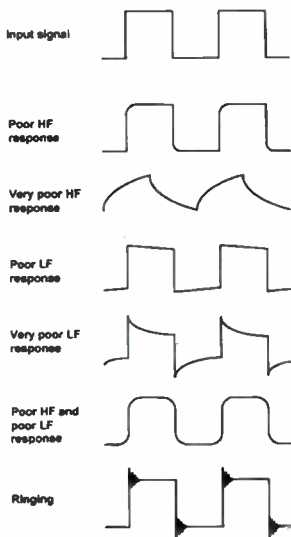

Fig. 31. Square wave performance checks using an oscilloscope

## Sine Wave Performance Checks

An oscilloscope can provide a very rapid assessment of the performance of an amplifier. A pure sine wave (of appropriate frequency and amplitude) is applied to the input of the amplifier (or other system under test) and the output is displayed on the screen of the oscilloscope. The effects of non-linearity, clipping, noise, distortion, etc. can be easily seen (see Fig.30).

## Square Wave Performance Checks

An alternative but equally revealing assessment of an amplifier can be made using a square wave test. An accurate square wave (of appropriate frequency and amplitude) is applied to the input of the amplifier (or other system under test) and the output is once again displayed on the screen. The effects of poor frequency response, "ringing", etc. can be easily detected (see Fig.31).

## Phase Measurement

A number of useful measurements can be made with an oscilloscope in X-Y mode. It is possible to carry out reasonably accurate measurements of phase angle using Lissajous figures (see Fig.32). In order to obtain these displays, the two signals must be applied with identical gain/attenuation and it is usually necessary to calibrate the instrument by applying the same sine wave signal to the X and Y inputs and adjust the gain controls to obtain a straight line at exactly 45° (see Fig.32). Thereafter, the signal to be measured is applied to the vertical channel (Y) whilst the reference signal is applied to the horizontal channel (X). The shape of the display indicates the phase shift between the two signals. This technique is ideal for rapidly checking the phase shift produced by a network, filter, or amplifier.

## Frequency Measurement

Lissajous figures can also be used to determine the frequency relationship between two signals (see Fig.33). The frequency ratio is given by the ratio of the number of "peaks" produced in the horizontal direction to the number of "peaks" produced in the vertical direction.

## Modulation Measurement

Finally, the depth of amplitude modulation (a.m.) can be easily determined using an oscilloscope (see Fig.34). The depth of modulation (per cent) is given by the relationship:

$$\text{Modulation depth} = V_m / V_c \times 100\%$$

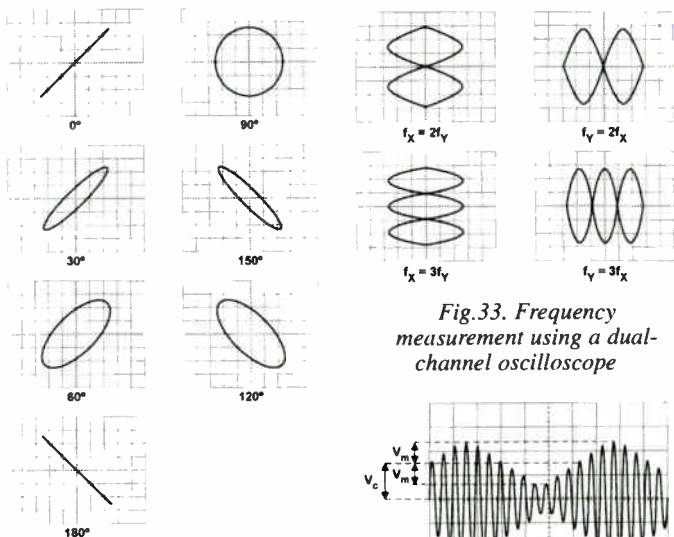

Fig.32. Phase measurement using a dual-channel oscilloscope

Fig.33. Frequency measurement using a dual-channel oscilloscope

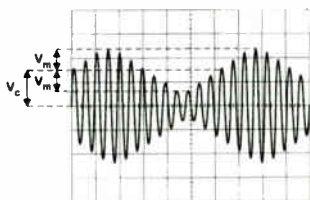

Fig.34. Amplitude modulation measurement using an oscilloscope

## DOs and DON'Ts of Using an Oscilloscope

- Ensure that the vertical gain and variable time/cm controls are placed in the calibrate (CAL) positions before making measurements based on the attenuator/timebase settings and graticule.
- Ensure that you have the correct trigger source selected for the type of waveform under investigation.
- Remember to align the trace with the horizontal axis of the graticule with the input selector set to "GND" before making measurements of d.c. levels.
- Make use of the built-in calibrator facility (where available).
- Use a properly compensated oscilloscope probe.
- Don't leave the intensity control set at a high level for any length of time.
- Don't leave a bright spot on the display for even the shortest time (this may very quickly burn the screen's phosphor coating).

© Wimborne Publishing Ltd 2005  
Tel. 01202 873872  
www.epemag.co.uk