

Electronics & **MUSIC Maker**

INCORPORATING COMPUTER MUSICIAN



MORAZ AND BRUFORD

MACHINES PROGRAMMED FOR GENES

LEVEL 42

ZEUS B HELD

COMPUTER

MUSIC

COMES OF AGE

ATARI ST MIDI MICRO +
HINTON
MIDIC
SOFTWARE

REVIEWS:

ENSONIQ MIRAGE KEYBOARD

SEQUENTIAL

TOM DRUM MACHINE

MICROSKILL AS32

ADDITIVE SYNTH

CHASE + SIEL SYNTH

EXPANDERS

KORG SDD2000

SAMPLING DELAY

PASSPORT MIDI

SOFTWARE

BOSS

MICRO RACK



RDD-10
Digital Delay

RPH-10
Phaser

RBF-10
Flanger

RGE-10
Graphic Equalizer

RCL-10
Compressor
Limiter,
Expander/
Noisegate

RAD-10
19" rack shelf
(accommodates 2 units)

BMR-5
9 1/2" rack

Compact, efficient, hi-tech sound processors at prices you can afford.
Perfect for home recording or live stage use.

Today's Buzz Word in Home Recording . . .

BOSS MICRO RACK SERIES

Send for leaflet quoting this publication to:

Roland (UK) Ltd.

Great West Trading Estate, 983 Great West Road, Brentford, Middx. TW8 9DN.

Telephone: 01-568 4578

Telex: 934470

Fax: 01-847 1528

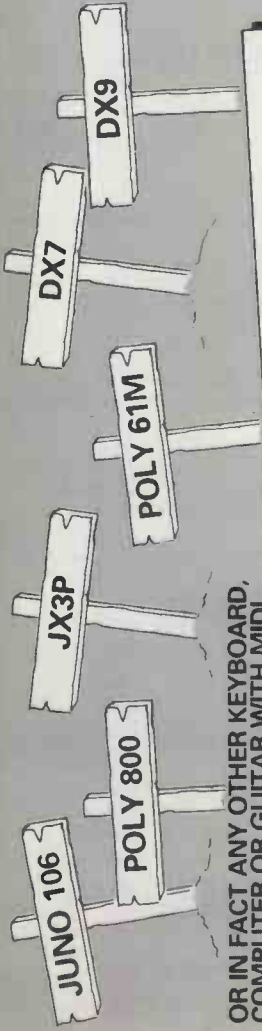

OR IN FACT ANY OTHER KEYBOARD, COMPUTER OR GUITAR WITH MIDI.

BRING THEM TO LIFE WITH THE SENSATIONAL CHASE SYNTHESIZER MODULE

If you've already a keyboard with Midi and digital filtering, now you've no need to throw it away to get those famous "Chase Bit One" analogue sounds. You can link it up as a mother keyboard to the Chase Synthesizer Module and get virtually all the advantages of a "Chase Bit One" (with touch sensitivity if your keyboard has this feature.)

GET THE FULLNESS & WARMTH OF ANALOGUE FILTERING AND MUCH MORE...

- Full Midi implementation
- Digital access control
- 6 voice programmable
- 24dB filtering
- 99 programmable memories
- Full analogue filtering
- Full touch sensitivity response
- Full assignable split mode
- Doubling mode
- "Chase Bit One" Sound Park

...AND ALL THE OTHER FEATURES THAT MADE THE CHASE BIT ONE THE PROFESSIONAL KEYBOARD OF 1985... ONLY THE KEYBOARD IS MISSING.

If you haven't tried it yet - see into the future this week and find out how the "Chase Bit One" Performance and Composition System is turning the music industry upside down. In the meantime you may be interested that it won't cost you an arm and a leg. The Chase Synthesizer Module for the next two months only can be yours for £699 inc. VAT.

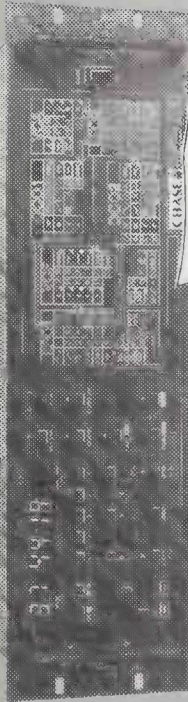

PROFESSIONAL KEYBOARD OF 1985

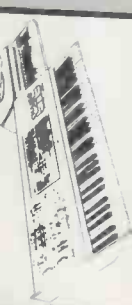

"CHASE BIT ONE"
A further consignment is now due from the factory. To ensure your model, place a small deposit now. Price still held down to

ONLY **£799** inc. VAT.

CHASE LONDON - Chase 22 Chiswick St. Dr. Euston Road, NW1 Tel: 01-387-7826/2488
 BIRMINGHAM - Chase 10 Priory Queensway, Tel: 021-236-8135
 BELFAST - Chase 55a Grosvenor, 208 York Street, Tel: 0232-249558
 BOURNEMOUTH - Chase Music, 6-7 Queens Place, BN1 2AC, Tel: 0202-292024
 BRISTOL - Chase Music, 10 N. Parade, Tel: 0272-554239
 CARDIFF - Chase 1, Leventer 2 21A, Parkway Road, Cardiff, Tel: 0222-718991
 CHESTER - Chase Music, 10, Victoria Road, Tel: 0275-598313
 CONKLETON - Chase Music, 10, Victoria Road, Tel: 0275-598313
 ENBUBURGH - Chase Music, 10, Victoria Road, Tel: 0275-598313
 GLASGOW - Chase Music, 10, Victoria Road, Tel: 041-339-3818
 HULL - Chase Music, 10, Victoria Road, Tel: 0482-321115
 LEEDS - Chase Music, 10, Victoria Road, Tel: 0532-438183
 LONDON - Chase Music, 10, Victoria Road, Tel: 01-387-7826/2488
 MANCHESTER - Chase Music, 10, Victoria Road, Tel: 0275-598313
 NOTTINGHAM - Chase Music, 10, Victoria Road, Tel: 0522-660205
 PERKINSVILLE - Chase Music, 10, Victoria Road, Tel: 0275-598313
 PLYMOUTH - Chase Music, 10, Victoria Road, Tel: 0238-328115
 SOUTHAMPTON - Chase Music, 10, Victoria Road, Tel: 0238-328115
 TOTTENHAM - Chase Music, 10, Victoria Road, Tel: 0238-328115

IT'S TAKING OVER

CHASE BIT

FANTASTIC PURCHASE

SAVE £100
SAVE £200
SAVE £300
SAVE £400
SAVE £500 + MORE

Chase's phenomenal buying power has done it again. We have secured a shipment from Crumar, the World's leading manufacturer of fully polyphonic keyboards, at unbelievably low prices and are passing these savings on to you. You can now afford better equipment and have less to pay. **SAVE over HALF PRICE** - but only while stocks last, so call in today. Many of these prices are unrepeatable.

CRUMAR ROADY PIANO

The electric piano of the 80's. Five full octaves of Piano, Vibra, and Lead Line Solo Synth and breath control are all possibilities that include melodic Vibes with variable tremolo depth and rate. Percussion that can duplicate a mallet sound, produce the accentuation of popular electric edge for jazz solos. 3 distinctive piano sounds that can be mixed in any combination and can be played on either the left side, the right or across the entire keyboard. Bass, that can be played percussively or simultaneously sustained with the Vibes.

R.R.P. £500
CHASE SCOOP
£199

CRUMAR COMPOSER

The Composer gives you that big fat Crumar sound by keyboard at the same time. Organ, Strings, Polyphonic Synth and Lead Line Solo Synth and breath control are all infinitely variable and mixable at the same time. Dynamic keyboard and many other features.

R.R.P. £1300
CHASE SCOOP
£349

CRUMAR DP80 PIANO

12 Incredible Piano Voices, the ability to create your own with. THE VOICES. Sit down at the Crumar DP 80 and you'll discover the world's most popular pianos are at your fingertips. Six presets function in two modes, the first six being more traditional acoustic and electric piano sounds, normally associated with acoustically oriented instruments. FREE SECTION. The seventh preset enables you to control the very special Free Filter Section. This expressive synthesizer voices individually coloured by the energy you direct into the keyboard. THE FEEL. The DP-80 has a true dynamic keyboard that you can adjust to suit your touch. You don't have to conform to it, the DP-80 conforms to you.

R.R.P. £1300
CHASE SCOOP
£449

B.C.R. ICH

B.C. RICH GUITARS NOW AVAILABLE IN THE U.K. ANOTHER CHASE EXCLUSIVE

CASIO

Complete Range of Keyboards at lowest possible prices

RING FOR DETAILS

CHASE SYNX 508

U.K. LAUNCH HALF PRICE

R.P.P. £899
CHASE SCOOP
£399

CHASE SYNX 508 5 voice, polyphonic synthesizer with full set of capabilities offering 64 voice programs and 8 sequencer programs. Features include ensemble, phrasing, chorus, ensemble mix, poly modes, hold, chorus controls and much more.

R.P.P. £899
CHASE SCOOP
£399

WANTED
Second Hand Synths, Keyboards, Organs, Guitars, Amps, etc.
BEST PRICES PAID

REPAIRS
We repair all leading makes of musical instruments. Enter your bought for us originally or not.

LONDON 22 Chalkton Street, off Euston Road, London NW1. Tel: 01-387 7626/7449
 MANCHESTER 58 Oldham Street, off Piccadilly, Manchester M4 1LE. Tel: 061-236 6794/5
 BIRMINGHAM 10 Priory Queensway, Birmingham, B4 6BS. Tel: 021-236 8146

Opening Hours: Mon-Sat inc. 10.00am-5.30pm
 All goods subject to availability.

PRICES
INCLUDE
VAT

EXPORT
PRICES
ARE LESS
VAT
AT 15%

J.S.G



INSTANT
CREDIT
NO
DEPOSIT
HP

104/6/8B Main Street, Bingley, West Yorkshire, BD16 2JH.
Telephone: Bradford (0274) 568843/564389/561044.

YAMAHA HI TECH
AUTHORISED DEALER

CX5M



CX5M PACKAGES - SPECIAL PRICES

NEW DX21	PHONE NOW
NEW RX21	COMING SOON
DX5	COMING SOON
DX7	PHONE
KX88 Midi Master K/B	BEST PRICE
RX15 Digital Drums	£1250
RX11 Digital Drums	BEST PRICE
TX7 DX Expander	£649
QX7 Sequencer	£449
TX816 Modular DX System	£4239
QX1 Sequencer	£2499
PF15 Piano	£880
PF10 Piano	PHONE
KX5 Remote	PHONE
PS6100	PHONE
CLAVINOVA YP40	£875



SIMMONS

SDS9 kit RING FOR
SDS200 PRICES
SDS400 AND
SDS800 COLOURS

NEW

SDS8 Kit	CHOICE	£650
SDS7 Kit	OF	£1875
SDS5 Kit	COLOURS	£995
SDS1	PHONE	
SDS6	PHONE	
SUITCASE Pads		£95
CLAPTRAP		£59

ALSO IN STOCK

DYNACORD Kit	£995
TRAMA Kit	£875
MPC Kit	£599
TAMA Kit	£875
CACTUS Kits	£495

OPENING TIMES

MON	11.00 am-9.00pm
TUE	CLOSED
WED	10.30am-5.30pm
THUR	11.00am-9.00pm
FRI	10.30am-5.30pm
SAT	10.00am-5.30pm



ensoniq MIRAGE
DIGITAL SAMPLING KEYBOARD

AT THIS PRICE
IT SOUNDS
TOO GOOD TO
BE TRUE

KORG

DW6000	£795
MIDI Pedals	£375
POLY 800	£475
POLY 61M (MIDI)	£595
RK100B Remote	£365
DDM-110 Drums	£199
DDM-220	£175
PSS50 Super Section	£275
EX800 - Poly 800 Expander	£295
KMS MIDI sync	£139



MULTITRAK	PHONE
MAX	£499
SIXTRAK	£545
PRO600	£995
DRUMTRAKS	£795
TOM	PHONE
MODEL 64 Interface	£129

CASIO

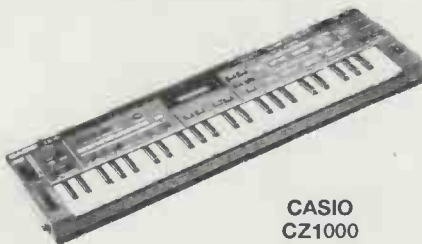

CASIO
CZ1000

CZ101	BEST PRICE
CZ1000	BEST PRICE
CT6000	VERY SPECIAL PRICE

FULL RANGE IN STOCK

KAWAI EP608 PIANO £995

KEYBOARD AMPLIFICATION

PEAVEY KB100 Combo	£229
PEAVEY KB300 Combo	£345
PEAVEY KB400 Top	£459
CARLSBRO K/B 150 Top	£239
CARLSBRO K/B 150 Combo	£385
CARLSBRO Cobra 70 Combo	£253
CARLSBRO Hornet 45 Combo	£169
McGREGOR 200 Combo	£395
McGREGOR 200 Top	£175
VOX 100w K/B Combo	£239
H/H K80 Combo	£235
H/H K100 Top	£195



JUNQ 106	£775
JX8P	
MKB 1000 Mother	
MKB 300 Mother	
MKS10 Planet P	
MKS 30 Planet S	
MKS 80 Super Jupiter	
MPG 80 Programmer	
JSQ 60 Dig K/B Rec	£139
MSQ 100 Dig K/B Rec (MIDI)	
MSQ 700 Dig K/B (MIDI-DCB)	
SBX 80 Sync Box	
SVC 350 Vocoder	
M110 MIDI Interface	
MD8 MIDI-DCB	
MM4 MIDI Thro Box	
SH101 Synth	£199
AXIS Remote Keyboard	
HP 20 Piano	
HP 60 Piano	
HP 70 Piano	
HP 300 Piano	£695
HP 400 Piano	£895
TR 808 Drums	£399
TR909 Drums	£395
TR707 Drums	£465
TR727 Drums	£465
DR110 Drums	PHONE

OBERHEIM

XPANDER	£2995
OB-8	£2595
DSX	£1155

360 Systems

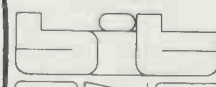

Polyphonic • 6 Voice •
Touch Sensitive •
Digital and Analogue

The BIT ONE

£750



DK80	£599
EX80 Expander	£345
MIDI Expander	£399
DK600	£775
MK900	£359
PIANO Quatro	£735
OPERA 6	£599
CRUISE	£399

**ALL PRICE INCLUDE
VAT & FREE
SECURICOR DELIVERY
(UK MAINLAND ONLY)**

CONTENTS



E&MM July 1985

Volume 5 Number 5

NEWS

- Comment**4
The critic under criticism.
- Interface**6
Another dip into the E&MM postbag.
- Newsdesk**8
If it's news, you'll read it here first.

HARDWARE

- Ensoniq Mirage**10
At last – the instrument with a name on everybody's lips receives an in-depth examination of its European version. Man-on-the-spot is Paul Wiffen.
- Expandability**16
Two manufacturers follow their already established polysynths with keyboardless voice expanders. Trish McGrath puts the Chase Bit 01 and Siel Expander 80 through their paces.
- Sequential Tom**20
Following the Drumtraks in vocation and the MAX in appearance comes TOM, Sequential's latest. Simon Trask finds out if reverse drum samples really do have a use.
- Microskill AS32**26
A British-built additive synthesis instrument with multiple keyboard splitting and overlaying, and up to 16 voices at its command. A dream come true? Simon Trask has the answer.
- Korg SDD2000**32
Korg's latest digital delay looks like any other – but it offers comprehensive MIDI-controlled sound-sampling facilities. Tim Goodyer checks it out.

CHECKLIST

- Electronic Percussion Checklist** 36
This month's Checklist turns its attention to the world of electronic drum kits and drum machines. Price guides will never be the same again.

MUSIC

- Out-Takes**42
Record reviews, readers' tapes, gig and video reviews – they're all here as E&MM's new music feature expands its critical horizons.
- Take Two**48
Patrick Moraz and Bill Bruford, two of music's best-established virtuoso players, talk about their two-year relationship and a new LP. Interview by Dan Goldstein.



- Improbability Factor: 42**54
Level 42 keyboardman Mike Lindup takes a break from recording of the next album to talk to Tim Goodyer about Fairlights and Synclaviers, among other things.
- Divine Production**59
German producer Zeus B Held – the man behind the name – shares sampling secrets and delaying tactics with Tim Goodyer.

TECHNOLOGY

- Fair Facts**64
A sneak preview of what you can expect to see at this year's British Music Fair – the first to open its doors to the public for years.
- Confessions**68
...of an English kit builder. An in-

sight into the problems and pleasures of constructing electronic music kits – by Godric Wilkie, who's built hundreds.

Patchwork74
The readers' synth sound page. This month, ever more resourceful patches for the Yamaha DX7 and Roland Jupiter 8 polysynths.

Back to Basics76
Steve Howell puts sex, murder and intrigue to one side to make way for a study of modulation in its many and various forms.

COMPUTER

MUSICIAN

- Editorial**81
Hyped up about hype. David Ellis challenges hi-tech advertising.
- Rumblings**82
Featuring sequencer software for the IBM PC from Octave Plateau, Sight & Sound's Music Processor software for the CBM64 and a music-copying program in use at Oxford University's Music Faculty.
- Atari 520ST**84
Not just another home computer; more like the future of the entire domestic micro industry, not to mention the MIDI software one. Simon Trask has the details.
- The Art of Going Soft**89
The Music 500 receives an AMPLE voicing and sequencing program to tempt junior programmers into getting their feet wet.
- Passport Software**92
Sequencing software aimed at the Apple II and CBM64. Four- and eight-track versions receive expert scrutiny from David Ellis.
- Hinton MIDIC**94
A MIDI utility hardware and software package for any RS232-equipped micro. Review by Simon Trask, who's thinking of having RS232 fitted to himself.
- EmmSoft** 100
Latest news from E&MM's own music software division.

NEWSDESK

Witches S...
The Staff... of the R...
...ket. last...
...ing...
... and dis...
... today

HARDWARE

A much-improved (since the preview in E&MM March '85, that is) Advanced Sound Generator from the **Oxford Synthesiser Company** is to be shown throughout this summer at various shows. It's still to come in a 6U-high, 19" rack-mounting format, but now includes an integral colour CRT as standard, as opposed to the large LCD previously fitted. It'll be MIDI-equipped, be both pressure- and velocity-sensitive, and employ floppy disk storage for sounds and sequences. First showing will be at the NAMM Music Expo in New Orleans at the end of June, and you can get further details from *Oxford Synthesiser Company, 5 Gladstone Court, Gladstone Road, Headington, Oxford.* ☎ (0865) 67065.

Now that readers of E&MM's sister magazine *Home Studio Recording* have done the dirty work by building **Tantek's**

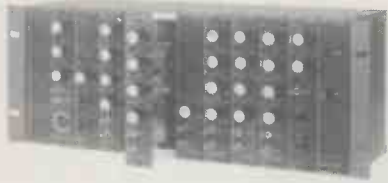

Tanrak modular effects/processing units from kits, E&MM readers can take advantage of the fact that it's now available ready built. The Tanrak is a 19", 4U rack-mounting affair, and currently numbers gates, parametric EQ, modulation oscillators and a multi delay among its fast-expanding range of units. If you do happen to like soldering things together, however, kit form units are still available and are backed by a Get-it-Going service to help in case of trouble. Information on either route to home studio heaven can be had from *Tantek, Enterprise House, Elder Way, Stevenage, Herts, SG1 1TL.* ☎ (0438) 726155.

The ever-resourceful accessory people **Micro Musical** have come up with an imported set of MIDI bass pedals called the ML50. Designed to compliment any MIDI-equipped keyboard and duplicating the lowest 13 notes (C to C), the ML50 will operate in either monophonic or polyphonic modes, and also features a 'computer note memory', whatever that may mean. There'll be an optional foot controller available for an extra £99, giving control over MIDI channel, a selectable six-octave range, and the option to add a fifth to the pitch of the notes trodden on. RRP of the pedals in their standard form is £199 including VAT. Further information from *Micro*

Musical, 37 Wood Lane, Shilton, Coventry, CV7 9LA.

MUSIC

If you're a **Bill Nelson** fan and bought one of the first 3000 copies of the boxed record set *Trial By Intimacy*, only to find that instead of the book of photographs (*The Arcane Eye*) that was supposed to be included, you were in possession of a pink order form for said book – which in turn was out of date – do not despair. It transpires that production of the book was delayed by printing difficulties, while the records themselves took longer than anticipated to get to the shops – hence the order form being outdated. In their infinite wisdom, Cocteau have altered the cut-off date to the end of September, so get 'em in for your copy of the book.

A quick **UK Electronica '85** update. The main evening act for this country's biggest electronic music festival is now confirmed as **Ashra**, who'll be supported by a set from **Steve Jolliffe**. The daytime headline spot goes to **Ian Boddy**. Ticket prices are £5 for each session, with a reduction of £1 for those in possession of a UB40 or student union card. There's also a £1 concession for both sessions if you buy your tickets in advance.

Anyone who particularly enjoyed last year's **UK Electronica** – or missed out but wants to know what went on – will be pleased to learn that a video of the proceedings is now available. It's available in both Beta and VHS formats, runs for 1hr 40mins, and includes footage of all the artists who appeared. Cost is £19.99 + £1 p&p, which should be sent to *Ron Bailes, 56 Kitlington, Downhead Park, Milton Keynes.*

TECHNOLOGY

A few books that may capture the imagination of the nation's youth, or at least, that of the one or two that are thirsty for information...

The Oxford University Press have just released **Peter Manning's** *Electronics and Computer Music*. This places the emphasis firmly on the technical aspects of computer music rather than the music itself – the information about which is hopelessly inaccurate in places – but could prove to be of interest nonetheless. The title *Micro Music for the Commodore 64 and BBC Computer* is almost a book in itself, but author **Gary Herman** has managed to persuade Papermac to publish the text he's written to accompany it. This includes numerous CBM and BBC

program listings to illustrate the information in its pages, and the book costs £8.50. Concentrating on the BBC B and its younger sister, the Electron, **Kevin Jones' Exploring Music with the BBC Micro and Electron** has almost as long a title as the last book. Published by Pitman and covering everything from pop to the classics – as intimated by the awful cover drawing – this also provides program listings in its efforts to enlighten. Mr Jones, incidentally, is a composer and musician who, the jacket notes inform us, has had one piece of his work for the BBC performed in Salzburg. Just what you always wanted to know.

STOP PRESS

They've done it again. **Computer Music Studios** have acquired yet more new premises, namely Park House in South Wales. Work is currently in progress to prepare the 'Computer Music Complex', which is intended to become 'the focal point of musical activity in Wales and the West Country', and will include a 16-track studio equipped with the newly-released RSD computer-controlled mixing desk. Also available will be a private six-bedroom flat, tennis courts and a swimming pool – spec on these to follow. The complex is expected to be completed shortly, and any enquiries should be directed to CMS at ☎ (0554) 751169.

Two more music packages for the CBM64 have been announced by **Commodore** themselves. They're called the **Sound Studio** and the **Sampler**. Commodore claim the **Sound Studio** turns the 64 into 'a professional music synthesiser and multi-track sequencer', and a glance at the paper spec reveals that it features three tracks, real- and step-time input, a helpful screen display and control over filters, PWM and so on. Cost is £14.95. The sampler – a simple, monophonic device, is a hardware/software package offering a ten-octave range as well as echo and harmonising facilities, and even comes complete with its own microphone. Price is not yet fixed, but it's unlikely to be in any way expensive.

Strong rumours are circulating of an upmarket digital sampling keyboard scheduled for imminent release by **Sequential**. A completely unbiased Sequential spokesperson has told E&MM the instrument will have the capabilities of an Emulator II and retail for around £2000. Release date will be sometime in September. Will it put the spanner in the **Mirage** works? We shall see. ■

CHROMATIX

OAK ROAD

EALING BROADWAY CENTRE

LONDON W5

01567 3623

CHROMATIX present the Yamaha modular recording system at a price you can afford!



MT-44D recorder: new model, higher specification four channel multi-track. Superb design and construction permits hi-fi quality recordings with Dolby B and C for less than £400.

RM-602 mixer: total flexibility with this new design recording mixer. Simply the best unit for 4-track recording with the advantage of stand alone usage and higher quality components.



GC-2020 comp/limiter: Dual channel unit with expander gate on both channels. Dual mono or stereo modes, 20Hz - 20kHz frequency response and 0.03% THD. Amazingly low price in this no-compromise unit.



GQ-1031 and Q-2031 graphics: Precision response shaping from these two superbly engineered equalisers. At such low prices, the home-recordist can now enjoy frequency designed recordings which are so important to achieving optimum results.

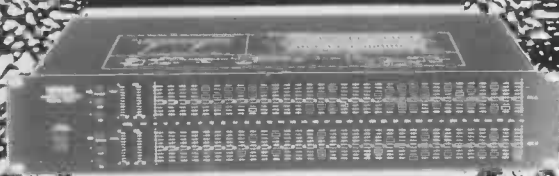

R-1000 digital reverberation: Precisely controllable natural-sounding reverberation. Variable decay and on-board parametric equalisation with insert points enable your recordings to benefit from digitally simulated ambience at a lowest ever price.



D-1500 digital delay: This MIDI controlled delay system is, we believe, the best on the market. 16 memories with immediate switching from MIDI codes enable stunning results at mixdown or in real-time as you record.



Dear E+MM,

review of
to upgrade
Pro 1 set
polysynth. I've looked at the new

INTERFACE

Write to: Interface, E&MM, Alexander House, 1 Milton Road, Cambridge
CB4 1UY

If you've a view, query or problem, write to Interface at the above address.

We endeavour to answer every letter regardless of whether there's sufficient space for its inclusion in the magazine, so please include your full address and phone number, and don't worry if the reply is a little while coming – some queries need more research than others.

Sex, Drugs and E&MM

Dear E&MM,

I am writing about the editorial Comment in the June issue of your rag. 'Who are today's average musicians?' – I am one. 'Where do they live?' – all over the place. 'What do they do?' – they learn to get a few notes out of their chosen instrument so that they can go on to taste the high life. By the high life, I mean long-legged women with a desire for diverse

play a note. And of course, with the arrival of the new remote keyboards, we keyboardists can be out at the front thrusting our bits and pieces at the audience with the best of them.

Let's face it, who gives a damn about the MIDI spec or how many bloody LFOs a synth's got? The true worth of any instrument is how many chicks it will pull for you.

So spare us the pious platitudes and the jargonese. We're all in it for the same thing, even you lot at the editorial office. It wouldn't surprise me if you have an office football team and all swap shirts with the voluptuous Trish McGrath after the match, and that's not to mention the mixed showers. And why are some of Tim Goodyer's reviews so short? Probably because he hasn't got the strength to write for very long!

We're all here for sex and drugs and anything else thrown in. So stuff the hi-

no success. Some of my friends showed me pretty instruments in pictures, but when I saw the prices I got a shock. I can't afford to pay \$500 – even for the best synthesiser – when I only earn \$20 a week.

If you have an old synthesiser or any other stage equipment which you want to throw away (even if it's broken) and you want to help, please pack it simply in a parcel and send it to me. This will make me happier than you can possibly even imagine.

Jacek Pietraszkiewicz
Rodakowskiego 1A/22
80-304 Gdansk
Poland

If the hi-tech word is going to be spread around the music world, people like this need your help. Any offers?

The Great Debate

Dear E&MM,

I'd like to congratulate Paul Walker for bringing interesting debate to the *Interface* page at last – but that doesn't mean I entirely agree with him. However, I *do* feel the synth industry has been going backwards lately, as the only recent innovations have been MIDI (which doesn't improve the sound) and sampling (which doesn't generate any sound at all).

Sampling machines might be a lot more affordable now, but I've no great urge to have one, for the simple reason that I don't have anything to sample! I don't own a grand piano, a clarinet or a cello, so what do I want a sampler for? I *could* sample other people's sounds, but where's the originality in that? I thought the objective of electronic music was to create ones new sounds, not regurgitate old ones.

I feel quite strongly that more research should be put back into synths. Yamaha showed what could be done with the DX series, but what's happened to everyone else? Nowadays, manufacturers are more interested in producing synths to a price (cheap?) than to a spec. And that's a shame.

Andy Horrell
Bristol

After last month's bombardment from the pro-sampling contingent, it's refreshing to see the other side of the argument being put forward in a calm and logical manner. We reckon there's still plenty more to be said on the subject, though, so don't be afraid to dedicate your opinions to paper...



physical pursuits, a healthy supply of life's dubious opiates and as much bread as they can get. There are some that say they do it for art's sake – who are they kidding?

Every muso chooses his instrument for a particular reason. Guitarists do it for the phallic symbolism of the instrument, drummers for the sheer 'physicalness' of hitting things, and keyboard players for the mixture of sexy and aggressive sounds they can get from the various keyboards available, and also because having a couple of sequencers means they can get away without being able to

tech, forget the specifications, get yourself a tight pair of trousers and a length of hosepipe (if you're not as lucky as me) and you'll be well away. It never fails.

'Long' John Gadocha
Barnstaple

Foreign Aid

Dear E&MM,

I'm a young keyboard player in Poland. For the last two years I've tried to do everything to get my own instrument – even the simplest synthesiser – but with

The case for the Fostex Tracker while stocks last, it's almost FREE

Remote control as shown is not included in this special offer.

Without doubt, the Tracker is the best value in four track.

Those very clever Fostex people have recognised songwriter's needs and have produced a whole range of accessories to compliment their palm sized studio.

Firstly, the battery pack and carrying strap come free with your purchase.

The 'Orange', seen in the photo, is a remote control that lets you punch in to record remotely. 'Juice' is their name for the mains adaptor to save on the cost of batteries.

Quite recently, the 'Squash' was introduced. This four channel mixer with a built in compressor lets you

bounce down or mix in extra inputs or a mike - while at the same time tightening the sound, adding commercial punch to your recordings.

The Tracker studio system offers you the chance to make professional sounding demos, anywhere the music is.

Which brings us to the offer. Because while stocks last, we're offering the custom carrying case FREE of charge with any X15 purchase.

Call in to the Turnkey Shop, watch the X15 video, hands-on demo for yourself, and walk off with the best deal in four track around.

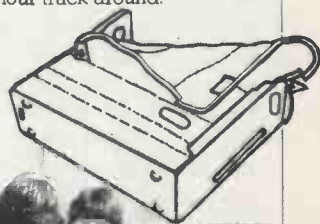

The best four track you can buy

This is a one off offer, intended only for an absolute perfectionist.

We have one only OTARI Series 5050 half inch four track recorder. Specifications are beyond impeccable. You need no noise reduction to achieve superb recordings.

XLR's, accurate metering, full alignment access, in fact every feature you would expect on professional recorders.

This is a unique opportunity for a very special customer, at an unrepeatable price.



Mixers. Do you have any choice?

While there are just one or two multitracks within reach, it can seem like hundreds of mixers to choose from.

We've got more than our fair share on show and on demo at the Turnkey Shop. The pick of the Soundcraft, SECK, RAM, Fostex, RSD, Soundtracs and Tascam ranges. Chosen and priced to represent the best value in multitrack.

Check out the widest range in eight and sixteen track at the Turnkey Shop at no obligation.

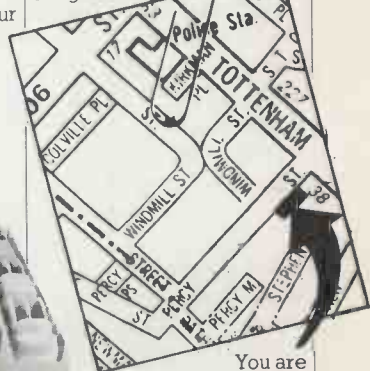

Instant Acoustics now on sale

Ilsonics sculptured foam panels can offer remarkable sound control. They absorb troublesome reflections as well as an open window. Just a few, placed carefully by trial and error, can correct the acoustics of recording room.

Ask for a copy of the Acoustics Cookbook, and discover how easily you can correct acoustics. Now on sale at The Turnkey Shop.

You are welcome to visit the Turnkey Shop any weekday, from 9:30 till 5:30, till 4:30 Saturdays.

Our expert sales staff are musicians too, and will be pleased to advise you on the creative as well as technical aspects of recording.

You will discover the widest range of the latest in recording products, and all the help and friendly advice you need.

Visit Britain's foremost showcase of Pro-Audio soon!

the
turnkey
shop

We are known to sell the odd mike.

If you've seen our green catalogue, then you'll be aware of the very wide range of mikes that we carry in stock.

Now, you can buy these direct from the Turnkey Shop.

As well as best prices on AKG, Shure, Sennheiser and Beyer, we feature several odd shaped, great sounding types.

For example, the budget priced P2M shown above is a consistent favourite. We also stock the C-Ducer range, plus tiny lavalier electrets that work well for close acoustic work. Call in for a demo. A full range of stands, clips and accessories is available.

In the Post

You can buy the products featured on this page directly by mail. Phone or send your order with Visa or Access number, or ask for a free copy of our 72 page catalogue. It's an invaluable guide to products and techniques.

Delivery charges apply as follows; orders up to £9 then £1, up to £40 then £2, from £40 to £300 then £3. Larger orders, please call for price quote.



Write to:
Turnkey by Mail
Brent View Road
London NW9 7EL
Telephone; 01-202 4366
Telex; 25769 A/B TKBAN

Downtown Soundcraft

As Soundcraft's main dealer, supply and installation of their products is a major part of our business. Major consoles are to order only, but the compact range is on demo display at the Turnkey Shop.

From 4 to 24 track, call in for information or specs. Nobody knows Soundcraft better.

The Turnkey Shop, 14 Percy Street, LONDON W1P 9FD. Nearest Underground station, Tottenham Court Road. Instant Finance of up to £1000 is available to personal callers who hold a valid Major Credit Card.

give electronic and avan-
the popular and mass media
this issue went ... pre-
significant
unexpected
The campaig
or to E&MM

COMMENT

Mistaken Identity

Is the critic becoming more important than the criticised? I hope not. But the sad fact is, there's an increasingly widespread trend that puts more emphasis on those responsible for commenting than on the cause of all the comment. It's a trend that's been blissfully absent from E&MM's pages for most of the time the magazine has been around, but it reared its ugly head this month – and for all the wrong reasons.

Believe it or not, last month's preview of the Anvil Percussion Synthesiser caused a minor rumpus. Why? Well, not for anything that was said during the course of the feature, but simply because of the identity of the man that wrote it – David Ellis. It seems a few people within the industry took exception to the good Doctor – who has a small but significant financial stake in the Anvil – being given space to comment on the machine's development.

'What's happened to E&MM's objectivity?' they cried. 'Nothing', we replied, scarcely able to defend ourselves for shock. Because from our point of view, there couldn't have been a writer better suited to previewing the Anvil. For one thing, David's reputation as a computer music commentator is as immaculate as it is long-lived; for another, we were assured an exclusive piece well in advance of any competing(?) magazines even getting a sniff of the product's existence. But most important of all, we were guaranteed an accurate, in-depth report on what is, after all, an extremely innovative

machine. Who better to comment on the design details of a piece of new technology than someone closely involved with its development?

And in case you're wondering, there *will* be an objective appraisal of the Anvil appearing in E&MM's pages, just as soon as the machine enters its final production stages – though that may yet be some months away. In the meantime, E&MM readers have a detailed, authoritatively-written, and far from one-sided (there *are* some criticisms in there, remember) piece on a new digital drum machine that hasn't even been talked about anywhere else. We think that's the way you'd prefer things to be.

Talking of identities, the entire magazine will probably be the subject of some confusion next month, when our familiar and long-serving banner artwork gives way to the crisper, more contemporary lines of the visual artefact represented here. It's only the second change of

front-cover image E&MM has undergone in its four-and-a-half-year history (the first took place in December 1981, when Rick Wakeman was on the cover and a glance inside would reveal David Ellis talking about the way the human body produces its own music), so we don't expect it to be an easy transition.

But the Publisher was adamant that something had to be done about the ageing Letraset that had been the magazine's mast-head all this time, so we've decided to let you all in on the secret to save unnecessary bewilderment when the August issue hits the newsagents' shelves in a month's time.

In fact, with the art department in its present rather boisterous mood, the inside of the magazine might end up looking a bit different next month, too. But so long as nobody mistakes E&MM for an inferior brand of musical instrument *critique*, we'll be happy. ■

E&MM

Editor Dan Goldstein Production Editor Trish McGrath Hardware Editor Simon Trask Music Editor Tim Goodyer Technical Editor Paul White Consultant Editor (Computer Musician) David Ellis Art Editor Stuart Catterson Deputy Art Editor Eddie Allen Art Assistants Sam Masters, Sally Baker Photography Tim Goodyer, Matthew Vosburgh Technical Illustrator Len Huxler Consultants (Music) Warren Cann, Ian Boddy, Geoff Twigg, Paul Wiffen Consultants (Technology) Ken McAlpine, Jay Chapman, Steve Howell, Jim Grant, Paul Williams Advertisement Manager Tony Halliday Advertisement Production Shaun Barrett Accounts Secretary Sonja Belts Mail Order/Subscription Cheryl May Director Dennis Hill Publisher Terry Day.

Electronics & Music Maker is published by Music Maker Publications, Alexander House, 1 Milton Road, Cambridge CB4 1UY. ☎ (0223) 313722. Typeset by Goodfellow & Egan, Cambridge. Printed by Thomas Reed Printers Limited, Sunderland. Distributed by Magnum Distribution Ltd, London. All material is subject to worldwide copyright protection, and reproduction or imitation in whole or part is expressly forbidden. All reasonable care is taken to ensure accuracy in the preparation of the magazine but Music Maker Publications Ltd cannot be held legally responsible for its contents. The Publishers cannot assume responsibility for the return of unsolicited manuscripts, photographs, artwork, or projects. Permission to reproduce printed circuit board layouts or to market kits commercially must be sought from the Publisher.

Subscriptions: UK £15.50, Europe & Overseas (surface) £16.20, Europe (airmail) £37.50. Binders: £3.95 (inc. postage).

© Copyright 1985 Music Maker Publications Ltd.

YAMAHA

PF10	P.O.A.
PF15	P.O.A.
DX7	P.O.A.
DX9	P.O.A.
RX15	£449
RX11	P.O.A.
QX7	£459
TX7	£649
PS6100	£949
KX88	£1299
KX5 remote	£199
QX1	P.O.A.
TX816	P.O.A.
TX812	P.O.A.
D1500	£POA
GC2020 2 channel stereo	£POA
R1000 Digital Reverb	£POA
CX5M MUSIC COMPUTER plus YK01 keyboard plus YRM101 and YRM102 voicing and music composer software package, price	£579

KORG

Poly 800	£549
DW6000	£859
RK100 remote keyboard	£399
DDM110	£299
DDM220	£229
EX800 Expander	£399
Super Section	P.O.A.
MPK130 Midi Pedal Board	£345
MR16 Midi Rhythm unit	£POA

AKAI

AX80 8-voice Programmable Poly-Synth £999
With Free Teac V400 Cassette Deck which normally sells for £129.

Oberheim

GET RID SALE!

Contact Sheffield store for unprintable deals.

TRACE ELLIOT MAIN DEALER

VERY LATEST PRODUCTS ON PERMANENT DEMONSTRATION

ensoniq MIRAGE IN STOCK NOW

These fantastic digital sampling keyboards at the unbelievable price of £1695 inc. VAT. Demand will far outstrip supply - so don't delay, try one today.



PART EXCHANGE WELCOME INSTANT CREDIT
(Subject to status, written quotations on request)

Marshall

TOPS ALL VALVE

100 w MV	£325
100 w Switchable, Split Channel & Rev	£369
100 w New Super Bass	£325
50 w MV	£265
50 w Switchable, Split Channel & Rev	£316
50 w New Super Bass	£265

COMBO'S

50 w 1 x 12 MV	£275
50 w 2 x 12 MV	£310
50 w 1 x 12 Split Channel & Rev	£357
50 w 2 x 12 Split Channel & Rev	£377
100 w 2 x 12 Split channel & Rev	£433

TELEY

TKO 65	£206
TNT 130	£284
COMBO 300	£429
AUDITION	£84
BACKSTAGE PLUS	£129
STUDIO PRO 40	£176
BANDIT 65	£229
SPECIAL 130	£289
RENOWN	£345
CLASSIC VTX	£365
MX VTX	£421
ENCORE 65	£288
ROCKMASTER	£306
HERITAGE VTX2X12	£459

CARLSBRO

NEW TAURUS CAB'S IN STOCK NOW

CASIO MAGIC

CZ101	£345
CZ1000 inc. free headphones	£495
CT6000	£645
CK500 (Keyboard, Radio, Tape-to-tape facility)	£299
Plus all other models in stock	
CASIO CZ5000 Polysynth	£895
CASIO SZ-1	£229

Fostex

Full range including B16's always in stock at sensible prices.
X15's still only £279

TASCAM

Porta One mini studio still only £425 while stocks last.

PAISTE

Fantastic range of these incredible cymbals at all branches.

SIMMONS

SDS8 Kits, Very special deals Contact us now!
SDS7 Kits. Assorted colours £1799
FANTASTIC NEW KITS (All with new floating playing surface)
Arriving NOW
SDS200 2 Pads, Stand and Controller £359
SDS400 4 Tom Pads, Stand and Controller £549
SDS800 4 Drum Kit, Stands and Controller £629
SDS9 5 Drum Kit, Stands, Controller with memory and program plus Digital delay £1199

RECORDING

Full range of Recorders, Mixers, Monitors, and Signal Processors. All on permanent demonstration at the very best prices.

SEARCHING FOR SOMETHING SPECIAL?

Visit our store at Mansfield where we stock professional equipment that you can only normally read about, all on permanent demonstration.

SEQUENTIAL CIRCUITS INC

MAX	£599
6-TRAKS	£699
DRUMTRACKS	£POA
MULTI-TRAK	£1199 (limited offer)
TOM DIGITAL DRUMS	£795

Roland

JX8P	£1159
PG800	£159
JUNO 106	£775
TR707 (definitely in stock)	£475
TR606	£169
MSQ100	£459
MSQ700	£799
JSQ60	£99
SRV2000	£POA
SDE2500	£POA

Ibanez

Don't buy a Guitar until you've tried the amazing new Ibanez guitars and basses, fantastic selection at incredible deals.

Fender GUITARS

New fantastic range new colours
STRAT R/W W/T 2 Strat P/ups plus 1 Humbucker £399
STRAT R/W W/T 2 Humbuckers £355
STRAT Standard R/W or M/N plus Trem £345
TELE R/W W/T 2 Humbuckers £379
TELE Custom Bound R/W 2 Humbuckers £345
JAZZ BASS SPECIAL R/W 1 Jazz P/U plus 1 Precision P/U £365
SQUIRE STRATS R/W W/T plus 2 Humbuckers £249
STRAT DELUXE M/N New Trem plus 2 Strat P/ups plus 1 Humbucker £589
STRAT DELUXE M/N New Trem plus 2 Special Humbuckers £599

Westone

Fantastic new range of Guitars and Bases
GUITARS
SPECTRUM ST Black or White £129
SPECTRUM MX Trans Red or Blue £155
SPECTRUM DX Black or Red £169
SPECTRUM GT Silverstone or Blueburst £195
SPECTRUM SX Black or Red £205
SPECTRUM LX Candy Red or Met Black £220
SPECTRUM FX Silverstone or Black £259
BASSES
SPECTRUM STB Black or White £149
SPECTRUM DXB Red or Black £175
SPECTRUM GTB Candy Red or Met Black £215
SPECTRUM LX Comes with both Fretted and Fretless neck complete with superb case £369

OPENING TIMES:
Mon-Fri 9.30am-6.00pm
Saturday 9.30am-5.30pm
Norwich Closed
Wednesday

CARLSBRO SOUND CENTRES

NOTTINGHAM 11, 13 Hockley Nottingham NG1 1FH Tel: (0502) 581 888

SHEFFIELD 720 City Road Sheffield S2 1GJ Tel: (0742) 640000

LEICESTER 2a Hummerstone Road Leicester LE5 0AR Tel: (0533) 24183

NORWICH 2 Sovereign Way Anglia Square Norwich NR3 1ER Tel: (0603) 668891

MANCHESTER 162-184 Chesterfield Rd North Manchester M19 1TD Tel: (0623) 651 633

Mail Order Form Please send the following goods I enclose a cheque/P.O. for

debit my Access Barclaycard, Diners, Amex (Delete where appropriate) Tick if H/P form is required:

Credit Card No. _____ Tel. _____

Name _____ Address _____ Postcode _____ Signature _____

To Carlsbro Sound Centres FREEPOST Mansfield Notts NG18 1BR

NO STAMP REQUIRED



HARDWARE

Ensoniq Mirage

The keyboard the world has been waiting for is now in production in Europe and should be in the shops by the start of July. But the first shipment won't be there long. *Paul Wiffen*



It all happened some while ago now, but the sight is still vivid in my memory. There was one small, unpromising-looking stand at February's Frankfurt music fair that was so busy, you were lucky if it took you less than an hour to get to the front of the crowd. One factor contributing to this chaos was the presence of two stunning German girls giving out glossy brochures, but the main reason was superficially rather more mundane. Three *extremely* dull-looking electronic keyboards, similar in size to a DX7 and obviously in a just-finished production state, wouldn't ordinarily command such universal attention.

But these instruments were different. Even with the help(?) of an unflattering speaker system struggling to make its presence felt in the face of strong competition from some triffid-like potted plants, the keyboards

sounded good. Lots of strings, brass and piano sounds being reproduced with uncanny accuracy by electronics were not, of course, a novelty. But when the girls told us the keyboards would be selling for under £2000, our mood changed from one of mild pleasure to one of uninhibited astonishment. Word spread around the rest of the fair like a forest fire, and chaos reigned on the stand for the entire week.

And so it was that the Ensoniq Mirage multi-sampling keyboard made its European debut. Six months later, its American designers have taken far too many orders in their homeland to make building instruments for Europe a realistic possibility, so Ensoniq's Brussels-based European arm has set up a production facility in Italy, where Mirages will be made under licence.

What's particularly gratifying is the fact that the RRP in Britain is to be £1795, lower than even the Frankfurt preview led us to believe, and that the European model will actually have a better all-round specification than its American counterpart. Read on and you'll find out why.

Story So Far

It's ironic that for as long as synthesisers have been in existence, keyboard players have been looking for some way of capturing acoustic sounds to augment their electronic ones. Proof, I suppose, that you can't do everything with electronics alone. The first mass-production machine to offer control of acoustic sounds from a keyboard (and hence a crude sound-sampling facility) was probably

the Mellotron. Huge numbers of them were sold in the late sixties and early seventies, and made records such as Bowie's 'Space Oddity' and Genesis' 'Watcher of the Skies' possible, but their analogue tape systems were not of the highest quality, they were extremely heavy and bulky, and they kept on breaking down. And that's quite apart from the fact that if you bought a Mellotron, you were restricted to the sounds its manufacturers chose to record.

It took the advent of (relatively) low-cost digital technology before user-sampling became a reality. The pioneer instrument in this field was the Australian Fairlight CMI, a legend in its own lifetime and rightly so, though if you wanted one when it hit the UK market back in 1980, you were talking telephone numbers. Then again, if you opted for the Fairlight's American rival, the Synclavier, you were talking positively *intercontinental* telephone numbers. Come to think of it, you still are.

But the important thing about both those instruments is that, by turning an incoming sound into a series of numbers, they offered people the opportunity to manipulate sampled sounds in just about any way they saw fit. So instead of just recording a sound, storing it in memory, and letting you play it from a keyboard, the Fairlight and Synclavier acted as complete computer music systems that let you change an acoustic sound beyond all recognition, augment it with electronic, synthesised timbres and make music out of the result thanks to some built-in composing software.

That's why both systems, in spite of being big, complicated and largely anachronistic machines whose abilities can now be bettered for a fraction of the cost, still sell in big numbers to studios and wealthy composers.

But for those of us who think telephone numbers should only be used in conjunction with Alexander Graham Bell's invention, the first major price break came with the release of the Emulator, or EI as it's subsequently become known. With a selling price of under 10 grand, it made sampling available to a wider range of musicians and brought the technique further into the eye of the general public. It was only eight-bit and could only hold two seconds of sample, but it did allow for a rudimentary form of looping.

Last year's Emulator successor, EII, came out at roughly the same price as its predecessor, and used some very clever companding to stretch the eight-bit analysis to give higher sonic fidelity. Where it really scored was in giving an unprecedented degree of control over sample performance, thanks to a superb combination of analogue (filter and envelope) and digital (editing and mixing) sound-manipulation techniques.

Yet still, all these advances had done nothing to bring sampling into the hands of the musician in the street. A few low-fi machines like the Electro-Harmonix Replays (now incorporated into the rather impressive Akai S612 Sampler) and the truly awful Movement Mimic attempted to change this, but made little impact on the average musician.

Enter the Mirage

What the world wanted – but for so long did not get – was an affordable sampling machine that was first and foremost a keyboard instrument, not a computer. Something in the sub-£5000 mark would have done, and some while ago, word reached us that a number of well-known synth manufacturers (from Sequential to Casio) were working on something along precisely those lines. But it wasn't forthcoming, and now, it would seem, a few ex-Commodore research people have beaten

them all to it. How? Well, principally by designing (and building) their own custom IC, the mysteriously-titled Q-chip, to take charge of some of the Mirage's most important functions.

The basic spec of the Mirage can be summarised as 2.2 seconds of 33kHz, eight-bit sample recording for each half of the keyboard. The two memory areas, called 'Upper' and 'Lower' in time-honoured polysynth terminology, are separated and cannot be joined together to form one long sample. Longer samples (anything up to 6.5 seconds) can be made, but only by reducing the sampling rate, which in turn reduces the audio bandwidth and therefore the sound quality. On its own, the Mirage can't sample any faster than 33kHz, but a very cheap hardware update due in August will allow the sample rate to be increased to 50kHz – that's the same as the £100,000 Synclavier, don't forget. Of course, you pay for this in terms of sample time (you don't get anything for nothing in this life) which will then be down to 1.3 seconds per half. More on that later.

When you power up the Mirage, it's no more than a useless bit of metal and plastic until you put one of the two 3.5" disks supplied into the drive located at the keyboard's left-hand end, just below the wheels. This is because the disks store not only sound samples and sequences but also the operating system that runs the Ensoniq's basic functions. To my way of thinking, this is more than just an inconvenience. When *will* designers of sampling

'The sequencer follows the American tradition of being real-time only, but it does what it purports to do well enough.'

machines (most of whom come from the computer industry, remember) realise that musicians on the move just can't afford to have the brains of their instruments on the flimsy, separate medium of the floppy disk? True, it's a vast improvement on the traditional cassette, but it still leaves the operating system exposed to erasure (from airport security systems, studio speakers, or 101 other sources of trouble) or theft by any passing berk who happens to like the colour of your disk storage box. What works perfectly well for a home micro or an office system isn't necessarily going to do the same for a musical instrument and the environments in which it's used, so why not put the operating system on EPROM? That way, you'd combine the stability and security of plug-in hardware with the instant upgradability of software.

Anyway, in its present form the operating system takes some 15 seconds to load, pairs of sounds thereafter loading in a mere six seconds. Whilst this may seem a little long to those accustomed to the near instantaneousness of the average analogue synth, I can assure you it's a snip next to the immutable 25 seconds of the EI or, wait for it, the 15 seconds of the American Mirage. That's right, the European version is actually *faster* than it's Transatlantic forebear, thanks to a superior, swifter disk drive. On stage, the difference between six seconds and 15 can be the difference between holding and losing your audience, so this is certainly a worthwhile improvement.

You can choose whether to load Upper, Lower or both sounds from disk, and each disk

stores three discreet pairs of samples plus four programs containing data relating to programmable parameter set-ups (see later). Aside from the two disks supplied, which contain excellent piano, strings and brass sounds the like of which have never been available under eight grand before, you'll have to buy any more at the fairly low price of £17.95 for pre-recorded disks (ie. library sounds) and the almost criminally extortionate rate of a tenner for a blank formatted one on which you can record your own sounds. There's really no excuse for this. If the formatting process can't be included in the operating system for reasons of space or incompatibility, it should at least be available on a separate disk. The idea that you must either stock up with dozens of formatted disks in exchange for a vast number of greenbacks or risk running out of the little buggers miles from a Mirage dealer is preposterous. Sadly, the Mirage isn't alone in having such a pernicious formatting system.

Sampling...

...is simplicity itself on the Mirage. The manual is a little thin on the finer points of rate and length, pre-supposing that you'll end up using the Ensoniq's default values for these parameters. An economical double seven-segment display gives a rough indication of threshold and distortion levels of the incoming signal (which can be set to accept either mic or line level inputs via a jack on the back panel, incidentally), and once you've set your desired sample length and rate, you simply arm the sampling by pressing Enter, and the recording begins as soon as the incoming signal crosses the threshold.

The manual comments glibly: "Don't be disappointed if your first samples aren't quite up to snuff. The Advanced Sampling Guide, available from your authorised Ensoniq dealer, combined with your increasing experience, will help you get better sounds." What it doesn't say is that this guide, excellent though it is, will set you back £50 when it becomes available in August. Another costly accessory for what's essentially an excellent-value product. Ah, well.

The story doesn't end there, of course. With your sound safely stored in the Mirage's memory, you're free to embark on such potentially rewarding pastimes as looping: that is, cycling round a defined section of the sample so that notes are prolonged indefinitely. Lack of time precluded an exhaustive test of this facility, but what I did manage to fit in was enough to convince me the Mirage's version of looping is one of the neatest and most trouble-free implementations I've yet come across. And the best testimony of that is the strings sample on the second library disk – smooth as silk.

Multi-Sampling...

...is a rather grandiose bit of American jargonese referring to the fact that you can apportion sections of the 64K of memory available for each half of the keyboard to different samples, and play these back in various split or doubled modes. Briefly, this enables you to construct the sort of multi-sound performance arrangements I was raving about in my appraisal of the EI not so very long ago (E&MM November '84, in fact). These include detuning samples against each other for phasing and chorusing effects, velocity switching between a 'hard-strike' and 'soft-strike' sound, and multi-timbral (more jargon!) keyboard set-ups.

If you want to, you can play a sample across the entire length of the Mirage's five-octave keyboard (another European hardware item that differs from its American counterpart).

This is a welcome relief from the ridiculous confines imposed by the Emulator and Synclavier systems, both of which suffer from hardware limitations on sample playback. The former can only replay the sample an octave up or down – infuriating when all you need is an extra semitone – while the latter has a maximum replay speed of 50kHz – so if you sampled at that rate, the note can't go any higher than the sampled pitch. The Mirage's approach is more akin to that of the Fairlight, which allows you to play pitches that are a good bit lower and higher than the original. I'd be the first to admit that the results of such practices are often pretty unbearable, but there's no reason to limit playback pitch simply because extremes of that parameter render the original sound unrecognisable. Some of the 'new' sounds are perfectly usable in their own right.

Not unexpectedly, the input filter and sample rate can both be adjusted, with the objective of obtaining the optimum sample result by minimising noise problems and other

'Like the Fairlight, the Mirage lets you play pitches that are a good bit higher and lower than the original.'

side-effects. Not quite so expected is the way the Advanced Sampling Guide really comes into its own here, almost justifying its high price in this area alone. Makes you wish the big systems offered the same sort of advice in addition to the facilities themselves...

However, the basic operating software is far from being omnipotent, but for those who want to take their fiddling a little further (*quite – Production Ed*), there's a more canny sample-manipulation package by the name of MASOS (Mirage Advanced Sample Operating System) available separately on disk. I can't tell you how much this'll cost because the final selling price hadn't been fixed at the time of writing, but I can tell you that however much it turns out to be, it'll be worth it. A quick demo was enough to convince me that it covers most of the remaining Ell provisions the basic Mirage system omits: positional cross-fades to cope with tonal changes in complex instruments or to mutate one sound into another as you run up and down the keyboard; experimental techniques of sample reversal and digital mixing; and a good bit more besides.

Synthesising

This is where the fun really begins. Even when you've sampled your sound and mucked about with its composition to your heart's content, you still have a full eight-voice analogue-type synthesiser to play it back through. You can store four complete synth set-ups on a single disk, and said set-ups can be anything from a fairly flat bank of settings (to allow the basic sample to shine through in all its original glory) to outrageously modified and unrecognisable versions that play merry hell with the sample's component frequencies. Enormous fun, and a complete doddle for anyone who's spent a couple of days with a standard digital parameter selection synth of the SixTrak/Poly 800 variety. It's certainly a hell of a lot easier to work with than a DX7.

Talk of standardisations brings me on to velocity-sensitivity, something that most self-respecting polysynths are equipped with



these days. The Mirage is no exception, and both filter and amplifier (brightness and loudness controls to the uninitiated) can be controlled by the speed of the key strike. There is one fairly awkward drawback, namely that the Mirage is currently unable to interpret incoming velocity data from MIDI. Try to control the Ensoniq from a DX7 (say), and the



former won't respond any differently to lighter or heavier strokes. Of course, you can always play your DX from the Mirage as there's not much to choose between their keyboards, though I gather the keyboard on the American version is somewhat lacking.

But the lack of velocity response will still be a big drawback if you want to use the Mirage with a Master MIDI keyboard or sequencer. It's that fact, as much as any other, that makes the performance of the Ensoniq's internal sequencer so crucial. Fear not: the recorder performs admirably. It follows the American tradition of being a real-time only device, but it does what it purports to do well enough.

At the moment, the software's memory capacity is only 333 notes, but a cartridge update will bring this up to 1500 in August for only 70 quid. The sequencer records accurately, and can be synced to the rest of the world via a Sync jack input or the MIDI clock and MIDI Start/Stop/Continue commands. Overdubbing is possible, and if the keyboard is set up with split points, there's no reason why that overdubbing can't be multi-timbral. Unfortunately, the Mirage can't look at more than one MIDI channel at once (at least until a software update changes things) to allow multi-timbral sequencing from an external source.

One glance at the back panel tells a story a lot of people won't want to hear: one solitary

Audio Out. So, no separate EQing of channels on the multi-timbral outputs in real time, I'm afraid. Personally, I'd defend Ensoniq's position over this one. The extra hardware in terms of sockets and routing adds more to the cost than you would believe, and I happen to think the Mirage is at the right price now. If you want separate outputs, you'll just have to start saving for an Ell...

As for the future, the manual includes time-honoured sales pitch that the Expansion Port next to the MIDI sockets will allow later Mirage products to be connected. This is presumably where both the Sequencer Expansion memory and the 50kHz sampling hardware should fit (will it preclude their simultaneous use?), as well as any other – as yet unsung – wonders that the chaps at Ensoniq might care to bring to pass.

Conclusions

When all is said and done, a sampling keyboard's life depends largely on two things: its sound quality and the flexibility of its post-sampling processes. Whilst both are pretty damn good in the basic Mirage, it seems Ensoniq are already preparing to see any competition off quickly, with the imminent arrival of both the 50kHz sampling cartridge

and the MASOS software. If updates continue at this sort of pace, the opposition may never catch up, and Ensoniq will enjoy a lengthy – and entirely merited – spell at the top of the hi-tech music tier.

As things stand the Mirage is an incredible leap forward for the cause of affordable quality sampling. Its present audio bandwidth gives it a sound quality which, though it lacks the sparkle of the Emulator II (Ensoniq's strongest competitor – at over four times the price!), is nonetheless extremely impressive. And with the promised 50kHz sampling, it may well equal or go beyond that level – though obviously with nothing like the same sample times unless *another* update brings extra memory space.

As for the price, if I was a religious man I'd say it was a miracle. As I'm not, I'll just call it a giant leap forward for the average musician. The only real precedent for this sort of price breakthrough is the Yamaha DX7, and just look at what *that* did to the synthesiser market, regardless of the fact that few players could actually fathom out its programming system to any great extent. The Mirage doesn't have any problems on that score. In fact, it doesn't have too many problems all round – save keeping customers supplied, that is.

Further information from Mirage, 3 Elystan Street, London SW3 3NT. ☎ 01-723 8664.

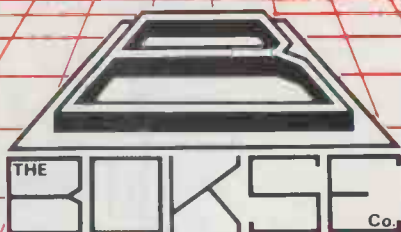

US-8 Universal Synchronizer

Interfacing and synchronization of timebased instruments

- 10 Input options
- 25 Output combinations
- Midi compatible
- Tempo display

The Bokse Company Limited

The Old Bakery, Litlington, Nr Royston, Herts. Telephone (0763) 852946

Selling Agent: Promark Electronics, P.O. Box 1, Ely, Cambridgeshire. Telephone: (0353) 61124

Lost your voice...

...amongst all those similar mass produced synthesisers? Are your recordings and live performances suffering a lack of identity?

Now there is an alternative.

The Polaris design brief was Sound, and guided by the likes of Herbie Hancock and Joe Zawinul the Polaris engineers have succeeded in creating a keyboard free from dull, muffled, hissing mediocrity. Sound explodes from Polaris. It's brighter, richer and more lifelike than instruments five times the price.

You might think that the sound has been achieved at the cost of specification. It hasn't! Polaris includes a velocity sensitive variable split keyboard, onboard performance data MIDI sequencing, layering, variable MIDI clock, 132 memories.... we won't bore you: the list is endless, largely because, at its heart Polaris has the 16 bit Intel® microprocessor, an intellectual giant which dwarfs its competitors.

But sound is the musician's first consideration and sound is Polaris' most important specification. The main effect will be on your music.



Aural Excitement **CHROMA** Polaris

For details of your nearest Polaris sales centre, write to: Arbiter Musical Instruments Ltd., Unit 8, Eldonwall Trading Estate, Staples Corner, Prestley Way, London NW2 7A4. Tel: 01-208 0022.

ROCK

Music

HI-TECH

Fender

FENDER Standard Strat, locking trem.....	£299
FENDER Gold Elite Tele, inc. case.....	£485
FENDER Master Series' Esprit, inc. case.....	£399
FENDER '57 Vintage Precision Bass, inc case.....	£299
FENDER '62 Vintage Precision Bass, inc case.....	£299
FENDER Squier Popular Strat.....	£199
FENDER Squier Strat, Humbucker, Trem.....	£189
FENDER Squier '57 Vintage Strat.....	£199
FENDER Squier '62 Vintage Strat.....	£199
FENDER Squier '57 Vintage Strat.....	£199
FENDER Squier '62 Vintage Strat.....	£199
FENDER Squier '62 Vintage Jazz Bass.....	£199
FENDER Squier '57 Vintage Precision Bass.....	£149
FENDER Squier '62 Vintage Precision Bass.....	£149
FENDER Squier Bullet black.....	£99
FENDER Squier Bullet S'burst.....	£99

YAMAHA

YAMAHA SG1300T, Ivory, Tremolo.....	£425
YAMAHA SG1000S, Jet Black.....	£299
YAMAHA SG500, Cherry Secondhand.....	£165
YAMAHA SG450T, White, Tremolo.....	£299
YAMAHA SG200, Sunburst.....	£179
YAMAHA SJ5F0, new model, Cherry.....	£289
YAMAHA SE200, new model, Black.....	£139
YAMAHA SE300, new model, Black.....	£169
YAMAHA SC600, 3 pick-up model, Brown.....	£199
YAMAHA SG35, Circa 1974, Brown.....	£85
YAMAHA BB3000 Bass, Black.....	£499
YAMAHA BB1600 Bass, Sunburst.....	£325
YAMAHA BB1100-S Active, Natural.....	£299
YAMAHA BB1000 Red.....	£249
YAMAHA BB400S Fretless, Black.....	£225
YAMAHA BB400S Cherry.....	£199
YAMAHA BB300, Jet Black.....	£159
YAMAHA BB300, Red.....	£159

Ibanez

IBANEZ RS1300, Locking Trem, Natural.....	£289
IBANEZ RS1100, All Black Model.....	£289
IBANEZ RS1010, 'Steve Lukather', Blue.....	£275
IBANEZ RS135, Tremelo, White or Yellow.....	£159
IBANEZ RS315, Tremelo, Blue.....	£199
IBANEZ Cimar, 3 pick-up, Trem, White or Blue.....	£135
IBANEZ AM205, Medium size body, Tobacco.....	£325
IBANEZ AM100, Full size body, Tobacco.....	£295
IBANEZ AM50, Small body, Tobacco.....	£275
IBANEZ AS80, Full size Artist Series, Natural.....	£295
IBANEZ AS80, Full size Artist Series, Cherry.....	£295
IBANEZ MC924 Active Bass, Ivory.....	£399
IBANEZ MC824 Passive, Walnut.....	£319
IBANEZ Road Star RB950, Blue.....	£265
IBANEZ Road Star RB850, Black.....	£265
IBANEZ Road Star RB750, Black.....	£245
IBANEZ Road Star RB820, Silver.....	£219
IBANEZ Road Star RB650, Black.....	£175
IBANEZ Road Star RB630, Black.....	£155
IBANEZ Blazer BL 800, Red.....	£165

WASHBURN

WASHBURN A-20V, Stage Series, Trem.....	£245
WASHBURN A-5V, Stage Series, Trem.....	£149
WASHBURN A-5, Stage Series, Red or Black.....	£129
WASHBURN Falcon, Last one left.....	£199
WASHBURN Force 3, Tremelo, White.....	£149
WASHBURN Force 4 Bass, Black.....	£145

Roland

GUITAR SYNTHESIZERS

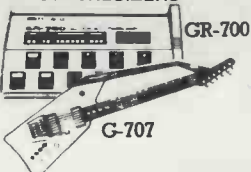

ROLAND GR707 Synthesizer with Tremelo finished in Silver, plus GR700, 64 Memory Programmer. You'll be amazed by the sound & our Price!



Aria

ARIA SB600 Bass, Black.....	£245
ARIA SB11 Special Fretless, Sunburst.....	£249
ARIA RSB Special, Black.....	£299
ARIA RSB Standard, Tobacco Sunburst.....	£149
ARIA RSB Deluxe.....	£275
ARIA CSB, Black 'n' Gold.....	£249
ARIA SB BC1 Black 'n' Gold.....	£225
ARIA SB Elite-1 Opal Blue.....	£245
ARIA RS Wildcat, Black, inc case.....	£199
ARIA RS Wildcat, White inc case.....	£199
ARIA Cardinal, Black 'n' Gold.....	£229
ARIA U60-T, Urchin, Black, inc case.....	£145
ARIA Cardinal CS Deluxe, Black.....	£205
ARIA Pro Deluxe, Tobacco, S/H.....	£125
ARIA TA30, Jet Black, Semi acoustic.....	£185

Tokai

CLASSIC RE-ISSUES

TOKAI TST 40, Hendrix Model.....	Best Price
TOKAI TST 50, '58 Vintage Models.....	Best Price
TOKAI TST 50, '64 Vintage Models.....	Best Price
TOKAI TST 40, Humbucking Pick-ups.....	Best Price
TOKAI TST 55, U/hard Models.....	Best Price
TOKAI TST 70, Locking Trem models.....	Best Price
TOKAI TTE50, Townsend model.....	Best Price
TOKAI TTE60, Quilted Mahogany Top.....	Best Price
TOKAI TTE70, Edge Binding, Sunburst.....	Best Price
TOKAI Talbo, Metal body, Models.....	Best Price
TOKAI Vintage Explorer, Natural.....	Best Price
TOKAI Flying V, inc case.....	Best Price
TOKAI Les Paul 57 model, White.....	Best Price
TOKAI Les Paul 58 model, Black.....	Best Price
TOKAI SG Custom model, Cherry.....	Best Price
TOKAI 335, Semi Acoustic, Tobacco.....	Best Price
TOKAI TJB45, Vintage Jazz Basses.....	Best Price
TOKAI 'Jaco Pastorius' bass.....	Best Price

Westone

WESTONE Super Headless Bases.....	£445
WESTONE Quantum, Headless, Black.....	£209
WESTONE 'The Rail', Headless, Black.....	£219
WESTONE Thunder III Jet, Black.....	£295
WESTONE Thunder II, Metallic Silver.....	£195
WESTONE Thunder I, Active, Black.....	£159
WESTONE Thunder I, Active, Light Oak.....	£149
WESTONE Thunder I, Standard, Oak.....	£125
WESTONE Thunder, Jet, All Black.....	£135
WESTONE Spectrum II, Tremelo, Black.....	£165
WESTONE Thunder II, Light Oak.....	£124
WESTONE Thunder Jet, All Black.....	£125
WESTONE Thunder I, Active, Oak.....	£149
WESTONE Thunder I, Active, Black.....	£159
WESTONE Thunder I, Tremelo, Black.....	£144

Vintage

VANTAGE Quest, Atak 1 Guitar, Black.....	£139
VANTAGE Quest, Atak 2, Black.....	£149
VANTAGE Avenger, coil taps, Trem, Black.....	£179
VANTAGE Avenger, coil taps, Trem, Black.....	£169
VANTAGE Avenger, coil taps, Black.....	£155
VANTAGE X-777, 3 pick-up, Trem, Black.....	£215
VANTAGE X-38T, 3 pick-up, Red.....	£215
VANTAGE X-35T, 3 pick-up, Black.....	£189
VANTAGE Profile Vintage Series, White.....	£149
VANTAGE Profile Bass, White.....	£129
VANTAGE Profile PB in Black M/N.....	£129
VANTAGE Quest Atak 1B, Black M/N.....	£149
VANTAGE Quest Atak 1B, White M/N.....	£149
VANTAGE Quest Atak 11-B, Black.....	£175
VANTAGE Quest Atak 11-B, White.....	£175

Vigier

VIGIER Arpege Bass Active para EQ one only, flame red.....	£499
--	------

CARLSBRO

CARLSBRO Hornet 45, Keyboard Combo.....	£168
CARLSBRO Hornet 45, Lead Combo.....	£149
CARLSBRO Cobra 90, Keyboard Combo.....	£130
CARLSBRO Cobra 90, Keyboard Combo.....	£249
CARLSBRO Cobra 90, Lead Combo.....	£199
CARLSBRO Cobra 90, Bass Combo.....	£199
CARLSBRO Sherwood 90, Solo Artist Combo.....	£259
CARLSBRO Stingray 150, Keyboard Combo.....	£385
CARLSBRO Stingray 150, Lead Combo.....	£325
CARLSBRO Stingray 150, Pro Lead Combo.....	£465
CARLSBRO Stingray 150, Bass Combo.....	£312
CARLSBRO Cobra 90, Keyboard Top.....	£159
CARLSBRO Cobra 90, Bass Top.....	£119
CARLSBRO Cobra 90, PA Top, Reverb.....	£169
CARLSBRO Stingray 150, Keyboard Top.....	£237
CARLSBRO Stingray 150, Lead Top.....	£217
CARLSBRO Stingray 150, Bass Top.....	£179
CARLSBRO Marlin 150, PA Top.....	£247
CARLSBRO Marlin 300, PA Top.....	£329
CARLSBRO X-90 Slave or PA Top.....	£129
CARLSBRO X-150 Slave or PA Top.....	£159
CARLSBRO S300 Stereo Slave.....	£289
CARLSBRO S600 Stereo Slave.....	£445

Marshall

HUGE SELECTION at the BEST PRICES
PHONE or GROAN!

Roland

ROLAND JC120, 120 watt, Jazz Chorus Combo.....	£445
ROLAND JC-50, 50 watt Jazz Chorus Combo.....	£245
ROLAND JC-77 80 watt Jazz Chorus Combo.....	Phone
ROLAND Spirit, 50B Bass Combo.....	£189
ROLAND Spirit, 15B Bass Combo.....	£115
ROLAND Cube 20, Lead Combo, Reverb.....	£119
ROLAND Cube 40, Lead Combo, Reverb.....	£159
ROLAND Cube, 100, Lead Combo, Reverb.....	£225

Fender

FENDER Twin Reverb II Combo.....	£449
FENDER Showman 2x10 Combo.....	£399
FENDER Concert 4x10 Combo.....	£369
FENDER Montreaux 1x12 Combo.....	£299
FENDER Deluxe Reverb 1x12 Combo.....	£235
FENDER Harvard Reverb 1x12 Combo.....	£129
FENDER Lead 50 1x12 Combo.....	£199

SESSION

SESSIONETTE 75 1x12 Combo.....	£245
SESSIONETTE 75 2x10 Combo.....	£275
SESSIONETTE 100 1x15 Bass Combo.....	£339
SESSIONETTE 100 4x10 Bass Combo.....	£348

KUDOS

KUDOS-251, 100 watt PA Cabs/Monitors each.....	£75
KUDOS-251, 100 watt PA Cabs/Monitors pair.....	£139
KUDOS-351, 200 watt PA Speakers pair.....	£249
KUDOS-655, 320 watt PA Speakers pair.....	£425
KUDOS-666, 600 watt PA Speakers pair.....	£525
KUYDOS-MX-6400 PA Mixer Amp inc Digital Echo.....	£545

WEM

WEM Songbird 200 watt PA cabs.....	£199
WEM Songbird 300 watt PA cabs.....	£249
WEM Phantom 600 watt PA cabs.....	£425
Speaker Stands for above, pair.....	£95

Traynor

TRAYNOR 12/201, 12/2 Pro Mixer.....	£485
TRAYNOR 6400 40 watt Mixer amp.....	£297
TRAYNOR 4200, 70 watt Mixer amp.....	£159
TRAYNOR PS 600, 300 Stereo Slave.....	£399
TRAYNOR CS 115H, Cabs Pair.....	£369
TRAYNOR CS 1012H Cabs.....	£275
TRAYNOR CS 120H Cabs, Pair.....	£319
TRAYNOR CS 112-H Cabs Pair.....	£175

TASCAM

TASCAM 38, 8 Track Reel-to-Reel.....	£1,850
TASCAM 22-4, 4-Track Reel-to-Reel.....	£799
TASCAM 244, Portastudio, 4-Track Cas.....	£699
TASCAM 246 Portastudio, New Model.....	£995
TASCAM 225 Syncset, Multi-Track Cassette.....	£199
TASCAM Porta-One, 4-Track Cassette.....	£425
TASCAM 234, Syncset, 4-Track, Cassette.....	£525
TASCAM MX-80 Syncset Stereo Mixer.....	£239
TASCAM PE-40 Syncset Stereo Pre-Amp.....	£199
TASCAM Flight Case for Syncset System.....	£99
TASCAM Complete Syncset Package, as above.....	£350

Clarion

CLARION XD-5, 4 Track Cassette Deck.....	£485
CLARION XA-5, Mastering Unit with Echo.....	£775
CLARION Trolley Console for above units.....	£125
CLARION Remote Controller.....	£29
CLARION System as above inc. Speakers.....	£1,299

Cutec

CUTEC MR808, 8-Track Video Cassette Multitrack Phone.....	
CUTEC MR402, Mix, 4-track cassette.....	£415
CUTEC MX1200, 12 into 2 stereo mixer.....	£325
CUTEC CS2200, Stereo Graphic, Spectrum Analyser.....	£199
CUTEC AE400, Flavour with Analog pre-delay.....	£129
CUTEC CD425 Digital Delay with Sub Delay.....	£325
CUTEC GE-2010 10-band Stereo Graphic.....	£98
CUTEC TFE-1531 15-band Stereo/31 band mono.....	£249
CUTEC SL-200 Stereo Compressor/Limiter.....	£279

Aria

ARIA R-504 4-Track Cassette.....	£399
ARIA SO-520 Stereo Graphic/Spectrum Analyser.....	£189
ARIA SO-522 Stereo Graphic.....	£149
ARIA AR-525 Stereo Reverb.....	£185
ARIA DEX1000, Digital Delay, LED Time Readout.....	£265

YAMAHA

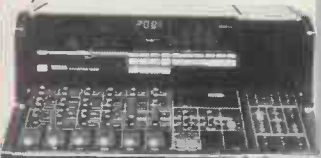

YAMAHA NEW MODEL MT44-D, 4-Track Cassette.....	£395
YAMAHA NEW MODEL RM602, 6 Channel, Mixer.....	£245
YAMAHA NEW MODEL RB-35B, Rack & Patchbay.....	£149
YAMAHA NEW MODEL MT System as above.....	£750
YAMAHA MS10, 20 watt Amp/Speaker Monitors.....	£99
YAMAHA GC2020 Stereo Compressor/Limiter.....	£229
YAMAHA R1000, Digital Reverb, Rack Mounted.....	£399
YAMAHA D-1500, Digital Delay, 16 Memories, Midi.....	£449

FOSTEX

FOSTEX X-15, 4-Track, inc. Power supply.....	£299
FOSTEX 250 Multitracker, 4-Track Cassette.....	£625

Ibanez

IBANEZ HD-1000, Digital Harmonizer & Echo.....	£345
IBANEZ DM-2000 Digital Echo, LED Readout.....	£299
IBANEZ DM-1100 3.6 second Digital Delay.....	£285

Vesta FIRE

VESTA FIRE MR1, Rack Mounted 4-track cassette.....	£499
VESTA FIRE VF -420 Digital Delay with sampling Phone.....	
VESTA FIRE RV-3 New Model stereo reverb.....	£199
VESTA FIRE RV2 Stereo Reverb.....	£229
VESTA FIRE SF-010 Dual Flanger/Chorus.....	£225
VESTA FIRE SL020 Dual Compressor/Limiter.....	£259
VESTA FIRE TC-810 Two Channel Aural Exciter.....	£185

NOVOLOGY

low prices!

BOSS EFFECTS



BOSS MICRO RACK SERIES

0-10 Digital Delay.....	£175
-10 Compressor limiter.....	£110
-10 Flanger.....	£110
4-10 Phaser.....	£110
5-10 Graphic EQ.....	£110
SS BX800 8 Channel Mixer, inc. Headphones.....	£246
SS BX600 6 Channel Mixer inc. Headphones.....	£135
SS BX400 4 Channel Mixer, inc. Headphones.....	£89

Accessit

CESSIT Compressor Unit.....	£49
CESSIT Noise Gate.....	£49
CESSIT Dual Sweep EQ.....	£49
CESSIT 15+15 Power Amp.....	£54
CESSIT Stereo Reverb.....	£129
CESSIT 4-way P.S.U.....	£31

SECK

DK Model 62 mixer.....	£375
DK Model 122 mixer.....	£539
DK Model 18-8-2 mixer.....	£1495

EVANS

EVANS ECHOS

ANS MDD-1500 Digital Delay with Sub Delay.....	£265
ANS MDD-1000 Digital Delay, LED Readout.....	£245
ANS EP-250 Analog with Reverb.....	£199
ANS AE-250R, Analog with Reverb.....	£175
ANS AE-250, Analog Delay.....	£169
ANS EP-100, Analog Delay.....	£110

RACK-MOUNTED ECHOS

IRG SDD-3000 Programmable Digital Delay.....	£699
IRG SDD-1000, 2 second Sound Sampling, Digital.....	£325
ILAND SDE-3000, Digital Delay, 8 Memories.....	£799
ILAND SDE-2500, 64 memories.....	£585
ILAND SDE-1000, Digital Delay, 4 Memories.....	£399
ILAND BOSS DE200, Digital Delay.....	£279
ASHBURN WD-1400 Digital Delay, Modulation.....	£235
JTEC CD425 Digital Delay with Sub Delay.....	£325
IA DEX1000, Digital Delay, LED Time Readout.....	£265
ANEZ HD-1000, Digital Harmonizer & Echo.....	£345
ANEZ DM-2000 Digital Echo, LED Readout.....	£299
ANEZ DM-100 3.6 second Digital Delay.....	£299
IMAHA R1000, Digital Reverb, Rack Mounted.....	£399
IMAHA D-1500, Digital Delay, 16 Memories, MIDI.....	£449

STEREO MIXERS

ARSOUND Dynamix, 16 into 2, Studio.....	£359
ARSOUND Dynamix, 12 into 2, Studio.....	£259
ARSOUND Dynamix, 6 into 2, Studio.....	£175
TR 12/8/2, Studio Mixer.....	£395
TR 6/4/2, Studio Mixer.....	£225
JTEC 12/1200X, 12 Channel, Graphic.....	£335
JTEC Mixer Case for above.....	£32
RAYNOR 12/201, 12 Channel Graphic.....	£485
RO-MARK MK-3, 3/4/2 Ideal for 8-Track use.....	£445
ECK 6-2.....	£375
ECK 12-2.....	£539
ECK 18-8-2.....	£1495
OSS, New Model 10-8-2.....	£399
OSS BX-800, 8 Channel, inc. Sel Headphones.....	£246
OSS BX-600, 6 Channel, inc. Sel Headphones.....	£135

MICROPHONES

Huge Selection always in stock:
Shure, AKG, Sennheiser, Beyer,
Audio-Technica, Fender,
Evans, JVC, Etc.
THE PRICE IS RIGHT!
SO PHONE TODAY

YAMAHA

WHAT'S BETTER THAN A DX7?
WHAT'S BETTER THAN A DX7
and TX7?
THE FABULOUS YAMAHA DX5
AVAILABLE NOW
BUT IF YOU CAN'T AFFORD A DX5
OR DX7 HOW ABOUT
THE NEW DX21!!

YAMAHA DX5 New Model.....	Best Deal!
YAMAHA DX7.....	Best Deal!
YAMAHA KX-88 Comprehensive M/Keyboard.....	Best Deal!
YAMAHA QX-1 Sequencer.....	Best Deal!
YAMAHA TX218 Expander.....	Best Deal!
YAMAHA TX816 Expander.....	Best Deal!
YAMAHA TX-7 Midi DX7 FM Expander.....	Best Deal!
YAMAHA QX-7 Digital Multi-track Sequencer.....	Best Deal!
YAMAHA KX-5 Remote Midi Keyboard.....	Best Deal!
YAMAHA TX-218 Rack Mounted FM Expdr.....	Best Deal!
YAMAHA TX-1 Single Expander Modules.....	Best Deal!
YAMAHA PF 15 & PF10 FM Digital Planos.....	Best Deal!
YAMAHA CP35 Stage Piano.....	Best Deal!
YAMAHA RX11 & RX15 Digital Drums.....	Best Deal!
NEW Model - RX21.....	Best Deal!
YAMAHA R1000 Digital Reverb Unit.....	Best Deal!
YAMAHA D1500 16 Memory Midi Delay Unit.....	Best Deal!
YAMAHA New MT Home Recording System.....	Best Deal!



CX5-ME MUSIC COMPUTER
YAMAHA CX5-ME Computer with YK01 Keyboard and
YRM-101 Music Composer Programme
TOP SECRET PACKAGE DEALS NOW AVAILABLE!
YAMAHA YK-101 Full Size Keyboard..... IN STOCK
YAMAHA YRM 102, 103, 104 and accessories IN STOCK
YAMAHA Real Time, Sequencer ROM ARRIVING SOON
YAMAHA RX Programmer ROM..... ARRIVING SOON
YAMAHA Sound Sampling Package..... SOON

Roland

WE DESIGN THE FUTURE

ROLAND JX-8P Synthesizer.....	Best Deal!
ROLAND PG-800 Programmer.....	Best Deal!
ROLAND JX-3P Synthesizers.....	Best Deal!
ROLAND PG-200 Programmer.....	Best Deal!
ROLAND Juno 106, Synthesizers.....	Best Deal!
ROLAND MKB 300 Mother Keyboard.....	Best Deal!
ROLAND MSK-10 Piano Expander.....	Best Deal!
ROLAND MSK-30 Poly Synth.....	Best Deal!
ROLAND AXIS Remote Midi Keyboard.....	Best Deal!
ROLAND MSG 700 Digital Recorder.....	Best Deal!
ROLAND MSQ 100 Digital Recorder.....	Best Deal!
ROLAND TR707 Digital Drums.....	Best Deal!
ROLAND GR700 & 707 Guitar Synth.....	Best Deal!
ROLAND SDE 1000 Digital Echo's.....	Best Deal!
ROLAND SH-101 Synth, MC202, MComp.....	Best Deal!
ROLAND TR606, TR303 & DR110, R/Units.....	Best Deal!
ROLAND JC Amplification.....	Best Deal!
ROLAND Cube & Spirit Amplification.....	Best Deal!

KORG

KORG DW 6000, Fabulous New Model.....	Best Deal!
KORG MPK-130, New Midi Bass Pedals.....	Best Deal!
KORG Poly 61, Midi Synthesizer.....	Best Deal!
KORG Poly 6, Synthesizer.....	Best Deal!
KORG Poly 800 Synthesizer.....	Best Deal!
KORG EX800, Midi Expander Modules.....	Best Deal!
KORG RX-100, Remote Midi Keyboard.....	Best Deal!
KORG EP-1, Stage Piano with Strings.....	Best Deal!
KORG 80-S, Symphonic Piano with Strings.....	Best Deal!
KORG 80 Symphonic Piano.....	Best Deal!
KORG SAS-20 Keyboard with Jazz Cartridge.....	Best Deal!
KORG SDD-1000, Digital Delay with Sampling.....	Best Deal!
KORG DDM-110, Digital Drum Rhythm Units.....	Best Deal!
KORG DDM-220, Digital Latin Rhythm Units.....	Best Deal!
KORG PSS-50, Digital Super, Section.....	Best Deal!
KORG KMS-30, Midi Synthesizer Box.....	Best Deal!

ensoniq

MIRAGE

THE SOUND SENSATION OF 85!!
★ Five octave velocity sensitive keyboard
★ 8 voice polyphonic
★ 16 different samples across the keyboard
★ Up to 8 second samples
★ 4 user samples split across keyboard
★ On board MIDI sequencer
★ On board 3.3" floppy disk drive
★ 4 sounds per disk
★ MIDI in/out
THE FIRST AFFORDABLE
PROFESSIONAL STAGE/STUDIO
SAMPLING KEYBOARD
PHONE FOR AMAZING PRICE..... NOW

SEL

SEL DK-80, amazing new synth.....	£699
SEL Expander-80 module, sequencer.....	£399
SEL CMK-49 keyboard.....	£125
SEL MIDI interface unit.....	£79

commodore

SEL Software for Commodore, Disk or Cassette
available..... POA

CASIO



CASIO CZ25000, amazing!.....	BEST DEAL!
CASIO CZ101, 32 Memory Poly Synth Midi.....	BEST DEAL!
CASIO CZ1000, Full Size Keyboard Version.....	BEST DEAL!
CASIO CT6000 Full Size Keyboard Midi.....	BEST DEAL!
CASIO CT410V, New Model Stereo.....	BEST DEAL!
CASIO CT310-S, Full Size Keyboard.....	BEST DEAL!
CASIO CT610 Stereo Model, Full Size Kb.....	BEST DEAL!
CASIO CK500, Keyboard & Cassette Deck.....	BEST DEAL!
CASIO CK100, Programmable, plus AM/FM.....	BEST DEAL!
CASIO KX-101, Keyboard, Cas & Radio.....	BEST DEAL!
CASIO MT-100, 768 Variable Acc'ments.....	BEST DEAL!
CASIO MT-800, With Stereo Speakers.....	BEST DEAL!
CASIO MT-400V, With Stereo Speakers.....	BEST DEAL!
CASIO SZ-1 4-track sequencer 1800 notes with MIDI.....	BEST DEAL!

bit

CHASE BIT ONE£799
Polyphonic ● 6 Voice ●
Touch Sensitive ● Digital and Analogue
This fabulous keyboard is now available
in Essex from Honky Tonk Music.
Come & hear why it won the 1985
Professional Keyboard of the Year Award

MAINFRAME

Professional keyboard stands. Hi-tech modular
construction in aluminium tubing for strength and rigidity.
Ideal for keyboards, sequencers, expanders.
LIGHT - STRONG - VERSATILE

Single tier.....	£79
Double tier.....	£99
Three tier.....	£149
Four tier.....	£165

RHYTHM UNITS

YAMAHA RX11, Digital, 29 voices.....	Best Deal!
YAMAHA RX15, Digital, 15 voices.....	Best Deal!
YAMAHA RX21 new model.....	Best Deal!
KORG/PSS-50 Digital, Super Section.....	Best Deal!
KORG DDM-110, Digital Drums.....	Best Deal!
KORG DDM-220, Digital Latin Percussion.....	Best Deal!
HAMMOND DPM-48 Digital, inc. 2 extra ROMS.....	£499
ROLAND TR909, Analog/Digital.....	£495
ROLAND TR707, All Digital.....	Best Deal!
ROLAND TR727 Latin.....	Best Deal!
ROLAND TR808 Analog.....	£299
ROLAND TR606, Drumatix.....	£185
ROLAND TB303, Bassline/Sequencer.....	£185
ROLAND DR-110, Doctor Rhythm.....	£124



New 'Electronic Drum Room' NOW OPEN

PEARL DRX-1, 5-Drum Kit, Programmable, stands.....	£895
SIMMONS SDS-85-Drum Outfit, stands.....	£699
TAMA Techstar 5-Drum Outfit, No Stands.....	£775
TAMA Techstar 5-Drum Outfit, inc. Stands.....	£875
ULTIMATE PERCUSSION UP-5, 5-Drum Outfits.....	£499
MULTI-KLONE 5-Drum Outfits, Black, Red or White.....	£399
KLONE-KIT II, 5-Drum Outfit, Red or White.....	£285
KLONE DUAL PERCUSSION SYNTH, Twin Pads.....	£199
PEARL Synchronic Synth, Twin Pads, Second Hand.....	£149

ATTENTION - ALL DRUMMERS
See our Full Page Advert in the New Rhythm Drum
Magazine - OUT NOW. Sister Magazine to ES.M.M.

ORDER FORM

ALL PRICES INCLUDE VAT
AND FREE DELIVERY
(UK Mainland)

NAME.....

ADDRESS.....

PHONE NO.....

ITEM(S) REQUIRED.....

SAME DAY DESPATCH
Southend (0702) 553647

ACCESS/VISA No.

Cheque enclosed HP Form Required Tick

everything for the modern musician

EXPAND ABILITY

Thanks to MIDI, you no longer have to surround yourself with keyboards to use a range of different synths. We put two Italian keyless expanders into the ring. *Trish McGrath*

Chase Bit 01 Synth Module

The latest hi-tech product from the rejuvenated Crumar factory – marketed in this country under the name of the UK importer, Chase Musicians – is based heavily on the deservedly successful Bit One polysynth (see review, E&MM October '84). But Chase are at pains to point out that several added features make this more than just a keyboardless Bit One, and on balance, I must say I'd have to agree with them. One thing is clear though – this module's appeal should in no way be confined to existing Bit One owners. Because whereas Yamaha's TX7 expander really needs an experienced DX7 owner to get the best out of it, the Bit 01 uses familiar analogue sound-generating technology. And as digital access synths go, it's surprisingly user-friendly, thanks to no less than four two-digit sets of numeric LEDs and some helpful front panel parameter graphics.

Whether or not it's wise to market the Bit 01 as a 19" rack-mounting module remains to be seen, but I'd imagine that many synth players (not to mention home studio owners) are now geared up for this sort of thing, what with the influx of rack-mounting digital delays and MIDI effects units.

Getting down to synth basics, the Bit 01 is a six-voice polyphonic, dual-oscillator touch-sensitive synth module, capable of operating in one of Normal, Double (bitimbral) and Split modes. Double mode sees polyphony reduced accordingly to just three-voice, while the programmable Split divides the six voices evenly to each side. The words 'Lower' and 'Upper' represent familiar terminology that's brought into play in the context of layering two sounds, the volume of two sounds (when layered), the volume of each side of the split point, and the two outputs on the rear panel (for stereo mixing).

The Chase's front panel follows recent synth design fashion by being sparsely populated, though more uncommonly, the controls that are there are logically laid-out and easy to get acclimatised to. To begin with, we find Lower and Upper Volume sliders, plus and minus incrementor buttons with accompanying Value LED, and three buttons that are used to decide which of Address (parameter), Lower program or Upper program the 0-9 selectors will affect. Further to the right are switches for Double and Split,



Tape (for saving and loading programs to normal audio cassette), Stereo Out, Park/Write and Compare – all of which come with their own LED indicator. These last two buttons, incidentally, allow you to 'park' your original sound before you begin editing and then 'compare' both versions later on; you can also park a sound while you search the memory for a suitable location in which to store it. With Stereo Out, the Bit 01's designers have supplied the option of bypassing the stereo output when in normal mode. This is a big improvement on the Bit One, where voices were assigned a place in the stereo image using what I can only describe as random logic.

The Expander's onboard memory will happily remember no less than 75 single sounds, while numbers 76-99 are reserved for 'patches' of double or split programs (another good point over the Bit One). And as if just having bitimbral patches wasn't enough, you can program the volume of the Lower and Upper voices, while the Upper part of a Split patch can be transposed in semitones within a range of plus three octaves or minus two, and is also programmable.

Snooping around the rear panel uncovers nothing unusual, namely the Memory Protect On/Off switch, and sockets for Release Pedal, Lower and Upper outputs, MIDI In, Out and Thru, and the mildly necessary IEC power socket.

Graphic Details

While they've undoubtedly incorporated much of the Bit One's sound-generating

circuitry into the Bit 01, Crumar have obviously given the Expander's two DCO sections a little more thought. Gone are the parameters to modulate the pitch with EG2 (yes, very useful), and in their place come 'Noise' and 'Detune' (for fine detuning of DCO2). Incidentally, both newcomers (formerly non-programmable slider controls on the Bit One) can be introduced with a good degree of control, the parameters being stepped from 0-63. I only wish other digital access designers

'As if just having bitimbral patches wasn't enough, you can program the volume of the Lower and Upper voices...'

would follow the Italians' example here – almost every synth parameter needs a resolution of more than the typical 15 steps...

Each DCO has Triangle, Sawtooth and Variable Pulse waveforms (which can be summed together in any order), with a footage selectable from a range of 32', 16', 8' and 4'. Frequency can be raised in semitone steps up to an interval of a major seventh (11 semitones). Pulse Width regulates the Pulse waveform (from 3% to 97%), while the keyboard dynamics can also be used to control the pulse width, and thus the harmonic content of a sound.

Moving onto the analogue low-pass

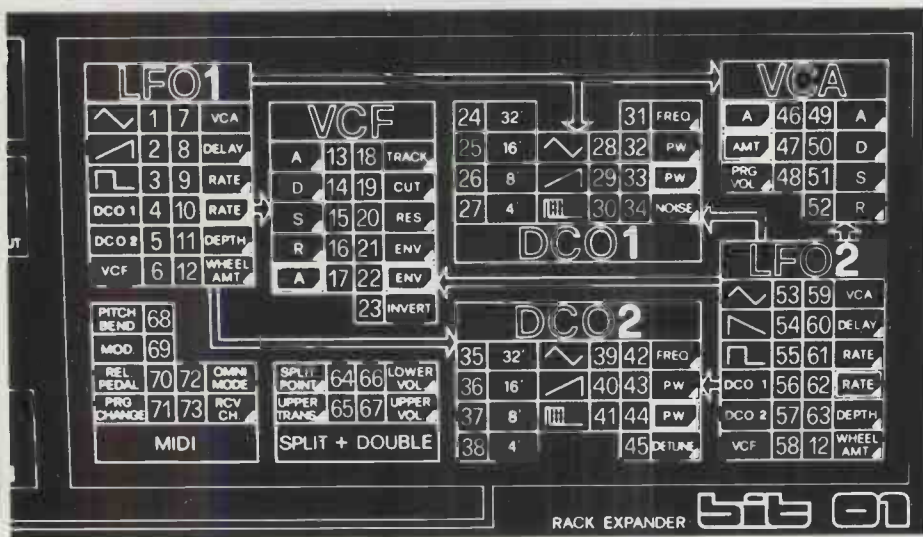
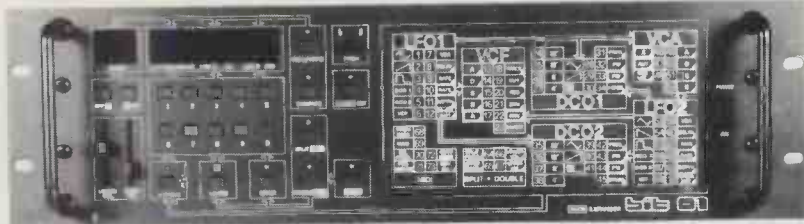

filtering section, no prizes for guessing it possesses parameters such as Cutoff Frequency, Resonance, Track, ADSR (EG1), and Envelope amount. Less usual perhaps is the way the Bit 01 allows keyboard dynamics to control both the attack of the filter's envelope (soft touch produces a slow attack, and so on) and the modulation depth of EG1. EG2 is tucked away in the VCA section, which also allows both the Attack time and Volume of a sound to be controlled with the ol' fingertips.

Another advance on the Bit One comes in the form of a Program Volume parameter – great for introducing new sounds during a song at an appropriate level.

Identified LFOs

No self-respecting synth would be complete without an LFO section, and the Bit 01 boasts two of them. These can be independently assigned to modulate DCO1, DCO2, the VCF, or the VCA (or all at the same time, if that's what you're into), while the mod wheel can introduce further vibrato to the DCOs. Waveform is selectable between Triangle, Sawtooth or Square, and the LFO section is completed with the addition of Rate (LFO speed), Delay (for delayed modulation), Depth, and Dynamic Rate (hardest key strike for maximum rate) adjustable parameters.

All in all, a comprehensive modulation

section, though it would also have been nice to be able to regulate the mod *depth* with key dynamics.

MIDI Modes

Again, Crumar have been doing their homework. Options to switch Pitchbend,

'Another advance on the Bit One is the Program Volume parameter – ideal for introducing new sounds at an appropriate level.'

Mod wheel, Release Pedal, and Program Change data in or out of the MIDI datastream are onboard, while the Receive Channel is selectable between Omni mode or channel numbers 01-16. Existing Bit One owners should remember that their synths won't actually *transmit* pitch, mod, and program change data; maybe the Italians didn't think they'd want an expander...

Seeing that the rich analogue sounds this particular Expander is capable of producing could be especially appealing to some of the DX fraternity, the good news is that E&MM's resident DX7 and review Bit 01 docked beautifully. Also a good match, as far as common features will take it, is the Casio CZ1000, but the Siel DK80, though it passes touch-sensitivity data faultlessly, won't communicate on the pitchbend or mod wheel front. Korg's Poly 800 is also uncooperative on the modulation front, though it doesn't mind disclosing pitchbend info. I guess incompatibility between wheels might not bother some, but it makes you wonder whether some manufacturers (and I don't just mean Crumar) are really taking MIDI seriously.

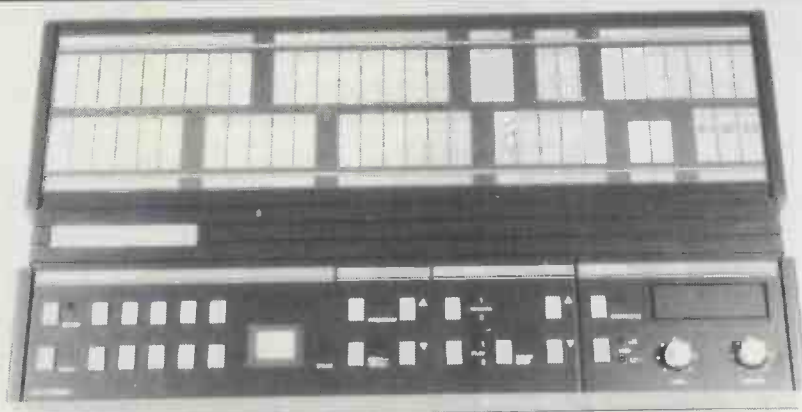

Siel Expander 80

Not so long ago (E&MM April '85, in fact), we put the Siel DK80 polysynth under the reviewing microscope, and discovered an amazingly versatile bitimbral synth that cost very

little money. And out of all good ideas, an expander is born...

But first the bad news: the Expander 80 is *not* bitimbral, though in all other respects, you could almost be looking at a DK80 after a spell through a crusher. The good news is that I'm not going to waffle on about the Expander (since I'm sure you couldn't possibly have missed the DK80 review), but I guess for those of you just back from the Arctic...

Features

The Expander 80 is housed in a very compact, grey moulded casing, which Siel have designed to be placed on top of a DK80 (they're supplying the brackets and the power supply is 'built for two'), though there's no reason why it couldn't find a suitable resting place somewhere else.

Programming is by the usual (read 'false economy pain in the neck') digital access method, while the parameter sections comprise Programming Unit, Edit, Sequencer, and Masters. The Expander 80 also has a parameter map for the DCO, VCF, VCAs and so on, so you know where you stand, synthetically speaking.

Like the DK80, the Expander comes stocked with 40 preset sounds and 10 user-programmable patches, and it also offers you the option of bringing another 50 or 100 sounds on-line by the use of RAM or ROM packs respectively.

Dissecting the edit map finds the DCO with a waveform selectable between

▷ Sawtooth (4', 8' or 16'), Square and Off,, with a separate set of parameters for setting the square wave's output level at each footage of 16', 8', 4' and 2'.

The VCF, meanwhile, comes equipped with Cutoff, Resonance, Keyboard Track (Full, Half or Off), Trigger (Multi or Single), and DEG level controls. The Expander follows DK80 design practice in being a one-filter affair, and personal taste will dictate whether or not you can live with this limitation. To me, playing a polysynth with only one filter is like trying to drive a car with only one wheel (*well, maybe not quite* — Ed).

‘It’s not possible to play sequences from both the DK80 and the Expander in sync, as they loop in any old fashion.’

The filter’s envelope is of the extended ADBSSR variety — the extra characters denoting the inclusion of Break Point and Slope parameters — while the Dynamics (key velocity affecting the sound’s timbre) can be either On or Off. One bonus the Expander has been given is that its Noise source can be routed to either the VCF (for tailoring by the Cutoff Frequency and Resonance), or directly to the VCA. Which brings us nicely to another dissimilarity with the DK80...

Whereas the self-contained polysynth was a 12-oscillator, bitimbral creation, the Expander is eight-note polyphonic (one oscillator per voice) in DCO Mode Whole, and four-note polyphonic in (pseudo) Double mode, though with correspondingly increased sonic fatness. However, just to make things more interesting, two VCA sections come on line in Double mode, allowing two different envelopes and dynamic responses for each layer, with each sent to a separate output on the rear (A/Mono and B). Again, both VCAs consist of ADBSSR envelopes, with processing of both Key Dynamics and Damp Pedal data being optional, and Detune allows for both Interval (in semitones up to a max of five octaves) and fine-detuning between the two layers of oscillators.

Remaining parameters include stereo Chorus (either On or Off) and Volume (for setting the relative levels between sounds).

Criticisms? Well, they centre around the level of noise emitted from the internal workings — with the Master Volume set at a reasonable level for a band rehearsal, say, it could well be a real nuisance. Some sluggish processing doesn’t go down too well, either. For instance, it takes a couple of seconds (and a few key stabs) for a drastic change to the VCA’s attack time to actually register. And this isn’t just apparent on the Expander — the DK80 suffers a similar operational reluctance. With the high speed of micro-processors these days, there’s really no

excuse for this sort of thing. Maybe Siel could do with a Bug-Gun.

Sequencing Sounds

The Expander’s modest two-track sequencer is straightforward both in concept (it’s a real-time only affair) and in use. Pressing Record 1 and 2 clears anything still in memory, while the Metronome can be selected (or so I’m told — the review model thought differently), using the cursors to vary the tempo. Pressing Start begins recording on Track 1, and you can play back the first track while overdubbing on Track 2.

Not surprisingly, there are limitations aplenty — like the mini-sized memory (about 300 notes), compulsory and independent looping of tracks, and non-storage of pitchbend or modulation, not to mention the four-note polyphony of Double mode. Better is the Sequencer Clock option, which offers three options for triggering sequence playback — MIDI, External (received from the Seq Clock input), and Internal.

Sadly, it’s not a realistic possibility to play sequences from both the DK80 and Expander in sync, seeing as they loop in any old fashion; but if you think your reflexes are up to it, have a bash anyway. In any case, the optional multi-footpedal sends Start and Stop commands to both instruments over MIDI, as well as a myriad of commands like Damper Pedal, Program Up, and interrupting key note data to another expander or MIDI keyboard.

The Expander’s rear panel boasts the usual trio of MIDI sockets, but MIDI data filtering is confined to just Program Change — either Internal (changes sent over MIDI Out), or External (program changes effected only by controller), or two-way conversation. MIDI Receive Channel can be set to Omni or any channel (Poly) from 01 to 15.

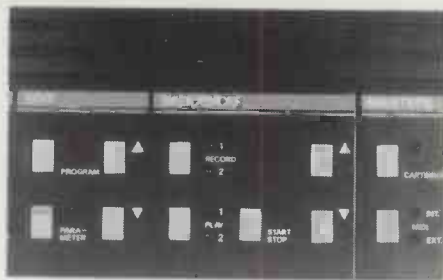

There are no problems when it comes to pitchbend and modulation data flow from the DK80 to Expander, but pitchbend is limited to the preset tone or so up and down. However, using another controller synth with a wider range gets over this snag, though on some counts, other synths don’t fare so well.

Korg’s Poly 800 transfers pitch wheel data but no modulation (again), the DX7 behaves in a similar fashion (though it isn’t coy about key velocity data), while the Casio CZ also sends pitchbend on cue. As we’ve said before, there’s no beating testing a new purchase with your current line-up. Better to be safe than incompatible...

Conclusions

In spite of sharing the same country of origin, the same intended musical function and some elements of paper specification, these two expanders aren’t strictly comparable. So I’m not going to come down on one side or the other, just draw a few separate conclusions.

Although it’s a pity Crumar haven’t seen fit to implement such niceties as allowing Lower and Upper sounds to be received on different MIDI channels and retaining the Bit One’s Unison mode, the Bit 01 represents as good value for money as you’re likely to find.

Plus-points include the number of innovative ways you can control the 01’s parameters with touch (it’d be a terrible waste to team up the machine with a non-touch-sensitive synth), the programmable double and split patches, the parking facility, and last but not least, the *sound*.

Factory programs offer a wide range of good, warm strings, piano, and brass voices, with percussive and effects sounds coming away with marginally fewer flying colours. But with a programming system as straightforward as this, some presets won’t last long.

Siel have certainly come up with a cost-effective package in the Expander 80. In fact, it’s the cheapest MIDI voice expander currently available — by quite some margin. But as with anything that cuts corners, there’ll be many who feel that it’s the corners that are worth dishing out good money for.

The inclusion of a Double mode goes some way to beefing up the sound of the EXP80, but human nature dictates that you’d prefer it to have gone the whole hog of separate filter section, LFO and complimentary waveforms. The Sequencer might be a novelty to the relative synth newcomer, but its drawbacks are unlikely to impress a seasoned player.

And so to the sounds. The presets are identical (rather than complimentary) to those on the DK80, so the same sort of comments apply. You won’t like them all, you may not even like any, but bear in mind that this is more a reflection on Siel’s programmers than on the 80-series circuitry’s capabilities. Personally, I’d like to hear Siel come up with the sound quality to match the versatility of their synths. Cost-effectiveness isn’t everything, after all.

If you find the Siel sound is to your liking and cash is at a premium, the Expander 80 should be well worth a look. But if the latter criterion doesn’t apply, you might find your aural senses more satisfied by the machine from the company up the road.

RRP of the Siel Expander 80 is £399 including VAT. Further information from Siel (UK), Ahed Depot, Reigate Road, Hookwood, Horley, Surrey RH6 0AY. ☎ (02934) 76153/4.

The Chase Bit 01 sells for £699. Further info from Chase Musicians, 58 Oldham Street, Piccadilly, Manchester. ☎ 061-236 6794/6.

KEYBOARDS

Roland
WE DESIGN THE FUTURE

Just about the fastest selling range on the market today - You can't lose!

Mother Keyboard System

- MKB 300 MIDI Keyboard
- MKB 1000 MIDI Keyboard
- MKS 10 Planet Piano
- MKS 30 Piano
- Juno 106
- JX3P
- JX8P

NEW HI-TECH SHOWROOMS NOW OPEN. ALWAYS ON DEMO.

or JX3P
or Juno 60
Percussion
Encoder

Roland JX8P with
PG 800 Programmer

CASIO

Casio have at last entered the Professional Keyboard market with the CZ101 & CZ1000 MIDI Synths. Excellent sounds at very low cost. Come and give them a try.

KORG

have the best products from Korg in stock. DW-6000 programmable Digital Waveform Synthesizer with MIDI is now in stock. Plus, Poly 800 (MIDI) Synth, EX800 (MIDI) Expander, MPK-130 (MIDI) Pedal Keyboard.

SEQUENTIAL CIRCUITS INC

Sixtrak, Multitrak
Drumtrak and TOM.

YAMAHA

HI-TECH DEALER

- CX5ME MIDI Computer with "built in" DX9
- DX5 Digital FM Synth (MIDI)
- DX7 Digital FM Synth (MIDI)
- KX5 Remote Keyboard (MIDI)
- TX7 Expander (MIDI)
- QX7 Sequencer (MIDI)
- QX1 Sequencer (MIDI)
- TX8 16 Voice Generator (MIDI)
- PF10 & PF15 FM Pianos
- D1500 MIDI Digital Delay £499
- R1000 MIDI Digital Reverb £399
- RX15 & RX11 Digital MIDI Drum Machines



NEW FROM YAMAHA
DX21 BUDGET SYNTH
RX21 BUDGET DRUM MACHINE

bit

The BIT ONE £799
Polyphonic • 6 Voice •
Touch Sensitive •
Digital and Analogue

AKAI

Akai have entered the market with some blistering products not least the AX-80 MIDI Synthesizer. Now in stock. £999

GUITARS & BASSES

Fender

The all new range of Fender guitars are now in stock and include some very tasty models indeed, Strats with humbuckers and fine tune. Wammy bars and nut locks as well as the normal single coil guitars. Edge bound Tele's and the wonderful Kanana series. All the new models at unbeatable prices.

Squier

These now famous guitars have been discontinued due to the re-organisation at Fender and the replacements for this quality of guitar are now a lot more expensive. Again we have managed to secure the last of this superb range at prices that can only be regarded as a "SNIP!"
£189 • £199 • £209 • Basses £149

YAMAHA 30% OFF!

We are offering 30% OFF stocks of current guitars and basses, eg
SG 1300 T £379 (with case)
BB 1600 £299 Plus Many Others

Tokai

These amazing replicas have caused quite a stir, not surprisingly when you consider you get a mid fifties and early sixties replica for the price of a copy. We carry all the models that upset the Americans - come and see why.



Status

Superb clarity and sustain - One piece carbon graphite central neck - Phenolic fingerboard (harder than Ebony) - Solid brass precision bridge assembly - Active EQ - Heavy duty cut

Wal

The Sound of British Wood Beautiful British Basses.

Jay Dee

Mark King and Roadie Models in stock.

Milbes

Fretless and half fretted handmade British basses.

Aria Bond

ESP

Kramer

Westone

WASHBURN Ibanez

NEW GUITAR & BASS SHOWROOMS NOW OPEN FULL RANGE OF EQUIPMENT ALWAYS ON DEMO.

AMPS & PA's

Fender

Amazing deals on the last of the USA valve amps, eg Twin Reverb £449, Twin Reverb Top £299. Deluxe Reverb EV £315, Concert 4 x 10 £369, Concert 2 x 10 EV £399 plus others.

CARLSBRO

MAIN DEALER We stock the full range of this British made gear at discounted prices. The new Taurus Series of High Performance P.A. Cabinets Systems arriving soon.

TRACE BLAUNT

We are the sole agents for the Cambs area for this superb British Made product which has been called the 'Rolls Royce' of bass amplification. Please ring us for latest stock position and prices or call in for demo. The new AH500X + AH350X now in.

SESSION

SESSIONETTE LEAD & BASS COMBOS
These incredible little British made amplifiers are always in stock at the best prices around.

We can supply almost any product by our efficient mail order service. Barclaycard and Access sales can be conducted over the phone. Bank drafts, Building Society cheques and Postal Orders have immediate clearance while personal cheques will take 5 working days to clear before goods can be sent

TELEPHONE SALES (0223) 316091



HOME RECORDING



Best UK Deal
New Mini Studio
244 Portastudio at £699.00.
NEW 246 Portastudio, now available.

TEAC TASCAM



FOSTEX A8/350 8 TRACK PACKAGE
Fostex

Fostex X15 ONLY £279
+ Free carry case.

DRUM MACHINES

We carry a comprehensive range of Drum machines and Rhythm units including Yamaha RX15 and RX11, Roland TR606, TR909, TR707 and TR727, Boss DR110, Korg KPR77, Soundmaster SR88, Soundmaster Six, M.P.C. Kit II Boss Hand Clap, Boss Perc, Synth, Yamaha MR10. Drumtracs, Drumulator, Korg DDM 110 and DDM220.

YAMAHA NEW

The Yamaha Recording System £749

The skilful packaging of the Fostex 250 Multitracker brings together a four track recorder and a frills free, four in, five buss mixer £699

EFFECTS & MICS

Tokai

This superb new budget range of pedals is now in stock. Come and tread on one today.

BOSS

The Boss range of pedals is quite easily the fastest selling effects in the UK. We carry the complete range of Boss pedals and our prices are most competitive.



Always in stock is a superb range of quality microphones from the following companies, all at very good prices. Shure, AKG, Audio Technica, Chaser, Beyers, etc.

STOP PRESS ARRIVING SOON!
"MAINFRAME" the ultimate support system for your keyboards and P.A.

THE
CAMBRIDGE
ROCK
SHOP

8 Burrell Street Cambridge Tel: (0223) 316091/65093 Next to the new Grafton Shopping Centre

MAIL ORDER

Sequential TOM

Programmable digital drum machine



Not content with producing the world's first tunable drum machine in the Drumtraks, Sequential have built another load of new goodies into its younger, cheaper brother. *Simon Trask*

It's now over a year since Sequential's first foray into the digital drum machine world produced the Drumtraks, the world's first tunable drum machine. That machine's original asking price of £950 was pretty much par for the course at the time, but the more recent offerings from Roland and Yamaha have changed people's expectations of how much a high-quality digital drum machine should cost. Yamaha's RX11 even offers tuning facilities, albeit with preset levels rather than the continuous variation present on the Drumtraks.

So with Sequential's earlier offering currently looking a bit long in the tooth (though still an excellent machine), a new drum product from the company has been on the cards for a while. And a few months back, that machine turned out to be the TOM, a programmable machine that combines many of the features that made the Drumtraks such a winner, with a price-tag that's significantly lower.

Overview

The visual side of the TOM has obviously been designed to match Sequential's MAX and MultiTrak polysynths, which means it has a very smart, clean-cut and contemporary appearance. What it also means is that the casing is a bit on the light side, though such considerations don't seem to have harmed Roland's TR707, a flimsy machine if ever there was one.

The TOM has eight sounds onboard and can provide access to a further seven via a plug-in cartridge. Internal sounds consist of bass

drum, snare drum, two toms, open and closed hi-hats, crash cymbal and claps, each sound being allocated its own triggering pad. There's storage space for 100 patterns and 100 songs, and standard (non-expanded) memory holds 2300 notes.

As drum machine pads go, the TOM's have a usefully firm response. But this is more than can be said for its non-instrument pads, which

'TOM puts a stop to tedious chip-swapping by allowing you to plug in a ROM cartridge containing seven extra sounds.'

is unfortunate as they probably get as much of a thrashing in the long term.

Operation of the TOM is divided into three modes: Pattern, Song and Control. In the tradition of Sequential's front panels, layout is clear and informative; the TOM adopts the sort of matrix display format previously used to present the MultiTrak's voice parameters, and combines it with the complete listing of functions that was adopted on the SixTrak. The result is a layout that gives easy, rapid access to every function, so all credit to Sequential on this one.

All of TOM's functions are listed in three

columns – one column for each of the modes mentioned earlier. Each column is headed by its own selector button and LED, whilst down the left-hand column are LEDs for each function in the columns. Parameter values appear automatically in a four-character, seven-segment display to the right of the function list, where they can be modified using a standard numeric keypad.

A neat feature is the way a number of functions can readily be accessed and altered during recording. These include metronome adjustment and switching, error correction, and instrument erasure together with Improv, Stack and Reframe record modes (all of these from the Pattern list), and instrument tuning, volume, pan and auto-repeat from the Control list. This gives you flexible control over both medium and material, which can only be a good thing.

Sequential have a knack of making the centralised digital access approach to programming work for them, and the TOM is no exception.

Sounds

The TOM's sound-generating circuitry is only capable of generating four sounds at any one time. This is an unusual and irritating limitation that'll be more apparent if you decide to avail yourself of the TOM's cartridge sounds. If you're into building up layers of latin percussion on top of the standard kit sounds, you might have one or four problems.

Fortunately, the effect of this limitation is lessened by the TOM's ability, when all four

ARTHUR LORDS PROFESSIONAL KEYBOARDS

It is our policy to be as competitive as possible on all our prices and in most circumstances we can better, or match any genuine advertised price.

CASIO

All Casio keyboards including the new CZ1000 MIDI equipped digital polysynth at just £495.



YAMAHA

Special clearance offer on DX9's. A genuine chance to own an FM digital poly at half the price of a DX7! Limited quantities only at just £695.



TECHNICS SYDP50

This new MIDI PCM digital drum machine has 23 preset patterns plus two variations of each rhythm. You can also program 7 of your own patterns, program a complete song using the built-in sequencer & introduce random rhythm fills at the touch of a button. Phone now for a colour brochure and price.

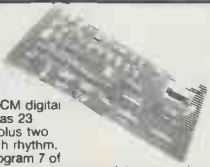

GETTING STARTED

Special package deal on our showroom demo (but as new) Yamaha amplification system. Comprises of a stereo 6 channel mixer, two 75 watt self powered PA speakers and an analogue delay unit. The ideal complete set up for a new band. Retail value £1744.

£950 THE LOT!!

ELECTRONIC PIANOS

The full range of Roland and Yamaha plus the Technics PV10 digital keyboard at £699 including flightcase and stand.



ROLAND JX-3P

Two oscillator preset and programmable polysynth. One of our best sellers. Few left at £699.

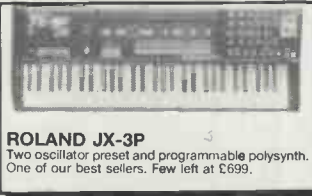

YAMAHA

Secondhand Yamaha PS6100 – the best orchestral keyboard on the market – as new condition. Only £850 including stand and pedal.



TO CLEAR

Viscount Intercontinental – 2 manual portable organ with Sharma speaker£545
Hammond X5 – 2 manual portable with Leslie£495
Logan String Melody – mint condition£199

3/5 KINGS RD SHALFORD Nr. GUILDFORD SURREY GU4 8JU Tel Guildford (0483) 570088

We run a fast and efficient MAIL ORDER SERVICE Access & Barclaycard welcome

SEE THE AMAZING
ENSONIQ MIRAGE SAMPLING
KEYBOARD AT

ONLY
£1695!!



**A1
MUSIC**
88 OXFORD ST., MANCHESTER
TEL: 061-236 0340

INSTANT CREDIT – HIRE PURCHASE – PART EX.

digimemory

DIGITAL EPROM-PLAYER
FOR ALL TYPES OF EPROMS



CHIPS/Eproms 2732/2764/27128/27256
pitch control (1 octave UP – 1 octave DOWN) 12kHz–42kHz
manual play knob
external trigger input
full dynamic (touch sensitivity) range 40dB
output 10K ohm (line level) +10dB maximum
external power supply 18:18 min/24:24 max +250mA/ –25mA

the winner

MICROPROCESSOR CONTROLLED
DIGITAL SOUND SAMPLER

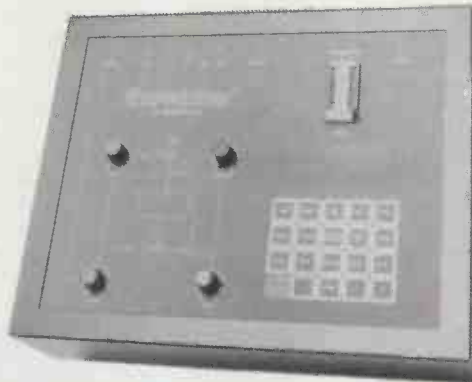

A microprocessor-controlled digital sound sampler, Eprom programmer, Eprom blower, Eprom copier, MIDI and computer serial in-output.

FEATURES INCLUDE:

Dynamic control, pitch control 1 octave UP/1 octave DOWN; Eprom programmer works from RAM to ROM and/or ROM to RAM; Epromblower enables to load each Eprom as selected; Eprom copier enables to make a copy of each Eprom; MIDI-interface enables connection directly to each keyboard with MIDI/in; computer in/output enables connection with each home and/or personal computer; special effects – with a very high quality standard – are: digital delay, echo and reverb; triggering by means of keyboard, triggermike, triggerpulse as well as external as internal.

ted
THE TED STORE LTD. NEWARK, N.Y.

DISTRIBUTED FROM: CAPELLE MUSIC
333 LONDON ROAD, HADLEIGH, ESSEX.
TEL: 0702-559 383

AVAILABLE FROM
ALL LEADING
RETAIL
SHOPS

channels are occupied, to assign a new instrument event to whichever channel has less remaining sound to generate. The arrangement is still a nuisance, though.

In the normal run of things, each drum voice is assigned to one channel, so if it's played again before the first sound has run its course, the sound is automatically retriggered. Stack mode, however, lets you reassign a sound to a different channel if that sound is already active. Quite a nice feature, though it quickly limits the number of *different* instruments that you can play at once.

'Full marks to Sequential for applying a bit of imagination to their programming facilities – and making them easy to use.'

A definite plus-point for the TOM – as it was on the Drumtraks – is its instrument tuning facility. A wide tuning range (32 levels) is available, and any instrument played/recorded assumes the current tuning value as applied to its own range. Tuning is thus note-specific as well as drum-specific, and it's possible to create a variety of disparately tuned sequences by adding a new note or notes each time round the Record loop.

You can vary tuning in real time during recording, and this allows not only the obvious tom rolls, but also a whole load of much more exotic – and more contemporary – effects. The TOM's demo patterns show these off rather well.

Instrument volume and instrument panning are also note-specific, and can also be varied during recording, and you probably don't need me to tell you that putting all these effects together can produce some startling percussive results.

As if this wasn't enough, the TOM also provides a Reverse facility (a first in the sub-£1000 drum machine world) instigated at the press of a button. It's certainly quite a novelty, hearing drum samples played backwards in this way, and better still, reversing is also a storable parameter. The only problem is that Sequential have omitted to give the Reverse function an LED to tell you it's activated, so it's all too easy to end up with a reversed cymbal thwack just at the point you wanted a conventional crash. The perils of experimentation...

Of course, all these weird and wonderful

voice-changing facilities wouldn't be much use if the voices were no good in the first place. Overall, the TOM's samples don't quite have the clarity and sparkle of their Japanese counterparts, but they possess a dryness that might well be appealing in its own right. And if you don't like the dryness, you can always use signal-processing to help relieve it.

If you work at it, you can get some sharp, well defined cymbal and hi-hat sounds and some colourful toms, though the bass drum seems to lack that last bit of 'oomph', no matter what you do with it.

Operation

Separate global controls are provided for volume, tempo up/down, start/stop, function select, and Reverse and Cartridge select.

You begin programming on the TOM by accessing the Pattern section. This has a



number of novel programming features in addition to simply opening up the machine's memory for real-time writing. For instance, a facility called Improv lets you record instruments as 'improvised' events that only occur on a selectable percentage of loops within a pattern – a very welcome surprise element, this. The same can be said for the already-mentioned Stack mode, and the Reframe facility, which lets you redefine the start-point of a pattern after it's been recorded – great for indecisive programmers.

Real-time programming is really the TOM's forte, but the Pattern section also includes a function called Single Step. The idea behind this is to provide a means of inserting and deleting voices, beat by beat, from an already-recorded pattern, but if you start off with nothing recorded at all (or delete all the voices in that pattern to give you a blank piece of paper, as it were), there's no reason why you shouldn't be able to use Single Step as a means of programming in step time.

Once you've finished with recording patterns, you turn to the TOM's Song section. But aside from the pattern-chaining function that is its *raison d'être*, Song mode has a number of interesting organisational features. For a start, 'subsongs' may be included as a link in the chain. These are other songs that can be

called up in the course of the current song, after which the next link in the chain is accessed. You can also set sequences of patterns to loop a number of times within a song chain, which can save a lot of programming time.

But most interesting of all in the Song section is the Human Factor facility. In essence, this lets you program a percentage of time that a song plays recorded instruments at slightly different tunings and levels from the ones already programmed for them. There isn't space to go into details here, but this sort of feature can make all the difference between a drum machine sounding like a box of moronic technology and the same unit appearing to be a much more versatile, *musical* instrument.

Full marks to Sequential, then, for applying a bit of imagination to their programming facilities – and making them easy to use.

Rear Panel

This houses sockets for left/phones and right/mono audio outs (phones receive a stereo signal), MIDI Out and In, clock out, tape out, clock/tape in, trigger out and programmable footswitch. Conspicuous by their absence are individual audio outs for each of the TOM's drum voices – and that's a real disappointment.

You can store patterns and songs over MIDI, but Sequential have sensibly provided a tape save/load option as well. All memory is saved in one go (so you can't choose between patterns and songs), and a complete 2300-note save takes about three minutes.

Trigger Out provides a 5V, 10msec pulse that can be used to trigger and step through non-MIDI sequencers (Sequential give the example of their own Pro One), and you can play/record these pulses by selecting Cartridge and tapping the eighth instrument pad.

Clock signals are output automatically when a song or pattern is running, and the power-up default clock rate is 24ppqn. Other possible settings are 0.5, 1, 1.5, 2, 3, 4, 6, 8 and 12ppqn, which is most odd, and would seem to imply that Sequential intend the TOM to act as a master device to trigger a sequencer, rather than another drum machine. For clock in, the TOM can adjust to 24, 48 and 96 ppqn, which is a lot more sensible.

The really good news is that the TOM can sync to and from tape *via* its tape out and clock/tape in sockets.

MIDI

The TOM operates in the same three MIDI modes as the MultiTrak, which should make for a good pairing. Sequential have implemented keyboard control of all the drum sounds *via* MIDI – and this includes the cartridge sounds, with internal and cartridge sounds being accessible at the same time. Instrument pan (left/centre/right) and trigger out facilities are also allocated to selected keys, whilst 32 adjacent keys are allocated to the 32 tuning levels. If your MIDI keyboard is velocity-sensitive, the TOM will receive these values from the instrument keys and assign them to its own volume levels. So it's not difficult to see that by pressing a tuning key and a panning key together with an instrument key or instrument keys on a dynamic keyboard,

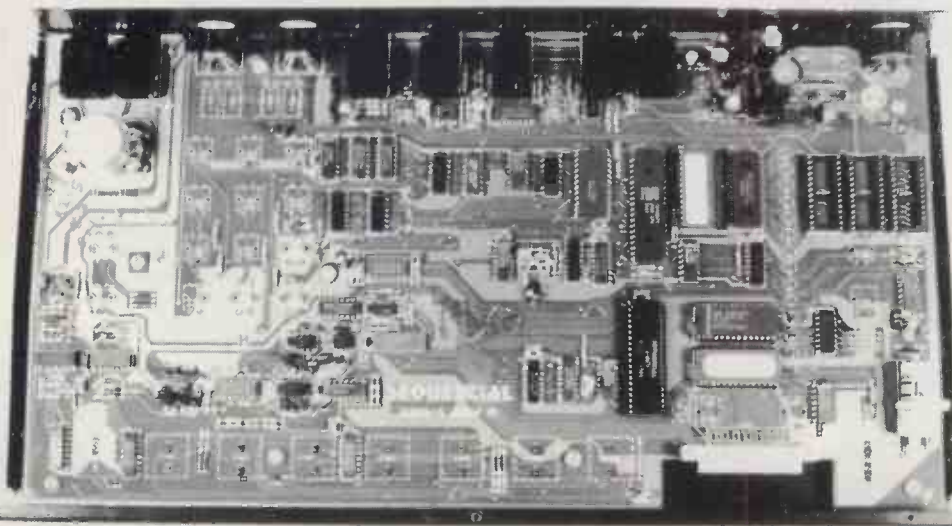

THE
NEW

ENSONIQ MIRAGE

is only a sssampler from the sounds of Gig Sounds
theres also

SIMMONS

ROLAND

AKAI

WAL

TASCAM

YAMAHA

FOSTEX

and TRACE ELLIOT

Come down, you wont believe your ears

GIG

SOUNDS

86-88 MITCHAM LANE STREATHAM SW16 01-769-6496/5681
22 RUSHEY GREEN CATFORD SE6 01 690 8621/2

programming the TOM becomes an extremely easy task. It's even possible to control instrument tuning by use of the synth's pitchbend wheel – logical, but not the sort of thing you can use lightly.

All this works the other way, of course, so that you can use the TOM's programming pads to play notes from a MIDI keyboard, and use its programming facilities to record sequences.

On the MIDI synchronising front, the TOM transmits MIDI timing bytes and MIDI start/stop/continue codes for linkup with a sequencer or even another drum machine.

Expansion

A strong feature of American drum machines in general is the way their designers give musicians the means to add drum voices without unnecessary duplication of hardware. Unfortunately, this has traditionally required users to open up their drum machines and swap chips each time they wanted some new sounds.

Thankfully the TOM puts a stop to this tedious process by allowing you to plug in a ROM cartridge containing seven sounds, giving a total of 15 simultaneously-available drum voices. Four such cartridges will be available by the time you read this review (though sadly not in time to actually *be reviewed*), with a sizeable RRP of £119 each – though when you consider that individual plug-in drum chips generally cost around the £30-40 mark, the price doesn't seem so bad.

Each cartridge gives you a different family of sounds: Standard Drumkit, Latin Percussion, Electronic, and Effects.

The first of these cartridges includes ride cymbal, cymbal bell, cowbell and rimshot; Latin Percussion includes conga slap, timbale, timbale rim, agogo bell and guiro; Electronic sounds include kick drum, tom, laser one and record scratch (!); and Effects include dog bark, car horn, orchestra 'tutt' and crowd. A few lemons, then, but a commendably wide range of voices to be going on with – and there may be more to follow.

Internal and cartridge sounds can all play at the same time – the only limitation is a physical one (the TOM only has eight programming pads, remember) at the recording stage. Another point to bear in mind, though, is that the limit of four voices playing at any given moment still applies, as this is a limitation of internal system design.

Anyway, equally commendable is the way Sequential have made room for future TOM memory expansion. Three IC sockets on the machine's PCB are reserved for plugging in three 8K RAMs, each of which gives another 2700 notes' worth of storage space. These RAMs can be bought for £39 each, and you can either fit them yourself or get your friendly local music shop to do it for you. A full complement (together with the inbuilt RAM) will give you a capacity somewhere in the region of 10,000 notes, which can't be bad.

Conclusions

Few hi-tech musical instruments escape a pros-and-cons specification that presents the musician with a purchasing dilemma. The TOM is no exception. In fact, it presents a number of intriguing dilemmas, and in the final analysis, personal needs and wants will

dictate the degree of its eventual success in the marketplace.

On the con side, there are quite a few aggravating minus-points that really detract from the machine's appeal. Like the lack of individual voice outputs, the four-at-once voice placement limitation, the lack of a really extensive step-time recording section, and a relatively high (though not exorbitant) price that betrays the higher manufacturing costs US hi-tech companies have to face by comparison with their Japanese and Italian competitors.

But the plus points are also significant, and plentiful. The built-in upgradability of the machine's voicing and memory spec is probably the biggest boon, but there's also the flexibility of the TOM's voice-controlling and programming sections to consider, too. For comparative newcomers to the field, Sequential have surely given their latest drum machine some design thought – and it's paid off. Credit is also due to them for attempting to get as much mileage out of MIDI as is possible in a drum machine context, whilst a healthy range of triggering and synchronising options should make TOM a flexible centrepiece of a combined MIDI and non-MIDI setup.

But the biggest dilemma of all is the one facing the reviewer. How do I end this review without coming to a wishy-washy, indecisive conclusion? I can't. Take the TOM for a spin, try out as many of its features as you can, and come to your own conclusions. I'm going to a special clinic for people who keep wishing drum machines had everything. ■

RRP of the TOM is £795 including VAT. Further information from: Sequential Europe, PO Box 16, 3640 Mijdrecht, Netherlands.

DON'T MISS OUT!

We are offering vast stocks of demonstration, s/h and new equipment at lower prices than ever before. If you are interested in any of the items listed we strongly advise that you contact us now.

- Roland _____ JX8P, PG800, Juno 106, JX3P, PG200, SH101, MKB1000, MKB300, MKS10, MKS30, MKS80, TR707, TR727, TR909, SDE1000, SDE2500, SDE3000, SRV2000, DDR30, HP100/50, MSQ100, MSQ700.
- Yamaha _____ DX7, DX5, TX7, QX7, QX1, TX816, TX216, TF1, KX88, CX5M, RX11, RX15, RX21, PF10, PF15, MT440, R1000, REV-7, D1500.
- Korg _____ DW6000, Poly 800, EX800, DDM110, DDM220, SDD1000, SDD2000, MPK130, KMS30.
- Recording Equipment _____ Tascam—38-8, 80-8, M50, 388, 246, Porta One, 244, Fostex—X15, A8, 350, Soundtracks 16-8-16, Allen and Heath 16-8-2, Sech 18-8-2.
- Electronic Drums _____ Simmons—SDS7, SDS8, SDS9, SDS Series 1000, SDS1, SDS64, SDSEPB, Tama—Techstar 5 Drum, Techstar 2 Drum, Techstar Sequencer, Ultimate Percussion—UP5, UPK2X.
- Ensoniq _____ Mirage Sampling Keyboard.
- Casio _____ C25000, C21000, C2101. S11.



Eddie Moors Music

679 Christchurch Road, Boscombe, Bournemouth. Tel: 0202-35135
302 509

ADVERTISEMENT

THE KORG DW6000

A BREAKTHROUGH IN DIGITAL WAVEFORM TECHNOLOGY.



It was in April's *What Keyboard* magazine that the British music public heard about the Korg DW6000 for the first time.

"Korg have gone the whole hog and produced a best-of-both-worlds, have-your-cake-and-eat-it instrument... all the sounds have that characteristic sparkle and clarity that we've come to associate with only one kind of instrument. And yet when you come to alter one of the sounds or even set up a new one from scratch, the control panel is cosily familiar."

So how does Korg manage to achieve the quality of digital sounds coupled with such ease of use? Quite simply, whereas on a traditional system the starting point is normally a couple of basic waveforms – for example saw tooth or square waves, Korg have replaced them with eight highly complex waveforms. As *What Keyboard* went on to state:

"If you listen to these 'raw' without any further

processing they clearly bear no resemblance to conventional synthesizer oscillator sounds; they're much more suggestive of real naturally occurring sounds."

The DW6000 has two oscillators per note, so you can combine one waveform with another giving 64 possible waveform combinations just to start with. Apart from these, the control panel on the DW6000 is very understandable. It only takes a minute to understand, with familiar VCF, VCF EG and EG etc., together with programmable portamento, chorus and noise generator, plus two modes of poly and unison mode for some very powerful lead sounds.

Also familiar from the Poly 800 are the six stage envelope generators. As *Electronic Sound Maker* pointed out:

"This feature alone on the Poly 800 produces effects unobtainable on anybody else's instruments, and on the DW6000 in conjunction with the digital

sounds it's a powerful combination indeed."

Sixty-four good programs should be more than enough for most needs and full Midi facilities mean you can link it to anything else you can beg or borrow.

Dominic Milano summed it up in *Keyboard* magazine*:

"The digital waveforms set the DW apart from the other instruments in this price range... it has a marked influence on the sound of the instrument giving it that combination of digital crispness and analog warmth that a lot of people are striving for."

And as Dave Foister said in *Electronic Sound Maker*:

"The DW6000, the first of a new hybrid of instruments; an instrument which brings controllable programmable digital sound within the reach of anyone who understands the basics of conventional synthesizers, and for that, the DW6000 has quite simply no competition."

Korg (UK) Limited, 32-34 Gordon House Road, LONDON NW5 1NE Tel: 01-267 5151

Microskill AS32

All-digital Programmable Polysynth

From the wilds of West Yorkshire comes a new computer-based instrument that could be Britain's answer to the PPG. We present an exclusive preview. *Simon Trask*



Last month we previewed an up-market British instrument, the Anvil drum machine, which on spec looks set to give the Linn 9000 rather more than a run for its money. Well, there must be something in the air, because now comes news of another British instrument with upmarket pretensions, the AS32 digital synthesiser.

The people behind AS32 are a company by the name of Microskill, and the instrument has already taken them some three years to develop. The company's main line of business is, in fact, developing real-time computer systems for the gathering of aircraft flight data information – not exactly the sort of background you'd expect to produce a serious, contemporary musical instrument. But just think for a moment. Your average digital polyphonic synth makes a pretty hefty demand on both hardware and software designers, with the emphasis well and truly on real-time processing. So in a sense, the development of an instrument such as the AS32 isn't totally unrelated to the everyday encounters of computer folk like Microskill.

Company directors Peter Smith and Peter Sutcliffe (the latter being head of AS32 development) recently visited E&MM's offices, bringing with them one of only three pre-production samples of the AS32 for your curious reviewer to investigate. They also sampled the delights of the local curry house and lived to tell the tale.

Initial Foray

First things first. The 'AS' bit stands for Additive Synthesis (the instrument's chosen method of sound creation – a feature it shares with the Anvil), whilst the '32' indicates the number of sound channels available. And yes, this does mean it's possible to play 32 notes at once (either through application of the forearm smash or – much gentler – the sustain pedal), but this entails using the machine's minimum voicing resources. The synth can in fact be 32-, 16- or eight-voice polyphonic depending on the number of channels allocated to each voice. All will be explained later.

For the technically-minded, Figure 1 provides an overview of the AS32's system architecture, and shows there to be no fewer than three processors running concurrently. At the heart of the system lies a 2MHz 68B09 with 64K of ROM and 96K of RAM, whilst a 1MHz 6803 handles keyboard scanning, and a 16-bit custom chip running at 10MHz handles all the sound-generation chores. The custom processor can perform several calculations in parallel ('pipelining seven-deep' is apparently the correct term here), resulting in a mighty impressive 70 million calculations per second. And I thought our Accounts Department was quick.

The AS32 has a six-octave (F-to-F) touch-sensitive plastic keyboard. Our sample had only attack velocity im-

plemented, though I gather release velocity will also be supported on the production model. Apparently, the Italian keyboard Microskill are using isn't capable of registering aftertouch, which is certainly an unfortunate state of affairs for a modern upmarket synth. Some alteration of the keyboard's action might not go amiss, either; there's far too much give during key depression, and it's a bit worrying that fully depressed keys lie flush with the rim of the outer casing. All in all, I don't think this keyboard is likely to get a very favourable reaction from the pro players it's aimed at.

If you've cast your eyes over the accompanying AS32 mugshot, you may well have noticed a fatal absence, or to put it another way: wot, no wheels? Fortunately, these will be catered for on the production model, with the standard pair of wheels being positioned left of the keyboard. One will be assignable to pitch bend or stereo bend (the panning of voices in the stereo spectrum) while the other will be allocatable to modulation or 'space stereo' (the width of the stereo spectrum used). All very well, but in these days of multiple controller assignments, a bit more imagination on the part of the AS32's designers probably wouldn't go amiss.

Front Panel

It's time for that familiar guided tour of controls and their layout. This time, though, you shouldn't pay too much attention to the paintwork. The layout has been finalised, but the fascia currently comprises no more than a bromide sheet overlaying touch-sensitive pads – such is the state of pre-production things.

Starting at the left, we have tuning, touch-response and volume selectors. Separate increment, decrement and display selection pads are available for each function, together with pads for toggling each function on and off. The tuning function is interesting: it stretches the tuning at each end of the keyboard to mimic the way a piano is tuned.

Next come four Effects pads that enable selection of different assignment options for the two performance wheels. To the right of these is a so-called Palette section. This displays voices currently on-palette and those currently selected, and enables voices to be called onto the palette and selected either singly or in certain combinations (see Figure 1). The Instrument section to the right of this

enables selection of Preset, Organ, Synth and Palette voices.

There's a numeric keypad that works in conjunction with a nine-character LED display of the Microskill's Voicing Editor section, situated centre-panel. This section is clearly laid-out, with an array of selector pads (a maximum of two parameters per pad) surrounding the display. The relevant LED blinks at you whenever you select a parameter for editing – a nice touch.

A column of four pads next to the Editor section allows for the introduction of good ol' shifted functions, and it'll be interesting to see how the Voicing Editor layout resolves clarity when faced with the increased number of functions Microskill are planning.

Voice Organisation

Figure 2 provides an overview of how the AS32 structures its voices. As you can see, sound data is held in a Waveshape library, whilst all parameters governing treatment of that data (together with pointers to individual waveshapes) are held in a separate Voicing library. This means that any waveform can be assigned to any set of voicing parameters, though careful planning is needed as editing a waveform obviously affects all voices to which that waveform has been allocated.

But if you want to make use of a voice,

you have to call it up to a location on the palette. Up to six voices can be held on the palette at any one time, and from there they can be placed on the keyboard either individually or in overlaid combinations 1+2, 3+4 and 5+6. It's also necessary to place a voice on the palette before it can be edited, so it's helpful to regard said palette as one big edit buffer. One useful consequence of this is that any alterations made to a voice can't be lost (even during power-down) until a new voice is placed in the same palette position.

At the time of writing, the AS32 has three voice types: Presets, Organs and Digisynths. Not an inspiring array of terms, to be sure, and soon to be changed. The organ voices, which have their own set of parameters, will probably be subsumed within one or both of the other voice types when the Microskill reaches the production stage. Whatever happens, you'll still be able to mix all types together on the palette, though presets are limited to Positions 1 and 3.

Each voice consists of two channels, each of which has its own waveshape and parameter assignments. If one of the channels has its volume zeroed (ie. is effectively turned off), then 32 notes are available simultaneously. If both channels are active, 16 notes are available. All pretty logical, so there are no prizes for

guessing that if voice combinations are called onto the keyboard (in the 1+2, 3+4 or 5+6 combinations mentioned earlier), a total of eight voices become available.

Eventually, the AS32 will be capable of operating in three modes, though only the one outlined above was in existence on our pre-production model. Each mode will have its own waveshape and voicing libraries, but Mode 1 voices will be compatible with Modes 2 and 3, and Mode 2 voices with Mode 3. And if everything goes according to plan, you'll be able to store up to 40 entries in each library in Modes 1 and 2, and seven in Mode 3.

You're probably pretty confused by now, so I'll explain the future modes a little further. Mode 2 will allow each octave (C-to-C) of the keyboard to be assigned its own voice or voice combination. This won't, however, give true multiple-split points, as voicing values are scaled across the octave from one set of parameters to another. The object of this is to enable a finer degree of voice editing over the keyboard range than is normally possible (a bit like the principle of assigning multiple samples across the keyboard, *à la* Emulator II and Kurzweil), but the more mischievous among you will no doubt try assigning completely disparate sounds at each octave just to see what the system comes back with. We shall see.

Mode 3 will go almost all the way and back again, by allowing true splitpoints to be assigned *every three notes*. The mind boggles. And in Modes 2 and 3, each keyboard 'map' is conceived as one voice, which means that palette organisation is the same for all three modes, including selection of voice combinations. Access to voice parameters in these modes is accomplished by keying a note in the appropriate octave or three-note group. Simple keyboard splits can be accomplished by assigning the same parameters to any number of three-note splits (a copying facility would come in useful here), or by taking a Mode 2 voice and 'tidying up' a particular splitpoint in Mode 3. It has to be said – in case you hadn't already gathered – that both methods are rather long-winded methods of achieving a simple split.

The only notable omission I can think of, which really should be rectified *post haste*, is the provision of a palette library for each mode. Still, overall it's an impressive set of voice organisation facilities.

Sound Editing

We already know that the AS32 uses additive synthesis as its method of sound creation. What this means is that timbres are created by building up harmonics (or partials), each with their own definable amplitude. The AS32 offers an impressive total of 64 partials, which are stored in RAM as tables of harmonic coefficients. When a voice is called onto the palette, a Fourier synthesis operation is performed on the appropriate waveshape library

Figure 1.

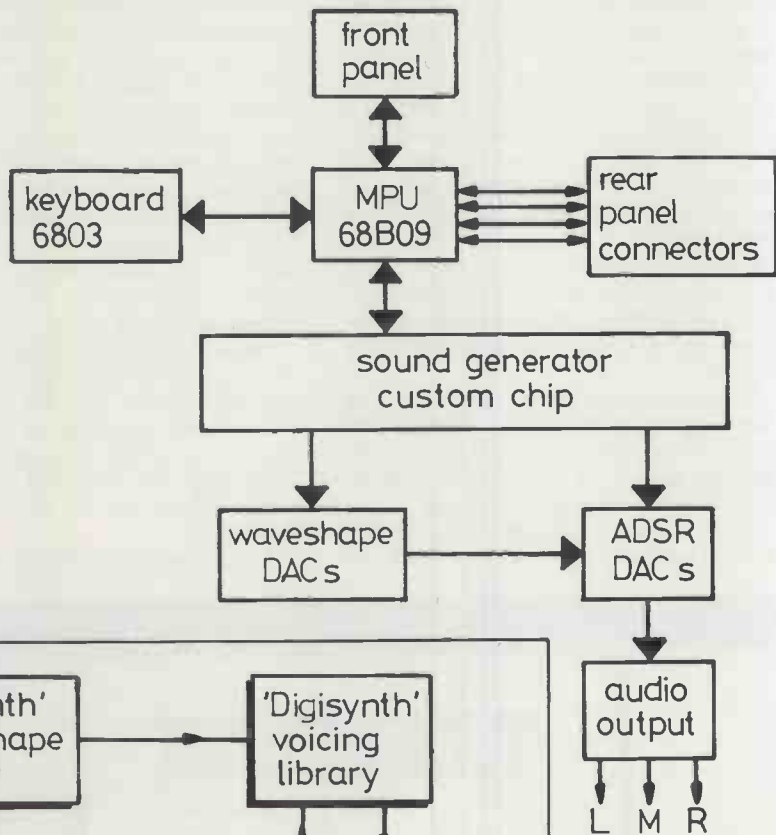
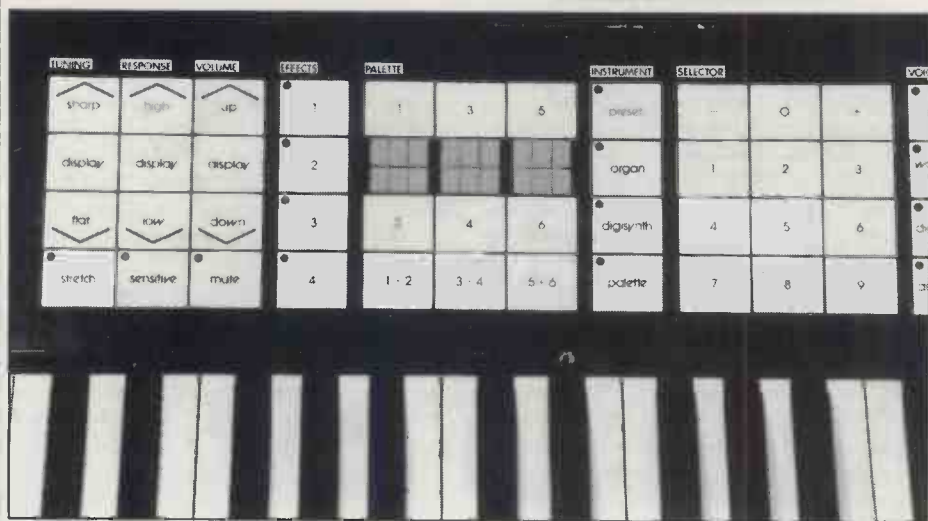

Figure 2.



find left, mono and right audio outs, with a three-state adjustable level switch; a headphone socket (similarly-equipped); MIDI Out, Thru and In (currently awaiting implementation); two stereo jack footswitch sockets (each capable of accepting two footswitch inputs); and three six-pin DIN sockets that are said to be connectors for external keyboards. Cartridge port, on/off switch and power socket are to the far right. The future status of the keyboard connector sockets is apparently uncertain, as they were conceived before the company was properly aware of MIDI, and may now be an unnecessary extra.

The left-hand footswitch socket is currently unallocated (likely candidates for implementation here are volume and modulation facilities), but its opposite number is currently assigned to sustain and selective sustain functions. Selective sustain is equivalent to the third pedal on a piano, ie. all notes sounding when the pedal is depressed are sustained, but any notes played *after* the pedal is depressed aren't affected – a very useful feature.

Conclusions

One thing is clear. Now that the software and hardware expertise have manifested themselves in something resembling a musical instrument, what that instrument now needs is the musical know-how to make it complete. There's no doubting Microskill have a powerful machine on their hands, but they'll need to listen to plenty of feedback from keyboard players before it'll become something musicians will actually want to use. To give the company credit, they are actively seeking such feedback, and the apparent ease with which they can incorporate resulting software changes is very encouraging. They've got a lot of things right, and I particularly liked the palette approach – though a palette library is a *must*, guys.

At the moment, the AS32 is lamentably short of anything like good sounds, but it's undoubtedly capable of producing them: what is there at the moment sounds extremely promising. A 'terminology gap' will also need to be closed if the AS32 is not to alienate potential customers.

More specifically, the advent of dedi-

entries, and the result placed in the waveshape store of the palette RAM. The appropriate voicing parameters are then read into the voicing store of the palette RAM.

As already mentioned, each voice can have up to two channels assigned to it, but each of these channels must be assigned its own waveshape, and editing of a waveshape is accomplished *via* selection of a channel (or 'digitone', to use Microskill's unfortunate choice of term). Using the numeric keypad, values from zero to 99 may be entered for the amplitude of each partial, with quick access to any given partial being afforded by the keypad's increment and decrement pads. Any adjustment is instantly available for your aural delectation.

There are 16 voicing parameters currently available for each 'digitone', though apparently Microskill have more up their collective sleeve. These include attack, decay and release rates, sustain level and slope, modulation rate and depth, detune and overall volume level. Also available is keyboard-tracking of both ADSR and waveshape.

There are two modes of transposition: one is available during playing, and is specific to a particular palette position and voice (with a range of up or down two octaves), whilst the other is available during editing, and is specific to a particular voice tone (with a range of down three octaves and up two).

'Response Curve' is a useful feature which, when set to maximum, reverses normal touch response, so that, for instance, heavier playing results in a quieter sound. The amount is individually adjustable for each digitone, which allows subtle variations in balance to be achieved through variations of touch on the keyboard. The facility could usefully be extended to allow variations between digisynth voices when two are selected on the palette.

Storage Media

At some point, you'll want to store those wonderful voices that the AS32 would seem to be capable of producing. What facilities are Microskill offering?

First off, let's say that the concept of

tape storage doesn't seem to be something that's entered the collective brain-cells of the AS32's developers. If you're used to developing aircraft control systems for a living, perhaps this isn't surprising.

What Microskill are planning to use instead is RAM cartridge storage. One cartridge will hold about a third of the internal waveshape and voicing library capacity for each of Modes 1 and 2, and a pair of waveshape and voicing entries for Mode 3. Not a tremendous amount, by any means, and the fact that only certain library entries can be stored could prove to be a nuisance, necessitating a certain amount of re-ordering *via* the palette.

Fortunately, Microskill do seem to be aware of the importance of developing a computer-based extension for the AS32, both for Fairlight-style display and manipulation of sounds and for saving of all libraries to disk *via* the computer. What isn't clear at the moment is whether this extension will take the form of a dedicated computer (in the manner of PPG's Wave-term) or whether software will be developed for a gaggle of popular home micros.

More unusually, the company are also planning to implement a high-speed parallel interface which could be used for memory access to a Winchester disk or for sampling. Sounds interesting.

A quick move of operations to the AS32's back panel. From left to right, we

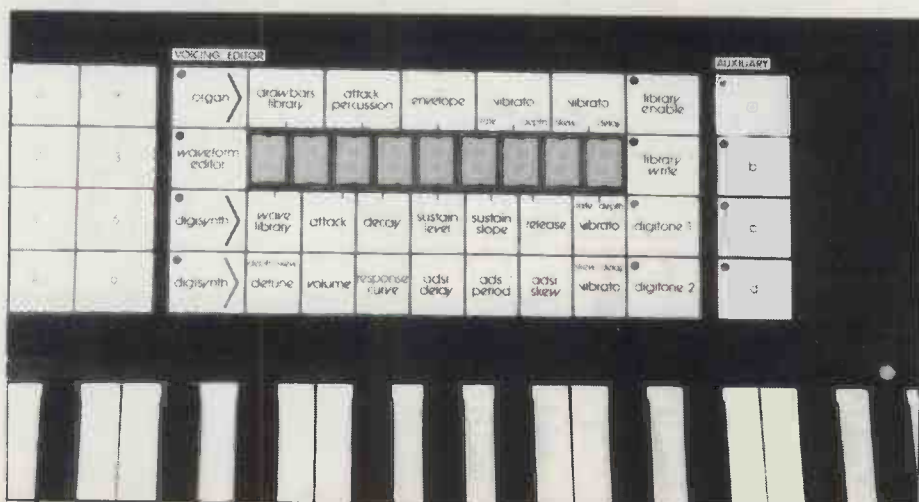

cated MIDI sequencers and MIDI software packages means the lack of any onboard sequencing facility is not in itself a great problem, but Microskill would be well advised to make the most of MIDI's multiple voice assignment possibilities when they get round to implementing the standard. A machine in the sort of price category currently being discussed – four to five grand – deserves nothing less.

Given their commercial background, it isn't surprising that Microskill are very aware of the importance of a computer extension to the AS32, and a good bet would surely be to apply their hardware and software knowledge to the production of a dedicated add-on similar to PPG's Waveterm. That would ensure both maximum flexibility and freedom from the home computer minefield.

Aside from all that, I'd say the AS32's biggest potential problem is that its sound-creation processes are rather time-consuming. Some effort expended on how to improve current editing facilities probably wouldn't go amiss. However, the other side of the coin is that additive synthesis is a very rewarding method of programming. Even in its simplest form, it offers the musician a means of coming to grips with the nature of sound in a far more concise way than subtractive or FM techniques will ever manage.

Still, AS techniques aren't exactly over-familiar to the majority of synth programmers, so a lot of people (Microskill

included) are going to have to do a fair bit of educational tutoring in an effort to get the system accepted.

It's a shame Microskill haven't implemented a filtering control of the sort found on both the PPG Waveterm system and the Anvil Percussion Synthesiser. There's no reason why more traditional facilities shouldn't be included, and the fact that filtering can be implemented in software *should* result in a system of some flexibility, if things are done properly.

Anyway, enough of my ramblings. Microskill will be exhibiting at the British Music Fair, by which time the AS32 should be in a more advanced state than it is at the time of writing. Try it out for yourself. For a non-music company's first-time offering, it's an impressive – if occasionally flawed – creation. ■

Further information from Microskill at Unit 3F, Springfield House, Hyde Terrace, Leeds LS2 9LN. ☎ (0532) 460085.



'THE MIDI SHOP', London's new centre exclusively for MIDI. If you would like to sample tomorrow's music, come and see our West London showroom. Where else would you go for the best in MIDI?

Drum & Rhythm Machines

MXR Digital Drum	£895
MPC Drum Computer	£299
Roland TR909 Rhythm Composer	£550
Roland Drumatix	£133
Oberheim DX	£1099
Sequential Circuits Drum Traks	£690



Digital Delays

Roland SDE1000	£299
Ibanez DM1000	£235
MXR175	£199
Vesta Fire Dig 410	£140
Cutec C425	£275
Korg SDD3000	£575
Deltalab Effectron	£295



Echo & Reverb

MXR 01A Digital reverb	£1325
NSF Echo plate	£450

SUMMER SALE OF NEW AND DEMO-EQUIPMENT KEYBOARDS AND STUDIO EQUIPMENT

YOU CAN'T GET ANY LOWER THAN THE MIDI SHOP



1 Felgate Mews, London W6 9JT.
Tel: 01-748 9009. Telex: 21897.

Noise Reduction

Itam DB30 8 channel	£195
Tascam DX4D 4ch	£189

Keyboards

Sequential Circuits Six Trak	£625
MAX	£535
Multitrak	£990
Roland Planet S	£565
MKB300	£620
Juno 106	£550

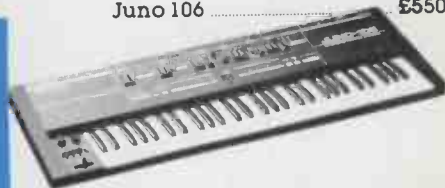

Siel DX80	£485
EC80	£329
Yamaha DX9	£639
Oberheim OB8	£2950
Expander	£2875



Mixers

Tascam Model 30	£649
Itam 12-4-8	£599
Itam Stereo 8	£335
Progressive Portamix	£295
Progressive Location Mixer	£550

ALL PRICES ARE EXCLUSIVE OF VAT

WIN A FABULOUS YAMAHA TX7 FM EXPANDER ROCK CITY/DX OWNERS CLUB COMPETITION

THIS IS THE FIRST OF A NUMBER OF SPECIAL EVENTS ORGANISED BY ROCK CITY THROUGH THE DX OWNERS' CLUB. OTHER COMPETITIONS/SPECIAL OFFERS/SEMINARS ARE TO FOLLOW SHORTLY. ALL THAT IS REQUIRED IS FOR YOU TO ANSWER THREE QUESTIONS AND SEND THE COMPLETED FORM TO:

TX7 COMPETITION, ROCK CITY MUSIC, 18 MOSELEY STREET, NEWCASTLE UPON TYNE NE1 1DE

1. ENTRANTS MUST BE FULLY PAID UP MEMBERS OF THE DX OWNERS' CLUB AND INCLUDE THEIR NEW MEMBERSHIP NUMBER ON THE ENTRANCE FORM.
2. THE WINNER IS THE FIRST CORRECT ENTRY PICKED AT RANDOM ONE WEEK AFTER THE CLOSING DATE. (31st JULY 1985).
3. THE WINNER WILL BE NOTIFIED BY MAIL SHORTLY AFTER THAT DATE.
4. THE JUDGES DECISION IS FINAL.
5. EMPLOYEES OF ROCK CITY, E&MM, AND YAMAHA ARE INELEGIBLE FOR ENTRY.

APPLICATION FORMS ARE AVAILABLE DIRECT FROM TONY WRIDE, DX OWNERS CLUB, PO BOX 6, RIPPON, NORTH YORKS HG4 2QT.

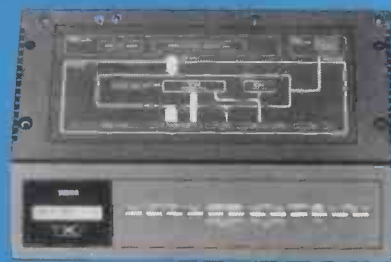

THE TX7 FM EXPANDER - A MIDI CONTROLLABLE DIGITAL FM TONE GENERATOR SYSTEM WHICH CAN DRAMATICALLY EXPAND THE POTENTIAL OF YOUR YAMAHA DX SYNTHESIZER. THE TX7 INCORPORATES A 32 VOICE MEMORY AS WELL AS 32 PROGRAMMABLE FUNCTION MEMORIES CONTAINING THE EFFECT DATA FOR ALL 32 VOICES. THERE ARE ALSO 32 FUNCTION MEMORIES AVAILABLE FOR USE WITH YAMAHA DIGITAL FM SYNTHESIZERS LIKE THE DX7 AND DX9. VOICES AND FUNCTION PARAMETERS CAN BE TRANSFERRED TO AND FROM DX SYNTHESIZER VIA THE MIDI INTERFACE. THE TX7 ALSO INCORPORATES A CASSETTE DATA INTERFACE THAT OFFERS CONVENIENT MASS STORAGE AND RETRIEVAL OF FM VOICES AS WELL AS FUNCTIONS.

NEW DX21 SYNTHESIZER

AN ENTIRELY NEW STEREO FM POLY SYNTHESIZER FOR LESS THAN £800 FEATURING MANY UNIQUE FEATURES. PHONE FOR DETAILS OF THIS HOT NEW KEYBOARD

NEW DX5 DIGITAL PROG SYNTHESIZER



DIGITAL PROGRAMMABLE SYNTHESIZER. STATE OF THE ART PERFORMANCE YET AFFORDABLE! 76 KEY VELOCITY SENSITIVE WITH AFTERTOUCH 16 NOTE POLYPHONIC (DUAL) OR 32 NOTE (SINGLE) 128 MEMORIES, 6x2 OPERATORS 32 ALGORITHMS 1 SPLIT CHANNELS! MIDI 8 PARAMETER DIGITAL EQ!

NEW RX21

AMAZING NEW PCM DRUM MACHINE FROM THE NOW FAMOUS RX STABLE AT AN AMAZINGLY LOW PRICE. PHONE FOR DETAILS

NEW REV7 STEREO DIGITAL REVERB



THE REV7 IS A QUALITY STEREO DIGITAL REVERB WITH A FULLY PROFESSIONAL WITHOUT THE PROFESSIONAL PRICE TAG

NEW KX88 REMOTE MIDI KEYBOARD

AMAZING MIDI REMOTE KEYBOARD FULL OF FEATURES, 88 NOTES, GREAT FEEL, 19 CONTROL EFFECTS, 192 PARAMETER CHANGES

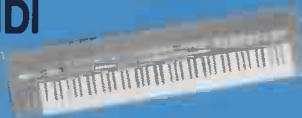

NEW MT44D TRACK RECORDING SYSTEM



ULTRA NEW MODEL WITH MANY FEATURES AVAILABLE AS SEPARATE UNITS

ROCK CITY

10 MOSLEY STREET,
NEWCASTLE UPON TYNE NE1 1DE
☎ 0632-324175

CX5M

THE CX5M IS NOW AVAILABLE WITH NEW SOFTWARE, REAL TIME MULTITRACK RECORDER 4 TRACK CONTROLLABLE FROM MIDI KEYBOARD FOR DX/RX ETC



PHONE US FOR AN AMAZING PRICE ON THIS UNIQUE COMPUTER

DX7



YES WE HAVE STOCK OF THE WORLDS MOST POPULAR SYNTHESIZER AT TASTY PRICES

RXII
UNBEATABLE PRICE £599

RX15
UNBEATABLE PRICE POA

PF10 PIANO
UNBEATABLE PRICE £499

PF15 PIANO
UNBEATABLE PRICE £899

QX7 DIGITAL SEQUENCER RECORDER £449

TX7 FM TONE GENERATOR £649

ANYTHING AND EVERYTHING YAMAHA MAKE WE STOCK IN FACT OUR STOCK OF YAMAHA IS SO LARGE IT WOULD TAKE PAGES TO LIST IT ALL. FROM GUITARS/DRUMS/POWER AMPS PA/ACCOUSTIC GUITARS/SIGNAL PROCESSORS THROUGH TO ALL HIGH TECH PRODUCTS. WE STOCK THE LOT! IF ITS YAMAHA ITS GOT TO BE ROCK CITY BEST ON STOCK, BEST ON PRICE

ATTENTION DX OWNERS CUSTOM ROM 64 UNIQUE SOUNDS CAN BE YOURS, PLUS A PLUG-IN-CHIP TO DOUBLE UP TO 128 AT THE FLICK OF A SWITCH THIS UTTERLY NEW CONCEPT IS A MUST FOR THE DX OWNER AND IS IDEAL FOR STAGE USE EVEN MORE AMAZING IS THE PRICE ONLY £45.50 ROM 64 SOUNDS £14.40 CUSTOM CHIP 64 SOUNDS

ROLAND MAKES IT HAPPEN! FAST THE BIG THREE

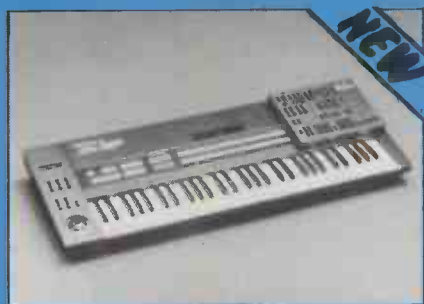

JX-8P
TOUCH SENSITIVE NEW
DIGITAL/ANALOGUE POLY
WITH OPTIONAL PG800
PROGRAMMER - AMAZING

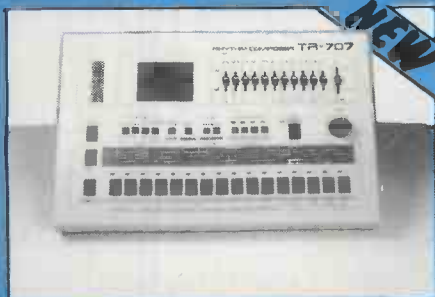

**TR707 DIGITAL MIDI
RHYTHM COMPOSER**
REAL/STEPTIME 69 PATT.
MIDI GRAPHIC DISPLAY
INDEPENDENT OUT

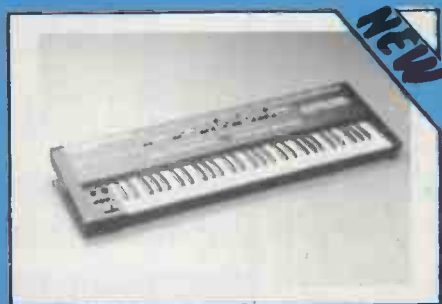

JUNO 106
WARM ANALOG SOUNDS
FROM THIS MIDI HYBRID
MACHINE AMAZING VALUE
PHONE FOR PRICE

MKB1000 + MKB300 MIDI KEYBOARD CONTROLLER
MKS10 PLANET P, MKS30 PLANET, MKS80 MODULES IN STOCK
NOW AT SPECIAL PRICES

**ALL BOSS, CUBES, JAZZ CHORUS, SEQUENCERS, GUITAR
SYNTHS, DIGITAL DELAYS IN FACT ANYTHING TO DO WITH
ROLAND ON DEMO.**

PLEASE RING US WITH ANY OF YOUR REQUIREMENTS

ROCK CITY

10 MOSLEY STREET,
NEWCASTLE UPON TYNE NE1 1DE
☎ 0632-324175

**THE MIRAGE DIGITAL
SAMPLING KEYBOARD
IS IN STOCK NOW**

ensonia

MIRAGE

ONLY
£1695

**IT SOUNDS SO
TRUE YOU'VE GOT TO
HEAR IT TO BELIEVE IT**

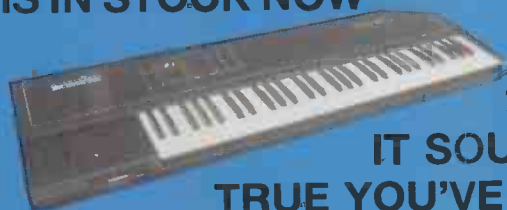

**AKAI AX80
PROGRAMMABLE POLY
SYNTHESISER**
£995



SIMPLY - LIVE PERFORMANCE ONE TOUCH EDITING
**SIMPLY - 96 PROGRAMMABLE PRESETS WITH
VISUAL DISPLAY**
**SIMPLY - A PROGRAMMABLE 8 VOICE POLYPHONIC
WITH 24 OSC'S**
SIMPLY - MIDI IN/OUT/THRU
**SIMPLY - ERASE OF PROGRAMMING WITH E-Z ACCESS
EDITING**
**SIMPLY - TOUCH SENSITIVE KEYBOARD FOR DYNAMIC
EXPRESSION**

SEQUENTIAL CIRCUITS INC

MULTITRACK	£1099
MAX	£POA
SIXTRACK	£POA
PRO600	£POA
DRUM TRACKS	£POA
TOM	£750

KORG®



**CASIO® FULL RANGE
IN STOCK BEST PRICES**

SIMMONS

**NEW MODULES
IN STOCK
RING FOR PRICES
& COLOURS**

bit on

**NO DEPOSIT HP
PART EXCHANGE
FREE DELIVERY
HAPPY SERVICE**

Korg SDD2000

MIDI-controlled Sampling Delay

The sampling story goes on as Korg join the ranks of manufacturers adding sampling options to a DDL. Theirs also has extensive MIDI facilities and a reasonable price-tag – could it be a winner? *Tim Goodyer*



In the recent history of the digital delay, two machines stand out as being land marks. First, there was the Boss DE200, the first DDL to offer users some means of triggering a sample held in memory from an external source. Second, there was the Yamaha D1500, the first DDL to be fitted with a MIDI interface that allowed remote selection of its programs from a connected MIDI instrument.

The subject of this review, Korg's *nouveau* SDD2000, is more expensive than either of those ground-breakers, but the reason for this is that it includes both the above features (and more) in an attempt to provide a comprehensive digital delay line that's also a monophonic sampler that's also got MIDI control that's also... and so on.

Layout

To look at it, though, you'd never guess the Korg had a single innovation to its name. It's housed in the now somewhat less than unusual n-n-nineteen-inch, 1U-high rack-mounting format, with all connections on the rear panel and all controls, overall tuning excepted, on the front panel.

Moving from left to right (it always seems the most logical way of doing things – don't ask me why), we find an input section consisting of a Level control and accompanying LED headroom ladder, an Output control governing the untreated signal level present in each of the Mix outputs, a Bypass switch to route the untreated input signal directly to the outputs, a Rec Cancel LED that lights in conjunction with the corresponding rear panel jack to indicate the holding of the signal at the moment of operation and simultaneous switching to Bypass mode, and a Rec Sync section that accommodates all the controls relevant to the

sequencing, sampling and trigger facilities. After that, we come to a handy MIDI Enable switch for alerting the SDD2000 to incoming MIDI information, a Programmer section containing all the 'conventional' DDL control parameters, (ie. Frequency, Intensity, Effect (effected signal level), Feedback and Time (normal or x4)), a Write switch, a Program/Parameter selection switch beside the central LED display for program number, parameter values and so on, an Incremental Control and, finally, a mains switch.

Fortunately for the proof-reader, the rear panel isn't quite so densely populated. It hosts sockets for MIDI Thru and MIDI In, the aforementioned Tune control pot, Trigger, Program advance, Record Cancel, and Bypass jacks, a Direct output, mixed and unmixed outputs, and a switchable (-35/-10dB) input.

The Korg will hold 64 user-programmable settings, which I reckon to be a goodly total, all in all. These are arranged in eight banks of eight, with the number of the program in use being shown on the left-hand side of the panel display. It isn't possible to store sampling or sequencing sounds with the power off, but it is possible to store the settings up to the point of making a sample.

The factory presets are all standard DDL patches, and are divided into groups of long and short delays, doubling, chorus, flanging and vibrato effects. And just in case you have difficulty distinguishing between these, there's a list of them included as part of the user manual.

Operation

In its DDL guise the SDD2000 works quite conventionally, with the possible

exception of incremental parameter setting.

To adjust the delay settings, you press the Program/Parameter button followed by the switch associated with your chosen parameter in the Programmer section. This causes the existing value to appear on the right-hand side of the display and brings the parameter under the control of the incrementor. The resultant setting can be committed to memory by pressing the Write switch, the desired program number, and then the Write switch again. A bit laborious, but you soon get used to it – owners of digital parameter access synths will know just what I mean.

Delay times are adjusted in a similar manner, this time using the Time switch in the Programmer section. This offers you a delay of up to 1092mS in length with a frequency response of 30Hz-18kHz or, with the 'Time x4' facility in operation, 4368mS with a 30Hz-4.5kHz frequency response. Sounds like another case of swings and roundabouts to me. Incrementation is in 1mS steps, except in x1 mode from 1-10mS, where 0.1mS steps come into use.

Alternatively, you can set the delay time by a 'tap' method, using trigger pulses derived from a drum machine or over the MIDI bus. Should you go for this option, the interval between the following two operations of the Rec switch (or footswitch) determines the delay time, so long as the elapsed time doesn't exceed the maximum dictated by the Time setting. If it does, the maximum delay time is implemented automatically.

Using trigger pulses from a drum machine entails following an almost identical procedure, with the pulses taking over the job of manual button-pushing. Working with the MIDI delay setting is also similar, but don't forget to throw the MIDI Enable switch into the On position. There won't be much in the way of communication otherwise. In fact, MIDI mode also gives you the option of syncing to every second, fourth, eighth or sixteenth beat. This is done (as are many things) by adjusting the incrementor just prior to going into Record.

MIDI, Sampling, Sequencing

As far as I'm concerned, the curious thing about MIDI is not that it's become so widespread so quickly, or that it's been talked-about so much, or that

Frazer Wyatt

CLEARLY IN THE LEAD



LOUDSPEAKERS FOR PA AND MUSIC INSTRUMENTS

Frazer Wyatt Industries, PO Box 89, Basingstoke,
Hampshire RG21 3JS, (0256) 27787.

SOHO SOUNDHOUSE

SONONIQ MIRAGE

DIGITAL SAMPLING KEYBOARD IN STOCK NOW £1695 SEND S.A.E. FOR FREE DEMO CASSETTE

Roland *Main Dealer*

JX 8P.....EPOA	TR 606.....£148
Juno 106.....£699	JC 120.....£475
TR 707.....EPOA	MKS 30.....£599
MSQ 100 S/H.....£319	SH 101.....£199
MSQ 700 S/H.....£639	MC 202.....£169
JX 3P.....£599	JSQ 60.....£99
	MKS 80.....£1399

YAMAHA *Hi-Tech Dealer*

NEW PRODUCTS
DX21 Poly Synth
Rev-7 Reverb
Real Pianos with MIDI
New CX5 software
CX5 MSX system

TX7 + Expander
OX7 Sequencer
816 FM modules, OX1
OX88 Mother keyboard
DX5, DX7, R1000, RX15,
D1500, RX11, PF10, PF15

KORG *Key Centre*

DW 6000 Polysynth.....	£799
DDM 110 Dig Drums.....	£199
DDM 220 Dig Percussion.....	£159
Poly 800 Polysynth.....	£475
PS 550 Supersection.....	£349
EX 800 Midi Expander.....	£299
KMS 30 Midi Sync Box.....	£129

SEQUENTIAL *Main Dealer*

MULTITRACK.....£1099
TOM.....£POA

PROPHET TB.....**DRUMTRAKS**
PROPHET V MIDI.....**SIX TRAKS**
PROPHET ONE.....**64 SEQUENCER £79**

NEW DRUMTRAKS CHIPS
40 Different sounds including SNOWWIS
electronics and latins. Send SAE for list.

TASCAM *Main Dealer*

PORTA-ONE Mini Studio	£419
244 PORTASTUDIO	£695
234 Syncaset.....	EPOA
32, 34, and 38 Open reel.....	EPOA
Model 2A 6:4:2 Recording mixer.....	EPOA
+ all Teac punch-ins, cleaners, accessories etc.	
MULTITRACK Well written, extensive	£499
PRIMER intro to multitracking inc. d&p	

Fender *U.K.'s largest sales & service centre*

Strats with locking Trem. Maple & Rosewood
Strats with locking Trem. & Humbuckers
Strats Van Halen style, Single P.U.
Tele. Vintage with binding, Colours
Tele. Twin Humbuckers, Coil Tap, Locking Trem.
P-J Boss. Both Pickups
THE SELECTION OF AMPS IS ENORMOUS

Fostex *Main Dealer*

X-15 July Offer	£279
inc. FREE carry case worth £20 inc P & P	
MN-15 Compressor Mixer.....	£45
XI-5 Power Supply.....	£25
250 Portastudio.....	EPOA
"Cookbook" multitrack handbook.....	£1.99

CASIO *Main Dealer*

0% Interest Free Credit
on CZ-101 & CZ 1000 synths
Call now with your personal details and collect
one of these remarkable digital synths with as
little as £40 per month to pay.
CZ-101.....£345 CZ1000.....£495

SUPER DEAL

Roland TR-909



ONCE IN A LIFETIME SUMMER CLEARANCE OFFER

- Separate outputs and level controls
- 36 patterns, 8 tracks of 896 measures
- 2 MIDI out, 1 MIDI in

- RAM Cartridge for trade storage
- Real and Slip time
- Sync 24 and Trig out
- Tape Sync
- Cassette save for tracks
- Eleven sounds. Seven tunable

RRP £999
SUPER DEAL PRICE
WHILE STOCK LAST

£269

NO CATCHES, BRAND NEW BOXED,
MANUFACTURERS GUARANTEE

HALF PRICE SUMMER SALE

ALL POA ITEMS ABOVE AT JUMBLE SALE PRICES. JULY ONLY

Yamaha RX11 Drums £595 Roland MC202 £159
Roland Jupiter 8 £1395 Mattel Synsonics Drums inc sticks £59

NEW	Rhodes Chroma.....EPOA	SECONDHAND	Korg Trident II.....£699
SH101 Expander.....£95	Rhodes V Piano.....EPOA	Moog Opus III.....£275	
Fender EL Rio.....£219	Roland PV Sync.....£275	Moog Rogue.....£139	
Fender Yale.....£175	Hikwatt Combo.....£239	Roland SH101.....£135	
Roland HP400.....£499	Tascam 225.....£199	Yamaha DX-7.....£1095	
BC Rich guitars.....£119	Roland SDE3000.....£649	Roland MSQ-100.....£309	
CX-5 set-ups.....EPOA	Rickenbacker.....£399	Chapman Stick.....£599	
Yamaha Comp-Lim.....£239	Digital Sampler.....£399	Twin Reverb.....£285	
Fostex A8+350.....EPOA	Boss BF-2.....£75	Boss SCC-700.....£449	
Isopatch 64 Bay.....£85	Boss CDE-2 or 3.....£70	Prophet V.....£999	
Korg Ex 800 Exp.....£299	Boss HM-2.....£45	Yamaha S4 Bins.....£250	
Boss DE200.....£259	Boss TU-12.....£140	Strats from.....£265	
1982 Strats from.....£475	Boss DM-3.....£85		

MATEL SYNSONICS DRUMS inc. FREE drumsticks & Amdck £59 inc Tuning Amp Kit worth £40 p&p

ACCESS, VISA, AM EX, H.P., PHONE ORDERS, WELCOME
ALL PRICES IN THIS ADVERT INCLUDE P & P. U.K. MAINLAND ONLY

CALLERS: 18A SOHO SQUARE, LONDON W1V 5FB. 01-434 1365

To: Soho Soundhouse Mail Order Freepost 38 London W1E 6QZ

Name

Address

Tel

Please send me Model No(s)

I enclose cheque/postal order/bankers draft/cash in reg. envelope or
debit my Access/Visa account no

for £ **NO STAMPS REQUIRED** EMM 7 85

24 HOUR SERVICE

HAMMOND



DIGITAL PERCUSSION MACHINE

RRP
£699

OUR PRICE
£499
+ P&P £10.00
LIMITED NUMBER

FREE DEMONSTRATION
TAPE AVAILABLE!

MAIL ORDER OR CALL IN OUR
SHOWROOM
BARCLAYCARD ACCESS TERMS

Please send me _____ Hammond DPM48 Percussion machine

I enclose cheque for £ _____

Name _____ Phone _____

Address _____

0378
75811

BRITANNIA LEISURE
175 HIGH ST., EPPING, ESSEX

0378
72021

▷ there's no replacement for it anywhere on the horizon. What's stranger is the way it creeps up on you, with a physical presence comprising no more than a set of DIN sockets and the odd switch dotted around here and there. Yet as we all know, it's a lot more powerful than that presence would suggest.

Take this Korg as an example. From the outside, MIDI looks to be an almost incidental facet of the machine. Yet in reality, its inclusion facilitates a very high degree of control over the delay in Sampling mode. And that's in addition to permitting programs to be changed remotely using the program selectors on a MIDI-equipped synthesiser.

Pressing the MIDI switch momentarily enables the MIDI functions and causes the LED in the switch to light. Simple enough. Holding the switch down and rotating the incrementor (doubtless still warm from investigation of the Trig Overdubs) by one position to the right displays the MIDI channel currently in use. And strike me down if further operation of the incrementor whilst the MIDI switch is held doesn't result in the MIDI channel being changed accordingly.

So far, so good. A competent machine that does its job with the minimum of operational demands being placed on the user (or indeed, the reviewer). Now it's time for things to get a little more complicated.

Once you've selected which sample length/recording bandwidth compromise to settle for, the trigger is automatic, and recording begins as soon as the signal level reaches a fixed threshold of +3dB – this is displayed on the LED headroom indicator. Once begun, recording will continue until the maximum sampling period is over, unless you stop the process manually using the Rec switch or its boot-operated alternative.

With recording completed, the SDD2000 enters an automatic Record Calibration sequence to ensure playback of the sample is in accordance with our Western conception of music. This calibration can be repeated at any time should the tuning drift, but that wasn't a situation I encountered in use.

When you enter Play mode, the LED display greets you with your chosen time setting followed by the word PLAY. If you've managed to stay awake this far you'll probably realise that if you're in Time x4 mode, the display's communication reads 4PLAY. Who said the Japanese don't have a sense of humour?

In Sequencing mode, playback begins immediately and the sample repeats *ad nauseum* until the mode is exited (or excited?) by a second poke of the Seq switch. Sampling mode, by way of complete contrast, reproduces the sample once on each demand from the rear panel Trig jack, ceasing playback on key release; unconditional release is available (if required) simply by the inhibition of MIDI note-off data. The only control afforded at this stage is editing the sample length down from the *end* of the sample, something that's accomplished



by holding the Time switch and rotating the incremental control.

'Not so complicated', I hear you say. Maybe not, but I haven't told you about sample note setting and the supported note range yet. Actually, they're not that complicated either, but you've got to read the instructions first.

Without getting into unnecessary detail here, accessing the Sampling and MIDI options simultaneously permits the SDD2000 to be used as a MIDI-controlled monophonic sampler. At full frequency response, a sample can be played back over a range of one octave, while a reduced-response sample will respond over nearly three octaves – 36 semitones, in fact.

The notes in question are termed 'the supported note range' and are determined by holding down both the MIDI and Seq switches and setting the lowest note of the range as indicated in the panel display; the upper one follows automatically. The key that reproduces the sampled sound at the same pitch as it was recorded is also user-determined, and can be anywhere within the supported note range. What this means is that you're free to choose to put your unaltered sample at the top or bottom of the supported note range, or anywhere else in between. The sound is then available at different pitches above, below or around the original with corresponding limitations on how far from that original pitch you can legally stray. Tuning is available courtesy of the pot on the rear panel, so no problems accommodating all those weirdo ethnic scales you've always wanted to play from your MIDI keyboard.

Conclusions

As a digital delay the SDD2000 works well, and sounds good using the normal Time setting. In the x4 mode it's the old story of trading the upper frequencies for an extended delay. Sixty-four memories should keep most of you occupied and provide plenty of scope for both live and studio work; hats off to Korg for realising

that four or eight memories just don't cover most DDL applications.

The factory presets are quite usable in their own right – just for a change – and provide a more than adequate starting-point for the development of your own programs.

Personally, I'm not over-enamoured of the incremental method of program selection/parameter adjustment. Manual program selection in particular can be a bit of a chore on the SDD2000, even though the control responds positively to the speed at which it's turned – it runs through the programs a lot more quickly if you treat it more like a roulette wheel than the lock on a safe!

Not surprisingly, the same time-versus-bandwidth dilemma applies on the sampling side, but a long attenuated sample isn't necessarily useless – it simply demands that the sound doesn't rely too heavily on its upper frequencies and can be treated with some care during mixing/equalisation.

The facility to curtail a sample is helpful, but it's a shame you can't cut the start of the sound as well as the end. Still, I guess with the trigger preset at +3dB, you're not going to have to edit out periods of silence on any of your samples. The ability to reverse a sample is also conspicuously – and regrettably – absent, but more positively, the MIDI implementation is such that the SDD2000 will respond to velocity information if requested to do so.

Would I buy one? Probably. I wouldn't recommend it specifically as a sampling unit because of the deficiencies just mentioned, but I doubt Korg intend it to be used as such anyway. Yet it's a clean-sounding, fairly friendly delay with a useful mono sampling facility, more useful still if you have a MIDI keyboard or sequencer to use as the controlling instrument. ■

RRP of the SDD2000 is £799 including VAT. Further information from Korg UK, 32-34 Gordon House Road, London NW5. ☎ 01-267 5151.

BONNERS

12A GROVE ROAD, EASTBOURNE, EAST SUSSEX

0323 639335 (6 lines - Telex)

Roland Main Dealer **KORG** Key Centre

 **YAMAHA** Hi-Tec Dealer

KEYBOARDS IN STOCK

YAMAHA HI-TECH DEALER FOR E. SUSSEX

YAMAHA DX5 New Model June/July
 YAMAHA DX7 Not due for replacement 1987... £P.O.A.
 YAMAHA KX-88 Comprehensive M/Keyboard... £P.O.A.
 YAMAHA DX21..... £P.O.A.
 YAMAHA TX-7 MIDI DX7 FM Expander..... £P.O.A.
 YAMAHA QX1 Digital Multi-track sequencer... £P.O.A.
 YAMAHA KX-5 Remote MIDI keyboard..... £199
 YAMAHA TX-216 Rack Mounted FM Expander... £P.O.A.
 YAMAHA TX-1 Single Expander Modules..... £P.O.A.
 YAMAHA PF15 & PF10 FM Digital Pianos..... £P.O.A.
 YAMAHA RX21 Drum Unit..... £P.O.A.
 YAMAHA RX11 & RX15 Digital Drums..... £P.O.A.
 YAMAHA REV7 & YAMAHA R1000 Digital
 Reverb Units..... £P.O.A.
 YAMAHA D1800 16 Memory -MIDI Delay Unit... £P.O.A.
CXS-ME MUSIC COMPUTER
 YAMAHA CXS-ME Computer with YK01 Keyboard and
 YRM-101 Music Composer Programmer..... £449
 YAMAHA YK-10 Full size keyboard..... IN STOCK
 YAMAHA YRM 102, 103, 104 and accessories IN STOCK
 YAMAHA Real Time, Sequencer
 ROM..... SEPTEMBER
 YAMAHA RX Programmer ROM..... SEPTEMBER
 YAMAHA Sound Sampling Package..... SEPTEMBER

ROLAND MAIN AGENTS FOR E. SUSSEX

ROLAND JX-8P Synthesizer..... £P.O.A.
 ROLAND Super Jupiter..... £P.O.A.
 ROLAND JX-3P Synthesizers..... £P.O.A.
 ROLAND PG-800 Programmer..... £P.O.A.
 ROLAND Juno 106, Synthesizers..... £P.O.A.
 ROLAND MKB 1000 Mother Keyboard..... £P.O.A.
 ROLAND MKS-10 Piano Expander..... £P.O.A.
 ROLAND MSK-30 Poly Synth..... £P.O.A.
 ROLAND AXIS Remote Midi Keyboard..... £P.O.A.
 ROLAND MSQ 701 Digital Recorder..... £P.O.A.
 ROLAND MSQ 101 Digital Recorder..... £P.O.A.
 ROLAND TR707 Digital Drums..... £P.O.A.
 ROLAND SDE 1000 Digital Echo's..... £P.O.A.
 ROLAND SDE2500 MIDI delay..... IN STOCK
 ROLAND SRV2000 MIDI reverb..... IN STOCK
 ROLAND SH-101 Synth+Hand grip..... £225
 ROLAND DR110, R/Units..... £P.O.A.
 ROLAND JC Amplification..... £P.O.A.
 ROLAND Cube & Spirit Amplification..... £P.O.A.

KORG KEY CENTRE FOR E. SUSSEX

KORG DW6000, New Model..... £999
 KORG MPK-130 New MIDI Bass Pedals..... IN STOCK
 KORG Poly 800 Synthesizer..... IN STOCK
 KORG EX800, MIDI Expander Modules..... £299
 KORG 80-S Symphonic Piano with Strings..... £699
 KORG SDD2000 Delay/MIDI Sampler..... IN STOCK
 KORG SDD-1000, Digital Delay with Sampling..... IN STOCK
 KORG DDM-110 Digital Drum Rhythm Units..... £199
 KORG DDM-220, Digital Latin Rhythm Units..... IN STOCK
 KORG PSS-50, Digital Super, Section..... IN STOCK
 KORG KMS-30 MIDI Synchronizer Box..... IN STOCK
 KORG KM-RX, 8 Channel Stereo Mixers..... £175
 KORG MM-25, 25 Watt Powered Monitors..... £125

CASIO MAIN DEALER

CASIO CZ101, 32 Memory Poly Synth MIDI..... £P.O.A.
 CASIO CZ1000, Full Size Keyboard Version..... £P.O.A.
 CASIO CZ5000 Synth..... £P.O.A.
 CASIO CT6000 Full Size Keyboard MIDI..... £P.O.A.
 CASIO SZ-1 Sequencer..... £P.O.A.
 CASIO CT410V, New Model Stereo..... £P.O.A.
 CASIO CT310, Full Size Keyboard..... £P.O.A.
 CASIO CT610 Stereo Model, Full Size K/b..... £P.O.A.
 CASIO CK500, Keyboard & Cassette Deck..... £P.O.A.
 CASIO CK100, Programmable, plus AM/FM..... £P.O.A.
 CASIO KX-101, Keyboard, Cas & Radio..... £175
 CASIO MT-100, 768 Variable Acc/ments..... £P.O.A.
 CASIO MT-800 with Stereo Speakers..... £P.O.A.
 CASIO MT-400V, With Stereo Speakers..... £P.O.A.
 TECHNICS DP50 digital drums..... £599
 TECHNICS PV10 PCM MIDI digital keyboard..... £499
 (RRP £899)

ADDITIONAL discounts for DX Owners Club members, please quote your membership number on all correspondence. Being a club member will automatically entitle you to many benefits.

ensonia

MIRAGE

IN STOCK

NOW

£1695

DIGITAL SAMPLER
KEYBOARD



Ensoniq's new Mirage doesn't just sound great; it sounds real. You see, Mirage doesn't synthesize sounds... it reproduces them. Note for note; timbre for timbre; resonance for resonance. From a concert grand to a thunder clap.

The Mirage has a velocity-sensitive keyboard that lets you control dynamics and timbre, so you can put more expression into your performance. And its simple keypad lets you customize sounds at the push of a button.

The Mirage is an 8-note polyphonic keyboard, so you can play up to 8 notes simultaneously. With up to 16 different sounds across the keyboard. And you can split the keyboard: piano on the lower half, strings on the upper, for example.

You control 71 different parameters of sound, including filtering, envelopes, and modulation. You can record musical phrases and overdub using Mirage's built-in sequencer.

But for the ultimate in creativity, you can sample your own sounds with the Mirage and save them on a diskette.

DRUM MACHINES

We carry a comprehensive range of Drum machines and Rhythm units including Yamaha RX15, RX11 and RX21 Roland TR707 and TR727, Boss DR110, Drumtraks, Korg DDM110 and DDM220



BOSS

We carry the complete range of Boss pedals and our prices are the lowest

CARLSBRO SESSION

WE ALSO CARRY HUGE STOCKS OF ALL SESSION AND CARLSBRO EQUIPMENT AND CAN GUARANTEE YOU THE BEST UK PRICE

SECK IN STOCK

Tascam
Porta One
Ministudio
BEST UK PRICE



● £200 to £1,000 No Deposit, Interest free instant credit - 0% apr Subject to status - ask for written details.

● FREE UK DELIVERY - IMMEDIATE DESPATCH

● MAIL ORDER - ACCESS BARCLAYCARD VISA AMEX DINERS sales can be conducted over the 'phone. Bank drafts, Building Society cheques and postal orders will take 5 working days to clear before goods can be sent.

● FULL 12 months parts and labour warranty

● All prices include VAT (overseas buyers exempt)

12 in
16 in
37 in
4 track monitor
>4 (8 track mono)
Dynamix 12>2
Dynamix 8>2
Personal Monitor
Monitors (pair)
400
A.0217
C.

HINES
BEST UK PRICE
BEATEN OR PRICE
MATCHED
BEST UK PRICE
BEATEN OR PRICE
MATCHED
BEST UK PRICE
BEATEN OR PRICE
MATCHED

CHECKLIST

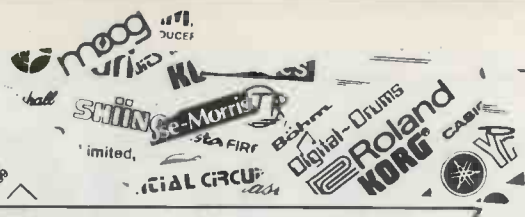

Our price guide with a difference enters its third and final phase this month with a roundup of all the electronic percussion products currently available. That heading encompasses electronic drum kits triggered by pads and dedicated, programmable drum machines. In other words, whether you're a drummer keen to make use of the new technology or a normal human being looking for a usable, versatile source of programmable percussion lines, you'll find a list of what's available over the following pages.

On the drum machine front, we've omitted those machines that don't offer any form of programmability (though these are now so small in number, you'd never notice they were missing), while hybrid machines that incorporate both sequencing software and some sort of manual 'pad' input caused us something of a categorising headache - in the end, we stuck them under drum machines.

Like last month's software CHECKLIST, this one's proved difficult to compile with any hope of achieving absolute completeness, simply because the market is moving ahead so rapidly. And one thing the electronic percussion sector seems to suffer from most of all (though it's to the benefit of the end user) is an ever-tumbling price spiral. Thus, you may well find you can pick up some machines - especially older ones - for a lot less outlay than even our 'typical retail' figures would suggest.

In all other respects, this month's CHECKLIST sticks to the well-tried formula of the previous two listings: a rundown of models, prices, and basic facilities, coupled with the comments (positive, negative, and overall) of E&MM's reviewing team where applicable.

Next month, it's the return of the polysynth...

DRUM MACHINE

Checklist

AHB

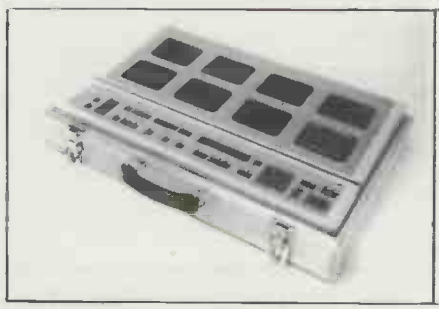

Inpulse One - £1095 Eight-voice digital drum machine. Eight pads for live performance, 99 programmable patterns, 15 songs, trigger inputs, individual voice outputs; 16-voice basic sound library includes bass drum, snare, handclaps, timpani, gunshot, conga, claves, hi-hat. **+** Build quality, ease of use, promise of expanding voice library; **-** some sonic disappointments, difficult to get hold of; **-** a fine machine that combines editing facilities with real-time playability, sadly underrated.

ANVIL

Anvil Percussion Synthesiser - £4995 16-channel programmable drum machine with analogue and digital sound sources, built-in sound-sampling, real-time sequencer, MIDI and external trigger connections, disk-drive for

storage of samples and sequences. To be reviewed.

BOHM

Dr Böhm - £669 (kit), £949 (built) 24-voice digital drum machine. 180 preprogrammed patterns, 36 programmable rhythms, 8 separate outputs; 2 bass drums, 3 snares, 2 rimshot snare rolls, 12 toms, 2 bongos, woodblock, 2 congas, 4 closed hi-hats, 2 open hi-hats, 4 cymbals, 2 tambourines, 2 maracas, claves, cowbell, hand-clap. **+** Vast range of built-in sounds, kit package gives the soldering-iron crowd a real bargain; **-** bewildering control layout, lack of decent interfacing facilities, ready-built price-tag slightly high; **-** a bit of an oddity these days, but pre-programmed patterns are useful building blocks for inexperienced programmers.

BOSS



Dr Rhythm Graphic DR110 - £125 Six-voice analogue drum machine. Built-in LCD, mono output; bass drum, snare drum, open & closed hi-hat, cymbal, handclap. **+** Superb display makes writing and editing patterns a doddle, unbeatable analogue clap sound; **-** Balance control offers only limited adjustment of voice levels; **-** successor to the immortal DR55 and justifiably popular, proves analogue technology still rules the roost at bottom end of electro-drum market.

CLEF

Master Rhythm - £129 13-voice analogue drum machine. 24 programmable patterns, mono output; 2 cymbals, rimshot, brushes, claves, snare, 4 toms, 2 bongos, conga, bass drum. **+** Wide range of voices for the money; **-** doesn't sound as good as DR110, and isn't as easy to use; **-** if the voices are the ones you want, there's simply no alternative.

E-MU SYSTEMS

Drumulator - £985 12-voice digital drum

CHECKLIST

machine. 36 programmable patterns, 8 songs, cassette storage of programs, sync (24, 48, 96 ppqn); basic sounds include bass drum, snare, clave, cowbell, handclaps, rimshot, open & closed hi-hat, 3 toms, cymbal - alternative sound chips also available. **+** digital voices still sound good next to Japanese competition, excellent range of additional ROM-based voices; **-** falling behind in both price and composing facilities; **-** still a decent bet, but the Drumulator II (when re-scheduled and re-titled) should be a real winner.

HAMMOND

DPM48 - £499 23-voice (15 programmable) digital drum machine. Seven programmable patterns, MIDI (In, Out, Thru) equipped; 4 toms, 3 bass drums, 3 hi-hats, 3 snares, 3 cymbals, 2 cabasas, clap, 2 agogos, rimshot. **+** Sounds good despite home organ origins, MIDI retrofit makes interfacing facilities complete; **-** lacks the informative display facilities of more recent models; **-** recent £200 price drop makes Hammond's only pro instrument irresistible: if only they'd come up with more...

KORG

DDM110 - £225 Nine-voice digital drum machine. 32 programmable patterns, LED display, real- and step-time programming, programmable trigger out, stereo output, sync (48ppqn); bass drum, snare, rimshot, 2 toms, open & closed hi-hat, cymbal, handclaps. **+** Cheapest digital drum machine on the UK

market, links neatly to MIDI (and tape) with optional KMS30 interface; **-** you don't get impeccable sound quality for this money, so some sounds bettered by analogue equivalents; **-** another justifiably popular machine, even with (unavoidable) digital noise problems.

DDM220 - £225 Latin Percussion version of DDM110, spec as above except for voicing; 2 congas, timbale, wood block, cowbell, agogos, cabasa, tambourine. **+** Marvellously realistic approximations of Latin drums that really do sound different; **-** nothing at this price, except non-Roland standard sync; **-** the first drum machine to offer more than the usual rock percussion set-up, and they're not charging the earth for it.

MR16 - £449 19-voice digital drum machine for connection to pre-existing MIDI software, individual and stereo outputs. **+** Voices identical to those of DDM110/220, hence pretty good; **-** no realistic applications given lack of specific drum sequencing software, some dodgy ergonomics; **-** a bit of a lemon unless some good software is forthcoming from Korg or some other source, though it's a sound enough idea in theory.

LINN

LinnDrum - £2650 23-voice real-time digital drum machine. 42 preset and 56 programmable patterns, 49 songs, individual and stereo outputs, cassette storage of programs, alternative sound chips available; 2 bass drums, 3 snares, sidestick, 3 hi-hats, 3 toms, 3 cymbals, 2 cabasas, 2 tambourines, 2 congas, cowbell, handclap. **+** The original still sounds excellent, open-ended voice structure, healthy service back-up the

world over thanks to instrument's popularity; **-** now looking very expensive against recent competition; **-** like the Rolls-Royce, outclassed and outdated, but a lot of people still ask for it by name...

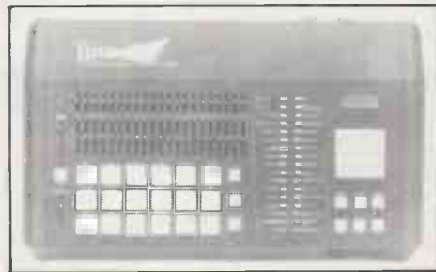

Linn 9000 - £4675 18-voice digital drum machine and MIDI sequencer. Individual and stereo outputs, 2 programmable trigger outs, MIDI (In, Out, Thru), tape sync facility, 32-track polyphonic keyboard sequencer, disk and cassette storage of programs; bass drum, snare, hi-hat, 4 toms, 2 congas, 4 cymbals, cowbell, handclaps, cabasa, sidestick, tambourine. **+** Superlative drum sounds, elegant all-in-one-box design concept; **-** horrendous price-tag, lack of step-time input and other crucial recording facilities, no sampling yet; **-** without its promised hardware and software updates (step-time input, editing, sampling), an expensive dinosaur.

MFB

512 - £299 Nine-voice digital drum machine. Eight song, 64 programmable patterns, trigger

“I've got a Korg Poly 800 already and I want to expand my sounds using midi.”

See the new Korg DW6000, first floor.

Ask Bernie to show you the versatile Korg EX800 module too. And the full range of Yamaha, Korg and Roland products. You'll find loads of new instruments throughout the store. As well as people who care about giving

you the right advice. Call in soon.

The Rose-Morris Music Store, 11 Denmark Street, London WC2. Tel: 01-836 0991/2. Mail Order, Export, Part Exchange, All Major Credit Cards accepted.

OPEN 10AM TO 6PM MON-FRI, 10AM TO 5PM SAT.

THE **Rose-Morris** MUSIC STORE

EXPERTS IN ALL THINGS MUSICAL.

CHECKLIST

▷ in, trigger out, individual (DIN) and stereo outputs; bass drum, snare, 3 toms, handclaps, cymbal, open & closed hi-hat. **+** Wonderful sounds for the money, light and compact; **-** terrible ergonomics, thus difficult to use; **-** Germany's little digital gem, though made in small quantities so you don't see many about.

MPC

Music Percussion Computer – £399 Nine-voice analogue/digital hybrid drum machine. 26 programmable bars, 25 programmable sequences, eight pads for live playing, real- and step-time programming, individual and mix outputs, tape sync facility, ZX81 interface; bass drum, snare, open and closed hi-hat, 4 toms, handclap, cymbal. **+** A marvellous idea (like a cheap Impulse One, though the MPC came first) backed up with some presentable sounds; **-** no MIDI, Sinclair software not very friendly; **-** a pioneer coming to the end of its useful commercial life, though it's still a worthwhile machine.

MXR

Drum Computer – £995 12-voice digital drum machine. 100 programmable patterns, 100 songs, sync to and from tape, individual and stereo outputs, cassette storage of programs; bass drum, snare, rimshot, 3 toms, bell, open & closed hi-hat, cymbal, claps, block. **+** Punchy, dynamic sounds, well laid-out controls; **-** lacks decent tuning and interfacing facilities; **-** another golden oldie (two years!) made cheaper by increased competition.

OBERHEIM

DX – £1575 18-voice digital drum machine. 100 programmable patterns, 50 songs, LED display, individual, stereo and mono outputs, real- and step-time programming, instrument sync (96ppqn) and sync to and from tape facilities, alternative sound chips available; 3 bass drums, 3 snares, 3 hi-hats, 3 toms, 3 cymbals, 2 shakers, handclap. **+** Usual Stateside virtues of good sounds and easy chip replacement for voicing variety; **-** usual Stateside vice of relatively high cost; **-** an underrated machine with price-tag that's ensured a low profile in UK, but updated version with MIDI as standard available soon, price TBA.

DX Stretch £TBA Hardware add-on for DX giving additional voices and MIDI facility. To be reviewed.

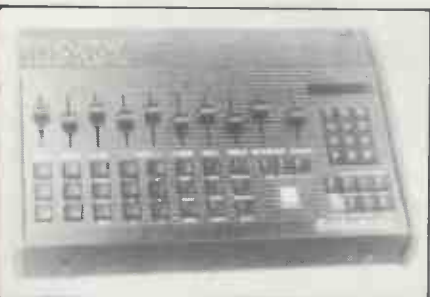

DMX – £2975 20-voice digital drum machine. 200 programmable patterns, 100 songs, real- and step-time programming, individual, stereo and mono outputs, sync (96ppqn) equipped, cassette storage of programs; 3 bass drums, 3 snares, hi-hat, gunshot, 2 toms, noise, conga, timbale, tambourine, rimshot, shaker, handclaps, cowbells, clave, 2 cymbals, punch. **+** As for DX,

plus usefully large range of onboard voices; **-** again, mainly the price; **-** the original Linn-beater, but like its rival, feeling the pinch from more cost-effective competition.

ROLAND

TR707 – £525 12-voice digital drum machine. 64 programmable patterns, liquid crystal display, real- and step-time programming, individual and stereo audio outputs, MIDI (In, Out) and Sync 24 equipped, cartridge and cassette storage of programs; 2 bass drums, 2 snares, 3 toms, rimshot, cowbell, handclap, tambourine, open & closed hi-hat, 2 cymbals. **+** Marvellous sounds, DR110-like display makes programming a piece of cake once you're suitably acclimatised, cartridge storage is great relief after tape, useful set of separate outputs; **-** not nearly as well-built as Roland's old TR808 analogue flagship, idiosyncratic programming technique, no individual voice tuning; **-** despite its limitations, the best middle-market drum box available – if you like Roland's programming system.

TR727 – £525 15-voice percussion version of TR707: facilities as above except for voicing; 2 bongos, 3 congas, 2 timbales, 2 agogos, 2 whistles, quijada, cabasa, maracas, star chimes. To be reviewed.

TR909 – £425 11-voice analogue/digital hybrid drum machine. 96 programmable patterns, real- and step-time programming, LED display, individual and stereo outputs, MIDI (In, Out, Thru) and sync 24 equipped, cartridge and cassette storage of programs; 2 bass drums, 2 snares, 6 toms, rim shot, handclap, open & closed hi-hat, 2 cymbals. **+** Mainly-analogue sounds will retain charm so long as TR808 remains in fashion...; **-** ...but sound weak next to Roland's own digital fare; **-** outdated machine now out of production, too, but haggle with the dealer and you've got yourself a bargain.

SEQUENTIAL

TOM – £795 Eight-voice digital drum machine. 99 programmable patterns, programmable tuning and volume, reverse play of sounds, real- and step-time programming, MIDI-equipped. **+** Basic sounds are pretty good, more sounds available on cartridge, unique sample reversal is a great gimmick; **-** lacks separate voice outputs, can only play four sounds at any one time, not as well built as Drumtraks; **-** confirmation of Sequential's electro-drum prowess, though lack of individual outputs should ensure continued success of Drumtraks as well.



Drumtraks – £995 13-voice digital drum machine. 99 programmable patterns, LED display, programmable pitch and volume, individual and mono output, MIDI (In, Out) sync (24 or 48 out, 24ppqn in) equipped, cassette storage of programs, alternative sound chips available; bass drum, snare, rimshot, 2 toms, 2 cymbals, open & closed hi-hat, claps, tambourine, cowbell, cabasa. **+** Superb sounds, tuning and editing facilities unrivalled at this price, sound

chips interchangeable with Linn's; **-** not as well laid-out as later TOM, though it's not that tricky to use anyway; **-** in terms of programming and tuning flexibility, still very hard to beat.

TECHNICS

DP50 – £595 25-voice (15 programmable) digital drum machine. Stereo outputs, MIDI (In, Out, Thru), 7 programmable patterns, 4 preset patterns per programmable voice; programmable sounds: bass drum, snare, 4 toms, 2 congas, tambourine, handclaps. **+** Well built, some excellent (but non-programmable) exotic percussion sounds; **-** complicated to use, no proper song storage or output facilities, preset patterns take up vital memory space, programmable sounds lack definition; **-** too flawed for professionals to take it seriously – unless they work in a cocktail bar.

YAMAHA

RX15 – £499 15-voice version of RX11; spec as below except: stereo only outputs, cassette only storage; bass drum, 2 snares, rimshot, 3 hi-hats, 3 toms, 2 cymbals, handclaps, cowbell, shaker. **+** Fine sounds, good range of editing facilities, informative (if limited) LCD; **-** not the easiest machine to use, lacks individual voice tuning; **-** Yamaha's first venture into programmable drum machines is a real success, especially in the context of an X-series MIDI system.

RX11 – £799 29-voice digital drum machine. 99 programmable patterns, real- and step-time programming, liquid crystal display, individual and stereo outputs, MIDI (In, Out) and selectable sync outputs, cartridge and cassette storage of programs; 3 bass drums, 8 snares, 2 rimshots, 5 hi-hats, 4 toms, 2 cymbals, 2 handclaps, 2 cowbells, shaker. **+** As RX15 only more so, separate outputs make it a studio user's dream; **-** more complicated than RX15, hence even trickier to use, range of sounds lacks imagination; **-** serious competitor for Roland TR707, once you've overcome its user-unfriendliness.

ELECTRONIC DRUM

Checklist

AKAI

AM10 – £TBA Prototype digital drum system. Single pad unit reading ROM sounds, level out, tuning, trigger in facilities. To be reviewed.

CACTUS

Desert Drums MkII – £799 Ten-channel, five-pad, analogue/digital hybrid modular drum kit. Rack-mounted voicing unit, sequencer connection facility, stereo outputs. **+** Interesting hybrid of digital (excellent) and analogue (not so hot) drum sounds, includes brave attempt at electronic cymbal; **-** crosstalk between adjacent pads, kit doesn't look or feel very impressive; **-** a pretty good all-rounder that takes more design risks than most, thus worth considering so long as you don't put appearances high on your list.

CHECKLIST

CLAVIA

ddrum - £295 Single-pad digital unit using ROM cartridges. Different duration sample chips available, battery powered, pitch control, trigger in. **+** Magnificent sound quality thanks to sample recording care on factory's part, vast (and expanding) range of sounds both conventional and unconventional; **+** almost absurdly expensive, digital noise intrudes on some samples, not everybody likes the idea of hitting a small, square pad; **+** the Rolls-Royce of digital drum units, and similarly pricey.



ddrum Rack System - £2023 Five-channel, rack-mounted digital electronic drum kit comprising ddrum electronics and set of Remo heads, expandable to eight channels, individual outputs. To be reviewed.

DYNACORD



Percuter - £550 Eight-channel digital electronic drum kit. Interchangeable digital modules, individual and stereo outputs.

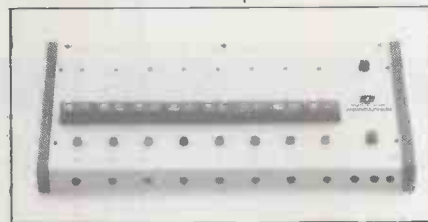

Big Brain - £795 16-channel drum sequencer. 50 programmable songs, 100 user-programmable patterns (50 optional preset or programmable), cassette storage of programs, MIDI (In, Out, Thru), Sync In & Out. Available July.
Boomer - £725 Digital percussion sound-sampler. Trigger in from pad or sequencer, editing facilities. Available July.
Digital Hit - £125 Single-voice digital percussion module. All Dynacord electronic percussion machines to be reviewed.

HOHNER

CDX9 - £TBA Eight-voice, seven-pad, digitally-sampled electronic drum kit. 2U rack-mounted voice unit, overall tuning facility, individual and stereo outputs.

CDX11 - £TBA As above, but with five voices and rimshot.

CLX1 - £TBA LFO unit for CLX2.

CLX2 - £TBA Individual drum voice module. Pad/MIDI triggering.

CQX3 - £TBA Real-time drum sequencer. MIDI (In, Out, Thru), external input from pads. All Hohner electronic percussion machines to be reviewed.

KLONE

Klone Kit 2 - £499 Five-channel analogue electronic drum kit. Individual tune, damp and level controls, snare noise and pitch-bend controls, individual and mix outputs. **+** Looks good, sounds pretty fair all-round (but especially snare); **+** sounds could do with a bit of 'dirtying', kit isn't of the sturdiest; **+** a little characterless, but it has its own appeal, is great for creating off-the-wall sounds, and modular configuration (see below) lends flexibility.

Dual Percussion Synthesiser - £299 Two-channel analogue electronic drum add-on. Basic spec as Kit 2. **+** Again, it looks good and it sounds OK, plenty of scope for 'weird' sound effects in addition to conventional percussion voices; **+** drum sounds lack bottom, feel; **+** a useful addition to either a Kit 2 or (better) an acoustic set-up.

“What's the latest thing in music computers? Oh, and what about home recording gear?”

The Yamaha CX5M and the Fostex range, basement.

The CX5 links with monitors, keyboards, midi and TV. The Fostex range is in our new 8 track home recording department. Why not call in soon for a chat and advice on what's best for you?

The Rose-Morris Music Store. 11 Denmark Street, London WC2. Telephone: 01-836 0991/2. Mail Order, Export, Part Exchange, All Major Credit Cards accepted.

OPEN 10AM TO 6PM MON-FRI, 10AM TO 5PM SAT.

THE **Rose-Morris** MUSIC STORE

EXPERTS IN ALL THINGS MUSICAL.

CHECKLIST

MAXIM

Electronic Drum System – £500 Five-channel analogue electronic drum kit. Mix, stereo and individual outputs, one factory preset, two user-programmable presets, one live setting, FX send/return, provision for two extra modules. *To be reviewed.*

MPC

DSM1 – £199 Non-programmable electronic drum module. Sensitivity, decay, pitch-bend, pitch, noise and click controls. Can be triggered by MPC Standard or Super Pads.

DSM8 – £199 Auto-tom unit producing tom roll from single pad strike or sequencer trigger, incorporates voicing circuitry and sequencing electronics. **+** *Certainly very clever, and pretty cheap for what you get; **-** has to be powered from MPC drum module, built-in tom sounds are hardly revolutionary; **-** decent budget sequencing machine for the lazy and/or incompetent.*

DSM32 – £299 128-memory analogue electronic drum module. Spec as for DSM1 plus modulation control. **+** *Excellent analogue sounds, mod control widens sonic vocabulary to include FM-like synth timbres, programmability well worth having; **-** dynamics not programmable, single decay control; **-** a very neat analogue kit, especially when triggered by same company's Super Pads (£299 for five with stands).*

Programmer 8 – £199 Eight-channel drum sequencing software for ZX81, Spectrum or Commodore 64 computers. **+** *Superb graphics display similar to Roland TR707/Yamaha RX software, hardware can be triggered by just*

*about any electronic percussion device; **-** Sinclair models lack sync facility, have software stored on tape; **-** well-considered package that makes drum programming a cinch and is capable of remembering an entire set's worth of rhythm patterns.*

PEARL

DRX1 – £1020 Five-pad analogue electronic drum kit with eight user-programmable kit sounds. **+** *Superb, responsive pads are among best available, unique Overtone control makes Latin Percussion sounds a possibility; **-** basic drum sounds lack character, kit a little pricey, needs overall volume control; **-** more than many, a drummer's electronic kit, or what you'd expect from an acoustic drum manufacturer.*

ROLAND

DDR30 – £1950 Digital electronic drum kit. Six-voice rack-mounted sound module, eight memories per voice, 32 kit memories, MIDI In and Out, individual and stereo outputs. *To be reviewed.*

SIMMONS

Clap Trap – £75 Single percussion unit for clap and similar sounds, now in second (digital) generation, internal trigger source, triggers to footswitch/mic/tape.

SDS1 – £250 Single pad digital module/pad. Derives sound from EPROM, battery power,

external trigger.

SDS6 – £1435 Eight-channel programmable drum sequencer. Programmable dynamics, 250 patterns per sequence, MIDI-equipped. **+** *Marvellous (and much-copied) LED pattern display, new-found MIDI compatibility; **-** a little bit expensive, all things considered; **-** a custom sequencer that makes an awful lot of sense for existing Simmons owners.*

SDS7 – £2156 Five-channel analogue/digital hybrid electronic drum kit. Expandable to 12 channels, each channel has individually-controllable analogue, digital and noise sound sources, 100 different 'kit' programs. **+** *Unrivalled sonic flexibility thanks to variety of sound sources, handy 'pad' program selector, impeccable pad design; **-** if you can afford it, nothing; **-** rapidly becoming to the electronic drum world what the LinnDrum is to the drum machine market, and deservedly so: MIDI coming soon.*

SDS9 – £1200 Five-channel analogue/digital hybrid electronic drum kit. Interchangeable PROM sounds, 20 user-programmable kits, 20 factory-programmed kits, auto-trigger facility, tape storage of sounds, individual outputs, MIDI-equipped. *To be reviewed.*

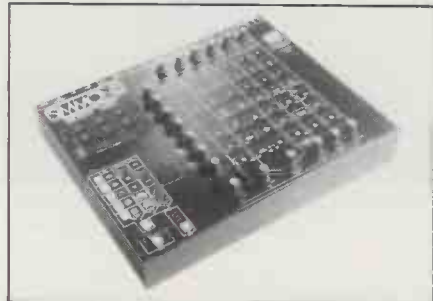

Subscribe Now!



SUBSCRIBE NOW to the biggest selling UK music monthly with a worldwide readership from Cambridge to Cape Town. With coverage of all the latest in instruments, computer music, keyboard amplification and accessories, plus interviews with the leading artists and performers of the day – can you afford to do without it? The subscription rates for 12 issues:

UK & Eire £15.50
 Europe & Overseas (surface mail) £16.20
 Airmail (Europe) £23.50
 Airmail (outside Europe) £37.50

(Please note that payment from overseas subscribers including Eire should be covered by a bankers' draft in pounds sterling.)

Please fill in the coupon below, and enclose it with your cheque or bankers' draft (made payable to Music Maker Publications) to: Mail Order Dept, ELECTRONICS & MUSIC MAKER, Alexander House, 1 Milton Road, Cambridge CB4 1UY.

Please send me the next 12 issues of Electronics & Music Maker (commencing from the issue);
 I enclose a cheque/postal order/bankers' draft* for £15.50/£16.20/£23.50/£37.50* made payable to Music Maker Publications.

Please type or print clearly:

Name

Address

Postcode

*Please delete as applicable.

CHECKLIST

SDS200 - £360 Twin-channel analogue electronic tom synth. Individual, stereo and mix outputs. *To be reviewed.*

SDS400 - £550 Four-channel analogue electronic tom synth. Individual, stereo and mix outputs, run generator feature. *To be reviewed.*

SDS800 - £630 Four-channel analogue electronic drum kit. Bass drum, snare, two tom channels, individual, stereo and mix outputs, built-in run generator. *To be reviewed.*

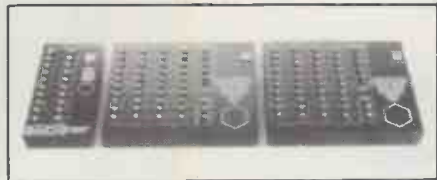

SDS EPB - £392 EPROM blower to be triggered by SDS7 and SDS1. Blows 8K and 16K EPROMs from onboard RAM, variable sample speed. **+** Quick, easy way of making your electronic drum kit sound like no-one else's, fits in neatly with Simmons scheme of things; **-** no avoiding the fact that sampling quality could be better; **=**

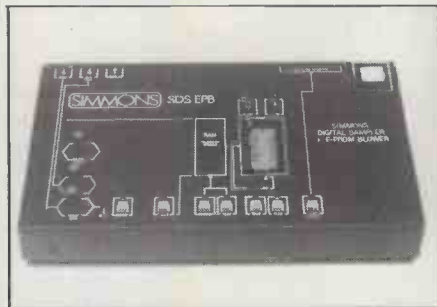

pioneer product that serves its purpose while leaving room for subsequent improvement. **v**

TAMA

Techstar TS500 - £930 Five-pad, six-channel analogue electronic drum kit. One preset and one user-programmable voice per channel, trigger inputs, individual and stereo outputs. **+** Generally good (if derivative) sounds, excellent pads, neat rimshot facility; **-** like so many imitators, it lacks character; **=** serviceable Simmons alternative from the first acoustic company to go hi-tech - with more products on the way in the very near future.

Techstar TS600 - £989 Six-channel analogue percussion synth. Four toms, synth and hand-claps, details as TS500.

TED

Digisound - £115 (single-sound), £149 (dual) Sampled-sound percussion machine triggered by built-in switch or external source. Sounds stored on EPROM. **+** High sound quality, ever-growing factory library of EPROM voices, now dynamic as well; **-** a teeny bit expensive, dual bass-and-snare model a bit silly as sounds can't be triggered together; **=** a neat electro-percussion add-on for non-drummers fed up with their drum-machine sounds.

Digimemory - £TBA Universal EPROM version of Digisound. *To be reviewed.*

The Winner - £TBA Microprocessor-controlled EPROM blower/programmer, built-in MIDI and serial computer interfacing. *To be reviewed.*

ULTIMATE PERC



UP5 - £555 Five-pad analogue electronic drum kit. Eight preset kit voicings, individual and stereo outputs. **+** Fine analogue sounds, follows Simmons philosophy of deliberately restricting range of sounds available; **-** nothing, save that it doesn't have Simmons written on it; **=** so long as you don't want access to a wide variety of drum sounds, the best way of getting into electronic drums.

K2 - £745 Analogue electronic drum kit. *To be reviewed.*

WERSI

CX5 - £TBA Electronic drum system comprising digitally-sampled drum sounds, five triggering pads, drum sequencer with 27 drum sounds, 64 pre-programmed rhythm patterns and one user-programmable song. Available September. *To be reviewed.*

GASPO!

Silly Summer Sale

Simmons SDS7 Kits from £1450

Roland TR909 Only £399

Roland TR606 Just £165

Guitars...some under half price

Rack mount DDL from £190

Huge discounts on all recording gear...Tascam prices slashed!

THERE'S NOTHING LIKE A NICE PUNT, IS THERE MR CROSSLAND?

SUPER SUMMER DEALS!

Here at J & C we are clearing all our ex hire & ex demo stock...everything must go at never to be repeated prices...so phone 021 643 4655/7...or come down to: 4/8 Smallbrook Queensway Birmingham

TELL 'EM ABOUT THE DEALS MR JONES, TELL 'EM ABOUT THE DEALS!

JONES+CROSSLAND

for the best prices in the U.K!

Amps by Peavey..JBL
Session..Fender..
Roland..Frazer..Wyatt

Keyboards you won't buy cheaper...Memory Moog as new £1400!
Jupiter 8 ex demo £1795...Roland JX8P S/H £1050...Yamaha KX5
Mother Keyboard new £199...ALL PRICES SLASHED ON
EXPANDERS & SEQUENCERS...S/H Roland MSQ700 £499...
Roland JX3P £675...Roland CSQ600 mono sequencer only £125...
Phone for more deal details on..Korg..Roland..Siel..Yamaha!
All interfaces..peripherals & other computer parts prices slashed!

Drums: Tama kits from £475..Yamaha kits New & S/H electronic kits from Simmons..Ultimate Percussion..Tama Techstar £699..Dynacord Percutter ex demo £899..Plus many more...
Cymbals: 25% off Zildjian & Paiste!

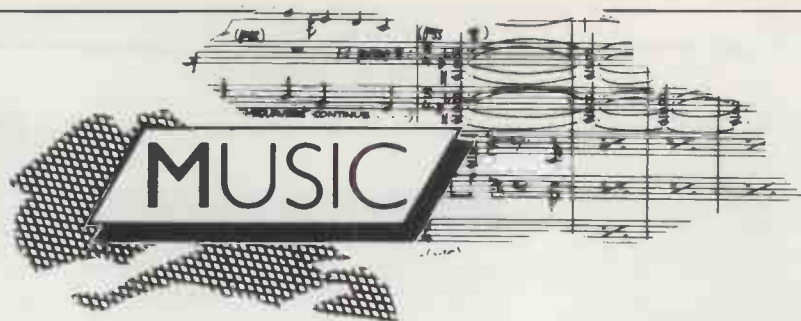

OUTTAKES

E&MM's intrepid music reviewers bite off more than they can chew, in the shape of a batch of readers' demo tapes, a video, a concert, and the usual crop of albums and singles. *Tim Goodyer & Dan Goldstein*

VINYL TAKES

Taking full advantage of the temporary adjournment in Police proceedings, **Stewart Copeland** has followed his excellent *Rumblefish* soundtrack with a quick scurry into the

African jungle to study its inhabitants and indigenous rhythms. The result of this venture currently takes the form of a video recounting its events, and an album covering most of the music on the video. Both bear the title *The Rhythmist*. What Copeland has actually done is to record a selection of African sounds, chants and rituals and subsequently rework them to his own ends, with the vocal

assistance of Ray Lema and a generous helping of computer technology. There is also, he admits, a certain amount of his own work in there too. The result is an album rich in surprising percussive sounds and high-brow technical manipulation. There are Police elements in there amongst all the tribalism, but the sounds that arise from this Afro-computer collision are well outside the blond



trio's regular beat, and well worth a listen. Some of the songs aren't bad, either.



From a little closer to home we find Pete Burns and his men, **Dead Or Alive**. On first hearing, *Youthquake* isn't up to the standard of its predecessor *Sophisticated Boom Boom*. The band have moved still further away from the hard funk they previously revelled in, so it's easy to jump to the conclusion that Burns and his sparring partners have softened up in a jelly-mould of electronics. Not so. A second listen quickly reveals that while some of the songs might lack instant appeal, they're by no means inferior to what has gone before. 'In Too Deep' is the wonderful 45rpm successor to the drabness of 'Lover Come Back to Me', and of course, there's always the irresistibly boppy 'You Spin Me Round' and brass-enveloped 'DJ Hit That Button'. The sound remains stark, electronic and expertly arranged, and there's the obligatory Fairlight to help the proceedings along where necessary. It's not breaking any new ground, but it's a lot of fun.

An unexpected cocktail of talent lies behind the **Paul Hardcastle** remixes of four Ian Dury oldies. The songs in question are 'Hit Me With Your Rhythm Stick', 'Sex & Drugs & Rock & Roll', 'Reasons To Be Cheerful' and 'Wake Up (And Make Love To Me)' and come packaged in a conventional 12" format. The result? It's funny, but it sounds exactly how you'd expect it to! In each case, we find the original track interspersed with '19'-type sequence and repeated sample work that even goes to the point of introducing elements of one song into another. On the negative side, this particular 'Wake Up' is in very great danger of turning into 'Billie Jean', and I know this isn't going to find favour in many quarters – ex-Blockhead and co-writer Chaz Jankel to name but one. It certainly won't be remembered in the same way as the original mixes, but I like it.

Four tracks from the forthcoming live double album constitute the new EP from featured-band **Level 42**, with both the EP and album titled *A Physical Presence*. This is the first live release from a band who've enjoyed a particularly loyal concert following almost from their inception. The EP features one previously unreleased track – 'Follow Me'. It's situated at the start of side one, so is presumably the justification for the record's release. There's no denying the standards of musicianship here; Mark King's thumb is well up to scratch on 'Mr Pink'. But the overall sound is a little thin, being at its weakest on the synth lead from 'Turn It On'. Still, that's

nothing unusual for a live recording, and the sound improves nicely with an increase in replay volume.

By contrast, the current single release from **Shriekback** – 'Nemesis' – is very, very strong; *noisy*, even. I was never all that impressed by Mr Andrews' contribution to XTC but, with the formation of Shriekback, came new hope and seemingly great potential. The band still possess that potential, but they're no closer to realising it now than they've ever been. The song is a clever cross-breed of pop song and chic chant, but it lacks an elusive, essential ingredient that would make it exciting music. The single takes the now-familiar double-single form and includes three live tracks – the charmingly-titled 'Suck', 'Mothloop' and 'Feelers'. I guess the only claim to fame the band can legitimately make is the rhyming of 'carthenogenesis' with 'nemesis'. It must have taken them days to think of that one.

When a list of contributing musicians includes the likes of Marcus Miller, Mark Knopfler, Omar Hakim, Nile Rodgers and Tony Levin, you have a right to hold at least reasonably high expectations of it. Even more so when the singer fronting this collection is



Bryan Ferry. As a prime mover behind Roxy Music, Ferry has fronted one of the most consistently fresh and invigorating bands in English rock history, as well as coming up with some meritworthy releases on his own account.

All of which makes it disappointing to find his latest solo outing, *Boys and Girls*, no more than a shadow of its predecessors. The immaculate (six-studio) production, faultless arrangement and impassioned, heartfelt vocals are all there as before, but the new album is in desperate need of a good foundation on which these building blocks can be laid.

Of the nine pieces on *Boys and Girls*, only 'The Chosen One' (spirited sequencer thrash under delightfully multitracked vocals) and the title-track (quiet drum machine and piano ballad) spring any surprises. The rest are predictable, formulaised and formless – a collection of immaculately-presented cameo pieces with precious little going on beneath the surface.

Maybe next time, Ferry'll spend a little less effort flying between overseas recording studios and recruiting more session musicians than it takes to make a Wham! album. Then we might see some music.

DEMO TAKES

Some musicians seek international recognition for their work, whilst others are content merely to see their names in print and receive a little criticism to help them on their way. But one thing they all have in common is their recourse to E&MM's Demotakes column.

The story so far. An Italian guitarist living and looking for a decent band or sessions in London sends his second demo to E&MM. The first one received no recognition but, being dedicated to his art, the artist perseveres at home with his TEAC 244, Simmons kit and trusty Schecter strat.

The outcome: five untitled, instrumental tracks of strong jazzy inclination, displaying an unusual degree of guitar virtuosity set unflatteringly against dryly-recorded electronic drums.

The musician in question is *Pino Consentini*, and all his material is undeniably both well-written and well-played, but would benefit greatly from improved production, and some sort of musical partnership to help eliminate the over-indulgencies our hero periodically allows himself. The fifth track is of particular note, but owes just a little too much to John Goodsall for complete comfort.

A single track entitled simply 'Hellen' is the showpiece for *Martin Straw*'s two linked ARP Quadras (very commonplace). The piece explores the textural alternatives to the world of vocal music, and with its richer-than-rich string sounds and fatter-than-that bass sounds, cannot fail to impress. Bearing in mind the mix has been executed in the complete absence of monitor speakers, the sound is well balanced – the product of either a very good ear or a charmed life. Unfortunately, the occasional but painful clash of bass notes suggests the latter explanation. I'd reckon this to be the result of inadequate preparation, and the feeling conveyed by this high-quality chaos is similar to a scene of awesome destruction in a Spielberg extravaganza. Never forget that sounds, whilst of great importance, are no substitute for musical structure.

After an uninspiring start, *A J Slater*, the man behind *Out Of Order*, finally makes good with the second side of his demo. Not that I'm trying to encourage an influx of over-long readers' tapes, you understand, as it wouldn't assist their appraisal in the slightest. But with cheap electric piano imitations and vocals of dubious pitching swept gaily aside, the songs on side two definitely warrant approval. The vocal undergoes an instant improvement through the inclusion of guest vocalist Gillian and the employment of double-tracking in her absence. The synth sounds, too, are more alive and appealing, restoring the faith in the Juno 60 that side one had depleted. Major failing of the revitalised *Out Of Order* is the common one of inadequate drum machine sounds and programming. Here the situation is highlighted by the exclusion of the offending Amdek in favour of what sounds like a pair of drum sticks used to keep time on one piece. The result is a real song instead of just a demo.

Recorded in a 24-track with the assistance of a thoroughly enviable list of equipment (it includes such goodies as an Emulator II, DX7,

▷ Prophet 5), this next is a very high-quality demo indeed. The aim of *The Screaming Trees* is to achieve commercial success and,



judging by Canadian gig reviews, they seem to be receiving a measure of that across the Atlantic already.

The music can only be described as American Rock. In other words, it takes none of the risks homegrown artists take so encouragingly at all levels. That said, the songs are all original, well performed, well arranged and well recorded. A little allegiance is owing to other, similar bands the likes of Styx, but there's the odd moment of inspiration like the opening of 'Call Me', which has some nice interplay between the Simmons drums and the Drumulator.

A polished and professional demo, but like package tours to Majorca, there's enough of this sort of thing around already.

If you've made a demo you're happy with and want a second opinion, send it securely wrapped (accidents do happen) to Demotakes, E&MM, Alexander House, 1 Milton Road, Cambridge CB4 1UY, including a recent photo and as many technical details as you can.

VIDEO TAKES

The video incarnation of *The Rhythmist* runs for 58 minutes, and is possessed of a storyline that could only be the work of **Stewart Copeland**. The venture is produced and directed by Jean Pierre Dutilleux, who also co-wrote the plot with our Stu.

The storyline has Copeland as the enigmatic Rhythmist who, with obligatory female company, makes ever more (in)consequential discoveries about African culture and draws ever more pretentious conclusions from them. Fortunately, it's all healthily tongue-in-cheek, so no worries on that score.

Only cause for concern is the editing, which doesn't let the film dwell long enough on any particular scene; the result is an ill-paced hotch-potch of images and ideas that are forgotten almost before they've left the screen.

The music makes up for the visual shortcomings, though. It's similar, on the whole, to the soundtrack LP just reviewed, but the extracts are shorter and less rambling, and there's a bigger variety of music to boot.

Worth seeing, so long as you don't take it too seriously.

LIVE TAKES

A small, crowded and sweaty jazz club – Islington's Bass Clef – was the venue chosen for **Patrick Moraz** and **Bill Bruford** to

showcase some of the material from their new album, *Flags*, and do more than a little improvising around it. Moraz' mastery of grand piano and Kurzweil 250, and Bruford's expert manoeuvring around a mixture of acoustic and Simmons drums, should have made the gig a veritable gem. But it wasn't to be.

The recurrent failure of the Kurzweil – presumably due to the heat and humidity – did nothing to help matters, but the shortcoming was fundamentally a musical one. From a fairly

promising opening, the material quickly revealed itself to be too unstructured to hold anyone's attention for any length of time, a fact underlined by the audience response to a piece from Moraz' solo past, 'Cachaca'.

More positive was a healthily inventive Bruford interpretation of Max Roach's 'The Drum Also Waltzes' – now that saw acoustics and electronics juxtaposed as well as we know they can be. Both musicians were on excellent form, and assuming you could see it, their technique was breathtaking. ■

230 High Street
Barnet Herts
01 440 3449

ESS
MUSIC

**SAMPLE
IT
NOW**



CREATE A WHOLE
NEW WORLD OF
MUSICAL SOUNDS
- ENJOY FREEDOM
FROM MONOTONY
BE YOURSELF
BUT ABOVE ALL...
DO IT NOW!



YAMAHA

**Hi-TECH, MIDI AND
SOFTWARE SUPPORT
NEW STUDIO EQUIPMENT
GUITARS AND BASSES**

Roland BACK AT ESS NOW!

KORG®

**DIGITAL WAVE SYNTH
SUPER DRUMS, POLY 800**



**Dynacord
DIGITAL REVERB**

Umm
British Made
SUPER VALUE

PERLEY
Smile - you CAN afford it!

WASHBURN
GUITARS & BASSES

IT COSTS NO MORE!

To buy from ESS We promise you
service, support and **DEALS**

230 High Street • Barnet • Herts • 01 440 3449

■ ACCESS ■ VISA ■ AMERICAN EXPRESS ■ DINERS
■ HFC ■ MAIL ORDER ■ TRANCASH №3038556
OPEN 10am ~ 7pm EVERY WEEKDAY
9-30 ~ 5-30 SATURDAYS

THE NEW SIMMONS SDS 800 SERIES



SDS 200 TOM TOM SYSTEM

SDS 800 DRUM KIT

SDS 400 TOM TOM SYSTEM

Take it any way you like.

There's never been a more flexible, better value for money way to play the power and versatility of Simmons than our new SDS 800 series. A choice of three systems which can be used by themselves, or as an expandable part of any acoustic or electronic kit. Systems with a whole range of Simmons innovations, like new pads that play and respond as well as any acoustic kit. And play it your way. See your dealer for more information about the SDS 800 series soon.

SDS 200 TOM TOM SYSTEM

- 2 TOM TOM CHANNELS.
- NEW STYLE PADS.
- FLEXIBLE SOUND PROGRAMMING.
- UNIQUE 'SECOND SKIN' CONTROL.
- HEADPHONE JACK.



SDS 800 DRUM KIT

- 4 CHANNELS, WITH BASS, SNARE AND 2 TOM TOMS.
- FULLY PROGRAMMABLE RUN GENERATOR THAT LETS YOU PLAY A MULTI TOM FILL BY HITTING ONLY ONE PAD.
- NEW PADS FOR DYNAMITE DYNAMICS AND GREAT FEEL.
- FLEXIBLE SOUND PROGRAMMING.
- UNIQUE 'SECOND SKIN' CONTROL FOR DOUBLE-HEADED TOM SOUNDS.
- HEADPHONE JACK SO YOU CAN PLAY, WITHOUT THE NEIGHBOURS PLAYING UP.

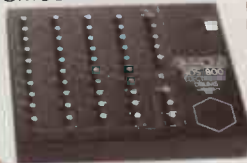

SDS 400 TOM TOM SYSTEM

- 4 TOM TOM CHANNELS.
- FULLY PROGRAMMABLE RUN GENERATOR.
- NEW STYLE PADS.
- FLEXIBLE SOUND PROGRAMMING.
- UNIQUE 'SECOND SKIN' CONTROL.
- HEADPHONE JACK.



SIMMONS

SIMMONS ELECTRONICS LTD. ALBAN PARK, HATFIELD ROAD, ST. ALBANS, HERTS. AL4 0JH

TEL: (0727) 36191 (5 LINES)
TELEX: 291326 HEXDRM G.

The Tools

RX11 - PCM Digital Rhythm Programmer



KX88 - Virtuoso Master Controller Keyboard

Never before has the musician had more creative power at his finger tips. And never before has Yamaha had so much to offer the creative musician in terms of complete MIDI musical systems:

Digital drum machines that capture the excitement and

purity of live drums whilst offering the relative novice the technique and expressive power of an experienced drummer.

A beautifully weighted Master Keyboard that feels like a grand piano and controls sound like anything you can imagine; and some things you can't.

QX7 Digital Sequence Recorder
(8100 notes; 2-track logic)

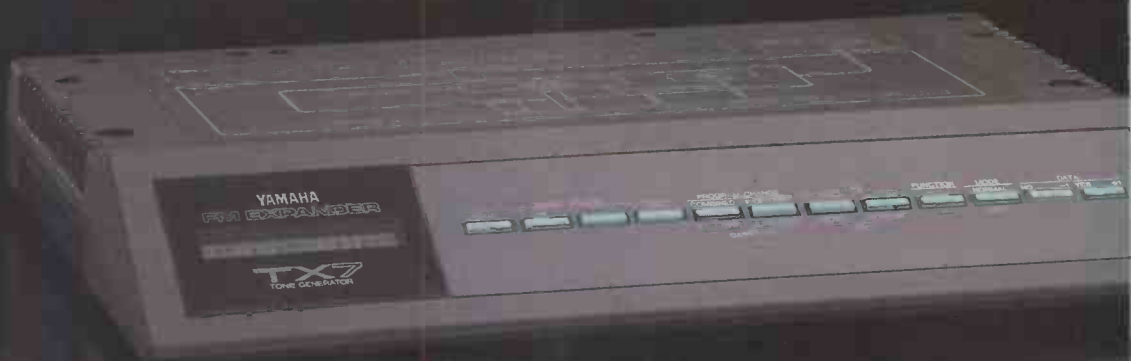

TX7 FM Tone Generator
(32 voice; 32 Function + 32 DX Function Memories)

Expression



TX816 - FM Tone Generation System (DX7 x 8)
QX1 - 8-track Digital Sequence Recorder

The extraordinary musical eloquence of digital FM synthesis available in modular form as the ultimate source for the creation of those sounds.

And sophisticated sequencers that allow complete dynamic scores to be written and executed by the composer

with uncompromised artistic control and integrity.

Whether you're an experienced professional or just starting out, you can trust Yamaha to have the right system to suit your needs.

Yamaha Musical Instruments: More Than Just An Expression

RX15 PCM Digital Rhythm Programmer



 **YAMAHA**
MUSICAL INSTRUMENTS

● MOUNT AVENUE BLETCHLEY MILTON KEYNES, BUCKS, MK1 1JE
☎ (0908) 640202 24hr Ansaphone (0908) 649222

TAKE TWO

Moraz and Bruford Embrace
the New

They started their career together as a piano and drums group, but now, two of modern music's most distinctive instrumentalists have added high technology to their line-up. *Dan Goldstein*

It's a hot, sticky Sunday afternoon in Central London, and two musicians, both as experienced in and as dexterous at their craft as any you could wish to meet, are in the throes of a last-ditch attempt to salvage some semblance of a live set from a recorded repertoire that's been almost entirely improvisational. The scene is Good Earth Studios, a sprawling underground reording complex with an over-enthusiastic air-conditioning system that succeeds in making the interior as

chilly as the exterior is humid. Even so, the players in question, drummer Bill Bruford and keyboardist Patrick Moraz, are sweating from their endeavours, and are initially reluctant to take a break from them.

'It'll have to be quick', mutters Bruford as he enters a rest room for some coffee. 'We've got a gig to do on Tuesday and it isn't really happening.' But it isn't quick. Both artists have got a lot worth saying, and given a little journalistic prompting,

are more than happy to dedicate some of it to tape.

Bruford is taller, calmer and more confident than his new-found musical partner. His list of playing credits reads like a catalogue of English seventies progressive rock: spells with Yes, Genesis, National Health, UK, a short-lived eponymously-titled outfit, and most recently, the rejuvenated King Crimson. His speech is clear and economical, but blissfully free of crass generalisation or unprovoked criticism of fellow musicians. And his prowess as a drummer, of course, is beyond question.

By contrast, Moraz is nervous, jittery and difficult to pin down. Like many great musicians, he's so addicted to what he does that any interruption to his train of composing thought is greeted with a shrug of the shoulders and an expression that says 'Can't you see I'm *playing* here?'. Eventually, though, the Swiss-born multikeyboardist warms to the prospect of a musician's conversation. Thoughts of his equally impeccable pedigree (Yes, The Moody Blues, and a broader range of solo projects than most composers are capable of undertaking in a lifetime, let alone the decade or so they've taken Moraz) are soon swept to one side as he gets stuck into the real business of talking about what modern music is, how it's made and why people make it.

Background

The coupling is an odd one, certainly, but it's been in existence for a couple of years now. It's resulted in two LPs, the critically-acclaimed *Music for Piano and Drums*, and a new, more instrumentally-varied release called simply *Flags*. And now, the duo are embarking on a fairly lengthy (and geographically diverse) concert tour that's to serve more than just a promotional function; above all, Moraz and Bruford just want to play live, in front of an audience.

'But more of that later. The first, most obvious question that must be asked of any couple is 'why get together in the first place?'

Bruford has the reasons at his fingertips. 'The first is economics, the fact that it's a lot *cheaper* to record, rehearse and gig with two than it is with five or six. Musically, I think two is a good number



because it means nobody's fighting for anybody else's aural space. In King Crimson – and Patrick would probably say the same for The Moody Blues – you know you can't play as much as you want to because you'll end up clashing with what other people are doing, especially now that technology has given each musician such a wide range of available sound-generation. It's quite a strong discipline holding back like that, and with just the two of you playing, you know that no matter what you do, you won't be heading for a complete aural mess.

'Then there's the question of logistics. If you've ever been in a group, you'll know that the more people there are involved in it, the more difficult it is to organise. So that was an advantage, coupled with the fact that Patrick and I live about 400 yards from each other, which is also a great help, obviously.'

But what about music? Surely there must have been some common musical ground between the duo that made them want to play, compose and record together?

Bruford isn't sure. 'Um, I don't really know. Perhaps you'd better ask Patrick. Patrick, have we got anything in common, musically?' Moraz pauses, for quite a while. Then: 'No. No, not really.' Now there's a strange feeling of unease in the room, as if a couple about to be married had suddenly realised they didn't like each other very much. Bruford continues the analogy in his own speech.

'I suppose it's a marriage of opposites. We're quite different from each other in many ways. We have very different personalities both inside and outside music. So to an extent, I think we agree to disagree.'

'There's a reason for that. It's important, I think, to have some degree of tension in a group, though it's equally important that you don't let that tension get out of hand. But if you have a group in which everybody agrees with each other most of the time, that can result in some very bland, predictable music. And if there's one thing that Patrick and I very much wanted to avoid when we started playing together, it was bland, predictable music.'

Improvisation

The route Moraz and Bruford have taken in their quest to avoid blandness and predictability is a well-trodden one: that of improvisation. As the supplier of melody, it falls to Moraz to do much of any initial writing the duo might feel is necessary, while Bruford feeds off him to derive a suitable percussion part, often giving the keyboardist some inspiration in return. It's a familiar enough pattern, but to find it used with such dedication and perception is rare – especially in the rock field.

In a fit of musicianly modesty, each player is anxious to apportion credit to the other. Bruford: 'Patrick is a very talented player, very quick, and very

adaptable. He's an excellent writer, but the speed is the main thing. When we got together, one thing we desperately wanted

'Just because you have a Kurzweil in the middle of the room, doesn't mean the 200-year-old Steinway in the corner doesn't have something to offer.'

to get away from was the endless rehearsing and six months to make an album that are the norm in a larger group format. So, that's been a major priority, to keep things as spontaneous and as rapid as possible.'

Moraz agrees. 'Although Bill and I have different personalities and different

musical tastes, we do have similar thoughts on writing and decision-making, so we work well together.'

'We want to make things happen as quickly as possible, and in some ways we have to, because we both have so many other musical commitments to fulfil outside this group. At the moment I'm recording a new album here with The Moody Blues, and rehearsing with Bill in my days off. Then there's a 15-minute modular symphony I have to write within the next two weeks – and I haven't even started it yet. So time is of the essence.'

'But being highly-polished musicians, working with a lot of high technology, means that we're in the fortunate position of being able to experiment first and worry about the results later. We can take liberties with the mechanics of making music, even though what comes out at the end isn't entirely satisfactory...'

'...I think that's what'll probably happen at some of our first live performances', interjects Bruford, clearly relishing the prospect. 'We're bound to make a lot of mistakes at first, and it's quite conceivable that Patrick will select the wrong sound on the synth and end up playing a strings



part on a piano. But that's what improvisation is all about. Nine times out of ten those mistakes don't really work and don't sound like anything more than mistakes, but on other occasions they do, and they show you an alternative way of playing something, a better way.

'That's one reason why I'm looking forward to playing live, because it introduces an element of risk that's even bigger than the one we're used to coping with in the studio. But then, I'm one of those eternal enthusiasts that's excited to play live period, no matter what attitudes I'm having to adopt. I expect the gigs to be fairly chaotic, maybe even rather wild, but the spirit will be there, and in any case, I rather like the chaos. It's not all that rare for chaos to turn into art overnight, and vice versa, of course.'

Instrumentation

If there's a recurring theme that runs through this duo's attitude to music-making, it's that self-limitation can be, paradoxically, the most broadening and eye-opening element. Their deliberate lack of rehearsal and pre-planning is one example of that ploy, and their choice of instrumentation is another.

As its title would imply, *Music for Piano and Drums* saw Moraz ditch his banks of synthesisers in favour of a traditional grand piano, and Bruford let electronics take a back seat to the open warmth and resonance of an acoustic drum kit. The technology was available to them, but they deliberately chose to avoid using it.

'It was by no means a facile or stupid idea', says Bruford. 'I think it's extremely good for musicians to realise – now and again – that just because you have, say, a Kurzweil in the middle of the room, doesn't mean to say Mr Steinway's 200-year-old creation in the corner doesn't still have something to offer. The older instruments are very, very beautiful, and it can be helpful to appreciate that once in a while.'

'What we're trying to do now with *Flags* is draw attention to the contrast that exists between those traditional instruments and the very latest that technology has to offer. Patrick is using just a grand piano and a Kurzweil 250, and I'm using a combination of acoustic drums and the Simmons SDS7. Both the Kurzweil and the Simmons represent the top level of today's technology, but we're missing out all that went on *between* the two landmarks, and that's the interesting thing.'

'It's an important and quite deliberate limitation. With *Piano and Drums* it felt as if we were painting with just red and blue, no other colours. This time around we've added perhaps green and yellow, so we've broadened things slightly, but the limitation is still there.'

'In many ways, I think you actually have more freedom when you're playing just the one instrument', Moraz continues. 'I've got all sorts of other keyboards, from

Mellotrons to the Yamaha GS1, but I feel I've got more opportunities when I've got just the piano or just the Kurzweil in front of me. If you've only got one instrument,

'We're in the fortunate position of being able to experiment with music first, and worry about the results later.'

there's nowhere else for you to run: you've got to solve the problem there and then. That's the sort of thing that makes you a better musician, I believe.'

Technology

Speaking of limitations leads us back to technological specifics. Since both men have embraced new musical technology with a great deal of enthusiasm, it seemed worth asking them if they felt there was anything left for modern musical technology to achieve. Is there a particular task that Moraz and Bruford would like to see tomorrow's musical instruments performing?

'Not really', Moraz muses. 'What's happening now is that technology is slowly breaking down the barriers between people and making music. Just working with Passport's Polywriter software, for instance, makes me realise that before very long, the skill of being able to write music in manuscript form will become largely redundant. Reading music will still be important, of course, but it's one less discipline that people are no longer forced to acquire.'

'The one really important thing technology can't do at the moment is participate in the writing process. But even that doesn't seem to be very far away. Something like the Kurzweil, for instance, is so intellectually powerful that it could easily be adapted to actually write music for you. I'm not suggesting that it would be nice to get rid of composers altogether, but to have the combination of human and computerised composition would be interesting, I think.'

Not surprisingly, Bruford isn't quite so full of praise for what contemporary percussion technology has to offer, but he's no less confident that progress will continue to be made – and fast.

'Patrick is at an advantage because as a keyboard player, he's automatically given access to whatever technological developments occur. That's just traditional – scientists and researchers use keyboards as controllers because they're the most versatile instruments designed – but drummers aren't that far behind. Things are moving quite fast now, and

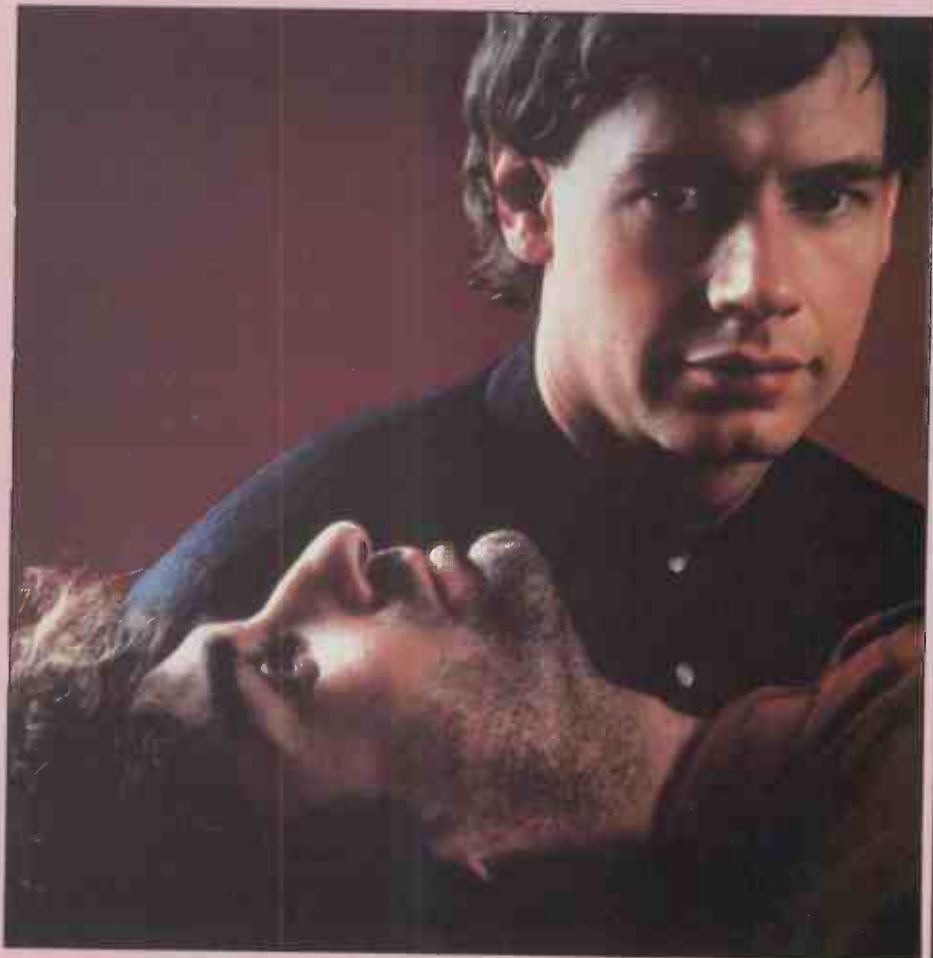

DEMONSTRATION
TAPE AVAILABLE
£2.90 INC. VAT

DIGITAL SAMPLING & DELAY LINE

THE INCREDIBLE **MCS-1** MIDI CONTROLLED

The MCS-1 will take any sound, store it and play it back from a keyboard (either MIDI or 1V/octave). Pitch bend or vibrato can be added and infinite sustain is possible thanks to a sophisticated looping system.

All the usual delay line features (Vibrato, Phasing, Flanging, ADT, Echo) are available with delays of up to 32 secs. A special interface enables sampled sounds to be stored digitally on a floppy disc via a BBC microcomputer.

Thanks to bulk component purchases and increased production capacity the MCS-1 is now available ready built, complete at the incredible price of **£649.00 inc. VAT.**

Kit Option
available
£499.00 inc. VAT



Specification:

Memory Size: Variable from 8 bytes to 64K bytes.
Storage time at 32 KHz sampling rate: 2 seconds.
Storage time at 8 KHz sampling rate: 8 seconds.
Longest replay time (for special effects): 32 seconds.
Converters. ADC & DAC: 8-bit companding.
Dynamic range: 72 dB.
Audio Bandwidth: Variable from 12 KHz to 300 Hz.
Internal 4 pole tracking filters for anti-aliasing and recovery.
Programmable wide range sinewave sweep generator.
MIDI control range: 5 octaves.
+1 V/octave control range: 2 octave with optional transpose of a further 5 octaves.

POWERTRAN

CYBERNETICS LIMITED

POWERTRAN CYBERNETICS LIMITED
Portway Industrial Estate, Andover, Hants SP10 3EM, England
Telephone: Andover (0264) 64455
Access/Visa cardholders – save time – order by phone.

certainly, something like the SDS7 is a big step forward.

'I'd say the sounds are probably all there now – these days I can even play pitched sounds on the drums while Patrick plays percussion sounds on the Kurzweil – so all that remains is the feel of the pads, that sort of thing. Drummers still aren't nearly as well catered-for as keyboard players in that respect, so there's still a lot of room for improvement when it comes to actually *hitting* an electronic drum and getting the feel and response of an acoustic one. But I do think progress is being made, and it won't be too long before things are more or less perfect.'

Criticism

Behind all this technology, of course, lies a desire to increase musical proficiency and dexterity that is clearly still present in the minds of both players, despite the enormity of their past achievements and the performing skill they exude in such vast quantities. Refreshingly, they seem to possess humility in abundance, and are constantly striving to improve their standing as musicians.

'Being your own critic is one of the most difficult things to sustain', says Bruford. 'But it can also be extremely rewarding. One of the most important things is not to get too carried away by adulation. Both of us have had plenty of that at some point during our careers, but we've also been around long enough to have had periods of great unpopularity as well, and that's not necessarily a bad thing. If you're criticised by somebody else, it makes you more inclined to start criticising yourself, makes it more likely that you'll start seeing your own faults. And as soon as you recognise your faults, you can go about correcting them.'

'I suppose the *best* way to improve your abilities is simply to carry on playing, as often and in as many different sets of circumstances as you can. It's difficult to put a finger on, but just being involved, daily, in an environment of high musical endeavour with Patrick makes me realise very clearly where my shortcomings lie, and just how big they are.'

It's more or less at this point that Moraz and Bruford realise that time is catching up with them, and that if our conversation is to continue, it's going to have to be in the main studio area while the duo resume their rehearsing.

As they begin, it's clear that things aren't 'really happening' now either, and both players start exhibiting signs of strain. How long can they continue like this?

Bruford: 'Oh, as long as we want to. I think both of us feel we're still some way off achieving what we really set out to achieve when we first formed the group. And I think we're both prepared to wait for quite a while before it starts to really come together.'

'It's ironic in a sense. The actual mechanics of our playing together take

place very quickly, so that, for instance, we only took five days to record *Flags*. But at the same time, the process of actually achieving our goals is a very lengthy, drawn-out one. It'll probably take years, in fact, perhaps ten albums or more.'

Five minutes ago, author and photographer would have dreaded the thought of another ten Moraz and Bruford LPs being foisted on the general public. Suddenly, however, the music emanating from the speaker system at Good Earth Studios has taken a distinct turn for the better. Where just a few moments before it had been disjointed and embarrassingly 'untogether', it now acquired a natural, pleasing flow that let us forget our prejudices and sit back, relaxed, in appreciation of two highly-talented instrumentalists going flat-out.

Like most improvised music, this is essentially a conversation between the participants that can easily leave an audience unmoved. The more dexterous those participants are, the more intense their dialogue becomes. And the more that happens, the more incidental the audience seems to be.

But in spite of that, Moraz and Bruford believe quite strongly that they are there to entertain their audience, and that they stand a better-than-average chance of doing just that.

'I suppose we are playing for ourselves first and foremost, because we're trying to achieve an elusive, almost unreachable goal that's unique to us. But I think almost all musicians go through that. They spend time sorting the good points from what they do and discarding all the dead wood, and all the time they're doing that, they're getting closer to attaining their particular goal.'

'So I think our music will undoubtedly appeal to a good many musicians who can put themselves in our shoes, if you know what I mean. And I don't see any reason why ordinary listeners – people who've never played a musical instrument in their lives – shouldn't find something in it, either. Obviously, we can't listen to what we do using precisely the same criteria a non-musician would, but we can get close to that.'

'One thing we wouldn't want to do, though, is compromise our music simply to satisfy the needs of the mass market. I mean, if the record company rang us up and told us they wanted *Flags* to be the next thing for teenage girls to fall in love with, I don't think we'd bother to take them seriously.'

Fair enough. Moraz and Bruford have been around too long to have to put up with that sort of compromise again. They're fortunate to have stayed the (quicken) pace of contemporary music, and they're equally fortunate to have almost complete artistic freedom now that they're approaching musical maturity. You get the impression that if that freedom was ever taken away from them, they'd probably just shut up shop and call it a day. ■

Akai (UK) Limited-Electronic Music Division, Haslemere Heathrow Estate, Silver Jubilee Way, Parkway, Hounslow, Middlesex TW4 6NF.
Telephone: 01-897 6388
Telex: 892555 AKAIUK G.

Stockists:

Aberdeen

Bruce Miller, 363 Union Street, Aberdeen, Scotland.

Cambridge

Cambridge Rock, 8 Burleigh St, Cambridge, Cambs.

Cardiff

Music Land, 148-152 North Road, Cardiff, S. Wales.

Chelmsford

Future Music, 10 Baddow Road, Chelmsford, Essex.

Eastbourne

Peter Bonner Musical, 12a Grove Road, Eastbourne, E. Sussex.

Edinburgh

Gordon Simpson Ltd, 6 Stafford Street, Edinburgh, Scotland.

Fleet

Kingfisher Music Co, 20 Kings Road, Fleet, Hampshire.

Glasgow

McCormacks Music, 29-33 Bath Street, Glasgow, Scotland.

Liverpool

Hesseys Music Centre, 62 Stanley Street, Liverpool.

London

Freedmans, 627-631 High Street, Leytonstone, London E11.

London Rock Shops, 26 Chalk Farm Road, London NW1.

Turnkey, 14 Percy Street, London W1.

Syco Systems, 20 Conduit Place, London, W2.

Chromatix, 12 Oak Road, Ealing Broadway Centre, London W5.

Rod Argent Keyboards, 20 Denmark Street, London WC2.

Gig Sounds, 86-88 Mitchum Lane, London SW16.

Maidstone

E & S Electronics, 2 Upper Fant Road, Maidstone, Kent.

Manchester

A1 Music Centre, 88 Oxford Street, Manchester.

Newcastle-upon-Tyne

Rock City Music Ltd, 10 Moseley Street, Newcastle-upon-Tyne.

North Mansfield

Carlsbro Sound Centres, 182-184 Chesterfield Road, North Mansfield, Notts.

Romford

Monkey Business, 66 Victoria Road, Romford, Essex.

Swindon

John Holmes Music, 21-23 Faringdon Road, Swindon, Wilts.

AKAI

A new world of sound creation



NOW AN INCREDIBLE EXPERIENCE IN SOUND CREATION...

THE AX80 SYNTHESISER

The AX80 is an 8-voice programmable polyphonic synthesiser which offers the unique combination of great sound, easy operation, and the best of today's music technology.

Just look at the features: stylish, well laid-out front panel; reliable touch-pad selection controls accessing 32 factory presets plus 64 user-defined sounds; single-touch editing; touch-sensitive keyboard; and fluorescent bargraph display of sound parameters. It all adds up to a synth which combines the familiarity of 'analogue' controls with digital precision.

And, of course, there's the MIDI interface, allowing you to link the AX80 into other modern music systems.

It's that special combination of versatility and ease of use that gives the AX80 and the whole AKAI Micro Studio System, the edge. If you're looking for a new creative experience, AKAI's got your sound.

For stockists see facing page.

AKAI

A new world of sound creation

IMPROBABILITY FACTOR: 42

With the help of keys player Mike Lindup, British funksters Level 42 approach normality with the impending release of a live double album. The interviewer fails to follow suit. *Tim Goodyer*

They're affectionately known as 'the boys from the Isle of Wight'. They borrowed Douglas Adams' favourite hitchhiking number, 42, for part of their name. And they've established themselves as one of the best funk bands Britain has produced in the last five years.

Yet in spite of achieving a considerable amount of chart success, Level 42 are still recognised primarily for their live performance. Many would rightly deem a live album to be long overdue, so the imminent release of a live double (appositely-titled *A Physical Presence*) should satiate a lot of appetites. An EP of the same name (featuring one previously unreleased track plus three more – all recorded live) will also be available by the time you read this, so you'd be forgiven for thinking the funk

'If you're making something that's going to be listened to over and over again, you've got to be a little bit perfectionist about it.'

foursome would be taking a well-earned break during the summer.

But nothing could be further from the truth. They'd just finished recording (and were about to begin mixing) the album that's to follow *A Physical Presence* at London's Maison Rouge studios when your intrepid reporter caught up with them.

I suppose it'd be fair to say that most people identify Level 42 with the dexterity of their bass player and lead singer, Mark King. But he's by no means the group's only strong suit. All four band members can do more than hold their heads above water in the playing skill department, and Mike Lindup, to whom most of the keyboard-playing duties fall and whose main claim to fame is that he's the only Leveller *not* to hail from the Isle of Wight, is no exception.

So, I'll shut up for a while and let him do all the talking...

A History

'I started piano lessons when I was five or six and also took up violin for about a year, but that didn't work out. It's a hellish instrument to try to get a good sound out of, especially when



you're six!

'But I carried on with the piano and went to a specialist music school in Manchester that takes people by audition, and covers academic subjects as well as a whole musical curriculum. Whilst I was there I took up percussion and, on reaching school-leaving age, I went to the Guildhall School of Music in London with percussion as a first study – though still continuing with the piano.

'Both my parents were musicians so I was always surrounded by music, but I think it was at college that I really got interested in music that wasn't classical. The college library had some key records in it – things like Herbie Hancock's *Head Hunters* and some Miles Davis. It was all stuff I'd heard vaguely but never really listened to before, so it was then that I started to enjoy listening to jazz and so on.'

That's all very well, but what about a practical involvement in music? When did

Lindup realise he'd had enough listening and wanted to do some professional playing instead?

'Well, it was at that time that we formed a band in which I played drums. It wasn't particularly good, but it was good fun. Then, in the second year at college, I met Phil (Gould, Level 42's drummer) because he was having lessons from the same tutor I was. One day I walked in and he was on the college drum kit doing the kind of thing I'd only heard before on Billy Cobham records. Over the next few months he introduced me to Mark (King) and Boon (Gould, Phil's brother and Level 42's guitarist). Mark was a drummer originally too, but he was working selling basses because he couldn't get a job selling drums, so it was there that he taught himself to play bass.

'We all used to get together and talk about how great it would be to have a band, and it finally started to come together around the start of '79. We wrote our own instrumental



stuff and were managed by John Gould, the third Gould brother, who worked for MCA Records. He knew Andy Soija who had a London-based independent label called Elite Records, and invited him down to hear us at a rehearsal studio. We played him all our stuff – which we thought was great – and he wasn't too impressed. So we started going through the dregs – all the riffs we had left.

'We finally played him a riff that he said he really liked, but it had to be a song; if we could put some lyrics to it, we were in business. Not wanting to miss the opportunity of a record deal, we did just that. We hadn't thought about singing but, as Mark had thought up the melody and thought he could make a good job of singing it, that's what he did. So we recorded 'Love Meeting Love' in a 16-track (and hiring all the instruments) and it turned out really well.'

So well, in fact, that the single made it to number 61 in the charts and brought the band a lot of attention as one of the new wave of British jazz-funk bands. Was it mostly luck?

'Andy Soija also had an import shop and knew that there would be a market for that track but, to us, it was just another one of our songs.'

The association with Elite, however, wasn't as fruitful as the band might have hoped – though it did produce another single, '(Flying on the) Wings of Love'. The projected album wasn't finished. 'We sort of fell out for various reasons – mainly to do with money!', Lindup recalls.

But then Polydor, who'd handled the band's record distribution thus far, were sufficiently impressed to step in and sign them – and team them up with producer Mike Vernon. The single that resulted, 'Love Games', and subsequent album *Level 42* climbed high in the charts, firmly establishing the foursome as a successful recording band. An unerringly steady string of high-charting singles and

albums has followed since then, and things are showing no sign of any slowing-up.

Live vs Studio

But the live Level 42 were already established – and going from strength to strength – by the time of their signing to Polydor. How did that side of the story come together?

'The live work started towards the end of 1980, though it wasn't very far afield; most of it was in the Home Counties.

'We don't consider ourselves to be primarily a live band, but I think we *do* come across very strongly live. There seems to be a great excitement whenever we play, and a lot of the music does seem to come alive in that situation.

'I've heard it said that the Synclavier is just a glorified DX7, but that's not being fair to it; it's got a much broader sound.'

'It sounds obvious, but the stage and the studio really are two very different environments. You go into the studio with new material and you don't even know how it will turn out, whereas live you're totally familiar with it and you can arrange it so that it will work really well. Then there's the fact that in the studio, you're making something that's going to be listened to over and over again, so you've got to be a little bit perfectionist about it. Mistakes and raw edges that are a part of live performance aren't really acceptable.

'Our fans are very loyal and something that pleases me is the across-the-board appeal we

seem to have. As well as the die-hard jazz-funkers that started with us, there are people of all ages and from different parts of the world that have heard and like the music. I think it's fantastic that we've got a style that isn't restricted to a fashionable clique.'

'So the gigging aim is one of excitement, but without the atmosphere of a concert hall and the additional medium of visuals to assist them, how do Level 42 achieve their enviable degree of success on vinyl?

'Well, we've always strived to achieve a strong sound on record, although it has been quite hard to do. That's really down to experience. This is our sixth album now, and we've learned a *lot*. It's an interesting learning process, trying to make what you hear in your head come out on an album.'

Some recording artists adopt the ploy of trying out fresh material on a live audience before committing it to tape, in an effort to make sure it receives a good reception. Level 42 would seem to be in a good position to take advantage of this, but they prefer to stay with the old favourites live until after the recording is completed.

'We've done that with 'Follow Me' on the live EP, which was received well but, on the other hand, when you go out and play a concert, people do want to hear certain tracks. If you play a set that's too unfamiliar, you're really not doing yourself any favours.'

Technology at Work

My guess is that Level 42 aren't exactly noted for technological innovation, yet there's always been a healthy awareness of, and readiness to use the latest the music hardware market has to offer. The band's last album, *True Colours*, was graced with the presence of a Fairlight, but the boys have moved on since then. How do you justify replacing a Fairlight?

'We've hired Geoff Downes' Synclavier for

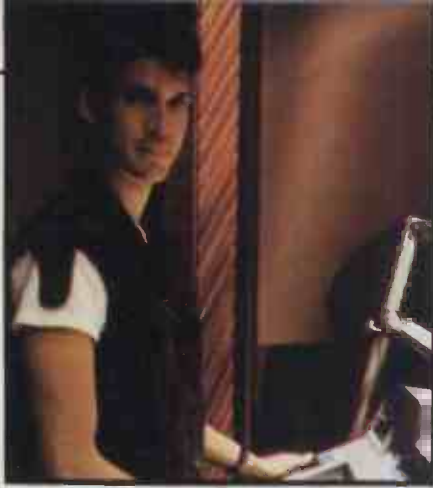

the album. It's such a flexible instrument. Sampling-wise it's brilliant – there isn't really anything that can touch it, not even an AMS, for sampling quality. And we've chosen to use it because Wally (Badarou, unofficial fifth member of the band) has his own Synclavier in Nassau.

'There's really no way we could have hired the Synclavier in and I could have played it straight away. Wally's had his for maybe one-and-a-half to two years now, and even he sometimes has difficulty if he comes up against a machine with recent updates that he hasn't got on his own. In fact, his has just been sent back to New England Digital for various updates like polyphonic sampling and 32 separate outputs. It's an incredible machine, it really is. Basically, when he gets it back he'll have his own digital recording studio – all he'll need is a PCM F1!

'Along with the DX7, the Fairlight has what the Synclavier hasn't in the form of good factory presets. Everyone's used them because they're good, and that's why you hear them a lot of the time. With the Synclavier, you're encouraged more to look for your own sounds. It's a matter of what you can make of it, and that only comes with familiarity. The synthesiser side of it is really good – I've heard that from the programs Wally's brought with him on disk. I've heard it said the Synclavier is a glorified DX7 but I don't think that's really being fair to it; it's got a much broader sound.'

The last time I saw Level 42, Lindup was using a Rhodes, MiniMoog and Prophet 5. Things have obviously changed a little since then, so what else is currently in residence on Lindup's keyboard stand?

'As well as the Synclavier on the album, I'm presently using a Prophet 5, a DX7, a Rhodes, a MiniMoog which I don't use on stage so much these days, a PPG Wave 2.3 which is a fairly recent acquisition, and also an Emulator II, which is an even more recent acquisition.

'The PPG is great. It has a sound all its own although I don't think it's as flexible as the Prophet – that's just personal taste, really. The idea of analogue controls on a digital synth is clever though. Having said that, the DX7 takes longer to program but is more accurate. The only problem I've found is that the one I've got is slightly unstable sometimes – it's very sensitive to power fluctuations, for instance.

'Live the keyboards have to be arranged for one player – me – so I need a set-up that'll allow me to do all I need to do without becoming too complex. I don't want to take out all the keyboards just for the sake of having them. Last year I used the Rhodes, Prophet, PPG and DX7, and that worked out really well. When we go out next I'll definitely be taking the Emulator because it's such a great instrument. I'm only scratching the surface of it at the moment, but it can certainly increase the possibilities of what you can do live.'

Not realising what they were letting themselves in for, the band let me hear rough mixes of a couple of songs from the new album. Some of the keyboard sounds were breathtaking. Tell us how, Mike...

'We've used all the keyboards on the album with the exception of the Rhodes. I always used to play Rhodes on the backing track, then overdub things and then maybe drop out the Rhodes. But you start thinking of synthesisers in different ways and using them more creatively, soundwise, when you work without that restriction. There are Rhodes-type sounds from the DX7 and Synclavier but a lot depends on the track, really.'

MIDI

You just can't talk keyboards these days without broaching the subject of MIDI. Sure enough, Lindup has found it a great, if as yet relatively unexplored, asset.

'We've used MIDI quite a lot on this album for sounds – because sounds are very important to us. One really successful combination that we've used is DX7 and Prophet 600 MIDI'd together. Good old analogue's still great – especially in the hands of a good programmer – and the DX7 is one of the most exciting synthesiser developments in recent years, so putting the two together offers all sorts of wonderful possibilities. The DX7 on its own is a bit thin; it's good for some things and not so good for others, but in combination with the Prophet 600, it can put a whole new colour on things.

'In Japan last August we supported a Japanese jazz-funk band, Casiopea, and their keyboard player had a DX1 MIDI'd to three DX7s – that was a very full sound. On the basis of that, the TX816 promises to be really interesting. I think it'll sound much more than it looks on paper.

'Funnily enough, I haven't used MIDI live yet, except for the sequencing on a couple of tracks like 'Hot Water'. I have an MSQ700 which I use with the DX7, and I think I'm going to be making a lot more of that when we go out again.'

And on the subject of sequencing, does it feature largely in the Level 42 scheme of things?

'We've used sequencing on several tracks, mostly from the Emulator and the Synclavier in particular. The Dr Click syncing unit has made things really easy – always having a click there means that you can sequence anything up at any stage.'

The Next Step

Trying to keep abreast of trends in new musical equipment is enough to keep you on your toes, at the very least. Is it as exciting as everyone's making out, or does Lindup feel things are getting out of hand?

'Reading magazines and so on, there's so much equipment coming out that you haven't really got enough time to collate information about a new product before there's something else that comes out that's better, cheaper and slightly more complicated. It is very exciting, but I need to go away for six months with something before I really get to know it.

'You can get really paranoid about not being up with the latest innovation – especially when you buy something and a year later it comes out cheaper and better. With the instruments that I've got now, there's so much I can do – particularly with the facility MIDI provides for combining sounds – that I shouldn't need to look for anything else in the next year or two years. But then again, I don't know what's going to be coming out, and as soon as you hear a great sound, there's a temptation to think "I must have that".'

'The only trouble is that if you don't hold yourself in check, you end up without any money!' I think this writer would probably vouch for that.

SOFTSEL®

It's available from your local Softsel dealer.

ADELPHI BUSINESS COMPUTERS LTD.
25 TRINITY STREET, COVENTRY,
WEST MIDLANDS CV1 1FJ.
TEL: (0203) 553944.

ADVANCED MICRO PRODUCTS
200 COURT ROAD, ELTHAM,
LONDON SE9 4EW.
TEL: (01) 851 3311.

COLIN GRACE ASSOCIATES LTD.
CLIFTON MEWS, 62 HIGH STREET,
SAFFRON WALDEN, ESSEX CB10 1EE.
TEL: (0799) 22532.

COMPUTER CITY
78 VICTORIA ROAD, WIDNES,
CHESHIRE WA8 7RA.
TEL: (051) 420 3333.

DEVERILL COMPUTER SERVICES LTD.
ITEC HOUSE, 34-40 WEST STREET,
POOLE, DORSET BH15 1LA.
TEL: (0202) 684441.

FAIRHURST INSTRUMENTS LTD.
WOODFORD ROAD, WILMSLOW
CHESHIRE SK9 2L.
TEL: (062) 553741.

GATE MICROSYSTEMS LTD.
ABBEY HOUSE, 10 BOTHWELL STREET,
GLASGOW, STRATHCLYDE G2 6NU.
TEL: (041) 221 9372.

MBS DATA EFFICIENCY,
MAXTED ROAD, HEMEL HEMPSTEAD,
HERTS HP2 7EL.
TEL: (0442) 60155.

PACE SOFTWARE SUPPLIES
92 NEW CROSS STREET, BRADFORD,
W. YORKS.
TEL: (0274) 729306.

PERSONAL COMPUTERS LTD.
220-226 BISHOPSGATE,
LONDON EC2M 4JS.
TEL: (01) 377 1200.

PROGRAMS UNLIMITED
19 IMPERIAL HOUSE, KINGSWAY,
LONDON WC1.
TEL: (01) 240 9006.

RAVEN COMPUTERS
28-32 CHEAPSIDE, BRADFORD,
YORKS BD1 4JA.
TEL: (0274) 309386.

STIRLING MICROSYSTEMS,
1 PARK ROAD,
LONDON NW1 6XE.
TEL: (01) 486 7671.

TASHA BUSINESS SYSTEMS
191 KENSINGTON HIGH STREET,
LONDON W8.
TEL: (01) 937 7896.

THAMES VALLEY SYSTEMS
GREYS HOUSE, 7 GREYFRIARS ROAD,
READING, BERKS RG1 1NU.
TEL: (0734) 581829.

UNITED SUMLOCK LTD.
36 KING STREET, BRISTOL,
AVON BS1 4DZ.
TEL: (0272) 276685.

MusicWorks™
HAYDEN
SOFTWARE



Make it big with Musicworks.™

They had everything going for them. Good looks, determination and a great image.

But one thing stood between the Sydney Saunders Skiffle Duo and success in the music business. Talent.

But blessed with a good ear for a winner, Sydney laid out a few notes for Musicworks. A major development from Hayden Software.

FOR BUDDING HOLLIES EVERYWHERE

Even if you can't read a note, Musicworks enables you to compose music directly on your Apple Macintosh™, and hear the results instantly.

You compose on a seven-and-a-half octave grid. Just like the keys on a piano. As you put down your notes you hear them. All in the click of a mouse.

When you've got your latest masterpiece sounding just right, Musicworks transforms it into a musical staff, inserts the right

notation and prints it in a professional format which any musician

can follow. Even Sydney.

Now he can drum up any tune he likes. Change and edit notes. And then play back the whole melody whenever he wants.

THE FAB FOUR

Another feature that Sydney likes to harp on about is Musicworks' built-in instrument selection.

Use up to four at a time from a total of 10 or listen to each one selectively. Musicworks also comes complete with templates which guide you through playing classical and popular selections.

It's available from your local Softsel dealer. Along with over 2,600 other titles from over 250 publishers.

However there's still one slight hitch in Sydney's rise to stardom. He's been charged under the Trade Descriptions Act over the name of his latest album – "Sydney Saunders Entertains".

Musicworks – A sound investment.

SOFTSEL®

**The number one distributor of software.
In the world.**

Softsel Computer Products Ltd, Softsel House, Syon Gate Way,
Great West Road, Brentford, Middlesex TW8 9DD.

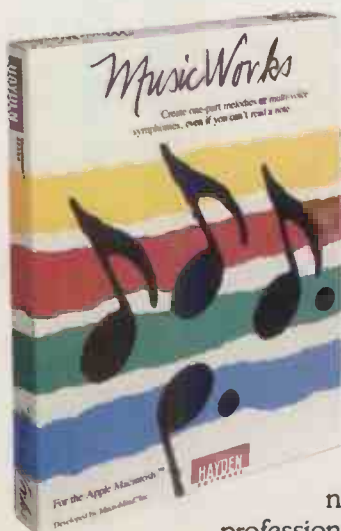

GREENGATE LTD
p r o d u c t i o n s



DS:3

Please send me information on the DS:3 Digital Sound Sampling Sequencer and its peripheral devices:

Name _____

Company _____

Address _____

Tel: _____

Greengate Productions Ltd., 24 Missden Drive, Hemel Hempstead, Hertfordshire, England, HP3 8QR. Tel: (0442) 3496

Greengate Productions, 2041 Pioneer Court, Suite 15, San Mateo, California 94403, U.S.A. Tel: (415) 345 3064



cont...

-2-

Well, the outcome of all this was that we decided to go for a Keyboard Sampling System which would not go out of date like last year's cars!So one of the most important factors was that the system should have a REAL computer as an integral PART of the whole device - not just an add-on at extra cost!

After all, if one is spending around sixteen hundred quid on something it's nice to know that you have a future! And computers ARE here to stay - In Music!

Eddie, of course, is being a pain - HE wants to sell the Porsche and get a Fairlight but after all it IS only an 8-bit - same as the DS:3... We listened to the new 'mainframe' single - "5 Minutes" - Virtually ALL DS:3 and it clinches it all for me.....!

Tell you what, when we get it next week why dont you - and have a bite to eat with us at the

DIVINE PRODUCTION

What have John Foxx, Black Uhuru, Fashion and Alphaville got in common? They've all had their work graced by the production of Zeus B Held.

Tim Goodyer

In today's musical climate, you can't get away from the ever-growing part played by production. These days, everything – from pop singles to film soundtracks to TV advertising – receives the attentions of a producer somewhere along the line. More than ever, production is becoming as important as the process of music-making itself, and as a result, some producers are becoming as well-known as the artists themselves.

Alongside the instantly-recognisable Steve Levines and Trevor Horns of this world (producers whose aural trademarks are as distinctive as they are successful) are a number of less-familiar names. Less familiar, that is, to everybody save those who list record-sleeve perusal above sex and alcohol in their everyday schedule. But their work is no

less important – just a little lower-key. German-born Zeus B Held is one such name, with credits ranging from cult-status artists like John Foxx to chart-toppers like Dead Or Alive. His work has obviously been fairly varied, yet despite an unforgettable name and a fair share of commercial success, he's not yet achieved known-by-every-household-in-Europe status. It's even doubtful whether he actually aspires to such infamy, which is why I didn't have to fight through hordes of media people to catch up with Held at Chaz Jankel's West London studio – where he's currently doing the production honours for This Island Earth.

Background

Held's musical life began with a family that built pianos as well as playing them, and progressed through the study of

'As long as you have a good desk, it's better to spend three days in a small studio than it is to spend a day in a big one.'

music theory and a flirtation with sax and trumpet before graduating to playing keyboards professionally, both as session player and with a Berlin band by the name of Birth Control. His first production venture was with a fellow German: performance artist and singer Gina X.

'I did six albums with Birth Control', he recalls. 'Tours, the whole number – playing Hammond organ, Clavinet, Rhodes and so on before getting into the synthesiser side of things. Then I made three solo albums, and on one of the albums I had Gina singing on one track, so that was how we met.

'Then we did an album on a rather small label and forgot about it; a couple of months later it was very successful in Clubland.'

The year was 1978 and the album was *Nice Mover*. From it came the 'Nice Mover' and 'No GDM' singles, the latter seeing yet another re-release earlier this year, continuing an unusually long-running success. How did it come about?

'I leased the master for five years to EMI, who released it twice, and then I put it out myself on the Statik label when I got it back – it seems people like it! It's actually a 16-track recording and there are only 14 tracks recorded on it – really what you hear is on the master tape. You push up the faders and it's there, it's not a complicated thing.'

Held's early success with the production of *Nice Mover* continued with the Gina X albums *X-traordinaire* and *Voyeur*. They aroused enough interest to establish Held as a producer of some note, and it wasn't long before he was in demand for other work.

'The Gina X project came about partly ▷



BRITISH

MUSIC

FAIR

Let's make music at the
BRITISH MUSIC FAIR

OLYMPIA 2 · LONDON : FRI · AUG 2 – SUN · AUG 4

**▲ BRITAIN'S BIGGEST MUSIC FAIR FOR EVERYONE...
...COME AND PLAY.**

- ◀ ALIVE WITH EVENTS, STARS, MUSICIANS AND MUSIC.
- ▶ **EVERY POPULAR INSTRUMENT ON DISPLAY...AND MORE.**
- ▶ TRY ANYTHING FROM A PENNY WHISTLE TO THE LATEST COMPUTERISED INSTRUMENTS AND EQUIPMENT.

ADMISSION £3.00 ADULTS : £1.50 CHILDREN UNDER 14

AUG 2 · 3 · 10AM - 7PM : AUG 4 · 10AM - 5PM

**OLYMPIA 2 : AT THE OLYMPIA EXHIBITION CENTRE,
KENSINGTON, LONDON.**

ORGANISED BY
PHILBEACH EVENTS LTD.
01-385 1200

FREE CONCERTS
TOP STARS AND FAMOUS MUSICIANS.
LIVE AT THE SHOW.
CONTINUOUS SESSIONS -
CLASSICAL, JAZZ, ROCK,
FOLK AND POP.



▷ because we were living in a house where a studio was being built', he reflects. 'At that time I worked with quite a lot of German new wave bands because I was involved in the studio choosing the keyboards and then standing in for the engineer when he wasn't available. Finally, bands started asking me to do their albums, so I did a lot of recording and co-production.

'But it was because of the Gina X stuff that Fashion, for example, contacted me. They came over to Cologne and we started there with four tracks. Then I went to England and worked a little bit in Birmingham on the arrangements: then it was back to Cologne, then to Paris, then back to England...'

...And the result was *Fabrique*, a classic fusion of electronics and the elusive element of feel that still has something worthwhile to say for itself three years after its release. It has a timelessness that was to become a Held hallmark as the producer's career unfolded.

Often accused of being the Frankies in everything but face, Trevor Horn defends his position as being both separate from and different to that of the bands he produces. So just what is the job of today's producer? Is it merely to assist the inexperienced recording artist in the transfer of ideas to tape, or does it extend to musical participation in the proceedings? Held finds it difficult to come down on either side.

'A lot depends on the band. If they have a song and a precise idea of what they want to do with it, then you just try to execute that idea as well as possible. But sometimes the song needs a lot of stripping down and building up again, and that's when you become involved with the music and the arrangement. Either way, you really have to sort out what you want with the band before you go into the studio.

'On the arrangement side of things, a producer should be able to tell if there is a note somewhere that is stopping the song sounding as good as it should – is it an F or an F#? – though it's better if you can do that without making a big fuss about music signs and harmony lessons. Sometimes it really doesn't matter if it's not musically correct, though, as long as it sounds good or exciting. You don't have to study piano for ten years to write a good sequence on the Fairlight!'

But too much pre-arrangement and deliberation has been the downfall of many a potentially exciting and lucrative idea before now. How does the producer seek to avoid falling into that trap?

'Sometimes you just have to take risks, and then it's good if you have a performer who is not perfect; that's the idea of pop music. If you take musicians from the music academy you don't get a good pop band. Tangerine Dream and Klaus Schulze, although untrained, use sounds that are almost like Debussy sometimes – and they don't know it!

'At the end of the day, music is about feeling. When you sit down and listen to

the end result of a piece of music, whatever it is, it transports a feeling. It does something to you.'

Recording

Yet anyone who's ever been into a recording studio will know that speed is far from being everything: preparation is of paramount importance as the phrase 'time is money' applies like nowhere else in the world. So how does Held approach the studio?

'The Fashion album was really the ideal situation because there were no time problems. Everybody was fresh and there was good co-ordination between the band, the record company and myself. 'Also, we chose to work in quite



small studios. As long as you have a reasonably good desk, it's better to spend three days in a smaller studio instead of one day in a big studio with all the latest state-of-the-art equipment. That way you have more time for research on your own songs.'

So much for the philosophy. What about the actual mechanics of making a recording?

'I really like to start with the SMPTE code on one track – even though it's really a 23-track recording you're making then – and use the SMPTE Reading Clock to run every rhythm box and every sequencer in time.

'In 99% of all rock music, the time is constant throughout the song, so even if I'm working with a real drummer, I still start with the click-track. In a way it takes responsibility away from the drummer. Because even if he is before or behind the beat, it can still be quite good. The Gina X stuff is all done with real drums – no drum boxes – but it was still done to a click-track.'

Nowadays, the presence of a sync pulse on the master tape – especially one as comprehensive as the SMPTE code – gives engineers and producers freedom to alter the direction of a recording at almost any point. Drum patterns can be substituted, sequencer lines altered, and even the key of a piece is far from sacrosanct. The difficulty is keeping this new-found freedom in check and avoiding wandering off at an unnecessary, self-indulgent tangent. Held is well aware of the problem.

'Sometimes an idea changes in the course of its realisation. You end up with something different, but you have to be able to recognise it on the way. You've got to be a little bit more careful with the

end result, see if you like it and then make it perfect.

'That's what happened with Fashion. The first tapes were a lot more jazzy than the finished album. During the recording it took a different direction, but we worked on it until we liked the end result.

'You've got to find the balance between what you want as a producer and what the band themselves want. It is, after all, primarily their music.'

Technology

After living in Cologne and Paris for a time, Held made a permanent move to London in 1983. Was this for purely aesthetic reasons, or were there musical motives behind the migration?

'London is much more musically active than the rest of Europe, not only in music itself but also in the activities and industry that surround music. Working here has got more advantages, more possibilities than anywhere in Europe – especially from a producer's point of view. It's better in terms of both the studios and hiring the latest technology into a studio session – it can be difficult, trying to get an AMS or a Fairlight in Paris!'

And so to the ubiquitous Fairlight, seen by differing factions as an unfortunate landmark in the decline of artistic creativity, an incredibly useful production tool or the gateway to contemporary musical freedom. The Held philosophy?

'I think the Fairlight is just one symbol of the new technology, in particular for working with sampled sound. We now have the Fairlight, the AMS, the Emulator, the Greengate and the Mirage.

'I used the Fairlight on a scratch version of The Beatles' 'Drive My Car' with Gina X, which wasn't released for two years. I thought it was really ahead of its time when we did it. Maybe some people didn't get the joke, but I did it when the sampling idea was quite new and the approach was certainly very naive. I had actually done an over-the-top version of 'Drive My Car' on one of my solo albums, using lots of little tape edits and reversed bits. I had all these bloody half-inch edits all over the table – all Paul Hardcastle has to do is push a button!

'The great thing about the Fairlight for me is Page R, but both the Fairlight and Synclavier open up new possibilities for song arrangement. Using the SRC, you can play live and correct things later; develop a good arrangement simply out of improvisation.

'But I feel these things are only just starting. In three or four years, there will be equipment that will do all of this – but much more cheaply. In Germany now, there are a lot of people building their own sampling keyboards and sequencers using computers. Once you've sussed out what you want, it's just a matter of taking the time to develop the software.'

The only operational question that needs answering is just whose responsibility the operation and application of the new machines should be. Currently, there are few people lucky enough (or

Carry out a great idea

...and get 10 free
TEAC HDX
cassettes worth
over £20*

Buy a Tascam Porta One, 244 Portastudio or 234 Syncaset before the end of August and we will give you ten top grade TEAC HDX new technology C90s absolutely free!

Offer closes August 31st 1985



Porta One

The smallest professional quality 4-track mixer/recorder available: 10 track capability, 4VU meters, trim and eq on each input, dbx noise reduction, internal battery or mains operation – a truly portable Ministudio.



244 Portastudio

The original 'One-Man-Band' for serious 4-track home recording: 10 track capability, 3 motor cassette deck, 2-band sweep eq, electronic punch in/out option, dbx noise reduction, universal inputs, 4-digit fluorescent tape counter, pan pots and much more.



234 Syncaset

A 4-track mixer/cassette recorder, rack styled: 4x2 mixer, easy record/sync assignment, 4 VUs with peak LEDs, 2 motor cassette deck, pan pots, touch controls, 4-digit fluorescent tape counter, overdub, mixdown.

* Actual SRP £23.80. TEAC HDX cassette tapes are specially developed to give higher output with wider response than other

non-Metal formulations, and are ideal for making high quality recordings on any Tascam portastudio.

Where to get your takeaway

AVON
Radford Hi Fi
Bristol
0272 428247
The Guitar Workshop
Widest
0272 742675
Duck Son & Pinker
Bath
0225 65975
London Rock Shop
Stratford
0272 276944
BERKSHIRE
Guitar Centre
Slough
0753 42720
ABC Music
Slough
0753 822754
BUCKINGHAMSHIRE
Jim Gentile
Leighton Buzzard
0908 613909
CAMBRIDGE
Stix
Peterborough
0735 52357
Cambridge Rock
Cambridge
223 316091
DEVONSHIRE
Radio Services
Exeter
0353 24244
Lawsons Music
Warrington
925 32591
econdogear Music
Exeter
0353 24244
LEICESTERSHIRE
McKenna Brown
Loughborough
642 248345
McKenna Brown
Leicester
642 483829
DERBYSHIRE
T.S.
Trent
0772 79809
HUMBERIA
Northern Sounds
York
900 4797
HEREBYSHIRE
Fisher Music
Leeds
332 48156
DORSET
ATV
Innis Church
202 473901
Movement Audio Visual
Dorchester
202 730865
SEX
Jim Gentile Music
Leigh on Sea
0272 29226
The Music Village
Hadwell
1 598 4228
The Music Village
Leeds
206 65652
The Music Village
Leeds
279 21744
GREATER MANCHESTER
Formula Sound
Stockport
61 480 3781
ounds Great
Leid Green
61 437 4788
1 Music
Manchester
61 236 0340
W. Audio
Leigh
204 385199
udio Services
Stockport
0632 2442
LAMPSHIRE
Vintages
Winchester
026 65353
elecomms
Portsmouth
1705 660036
Hamilton Electronics
Southampton
0703 28622
ISLE OF MAN
Music Mann
Douglas
0624 27077
IRELAND
Session Music
Bellfast
0232 238502
Audio Visual Imports
Dublin
0001 782288
Nicholl Bros.
Ballymena
266 49616
KENT
Unisound
Chatham
01 328 8448
Michael Stevens & Partners
Bromley
1 464 4157

Music Unlimited
Gravesend
0474 23470
Canterbury Hi Fi
Canterbury
0272 65315
ESE Audio
Gillingham
0634 375421
CTI
Maidstone
0622 79151
Wing Music
Sidcup
01 300 3838
LANCASHIRE
Blackpool Sound Centre
Blackpool
0253 25544
LEICESTERSHIRE
Carlisle Sound
Leicester
0533 24183
CENTRAL LONDON
Soho Soundhouse
01 434 1365
ITA
01 724 2497
Scenic Sounds
01 734 2812
Music Laboratories
01 388 5392
The Turnkey Shop
01 637 1701
OUTER LONDON
Tempo Music
West Ealing
01 567 0212
Gigsounds
Calford
01 590 8621/2
London Rock Shop
NW1
01 267 7851
Unisound
Millbury
01 328 8448
Gigsound
Sireatham
01 796 6496
Harrow Music
Harrow
01 427 2250
Turnkey
Brent
01 202 4366
70 Sound
Fulham
01 736 1860
Holiday Music
Leytonstone
01 558 2666
Sidney Parsons
Harrow
01 427 2250
MERSEYSIDE
Frank Hessey
Liverpool
051 236 1418
NORFOLK
Carlisle Sound
Norwich
0603 666891
Soundgear
Great Yarmouth
0493 603764
NORTHAMPTONSHIRE
Music Market
Northampton
0604 28419
NORTHUMBRIA
Concert Acoustics
Cramlington
0670 737272
NOTTINGHAMSHIRE
Carlisle Sound
Mansfield
0523 651633
Carlisle Sound
Nottingham
0602 581888
OXFORDSHIRE
Laughing Gear Music
Oxford
0865 725221
722027 Oxford Lights
Oxford
0865 722027
SCOTLAND
Stereo Showcase
Glasgow
041 332 5012
Holburn Hi Fi
Aberdeen
0224 25713
McCormacks
Glasgow
041 332 6644
James Grant
Glasgow
041 339 3618
Sound Control
Edinburgh
031 557 3986
Hamilton Music Centre
Hamilton
0698 283325
Sound Control
Dunfermline
0383 733353
SHROPSHIRE
Salop Music
Shrewsbury
0743 64111

wealthy enough) to have had the opportunity to become familiar with them. Will this open up a market for people who specialise in music programming to the exclusion of all else?

'Well, I see it as part of the rôle of the producer to know about these things, and be able to use them just as he should be able to record and mix things on his

'All that MIDI offers could have been available much sooner if synth systems had been made more compatible in the first place.'

own. But in some situations, I do prefer to have a programmer in because guys that work with these things every day are a lot faster at sampling and treating sounds than I am.'

MIDI is another revolution – albeit a quieter, more surreptitious one – that's had an incalculable impact on both live and recorded aspects of modern keyboard music. Some musicians welcome its arrival, complete with shortcomings, but others resent it, if only for effectively outdating their favourite polysynth. How useful has it proved in the production camp?

'All that MIDI offers could have happened much sooner if synth systems had been made more compatible in the first place. In the early days, there were even problems connecting a MiniMoog to an ARP sequencer, so MIDI is great – not least because of the possibilities it affords to change and build up sounds after recording. It should also help people to realise things that were created in the studio in a live situation – without the use of tapes.'

'I recently heard a rumour that there is soon to be a MIDI pickup for the grand piano. For me, there's simply no comparison to sitting down and playing a grand piano, so that would be perfect. There must be some way of recording the note information of a performance on a piano and then going back over that performance, correcting and altering things and substituting different sounds in places.'

'There really are a lot of eventualities that can be covered with technology to help free the musician. And if it's all done properly, it *does* help people make good music.'

Twelve Inches

But back to the question of the producer's rôle and how far it should intrude on a musician's work. If there's one medium that *potentially* allows the recording people to go one-up on their musician colleagues, it's surely the 12"

single, the most successful of this decade's record industry marketing phenomena. Is there really any more to them than the continued prosperity of the record companies and the satiation of the producer's itchy fingers, or do they have a musical and technical validity? Held explains.

'The original idea of the 12" was to give a better sound – by virtue of the groove spacing and playing speed – and you *can* hear a big difference, especially on a big sound system. There's less hiss, more bottom and more top – even towards the centre of the disc where the quality deteriorates.'

'Musically the 12" allows you to have different constellations of sound, to change your perspective – not only melodically but rhythmically too. There just isn't enough space to do that in the three-minutes, thirty-seconds 7" single formula.'

And the format has become even more popular among producers as new technology has added breadth to the creative possibilities it affords, as Held enthusiastically confesses.

'Sometimes you can just go to Page R on the Fairlight, stick a cello in the bass sequence, and you have a good, funky rhythm with the funky bass played by a cello! It takes a little time, but if you can afford it, the AMS and the Fairlight are great for doing that.'

'You can do tremendous dub versions of songs like that. There are two black guys that work at Shakedown Studios in New York with Arthur Baker. They're only 19 or 20 and they do nothing but edit 12" mixes. It's great that there are people now who specialise in editing. Listening to those records shows you how it's possible to re-introduce excitement and risk just by editing tape. With a couple of ruthless edits, you can completely change the atmosphere of a piece. Instead of the usual middle eight, which was an extra part in the old pop song that would appear only once, it's now possible to use a dub section instead. That's something that actually changes the traditional methods of composition.'

The Future

With electronic innovation outdating equipment more quickly than ever before, and the recording studio being as much on the front line of technology as the *environs* of the keyboard player, what may we expect to provide our aural entertainment in the future?

'I'm looking forward to digital recording and editing. In video and film work there is no physical editing at all – everything's done by giving commands. The edits themselves are so smooth. And anything you do is easily reversible – so you can change your mind if you want – and you can copy without losing any quality.'

Quality is one thing Zeus B Held himself doesn't seem to be short of. Just ask John Foxx, Black Uhuru, Fashion, Alphaville or – in a month – This Island Earth.

TASCAM
TEAC Professional Division

Harman Audio (UK) Ltd, Mill Street, Slough, Berks. SL2 5DD

FAIR *facts*

August's British Music Fair sees the public admitted to a national musical instrument exhibition for the first time in several years. Here's a sneak preview of what you can expect to find.

For too long, the UK's only national showcase for modern musical instruments has closed its doors to the people who keep the industry going – musicians. It was a policy that resulted in a series of dull, apathetic exhibitions in which the hi-tech manufacturers, in particular, suffered from having to show their wares within the confines of small, poorly-lit hotel rooms and conference halls.

Fortunately those days are now at an end, and August's British Music Fair will be as much an event for musicians as it will be for the music industry as a whole. Not only that, but for the first time in goodness knows when, the most important show in the UK music business calendar will take place under one roof – so no more tired limbs for visitors struggling from one small hotel to another in blistering summer heat.

The organisers hope the new-look British Music Fair will become an event of greater worldwide significance, and on the face of it, there's no reason why that shouldn't happen. After all, this country's been in the forefront of popular music development since The Beatles stood the music world on its head in the early sixties, and as a consequence of that, these isles house one of the most musically-active populations on the globe.

Yet the BMF is under a lot of competition from established musical instrument shindigs. And more worryingly, the Stateside NAMM Music Expos and the incomparable Frankfurt Musikmesse have succeeded in becoming *the* music showcases whilst remaining ostensibly trade-only affairs. So if the British Music Fair is to see beyond its national nose, it'll need more than just a public presence; it'll need an absolutely *massive* one.

The Attractions

So what, precisely, will this year's British Music Fair have to offer the prospective visitor? Well, the first thing that springs to mind is a pleasant, spacious environment well suited to the demonstration of modern musical instruments. That might sound like an obvious prerequisite for a music fair, but the sad fact is that recent UK efforts in this direction, even the public ones, have hardly been conducive to active demonstrations and musical performances.

If your memory goes back that far, you may well recall previous public shows at Olympia that were distinguished more by the venue's unsuitability for music than anything else. Thankfully, those days are now gone, because Olympia has been the subject of a recent – and very extensive – refurbishment programme that's resulted in the interior being totally redesigned and refurbished, and the hall being given the new title of Olympia 2. It's a big place – though obviously nothing like the size of Frankfurt's gargantuan exhibition centre – so overcrowding is unlikely to be a problem, even if public response is bigger than the organisers hope it will be.

It's also easy to get to, regardless of what part of the country you're coming from. It has its own tube station, is served by any number of bus services linking its Kensington location with Central London, and has plentiful, custom-built car-parking just around the corner.

But quite apart from the convenience and suitability of the venue itself, there's the fact that the companies exhibiting at this year's British Music Fair are going about their business in an encouragingly positive and considerate manner. It's as if they recognise that a public exhibition is much more of a challenge than a trade-only one, though it's also a lot more potentially rewarding, of course.



If you're wondering exactly *who* will be exhibiting at the BMF, the answer is almost everybody. The list of hi-tech representatives is particularly impressive, with Casio, Roland, Korg, Siel, Simmons, EMR, Yamaha, Panasonic, Oberheim, 360 Systems, Jellinghaus, Ultimate Percussion, Ibanez, Microskill and PPG all confirmed at time of going to press. And judging from comments E&MM has received from key personnel, it seems most of those exhibitors are planning to give musicians as much opportunity as possible to try instruments out for themselves, without pressure, without obligation, and without disturbing anybody else.

The Products

For the British Music Fair to be a really major success from a product standpoint, it's going to be of paramount importance that manufacturers have something new on show in one form or another. What that means in practical terms is the urgent flying-in of pre-production, often prototype machines from the summer NAMM Expo in New Orleans (which'll most likely be over by the time you read this), something that many multi-nationals have shown reluctance to do for past BMFs.

If our preliminary enquiries are anything to go by, the presence of the general public could be the factor that makes the manufacturers change their minds. Far more than is usual, the major musical instrument companies have been playing their new-product cards extremely close to the chest, refusing to give any more than the odd titbit of news to gossip-hungry media people such as ourselves.

So it hasn't been easy, scouring the industry for information on what will, or won't, be on public show in August. Take Yamaha, for instance. Most of the trade now knows about the baby DX21 stereo FM polysynth that'll be hitting the High Street shops shortly after the show draws to a close, but precise details about the keyboard's specification, price and packaging remain very much For Their Eyes Only. The same goes for the downmarket PCM drum machine, rumoured to carry the RX21 model number, that will be announced simultaneously by Yamaha's unceasingly-active hi-tech division. A lot of people know that it exists, but far, far fewer know precisely what combination of facilities it will offer, or at what cost.

More concrete (if that's the word) are Yamaha's new range of

COME AND SEE THE AMAZING

ensoniq

MIRAGE

AT



Southern Music

40-41 CASTLE ST., BRIGHTON, SUSSEX

☎ **0273-733387/770507**

CREDIT FACILITIES AVAILABLE

SUPERB EFFECTS

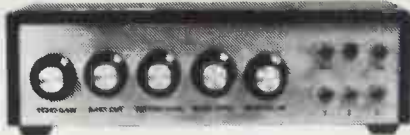

- MONO-STEREO ECHO-REVERB (P.E. Sept. '84) 200ms echo (extendable), lengthy reverb multitracking. Kit as published. Set 2188K.....£56.66
- ENHANCED PHASER (P.E. Oct. '84) Enhanced phasing with modulated filter shifting. Kit as published. Set 226BK.....£39.13
- RING MODULATOR (P.E. Nov. '84) Fabulous effects generation. With multiwaveform VCO, noise gate & ALC. Kit as published. Set 231BK.....£39.99
- MONO-STEREO CHORUS-FLANGER (P.E. Jan. '84) Superb dual mode music enhancement. Kit as published. Set 235BK.....£56.66
- CYBERVOX (E.E. Apr. '85) Amazing robot type voice unit, with ring modulator and reverb. Kit as published. Set 228BK.....£37.40
- STEREO NOISE GATE & VCA (P.E. May '85) Automatic noise reduction circuit for mono or stereo. Kit as published. Set 227BK.....£26.61
- SIGNAL GENERATOR & F-V (P.E. Jan '85) Audio test equipment. Multiwaveform VCO, & frequency to voltage converter, & sweep generator. Kit as published. Set 233.....£46.96
- BLOW BOX: Voice operated VCF & VCA for fascinating effects. Set 214BK.....£29.33
- COMPANDER. Mono or stereo compression-expansion, switchable. Set 238BK.....£22.99
- ENVELOPE SHAPER. Note triggered ADSR with VCA. Set 174BK.....£25.20
- FREQUENCY DOUBLER. Guitar octave raiser & tone changer. Set 98BK.....£15.30
- FUZZ. Smooth distortion, retains attack & decay character. Set 209FBK.....£19.58
- GUITAR SUSTAIN. Extends note decay time, with noise gate. Set 222BK.....£25.31
- GUITAR TO SYNTH INTERFACE. With voltage & trigger outputs. Set 173BK.....£41.41
- HAND CLAPPER. Auto & manual variable clap effects. Set 197BK.....£26.69
- MOCK STEREO. Splits mono signal into stereo imitation. Set 213BK.....£24.37
- MUSIC MODULO. 8 VARIABLE TREMOLO & wah guitar effects. Set 196BK.....£23.56
- RHYTHM GENERATOR. Computer driven, BBC, Apple, 64 & similar. Set 185BK.....£34.64
- STORM EFFECTS. Auto & manual wind, rain & surf effects. Set 154BK.....£23.60
- TOM-TOM SYNTH. Sound triggered, multivariable drum effects. Set 190BK.....£19.37
- TREMOLO. Mono variable depth & rat modulation. Set 136BK.....£15.62
- VOCODAVOX. Modular vocoder, 7 chans extendable. Set 152BK.....£79.95
- VODALEK. Simple robot type voice emulator. Set 155BK.....£18.31
- WAH-WAH. Auto, manual & note triggered, switchable. Set 140BK.....£24.36

ADD 15% VAT. Add P&P £1.50 each Kit (Overseas Rates in Catalogue)

Project texts & circuits can be bought separately at 50p each plus large SAE. Boxes are steel & aluminium with black finish. All kits include PCBs, parts, instructions, boxes, wire, solder.

SEE OTHER ADVERT FOR MORE AUDIO EFFECTS KITS. FOR CATALOGUE OF OVER 70 KITS SEND 9+4 S.A.E. (FOR OVERSEAS CATALOGUE SEND £1 OR 5 IRC'S). MAIL ORDER. PAYMENT TO PHONOSONICS, CWO, CHQ. PO, ACCESS, VISA. INSURANCE COVER 50P PER £50 (OBLIGATORY ON CREDIT CARD ORDERS. DETAILS CORRECT AT PRESS. E&OE.

BECKER-PHONOSONICS,
MAIL ORDER DEPT MM57, 8 FINUCANE DRIVE,
ORPINGTON, KENT BR5 4ED. TEL: 0689 37821

DOUGIE'S

Music Store

5-7 CHESTER ROAD, NORTHWICH, CHESHIRE
TELEPHONE 0606 782522
OPEN 10-6 (CLOSED WEDS - BOTH BRANCHES), LATE NIGHT THURSDAYS

IN STOCK NOW ENSONIQ MIRAGE

FLASH STREET ELECTROMUSIC

(ABOVE JAMM STUDIOS)
END OF GT. MOOR ST.
BOLTON, LANCs.
TELEPHONE -
0204 397893

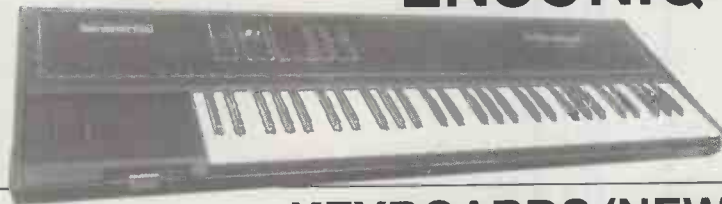

**THIS AINT NO VISION, MAN - WE ARE OFFICIAL
AGENTS FOR THIS AMAZING NEW BEAST (AT BOTH
STORES) SALE £1695 - CALL FOR A DEMO NOW
BE SAMPLIFIED AT FLASH ST & DOUGIES**

KEYBOARDS (NEW AND S/H) ETC

Approx

£99
ARP Axe s/h
ARP Solus s/h
Roland SH09 s/h
Roland SH101 s/h
Korg MS10
Octave Kitten
Yamaha CS01
Moog Rogue s/h
Crumar Pianos s/h

£199
Teisco 110F s/h
Octave Cat (duo Phonic)
SC PRO1 s/h
Hohner Duo
Moog Prodigy
Eko K2 pedals

£299
Multimoog s/h
Yamaha CS150 s/h
Yamaha CR piano
Yamaha CE20
Wurlitzer EP20 s/h
Yamaha CS50 s/h
ARP Odyssey s/h
Moog Opus III s/h

£399
Roland JP4 s/h
Roland Juno 6 s/h
Yamaha SK20 s/h
Yamaha CP30 piano
Korg Landa s/h
Casio CZ101
Casio CZ1000
Polymoog K/B s/h
Oscar

£499 & MORE

Minimoog.....£499
Siel DK80..... **Sale Price**
SC Multitracker..... **£1099 Reduced**
SC 800 Sequencer..... **Offers**
SC T-8..... **Try our P/Ex Deals!**
Korg DW6000..... **Sale Price**
Korg BX3 organ..... **In Stock**
Roland Juno 106..... **In Stock**
Roland JX8P..... **In Stock**
Roland HP300..... **Sale Price**
Roland HP400..... **Sale Price**
Roland MKB1000..... **£999**
Roland MKB1000..... **£799 (marked)**
Roland MKB3000..... **In Stock**
Yamaha CP70..... **POA**
Yamaha SK50D..... **POA**

FOSTEX PACKAGES

X15+8570+MN15+H/Phones+Mic+Orange

£350

250+ F/Sw+Pair of Mons+H/Phones

£699 one only

A-8+H/Phones+Pair of Mons+2 Mics

£1499

THE BEST DRUM COMPUTERS ON THE MARKET

A) Korg DDM110 All in.
B) Roland TR707 Stock
C) Tom On Demo

CASIO KORG JVC YAMAHA OSCAR ROLAND SEQUENTIAL SIEL BASS

MIDI-equipped electric pianos and a new digital reverb machine, the REV7, that's already been seen at pro audio fairs at home and abroad, and incorporates much of the technology present in the upmarket REV1 into an altogether more affordable – and MIDI-compatible – package.

Yamaha's great Oriental rivals, Roland, aren't being any more cooperative when it comes to releasing advance product news. They have a competitor for the REV7 in the shape of the SRV2000 digital reverb unit, and also have a new rack-mounted digital delay by the name of SDE2000. Like the SRV, and almost every product Roland release these days, it's got MIDI on the back. Otherwise, what we know is what we knew six months ago: the excellent JX8P poly, the full range of rack-mounting MIDI synth modules (and their matching mother keyboards), the SBX80 Sync Box, and a clever little Boss sampling delay pedal called DSD2. If there's going to be anything more revolutionary on show (and it's our strong suspicion that there will be), Roland are being decidedly cagey about it.

Much the same can be said of Korg, who we expect to have a new upmarket polysynth, the DW8000, as the centre of attraction on their stand (itself only a small part of a huge Rose-Morris distributor presence). If our information is correct, the 8000 will be based extensively on the DW6000 introduced at the start of '85, with the important addition of a dynamic keyboard. Other goodies on show will be the SDD2000 sampling delay (reviewed elsewhere this issue), and the already-successful DDM digital percussion machines, plus EMR's MIDI software packages for Commodore, Sinclair and BBC micros.

The Presentation

But if exhibitors are being reluctant to disclose the precise nature of the instruments they'll have on show, they've been a good deal more forthcoming about telling us *how* those instruments will be presented to the public.

Given the open-plan nature of Olympia 2's layout (the BMF will be operating on three such open levels), it seems likely musicians will be greeted with something of a 'mini-Frankfurt' atmosphere, with fairly narrow gangways separating the vast, sprawling stands of the multinationals from the less ambitious, more enclosed sites of the smaller firms. Wherever you choose to go, space should be the keynote of the show's *ambience*, and at the moment, there's every indication that the exhibitors will be making efficient – and helpful – use of that space.

Roland, for instance, will have demonstrations on the hour, every hour, by session players Mark Wood and Michael Giles in a soundproofed, air-conditioned booth, and there'll also be an entirely separate recording room (reflecting the company's growing interest in this area), a constantly-manned Boss stand, and what Roland term a 'program your own' electronic percussion stand.

Yamaha aren't expected to be outdone in this area without a struggle, however. The man who's done more to bring the gospel of FM synthesis home than any other, Dave Bristow, will be on-hand throughout the show's proceedings for demonstrations and impromptu Q&A sessions, and it's hoped that he'll be joined by FM pioneer John Chowning at some stage to co-host one of Yamaha's three hi-tech concerts in the Apex suite...

And so to the finer points of getting to this year's British Music Fair. If you can prove you're a legitimate (well, it would make a change) member of the music industry, you can get in on any of the trade days, July 30, 31 and August 1. This will automatically assure you a less crowded arena round which to stroll, but will also deprive you of seeing (and hearing) a load of concerts, recitals and so forth that are planned for the public days. Those public days follow directly on from the trade ones on August 2, 3 and 4, and admission will be £3 for adults, £1.50 for OAPs and children under 14.

E&MM's publishers, Music Maker Publications, will be there in force, with a huge 30ft stand selling back issues of E&MM and its many sister magazines. It'll be selling T-shirts and sweatshirts too, so as you wander round the Fair, you'll be able to tell the world which musician's magazine you value above all others. ■

Tickets for the British Music Fair are available on the door, or in advance from The Box Office, Earls Court Exhibition Centre, Warwick Road, London SW5 9TA. ☎ 01-373 8141.

MIRAGE

3 ELYSTAN STREET LONDON SW3 3NT

Your nearest oasis ✨

Barnet

ESS, 230 High Street, Barnet, Herts.
Tel: 01 440 3440

Bingley

ISG Music, 104 Main Street, Bingley,
W. Yorks.
Tel: 0274 561044/564389

Birmingham

Jones & Crossland, 4-8 Smallbrook,
Birmingham B5 4EN.
Tel: 021 643 4655/7
Musical Exchanges, 89 Old Snow Hill,
Birmingham, W. Midlands B4 6HX.
Tel: 021 236 7544

Bolton

Flash Street Electromusic,
Flash Mills, Great Moor Street,
Bolton
Tel: 0204 397893

Bournemouth

Eddie Moors Music, 679 Christchurch
Road, Boscombe, Bournemouth.
Tel: 0202 35135

Brighton

Southern Music, 41 Castle Street, Brighton,
Sussex.
Tel: 0273 733387

Bristol

The London Rock Shops, 7 Union Street,
Bristol.
Tel: 0272 276 944
Guitar Workshop, 159 St Michaels Hill,
Bristol 2.
Tel: 0272 742675

Cambridge

Cambridge Rock Shop, 8 Burleigh Street,
Cambridge.
Tel: 0223 316091

Cardiff

Livewire, 21A Penylan Road, Roath,
Cardiff CF2 3PG.
Tel: 0222 496619

Chelmsford

Future Music, 10 Baddow Road,
Chelmsford, Essex.
Tel: 0245 352290

Croydon

Rockbottom, 68/70 Lloynd Road, West
Croydon, Surrey CR0 2TB.
Tel: 680 1042/681 0328

Eastbourne

Peter Bonner Musical, 12a Grove Road,
Eastbourne, East Sussex BN21 4TJ.
Tel: 0323 639335/645775

Epsom

Bootleg Music, 5-7 South Street,
Epsom, Surrey.
Tel: 78 24528

Fyfe

Sound Control, Elgin Road, Dunfermline,
Fyfe.
Tel: 0383 733 353

Glasgow

James Grant Music, 404 Byers Road,
Glasgow G12.
Tel: 041 339 3618
McCormack's (Music) Ltd., 33 Bath Street,
Glasgow G2 1HT.
Tel: 041 332 6644

Guildford

Andertons Musical Instruments,
91 Haydon Place, Guildford,
Surrey GU1 4LR.
Tel: 0483 38212

Hadleigh

Honky Tonk Music, 300-302 London Road,
Hadleigh, Essex SS7 2DD.
Tel: 0702 553647

Harrow

City Music, Pinner Road, North Harrow,
Tel: 863 1841

Jersey

City Music, 8 Esplanade.
Tel: 0534 78901

Leicester

Carlsbro Sound Centres,
22 Humberstone Road, Leicester LE5 0AR.
Tel: 0533 24183

Liverpool

Hessy's Music Centre, 62 Stanley Street,
Liverpool L1 6AY.
Tel: 051 236 1418

London

Chromatix, Ealing Broadway Centre,
Oak Road, London W5.
Tel: 567 3623

Freedmans, 627/631 High Road,
Leytonstone, London E11.
Tel: 539 0288

Future Music

202 New Kings Road, Fulham,
London SW6.
Tel: 731 5993
Gig Sounds, 22 Rushey Green, Catford,
London SE6.
Tel: 690 8621

Gig Sounds, 86 Mitcham Lane,
Streatham, London SW16.
Tel: 769 6496

Holiday Music, 579 High Road,
Leytonstone, London E11 4PB.
Tel: 558 2666

The London Rock Shop,
26 Chalk Farm Road, London NW1.
Tel: 267 5381

Rod Argent's Keyboards,
20 Denmark Street, London WC2.
Tel: 379 6690

Rose Morris, 11 Denmark Street,
London WC2 8LS.
Tel: 836 9562

Soho Soundhouse Ltd., 18A Soho,
London W1V 5FB.
Tel: 434 1365

Syco Systems, 20 Conduit Place,
London W2 1HS
Tel: 724 2451

Tempo Music,
160 Broadway, West Ealing W13 0TL.
Tel: 567 0212

Manchester

A1 Music Centre, 88 Oxford Street,
Manchester M1 5NJ.
Tel: 061 236 0340

Mansfield

Carlsboro Sound Centre,
182-184 Chesterfield Road, Nth.,
Mansfield Notts. NG19 7JD.
Tel: 0623 651633

Newcastle-upon-Tyne

Rock City Music, 10 Mosley Street,
Newcastle-upon-Tyne NE1 IDE.
Tel: 0632 324175

Norwich

Carlsboro Sound Centre,
2 Sovereign Way Anglia Sq.,
Norwich NR3 1ER.
Tel: 0603 666891

Northwich

Dougie's Music,
5/7 Chester Road, Castle,
Northwich, Cheshire
Tel: 0606 782522

Nottingham

Carlsboro Sound Centre, 11-13 Hockley,
Nottingham NG1 1FH.
Tel: 0602 581888

Plymouth

City Music, Drake Circus, Plymouth.
Tel: 0752 23011

Portsmouth

Future Music, 104-106 Elm Grove,
Southsea, Portsmouth, Hants.
Tel: 0705 820595

Romford

The Music Village, 10 High Road,
Chadwell Heath, Romford, Essex.
Tel: 599 4228

Sheffield

Carlsboro Sound Centre, 720 City Road,
Sheffield S2 1GJ.
Tel: 0742 640000

Stockport

Audio Services, Studfo House,
High Lane Village, Nr. Stockport SK6 8AA.
Tel: 06632 2442

Torquay

City Music, 65 Market Street, Torquay.
Tel: 0803 25488

Warrington

Dawsons, 65 Sankey, Warrington,
Cheshire WA1 1SU.
Tel: 0925 32591

ensonia

Europe: 65 Ave Stalingrad, Brussels 1000, Belgium.
U.S.A.: 263 Great Valley Parkway, Malvern Pennsylvania 19355



This is a Mirage.

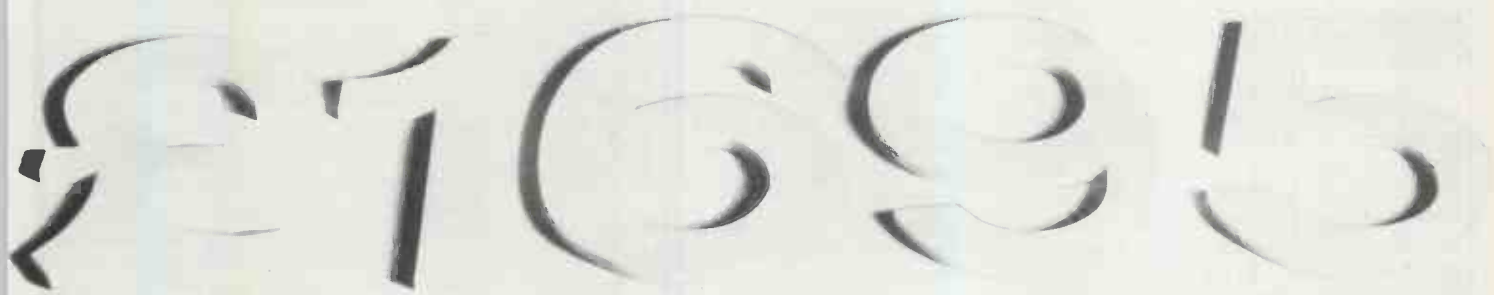

This is not.

The Mirage Digital Sampling Keyboard.

Rush to your nearest oasis before it's gone!
See facing page for details.

TECHNOLOGY

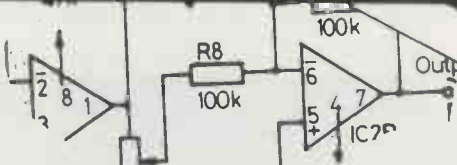

confessions of an english kit builder

To those that build them, electronic music kits are an endless source of satisfaction, despair, relief and a whole host of other emotions. Now a confirmed addict tells of his experiences with one well-known kit in particular. *Godric Wilkie*

I didn't need much convincing. I'd already built several of Tim Orr's circuit designs, had a great interest in MIDI through having a DX synthesiser, and been wanting a cheap(ish) way of getting into sound-sampling for some while. So, when I saw the photograph of the Powertran MCS1 on the cover of E&MM September '84 and found that the acronym stood for MIDI Controlled Sampler, 'sounds interesting' was an understated version of the thoughts that came into my head.

After a quick call to Powertran to clarify certain points, I was convinced that I must have one. Convincing my bank manager took a little longer. However, on October 29 of last year, the requisite cheque and order were despatched to Andover, and I sat back in eager anticipation.

But as Mrs Beeton might have it, 'First catch your kit'. Due to, ahem, early production problems, my kit wasn't delivered for another eight weeks, and even then I was short of a few 'minor' items like the EPROM and User Manual. But having waited that long, I wasn't going to be deterred by the absence of instructions – I decided to start building the thing that evening.

If you're planning on building the MCS, I suggest you prepare yourself for saying goodbye to quite a few evenings. Construction took me about 15 hours, all told. Mind you, that was without the guide, so you might manage it in 10 or 12, patience permitting.

The Beginning

The first (and most pleasant) task was to unpack the bits and throw away all the polystyrene chips, something I regretted later when I reflected on how great they would have been for putting in people's

crisp packets in crowded pubs. Ordinarily, the next job would have been to check what I hadn't binned against a component list, just to make sure there was nothing vital missing. This wasn't actually possible given the absence of such a list, but that didn't stop me having an educated(?) sniff around.

The components turned out to be to Powertran's usual high standard, with the exception of the IC sockets and key-switches, more of which anon. There are three PCBs in all: one a single-sided affair and the remaining pair two-faced, as it were. But the MCS1's *pièce de résistance* is its main logic board. Quite simply, this is the best PCB I have ever seen in a kit, and quite a bit better than a few ready-built items, too. It looks like a computer-aided design job, but I'm assured that it was laid-out with the assistance of nothing more revolutionary than the human brain. It also comes with a label informing you that it's already been electronically tested – before you've even unpacked it.

The main logic board shares two excellent features with its sister PCBs, namely a silk-screen print of the component layout and solder resistance on both sides. The former (obviously) helps you put all the bits in the right place; while the latter takes the form of an insulating coating that prevents you shorting address lines and the like when you come to soldering them in; it also stops bits of stray swarf and other metallic rubbish having a similar effect, long after you've finished any soldering. It doesn't, however, offer any protection against misplaced glasses of Mouton Cadet '58, so think before you drink before you build.

But the IC sockets are disappointing – cheap versions of what is, after all, an absolutely crucial component. The main

problem is the inordinate amount of force you need to apply in order to insert the chips into them properly: it doesn't make electrical connection any more reliable and it puts unnecessary strain on the PCB. And the fact that an altogether superior quality socket is available at only a penny or two more only serves to make the inclusion of these things an even greater silliness on Powertran's part. Ah, well.

The Building

Let construction begin. I spent the first night assembling the case, the front and back panels, and the front and the back PCBs, and doing the mains wiring. This took me two-and-a-half hours. A day later, I put the resistors and the IC sockets on the main logic PCB. This involved the best part of 2000 individual solder joints, and took me just under five hours. During the next session, I finished the logic PCB by fitting the capacitors, semiconductors (though not the ICs) and power supply components. This took me four hours. I spent one, final session wiring up the PSU, the PCBs and the front panel controls, which took an hour and a half.

The above schedule might sound a little on the lengthy side, but the whole process was quite easy to accomplish with the aid of the PCB silk-screening and the relevant copy of E&MM.

So there was my finished – though currently unpopulated – MCS1 sitting in front of me, and there were still a few postal days before Christmas. Would the missing EPROM arrive before the festivities so that I could show off the sampler's abilities to my brother, or would he get the chance to bore me to tears with his QL chess program instead? Well, I'm afraid to say the Royal Mail assumed me to be a

company closing down on December 20 and wanting no more post. And sure enough, first post on January 2, my EPROM and elusive MCS1 manual were delivered to my door. If there'd been a decent MIDI interface package for the QL, my Christmas would at least have been bearable...

And so to the 52 million dollar question. Would it work? Before trying to find out, I checked the values of the components I'd put in against those on the overlay. What's this? Capacitors of 0.47mF instead 4.7mF – four of them. Poor printing quality on tantalums is my excuse.

But nothing else seems to be amiss. Flinchingly, I turn on the machine with the help of a long stick. No bang, no puff of smoke, no wailing or gnashing of teeth – just the quiet hum of an underloaded transformer. I check a few voltages: all present and correct. Time to have a cup of coffee to see if anything blows up while my back is turned. One cup of Nescafé later, I check the voltages again: still no problems.

Scarcely able to believe my good fortune, I populate the board as per Mr Orr's instructions. Still nothing goes bang. I'm getting worried. To make matters worse, the unit actually seems to work. At least, all the front panel controls – with the exception of one keyswitch – seem to be behaving themselves admirably.

I decide there's only one thing for it. I dig out my trusty oscilloscope, and set to work looking for erroneous waveforms. Eventually, I discover that the PLL frequency is below spec. Aha! Another wrong capacitor, this time 470pF instead of 47pF. Obviously, Powertran had had the same trouble with powers of ten that I do, supplied me with the wrong component, and I'd fitted it without noticing. Anyhow, a quick dip into my component stocks soon solves the problem, and the PPL frequency comes out something like normal (680kHz compared with TO's quoted 700kHz – sounds close enough for me).

I'd found something wrong and felt a little more at ease, so I went to bed (it was 3.15am). But I was still worried that things were going far too well. Next day I checked the audio side of my MCS1, and found that it was all rather superb. Serves me right for being such a pessimist, I suppose.

The last job was to calibrate the MCS1's CV/octave relationship, something that proved fairly difficult to get a grip of without my reading through the procedure a few times. I attempted some semblance of accuracy with an admittedly inadequate 3½-digit Beckman multimeter, though the whole process took me a good couple of hours. But imagine my surprise when I plugged in my Pro One and found it to be decidedly ill-tempered. No two semitones were alike, and even after setting-up by ear, results were disappointingly unpredictable.

Thinking the error might lie in Sequential's wondrous monosynth, I checked the Pro One by plugging it into a

multimeter and then into a Transcendent Polysynth. This done – and several hours later – the Pro One was satisfactorily recalibrated and put to work on the MCS1 once again. The results were a little better, but there was still some slewing between notes – regardless of where the CV/gate information was coming from.

To be fair, though, this is a property of the VCO that can't easily be remedied without introducing other problems, and in any case, I suspect some owners will make use of the facility without even noticing something is amiss.

The Quibbling

I've already mentioned the below-par IC sockets, an economy measure on Powertran's part that's difficult to justify from where I'm sitting now; maybe things are different in economic reality. Either way, it's not the only fault I can find in the way this kit is packaged. The major quibble surrounds keyswitches. Frankly, I can't decry those on the MCS too much, even though their dreadfulness is more than compensated for by the excellence of the PCBs. The switches each comprise four separate parts that have to be assembled before you can solder them in. That wouldn't be so bad if the MCS1 didn't require 24 of these awkward little buggers. Tedium sums up the main emotion one experiences on going about fitting them.

They also lack feel. In fact, one of them had so little it refused to work at all; I had to modify it before it would function properly. Part of the problem lies with the LED holders (each of the keyswitches has one built in, in itself a useful enough feature to have), which turned out to be very variable in size and prevented their parent keys from being depressed.

I fear this is another false economy on Powertran's part, as these switches are – unsurprisingly – some of the cheapest available. What complicates matters further is the fact that half the switches have to be assembled with their LEDs the other way around, and the only reason I can think of for this is that it made designing the PCB easier.

Another niggle is that the PCBs, especially the front panel one, could do with being better braced mechanically. A couple of extra pillars in the middle of the keyswitch section would stop the keys retreating whenever you press them, a feature that contributes to the difficulties described above. A similar provision somewhere in the midst of the logic board would probably help, too.

And another thing. A lot of the screws that come with the MCS1 kit are obviously too long for the job. The main offenders are the logic-board fixing screws, but the voltage regulator/heatsink items are also guilty.

Then there are the tinier, less significant points that could be cleared up on future production MCS1s. Why, for instance, can't the front panel PCB be extended to

include some more panel components, like the pots and the two LEDs? And why don't Powertran adopt ribbon cable connectors between the boards? They'd make construction a lot easier, and also allow PCBs for ready-built machines to be tested prior to assembly.

Well, I guess that sounds like an awful lot of flaws. It isn't. In most respects, the MCS is a really well thought-out and executed kit design. But as with a lot of things, the faults that are present draw attention to themselves simply by virtue of being few in number.

The Judging

Despite a sampling orgy involving cats, milk bottles, the postman and a cast of thousands, I'm still getting to grips with my MCS1. It isn't the easiest bit of gear to use. However, it is obvious, even to my meagre intellect, that Mr Orr has excelled himself with this one.

The MIDI performance is exemplary, the effect of aftertouch-induced vibrato simply stunning to behold. The delay line mode is also superb, with both sample rate and memory size being variable over a range wide enough to give the machine an awful lot in the way of versatility. As Powertran themselves admit, the CV/gate section is the one area of performance that really brings the MCS down. It's usable, but it isn't perfect, and I reckon most people will end up using it primarily for special effects purposes.

The kit is mechanically OK and, in spite of its size, surprisingly easy to build. After all, if I can do it without a manual, it must be a doddle. Talking of manuals, this one lacks the notes on component identification, hints on order of component assembly, and tips on how to create a neat appearance that were once *de rigeur* for Powertran literature. Now, that sort of thing isn't of much interest to a seasoned pro like me, but I imagine it would be useful to mortals of lesser kit-building experience and confidence.

Does the omission imply that Powertran don't think their kit is suited to beginners? If it is, it's a mistake, because as I've just intimated, the only thing about putting the MCS1 together that's in any way daunting is its sheer physical size. Admittedly, the equipment required to test the machine and calibrate the CV/octave relationship (oscilloscope, frequency meter and multimeter) aren't exactly average hobbyist material, but it is possible, assuming the machine works first time, to set it up with no more than a multimeter and a pair of ears.

Anyway, I'm looking forward to linking mine to a BBC Micro and getting to grips with what could, given availability of the right software, become a powerful – and gratifyingly cost-effective – computer music system in its own right. The sound dump software is out now, but what are the 'future facilities' hinted at in the MCS brochure? Actually, I think I know already, but I'm keeping it under my hat. So there. ■

FANTASTIC NEW Roland PRODUCTS

NEW

ROLAND SRV2000
STEREO DIGITAL REVERB £1275
INCREDIBLE SOPHISTICATION UNBELIEVABLE PRICE



MIDI Controllable - Totally Programmable - 99s Delay!
Rolands new SRV2000 Digital Reverb offers a unbeatable new market leader in digital reverbation! With the worlds first MIDI controllable unit. Look at these features and compare the competitors price! 24 memories! Parametric EQ control! for room size PRG delay, Gate/Damping, Rev time MIDI + 6 integrated display, stereo output of up to 99 seconds! Many other features!
ORDER NOW FOR JULY DELIVERY

NEW

JX8P TOUCH SENSITIVE POLY SYNTH



Rolands Brand new Digital Analogue Polysynth with optional PG800 Programmer
AVAILABLE NOW
JX8P £1165

NEW

ROLAND DIGITAL DRUM SYSTEM!
State of the Art sounds and performance DDR30 drum module has PCM sound, sophisticated editing + MIDI in and out. All pads natural feel and fully touch sensitive.
£1699



ROLAND SRV2000 NOW IN STOCK!!!

NEW

ROLAND SDE2500
MIDI DIGITAL DELAY



A MIDI controllable Digital Delay with 64 memories. Available June 1985

NEW

TR707 DIGITAL MIDI RYTHM COMPOSER
TR727 DIGITAL MIDI PERCUSSION COMPOSER



Rolands new TR707 and TR727 continue their fantastic success in low price, high quality rhythm units both units feature real and step time, 69 patterns, MIDI, graphic display independent outputs, memory expansion cartridge. New TR727 percussion sounds include Bongos, Conga, Timbace, Ago, Cabasa, Maramba, Whistle, Quisada and Tubular Bell!!
£465

NEW

BOSS MICRO RACK MIDI UNITS



Ideal for the home recording freak!
Boss offer the novel concept of effects in a neat 19" rack format (2 per rack)
Range includes:
RDD-10 Digital Delay £175
RCL-10 Compressor/Limiter £110
RBF-10 Flanger £110
RPH-10 Phaser £110
RGE-10 Graphic EQ £110

NEW

ROLANDS NEW SUPERCUBES

Roland introduce a completely new range of their ultra successful compact cubes!

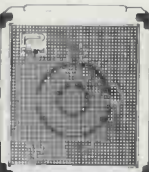

SCC40 Lead 40W £215
SCC60 Lead 60W £245
SCC60 Lead 100W £329
SCB40 Bass 40W £225
SCB60 Bass 60W £259
SCB100 Bass 100W £319
New JC77!!
2x10" 80W Jazz Chorus £475
ALL AVAILABLE NOW

NEW

BOSS DSD2 DIGITAL SAMPLER/DELAY

Continuing BOSS's remarkable market domination, The new DSD2 offer the worlds first portable battery powered sampler delay in a compact pedal. Equally versatile as a sampler or delay featuring 200 to 800 milliseconds - sample MIDI with pitch variation and overdub facility! Incredible!!



AVAILABLE JUNE 85
£175

NEW

ROLAND PIANO PLUS 50/100
MIDI ELECTRONIC PIANOS



Rolands New Series of HP100/50 Electronic Pianos offer 4 superb new sounds with the MIDI connect!
78 keys stereo, key transpose, chorus and with touch sensitivity and MIDI channel program assigns capability make an ideal budget MIDI keyboard controller, as well as piano!
AVAILABLE JULY 85

NEW

BOSS MICRO RACK MIDI UNITS

Supporting the MIDI revolution Boss offers a new range of MIDI control units that fit the micro rack standard. Range includes
MI-30 MIDI channel filter/converter £199
MI-40 MIDI input selector £85
MI-50 MIDI output selector £85
MI-10 MIDI to CV interface £245
AVAILABLE AUGUST 85

FUTURE MUSIC

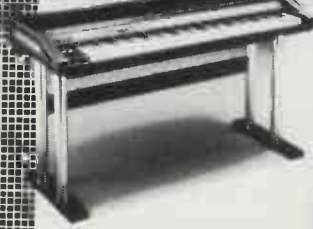

MKB1000 - MKB300
MIDI KEYBOARD CONTROLLER

SPECIAL OFFER!!

MKB1000 & MKB3000
WITH FREE STANDS (AND FLIGHT CASES WORTH OVER £300)

JUNO 106 POLY SYNTH



THE WORLD'S BEST SELLING ANALOG SYNTH!!
NOW ONLY **£699!!**
MIDI - 128 MEMORIES

MKS80 SUPER JUPITER
MIDI 8 VOICE MODULE
£1589



MKS20 PLANET
POLY SYNTH MODULE
£769



MKS10 PLANET P
MIDI PIANO MODULE £839



MPG80 PROGRAMMER



PHONE

MSQ100 & MSQ700
POLYPHONIC SEQUENCER MIDI!

REAL OR STEP TIME



MSQ100 PHONE
MSQ700 PHONE
SBX80 SYNC BOX
£839



The SBX-80 is an affordable programmable tempo controller that can generate and read SMPTE time code thus the SBX-80 can be used as a master tempo controller for almost all electric instruments.

ROLAND SPECIAL OFFERS!!

KEYBOARDS	AMPS	BOSS BARGAINS
All Keyboards include free stand!	JC120 jazz chorus..... £475	DD2..... £135
JX8P + stand..... £1150	JC50 jazz chorus..... £299	DR110..... £125
JX8P + PG800 + stand..... £1299	JC77 jazz chorus..... £239	CE2..... £75
JX3P + stand..... £599	CUBE60K keyboard..... £215	BF2..... £69
JUNO 106 + stand..... £1699	SUPERCUBE 40 lead..... £239	CE300..... £185
JPR + stand..... £1999	SUPERCUBE 60 lead..... £239	DM3..... £99
SH101 + MGS1..... £225	SUPERCUBE 100 lead..... £329	HM2..... £49
JUNO 60..... £599	SPIRIT 25A lead..... £139	PC2..... £59
JPE..... £399	CUBE 40 chorus..... £199	HA5..... £39
MKB 1000 master MIDI controller..... £599!!	CUBE 60 chorus..... £255	DS02 sampler delay..... £175
MKB300 master MIDI controller..... £599!!		
AX15 remote keyboard..... £395!!		
SEQUENCERS	PA & EFFECTS	SUPERDEALS! ALL EX-DEMO OR S/H
JSD60..... £99!!	SDE1000..... £325	JX8P + PG800 ex dem..... £1195
MSD700..... £829!!	SDE3000..... £399	JUNO 106 s/h..... £395
HS0100..... £399	DE200..... £299	TR909..... £250
MC4B..... £399!!	SDE2500 new MIDI..... £299	TR808..... £250
CMU800..... £99	All above available including Delta Sound Sample hardware fitted..... £PHONE!!	MSQ100 sequencer ex dem..... £350
CMU802..... £49!!	SSI140 PA speakers..... £145!!	JSQ60 sequencer..... £79
CMU807..... £175	SS160 PA speakers..... £196!!	MC4B..... £399
	SS180 PA speakers..... £199!!	RM1200 mixer..... £495!
	SRA2000 digital reverb..... £1399!!	RM1600 mixer..... £695!
DRUM MACHINES	GUITAR SYNTHS	CALL FOR EXTRA SPECIAL SUMMER PRICES
TR707..... £465	GR300 + GR303..... £750!!	
TR808..... £250	GR300 + GR808..... £795!!	
TR909..... £575	GR300 + G207..... £595!!	
TR606..... £250	GR300 + G305..... £695!!	
CR8000..... £299	GR300..... £495!!	
CR5000..... £249	GR700..... £1395!!	
PR110..... £125	G707..... £850!!	
BOSS RMK100..... £49	G707 + GR700 package..... £1799	
NEW Electronic kit..... £1699		

ROLAND GUITAR SYNTHS - GR707 & G700

The worlds 1st and only MIDI guitar system!! With a choice of 5 guitars or custom fit your own guitar. Fitted by experts!! Call for info!!



★ NEW DX21 BUDGET FM SYNTH £1699!!! ★
 ★ NEW RX21 DIG. DRUM MACHINE – COMING SOON – PHONE!!! ★

YAMAHA HI-TECH DEALER—INCREDIBLE NEW PRODUCTS

NEW
DX5  **£2999**

Digital programmable synthesizer. State of the art performance yet affordable! 76 Key velocity sensitive with aftertouch 16 Note Polyphonic (dual) or 32 note Poly (single) 128 Memories, 6x2 operators 32 Algorithms! Split channels! MIDI 8 parameter digital EQ!

NEW
KX88 REMOTE MIDI KEYBOARD  **£1399**

Yamaha invent the ultimate in midi remote keyboards! Light and portable yet full of features! 88 notes wood keys, beautiful feel! 19 different control effects 192 parameter change possibilities. THE ULTIMATE!

NEW
QX1 MEGA SEQUENCER!  **£2499**

Incredibly sophisticated state of the art data storage, the most powerful yet!
 8 Polyphonic channels, built in disc drive with one megabyte storage (80,000 notes!)
 Extremely sophisticated editing.
 Best Yet!

NEW
TX816/TX812 FM TONE GENERATOR SYSTEM  **£4199**

System of the future now! 8 DX7s in a rack creating unbeatable versatility, 32 voices per module individual MIDI channel assign.
 TX812 ideal starter with two modules and rack expandable with additional TFI modules!

NEW
QX7 DIGITAL SEQUENCE RECORDER  **£499**

Yamaha continues the fabulous X7 range with an incredibly cheap poly, midi sequencer! 2 track, 16 midi channel sequencing in real or step time! MIDI in and out! Storage! Editing! Just like a multi track but with digital quality!

NEW
MT44D 4 TRACK  **£799**

Yamaha have completely redesigned the popular MT44 system with sharp new looks and many new features, LED Display, 6 input mixer new patchbay etc.

NEW
TX7 FM TONE GENERATOR  **£699**

DX7 half price!!? Almost! All the functions of the worlds best selling synth in a compact keyboard controlled through MIDI! 6 Operators, 16 note polyphonic, 32 memories, LCD display! Low price!

NEW SOFTWARE
CX5M  **PHONE**

Yamaha's affordable music computer now with new software! Real time multitrack recorder, 4 track controllable from MIDI keyboard (DX7 etc)!
RX drum machine programmer!
 Program your RX11 or RX15 with fabulous graphics from a CX5 just like the DX7 cartridge!

202 NEW KINGS ROAD,
 FULHAM, LONDON SW6
 OPP. PUTNEY BRIDGE TUBE
 TEL: 01-731 5993
 01-736 4771

10 BADDOW ROAD,
 CHELMSFORD, ESSEX
 TEL: 0245-352490

104-106 ELM GROVE,
 SOUTHSEA, PORTSMOUTH
 HANTS.
 TEL: 0705-820595

85 ST. MARY'S STREET,
 SOUTHAMPTON, HANTS.
 TEL: 0703-26798

Instant Credit Available.



REV-1 PROFESSIONAL DIGITAL REVERB

Yamaha Introduce the world beating REV-1 Digital reverb! 19" Rack mount unit plus multifunction remote control with superb LCD graphics. Max reverb time 99s, 90 memories (30 preset) Packed with features! Simulate any kind of reverberation system characteristic!



ON DEMO NOW!
£POA

REV-7 PROFESSIONAL DIGITAL REVERB WITH MIDI

Yamaha break the price performance barrier with the brandnew REV-7! 19" rack mount unit with remote simulates any reverb characteristic! New LSI chips



give up to 15 early reflections and 99.9 milliseconds of initial delay. Parametric Eq. MIDI, 30x presets, stereo, 60 user memories!!! **£1199**

COMING SOON

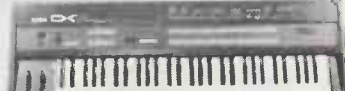
DX7  **PHONE**

The worlds best selling synth now even more versatile with the new QX7, TX7 modules!

RX11 RX15

Now programmable from a CX5 with superb graphics, and controllable through MIDI. Real and step time fabulous digital sound quality.
 RX11 has individual outputs and cartridge memory expansion.



PHONE

YAMAHA PA – GUITARS – AMPS – DRUMS

YAMAHA GUITARS

NEW ELECTRIC/ACOUSTICS



FNS75E £299.00
 FNS95E £349.00
 CN525 classic £299.00

NEW ELECTRICS

New SE200 3pu £169.00
 New SE300 w/trem £199.00
 SG1300TS trem/lock nut £539.00
 SE700HE Humbuckers £429.00

NEW BASSES

BB1100s Active EQ £399.00
 BB300 £199.00
 BB400 SF Fretless £279.00
 BB3000 £699.00

YAMAHA DRUMS

Series 9000 standard sizes now also available in power tom and new finishes. In Stock!
 Series 5000 also now available in Power tom. In Stock!



YAMAHA PA

The new compact high powered S250 speaker system comprising of the S250X full range cabinet, 250w handling with carbon fibre cones and high frequency compression driver and horn.
 The S250G is a high powered bass which when used in conjunction with the S250s give a full range system capable of handling 1100 watts.

S250X £399.00 each S250S £499.00 each

CALL IN FOR FULL DEMONSTRATION

YAMAHA SPECIAL OFFERS

MT44 MULTITRACK RECORDER	£499
CS01 PORTABLE SYNTH	£99
PF10 DIGITAL ELECTRONIC PIANO	£499
R1000 DIGITAL REVERB	£499
MR10 DRUM MACHINE	£69
KX5 MIDI REMOTE KEYBOARD	£295
CX5M (Free YK01 K/bd & S/ware)	PHONE
RX11 DIGITAL DRUM MACHINE	PHONE
RX15 DIGITAL DRUM MACHINE	£499

YAMAHA GUITARS SPECIAL OFFERS

SE200	£115
SG1300T	£349
SG200	£149
SG1000	£289

Also incredible prices on Yamaha acoustics and classicals.
 Call for info and prices.

NEW

ensoniq MIRAGE

COMING SOON! THE SOUND SENSATION OF 85!! **£1695**
INCREDIBLE FEATURES! SUPER PRICE

Ensoniq introduce the Mirage the first integral touch sensitive sound sampler at a real price! Look at these features:

- ★ Five octave velocity sensitive keyboard
- ★ 8 voice polyphonic
- ★ 16 different samples across the keyboard
- ★ Up to 8 second samples
- ★ 4 user samples split across the keyboard
- ★ On board MIDI sequencer
- ★ On board 3.3" floppy disk drive
- ★ 4 sounds per disk
- ★ MIDI in/out

ENSONIQ MIRAGE



IN STOCK NOW!!!

**DW6000
UNBELIEVABLE
NEW LOW
PRICE £699
ALSO POLY
806 £399**

KORG

DW6000 PROGRAMMABLE DIGITAL WAVEFORM SYNTHESIZER

A digital synthesizer that responds like a musical instrument! Korg's new DW6000 offers advanced digital sound quality with easy to use analog processing and control!!! + MIDI interface. Look at these features! 6 voice 69 memories complete sound generation through harmonics synthesizer encoded in 2x256 ROM chips. 2 oscillators with 8 waveforms each.

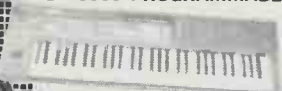

SDD2000 DIGITAL SAMPLER/DELAY

Korg introduce a new rackmount effect for the exciting new world of sound sampling! and it's controllable from a polyphonic MIDI keyboard! Sampling at last affordable! 4368MSEC in both DECA-1 sample mode make sequencing as well as single note sampling and digital delay possible with 64 memories transposable through MIDI!

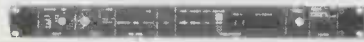

£699



MR-16 MIDI RHYTHM UNIT

The answer! Digital drum sounds controllable through MIDI at new low price! 19 high quality PCM recordings triggered by MIDI keyboard, drum machine, sequencer etc!!

PHONE

**SPECIAL PACKAGE
OFFER!!
DDM110 DIGITAL
DRUMS + DDM
220 DIGITAL
PERCUSSION
ONLY
£399**

SEL



SIEL DK80 DYNAMIC POLYSYNTH

Introduce a brand new Touch Sensitive Polysynth at the incredible low price of £699

Look at these features!

- 12 notes (6 note Poly) Dynamic Keyboard, Built-in 2 track real time Poly MIDI sequencer!
- 150 programs, stereo advanced MIDI

£599



SIEL MIDI EXPANDER 80

19" rack 8 voice 50 memories, RAM & ROM extensions + 300 note Polysequences on board!

£399

CASIO

CZ5000 NOW IN STOCK £899

CZ101 AND CZ1000

Casio's world beating CZ1000 now available with full size keys



**CZ101 £345 ★ CZ1000 £495
WITH FREE ASTO KEYBOARD AMP**

SZ1 DIGITAL SEQUENCER

Real or step time
MIDI, RAM cartridge
4 track 1800 notes

£345

FUTURE MUSIC

NEW

SEQUENTIAL CIRCUITS

£999!!

The powerful new **MULTITRACK** fully touch sensitive polysynth on board powerful sequencer



Introducing **TOM**
The state-of-the-art **£699**
Digital drum machine

SEQUENTIAL CIRCUITS SPECIAL OFFERS!!
MAX £395! SIXTRACKS £595 DRUMTRACKS £895
LIMITED OFFER TIME!!

NEW

AKAI MG1212

The incredible 12 channel integral recorder on 1/2" cassette tape **SMPT** VERSION SOON!

£5999

AKAI MIDI DIGITAL SOUND SAMPLER AND QUICKDISK

PACKAGE PRICE £1150

AKAI AX80 8 VOICE TOUCH SENSITIVE POLYSYNTH WITH NEW SOUNDS AND NEW LOW PRICE! ONLY

£999



SIMMONS

FANTASTIC NEW PRODUCTS FROM THE WORLDS LEADERS IN ELECTRONIC PERCUSSION!

SDS9 COMPLETELY REDESIGNED 5 PIECE KIT WITH MANY NEW FEATURES

- ★ Snare drum has two pick-ups gives rim shot on cross stick as well as 3 digital snare sounds
- ★ MIDI in and out

SDS series 1000

SDS200
SDS400
SDS800

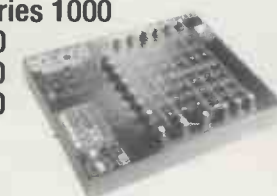

Add a Simmons system to your kit! Now with SDS Series 800 you can add a 4 piece kit at fabulous affordable prices.

SDS64

All new software for programming Simmons from Commodore 64 into trigger inputs terrific graphics.

£59

ALSO IN STOCK

SDS1

Simmons digital drum complete with choice of EPROM £249 Library sounds £24

SDS7

The worlds leading digital drum synth complete with stands with free BD pedal of your choice £1995

SDS8

Simmons on a budget. the popular kit at low price and the exclusive Simmons sound £595

SDSEPB

Simmons revolutionary digital sound sampler for SDS1 and SDS7 £390
6 pack EPROM £99
Eraser £39

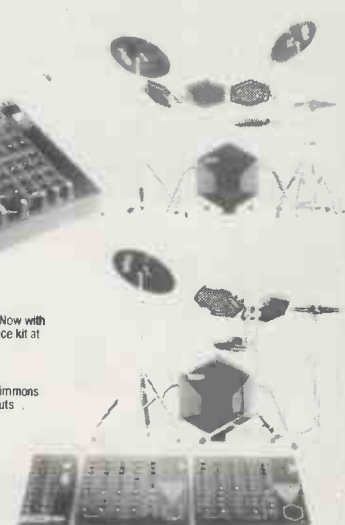

Fostex



★ BRAND NEW FOSTEX A80 MULTITRACK SYSTEM NOW IN STOCK ★ FOSTEX HAVE COMPLETELY REDESIGNED THE A8 SYSTEM WITH THE MODEL A80 8 TRACK RECORDER AND NEW 450 MIXER. THIS STUNNING NEW SYSTEM INCLUDES MANY NEW FEATURES: SMPTE & MIDI INTERFACE, BAR GRAPH METERS (ON A8) AND MORE. THE FOSTEX WORLD BEATING SYSTEM - THE DOMINATION CONTINUES. PHONE FOR PRICE



FOSTEX 250
Multi tracker. Still the best four track cassette system at a price you can afford.
Phone for details or call in for a demo. **PHONE**

FOSTEX B16+RAM MEGA GREAT COMBINATION £5295	FOSTEX B16+AHB SYSTEM 8 16:16 AHB'S MOST SUCCESSFUL MIXER £5335
FOSTEX B16+DYNAMIX 24/8/16 BEST VALUE SYSTEM £4950	FOSTEX B16+CMC24 LATEST COMPUTER MIXER £5995
FOSTEX B16+SOUNDTRACKS MOST POPULAR COMBINATION £5650	FOSTEX B16+RSD 16/16/2 EXCELLENT FACILITIES £5295
FOSTEX B16+SECK 18/8/2 NEW SECK MIXER SET TO BE A WINNER £4965	FOSTEX B16+SDUNCRAFT FOR THE PROFESSIONAL £6999

FOSTEX X15

The portable multitrack phenomenon with free case

£279

Or with MN15 + PSU **£355**

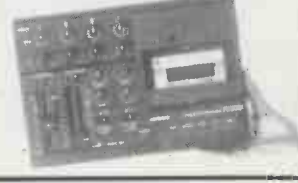

Accessit

STILL THE BEST VALUE IN BUDGET SIGNAL PROCESSORS

COMPRESSOR	£52.00
NOISE GATE	£52.00
DUAL SWEEP EQ	£52.00
STEREO REVERB	£132.00
FOUR WAY PSU	£33.00
SINGLE PSU	£8.00

RACK MOUNT KITS AVAILABLE
STUDIO/DISPLAY RACKS FROM £65.00
FULL RANGE OF TANNOY MONITORS AND QUAD POWER AMPS IN STOCK

202 NEW KINGS ROAD, FULHAM, LONDON SW6
OPP. PUTNEY BRIDGE TUBE
TEL: 01-731 5993
01-736 4771

10 BADDOW ROAD, CHELMSFORD, ESSEX
TEL: 0245-352490

104-106 ELM GROVE, SOUTHSEA, PORTSMOUTH, HANTS.
TEL: 0705-820595

85 ST. MARY'S STREET, SOUTHAMPTON, HANTS
TEL: 0703-26798

Instant Credit Available.

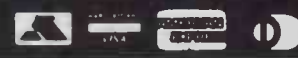

HOME RECORDING & PERSONAL MULTITRACK

★ FOSTEX ★ REVOX ★ AKAI ★ YAMAHA ★ SECK ★ RAM ★ SOUNDTRACS ★ ALLEN & HEATH ★



RECORDERS FOSTEX X15 £299.00 FOSTEX 250 £720.00 FOSTEX A8 £1375.00 FOSTEX B16 £4,000.00 YAMAHA MT44D £399.00 AKAI MG1212 £5399.00 REVOX B77 £999.00	MIXERS DYNAMIX 16:8:2 £995.00 RAM R10 £699.00 FOSTEX 7850 £535.00 ACES 10:8:2 £399.00 AHB 16:8:2 £1595.00 AHB CMC 24 £2750.00	SOUNDTRACS 16:8:16 YAMAHA RM6D2 £2385.00 SECK 18:8:2 £1493.00	MONITORS TANNOY Staffords £145.00 TANNOY Oxfords £225.00 YAMAHA Ns10 £199.00 YAMAHA S10X £69.00 YAMAHA S20X £110.00	POWER AMPS QUAD 303 £179.00 QUAD 405 £269.00 ROLAND SRA1200 £399.00	ROLAND SRA2400 £725.00 ROLAND SRA4800 £1450.00	DRAWMER Noise Gate £335.00	YAMAHA D1500 MIDI £550.00 BOSS DE200 £275.00 BOSS CE300 CHORUS £325.00 IBANEZ HD1000 £325.00	YAMAHA CQ1031 31 band £229.00
COMPRESSOR/LIMITERS DRAWMER Compressor £395.00 FOSTEX 3070 comp/W/M £249.00 YAMAHA CG2020 £229.00 ACCESSIT Compressor £52.00	DIGITAL DELAYS ROLAND SDE3000 £795.00 ROLAND SDE1000 £395.00 ROLAND SDE2500 MIDI £585.00	DIGITAL REVERB YAMAHA Rev 1 £POA YAMAHA R1000 £475.00 ROLAND SRV2000 £1425.00	SPRING REVERB GI British Spring £229.00 ACCESSIT Stereo Rev £132.00 FOSTEX 3180 Stereo £340.00 BOSS RX100 £125.00	NOISE GATES ACCESSIT Noise Gate £52.00	YAMAHA D1500 MIDI £550.00 BOSS DE200 £275.00 BOSS CE300 CHORUS £325.00 IBANEZ HD1000 £325.00	YAMAHA CG2020 £229.00 ACCESSIT Compressor £52.00	YAMAHA CQ1031 31 band £229.00	YAMAHA D1500 MIDI £550.00 BOSS DE200 £275.00 BOSS CE300 CHORUS £325.00 IBANEZ HD1000 £325.00
MICROPHONES DRAWMER Compressor £395.00 FOSTEX 3070 comp/W/M £249.00 YAMAHA CG2020 £229.00 ACCESSIT Compressor £52.00	DIGITAL DELAYS ROLAND SDE3000 £795.00 ROLAND SDE1000 £395.00 ROLAND SDE2500 MIDI £585.00	SPRING REVERB GI British Spring £229.00 ACCESSIT Stereo Rev £132.00 FOSTEX 3180 Stereo £340.00 BOSS RX100 £125.00	NOISE GATES ACCESSIT Noise Gate £52.00	YAMAHA CG2020 £229.00 ACCESSIT Compressor £52.00	YAMAHA D1500 MIDI £550.00 BOSS DE200 £275.00 BOSS CE300 CHORUS £325.00 IBANEZ HD1000 £325.00	YAMAHA CQ1031 31 band £229.00	YAMAHA D1500 MIDI £550.00 BOSS DE200 £275.00 BOSS CE300 CHORUS £325.00 IBANEZ HD1000 £325.00	

ALL ITEMS EX-DEM OR S/H

FUTURE MUSIC ★ SUPERSALE!!

★ TANNOY ★ JBL ★ QUAD ★ ACCESSIT ★ BOSS ★ ROLAND ★ DRAWMER ★ BEYER ★ AKG ★

GUITARS ELECTRICS GIBSON Les Paul d/lux s/h £450.00 GIBSON Flying V s/h £499.00 YAMAHA SG3000 new £595.00 IBANEZ Musical Active £399.00 NEW Squier 'Vintage' Strats £215.00 NEW Squier 'Vintage' Tele £225.00 FENDER Bullet £145.00 KRAMER DM2 2000 £199.00 IBANEZ RM 50 s/h £150.00 IBANEZ AR100 s/h £195.00	WASHBURN 'Solid' Acoustic £225.00 YAMAHA 'Montana' Folk £65.00	SEQUENCERS ROLAND MSQ1000 ex dem £349.00 ROLAND CX0100 s/h £98.00 ROLAND CS0600 ex dem £149.00 ROLAND JS060 ex dem £125.00 ROLAND MC4B ex dem £399.00 ROLAND MC202 s/h £149.00 SIMMONS SDS6 ex dem £999.00	KEYBOARDS JUNO 106 ex dem £595.00 ROLAND MKB1000 £2999.00 OBERHEIM Expander £POA RHODES 88 s/h £395.00 CASIO 301 s/h £175.00 ROLAND MKB1000 £1199.00 KORG Micro Preset s/h £99.00 KORG MS10 s/h £135.00 ARP OMNI s/h £199.00 CLAVINET D6 s/h £150.00 CRUMAR Piano £125.00 MELLOTRON £Offers!! ROLAND Juno 6 s/h £595.00	COMPUTER MUSIC BBC B + Opus drive + EMR ex dem £499.00 COMMODORE 64 + Disk £395.00 ROLAND MK4B £399.00 YAMAHA (Japan ESC) £299.00	DRUM MACHINES MIXR digital drums ex dem £499.00 ROLAND TR909 £299.00 ROLAND TR909 s/h £199.00 ROLAND CR8000 ex dem £225.00 ROLAND CR5000 ex dem £199.00 MATEL SYNSONIC £75.00 ROLAND TR606 ex dem £175.00 KORG DDM220 £199.00	ELECTRONIC DRUMS SIMMONS SDS5 ex dem £750.00 SIMMONS SDS8 ex dem £595.00 SIMMONS SDS6 ex dem £595.00 SIMMONS Cymbalmod £POA ULTIMATE K2 complete ex dem £750.00	TED Digsound modul single £125.00 TED Digsound modul double £99.00	AMPS BADGER Minvet £85.00 BADGER Downbeat £65.00 BADGER Keyboard 15 £85.00 FENDER 15" bass cab £149.00 FENDER Sidekick 30 bass £125.00 FENDER Sidekick 50 bass £199.00 FENDER Harvard rev £159.00 FENDER Yale £225.00 FENDER Studio Lead £275.00 OHM 'Tramp' bass £95.00 OHM 'Tramp' lead £85.00 HIWATT 100 top s/h £99.00 4x12 cab s/h £75.00 LANEY 100 slave £75.00 LANEY 120 combo £195.00 PR s/h Custom bass bins £399.00 CUSTOM Sound Cab £98.00	ACUSTIC DRUMS YAMAHA 9000 red ex dem £1199.00 GRETSCH 5 piece £599.00 NATAL Congas s/h £295.00 PAISTE 38" gong s/h £495.00
---	--	--	---	--	--	---	---	---	---



the winner IN STOCK NOW

Delta Digital Delay Sampler Conversions!!!
SX301 convert your existing digital delay to a sampler £POA
SX303 convert your existing digital delay to a sampler with a one volt per octave interface Mini version soon!! £7.£375
Or buy 4 digital delay with Delta sound sampling hardware fitted to the shelf!! At very attractive package price!!!
ROLAND SDE1000 £425.00
ROLAND SDE3000 £299.00
ROLAND SDE2500 PHONE
BOSS DE200 PHONE
YAMAHA D1500 PHONE
KORG SDD1000 PHONE
Powerban PHONE
etc. call for more info.

GREENGATE DS3

Polyphonic digital sound sampler now with looping MIDI and super graphics!
Incredible price breakthrough sound sampler board for Apple IIe only £250 with digital scan 4 poly keyboard £550 + VAT.
Complete Apple IIe system Apple IIe + 2 drives, cards, keyboard and software £1400 + VAT.
New looping software in stock.

FOR DELIVERY CHARGES PLEASE PHONE FOR QUOTATION

Name _____ Telephone No. _____
Please send me the following goods _____
I enclose a cheque/P.O. for £ _____
No. _____ Signature _____
Please send me details on the following goods (enclose a large s.e.) _____
E&MM/7/85

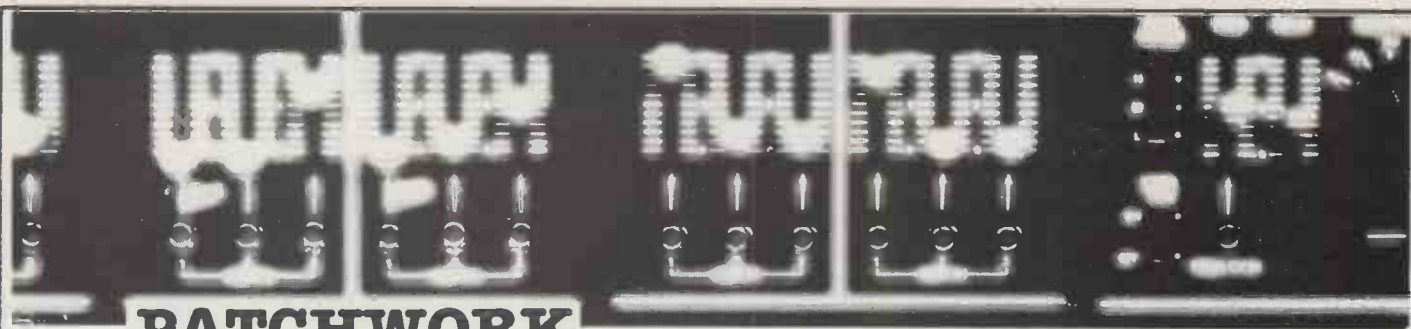

PATCHWORK

More details of synth patches and how to get the best from them...

ROLAND JUPITER 8

'Japanesque'

**Wendy
Birmingham**

JUPITER-8

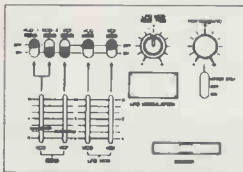
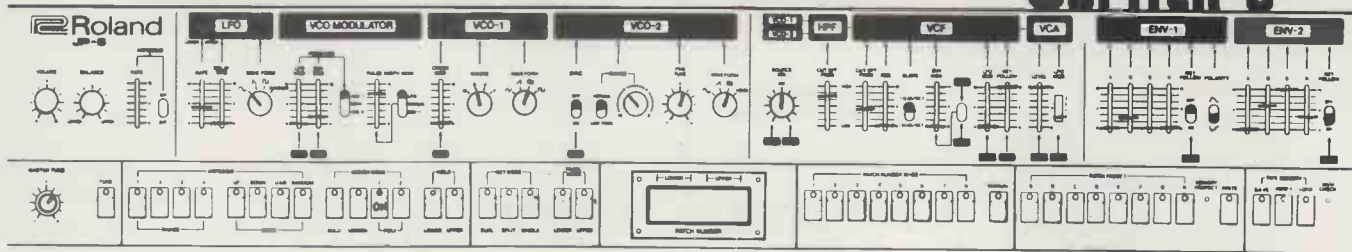

An Oriental-style patch falling somewhere between conventional brass and string sounds in application. Most usable over the upper two thirds of the keyboard, it's

best suited to slower chord progressions or the odd bit of lead work. Pitchbend can also be used to add expression if required.

UMI- 2B MIDI MYRID SYSTEM

This amazing MULTI-MIDI controller is the most powerful in the world: full control of up to 16 polyphonic channels of MIDI keyboards, MIDI drum machines and MIDI reverb/delays. Let us show how to harness the real power of MIDI sequencing with this unique BBC B micro interface.

Screen display details and full specification*available on request.



The London Rock Shops

LONDON: 26 Chalk Farm Road, London NW1 Tel: 01-267 7851/5381/1771

BRISTOL: 7 Union Street, Bristol, Avon Tel: 0272 276944

BACK TO BASICS

Our beginner's guide to analogue synths comes to the complex and thorny topic of modulation. *Steve Howell*

We've now seen how most individual bits of analogue synthesiser work. We've covered the VCO, VCF, EG and LFO, and what you've learned about those can be applied to just about any analogue synth, from a humble SH101 to a Prophet T8. So, now with the basic building blocks safely out of the way, we can go back to VCOs and look at some of their more complex functions.

A lot of what I'll be looking at will be of particular relevance to synths with two oscillators, though that's not to say you should stop reading if your synth has just the one. You're bound to come up against a pair of VCOs one day, after all.

Having said that, the first subject to come under discussion – Pulse Width Modulation – is by no means confined to dual-oscillator instruments. As we saw when we covered the VCO from a general viewpoint, many designs give you a square wave output whose width is continuously variable. This usually manifests itself in one of two ways. Either the selector that switches between the various available waveshapes has a variable pulse width control for the square wave, or there's a position on said switch that handles the pulse width as a separate entity from the square wave. In practice, both systems perform exactly the same synthetic task.

To recap on something I've already been into in a previous instalment, a square wave with a perfectly symmetrical shape creates a hollow sound not unlike that of a clarinet. As soon as you vary the width of the waveform, however, the sound becomes thinner and more nasal as a result of drastic changes in harmonic content. To be more specific, a symmetrical square wave creates only odd harmonics, whereas the same wave at one extreme of its pulse width contains a high number of both odd and even harmonics. The result is shown in Figure 1; analogue synth experts will realise that the harmonic structure is not unlike that of a sawtooth waveshape – except that there are even more harmonics. Not surprisingly, a good deal of variation in harmonic content exists between these two extremes of waveshape, and that's the parameter that a synth's pulse width control gives you.

But the real beauty of the pulse/square wave is that its width can be varied automatically, courtesy of your friend and mine, voltage control.

Automatic Control

Figures 2a and 2b show block diagrams of different sorts of PWM section. The first demonstrates Roland's method – whereby a slider has a switch that selects between LFO, EG and a DC voltage source – while the second shows the way most other

manufacturers go about doing things. The latter incorporates that old favourite, the summing amplifier, in this case fed by a DC voltage source and a modulation source, governed by separate controls. The former, on the other hand, has just the one slider to regulate the level of voltage coming in, be it from a DC source (for setting pulse width manually) or a control source (for varying the width automatically).

It's pretty obvious that the system in Figure 2b is the more versatile, as it allows you to set the width of the pulse using the DC voltage source and *then* mix in voltage control as well. In other words, you can begin with a width that isn't symmetrical and sweep the pulse from that point, the maximum sweep amount being governed by the modulation level control. The difference is a subtle one, but it certainly makes the effect more controllable.

What does a modulated pulse width sound like? Well, that depends on the control source you're using. In both of the diagrams just discussed, the control sources are the sine and triangle output of an LFO or EG. There's a good reason for this, in that these two devices have now been

adopted as the standard controllers by most of the modern synth industry, as a result of their producing the most musical effects. That's not to say a lot of fun can't be had from using other, less conventional sources (being the owner of a good ol' fashioned modular system, I can vouch for the usefulness of, say, routing a keyboard's CV to the PWM section so that pulse width can change across the keyboard's length), but as so often happens, sheer cost prevents most designers from implementing such electronic exotica.

But let's confine ourselves to the most commonly-found modulation sources. Selecting an LFO to do the job means you can sweep the pulse width between its two extremes at a rate determined by the LFO frequency. You can also decrease the amount of LFO modulation, if a somewhat subtler effect is what you're after.

There is a second effect associated with syncing, however, and it comes to the surface whenever you alter the frequency of the synced VCO. To demonstrate it to yourself, sync two VCOs together using a square wave output on each, set the filter so that the sound passes through unaffected (ie. with the cutoff frequency control at maximum), and make sure sustain portions of the EGs are up full. Now hold down a note on the keyboard and adjust the frequency control on the synced VCO (it's impossible to be specific here; most synths give the synced oscillator a Sync switch to identify it, some do things the other way around). As you make that adjustment, you should hear the characteristic heavy flanging sound.

Exaggerating the effect is easy: just boost the level of the synced VCO so that becomes the dominant tone. You could also try experimenting with different waveshapes and combinations of waveshapes – at various frequency settings.

A lot of sync effects are nicely suited to beefing-up lead lines, and devotees of the Jan Hammer school of heavy metal synth playing will already be familiar with the sort of things that are possible. You can also use them to create powerful bass sounds – especially if you're going to sequence them.

Voltage Control

Of course, any voltage-controlled oscillator also lets you create sync sweep effects automatically by using a source of varying voltage. Connecting a very slow LFO to only the synced VCO (let's call it VCO2 from now on, OK?) and setting the modulation level fairly high means that the effect I've just talked about will be heard as an automatic sweeping effect.

Alternatively, you could select some other modulation source for your sync

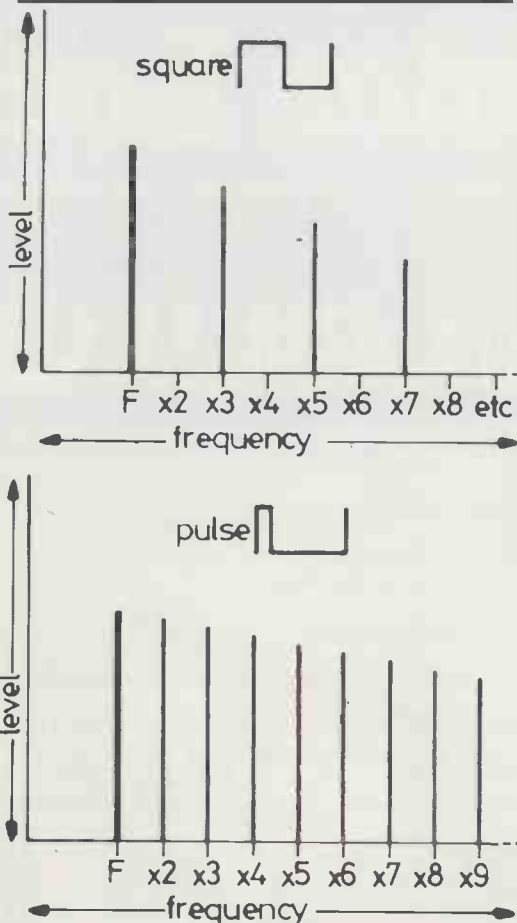
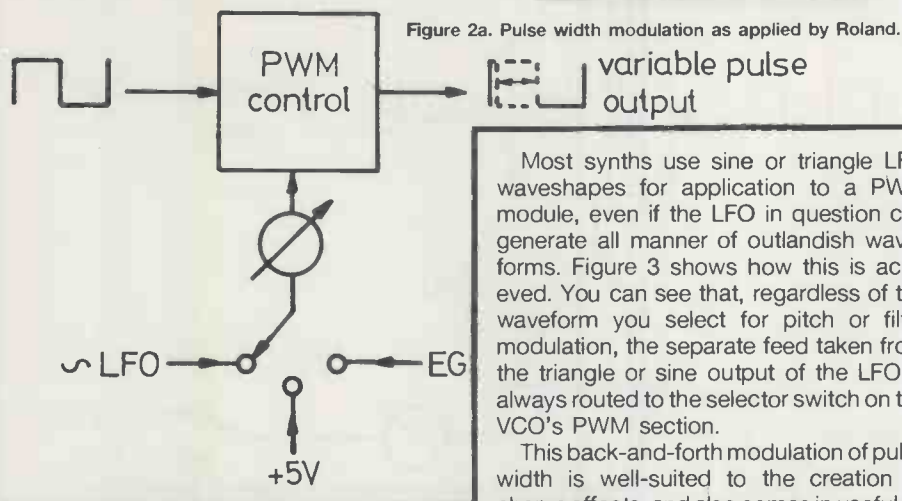

Figure 1. Square wave and pulse wave harmonic spectragraphs.



Most synths use sine or triangle LFO waveshapes for application to a PWM module, even if the LFO in question can generate all manner of outlandish waveforms. Figure 3 shows how this is achieved. You can see that, regardless of the waveform you select for pitch or filter modulation, the separate feed taken from the triangle or sine output of the LFO is always routed to the selector switch on the VCO's PWM section.

This back-and-forth modulation of pulse width is well-suited to the creation of chorus effects, and also comes in useful for thickening-up ensemble sounds such as strings. If your synth has just the one VCO, PWM can be an effective way of giving the *impression* you're using a couple of detuned VCOs. On the other hand, deep, fast PWM can sometimes give the impression of vibrato, as the human ear perceives the harmonic shift as a pitch one. And if you find this effect more of an irritation than anything else, you simply back off the modulation depth or LFO speed, and all will be well again.

In the past, synth manufacturers have seen fit to endow their instruments with just a single LFO, something that (obviously) restricted the possible applications of PWM because the section had to share the

same rate as the vibrato (or whatever). Thankfully, today's designers have seen the light and given a lot of contemporary synths two or more LFOs. This really is a wizard wheeze, as it lets you set up *different* speeds for vibrato, filter sweep and PWM; the resulting range of possible sonic effects is, frankly, vast.

Dynamic Control

And so we come to the other most common form of PWM, namely that which uses an Envelope Generator for dynamic control. Here, the width of the pulse varies in accordance with the voltage output generated by the EG. As the EG voltage rises during its attack cycle, so the pulse width gets narrower. When the EG voltage falls during the decay cycle, the pulse width broadens out, eventually returning to its original width during the release portion, when the EG's output falls to 0V.

This technique comes in particularly useful for adding 'bite' to synth sounds such as bass guitar, harpsichord and clavinet imitations. And some of today's velocity-sensitive keyboards are fitted to synths that allow you to vary the pulse width depending on how hard you hit the keyboard, giving PWM a new lease of expressive life, regardless of how it's implemented in a synthetic sense.

And so to another VCO-related effect, that of phase-locked synchronisation. If you've never encountered that expression before, don't worry - it's often abbreviated

sweeping, the most common of these sources being the EG. Most of today's synths let you route the VCF's EG to the VCO's, and by routing it only to VCO2, you allow sync sweeping to be governed by the setting of the synth's ADSR controls, and by the modulation amount. You may find you'll have to compromise between the filter's envelope shape and the VCO's in order to get exactly the effect you're looking for, but there's plenty of room for manoeuvre.

Touch-sensitive synths offer an even greater degree of control, as you can often route the voltage generated by the dynamic keyboard to VCO2, thereby putting the sync effect under (literally) fingertip control.

LONDON · BRISTOL · LONDON · BRISTOL · LONDON · BRISTOL · LONDON · BRISTOL · LONDON · BRISTOL · LONDON · BRISTOL · LONDON · BRISTOL · LONDON · BRISTOL · LONDON

The London Rock Shops

10 STEPS TO BETTER HOME RECORDING WITH YAMAHA

1. R-1000 DIGITAL REVERB: No digital competition at this price RRP £566 £399.
2. D-1500 DIGITAL MIDI DELAY: first MIDI DDL - call in for demo RRP £639 £499
3. GC-2020 COMPRESSOR/LIMITER: "virtually perfect" Home Studio Recording £229
4. MT-44D 4-TRACK CASSETTE MULTITRACKER: updated black model great results £399
5. RM-6026 CHANNEL MIXER: excellent features, ideal for MT-44D or submix £249
6. Q-2031 DUAL 31-BAND GRAPHIC EQUALISER: unmatched at this price £300 GQ-1031 £199
7. RX-11/15 DIGITAL DRUM MACHINES: The digital price busters - Ring for prices
8. CX-5M MSX MUSIC COMPUTER: 8 track FM sequencing facility £499 inc. keyboard
9. NEW REV-7 MIDI DIGITAL REVERB: Professional reverb..... Price to be advised
10. BUY YOUR YAMAHA EQUIPMENT FROM THE LONDON ROCK SHOPS AND YOU'LL ALWAYS GET A BETTER DEAL..... REMEMBER..... YAMAHA GET IT RIGHT!!

INCORP. COMPUMUSIC

THE LONDON
ROCK SHOP

26 CHALK FARM RD. LONDON NW1. ☎ 01-267-5381

See Yamaha in action at the
British Music Fair: London
Olympia 2 August 2nd-4th

Rock 'n' Roland

THE LONDON
ROCK SHOP

7. UNION STREET. BRISTOL. ☎ 0272-276-944

TECHNOLOGY

to 'Sync' by synth manufacturers. For reasons that will become obvious, Sync never puts in an appearance on anything less than a dual-oscillator synth, and even then, designs that incorporate digitally-controlled oscillators (DCOs) rarely feature it, either.

The facility was originally conceived as a means of setting up intervals between VCOs without any of the unpleasant beating effects that normally accompanied such a practice. It works, too. Syncing two VCOs together means you can tune them exactly an octave apart without any of the tuning discrepancies normally associated with using two oscillators. In short, syncing means that the sound has all the pitch and tone qualities of two VCOs locked together, but with the pair of them in perfect phase.

Time to move on to one of the current synth scene's biggest buzzwords - FM synthesis. Thanks to Yamaha's excellent DX polys, complex FM synthesis is now available to more musicians than ever, even if it isn't presented in the most accessible way. But what many synth players don't realise is that FM is actually lurking in the depths of the humblest, dual-VCO analogue synth, albeit in a fairly crude form.

In fact, FM is not the mind-mangling concept many would have you believe. Essentially, it's a distortion effect that arises when one audio signal is used to distort another. Feeding the output of a VCO into the CV input of another creates just such an effect, and the rule of thumb is that the more signal you feed in, the higher the harmonic content of the modulated VCO. This leads us on to those well-known FM expressions, 'modulator' and 'carrier'.

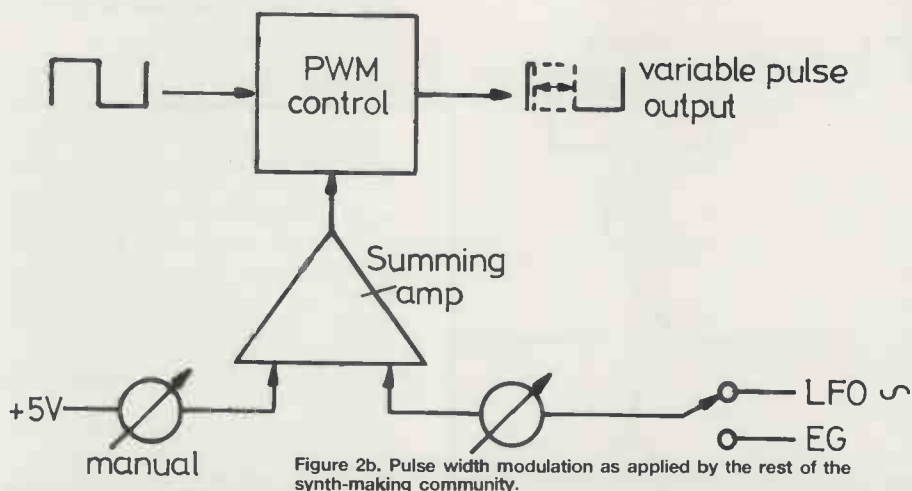

Figure 2b. Pulse width modulation as applied by the rest of the synth-making community.

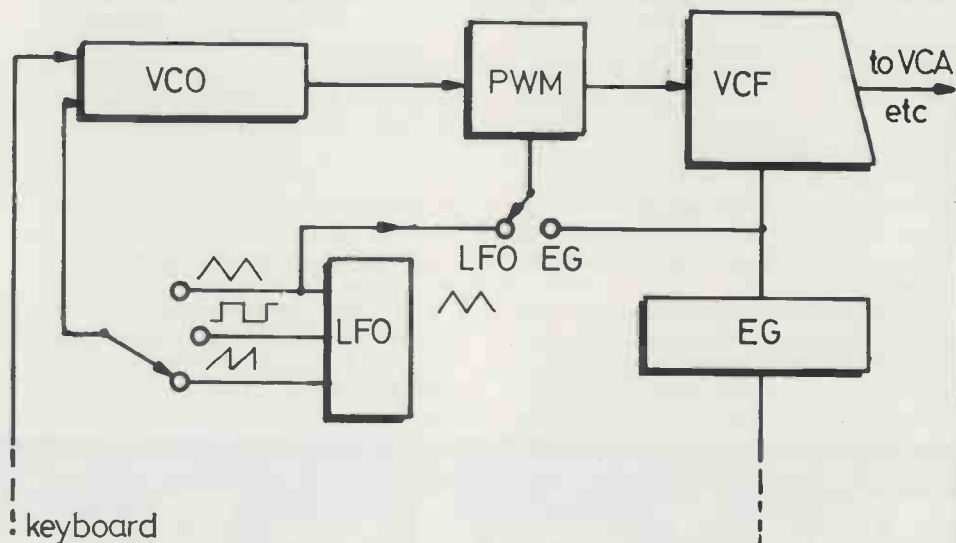

Figure 3. Layout of typical synth, showing how the LFO is always routed to the PWM section.

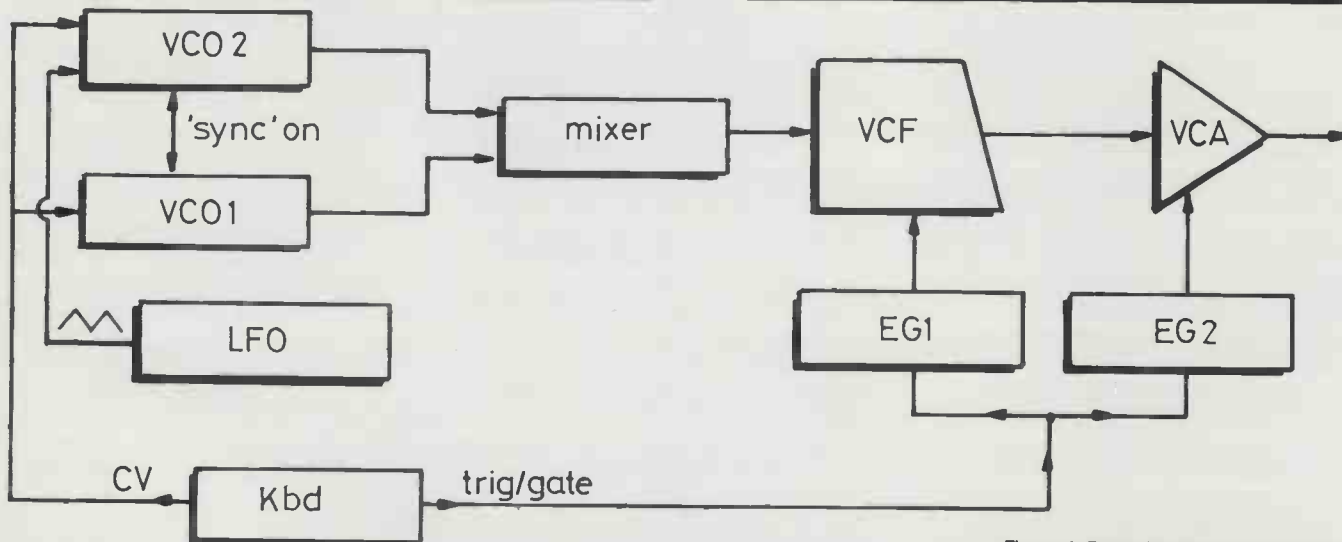

Figure 4. Patch for sync sweep effects.

The modulator in this case is the modulating VCO, while the carrier is (surprise, surprise) the one being modulated.

In addition to modulation level, another parameter crucial to the operation of basic FM is the frequency ratio between the two oscillators involved. If they're tuned to unison or an octave apart, the resulting sound will be concordant (ie. in tune), but if the modulator's frequency is an odd one that isn't harmonically related to the other, the sound becomes discordant - hence all

those wonderful 'clangy' tuned percussion sounds DX7s are so good at creating.

In case you weren't previously familiar with the term, the switching-in of one VCO to modulate another is known as cross-modulation. What the principle can do in sonic terms is give an analogue *approximation* (the closeness of which will depend on the individual character of your oscillator and filter sections) of digital clarity. It can't provide a vast range of high-quality acoustic approximations the way a proper

FM synthesiser can, but it's certainly a step in the right direction. If only more analogue synth owners knew it was there...

As I've said, the higher the modulation depth, the richer in harmonics the resulting sound will be: this is a pretty effective way of adding harmonics to a sound *without* resorting to the usual analogue practice of filtering an existing waveform.

A word of warning, though. Introducing cross-modulation almost invariably knocks the sound out of tune. The reason

TECHNOLOGY

for this is that the modulated oscillator sees the incoming signal as a DC voltage, because the modulator is in the audio frequency range. The summing amp principle shifts the carrier VCO up in pitch. This can easily be rectified by retuning the modulated VCO, but this, in turn, affects the overall sound because the frequency ratio between the two oscillators is altered as a result.

You can also come up against tuning problems that arise simply because your synth's VCOs have inherent inadequacies built into their design. They may sound in tune at first, but as soon as you apply cross-modulation, FM-type sounds soon acquire an excessively 'clangy' quality at either extreme of the keyboard, as the

VCOs begin to go out of tune. True, you can get around this one by syncing the two VCOs together (as just discussed), but the problem here is that some synths offer only a choice of sync or cross-mod - not both at once.

In other words, using FM synthesis techniques on an analogue synth means experimenting with various different tunings - if you're keen to extract the best results. Mind you, many modern synths bypass all these tuning hiccups by virtue of having digitally-controlled oscillators, so you may not have to worry too much about the last paragraph or three. ■

After several months of comparatively trouble-free production, Back to Basics fell victim to the Curse of the Gremlins in

E&MM June. First off was a typesetting error that resulted in a migration of parentheses, viz the sinewave clause that should have related to the triangle description rather than the square wave one it followed in print. That was a fairly obvious mistake that may well have been spotted by the alert amongst you, as was the artwork muck-up that resulted in the captions for Figure 6 being transposed, with sawtooth text referring to a drawing of a triangle wave and vice versa. Come to think of it, the sawtooth wave image could have been going through a rather more dramatic speeding-up of frequency, but we're not going to draw another one here, so you'll just have to leave it to your imagination...

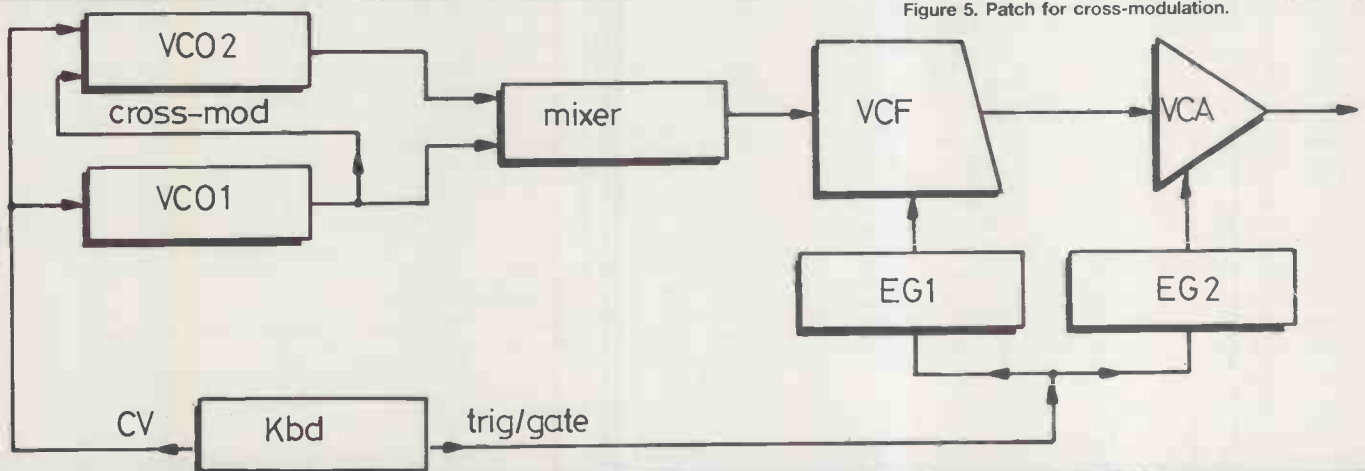

Figure 5. Patch for cross-modulation.

Roland GET IT RIGHT!!

NEW SRV - 2000 MIDI DIGITAL REVERB.

Roland break the digital reverb price barrier! RRP £1450 MIDI - controllable - the world's first! At last a really versatile, professional 99 second reverb at a price to suit most 8 and 16 track studio owners. This will surely enhance your studio sound more than anything else - at a price that is affordable.

SBX - 80 SYNC BOX SMPTE/MIDI

The SBX - 80 generates and reads SMPTE, syncing it to any other time base for locked control of MIDI sequencers and SMPTE compatible tape and video recorders. Essential for the audio-visual music studio. RRP £950

TR - 707 & NEW TR - 727 DIGITAL DRUM & PERCUSSION UNITS

Fully MIDI compatible, cartridge RAM storage, individual outputs, LCD graphic display, powerful PCM sounds.....unbeatable value!

TR - 707 RRP £525

TR - 727 RRP £525

BOSS EFFECTS PEDALS & RACK-MOUNTING UNITS

Boss is now the world's largest manufacturer of effects pedals. They have the widest range and are certainly the most reliable - at The London Rock Shops we have the complete range on permanent demo. These are the latest additions to the range: DSD-2 Digital Sampler pedal £245 DD-2 Digital delay pedal £195 CE-300 19" rack Chorus unit £230 de-200 Digital delay w/trig. £350



Please call in person for our very special summer prices.

SDE SERIES DIGITAL DELAYS

SDE - 1000 : 1.125 secs. (17kHz to 375ms) 4 memories £465
New SDE - 2500 MIDI : Multi memory for multi MIDI! £600
SDE - 3000 : 4.5secs. (17kHz to 1.5secs) 8 memories £950 with full digital display and foot control for s-o-s

JX 8P POLYPHONIC MIDI SYNTH

Velocity & pressure sensitive, 2 x DCO per note, 2 x envelopes, analog/digital sounds, 64 + 32 internal memories with 32 RAM pack option, patch chain function, illuminated alpha-numeric display, full MIDI spec.....RRP £1325 Optional PG - 800 easy programmer with sliders RRP £180

MOTHER KEYBOARD MODULAR MIDI SYSTEM

MKB - 1000 £1665 7 octave weighted keys plus heavy duty KS - 1000 stand £150
MKB - 300 £990 6 octave touch sensitive "Mother Keyboard" MIDI controller
EP - 50 £625 6 octave MIDI electronic piano controller
MKS - 800 £1800 "Super Jupiter" polysynth module
RAM pack storage dynamic control
MPG - 80 £395 Optional programmer for Super Jupiter MIDI polysynth rack module
MKS - 10 £950 "Planet P" 19" rack-mounting touch-sensitive MIDI elect. piano
MKS-30 £875 "Planet S" 19" rack-mounting touch-sensitive MIDI polysynth

NEW BOSS MICRO RACK RECORDING SYSTEM

RDD-10 Digital delay £200 RAD-10 rack adaptor holds two Boss Micro Rack
RCL-10 Compressor/Limiter £125 units in a conventional 19" 1 unit high rack
RGE-10 Graphic Equaliser £125
RBF-10 Flanger £125 These units are ideal for a modular home studio
RPH-10 Phaser £125 set up and can be joined together for stereo
MI-10 MIDI to CV I'face £275 applications
MI-30 MIDI channel filter £225
MI-40 MIDI input selector £75
MI-50 output channel selector £95

Please note: all prices quoted are RRP. It is London Rock Shop policy to sell at the most competitive prices in the U.K. Supply and demand controls the ultimate price to you as best-selling units are almost always under-supplied. Please don't ring and ask for our price but come and see us - we have the best displays and information centres in the U.K.

The London Rock Shops

LONDON: 25 Chalk Farm Road, London NW1 Tel: 01-267 7851/5381/1771

BRISTOL: 7 Union Street, Bristol, Avon. Tel: 0272 276944

FREEDMANS

MULTI TRACKERS - DIGITAL DELAYS - EFFECTS



ORDERS OVER £100
CARRIAGE FREE

DRUMS - P.A. - TUMPETS - ACCORIONS - MIC STANDS - GUITAR STRINGS - MIXERS - KARAOKE - SPEAKERS

SYNTHESIZERS

- ROLAND 5X8P £1250
- ROLAND JUNO 106 £699
- ROLAND JUNO 6 £499
- ROLAND MKB 1000 £1
- ROLAND PLANET P £1
- ROLAND PLANET S £1
- ROLAND JX3P £699
- YAMAHA DX 9 £799
- YAMAHA DX 7 (DAMAGED) £1089
- YAMAHA TX 7 FM GENERATOR £699
- YAMAHA TX 216 2x FM MODULES £1999
- YAMAHA SK 20 £595
- CASIO CZ101 £345
- CASIO CT1000 £495
- AYAI AX 80 £999
- SEQUENTIAL MAX £625
- SEQUENTIAL 6 TRAK £599
- KORG POLY SIX £625
- ROLAND SHOR WITH GRP £225
- ROLAND SH1000 S/H £199
- ROLAND S104 £275
- SEQUENTIAL MULTITRACK £*

SEQUENCERS

- YAMAHA QX7 £*
- ROLAND MC202 £169
- ROLAND MS100 £*
- ROLAND MS100 £*
- ROLAND MC4B + ORB + MTR 100 £499

COMPUTER + SOFTWARE

- YAMAHA CX5M £469
- YAMAHA YK 01 £85
- YAMAHA YK 10 £165
- ALL AVAILABLE SOFTWARE IN STOCK AT £36 EACH
- EMR MIDI INTERFACE FOR BIC'S & SPECTRUM £150
- RHYTHM UNITS**
- SEQUENTIAL DRUMTRACS £799
- ROLAND TR 904 £425
- KORG DDM 110/220 £*
- ROLAND TR 707/727 £*
- KORG KPR 77 £199
- ROLAND CR 5000 £255
- ROLAND CR 8000 £355
- BOSS 110 £119
- TECHNICS DP50 £595
- HAMMOND DPM 48 £499
- Dr BOHM DIGITAL £265
- ROLAND TR 606 £189
- ROLAND TR 303 £169
- YAMAHA RX11/RX15 £*

MULTI-TRACK

- FOSTER X15 £299
- YAMAHA MT44 + MA30 + PO30/20 £479
- CLARION £499
- CUTEL £399
- YAMAHA MT44D + RM602 + RB35 £799
- YAMAHA G0 1031 G-EQUAL 31AUD £199
- YAMAHA Q 2031 G-EQUAL 310A-DX 2 £399
- YAMAHA GR 2020 COMP/UNIT STEREO £229

PIANOS

- YAMAHA PF 10 DEMO MODEL £699
- YAMAHA PF15 + FREE CASE £1049
- RHODES S4 STAGE S/HAND £275
- CLAVINET S/HAND £225
- CLAVINET DUO S/HAND £325
- ROLAND HP 20 £265
- ROLAND PIANO + 450 £1350
- ROLAND PIANO + 350 £1150
- TECHNICS DIGITAL 10 £799

ELECTRONIC KEYBOARDS

- TECHNICS SK 250 + FREE STAND/RAN/BOOK £469
- TECHNICS SK 150 + " £369
- YAMAHA PS 6100 £499
- YAMAHA PS 55 + FREE STAND/CASE/ADAP £499
- YAMAHA PS 35 + FREE CASE/ADAP £379
- YAMAHA PL 1000 + FREE STAND/CASE/ADAP £525
- YAMAHA PS 300 £140
- YAMAHA PL 100 + FREE ADAPTOR £175
- JVC KB 606 £595
- CASIO CT 6000 £699
- MOST CASIO MODELS IN STOCK NOW!

ROLAND AMPS

- CUBE 20 £125
- CUBE 40 £165
- CUBE 60 £190
- CUBE 60A £210
- CUBE 60C £175
- CUBE 60C £205
- SPART 10A £*
- SPART 25A £*
- 13W 60 £*
- 13W 100 £*
- JC 50 £*
- JC 77 £*
- JC 120 £*
- JC 120H £*
- SUPER CUBES 40/60/100 £*

P.A. BY KUDOS

- CONSOB BY SESSION
- COMPLETE RANGE OF MARSHALL IN STOCK
- AMPs & CABS IN STOCK NOW!
- INCLUDING STUDIO SERIES COMBOS
- PRACTICE AMPS BY BADGER FROM £53
- OHM AMPLIFICATION
- NEW V-AMP COMBOS
- MARSHALL SPECIALS
- ONE ONLY MARSHALL 200W LEAD (SWITCHABLE HEAD) £399

SCHOOLS

PLEASE NOTE - WE DESPATCH GOODS AGAINST RECEIPT OF AN OFFICIAL ORDER

£* BEST PRICES QUOTED TO PERSONAL SHOPPERS

EFFECTS

- BOSS BF2 FLANGER £71
- BOSS CE2 CHORUS £*
- BOSS CE3 CHORUS STEREO £*
- BOSS CS2 COMPRESSOR
- BOSS DD2 DIGITAL DELAY £135
- BOSS DE2 DIST/FEEDBACK (NEW) £*
- BOSS DM3 DELAY (NEW) £85
- BOSS DS1 DISTORTION £47
- BOSS GE7 GRAPHIC £67
- BOSS MC2 MAND CLAPPER £51
- BOSS HM2 HEAVY METAL £*
- BOSS OC2 OCTAVE £*
- BOSS OD1 OVERDRIVE £48
- BOSS PL2 PERCUSSION £44
- BOSS PH1R PHASER + RES £67
- BOSS PH2 SUPER PHASER (NEW) £*
- BOSS SD1 SUPER OVERDRIVE £67
- BOSS TM1 TOUCH WARM £55
- BOSS DX 400 MIXER £75
- BOSS BX 600 MIXER £*
- BOSS BX 800 MIXER £*
- BOSS DE 200 DIGITAL DELAY (NEW) £*
- BOSS CE 300 CHORUS (BLACK) (NEW) £*
- BOSS PLAYBUS + PHONES £135
- BOSS TUN2 TUNER £*
- BOSS TUN12M TUNER £*
- BOSS KM4 MIXER £41
- AMDEK KITS**
- RMK 100 PROG RHYTHM £33
- PDK 100 POWER DISTRIBUTOR £16
- EFFECTS BY - WASHBURN**
- PEARL, ARION, GUYATONE IN STOCK NOW!
- SPECIAL**
- VOX COMPRESSORS £20**

HH BARGAINS
1 ONLY P/BASS HEAD £260 (150W)
1 ONLY BASS MACHINE HEAD £325 (250W)
1 ONLY POWER BABY LEAD COMBO £299 (150W)

PERSONAL HEADPHONE AMPS

- NANYO PERSONAL STUDIO £95
- ARION HOT WATT £89
- JMS ROCK BOX £119
- BOSS PLAYBUS INC PHONES £175

ROCK EFFECTS

- DIGITAL DELAYS BY:-**
- BOSS, IBANEZ, WASHBURN, YAMAHA
- YAMAHA R1000 £495 (REVERB)
- DELTA LABS EFFECTON JUNIOR DELAY £219
- STANK IN A RACK £*
- FRONTLINE X4 MULTI EFFECT £*
- PICKUPS**
- LARGE RANGE IN STOCK BY:-
- DI MARIO - SEYMOUR DUNCAN - EMG.

HOT LICKS INSTRUCTION TAPES (ALL POST FREE)

- HOW TO PLAY GUITAR 1 TO 6
- ROCK GUITAR 1 TO 6
- LEAD GUITAR 1 TO 6
- ADVANCED LEAD GUITAR 1 TO 6
- BLUES GUITAR 1 TO 6
- RHYTHM & BLUES GUITAR 1 TO 6
- JAZZ ROCK FUSION GUITAR 1 TO 6
- JAZZ GUITAR 1 TO 6
- WASHBURN GUITAR 1 TO 6
- SYNTHESIZER WORKSHOP 1 TO 6
- ROCK PIANO 1 TO 6
- ACOUSTIC LEAD GUITAR 1 TO 6
- HEAVY METAL GUITAR 1 ONLY
- KEYBOARD CHOP BUILDER 1 ONLY
- STEVE MORSE CLASSIC GUITAR 1 ONLY
- HOT TRACKS 1 ONLY
- ALL THE ABOVE £8-95 EACH**
- STEVE MORSE MASTER SERIES 2 TAPES + BOOK £18-90 COMPLETE
- TAL FARLOW MASTER SERIES 2 TAPES + BOOK £18-90 COMPLETE

GUITARS

- LARGE STOCK OF ELECTRICS, BASS, ACOUSTIC + CLASSIC GUITARS BY:-
- YAMAHA, WESTONE, IBANEZ, WASHBURN, SQUIER, KAWAI, LOWDEN.
- SQUIER STRATS '57 £221 '62 £229
- SQUIER PRECISION '67 £211 '62 £220
- SQUIER JAZZ '62 £221
- SQUIER PAISLEY TELE RE-ISSUES £249
- WASHBURN TOUR 24 BR £310
- WASHBURN WOODSTOCK ACTIVE £299
- WASHBURN MONTEREY ACTIVE £399

DRUMS

- ULTIMATE PERCUSSION ELECTRONIC KIT**
- COMPLETE WITH 5 PADS & ELECTRONICS ONLY £499
- (STANDS & PEDALS ALSO IN STOCK)
- PREMIER ROYALE 5 DRUM KIT WITH STANDS & CYMBALS £450
- TRAK POWER KIT £495 WITH CYMBALS & STANDS £495
- TAMA SWINGSTAR KIT £469 WITH CYMBALS & STANDS
- PEARL EXPORT DEEP FORCE 5 DRUMS + STANDS £465
- MIRAGE 3 DRUM KIT WITH STANDS £195
- LUDWIG BIG BEAT KIT WITH 26" BASS DRUM £195
- MANY MORE IN STOCK

MICS

- BY SHURE, BEYER, SONY, AUDIO TECHNICA, FENDER
- NEW SHURE PROLOGUE MICS:-
- 10 LOIMP £19 - 12 LOIMP £28 - 14 LOIMP £36
- 10 HI IMP £21 - SHURE 565D (UNIDYNE III)
- COMPLETE WITH CABLE £69.

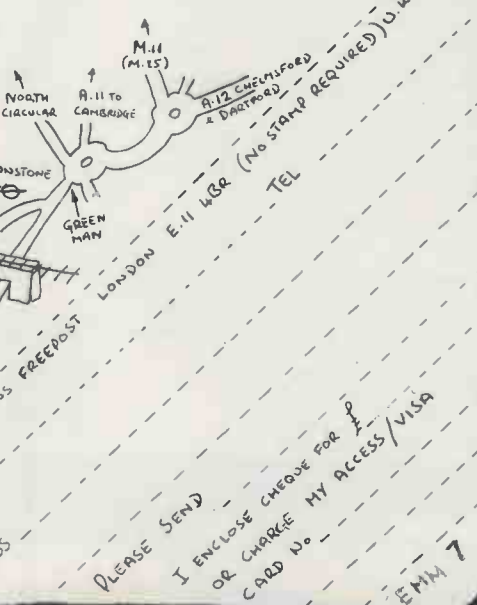

PRICES INCLUDE 15% VAT (OVERSEAS BUYERS EXEMPT)
FULL PARTS AND LABOUR GUARANTEE
ON ALL ITEMS - P/X - H.P. 34.7% APR.

FREEDMANS

01-539 0288 (TWO LINES)
627-629-631 HIGH ROAD LEYTONSTONE
LONDON E.11 4PA ENGLAND



(CLOSED THURSDAYS)

NAME _____ ADDRESS _____

PLEASE SEND I ENCLOSE CHEQUE FOR £ _____ OR CHARGE MY ACCESS/VISA CARD No. _____

EMM 7

COMPUTER MUSICIAN

One of the sometimes less than ingratiating sides to putting together *Computer Musician* every month is the fact that I'm obliged to wade through piles of advertising hyperbole. You know, the 'this is the most amazing bit of software ever seen' syndrome, and the 'you'll be sorry if you don't buy it' blackmail ploy. And as many will no doubt appreciate from personal experience of the consumer vs. manufacturer battleground, it often takes an immense amount of imagination to sort wheat from the chaff in promo leaflets.

So, in all honesty, wading through this or that company's paean to their technological brilliance doesn't cut an awful lot of ice with this reader. After all, what would *you* say to the following excerpt from one American company's brochure:

'MIDI. A simple word for a revolutionary musical idea: the most exciting thing to come along in synthesizers since the invention of synthesizers themselves. Unprecedented power and convenience, new worlds of timbre and time, symphonies and songs bound only by the limits of a creative mind...'

Oh, yes. Absolutely. Nothing like a bit of alliteration to get the old taste buds tingling. But pull the other one, mate. We heard all that from Electromusic Research in their MIDI step-time software manual – and a lot of MIDI software has passed under the bridge since then. Too much, some might say. And to what

effect? Well, it's certainly meant a polarisation of pricing attitudes.

There are those that see the MIDI as an ideal means of milking musicians for all they're worth, on both the hardware and software fronts. Other, more circumspect companies like Island Logic, with their new MIDI Music System software for the Commodore 64, see this as a chance of breaking into a whole new area of the entertainment business. And as Casio have shown with the CZ101, that's also translating into cut-price (and multi-timbral!) MIDI keyboards. Not quite the 'sub-£100' MIDI keyboard I suggested in a CM Editorial a while back, but we're getting there slowly but surely. The more pricing realism the market receives, the healthier it will be.

In truth, though, I love getting all the bumpf. But it's even better if we actually get to see the product behind the glossy brochure. So, dear companies big and small, if you've got a product in the computer music field that you'd like castigated, congratulated, or castrated (perm any two from those three) in these pages, please send us the real McCoy, rather than just an advertising copy version. And if you're of Bulgarian origin, don't feel that E&MM won't be interested. We're always delighted to hear from anyone, no matter what part of the globe they originate from. Who knows? Maybe the Zlatna Panegas of yesterday were the Series III Fairlights of today... ■

David Ellis

LOOK!

You won't believe your ears...

WOW!

beyond all musical barriers

Fantastic!

Unbeatable!

THE HIGHEST TECH

limited only by your imagination.

SIMPLY OUT OF THIS WORLD

Rumblings...

A further bulletin on latest developments in the computer music field.

David Ellis

According to Kiki Ebsen, Vice President of Marketing for a Californian company called **Syntech**, 'Studio 1-2-3 is by far the most exciting software around' and is 'truly musician friendly'. Which is the sort of hype we've come to expect from companies attempting to break into an already-flooded MIDI software market. The sort of hype, in fact, I've just been talking about in this month's Editorial (what d'ya mean, you always skip that bit?). But don't let that put you off - Studio 1-2-3 makes more sense than many.

For starters, the software is available for not one but three different micros - Commodore 64, Apple II, and IBM PC. Furthermore, Syntech's product seems to be the first on the scene to work with Sequential's own MIDI interface for the 64 - good news if you're bored with their software. And if you don't already have one of the Passport/Yamaha MIDI cards for the 64 or Apple, Syntech will be only too happy to supply their own MIDI card, 'available for the lowest prices'.

Studio 1-2-3 looks equally promising on the software side. Sixteen eight-track sequences in memory at once for chaining into up to four songs; record and playback from any 'transport position'; real-time punch-in during playback; auto punch-in/out using preset edit points; auto-correction; all manner of editing facilities; and last but far from least, a digital delay emulation mode which Syntech say 'can be reversed for greater effects'. Shades of the infamous Zlatna Panega ACS100?

For further information, contact *Syntech*, 7925 Maestro Avenue, Canoga Park, CA 91301, USA. ☎ 818-704-8509.

Take Note

Word reached us recently from an organisation called **Take Note** about their plans to put computers and music on a firmer footing in education. They say they're currently in the process of setting up a co-operative enterprise whose activities will cover many of the points raised in the Editorial of May's *Computer Musician*. Nice to know *somebody* takes note of my ramblings...

Take Note also intend providing an overall educational programme for computers and music - peripatetic seminars, videos and teaching sessions - which they see as being of value to both educational establishments and community groups. I heartily support all that.

Also on the cards is a much-needed

advisory service for prospective purchasers of computer-based music systems, plus relevant workshops at a recording studio that's being set up in London's docklands.

We'll keep you posted on further developments, but for more info on present activities, contact *Take Note*, 1 Cooper Court, Clays Lane, London E15. ☎ 01-534 8658.

Sight + Sound

Yet more musical activities on the Commodore 64 come courtesy of **Sight & Sound** Music Software in Wisconsin. But programs doing valiant battle with recalcitrant SID chips are ten-a-penny, you cry. True, but the real interest of Sight & Sound's 'Music Processor' actually lies in non-aural directions, because they've just upgraded the software by adding a pretty impressive printout facility. What's more, it's cheap - \$29.95 over in the States.

Something else they've just released is the 'Music Video Kit'. Sight & Sound claim that when this is combined with the Music Processor, 'it's possible to design, orchestrate and record computer-animated music videos on the personal computer'. Sounds like fun. For more details, write to *Sight & Sound Music Software*, PO Box 27, Department R2D2 (oh, yeah?), New Berlin, Wisconsin 53151, USA.

Dreaming Spires

'Descending from ivory towers' is hardly a description you'd expect to attach to as solidly a musicological establishment as the Music Faculty at **Oxford University**, but on the basis of a report in the *Sunday Times* of June 2, it seems that even they are being dragged into the hi-tech eighties. Actually, that's a mite unfair. After all, if they've got a Fairlight in situ at the department, they can't be that behind the times!

But this particular story relates to the age-old problem of copying music from illegible manuscript to the printed page. Seems a doctoral student by the name of Richard Vendome had the unenviable task of copying out 400 17th Century keyboard pieces for his thesis. Realising the Herculean task ahead of him, he made use of the wisdom of a physicist friend to learn about computers. A year and a bit later, the musicologist had been transmogrified into a programmer, and his thesis was nearing completion cour-

tesy of a self-penned music-copying program.

More than that, Oxford University Press have announced their intention to market the software next year at an expected selling price of around £500. So who said academic music doesn't pay?

OTT with OP?

At long last, **Octave Plateau** have released their IBM PC MIDI sequencing software, now known by the ever-so-humble name of 'Sequencer Plus'. And it really does sound ever so impressive, what with up to 64 polyphonic tracks and 60,000 notes if you've got 640K in your IBM PC. Putting the software on an IBM PC also means that you've got more dots for your dollars in a visual as well as audible sense. Somehow, after you've seen step-time graphics on an IBM PC or an equivalent hi-resolution micro, all those MIDI programs running on Apples, Commodores and the like look pretty pathetic.

That doesn't just go for Octave-Plateau's step-time graphics (which do a better job than most at representing all the vertical relationships in polyphonic music without resorting to traditional notation), but even those for the Sequencer Plus' 'Main Track Menu'. This time, for each of the tracks, you get the name of the instrument assigned to that track, the corresponding MIDI channel, the program number, any track-specific transposition, quantisation, looping, muting, and then the number of bars. It's amazing how well-laid-out information turns what can be a toy in some people's hands into a really professional-looking musical tool.

But at 'between \$400 and \$500', Octave Plateau's software is also very expensive. Not quite in the same league as the UMI software for the BBC Micro, I grant you, but still more than the average guy in the street is going to be prepared to fork out for a software sequencing package, MIDI or not. Remember also that on top of that sum, there's the Roland MPU401 to be added into the picture. And is the IBM PC really such a hot option in these imminent days of sub-£1000 micros with 68000 processors and massive amounts of RAM? Let's hope that Octave Plateau are thinking of doing a version of Sequencer Plus on the Atari 520ST and Commodore Amiga, because from what I've seen, the software really does look too good to miss. For further info, contact *Octave Plateau*, 51 Main Street, Yonkers, NY 10701, USA. ☎ 914-964-0225.

WHITE ELECTRIC

MUSIC

ROLAND JX8P MIDI POLY SYNTHESIZER..... BEST DEAL
 ROLAND PG800 8P PROGRAMMER..... BEST DEAL
 ROLAND JUNO 106 MIDI POLY SYNTHESIZER BEST DEAL
 ROLAND SKV2000 DIGITAL REVERB, MIDI,
 PROGRAMMABLE BEST DEAL
 ROLAND SDE2500 DIGITAL DELAY MIDI,
 PROGRAMMABLE BEST DEAL
 ROLAND TR707 DIGITAL DRUMS..... BEST DEAL
 SEND FOR OUR ROLAND INFO PACK FREE!!

RECORDING EQUIPMENT

YAMAHA MT44-D
PHONE FOR A
ONCE ONLY
BEST DEAL



ALLEN & HEATH SERIES 21 16-4-2 MIXER..... BEST PRICE
 ALLEN & HEATH SERIES 8 16-4-2 MIXER..... BEST PRICE
 ALLEN & HEATH SERIES 8 16-8-2 MIXER..... BEST PRICE
 ALLEN & HEATH SERIES 8 16-16-2 MIXER..... BEST PRICE
 SECK 18-8-2 MIXER..... BEST PRICE
 SECK 12-2 MIXER..... BEST PRICE
 MTR 12-4-2 MIXER..... £395
 MTR 4-4-2 MIXER..... £225
 STAR SOUND 16-8-2 MIXER..... £1030
 STUDIO MASTER 16-8-2 MIXER..... £1180
 PROMARK 8-4-2 MIXER..... £466
 RAM 10-4-2..... £550
 STAR SOUND 16-8-2..... £1032
 STAR SOUND 6-2 MIXER..... £175
 MONITORS BY TANNOY/JBL/YAMAHA/EV ETC

MOTHER KEYBOARD SYSTEM
 ROLAND MKB300 MIDI KEYBOARD..... LOW PRICE
 ROLAND MKB1000 MIDI KEYBOARD..... LOW PRICE
 ROLAND MKS10 PLANET P. MIDI PIANO MODULE..... LOW PRICE
 ROLAND MKS30 PLANET S MIDI POLY SYNTH
 MODULE..... LOW PRICE
 ROLAND SH701 MONO SYNTHS ALL
 COLOURS..... VERY LOW PRICE
 ROLAND MC202 MICRO COMPOSERS..... BEST DEAL
 ROLAND TR606 RHYTHM UNITS..... VERY LOW PRICE
 ROLAND MSQ700 DIGITAL RECORDER..... BEST DEAL
 ROLAND MSQ100 DIGITAL RECORDER..... BEST DEAL
 ROLAND DR110 RHYTHM UNITS..... BEST DEAL
 WE OFFER THE HIGHEST SERVICE WITH THE LOWEST
 PRICES ON ALL ROLAND PRODUCTS PLEASE PHONE.
 ROLAND AMPLIFIERS, CUBES, SPIRITS, JAZZ CHORUS ETC.
 ALL AT PRICES YOU'LL LOVE. PHONE.

YAMAHA R1000 REV..... £389
 YAMAHA R1000..... £299
 DYNACORD DRP-16..... £635
 DYNACORD EXPANSION CHIP..... £59
 LEXICON PCM-60..... £1880
 MXR 01-A..... £1960
 GREAT BRITISH SPRING MK3..... £210
 ACCESSIT STEREO REVERB..... £125
 ACCESSIT NOISE GATE..... £49
 FOSTEX 3070 COMP/LIM..... £225
 YAMAHA GC2020 COMP/LIM..... £229
 ACCESSIT COMPRESSOR..... £49
 YAMAHA GQ1031 GRAPHIC..... £199
 YAMAHA GQ2031 GRAPHIC..... £399
 TEAC GE-20..... £182
 ROLAND SBX80 SYNC BOX..... BEST DEAL
 BOSS DE200..... PHONE
 YAMAHA D1500..... £575
 KORG SDD1000..... £319
 IBANEZ HD1000..... £275
 IBANEZ DM1100..... £280
 IBANEZ DM2000..... £295
 IBANEZ SDE1000..... PHONE
 ROLAND SDE3000..... PHONE
 ROLAND SRE555..... PHONE
 JHS DX777..... £159



YAMAHA DX21 (NEW MODEL) EM POLY SYNTH ... ONLY £699
 YAMAHA RX21 DIGITAL DRUM (NEW MODEL) ... UNDER £300
 YAMAHA DX5 (NEW MODEL) BEST DEAL
 YAMAHA KX88 MOTHER KEYBOARD BEST DEAL
 YAMAHA TX7 MIDI DX7 EXPANDER BEST DEAL
 YAMAHA QX7 DIGITAL MULTI TRACK..... BEST DEAL
 YAMAHA TX1 SINGLE EXPANDER MODULE..... BEST DEAL
 YAMAHA PF15 & PF10 PIANOS AMAZING PRICES
 YAMAHA RX15 £419 YAMAHA RX11 £599
 YAMAHA CX5M MUSIC COMPUTER WITH FREE
 KEYBOARD WE CAN'T PRINT OUR LOW PRICE
 UNIQUE ROM FOR DX7 64 BRAND NEW SOUNDS & ADD ON
 CHIP WHICH DOUBLES TO AN INCREDIBLE 128 NEW
 SOUNDS..... PHONE FOR DETAILS

YAMAHA SIGNAL PROCESSORS

GC2020 2 CHANNEL COMPRESSOR/LIMIT PHONE
 FOR SUPER DEAL
 D1500 MIDI DIGITAL DELAY 16 PROG MEM & PASS FOR
 INSTANT RECALL PHONE FOR SUPER DEAL
 GQ1031 31 BAND GRAPHIC EQ HIGH QUALITY
 LOW LOW PRICE
 Q2031 STEREO 31 BAND GRAPHIC EQ AMAZING PRICE
 Q1027 27 BAND GRAPHIC EQ A MUST FOR ALL PRO AUDIO
 USERS..... BEST DEAL

NEW - NEW - NEW

YAMAHA
DX21
£699

YAMAHA
REV 7
YAMAHA RX21 UNDER £300
£1199

ORDER FORM

ALL PRICES INCLUDE VAT & DELIVERY

NAME _____

ADDRESS _____

Tel _____ Item(s) Required _____

ACCESS/VISA NO _____

CHEQUE ENCLOSED HP FORM REQUIRED

WHITE ELECTRIC 5 Station Road, Sunderland,
 Tyne & Wear SR1 3NR. Tel: 0783 78058/655168

Atari 520ST

16-bit Home Computer

From the home of Space Invaders and Pacman comes a micro so powerful, it could turn the home computer market on its head. Better still, it's got MIDI on the back. *Simon Trask*

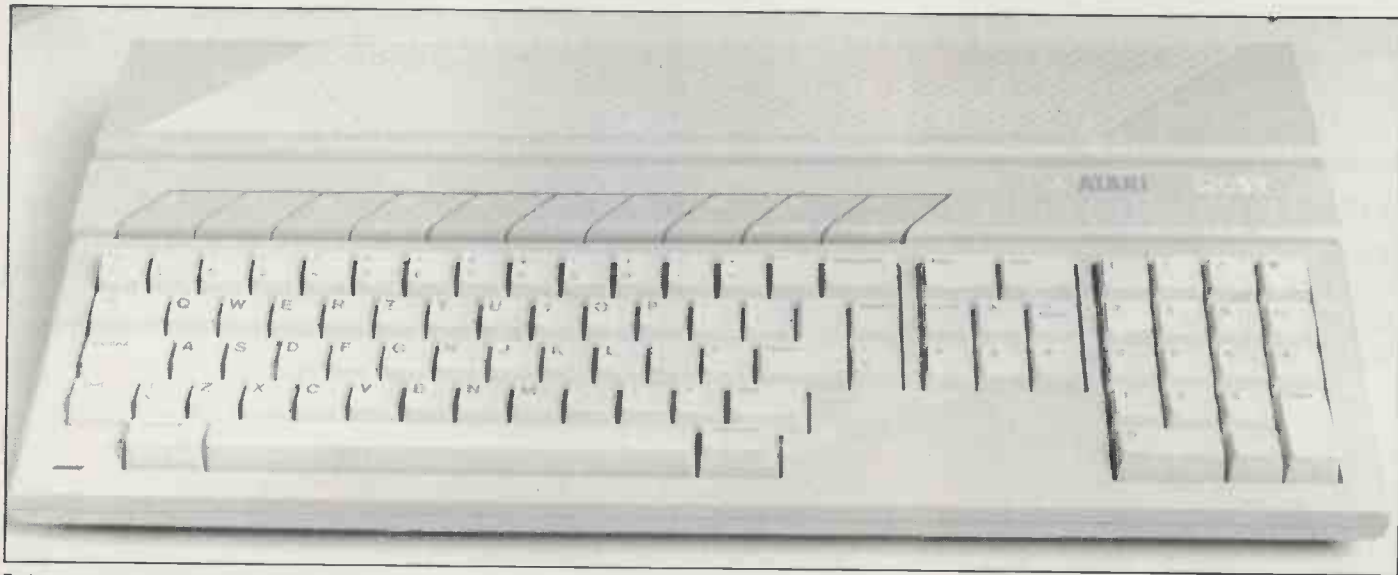

It's unfortunate, I know, but up until recently – and much to the chagrin of musicians interested in using computers for musical ends – the average home micro has sounded dismal. People have tried, some of them very hard, to extract something useful from the dreaded internal sound chip, but it's been an uphill struggle with not an awfully big reward at the top.

Come the MIDI age, though, and both these limitations have been neatly side-stepped. Suddenly, the world and his drum machine know just how good computers can be at storing and manipulating music. And as experience with MIDI has increased, so MIDI software has improved to the point where current packages are stretching today's eight-bit micros – Commodore, Beeb and so on – to their absolute limit.

The obvious next step is to write for computers that provide both greater processing power and increased memory: the new 16-bit ones, in other words. Now, the IBM PC and Apple Macintosh have both received much attention from software houses in the US of A – the Mac has even been graced with the attentions of E-mu Systems and Kurzweil. However, neither of these machines has a particularly high profile over here, and their pricing puts them firmly in the business, rather than the domestic, domain.

The machine that could well fill the above rôle is a new sub-£1000 16-bit micro from Atari, the people who brought you Space Invaders, Pacman and, up till now, nothing of any musical interest whatsoever. The computer in question goes by the name of 520ST, and has an impressive 512K of onboard RAM. However, a planned 128K machine (the 130ST) has been abandoned, a decision that may turn out to be unfortunate. An initial package of 520 computer, 360K (formatted) 3.5" floppy disk drive and monochrome monitor – together with BASIC and Logo programming languages – is planned to go on sale in mid-August for £750, which does

sound like good value for money. It seems a later package will replace the mono monitor with a colour version, while a 1Mbyte floppy disk drive and a 10Mbyte hard disk unit are scheduled for separate release in August and September respectively – prices for these aren't yet known. As if that weren't enough good news, the ST will also feature the GEM, or Graphics Environment Manager, an operating system developed by American company Digital Research as a rival to the sort of graphics user-environment introduced by Apple with their Lisa and Macintosh computers.

Aside from any other considerations, this machine has attracted the attention of musicians because it has an inbuilt MIDI capability – a world first outside Yamaha's CX5M, and confirmation that the computer world isn't treating music as an afterthought any more. Jack Tramiel's company aren't going to have things all their own way, though, because Commodore also have a 16-bit contender, the Amiga, waiting in the wings. That too will have MIDI tacked on to its hindquarters, but its release is still some months away; the 520ST is imminent.

Only problem is, the MIDI software that'll be available for STs isn't yet on public view. There's a possibility the Island Logic people will be hired to write some of it here in the UK, while further packages are expected in from the US in the near future. It should be worth waiting for, though, as it's rumoured to make full use of the graphics windowing and icon techniques that the aforementioned GEM environment makes possible, and which have characterised both Island Logic's previous work on eight-bit micros and the music packages currently available for the likes of the Apple Macintosh.

From the Outside

With the ST, Atari have gone for the sleek yet understated look beloved of the business micro fraternity – to whom the machine should

sell in large numbers, given the right software support. The keyboard is suitably professional in feel, and an 18-key numeric keypad and cursor keypad are provided to the right of the standard QWERTY layout. Across the top of the keyboard are ten function keys, and behind these – in the same slanting pose – lies a plentiful supply of ventilation slots. The ST peripherals are designed in a matching style, and that gives the range an integrated appearance that'll no doubt be the envy of many a UK designer.

The ST has three screen modes: 320x200 pixel resolution with a maximum 16 colours on screen, 640x200 resolution with up to four colours, and 640x400 resolution which gives a monochrome picture. Display memory resides as a 32K block of main memory, and an amazing 512 colours are available for placing on the colour palette. This doubles Atari's earlier record of 256 colours, and leaves other micros standing, though early STs won't let you witness them on either the supplied mono monitor or a colour TV.

Talking of graphics capability brings us nicely back to the GEM graphics environment. Most of GEM is written in a high-level language called C, and is designed to be easily transportable across 16-bit machines, working independently of both operating system and languages. On the ST, GEM sits on top of the unfortunately-named TOS (for Tramiel Operating System), which is basically an extended CPM-68K BIOS.

Figure 1 shows an overview of GEM and the various levels at which it operates. There are two ways the programmer can interface with GEM: the Virtual Device Interface (VDI) and the Application Environment Services (AES). The former provides standardised means of access to the ST's graphics capabilities, while the latter allows you access to *all* GEM's graphics features – like graphics handling facilities for monitoring mouse movement (Rentokil eat your heart out), translation of text data into pull-down menus, and the creation, storage

and retrieval of elements such as windows and icons.

In addition to all those windowing, icon, and pull-down menu facilities, the system also provides a 'mouse' controller which plugs into a joystick port. The mouse's movements across a physical plane are translated by software into screen positions, and this enables a small pointer arrow to be positioned at any icon or word on the screen. You then press a button on the mouse to select the option shown.

This system really is a quantum leap in user-friendliness, and a crucial blow against the tyranny of the QWERTY keyboard — though it's still possible to use the cursor keys or a joystick in place of the mouse if you're a traditionalist. On a more general level, I'm convinced that GEM (together with rivals such as IBM's Topview and Microsoft's Windows) represents the immediate future direction in computer graphics, for both end-users and software writers. With British firms Sinclair, Acorn and ACT also showing interest in GEM, we'll probably all be conversant with windows, mice and icons before the year is out. But Atari will be there first.

Hardware

Enough of what comes up on-screen. Let's delve a little deeper into the internals that make the new Atari tick. At the heart of the ST system lies an 8MHz Motorola MC68000 processor. For the bit-hungry, this has a 16-bit data bus, a 24-bit address bus and 32-bit internal architecture — with eight 32-bit data registers and eight 32-bit address registers. It's closely related to the 68008 processor used in Sinclair's QL, the main difference being that the latter has an eight-bit data bus. Other features of the 68000 are seven levels of interrupt, 14 addressing modes, five data types, memory-mapped I/O and 56 instructions.

Directly addressable memory range totals 16Mbyte, but don't get carried away with

thoughts of multi-million-note MIDI sequencing programs. The 520ST has 512K of RAM onboard, which a quick spot of arithmetic will tell you is still eight times the 64K maximum memory addressable by an eight-bit processor.

Happy to report, the ST scores very well on interconnection facilities (see Figure 2). The side panels contain an expansion ROM slot (giving 128K extra ROM) and two joystick ports, one of which also acts as the mouse

'The internal chip might be useful to some, but the heart of the matter for the musician is the ST's inbuilt MIDI interface.'

port. These ports are read by the so-called Intelligent Keyboard (or 'ikbd') controller, which is also responsible for scanning the keyboard. All 'ikbd' functions are handled by a 1MHz HD6301V1 eight-bit processor, which in turn communicates with an MC6850 ACIA.

Along the rear panel are video ports for output to both television and monitor (the latter supported by RGB and composite video outputs for colour and monochrome capability), a Centronics parallel interface port for printers, an RS232C interface for communication via modem (with data transfer rates ranging from 50 to 19200 baud), MIDI In and Out/Thru sockets (the five-pin DINs that'll be familiar to even the most computer-illiterate muso), and floppy and hard disk drive parallel interfaces.

An MK68901 Multi Function Peripheral chip supports the Centronics and RS232C interfaces, and provides interrupt control for these together with the disk drive controller, intelligent keyboard controller and MIDI (the

MK68901 itself occupies the highest-but-one position in the 68000's seven interrupt priority levels).

A Western Digital floppy disk controller is provided onboard, and the good news here is that two floppy disk drives can be daisy-chained together. Both floppy and hard disk interfaces make use of DMA (Direct Memory Access) for fast data interchange. Puzzled? Well, DMA is a technique whereby data may be transferred between a peripheral and main memory without having to pass through the main processor. DMA speed for the ST hard disk is an amazing 1.33 Megabytes per second, and as mentioned earlier, the drive which Atari are planning to introduce will have a storage capability of 10 Megabytes.

But even this amount of memory, once an outlandish figure in the daydreams of computer buffs, seems small next to the capacity of the Atari CD ROM unit. This is similar to the Compact Disc systems currently available in the audio market, except that since we're talking digital information here, not analogue music, no digital-to-analogue conversion is necessary. One CD can store up to half a gigabyte of data, which you've got to admit is pretty impressive. However, the sad fact is that current laser-disc technology is capable only of reading from disc, not writing to it, so ROM is all we'll be getting on CD for the time being. Still, rumour has it that Atari are planning to put the complete Encyclopedia Britannica on one CD, which is as good a place as any to start, I suppose. The company have just exhibited a prototype CD ROM system at the summer Consumer Electronics Show in the States, and the production model should be on sale over here before the end of the year. Price has yet to be finalised.

Incidentally, Atari are not alone in this field, as Hitachi have just produced a CD ROM unit with a parallel interface for the IBM PC, and interfaces for other machines are expected later in the year, so this is evidently an emerging technology.

Figure 1. GEM software memory map.

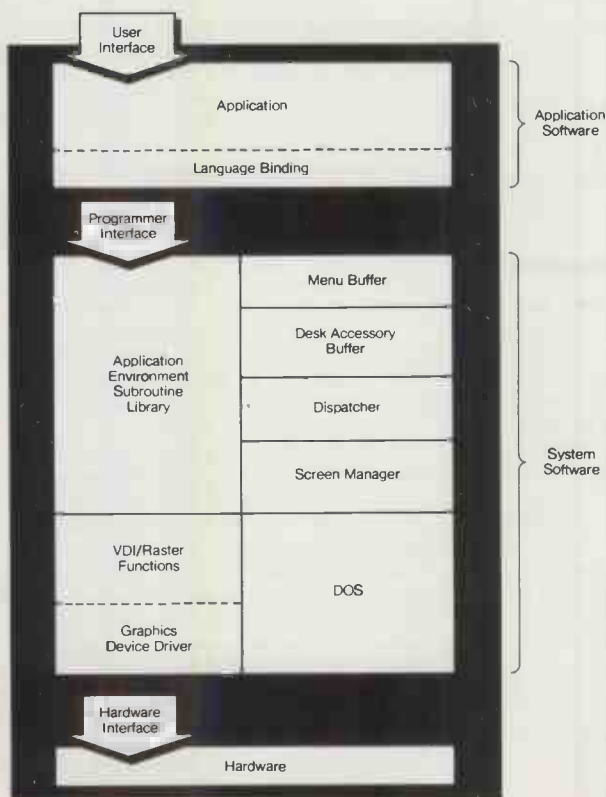
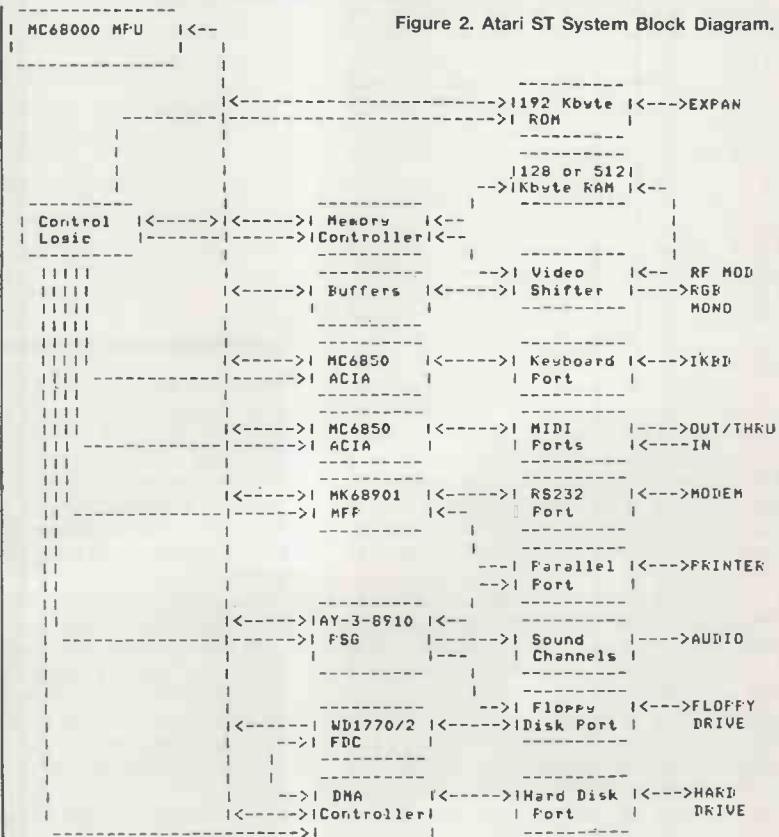
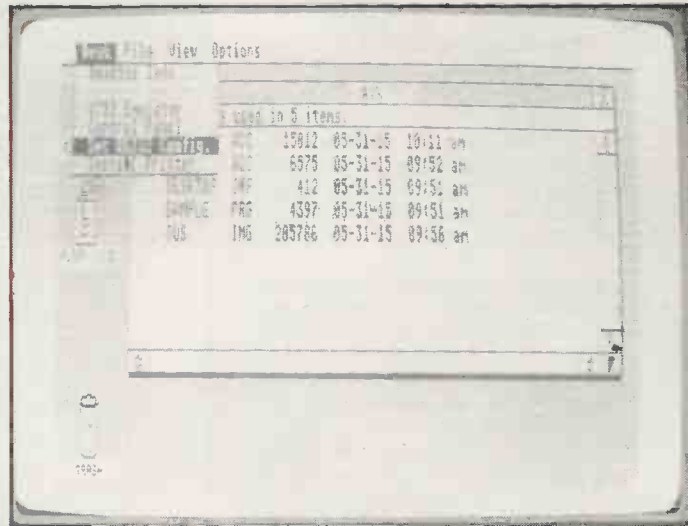
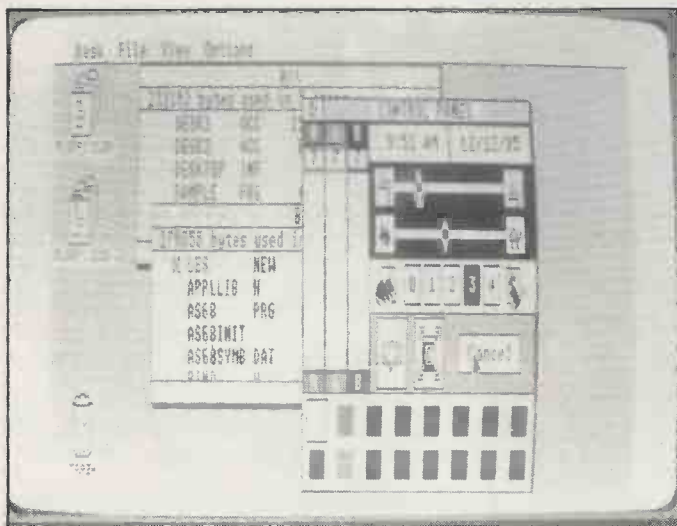

Figure 2. Atari ST System Block Diagram.



Atari Corp Confidential



▷ Music

There are two sides to the ST's musical capabilities. Because as well as MIDI, Atari have seen fit to include the General Instruments AY-3-8910 Programmable Sound Generator, a positively aged device that's most recently seen service in Amstrad computers. The chip offers three independent channels of sound, each with a standard amplitude ADSR and each capable of generating a square wave at frequencies over a range of between 30Hz and a bat-favourite 125KHz. A single noise generator register is provided, and noise can be mixed in with the voice channels.

Sounds awfully familiar, doesn't it? Actually, I can't help feeling the AY's inclusion is a trifle redundant on a machine such as the ST, because although it may prove useful to the micro owner with a passing interest in music, the heart of the matter for the *musician* is the inclusion of an inbuilt MIDI interface.

And the Atari doesn't stop at providing the requisite DIN sockets mentioned above. As already intimated, the ST's operating system is basically an extended CP/M-68K BIOS, and it functions through BIOS vectored calls, with parameter values passed and returned through the 68000's registers. Among the extended BIOS functions are several dealing with access to the MIDI ports. Two of these functions send and receive a byte to/from the MIDI ports (specifically, they place a byte in an output or input queue, and an automatic interrupt routine handles the appropriate transfer). Other functions are available for determining MIDI byte ready-to-send and ready-to-receive status, and for setting the MIDI buffer location and size.

At the hardware level, MIDI communication is controlled by a familiar MC6850 ACIA (Asynchronous Communications Interface Adaptor) supplied with transmit and receive clock inputs of 500kHz. As most of you will know, the MIDI data transfer rate is 31.25k Baud, and the ST generates this simply by setting the ACIA Counter Divide Select to divide by 16.

Now, all this will mean little unless you're already familiar with MIDI hardware standards. A lot of musicians aren't (some just don't want to be), so with luck, access to the Atari's MIDI will be made a lot easier by the various programming languages that will become available for the ST. Word has it the MIDI software under development in the States is being written in Forth, and as it's ridiculously easy to build up libraries of routines in this language (or dictionaries of words, to use the Forth terminology), it's not inconceivable that a set of MIDI routines could be released for use

by anyone in their own programs.

Still on the software side of things, the BASIC supplied as standard with the ST is a version of Digital Research's Personal BASIC, but as Atari UK have yet to receive a command word list, it's not clear whether this has been expanded to take account of MIDI. As the man on the news bulletin said, we'll bring you more details as soon as they become available.

The main objection I have to the ST's implementation of MIDI is simply that it is just that — nothing more. Put it this way. A lot of the currently-available MIDI interface boxes that upgrade an existing micro to the MIDI standard have quite a bit more in the way of hardware than that description might imply. Some of them have line sync facilities to allow non-MIDI drum machines of various clock rates to be included in a MIDI setup; some also offer a sync-to-tape facility. Others provide more than one MIDI Out port, to ease cabling and to avoid the sort of sequencing problem you get

'We should see some MIDI software that's easier to use, offers more musical memory, and provides more facilities than today's packages.'

when your synth has no MIDI Thru and you want to drive an expander or a drum machine, say. There's also the trend among designers of dedicated sequencers to provide a MIDI Out for each sequencer track, which sounds a bit ironic for a system that has the capability to transmit all its information along a single cable, but nevertheless has a good deal of practical logic to it.

The upshot of all this is that putting MIDI In and MIDI Out sockets on the rear of a computer — which is what Atari have done with the ST — doesn't necessarily make the machine an ideal centre for musical communications. In their defence, it's worth saying that this isn't really what Atari intend the ST's version of MIDI to do. But it *could* have been designed to do it, and if it had, it would have transformed an already wonderful computer into a modern musical powerhouse.

As things stand, we're left with Atari's suggestion that seeing as MIDI provides a

high-speed serial interface capability, there's no reason why the ST's MIDI ports can't be used for local area networking. It doesn't help the musician, but it does make sense.

Conclusions

There's no question that the ST is a very impressive computer. So impressive, in fact, that it could revolutionise a personal computing market in which other computers have either failed (Sinclair's QL) or not yet materialised (the 68000-based offerings from Commodore and Amstrad, for instance).

The 'budget package' approach that's worked so well for Amstrad should do the same for Atari, though I still feel the decision not to go ahead with the 128K version of the ST could prove to be a mistake. Why? Because no matter how good the machine is, the £700-800 price-tag for the initial 520ST package still puts it firmly in the lower-end business machine range. It's a lot for a home user to pay, and a cheaper 128K version (with the option to upgrade to 512K, of course) could only be a good thing.

The user-friendly GEM graphics front-end is bound to be a big attraction (especially as it's on ROM), as will the availability of a large number of tried and tested language implementations, and other software packages courtesy of Atari's licensing agreement with Digital Research. If you're a programmer and you've always wanted to get into Forth, C, Pascal, Lisp or even Cobol, this could be your big opportunity. And of course, there's always 68000 assembler for those of sado-masochistic tendencies. Apparently, no less than four 68000 packages will be available from third-party suppliers, so no hiccups there.

Aside from the large amount of memory already onboard the ST, a further attraction is the prospect of an affordable 10MByte hard disk with a direct memory access speed of 1.33 Megabytes per second.

As for the music, the significant thing about the Atari is not that it has a good implementation of musical facilities (it hasn't), but that the now universal MIDI standard has been applied to a micro that's got more all-round competence than anything else available to the home user. And what we should see as a result is some MIDI software that's much easier to use, offers far more musical memory, and provides a bigger range of facilities than any package written for today's machines. That, to me anyway, is some prospect. ■

Further details on the 520ST from Atari UK, Atari House, Railway Terrace, Slough, Berkshire SL2 5BZ. ☎ (0753) 33344.

BRITAIN'S BEST CHOICE!

KEYBOARDS & EXPANDERS

rrp ABC Price

Roland JX8P NEW £1325.00 **£1195.00**



Roland Juno 106
£880.00 **£775.00**



Roland SH101 £385.00 **£220.00**
Roland MKB 1000 Mother Keyboard £1665.00 **£1395.00**



Roland MKB 300 Mother Keyboard
£990.00 **£849.00**

Roland MKS10 Plano Module £950.00 **£795.00**
Roland MKS30 Synth module £875.00 **£755.00**



Roland MKS80
£1800.00 **£1495.00**

Roland HP450 NEW Plano £1350.00 **£1195.00**
Roland HP350 NEW Plano £1130.00 **£895.00**
Roland EP50 Midi Piano £625.00 **Available soon**

Yamaha DX5 £2999.00 **Available soon**

Yamaha DX7 £1449.00 **£1299.00**
Yamaha KX5 £449.00 **£199.00**
Yamaha PF15 £1099.00 **£935.00**
Yamaha PF10 £849.00 **£499.00**

NEW Yamaha DX21 Stereo FM Synth **EPOA**



Yamaha TX7 'DX7' Expander
£699.00

Yamaha KX88 New Midi Keyboard £1399.00
Yamaha TX816 £4199.00

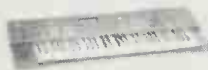

Casio CZ 5000 **only £895.00**

Casio CZ101 Midi Synth £395.00 **£345.00**
Casio CZ1000 Midi Synth £550.00 **£495.00**
Casio CT6000 Midi £695.00 **£645.00**
Siel DK80 £699.00
Siel Expander 80 NEW £399.00
Oscar Midi Synth £599.00



Korg DW600 NEW
£1095.00 **£799.00**

Korg Poly 800 £625.00 **£499.00**
Korg PK100 £519.00 **£449.00**
Korg EX800 £479.00 **£399.00**

Sequential Max £499.00
Sequential Multi Tracs **£1199.00**

HOME RECORDING AND ACCESSORIES



Yamaha MT44D
£399.00

NEW Tascam 388 8 track Portastudio **£2750**
NEW Tascam 246 6 Into 4 Portastudio **£950**
Tascam Portastudio 244 **in stock £449.00**
Tascam Portatone **£199.00**
Yamaha GQ1031 graphic **£399.00**
Yamaha GQ2031 stereo graphic **£249.00**
Yamaha RM602 mixer **£149.00**
Yamaha PB35B patchbay & rack **£229.00**
Yamaha G2020 compressor **£499.00**
Yamaha R1000 digital reverb **£599.00**
Yamaha D1500 digital delay **£399.00**
Roland SDE1000 digital delay **£699.00**
Roland SDE3000 digital delay **£599.00**
Roland SDE2500 digital delay (MIDI)
Roland SRV2000 digital reverb (MIDI) **£1275.00**
Boss DD2 digital delay **£155.00**
Boss KM60 6 into 2 mixer **£175.00**
Boss BX400 mixer **£86.00**
Boss BX600 mixer **£130.00**
Boss BX800 mixer **£235.00**

Fostex

Fostex in stock NOW!



Fostex X15 £299
Fostex 250 £699
Plus all FOSTEX & ACCESSIT Accessories

The Mirage

only £1695.00

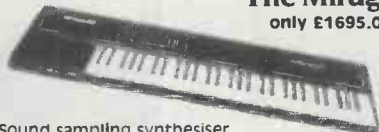

Sound sampling synthesiser

- 5 octave touch sensitive
- 8 voice polyphonic
- 16 different samples across the keyboard
- Up to 8 second samples
- 4 user samples split across the keyboard
- Midi sequencer
- 3.3" floppy disc drive

Up to 30% off Korg, Roland, Casio, Yamaha, Sequential Circuits, Boss, Tokai, Aria, Westone, Peavey, Carlbro, Tascam etc. — send for one of our Free info packs with details of our prices and 7-day money back guarantee.

DRUM MACHINES & SEQUENCERS



rrp ABC Price

Roland TR909 £800.00 **£395.00**
Roland TR707 £525.00 **£495.00**
Boss DR110 £150.00 **£125.00**
Yamaha RX15 £499.00 **£449.00**
Yamaha RX11 £799.00 **£695.00**

NEW Yamaha RX21 PCM Digital Drum Machine **EPOA**
Korg DDM110 £256.00 **£225.00**
Korg DDM220 £256.00 **£225.00**



YAMAHA CX5 MUSIC COMPUTER

NEW SOFTWARE AVAILABLE NOW!

CALL IN AND ASK ABOUT

OUR AMAZING COMPUTER PACKAGE DEALS

Roland MSQ100 £525.00 **£425.00**
Roland MSQ700 £950.00 **£825.00**
Roland JSQ60 Sequencer for Juno 106 £299.00 **£129.00**

WE MATCH OR BEAT ANY GENUINE ADVERTISED PRICE — YOU CANT BUY BETTER!

Roland TB303 Bassline £290.00 **£149.00**
Roland TR606 £290.00 **£189.00**



Yamaha QX7 NEW!!
£499.00

Yamaha QX1 **£2499.00**

NEW ROLAND PRODUCTS

NEW BOSS MICRO RACK MIDI UNITS IN STOCK!

MI-40 MIDI Input Selector **£65**
MI-50 Output Selector **£85**
MI-30 MIDI Channel Filter/Converter **£199**
MI-10 MIDI to CV Interface **£245**
Available August 1985
Boss Micro Rack Series
RDD-10 Dig. Delay **£175**
RCL-10 Compressor Limiter **£110**
RPH-16 Phaser **£110**
RBF-10 Flanger **£110**
RGE-10 Graphic EQ **£110**



Roland Digital Drum System DDR30
£1699

Roland SRV2000 Stereo Dig. Reverb
£1275

Roland SDE2500 Midi Digital Delay
£599.00

TR707 Digital-Midi Rhythm Composer > **£499**
TR727 Digital Midi Percuss. Composer
Midi Electronic Pianos Available NOW!

ABC music

for the modern musician

14-16 High St. Addlestone
TEL: 0932 40139/54877

56 Surbiton Rd. Kingston
TEL: 01-546 9877

324-326 Farnham Rd.
Slough TEL: 0753 822754

OPEN TILL
7.00 PM
THURSDAYS

If you are unable to visit one of our shops ask about our Instant Mail-Order Service. Phone your credit-card FOR SAME DAY DESPATCH.

Please supply

I enclose £ Access or Barclaycard No.

Name

Address

Day-time/Works Tel. No

AFFORDABLE MCS

64K DIGITAL SAMPLER & DELAY LINE FOR SUPERB MUSICAL EFFECTS



PUBLISHED IN PRACTICAL ELECTRONICS

Full 64K memory. Up to 67kHz sampling rate. Audio bandwidth over 15kHz. Features special wow-less circuit controlling musical delay range from 4ms to 8 seconds. Maximum special effects delay 65 seconds. Companding ADC & DAC converters with equivalent of 15 bit sampling. Infinite loop sample storage. Controllable sweep modulator. Internal and external digital and voltage control. Effects generation for chorus, double tracking, reverse tracking, echo, flanging, phasing, reverb, vibrato, looped repeat and pitch variation, micro-processor control. BBC, Apple, Commodore and similar micros, or stand-alone. Mains powered.

19" RACK MOUNTING UNIT KIT 234-R £295 + VAT & £3.50 P&P
PUBLISHED TEXT AVAILABLE SEPARATELY AT £1.50 INCL. POST

MINI MCS

MICRO CONTROLLED SAMPLER FOR ECHO, REVERB AND OTHER DDL MUSIC EFFECTS



PUBLISHED IN PRACTICAL ELECTRONICS

Abridged version of the above sampler excluding on-board memory and timing. For direct control from a micro such as BBC, Apple, Commodore and similar. Includes companding ADC & DAC, computer interface, mix, feedback, filter, gain, level, PSU.

KIT 246-BK £95 + VAT & £1.50 P&P

Both above units also enable a computer to be used as an audio oscilloscope and frequency counter.

Computer program listings for audio sampling and control available.

SEE OTHER ADVERT FOR MORE AUDIO EFFECTS KITS. FOR CATALOGUE OF OVER 70 KITS SEND 9+4 S.A.E. (FOR OVERSEAS CATALOGUE SEND £1 OR 5 IRC's). MAIL ORDER. PAYMENT TO PHONOSONICS, CWO, CHQ. PO, ACCESS, VISA, INSURANCE COVER 50P PER £50 (OBLIGATORY ON CREDIT CARD ORDERS). DETAILS CORRECT AT PRESS. E&OE.

BECKER-PHONOSONICS,
MAIL ORDER DEPT MM57, 8 FINUCANE DRIVE,
ORPINGTON, KENT BR5 4ED. TEL: 0689 37821

Experience **tanrak**....

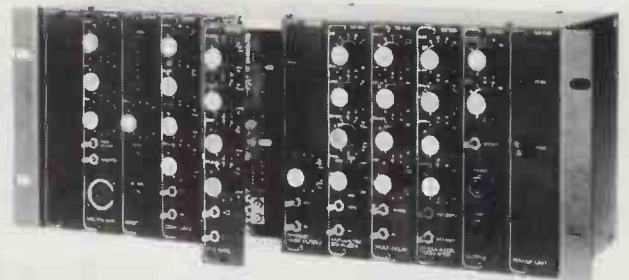

A rack mounting modular audio processing/effects system thoughtfully designed with the special requirements of the smaller studio in mind, and manufactured to the highest standards using only quality parts.

ALSO AVAILABLE IN KIT FORM

Send for an informative brochure to:

Dept. EMM,
P.O. Box 54,
Stevenage,
Herts.

tantek

expertise in electronics & electro-music

MUSICAL DISCOUNT WAREHOUSE

CASIO CZ101 - IN STOCK NOW



NEW LOW PRICES

Polyphonic Digital Sound, full assignable MIDI (ideal for computer multi-track) amazing low price. Also available CT6000 and CZ1000 Arriving shortly - CZ5000

BIT ONE IN STOCK

Touch Sensitive Split Keyboard with full new updated MIDI
AMAZING VALUE
BIT 01 EXPANDER
JUST ARRIVED



ROLAND JX8-P

Don't try this one unless you can afford it or it'll break your heart

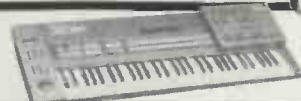

ROLAND TR707

Digital Programmable Drum Machine, MIDI, Now very affordable. Superb Sound - IN STOCK NOW

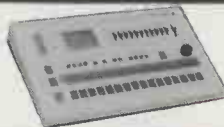

CHEAP AUTOMATION

TB303 Bassline..... £139
JSG60 (sequencer for Junc 106).....£99.50
Hardware & Software Packages for BBC & Commodore
Korg KMS30 MIDI Sync ...£120
KORG Super Section, our price.....£299
KORG SDD1000 DDL.....£299

KEYBOARD MIXERS!
Boss 8>2
Only £199

SEQUENTIAL MAX

Second hand bargain
DRUM MACHINES
Korg DDM 110/220; Roland TR707/DR110/TR606; Sequential Drum Traks
SIEL EXPANDER 80
First affordable touch sensitive expander, full MIDI spec. Also in stock Korg EX800

MORE THAN A MIDI SEQUENCER
MORE THAN A MIDI CONTROLLER
MORE THAN USER FRIENDLY
MORE THAN YOU THOUGHT POSSIBLE

THE JORETH MUSIC COMPOSER SYSTEM

UNEQUALLED ADAPTABILITY & EXPANDABILITY
EASY OPERATION FOR THE BEGINNER
VERSATILE AND PROFESSIONAL FOR THE EXPERT
UNRIVALLED SOPHISTICATION
IN MIDI BASED SOFTWARE
FOR THE COMMODORE 64

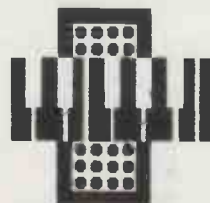

JORETH MUSIC

FOR MORE DETAILS PHONE

0386 831615

HOBBS MUSIC

All products with full manufacturers Guarantee
MARY STREET
LANCASTER
LA1 1UW
0524 60740
0524 34443
CASES MADE TO ORDER

ACCESS
VISA
AMEX
Securitor
Delivery
Showroom closed
Wednesdays

THE ART OF GOING SOFT

The beginner's guide to programming takes a new turn this month with an AMPLE program for Hybrid Technology's Music 500 synth add-on.

Andrew McKernan

Back in December '84, E&MM gave something of a rave write-up to a small, unobtrusive-looking box of synthetic tricks called the Acorn Music 500. Said box turned out to be a remarkably versatile (especially for its £199 asking price) music synthesiser add-on for the BBC Micro. For one thing, the sound itself was excellent, and for another, the Music 500 employed an ingenious music production language by the name of AMPLE.

What sets AMPLE apart from standard programming languages is that it's been designed specifically with music (and musicians) in mind. And one of the real advantages of the way it's been conceived is that it grows with the user, rather than acting as the sort of restriction standard programming languages are so good at putting up.

However, to quote from that December review, 'getting the best out of the system takes time...like buildings, complex sonic edifices aren't manufactured overnight, so a measure of exploration and experimentation is inevitable.'

To try to ease that exploration (and to quench the thirst for AMPLE programming building-blocks which, judging by the E&MM mailbag, an awful lot of Music 500 owners now want to be given), we present *Starflight 500*, a simple but effective piece of music that's been written specifically to demonstrate the basic features not only of AMPLE but also of the Music 500 as a whole.

As well as being worth listening to in its own right, the program shows some easy scoring techniques and includes a range of useful 'instruments' for you to use in your own pieces.

Piece Structure

Starflight comprises four instrumental parts: percussion (bass drum and cymbal), bass (of the electronic variety), chordal backing (three-voice polyphonic organ) and lead (synth) respectively. The structure of the piece is reassuringly simple. Its intro starts with a basic rock rhythm on drums, then adds the bass playing a semiquaver fifths-and-octaves pattern. A chords-only verse is followed by the lead coming in for the next three

```

RUN CLEAR
10."riff" [ SCORE pattern
20.CCCC % intro
30.5 FOR( CCCC FFCC GGFF EEDG )FOR
40.CCCC % outro
50.0,^ ]
RUN CLEAR
10."pattern" [ 0:0,
20.NOTE( DURATION VOICE % as normal
30.SHIFT % instead of PITCH
40.SIMPLEACT % use normal notes
50. % play bass pattern
60.-2:12,CCgg CCgg CCgg GGgg 0:0,
70.pattern % use 'macro' notes
80.)NOTE ]
RUN CLEAR
10."drum" [ 2 CHANS SOUND
20.ON CHAN 1 WAVE % sine wave
30. 2 AENV 2 PENV % percussive
40. 128 AMP 3 POS % loud, pan left
50.1 CHAN 140 SHIFT % higher pitch
60.]
RUN CLEAR
10."cymbal" [ 2 CHANS SOUND
20.ON CHAN 2 WAVE % noise wave
30. 6 AENV 128 AMP
40.1 CHAN ON RM 20 OFFSET % ring mod
50.2 CHAN 115 SHIFT ]
RUN CLEAR
10."kit" [ % drum kit
20.2 VOICES
30.1 VOICE drum 2 VOICE cymbal ]
RUN CLEAR
10."synth" [ 2 CHANS SOUND
20.1 CHAN ON RM 300 OFFSET % detune
30.ON CHAN 4 WAVE 7 PENV
40. 3 AENV 128 AMP -2 POS % left
50.]
RUN CLEAR
10."organ" [ 3 VOICES % polyphonic
20.1 VOICE synth 110 AMP 3 POS
30.2 VOICE synth 110 AMP 3 POS
40.3 VOICE synth 110 AMP 3 POS ]
RUN CLEAR
10."rand" [ 0 RAND! % noise wave
20.128 FOR( RAND? INDEX WG! )FOR WGC ]
RUN CLEAR
10."bass" [ 4 CHANS SOUND
20.% fuzzy main sound:
30.1 CHAN 4 WAVE 5 AENV
40. ON SYNC 5000 OFFSET 1 PENV
50.2 CHAN 3 WAVE
60.% bright percussive slap:
70.3 PAIR CHAN 2 WAVE 4 AENV
80.4 CHAN 20 OFFSET % for phasing
90.ON CHAN 115 AMP -3 POS % right
100.]
RUN CLEAR

```

```

AMPLE
10."play" [ ] "/bars" [ ] "tune" [ ]
20."melody" [ ] "chords" [ ] "x" [ ]
30."y" [ ] "rhythm" [ ] "riff" [ ]
40."pattern" [ ] "drum" [ ]
50."cymbal" [ ] "kit" [ ] "synth" [ ]
60."organ" [ ] "rand" [ ] "bass" [ ]
70."setup" [ ] "perc" [ ] "eseg" [ ]
80."delvib" [ ] "bright" [ ]

RUN CLEAR
10."play" [ setup % waves and envs
20.0 VOICES % make all voices free
30.4 PLAYERS 1000 TEMPO
40.1 PLAY( kit          rhythm )PLAY
50.2 PLAY( bass 4 /bars riff )PLAY
60.3 PLAY( organ 8 /bars chords )PLAY
70.4 PLAY( synth 24/bars melody )PLAY
80.GQ ]

RUN CLEAR
10."/bars" [ % <n> /bars : count bars
20.192 #* , / ]

RUN CLEAR
10."tune" [ 48, % 16 bars
20.G/// /fed c/// ////
30.A/// /gfe G/// ////
40.B/// /gAB C/// /fGA
50.B/// /agf G/// //// 0, ^ ]

RUN CLEAR
10."melody" [ SCORE % 3 verses
20.0: tune 1: tune 2: tune ]

RUN CLEAR
10."chords" [ SCORE 96, % 80 bars
20.5 FOR(
30.c(GE) / c(AF) c(BG)
40.c(GE) / c(AF) c(BG)
50.F(CA) / F(DB) F(EC)
60.c(GE) / c(AF) c(BG)
70.G(DB) / G(EC) G(FD)
80.f(CA) / f(DB) f(EC)
90.e(BG) / e(CA) e(DB)
100.d(AF) / d(BG) d(CA)
110.)FOR 0,^(^^) ]

RUN CLEAR
10."x" [ 1;-4:D ]

RUN CLEAR
10."y" [ 2;2:C ]

RUN CLEAR
10."rhythm" [ SCORE 12,
20.% X hits drum, Y hits cymbal
30.24 FOR( X///Y//X X///Y///
40.      X///Y//X X/Y///Y/
50.      X///Y//X X///Y///
60.      X///Y//X X///Y/Y/
70.)FOR ]

10."setup" [
20.1 WMOD WZERO      % sine
30. 127 1 WH! WHG WGC
40.2 WMOD rand       % bass & noise
50.3 WMOD WZERO WGC % null for sync
60.4 WMOD bright     % for synth
70.1 EMOD 20 perc    % bass pitch
80.2 EMOD 15 perc    % drum amp&pitch
90. ON EBIG
100.3 EMOD ADSR      % synth amp
110. 800 DECAY 79 SUSTAIN 100 RELEASE
120.4 EMOD 30 perc   % slap amp
130.5 EMOD ADSR      % bass amp
140. 50 DECAY 110 SUSTAIN 10 RELEASE
150.6 EMOD 110 perc  % cymbal
160.7 EMOD delvib   % synth pitch
170.]

RUN CLEAR
10."perc" [ % <decay> perc : make env
20.ADSR DECAY 0 SUSTAIN ]

RUN CLEAR
10."eseg" [ % dx dy x n eseg
20.#12 #212 ELEV EGRAD ]

RUN CLEAR
10."delvib" [ 4 2 0 ESECT
20.-127 1 0 1 eseg % start at zero,
30. 1 60 0 2 eseg % delay 60cs,
40. 2 5 2 3 eseg % shallow up,
50.-4 10 -2 4 eseg % and down.
60.8 10 4 5 eseg % full up, and
70.-8 10 -4 6 eseg % down (repeats).
80.]

RUN CLEAR
10."bright" [ WZERO % define harmonics
20.181 1 WH! 155 2 WH! 181 3 WH!
30. 62 4 WH! 76 5 WH! 37 6 WH!
40. 14 7 WH! 3 8 WH!
50.WHG WGC ]

RUN

```

Table 1. The *Starflight 500* listing.

verses, and things wind down with the reverse of the intro, another verse without lead, then another that loses the chords, a third that has just the drums on their own, and a final passage of blissful silence.

In usual AMPLE fashion, `play` is the crucial word in the program. It 'hires' the piece's parts, and gives them both their instruments (the words `kit`, `bass`, `organ`, and `synth`) and their scores (rhythm, riff, chords, and melody).

All the parts start together, but the bass, chords and lead wait for four, eight and 24 bars respectively before coming in. These entries are set using `/bar`, an additional music word – defined as part of the program – that counts the specified number of bars. For instance, `4/bar` counts four bars; couldn't really be simpler, could it? It works by multiplying the number of bars by the bar length (in this piece, 192 units) and playing a / (a dummy note) of that length.

The lead line plays the same tune for each verse, but in different registers. However, rather than write out the tune three times, *Starflight* writes it once as tune without an octave setting. The complete lead score, melody, then uses this three times with individual octave settings – like a sort of 'musical



subroutine', in fact. As for the chords, they're written without any funny business: just inside a FOR loop that plays the verse a total of five times.

The rhythmic content of the tune is pretty straightforward, so it's scored in step time; note length is set once at the start, and longer notes are made using /. The rhythm is notated with two extra music words that hit the drum and cymbal, namely X and Y respectively. Each of these sets the voice (with ;) and the octave (with :) and plays a single note. Silent beats are marked with / - equivalent to a rest but more versatile for percussion instruments with zero sustain levels.

Now comes the sneaky bit. The bass score (riff) is nothing more than the same pattern transposed up and down, so the part's been programmed in AMPLE so that each note plays the pattern transposed by the note pitch, pretty much in the style of a synth keyboard transposing a sequencer pattern. All this makes programming the score, and modifying its structure, an absolute doddle.

pattern is really the word that does the magic, using the NOTE structure. The usual PITCH has been replaced by SHIFT followed by the notes of the pattern. Normal note action is restored with SIMPLEACT before the notes, and pattern is re-invoked afterwards. This bit is actually rather vital - without it, each note would attempt infinite self-transposition, which isn't a very nice thing to happen to any note, let alone a *Starflight* one... Notice, finally, that the note pitch is fixed to octave 0 after each note.

Sounds + Envelopes

Well, so much for the music. What about the synth sounds that are used to play it? Let's start with the drum kit sounds. The bass drum uses a fairly predictable sine wave and (obviously) a percussive volume envelope, but it also has a pitch envelope that smudges the tone to remove any unwanted pitch sensation. Channel 2 does the same, but is shifted up in pitch to make the drum sound more 'toppy'.

As for the cymbal, this is based on a waveform consisting entirely of a scatter of random points. This has a metallic tone if untreated, but gives dense white(ish) noise when ring-modulated with itself. And as luck would have it, those are precisely the two elements we need to make a basic cymbal sound. So, Channel 1 makes the noise and Channel 2 provides the metallic ring at a carefully selected pitch.

Ring-modulation also comes into the picture on the synth sound, but here it's used in an entirely different way. The two channels play at the same pitch, but with a small offset. The modulation creates a new waveshape which changes as the waveforms phase against each other. Result? A changing timbre instead of the

normal detune effect. Envelope 7 adds a tasteful (or so we think, anyway) delayed vibrato to both channels.

On hearing *Starflight* for the first time, you could be justified in thinking that 'organ' is something of a misnomer for the chordal sound. It is, after all, little more than a variation on the lead synth sound. Each voice is set up using synth, then made quieter and panned to the right.

Last but not least, we come to the bass sound. This is a two-part affair that uses four channels. Channels 1 and 2 form the main bass tone using synchronisation and a pitch envelope to give a shallow filter-sweep effect, while 3 and 4 make a bright percussive 'slap' with detuning for subtle phasing.

Starflight uses two words that make envelopes easier to define. perc takes a number and creates a complete percussive envelope with that decay time, while eseg combines the functions of EGRAD and ELEV to program an envelope segment in one go.

eseg is used by delvib, the definition of the delayed vibrato. This definition starts off with an ESECT that says how many line segments each of the three sections will have: 'on' has four, 'repeat' has two and 'off' has none. The gradients and endpoints of the six segments are then set in turn by eseg. The on section is responsible for the delay and a single build-up cycle, the repeat section forms the vibrato itself, while the off bit is (not surprisingly) empty, so that the repeat section runs on until the next note.

Using It

To kick off, simply type in the program just as it appears here. To add the finishing touch and save the program, enter the listing in Table 2. You can now

```
CLEAR
10.% Starflight 500
20.% (C) 1984 Andrew McKernan
30.play
"star"SAVE
```

Table 2.

play *Starflight 500* just by entering "star" followed by LOAD and RUN.

If you come up against an error whilst in the throes of compiling an AMPLE word, check and correct the offending line and enter RUN again, remembering to CLEAR before starting on the next word. When all is done, simply type play to run the piece. You may hear some obviously wrong notes or out-of-step parts. If you do and they're not too drastic, use EDIT on the offending score word(s) and check it/them against the listing. If, on the other hand, you've made an irretrievable cock-up of the entire proceedings, you're best off listing the whole program on a printer by entering ON PRINT WRITE OFF PRINT.

As for fiddling around with the program once the listening process has exhausted you, try typing in the interacting commands shown in Table 3 while *Starflight* is

```
Change tempo:
800 TEMPO % faster
1200 TEMPO % slower
1000 TEMPO % normal

Step music manually;
ON FREEZE % halt music
SCAN 12 FAST #2 % press SPACE to step,
% RETURN to exit
OFF FREEZE % continue music

Change drum decay:
2 EMOD % modify envelope 2
50 DECAF % ... thicker
100 DECAF % ... 'simmonsy'

Pan bass:
2 SHARE 1 VOICE % player 2's first voice
SCAN POS % use ':' and ')' to pan,
% RETURN to exit
```

Table 3. Interactive commands.

playing. You could try remixing the piece using the bass-panning commands from Table 3 to set AMP and POS individually for each voice. Write the finished settings into the instrument definitions (see the last line of bass), or in the case of organ, after the instrument name so that each voice has its own level and stereo position. Another idea is to store all the settings in a single word, as shown in Table 4. You can then make live

```
"desk1" [ % all 'desk' settings
1 SHARE % kit player
1VOICE 128 AMP 3 POS % drum
2VOICE 125 AMP-3 POS % cymbal
... settings for
players 2,3 & 4 ...
```

Table 4.

changes between complete setups by entering desk words as commands.

Actually, the percussion score of *Starflight* is a prime target for tinkering. Fetch the listing with "rhythm"EDIT as normal, then add 80.play so that the piece starts automatically each time you RUN the modified listing. An alternative for lines 30 and 50 is shown in Table 5.

```
X/// /Y/X X/// /Y//
X///Y^/X X///Y///
X///Y^/X X/Y^/Y/
X///Y^/X X///Y///
X///Y^/X X///Y/Y/
```

Table 5. Possible rhythmic modifications.

Since the cymbal envelope has an immediate release, you can use rests to chop the sound short, as the remainder of Table 5 shows. Remember, to play X and Y on the same beat, all you need do is write X(Y).

Happy fiddling! ■

Further information on the Music 500 can be had from Hybrid Technology, Unit 3, Robert Davies Court, Nuffield Road, Cambridge CB4 1TP. ☎ (0223) 316910.

Passport MIDI/4 Plus and MIDI/8 Plus

Software for Apple II and Commodore 64

One of computer music's pioneer companies has further refined its professionally-oriented packages. They've got a UK distributor now, too.

David Ellis

Since E&MM last visited the products of Passport Designs back in September '84, a good deal of MIDI bytes have passed under the hi-tech bridge. Passport have secured a cozy little niche for themselves in the music entertainment market courtesy of their emetically-named MIDI Hitware – encoded versions of pop classics for anyone with either an Apple II or Commodore 64 and a polyphonic synth of some description to tag onto the end of the ubiquitous five-pin DIN lead.

But Passport haven't given up on the semi-pro and pro end of the software game. Far from it. In fact, as their newly-released MIDI/4 Plus and MIDI/8 Plus software packages show, they're keeping well and truly abreast of what musicians want out of the MIDI.

However, although the software side of things is encouraging, all is not sweetness and light in the hardware department. As Passport are pleased to tell you, their MIDI cards for the Apple II and Commodore 64 are now the 'industry standard' for those micros. This means that the Apple MIDI card is compatible with just about any bit of MIDI software being produced for the Apple II, and a good deal of that coming out for the Commodore 64 shares a similar compatibility. Which is good news, undeniably. But where the thorn enters the flesh is with pricing policies: Passport's MH01 card (MIDI In/Out and drum sync) retails for \$150, while the MH02 card (MIDI In/Out, drum and tape sync) sells for \$200.

Because those cards are industry standards, everyone is busy copying and flogging them for half the price. As I mentioned in *Rumblings* last month, such cards include virtually identical offerings from Decillionix (\$99) and Mimetics (\$95), and now there's an even cheaper one available from Syntech (see this month's *Rumblings*). All of which must make Passport sick as a parrot, and should persuade them to drop their MIDI card prices by 50%. After all, what's the point of being an industry standard if everyone's lapping up your cream?

MIDI/4 Plus

But on to the software. The version of MIDI/4 without the 'Plus' was what



appeared in these pages last year. As I recall, my main criticisms centred around the very simplistic editing facilities (punch-in but no punch-out) and the lack of any flavour of step-time sequencing. Yet as a basic, four-track, overdubbable polyphonic sequencer, it worked well. It also sold well, with 'thousands of users', according to Passport's hyper-efficient promotional department.

Seeing as I've already reviewed MIDI/4, I don't intend to go through the ins and outs of the old side of the new software (if you see what I mean), but I guess a few brief reminders of operational basics are in order in advance of looking at the 'Plus' features. In brief, MIDI/4 Plus provides a

5000-note capacity, four-track sequencer, with those notes being dynamically assignable to the four tracks. Thus, it doesn't matter if you record 10 notes on three of the tracks and 4990 on the fourth – the software won't grind to a halt.

The main screen display is clear and to the point, showing that each of the four tracks can have individual modes (Rec, Play, or Off), MIDI channels, presets, and instrument names. Just what you'd expect from any MIDI sequencer, in fact. Then there are the global factors down below, like tempo, transposition (shame it's not separately assignable to each track) and beats per measure. Finally, at the bottom of the screen, there's a region where commands, amounts of memory used/left, and the clock appear. The latter feature is greatly improved over the straight MIDI/4, as you now get a real-time readout of your location in the sequence, with three elements representing measure number, beat, and beat subdivisions.

As before, setting the status of a track to Rec and pressing the space bar starts the recording process. But it's when you're playing back a sequence that the 'Plus' differences really show up. Pressing Escape during replay puts the sequencer into Pause mode, and this, in turn, opens the door to six further commands: fast forward, fast rewind, single-step forward, single-step rewind, punch-in record, and punch-out record. In contrast, the old MIDI/4 only had punch-in and required the user to re-record everything after the punch-in up till the end of the track. Aren't software updates wonderful!

Two crucially important sections are accessed by pressing 'E' (for Edit) and 'U' (for Utilities). Taking the Edit section first, two features (track erasing and track mixing) are the same as they were on the MIDI/4, but again, it's the 'Plus' additions that are particularly welcome, as they allow track-specific linking and auto-correction. The linking feature allows an entire source track to be appended to the end of a destination track (at the point where the space bar was pressed to stop recording). It's useful, but it's a shame the software doesn't dig deeper and allow a user-defined range of measures to be linked. In fact, linking is more useful than you might think at first, because you can

'What might tip the balance in favour of MIDI/8 Plus is if you're using a multitimbral keyboard such as one of the new Casios.'

Hinton MIDIC

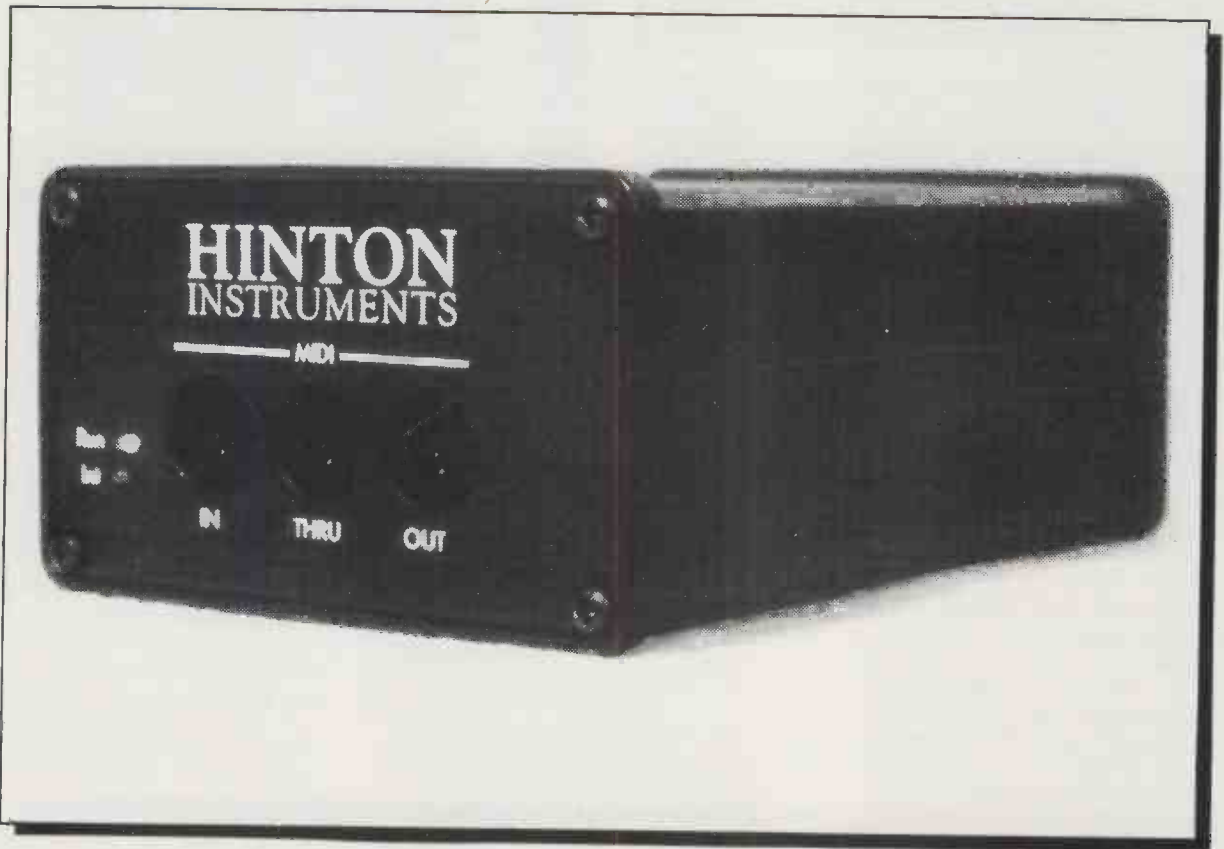

MIDI Hardware and Software for RS232 Interface Standard

Up till now, most MIDI software packages have been written specifically for certain computers. But in the shadow of Oxford's dreaming spires, they see things somewhat differently... *Simon Trask*

Whichever way you look at it, there's one inescapable fact about the burgeoning MIDI software industry. It now has countless sequencing and patch dump programs to its name – probably far more than can actually be supported in the marketplace, in fact – but very little in the way of general-purpose utility software and hardware. The Hinton MIDIC, an entirely new system from sunny Oxfordshire, is an attempt to change that. The only other package at all similar is Roland's MPU401 MIDI Processing Unit, but that unit's appeal is limited in this country by virtue of the fact that it'll only work with the Apple II/Ile and IBM PC computers (long-planned Commodore 64 and BBC versions have yet to materialise).

From the outside, MIDIC is a self-contained, Z80-based microprocessor system on a single Eurocard housed in a robust aluminium casing measuring 2.5" x 4" x 6.5". But crucially, and unlike the MPU401, MIDIC has been designed to work with any computer or terminal that has an RS232 interface. That means designers Hinton Instruments have ensured themselves a broad range of potential users, and that they can draw comfort from the fact that any change of computer is unlikely to leave their MIDIC system out in the cold. Because in case you weren't aware, RS232 is a world standard communications protocol used for the transmission and reception of data over the phone network *via* modem, and the current explosion of interest in

this field means that even if a computer company fails to fit the system to their latest machine, an RS232 add-on from an enterprising peripherals firm is never too far round the corner.

Making Connections

But what *is* MIDIC? And what's all this talk about RS232 when everyone knows that MIDI is where it's all at, musically speaking?

Well, MIDIC is an intelligent buffered interface unit that sits between instrument and computer, with MIDI cables at one end (one each of MIDI In, Thru and Out sockets are provided) and an RS232 cable at the other. The user manual gives

full instructions for getting MIDIC up and running, and thankfully, it's a pretty straightforward procedure.

The idea behind MIDIC is 'to make life with MIDI easier' (Hinton's words), a sentiment I wholeheartedly applaud. It sets out to do this by, among other things, allowing you to read data from and send data to any MIDI instrument, filter out selected MIDI codes, convert MIDI channels, and leave all MIDI timing considerations to MIDIC. In many instances commands are issued by single keypresses, and a 'helplist' of commands can be summoned at any time simply by keying 'H' on the host computer. Thankfully, upper and lower case characters are treated as being the same.

Within the Hinton unit is current MIDIC software version 1.1, which is held in an 8K EPROM, along with 10K RAM for buffering MIDI data. There's also space for another 8K EPROM, the intention being that other software houses (or indeed Hinton Instruments themselves) can build their own software into the MIDIC system – definitely an appealing idea.

The price of the above configuration is £300 excluding VAT, or £350 for the version with battery backup. However, there are some other costs to bear in mind – an RS232 cable, for instance. Currently, Hinton Instruments can provide 1.5m MIDIC RS232 cables for the BBC B, Apple Macintosh, RML 380Z and 480Z, Sinclair Spectrum and QL micros, along with a 'null modem' cable for those computers with standard RS232 pin-outs; cost is £15 per cable. Alternatively, MIDIC pin connection details are given for the above-mentioned computers and for making up a standard RS232 cable, should you wish to follow that route.

Further possible costs are an RS232 interface unit and terminal emulation/comms package, though one nice consequence of using RS232 is that, for reasons outlined earlier, any purchases you make on this front will not be limited to MIDIC applications. For this review, I used a BBC B fitted with Commstar, a ROM-based intelligent communications package that also sees use in a conventional modem system.

MIDIC requires an external power supply, and this may be supplied either by the host computer via pin 25 on the RS232 D-connector, or from an optional 6V DC supply.

As you may know, the MIDI protocol allows no restraint to be put on the reception of data. This is understandable as MIDI is essentially a real-time system, so the receiver should always be in a position to handle data when it arrives.

But RS232 has no such requirements made of it – in fact, a receiver may often need to tell the transmitter to wait a while (well, a few microseconds). This process is termed 'handshaking', and the RS232 standard allows for several handshaking lines. MIDIC will work at the following baud rates (ie. speeds of data transmission): 150, 300, 600, 1200, 2400,

4800, 9600, 19.2K and 38.4K. The alert among you will notice that none of these equate with MIDI's 31.25Kbaud (and only one of them is actually *faster* than MIDI), which is where the handshaking comes in. However, as MIDI data will just stream into MIDIC regardless, some form of buffering is necessary. The 10K RAM inside MIDIC is logically divided into four buffers: MIDI input, RS232 input, MIDI output and RS232 output. The RS232

'If you incorporate too much MIDI processing into your system, you run the risk of introducing noticeable delays.'

output (ie. MIDIC-to-computer) buffer has, logically enough, been allocated the lion's share of MIDIC's RAM – 7K of it, in fact.

Getting Started

The MIDIC 1.1 software operates in two modes, Process and Interface, with the idea behind the former being to give musicians a means of equipping MIDI synths with MIDI facilities the original designers didn't think fit to include. It

this context refers to the removal of specific MIDI codes from a datastream, so that, for instance pitchbend on a master instrument doesn't always have to be copied by a slave. On the other hand, generation commands allow the insertion of timing and synchronisation codes into a MIDI datastream, so that MIDIC can be used to control drum machines and sequencers, for example. As for assignment commands, their purpose in life is to rejuvenate an otherwise unassuming MIDI system by giving it powerful voice and channel control facilities.

On power-up, MIDIC goes through a self-checking phase, and if all is well, the small 'Run' LED on the unit's front panel blinks rapidly to show that it's awaiting a character over RS232. While things are in this waiting state, any data arriving on MIDI In is echoed on MIDI Out, as well as MIDI Thru.

To instigate communication between computer and MIDIC, you have to transmit a character over RS232 from your computer. This character is then analysed by MIDIC to match MIDIC's baud rate with that of the computer, after which a sign-on message is sent to the computer. If you're using a comms package this message will automatically appear on the VDU screen, but if you're using MIDIC with your own MIDI software, don't discard this message altogether – it's advisable to search for the space+delete terminators as a sign of successful communication.

With all preparations completed, Process mode is the default mode on entry. Everything received on MIDI In is still retransmitted on MIDI Out, but now a

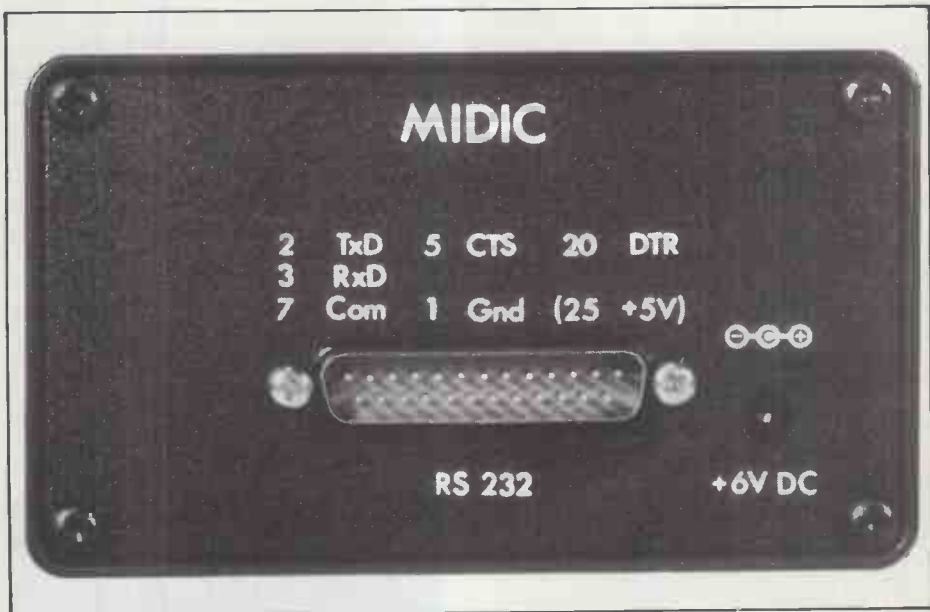

offers filtering, generation and assignment commands for the control of MIDI data, whilst the latter allows MIDI data to be presented over RS232 in two formats, ASCII and Binary, which basically offset clarity against memory usage.

A few quick words of elucidation are probably in order here. First off, filtering in

number of processing operations (which allow incoming MIDI data to be altered in various ways) can be brought into the picture.

Processing

Let's look at filtering commands first.

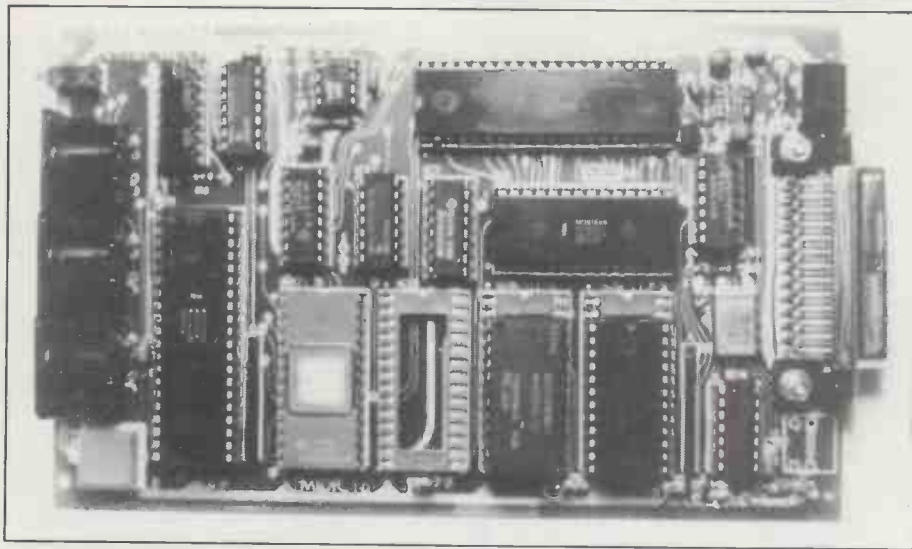

they're on separate channels), MIDI sequencer and drum machine start-up, and MIDI mode selection for individual instruments.

The register definitions let you define up to four splitpoints and/or overlays, each with its own voice. The channel conversion facility, meanwhile, allows a master synth to effectively transmit MIDI data over several MIDI channels. A simple application would allow, say, a DX7 to transmit over any one of the 16 channels available, or you could use one assignment memory as a 'MIDI off' control for those occasions when you suddenly want to play your master synth by itself.

In reality, if you incorporate too much MIDI processing into your system you run the risk of introducing noticeable delays, so don't get carried away with your newfound MIDI freedom. It's all a matter of experience and commonsense, really.

You can select your chosen assignments on the host computer over RS232, or on the master synth over MIDI In by selecting an appropriate patch number twice. This latter facility is useful if danger-fraught (Casio's CZ101/1000 synths won't transmit double selects, for instance), but it really comes into its own if you want to use battery-backup. This option is available for £50 on top of the basic 1.1 system, and allows all Process mode settings (including keyboard assignments) to be stored when the unit is powered down. Interface mode and Tempo Generator On aren't recalled states, but the baud rate and current assignment number are.

The main benefit of battery backup is that it allows you to use MIDIC without a computer, something that could certainly come in handy at a gig, for example. However, as assignment memories aren't retained through power-down with the basic system, battery backup is actually useful for any situation – though assignments *can* be downloaded over RS232 for storage and subsequent retrieval.

One irritating feature of the assignment system as it stands is that assignments can't be edited, so if you make a mistake, or you want to change one code, you have to redo the assignment from scratch. There's scope here for a spot of home programming – but that's not going to be much consolation for non-software writers.

Interfacing

Whereas Process mode allows you to set up a number of data processing options, Interface mode actually allows MIDI data to be communicated over RS232. The two available sub-modes govern the form in which this data is transmitted and received by MIDIC: ASCII mode and Binary mode.

The standard use of RS232 is to communicate ASCII text files (either to another computer or to a printer). A comms package will therefore treat incoming bytes of data as representing

▷ The MIDIC way of doing things lets you filter out codes prior to the MIDI data-stream being passed to MIDI Out and MIDIC's RS232 Out buffer, and only incoming MIDI codes are suppressed – all codes may still be transmitted. Control of the MIDI Out route means that MIDIC can, for instance, act as a 'control extension' for a synth that has no MIDI filtering facilities. For the RS232 route (which comes into action when you enter Interface mode), filtering can simplify the procedure of programming by only sending data required by the program over RS232. Filters implemented in MIDIC 1.1 are pitchbend, active sensing, aftertouch, all Real Time codes, and System Exclusive. Pitchbend and aftertouch are not channel-specific. There's also an implementation of channel filtering that enables you to specify anything from 1 to 16 channels as being recognised for MIDI reception.

The second form of Process command is the generation type. With these, you can use MIDIC to generate active-sensing clocks, say, for synths that lack them. Tempo commands allow MIDIC to insert MIDI timing clocks between other MIDI codes being output, and you can send MIDI Start, Stop and Continue codes using single keypress commands on MIDIC 1.1, adjusting tempo in a similar manner. These timing commands can be sent in ASCII mode as well, and MIDIC also lets you set tempo in crotchets per minute, with a display of your chosen value being available at any time.

You'd be right in thinking that list is a long one, but it isn't excessively so. All these generation commands greatly ease the would-be programmer's task by allowing MIDIC to take control of one of the most difficult aspects of MIDI – timing. Further useful commands simplify the task of dealing with timing on input MIDI data, and these come into operation in Interface mode (see later).

A 'reverse generation' command allows running status processing to be carried out on MIDI output. By removing unnecessary status bytes from the MIDI datastream, associated time delays can be removed. This feature is useful for reducing the amount of data transmitted

when using Assignment Processing.

The third category of Process command is keyboard assignment. More than any other MIDIC feature, it's this one that allows a comparatively humble synth to assume the rôle of MIDI controller keyboard. Sixteen assignment memories are available in total, and they operate only on data received via an assignable Basic Channel (1-16), which means that MIDI data received on other channels is subject only to the general filtering commands of MIDIC.

Each assignment memory consists of four 'registers', a name (up to 28 characters long), and a list of MIDI codes that's transmitted as soon as the assignment is selected. The registers are used for defining up to four keyboard ranges, which can be defined either by typing in MIDI pitch codes over RS232 or by keying notes on a connected MIDI keyboard. You can assign each register its own output MIDI channel, and pitchbend, aftertouch and all-notes-off commands may be enabled for the assigned channel of each register. You can even transpose incoming pitch data over the entire MIDI pitch range prior to transmission on the assigned channel.

The MIDI event list for each assignment enables you to enter a sequence of up to 50 MIDI codes. The only hassle is that you have to input them in hex format – and make sure you get them right first time, as there's no error-checking. But because any MIDI codes can be transmitted, the possibilities of the assignment system are many and varied. Obvious uses include separate patch selection for each instrument in a MIDI setup (as long as

```

10K  MIDIC  Vers:0.7v
Copyright (c) 1985 Hinton Instruments
Process Mode

A - ASCII/Binary select (1/f)
B - Base Channel select
C - To setup Channel filtering
D - Dump Assignment settings
E - Echo RS232 (1/f)
F - Go to Interface mode
G - Insert Timing on input (1/f)
H - Keyboard Assignment
I - Active Sensing Generator
J - Set Tempo Crotchets/Min
K - Pitchbend filter
L - Real Time filter
M - Active Sensing filter
N - Channel & Poly AfterTouch filter
O - Update Battery Backup RAM
P - Wait for Timing on output (1/f)
Q - System Exclusive filter
R - Autostart control
    
```

MIDI

MIDI OUT

**RRP £199.00
INC. VAT**

AVAILABLE FROM ALL
GOOD MUSIC STORES IN
CASE OF DIFFICULTY
CONTACT US DIRECT.



BASS PEDALS ML-50

MIDI IN

JUST PLUG IN TO ANY MIDI ORGAN, KEYBOARD, SYNTH.



MIDI BASS PEDALS ML-50

You can't put a foot wrong with this **brand new design** which utilises the **MIDI** facilities of today's popular keyboards. The high quality **13 note C to C** instrument adds professional pedal power to the bottom octave of any **MIDI keyboard**, and can control auto chord and rhythm sections. Operates in full **polyphonic mode**, or **monophonic**, with **computer note memory** system for easy error free footwork.

A rugged, compact, lightweight attractive design using the most advanced and reliable techniques and materials.

Built-in power supply for direct mains operation at 240v 50Hz.

OPTIONAL FOOT CONTROLLER RRP £99.00 INC VAT

This unit provides the following extra facilities:

- (a) MIDI Channel Selection 1-15
- (b) Octave Selection 1-6
- (c) Added Fifth Selection
- (d) Mono/Poly Selection

AVAILABLE FROM ALL LEADING MUSIC STORES



MICRO MUSICAL LTD., 37 WOOD LANE, SHILTON, COVENTRY CV7 9LA. U.K.
Tel: (0203) 616760

FROM THE
PUBLISHERS OF:

ELECTRONICS & MUSIC MAKER

The world's biggest music technology magazine — for the modern keyboard player and synth programmer.

HOME STUDIO RECORDING

The magazine that takes the mystery out of recording at home — from 4 tracks to 24.

GUITARIST

Britain's only specialist guitar-playing magazine — for electric and acoustic players, guitarists and bassists.

NOW RHYTHM

For the modern drummer and drum machine user. The perfect beat that completes an unbeatable music family — on sale every month at all good newsagents.



ON SALE
AT ALL
LEADING
NEWSAGENTS

MUSIC MAKER PUBLICATIONS.
SIMPLY MORE TO READ.



Music Maker Publications 1 Milton Road, Cambridge CB4 1UY (Tel 0223 313722)

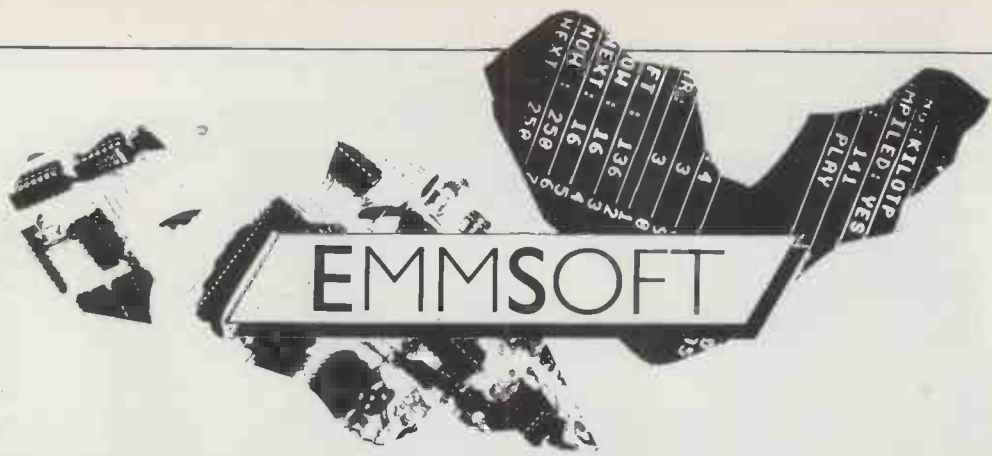

The latest from EmmSoft, the hardware/software marketing division of Electronics & Music Maker.

EmmSoft has taken under its wing both past micro-based projects and will include future E&MM software developments. The following guide summarises the EmmSoft projects for which printed circuit boards and software packages are available, and this will be updated every other month. All prices quoted are inclusive of VAT and postage and packing – please allow 28 days for delivery. Send your order, with payment in sterling cheque, postal order or bankers' draft payable to Music Maker Publications, to **EmmSoft, E&MM, Alexander House, 1 Milton Road, Cambridge, CB4 1UY.**

MicroMIDI *May 83*

A single-board serial interface that will link any MIDI synth to the Sinclair Spectrum microcomputer. Features include three parallel I/O ports, crystal-controlled data transfer, and opto-coupled output.

The PCB is available from EmmSoft at £4.25.

MicroMIDI II *July 84*

A revised, simpler version of MicroMIDI was published subsequently which incorporated the same facilities with the exception of the three parallel I/O ports.

The PCB is available from EmmSoft at £4.25.

As part of the 'Spectrum MIDI' article in E&MM July 84, two software programs were published – a SixTrak Patch Dump and DX7 MIDI Dump – both of which will run on either version of MicroMIDI.

A cassette containing an expanded version of Steve Parr's DX7 MIDI Dump program (including a short sequencing routine) can be obtained from SDS, 18 Cambalt Road, London, SW15 6EW, for £5.95 including postage and VAT.

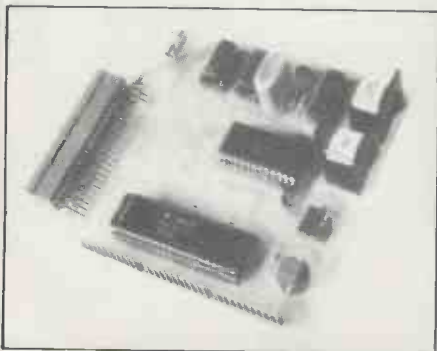

OMDAC *June 83*

The OMDAC, when used in conjunction with a Z80-based microprocessor, will provide eight sets of gate, trigger and control voltages compatible with most one-volt-per-octave synthesisers.

A 'Patch Change' program for the Spectrum was published in E&MM September 84, while the second OMDAC Update (E&MM October 84) enables the hardware to be modified to run on the BBC microcomputer. Further OMDAC software is in the pipeline (see also 'Drum Sequencer', E&MM November 84).



BeeBMIDI *June & July 84*

A MIDI interface for the BBC Model B microcomputer, Part 1 of BeeBMIDI contained the technological and constructional details, while Part 2 continued with a full parts list and some MIDI software routines. The PCB is available from EmmSoft at £4.95.

BeeBMIDI Software *August 84*

A full listing of a comprehensive dump program written in BBC BASIC and 6502 Assembler for the Yamaha DX7, with the software also available on cassette (for the sore-fingered) from EmmSoft, price £3.95 (reduced from £7.95).

January 85

BeeBMIDI Part 6 features a program that allows you to dump Roland Juno 106 voices onto disk or tape, and which can be adapted to suit other micros and MIDI synths. The program is available on cassette from EmmSoft, price £3.95.

Further software for BeeBMIDI is

currently under development.

Please note that the opto-isolator with the right specification is available from EmmSoft at £2.75. The Maplin component was quoted in the BeeBMIDI parts list in order to ease the problem of purchasing the correct opto-isolator, but this subsequently proved to be unsuitable.

February & March 85

BeeBMIDI 7 & 8 feature the DX7ED software package, a comprehensive DX7 editing program which receives voice parameter information from the DX7 and displays it clearly in useful related sets on screen, allowing the amplitude/time graphs of all six Operators' envelope generators to be viewed at the same time, and complete sets of envelope generator and operator parameters to be altered and/or swapped about at will. DX7ED is available from EmmSoft on cassette, price £24.95, but members of the DX7 Owners' Club can take advantage of a special offer – further details from the Club.



Drum Sequencer *November 84*

Some new software for the BBC Micro that allows E&MM's electronic percussion modules to be sequenced using either the OMDAC or the user port of the BBC B.

Available on 40- or 80-track disk (please state preference) from EmmSoft at £8.95.

KITS

'I CAN'T BUILD THAT!
— BUT WE CAN
YOU BUY THE KIT —
WE BUILD IT

ALSO
CUSTOM BUILT EFFECTS PEDAL BOARDS
(HAVE YOUR EFFECTS PEDALS
BUILT INTO A 19" RACK)
PATCHBAYS, CONNECTOR BOXES AND
ANYTHING FOR THE MUSICIAN AND
HOME RECORDING ENTHUSIAST
ALSO E&MM BBC MIDI INTERFACE
BOXED AND TESTED £POA
WE WILL BE PLEASED TO DISCUS
YOUR PARTICULAR REQUIREMENTS

Contact:
Derek or Graham
Clartaley Electronics Ltd
Ash Vale
Aldershot
(0252) 512003

ALL WORK WARRANTED

XRI SYSTEMS—MICON

MIDI SYSTEM CONTROLLER

FOR A 48K

ZX SPECTRUM

Features include:

- **STEP SEQUENCER**
with 24000 events • Music Score
• Full Edit Facilities • Input from Synth
- **REAL TIME SEQUENCER**
with Correct • 10 Sequences • Patch Dump
• Recording with Metronome
• External Drum Machine
- **SYNC**
From MIDI Sync 24 or Internal Micon Clock
- **PRICE** — Interface and Software — cheques and
PO's payable to XRI Systems

£108

CASIO EDITOR	£22.95
DX7 EDITOR	£24.95
JUNO 106 TOOL KIT	£19.95
SYNC CONVERSION KIT	£14.95

- **ADDRESS** — 10 Sunnybank Road,
Sutton Coldfield, West Midlands.
Tel: (021) 382 6048

MICROSOUND DIGITAL MUSIC SYSTEM

THE FIRST PROFESSIONAL DIGITAL SAMPLING SYSTEM FOR THE COMMODORE 64

SYSTEM SPECIFICATION

Sample recording

User definable trigger level, trigger delay, input filter level (bandwidth 4–15KHz), and sample rate (4–33KHz).

Real time bar graph display of input level with clipping indicator.

Sample editing

Mix, reverse, loop or delete any part of the sampled sounds.

The full 40K sample memory displayed on one screen, complete with two sets of start/finish pointers and the edit cursor.

Select any section of memory for the storage/playback of samples.

Sample playback

Via Microsound 64 keyboard. Envelope/LFO control of amplitude, LFO rate controlled in real time by the keyboard's slider control.

Programmable output filter level and looping on/off function. Samples played back over the full 4 octave range with no distortion.

Split keyboard facility allows all the aforementioned functions to be programmed for EACH half of the split.

Via QWERTY keyboard. All the above except LFO modulation.

Via MIDI. As QWERTY but with programmable MIDI channel allocation.

Sample storage

The 40k sample area can be saved directly onto disk along with all the user defined variables set up in the program (eg. envelope levels, filter levels etc.) This allows the sounds to be loaded and played back exactly as they were set up originally. Files may be deleted if necessary.

A catalogue of the sound files on the current data disk is also displayed.

Hardware

A robust, compact unit measuring just 230 × 120 × 35mm.

Built in MIDI interface for the reception transmission of MIDI data.

Pre/de-emphasis circuits to eliminate quantisation noise.

Programmable 24dB anti-aliasing (distortion) low-pass filter, bandwidth variable between 4 and 15KHz.

Digitally controlled output amplifier for real time envelope LFO modulation.

Input amplifier with adjustable input level, suitable for mic or line signals.

Output volume control and power on/off switch.

Power supplied either by battery or optional AC adaptor.

Connection via COMMODORE 64 cartridge port.

System described above (excluding keyboard) ONLY £299 inc. VAT and P & P

7 days money-back guarantee
Dealer enquiries welcome

Microsound 64 keyboard and SiD-based polysynth software (still the best available) NOW ONLY £149 inc. VAT and P & P

Microsound Ltd., PO Box 14, Petersfield, Hants. GU32 1HE. Tel: 0730 87403

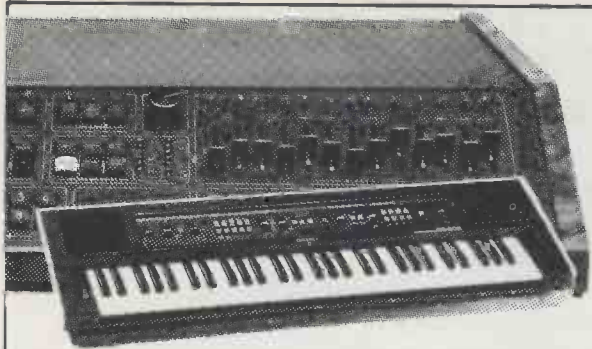

SELL IT FOR NOTHING

With a Free Classified Ad in Electronics & Music Maker

Now sales and wants ads from private individuals can be placed free of charge in E&MM's classified section. Which means if you've got some gear you need to sell, or a particular item you want to track down, all you need do is fill in the coupon below, send it to us on or before the specified date, and your ad will appear in the following issue. Simplicity itself. So for the price of a postage stamp, you'll reach a bigger audience of electronic music players than any competing publication. If you'd like your ad to appear for a second month, simply send in the order form again - and we'll oblige. (Please, no phone calls or cryptic messages!) Note though that this service is available only to private individuals: companies must use the standard classified order form.

CASIO MT-70 programmable polyphonic keyboard, plus accessories £145. Acorn music 500 used twice, mint condition, £180. Phone Dave 0933 226776.

COMMODORE 1541 disk drive and 1525 printer, both cost £200 sell for £100 each. Phone Jerry 01-690 4848 daytime.

YAMAHA CX5M full size keyboard £550. (Boxed, unwanted gift), + Korg Polysix £400. Will sell separately or together £900. Knowle 3862.

POWERTRAN MCS1 MIDI sampler £760. Drummulator £500, Vestfire Limiter £55, Custom Sound 150w bass cabinet £60. John 01-640 7007.

REBIS rack, 2 compressors, 2 gates, 4 parametric EQs, patch bay, £550 ono. Curman RV1 spring reverb, £150. Dave 01-743 3055.

POWERTRAN T2000 synth and 1024 composer/sequencer (with external sync), £150 or swap for SH101. Phone Kevin on 0353 87498 (Cams).

JUPITER 6 £1050 or swap for Sixtrak/Drumtraks or Sixtrak + £600. Also Yamaha DX7 £1100 both £2000. Phone Kevin, Waltham Cross (0992) 39775.

ROLAND TB303 bassline sequencer, v.g.c., still boxed, £100 ono. Tel. Ambleside (0966) 33701.

PROPHET-T8 immaculate custom aluminium flightcase, offers, Psionics EQ4 parametric, each band individual accessible £300. Roland rack phaser, £150. Paul, 01-884 0474.

SCI Pro One home use only, as new £260. Fender Mustang bass £110. Tel. 01-215 4151 work, 0474 67730 home, Mike.

CASIO CZ101 polysynth for sale mint condition, £299. Tel. Leighton Buzzard (0525) 370242 evenings.

JX3P + PG200, + flight case, + stand + ex £850. Phone Mic 021-477 3827.

HI WATT 100w bass amplifier,

v.g.c., £130. Customsound monitor £40. Customsound bass cabinet 100w £60. Vestfire limiter £55. 01-541 5006.

WANTED faulty, damaged synths and vocoders and EMS products. Tel. 021 523 6752 evenings.

WANTED Roland 100w system modules and racks, also wanted pair of Fostex 6301 personal monitors. Phone Chris, Bolton (0204) 35796.

MOOG Opus III £240. Roland SH09 and Roland CSQ600 sequencer £240 The pair. Korg guitar synth £110. Reading (0734) 693166.

DX7 instruction video 'Getting Started' by Dave Bristow, Beta Format £10. Phone Barnsley 290126.

YAMAHA PS6100 midge ure think ?? Brilliant buying house forces sale, £825. Boss DR110 £80. Ian 0992 22833 evenings.

TEAC Portastudio (144) recent service, £320 ono. Sony stereo 1/4" tape deck 7 1/2 3/4 needs service £20. Guildford 65757.

CASIO MT40 portable keyboard, 22 voices, auto bass, rhythms, polyphonic, £25. Harpenden 3398 (Herts).

YAMAHA PS20 portable organ mint condition £220 ovo. Doncaster (0302) 61672 after 6pm weekdays only.

KORG EPS1 for sale, touch dynamic piano, and strings, v.g.c., £500. Phone Yeovil (0935) 76441.

JEN SX1000 mono synth £95. Hohner string machine £120. Casio MT65 with case £120. CT301 £150. All ono. Cheltenham (0242) 517264 6-7pm.

EXPERIENCED musician Yamaha DX7 and Drumtraks offers session time in exchange recording time 8 or 16 track. Brian 905 2018.

OCTAVE KITTEN 2 mono synth, good condition, £120 or swap part exchange for rack DOL. Tel. (0257) 452303.

YAMAHA CS15D mono-synth

presets plus variable synth section, plays two sounds together, v.g.c., £150 ono. Phone Martin on Basildon 411890 (S. Essex).

SIEL MIDI expander 12DCO 6 voice. 95 superb programmable factory voices, receives master keyboard, dynamics! £250 ovo. Chris 01-675 7415.

DO YOU want news - info about electronic music? SAE for details to EMIX (EMM) 33 Peel Road, North Wembley, Middx. HA9 7LY.

15" 100W speaker excellent, tatty cabinet, £55 ono. Swap px for SQ01, bassline or Logan string machine? Phone John 01 908 4709 evenings.

SIMMONS SDSV 7 modules 3 toms. SNRE B/O H/H cym + rubber surfaced pads £1000 ono. Phone Watford 26020.

YAMAHA Polysynth, strings organ, keyboard, beautiful sounds with case. £350 ono. Roland Bassline TB303 £125 ono. Tel. Steve 0782 262286.

CASIO PT-50 plus books, supply and ROM cartridge, eight voices, sixteen rhythms, £130 new, £80 ono. Ideal beginner (0476) 65821.

SCI Sixtracks £390, Rhodes 73 Mk1 £275. Korg Poly 61 £390. All excellent condition, Wanted Korg MS50. Tel. 03473 777.

ELECTRO Harmonix super replay £360. Roland SH101 £170. Roland SH101 £170. Yamaha RX15 drum machine £360. All mint and ono. Phone 0602 626745 afternoons.

ROLAND RS09, as new, £180. Roland EP10 piano/harpsichord with hard case, £155, v.g.c., both home use. 0268 741413 evenings.

ROLAND TR606 drum machine £110. Casio MT65 £75. Marshall top MV50 watt £125. All in mint condition. Phone Tonbridge 366223.

ROLAND SH101 and CR8000 £400. Ibanez AD202 delay/effects rack £80. Wasp £60. Jim, 6 Queens Road, Exeter. (Work) 0392 32751.

AMPEX ape 2" uncut used once, 3 rolls, £12 each. PPhone 01-994 48673 (Steven).

SEQUENTIAL Six Trak, unwanted, complete in box, less than 10 hours use. £525. Phone (0624) 814066.

STRING synthesiser £180. Stix drum machine, £75. MPA200 amplifier £50. Audio Technica PRO1 £15. 200w cabinet £65. Phone (0904) 24724.

BIT One three months old, limited home use only, £700. Tel. S-O-T (0782) 722076 after 6.30.

THOMAS Playmate with fancy voice arpeggio, magic and orchestral presence, hardly used, over £1000 new, £500 ono. Dunstable 696703.

ECHO 1 keyboard for use with Commodore 64K computer, 3-note, 3-octave polyphonic full size keys, excellent quality, £75 ono. Rob, Newport (0633) 614976.

FOSTEX Package, A8, desk, meter, bridge, £1199, reverb £199, TB303 £199, Roland CR300 guitar synth, £449. Tel. 0268 742082 (Essex).

ACORN Music 500 synth, unwanted gift, 2 weeks old, boxed and guarantee, manual, software, lead, £175. P/exchange A3340. A. Hubbard, Orchard House, Brecon.

SWAP TAPE of your music for tape of mine, Steve Hartwell, 37 Pointout Road, Southampton S?1 7DL.

ROLAND System 100, keyboard plus expander, £250. Phone Mike 021-354 3020.

CADEY 1-inch 8-track with noise reduction for sale. Papst motors, Branch and Appleby heads - a pro machine for less than a Fostex! Including 30 reels of tape. Good condition. A bargain at £1200. Ring 0222 21802 (anytime).

VOCODER (Electroharmonix) for sale. Hardly used, excellent condition and performance. Comparable to Roland SVC350. Only £195. Ring 0222 21802 (anytime).

E&MM FREE CLASSIFIED ORDER FORM

Fill in the form below to a maximum of 20 words (one in each box), and send it to: *E&MM Free Ads, Alexander House, 1 Milton Road, Cambridge CB4 1UY*. Please print clearly in BLOCK CAPITALS. The ad must reach us on or before Friday, July 5, for inclusion in the August issue of E&MM.

1	2	3
4	5	6
7	8	9
10	11	12
13	14	15
16	17	18
19	20	

SWAP Commodore 64 & Data unit, software, loads of extras. Brand new, boxed, For GR300 & Footswitches. Must be v.g.c. 0684 294059 Chris (Gloucs).

WERSI Helios W2S with sound computer, arpeggiators, multi-guitar coupler, £3990. Finance available. Mr Shevels, 118 Braunespath Estate, New Brancepeth, Durham.

KORG Poly 800, polyphonic synthesiser, perfect, boxed, £390 ono. Phone Paul 0247 878080.

YAMAHA Mk100 Portasound poly keyboard/synth, excellent condition, still under guarantee, £200 ono. Tel. (091) 253630 evenings.

GULBRANSEN Palace Spinet organ, drawbars, percussion, piano, synth, brass, theatre, vibes, etc. was £5150, bargain £2250 ono. Telephone 0624 73634.

WURLITZER Electric piano EP200, good cond., £250 ono. Roland SH09, synth, good condition £99 ono. Tel. 0934 517199 after 6pm.

KORG mono/poly synthesiser splitable VCOs, cross modulation, sync, effects, delivery possible in southern England. Phone Bournemouth (0202) 579640.

TASCAM 4 track v.g.c., £690. Bryant 16-4-2 £200. Casio 1000P £195. 200W Fender mixer + two 100w bins £250. All ono. (0532) 556516

SEQUENTIAL CIRCUITS pro-one synth, home use only. As new, £290 ono. Phone Julian (06465)

265 evenings.

PHILIPS Laservision plus 15 discs £150 ono. Refund if buyer collects. Write: Mr Scott, 26d Harden Place, Hawick, Roxburghshire, Scotland TD9 7BY.

E&MM PITCH TRANSPOSER for sale - slight problem on clock needs correction - can consult E&MM £160. Contact Jonathan or Harun on 01-267 7777.

ALPHA Syntauri Soundchaser owners wanted to exchange information about hardware, software. Write Falzoni Vitorio, 139 Corso, Grosseto 10147 Torino, Italy.

ROLAND TR808 + MPC synth unit as new £350. Tel. Mark 0803 862592 (Dorset).

STUDIO Clearance Transcendent polysynth CV/gate mod, £300. Transcendent 2000 £60 tape sync box £30. Flightcased Canary 6-2 mixer £100. 01-542 1764.

BRAND NEW unused boxed Sequential Six-Trak £550 ono. or swap for Portastudio or Drumtraks or Drumulator. Glyn 01-558 5051.

AKAI 4000DB 2 track reel to reel, v.g.c., Dolby, S.O.S., little head wear, £100. Tel. 01-876 0599.

PRO-ONE v.g.c., £200. Contact Simon, Bristol 0272 730013 evenings.

SCI PRO ONE home use only, superb condition, boxed, £245 ovno. Tel: Ipswich 214295.

ROLAND SH101 and power supply, 18 months old, as new condition, home use only, £135. Tel: 0202 478201 evenings.

RHODES 54 Hammond X5, Teac

Portastudio 144 Crumar Composer, pair 100w flared horns, offers invited. Tel. 05438 761871/0902 730466.

RHODES Stage 73 MKII flat top perfect £450. Korg MS10 plus SQ10 sequencer £180. Tel. 01-397 5034 evenings.

ROLAND MC202 Micro composer with power unit, mint condition, £100. Phone Matthew (0344) 423649 (Bracknell) evenings.

BBC Micro + disc drive, disc interface, data recorder, software, swop for Teac A3440 or other equipment. Tel: 01-642 1830.

PROPHET Five 40 memories, cassette dump, flight cased, marvelous sounds, absolute bargain at £600. Medway 717919 (Kent) or Swap DX9.

COMPLETE sets of back numbers International Musician, One Two Testing, Sound Maker, Home Computer Course. Details Paul 01-370 7721 evenings.

WANTED synth player Poly into dream schroder schulze record and gigs. Phone Reading 876471 now. No Pro's.

COBRA 90 keyboard amp with 15x1H speaker cab £210. Juno 6/60 flight case, £35. All as new bargains. 0308 25819 (Dorset).

REFLECTIONS C60 chrome cassette of rhythmic melodic electronic music £2.50 from Pete Tedstone 188 Austin Road, Bromsgrove, Worcs. B60 3NY.

ROLAND TR-808 £250. Plus Roland MC-202 microcomposer £115. Phone Coventry (0203)

75060.

MAPLIN 3800 synth £160. Clef strings £140. Elektor piano £120. Offers or swaps (?Oscar) considered. Bill Knowle 78488 evenings.

WASP special and caterpillar keyboard (black paint job) £100. The pair. Phone Dave (0743) 54829 after 6pm.

KORG POLY 61 never gigged, mint 9 months old, £475. Roland TR808 £275. Powertran composer digital sequencer, never used, offers. Southampton 463445.

YAMAHA CS01 mono synth with breath controller, v.g.c., £80 ono. Contact Lynne Tennant, George Hotel, Hathersage, Nr Sheffield. Tel. 0433 50436.

SENSOR electric piano including stand and pedals £150. Also Kay drum machine £40. Phone Andy (0702) 545447 after 7pm.

ROLAND Mc202, softcase, mains adaptor Rh10 headphones, £130. Two Roland CMA15 monitor amplifiers on stands, £130. Telephone Hemel Hempstead (0442) 68375.

VOCODER wants Elektor filter boards for the Elektor vocoder. Ole Overlie, Hatleberg A-417 5033 BG-S Norway.

COMPLETE set of E&MM back issues won't split. Phone Graham 01-552 2951.

KORG Polysix 32 memory poly effects immaculate, home use only. Tel. Southampton (0703) 738980.

COURSES

Nottinghamshire County Council Education Newark Technical College MUSICAL INSTRUMENT ELECTRONICS COURSE

Leading to B/Tec National Diploma in Musical Instrument Technology (Subject to B/Tec approval).

Further details and application forms for this new full time two year course are available from:

The Principal, Newark Technical College, Chantry Park, Newark, Notts. NG24 1PB. Tel: Newark 705921

APPOINTMENTS

Nottinghamshire County Council AN EQUAL OPPORTUNITIES EMPLOYER NEWARK TECHNICAL COLLEGE LECTURER

GRADE II £7548-£12,099 P.A. (Pay Award Pending)
MUSIC AND MUSICAL INSTRUMENT TECHNOLOGY

Required for 1 September 1985 or as soon as possible thereafter. Applications are invited from persons with practical experience within the music trade in the repairing and servicing of electronic musical instruments with particular reference to organs, keyboards and synthesisers. The successful candidate will act as joint course director with a member of staff from the department of engineering and science for a major new course in musical instrument electronics which will commence in September 1985.

Entry point on the scale according to qualifications and experience.

Further details and application forms are available from:

The Principal of the College, Chantry Park, Newark, Notts NG24 1PB. Tel. Newark 705921.

To whom completed applications should be returned as soon as possible.

Advertisers Index

A1 Music	21
ABC Music	87
Akai UK	52/53
Arbiter Musical Inst.	13
Arthur Lord Organs	21
The Bokse Co. Ltd	13
Bonnors	35
Britannia Leisure	33
British Music Fair	60
Cambridge Rock	19
Capelle Music	21
Carlsbro Sound Centre	9
Chase Musicians	1
Chromatix	5
Clartaley Electronics	101
Dougies Music	65
Eddie Moors Music	18
Ensoniq Mirage	66/67
E.S.S.	44
Flash St Electromusic	44
Frazer-Wyatt Ind.	33
Freedmans	80
Future Music	70/71/72/73
Gigsounds	23
Greengate Prod.	58
Harman UK	62/63
Hobbs Music	88
Honky Tonk Music	14/15
ITA	29
JSG Music	2
Jones & Crossland	41
Joreth Music	88
London Rock Shop	74/75/77/79
Micro Musical	97
Microsound	101
MPC Electronics	IBC
Phonosonics	65/88
Powertran	51
Rock City	30/31
Roland UK	IFC
Rose Morris Retail Store	37/39
Rose Morris & Co	25
Simmons Electronics	45
Softsel	56/57
Soho Soundhouse	33
Summerfield	OBC
Southern Music	65
Turnkey	7
White Electric Music	83
XRI Systems	101
Yamaha	46/47

FOR SALE

AUTO DROP IN UNIT, ideal for Portastudios etc. Drop in at marked point on tape, or in-out. £40. Send SAE for details. Foxland Electronics, 39 Bates Street, Sheffield S10 1NP.

JAZZ, ROCK & STUDIO MUSIC SUMMER SCHOOL

at the
Guildhall School of Music & Drama, London
Sunday 4-Friday 9 August, 1985
Including:
Intensive Recording Engineers course in Professional 16-track studio.
Intensive Practical Course - tutors inc.
Henry Thomas, Tony Coe etc
Admin. Cheryl King, 01-8005684
2 Lordship Park, London N16

LOTUS RECORDS: THE 1985 CATALOGUE

FEATURING
SYNTHESIZER MUSIC: the finest selection available anywhere in Europe.
PROG-ROCK: UK groups, new and old, plus many talented European groups.
PLUS
Euro-Rock/Fusion Music and Jazz-Rock/Space-Rock/
Industrial Music/Electric Guitar-Dominated Inst Music
FEATURING
Records/Cassettes/Video/Compact Discs/
T-Shirts/Magazines
Mostly unavailable anywhere else
UK Electronica '85: Exclusive news of the Synth Music Festival of the Year, Headlined by Ash RA, on 24/8/85 at Sheffield Univ.
To receive this free catalogue:
UK: Send medium/large SAE/Europe:
Send 3 international reply coupons/Overseas:
Send 5 international reply coupons
TO
Lotus Records, 4/5 Piccadilly Arcade, Hanley,
Stoke-on-Trent, Staffs
**WE DISTRIBUTE THE MUSIC
MOST OTHERS WON'T TOUCH**

GATEWAY STUDIO



The Gateway School of Recording and Music Technology

Consultants in
Studio Synthesiser
and Computer Music
applications

RECORDING & SYNTHESIZER COURSES

Call us at Gateway for details of our Primary and Advanced recording courses, Synthesiser courses and Specialist courses in Computer/Synthesiser interfacing. We are at present planning short orientation courses for the Synclavier and other advanced keyboards, and we would like to hear from you about courses you would like to be involved in.
Write to Gateway School of Recording and Music Technology, 1a Salcott Road, London SW11 5QD or call 01-350 0340. Our courses are arranged in co-operation with Bandive, The Fostex Corporation, Soundcraft, Teac and Roland UK.

These courses should not be confused with any others

CLASSIFIED

Rates for 1985: Lineage 35p per word (min 12 words); Box No. 80p extra. Semi-Display: £1.00 extra. Display: £12.00 per single cm. column

All lineage advertisements must be pre-paid. Closing date: 6 weeks preceding cover date. Advertisements are accepted subject to the terms and conditions printed on the advertisement rate card (available on request).

HI-TECH MUSIC CENTRES

YES, we've got the latest gear you want from YAMAHA, ROLAND, SCl, KORG etc. like DX-7's, PF-15's, JUNO 106, Six-trac, Drumtraks, Poly-800 all on demonstration and available at the right prices! Plus INTERFACES for BBC B and CBM 64 Computers, all MIDI'd up and ready for you to try. Call 01-863 1841 for Catalogues, Prices, and Advice.

City
Music

Phone 01-863 1841
for an invitation to
our next
Midi Synth Show

NORTH HARROW: Pinner Rd. 01-863 1841
TORQUAY: 65 Market St. 0803 25488
EXETER: Queen St. 0392 51846
PLYMOUTH: Drake Circus 0752 23011
TRURO: 16 Pydar St. 0872 71359
JERSEY: 8 Esplanade 0534 78901

MUSIC LAB SERVICE

Officially appointed

REVOX TEAC/TASCAM Service Agents

A fast, efficient repair service
with collection and
delivery available

Contact Nikki Antoniou on
01-388 5392

72 Eversholt Street, London NW1 1BY

CLEF ELECTRONIC MUSIC

The NEW CLEF DIGITAL C.M.S. WHEN WE SAY 'PROGRAMMABLE' WE MEAN IT!

The new Clef Computer Music System is a FULLY programmable Digital Synthesizer. It's so programmable that you need a BBC Microcomputer to run it. Programmable waveforms on 32 independent oscillators. Programmable shape and keyboard touch response on 32 envelopes. Programmable stereo on each Osc/Env. Up to four different Osc/Env's per note. 5 Octave touch sensitive keyboard, real time polyphonic sequencing and massive potential for future software. In short, the Musical control you've always wanted at an affordable price.



Phone or write for full details
EXPERIMENTERS! PDSG,
P.S.U. & Keyboard available
separately as promised in
E&MM. Demonstrations by
appointment at:

CLEF PRODUCTS (ELECTRONICS) LIMITED
Dept E&MM7/85 67 Thornway, Bramhall,
Stockport, Cheshire SK7 2AH. 061-485 4889

BAND-BOX
Programmable backing trio
THREE PIECE BACKING BAND
Generates the sounds of three
instrumentalists to back
Soloists & Cabaret Acts
DRUMS+BASS+KEYBOARDS
Over 3,000 chord changes (60
scores) on 132 different chords
- 16 chord sounds
RRP £499.00



Loudspeaker Cabinet Fittings

From Adam Hall Supplies:
Coverings & frets • flight case parts
• Celestion power speakers •
Rean jacks & fittings • P&N stands
Send 30p PO/cheque for Illustrated
catalogue

**ADAM HALL
SUPPLIES LTD**
Unit M,
Carlton Road,
Grainger Court,
Southend-on-Sea
Essex

Celestion
Cabinet Handbook
Available NOW
Extra **£1**

**MIDI for PF10/15 and
YP40 keyboards
DX7-TF1 internal
memory expansion**

**RX15 internal memory expansion
TF1 modules: fly-cases for 1.2.3 or
4 modules with power.**

POLYTRAK

Ph.(50)404816
29 RUE DE VERSDIX
01210 FERNEY, FRANCE

MAKING TRAKS HIRE — PROGRAMMING

Helps you get your ideas onto tape
PHONE
to rent a MIDI synth, drum machine or portastudio.
Special package prices and free London deliveries.
PHONE
for free, impartial advice on setting up or upgrading
your studio
PHONE
for help with production and arrangements or if your
demos don't sound the way you want
01-727 7758

PRACTICAL COURSES IN PROFESSIONAL SOUND PRODUCTION TECHNIQUES

inc. Multi-track Sound Production and Computer-assisted
Mixing Consoles, Digital Sound, Analogue/Digital Sound
Synthesisers & Drum Computers etc. Sound Post-production
of TV/Video Programmes, Pop-music Video Production,
Production Jingles, Commercials, Film Music and Song
Arrangements.

Instruction by professionals working in the industry and
practical experience on state-of-the-art equipment throughout
the course.

Three-month and short-term courses in modern studio.

For further information contact:

Media Production Services
238-246 King Street, London W.6 Tel. 01-274 4000 Ex. 409



ELECTRONICS LTD

'Tomorrow's Designs Today'

**MEL GAYNER OF SIMPLE MINDS
USES M.P.C. ELECTRONIC
PERCUSSION.**

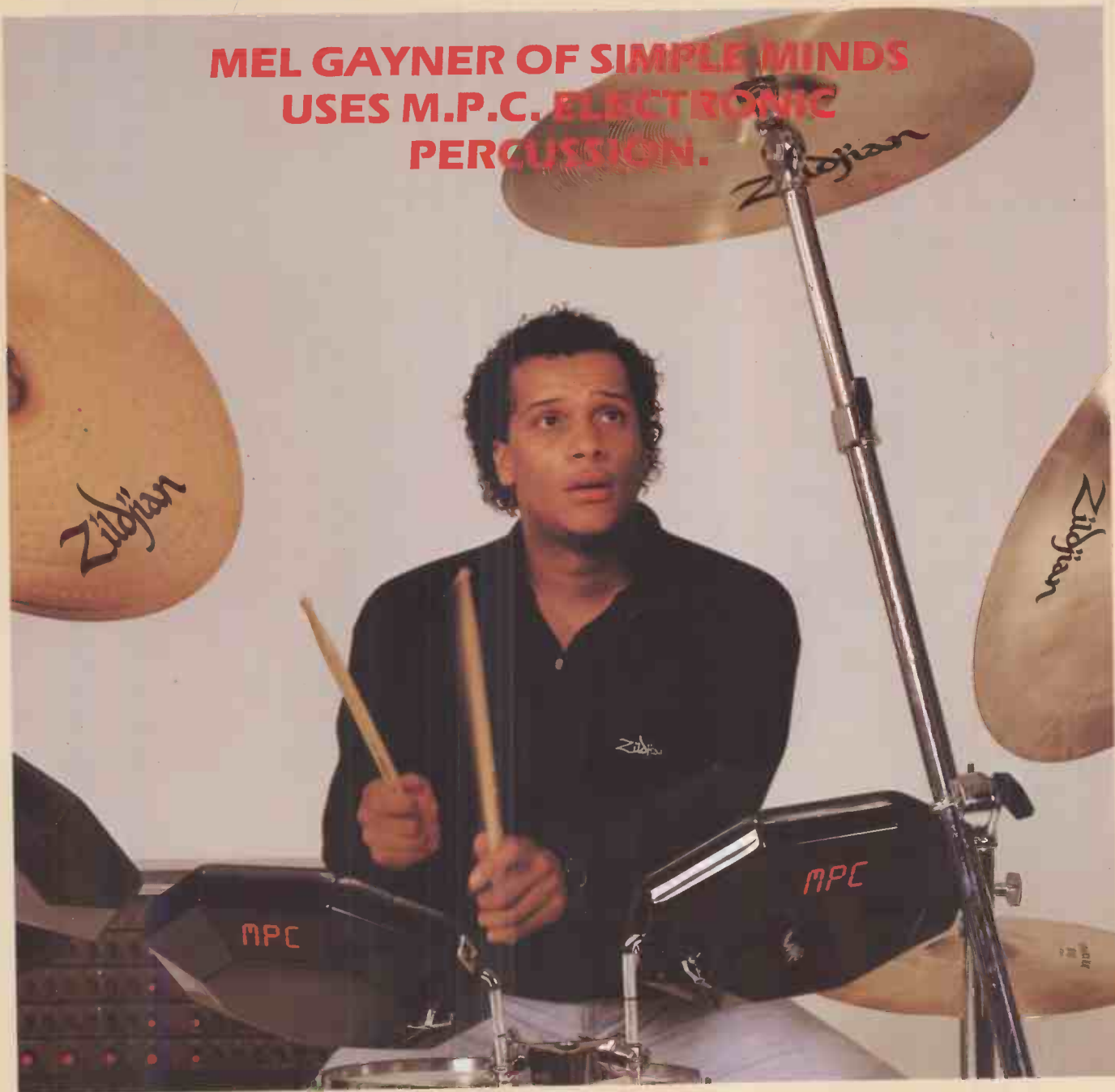

M.P.C. SUPER PADS

FOR FURTHER DETAILS CONTACT:-

**— "THE NEW GENERATION
HAS ARRIVED"**



MPC ELECTRONICS LTD
THE GABLES, STATION ROAD, WILLINGHAM, CAMBS CB4 5HG, U.K.
TEL. WILLINGHAM (0954) 60264 (24HR) TELEX EARFAIR 81648

WE SYNTHESIZE WITH YOU

AS GOES THE MUSIC...

IBANEZ MASTER SERIES

Music is constantly moving, constantly changing. And so are the needs of today's musicians. They are looking for new avenues of expression, and they're not finding them in yesterday's effects. New music requires new sounds - enter Ibanez Master Series

Ibanez proudly presents nine all new pedal processors guaranteed to make you think twice about your

present effects system. Each Master Series processor expands the horizons of its predecessor with new features, new circuitry and a new chassis design. Each has been meticulously designed and built to deliver the most musically effective sounds available anywhere.

But to appreciate all of the Master Series innovations, we invite you to get on down to your Ibanez dealer and audition the Master Series for yourself. Your new sound is waiting for you!

SOUND INNOVATION
Ibanez



For latest full colour catalogue of Ibanez effects send 30p to Summerfield (Dept EMM), Saltmeadows Road, Gateshead NE8 3AJ.