

# Electronics & **MUSIC Maker**

FEBRUARY 1982 75p

Featuring  
**IKE  
ISAACS**

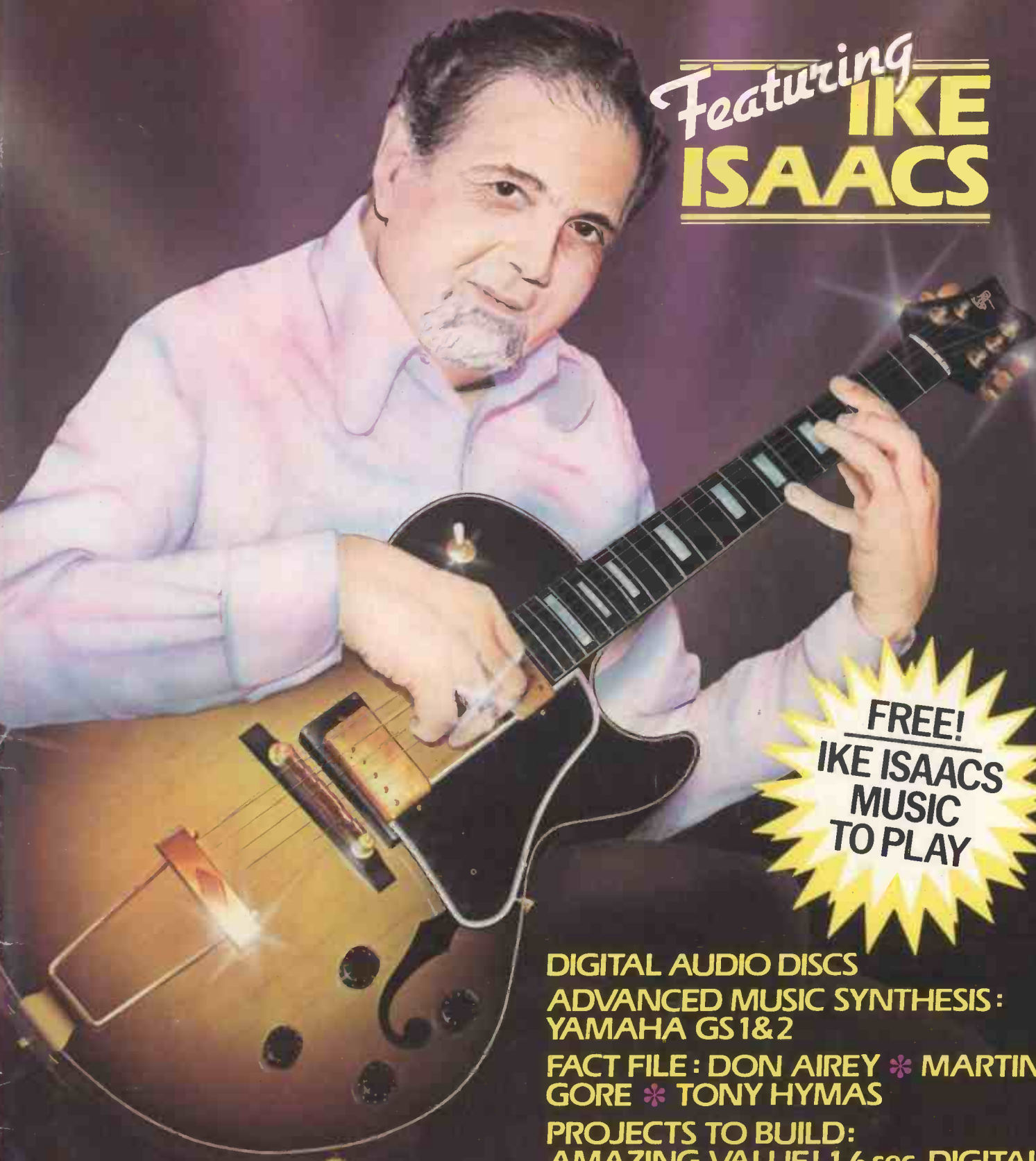

**FREE!**  
**IKE ISAACS**  
**MUSIC**  
**TO PLAY**

**DIGITAL AUDIO DISCS**  
**ADVANCED MUSIC SYNTHESIS :**  
**YAMAHA GS1&2**

**FACT FILE : DON AIREY \* MARTIN**  
**GORE \* TONY HYMAS**

**PROJECTS TO BUILD:**  
**AMAZING VALUE! 1.6 sec. DIGITAL**  
**DELAY EFFECTS UNIT-UNDER £200**  
**\* DRUM GENERATOR BOARD FOR**  
**ANY MICRO \* SPECTRUM SYNTH.**

REVIEWS: KORG TRIDENT POLYPHONIC SYNTHESISER

● TOKAI ST50 GUITAR ● TOKAI PB80 BASS GUITAR

● ROLAND TR-606 DRUMATIX ● JHS AMPLIFIERS

● MENTA MICRO ● AKG MICS ● FOSTEX A-8 RECORDER

# QUALITY & VALUE FOR MONEY



## BASSES — ALL ACES

### Specifications:

#### THE ARIA SB 1000 Price £485.74 in case + VAT

Designed as an ideal studio instrument. The Maple/Walnut laminated neck has a Jacaranda fingerboard available either fretless or with 24 nickel silver frets. The solid Ash body has Oak or Natural finish. Moulded type MB1 pickup gives outstanding performance and wide tone range enhanced by 6-position tone selector. The Active Noise Killer Circuit reduces unwanted hum and noise without adverse effect to high frequencies.

#### THE ARIA SB 700 £354.20

Body specification and timbers as SB 900. Equipped with one MB 1 double-coil pickup with one volume and one tone control, plus coil tap switch.

#### THE ARIA SB 900 £444.20

Maple/Walnut laminated Transmit neck, 860mm Rosewood fingerboard, with 24 nickel silver frets, Ash/Maple/Ash solid body finished in Natural, Oak or Walnut. Two MB 1 double coil pickups, two volume controls, a single tone control and a 3-position pickup selector switch. Also phase and coil tap switching.

#### THE ARIA SB 600 £296.44

Maple 3-piece neck with 860mm scale, and Rosewood fingerboard with 24 nickel silver frets. Laminated Maple body. Pickup and controls as SB 700.

SB 1000

SB 900

SB 600

SB 700



## PRICES INCLUDE CASE

What musicians say about their



#### SB 1000

Stewart Cochrane 'Best bass guitar on the market'

Gavin Smith 'Before purchasing, I tried every make of bass I could find. The SB 1000 was the best'

Jack Bruce 'A bloody good axe'

Paul Reveley 'Makers of some of the finest instruments in the world'

#### SB 900

Edward Caldwell 'Professional bass all round. Excellent price tag'

Ray Ferguson 'My second Aria but this beats all. Excellent'

Chris Adnett 'I am amazed at the quality within the price range'

#### SB 700

J W Stretton 'Excellent sound, superb finish. Best money value there is'

Neil Pitcher 'Superb craftsmanship and great value for money'

M G Salter 'I found all the Aria basses excellent to play'

#### SB 600

Sam Bolton 'The excellent reviews are well justified'

John Buxton 'Nothing compares for value for money'

Mark Boage 'Excellent value for money'

THANKS FELLAS — ENJOY THE GIGS

I'm interested in



Rush brochure to me free

Name: .....

Address: .....

.....

.....

.....

E&MM/2/82

WATCH OUT FOR DETAILS OF

## t.c. electronic

Effect units designed to put a smile on your ears

## GIGSVILLE

PHOENIX WAY, HESTON, MIDDXX

01-897 3792



# Roland

Contact your specialist  
Roland dealer today.

## MAIN DEALERS

**ABC Music**  
Addlestone, Surrey  
Tel 0932 40139  
(and branches)

**A1 Music**  
Manchester.  
Tel 061-236 0340

**Rod Argents Keyboards**  
London WC2.  
Tel 01-240 0084

**Bootleg Music**  
Epsom, Surrey. Tel 78 24528

**Carlsbro Sound Centre**  
Mansfield, Notts.  
Tel 0623 26976 (and  
branches - Sheffield and  
Nottingham)

**Coventry Music Centre**  
Coventry. Tel 0203-58571

**Duck Son & Pinker**  
Gloucester. Tel 0452-21061  
(and branches - Bath, Bristol,  
Swindon, Weston-Super-  
Mare)

**Elvic Electronics**  
Braintree, Essex.  
Tel 0376-21439

**Freedmans**  
Leytonstone, London E11  
Tel 01-539 0288

**Future Music**  
Chelmsford, Essex.  
Tel 0245-352 490

**Gig Sounds**  
Streatham, London SW16.  
Tel 01-769 5681

**Bill Greenhalgh**  
Exeter, Devon.  
Tel 0392-58487

**Guitarzan**  
Cleveland. Tel 0642-456184

**Frank Hessy**  
Liverpool. Tel 051-236 1418

**Hodges & Johnson**  
Westcliff-on-Sea, Essex.  
Tel 0702-48324 (and  
branches - Southend,  
Maidstone, Leigh-on-Sea,  
Colchester, Chelmsford,  
Romford, Chatham)

**Honky Tonk Music**  
Hadleigh, Essex.  
Tel 0702-553647

**JSG Music**  
Bingley, Yorks.  
Tel 02745-68843

**Kingfisher Music**  
Fleet, Hampshire.  
Tel 02514-21554

**London Rock Shop**  
Camden, London NW1.  
Tel 01-267 5381

**Macaris**  
London WC1.  
Tel 01-836 2856

**McCormacks Music**  
Glasgow. Tel 041-332 6644

**Eddie Moors Music**  
Boscombe, Dorset.  
Tel 0202-35135  
(Bournemouth)

**Music Ground**  
Doncaster. Tel 0302-843037

**Rock City Music**  
Newcastle. Tel 0632-324175

**Session Music**  
Belfast. Tel 0232-38502

**Sound Centre**  
Cardiff. Tel 0222-34018

**Sound Pad**  
Leicester. Tel 0533-24183

**South Eastern  
Entertainments**  
Lewisham. Tel 01-690 1404

**Side Street Music**  
Edinburgh.  
Tel 031-337 1071

**Woodroffes**  
Birmingham.  
Tel 021-236 4992

# Roland

The amazing BOSS DR-55 Doctor Rhythm is available by post from The London Rock Shop for only £65.00 (post free). R.R.P. £95.00

Personal callers welcome. We're open 7 days a week! Send 25p in stamps for BOSS full colour catalogue and BOSS by mail, mail order form.

Telephone enquiries ring 01-267 7851

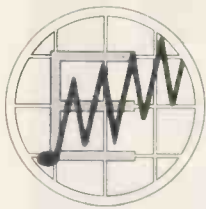

# Electronics & Music Maker

VOLUME 1 NUMBER 12  
FEBRUARY 1982

## Editorial & Production

Editor	Mike Beecher
Art Editor	Peter Blackmore
Technical Editors	Peter Maydew Ian Miller
Editorial Secretary	Holly Baker
Editorial Assistant	Toni Markwick
Technical Artists	John Dudley David Stacey
Administration	Louise Thorn Kim Freeman
Photography	Ian James
Music Preparation	Chris Francis

## Consultants

Keyboards	Rick Wakeman
Electro-Music	David Ellis
Guitar	Adrian Legg
Percussion	Warren Cann
Organ	Ken Lenton-Smith
Stage Equipment	Ben Duncan
Video	Andy Emmerson
Studio Recording	Mark Andrews
Projects	Robert Penfold
Microprocessors	Peter Kershaw
Hi-Fi	Jeff Macaulay
Technical Lab	Bob Kirsch Dave Goodman
Studio Technician	Glenn Rogers

Editorial Offices 282, London Road,  
Westcliff-on-Sea, Essex SS0 7JG.

Tel: (0702) 338878/338015  
Advertisement Manager Graham Butterworth  
Tel: 01-527 3376.

Advertisement Sales Terry Day, Dennis Hill  
Advertisement Offices Electronics & Music  
Maker, Hillcroft House, 16, The Avenue,  
Highams Park, London E4 9LD. Tel: 01-527 3376.

Publishers Maplin Publications,  
282, London Road, Westcliff-on-Sea,  
Essex SS0 7JG.

Distributors Cemas Ltd, Cemas House,  
New Road, St Ives, Huntingdon, Cambs.  
Tel: 0480 65886/2.

Printers Eden Fisher (Southend) Ltd.

Typesetters Quillset (Southend)

Subscriptions Rates for 12 issues:

UK £10.75; Europe & Overseas (Surface) £11.25;

Airmail (including Europe) £25.95.

Binders £3.95 inc. p&p Overseas add 11p extra

covered by bankers draft in pounds sterling

## Copyright

All material is subject to world wide Copyright  
protection, and reproduction or imitation in whole  
or part is expressly forbidden. All reasonable  
care is taken to ensure accuracy in preparation  
of the magazine but Maplin Publications cannot  
be held legally responsible for its contents.  
Permission to reproduce printed circuit board  
layouts commercially or marketing of kits must  
be sought from the publisher.

©Copyright 1982 Maplin Publications.

THE TOP SELLING MUSIC MONTHLY IN THE U.K.

## CONTENTS

### SPECIAL FEATURES

Ike Isaacs ..... 38

*This well respected jazz  
guitarist talks about the origins  
and technique of the guitar;  
plus free pull-out music:  
"After Hours" - one of his  
pieces to play.*

Digital Audio Discs ..... 5

*An explanation of the  
technology behind the new  
sound recording revolution:  
how the LP went in for a  
transplant and came back a  
DAD!*

Inside the Yamaha GS1 & 2 .... 9

*This month's Advanced Music  
Synthesis explains why these  
digital synthesisers are 'very  
expensive and very good.'*



## INSTRUMENT REVIEWS

### Synthesiser:

Korg Trident Polyphonic .. 12

### Microphones:

AKG D330BT and D202 ... 15

### Micro Peripheral:

MENTA ..... 16

### Percussion:

Roland TR606 Drumatix .. 18

### Amplifiers:

JHS C50PM and C20B ..... 20

### Tape Recorder:

Fostex A-8 8 track ..... 23

### Guitars:

Tokai ST50 guitar and PB80  
bass ..... 29



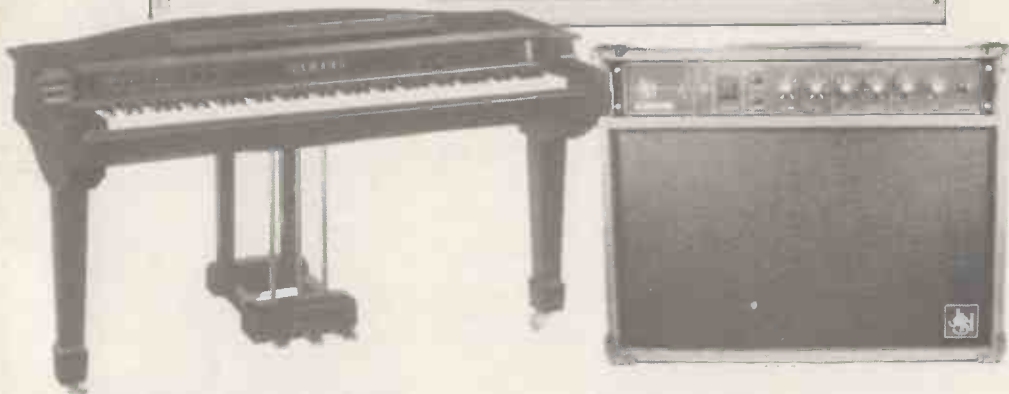
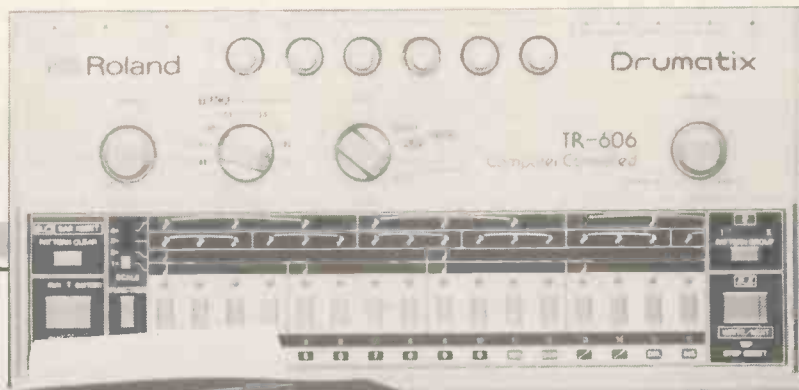

## REGULAR FEATURES

- Fact File - Don Airey, Martin Gore and Tony Hymas* ..... 31  
*A History of Electronic Music* . 32  
*Home Electro-Musician:*  
*Johnny Demestos* ..... 34  
*Sound on Stage - Vocal P.A.* ... 36  
*Organ Talk* ..... 46  
*Micromusic - Polyphonic Sequencing with the ZX81* 52

## PROJECTS

### Digital Delay Effects Unit:

*Introducing a low cost project, but with a specification equivalent to studio units costing much more* ..... 60

### The Spectrum Synthesiser:

*The final part of our professional quality monophonic instrument* ..... 64

### Percussion Sound Generator Board:

*Part 3 of the Electric Drummer - also works with your microcomputer* ..... 72

## WORKSHOPS

### Guitar Workshop:

*Screening a Stratocaster* ... 43

### Making Notes:

*Forming a Major Scale* ..... 44

### Electro-Music Engineer:

*Resonant Filters* ..... 50

## NEWS

- Readers Letters* ..... 4  
*Special Offer - Whirlwind Low Noise Lead* ..... 8  
*Back Issues* ..... 19  
*Electro-Musician's Directory* ... 35  
*E&MM Demonstration Cassettes* 35  
*America* ..... 54  
*Music Maker Equipment Scene* ..... 57  
*Video and Book Reviews* ..... 58  
*Record Reviews* ..... 59  
*News* ..... 74  
*New Products* ..... 75  
*Next Month* ..... 78  
*Events, Binders* ..... 78  
*Classified* ..... 79  
*Subscriptions* ..... 80  
*Electro Record* ..... 80

## EDITORIAL

This month's issue once again gives you the opportunity to play music by an important performer. Music is for musicians of any age and Ike Isaacs is one "master of his art" who is a great inspiration to young and old.

A glance at the Yamaha GS1 article might convince you of the need to digest all the technical information we give you with increased vigour — if music is to benefit from the technological developments, no musician or music company can afford to ignore the technical advances being made in instruments.

We also start a new video music column. The music video film is used a lot on television and most video shops stock them, but are they really worth buying? We'll be reviewing these to help you evaluate this new area of music entertainment.

If you're willing to build equipment yourself, two new projects should save you a lot of money and give you the chance to use digital effects and programmed drums in your music.

Since the December issue, Electronics & Music Maker has put its whole effort into providing a monthly magazine for the practical musician — with tremendous response from our readers. Not only does the magazine have a large U.K. distribution but it reaches a wide international readership as well.

An interesting development in LED displays has recently been unveiled by the Japanese Sanyo Electric Co. — a BLUE LED, which will complement the current red, orange, yellow and green types. With the combined red/green LED already available, it shouldn't be too long before we see a single LED package capable of emitting red, green and blue in combination for full colour graphic displays. No doubt these will then become a feature of musical instruments.

Looking at the year ahead, the availability of cheaper 8-track recording on standard ¼" tape, along with cheaper instruments that enable musicians to "arrange" their sounds, is likely to make 1982 the year that emphasises instrument portability, programmability and price.

*Ike Isaacs*



# Readers Letters

Send to: Reader's Letters, Electronics & Music Maker  
282 London Road, Westcliff-on-Sea, Essex SS0 7JG.

## Digital Guitars

Dear Sir,  
I would like to do a project on a digital sound effect generator to be connected between a guitar and an amplifier. By means of a digital to analogue and an analogue to digital convertor the signal from the guitar is transformed first digitally and then back again to an analogue signal. Using a microprocessor the digitalised signal is altered by a special programme from a memory according to the effect desired. This altered digitalised signal is fed through an amplifier and heard through a loud-speaker.

Is this a feasible project and how and where can I obtain more information on it? Has it been done before? Can one find a correlation between the normal signal and the effect required using a correlator?

D. Adib  
Wakefield, W. Yorks

The digital guitar effect idea is an excellent one, so it is a pity that present day microprocessors are not fast enough to do the complicated manipulations required. Maybe some day?

Meanwhile, if you still want to know more, the book to read is "Musical Applications of Microprocessors" by Hal Chamberlin, published by Wiley. Not only will this explain why your idea is at present unworkable, but may well give you an idea for some other project!

## A Noisy Noise Annoys

Dear Sir,  
With reference to the May edition of Electronics & Music Maker Vero Project 4 - Signal Mixer. I have assembled the project as shown and am using it to mix in 4 microphones. All 4 channels are controllable and work well apart from a continuous hiss which becomes quite loud when volume is increased on recorder. This is also shown visually on the VU meter. The sound is the same with or without microphones connected. Having checked all components and connections I can only think the sound is being generated by the mixer unit. Could you please help?

M. Johnson  
Whitby, N. York

The Vero mixer is only a very simple device, and some noise from the op-amp is to be expected, unfortunately. If you are using low impedance microphones, the resistor values can be considerably reduced to help this. With 50K impedance microphones, for instance, all resistors except R5 and R6 could be reduced by a factor of 20, including the pots; C2 should be increased by the same factor.

If you are feeding a microphone input from the mixer, R7 may be reduced still further if required; although better results should be obtained from feeding a less sensitive input, in which case R7 would be better left at a high value.

## Ultravox Tour

Dear Mike,  
So far the tour is very successful, we're consolidating ourselves over here more with every gig. We have an excellent crew and organisation (as I loosely call it) is "vicious but fair"... We finish Europe on December 14th. As soon as I get back I'm in the studio for a week with Helden, my own project, then I'm off to L.A. for a week of Christmas with some of my family. Then I believe it's Canada for 2 weeks,

then New Zealand, Australia, Japan (we're no. 3 in their International Chart), and then America. Keeps me off the streets, yes?

Warren Cann  
Berlin

## LED Tempo Readout

Dear Sir,  
In your April 1981 issue, Warren Cann mentions that he has a three digit LED readout of the tempo set (measuring frequency period). As he is on your consultant panel, I wonder if you could ask him what components are needed and how it is constructed, as I would like one for my drum machine.

Andrew Smith  
Walsall

Thank you for your inquisitive letter, the solution to your request is actually much easier than you think! The quick and dirty way to obtain a tempo read-out, at least regarding a CR-78, is to tie into the master clock voltage with a multi-meter. I have a jack-socket on the back of my CR-78 which connects to a simple, cheap, LED type multi-meter (battery operated so not even mains to get in the way) set to 0-10V DC. The clock voltage for any given tempo will always be the same; the actual figure given on the display read-out is not a measure of a frequency period but a DC voltage, it makes no difference, the figure is arbitrary to tempo.

Warren Cann

## PETs in the Wilderness

Dear Sir,  
I wish to congratulate you on the idea of issuing a magazine especially for those who are interested in Electronics and its use in the composing and performing of music. For myself, I have a Commodore PET 8032 with trimmings (with the help of which this letter was prepared and printed) and a Conn Artist 721 Classical Organ, and a piano.

Some years ago I tried to design and make a Rhythm Generator - in those days I used to play some light music - and I have never really given up the idea. I love really exciting Latin-American music with really exotic percussion, and I would love to be able to play it right at home - which is by the side of the Wilderness Lagoon, about 9 miles from the nearest town of George. The Linn RG described in E&MM of July on page 80 is the nearest yet to what I had in mind, but the price!!!

One last thing - during the last few weeks our land has experienced a lot of cold, wet weather - in some parts of Southern Africa snow fell for the first time in living memory - and my PET got so cold that it refused to load its Word-processing programme - it was just too cold for Words!!!

F. Nesor  
Wilderness 6560  
S. Africa

## Synwave Problems

Dear Sir,  
I recently built your Synwave and Syntom projects. However, I have found that the Syntom is much more sensitive to a tap on the case than the Synwave, the latter having to be hit sharply in the area very near the internal microphone's position to get a reasonable sound level out. This also means that the 'click' of the tap is picked up and fed to the external amplifier thus producing unwanted noise that precedes the production of the desired sound effect.

Please could you tell me how I can increase the sensitivity of the Syn-

wave to be on a par with that of the Syntom (without any major rewiring, or component changes on the PCB) as this would alleviate the unwanted 'tap noise' as the case need not be struck so hard to obtain the required sound effect. Also, is there any way that the 'seawave' volume can be increased at low pitch and Q settings without affecting the versatility of the instrument at other settings?

A. J. Dolan  
Ilford, Essex

The "Synwave" unit is slightly less sensitive than the "Syntom" unit, and this can make it slightly awkward to use the two units together. A simple way of increasing the sensitivity of the "Synwave" unit is to replace the crystal earphone pick-up with a 27 mm diameter Piezo ceramic transducer of the type used in the "Hexadrum" project (Maplin order code QY13P). These give a higher output level than a crystal earphone. The output of the unit inevitably falls off slightly at low frequencies as the basic signal is white noise, and this has a high frequency bias. Very deep "wave" sounds can be produced with the aid of external bass boost, and the "Bass And Treble Booster" featured in the November 1981 issue of E&MM is ideal for this purpose.

Robert Penfold

## Music at City University

Dear Editor,  
My attention has been drawn to a false impression given by a few words of Dr. Kevin Jones in the article "Music at City University" in the October issue of E&MM, giving the impression that there was no computer music in the U.K. outside City University.

In fact - digital synthesis such as the Fairlight CMI aside - University College, Cardiff and the Music Department at Durham University have working computer music systems; Glasgow University may have one working soon. Durham, for example, has the first fully operational 'Music 11' programme in the U.K. on a PDP11 computer in the Music Department. Dr. Peter Manning has developed strong links with American and European studios with similar concerns and has pioneered such work in this country.

I hope to bring readers of E&MM more details of these developments.

Simon Emmerson  
City University

## dbx Noise Reduction Review

Dear Sir,  
Thank you for this interesting article. I should however like to enquire about these points:

(1) Page 48, column 3, 3rd & 4th lines from bottom:

Surely the pre-emphasis cannot be 12dB/octave as stated? This would lead to an enormous HF boost at extreme frequencies. I always understood that the pre-emphasis reached a maximum of 12dB at HF.

(2) Page 48 column 4, 7th & 8th lines from bottom:

I refer to the figure of 20dB/octave. Is this not also a maximum figure of 20dB, not 20dB per octave? i.e. same remarks as for (1) above.

(3) Page 49, column 1, lines 19 and 20:

I think that the reference to de-emphasis in the control chain of the expander is incorrect. There needs to be pre-emphasis (as on encode) otherwise the result will NOT be "an increase of gain at HF", as the writer

states, but a decrease.

If this is so, the block diagram for the expander, in figure 1, should show pre-emphasis not de-emphasis in the side-chain.

(4) I am confused as to whether dbx have changed their turnover frequencies for signal path pre-emphasis and side-chain pre-emphasis. The present article gives no precise figure for signal pre-emphasis, but quotes 200Hz for the side-chain.

Thanking you in advance for your help. I'm a regular subscriber to E&MM and await each new edition eagerly. The audio/music projects are especially welcome, so please avoid becoming another tedious computer-orientated magazine!

Ian Godfrey  
Eastham, Merseyside

I bow my head in shame! Yes, you're absolutely right about the degree of pre-emphasis and so on. I think some gremlins must have been at work whilst I was putting pen to paper - thanks for keeping me on my toes! Incidentally, when checking the figures you mention with BSR, I also quizzed them on what changes had been made to dbx to improve performance. Apart from high slew-rate op-amps (LF351s actually), which obviously account in part for the improved high frequency tracking, and some subtly altered time constants along the line, the main change has been the use of much more accurate component values, thereby ensuring that the various filters in the compressor and expander sections behave exactly as they should. Regarding your last point, the turnover frequency for side-chain pre-emphasis appears to be around 200 Hz (from the graphs supplied by BSR), but I can't be any more accurate than that.

Dr. David Ellis

## Where have all the Projects gone?

Dear Sir,  
I have just opened my December issue of Electronics & Music Maker, and was horrified. Shouldn't you rename the magazine "The Electronic Musician"? What has happened to all the PROJECTS? I really enjoyed the magazine up to the December issue, a nice blend between electronic projects, electronic music and computing. The perfect magazine. But what has happened? I really enjoyed making the 'Syntom' and 'Synwave' and at the moment I am constructing your 'PartyLite' but alas I fear no more. I don't know what has happened to the projects in E&MM, but please bring them back, you were such a great magazine with them.

Adrian Smith  
Chippenham, Wilts.

We are planning a survey to see what our reader's opinions are.

## Rick Wakeman

Dear Sir,  
I could not have been more pleased to learn that Mr. Rick Wakeman has become a member of your prestigious team of consultants - I have deeply admired his contributions to Rock Music since the earlier days of his solo career (the release of 'Myths and Legends' to be precise). I could not have suggested a more suitable person to occupy this position had I been asked! I particularly admire Rick's emphasis on technique at the keyboard - a view which I strongly believe more Rock musicians should adopt.

M. Smith  
High Wycombe  
Bucks

# DIGITAL AUDIO

How the LP went in for a transplant and came back a DAD

by David Ellis

Once upon a time there was a circular piece of plastic spinning around quite happily at 78 revolutions per minute. He didn't mind that the speed wasn't always constant, or that people stuck pins into his grooves and even went so far as to turn him into flower pots when they got fed up with his musical repertoire. After all, he knew he was just about the most exciting thing since sliced bread. But, over the years, he found himself spinning slower and slower, getting thinner and thinner, becoming noisier and noisier, and, to cap it all, found that his skin was developing crinkles, which necessitated painting himself with bright colours to disguise his poor condition. So, realising that his end was nigh, he buried himself away in a laboratory for five years and a day, cast the magic spell, pulled the power switch, and lo and behold: the son of senile vinyl was born. This bumptious youngster rotated at 1.25 m/sec, never had pins stuck in him, and couldn't be made into flower pots. But, seeing that he was set to take over the world, his creator put him in wraps under a cloud of speculation. Then, one day in the autumn of '82, he was released on the poor, unsuspecting world...

In reality, the digital audio disc (DAD) seems certain to need a fairly generous helping of public support if he's to achieve his desired aim in life, and, given the current economic condition, he probably couldn't have chosen a worst time for his parturition. Fortunately for us, it seems unlikely that he'll have much in the way of competition from rival siblings, as, for once, the battle of the technological giants seems to have occurred long before the expected delivery date. This still leaves a fundamental question to be answered: will he deliver all that his genes seem to suggest?

## Conception

By the early '70s, several major companies were working on various methods of recording the wide bandwidth of video signals on to disc and tape in formats supposedly convenient for public assimilation. In Europe, Philips had shown the first optical video disc as early as 1969, but others were not far behind. The general target was to produce consumer video disc and tape recording systems commercially comparable with the LP and compact cassette. By the mid '70s, several companies had started work on the concept of the digital audio disc, but much of what followed proved more frustrating than fermentive.

The Telefunken Teldec system resolutely stuck to keeping a stylus in contact with the disc surface. In this case, the 'stylus' was a wedge-shaped plunger attached to a piezoelectric transducer generating a voltage in response to digital hills (1s) and dales (0s) on the disc. The JVC variable capacitance system looked ingenious, but, in practice, there were many problems involved in controlling the stylus tracking and ensuring conductive discs of adequate pressing quality. Philips instead went for a then



revolutionary design using an AlGaAs laser that was able to track pits etched on to a disc a fraction of the size of a normal disc. The success of this idea lay with some extremely sophisticated servo mechanisms, and, at that time, it wasn't possible to pack all the necessary electronics into a convenient LSI package.

Sony were also engaged on their own digital research, but, rather than going their

own way, decided to team up with Philips in 1979. In 1980, the two giants introduced the format of the Compact Disc, a mere 12cm in diameter and capable of storing more than an hour of stereo on each side. Some of the main changes to the original Philips design that resulted from this merge of minds were a subtly altered sampling rate (44.1kHz rather than 44.3kHz), an increased bit code length (16-bit rather than 14-bit), improved

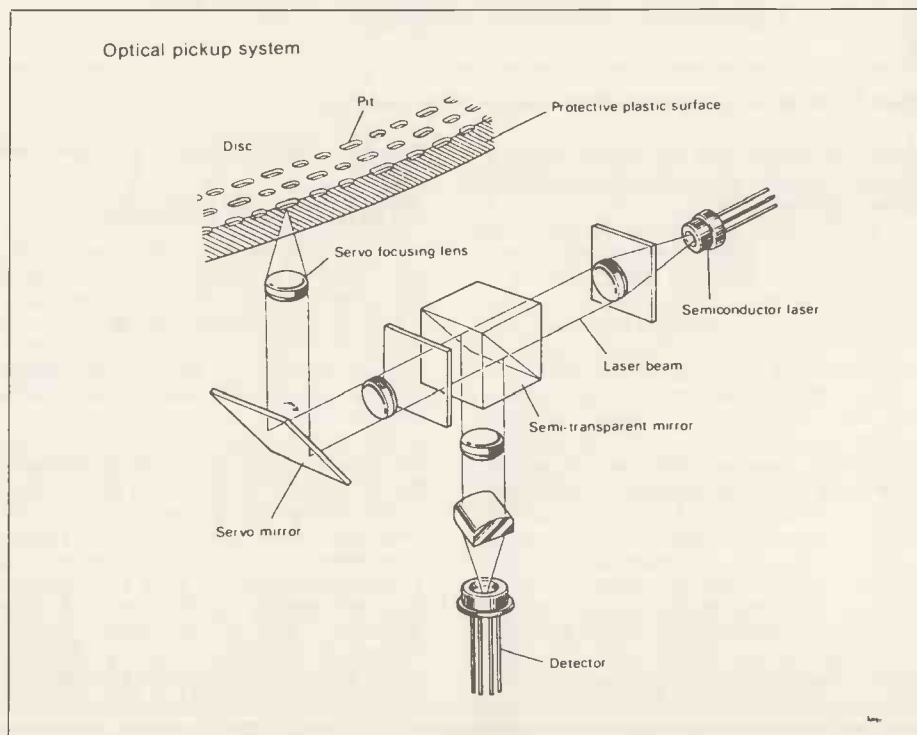

Figure 1. The optical system of the Compact Digital Audio Disc.

## Audio Performance

Number of channels:	2 and/or 4 <sup>2</sup>
Frequency response:	20 to 20,000 Hz
Dynamic range:	>90dB
S/N ratio:	>90dB
Channel separation:	>90dB
Harmonic distortion:	<0.05%
Wow and flutter:	Unmeasurable (quartz crystal accuracy)

## Signal Format

Sampling frequency:	44.1kHz
Quantisation:	16-bit linear coding/decoding
Modulation system:	Eight to Fourteen Modulation (EFM) <sup>3</sup>
Bit rate:	4.3218Mb/sec

## Error Correction

Error correction system:	Cross Interleave Reed Solomon Code (CIRC) <sup>4</sup>
Maximum correctable burst length:	4000 bits

## Disc

Diameter:	120mm
Thickness:	1.2mm
Starting diameter of program area:	50mm
End diameter of program area:	116mm
Direction of rotation:	Anti-clockwise
Scanning velocity:	1.2 to 1.4m/sec
Speed:	500 to 200rpm (depends on distance from centre)
Recording time:	60 minutes (stereo) <sup>5</sup>
Track pitch:	1.6µm
Material:	Transparent plastic coated with Al layer and protective coating

## Optical Stylus

Wavelength of AlGaAs laser:	0.78µm
Numerical aperture:	Ratio << 1.75
Focus depth:	2µm
Beam diameter at disc surface:	1mm

### Notes:

1. As at September 1981.
2. 4 channels with reduced recording time.
3. EFM: new modulation method for increased signal packing density and meeting requirements of optical servo systems.
4. CIRC: new error correction code for protection against scratches.
5. Single-side disc, double-sided disc optional.

Table 1. Technical specifications of the Compact Digital Audio Disc.

error correction, and an optical readout system using an advanced semiconductor laser (see Figure 1).

Much of the hard engineering work for a compact disc player had already been carried out in bringing video systems to fruition, but this meant there was a considerable danger that some manufacturers might be tempted to use their own knowhow and jump the Philips-Sony gun with their own systems. To prevent this from happening, 49 companies from Japan and elsewhere set up a special DAD committee in late 1978. Between then and December 1980, the following aspects for getting a system off the ground were considered: basis of signal extraction, including optical, capacitance and mechanical methods; signal specification, including sampling frequency, number of bits, redundancy and modulation system; functional features, including the number of audio channels, access methods, playing time and disc diameter. By April 1981, the die had been cast and the final recommendations were made to the Japanese standard bodies; the

Compact Digital Audio Disc was duly elected.

## Anatomical Details

The clouds of speculation surrounding the DAD were at least partially dissipated by the specifications laid out for the system (Table 1). In the absence of playing with the real thing, they certainly provide plenty of food for thought! The hours-worth of digital information per single-sided disc is stored as  $5 \times 10^{12}$  bits on a spiral track, which, if unwound into a straight line, would extend for something like 2½ miles! In addition to the bits used for the coding of the sound signal, another chunk is added to cope with error correction and system control. Each bit is represented, on the disc, either by a flat surface representing a '1', or a microscopic pit, representing a '0' (so that's what McEnroe's "pits of the world" outburst referred to: being zero in his digital estimation!). The 16-bit PCM (Pulse Code Modulation) code that these bits represent allow  $2^{16}$  or 65,536 different sample (analogue) values to be provided for — a far cry from the

paltry 2<sup>8</sup> or 256 steps of resolution in use with most digital synthesisers. Even though quantisation at the 16-bit level results in superb accuracy in converting audio signals to digital code and back, the increased number of bits per word necessitates a very efficient means of shifting all this data. It was fortunate for Philips and Sony that the semiconductor laser was going through a parallel development at the same time as the initial DAD research, and provided an ideal though problematic solution to the system requirements for rapid data transfer.

As the disc rotates, it is scanned from the underside, starting at the centre and moving to the outside, by a spot of laser light kept in place by a leading guide track. This beam detects the sequence of pits and flats at a rate of approximately 4.3 million bits per second (4.3 Mb/sec). The pits themselves are just 0.6µm wide, 0.2µm deep and between 1 and 10µm long; compare this with the 50µm width for the average LP groove or human hair! The output from the optical pick-up is in the form of the 16-bit PCM code. A digital-to-analogue (D/A) converter decodes the data stream word by word and synthesises them into a conventional audio stereo signal. To ensure that defects in the disc or in the player do not affect the quality of the signal, considerable protection is built in via the coding scheme. One technique of correcting errors used in the system is the so-called 'interpolation code', by which redundant information is introduced into the music signal code and then used for making corrections if decoding 'checks' indicate that some bits have got lost on the way. In fact, this technique has some parallel with the way in which genes operate in ourselves and everything else that's going about the business of life. Here, though, the code (a 4-digit one) is found in the stuff of genes, DNA, and stretches of this code include redundant or repeated sequences to protect against the havoc caused by a bolt of gamma rays poking a hole in one's genetic blueprints. And, talking of poking holes in things, that's precisely what the DAD error correction is capable of coping with; not just a gamma ray sized-hole but one that's been caused by drilling a 2.4mm hole through the disc! I can just see all the eager beaver Sony demonstrators going around with power drills and generously carving up every Compact Disc that comes in reach . . .

All this technology is impressive but one thing that's still under further development is an integrated D/A converter. So far, at the various demonstrations of the DAD player around the world, an additional box of more or less discrete circuitry has been added to the system. Sony U.K. inform me that the first totally integrated versions of the converter and servo circuitry are practically complete and should be at a pre-production stage by the end of the year.

## Public Exposure

It is rather curious talking about something that's only as tangible as a photo of a mock-up and a wadge of specifications. I suppose patience will be rewarded in the



# the future of 4 track

The Fostex Multitracker is a Personal Recording Studio, that challenges the quality and facilities of open reel.

## Separate but together?

Mixer and recorder work as one but you can use them independently. The mixer is four in, four out, with gain, tone, echo and pan. The four track tape deck has remarkable features.

## How about noise?

Sound quality is astonishing. The latest Dolby 'C' circuitry achieves a drama-



tic 71dB signal to noise ratio. It's performance you would expect from open reel. And there's more. Dolby's new system has side benefits that result in tighter, more transparent recordings.

## Full function four track?



There are no restrictions, all four tracks can be recorded at once. Any input can be switched to any track. Or plug into the recorder direct, from another mixer, to add more channels or to capture a live performance.

## Is ping-pong possible?

Selsync is fully automatic, and you can bounce adjacent tracks with quality. With a little forethought, you can perform the ten track bounce with hardly any noise build up.

## It's a solenoid transport?

The high speed, two motor design is microchip



controlled, with varispeed and a digital counter plus return to zero. It's all there to speed your creativity.

## Why a footswitch?

Have you ever tried to work a tape recorder while playing an instrument? With the Multitracker you simply preselect the tracks you want to overdub or correct, then run the machine in 'record ready' and hit the footswitch on cue.

## Are four inputs enough?

The whole point of multitrack is to record a tune a part at a time. With one or two musicians, four is plenty. When you overdub, the inputs are used over again.

## Is monitoring complicated?

An automatic 'monmix' switches between live and signal already on tape, depending on which tracks you select for record. All you adjust is level. You can also check the stereo mixer output for quality and balance.

## How about effects?

Your echo unit connects to the 'aux' send and return sockets. You can

also use limiters, equalisers etc or existing pedal effects.

## Why Personal Multitracker?

The Fostex Multitracker, and each product in the range is designed for musicians and song-writers. Easy to use and own. We don't believe you need to go into the studio business to own the tools of your trade.

**Visit a Fostex Dealer and discover the remarkable Multitracker for yourself. It will make you think twice about open reel.**

**Call or write for a full dealer list and 12 page brochure covering the entire range of Personal Multitrack products.**

Dolby and the Double D symbol are trademarks of Dolby Laboratories.

# Fostex



Bandive Ltd. 10 East Barnet Road New Barnet Herts EN4 8RW. Tel. 01-440 9304

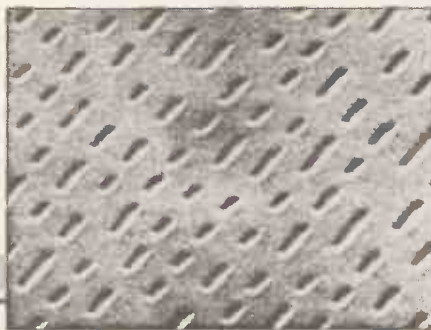

High power magnification of the disc surface.

long run, but it's very difficult to predict what the public and record industry will make of the Compact Disc. A conservative estimate of the time for take-over in this country is put at about six years. Back in Japan, though, Sony have been planning their campaign for at least this amount of time, as is evident from the progress report below:

**October 1976:** Digital audio processor for recording and playback on VTR (12-bit, 2-channel).

**September 1977:** PCM-1 digital audio processor for recording and playback on VCR (13-bit, 2-channel); digital disc system using direct PCM-encoded signal (900 rpm, 60-minute play, optical laser pick-up).

**May 1978:** X-22DTC ¼-inch, stationary head, digital audio recorder (38 cm/s, 12-bit, 2-channel); digital FM broadcasts in Tokyo.

**October 1978:** Long-playing PCM disc (450 rpm, 180-minute play); PCM 3224 stationary head professional 24-channel PCM recorder (1-inch tape); DMX-800 professional 8-channel digital audio mixer.

**May 1979:** PCM-10 domestic digital audio processor and PCM-100 professional digital audio processor; DEC-1000 digital audio editor for use with audio processors.

**October 1979:** PCM-3324 professional sta-

tionary head 24-channel audio recorder (½-inch tape); PCM-3204 stationary head 4-channel audio recorder (¼-inch tape).

**May 1980:** Studer and Sony agree on standard format for stationary head digital audio recorders.

**June 1980:** Philips and Sony embark on joint development of the Compact Disc.

**October 1980:** Prototype of Compact Disc system shown at Japan Audio Fair.

**February 1981:** Production begun of Compact Disc mastering system, including PCM-1610 professional audio processor, DAE-1100 digital audio editor and DRE-2000 digital reverberation.

### The Goods

As things stand at present, about eleven different hardware manufacturers are gearing up to producing Compact Disc players, including: Matsushita, Sharp, Sanyo, Nakamichi, Onkyo, Philips, Saba, Rotel, Revox and Pioneer. None of this would make much sense unless discs themselves are made available. The CBS/Sony plant in Japan aims for 100 titles by the launch date in the Autumn of 1982. These should then be

followed by titles from the Pioneer plant in Japan and the Polygram plant in Europe. Where disc production goes after this is anybody's guess, and I wonder whether the ailing record industry here will do anything other than the usual British thing of burying their collective heads in the sand. The one glimmer of hope is the VHD disc pressing plant that Thorn-EMI are starting up in January 1982, and with a bit of luck may be adaptable to pressing Compact DADs — if adequate pressing quality can be assured.

Finally, the cost. Well, fortunately, it should be somewhat less than the complex electronics might suggest. Sony won't be led into giving a 'yes' or 'no' to the various figures that are floating around, so their quote of "the price of a top-class record deck" is as far as we're going to get for the moment. Mind you, system development won't stop with the standard domestic Compact disc player. The miniscule size of the disc, coupled with the dogged determination of the laser to keep on tracking come what may, makes it a very practical and attractive proposition to develop a car and Walkman version of the player. This is Sony's next line of approach: total aural domination. Tomorrow, our ears; next year, our minds? **E&MM**

# SPECIAL OFFER

Each month, Electronics & Music Maker gives a special offer to its readers that represents a substantial saving on normal retail prices.

## WHIRLWIND GUITAR LEAD

Instrument leads are always coming apart when you least expect them to, and if yours do, this month's special offer will be of interest. The Whirlwind Ultrasnake is a 30 foot professional quality lead which maybe used for guitar, keyboards, PA or in the studio. It uses low noise Belden cable, terminated with two solid brass ¼" jack plugs with stainless steel tips. Special attention is paid to reliability, in particular strain relief, and the lead should last for years. No more crackles and pops, and no more embarrassing silences!



Rec price £14.72

**Offer Price £10.99**

(inc VAT, P&P)

Please complete order form below. Offer open to readers in the UK, Republic of Eire and Europe only. (European customers please add £1.10 for Airmail postage.) Closing date: 28th February 1982 — subject to availability. Overseas payments including Republic of Eire should be covered by a bankers draft in pounds sterling. Please allow 28 days for delivery.

Send this coupon and cheque/P.O. to:  
ELECTRONICS & MUSIC MAKER (Special Offers)  
282 London Road, Westcliff-on-Sea, Essex SS0 7JG.

Please send me:

Quantity	Item	Item Price £	Total £
	<b>Whirlwind Guitar Lead</b>	<b>£10.99</b>	

I enclose a cheque/P.O. payable to:  
Electronics & Music Maker for: £.....

PLEASE PRINT  
Name: Mr/Mrs/Miss .....

Address .....

All prices shown include VAT, postage and packing

E&MM/2/82



# Inside the Yamaha GS1 and GS2

Martin Christie

Yamaha's latest polyphonic synthesiser, the GS1, is to digital synthesisers what their GX1 was to analogue instruments; very expensive and very good. This state of the art machine is a constructive synthesiser utilising the phase modulation principle. It is capable of producing sounds of much greater subtlety and definition than was possible using analogue techniques. Only the output has been changed (to analogue) to protect the sound quality.

The electronics of the instrument is a rather unorthodox hybrid of radio and computer techniques, and Yamaha have chosen an equally unorthodox casework to house it. The cabinet is in the style of a mini 'grand' piano with a beautiful wood veneer. The control panel at first glance could pass for a conventional piano front. The buttons and control knobs are deliberately unobtrusive, as is the Yamaha name plate in relatively small dull brass letters. This is definitely intended to be a real musician's instrument, and the cabinet styling is an essential component in this very special relationship between player and instrument.



## The FM Principle

Nearly all synthesisers create sound timbres by regulating the proportions of the various harmonics of a note. In an ordinary analogue synthesiser, this is done by filtering a harmonically rich waveform, however, only rudimentary control is possible by this means. In addition, non-harmonic timbres are not possible without extra complexity. Better control of the sound may be obtained by building up the individual harmonics separately, a procedure known as additive, or Fourier Synthesis. This method is well suited to digital techniques, where each harmonic is computed as a sine wave of the appropriate frequency; the individual harmonics are then added together and fed to a digital to analogue converter. The amplitude of each harmonic may be controlled separately, and the system has great flexibility; however, a lot of computation is required.

The GS1 uses a quite different system known as frequency modulation — FM for short — and the circuitry for achieving this is shown in Figure 1. Taking just the top line for the moment, the carrier phase generator and sine conversion block produce a digitally encoded sine wave, whose amplitude may be controlled by the 'output level' multiplier. The sine conversion can be thought of as a ROM loaded with sine values, which is stepped through by a counter (the phase generator); the speed at which this happens is controlled by the key code data, i.e. the pitch information.

The modulator phase generator and its sine converter and multiplier are a duplicate of the above; note that the keycode data need not be the same as that of the carrier, however, or even related to it at all. The sine wave values produced by the modulator section are added to the carrier phase data, with the result that the carrier sine wave is modulated by the modulator sine wave. Two very simple examples of this are shown in Figures 2a and 2b. The dotted sine waves

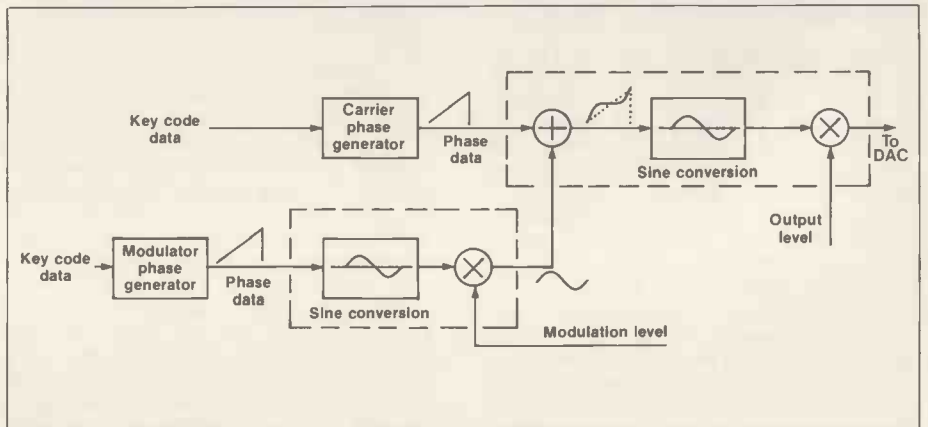

Figure 1. Simplified block diagram of one FM circuit.

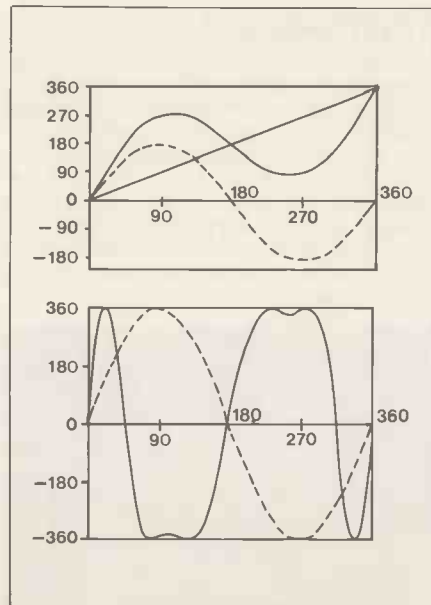

Figure 2a. FM waveform example with modulation frequency = carrier frequency.

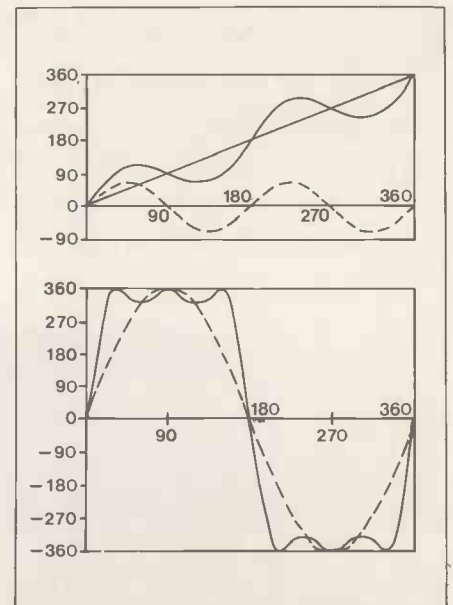
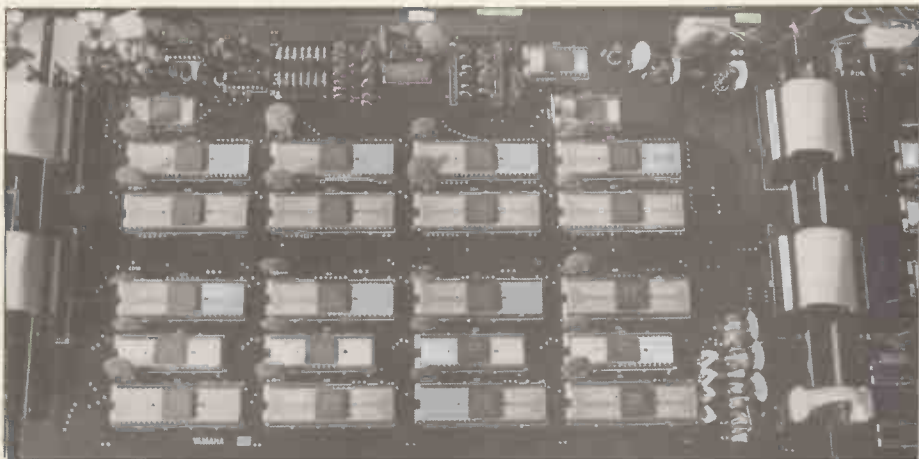
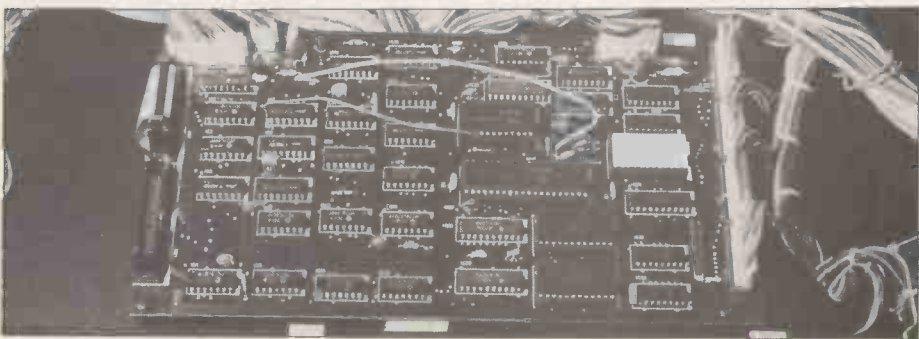

Figure 2b. Waveform example with modulation frequency = 2 x carrier frequency.



One of the FM circuit boards.



Microcomputer board.

represent the modulation frequency in the top graphs, and the unmodulated carrier frequency in the bottom graphs. The solid waveform in the top graphs shows the modulation superimposed on the phase data, and the resulting waveforms are shown solid in the bottom graphs.

Note that in Figure 2a the modulation frequency is the same as the carrier frequency, a situation known as phase modulation, whereas in Figure 2b the modulation frequency is twice that of the carrier. The waveforms may be changed during the sounding of a note by altering the amplitude of the modulation wave under the control of an envelope generator; a second EG determines the volume of the final sound. There are, in fact, four of these FM circuits in the GS1 — two per channel — and two in the GS2, so very complex sounds may be produced.

Although the block diagram of the FM circuit may appear simple, the four FM circuits, eight envelope generators and two DACs in the GS1 require a total of forty Yamaha LSI ICs, and there is more circuitry to come, as we shall see. Without Yamaha's in-house LSI capability it is extremely unlikely that such an instrument could have been built.

The advantage of the FM system is its

speed; in fact, the circuitry is so fast that it may be multiplexed 16 ways. In other words, although up to 16 notes may be played at once on the GS1 or GS2, they all share the same sound generator, and this obviously reduces the electronics to a manageable amount. The disadvantage is that control of the sounds by the player is difficult, and so the GS1 is not an orthodox user programmable synthesiser. Its 16 voices are initially input from magnetic voice strips, and the control of this data is handled by a microcomputer based on the 8035. Two 16K CMOS RAMs retain voice parameter data, and program data is held in a 16K EPROM. Each of the eight envelope generators requires 256 bits of voicing data per sound type, hence  $16 \text{ sounds} \times 8 \times 256 = 32\text{K}$ .

## The Keyboard

The 88-note touch sensitive keyboard connects via a diode matrix to a keycoder IC, which is now standard practice for Yamaha keyboards. This chip detects key information from key contacts between octave and note terminals at the IC input. The GS1 has two inputs per note; the key contacts are staggered in such a way that the velocity is sensed by the time interval between those contact points and the particular common octave terminal.



Close up of the magnetic card reader.

Key code data from the keycoder is output on a serial data line to a channel processor IC, which reorganises this serial data into 16 channels of parallel keycode and initial touch data. The key code data feeds the four FM circuits in parallel, whilst the initial touch data is converted to 10 bit parallel data via the initial touch generator IC. This information is used by the eight envelope controller ICs of the FM circuits.

Aftertouch information is derived from stress sensing bridges located beneath each key. The output voltages of these are sampled by four multiplexer ICs controlled by serial key code data. The voltage samples are converted by an aftertouch generator IC and A to D converter into 8-bit parallel digital data. This data is ORed with the initial touch data lines.

The 88 keys of the GS1 are divided into groups of five keys at the bottom of the keyboard, five keys at the top of the keyboard and 26 groups of three keys in between. Each group has its own envelope generator depth setting. The reactive levels of these carrier and modulator settings is the foundation of the phase modulation system voicing. By using this number of individual level controls across the keyboard range, a very high degree of accuracy and character is achieved by the synthesiser. The other sound parameters are scaled or graduated across the keyboard range, again to have a more natural response.

## The Analogue Circuitry

Output data from each pair of FM circuits is added and converted to analogue, and a digital compander circuit is used to improve this performance. The rest of the circuitry is analogue, and consists of a three section tone control, tremolo (performed by voltage controlled amplifiers) and ensemble, courtesy of three analogue delay lines.

## Specifications

Specifications for Yamaha's "Grand Synthesiser" are as follows:

88 note keyboard, A to C  
 4 x FM digital tone generators (16 note polyphonic)  
 16 voices (stored in RAM); alternative voices may be added from a library of magnetic voicing strips.

Controls are:

- 1) Master pitch
- 2) Detune
- 3) Vibrato speed, depth and on/off
- 4) Tremolo speed, depth and on/off
- 5) Ensemble on/off
- 6) Touch response on/off
- 7) Equalisation: bass, middle and treble
- 8) Master volume
- 9) Store switch
- 10) Headphone jack output
- 11) Foot controller jack input
- 12) Line out switch
- 13) Pedal controls: damper, tremolo and vibrato
- 14) Unbalanced outputs: channel 1, channel 2 and mixed
- 15) Balanced outputs: channels 1 and 2

From the Leading U.K. Casio Specialists  
**THE SENSATION OF THE JAPANESE MUSIC FAIR**

Read what the Experts have to say about the CASIOTONE 701

**"Electronics & Music Maker"**

"To sum up, the Casiotone 701 is certainly an instrument that opens up home music making for all the family."  
 "...one of the most advanced musical teaching aids so far developed."  
 "...this instrument is going to be one of the biggest sellers of 1982."

**"Keyboard & Music Player"**

"... what is going to become THE instrument of 1982."  
 "The sophistication ... is quite remarkable ... will really stimulate the home market ... it is probably the best instructive keyboard I have come across. But it is also a top line musical instrument capable of satisfying even the most proficient musician ... I suggest you place your orders now."

**THE REVOLUTIONARY CASIOTONE 701**

Complete programmable polyphonic keyboard

RRP £555

**ONLY £495**



**OPERATION**

- ★ Input an entire piece of music, specially scored in bar code and read by a light pen attached to the instrument.
- ★ Alternatively, program your own melodies, chords and tempo, from the keyboard, into the extensive memory (up to 5 minutes playing or more) with full editing facilities.
- ★ 3-WAY PLAYBACK.
  1. Automatic playback of the entire piece; melody, chord, bass and rhythm with arpeggio. Follow the melody as it plays via lamps above each individual key.
  2. Manual melody playing, guided by the keyboard lamps, with automatic bass and rhythm accompaniment.
  3. ONE KEY PLAY facility, allows the melody line to be played, simply by stroking one key. Non-players can become Instant Musicians!

**SPECIFICATION**

- ★ The 5-octave, 8-note polyphonic keyboard can be split into 2 and 3 octaves and a different voice can be selected for the accompaniment.
- ★ 20 "breath-takingly clear and bright" (K&MP) pre-set instruments and voices, including: Jazz Organ 1&2, Flute/Piccolo, Tibia/Full Tibia, Diapason/Woodwind, Pipe Organ/Brilliant Organ, Piano/Electric Piano, Vibraphone/Marimba, Celesta/Chime, Oboe/Bassoon, Funky/Wah Brass.
- ★ 3-way chord section: "Fingered chord" mode plays 4-note chords. "Memory on" holds the notes after release of keys. "Casiochord" auto accompaniment with walking bass, arpeggio. Major, minor, 7th, etc.
- ★ 16 rhythm accompaniments with "fill in" variation and two percussion effect buttons. Start/Stop, Synchro, Tempo and Balance controls.
- ★ Variable Vibrato and Sustain. Jacks for sustain, volume, rhythm start foot switch, phones and line out. Instruction manual & music books. Optional extras: Pedalboard, hard case, pedals. AC operation only.

**FREE**

SECURICOR 24 hour delivery. Our famous "Order Today, Play Tomorrow" service. (Not MT31, MT40.)  
 CREDIT 0% interest, ¼ deposit, 12 monthly repayments. (Not MT31, MT40.)  
 OR reduced rates for longer periods (CT701 only).  
**ON ALL PURCHASES OVER £90.**  
 INTEREST (0%) on ACCESS, BARCLAYCARD or VISA purchases for the first 6 months.

Fastest delivery/Lowest prices include VAT, P&P/Money back guarantee if not delighted/Same day despatch/TEMPUS extended 18 month guarantee. We have specialised in Casio products for over 5 years.

**NEW PORTABLE CASIOTONE KEYBOARDS**

**CASIOTONE MT-31**



**Only £69**

- 37 Key, 3 octave keyboard
- 22 preset sounds including Electric Piano, Piano, Organ, Flute, Harpsichord, Cello
- Vibrato, sustain
- 8 note polyphonic
- Battery or optional AC adaptor

**CASIOTONE MT-40**



**Only £99**

- 37 key, 3 octave keyboard plus bass keyboard
- Automatic accompaniment feature
- Rhythm Box
- Vibrato, sustain
- 8 note polyphonic
- Battery or optional AC adaptor

**OTHER CASIOTONE KEYBOARDS**

Professional: CT-101 £225, CT-202 £275. Domestic: CT-403 £275, VL-TONE £35.95. Details and accessory price list on request. 10% OFF accessories when you purchase your keyboard from us.

Send cheques, Postal Orders or cash (Registered) by FREEPOST (no stamp required), or phone your credit card number to:

**TEMPUS**

FREEPOST, Dept E&MM 2/82  
 38, Burleigh Street  
 Cambridge CB1 1DG  
 Telephone: 0223 312866

# Korg Trident Polyphonic



It really must be quite difficult for musicians to assess the more expensive large scale polyphonic synthesisers. Not too many shops can afford to have demonstration instruments for customers to try out, and since these instruments often have multiple outputs (and no built-in echo or reverb) it certainly makes hearing realistically the true potential of sound sources and treatments unlikely. Of course, many dealers are aware that the 'non-musically educated' salesman is just *not* on - no 'genius at the keys' is called for, simply people who know the instruments' functions well enough to demonstrate them. The larger instrument manufacturers (and shops) often hold regional seminars which are always worth attending and usually free as well. Reading our reviews should help, and listening to the E&MM cassette should give a lot of people a chance to hear the instruments not at their local shops. You may hear an instrument being played at a concert. Rick Wakeman played a stack of Korg instruments recently at Hammersmith, London (see the December 1981 E&MM feature) and out of the mêlée of instrumental music suddenly came this big orchestral sound - all issuing forth from one instrument, the Trident!

So I'll take a closer look at this impressive synthesiser and perhaps the review will set a few musical minds tingling. Actually, it's been quite a while since I've had that 'shivers down the spine' feeling one usually gets with classical music from a synthesiser - but here it is! So many musicians are still experimenting with multi-tracking, drum machines and effects, that it's easy to overlook the importance of dynamics and subtle layering to enhance the emotional levels that music has always been capable of. There's no criticism implied here - there is so much to learn about the applications of electro-music that it can be a lifetime study, as I'm finding out!

The Trident is really 3 main instruments in one, with 8-voice programmable polyphonic synthesiser, brass and strings. The synthesiser section can be programmed with sounds that are stored in 16 preset memories and it also contains 3 presets for piano tones. Both brass and strings have their own independent sound shaping sections and strings have a unique bowing effect treatment. In addition, a flanger is built into the instrument for on-board treatment for one or more sections. Although the keyboard is not touch-sensitive, there is an 'octave split' facility that lets you place the 3 sections in upper, lower or both keyboard ranges. Further performance effects can be obtained with the joystick controller and delay vibrato.

The instrument is well constructed in the shallow angled style adopted for most of the Korg range except the large 'studio' synthesisers, with rosewood end pieces and plastic/metal panels, measuring 1012(W) x 52(H) x 520(D)mm. It is easily portable at 21 kg and consumes some 40 watts. Nice Korg touches are the main cable tie-up brackets at the rear and also the top panel legending which is useful in the confines of a small



Korg Trident Polyphonic Synthesiser.

studio for locating sockets.

The Trident's sound generation is by eight VCOs, which are controlled by the keyboard via microprocessor based key assigner. The VCOs are actually linear types, which have superior stability and tracking; there is only one antilog converter which is multiplexed between the VCOs so that they all have exactly the same characteristics.

The VCOs feed eight separate VCFs (based on the SSM 2044 IC) and eight VCAs for the synthesiser section; the string section also has eight VCAs and VCFs, but the filters are simple single-pole types in this case. The brass section also uses eight VCAs, but only one common filter (an SSM 2044), and the bowing effect is also achieved with a single VCA and VCF common to all the voices.

Widespread use is made of 'bucket brigade' analogue delay (BBD) devices; three are used in a 3-phase ensemble generator, with a fourth to provide vibrato. A compressor/expander system is used in this section to reduce noise. A SAD 1024, which has a longer delay time, is used in the flanger section to produce an intense flanging effect.

All the control sections are located in one main block above the keyboard (from left to right): Key Assign, Flanger, Synthesiser, Brass, Strings and Output; the joystick is in the usual position to the left of the keys. On the rear panel is a memory protect switch which ensures 'permanent' storage of your 16 preset synthesiser sounds, along with 13 jack sockets for signal outputs and various control options. It's worth noting these initially as they offer several useful functions. First, volume pedals (such as Korg MS-01,04) can control a mixed volume output or any one or more of the 3 main sections with low/high level output jacks sockets provided. The Brass and Synthesiser sections' VCFs can have their cut-off frequency modulated via a pedal - making a possible five pedals usable in a working situation! There is a damper jack for footswitch control of piano presets (Piano 1,2,Clav) sustain and extension of synth release time. A Brass external trigger IN gives that extra control from a sequencer, drum machine, foot-switch or trigger controller (e.g. Synclock).

## Key Assign

The Trident uses micro circuitry to process information from the keyboard and controls 8 separate synthesiser units for polyphonic 8-note playing. A total tune control sets the keyboard pitch  $\pm$  one semitone for matching to other instruments.

An Assign mode switch gives two options of playing action for the synth section: either employing a different VCO Circuit Module for each key, so that long release settings will continue for each note; or where the same module operates for each key (unless additional notes are played), so that only the last notes have the release. The first mode is ideal for harp, guitar and piano style playing, whilst the second effectively emulates an ensemble. One little irritation however is that no change of mode must be made whilst notes sound or you'll have a temporary drop in pitch to the lowest note!

## Synthesiser

This section consists of 2 VCOs, VCF and VCA programmable controls which are coloured orange. VCO1 contains 16',8',4' pitch selection of sawtooth, square wave, pulse width (PW) and pulse width modulated (PWM) waveforms. So anything resembling a sine or triangle is obtained by filtering one of these. In fact, the waveforms on an oscilloscope showed slight impurity in the stated waves (with a reversed sawtooth used), although it was not really noticeable when listening. There's also PW/PWM basic pulse 'shape' and PWM 'speed' controls. The speed varies from 2 cycles per second to a fast buzz. Some slight jitter of the waveform was noticed when pulse width was manually changed.

VCO2 can be added to VCO1 at 16',8' and 4' pitches and it's nice to see a programmable 'detune' pitch control ( $\pm$  one semitone). Often, this has to be done manually on other synthesisers. Korg takes this a step further by providing a 'detune' switch that lets you readjust VCO2 detune, yet still holds programmed settings.

No noise generator is provided, which is a surprise on an instrument of this calibre.

The VCF is a low pass type with cut-off



# you don't need a pilot's licence to play one...

The Korg Delta is very easy to play and yet incredibly versatile. The strings and polyphonic synthesizer section are separated to give you complete control of sound.

The synthesizer section is fully polyphonic with easy to operate voltage controlled filters and envelope generator. The strings sound has attack and release controls which are independent of the synthesizer. There are also separate outputs for the synthesizer and string section which enables you to obtain a stereo effect. In addition a joy stick control gives quick, convenient control of pitch bend vibrato and other effects.

The facilities of the Korg Delta can be further expanded by connection to other keyboards, rhythm units and effects pedals using the input and outputs on the rear panel.

So take off to your nearest Korg Key Centre and break the sound barrier with the Korg Delta.

## **KORG** inspires your creativity.

32/34 Gordon House Road, Kentish Town, London NW5 1NE. Tel: 01 267 5151.



Korg Key Centres stock a wide selection of Korg synthesisers and can give you professional advice. Write or telephone for the name and address of your nearest dealer

Name \_\_\_\_\_

Address \_\_\_\_\_

E&MM2/82

To Rose-Morris, 32/34 Gordon House Road,  
London NW5 1NE Tel: 01-267 5151

Dear Rose-Morris, please send me

- details of the Korg range  
 the name & address of my  
nearest Korg Key Centre





The Trident opened up.

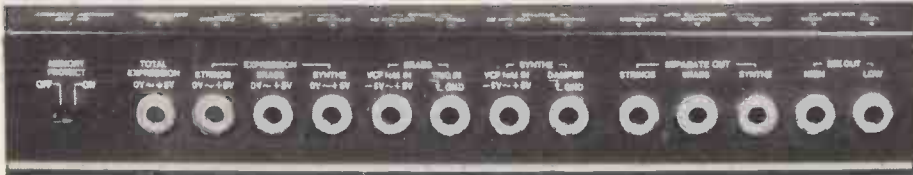

Rear connections.

frequency, resonance and EG depth controls. The latter is interesting because at positions right of centre '0' it gives increasing positive intensity for the EG shape, and to the left it gives increasing negative intensity. A three-position switch selects the amount of change in cut-off frequency according to keyboard notes played - either off, half or full. Since the filter will go into self-oscillation above setting 8 on resonance, this keyboard track switch is useful for using the filter oscillation musically.

The VCA can be switched to operate from the EG controls (the usual ADSR) or with on/off organ style keying. Maximum times are: attack 25, decay 18, and release 18 seconds.

Besides the detune option, there is a cut-off frequency 'fine' adjustment control (with centre indent) and a solo release on/off switch which are not programmable. The latter puts release on the last note only during mono solos.

Programming is extremely easy. Once a synthesiser sound is created in the 'manual' mode, one of the sixteen 'program' positions is selected using Bank A, B and program 1-8 buttons. Having selected Bank A or B with memory protection switch off, a press of the 'programmer write' button at the same time as a program number button will store your settings.

Three piano tone presets are also provided: Piano 1 - acoustic, Piano 2 - electric, and Clav - a bright 'clavinet', harpsichord type of sound. They are really programmes that are internally preset settings of the synthesiser section. Some improvements to these sounds could have been made by the provision of a separate EG for the VCF. Nevertheless, the cut-off frequency 'fine' control allows plenty of tonal adjustment.

A volume control and on/off output switch completes the synthesiser section. Similar controls are given for brass and strings so that together they really act as mixer levels with a total volume mix for the three sections provided in the final output stage. Here also is a phones output socket and level control.

## Brass

Some fine brass sounds, solo and ensemble, can be achieved with this section, and the provision of VCF and EG controls gives the player what is in effect use of another poly synthesiser (but with only one common filter). Both 16' and 8' pitches can be combined and sent to a VCF (similar to

the synthesiser). Thus, the possibility of using two oscillating filters at once gives scope for new effects. The EG intensity for the brass only sets positive levels for the ADSR shaping controls provided. Maximum times for the EG are: Attack 4, Decay 6 and Release 14 seconds.

An interesting item from the top-of-the-range Korg studio PS3300 is the Trigger Select. This will restrict operation of the Brass EG until 2,4,6 or 8 notes are played together, according to the switch position. Multiple or single triggering is also selectable and an external foot switch will also trigger this section. These internal interfacing extras give the brass much greater independence when playing with synth and strings in the same part of the keyboard - brass sounds fade away or punctuate, whilst strings hold on and synth has a contrasting character of its own. So here's how the Trident makes such a powerful orchestral blend in live performance.

## Strings

The full blend of double bass, cello, viola and violin is captured using the 16', 8' and 4' pitches in combination or separately. Volume shaping is done with attack and release controls, with full sustain level held whilst one or more notes are played. Maximum times are: attack 12 and release 16 seconds. Instead of a VCF, the strings go through an adjustable equaliser with high and low settings. When using these with a filter 'keyboard balance' control, a wide range of string timbres that mellow or brighten over the keyboard can be obtained. For example, it's usually essential to soften the bass and brighten the top octaves to get a string quartet sound.

Three effects can be switched in or out independently: Vibrato, Ensemble and Bowing. Vibrato is generated with a BBD chip and can be delayed up to 1 second. Vibrato intensity and speed can also be set. Ensemble is the familiar 3-stage BBD phase effect for string orchestra sound. 'Bowing' is an effect so far unique in name to this Korg instrument, but it actually is simply a preset AR envelope that operates on new keys played (after all notes are released) to simulate the accent heard at the start of bowing across the string. When creating solo instrumental sounds it adds that extra touch of realism. Tone and volume level controls adjust the depth of filter and amplifier change. It obviously only works when the string attack time is kept short.

## Vibrato and Joystick

Besides the strings having vibrato, a general vibrato is provided operating on all three sections at once. A fixed delay of 1/2-second can be switched in and intensity can be adjusted. Hence, the quality of orchestral strings, for example, is due to five BBDs operating at different speeds to give that minute variation of pitch common to unison strings.

The performance control on the Trident is the traditional Korg 4-way joystick. I enjoy using this, although you obviously have to take your left hand off the keys to move it, and that's really not the answer for a polyphonic - maybe we'll be going back to the knee levers and foot pedal rocker switches next! If you play in a band, it's no problem of course - it's the solo player that is restricted somewhat. Left and right movement of the joystick gives pitchbend down and up a fifth. Move the stick up and you get vibrato, move it down and trills appear - both set by intensity and speed controls. Trills can be done up to a minor 3rd interval.

Finally, the Trident in many ways achieves a characteristic sound all of its own simply because it incorporates a very good flanger. This creates not only flanging, but rich phasing effects that can be switched in or out of each section. Using speed (with up to 15 seconds per cycle), intensity, feedback and centre delay time (called manual) controls, some remarkably clear metallic sounds, moving phase and flange, feedback swoops etc. are easily produced. The flanged signal returns onto the separate section lines prior to mixing and therefore gives an unusual mix with 2 or 3 sections in flange mode - each output carrying a general flange mix. Some signal cancellation might be expected, but in fact the aural result is a pseudo stereo effect that spreads the sound nicely.

## Conclusions

Flanger adds the finishing touch to an instrument that has the potential to produce a tremendous variety of musical sounds. Since flanging and phasing have become vital sound treatments for the musician, it is a sensible addition for the Trident.

I would have liked a separate EG for the synthesiser VCF and the inclusion of a noise generator - both important items for good synthesis. I also have to admit a preference for left volume controls in one place for all sections, although the optional pedals more than make up for this. It is surprising that no touch-sensitivity is incorporated - Korg's Sigma has it and it would have given that extra playability in performance.

The control parameters are more than adequate and the layering and synthesising possible on the Trident, combined with programming makes this an instrument that gets better the more you play it.

**Mike Beecher, Peter Maydew E&MM**  
The Trident costs £2,310, including VAT and is distributed in the U.K. by Rose Morris & Co., Ltd., 32 Gordon House Road, Kentish Town, London NW5. Tel: 01-267 5151.



# AKG D330BT and D202



This series is like embarking on the Ark. Not in the sense that there is anything ancient about the microphones involved, but just that it's two of a kind each month. Two of an AKG kind this time; the new D 300 series features three mics and the D 330 BT is discussed here. Also, and going back a few years since it first became available, we have the famous D 202.

AKG's D 300 series are described as 'musician's microphones for vocalists'. Apart from the D 330 BT with bass and treble frequency contour switching, there are the D 320 B with bass only switching and the plain D 310. The latter is cardioid in pickup pattern whereas the former are both hypercardioid. The D202 has indeed been in the AKG range for many years, in fact I get the impression that they have tried to 'phase it out' having produced a smaller version, the D 222, but it seems that demand prevents its demise. It is a unique cardioid having two moving coil transducers, one for low frequencies and the other for high frequencies — sort of loudspeaker woofer and tweeter in reverse. A three position bass roll off switch is provided. There is a further two-way microphone in the AKG range, the D224.

I am trying to make these reports essentially practical, emphasising the user aspects. Where possible, I try to involve them in the activities current at the time. This latter aspect proved possible this month as we shall see. Apart from that, I start by lining up the pair specific to each report with two other mics, to maintain contact with the wider mic world, and subject each in turn to a variety of sound sources and even abuses, recording the results at 15 ips with Dolby A on a Revox B77.

To deal with the common aspects first. Both are Cannon plug equipped and can be used balanced or unbalanced, depending how the connection is made to the amp or mixer. In current parlance both are 'low' impedance (300 ohms) requiring connection to pre-amps with an input impedance three to 10 times that figure.

## AKG D202

I've owned a pair of these fine microphones for half a dozen years or more. It was, in fact, these which brought home to me the need to buy quality at this vital start of the recording chain. Since then I've added the superb AKG C414 capacitors, various Calrec capacitors, and have access to that ultimate in mic technology, the Calrec Soundfield. Initially I used the D202s as crossed pairs, and things were such a step forward over the cheapies I'd been using that the memory of the improvement is still with me. Now the D202s are regularly used as solo reinforcement in classical orchestral and choral recording, infill mics in brass band sessions (euphoniums always face away from the main crossed pair!), bass drum miking in multi-mic pop situations, and up to now for the overdubbing of the vocals in that field.

In the basic test line-up I took the opportunity to add one of my long-standing D202s. This was to find out if any noticeable differences could be heard. There were



AKG D330BT

AKG D202

none! Actually it is difficult to know just how 'new' the test sample is as it did not carry a serial number. Years ago the mics were supplied with machine run individual response curves and it would have been nice to see the curve for the test sample, but there was'n't one in the carrying case. I assume they are still usually issued?

As indicated earlier I have frequently used a D202 for vocal overdubs. This I would do at some 18 inches as I basically do not like overclose miking. The opportunity arose to invite Anita and Chris of 'The Crew' to come along and try the mics in the test line up, by redoing the vocal overdubs to the backing tracks still on the shelf. I can now say that at the rather dry acoustic of my treated listening room the need for a 'vocal' mic instead of the 'flat response' type was very evident. In fact, Anita very much liked the D330 BT. Originally, however, we deliberately operated in a bright acoustic for the overdubbing, and this brings out a point I can't help repeating — a given mic's on axis and off axis characteristics will affect the detail nature of the sound acquired. So in a way, I say what price copious published response curves? They cannot do much to really inform one how a mic will sound — there is only one real way, use the thing. It's even more difficult for someone attempting what I am doing, and I am not sure that response curves would assist.

Back to the D202. The mic does not have the usual proximity effects of directional microphones; the sound character does change close to, but there is not the bass rise normally experienced. Could be due to the dual moving coil design and the long, resistance terminated path behind the low frequency unit. Some EV mics are similarly arranged and they have reduced proximity effects.

## AKG D330 BT

I partnered this with the Beyer Soundstar Mk II from a previous survey so as to retain my bearings. It is obvious that the AKG has a more forward vocal presence; this at the minimum setting of the three available. The response should not be seen as treble lifts but as broad peaks between about 3kHz and 10kHz. The switch indications might indicate the former, as can be seen in the mic's photograph, but then it would be difficult to show the true state. The mic is versatile in the bass region also, as there is a similar three-position switch operating in this area. Its purpose is to cancel the proximity rise of close usage, and this it does in its mid position, but I find the cut overdone in the third position. Somewhat like a telephone call in sound in my view! I certainly am cheered to find that the subjective results tie in very well with what I would expect from the curves on AKG's user instructions. The third switch position curve is already some 4dB down at 1kHz, and it certainly sounds like it with a noticeable reduction in signal level.

As mentioned earlier, Anita Tedder of The Crew was taken with the D 330 BT. She and Chris offered some pointers on the design features of vocal mics from their stage performance point of view. Mesh headed mics appeal, and preferably these should be silver coloured as it greatly helps in finding the right place to sing to when faced with the glare of the stage lighting. Also the tapered body shape of many vocal mics meets with their favour. The AKG D330 BT mic has a tapered body and silver coloured mesh head!

Some of the AKG booklets are full of great detail on mics in general and their individual designs. Perusal tells me that the D330 BT has 'two counterphased acoustic transducers: one receiving sound: the other picking up impact and handling noise only'. Sounds like a good idea, so I set about comparing the handling noises of all the recently surveyed mics. First of all I made sure that the mixing desk sensitivities were adjusted to give similar acoustic signal levels, and then a 'standard' handling sequence was devised. The AKG comes out way ahead of the rest with some 15dB improvement over the average, and some 10dB over its nearest rival, the Calrec CM656D.

Quite evidently the AKG D330BT has had a lot of thought put into its design. The styling involves circular rings behind the mesh head which are part of a necessity — they conceal the opening to the diaphragm rear common to all cardioids. The top ring unscrews allowing easy dismantling, down to the plug in transducer assembly. The stand clip supplied looks and feels indestructible, it being made of a hard yet flexible 'rubbery' plastic.

Overall I can predict the D330 (and the others in the D300 series) becoming as long lived and respected as the D202 has become in its continuing lifetime.

Mike Skeet

E&MM

# MENTA

## MICRO ELECTRONIC MNEMONIC TEACHING AID

**M**enta comes from Dataman Designs, the people who brought you Softy and Softy 2, and in fact uses the same vacuum formed case as Softy 2. This case, along with its general shape and the membrane keyboard, means that Menta looks very much like the Sinclair ZX80, but in fact it isn't a personal computer at all; neither does it work in BASIC.

Instead, Menta is aimed at education, for teaching machine code programming and the rudiments of computing; and at engineers for micro based system development. The basis of the machine is a Z80 microprocessor running at a little over 2.2MHz (half of TV colour subcarrier frequency, in fact), supported by a 2K monitor program in EPROM and 1K of RAM. The RAM is split into four 'pages' of 256 bytes each, and each page's contents may be displayed on a TV as 16 rows of 16 bytes, each byte being represented by two hexadecimal digits. The usual UHF output lead is provided to feed your television, and a seven-segment LED display indicates which page is currently being shown on the screen.

Apart from a handful of logic ICs, the other major component is an 8255 I/O port, with a total of 24 lines (three groups of eight) which are available on a 26-way connector. Many of these lines are also used to monitor the keyboard, and to drive the seven-segment display, a beeper which makes an annoying squeak whenever a key is pressed, and a cassette interface which uses only one jack socket doubling for input and output; this stores the entire RAM contents using Dataman's Transwift system, which only takes 4-8 seconds to do the job.

### The Monitor

Menta's monitor program is what gives the machine its personality, and does all the things you would expect, plus some you would not: especially considering the small size of the ROM. All the 'housekeeping' is taken care of by software, including nearly all the TV display work; a divider chain takes care of the parts which are too fast for the microprocessor.

From the user's point of view, hexadecimal characters may be entered into the memory to form a machine code program which can be seen in its entirety on the screen. The program may then be run all at once, or in a single step mode where the effect of each instruction may be examined; this is very useful for debugging recalcitrant programs, since the only way of stopping a program which is running at full speed is to press 'interrupt' or 'reset' by which time the damage has usually been done.

To aid the programmer, the contents of all the Z80's registers are displayed at the bottom of page 3, and may also be changed if required in the same way as any other area of RAM. A cursor on the screen indicates the byte into which information will be entered next, and this cursor may be moved freely about by four keys (up, down, left and right); the cursor's address is displayed along with the register contents so you always know where you are, on page 3 at least.

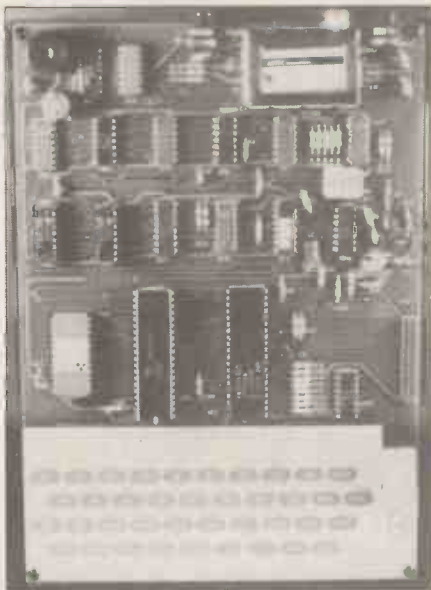

One useful feature is the Assembler mode; when this is in use, all the common Z80 instructions may be entered in two or three keystrokes using the mnemonics printed by each key. You can, of course, easily key in any instruction in hex form if the assembler won't handle it. There is even a facility for calculating the displacement for relative jumps; although fiddly, it saves time and removes a common source of error. All things considered, the assembler is a very useful part of the machine.

### The Manual

The manual is an important part of any educational product. I dream in hex code some nights, so it's difficult for me to say how useful the Menta book is to a beginner; certainly everything seems to be there, from the binary number system up to a fictitious microprocessor controlled drinks machine, which sounds like something from 'The Hitchhikers Guide to the Galaxy'! There is also a circuit description, a list of Z80 mnemonics, data sheets on the Z80 and 8255, and some sample programs including a simple music program which turns the beeper into a one octave monophonic 'organ'. A separate book contains a listing of the monitor program, which is liberally documented and makes fascinating reading for those who can understand it.

As a reference book for the busy engineer, however, the manual would be vastly improved by the addition of an index; as it is, there aren't even any page numbers and finding something quickly is made difficult if you don't even know if it's in the book at all!

Quibbles apart, though, a well thought out and useful device; the ports could also make the machine into a handy drum controller or music sequencer. You could make a programmable drum machine in conjunction with this month's percussion generator, for instance, and still have outputs left over for a synthesiser!

**Peter Maydew**

**E&MM**

*Menta is available from Dataman Designs, Lombard House, Dorchester, Dorset and costs £115 plus VAT.*





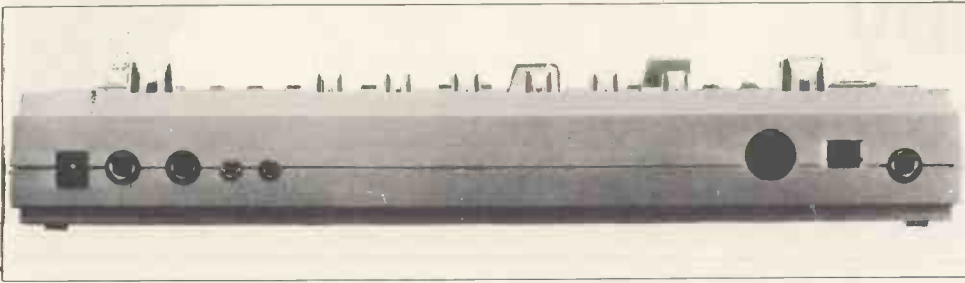

another to build up your drum pattern, you can add accents (AC) with the last position on the Track/Instrument rotary. When the pattern's complete, press the Run/Stop button which will bring it to a halt. The pattern at location one is thus safely tucked away in the memory, and you can now continue to write patterns into other locations.

Why are there so many pattern locations, you ask? Well, the whole point of the 606 is its ability to use the patterns linked together, forming complex rhythm compositions to fire your music and making the machine a composing tool rather than merely a rhythm box. If you turn the Mode rotary to Pattern Play, you can hear individual patterns by pressing a selector switch for a location, and hitting Run/Stop. Again, the Tempo rotary regulates the pattern's speed, and the individual mix rotaries let you alter the levels of the drum/percussion sounds within the pattern.

The 16 locations are divided into four groups of four (1-4, 5-8, 9-12 and 13-16), so that you can 'chain' patterns within the groups. If you press selector switches one and three simultaneously, for example, LED one will flash and LEDs two and three will

stay lit. Pressing Run/Stop will give you pattern one, followed by pattern two, then pattern three, back to pattern one, and so on until you hit Run/Stop again. If you hit the Tap button while you're running one of these chains, you'll jump automatically to the beginning of the next pattern in the chain. This chaining arrangement is thus of obvious use when building up drum compositions of a reasonably basic kind.

More adventurous is the machine's ability to write and play 'tracks', as mentioned earlier. Having written patterns into the locations with a track composition in mind, the user can place these patterns into the 606's track memory in any order and with various repeat and return options for standard verse/chorus pieces or, ideally, for more complex musical needs. A track is composed by setting the Mode rotary to Track Write and the Track/Instrument rotary to the required track — there are eight tracks available, seven of 64 bars each and one of 256 bars. Up to four of the 64-bar tracks can be chained together to realise 256-bar compositions. The Clear/Reset button sets the first bar of the track — the patterns are put into the Track memory with a combination of the selector switches and the Tap

button — and the Clear/Reset button marks the last bar of the track. You can check through the composed track bar by bar by pressing the Tap button, which will light the LEDs in memorised order, one by one for each pattern. You can also locate any bar, by number, by punching its number into the selectors — handy for editing or checking.

So, from this necessarily brief outline of the 606's facilities, one major fact should be emerging: to get the best from this lovely new machine, you really have to use the old, old method of pen and paper to write down rhythms. To get the most from it you'll have to commit thoughts to paper at an early stage, otherwise you'll get into an awful mess. Whether you go the whole hog and use proper drum notation or your own code is up to you. But write you must.

My only real criticism of the 606 is a personal one — I didn't like the cymbal and open hi-hat impersonations at all, and kept their 'chinging' sound down low with the mix rotaries when playing back patterns and tracks. But the 606 is a tool which will aid the creative musician in many a task, and I must say it is excellent value and a remarkable machine.

Tony Bacon

E&MM

## CASSETTE REVIEW

ELECTRONICS & MUSIC MAKER invites you, the home electro-musician, to send in a cassette of your work for possible appraisal and comment in future issues. So if you're producing any sort of good, original music in your home studio (and the definition of 'studio' is anything from a single mic feeding an old cassette machine to a 46-track computer-assisted mixdown facility), then send in a cassette of what you consider to be your best or most representative work. It could be a one-off, spontaneous piece, or even a proper cassette-only independent release. Remember to make it an ordinary mono or stereo 1 7/8 in/s (standard speed) cassette, and write your name and address somewhere on the *cassette itself*, even if you enclose other information (which, of course, we'd welcome). E&MM supports the home electro-musician, and in this way we hope to bring readers' attention to a few interesting tapes and projects every month or so. Send your cassette to:

**E&MM Review**

**282 London Road, Westcliff-on-Sea  
Essex SS0 7JG**

## BACK ISSUES can be obtained from E&MM at £1.10 each (inc. postage)



**MARCH** Matinee Organ ★ Spectrum Synthesiser ★ Hi-Fi Sub-Bass Woofer ★ Balanced line system ★ Yamaha SK20 review ★ BBC Radiophonic Workshop  
**APRIL** Syntom Drum Synthesiser ★ Workshop Power Supply ★ Direct Inject Box ★ Ultravox ★ Paia 8700 review ★ Matinee ★ Spectrum  
**MAY** Noise Reduction Unit ★ Lowrey MX-1 review ★ Apple Music System ★ Matinee ★ Spectrum  
**JUNE** Wordmaker ★ Guitar Tuner ★ Hi-Fi/Group Mosfet amp ★ Fairlight CMI review ★ David Vorhaus ★ Matinee  
**JULY** Alphadac 16 Synthesiser Keyboard Controller ★ Synwave effects unit ★ Matinee ★ Atari Music ★ Duncan Mackay ★ PPG Wave 2/Wersi Pianostar reviews

**AUGUST** PA Signal Processor ★ Powercomp ★ Hexadrum ★ Matinee ★ Resynator/Casio VL-Tone reviews ★ Irmin Schmidt  
**SEPTEMBER** PartyLite ★ Tape-Slide Synchroniser ★ Synpac 9V effects supply ★ Noise Gate ★ PA Signal Processor ★ Digital Keyboard ★ One-handed Guitar ★ Chromascope & Linn Drum reviews ★ Kraftwerk revealed  
**OCTOBER** Harmony Generator ★ Securigard burglar alarm ★ Effects Link FX-1 ★ Music at City University ★ dbx noise reduction & Blacet Syn-Bow reviews ★ Micro interfacing ★ Disco equalisation and metering  
**NOVEMBER** Landscape explored ★ Casio MT-30, Roland GR-300 Guitar Synthesiser, Roland CPE-800 Compu-Editor reviews ★ Melody Making on the Apple ★ Phasing ★ Auto Swell - Electric Drummer - Soundbooster - Toneboost projects  
**DECEMBER** Rick Wakeman in 1984 ★ Orchestral Manoeuvres in the Dark ★ Bio Music ★ Yamaha CS70M, Vox Custom Bass & Custom 25, Roland CR5000 & CR8000, Alpha Syntauri, Fostex 250 ★ Synclock project ★ Make music with the ZX81  
**JANUARY** The New Tangerine Dream ★ Japan Music Fair ★ Fact File ★ Guitar Workshop ★ Reviews: Casiotone 701, Teisco SX-400, Aria TS-400, M.C.S. Percussion Computer, Soundchaser, Beyer Mics, TC Effects Boxes, Tempo Check ★ Projects: Spectrum Synthesiser, Electric Drummer, Volume Pedal

# John Hornby Skewes Amplifiers

## C50PM Guitar Amplifier

If your enthusiasm was fired by our December review of the Vox AC30, and you rushed down to your local music shop thinking a 30 watt amplifier wouldn't cost much, your excitement was probably dampened considerably when you were asked for over £300. By way of recompense, therefore, this month's amplifier is more affordable.

The JHS C50PM is a 50 watt solid state amplifier with two 8" speakers, costing £139 including VAT. Have I said enough to confirm your prejudices? Cheap oriental rubbish, right? Wrong! For a start, the label on the back says 'Made in U.K.' and there are definite signs that someone has been thinking about the details of this unit. Take the cabinet, for instance; this is covered in a very handsome deep grained brown PVC material, which looks commendably hard-wearing. With its brown and yellow control panel, the whole amplifier looks pretty smart in fact. There is a plastic corner cap for every corner — so many manufacturers only fit four, or even none at all — and these are soft, thick plastic that is unlikely to break easily.

The cabinet measures 21 x 16½ x 9½ inches, and although the lightweight construction (½" chipboard with 1" square framing) doesn't do much for the sound, it does make the amplifier easy to carry single-handed. The sort of person who is likely to buy this amp would probably take it to gigs in the back of a car, or even on the bus; so it doesn't have to be built to battleship standards, but the lack of weight will save a lot of cursing from those who have to do their own roading.

There are two input sockets — 'bright' and 'normal' — sharing a single input volume control, and a master volume control, called 'gain' on this amplifier; more of this later. As well as the normal bass and treble controls, which work well and have sensible turnover frequencies, the C50PM also has a parametric midrange tone control. An unusual feature, this, on a budget amplifier, and despite one of the controls being noisy this is one of the most useful facilities on the unit. There is plenty of range on the gain control — up to 20dB cut or boost — and the frequency knob covers 80Hz to 1.25kHz; in other words, exactly the same four octaves spanned by a 24 fret guitar! Obviously that engineer has been thinking again, and has taken into account the special requirements of the electric guitar.

It is, in fact, impossible to set the tone controls to give a flat response, not that it really matters on a guitar amplifier as long as the final sound is acceptable; which it is. As well as a wide range of tonal possibilities, some special effects are available; I turned up the volume to get feedback from my guitar, and found I could control the pitch at which feedback occurred by sweeping the mid-frequency control. Conversely, this control should also be good at reducing feedback.

The final item on the front panel is a socket for a footswitch; this introduces diodes into the preamp signal path to give clipping. The effect is a fairly harsh fuzz 20

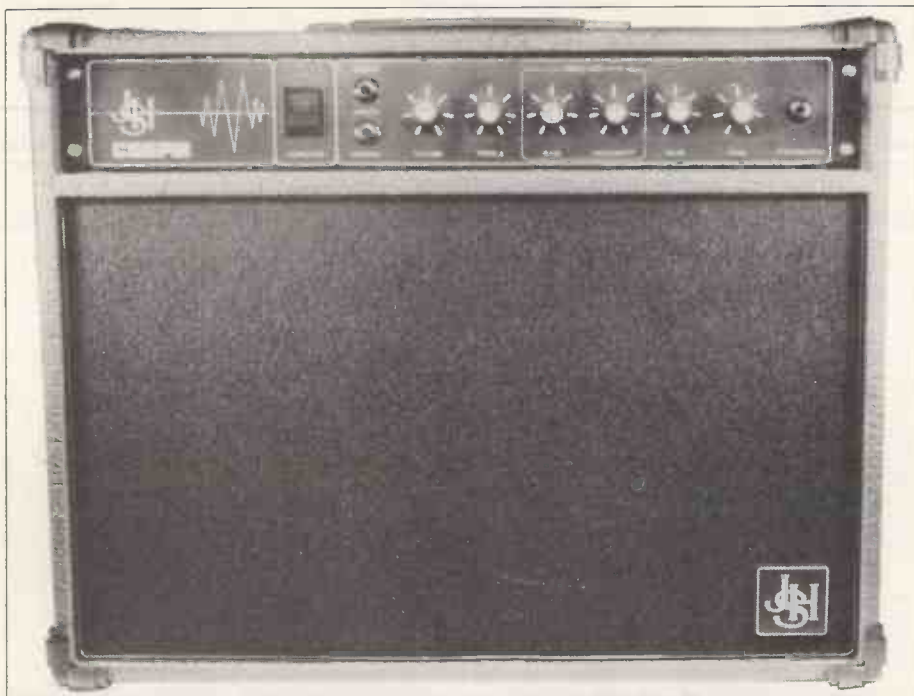

JHS C50PM.

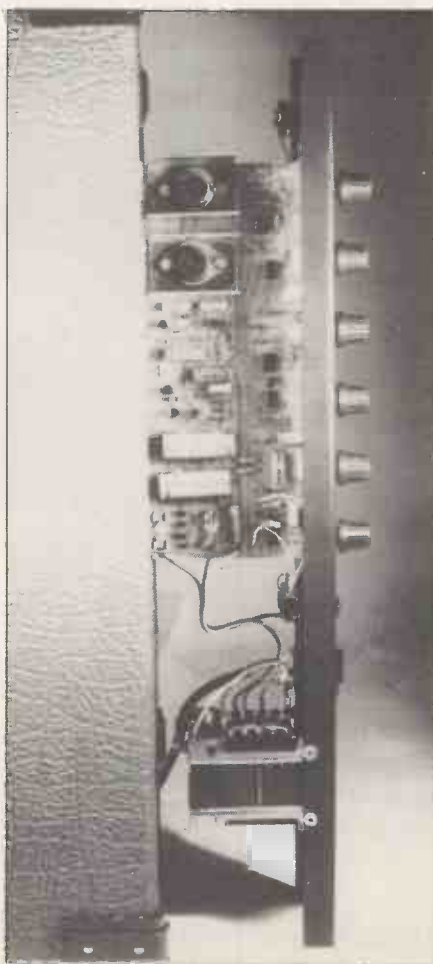

Inside the C50PM.

## Test Results

### C50PM

Power: 30W RMS continuous  
35W @ 10% distortion  
Sensitivity: 15mV for 30W out  
Signal to noise ratio: 40dB  
Bass control: ±10dB @ 65Hz  
Mid control: ±20dB, 80Hz to 1.25kHz  
Treble control: ±10dB @ 2.5kHz  
±15dB @ 7kHz  
(through bright input)

sound, unfortunately also accompanied by a drop in volume. The depth of fuzz can be controlled with the input volume control, whilst the volume is regulated with the gain control which is situated at the preamp output.

Although it's nothing like the good old valve sound, at full steam the fuzz sounds better than some effects boxes, I must admit, and is perfectly adequate for single note lead lines. On chords, however, the sound is very discordant and jangly, and any attempt to tone down the distortion by backing off the input volume just makes the fuzz sound as if it were 'laid on top' of the original signal; that is, when the notes decay, the fuzz suddenly goes away leaving the unaltered guitar sound.

With a reasonably powerful guitar, however, it's possible to overload the preamp section itself, leaving the fuzz switched off. Simply turn the input volume up to near maximum, and turn down the gain; the

# WANTED

## The Magnificent Seven



A superb new range of British made amplifiers makes its debut for 1982. A range to suit all musicians, from the beginner to the most discerning professional.

Seven models are available ranging from a 5 watt practice amplifier to a shattering 100 watt combo model.

The entire range is resplendent in tough brown vinyl covered cabinets with new fascia panels giving a colourful dynamic appearance.



Available from good music stores or send a stamped addressed envelope for free literature:-

Name: \_\_\_\_\_

Address: \_\_\_\_\_

Trade Distributors,  
JOHN HORNBY SKEWES & CO. LTD.,  
Salem House, Garforth, Leeds LS25 1PX.

sound is roughened up slightly, but not so distorted as to be a nuisance on chords, and I much prefer this effect to the 'genuine' fuzz. If you turn everything up so that the power amplifier clips as well, the harshness comes back; I'm a valve amp fan, mind, and the JHS is better than some transistor amplifiers in this respect, possibly due to the speakers used (two anonymous 8" units). On the other hand, if you're a punk and enjoy sending your audiences home with their spectacles cracked, this could be just the amp for you. Otherwise, be careful to avoid overdriving the output stages.

Because the tone controls have so obviously been designed to work best with a guitar, I've referred to this unit as a guitar amplifier throughout the review. In fact, the power supply and heatsinks aren't really big enough for the continuous sounds coming from an organ or synthesiser, and under these conditions only about 30 watts are available before clipping sets in.

In the studio, background noise — hiss and cabinet rattles — would probably be too obtrusive; on stage, however, in a pub or club this amplifier should be ideal, and I imagine this is the market it's aimed at.

If you've only got £139 to spend on an amplifier, you can't expect perfection; give this one a try, it's British and gets full marks for effort.

## C20B Bass Amplifier

This is quite a different kettle of fish; it's a 20 watt bass amplifier, measuring 19½ x 15½ x 9½ inches, and fitted with two of the same 8" loudspeakers in a sealed compartment. This amplifier is intended solely as a practice amplifier for bass guitar, and as such has virtually no competition. Such devices are few and far between. As you would expect, such a compact speaker arrangement is not especially efficient at reproducing bass; to get a decent sound the amplifier has to work quite hard, and there is no chance of competing with a drummer (is there ever?). Whether or not you are willing to pay £105 for a private practice amplifier is up to you, although this unit may have a use in a primarily acoustic group, playing folk music for instance. A bass guitar and one of these amplifiers would be a much more portable alternative to an acoustic bass in these circumstances.

Portability is helped by the lightweight construction, which is identical to the larger unit: ½" chipboard with 1" square framing, brown PVC covering and corner caps. All the electronics except the transformer and mains switch are mounted on a single PCB: there is no chassis, the PCB and transformer are mounted on the front panel, which is a length of aluminium angle screwed into the front of the case. The C50PM is built the same way, incidentally.

There are two input sockets — why? — a volume control, and four tone controls. Treble and bass have had their turnover frequencies chosen sensibly once again, although the bass control has a rather limited range, being capable of only 10dB cut or boost; this may have been done to protect the speakers. The other two are fairly

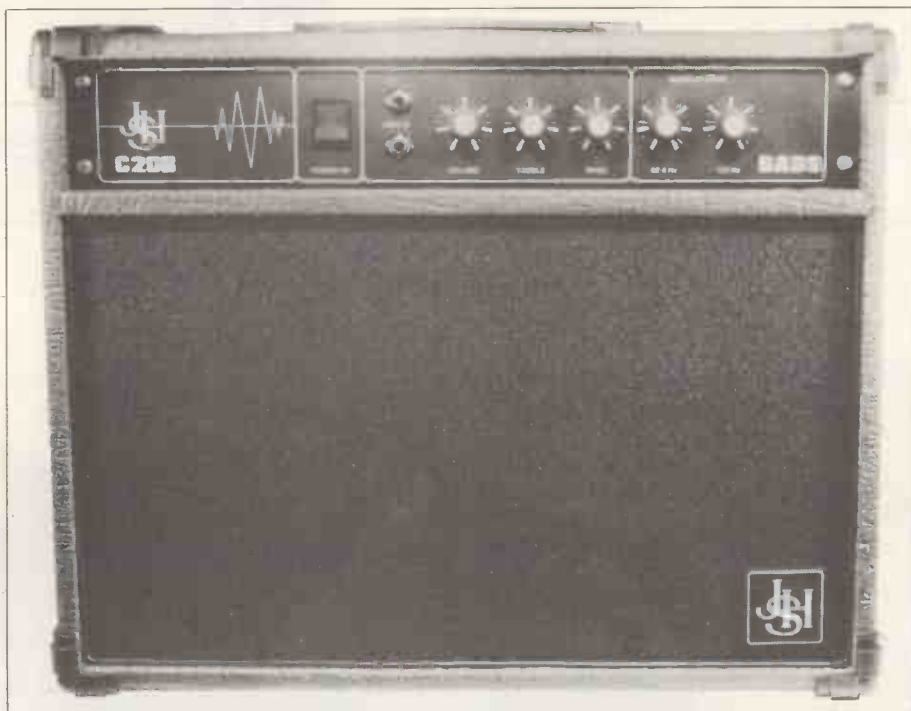

JHS C20B.

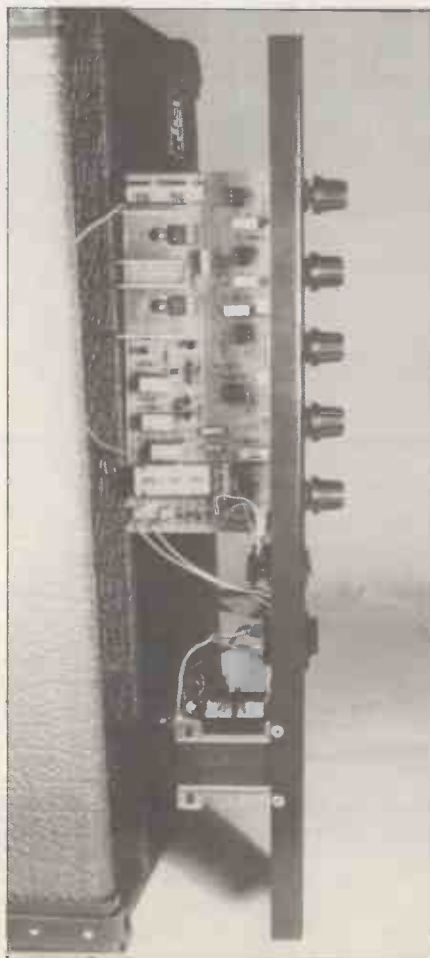

Inside the C20B.

## Test Results C20B

Power: 21W RMS continuous  
28W @ 10% distortion  
Sensitivity: 150mV for 20W out  
Signal to noise ratio: 63dB  
Bass control: ±10dB @ 25Hz  
65Hz control: ±18dB, 20Hz bandwidth  
125Hz control: ±12dB, 40Hz bandwidth  
Treble control: ±15dB @ 10KHz

Measurements by Dave Goodman.

sharp band-pass/stop filters, which act like a two section graphic equaliser. The lower one is centred on 65Hz — C above bottom E on the bass — and has a range of ±18dB, while the upper filter is centred on 125Hz, an octave above the lower one, and has a gentler range of ±12dB. If anything, the 65Hz control has too much range; things need to be turned up quite a way to get a meaty sound but it's easy to go too far with this one, and horrendous distortion is the result.

Apart from that, the sensitivity has been kept low on this amplifier, at 150mV as compared to 15mV for the C50PM; possibly for this reason, the noise level is much lower and the unit is commendably quiet.

I must admit to having reservations about the usefulness of this device, but it's well made, the tone controls are well thought out, and at the price there's nothing else like it.

Peter Maydew

E&MM



# Fostex A-8

## 8 Track Recorder/Reproducer



Until some months ago, Fostex was virtually unknown in the U.K. and Europe generally. Even so, since its emergence at the Los Angeles AES convention in early May, news had begun to filter across of the impressive line of lightweight, "affordable" pro quality open reel recorder/reproducers, mixers and other "creative sound" instruments for musicians.

Fostex is a relatively small division owned by Foster Electric Co Ltd of Japan, supplying a large range of electro-acoustic components from speakers to microphones, to major manufacturers such as Sony and Phillips. Yoshiharu Abe, formerly a director and chief audio engineer at Teac/Tascam, is now managing director of the Fostex team. Fostex joins the number of Japanese companies that are prominent in the recording field, including Teac/Tascam, Otari and Sony.

The current A-series range of recording equipment includes the A-2 3-head 2-track, A-4 3-head 4-track (both with 7½/15in/s and varispeed) as well as the A-8 2-head 8-track 15in/s featured in this review. In addition, there is the 250 "Multitracker" 4-channel cassette recorder/mixer (reviewed in December) and the 350 recording mixer (8x4x2). All are styled in the Fostex smart presentation. Ancillary units include digital delay, graphic equaliser and 4-channel Dolby C noise reduction unit.

The A-8 Recorder/Reproducer represents a significant development that is likely to affect the recording industry in general. In retrospect, the introduction of the first multi-track machine came in the 1940's and the next 20 years were limited to mainly 4 and 8-track recording for professional studios. The production of the Beatles Sgt. Pepper album marked a major milestone during a time when recording began to develop rapidly. More equipment became available and studios using the new technology profited. By the end of the 60's, the pro musician had become dependent on multi-track and the Teac A3340 (originally made in Japan, but sold in America with Simul-Sync) established itself as a hi-fi machine for the demo studio — starting a new industry that enabled more musicians and song writers to work independently. Incidentally, the Teac machine was originally intended for the "quad" hi-fi market, but when this began to flounder, the manufacturers added the Simul-Sync to steer it in the new direction.

Now we have the opportunity for another big change, with the possibility of many artists (and this must include the ever increasing number of musicians making music in their home studio), producing high quality recordings and demos. The combination of the A-8 8-track recorder and the 350 recording mixer makes a package that is a cost investment equivalent to buying your own micro system. The A-8 also costs half the price of its closest competitor (with ½" tape).

### A-8 Features

Fostex range has been designed to be ultra compact and appealing for domestic use in the home or in the small studio. It



Fostex A-8 Recorder/Reproducer.



The record/replay head, cue lever and headshield.

weighs only 29lbs, measures 14"(W) x 13½"(H) x 8"(D) including headblock, and consumes 60W of power. This obviously puts it in a different light from previous semi-pro machines that are heavier and larger — in fact, when you see it alongside other machines, it's hard to believe that it can hold all the mechanics and electronics required.

The A-8 has avoided most of the problems that have put off potential 8-track users, through the use of standard ¼" tape which reduces running costs and yet maintains an acceptable level of performance by incorporating built-in noise reduction. All unessential features have been omitted, e.g. headphone monitor, level controls, infra-red stop, oscillator, pause, dual speed and full input record facilities at any time.

As a result, the facilities of the A-8 go a long way towards making the Fostex philosophy of "Personal Multi-track" as simple as possible, allowing the musician to concentrate on his creative composing. The Fostex term "Personal Multi-track" is quoted to mean "high quality recording equipment that's easy to use and truly affordable". Eight

track recording eliminates a lot of the chore of bouncing tracks from one 2 or 4-track machine to another and the A-8 is designed to be usable even from an 8-channel stereo mixer. At the same time, the A-8 provides some very desirable improvements, such as solenoid operated transport functions that are all remote controllable, return-to-zero button, punch in and out, and 4-digit LED counter with ½-inch high numerals that operates via the supply reel. Simul-sync is not needed either, as the record/replay come off the same head and is therefore always "in sync".

One tape speed of 15 inches per second (38 cm/s) is available which gives around 22 mins running time for an 1800ft reel of 7" tape. Tape wind time in fast forward and rewind is approximately 128 seconds. The speed can be varied smoothly with the pitch control over ±10% during record or play. Nominal 15 ips is positioned at its centre "click-stop". The recommended tape thickness to avoid print-through and stretch is 1 mil (or 35 microns). The review model was evaluated with TDK LX35/90B successfully with no noticeable print through after a month of storage. The reduction of the maximum size spool from the usual 10½" to 7" contributes to considerable cost saving in choice of motors and chassis support.

The transport control buttons are situated at the lower right of the front panel and features the "soft touch" of many current hi-fi machines, whilst retaining sufficient positive feel to let you "play" the controls with one hand. Micro-chip logic safely controls transport functions so that switches can be selected, e.g. from "f.fwd" to "rewind" without using "stop" in between. An

### FOSTEX Multitracker

It's a Personal Recording Studio that challenges the quality and versatility of open reel. A dramatic, 71dB S/N ratio is achieved using the latest Dolby C. There are no restrictions. You can record up to four tracks at once. As mixer and recorder are together but separate, you can plug in direct and capture a live performance or perform complex productions. Tape runs at twice normal speed and there's a digital counter with zero return, varispeed and footswitch punch in, so nothing gets in the way of creativity. The mixer accepts any signal, with bass, treble, echo, pan on each channel. These switch from laying tracks to mixdown. Automatic monitoring lets you listen to the mix you are recording plus tracks already on tape. Just plug in a mike and cans, and you have your own four track demo setup. **The Multitracker will make you think twice about open reel.** Full catalogue of Fostex Multitrack Products on request.

£711.39



### Goldline Analyser

Tune any sound system quickly and accurately with this hand held spectrum analyser. Built in microphone displays signal on 10 band LED display. Kit includes a noise source to feed through your system. **Now you can set your graphics and see the results.**



£199.50

### No Brand Stand

Usually sold by the big name mike makers under their own names. We've tracked down the source in Germany and offer substantial savings by buying direct. It is very stable, uses non slip clutches, and quickly folds for storage. The boom reaches everywhere. **We're so convinced of it's usefulness we offer discount when you buy six!**

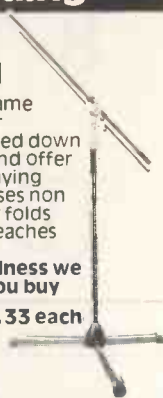

£137.31

£26.33 each

### Mod Patch

A 16 pair jack-bay you can install without soldering. Use jack or phono terminated cables to connect your system inputs and outputs directly to the rear. Each pair of sockets is switched together by the printed circuit assembly, so you don't need a rats nest of cables for normal operation. Push in a patch cord and you break into the circuit, instant access to your recording or PA signals for effects and rerouting. Fits a standard rack. (Specify jack or phono when ordering).



£59.16

### SECK Producer £339.25

A state of the art stereo design for production, broadcast and disco. Many new features include long 100mm faders, 'senstart' deck switching, voltage control, electronic cue selection, powerful headphone amplifier and separate mono or 'growl' output. Suitable for desk or rack mounting. Call or write for more details.



### XLR Sale

From one up at quantity prices. Our massive purchase of professional connectors results in lower cost to you. Compare these inclusive prices; Male, Cord £1.27. Male, panel £1.12. Female, Cord £1.51. Female, panel £1.83. Call for quantity discounts.



### Electronic EchoMike

Achieve richer, fuller vocals with this breakthrough product. Built in analog delay circuitry offers direct, fingertip control of echo level, from subtle doubling to deep dramatic effects. The cardioid electret, microphone capsule minimises the chance of feedback for live or stage applications. Discover how echo can enhance your performance. Comes with stand adaptor, lead, plug and battery.

£35.95



### Accessit

A unique range of add-on signal processors for PA or studio use.

Compressor £31.97 Variable threshold and speed give scope for effects. Parametric £31.97 Low and high band, tunable equaliser design. Booster £33.12 Four way line amplifier solves all matching problems. Compander £34.27 Up to 30dB of noise reduction for semi-pro recorders. Reverb £33.12 Custom spring and variable EQ ensure a natural sound. Power Supply £28.52 Mains operated, will power up to four Accessit units. Rackit £19.55 Mounts three Accessit units to standard 19" rack.

Send for the new data folder including specification cards, application notes, review reprints and details of the 21 day free trial offer.

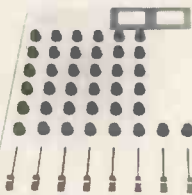
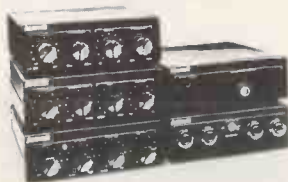

SECK 62  
£108.22

£152.25  
Assembled

12 page brochure on request.

SECK is a six input stereo mixer featuring wide range gain treble, bass echo and foldback pan on each channel. For compact PA, keyboards, stage monitoring or recording, the ultra slim design is at home anywhere, available ready to go or save over £50 by putting it together yourself (about 8 hours).

### Mikes by Mail

- AKG D12...£82.92
- AKG D190...£44.97
- AKG 222...£78.32
- Shure SM57...£61.67
- SMD 421 UN...£86.30



### Made for each other

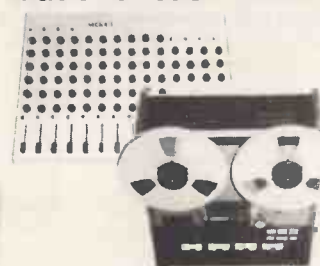

We supply expert systems around Teac's 3440. Seen here with the Seck 104 mixer, a perfect pair for full monitoring, echo and mixdown at the touch of a switch. Price including leads is £1111.00 (excl.) Other packages start at £799.00 (excl.), so let us quote our best price for your requirements.

### Microchip Orchestra



The revolutionary musical instrument that turns you into an instant musician. Order the Casio VL-Tone now, and try it at no obligation for 14 days. FREE with your order, a jack connector lead to your amplifier or mains adaptor at only £1.75.

£35.95

### EXR Excitement £349

Aural excitement was first used on hit records in the late 70's. It's a patented process, the exact workings of which are only known to its manufacturers. In line with live or recorded signal, sounds become clearer, more transparent. Bass sounds tighten up, treble sparkles. The EXR offers the possibility of this exciting new development to every sound engineer. We urge you to hear it for yourself, you may not believe your ears. Available on 14 day sale or return.



### Mike Arm

Put your mike in an awkward position. Long reach and clamp mount make it ideal for any presenter.



£27.37

### Mighty Auratones



TEAK £56.92  
ROAD £66.12

These innocent looking speakers are used as reference monitors in top studios throughout the world.

Ideal for a micro PA system. Sold only in pairs.

**FREE**  
turnkey



Call or write for 32 page Turnkey catalogue

"The Multitrack Primer" - from TEAC is a practical guide to setting up a home studio with many tips on wiring, acoustics, mike placement etc. The book is packed with superb illustrations. The best guide around by far.

£3.50

All prices shown are inclusive of postage and VAT. You can order by phone using Visa or Access Cards, or drop in and see us! Export enquiries welcome.



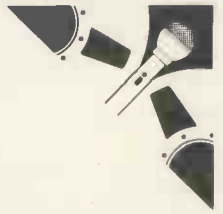

The base plate removed to reveal servicing presets.

additional item is the "return-to-zero" rewind button that will stop the transport at your chosen reset point ("0") of the LED counter, e.g. at the start of the new piece. Switch-off occurs at zero and gives a 1-4 digit "overrun" that in practice leads in nicely to a replay (provided you've sufficient leader tape if you're returning to the tape start). Actual tape locations do remain accurate — often a failing of the usual mechanical counter.

An Edit in/out switch turns off the take-up reel motor and spills tape (only during play, for safety), so that it can be spliced.

Since the 1/4" tape format makes the eight "tracks" very narrow, the new Dolby-C noise reduction system is built in to the recorder to maintain an acceptable signal-to-noise ratio (quoted as 73dB weighted). However, it may be switched out if you wish to use an external unit. A high standard of reproduction is achieved using Dolby C and is quoted to give 10dB improvement over the Dolby B system, yet maintaining full dynamic range and high frequency transients. It is nice to see the Dolby incorporated as part of the A-8 instead of being an expensive extra.

To the left of the transport controls are nine push switches that define the recording/replay modes. Four input record amplifiers only are provided, so that either tracks 1-4 or 5-8 may be selected in one go — certainly no problem for the home studio musician working alone. Pressing record and play buttons simultaneously puts the tracks (chosen from the upper row of four buttons) into record. Any track can be dropped from record by releasing the appropriate switch.

Monitoring is done via the eight VU meters (-20 to +5dB) mounted in two banks of four and when a track is selected for record, its red LED just above the appropriate meter flashes a useful warning of correct track selection. Once the transport is in record mode, the LEDs of recording tracks remain lit, as well as the tape counter LED.

One of the most important innovations of the A-8 must be its "punch in/out" function. By inserting any SPST switch with a 1/4" jack (e.g. guitar or effects switch) at the rear of the machine, record start and stop may be made using your foot, leaving your hands free to play. "Record" mode is not selected, simply "play", and at the appropriate point in the music you "punch in" your correction or additional track.

The lower row of push buttons selects line in or replay for monitoring the track group in use. The other group of tracks not in record mode is always in replay. When using the A-8



The guides (with plastic inserts), pinch roller and capstan wheel.

with the Fostex 350 mixer, only one switch change on a channel puts it into tape replay immediately — a useful time saver when concentrating on the instruments. The group selected for record will also remain in replay mode but the "ready to record" tracks will drop into "line in" once recording commences. If a track is switched to line in it will remain so in record or replay.

Another important point is that the locations of the erase head is close enough to the record/replay head to allow quick drop-ins. Using the punch-in facility the continuous movement of the tape prior to record "punch-in" ensures silent change over, although using the record/play transport functions requires the usual small manual windback of the tape to remove the "click" at the start.

All level setting of the A-8 inputs and outputs is done from your external mixer and signals are medium impedance, unbalanced at a normal level of -10dBV. The input and output sockets are RCA phono types and the remote control connects via a multiway socket.

## Transport

Threading tape on the A-8 is quick and easy. A suitable 7" reel of tape is placed on the left hand supply reel table and fastened with a knob that screws on to the centre pillar, having first located a smaller post in one of the tape hub holes (most tapes have this extra hole although it may be covered by a label). This simple method is quite adequate in use and holds the tape securely.

A take-up reel is clamped similarly on the right hand table — Fostex supply a well made metal 7" reel for this purpose. The supply reel tape passes under a moving tape guide that also acts as a tension arm, over the

supply idler roller, which lines up the tape and acts as a mechanical filter. It then passes under the headblock containing two heads for erase and combined record/replay, between the metal capstan and rubber pinch roller (the latter well enclosed with a removable metal cover), over the take-up idler roller, under the take-up tape guide (and tension arm), and finally on to the take-up reel.

The headblock presents no problems during threading as the tape simply passes under it and will locate itself correctly when the tension is taken up.

In the headblock, three height guides are used and have internal rotating plastic inserts similar to the other guides. Height and azimuth adjustments can be made using the three screws that fasten each head to the top metal plate. There is also a pillar that mechanically lifts the tape away from the heads during fast transport. A spring-loaded "cue" button protruding from the block allows monitoring of the recorded tape during fast forward or rewind.

An unusual feature is the additional headshield that is manually "push-switched" into place over the tape (at the record/replay head) after the tape has been threaded. If the headshield is not depressed during threading, of course, no sound will be heard as the tape does not make contact — a task easily forgotten! It is provided to shield the sensitive recording circuitry from stray hum and noise.

Once the tape is threaded on the A-8, it is necessary to turn the take-up reel sufficiently for the tension arms to be under tension, otherwise the transport will switch off. Thus, when the tape is finished or when a tape reel is knocked accidentally, the transport will stop.

## Construction

The audio electronics are fully modular using screened PCBs and there is a large mains transformer mounted away from the heads between the reel tables. Beneath the transformer are three small DC motors (which are less affected by heat than AC motors), that drive the two reels and capstan. The reel tables and capstan are each indirectly driven by a strong rubber band that has a life expectancy ten times longer than the record/play head (the latter should last over 1000 hours continuous use). The main fuses are easily reached at the top of the chassis, with the transport and micro control board able to be lowered for access. Dual channel replay and record modules plug into a mother board with master bias oscillators. All interconnections are neatly made with connectors and coded ribbon cable.

Under the top outer casing of two tone grey plastic is a pressed metal deck plate which, despite the overall light weight, appears to be quite adequate. Complimenting the smart outer appearance of the machine is a brushed aluminium meter panel, and logo and trim lines in "Fostex" orange (a favourite colour of Abe, the M.D.).

Four press studs secure a bottom plate

## Fostex A-8

and these can be prised off with some difficulty to reveal all the trimmers necessary for complete setting up of the machine. Channels were not numbered on the review model but were found by gently touching a small screwdriver tip as it rests on one of the eight presets in the selected adjustment, for level or EQ (future A-8's have labelling). No sophisticated equipment is needed for setting up and most of it can be done using in/out checks with the meters, an oscillator and an oscilloscope, although alignment tapes are quoted in the manual along with procedures.

Of course, regular cleaning and demagnetisation are essential and the 16-page manual supplied gives instructions in these areas as well as full operating details. Lining up different tapes is not really a problem and is done by adjusting the various presets for record and bias according to the straightforward instructions.

### On Test

The Fostex has been used daily for over a month in the production of E&MM demo cassettes and for backing tracks and music at recent exhibitions and lectures. During that time, my initial scepticism of the machine turned to one of complete confidence in the recorded results. E&MM's electro-music studio is packed with recording and computer equipment at one end and synthesisers, sequencers, drum machines and rack mixers/effects at the other. By mounting the recorder on one of its packing pieces, I could situate it directly behind the equally small 350 mixer and take up very little shelf space indeed. I then positioned a Yamaha guitar on/off switch with a long lead at the keyboard end ready for punch-ins. With remote control at your playing position and optimum levels set for undistorted input, it was simply a matter of selecting the track(s) for record and getting on with the track laying.

The reset-to-zero is a boon in use and the LED counter is readable from at least 15 feet away. The combined record/replay head may be regarded as a limitation for the more advanced studio (since off-tape monitoring cannot be done on the tracks in record). But for the musician who does both the recording and playing it becomes an advantage, as simul-sync switching is not required and the whole operation is simplified.

When cueing up a track, movement of the tape in "stop" mode is against the head for aural monitoring of the correct position. It takes under half a second for the transport to pick up, so instant drop-ins from one section of music to the next are best done using the punch-in facility.

Despite the small size of the VU meters, they are accurate enough and the extra 2dB headroom is useful. The LED indication of "record" and "ready to record" is a good implementation too. Anyway, I tend to meter from sub-mixers for the keyboards and have a Brenell PPM dual meter box in the playing area monitoring the stereo line in.

The A-8 is certainly best with noise reduction and because it's highly unlikely



The Fostex equipment alongside Revox and Teac machines during review test.



Mickey Matsumoto, engineering manager and Yuki Ikeda, overseas sales manager at the Fostex launch in London.

that you'll want to play a master tape on another machine, there are none of the usual stringent setting up requirements.

In the whole 1½ months of use, I did not encounter overload distortion problems, even though I kept the signal (without limiting) well up to 0dB average. This implied adequate headroom in the input, noise reduction and output stages (and of course, a good tape!). At one point I was recording over used tape new material and this, as with most semi-pro recorders, is best done after a "silent" record run-through to avoid the chance of clicks and extracts breaking through. The erase function was satisfactory even on high levels of the full eight tracks.

Once the system is connected up, I must admit to staying with the A-8, rather than use the 4 track! On first use, the pulley drive noise during fast wind worried me slightly, but the transport is perfectly reliable with no tape slipping or breakage. This is where the micro logic control plays its part.

Dolby noise "breathing" was not evident although on occasional punch-in's clicks were recorded. The Edit spill is usually a pro-studio machine facility and was a new feature for me as I've got used to spooling my own tape by hand over the years. The pitch control musically provides a noticeable change, and although the amount of control (just a fraction under a tone up or down) is fine for matching instruments, voices etc., I still had to resort to Revox Varispeed for larger pitch jumps and analysing music at slow speeds.

One slightly disturbing effect that occurs on record, is that the meters adjacent to the

tracks in use pick up part of the signal as well. On playback, however, all is as it should be. It is possible to detect during playback through a mixer a slight breakthrough of sound on adjacent clean tracks, but this is no worse than some 4-track machines and has no deterrent effect unless you're monitoring "silence" with blank tracks full up and full tracks with sliders down. For horizontal operation, clearance has to be made for the connection sockets at the rear.

In conclusion, the A-8 will produce recordings of a high quality, acceptable for concert and stage masters and radio stations, and may well provide demo cassettes that find their way on to records. In the studio, I was able to put together 8-track tapes very quickly with a minimum of operation. Doing a live recording of a gig or concert is much less hassle with gear, as the complete 8-track system of A-8 recorder and 350 mixer sits easily on the front seat of your car. There are plans for dealer "recording" workshops with the Fostex which is good news and a tape competition too.

If you're one of those dedicated musicians who, like me, has spent years first bouncing tracks from mono tapes/cassettes, stereo reel to reel, right up to the luxury of 4-track, then the A-8 has to be a very serious proposition in view of its potential, portability, performance and price.

**Mike Beecher**

**E&MM**

Recommended retail price is £1177.80 exc. VAT. Further information from the U.K. distributor: Bandive Ltd, 8 East Barnet Road, New Barnet, Herts EN4 8RW. Tel: 01-440 9304.

# MUSIC KITS

ALL WITH PRINTED CIRCUIT BOARDS!

Kimber-Allen Keyboards	SEE LISTS	P.E. Minisonic Synth	SET38	181.56	
128-Note Sequencer	SET76	120.45	Phaser	SET88	21.08
16-Note Sequencer	SET86	64.63	Phasing & Vibrato	SET70	36.25
3-Channel Mixer	SET107	21.50	Practise Amplifier	SET106	22.15
3-Microphone Mixer	SET108	12.99	Pulse Generator	SET115	24.84
6-Channel Mixer	SET90	96.67	Rhythm Generator	SET103	SEE LISTS
Analogue Reverb	SET83	45.92	Ring Modulator	SET87	13.62
Audio Effects	SET105	15.12	Sewar	SET101	31.85
Chorosynth	SET100	125.04	Signal Tracer	SET109	17.50
Compressor	SET120	25.05	Simple Phase Unit	SET25	10.54
Digital Reverb	SET78	75.50	Smooth Fuzz	SET91	11.68
Discostrobe	SET57	39.78	Speech Processor	SET110	12.18

**NEW LIST NOW READY!**  
SEND S.A.E. FOR FREE COPY

Drum-Synthesiser	SET119	50.11	Split-Phase Tremolo	SET102	29.98
Enlarger Timer	SET93	39.22	String Ensemble	SET77	214.47
Formant Synthesiser	SEE LI	342.71	Switched Treble Boos	SET89	12.51
Frequency Doubler	SET98	11.75	Synthesiser Interface	SET81	9.49
Funny Talker	SET99	16.55	Transient Generator	SET63	16.86
Guitar Effects	SET42	15.92	Tremolo	SET116	13.47
Guitar Multiprocessor	SET85	79.15	Tuning Fork	SET46	37.04
Guitar Overdrive	SET56	21.17	Voice Operated Fader	SET30	9.85
Guitar Sustain	SET75	11.77	Voice-Scrambler	SET117	21.81
Headphone Amplifier	SET104	21.15	Voltage Cont Filter	SET65	15.58
Metronome	SET118	10.58	Wah-Wah	SET58	14.01
Microphone Pre-Amp	SET61	11.32	Waveform Generator	SET112	23.13
Noise Limiter	SET97	15.96	Wind and Rain Unit	SET28	11.39

## PHONOSONICS

DEPT. MM21, 22 HIGH STREET,  
SIDCUP, KENT, DA14 6EH.

Telephone: 01-302 6184

SETS INCLUDE PCBs, U.K. P&P., 15% VAT, RES, CAPS, S'C.s, POTS, KNOBS, SW's, SKTS, WIRE, SOLDER, BOX, PHOTOCOPY OF ORIG. TEXT, FULLER DETAILS AND MORE GREAT KITS IN OUR FREE CATALOGUE.

Prices correct at Press, E.& O.E., subject to stock

**Don Larking**  
Audio Sales

**Fostex Fostex**

FOR THE FULL RANGE  
AND DEMONSTRATIONS

IT'S GOT TO BE

**DON LARKING**  
**AUDIO SALES**

50, Cheapside, LUTON, Beds.

Tel: 0582 27195 or 26693

Telex: 825488 DONLAR

New & Used Professional Recording Equipment  
Showroom open:- Mon-Fri 10am - 6pm Sat.  
By appointment



Just **50p** will bring you the latest Wilmslow Audio  
80 page catalogue packed with pictures and specifications  
of HiFi and PA Speaker Drive Units, Speaker Kits,  
Cabinet Kits . . . .

1000 items for the constructor.

**CROSSOVER NETWORKS AND COMPONENTS.**  
**GRILLES, GRILL FABRICS AND FOAM. PA, GROUP**  
**DISCO CABINETS - PLUS MICROPHONES -**  
**AMPLIFIERS - MIXERS - COMBOS - EFFECTS -**  
**SPEAKER STANDS AND BRACKETS - IN-CAR**  
**SPEAKERS AND BOOSTERS ETC. ETC.**

★ Lowest prices — Largest stocks ★

★ Expert staff — Sound advice ★

★ Choose your DIY HiFi Speakers in the comfort ★  
of our listening lounge.

(Customer operated demonstration facilities)

★ Ample parking ★

★ Access Visa American Express accepted ★



0625 529599

35/39 Church Street, Wilmslow, Cheshire SK9 1AS



Lightning service on telephoned credit card orders!



## S & R AMPLIFICATION



★ 500 WATTS SINE WAVE PER CHANNEL INTO  
2 ohms. ★ 0.005% DISTORTION AT ANY FRE-  
QUENCY FROM 20HZ TO 20KHZ. ★ SIGNAL TO  
NOISE RATIO 120DB. ★ POWER BANDWIDTH 10HZ-  
100KHZ ± 1db. ★ DUAL POWER SUPPLIES USING  
TOROIDAL TRANSFORMERS. ★ HIGH TECHNO-  
LOGY MOS-FET OUTPUT STAGE. ★ FAN COOLED.  
★ WE HAVE JUST DESCRIBED OUR STANDARD  
NO-FRILLS POWER SLAVE AMPLIFIER. ★ ANY IN-  
PUT SENSITIVITY CAN BE CATERED FOR AS STAN-  
DARD. ★ STUDIO VERSION AVAILABLE WITH  
METERS BALANCED LINE ETC... ★ STANDARD  
PRICE £385.00. ★ STUDIO VERSION £455.00.  
★ ALSO AVAILABLE AS SINGLE 500WATT £195.00.

**S & R AMPLIFICATION**  
6 Tanners Hill, Deptford, London SE8  
Telephone: 01-692 2009

# CLEF ELECTRONIC MUSIC



## ELECTRONIC PIANOS SPECIALISTS SINCE 1972

Clef Pianos adopt the most advanced form of Touch Sensitive action which simulates piano Key inertia using a patented electronic technique.

**7 1/4 OCTAVE DOMESTIC MODEL**  
**COMPONENT KIT £244**  
**COMPLETE KIT £399.90**  
**MANUFACTURED £675**



Two Domestic Models are available including the 88-note full-size version.

Four intermixable Voice Controls may be used to obtain a wide variation of Piano Tone, including Harpsichord.

Both Soft and Sustain Pedals are incorporated in the Design and internal Effects are provided in the form of Tremolo, Honky-Chorus, and Phase/Flanger.

A power amplifier integrates into the Piano Top which may be removed from the Base for easy transportation.

**SIX OCTAVE DOMESTIC MODEL**  
**COMPONENT KIT £217**

**COMPLETE KIT £363.90 MANUFACTURED £595**



Component Kits include Keyboard, Key-switch hardware, and all electronic components and may be purchased in four stages at no extra cost.

Complete Kits further contain Cabinets, wiring harness, Pedals and in the case of Domestic Models both Power Amplifier and Speaker.

The Six Octave Stage Piano has the same range of Voices and Effects and is designed for use with an External Amplifier and Speaker.

**SIX OCTAVE STAGE MODEL**  
**COMPONENT KIT £217**

**COMPLETE KIT £349 MANUFACTURED £530**

Since 1972 Clef Products have consistently produced leading designs in the field of Electronic Musical Instruments, many of which have been published in technical magazines. With musical quality of paramount importance, new techniques have been evolved and the latest musically valid technology has been incorporated into projects which have been successfully completed by constructors over a wide range of technical capability. Back-up TELEPHONE advice to our customers is available from the Designer of all Kits advertised.

## "THE COMPUTER BAND-BOX"

(As Published in conjunction with 'Practical Electronics')

**Complete Kit**  
**£289**



**MANFD.**  
**£399**

### A revolution in the field of Computer Music Generation!

*A MUSICIANS INSTRUMENT FOR SOLOISTS — SINGERS — RECORDING PRACTICE — LIVE PERFORMANCE — COMPOSITION*

The BAND-BOX provides an Electronic Backing Trio consisting of Drums, Bass, and a Chord Instrument (one of 16 Waveform/Envelope combinations), with the capacity to store over 3,000 User Programmable Chord Changes on more than 120 different Chords. Using advanced Microprocessor technology, Playback of 50-100 Scores can be executed in any Key and at chosen Tempo. Complete Music Pad is electronically Indexed and stored on secondary battery back-up. Facility exists for composition of Intro, Repeat Chorus, and Coda sections including Multiple Score Sequences. Sockets are provided for Volume Pedal and Footswitch plus separate and mixed instrument Outputs. Total size 19" x 11" x 4 1/2" incorporating Master Rhythm.

## THE Programmable DRUM MACHINE

(As Published in conjunction with 'Practical Electronics')

**EIGHT TRACK PROGRAMMING/TWENTY-FOUR PATTERNS/TWELVE INSTRUMENTS SEQUENCE OPERATION.**

**COMPLETE KIT £79.00**  
**MANFD. £119.00**

available to twelve, grouped into sounds typical of playing with Drumsticks, Brushes, or Latin American Bongos and Claves.

Sequence operation allows two rhythm sections to be coupled with the second (B) section appearing at four, eight or sixteen Bar repetition. All drums can be adjusted for level and resonance on internal controls to suit individual taste, thus producing good musical sounds in a battery driven unit 8 1/2" x 5" x 2 1/2".

The Clef Master Rhythm is capable of storing 24 selectable rhythmic drum patterns, invented, modified, and entered by the Operator on to Eight Instrumentation tracks. A three position Instrumentation control expands the number of instruments



### STRING ENSEMBLE

(As Published in conjunction with 'Practical Electronics')

Versatile String Synthesiser with split keyboard facility and impressive voices. 49 note organ diode keyswitch system with four pitches plus two phase Chorus generator. Kit includes Swell Pedal.

**COMPONENT KIT £179.00**

### ROTOR-CHORUS

Comprehensive two speed organ rotor simulator plus a three phase chorus generator on a single 8" x 5" pcb. The kit includes all components for mains operation and a stereo headphone driver pcb. Easily integrated with existing organ/amplifier system.

**COMPONENT KIT £89.00**

### KEYBOARDS

Our Square Front Keyboards are chosen for their superior feel to the discerning musician whilst giving adequate physical strength for the high impact playing present in the Piano application.

**88 NOTE (A-C) £57.00**  
**73 NOTE (F-F) £47.00**  
**FIVE OCTAVE £38.00**  
**FOUR OCTAVE £28.75**

PRICES INCLUDE VAT, UK CARRIAGE & INSURANCE (CARRIAGE EXTRA ON MFD PIANOS). Please send S.A.E. for our complete lists, or use our telephone. VISA/ACCESS Service. Competitive quotations can be given for EXPORT orders — in Australia please contact JAYCAR in Sydney.

ALL INSTRUMENTS MAY BE SEEN IN OUR SHOWROOM

# CLEF PRODUCTS (ELECTRONICS) LIMITED

(Dept. E&MM/2/82), 44a Bramhall Lane South, Bramhall, Stockport, Cheshire SK7 1AH 061-439 3297

# Tokai ST50 Guitar and PB80 Bass



The ST50 guitar.

Reviewing new instruments for you guitar buffs out there is not quite the easy, pleasant task you may imagine it to be. By and large, there is more to depress the budding muso than there is to impress him. But once in a while along comes something that really catches your eye. The something that caught my eye is the new Tokai range of guitars from Japan, and the reason for this is Tokai make a 'new line' of instruments that are closer to forgeries than copies, so closely do they resemble the real thing.

The Tokai factory in Hamamatsu, just outside Tokyo, has for some time now been producing instruments under license for some of the major names including the Yamaha company. The factory is huge, ten times the size of either the Gibson Kalamazoo or Fender Fullerton plants. Word has it that Tokai owner Mac Seshimoto has done a deal with Fender, and will now be producing instruments for them at his factory.

The distributors in the U.K. for Tokai (pronounced *tock-aye*) are Blue Suede Music of Lancaster, and initially they will be importing around 55 of the 100 or so models in the Tokai range; they've already sold the first shipment. Amongst these will be an amazing copy of a 1958-1960 Gibson Les Paul Standard, complete with tigerstripe top. Though this is more expensive than Gibson's own ill-fated reissue, the Heritage series, it is a much more accurate copy, the pickups don't sound mushy and the neck angle is correct. If bass is your thing then Tokai have several choices for you, six variations of the Precision Bass (more of these later) and a choice of nine Jazz basses, three of them fretless. If dot fretboard 335's are your turn on take your pick from four of these. You may have had trouble finding one of those beautiful old Custom Telecasters, the type with the double binding that Andy Summers uses, Tokai have one of these too. Where these Japanese 'pirates' are really going to

score is with their range of Stratocasters which number around two dozen. Tokai have copied the neck profile of the 1964 Fender Stratocaster (pre CBS of course) and come up with the ST 64 range. They've also copied a 50s maple neck Strat and given us the ST 54 range, which to my mind is the biggest thrill in guitars since way back when.

## ST50 Guitar

The Tokai ST50 from the ST54 Vintage range (damn confusing all these numbers) is in effect a copy of the 1954 two tone sunburst Fender Stratocaster, a very endearing one at that. I showed the instrument to fellow Japanese guitar loather Richard Thompson, who does in fact play one of the originals. I had to agree with him when he said "It looks like the Japanese have finally cracked it." Some people have said that they are still only copies. So what is the average Schechter, have you asked yourselves?

To start with, do you like your headstocks small, pre-CBS in other words? Of course you do. Now look a little closer at that writing on the headstock. Those Japs sure are inscrutable, they've very cleverly changed the writing so as to avoid any copyright complications. "Original contour body" becomes "Oldies but Goldies", and the patent numbers are replaced by the legend "This is the exact replica of the Good old Strat"; how right they are.

The finish is breathtaking and would do credit to a master forger, or a master sprayer if it comes to it. Colour options are flamingo orange (very close to Fender's own Fiesta Red), metallic red, metallic blue, black, olympic white, natural, three tone sunburst. My test model is in the original style two tone sunburst. The guitar balances perfectly, and feels just right as far as weight goes. One annoying thing I notice is that Tokai have omitted to give us a bridge cover, they're pretty useless but make wonderful ashtrays.

The guitar neck sports the usual 21 frets, and the gauge is somewhere in between Fender thin and Gibson fat frets. There is one circular string guide and the nut is made of plastic. Neck camber is medium, and my test model is fitted with a delicious 'U' style neck which is incredibly comfortable to play. The range is offered with optional 50s style 'V' neck, which is perhaps slightly more ethnic given the situation. Both necks, I hasten to point out, are extremely comfortable; I've tried them both. Position markers are black dots as you would expect, and the grain on the timber is something to behold and marvel at. Machine heads are Tokai heads in the old Fender (Kluson) style, they perform very well and much better than you could hope to find on an old Fender.

Bodies for the Tokai ST50 (ST54 range) come in a choice of Alder, Linden or Castor Arabia which I have to confess I've never heard of, no matter. The neck joint is of the four bolt type and the fit is excellent; in other words no space to wedge in a selection of your favourite picks. Action is superb, and the bridge saddles look exactly like the old Fender type and adjust in the same manner. Three tremolo return springs are fitted to the guitar as standard, with another two in the case should you like to add them. The guitar holds its tune very well after I've given the tremolo a severe thrashing, which is unusual considering the guitar is fitted with very light strings.

Controls are identical to a Fender Strat, two tone and one volume, with the selector switch changed to a five way type which is eminently sensible if you're serious about doing business with this guitar. It's easy to change a string without removing the back plate, a positive bonus. The back plate and scratchplate are made from a single white plastic laminate which should in fact be a little thinner. Pickup covers on the originals were ceramic, on the Tokai they are plastic and all the metal parts are chromed.

Pickups are Tokai's own ST Hot and hot



The PB80 bass.

they are too. I noticed that the pole pieces are set higher than Fender pole pieces, though I doubt this explains away the sound. The tone, without mincing words, is that of a 1950s Fender Stratocaster, and it is staggering. I have never ever felt, played or heard a copy like this before. These pickups are a little less powerful than the originals but the tone is all there. Fender pickups have a very annoying habit of pulling on the bottom E, which has the effect of creating two notes instead of one. On my Tokai there is none of this, intonation is superb.

The main problem with this guitar, and indeed with all the Fender style models in the Tokai range, is this. There is no groove provided in the scratchplate below the neck for trussrod adjustment, this necessitates removal of the scratchplate, which is very laborious. Hopefully Tokai will remedy the situation.

All in all, of the thousands of guitars it's been my pleasure to play, this is one of the finest. And the price? Around £195 — treat yourself. You won't be disappointed.

## PB80 Bass

And now, for the bass faces out there in guitarland, we have the Hard Puncher series. My test model is the PB80 which is not unlike a 50s maple neck contour body Precision, complete with anodised aluminium scratchplate in silver. The scratchplate should be gold, however . . .

This guitar has a two piece body of Castor Arabia/Alder or Linden, type not specified. Machine heads from the front look like the normal Precision type, i.e. large Klusons. From the back we discover a funky reverse gearing, which means the system works in the opposite direction when you turn the pegs in the normal manner. Nice one here — there's even a strap button on the reverse of the headstock.

The neck is maple, has a slight camber,

and there are 20 frets which are pretty much Precision gauge. Neck fit is again excellent and of the four bolt type, whilst the whole neck and board are lacquered, a bit too heavily I would say. The nut is plastic, inlays are black and colour options are the same as for the ST54 Vintage guitar range.

Weight is average for a Precision, but the

balance is not as good as I'd hoped. The instrument is definitely neck heavy, and the neck itself is a little on the large side though it does play well. The contour of the body at the bottom left bout should be a little thinner than that on my test model.

All fittings are chrome, the bridge arrangement consists of four separate saddles and controls are one tone and one volume. My PB80 is in a two tone sunburst finish (again) and is very imposing, a classic in other words. One odd thing is this, the PB80 has no thumb rest but holes have been drilled in the scratchplate should you require to add this or a hand rest . . . How odd.

After I've been playing the bass for twenty minutes it's still in tune and it is sounding very tasty indeed. The pickups which could have been either Tokai's PB Vintage, PB Super or PB Dynamic (sorry, but the literature is in Japanese) have lots of sparkle on the top end and pack plenty of punch.

Once again, trussrod adjustment is impossible without removing the scratchplate, and I sincerely hope that Tokai will do something about this.

Fender style cases to fit these Tokai models are not included in the price of the guitar, but the case for this bass is particularly handsome due to its tweed/linen finish capped by a metal plate bearing the Tokai name.

The PB80 costs around £300, which is reasonable, but expensive when you compare it with its sister model that I've just reviewed. I have been able to draw several conclusions from my week spent in the company of the Tokai range. These guitars are a positive breakthrough for guitar players at all levels, i.e. beginner to pro, due to the price and the quality respectively. If Tokai can improve on their current output they are destined to carve for themselves a very large slice of the guitar market.

Max Kay

E&MM



Close-up of the ST54's headstock.



## Martin Gore *Depeche Mode*



Photo: Antione Giacomoni

"In the beginning we had to use keyboards, because of the problems the backline was posing us — we had to cart around amps and things. With synths we could DI, which made it a lot easier when we were having to travel up to London. We prefer the sound anyway, there's so many different sounds on the synth, whereas with the guitar you're stuck with the sound."

### Keyboards

Live: Yamaha CS5; Studio: PPG-wave computer. "The PPG is really different, the sounds are so clear on it. Before, we were using things like the JP4, but with the PPG the sounds are so clear, you can go through the waveforms on it — it's just so much better. It all comes up on a little screen — you can see exactly what you're putting in. When you play your recorded sound back, your program number, all the things you've used come up on the screen so you know exactly what's in the sound. We're not too sure about it yet, we're getting to know it. We work with Daniel (Miller, producer) on that, he knows a lot about synths and helps us. In the price-range, the PPG was by far the best that we went to see.

"At the moment there's a lot of trouble with the compatibility of sequencers and keyboards — we've had a lot of trouble linking things up. If manufacturers could make them all interchangeable it'd make things a lot easier. Obviously they want their sequencers to work with their keyboards: it's a problem."

### Sequencers

An "old ARP sequencer"; Roland MC4.

### Amplification

All DI.

### Percussion/drum machines

Korg KR55; snare drum trigger from KR55 to drive sequencer (pulse through voltage inverter in ARP 2600 because of incompatibility).

### Favourite studio/engineer

Blackwing/Eric Radcliffe, John Fryer. "As well as knowing exactly what they're doing, they're really friendly, which helps a lot."

### Home recording

Teac 3440: "We bought it recently for the last tour — I don't get the time to use it as much as I'd like to, we're never at home!"

## Tony Hymas *Ph.D.*



"Keyboards are a pretty dominant factor in my music at the moment, and when I concoct tapes at home they're obviously very keyboard-orientated. But on the other hand I'm trying to get sounds that do sound a bit natural and do have sound pictures associated with them. So I suppose it's the terrible thing of the keyboard player trying not to sound like a keyboard player. In search of an answer, I plough on."

### Keyboards

Bechstein grand piano; Prophet-5; Rhodes Suitcase 73; Minimoog; ARP Odyssey; Oberheim OB1. "Somebody brought a Prophet round once and I fell in love with it — if I really like the look of something I'm afraid I have to go and buy it. I found it difficult to come to terms with my first synth, the ARP, so I went and got the OB1 which you could preset sounds on. But for lead work I end up using the Minimoog a lot, and the Prophet funnily enough. I came to the Minimoog quite late, I only picked mine up about nine months ago when I realised they were gonna stop making them. It's got a marvellous sound all its own. I still love the sound of the Rhodes, too.

"One criticism: I wish the knobs on the Prophet didn't have such a large area for parallax problems — the mark on top of the knob's at least 1/2in away from what you're lining up to. It should be flush, like Moog's."

### Sequencer

Roland CSQ600 (to OB1).

### Amplification

"I've tended to use Amcrons on tour, which have all been provided. At home I just DI everything."

### FX

Electro-Harmonix Electric Mistress flanger on Rhodes "still makes a great sound". Great British Spring reverb.

### Percussion/drum machines

Roland TR808. "A digital readout for tempo would have been useful, it's extremely difficult to fine-tune accurately with the knob."

### Favourite studio/engineer

Rampport/Will Reed-Dick. "I'm very happy working there, we get on very well."

### Home recording

Fostex A8 8-track; Fostex 350 mixer; Revox stereo.

## Don Airey



"The finest keyboard to me is a grand piano — playing multi-keyboards, there's so many problems with balance and you're always compromising. I think that makes electronic keyboards difficult to play, but I don't know what my life would be like without a Minimoog or a CS80, they open up so many avenues to you as a performer."

### Keyboards

Hammond B3 'customised' + two Leslie 147 cabinets; Yamaha CS80; Minimoog (stable oscillator boards, sync on oscillator 2, sequencer input mods); ARP Odyssey; Hohner Clavinet C; Rhodes Suitcase 73; Roland Vocoder Plus; Oberheim OBXa; Casiotone 201. "I get a lot of my sound from the B3 and the CS80 together, a real meaty sound for heavy rock. I could go on for hours about the CS80, the rich sound of the oscillators, it's an absolute masterpiece of design and I'm really surprised Yamaha have given up that direction. I've had the Odyssey six years and never had it seen to, ARP say it'll be good for another six — an amazing machine. The Clavinet's a real old one, beautiful sound. The Vocoder I use mainly for its strings, nice little machine, and the OBXa I prefer to the Prophet or OBX; it's made a great impact on me. The Casio's a good hotel-room practice keyboard.

"But I'm dismayed at the kind of product coming out, there's so much rubbish. I don't think we've made any real progress since the 60s in the kind of sounds you can get from synths."

### Sequencer

Sequential Circuits 800 (to Minimoog).

### Amplification

Two Moog Synamps and cabs.

### FX

Lexicon PCM41 digital echo; H/H Tape Echo; MXR Flanger; CS80 in stereo through MXR Stereo Chorus, "a subtle, harmoniser-like effect".

### Percussion/drum machines

"An old Hammond drum machine."

### Favourite studio/engineer

Morgan 1/Chris Tsangarides: "I seem to spend a lot of my time there, I always enjoy playing there." Marcus/Pete McNamee: "Marvellous studio, very fine engineer."

### Home recording

Teac Portastudio; Revox stereo. "I'm thinking of buying an Otari 8-track."

# A HISTORY OF ELECTRONIC MUSIC

In the late 1950's, as we have seen 'musique concrète' was popular as a method of producing new and unusual sounds, which could be transformed, manipulated and used as the basis of much new music. Although popular for quite a while after this, one development was to have a greater effect on the music right up to the present day. It was the synthesiser. The word synthesiser is often misused, and in this text it denotes a multi-function machine possessing sound generators, filters, mixers etc. Harry Olsen and Herbert Belar completed the first synthesiser in 1955 — the RCA Mk I. However, in 1959 the Columbia Princeton Studio acquired the RCA Mk II synthesiser. It was unlike the previous Mk I version in as much that it functioned on a binary number system. The Mk II version also made use of punched paper rolls. In a binary system there are only two digits, 0 and 1. The control of each component (sound sources, filters and modifiers) is contingent upon specific binary information. Composers were able to specify the various elements of composition in a decimal form and then assign them a binary code. The encoded numbers were punched in to the paper roll which was divided into five paired columns, one column signifying 0, and the other, 1. The information was then conveyed to appropriate circuits via sets of brushes sensing the holes and activating the appropriate relays.

With its unique control system, the Mk II was capable of controlling frequency, duration envelope, harmonic spectrum and temporal progression of sonic events. It could be programmed to play forward, backward, faster and slower — techniques which would have taken a composer a lot of time and patience to accomplish using classical studio techniques.

Milton Babbitt, co-director of the studio, loved the freedom that the Mk II had given him and used it for his most important works including 'Ensembles for Synthesiser' (1961-63)<sup>1</sup>. 'Ensembles' is an effort to produce instrumental sounds, rich in complex rhythms, pitches and organisation not available from conventional musical instruments. It makes a convincing case for the use of electronics in music, and although not that accessible, it makes rewarding listening after several hearings.

At about the time of the arrival of RCA's Mk II synthesiser, Harold Bode, a German engineer, suggested in an article a new concept in the design of equipment using modular systems. The advantage being that each piece of electronics (oscillators, ring-modulators, etc) would be self-contained and thus the user could custom build his own system.

Three years later at the request of a young composer, Max Deutsch, Robert Moog built a modular voltage controlled oscillator (VCO) and a voltage controlled amplifier (VCA). The following year he completed a voltage controlled filter (VCF). The revolution of using voltage control was not appreciated by composers until 1967. Prior to Moog's voltage control, electronic devices were

Derek Pierce

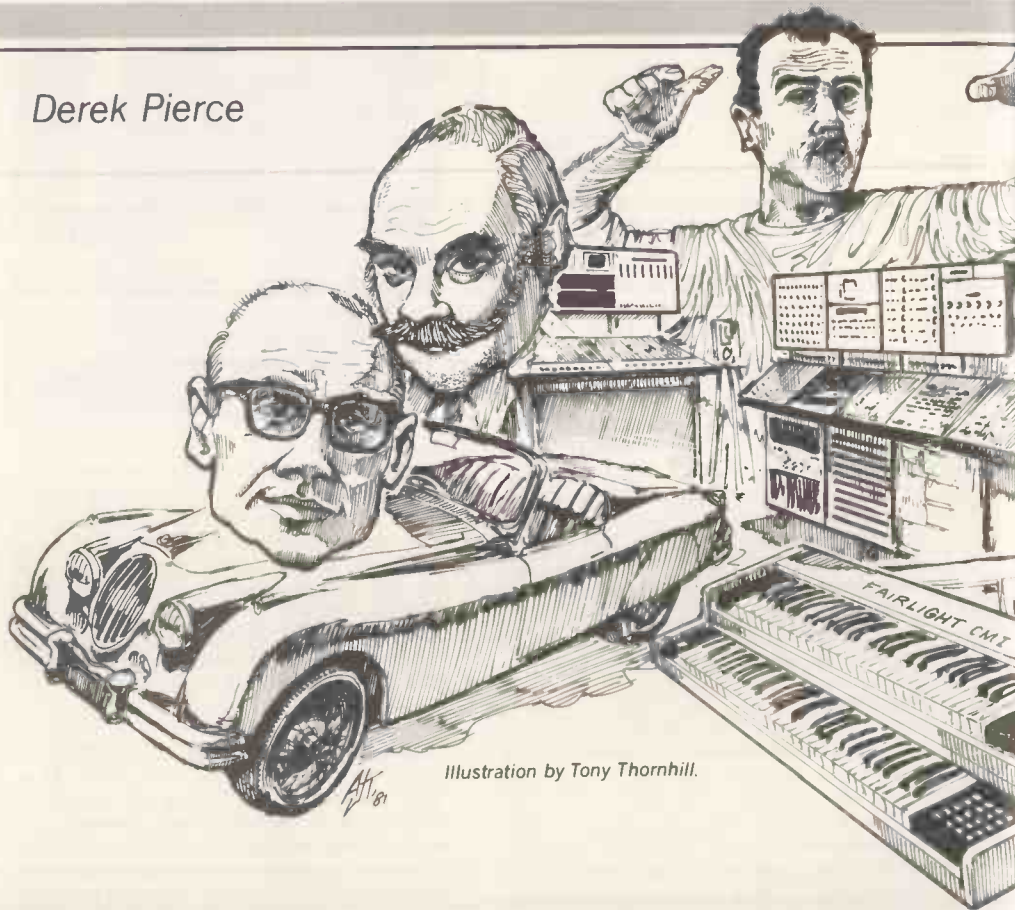

Illustration by Tony Thornhill.

controlled manually, composers needed to turn knobs and dials to give them the variations they needed. Their manual dexterity limited the number, speed and accuracy of changes that could be made. Since an electrical signal can move considerably faster than human dexterity, and can be measured accurately with a voltmeter, voltage control provided a major step for electronic music composers.

Control voltages can be divided into two main categories, passive and active. The former consists of those voltages produced by the keyboard, sequencer, or random voltage generators. The latter are derived from VCOs, VCAs and VCFs. Frequency followers and envelope followers convert pitch and amplitude respectively, to proportional voltages which can also be used to control modules. By joining together various modules the voltage from one can be used to control the other. For example, frequency modulation is achieved by periodic variation in the frequency of VCO 1 by, say, VCO 2 and using a fairly slow modulation rate produces the familiar vibrato effect.

Although the Moog voltage controlled synthesiser became much better known, it was not the only one available in these early years. In California for instance, Donald Buchla, an engineer working with composers Morton Subotnick and Ramon Sender, jointly developed "an electronic music 'machine' that would satisfy our needs as composers", to quote Subotnick. Thus was born the Buchla synthesiser although, unlike the Moog, it did not use a keyboard. This made it less popular for the

roles in which the Moog became well known, i.e. as a keyboard instrument in rock music and jazz.

Although at the time the synthesiser was not available to the general public, the need for a live performance synthesiser was realised by Paul Ketoff, a technical supervisor of NIS Films in Rome. He developed the 'Synket' for live performance, notably used by American composer John Eaton. Eaton first employed the Synket with soprano and piano in 'Song for R.P.B.'. His fascination for microtones is immediately apparent in his compositions, being found in both vocal and synthesiser parts. It is not surprising, therefore, that he went on to form the Microtonal Music Ensemble. He later expanded his number of synthesisers to perform 'Blind Mans Cry'<sup>2</sup>, a piece with an intense vocal style that blends with the Synkets to produce an expressionistic atmosphere. Returning to the more popular Moog, it is interesting to listen to a recording of 'Reconnaissance' by American jazz trumpeter Donald Erb (None-such H 71223). This record is one of the first to bring together conventional instruments, i.e. trombone, bass, violin and the new range of Moog instruments, which were able to realise many of the effects of the electronic music studio during live performance. Despite the fact that during 'Reconnaissance' performance, Erb needed the assistance of three helpers to move the plugs and switches of the Moog's control panels!

Before synthesisers became commercially available, American musicians in particular showed an interest in the application of computers to musical composition.



Fairlight CMI.

oscilloscope and redrawn using a light pen to produce an even greater variety of sounds.

Computer generated sounds were first produced by Max Mathews of the Bell Telephone Company, New Jersey in 1957 and composers who used this technique included John Pierce, James Tenney, Jean Claude Risset and Frederick Moore. By 1968 Mathews had also developed the light pen as used later in the Fairlight CMI.

The third possibility in the area of computer music, was the use of the computer to control synthesiser or other analogue equipment. Peter Zinovieff was a pioneer in this field. Working in England early in 1968, together with English manufacturers EMS who produced the first cheap and portable machine, he designed one of the first synthesisers to include a computer, the Synthi 100.

One early application of computer control, was as a sequencer (a device which produces a series of voltages one after the other and used to control modules). This particular function is popular today and is used to full effect by such people as Giorgio Moroder, Kraftwerk, Tangerine Dream etc.

The development of both the voltage control synthesiser and the computer have gone hand in hand right up to the present time, resulting in an increased popularity of both in the field of music. In spite of all these electronic developments, many composers continued to use 'natural' sounds, one of the most notable being Pierre Henry's 'Variations for a Door and a Sigh' (1963)<sup>3</sup>. 'Variations' offers proof that the French tradition of 'musique concrète' was still a viable compositional tool. The tape music of Italian Luigi Nono was also to the fore in this particular form of music, being both highly theatrical and immensely political.

During the period being discussed here, Stockhausen was busy formulating a concept known as *intermodulation*. It was a logical development of previous methods of treating timbre, and was the result of combining two or more sounds so that their interaction transformed the final result. Whatever sonorous elements were used i.e. rhythm, pitch or timbre, Stockhausen maintained the result was a higher unity. The first composition to use this concept was 'Tele-musick'. This was an attempt towards a universal music as the result of an inter-modulation between folk music and electronically produced sounds.

As well as the highly composed areas of electronic music, there was a school of electronic music improvisation developing, being influenced by both composers in the Cage school, as well as the self expression offered by jazz. One of these was the London based AMM group which included composer Cornelius Cardew, as well as several jazz musicians. A former associate of Stockhausen, Cardew stated that AMM stood for "a very pure state of improvisation operating without any formal system or limitation". Free music indeed!

Various other electronic improvisation groups flourished particularly in Europe. A group of American composers living in Rome formed *Musica Elettronica Viva* (MEV) in 1966. Their line-up included conventional instruments as well as tape recorders, a Moog synthesiser, photocell mixers and various other unusual devices. Brainwave amplifiers, for instance, were used to derive control voltages from neurological responses such as blinking. One of their finest pieces on record is entitled 'Spacecraft'<sup>4</sup>. Brainwave amplifiers and photocell mixers added new resources to improvisational situations. Brainwave amplifiers connected the performer's physiological response to the production of sound. Light beam mixers added a new approach to the control of sound by using a different medium to control it.

The response from the sounds produced, together with the feedback obtained both visually and acoustically, linked the musicians, their environment and the audience. To MEV this total involvement was an ideal. America, too, had its improvisational groups, the foremost of these being the Sonic Arts Union, formed in 1966 by American composers Robert Ashley, Gordon Mumma, David Behrman and Alvin Lucier. Most of their works were improvisatory, and some theatrical as well. Electronics were essential, particularly in the slow textural transformations that were their trademark. Gordon Mumma introduced the *Cybersonic Console* in a piece entitled 'Medium Size Morgraph' in 1963. It was, in fact, a console worn by the performer that responded to live sounds and either transformed or generated electronically new sounds from this information.

This fascination for exotic electronic devices is also a characteristic of the Sonic Arts Unit as a whole. They were probably the first group to use the *Vocoder*, a device produced by Sylvania Electronic Systems for the transmission of speech along telephone lines. It coded the voice in much the same way as the previously mentioned DAC and decoded it at the receiving end of the line.

Needless to say the developments and trends in the 'art' music world gradually found their way into the worlds of jazz and rock music. In the next part of the series we will look at developments in these two areas.

E&MM

#### Discography

- (1) *Ensembles for Synthesiser*. MS 7051.
- (2) *Blind Mans Cry*. CRI S 296.
- (3) *Philips 836 898 DSY*.
- (4) *Spacecraft & AMM Live*. Mainstream 5002.

Three distinct possibilities existed for their use.

The first of these possibilities occurred at the University of Illinois in 1957. A programme written by Lejaren Hiller and Leonard Isaacson was used to produce the score for a string quartet. It defined such parameters as pitch, duration and orchestration and gave rise to 'Illiac Suite for String Quartet'.

This method was used by Yannis Xenakis later, to compose 'Amorsima-Morsima' and 'Strategic, Jeu pour deux Orchestres'. Xenakis had by then formulated a compositional process based on statistics, probability theory and the theory of games.

The second possibility became popularly known as 'computer music'. In this medium, the computer actually produced the sounds by means of a 'Digital to Analogue converter'. A closer look at the Fairlight Computer Musical Instrument, available commercially since 1979, should provide us with all the elements used in digital sound generation. (Reviewed in detail in June 1981 E&MM.) For example, by analysing a waveform, it may be broken down into a series of numbers, converted to a binary code, and then stored in a computer's memory bank. On recall, this code can be transposed up or down in pitch as well as altering dynamics or harmonics. One of the main features of the Fairlight is its ability to 'sample' natural sounds through a microphone or tape recorder. This enables it to produce scales out of any sound from animal noises to the sound of breaking glass. (It's played on E&MM Cassette No. 2.) The resultant waveforms can be displayed on an

# HOME ELECTRO-MUSICIAN



It's like the 'Man' says, most Muso's dream of having their own studio someday, but like a lot of ambitions it often dissolves into an all or nothing syndrome. Getting our "Demesto-studio" together happened more by accident than deliberation. Literally that is! It all started one night, by being dragged into a trad band rehearsal to supplement an itinerant rhythm section. Most of the players frowned at my guitar and amp, so I never actually switched it on. That is until one stormy night when the Pie-ana player blew his lid and split. Suddenly I was no longer one of the great unwashed, and they chorused 'Plug it in Johnny, wind it up and go-go!' From then on my motto became 'If you can't join them — beat them'.

The music transgressed through every phase you could name, ending up as Heavy-Metal, and eventually getting banned from more places than we were booked. During this period, many feeble attempts were made at recording, ranging from a Fidelity reel-to-reel with crystal mike, to a portable cassette player strategically placed on the floor. Well, it certainly had ambience, with every single clatter being picked up, together with the strains of competing Bingo callers and juke boxes.

During this time, however, a few original musical gems(?) had been incubating, and crying out to be put down on tape. We had a brief stab at a two-track studio someone had set up in a disused and supposedly haunted cinema. It was a step forward, but the guy spent more time fiddling with the gear, than we did recording, and we had to be placed so far apart to get adequate separation, the drummer had to lip read to get his timing.

Then one wet Monday I was blithely riding my push-bike home, at only 29.5 mph (honest) when I was sideswiped by a car driven by the wife of a Fuzz man. Apart from lifting me 30 feet across the road, she actually complained I had bounced on her bonnet!

Well, at first I thought 'That's that', but it's an ill wind they say — etc, and remembering that I still belonged to a well known cycling touring organisation, I contacted their legal department.

Perry Mason-Rock couldn't have done a better job, they put the bite on. More than enough for a new bike, in fact just enough for the deposit on a TEAC 3340-S. So I picked up an old frame from the dump, re-cycled my bent bike, and blew the rest on the 4-track.

We couldn't afford any accessories other than a mic, one reel of tape, and a pair of quadrophonic cans. The jump in quality was startling, but with a recorder as a friend, you don't need critics. All those bits we used to fake our way through on a live show, now sounded worse at each playback.

At first we tended to squander the use of tracks, with most of the rhythm sounds on one and everything else just scattered around the remainder, but a bit of discipline and planning gradually takes over, and it's surprising how much can add on a 'take', especially with a running 'drop-in' which is easy on the Teac.

Eventually we acquired a four-channel power amp enabling us to replay each track

through its own speaker (4 x Poly Planar which we built ourselves). This avoids switching and enabled a more critical assessment. This was also coupled to a stereo tuner, record deck, and an Akai three-head cassette recorder. Our present mix-down unit (also self built) is totally passive, but with pan, effects send and receive, plus thumbwheel switches allowing us to cross-patch any input or output, and generate tape-echo during recording. The mic inputs of the recorder are very sensitive and easily overload on close-miking so we have constructed a double four into two mixer, with five-band graphics on each channel.

Noise and distortion was troublesome at first, but a bit of detective work cured that. For example a combo amp was giving us static, what with noisy controls, hum, CB and police breakthrough, even picking up Radio Moscow late at night. However, careful earthing, replacing pots and judicious use of kitchen foil has improved its performance so much we can even use the input channels of the combo as an additional mixer.

Tape, no corners should be cut here, only the best is good enough. We tried once economising with unlabelled tape and although the response and definition seemed fine, the final mix-down never matched earlier results. Doing an A/B comparison with a top quality tape gave a staggering 12dB increase in output for the same input level as the cheapo brand. Maxell and TDK are favourite now.

The band has now shrunk to a duo — it's much harder, but freer, and the music is better, having developed a style of making each note or sound really count, and utilising harmonies to the full. Yet so far our individual ideas are still widely diverse enough to avoid falling into the trap of an M.O.R. standard duo sound.

Our music puzzles some people, partly because of N.D.I. (no detectable influence!) and every number is really different, not by design, it just comes out that way. If one had to put a label of it we'd settle for 'Social Comment', probably as a result of playing in all those 'dives'.

The first studio was set up in the bedroom, tricky but interesting, at least it provided a better line than 'Come up and see my etchings'. We used to say the acoustics were better, but they weren't really convinced.

The technique that suits us is to get the equalisation on each instrument and track exactly as we want it at the start, double-checking on playback as we go, by listening to everything at normal hi-fi room level before proceeding. Then we use cans for the full recording to tighten up the timing, because every metre of distance between you and the sound source represents about a three millisecond delay (not many people know that!).

Our instruments consist of an Ibanez steel, and a Yamaha gut, six-string acoustics, a Vantage, a CSL, and a souped-up Wilson with preset tone and levels operated by pneumatic foot switch (six-string), a seven-string Custom, combined bass and lead guitar with tremolo arm and built-in five-way



active electronics. A standard four-string electric bass, a Pakistani banjo operated by typewriter keys, a five-octave Teisco with a three-way keyboard split, and our *piece de resistance* the "Pukerphone": merely a section of plastic drainpipe with grooves cut across, but with the addition of a mike and reverb it becomes an amazing electronic marimba. Although we mainly use guitars, each one has a characteristic sound of its own if you treat it right.

Accessories include electronic drums, home-built but tweaked up really neat, Dod analogue echo, Melos tape echo, phaser, fuzz, and wah, plus a beat-up drum kit, which having repaid its cost of £15 several times over is now in semi-retirement. Oh, yes, and some Indian goat bells — in fact we are willing to give any sound source a chance, even persuading one puzzled North Sea oil baron to start up his seven-litre "Transam" to get a really throaty engine sound for one number. Also whirling a mic around on 10 feet of lead to get a doppler effect — not very commercial but different.

"So what!" you may well ask, and we would be the first to agree that it all seems quite a ways from the totally different ball game of the pro studios, but 'all is not gloom, buddy' for all of a sudden it seems the cleaner and more spontaneous sound of four-track is coming back (that's if it ever went away).

Finally, for those of you that could do with a glimmer of hope or encouragement: Surprise surprise, one of our cheeky little compositions entitled 'Working in a Factory' (what else?) has just won an international song competition, and soon should be straining the loudspeaker cones of your trannies. Admittedly it's been re-recorded by someone else, but it has spurred us on to try and produce an LP cassette of our own: 'Vintage Demestos', and besides, you'll be able to sit there and say 'I'm sure I could do better than that'.

For our money, imagination is the name of the game!

Johnny Demestos

E&MM

FEBRUARY 1982

E&MM

**LISTEN TO  
THE SOUNDS  
IN E&MM!**

# ELECTRONICS & MUSIC MAKER DEMONSTRATION CASSETTES

Electronics & Music Maker is the first monthly publication to produce its own cassettes that will provide a unique aural complement to the magazine. Produced in our own recording studio, these C60 cassettes will allow you to hear the sound of instruments and electro-musical effects in our features and reviews.

**Demo Cassette No. 1 (March/April issues) contains:**

1. Matinee Organ. 2. Yamaha SK20 Synthesiser. 3. Guide to Electronic Music Techniques. 4. Sharp MZ-80K music/sound effects. 5. Warren Cann plays Syntom Drum Synthesiser project. 6. Paia 8700 Computer music. 7. Frankfurt Music Fair.

**Demo Cassette No. 2 (May/June issues) contains:**

1. Tim Souster. 2. Adrian Wagner plays Wasp & Spider. 3. Lowrey MX-1 Organ. 4. Apple Music System. 5. E&MM Word Synthesiser. 6. Fairlight Computer Musical Instrument. 7. Sharp Composer program. 8. Yamaha PS20 keyboard. 9. Vero musical projects. 10. David Vorhaus LP "White Noise" excerpt.

**Demo Cassette No. 3 (July/August issues) contains:**

1. PPG Wave 2 Synthesiser. 2. Syn-

wave project. 3. Wersi Pianostar played by Hady Wolff. 4. Alphadac 16 music. 5. Atari 400/800 music. 6. Duncan Mackay. 7. Hexadrum project. 8. MTU music. 9. Casio VL-Tone. 10. Irmin Schmidt's Toy Planet LP extracts.

**Demo Cassette No. 4 (Sept./Oct./Nov. issues) contains:**

1. Linn Drum Computer. 2. E&MM: Harmony Generator project. 3. City University music. 4. Casio MT-30. 5. Roland instruments: Jupiter 8, TR808, MC-4, & GR300. 6. Steve Howell piece. 7. 'Ecstasy' LP by Georg Deuter excerpt.

**Demo Cassette No. 5 (December/January issue) contains:**

1. Teisco SX-400 Synthesiser. 2. Polyphonic ZX81 music. 3. Movement Drum Computer. 4. Study Music 1: Backing Music on synthesisers for you to play solo with of Dec. '1984' music. 5. Casio-tone 701 light pen music and presets. 6. Dave Bristow plays Yamaha CS70M. 7. Roland CR8000 excerpt. 8. E&MM Syn-clock project: control examples. 9. Study Music 2: 'Exit' music minus theme for you to solo with, from Jan. issue. 10. Alpha Syn-tauri computer music. 11. Elka X-50 Organ. 12. Soundchaser Computer pieces. 13. Richard Mitchell's electronic music for film: examples of commercials, etc. 14. Ian Boddy music.



Please allow 28 days for delivery

E&MM Cassettes Dept., Maplin Publications, 282 London Road, Westcliff-on-Sea, Essex SSO 7JG

Please send me the following Demonstration Cassettes:  
(Price quoted inc. VAT and p&p) Overseas add 19p per cassette.

Cassette No.	Quantity	Price	Total
Demo Cassette 1 for March/April issues		£2.45	
Demo Cassette 2 for May/June issues		£1.99	
Demo Cassette 3 for July/August issues		£1.99	
Demo Cassette 4 for Sep/Oct/Nov issues		£1.99	
Demo Cassette 5 for Dec/Jan 1982 issues		£1.99	
			£

I enclose a cheque/postal order payable to: Electronics & Music Maker

PLEASE PRINT

Name .....

Address .....

E&MM/2/82

## ELECTRO-MUSICIANS DIRECTORY

This special directory is a great way of making contact with other electro-musicians and costs less than any other Classified advertising. The information is presented in condensed form to allow us to insert the maximum number of entries each month.

To fit the maximum information on a line please use the codes listed: Inst. categories (except M&C) imply the use of electronics with inst. specified.

Ian Boddy, South Shields, Tyne & Wear, 0632 554086, K, A, E, -.  
 Rich Wilde, Hull, N. Humber, 0482 702850, KDV, M, RE, -.  
 Kevin Tweedy, Woolwich, SE London, 01-854 4033, K, M, BERG, -.  
 David Jones, Bangor on Dee, Cldwyd, 0978 780762, K, B, E, -.  
 Paul Williams, Stevenage, Herts, 0438 50471, K, B, E, -.  
 Keith Bottomley, Oldham, Lancs, 061-624 6343, G, B, E, -.  
 David Steel, Leeds, Yorks, 0532-673251, KOGE, B, V, -.  
 Peter Dome, Sheffield, Yorks, 0909 567151, KO, M, V, -.  
 Frank Warby, Rainham, Essex, 04027 53873, KEGV, M, V, -.  
 David Hunt, Sheffield, S. Yorks, 0742 307949, K, M, EV, -.  
 P. Chegwin, Prescot, Merseyside, 430 7312, K, M, ER, -.  
 Martin Naylor, Wembley, Middx., 01-902 2941, GED, A, E, -.  
 John Sands, Middlesbrough, Cleveland, 0642 211934, K, M, PEV, -.  
 Gary Masters, Acton, London, 01-993 2894, KW, A, V, -.  
 Chris Varnham, St. Albans, Herts, 0727 55005, KO, M, R, -.  
 Peter Musk, Leicester, Leics., 0533 896033, K, B, E, -.  
 Marvin Wilson, Leeds, Yorks, 0532 864129, K, B, E, -.  
 Eddie F, Dagenham, Essex, 01-595 2409, G, A, REP, -.  
 Roy McBridge, Forfar, Angus, 030-781 405, G, B, R, -.  
 Dave Stobie, Edinburgh, Midlothian, 031 3343944, K, M, V, -.  
 Robert Mackenzie, Billericay, Essex, 02774 59949, K, B, V, -.  
 Paul Miller, Portadown, Armagh, N.I., 0762 35525, K, M, V, -.  
 Clive Allen, Llandudno, Gwynedd, 0492 82930, G, M, B, -.  
 Martin Davies, Bridgwater, Somerset, 0278 55060, D, M, V, -.  
 Mark Woodham, Northampton, Northants, 0604 45622, KOC, A, E, N.  
 Chris Askwith, Leeds, West Yorks, 0532-682816, G, M, R, -.  
 Steve Gould, Halesowne, West Midlands, 021 5594602, K, B, E, -.  
 R. Pearson, Whitechapel, E. London, 01-986 7407, K, B, E, -.  
 Colin Potter, York, N. Yorks, 0347 810188, KGEV, M, PE, -.  
 Andrew Walden, Capel St. Mary, Suffolk, 310439, K, B, E, C.  
 Gareth Prosser, Ipswich, Suffolk, 0473 58647, G, A, PRE, DC.

Kevin Bantoft, Ipswich, Suffolk, 0473 213632, E, B, R, N.  
 Nigel Langford, Ipswich, Suffolk, 0473 75118, EG, B, RE, N.  
 Jim Black, Newcastle, Tyne & Wear, 0632 329418, G, A, RPB, DC.  
 Andrew Hammond, Maidstone, Kent, 0622 677776, GV, M, EV, C.  
 Allan Bula, Bexhill, E. Sussex, 0424 210410, K, B, V, N.  
 Philip Hammond, Maidstone, Kent, 0622 677776, E, M, EV, C.  
 Neil Cox, Preston, Lancs, 0772 35350, K, B, EV, N.  
 Andy Pask, Gloucester, Glos, 045282 2770, KMC, MMB, CPE, D.  
 Nick Broom, Norwich, Norfolk, 0603 712646, KD, B, P, C.  
 Gareth Hughes, Swansea, West Glamorgan, 0792 464792, GM, M, E, C.  
 Kendall Wrightson, Hungerford, Berks, 0488 62309, KC, BM, EVPR, C.  
 Derek Purden, Stalybridge, Cheshire, 061 3037330, D, A, V, N.  
 Chris Allard, Hampton, Middx, 01-979 5185, KGD, A, JRV, N.  
 Bill Woods, Westhill, London, 01-341 0130, G, A, JPR, N.  
 Dennis Clapham, Carew, Dyfed, 06467 453, KGES, A, PREGV, C.  
 Chris Varnham, St Albans, Herts, 0727 55005, KO, M, PR, N.  
 B. Kear, Hounslow, Middx, 01-577 3118, GE, A, REG, N.  
 C. Reeve, E. Putney, London, 01-870 5590, GW, A, V, N.  
 Bob Stennett, Southfields, London, 01-874 3486, G, A, Y, N.  
 Neil Johnson, Southend-on-Sea, Essex, 0702 67375, KGB, A, JPR, N.  
 Dillon Tonkin, Whetstone, London, 01-445 2617, KOG, A, CPRE, N.  
 Richard Young, Clapham, London, 01-223 2811, KG, A, CJRE, N.  
 C. White, Edgware, Middx, 01-958 9121, KO, M, RE, N.  
 Phil Towner, London, 01-673 8781, D, A, V, N.  
 R. Shore, Bournemouth, Sussex, 0202 521253, KOGE, A, V, C.  
 Darren Tansley, Colchester, Essex, 0787 227473, KG, M, E, N.  
 D. Goodall, Sheffield, Yorks, 0742 348372, KO, A, CRE, N.  
 Peter Makin, Bolton, Lancs, 0942 892193, GM, M, PREV, C.  
 Mark Shreeve, Enfield, Middx, 01-363 2589, KG, A, EPCV, N.

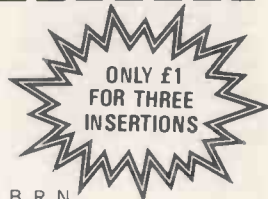

**NAME  
TOWN  
COUNTY  
TELEPHONE**

**INSTRUMENT**  
 K=KEYBOARDS  
 O=ORGAN  
 G=GUITAR  
 E=ELECTRIC BASS  
 M=SOUND ENGINEER  
 D=DRUMS  
 V=VOCALS  
 S=STRINGS  
 W=WOOD

B=BRASS  
 C=COMPOSER

**LEVEL**  
 B=BEGINNER  
 M=AVERAGE  
 A=ADVANCED

**TYPE OF MUSIC**  
 C=CLASSICAL  
 J=JAZZ  
 P=PROGRESSIVE

R=ROCK  
 E=EXPERIMENTAL  
 B=BEAT  
 G=REGGAE  
 O=ORGAN  
 V=VARIOUS

**ELECTRONICS**  
 D=DESIGNER  
 C=CONSTRUCTOR  
 N=NEITHER

(Fictitious example) ▶

NAME	TOWN
BILL JONES	SOUTHEND
COUNTY	TELEPHONE
ESSEX	0524 61232 STD Code + no
INSTRUMENT	LEVEL
K	M
MUSIC	ELECTRONICS
E	C

Send your information in this format for your directory ad next month (closing date 20th December).

Cheques made payable to Maplin Publications. £1.00 for 3 insertions.

# SOUND ON STAGE

Ben Duncan

## Vocal PA

Initially, vocals can be expediently taken care of with a simple mixer amplifier; something similar in concept to an instrument amplifier. Indeed, on countless occasions in the past, guitar amplifiers have been adopted for this very task, with apparent success, because high impedance microphones deliver much the same output voltage as a guitar pickup. As guitar and vocals alike operate over a similar frequency range (viz: they are vocalising instruments), tone controls which work well in conjunction with a guitar will tend to suit vocals as well. However, a high impedance microphone prefers to 'see' an input impedance around 50k, and whilst higher values aren't intrinsically erroneous, or necessarily deleterious to the frequency response of the microphone, the high impedance (470k to 2M) seen by the microphone when looking up a guitar amplifier's input socket may give rise to a higher level of hum and noise than is necessary, especially in the case of valve instrument amps.

More insidious is the fixed 'equalisation' in many guitar amplifiers, particularly in the classic valve models. In this case, even if you set the tone controls to their central, nominally 'flat' position, the frequency response of the amplifier remains far from flat. This 'tweaking' is to provide a meaty guitar sound, of course, but its concealed and unpredictable nature is unhelpful in conjunction with vocals, where equalisation for a tasty sound is usually compromised by the need to control the threshold of acoustic feedback. Thus the result of borrowing guitar amplifiers for the fledgling vocal PAs of the mid-60s was to render the feedback-prone vocals inaudible in the face of the guitars' sudden augmentation in the shape of the first Marshall stacks. And as rock invariably demands loud vocals, a mixer-amplifier designed specifically for this task, exhibiting an essentially flat response and usable equalisation is required.

Here, equalisation brings home the key difference between amplifying guitars and vocals. The guitar isn't usually prone to feedback, thus tonal aberrations can be introduced or banished ad-lib, purely to create a suitable sound; the player+guitar+amplifier+speaker(s) being regarded as an instrument in their own right, and the concept of a flat response within this 'instrument' is clearly nonsensical. In addition, every component and parameter of the 'instrument' can serve to alter the sound — from the player's technique to the design of the speaker cabinet.

By comparison, for vocals, the overriding need to be audible over or amongst similar, sustained vocalising sounds (viz: guitars) calls for high sound levels which inevitably raise the spectre of acoustic feedback. So, in turn, high level vocals initially demand the discipline of an essentially flat frequency response throughout the vocals amplification system. At the same time, the human voice, unlike a guitar, can't be so readily tweaked — exotic bodies (voice boxes) and strings (vocal chords) aren't available on the



Rick Wakeman band

NHS, thus the onus of generating a 'tasty' sound falls squarely on the sound system. The art of vocal PA then, is to balance the conflicting requirements of achieving high levels (tonal aberrations unwelcome) and a suitable vocal sound from a less than perfect instrument (tonal aberrations required), and the distinction between the instrument and the medium of communication is less clear cut.

Amplifying this argument(!) it's apparent that all too often, the vocal sound system is called upon to do four jobs: (1) Correct its own deficiencies; (2) correct the deficiencies in the vocals; (3) produce an output that's audible over 'walls' of guitar sound and (4) counteract its own tendency to produce howls of feedback. Now these factors interact as a foursome in a complex manner, and frequently conflict with each other. Here, the golden rule 'simplify and lighten' suggests that the number of requirements should be trimmed. This we can do by starting out with essentially flat microphones, amplifiers and speakers. From this reference point (which cancels the first requirement) we can go on to add tonal aberrations (i.e. "equalise") to achieve a good vocal sound — and help cut through the guitars. As a pair, these needs are frequently complementary in any case, so

we're left with the basic two-sided conflict: vocal sound versus feedback threshold. But, of course, the inherent lack of colouration in the system will make howlround much less of a problem in any case. As a result, the sound level can be higher, and there's less need to 'equalise' for the sake of being audible over other instruments; thus the dilemma becomes self correcting.

With the above in mind, it's clearly much better to invest your funds in high quality microphones and speakers boasting an essentially flat response, rather than to eschew these for the sake of elaborate, yet expensive equalisation controls on your vocals mixer-amplifier. Using a 'flattish' sound system, a bass control centered around 100Hz to regulate the 'body' of the vocals, together with presence and treble controls, centered about 5kHz and 10kHz respectively and controlling the upper harmonics will be adequate in most cases. Four band equalisation, having an additional control in the low midrange to take care of the muddiness in close-miked vocals is another useful tool, as too is an integral multiband or graphic equaliser: but without an inherent lack of colouration in the system, these are really useless gimmicks.

Aside from such parameters as equalisation and input impedance, vocal mixer-

amplifiers differ from instrument amplifiers in one other crucial respect — the arrangement of the inputs. Clearly, in the case of vocals, two or four inputs will often be in use simultaneously. In this case, inputs which are regarded broadly as *alternatives* and which differ greatly in their facilities and characteristics aren't helpful, as in an instrument amplifier. On the other hand, a potential trap here is the multichannel mixer-amplifier with parallel inputs. In this case, each channel features a pair of input sockets, having identical characteristics as regards sensitivity and impedance, together with common gain and equalisation controls. Although this arrangement seems attractive, in that the mixer-amp's fascia is filled with a myriad of input sockets, the concept is, at best, a compromise; control over each pair of microphones is limited by the shared controls, a situation that is highly unsatisfactory, except possibly in the case of tightly disciplined close harmonies. The moral here is to be sure that you buy a *usable* six channels rather than three *pairs* of channels.

Another, more amenable species of twinned input is one providing sensitivities (circa 1-10mV/30-100mV) and input impedances (600 ohms to 1k/50k) tailored to both low and high impedance microphones respectively. Sometimes, this facility is provided via a single switched input, or otherwise the inputs are suited only to high impedance microphones. In this case, a low impedance microphone can be made to suit by means of a matching transformer (see E&MM, December 1981).

The vast majority of vocal mixer-amplifiers use transistor circuitry, and if vocals are seen primarily as another instrument rather than as an extrinsic and straightforward means of linguistic communication, then a valve amplifier may provide more expressive results for a solo vocalist, foibles regardless. In particular, valve amplification will lessen the unpleasant consequences of grossly overloading the microphone.

## Interface 1: speakers on stage

At one stroke, standing on a stage can sweep aside all the perfectionist — even romantic — aspects of playing music. In small venues, the acoustics appear to be specially designed to distort and destroy music, the stage — if it exists at all — is invariably cramped, and the distant mains socket usually has a broken switch. And even if you remembered to bring an extension cable, you still have to combat the audiences' passivity. Yet skilled musicians such as Nik Turner and Robert Fripp prefer to play small venues, however inauspicious they might seem at first sight.

The first step in accommodating the shortcomings of the small venue is to develop an awareness of acoustics. The sharp, transient sound of a handclap contains a wide range of frequencies, and can give certain useful clues as to the deadness,

and the nature of any severe colouration introduced by the room. In general, long rooms with low ceilings sustain standing waves (eigentones) at low frequencies, thereby muddying the electric bass and making the bottom end of the vocal range prone to howl — (or boom!) — round. The other common hazard is an excess of absorbent surfaces — carpets, people, plants, furniture and 'acoustic' ceiling tiles. Apart from skimming off much of the high frequency content in the music, these furnishings also tend to diminish the perceived sound level overall. At the same time, the absence of equalisation will make the music seem flat and lifeless. Apart from boosting the treble, little can be done to compensate, apart from being aware of the relatively flat and demure sound as perceived by the audience, and playing a loud and strident set in defiance!

Complementary to an appraisal of the acoustics is an intuitive understanding of the sound projection properties of your speaker cabinets. Most instrument amplifiers are paired with direct radiator speakers, and apart from the tendency for the sound field to become omnidirectional at low frequencies (below circa 250Hz) and beamlike at high frequencies (above 1 to 3kHz) drivers in this configuration are mercifully quite well behaved in small venues. The vocalists' and bassist's amplification systems may use horn-loaded (i.e. bins) or vented (Thiele or reflex) enclosures however. Whilst these are superior in most respects to direct radiators, for these applications at least, they can interact in peculiar ways with the air in a small venue. Typically, the bass will be mysteriously lacking — even though the walls are shaking! A more mundane difficulty arises when a radial horn, intended to 'shoot' high frequencies over several hundred feet refuses to cover an audience at short distance. Two factors are apparent here. Firstly, horn speakers intended for large auditoriums will rarely form a coherent wavefront in the first five to twenty feet; in this region, which will often include 99% of your audience in a small club, the sound is subject to all manner of aberrations. Secondly, horn speakers are particularly adept at acting as involuntary microphones, sensing the sound energy in the room, and reflecting it back to the amplifier. This 'ricochet' effect, originally proposed by Richard Elen and George Chkiantz (who also, incidentally, produced the early Hawkwind albums), can again be held responsible for all manner of spurious, if subtle, changes in the sound quality which (quote) "didn't happen at the club we were in last night".

If your vocal PA doesn't exhibit a flat response, it will invariably be necessary to place the speakers well forward of the microphone(s) and as far away in the lateral sense as possible. Careful positioning of the mics (as central as possible) and speakers (aim them away from the stage, unless there are nearby reflective surfaces — such as bare walls — in which cases 'straight ahead' will have to suffice) together with intelligent experimentation will help to achieve usable vocal levels. If there isn't a curtain along the

rear of the stage, beware of reflections arising from the sound 'out front', and experiment with the angle of the microphone. Also, beware of placing the instrument amplifiers so that they radiate directly at the vocal microphone(s); this involuntary 'miking up' will only serve to muddy the vocals and render them more unintelligible than they need be.

Once the bassist has tuned up, cabinets with castors will begin to execute a random choreography and produce peculiar percussive sounds unless they are turned over so that they lie flush with the floor... whilst discrete and lightweight bass amplifiers (or 'heads') usually benefit from a firmer or at least less agitated surface than the top of a bass cabinet; foam rubber, 'gaffer' tape, flightcase clips or even a separate amplifier stand are typical solutions here.

## Interface 2: musicians on stage

The cynical quip "musicians need to hear each other slightly more than the audience needs to hear them" emphasises the crucial nature of the rapport between the members of a band playing music which is largely improvised. For instance, vocalists and lead guitarists need to hear the rhythm of the drums and bass and vice versa. Without a powerful and elaborate stage monitoring system, half the battle is to arrange yourself so you can hear the instrument(s) you need to hear most of all; deaf drummers, sitting inside one of the loudest instruments of all at the rear of the stage face the most serious and perpetual communications problem. Yet, somehow, by dint of practice and the development of intuition, they manage to play in time. And this telepathic rapport is the other half of the battle: if you cannot produce a balanced sound on stage, additional practice in working together as a unit should take precedence over thoughts about stage monitoring, unless perhaps your forte happens to be an especially loud and chaotic species of heavy metal.

The next question is "What does it sound like out front?" Of course, you can ask a friend to stand in the middle of the venue during your rehearsal, and return with comments. But unless they're perceptive, and dedicated to your long term musical interests, they're unlikely to be critical and will usually just assure you that "It sounds great". So unless you're fortunate enough to come across the services of a skilled sound engineer or fellow musician, you will have to adopt a rule of thumb: if each member of the band feels the music sounds balanced on stage then it's as near balanced out-front as makes no difference. And without a PA, your performance depends — in the end — entirely upon the discipline within yourselves; nobody outside the band can help. This factor, together with the dictates of fashion, requires that every band shall gain access to a PA willy-nilly — and the sooner the better; a giant topic to be dealt with shortly.

# Featuring **IKE ISAACS**

## Reminiscences of the Guitar

IKE Isaacs has recently left the U.K. to start his own guitar school in Sydney, Australia. He was born in Rangoon, Burma, in 1919 and studied Maths, Physics and Chemistry for his B.Sc. During the war, he was evacuated to India with the Japanese occupation of Burma. After the war, he was offered a job in a band for six months - and the six months are still going along!

For over thirty years he has been a master of the guitar player's art and has worked with artists from Frank Sinatra to Stephane Grappelli. The Japanese Aria Guitar Company have manufactured the 'Ike Isaacs' TA 1500 semi-acoustic instrument, setting Ike's high standard of quality he expects from workmanship and performance. At the age of 62 he is prepared to dedicate many more years in the teaching and playing of the guitar.

I call the last 25 years the 'Guitar Age' because there have been so many millions of guitars sold in all shapes and sizes. There has been someone in nearly every family who plays a guitar, so the interest in the instrument has been tremendous, even though many people never go beyond the basic stage. Like anything that proliferates, the guitar has really developed since I was a kid.

The basic guitar in those days was an acoustic instrument and it was popularised with chord strumming and folk guitar style, with a wide standard of playing realised even in those formative years. I am talking about the times when people played and accompanied blues, protest and religious songs. Then came the emergence of the jazz band using the tuba and banjo. Later, the strident brassiness of the tuba was replaced with the double bass and the rumbustious 'plinky-plonking' banjo was exchanged for the acoustic guitar.

The main function of the acoustic guitar was for rhythm playing by strumming chords. Of course, there was no amplification for it and only one microphone in the jazz band usually, so the player would raise the action of his guitar (by lifting the bridge), use heavy strings and really play hard. This style of playing was often detrimental to improving techniques and made fast runs very difficult. So playing had to be moderated for the structure of the instrument. Subsequently, the guitarist



Ike Isaacs

was often given a monotonous role as a rhythm 'ox', having only an occasional few solo bars in an introduction, modulation to the middle eight, or ending.

One way of improving the situation was to do other work with quartets and trios using a second instrument with a lower action that played softer. This music was more sophisticated, demanding a better technique from the player for arpeggios and single line passages. Equal importance was apportioned to the ensemble instruments and many of these combinations became well known, e.g. the Joe Venuti/Eddie Lang Duo, the Adrian Rollini Trio and Quartet, and the Karl Kress and Dick McDonough Duo, who all played some tremendous music. There was also Tony Mottola, still doing some fine sessions in New York, who started off in the early days. George van Eps was one of the innovators of guitar and chord playing styles, and must now be the 'Daddy' of them all coming up to 70 years of age. He's still playing brilliantly and like many long-standing guitarists has moved from acoustic to electric. He recently published a book 'Harmonic Mechanisms for the Guitar' which is a must for every serious guitar player. It's an in-depth study of left

handing fingering and co-ordination of right and left hands. When you can master these techniques you can really play anything. (Sevcik did a similar system for the violin). Eps' teaching brings the playing of the guitar to a very advanced complicated level. Everybody needs to play his method if they want to play better music.

The jazz guitar started as an acoustic guitar that was amplified. One problem with this instrument was its susceptibility to feedback from its big sound chamber, and lower notes especially were prone to this. Moving from open strings to octaves often induced vibrations too, so certain 'wolf' notes appeared on the guitar as well as others caused by the amplifier resonating.

The semi-acoustic developed into an instrument with two pick-ups screwed to the body. This meant that vibration was reduced, although it still suffered from feedback at times. It is not uncommon to find the semi-acoustic in use with a rock group where feedback is overcome simply by the forward positioning of the PA.

The length of the acoustic guitar note is shorter than that on the semi-acoustic because of the body structure. A normal acoustic with a solid wooden



"After the war, I was offered a job in a band for six months - and the six months are still going along!"



bridge that's moveable gives a good punchy sound for rhythm playing but it does not give a good sustain note. A round hole guitar will also give more sustain than an F hole instrument. The latter was used for clean chord accompaniment in the rhythm section of a big band. Changing an acoustic to semi-acoustic was often done by inserting a pick-up and a metal bridge, whilst maintaining the same distance from neck to bridge.

Then came the electric guitar, achieved with a basic magnet and a hand wound coil as a pick up in the most crude form in the early days. It was played by people like Floyd Smith and Charlie Christian. I played this early electric myself, using a home wound coil with an amplifier built by a friend. Then I came across my first semi-acoustic guitar with the pickup screwed into the body rather than a floating version, and that gave a different sort of sound, with a little more sustain. We tried very hard in the early years of the guitar to get the variety of sounds from the instrument itself, but of course today you can use graphic equalisers, compression, delay and effects to simulate more or less any sound you want. You can therefore



often compensate for deficiencies on your instrument. But I have found that the valve amp gives a particularly warm sound which you won't find with transistors. It's really the transistor 'brittleness', whereas the valves give a little more 'meat' and density in the note as well as more 'elasticity' to the sound - a note doesn't just end suddenly.

I became involved with Jimmy Burns in Essex, in the making of guitars and we worked on the Hank Marvin (Shadows) and Bison guitars. We spent many sleepless nights improving the designs - I was very exacting and a critical listener. We did the Orbit amplifiers too. The instruments were very good for that time, but unfortunately were not as successful as they could have been.

## Choosing Guitars

Many guitar manufacturers now provide cheap instruments for music students, and these days they are very good - only a shade off some of the best guitars. You can't go far wrong by choosing one of the good copies to start off with. One problem with maintaining quality is the shortage of good wood for acoustic models. You don't need the highest quality wood to get a satisfactory acoustic sound. As long as the instrument is well made, the structure design and strutting is right - then the results should be satisfactory. For notes to sustain well enough, in essence, it's the sound vibrating between two fulcrums and how much stability we have at the peg head and tail piece that is important. The bridge must be rigid to transmit the sound and attention to all these details improves the quality. The volume is dependent on the acoustical body shape.

Choosing the right strings for your playing is a vital prerequisite. Strings have to be selected for their gauge - how thin they are, the kind of flexibility they have for bending the pitch, and also the metal content of the string which affects the pick-up sensitivity - nickel quality gives more volume, silver steel is not as bright in tone. So the more iron content, the better the string sensitivity. Tension across the strings should also be equal - and not many guitarists check out this and other points on their instruments with that essential care. On the other hand, instruments from some manufacturers are precisely set up so that they not only look good but sound good too - the weight, balance, general feel of the finger board and finger pressure on the strings are the first things a guitarist

looks for when trying out a new instrument.

I also spent a lot of time working on solid electric guitars when I was with Jimmy Burns. We paid attention to design of rigid bridge and machine anchor points, correct weight, and a stable neck that did not move around. In other words the string vibration was very free, resilient and elastic, but with a strong stable fulcrum. We would often come up against problems when developing the instruments, such as extraneous sounds that usually came from the down-bearing on the bridge and the nut. Nuts can be made of plastic, bone, and ivory but on the solid instruments they are often metal. The sharper the angle of the strings (or downbearing) is on the nut and the bridge, then the clearer the sound and the better the sustain. The bass end has to have a springiness that gives plenty of potential energy, and the Fender was very good for that even in the early days. Guitars have changed from picking, plucking instruments to ones that can sustain sounds like a blown instrument over several bars. Consequently, playing styles also changed. Sustain, for example, was first achieved with a solid guitar using light gauge strings, then later by means of electronic effects units.

There are three scale lengths of guitar: long, medium and short, altering the fret spacing and the overall nut to bridge distance. Short scale instruments help beginners and also make big stretch chords much easier. The long scale gives a much deeper sound and some classical guitars using this are very difficult to play because of the finger stretch required, but do give more sonority. I use the normal medium scale and sometimes the short scale (which incidentally, is used a lot on rock guitars).

## Playing

I play my chords in different positions on the guitar without restriction according to the register or inversion I require. What is important is that provided your fingers are flexible enough, it's no harder really to play one open stretch chord from another - it's just thinking right. How you place your fingers is, of course, important too. A lot of people do not place their hands correctly and it becomes difficult to play the faster passages.

I've written a very simple book called "Photo Guide for the Guitar" and this gives you the fundamental concepts of holding the guitar. The first principle is

# After Hours

IKE ISAACS

'After Hours' is a finger exercise in jazz idiom that uses certain chord changes that are played in a series of fast passages. It demands the use of fingers in a different way, by using barres with the 1st, 3rd and little finger as well. It uses a pattern based on D major and A major harmony, with a middle section sequence from F# major. 'After Hours' appears in a book of music entitled 'Guitar Moods' - chord concepts by Ike Isaacs, and is available from music shops.

Ike Isaacs introduces and plays this challenging piece on his Aria guitar on demo cassette No. 6. It's a chance to hear the superb interpretation and technique of one of the great contributors to the art of guitar playing.



Moderato(not too fast)

0 0 0 0    2 1 1 1    1 2 1 1 3    4 4 3 3 3    4 3 2 1    4 2 1 1    4 2 1 1    3 2 1 1    4 3 2 1    4 0 0 0    0 0 0 0    3

Em7 D Bm7 D6-9 Dmaj7 C#m7 Bm7 F13 Bbmaj7 A11 Em7 D Bm7 D6-9 add2 C#

Dmaj7 C#m7 Bm7 F13 Bbmaj7 A13 Em7 D Bm7 D6-9 Dmaj7 C#m7 Bm7 F13 add 2 C#

Bbmaj7 A11 G#m7 Am11 G#m7 Gm7 F#m7+ Fm7 B7#9 Bb7-11+ A13 b5 b5

Dmaj7 C#m7 Bm7 F13 Bbmaj7 A7 Em7 D Bm7 D6-9 Dmaj7 Bm7 F13 add 2 C# C#m7

Bbmaj7 A13 Em7 D Bm7 Dmaj7 C#m7 Bm7 F13 Bbmaj7 A11 1 1 0 0 3

© Copyright 1971 by KADENCE MUSIC, re-assigned to IKE ISAACS MUSIC

Reprinted by permission.

1 4 3 2    1 4 3 2    3 3 3 2    4 3 3 2    4 1 1 1    4 3 3 2    3 3 3 1 2    2 2 3 1    4 2 3

G#m7 <sub>b5</sub>    Am11    G#m7 <sub>b5</sub>    Gm7    F#m7+    Fm7    Em7    Dadd2    F#9+    B9b5    B9

4 3 3 1 2    3    2 2 3 1    4    4 3 3 1    2 2 3 1    4    4 2 2 1 0

E13    A9b5    A9    D13    G9b5    G9    E13

4 2 2 1    2    2 2 3 1    4    4 3 3 1 2    3    2 2 3 1    4 3 3 1 2    0 0 0 0

E13    A9b5    A9    D13    G9b5    G9    C13    E13    E9    Em7

4 2 1 1    4 2 1 1    4 2 1 1    3    3    3    3

F13    G13    A13    Em7    D    Bm7    D6-9    Dmaj7    C#m7    Bm7    F13    Bbmaj7    A7    Em7    D    Bm7    D6-9    add2    C#

1 1 0 0    3    3    3

Dmaj7    C#m7    Bm7    F13    Bbmaj7    A13    Em7    D    Bm7    D6-9    Dmaj7    C#m7    Bm7    F13

1 4 3 2    1 4 3 2    3 3 3 2    4 3 3 2    4 1 1 1    arm 12

Bbmaj7    A11    G#m7b5    Am11    G#m7    Gm7    F#m7+    Fm7    Em7    Dadd2

*"In many respects the 'Guitar Age' is not ending - for me, it's just starting all over again."*



that it is really the same as grasping something ordinary like an apple or orange. The general "fist" movement is the thing, as well as conceiving the amount of "grasp" necessary to play a chord. This concept is very important, so that a simple E major chord requires a small grasp, and a barre requires something more — too many people over-press on the strings. Following my basic rules, I have taught pupils to play an F barre in just 20 minutes.

If I had a guitar and was given the ability to play the music of the kind that the kids are playing today, I'd have to use very light gauge strings along with all the gadgets. I'd have a certain degree of distortion, although for chords it is not very desirable so my chord playing would probably deteriorate. If you play chords, intonation has to be very accurate. With single line playing on a very low action guitar you can put your instrument out of tune while playing, but that doesn't worry the 'lead' player as he bends and stretches the strings to compensate. For the 'rhythm' players' chords it wouldn't be acceptable. So the solid electric guitar is totally different in concept musically and in its playing technique from the semi-acoustic.

When the solid guitar came in, it was immediately used for rhythm, bass and lead. Playing rhythm on a solid instrument requires a style completely different from the steady 'four' of the semi-acoustic used in the dance bands and early groups. The style is based on chords that punctuate and provide rhythmic effects. Variations in the decay of the guitar note has become important and so has the use of glissandi and note bending. The combination of single line phrases, chord patterns, detuning and other 'performance' effects that a modern guitarist uses either often far outweigh or are far more subtle than the keyboard synthesists' hand pitch wheel and foot control.

## Tuning

I've got relative pitch - I hear a B easily and I can pick up a guitar and tune it accurately to concert pitch. It doesn't matter whether it's A440 or not. Of course, the weather and your own hearing that day and so on can affect the way you tune. The best way of tuning is 'by ear' providing your guitar is completely 'in tune' to begin with as regards frets, bridge position etc. The bridge point-of-contact is important for correct tuning for the octaves. One way of tuning accurately is to take the harmonic on the 12th fret, sound it, and

dépress the note. If the note is sharper than the harmonic, you move the bridge point-of-contact so that they coincide (and forward if the note is flat). To get a greater degree of accuracy you take the 19th fret (a B on the E string) and do the same thing. I also check the pitch and generally try chords over the guitar to verify what I have done by ear, and from the harmonics. In certain keys, I will re-adjust the strings slightly e.g. to make an A chord have more of a C# than a Db.

Many people don't bother to use the wide range of chords possible on the guitar, but "Why do you want to speak in sentences when you can have command of the whole language?". All those major sevenths, minor ninths and 13ths etc. should be avidly explored by any serious guitarist, no matter what kind of music he plays - and the musician that uses a computer to make music has to know his chords and harmonics to explore additive and subtractive synthesis. It's a visual thing as well. For example, a keyboard player going from G13 to C#13 has to reshuffle his fingers to suit, but the guitarist can use the same visual shape of his fingers up or down the frets for G13, Ab13, A13 and so on - a big advantage. Each type of chord has its own visual shape.

Jazz players like to use fast chord changes with minimum hand movement. Solo players like to add harmonics, but you don't hear harmonics used too much in rock music because it's a physical thing you have to practise. Also the rock players' often using a plectrum to strike the strings. Actually there are many fret positions on a solid guitar that you can pick with a plectrum that give a 'whistling harmonic'.

The string's internal stretching is another important aspect in bending notes. In a series of notes you can either have a straight or bent note (pushing or pulling the string on the fret end). On my Aria guitar you cannot get very much inflection as the strings are medium grade, but on a solid instrument the light strings produce an internal stretch that gives a livelier sound. Some electric strings are flat wound, but they are not used a lot these days in pop music - it's a jazz player who likes these because they cut down the finger noise.

The rock player can also extend his

range of sounds using effects such as phasers, flangers, wha-wha, distortion, fuzz, overdrive, sustain, echo and chorus etc.

## Jazz and the Guitarist

The word 'jazz' is a flexible word. Jazz is an idiom - the ingredients it takes to be a good jazz player is the same as for a good instrumentalist. It makes demands on harmonic sounds, scales, arpeggios and the general playing of your instrument, certainly as much as classical music does.

Although jazz music has come to imply the use of extended chords, the major seventh and so on - the important aspect in its early stages was simply its 'idiom' - the way one played a 'blue' note (one that was slightly out-of-tune or out of the key tonality) and made general inflections. Modern classical music has also had an influence on jazz players. For instance, Charlie Parker was a major voice and he listened a lot to Stravinsky and other modern classical composers. Thus every avenue of music is worth exploring as it can influence your own style of music tremendously.

The guitar is surprisingly accessible to older people too. A local man aged 64 asked to play, so I got him a second-hand £10 guitar, fixed up the action so it was adequate, and he came for an hour and was soon accompanying himself, busily playing 'Home on the Range'!

In many respects the 'Guitar Age' is not ending - for me, it's just starting all over again! One person can spend ten years working hard on the guitar - it's such an individual instrument, but some kid who has been playing for just six months can do something that he can't do - and that is frightening. I can play something that Joe Pass can't play - equally there may be some kid who can play a piece neither of us can play. Toots Thelma, a great jazz harmonica and guitar player became intrigued by the Chet Atkins style of music which was far removed from the usual style of jazz we played and thus gave himself yet another challenge on the guitar. So the actual styles of guitar playing are the things that govern the technical prowess needed to be able to perform on the instrument. The guitar offers far more technical difficulties than most instruments and that is why the guitarist is the perennial student. Mastering a passage can often be so close, yet so far!

From an interview with Mike Beecher  
E&MM

FEBRUARY 1982 E&MM

# GUITAR WORKSHOP

Peter Cook

## Screening a Stratocaster

Nothing sounds quite like a Fender 'Strat', but unfortunately along with their pleasing, distinctive tones lurks the less desirable presence of background hum. In the early fifties when these guitars were revolutionary in their concept, I'm sure the unwanted hum was quite acceptable; bearing in mind that the amps of that era generated plenty of their own extraneous noise, thereby disguising the guitar's Achilles heel. Today the high output sophisticated PA rigs, coupled with multiple effects and lighting consoles leave no place to hide. But don't panic, there is a way to greatly improve this situation without the trauma of changing the guitar's character.

Those inquisitive enough to have peered beneath the scratchplate will probably have noticed that all the internal wiring is unshielded, as are the routed recesses; with the exception of a alloy shim mounted behind and echoing the shape of the scratchplate on earlier Strats, and a foil groundplate mounted on the control area of the scratchplate on most other models. In combination with the single coil pickup, there lies the problem.

The first rule when you are going to carry out any work on your instrument is to find a well cushioned and uncluttered working surface; also make sure that the lighting is adequate and that you don't cast a shadow over the work area. Before starting work, have a mental run through of the procedures and tools that will be necessary.

Once the guitar has been de-strung, the first task is to remove the scratchplate; this is achieved by undoing the small Phillips screws on its perimeter (using the correct screwdriver of course). The pickups and electronics are mounted on the scratchplate, and are therefore withdrawn at the same time; although three wires, two to the jack and the other to the tremelo spring anchor will prevent complete separation until they have been unsoldered from the chassis (two black) and from the centre tag (white) of the volume potentiometer. A 65W soldering iron should be used for the chassis connections, with a 25W instrument for the centre tag. Remember that hot solder can easily damage the guitar's finish, so cover any surface likely to be affected before picking up your iron.

Once the scratchplate has been safely removed, unscrew the two screws securing the jack plate and withdraw it complete with wires. By this time you should be gazing down on a near naked body and neck. Although the most effective way to screen it would be a laminated copper and brass lining it shouldn't take more than a second glance to realise that this option is totally impracticable. Even the use of tin foil rarely achieves an acceptable result, so thank goodness for modern technology in the form of carbon conductive paint which can be used to coat all the routed cavities on the top of the body.

Whilst the carbon is drying (usually at least two hours) the task of removing and screening the pickups can be undertaken.

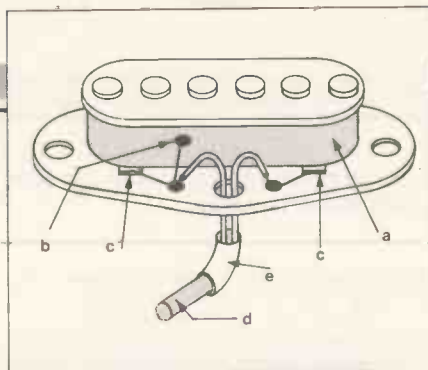

Figure 1. Screening a Stratocaster pickup: a) brass shim wound round the coil; b) earth connection; c) tape over the coil wires to prevent damage by the shim; d) screening braid held in place by heat-shrink sleeving (e).

Unsolder the pickup lead from the volume pot chassis and switch, taking care to mark or colour code the connections for reference when reconnecting. Separate the pickups from the scratchplate by unscrewing the retaining screws; watch out for the springs, which are easily lost, although older Strats used rubber tube. Once the pickups are free remove the covers (take care, the coils are delicate) and using a 3/8" masking tape, wrap the coil twice. The next stage is to wrap the coil with brass shim which should be cut to a 3/8" width with a 1/2" overlap on one circuit of the coil; tin the ends before wrapping so that minimal heat will be required to solder the shim once in place. Remember, too much heat will damage the pickup, so have a dummy run first to make sure that everything is to hand and that you are familiar with the procedures required.

Finally, solder a thin strand of wire from the shim to the pickup eyelet housing the black lead and replace the covers; (depending on the circumference of the pickup it will probably now be a tight fit, so use your brain not brawn) place the pickup in a safe place until required for re-assembly. NB: care should be taken when handling the brass shim, as the edges are as sharp as razor blades.

For those Strats with no ground plate on the scratchplate it will be necessary to make one. The pots and switch will need to be removed, then using the brass shim cut out an area large enough to cover all the circuit area. Using a contact adhesive (Thixofix etc)

lightly coat both the shim and scratchplate (the surface liquid from the top of the tin is best as it spreads thinly) and when touch dry bring both surfaces together; use a rag, not your fingers when rubbing down the edges as the shim could quite easily slice their ends off. Insert a sharp blade from the underside and rotate it in the pot and switch holes to cut away the unwanted brass, before replacing the circuit.

There are two methods of screening the internal wiring; one is to replace all the wires with screened cable, the other is to sheath the existing wire in braid. The latter is my preference; to achieve this strip the braid from some screened cable, taking care to keep the centre cavity open (if the braid is compressed it is more manageable). One by one unsolder the pot end of the circuit wires and slip over the appropriate length of braid, stopping a short distance from the soldered end, but allowing enough overlap to form an earth tag at the pot end (the braid need only be connected one end to provide a screen). In order to secure the free end of braid and prevent it from shorting to the 'hot' terminal, slide a short length of heat-shrink sleeving over the join and apply heat (gas lighters are fine, but matches blacken the surface). Resolder the 'hot' wire and solder the braid tag to ground before proceeding with the next wire. Once all the wiring, including the pickup leads and jack socket leads have been screened accordingly, the pickups can be refitted to the scratchplate and re-wired in, following the colour codes already marked.

One last step before reassembling the scratchplate to the body is to ground the carbon painted surfaces; the easiest way is to screw a solder tag into the side of the switch cavity (making sure that there will be a clearance between it and the switch) and connect it to the circuit's ground using an 8" length of insulated cable.

Providing that all the connections have been made correctly, and that any exposed screening braid in the close proximity of 'hot' wires has been sheathed by heat-shrink, once re-assembled your Strat should be a sight for sore ears.

E&MM

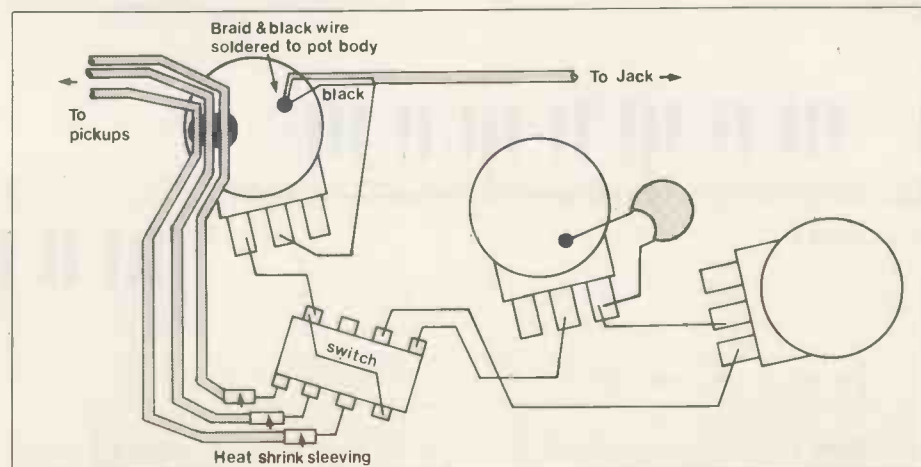

Figure 2. Wiring of the controls. The short wires to the tone controls need not be screened, since they are inside the control cavity.

# MAKING NOTES

This new workshop series goes right back to the basics of reading music. Its direct approach is aimed at all our readers who have not had the chance to get to grips with music notation.

## PART 3

This month I will illustrate the simplicity of forming a Major Scale. I can imagine the groans and comments after mentioning this subject, but read on, to discover how Major Scale formation is the basis for understanding so many aspects of 'Musical Interpretation'.

SEMITONES and TONES are musical distances between notes on the keyboard. A SEMITONE is the distance between any two notes immediately next to each other, black or white.

A SEMITONE DISTANCE occurs between WHITE to BLACK notes (1), BLACK to WHITE notes (2) and WHITE to WHITE notes (3). (See Figure 1.)

Strike each note separately when playing SEMITONES or a discordant sound will occur.

A TONE DISTANCE is equal to two Semitone Distances and there is always a note in the middle. To form a Tone Distance play any 'C' note on your keyboard and then the 'D' note next to it. There is a black note in the middle of these two notes. The first semitone occurs between the 'C' note and the black note (C# or Db) and the second semitone occurs between the black note and the 'D' note. Therefore 'C' to 'D' is a TONE DISTANCE.

There are four ways of forming a Tone. (See Figure 2.)

- (1) WHITE NOTE to a WHITE NOTE.

- Black note '\*' in the middle.  
 (2) BLACK NOTE to a WHITE NOTE.  
 White note '\*' in the middle.  
 (3) BLACK NOTE to a BLACK NOTE.  
 White note '\*' in the middle.  
 (4) WHITE NOTE to a BLACK NOTE.  
 White note '\*' in the middle.

These tones and semitones combine in a set sequence to form a MAJOR SCALE, consisting of eight notes. Any note on the keyboard can be the first note of a Major Scale, called the ROOT NOTE, which will give the scale its name. Each note of the scale follows an alphabetical sequence, ascending from the root note. (See Figure 3.)

Every MAJOR SCALE is formed by this sequence of tones and semitones. To find the 'C' Major Scale, which consists entirely of white notes, start with a root note of 'C', and using the tones and semitones in the sequence displayed in the box, find the other seven notes 'D', 'E', 'F', 'G', 'A', 'B', 'C' to complete the 'C' Major Scale. (See Figure 3.)

### 'C' Starting note — ROOT NOTE

- 1) 'C' to 'D' is a TONE
- 2) 'D' to 'E' is a TONE
- 3) 'E' to 'F' is a SEMITONE
- 4) 'F' to 'G' is a TONE
- 5) 'G' to 'A' is a TONE
- 6) 'A' to 'B' is a TONE
- 7) 'B' to 'C' is a SEMITONE
- 8) 'C' is the 8th Note — same name as the

ROOT NOTE which becomes the first note, Root Note, of the next ascending 'C' Major Scale.

The 'F' Major Scale is found using the same tone, semitone sequence starting with a root note of 'F'. There is one black note in this scale and by naming it 'Bb' and not 'A#', the alphabetical sequence is maintained. (See Figure 5.)

Using the tone, semitone sequence, start with a root note of 'G' to find the 'G' major scale, which also has a black note in it. This time it is named 'F#' (rather than 'Gb') maintaining the alphabetical sequence. (See Figure 6.)

It is not essential to practice scales, but playing them will improve your fingering technique. When I was teaching the electric organ some of my pupils suffered from arthritis in the finger joints and discovered that playing one or two scales, before actually playing their favourite music, was a form of physiotherapy helping to keep the fingers supple. Many musicians go through some kind of finger warm-up playing session before a gig and the piano as a practice instrument in particular helps to strengthen weak fingers.

As I have established, in major scales the semitone distances occur between the 3rd and 4th and the 7th and 8th notes, while between all the other notes the distance is a tone. There is more than one form of musical



Figure 1.



Figure 2.

ROOT NOTE - TONE - TONE - SEMITONE - TONE - TONE - TONE - SEMITONE.

Figure 3.



NOTE NUMBERS: 1 2 3 4 5 6 7 8  
 FINGERING: 1 2 3 1 2 3 4 5

Figure 4.

ROOT NOTE - TONE - TONE - SEMITONE - TONE - TONE - TONE - SEMITONE.  
 'F' 'G' 'A' 'Bb' 'C' 'D' 'E' 'F'



NOTE NUMBERS: 1 2 3 4 5 6 7 8  
 FINGERING: 1 2 3 4 1 2 3 4 The Thumb plays 'F' and 'C' Notes.

Figure 5.

scale and each one can be recognised by its sequence of tones and semitones. Enjoy finding the remaining nine major scales from the root notes of D $\flat$ , D, E, G $\flat$  (F $\sharp$ ), A $\flat$ , A, B $\flat$ , and B using the tone/semitone sequence. It's a good idea to write each scale down in a music manuscript book either as note names or as notes upon a staff, to fix them in your mind.

Here are some basic tips for writing notes. (See Figure 7.) The heads of the notes shape and the stems are attached to the side. Stems are drawn *upward* on the right of notes written *below* the middle line ('B' on the treble staff, 'D' on the bass staff). Stems are drawn *downward* on the left of notes written *above* the middle line. Notes on the middle line can be drawn with their stems up or down.

When writing joined quavers or semi-quavers, if the majority of notes are written *below* the middle line of the staff the joining line is drawn *above* them. If most of the notes are written *above* the middle line of the staff the joining line is drawn *below* them. (See Figure 8.)

When writing dotted minims and dotted crotchets, if the note is in a space, place the dot beside it. If the note is on a line, place the dot in the space above it. This will also apply to dotted quavers. (See Figure 9.)

What is a key signature? Although I often ask this question, few musicians know the answer or seem to feel the need to understand what it is or why it is there.

Sharps and flats written on the treble and bass staves at the start of the manuscript are not just intended to be decorative but will tell you how to interpret the notes into a

complete, melodious (in tune) arrangement. At this stage of learning the sharps or flats perform two functions. (1) to indicate the notes which are to be sharpened or flattened throughout the music. (2) They are used as a 'signature' for identifying the 'key' (hence the term 'key signature'), or scale in which the music is written, in the same way that we identify ourselves by our own personal signature.

The sharps or flats are not just 'plucked out of thin air'. A major key of music revolves around the notes of a major scale, so a composer uses the sharps or flats peculiar to one major scale as the 'key signature', to show you the key in which the musical arrangement should be played.

To recognise a 'key' of music, read the key signature and identify the major scale from which the sharps or flats are taken. The name of the scale will also be the name of the key you are playing in.

The one flattened note (B $\flat$ ) in the 'F' major scale (see Figure 5) will be written upon the 'B' line of the treble and bass staves to tell you that the music is written on the 'key' of 'F' major. All the notes of 'B' are read and played as 'B $\flat$ ' when music is written in this key.



Music written in the key of 'C' major will be recognised by the *absence* of a key signature because there are no sharps or flats in the 'C' major scale. (See Figure 4.)

The one sharpened note (F $\sharp$ ) in the 'G' major scale, written upon the upper 'F' line of the treble and bass staves tells you that the

music is written in the key of 'G' major. When playing in this key, all the notes of 'F' must be sharpened.



The key signature for music written in the key of 'E $\flat$ ' major uses the three flats, 'B $\flat$ ', 'E $\flat$ ', and 'A $\flat$ ' from the 'E $\flat$ ' major scale and all the notes of 'B', 'E', and 'A' must be read and played as flattened notes. (See Figure 10.)

The 'E $\flat$ ' major key signature on the treble and bass staves.

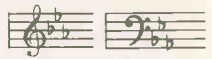

Sharpened and flattened notes occurring in the music, other than in the key signature, will be preceded by a sharp (#) or flat (b) sign and are termed 'accidentals'.

The 'natural sign' (n) will cancel a sharp or flat and the note it is written against will be played as a natural note.

The final illustration (see Figure 11) shows an accidental (#) preceding the third note of 'C' in the first bar — play 'C $\sharp$ '. In the next bar the first two notes of 'B' are played as 'B $\flat$ ', as in the key signature. The third note of 'B' in this bar is preceded by a 'natural sign' (n) — play 'B' natural. The accidental (b) preceding the fourth note of 'B' restores it to 'B $\flat$ '.

A manuscript is an instructional guide and everything included on the staves: key signature, time signature, notes and their values etc, all have an important meaning. Memo!! read the instructions first!

Join me again next month, when I will be showing how to use the major scales for forming left hand chords and inversions, and how simple it is to interpret chord symbols on to the keyboard. **E&MM**

ROOT NOTE -	TONE -	TONE -	SEMITONE -	TONE -	TONE -	TONE -	SEMITONE.
'G'	'A'	'B'	'C'	'D'	'E'	'F $\sharp$	'G'
FINGERING 1	2	3	1	2	3	4	5



Figure 6.

Figure 9.



Figure 7.

ROOT NOTE -	TONE -	TONE -	SEMITONE -	TONE -	TONE -	TONE -	SEMITONE.
'E $\flat$ '	'F'	'G'	'A $\flat$ '	'B $\flat$ '	'C'	'D'	'E $\flat$ '
FINGERING 2	1	2	3	4	1	2	3

Figure 10.



Figure 8.

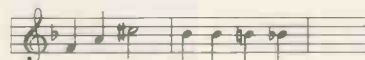

Figure 11.

# Organ Talk

Ken Lenton-Smith

## A Generation Onwards

The Electronic Organ Constructors' Society celebrated its 21st year of existence a few weeks ago. Those who decided to form this society were already actively engaged in building organs, but in those days it was necessary to be a diehard enthusiast and very little practical information was then available. Little did they dream that the 'organ-on-a-chip' would become a practical reality.

It is fascinating to consider the speed with which electronics has advanced over the past three decades. The transistor was born just over thirty years ago, but some years were to elapse before that first, rather flimsy point contact device was perfected and became a commercial proposition — the pnp junction transistor. Silicon replaced Germanium and new devices appeared in rapid succession, including encapsulated blocks of transistors and, of course, the IC itself. In a life-time, most of us have seen the transition from the era of the valve to micro-miniaturisation of complete circuit blocks consuming only small quantities of power. The LCD watch, digital multimeters, mini-computers and indeed space research are facts of life we accept, but none of these would have been possible without solid-state circuitry.

How has all this affected the organ constructor? E.O.C.S. has, of course, moved with the times. The club was formed to pool information originally and current editions of its magazine contain novel and interesting circuitry to aid its members. In today's realm of logic families, special purpose ICs and digital techniques, it may be interesting to look at the hurdles that faced the previous generation. My research may encourage someone to lay down the keel of an organ when he sees how much easier the process is today.

Publications dealing with organ construction were rather uncommon and, without knowledgeable guidance, it seems that it was necessary either to be an expert on electronics or simply operate on the 'wet finger' technique. Occasional magazine articles appeared which stimulated interest although they often dealt with a very basic single manual affair — and were based on valve circuitry. A number of the society's members were drawn in by a small ad. of the time which invited readers to send for a two manual and pedal circuit at a fairly inflated price: the end result was a very unstable instrument. Indeed, this particular organ circuit contained so many problems that it was the reason for starting up a constructors' society.

Books by the American author, Richard Dorf, and by Alan Douglas, doyen of the organ enthusiasts in the U.K., were followed eagerly — when they could be obtained. Both authors have continued to write on the subject and their books are now far less difficult to find. (Alan Douglas was an active member of E.O.C.S. from its inception and only recently retired as the society's President.)



Maplin Matinée kit organ.

Having managed to glean a few ideas, the constructor had to decide on a method of tone generation. Those with engineering facilities cut toothed wheels to rotate in front of magnet/coil assemblies on the Hammond principle. The valve was the state-of-the-art device at that time so the majority of builders used this — or possibly neon lamp relaxation oscillators.

One of the advantages of a valve organ was that the player kept warm on cool evenings! A typical valve instrument generating six octaves would have required three double triodes for each of the 12 chromatic notes: one triode section would have been used as a master oscillator and the remaining five sections as frequency dividers. Throw in a few more valve stages for vibrato, mixing and preamplification and up to 25 amps of filament current was required, excluding the main amplifier.

The Eccles-Jordan (bistable) divider was invented in 1919, I believe, and of course the transistorised version of this circuit forms the basis of most of today's generators — probably encapsulated and combined with keying circuitry. In valve terms, two triodes were required and, although certain manufacturers used valve bistables, the constructor had to find a cheaper method. Consequently he would have chosen an R-C divider using a single triode stage, possibly a blocking oscillator. The latter method and

neon relaxation dividers produced a sawtooth waveform containing the full series of harmonics, ideally suited to subtractive tone-forming.

The HT requirement for a valve organ was in the region of 150mA at 300V, perhaps dropped in stages. This was sufficient to sharply remind the constructor if he was careless! Testing a partly-completed circuit meant muting the power supply with hefty resistors to dissipate unwanted power — a very time consuming and tedious process. The eventual change to solid-state methods was joyous — no real problems with a breadboard and battery. The roles have been reversed since now the constructor has to avoid giving his CMOS a shock inadvertently!

Twelve master oscillators — one for each note of the chromatic scale — were required and each had to be tuned accurately. Based on a triode section, the oscillators were usually of the L-C type (typically Hartley) and occasionally of phase-shift configuration. There was no difficulty in making these stable but, before the Leslie speaker became popular, good vibrato was a prerequisite. Unfortunately, stable oscillators are difficult to modulate with vibrato so the 'Q' of these valve oscillators had to be diluted until a compromise between stability and vibrato could be found.

Any commercial circuitry that could be obtained was scrutinised for ideas. Both



# The WERSI Concept

Build your own electronic organ with the WERSI system

WERSI presents their new generation of electronic organs and accessories to you, the do-it-yourselfer. All the tools you need are illustrated left. The electronics involved is very revolutionary, making it very easy to understand. Every non-specialist who can read is able to do it. Building a WERSI organ from a kit can save you more than half the cost of a similarly equipped ready-made instrument and that means with WERSI and your own initiative and involvement you can afford a sophisticated electronic organ.

Do you have to be a virtuoso or a music lover to benefit from building a WERSI organ? No . . . this would mean failure to recognize the sense of the hobby. Even after your project is completed you will be able to discover new excitement from the world of music.

Whether you play haunting blues, stomping disco, liturgical hymns or classic renditions the new generation of WERSI organs will make your life more enjoyable.

Want to know more? Just fill in the coupon below, enclosing £1.00, and we'll send you the big, full colour catalogue. It will answer all your questions.



**AURA SOUNDS LTD** are the first company to successfully market WERSI organs and kits in the U.K. We have three modern show-rooms where we pride ourselves you will receive a friendly welcome Why not pop in and see the WERSI range for yourself — we can always arrange a free demonstration. We also offer a free technical telephone support service which is second to none.

Alternatively, fill in the coupon below for the full colour catalogue. For immediate action telephone 01-668 9733 24 hour answering service quoting Access/Barclaycard Number.

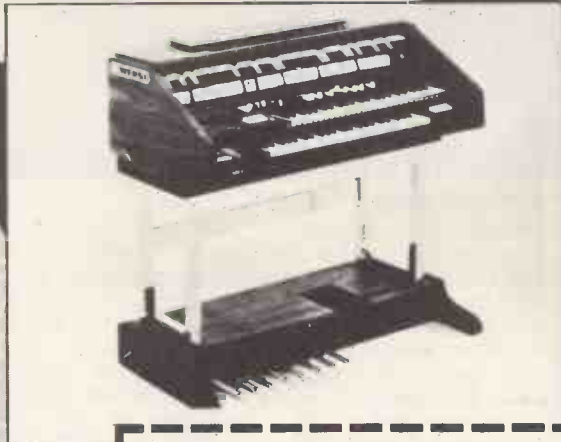

**AURA SOUNDS LTD.**  
14-15 Royal Oak Centre, Brighton Road, Purley, Surrey.  
Tel: 01-668 9733  
17 Upper Charter Arcade, Barnsley, Yorkshire.  
Tel: (0226) 5248  
1729 Coventry Road, Sheldon, Birmingham. Tel: 021-707 8244  
NOW OPEN — The Micro Centre, Albany Road, Newquay, Cornwall. Tel: Newquay 5953

Please send me the full colour WERSI Catalogue. I enclose cheque/P.O. for £1.

NAME \_\_\_\_\_

ADDRESS \_\_\_\_\_

2/82

Send to Aura Sounds Ltd., 14/15 Royal Oak Centre, Brighton Road, Purley, Surrey.

**WERSI and AURA — The Winning Combination**

Access/Barclaycard 24 hr telephone service.



One of Wersi's kit organs.

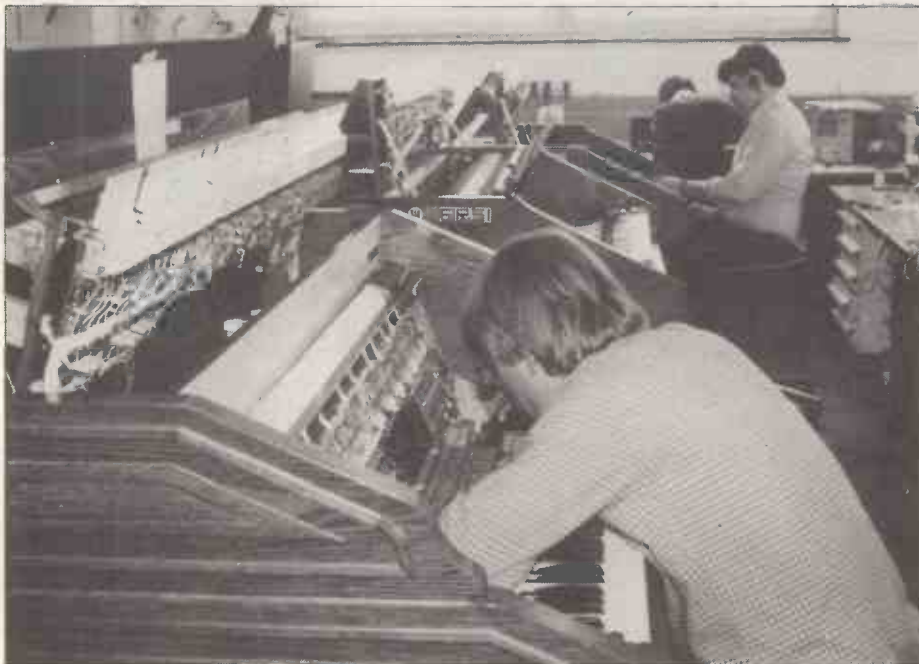

Part of Wersi's development laboratories in Germany.

Allen and Conn used free phase methods, where each frequency was separately produced and tuned (analogous to the pipe organ, in fact). The chorus effect obtainable from this system was an enviable feature and many home-brewed instruments employed this principle. However, they were hardly portable due to the weight of the inductors used at the lower end of the frequency scale. The free phase organ is still popular today, the transistor version with pot core inductors being far less unwieldy.

Keying the generated frequency was problematical before the advent of transistors. Both the power requirement and cost of valve operated 'gates' were such that the principle was feasible only in expensive commercial instruments. The constructor avoided metal to metal key contacts because, due to the fairly high impedances involved, clicks and thumps could be clearly audible. Resistive switching was often used to hide the transients: the key contact could be made to traverse a piece of pot. card or dip into a conductive liquid, such as com-

mercial anti-freeze! Another method used at the time was to place a chain of high value resistors between the generators and pre-amplifier, the playing key (at rest) earthing out a centre tap: this method was unfortunately prone to causing embarrassing ciphers. Diode keying began to take over, allowing several pitches to be keyed from one pair of contacts carrying a keying voltage: some control over sustain was another advantage of diode keying. Free phase organs, as is still the case today, used DC switches under the playing keys to supply the various individual oscillators. An R-C network after the keyswitch allowed the generated tone to rise and fall away in volume, giving an effect similar to the pipe organ.

Professionally made keyboards were less easy to obtain than today and often had to be sprung and contacts of some sort fitted. The keys were often heavy and suffered from considerable inertia, unlike the modern plastics key with metal extension. Those tempted to cannibalise old pianos found



themselves with unmatched keyboards and pivot points that were in the wrong place.

Tone forming methods do not seem to have changed radically. The generated waveform has, however, tended to move from sawtooth to square wave for reasons of economy and the ease with which bistable dividers can be synchronised. Keyed signals from the generators were applied, by means of the stop switches, to various filters — much as they are today. Low-pass, high-pass and tuned filters subtracted unwanted overtones from the rich sawtooth waveform to give flute, string and reed tones.

A sawtooth wave is almost ideal, except when trying to imitate a clarinet or similar stop. To surmount this difficulty, earlier instruments incorporated an *outphaser*. This circuit mixed 8' and 4' (sawtooth) pitches in phase opposition and produced an 8' square wave which was ideal for those woody, hollow voices.

Outputs from the various departments had to be applied to further valve stages for mixing, preamplification and possibly reverberation drive. It was not unusual to use a ni-chrome electric fire element as the reverb spring, with an ordinary crystal cartridge at each end acting as transducers. Rather Heath Robinson perhaps, but the idea often worked adequately!

Before the LDR arrived, the Swell Pedal had to consist of a Meccano-gearred pot. This often became noisy after a short period of use, especially if the instrument was played by someone with a rhythmic right foot! The main amplifier itself had to be treated with respect, with possibly 450V on the anodes of the output valves. Fortunately, Messrs Tobey and Dinsdale soon ousted that bulky and heavy chassis from the organ and were the forerunners of current small but powerful power amplifiers.

Yes — organ construction was a massive commitment a generation ago. Also, there was nowhere you could actually go to hear your organ before you built it: once started, the process could take a couple of years because of the time involved in winding hundreds of coils and working out a suitable method of keying.

If fathers were game for the task, it's that much easier for their sons. There is no lack of published detail, solid state circuitry has reduced the risk of a good 'belt' to those unused to the art of electronics and purpose-designed devices have telescoped both the time and space involved. Specialist suppliers such as Wersi, offering a vast range of superb instruments, and Maplin are extremely helpful to those venturing into construction.

If building from a kit, it is possible to listen to the final version before deciding if it is to your musical taste. Finally, it is probably true to say that, thanks to the mass production of solid-state devices, the cost of building an organ has risen slower than inflation over the past thirty years.

Perhaps the only aspect to cause the constructor to hesitate today is the choice of possible avenues — but that must be his decision!

**E&MM**

# PLAY THE ORGANLIKE JERRY ALLEN.



A Welson is what Jerry Allen plays!  
Welson UK are one of the best known names on the British market and it seemed only right that Britain's best known organist should help demonstrate the range and versatility of these superb Italian organs.

Welson UK offers a full range of organs to suit all homes and all pockets. If you're interested in the Welson range, and you want to know what Jerry Allen sees in Welson UK, clip the coupon. You could soon be playing like Jerry Allen.

**WELSON UK**  
*In tune with tomorrow*

# MAKE SURE IT'S A WELSON.

I am interested in Welson UK Home Organs  Welson Portables  Please send me more information. (Tick as appropriate)

NAME

ADDRESS

Send to: Welson UK, 10-12 Cornbrook Park Road, Manchester 15. Tel: 061-872 7661

E&MM/2/82

# ELECTRO-MUSIC ENGINEER

Charles Blakey Digisound Ltd

## Resonant Filters

Most readers will have seen pictures depicting the spectrum analyses of conventional musical instruments. Invariably these show that the amplitude of the harmonics do not fall off in a uniform manner and often the second, third and some higher harmonics are greater in amplitude than the fundamental. Thus simple analogue synthesis using a waveform with a high harmonic content, such as a sawtooth or pulse waveform, cannot faithfully reproduce the sounds of these instruments and the usual low pass filtering obviously does not help this situation.

The reinforcement of harmonics, or even the production of inharmonics, stems from the shape of traditional instruments as well as the materials used in their construction. The effect of these factors is to cause vibrations in, or within, the body of the instrument when it is played. These vibrations give rise to resonant frequencies known as "formants" and fortunately for electronic synthesis the formants remain constant irrespective of the note played. The violin provides an excellent example of the importance of formants, even though their nature is somewhat different when compared to most other acoustic instruments. It has been demonstrated that one of the features of the Stradivarius is that its resonant frequencies are about 1kHz higher than poorer quality violins and consequently the effect of this is to reinforce the higher harmonics and give a more pleasing tone.

The formant frequencies of conventional instruments are generally in the range of 100Hz for a double bass up to about 3500Hz for a modern violin. They are best synthesised by using a number of filters which may either be used to boost a comparatively narrow frequency band or which can reinforce several of the higher harmonics simultaneously. Such filters do not have to be incorporated within a synthesiser but may be a post treatment of the sound in much the same way as effects units. Furthermore the use of such filters is not confined solely to imitative synthesis of conventional instruments but can be put to good use with almost any type of sound, including vocals.

The essential features of resonant filters are the ability to manually adjust their frequency within the range given above, a variable Q (quality factor) and also control of gain. Perhaps it will help some readers if Q is briefly explained. Figure 1 shows the output from two band pass filters and the first peak has a Q of about 4 and the second peak a Q of about 1. It is evident that the higher the Q the narrower the band of frequencies that are passed by the filter. Q is easily determined by first measuring the amplitude of the peak and the frequency at which it occurs and then measuring the frequencies on either side of the peak where the amplitude is 0.707 (-3dB) of the peak amplitude. If the peak frequency is now divided by the difference of the other frequency measure-

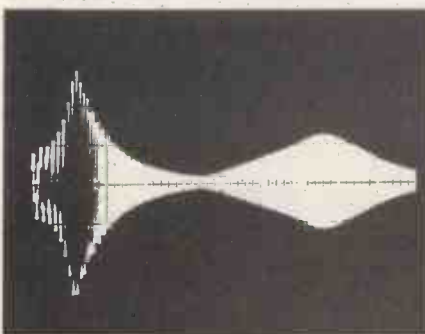
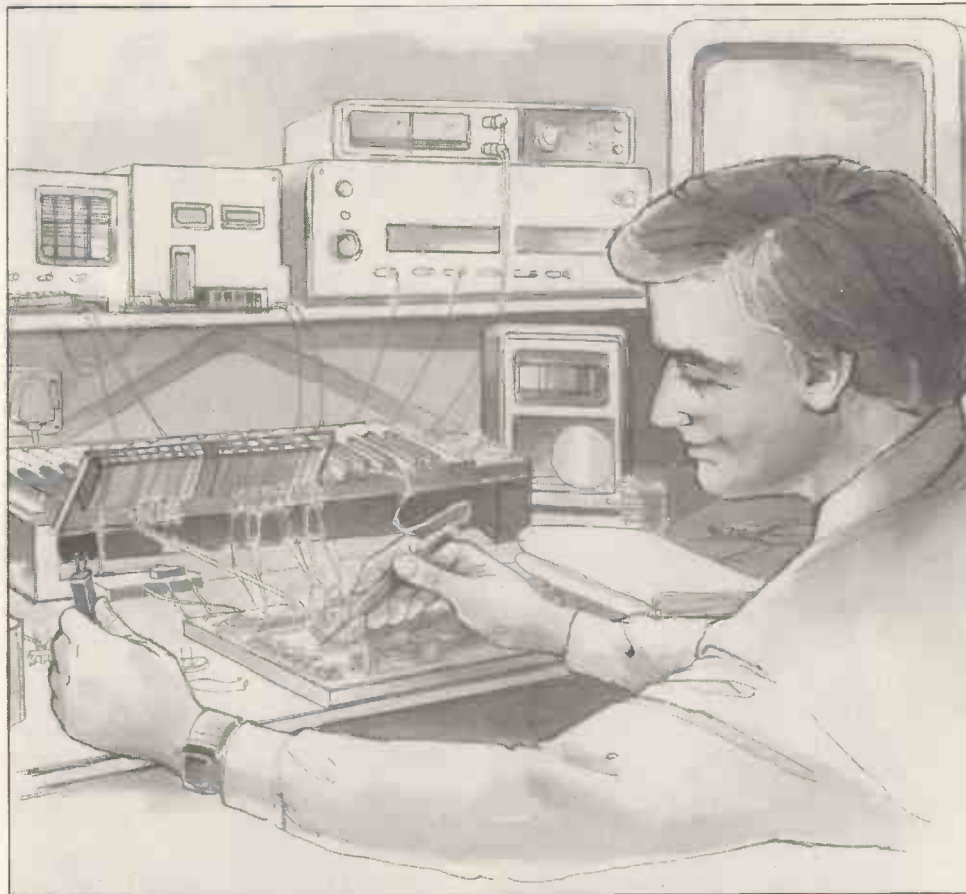

Figure 1. Band pass filtered signal.

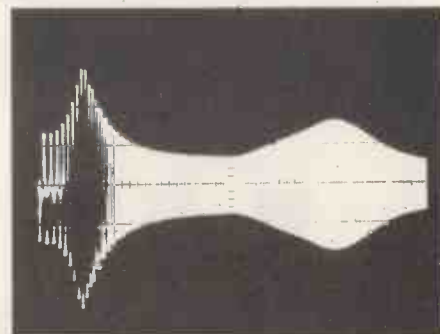

Figure 2. Band pass filtered signal plus a proportion of the original signal.

ments then the answer is the Q value.

A resonant filter is essentially a band pass filter but if the type of filters shown in Figure 1 were used then much of the original signal will have been filtered out whereas the intention, as described earlier, is to enhance certain frequencies and add them to the original signal. This is achieved by mixing a proportion of the original signal with the band pass filtered signal and the result of this is shown in Figure 2. The other control mentioned was gain since we may only wish to slightly enhance a narrow band of frequencies (high Q) or alternatively strongly enhance a wide band of frequencies (low Q). Often this is achieved by increasing the overall gain of the filter but the problem here is that one has to constantly be aware of the Q factor since it is easy to overload the output

causing distortion or clipping. The usual approach, however, is to limit the gain such that the signal will not distort at highest Q but this inevitably means a restricted boost at low Q settings. In the design shown in Figure 3 the approach is quite different since the Q may be varied from about 0.5 to 10 and over the frequency range 25Hz to 3,300Hz the amplitude of the output remains substantially constant, that is, within  $\pm 1$ dB. Thus the output will not overload irrespective of Q and the "gain" is varied by the attenuating potentiometers RV3 and RV6.

The design is based on a new filter IC from Curtis Electromusic Specialities (CES). The part number is CEM 3350 and its correct description is a "Dual Voltage Controlled State Variable Filter". Since it is a dual filter then two resonant filters may be constructed

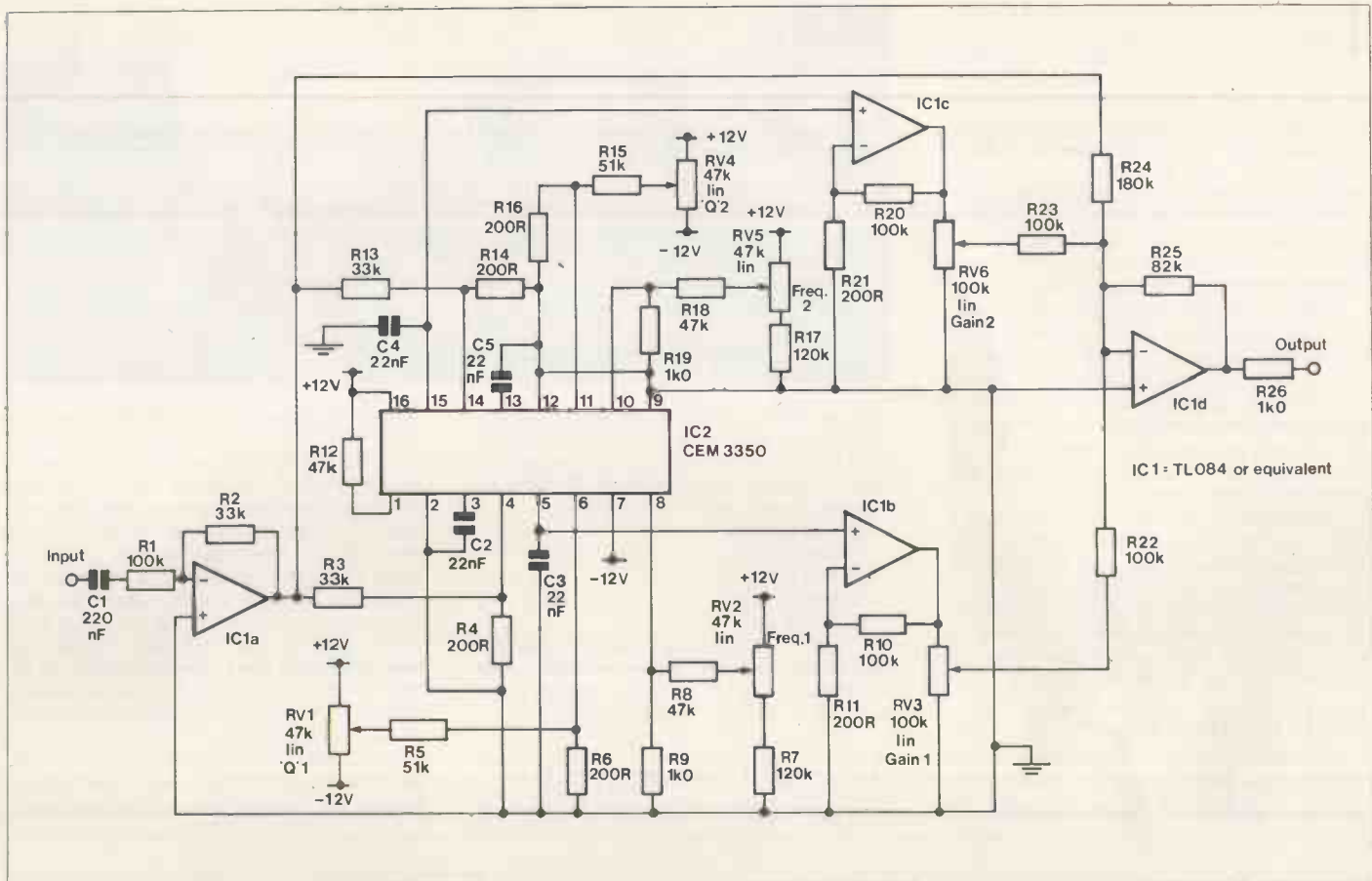

Figure 3. Two resonant filters using the CEM 3350 IC.

from a single IC. The CEM 3350 will not be described in detail at this time but its versatility is such that it is certain to gain favour for many novel filter applications as well as for conventional voltage controlled filters. One important point to note, however, is that its power requirements vary from the other CES ICs which have been described in earlier issues of E&MM. The IC is not guaranteed to withstand operation from dual power supplies whose total voltage is in excess of 26V. On the other hand it will operate with supplies down to about  $\pm 3V$  and so is well suited to battery powered projects. For the design example  $\pm 12V$  supplies are used and zeners or voltage regulators may be used with higher voltage supplies.

The dual resonant filter illustrated in Figure 3 is very compact since it requires only two DIL packages, the CEM 3350 and a quad op-amp such as the TL084, and a handful of other components. Another feature is that no trimmers are required which in turn means that no test equipment is needed for setting up the filters. The input signal is applied to IC1a and thence split three ways: to each of the resonant filters and to IC1d where the outputs of the filters are summed with the original signal. The resistors R22 to R25 are chosen such that the resonant frequency bands may be boosted by +15dB over the original signal while the overall peak to peak gain is unity when a filter is at maximum boost. In many

applications the input stage, IC1a, would not be required but since the summing amplifier, IC1d, causes a polarity inversion then IC1a corrects this and prevents signal cancellation effects. A bonus from using IC1a and IC1d is that it becomes a simple matter to modify the circuit for various signal levels without having to alter components connected to IC2. For example, the design is configured for a 10V p-p signal and to alter it for, say, 5V p-p then R2 would be changed to 68k and R25 to 39k. The signal input to the filters is further attenuated by R3/4 and R13/14 and applied to pins 4 and 14 of the CEM 3350, which are termed the "Variable Gain Inputs". There are also "Fixed Gain Inputs" at pins 2 and 12, which are grounded in this application, and using these latter inputs allows user flexibility in achieving various characteristics.

Pins 3 and 13 of IC2 are the low pass outputs from the filter while pins 5 and 15 are the band pass outputs. The latter are used for the present application and since the outputs are of high impedance they are buffered by IC1b and IC1c which are configured as non-inverting amplifiers. The gain of the latter are set to restore the signal to its original level.

The Q controls for the CEM 3350 (pins 6 and 11) have an exponential response and thus give a more "natural" control response although this feature is not of special

importance for the resonant filters. RV1 and RV4 and associated attenuating resistors control the Q of the filters, to the limits stated earlier, and an increasing negative voltage increases the Q factor.

The frequency controls for the filters also have an exponential response scaled at a nominal 18mV per octave. The frequency is adjusted by RV2 and RV5 and associated resistor networks, with R7 and R17 used to restrict the upper frequency limit. The reason for limiting frequency is twofold. Firstly, higher frequencies will result in wider amplitude variations to that specified above of +1dB. Secondly, since resonant filters only require a limited frequency range it enables specific frequencies to be more accurately obtained with a single potentiometer. Note that these potentiometers should also be "reverse" wired since the frequency decreases with increasing positive voltage.

The last component is R12 which is connected from the positive supply pin to the current reference pin (pin 1). For normal applications a nominal reference current of 400uA is required for the four exponential generators in the CEM 3350 and this is produced by R12.

As stated earlier, resonant filters are valuable for both imitative and creative synthesis and it is hoped that this simple and effective design will encourage synthesists to explore their applications.

# Micromusic



## Make polyphonic music with the ZX81

In the January issue we described an 8-bit output port; whilst this is fine for those synthesisers with a digital input, most operate with a one volt per octave control voltage. Figure 1 shows a digital to analogue converter (DAC) to provide this voltage from a digital input. IC1 is the converter IC itself; although this is an 8-bit device, only the six most significant bits are used to give a little over five octaves range. Bit seven is the gate signal, and in many cases this can be connected direct to the output port; or via a simple amplifier if 15 volt gates are required.

IC3 is a voltage regulator (pin connections are given for the DIL version of the 723) which feeds a stable reference current into pin 14 of IC1 via the 5k1 resistor. The 5k0 preset allows adjustment of this current to give an accurate one volt per octave output. IC2 actually gives a current output of 417uA per octave, and IC2 converts this to the required voltage swing.

Temperature stability is important in a circuit such as this, and metal oxide or metal film resistors should be used for best drift characteristics; the preset should be a cermet type for the same reasons, preferably of the multi-turn variety to make setting up easy. The 15V supply rails can often be derived from the synthesiser to be driven.

### Setting up the DAC

With the converter connected to the lower six bits of the ZX81s output port, monitor the voltage output with a digital voltmeter. The



simple BASIC program below causes the output code to change by one octave every time NEWLINE is pressed; simply adjust the preset until the output voltage changes by exactly one volt when this is done.

```
10 POKE 16351,1
20 INPUT N$
30 POKE 16351,13
40 INPUT N$
50 GOTO 10
```

Note that this program uses port address 16351; i.e. the one shown in Figure 1 last month, with links 'A' being connected to put the port in memory address space.

### A Polyphonic Sequencer

We are now in a position to create a

sequencer program using all topics we have covered so far. This program is in machine code for speed, and can drive up to seven synthesisers if you have them. The port circuitry given last month is used, but with links 'B' connected. An extra latch will be required for every synthesiser output; if more than four output ports are used, an additional 74LS02 will be needed as well. The program addresses the first port at 1F (hex) and so the first latch should be selected by IC1 pin 15, the second by pin 14, and so on. The input port is still situated at DF, and is therefore selected by pin nine as in the original circuit.

The note codes are stored in string array A\$, which needs to be dimensioned beforehand in the form A\$(N,V). V is the number of

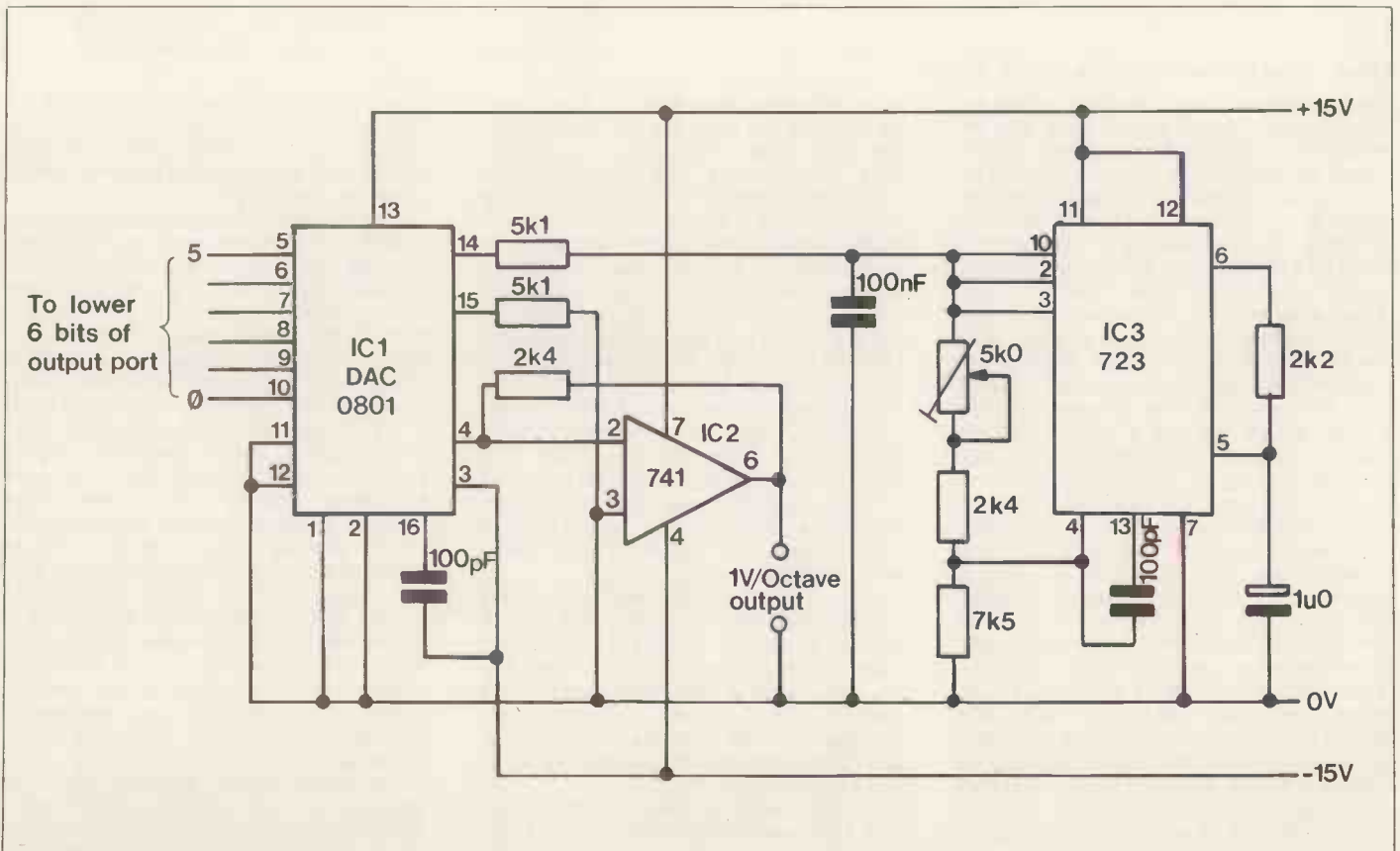

Figure 1. A six bit digital to analogue converter for driving synthesiser control voltage inputs.

voices, and should always be included even if it's one. To avoid complexity in the machine code, the music is split up into 'events' of equal time duration. If a semi-quaver is the shortest note in the piece to be played, this will be one event; in this example, a crochet would occupy four events, a minim eight and so on. Thus N in the array dimension is the number of events; the program simply steps through the array from one to N, outputting each line of V 'voices' to the ports. The speed at which this happens is governed by pulses applied to bit seven of input port DF, so the music can be synchronised to a drum machine or 'click track' recorded on tape.

If the array is dimensioned A\$(10,3) for example, the sequence of events would be as follows: when the input pulse goes low, the code corresponding to character A\$(1,1) will appear on port 1F; A\$(1,2) will appear on port 3F and A\$(1,3) will be sent to port 5F. When the pulse goes high, A\$(2,1), A\$(2,2) and A\$(2,3) will be output from the ports in the same order, and so on.

It should be evident by now that an efficient method of filling up A\$ is going to be necessary, and a BASIC program to do this will be discussed later (although no claims are made for its efficiency!).

The complete machine code listing is given in Table 1, and should be entered using the 'machine code monitor' given in December. Note that the program starts at location 16524, so there will be some blank

bytes at the beginning; nearly 180 bytes are used, so make sure your REM statement has sufficient characters in it. Once the program is entered, save it on tape to avoid disaster.

## Machine Code Description

The program consists of six subroutines, as follows:

### 16524

This looks at the BREAK key, and returns with the carry flag reset if it is pressed.

### 16531

Register C is used to hold the current port address; this routine adds 20 (hex) to the value of C to get the next address.

### 16536

This routine is an aid to tuning up, and sends the code for middle A to all the ports (with bit seven set) so that the synthesisers may be tuned together. When the BREAK key is pressed, all the gate bits are reset to turn off the sound.

### 16566

Machine code programs do not have access to BASIC variables, and this segment locates A\$ in the variable memory space.

### 16621

This is a subroutine used by the final program segment, and in fact does most of the work of outputting each voice in a particular time event to its respective port.

### 16640

The final part is the actual playback routine itself; this uses all the other sub-routines, except the tune routine, monitors the sync. input and detects the end of the piece. This is indicated by A\$(N,1) being either STOP (code 227) or GOTO (code 236). As you might expect, GOTO causes the sequence to start again from the beginning, whilst STOP returns the BASIC and ends the piece.

The only machine code routines that would normally be called from BASIC would be 16536 (to tune up) and 16640 (to start playing the piece); type PRINT USR (16536) or (16640).

Next month we will cover ways of programming the music; for the time being, it should be possible to develop short sequences by entering the note codes into A\$ by hand. Remember that the numbers need to be converted into their corresponding characters first.

## The Gremlin Department

My apologies for a couple of mistakes that somehow crept in last month. Firstly, in Figure 1, the lower output pin of IC1 was shown as pin eight; this should be pin seven to correspond with the address table. Second, line 210 of the sequencer program may have puzzled those of you who couldn't find the function TEN on your ZX81; that should have been LEN of course.

Peter Maydew

E&MM

Table 1. Machine code listing for the polyphonic sequencer program.

Hex	Opcod	Decimal location				
01 FE 7F	LD BC, 7FFE	16524	FE A0	CP A0	C9	RET
ED 78	IN A, (C)		28 10	JR Z	CD B6 40	CALL 16566 16640
1F	RRA		FE E0	CP E0	E5	PUSH HL
C9	RET		28 13	JR Z	DD E1	POP IX
3E 20	LD A, 20	16531	23	INC HL	DD 23	INC IX
81	ADD A, C		5E	LD E, (HL)	DD 23	INC IX
4F	LD C, A		23	INC HL	CD 8C 40	CALL 16524
C9	RET		56	LD D, (HL)	D0	RET NC
01 1F 07	LD BC, 071F	16536	23	INC HL	DB DF	IN A, DF
3E A2	LD A, A2		18 0F	JR	17	RLA
ED 79	OUT(C), A		11 06 00	LD DE, 06	38 F7	JRC
CD 93 40	CALL 16531		18 0A	JR	CD ED 40	CALL 16621
10 F7	DJNZ		23	INC HL	CB 77	BIT 6, A
CD 8C 40	CALL 16524		CB 16	RL (HL)	28 05	JR Z
38 FB	JR C		30 FB	JR NC	FE E3	CP E3
01 1F 07	LD BC, 071F		18 F4	JR	20 E2	JR NZ
3E 22	LD A, 22		11 12 00	LD DE, 12	C8	RET Z
ED 79	OUT(C), A		19	ADD HL, DE	CD 8C 40	CALL 16524
CD 93 40	CALL 16531		18 D1	JR	D0	RET NC
10 F7	DJNZ		11 06 00	LD DE, 06	DB DF	IN A, DF
C9	RET		19	ADD HL, DE	17	RLA
2A 10 40	LD HL, (VARS)	16566	C9	RET	30 F7	JR NC
7E	LD A, (HL)		46	LD B, (HL)	CD ED 40	CALL 16621
FE C6	CP C6		0E 1F	LD C, 1F	CB 77	BIT 6, A
28 2A	JR Z		DD 7E 00	LD A, (IX)	28 DB	JR Z
FE 80	CP 80		ED 79	OUT(C), A	FE E3	CP E3
C8	RET Z		CD 93 40	CALL 16531	20 CD	JR NZ
E6 E0	AND E0		DD 23	INC IX	C9	RET
FE 60	CP 60		10 F4	DJNZ		
28 0F	JR Z		DD 7E 00	LD A, (IX)		

# America

Tim Schneckloth

What is the quintessential solid body electric guitar? I suspect most people would say it's one of the vintage Gibson Les Paul models. Others might vote for the versatile Fender Stratocaster or one of the Gibson SGs.

For this writer, though, it has to be the Fender Telecaster — one of the few electric instruments that have developed a real identity and mystique. For those of us who grew up in the American Southwest in the '50s and '60s, the mere sight of a Telecaster brings back a rush of memories. And the instrument's sound evokes even stronger recollections. There was the late Mike

Bloomfield at the 1965 Newport Folk Festival, backing Bob Dylan and Paul Butterfield with screaming, penetrating Telecaster sounds that we swore could be heard around the world. A few years before that, we could often see the great James Burton on television, bending his Telecaster strings way up, making the instrument talk in ways we hadn't thought possible. Then there were the unmistakable Telecaster sounds on some of Jeff Beck's early Yardbirds recordings. Ray Davies had one hanging around his neck while he shook his finger at us in '64. And when the '70s came in, playing country and blues Telecaster became an art form

unto itself — players like the late Clarence White (with the Byrds), Amos Garrett, Roy Nichols and Arlen Roth brought their string-bending, pedal steel-like techniques to perfection. And, I would suggest, Bruce Springsteen's live show would be at least a little less powerful — both musically and visually — if he used any other guitar.

Over the years, Fender (now owned by CBS) made modifications and "improvements" on the Telecaster, only to find that the older, vintage models had greater appeal. So, in a smart marketing move, Fender is now offering a model called the "Vintage Telecaster". It, I gather, is an attempt to



Fender Vintage Telecaster guitar.



Fender Lead III guitar.



Fender Bullet Deluxe guitar.

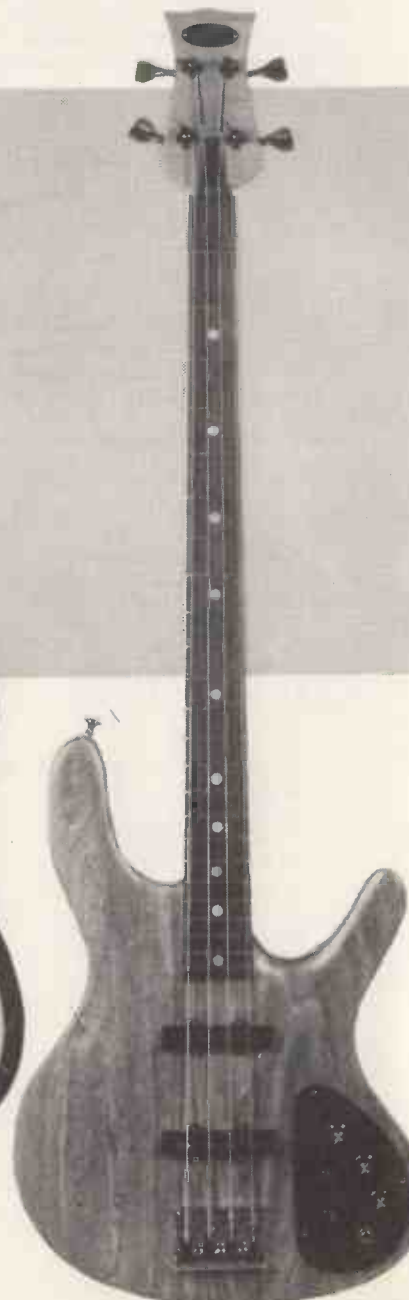

Evan JB-2 bass.





Steinberger bass.

come as close to the original 1950s instrument as possible. How well they've succeeded in reproducing a classic depends on the taste of the individual who tries it out. It has the keening, hot, single-coil pickup sound that Telecasters are famous for, but somehow it just doesn't seem the same. Maybe a few years of ageing will balance everything out.

Fender is keeping busy these days. Other new instruments introduced by the company lately include the Bullet, the Bullet Deluxe and the Lead III. Let's take them one by one.

The Bullet and Bullet Deluxe are aimed at the younger market; they're designed for maximum quality at a fairly low price. Both Bullets feature two single-coil high-output pickups which, according to Fender, provide good sustain capabilities. Both instruments are full-scale (25½ inches) and include curved rosewood fingerboards, six indi-

vidually mounted keys and six adjustable bridge saddles, allowing variation in action, height and intonation.

The Bullet has an innovative self-shielding pickguard/bridge combination that increases sustain by creating a fuller mounting surface. The powder coating on the pickguard is durable and scratch resistant. The Bullet Deluxe model, however, features a standard six-section bridge and separate pickguard. The standard case provided with both models is a new vacuum-formed model. Suggested retail prices are \$249 for the Bullet and \$299 for the Bullet Deluxe.

Also new from Fender is the Lead III, an addition to the company's moderately-priced Lead Series. It features two humbucking pickups, designed for high output and maximum sustain. The guitar also includes a pickup selector switch and a coil tap switch for additional tonal variations.

Other features include six bridge sections for perfect intonation and action adjustments, electrostatic shielding for low noise performance, sturdy switches and a solid ash body. It's available with a rosewood or maple fingerboard and comes fitted with six individual machine heads. Case is included in the \$479 suggested retail price.

On the amplifier scene, Fender is offering a new Bassman Compact Amp, a 50-watt unit with a 15-inch heavy duty speaker. A special feature is a compressor with threshold control and an LED indicator, intended to prevent overload and expand dynamic range. It has high and low inputs to accommodate instruments of differing output levels; controls include bass, treble, midrange, volume and master. The amp's rear panel includes preamp-out and power amp-in jacks for effects patching. Retail



price is \$395.

Other American companies have some new guitar and bass designs coming off their drawing boards. One of the most intriguing is the Steinberger Bass, designed by Ned Steinberger of the Steinberger Sound Corporation. I first saw this instrument being played by Andy West of the Dregs, who was plucking the bass while sitting in a hotel hallway. On first sight, it looks rather ridiculous, since the instrument has no head and not much of a body; it looks as though the musician is playing a slightly elongated guitar neck and nothing else. When it's all plugged in, however, it has a great sound and undeniably striking visual appeal. According to a Steinberger spokesman, the bass relies "entirely on plastics for its shape, breaking with the traditional assumption that electric guitars must imitate the look, sound and feel of their electric parents".

Another nice new bass on the market is somewhat more traditional in design but is innovative nonetheless. It's the JB-2 bass from Evans Guitars in New York State. It includes Seymour Duncan high output pickups, Schaller tuners and a Badass #1 bridge. It's available in 21 or 24 fret models and can be purchased in fretted or fretless versions. The instrument has a smooth neck/body joint that provides easy access to all notes. The strings cross high over the body, making it easy to get those funky popping, snapping and slapping sounds. The JB-2 is totally handmade and weighs 7.5 pounds.

New amplifiers coming out of the U.S. include a couple of new models from St. Louis Music Supply. This company has had considerable success with its low priced, compact, versatile Crate amp line, and, at this point, they've decided to try their hands at marketing larger amp units. Their initial try at this market is the Crate Condor CR-260, a 260-watt stack that should provide suf-



Crate Condor CR-260.



Crate CR-110.



Shure PE-2 Series microphone.



regulated by a line out level control like the control used by studio musicians. Other controls include an active bass, fat switch, active midrange frequency and level controls, active treble, bright switch, reverb, gain and master controls in both the normal and overdrive channels. A full effects loop is also included.

Crate's other new entry lies at the other end of the amplifier spectrum — it's called the CR-110 and has only 15 watts RMS and a 10-inch speaker. It has a lot of features for its size, though: overdrive gain and level controls, a manual overdrive switch, volume for the normal channel, bass, midrange, bright switch and treble controls. It also has high and low inputs, channel footswitch jack and a line out jack, with the low input doubling as a channel footswitch jack and a line out jack. The amp is available in two different cabinet styles — Crate's well-known dovetail ponderosa pine design and a textured black tolex model.

On the sound reinforcement front, new things are coming from Shure Bros., including the PE-1 and PE-2 Series "Suedecoat" mics. These series consist of six models of unidirectional, dynamic microphones for vocalist or instrumental use. The special features of the PE-2 Series mics include two built-in, recessed tone-shaping switches for presetting either high frequency boost or low frequency cut-off, eliminating boominess and enhancing presence. Also new from Shure are two microphone mixer models, the M267 and M268.

Owners of the Bose model PM-2 Power-mixer will be glad to hear of the availability of the Bose SB-2 Series Box, a new "black box" accessory designed to expand the capabilities of the PM-2. The unit plugs directly into the output jacks of the PM-2 mixer and allows impedance-corrected connection of two to four pairs of 802 speakers without the need for any additional amplifier power. Its suggested retail price is \$38.

And, for those of us whose ears need a little help now and then, there's the Accupitch 440, a microcomputer tuner accurate to 1/100th of a semitone. The Accupitch, which is available from Guild Guitars, can be used with either electric or acoustic instruments. It features dual LED indicators and metered readout, plus a seven-tone generator including "A" 440. An output jack is provided so that the unit can be hooked up to an amplifier. Suggested retail price is \$89.95. **E&MM**

*Companies and manufacturers mentioned:*  
 Fender/Rogers/Rhodes, CBS/Arbiter Ltd, Fender House, Centenary Estate, Jeffrey's Road, Brimsdown, Enfield, Middlesex.  
 Steinberger Sound Corp., 148 Sullivan St., Brooklyn, NY 11231.  
 Evans Guitars, John Hornby Skewes & Co Ltd, Salen House, Garforth, Leeds. Tel: (0532) 865381.  
 St. Louis Music Supply Co, 1400 Ferguson Ave, St. Louis, MO 63133.  
 Shure Electronics Ltd, Eccleston Road, Maidstone ME15 6AU. Tel: (0622) 59881.  
 Bose (UK) Ltd, Trinity Trading Estate, Sittingbourne, Kent. Tel: (0795) 75341/5.  
 Guild Guitars, C. Summerfield Ltd, Saltmeadows Road, Gateshead, Tyne & Wear.

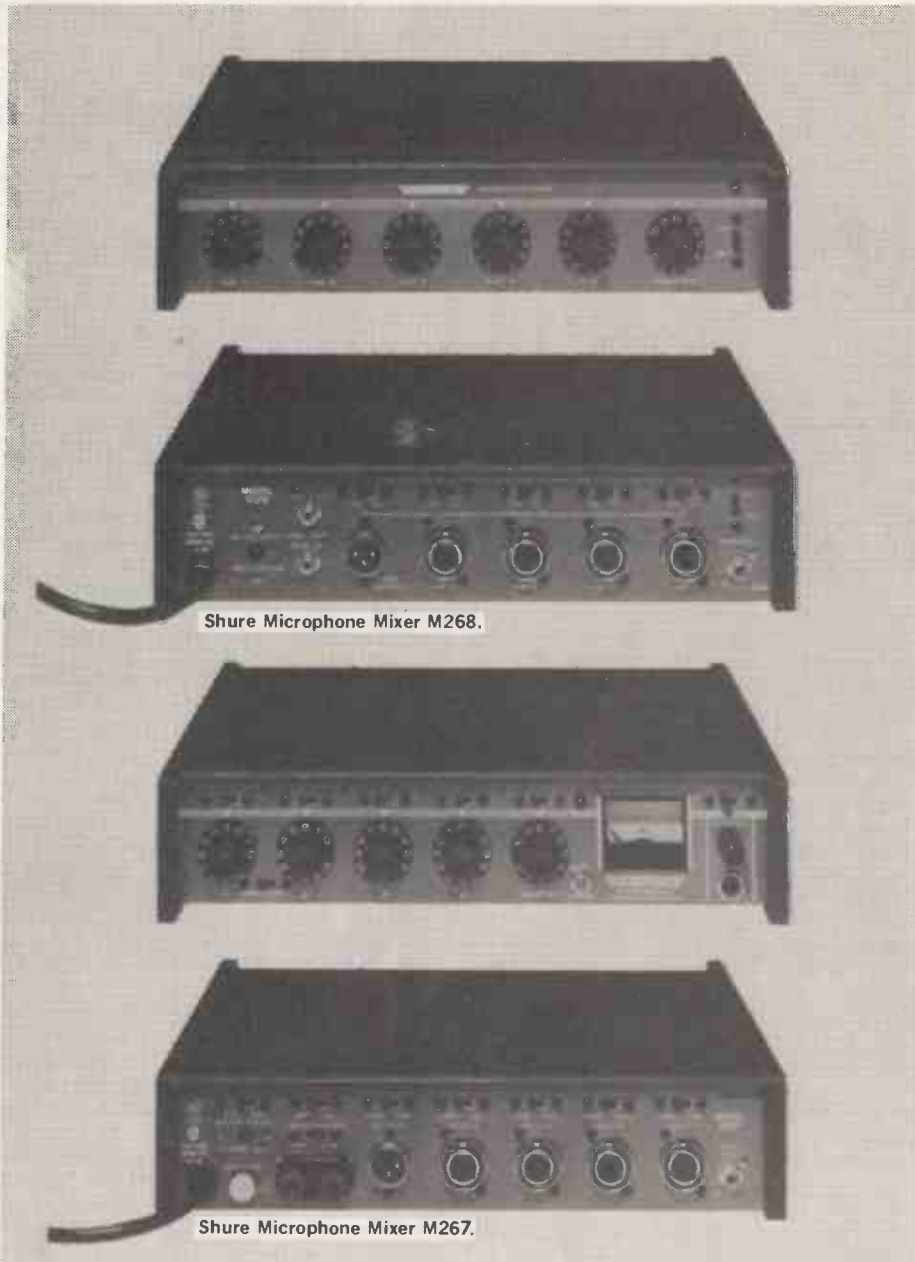

Shure Microphone Mixer M268.

Shure Microphone Mixer M267.

ficient amplification for any performance site smaller than the Grand Canyon.

The stack consists of three units that include two 130 watt amps — one preamp/power amp in the head and a second slave amp down below in the lower ported enclosure. Each enclosure is fitted with two 12-inch Celestion speakers.

The preamp includes a special "sequential cascading gain". According to the manufacturer, this allows the player to "add gain on top of gain, providing the advantages of greater reliability, more control and greater sound potential than conventional tube amps". A balanced low impedance line out and separate high impedance line out is



Bose SB-2 Series Box.

# MUSIC MAKER EQUIPMENT SCENE

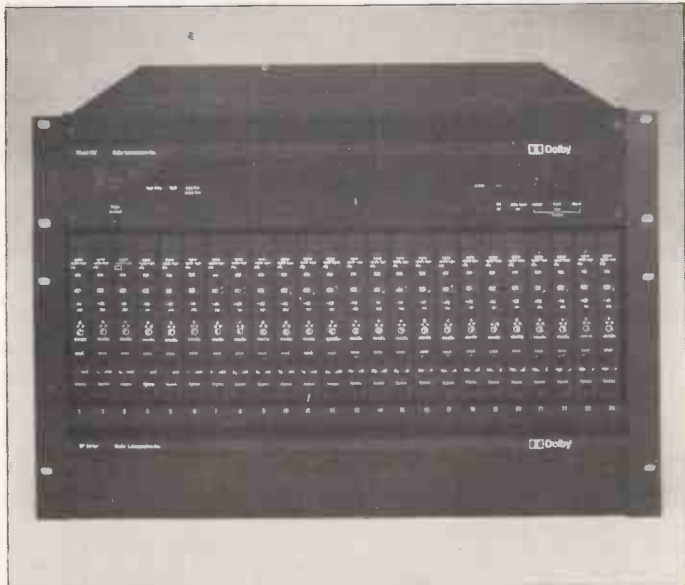

## DOLBY

Dolby Laboratories have announced a new professional multi-track noise reduction unit, their SP series, which is now in production. It provides up to 24 channels of Dolby-A with a separate power supply unit housing two fans. Each channel consists of a standard Dolby 22 module plugged into a new interface card designed for high headroom and low distortion. Controls allow rapid

resetting of Dolby level for non-standard-level tapes, LED level display for each channel enabling calibration to  $\pm 0.1$ dB, and further LEDs for checking clipping and assisting alignment with peak reference level (DIN) tapes. All record/play functions have discrete FET switching. The established Dolby MH series will continue to be produced.

For further details contact Dolby, 346 Clapham Road, SW9.



## PRELUDE 1

Keyboard players will be interested to learn of a new 'electronic tutor' developed by a company in Preston. The Prelude looks like a pocket calculator, sitting in the hand and giving an instant liquid crystal guide to more than 600 chords, as well as major and minor scales.

The advantage of the Prelude over more conventional printed tutors is its immediacy — you punch in the chord you need and the 'answer' is instantly displayed, and the device should interest all keyboard players who need a bit of help in the chord construction department.

A handy tool for the polyphonic amongst us, the Prelude sells for £19.95 (inc VAT).

It can be bought mail order for an extra 40p from the makers, Speedyplain Ltd, Freepost, Longton, Lancs PR4 5YL.

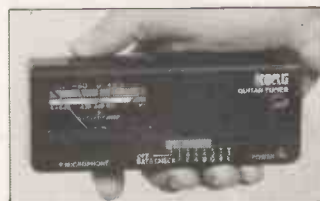

## KORG MICRO SIX

A new addition to the successful Korg range of instrument tuners is the Micro Six, which will be reviewing in the near future. It is a compact

device designed for acoustic and electric guitars and electric basses. The Micro Six is based on a quartz crystal oscillator, and is claimed to be accurate to within 0.025 of a semitone. The tuner's range will now comfortably encompass open bass string tuning, which has posed problems in other devices. You even get a colour option — black, blue or white — and the Micro Six will cost you £27.50p (inc VAT).

For more information contact Rose-Morris, 32-4 Gordon House Road, London NW5. Tel: 01-267 5151.

## JAPANESE GUITARS

Debate continues as to which Japanese guitars are made at which factories — some people have even argued that all oriental guitars come from one huge factory! This is far from the truth, and to dispel these rumours and give a guide to what comes from where, here is a table of the major brands and the factories at which they are made, followed by a map with the factories marked on it and a key with their addresses. Corrections and additions are welcomed.

BRAND	FACTORY/ FACTORIES
Aria	Aria (Nagoya); Aria (Tatsuno); Fuso
Aria Pro II	Matsumoku
Cimar	Chusin
Daion	Daion
El Maya	Chusin
Epiphone (acoustic)	Terada
ESP	ESP
GR (Roland gtr synth)	Fuji Roland
Greco	Fuji Gen-Gakki
Hohner	Terada
Hondo Pro II	Matsumoku
Ibanez	Chusin; Fuji Gen-Gakki
Ibanez (acoustic)	Hoshino
Kasuga	Kasuga
Kawai	Kawai
Maya	Chusin
Navigator	ESP
Terada	Terada

- |          |              |
|----------|--------------|
| Tokai    | Tokai        |
| Vantage  | Matsumoku    |
| Westbury | Matsumoku    |
| Yamaha   | Nippon Gakki |
- 1 **Aria (Nagoya)** Aria Musical Instrument Manufacturing (Nagoya) Ltd, Nagoya, Aichi Pref.
  - 2 **Aria (Tatsuno)** Aria Musical Instrument Manufacturing (Tatsuno) Ltd, Kamiina, Nagano Pref.
  - 3 **Chusin** Chusin Musical Instrument Manufacturing Inc, Minami, Nagano Pref.
  - 4 **Daion** Daion Co Ltd, Osaka.
  - 5 **ESP** Electronic Sound Products, Tokyo.
  - 6 **Fuso** Fuso Musical Instrument Manufacturing Co Ltd, Niwa, Aichi Pref.
  - 7 **Fuji Gen-Gakki** Fuji Gen-Gakki Manufacturing Co Ltd, Matsumoto, Nagano Pref.
  - 8 **Fuji Roland** Fuji Roland Co Ltd, Matsumoto, Nagano Pref.
  - 9 **Hoshino** Hoshino Musical Instrument Manufacturing Co Ltd, Owariasahi, Aichi Pref.
  - 10 **Kasuga** Kasuga Musical Instrument Manufacturing Co Ltd, Niwa, Aichi Pref.
  - 11 **Matsumoku** Matsumoku Industrial Co Ltd, Matsumoto, Nagano Pref.
  - 12 **Nippon Gakki** Nippon Gakki Co Ltd, Hamamatsu, Shizuoka Pref.
  - 13 **Terada** Terada Gakki Co Ltd, Nagoya, Aichi Pref.
  - 14 **Tokai** Tokai Gakki Co Ltd, Hamamatsu, Shizuoka Pref.

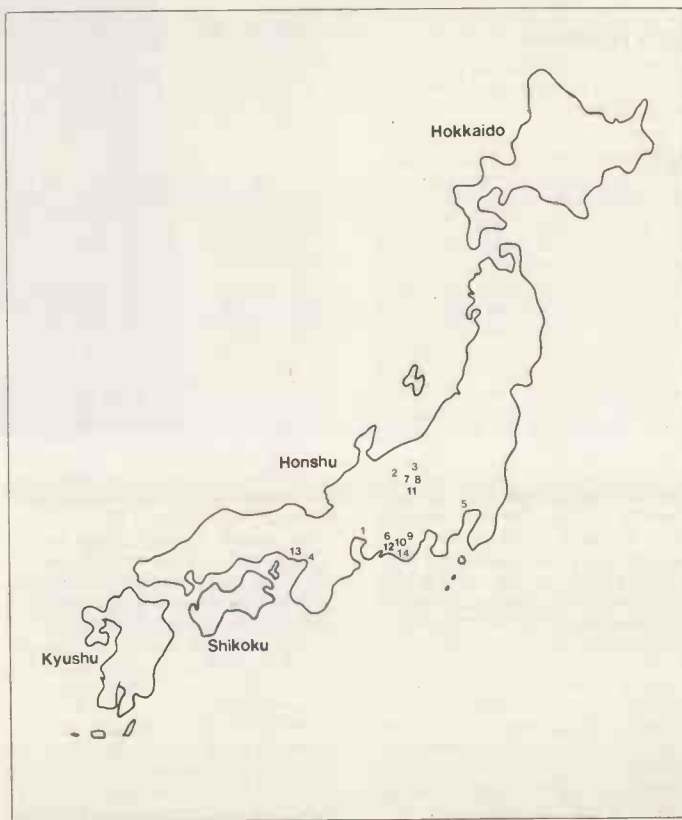

# MUSIC VIDEO

A compilation of the top selling music video cassettes in the U.K.

This month we start a video review column and welcome comments and views on a particular music video from readers in this new area of music enjoyment.

- |  |                     |
|--|---------------------|
| 1. Queen - Greatest Flix               | EMI                 |
| 2. Rock Flashback - Deep Purple        | BBC/3M              |
| 3. The Best of Blondie                 | Chrysalis           |
| 4. Elvis - The King of Rock 'n' Roll   | World of Video 2000 |
| 5. Siouxsie & The Banshees             | Spectrum            |
| 6. Kate Bush Live At Hammersmith Odeon | EMI                 |
| 7. Pink Floyd Live At Pompeii          | Spectrum            |
| 8. Toyah At The Rainbow                | BBC/3M              |
| 9. Thin Lizzy - Live & Dangerous       | VCL                 |
| 10. Quadrophenia                       | Spectrum            |
| 11. The Tubes Video                    | EMI                 |
| 12. Iron Maiden                        | EMI                 |
| 13. Paul McCartney & Wings Rockshow    | EMI                 |
| 14. The Jazz Singer                    | EMI                 |
| 15. Slipstream - Jethro Tull           | Chrysalis           |
| 16. Elvis In Hawaii                    | Mountain            |
| 17. James Last Live In London          | Spectrum            |
| 18. ELO Live In Concert                | VCL                 |
| 19. Alice Cooper In Concert            | Magnetic Video      |
| 20. Grease                             | CIC                 |

Compiled by HMV Shop, 363, Oxford St., London W1

# VIDEO REVIEW

## Fleetwood Mac Warner WEV 4022

Two types of music video are now generally available and thus merit review in E&MM: incidental recordings of performances, live or studio; or dedicated audio visual interpretations of the artist's music. Both have their merits, for the first type tends to give a more authentic portrayal, whilst the second allows greater artistic content and will usually be a purpose-made video film with high product costs (up to £20,000 for three minutes).

The Fleetwood Mac video is the "performance" type with orchestra pit close-ups and head-on full stage shots. Interest is maintained with the shot interviews and "individual group members at work" sequences.

The film begins with dressing room scenes leading to auditorium audience enthusiasm. There's plenty of atmosphere here and in the other examples of live music which include extracts from: Sisters of the Moon, Walk a Thin Line, Angel, Save Me a Place, Tusk, Songbird, The Chain, Go Your Own Way, Never Make Me Cry, Sara, Think About Me, Not that Funny.

A music video "artist survey" such as this obviously aims to give you some insight into the personalities and social background of Fleetwood Mac. Mick Fleetwood talks with Mrs Fleetwood about management problems, set in the grounds of their large

house, beset with the trimmings of success — the swimming pool etc. Later, there are scenes on their yacht. There's a visit to a Los Angeles studio, with Lindsey Buckingham singing whilst Mick adds a drum track, and also further sequences of Mick playing Indian drum and kit solos. Glimpses of the group show John enjoying the stage shows and playing a bass solo. Stevie comments on life on the road. Christine sings, plays accordion and goes to ballet classes, whilst Lindsey plays 12-string acoustic and sings. There's scenes of setting-up prior to a big live show at the St Louis Checkerdome.

The music quality is satisfactory and, of course, mono. With a hi-fi link to the video, the sound was slightly restricted in bandwidth, although not noticeable on TV speakers.

Stage shots are generally "grainy" because of the problems of live performance filming and Christine sings one song out-of-sync. "Fleetwood Mac" is certainly worth renting to gain an insight into this popular established group, although more complete songs should have been included. Interviews are "one-view" standard, although performances are worth seeing several times. Actually made in 1980, so it's probably pretty good for its time. A lot more would have been done these days to improve the visual interest. ... Mike Beecher

# BOOK REVIEW

## Rock Hardware

Edited by Tony Bacon  
Published by Blandford Press  
Price £10.95

With the passage of twenty or so years of proliferating technology aimed at the playing or recording of rock music, some sort of appraisal of "where things are at" is badly needed. It's fairly easy to find magazines and/or books dealing with one side of the business or the other, and one man's meat is another man's poison, but "Rock Hardware" actually puts just about everything under the one roof of a 224 page book, with a mass of colour photos and illustrations, and under the guidance of twelve chapters by various learned contributors.

An intelligent introduction to rock, and the development of it (presumably by Tony Bacon), gets the book off to a good start. Three chapters on guitars (acoustic, electric, and bass) follow, making generally interesting reading, though I wouldn't profess to know more than a smattering about the first and third of these. "Drums and Percussion" is somewhat limited in its scope, with no mention of such clangorous essentials as gongs, tam-tams, and sundry other exotics, and only an incidental reference to electronic drumkits. "Keyboards" follows the construction and use of the grand piano with a

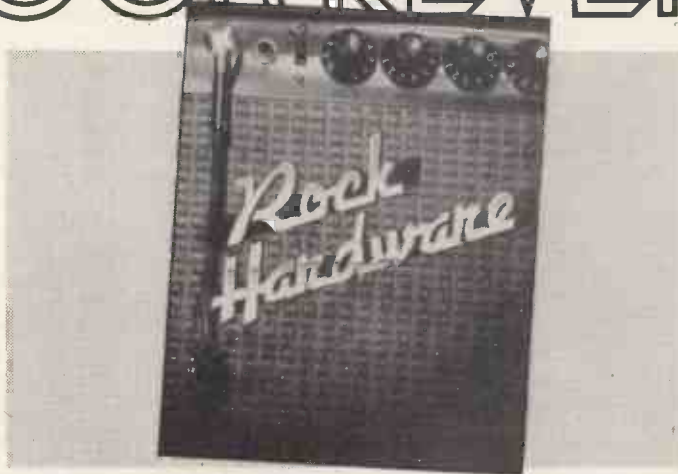

consideration of the Hammond organ, Rhodes piano, and Mellotron. "Synthesizers" is an interesting contribution from Dave Crombie, who takes sound synthesis from waveform origins and charts its progress via Moog and his voltage-controlled modules up to present-day sequencers *en masse*, digital control techniques, and so on. Also, this is the one chapter in the book which explains how things work and how they can be used musically.

"Effects Units" attempts the almost impossible: a consideration of the mind-boggling variety of FX units on the market. Five pages scarcely scratches the surface; indeed, five

pages could hardly do justice to the fifty-odd units offered by Electro-Harmonix alone! Mind you, a thorough, objective guide to foot and rack FX units is ripe for the writing. "Woodwind, Brass and Strings" considers the flute, the saxophone, brass (very briefly), the harmonica, and the violin. In describing the hardware, the chapter certainly does its bit, but exposing the innards of a fiddle doesn't really help me to understand how this instrument, dragged by the scruff of its tail-piece into rock music (pace ELO), really fits into the brief of "Rock Hardware".

"Amplification" didn't in all honesty grab much of my attention,

but "The PA System" came much closer to being a useful chapter. The contributor charts the development of the modern PA system and takes in along the way microphone techniques, mixing, and the positioning of speakers. "Playing Live" examines rock in small venues, medium-size venues, and, logically enough, large venues, and culminates with a consideration of the demands placed on the modern performer to satisfy the insatiable appetite of the Media and Public for video promotion, chat show appearances, or whatever.

The final chapter, "Recording", takes the reader to the other side of the mixing desk, and, like other chapters, follows the path of technological innovation. Thus, we're taken on a journey from Edisonian waxings to the ultimate sophistication of computer mixers like the Solid State Logic 4000 Series, but with plenty of hints on the construction of mixers, the organisation of the recording session, and special effects thrown in for good measure.

"Rock Hardware" certainly has plenty of "ogle value", and the contributions are good enough to push the overall impression of the book away from the dangerous territory of being yet another display piece for the coffee-table. But it could have gone even further!

David Ellis

# RECORD REVIEWS

## Sons and Fascination by Simple Minds Virgin Records V2207

Every age seems to produce something different (yet, is anything ever new?) and the music biz displays trends and ideas like no other area of commerce.

We have had (and still have) rock 'n' roll, punk, new wave, new romantics, electronic music of various ilk, the minimalists, HM revival (was it ever dead?); "Whatever next?" cry the public (and the record companies too, for if they knew that they would be very happy record companies indeed).

Increasingly, many bands seem to be writing the type of material found on this album. Classification is difficult and therefore description is not easy.

The production is by Steve Hillage (the Steve Hillage?) and, for all the modernist arrangements, lyrics and production, the sound is very full, almost mellow, and lacks the brash harshness and demanding air of other contemporary bands.

The album contains eight songs (longer than the average song) and some seem just a little too long, but the album is a collection of album tracks not singles (although it would be interesting to see how a track from this album would fare on the shelves — 'Seeing out the Angel' is perhaps the most immediately appealing) and it would be more constructive to look at the album from this point of view.

Very little information is given on the record or sleeve other than the lyrics are by Jim Kerr and the music is by Simple Minds. The lyrics are far back in the mix and quite impossible to hear clearly which may or may not



be a good thing. What sort of lyrics would you expect from songs called: 'In Trance as Mission', 'Sweat in Bullet' and '70 Cities as Love Brings the Fall'? You are probably right!

The tunes are welded together by extremely efficient musicians who produce interesting sounds and rhythms but the essential melodic element (is it indeed essential?) is not quite there. One almost gets the impression that they deliberately avoided writing 'catchy' tunes. As soon as a song nears a hook, it is sidetracked by an element of obtuse character. Interesting in its way and not altogether unpleasant but curious for all that. Is this the direction music is now heading? It has been done before — notably John Foxx — but each band adds its own character and style.

'In Trance as Mission' is based on a curious 4/4, 2/4 time signature;

'Sweat in Bullet' hovers around a two-bar jazz/funk riff on organ; multi-layered vocals in '70 Cities as Love Brings the Fall' tend to crowd each other; 'The Earth that You Walk Upon' begins with sixteenths on wood blocks and has nice melodic sequences around a C - Bb riff; 'Seeing out the Angel' opens with a brilliant riff on synth and hints of a demonic choir drifting around in the background. The vocal melody seems a little plain when it enters but the synth and choir keep floating forward — very atmospheric. I like this one.

The album would not be out of place in a John Peel program and while it is not 'experimental', the music has been developed from various roots and such developments by bands and individuals should be encouraged.

Ian Waugh



## Speak and Spell by Depeche Mode Mute STUMMS

'Speak and Spell' is the first album from Depeche Mode, the synth-pop band who already have two hit singles under their belt. Although they've not been playing synthesisers for long it certainly doesn't show because the album has a very clean and solid sound, partly due, I'm sure, to Daniel Miller's co-production.

The album has eleven tracks on it which all have the classic Depeche Mode characteristics: synthesised drums, bouncing sequencer patterns and bright synthesiser sounds which drive the album along at a very danceable pace. The two singles, 'New Life' and 'Just Can't Get Enough' start and finish the album respectively and of the remaining nine tracks 'Big Muff' (no comment!) is my personal fave. It is the only instrumental on the album and features some very hypnotic sequencer patterns, plus terrific tom-tom and syndrum sounds. It's very well arranged and is something I hope the band will pursue in future. The songs are based around a disco-type beat (except 'Any Second Now (Voices)' which is a haunting song featuring only harmony vocals and a very plaintive synth backing) and some really nice multitracked sequencer riffs which create strong rhythmic structures. The songs are quite simple but are usually well arranged and extremely listenable.

Equipment used (which is not

listed, incidentally) is quite modest by today's standards. An ARP 2600 was used in conjunction with an ARP analogue sequencer. The drum sounds were generated using the 2600 for the bass drum, the rhythm being provided by the sequencer which also triggered a Korg KR55 for the snare drum sound. I'm also pleased to see that there is no obnoxious synthesised hi-hat sound on the album — I find the constant 'Tsss tsss tsss' so ably provided by rhythm units thoroughly nauseating. The drum sounds on the album are of an extremely high quality throughout, considerably better than if they had used a rhythm box. There was some talk of the band using a Movement Drum Computer on the album. This is a Nascom-based digital drum unit similar in ways to the Linn, but unfortunately the sounds were (to quote Daniel Miller) "a bit naff!" so it wasn't used. Other synths used on the album were a Moog Prodigy, a Yamaha CS5, a Sequential Circuits Pro-One, a Roland SH1 and Jupiter 4. It goes without saying that various effects were used, especially on the vocals ('Boys Say Go' features what appears to be a wonderful reverse reverb effect on a chant of the title) but the overall use of synths and electronics is tasteful and intelligent throughout.

The album doesn't have the lush continental sound of Bocquet, Grosskopf or Tangerine Dream, but that is not necessarily a bad thing; Depeche Mode have a style and sound of their own which, for me, is streets ahead of the doom-laden sound of Orchestral Manoeuvres or the wimpy Soft-cell. My only reservation is the vocal line which seems slightly characterless. Nevertheless, an impressive debut album.

Steve Howell

## Incandescence by Can Virgin Records OVED 3

Your opinion of Can will vary according to which of their records you have heard. Always, seemingly, working on the fringes of whatever 'type' of music they were into at the time, their explorations have run them through the gamut of rock, heavy metal, disco and experimental electronic music.

This album is a compilation of tracks from their previous albums and it runs the gamut quite successfully. It is an amalgam rather than a fusion of styles. My first reaction was 'different': my second was 'interesting'; and all the time I knew that I was liking what I was hearing.

Track one, 'I Want More' was a hit single around 1976 but it has all the ingredients of modern electro-pop-music: a catchy tune and short melodic riffs on the synthesiser — reminiscent of Orchestral Manoeuvres although Can came first. It would be interesting to see this re-released as a single again.

'Full Moon on the Highway'

screeches into HM/rock with over-driven guitar and a rhythm pushing out a solid four to the bar. Just as you have worked out the style, severely treated vocals push you into the realm of experimental electro-rock. Heavy vocoders!

'Gomorrhah' (1973) was originally the theme from a German TV series. An instrumental, lyrical in construction and electronic in nature, it flows and rings from beginning to end. Synth, guitar and the lighter elements of the drum-kit phase from one layer of sound to the next.

'Hunters and Collectors' could possibly be described as rock. Drums busy playing 16ths; the themes are excursions into electronic sounds and catchy riffs drift in and out of the vocals.

'The Empress and the Ukraine King' is one of the earliest tracks, from 1969, and begins in a funky mood with a guitar riff which runs, almost continuously, through the song. The drums bongo in the background with Latin accents on the cymbals. Guitar

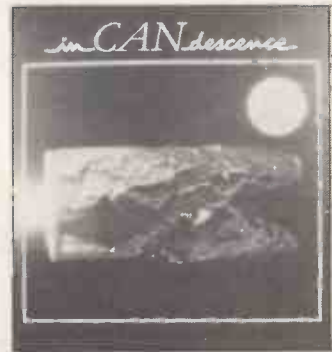

fills are sustained chords and a manic saxophone falls in for the closing bars. It slithers out like a dying cat taking the song with it.

On side two, 'Mother Upduff', also from 1969, plasters a violent, insistent rhythm track across the speakers while a voice relates the sorry story of Mother Upduff who is pulled into the water by a giant octopus while on holiday, wrapped in a tent, put on top of a car which is subsequently stolen and, one presumes, never heard from again. Draw your own conclusions.

'Call Me' drifts in through a wall of wind with guitar, synth and drums forming atrocious combinations which shouldn't work but do. HM fills on guitar, Tangerine Dream bass riffs, layers of synth — all form a fascinating collage.

'Half Past One' has a slightly eastern flavour with fat organ/synth notes bubbling up and down the scale while acoustic guitar twangs add an ethnic feel.

'Laugh Till You Cry... Live Till You Die' is reggae. The guitar, synth and drums fill in the gaps the others leave.

The final track, 'E.F.S. No. 36' is a short blues for piano and sax (according to the cover notes) but the sax sounds more like a trumpet: it wails and wails throughout. Quite tongue in cheek. Play it again, Can.

The tracks are stylistically diverse but similar elements of technique and sound are evident throughout. None of the tracks sound out of place and the whole album is a total listening experience.

Ian Waugh

# DIGITAL DELAY EFFECTS UNIT

**PARTS COST GUIDE**  
**£182**  
 with full memory

by Tim Orr

- ★ Digital encoding for studio quality results
- ★ Time delays from 0.625ms to 1.6 seconds
- ★ Produces all the popular time delay effects:
- ★ Phasing ★ Flanging ★ ADT and chorus
- ★ Echo (including 'freeze' for infinite repeats)
- ★ Time domain vibrato, etc.



Many musical effects such as echo boxes, flanging pedals etc. use a time delay as part of their circuitry. The cheaper units, aimed at the stage musician, offer only one or two effects per box; in addition, they use analogue delay components whose sound quality deteriorates considerably as the delay increases. High quality delay units for studio applications, in contrast, use digital techniques offering theoretically unlimited delay times; however, they are very expensive, often with four figure price tags.

Now, the E&MM Digital Delay Effects Unit offers you the best of both worlds; it gives all the time delay effects, with digital quality, all for the price of a high quality analogue unit (but with much superior specifications). The most popular effects are shown in Figure 1, along with the various ways of producing them. The E&MM Delay is shown in block diagram form in Figure 2, and by manipulating its variables all the effects in Figure 1 may be obtained. These are introduced here; the project will be concluded next month, with full circuit and construction details.

## Phasing

Phasing is produced by mixing an audio signal with a delayed version of itself. The frequency response this produces is known as a comb filter. Feedback is sometimes used to make the frequency response more peaky, which in turn produces a more noticeable colouration of the sound. By slowly modulating the time delay, the notches in the comb filter expand and contract, producing an interesting musical effect. Phasing effect pedals use a phase shift filter rather than a time delay line, although the effect is the same. Phasing is characterised by having very few notches within the audio band, typically 2 to 5. This is equivalent to time delays between 0.2ms and 0.5ms.

## Flanging

Phasing and flanging are often confused, which is not surprising as the two effects are produced in a similar way. To obtain a flanging

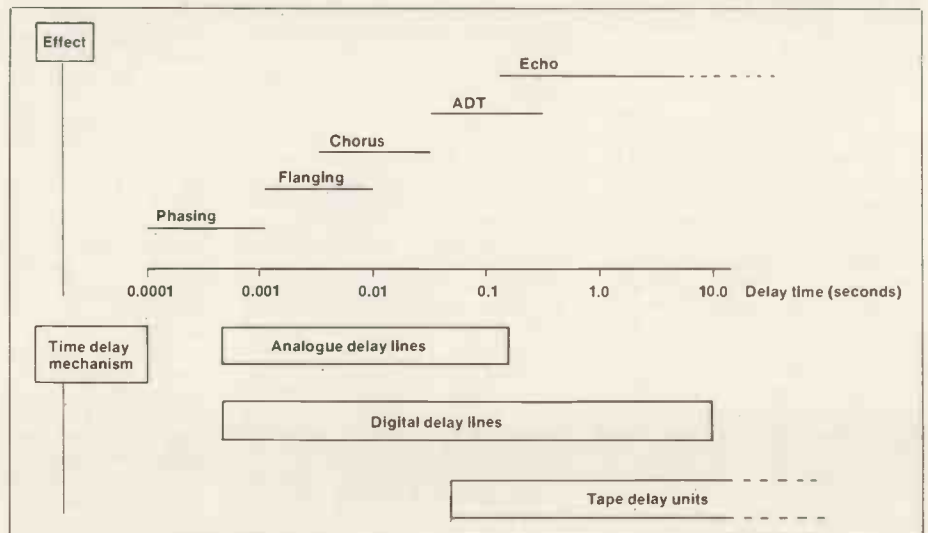
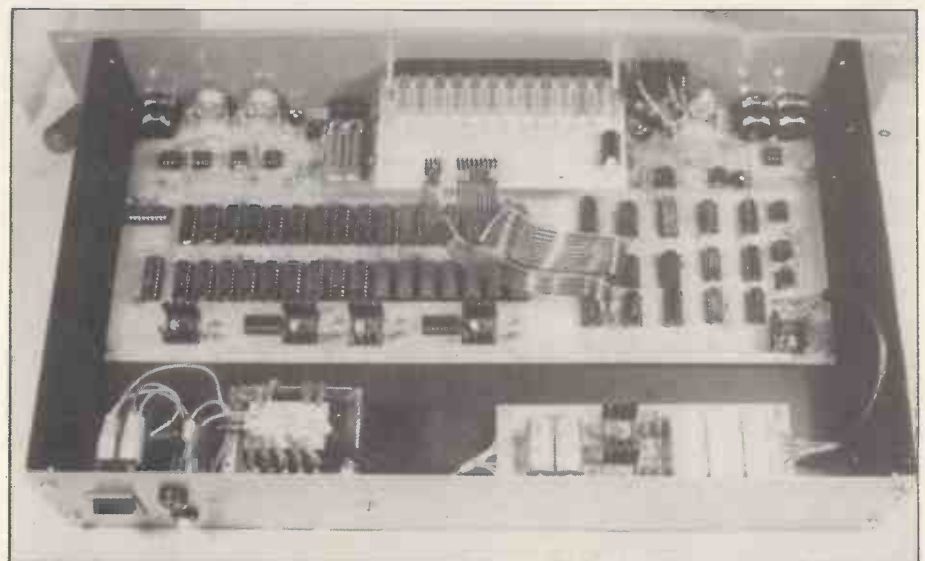

Figure 1. Effects obtainable with time delays.

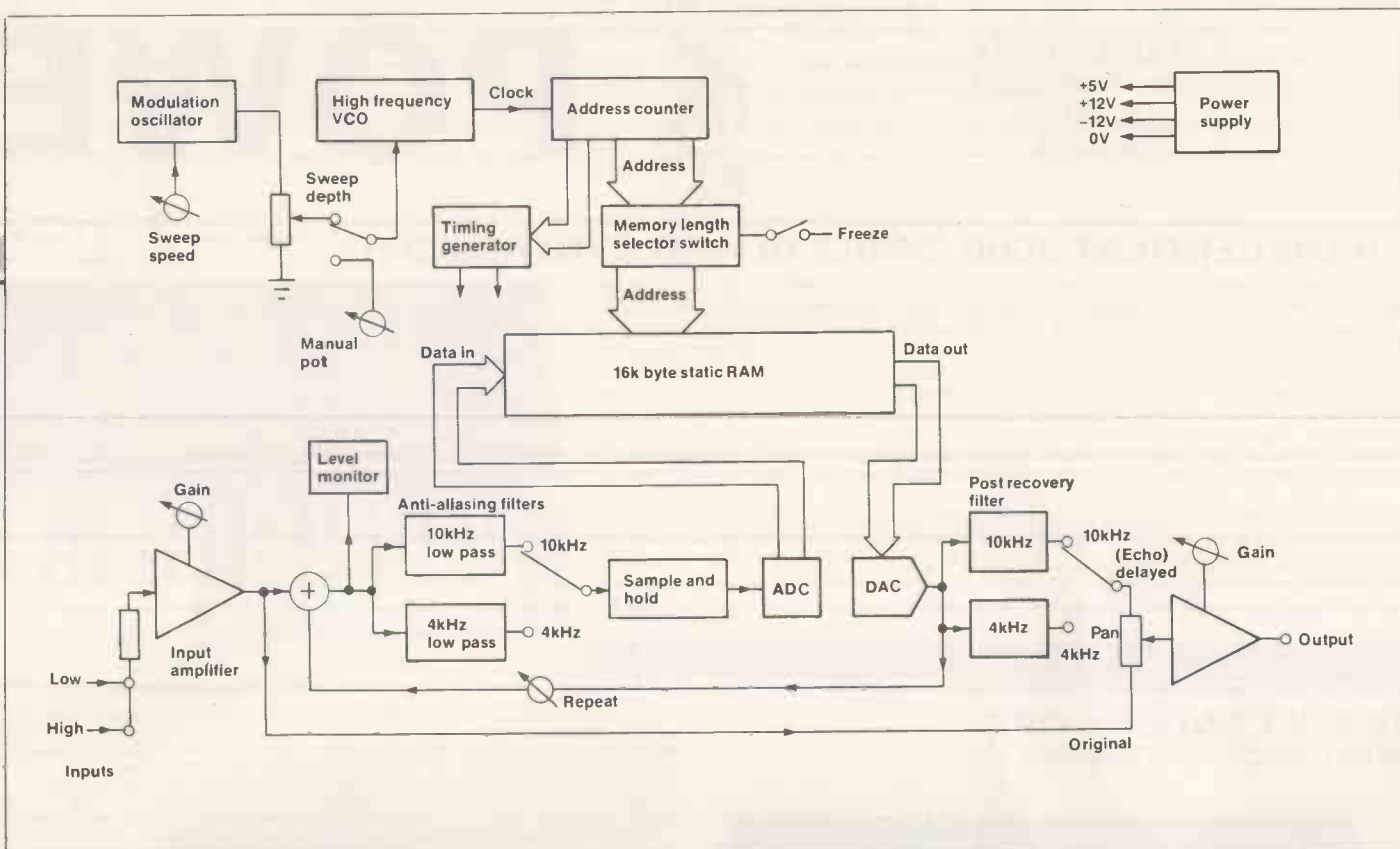
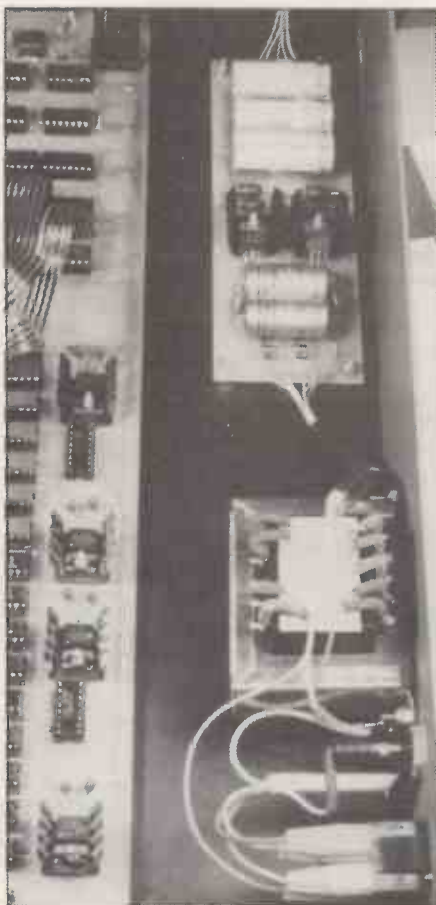

Figure 2. Block diagram of the digital delay line.



effect use a time delay varying between 1 and 10ms. A 10ms delay will produce a comb filter with 100 notches (over a 10kHz bandwidth). Flanging often uses strong feedback which produces a heavy colouration of the sound.

#### ADT & Chorus

ADT (Automatic Double Tracking) and chorus are both very similar effects. The chorus effect uses a time delay that is slowly

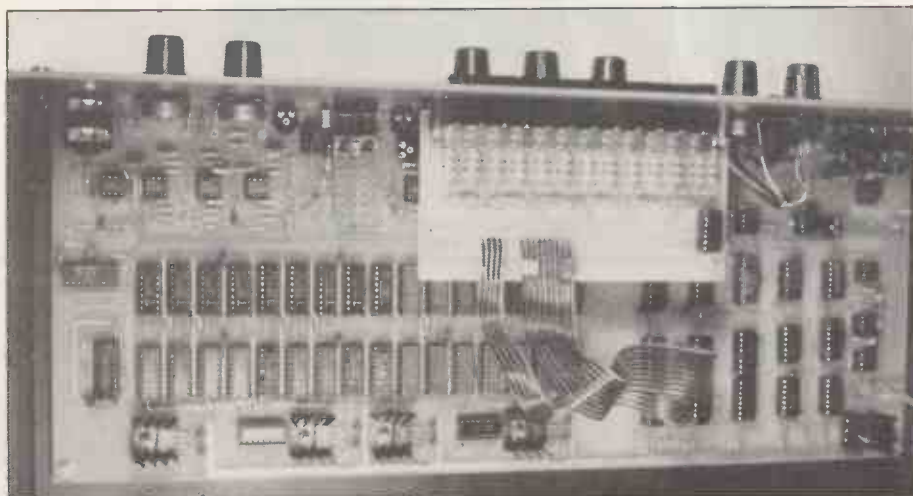

modulated, and the original and the delayed signal are mixed together producing a 'spacey' effect. ADT uses a longer time delay to simulate a very short echo, short enough to give the impression of two sound sources.

#### SPECIFICATIONS

Size: 2 unit (3.45") high, 19" rack mounting, 10" deep.

Delay time: 0.625ms to 0.64s at 10kHz bandwidth.

1.6ms to 1.6s at 4kHz bandwidth. Both time delays can be halved using the manual control pot.

Modulation oscillator: Triangle sweep; rate, 0.025Hz to 17Hz.

Memory size: 16K bytes, 128K bits.

Input impedance: Low 1k5

High 28k5

Output impedance: 220 ohms.

Output level: +3dBm, with 30dBs of available attenuation.

Typical signal to noise ratio: 75dB (this is not signal to quantisation noise).

Overload LED: Turns on 6dB before clipping.

#### Echo

Time delays greater than 30 or 40ms become noticeable as distinct echoes. Time delays of around one second are very useful for building up melodies with several repeats. Also, it is possible to freeze the sound in the digital memory and have it continuously recirculate without degeneration. This repeating sound may then be used as a sequencer-like backing, or transposed using the delay time controls.

#### Vibrato

Vibrato can be produced on any time delay setting, but best results are obtained on the 40ms delay with 10kHz bandwidth. A modulation speed of 3 to 7Hz with a small modulation depth should do it. **E&MM**

The E&MM Digital Delay Line is obtainable as a complete kit of parts from Powertran Electronics, Portway Industrial Estate, Andover, Hants SP10 3WW. With ¼ memory, i.e. 400ms maximum delay, the kit costs £130 + VAT. Extra memory parts are £9.50 + VAT per 400ms, so the full 1.6s delay would cost £158.50 + VAT.

Quite simply  
the best way  
to make  
"MUSIC"



# POWER

## TRANSCENDENT 2000 SINGLE BOARD SYNTHESISER

Cabinet size 24.6" x 15.7" x 4.8" (rear)  
3.4" (front)

Designed by consultant Tim Orr (formerly synthesiser designer for EMS Ltd.) and featured as a constructional article in ETI, this live performance synthesiser is a 3 octave instrument transposable 2 octaves up or down giving sweep control, a noise generator and an ADSR envelope shaper. There is also a slow oscillator, a new pitch detector, ADSR repeat, sample and hold, and special circuitry with precision components to ensure tuning stability amongst its many features.

The kit includes fully finished metalwork, fully assembled solid teak cabinet, filter sweep pedal, professional quality components (all resistors either 2% metal oxide or 1/2% metal film), and it really is complete — right down to the last nut and bolt and last piece of wire! There is even a 13A plug in the kit — you need buy absolutely no more parts before plugging in and making great music! Virtually all the components are on the one professional quality fibreglass PCB printed with component locations. All the controls mount directly on the main board, all connections to the board are made with connector plugs and construction is so simple it can be built in a few evenings by almost anyone capable of neat soldering! When finished you will possess a synthesiser comparable in performance and quality with ready-built units selling for many times the price.

Comprehensive handbook supplied with all complete kits! This fully describes construction and tells you how to set up your synthesiser with nothing more elaborate than a multi-meter and a pair of ears!



COMPLETE KIT ONLY £165.00 + VAT

## TRANSCENDENT DPX MULTI VOICE SYNTHESISER

The Transcendent DPX is a really versatile 5 octave keyboard instrument. These are two audio outputs which can be used simultaneously. On the first there is a beautiful harpsichord or reed sound — fully polyphonic, i.e. you can play chords with as many notes as you like. On the second output there is a wide range of different voices, still fully polyphonic. It can be a straightforward piano as a honky tonk piano or even a mixture of the two! Alternatively you can play strings over the whole range of the keyboard or brass over the whole range of the keyboard or should you prefer — strings on the top of the keyboard and brass as the lower end (the keyboard is electronically split after the first two octaves) or vice-versa or even a combination of strings and brass sounds simultaneously. And on all voices you can switch in circuitry to make the keyboard touch sensitive! The harder you press down a key the louder it sounds — just like an acoustic piano. The digitally controlled multiplexed system makes practical touch sensitivity with the complex dynamics law necessary for a high degree of realism. There is a master volume and tone control control, a separate control for the brass sounds and also a vibrato circuit with variable depth control together with a variable delay control so that the vibrato comes in and only after waiting a short time after the note is struck for even more realistic string sounds.

To add interest to the sounds and make them more natural there is a chorus/ensemble unit which is a complex phasing system using CCD (charge coupled device) analogue delay lines. The overall effect of this is similar to that of several acoustic instruments playing the same piece of music. The ensemble circuitry can be switched in with either strong or mid effects. As the system is based on digital circuitry data can be easily taken to and from a computer (for storing and playing back accompaniments with or without pitch or key change, computer composing, etc., etc.).

Although the DPX is an advanced design using a very large amount of circuitry, much of it very sophisticated, the kit is mechanically extremely simple with excellent access to all the circuit boards which interconnect with multiway connectors, just four of which are removed to separate the keyboard circuitry and the panel circuitry from the main circuitry in the cabinet.

The kit includes fully finished metalwork, solid teak cabinet, professional quality components (all resistors 2% metal oxide), nuts, bolts, etc., even a 13A plug.



Cabinet size 36.3" x 15.0" x 5.0" (rear) 3.3" (front)

COMPLETE KIT ONLY £295 + VAT

## TRANSCENDENT POLYSYNTH EXPANDABLE POLYPHONIC SYNTHESISER

Cabinet size 31.1" x 19.6" x 7.6" rear 3.4" front

By brilliant design work and the use of high technology components the Polysynth brings to the reach of the home constructor a machine whose versatility and range of sounds is matched only by ready built equipment costing thousands of pounds. Designed by synthesiser expert Tim Orr and being featured in Electronics Today International, this latest addition to the famous Transcendent family is a 4 octave (transposable over 7 1/2 octaves) polyphonic synthesiser with internally up to 4 voices making it possible to play simultaneously up to 4 notes. Whereas conventional synthesisers handle only one at a time.

The basic instrument is supplied with 1 voice and up to 3 more may be plugged in. A further 4 voices may be added by connecting to an expander unit, the metalwork and woodwork of which is designed for side by side matching with the main instrument. Each voice is a complete synthesiser in itself with 2 VCOs, 2 ADSRS, a VCA and a VCF (requiring only control voltages and a power supply, the voice boards are also suitable for modular systems). One of these voices is automatically allocated to a key as it is operated. There are separate tuning controls for each VCO of each voice. All other controls are common to all the voices for ease of control and to ensure consistency between the voices.

Although using very advanced electronics the kit is mechanically very simple with minimal wiring, most of which is with ribbon cable connectors. All controls are PCB mounted and the voice boards fit with PCB mounted plugs and sockets. The kit includes fully finished metalwork, solid teak cabinet, professional quality components (resistors 2%, metal oxide or metal film of 0.5% and 0.1%), nuts, bolts, etc.



COMPLETE KIT ONLY £275 + VAT  
(single voice)

PLUG IN EXTRA VOICES ONLY £39.50 + VAT

## DIGITAL DELAY LINE

As featured in this magazine

COMPLETE KIT £130.00 + VAT  
(400 milisecond delay)

£9.50 + VAT

Extra 400 Milisecond delay  
Up to a maximum of 1.6 seconds delay

**PRICE STABILITY:** Order with confidence. Irrespective of any price changes we will honour all prices in this advertisement until March 31st if this month's advertisement in Electronics & Music Maker is quoted with your order. Errors and VAT rate changes excluded.

**EXPORT ORDERS:** No VAT. Postage charged at actual cost plus £1.00 handling and postal documentation.

**U.K. ORDERS:** Subject to 15% surcharge for VAT. \*No charge is made for carriage, \*or at current rate if changed. Quote E&MM on all enquiries

**SECURICOR DELIVERY:** For this optional service (U.K. mainland only) add £2.50 (VAT inclusive) per kit.

**SALES COUNTER:** If you prefer to collect your kit from the factory call at Sales Counter Open 9 a.m.-12 noon, 1-4.30 p.m. Monday-Thursday.





## 1024 COMPOSER



Programmed from a synthesiser, our latest design to be featured in Electronics Today International, the 1024 COMPOSER controls the synth. with a sequence of up to 1024 notes or a large number of shorter sequences e.g. 64 of 16 notes all with programmable note length. In addition a rest or series of rests can be entered. It is mains powered but an automatically trickle charged Nickel Cadmium battery, supplying the memory preserves the program after switch off. The kit includes fully finished metalwork, fibreglass PCB, controls, wire, etc. — complete down to the last nut and bolt!

**COMPLETE KIT ONLY £85.00 + VAT!**

## BLACK HOLE CHORALIZER



De Luxe version (dual delay line system) also available for **£59.80 + VAT**  
Cabinet size 10.0" x 8.5" x 2.5" (rear) 1.8" (front)

The BLACK HOLE designed by Tim Orr, is a powerful new musical effects device for processing both natural and electronic instruments, offering genuine VIBRATO (pitch modulation) and a CHORUS mode which gives a "spacey" feel to the sound achieved by delaying the input signal and mixing it back with the original. Notches (HOLES), introduced in the frequency response, move up and down as the time delay is modulated by the chorus sweep generator. An optional double chorus mode allows exciting antiphase effects to be added. The device is floor standing with foot switch controls, LED effect selection indicators, has variable sensitivity, has high signal/noise ratio obtained by an audio compander and is mains powered — no batteries to change! Like all our kits everything is provided including a highly superior, rugged steel, beautifully finished enclosure.

**COMPLETE KIT ONLY £49.80 + VAT!**  
(single delay line system)

As featured in Electronics Today International — July Issue!

This versatile new mixer, shown here fitted to our console, has 2 stereo inputs for magnetic cartridges, a stereo auxiliary (e.g. cassette or jingle machine) input and a microphone input. The decks can be automatically panned either fast or slow and all 3 music inputs can be mixed with slider controls. There is a 5-section graphics equaliser and a beat-lift control. Also there is a voice-over unit (ducking) and an override button for interrupt announcements. The microphone input can be modulated at a variable rate to produce 'growl' effects and there is monitoring of any music input (pre-fade listen) via the stereo headphone socket and a pair of LED PPMs. The mixer kit includes fully finished metalwork fibreglass, PCBs, controls, wire etc. — complete down to the last nut and bolt!

The console is shown fitted with two 19" panel units

- a Chromatèque 5000 lighting controller
- an SP2-200 stereo 100W/channel power amplifier. For a 200W/channel system two SP2-200s could be fitted.
- Power supply for mixer with screening metal box **£9.90 + VAT.**
- Console complete with switch panel, lid feet and carrying handles **£69.50 + VAT.**
- BSR P256 — their latest belt-drive disco turntable **£29.50 + VAT** each.

## DJ90 STEREOMIXER

**COMPLETE KIT (as shown in centre of console) only £97.50 + VAT**



## ETI VOCODER



Features as a construction article in Electronics Today International this design enables a vocoder of great versatility and high intelligibility to be built for an amazingly low price. 14 channels are used to achieve its high intelligibility, each channel having its own level control. There are two input amplifiers, one for speech either from microphone or a high level source e.g. mixer or cassette deck and one for external excitation (the substitution signal) from either high or low level sources. Each amplifier has its own level control and a rather special type of tone control giving varying degrees of bass boost with treble cut or treble boost with bass cut. The level of the speech and excitation signals are monitored by LED PPM meters with 10 lights — 7 green and 3 red which indicate the level at 3dB steps. There are three internal sources of excitation — a noise generator and two pulse generators of variable frequency and pulse width. Any of the internal sources and the external source can be mixed together. There is a voiced/unvoiced detector which substitutes noise for the excitation signal at the points in speech where the vocal chord derived sounds of the speaker are substituted for by the unvoiced sounds of sibilants, etc. There is a slow rate control which smooths out the changes in spectral balance and amplitude enabling a change of the speech into singing or chanting and other special effects. A foot switch is provided to permit a complete freeze in spectral balance when the freeze is in operation.

An output mixer allows mixing of the speech, external excitation and vocoder output. The majority of the components fit into the large analysis/synthesis board with the rest on 8 much smaller boards with the controls and sockets mounted on them for ease of construction. Connectors are used for the small amount of wiring between the boards.

The kit includes fully finished metalwork, professional quality components (all resistors 2% metal oxide), nuts, bolts, etc — even a 13A plug!

**COMPLETE KIT ONLY £175 + VAT!**

## MPA 200 100 WATT (rms into 8 ohm) MIXER/AMPLIFIER



Featured as a constructional article in ETI, the MPA 200 is an exceptionally low priced — but professionally finished — general purpose high power amplifier. It features an adaptable input mixer which accepts a wide range of sources such as a microphone, guitar, etc. There are wide range tone controls and a master volume control. Mechanically the MPA 200 is simplicity itself with minimal wiring needed making construction very straightforward.

The kit includes fully finished metalwork, fibreglass PCBs, controls, wire, etc. — complete down to the last nut and bolt.

**COMPLETE KIT ONLY £49.90 + VAT!**

## SP2-200 2-CHANNEL 100 WATT AMPLIFIER



The power amplifier section of the MPA 200 has proved not only very economical but very rugged and reliable too. This new

design uses 2 of these amplifier sections powered by separate power supplies fed from a common toroidal transformer. Input sensitivity is 775mV. Power output is 100 rms into 8 ohm from both channels simultaneously.

The kit includes fully finished metalwork, fibreglass PCBs, controls, wire etc. — complete down to the last nut and bolt!

**COMPLETE KIT ONLY £64.90 + VAT!**

## CHROMATÈQUE 5000 CHANNEL LIGHTING EFFECTS SYSTEM

This versatile system featured as a constructional article in ELECTRONICS TODAY INTERNATIONAL has 5 frequency channels with individual level controls on each channel. Control of the lights is comprehensive to say the least. You can run the unit as a straightforward sound-to-light or have it strobe all the lights at a speed dependent upon music level or front panel control or use the internal digital circuitry which produces some superb random and sequencing effects. Each channel handles up to 500W and as the kit is a single board design wiring is minimal and construction very straightforward. Kit includes fully finished metalwork, fibreglass PCB controls, wire etc. — Complete right down to the last nut and bolt!



**COMPLETE KIT ONLY £49.50 + VAT!**

To POWERTRAN ELECTRONICS, Portway Industrial Estate, Andover, Hants SP10 3WW

Please supply.....

..... Total purchase price £.....

I enclose Cheque  Postal Orders  International Money Order

Please debit my Access/Barclaycard Account No. ....

.....

NAME.....

ADDRESS.....

Signature.....

**ALL U.K. ORDERS  
DESPATCHED  
POST FREE**

DEPT  
E&MM  
2/82

All projects on this page can be purchased as separate packs, e.g. PCBs, components sets, hardware sets etc. See our free catalogue for full details and prices

# POWERTRAN ELECTRONICS

PORTWAY INDUSTRIAL ESTATE, ANDOVER, HANTS SP10 3WW  
ANDOVER (STD 0264) 64455

# The SPECTRUM SYNTHESISER

Professional  
Quality  
Monophonic  
Instrument

- ★ Low Cost
- ★ Easy to Construct
- ★ FM and Sync.
- ★ Stereo Outputs
- ★ Sequencer Effects
- ★ Interface Facilities
- ★ Four Octave Keyboard
- ★ Performance Controller

## PART 2



PARTS COST  
GUIDE  
£200

Since publication of the Spectrum articles was delayed earlier this year, many improvements have been made to the original design. The synthesiser can still be built for around £200, plus cabinet, yet offers features found only on expensive commercial instruments.

For the benefit of newcomers to the magazine, and to bring our regular readers up to date with the improvements that have been made, we have

reprinted some of the original material. This is the final part of the project which contains sufficient information to enable experienced constructors to build the Spectrum. PCB track layouts and component overlays, cabinet drawings, a wiring chart and more comprehensive circuit descriptions are available in the Spectrum Synthesiser book, available from Maplin Publications for £1 plus 24p postage.

### Ring Modulator and Noise

The ring modulator (Figure 15) is based around IC20 and processes the pulse wave of VCO1 and the triangle wave of VCO2 to produce complex non-harmonic sounds. It functions in a similar way to the rampwave shaper of the Spectrum LFO by inverting the triangle wave about its midpoint when the pulse wave is high, and leaving it unchanged when low. This constitutes four quadrant multiplication of the value of the triangle wave by the value of the pulse wave (-1 or +1). When the pulse output is low TR12 is off and the triangle wave is inverted with a gain of 2 by IC20a. The output is mixed with the original triangle wave of half the amplitude and opposite phase by IC20b. With the pulse output high the collector of TR12 is at -15V and the output of IC20a is positive. This reverse biases D32, and no signal reaches IC20b via R221. The original triangle wave is inverted by

IC20b and shifted by the current through R220. The output of IC20b is the required product.

The noise generator is quite conventional, using the thermal noise of a semiconductor junction as a source. TR14 amplifies the noise on the emitter of TR13 to about 4mV p-p, which is boosted to  $\pm 2.5V$  by IC21. RV31 mixes the noise and RM signals, which are then fed to IC22, a transconductance amplifier which acts as a VCA. S11b selects the appropriate modulation source, which is conditioned by IC23. The LFO signals are symmetrical about 0V, whilst +EG swings from 0V to +5V and -EG goes from 0V to -5V. In order that all these signals have the same effect, therefore, an offset is selected by S11a and added to the modulation so that pin 6 of IC23 always swings between 0V (maximum gain) and about -14 volts. The CA3080 is really a current controlled amplifier, and so R237 converts this voltage swing into a control current. Since IC23 cannot completely cut this current off, R238

and diodes D33-D35 are included to ensure that the amplifier is truly off at the maximum negative control voltage.

### The Filter

The heart of the filter is the CEM 3320 IC from Curtis Electromusic Specialities. Designed especially for use in voltage controlled filters, this IC contains four identical filter elements controlled by a temperature compensated exponential converter. Each element contains a transconductance type amplifier plus a-buffer amplifier to avoid loading of the TCA's output. Depending on how the circuit is connected, either low pass or high pass filter sections may be created as in Figure 16; the three modes of the Spectrum's filter are formed by different combinations of these.

The low pass response is obtained with four low pass filter sections; since each section has a roll-off of -6dB/octave, the overall filter slope is -24dB/octave. The band pass response has

two low pass sections, preceded by two high pass sections so that only signals in a narrow range of frequencies are allowed through. The low band pass position, as you might expect, is a mixture of the preceding two configurations and consists of only one high pass section followed by three low pass stages. Switch S12 rearranges the signal paths and biasing around the IC to allow the three different configurations to be achieved.

IC24b is a four input mixer, accepting signals from the VCOs, the noise/, RM VCA and the external input socket JK7. R242 is included to combat stray capacitance effects caused by the long leads to the VCO waveform selectors.

The CEM 3320 does not have a summing control input as the oscillators do, and so IC26 performs this function. As well as modulation inputs selected by S13, the key CV is fed in via the 'keyboard follow' control RV40. When this control is at maximum, the filter's cut-off frequency has the same 1V/octave law as the oscillators, and hence will track the keyboard so that the notes have a constant timbre. On most acoustic instruments, however, the upper notes have less harmonics than the lower ones, and if the key CV is attenuated by RV40 this effect may be obtained on the Spectrum. RV37 is included to allow setting up of the 1V/octave law, and if required, may be set to give the reverse of the above effect. In this case, setting the 'keyboard follow' control to 10 will cause higher notes to have more harmonics, and true keyboard following will occur at some lower setting.

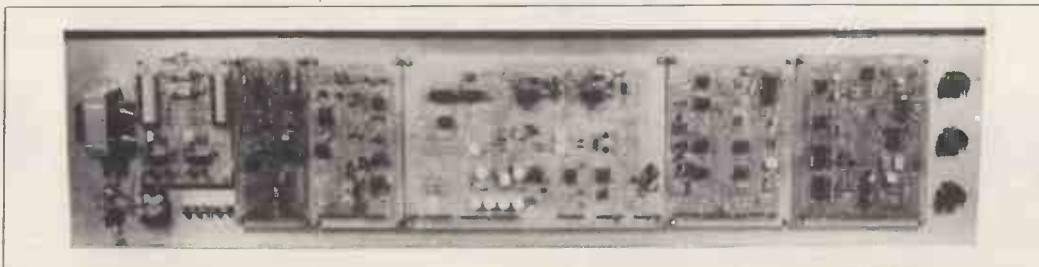

PCBs mounted on the back panel.

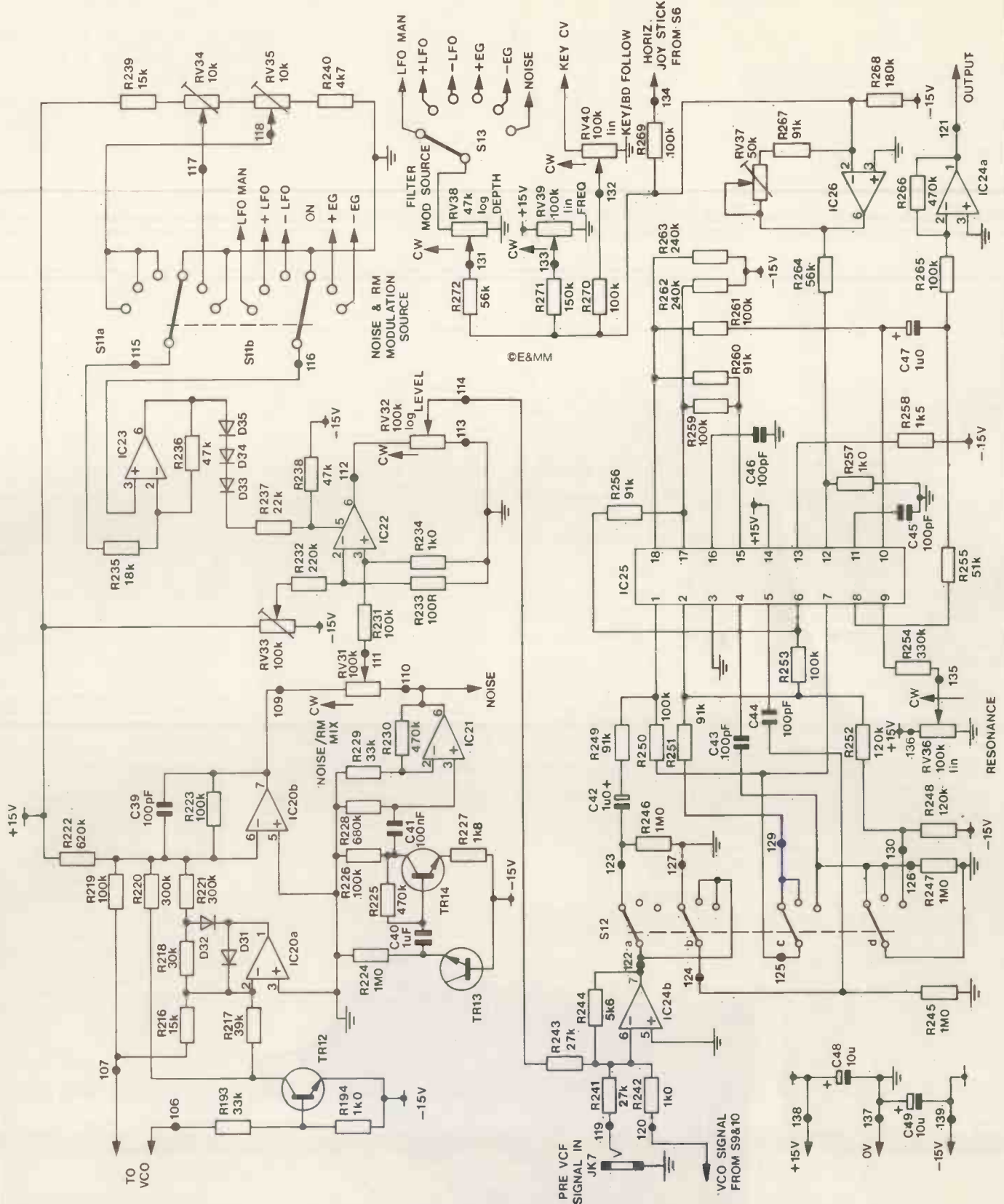

Figure 15. Circuit of the ring modulator, noise generator and filter.

## Voltage Controlled Amplifier and Pan

The last board in the synthesiser, but by no means the least, contains two VCAs and two envelope generators (EGs); the overall circuit is given in Figure 17. Both VCAs are contained in IC28, a CEM 3330.

IC28a performs the envelope shaping function, and is fed with the envelope signal via R274 since this IC works with current inputs and outputs rather than voltages. R273 performs the same function for the audio input, whilst IC29b converts the output current back into a voltage.

Panning and modulation are performed by IC28b, which works in an identical manner to IC28a; audio and control inputs are via R287 and R288 respectively, and output conversion is done by IC29c. When the FUNCTION switch S14 is in one of the MOD positions, both stereo outputs are connected to the second VCA, which then simply modulates the amplitude of the envelope shaper output according to the LFO waveform. IC30 amplifies and level shifts the selected waveforms so that the top end of RV42 always swings between 0 and +12V. Instead of going to 0V, which would cause IC28b to cut off the signal when the DEPTH control was at minimum, the other end of RV42 goes to a reference voltage generated by R292, 293, RV44 and buffered by IC27a.

In the pan mode, only one stereo output comes from the second VCA; the other is fed from the input of this VCA, the envelope shaper's output, via IC29d which subtracts the first channel's signal. This means that as one channel's output becomes louder, the other becomes softer and vice versa, in such a way that the total output is constant; so the volume is unaffected, but panning is achieved. The gain of the various circuits is arranged so that when IC28b is at around unity gain (100uA into pin 12) the output of the two channels is equal; i.e. 3V peak to peak with one VCO on, no filtering and RV45 at maximum. With full modulation, therefore, each output swings between zero and twice this figure.

IC29a combines half of each of the stereo outputs to give a mono signal of the same amplitude, which is affected by modulation but not by panning.

While the Spectrum's output is normally in the region of 3V pk-pk, 1V rms, factors such as modulation, resonance on the filter etc. can increase this to a maximum of 25V pk-pk. If required, the output may be attenuated by inserting resistors in series with the clockwise tags of RV45a and b. The output may be fed into any impedance greater than 25k; below about 10k, loss of bass may become apparent.

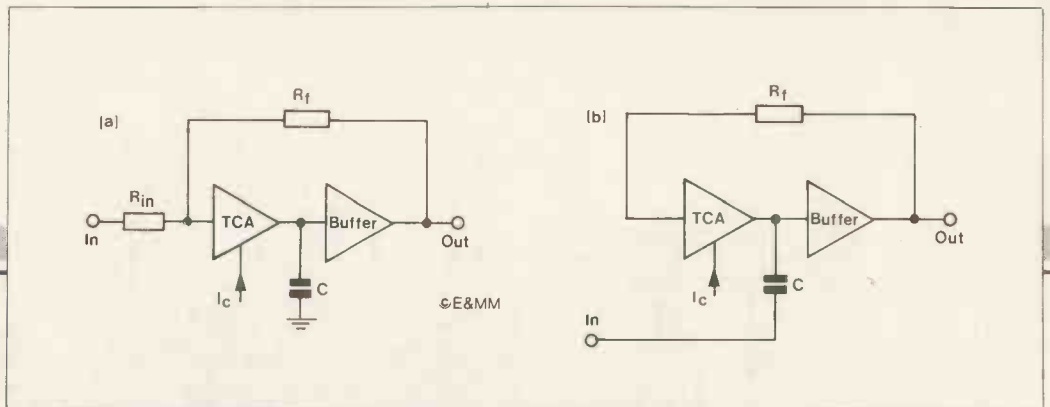

Figure 16. Single filter element of the CEM 3320. a) Low-pass. b) High-pass.

## Envelope Generators

Once again, Curtis Electromusic come to the rescue and each envelope generator is built with a CEM 3310. Both circuits are identical in most respects, except that IC32 has an inverter on its output to provide EG+ and EG- signals, plus the circuitry for achieving key repeat.

R309 and 311, C59 and 61 set the speed range of each generator, and have been chosen to facilitate setting very fast attack times whilst allowing slow decay and release. These components affect all three times equally, and if desired, R309 and 311 may be increased to 'slow down' the envelope times.

Sustain level is controlled by RV48 and RV53. It is important that the sustain control voltage at pin 9 of each IC should not exceed the peak level attained during the attack phase; since this level is available on pin 3, the sustain pots are simply run from this voltage. If external modulation of sustain level was required, a more elaborate level sensing circuit would be necessary (as described in the Curtis data sheet).

Pin 4 is the gate input, and the trigger signal for pin 5 on each IC is derived by C57. In addition, IC33a and TR15 are brought into play on the 'repeat' and 'key repeat' functions; IC33a detects when the envelope output has reached the sustain level (i.e. the attack and decay phases are finished) and TR15 briefly pulls the trigger inputs high to restart both envelopes.

IC27b detects the signal at pin 16 of IC32, and lights D38 to indicate when this IC is in its attack phase.

## Keyboard Construction

Use the printed circuit board as a template to mark the fixing holes on the

underside of the keyboard chassis. Mark them such that the edge of the board holding the bars will be about 5mm from the plungers and then drill for 6BA clearance. Fit the 48 divider resistors on the component side of the board along with the 12 veropins and solder in place. Cut the palladium bars to length and fit them to the track side using small loops of wire passed over the bar, through the mounting holes and twisted on the component side. Make sure each bar is well seated before soldering at each loop position on both sides.

The gate bar should lie flat on the PCB, whilst the S/H bar should be spaced away from the surface slightly by wrapping the mounting wire round the bar before soldering. This gives one wire diameter under the bar, and ensures more reliable contact.

Cut each plunger to length, leaving the nearest slot to the key end for the contact. Tin 5mm of both ends of the contact springs and fit each one by passing the thin end through the detached plunger and soldering it to the pad on the PCB. If you've marked the PCB mounting holes correctly then for proper operation the end of the spring should be about 2mm from the far edge of the pad. The positioning of the PCB and the springs on the PCB is not critical as long as when the PCB is mounted and the plungers clipped on, the springs are under slight tension to ensure positive contact. Mount the PCB to the chassis using 6BA bolts, 1/2" spacers and nuts, and washers to separate them further. The keys opposite the mounting positions will have to be temporarily removed to fit the bolts, and this should be done before drilling if a hand-held drill is used, to avoid the possibility of damage to the keys. Again, the spacing is not critical so long as all the contacts normally clear both bars and make contact with both when their keys are depressed. A 1/2" spacer and

one nut were found to be about right, though washers could be used if a high or low action to the keys is preferred. Connect the two halves of the board together using short wire links across the Veropin pairs. This completes the keyboard construction.

## Setting Up

The power supply should be set up first; none of the other circuits will work without it, of course, and various voltages are derived from the + and -15 volt rails. Adjust the output voltages without the rest of the circuitry connected to begin with; RV1 sets the +15V output, RV2 the -15V. Use the most accurate voltmeter you can get hold of; a digital multimeter would be best, and an oscilloscope is likely to be more accurate than a cheap mechanical meter. On the prototype, the entire synthesiser consumed around 115mA on the +15V line, and 130mA on the -15V line. If you have a dual bench power supply, you may like to check the consumption of the rest of the synthesiser before connecting it to the PSU. If not, the Spectrum's supply has current limiting to protect it from faults, but it is still worthwhile to insert a current meter in each supply line in turn to check for excessive current drain. Once you are sure there is nothing drastically wrong, the power supply can be connected up to the rest of the circuitry. Connect the output socket(s) to an amplifier, and you should be able to persuade the synthesiser to make some sort of a noise, although it will probably be horribly out of tune. After allowing everything to warm up for as long as possible — 1 hour say — the rest of the circuits can be set up in the following order.

## Keyboard Controller

Set the TUNE control to midpoint, and the GLIDE control to zero. Monitor the key CV output from the VCO (pin 99) with the most accurate voltmeter at your disposal. If the Spectrum is to be used with other equipment already calibrated at 1 volt per octave, a digital meter will be essential here; otherwise, this measurement is less critical.

Press middle C on the keyboard. The key CV should be roughly 0 volts; make a note of what it actually is. Now press the next C up from middle C, which should produce a key CV 1 volt above that for middle C. If it is more than this, turn RV3 clockwise and vice versa. The middle C key CV will now have changed, so repeat this procedure as many times as necessary to obtain the correct 1 volt per octave change.

## VCO Octaves

The VCOs are the heart of the synthesiser, and time and trouble taken in setting them up carefully will be directly reflected in the final performance of the instrument. Some way of monitoring the oscillators' frequency and comparing it with a reference will be necessary. The ideal solution is a digital frequency meter, which combines monitor and reference in one.

Set VCO1's range to 8', and sound the first A up the keyboard; note its frequency, which will eventually be 220Hz; don't worry if it isn't.



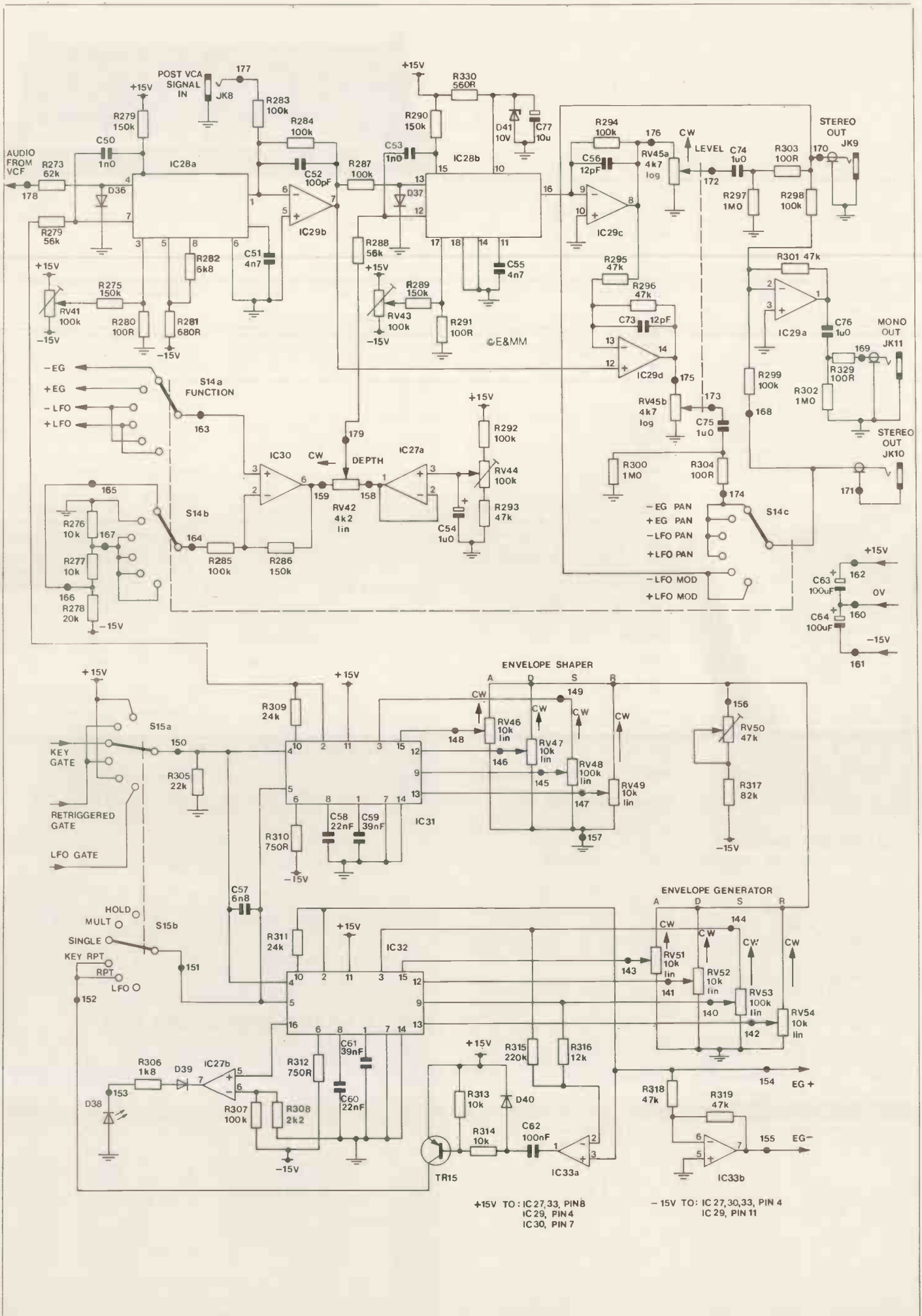
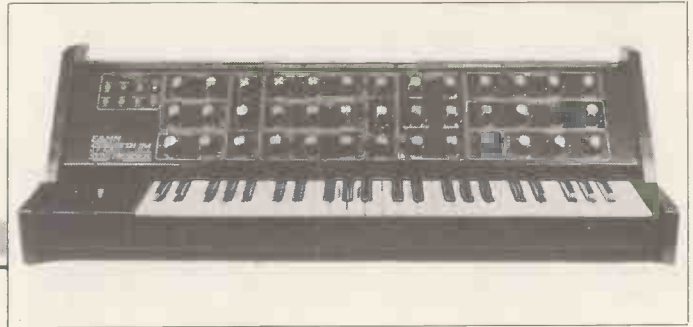

Figure 17. VCAs and envelope generators circuit diagram.



Press the second A up, and its frequency should be an octave above the first; i.e. exactly twice that of the first.

If it is flat, i.e. lower than it should be, turn RV23 anticlockwise and vice versa.

Now go back to the bottom A, which will also have changed, and repeat the process as many times as is necessary to obtain an exact doubling of frequency when going from the first A to the second.

The upper frequency range needs to be set separately; set VCO1's range to 2', and once again play two notes an octave apart. This time, leave RV23 strictly alone and adjust RV55 to give a doubling in frequency. The VCO will always be flat, so turn RV55 anticlockwise to correct this; this adjustment is not as critical as the basic low frequency one.

## VCO2

No references are required for the rest of the tuning up; VCO2 is best adjusted with reference to VCO1 to ensure the two oscillators track exactly.

Listen to VCO1 and VCO2 together, both on the 8' range and with VCO2's TUNE control central. Press any note low on the keyboard, and tune the VCOs together with RV18. Now press a high note and, by switching VCO1 and VCO2 off alternately, determine whether VCO2 is sharp or flat in relation to VCO1. If it is flat, turn RV24 anticlockwise and vice versa.

Repeat the above paragraph until the oscillators stay in tune over the whole span of the keyboard, but without changing ranges at this point.

Now switch both VCOs to 2' range, and repeat the procedure, tuning RV56. VCO2 will always be flat to begin with, and so RV56 will need to be turned anticlockwise.

## VCO Range Switches

Set both VCOs to the 64' range, play a high note, and tune the oscillators together using RV17 or 18. Switch VCO1 to 32' and adjust RV19 for minimum beating; then switch VCO2 to 32' and tune the VCOs together again with RV20. Switch VCO1 to 16' and adjust RV12, then switch VCO2 to 16' and both oscillators should be in tune; if not, trim RV20 very slightly. Switch VCO1 to 8' and adjust RV11; adjust RV10 with VCO1 on 4' and VCO2 on 8', and finally switch VCO1 to 2' and VCO2 to 4' and adjust RV9.

The oscillators should now remain in tune with each other over the whole range of the keyboard and range switches; in practice, slight anomalies in the control characteristics will prevent perfection being achieved, but only the slightest touch of VCO2 TUNE should be necessary to correct any mistracking.

## VCOs — Final Adjustments

Once the oscillators are tracking satisfactorily, set VCO2 TUNE and the keyboard TUNE to mid position, and tune the second A up the keyboard to middle A, or 440Hz. RV17 tunes VCO1, and RV18 tunes VCO2. If the Spectrum is to be used with another instrument which cannot be tuned, you may prefer to tune up to that instead.

RV27 may be used to set the width of VCO2's pulse output, or simply left midway.

RV29 should be set to give 3.85 volts on its wiper, and RV30 to give 1.6 volts on its wiper.

The final VCO adjustment is to centre the horizontal joystick movement. Loosen RV13's clamp screw, shown in Figure 25. Set controller FUNCTION to VCO1, and DEPTH to 10, whereupon VCO1 will probably go wildly out of tune. Hold the joystick lever and RV13's trim tab central, and rotate the body of RV13 to bring VCO1 back into tune; then do up the clamp screw. Once the joystick is mounted, and after transporting the synthesiser, adjust the trim tab so that when the controller DEPTH control is rotated back and forth, no perceptible pitch change takes place.

## LFO

RV8 is the only adjustment on the LFO. Set oscillator modulation as follows: SOURCE to LFO MAN, DEPTH to 10 and FUNCTION to VCO 1 + 2. Modulation of the VCOs will now be apparent; with the joystick lever and RV7's trim tab central, adjust RV8 until there is no modulation breakthrough.

## Noise and RM VCA

Switch off both VCOs, and turn up the NOISE AND RM LEVEL. Select square wave output from the LFO, and turn noise & RM modulation SOURCE to +LFO. Turn RV35 fully anticlockwise, so that noise comes through loudly whilst the LFO LED is off, and quietly when it is on; a fairly slow LFO rate is advisable. Now turn RV35 clockwise until the noise is just cut off during the LED on periods. If any clicking or thumping is apparent as the LFO switches, adjust RV33 to get rid of it.

Now turn the SOURCE switch to +EG, turn the envelope generator SUSTAIN to zero, and turn RV34 fully anticlockwise. Some noise will now be heard on the Spectrum's output; turn RV34 clockwise until it just disappears. Turn down the noise LEVEL, and return SUSTAIN to 10.

## Filter

RV37 adjusts the filter's volts per octave characteristic, which is not

nearly as critical (or difficult) as the adjustment of the VCOs, and may be done most simply by ear. Set the filter controls as follows: RESPONSE to BP, FREQUENCY about midway, KEYBOARD FOLLOW to 10, RESONANCE to 10 and DEPTH to 0. The filter should oscillate with a pure tone which can be played from the keyboard; to avoid confusion, make sure both VCOs and the noise & RM are off. Set RV37 midway, and play a scale on the keyboard; e.g. C major, all the white notes between one C and the next. If the scale sounds 'compressed' — as if it should go on longer to reach the proper note — turn RV37 clockwise, and vice versa.

Altering RV37 will also alter the tuning of the whole scale, but carry on playing and adjusting until the scale 'sounds right'; like the doh, re, mi... etc you learnt in school.

Finally turn the resonance down ready for the final setting up.

## VCA and Pan

With the synthesiser still set to give no sound, turn the GATE MODE switch to LFO, set the envelope shaper SUSTAIN to 10 and ATTACK and RELEASE to 0. Turn up the LEVEL

control, and there will be a 'thump' each time the LFO switches (along with some background noise). Adjust RV41 to minimise this thump.

Now switch the GATE MODE back to HOLD, and select either LFO MOD on the OUTPUT FUNCTION selector; the LFO should still be giving a square wave. Turn up the DEPTH control, and the thumping will return, but sharper this time — more of a clicking sound. Adjust RV43 to get rid of this as far as possible. If necessary, keep turning up the amplifier's volume as these adjustments progress to keep the clicking audible.

Turn DEPTH back to minimum, select any 'pan' position on the FUNCTION switch, and monitor the stereo outputs with a dual beam scope or well-balanced amplifier and headphones. Turn on one of the VCOs, and adjust RV44 to give equal outputs from each channel.

Finally, adjust RV50 to give -0.24 volts on pin 156 — or the clockwise tag of any ATTACK, DECAY or RELEASE pot — with respect to 0V.

This completes the construction of the Spectrum Synthesiser. Articles on playing technique and details of a demonstration cassette will be published in future issues of E&MM.

## KEYBOARD PARTS LIST

<b>Resistors</b>			
R8-55	47R 2%	48 off	(X47R)
<b>Miscellaneous</b>			
49-note C-C keyboard			(XB17T)
Contact springs		49 off	(QY07H)
Palladium bars, 1.2mm x 330mm		Set of 4	
24-contact PCB			(GA09K)
25-contact PCB			(GA10L)
6BA 1" bolts			(BF67H)
6BA 1/2" spacers			(FW35Q)
6BA washers			(BF22Y)
6BA nuts			(BF18U)
Veropins			(FL24B)

## POWER SUPPLY UNIT PARTS LIST

<b>Resistors — 5% 1/2W carbon unless-specified.</b>			
R1,2	2R2 1/2W	2 off	(S2R2)
R3,4	3k3 1%	2 off	(T3K3)
R5,6	3k0 1%	2 off	(T3K0)
R7	330R		(M330R)
RV1,2	1k cermet preset	2 off	(WR40T)
<b>Capacitors</b>			
C1,2	2200uF 25V axial elect.	2 off	(FB90X)
C3,4,7,8	2u2 63V PC elect.	4 off	(FF02C)
C5,6	100pF polystyrene		(BX28F)
<b>Semiconductors</b>			
IC1,2	uA723 14-pin DIL	2 off	(QL21X)
TR1,2	BD135	2 off	(QF06G)
D1-D10	1N4001	10 off	(QL73Q)

Miscellaneous			
T1	240V prim. 0-15, 0-15 sec. 10VA		(LY03D)
S1	DPST rocker switch with neon		(YR70M)
FS1	20mm 500mA quick blow fuse		(WR02C)
	20mm panel fuseholder		(RX96E)
FS2,3	20mm 1A quick blow fuse	2 off	(WR03D)
	20mm chassis fuseholder	2 off	(RX49D)
	14-pin DIL socket	2 off	(BL18U)
	PCB		(GA03D)
	3A 3-core mains cable 2m		(XR01B)
	13A mains plug		(HL58N)
	6BA 1" bolts		(BF07H)
	6BA 1/2" spacers		(FW35Q)
	6BA nuts		(BF18U)
	4BA 1/2" bolts		(BF03D)
	4BA nuts		(BF17T)
	4BA solder tags		(BF28F)
	Cable grommet		(LR48C)
	Veropins		(FL24B)

## KEYBOARD CONTROLLER PARTS LIST

### Resistors — 5% 1/4W carbon unless specified

R56	33k		(M33K)
R57	5k6 1% film		(T5K6)
R58,59	470R 1% film	2 off	(T470R)
R60	1M0		(M1M0)
R61,85	4k7	2 off	(M4K7)
R62,75	1k0	2 off	(M1K0)
R63	470k		(M470K)
R64,74	100R	2 off	(M100R)
R65,66,78,79	10k	4 off	(M10K)
R67,70,73,80	100k	4 off	(M100K)
R68,69	3k3	2 off	(M3K3)
R71	10M 10%		(M10M)
R72	220k		(M220K)
R76	47k		(M47K)
R81	330k		(M330K)
R82,84	22k	2 off	(M22K)
R83	2k2		(M2K2)
RV3	5k0 multi-turn cermet preset		(WR48C)
RV4	2M2 log. pot.		(FW29G)

### Capacitors — polycarbonate unless specified

C9	68nF		(WW39N)
C10,12,14	100nF	3 off	(WW41U)
C11,13	470nF	2 off	(WW49D)
C65,66	100uF 25V PC elect.	2 off	(FF11M)

### Semiconductors

IC3,4	1458C	2 off	(QH46A)
IC5	CA3240E		(WQ21X)
IC6	CD4093BE		(QW53H)
TR3	2N3819		(QR36P)
TR4	BC182L		(QB55K)
TR5	BC212L		(QB60Q)
D11-D19 (no D15)	1N4148	8 off	(QL80B)

### Miscellaneous

	8 pin DIL socket	3 off	(BL17T)
	14 pin DIL socket		(BL18U)
JK1,3	3.5mm jack socket	2 off	(HF82D)
	PCB		(GA55K)
	Veropins		(FL24B)

## VCO PARTS LIST

### Resistors — 5% 1/4W carbon unless specified

R77,89	27k 1% film	2 off	(T27K)
R86,87,149,			
150,176,178	1M0 1% film	6 off	(T1M0)
R88	110k 1% film		(T110K)
R90,143,210,211	10k	4 off	(M10K)
R133	3k9 1% film		(T3K9)
R134,135,136,			
137	2k4 1% film	4 off	(T2K4)
R138	3k0 1% film		(T3K0)
R139	56k		(M56K)
R140-142,144,			
152-161,174,			
180,187,188,			
192,198-200,			
205-207	100k	25 off	(M100K)
R145	240k 1% film		(T240K)
R146,166,167	220k 1% film	3 off	(T220K)
R147,148	91k 1% film	2 off	(T91K)
R151	2M2 10%		(M2M2)
R162,163	100k 1% film	2 off	(T100K)
R164,165	47k 1% film	2 off	(T47K)
R168,171	24k 1% film	2 off	(T24K)
R169,172	910R 1/2W	2 off	(S910R)

R170,175	510k 1% film	2 off	(T510K)
R173	560k		(M560K)
R177,179	5k6 1% film	2 off	(T5K6)
R181,184,325,			
327	470R	4 off	(M470R)
R182,185	1k8 1% film	2 off	(T1K8)
R183	300k 1/2W		(S300K)
R186	180k		(M180K)
R189	1k0		(M1K0)
R190	680k		(M680K)
R191	120k		(M120K)
R195,202	330k	2 off	(M330K)
R196,203	240k 1/2W	2 off	(S240K)
R197,204	150k	2 off	(M150K)
R201,208	47k	2 off	(M47K)
R209	3k3		(M3K3)
R212	68k		(M68K)
R213,214	220k	2 off	(M220K)
R215	6k8		(M6K8)
R324,326	1M0	2 off	(M1M0)
R328	100R		(M100R)
RV9,10,11,12,19	1k0 cermet preset	5 off	(WR40T)
RV14	10k log. pot.		(FW22Y)
RV15	47k log. pot.		(FW24B)
RV16,25	470k lin. pot.	2 off	(FW07H)
RV17,18	100k cermet preset	2 off	(WR44X)
RV20,21,22	50k cermet preset	3 off	(WR43W)
RV23,24	10k multi-turn cermet preset	2 off	(WR49D)
RV26	100k lin. pot.		(FW05F)
RV27	100k min. horiz. preset		(WR61R)
RV5,28	220k lin. pot.	2 off	(FW06G)
RV29,30	2k2 min. horiz. preset	2 off	(WR56L)
RV55,56	22k min. horiz. preset	2 off	(WR59P)

### Capacitors — monolithic ceramic unless specified

C21,24,25,26,27,			
28,29,30,33	100nF	9 off	(YY11M)
C22,23	1nF	2 off	(YY24B)
C31,34	1nF 1% polystyrene	2 off	(BX56L)
C32,35,71,72	10nF	4 off	(YY08J)
C36	1uF polycarb.		(WW53H)
C37	270pF ceramic plate		(WX61R)
C38	100pF polystyrene		(BX28F)
C69,70	100uF 25V PC elect.	2 off	(FF11M)

### Semiconductors

IC7,14,19	1458C	3 off	(QH46A)
IC13	LF353 or TL082		(WQ31J)
IC15,16	CEM 3340	2 off	
IC17	CD4093BE		(QW53H)
IC18	CD4013BE		(QX07H)
TR15	BC212L		(QB60Q)
TR16,17	2N3819	2 off	(QR36P)
D28	Red LED		(WL27E)
D29,30	1N4148	2 off	(QL80B)

### Miscellaneous

S3-10	Rotary switch 2-pole 6-way	8 off	(FF74R)
RV7,13	Joystick, 100k lin. pots.		(XB09K)
JK2,4,5,6	3.5mm jack socket	4 off	(HF82D)
	8 pin DIL socket	4 off	(BL17T)
	14 pin DIL socket	2 off	(BL18U)
	16 pin DIL socket	2 off	(BL19V)
	PCB		(GA36P)
	Veropins		(FL24B)

## FILTER BOARD PARTS LIST

### Resistors — 5% 1/4W carbon unless specified

R193,229	33k	2 off	(M33K)
R194,242,257	1k0	3 off	(M1K0)
R216,239	15k	2 off	(M15K)
R217	39k		(M39K)
R218	30k 1/2W		(S30K)
R219,223,226,			
231,250,253,			
259,261,265,			
269,270	100k	11 off	(M100K)
R220,221	300k 1/2W	2 off	(S300K)
R222	620k 1/2W		(S620K)
R224,245,246,			
247	1M0	4 off	(M1M0)
R225,230,266	470k	3 off	(M470K)
R227	1k8		(M1K8)
R228	680k		(M680K)
R232	220k		(M220K)
R233,234	100R	2 off	(M100R)
R235	18k		(M18K)
R236,238	47k	2 off	(M47K)
R237	22k		(M22K)
R240	4k7		(M4K7)
R241,243	27k	2 off	(M27K)
R244	5k6		(M5K6)

R248,252	120k	2 off	(M120K)	C17,18	10nF	2 off	(WW29G)
R249,251,256, 260,267	91k 1/2W	5 off	(S91K)	C19	6n8		(WW27E)
R254	330k		(M330K)	C20	100nF		(WW41V)
R255	51k 1/2W		(S51K)	C67,68	100uF 25V PC elect.	2 off	(FF11M)
R258	1k5		(M1K5)	Semiconductors			
R262,263	240k 1/2W	2 off	(S240K)	IC8	LF351 or TL081		(WQ30H)
R264,272	56k	2 off	(M56K)	IC9,10,12	1458	3 off	(QH46A)
R268	180k		(M180K)	IC11	CA3140 (see text)		(QH29G)
R271	150k		(M150K)	TR6,8,17	BC212L	3 off	(QB60Q)
RV31,36,39,40	100k lin. pot.	4 off	(FW05F)	TR7	2N2646		(QR14Q)
RV32	100k log. pot.		(FW25C)	TR9,11,16	BC182L	3 off	(QB55K)
RV33	100k min. horiz. preset		(WR61R)	TR10	2N3819		(QR36P)
RV34,35	10k min. horiz. preset	2 off	(WR58N)	D20	Red LED		(WL27E)
RV37	50k cermet preset		(WR43W)	D21-27,D15	1N4148	8 off	(QL80B)
RV38	47k log. pot.		(FW24B)	Miscellaneous			
Capacitors					PCB		(GA53H)
C39	100pF ceramic		(WX56L)		Veropins		(FL24B)
C40	1uF polycarb		(WW53H)	S2	Rotary switch 2-pole 6-way		(FF74R)
C41	100nF polycarb.		(WW41U)				
C42,47	1u0 100V PC elect.	2 off	(FF01B)				
C43-46	100pF polystyrene	4 off	(BX28F)				
C48,49	10uF 35V PC elect.	2 off	(FF04E)				
Semiconductors							
IC20	1458C		(QH46A)				
IC21,23,26	741C	3 off	(QL22Y)				
IC22	CA3080E		(YH58N)				
IC24	LF353 or TL082		(WQ31J)				
IC25	CEM 3320						
TR12,13,14	BC182L	3 off	(QB55K)				
D33,34,35	1N4148	3 off	(QL80B)				
Miscellaneous							
S11,13	Rotary switch 2-pole 6-way	2 off	(FF74R)				
S12	Rotary switch 4-pole 3-way		(FF76H)				
JK7	3.5mm jack socket		(HF82D)				
	8 pin DIL socket	6 off	(BL17T)				
	18 pin DIL socket		(HQ76H)				
	PCB		(GA57M)				
	Veropins		(FL24B)				

<b>ENVELOPE SHAPER BOARD PARTS LIST</b>							
Resistors — 5% 1/2W carbon unless specified							
R273	62k 1/2W		(S62K)				
R274,288	56k	2 off	(M56K)				
R275,279,286, 289,290	150k	5 off	(M150K)				
R276,277,313, 314	10k	4 off	(M10K)				
R278	20k 1/2W		(S20K)				
R280,291,303, 304,329	100R	5 off	(M100R)				
R281	680R		(M680R)				
R282	6k8		(M6K8)				
R283,284,285, 287,292,294, 298,299,307	100k	9 off	(M100K)				
R293,295,296, 301,318,319	47k	6 off	(M47K)				
R297,300,302	1M	3 off	(M1M0)				
R305	22k		(M22K)				
R306	1k8		(M1K8)				
R308	2k2		(M2K2)				
R309,311	24k 1/2W	2 off	(S24K)				
R310,312	750R 1/2W	2 off	(S750R)				
R315	220k		(M220K)				
R316	12k		(M12K)				
R317	82k		(M82K)				
R330	560R		(M560R)				
RV41,43,44	100k min. horiz. preset	3 off	(WR61R)				
RV42	4k7 lin. pot.		(FW01B)				
RV45	4k7 log. dual gang pot.		(FX08J)				
RV46,47,49,51, 52,54	10k lin. pot.	6 off	(FW02C)				
RV48,53	100k lin. pot.	2 off	(FW05F)				
RV50	47k min. horiz. preset		(WR60Q)				
Capacitors — polycarbonate unless specified							
C50,53	1nF ceramic plate	2 off	(WX68Y)				
C51,55	4n7	2 off	(WW26D)				
C52	100pF ceramic plate		(WX56L)				
C54	1u0 100V PC elect.		(FF01B)				
C56,73	12pF ceramic plate	2 off	(WX46A)				
C57	6n8		(WW27E)				
C58,60	22nF	2 off	(WW33L)				
C59,61	39nF	2 off	(WW36P)				
C62	100nF		(WW41U)				
C63,64	100uF 25V PC elect.	2 off	(FF11M)				
C74,75,76	1u0	3 off	(WW53H)				
C77	10u 35V PC elect.		(FF04E)				
Semiconductors							
IC27,33	1458C	2 off	(QH46A)				
IC28	CEM 3330						
IC29	LF347		(WQ29G)				
IC30	741C		(QL22Y)				
IC31,32	CEM 3310	2 off					
TR15	BC212L		(QB60Q)				
D36,37,39,40	1N4148	4 off	(QL80B)				
D38	Red LED		(WL27E)				
D41	10V 400mW zener		(QH14Q)				
Miscellaneous							
S14	Shaft assembly and 2-pole 6-way wafer	2 off	(FH46A) (FH48C)				
S15	Rotary switch 2-pole 6-way		(FF74R)				
JK8	3.5mm jack socket		(HF82D)				
JK9,10,11	Standard mono jack socket	3 off	(BW78K)				
	8 pin DIL socket	3 off	(BL17T)				
	14 pin DIL socket		(BL18U)				
	16 pin DIL socket	2 off	(BL19V)				
	18 pin DIL socket		(HQ76H)				
	PCB		(GA59P)				

## LFO PARTS LIST

Resistors — 5% 1/2W carbon unless specified							
R91	220R		(M220R)				
R92,100,103, 110,323	33k	5 off	(M33K)				
R93,99,104,105, 106,116,117	10k	7 off	(M10K)				
R94	56k		(M56K)				
R95,118	47k	2 off	(M47K)				
R96,108	1k0	2 off	(M1K0)				
R97	180R		(M180R)				
R98	4M7 10%		(M4M7)				
R101,111,320, 321,322	39k	5 off	(M39K)				
R108	1k8		(M1K8)				
R107	10M 10%		(M10M)				
R109	150k		(M150K)				
R112	13k 1/2W		(S13K)				
R113	270k		(M270K)				
R114	390k		(M390K)				
R115	75k 1/2W		(S75K)				
R119	240k 1/2W		(S240K)				
R120	120k		(M120K)				
R121	24k 1/2W		(S24K)				
R122,123	100k	2 off	(M100K)				
R124	5k1 1/2W		(S5K1)				
R125	27k		(M27K)				
R126	18k		(M18K)				
R127	30k 1/2W		(S30K)				
R128	6k8		(M6K8)				
R129	2k7		(M2K7)				
R130	180k		(M180K)				
R131	22k		(M22K)				
R132	82k		(M82K)				
RV6	220k log. pot.		(FW26D)				
RV8	470k min. horiz. preset		(WR63T)				
Capacitors — polycarbonate unless specified							
C15	330nF		(WW47B)				
C16	220nF		(WW45Y)				

The CEM ICs are only available from Digisound Ltd, 13 The Brooklands, Wrea Green, Preston, Lancs PR4 2NQ. The price for the set of 6 is £32.43 inc. VAT, p&p. The remainder of the parts, including a drilled joystick mounting plate and front panel finished in black with white legend, may be obtained from Maplin Electronic Supplies Ltd, PO Box 3, Rayleigh, Essex SS6 8LR; Order number LW60Q, price £167.50 inc. VAT and U.K. inland carriage. The front panel and joystick panel are available separately; order nos. are XG08J (£14.95 + £7 UK car.) & XX46A (£1.80) respectively.

Drilled joystick black mounting plate.  
Drilled black front panel with white legend.



# MOVEMENT

# AUDIO

# VISUAL

RECORDING EQUIPMENT SALES AND COMPLETE STUDIO INSTALLATIONS  
61 Taunton Rd, Bridgwater, Somerset, TA6 3LP. Tel 0278-424560 (24hrs)



OUR STOCKS INCLUDE  
TASCAM 4, 8, 16 TRACK \* JBL PROFESSIONAL  
MCS PERCUSSION COMPUTER \* AUDIO & DESIGN \* QUAD \*  
ALICE \* KLARK TEKNIK \* ELECTROVOICE \* ROLAND \* MXR \*  
SESCOM \* CALREC \* AKG \* TANNAY \* STATIC  
PLEASE TELEPHONE FOR OUR PRICE LIST AND BROCHURE



## NEW AND USED ITEMS IN STOCK

### RECORDERS

TEAC 32/2B 2T  
TEAC 35/2B 2T  
TEAC 3440 4T  
TEAC 80/8 8T  
TEAC 85/16 16T  
REVOX B77 2T  
REVOX PR99 2T  
ASC 3-speed 2T  
TEAC RC70 Remote for 3440  
TEAC RC170 Remote for 80/8  
TEAC AG85 Remote & auto locator for 85/16

### MIXING DESKS

TEAC Model 1 mix down unit  
TEAC Model 2A with meter bridge  
TEAC Model 3 8 into 4  
TEAC Model 5 8 into 4  
TEAC Model 15 24 into 8/16  
ALICE 12 into 4/8  
ALICE 16 into 4/8  
ALICE 22 into 16/16  
MM 12 into 2

### SPEAKERS

AURATONE  
JBL 4311 Control monitors  
JBL 4315 Compact monitors  
JBL 4331 Studio monitors  
JBL 4333 Studio monitors  
JBL 4343 Studio monitors  
JBL 4350 Studio monitors  
JBL Electronic crossover  
TANNOY Super Red SRM 12X  
LOCKWOOD MAJORS HPD  
WARFDALE Lazer 80  
WARFDALE E90's

### AMPLIFIERS

QUAD 405  
CROWN D75  
CROWN D150A

### CROWN DC300A

### EQUALISERS

TEAC GE20 Stereo 10 band graphic  
MXR Stereo 15 band graphic  
MXR 31 band graphic  
AUDIO DESIGN 503 Scamp sweep  
AUDIO DESIGN 507 Scamp octave  
KLARK TEKNIK DN22

### MICROPHONES

ELECTROVOICE RE20  
ELECTROVOICE 671  
ELECTROVOICE DS35  
ELECTROVOICE 635A  
ELECTROVOICE DO50  
CALREC C Series

### EFFECTS

STATIK Stereo Reverb  
ROLAND 201 Space Echo  
ROLAND 501 Space Echo  
AUDIO DESIGN S23 Scamp pan module  
AUDIO DESIGN S24 Scamp ADT flanger  
EMT 140 Stereo echo plate  
AUDICON Stereo echo plate  
EVENTIDE Instant flanger  
EVENTIDE Digital delay  
KLARK TEKNIK DN36 Time delay clap trap

### COMPRESSORS/ LIMITERS/GATES

AUDIO DESIGN F300 Scamp expander gate  
AUDIO DESIGN S100 Scamp dual gate  
AUDIO DESIGN S01 Scamp compressor/limiter  
AUDIO DESIGN S02 Scamp mike preamp  
AUDIO DESIGN S05 Scamp Dynamic filter HI

AUDIO DESIGN S06 Scamp Dynamic filter LOW  
AUDIO DESIGN S14 Scamp LED 4 column display

### NOISE REDUCTION

TEAC DX2A DBX for 32/2B  
TEAC RX9 DBX for 3440  
TEAC DX8 DBX for 80/8  
BEL noise reduction (various)  
DOLBY 361

### CASSETTE DECKS

TEAC A770 Computer control 3 head  
TEAC C3X 2 speed 3 head  
TEAC M133 3 channel A/V  
TEAC M144 Portastudio 4T

### ACCESSORIES

TEAC PB64 patchbag  
TEAC E3 De/Mag  
TEAC NAB centres  
TEAC E2A Bulk eraser  
AUDIO DESIGN D1 box  
Microphone boxes 2/6/12 way  
Acoustic screens  
2"/1"/1/2"/1/4"/Ampeg & Agfa tape in stock

### MUSICAL INSTRUMENTS

MCS Drum computer  
SIMMONS Drum Synth (4 drums)  
ARP Sequencer  
YAMAHA CS80 Polysynth  
YAMAHA CP80 Piano  
LESLEY 145 cabinet  
ROLAND JP4  
ROLAND JP8  
ROLAND String/vocoder  
KORG Monosynth  
Set of Congas  
SHEARGOLD fretless bass  
FENDER Champ

For Discounted & Package Prices Tel: (0278) 424560 (24-hour service)

# ELECTRIC DRUMMER

Part 3



Peter Kershaw B.Sc

## Percussion Sound Generator Board

The board described provides a very low cost method for producing the more common sounds associated with automatic rhythm generators. The nine instruments fit on a single, six-inch square PCB and the total component cost is less than £20. Facilities are provided for accenting, and the unit can be driven from a rhythm generator IC or a control system such as the Electric Drummer, or it may be connected to a microcomputer.

- INSTRUMENTS**  
 Bass Drum  
 Snare Drum  
 Low & High Tom-Toms  
 Low & High Bongos  
 Wood Block  
 Cymbal  
 Hi-Hat (Open & Closed)



### The Resonant Sounds

The instruments producing a sound which may be represented by a decaying sinewave are:

- Low & High Tom-Toms
- Low & High Bongos
- Bass Drum
- Wood Block

The decaying sinewave can be produced by applying a pulse to a resonant tuned circuit, i.e. a capacitor and an inductor connected in parallel. However, to produce the sorts of frequencies we require (down to 50Hz for the bass drum) the necessary inductors would be bulky and expensive.

For this reason, the circuits employ a very simple gyrator. Whilst the theory of operation of gyrators is too lengthy to explain here, one common application is to make a small capacitor look like a large inductor. For example, in the "block" circuit C30 is the small capacitor, and IC10, R59 and R60 complete the gyrator. This apparent inductor is in parallel with C29 to form the resonant

circuit. C28, R58 and D12 ensure that the circuit is only triggered on negative edges of the input signal.

To accomplish the accenting, a CMOS OR gate is used. A low level on the input to the gate will allow trigger pulses to pass through it, causing a higher voltage "spike" on the gyrator input and therefore a greater "jolt" to the resonant circuit.

The following hints should help the constructor to develop different resonant sounds: the ratio between R56 and R57 controls the level of accenting. C29 controls the frequency, R59 and R60 control frequency and damping. It is possible, when using very low values of R60 and high values at R59, to get the circuit to self-oscillate. As this situation is approached, the circuit becomes less stable and more sensitive to noise. This is the case with the wood block sound, and for this reason the use of a low noise op-amp such as the LH0042C is recommended for IC10.



Sound Generator Board PCB.

### PERCUSSION SOUND GENERATOR PARTS LIST

Resistors — all 1/4W 5% carbon unless specified

R1,2,8,77,78	2k7	5 off	(M2K7)
R3,4,13,14,23,24,27,40	470k	8 off	(M470K)
R5,15,25	6k8	3 off	(M6K8)
R6,55	2M2	2 off	(M2M2)
R7,17	560k	2 off	(M560K)
R9,19	220k	2 off	(M220K)
R10,20,30	5k6	3 off	(M5K6)
R11	39k		(M39K)
R12	27k		(M27K)
R16	4k3 1/2W		(S4K3)
R18,29	180k	2 off	(M180K)
R21,70,76	47k	3 off	(M47K)
R22,32,37,42,47,52,57	22k	7 off	(M22K)
R26,74,79	10k	3 off	(M10K)
R28,61-69	100k	10 off	(M100K)
R31,36,41,46,51,56	33k	6 off	(M33K)
R33,38,43,48,53,58	330k	6 off	(M330K)
R34,39,54	1k0	3 off	(M1K0)
R35	680k		(M680K)
R44,49	120R	2 off	(M120R)
R45,50	1M0	2 off	(M1M0)
R59	27R		(M27R)
R60	510k 1/2W		(S510K)
R71,72	100R	2 off	(M100R)
R73	470R		(M470R)
R75	68k		(M68K)
RV1-9	100k min. horiz. preset	9 off	(WR61R)
RV10	10k log. pot.		(FW22Y)

Capacitors — all polycarb. unless specified

C1	3n3		(WW25C)
C2	1u0 tantalum		(WW60Q)
C3	220pF ceramic plate		(WX60Q)
C4	470pF ceramic plate		(WX64U)
C5,9	68nF	2 off	(WW39N)
C6,15,18,33	100nF	4 off	(WW41U)
C7,12	680pF ceramic plate	2 off	(WX66W)
C8,30	47nF	2 off	(WW37S)
C10	470nF		(WW49D)
C11	1n0		(WW22Y)
C13,16,21,24,25,28,29,31,32	10nF	9 off	(WW29G)
C14,17	22nF	2 off	(WW33L)
C19,22,23,26	27nF	4 off	(WW34M)
C20	56nF		(WW38R)
C27	220nF		(WW45Y)

Semiconductors

IC1,2,3	4071		(QW43W)
IC4	4016		(QX08J)
IC5-9,11	741C	6 off	(QL22Y)
IC10	LH 0042C (see text)		(QH35Q)
IC12	SN76477		(YH32K)
TR1-6	BC179	5 off	(QB54J)
TR7	2N3704		(QR28F)
D1-12	1N4148	12 off	(QL80B)
D13	BZY88C5V6		(QH08J)

Miscellaneous

JK1	Moulded mono, standard 1/4" jack sckt		(HF90X)
	PCB		(GA60Q)

The PCB is available from Maplin Electronic Supplies Ltd, PO Box 3, Rayleigh, Essex SS6 8LR, price £4.72, as are all the components.

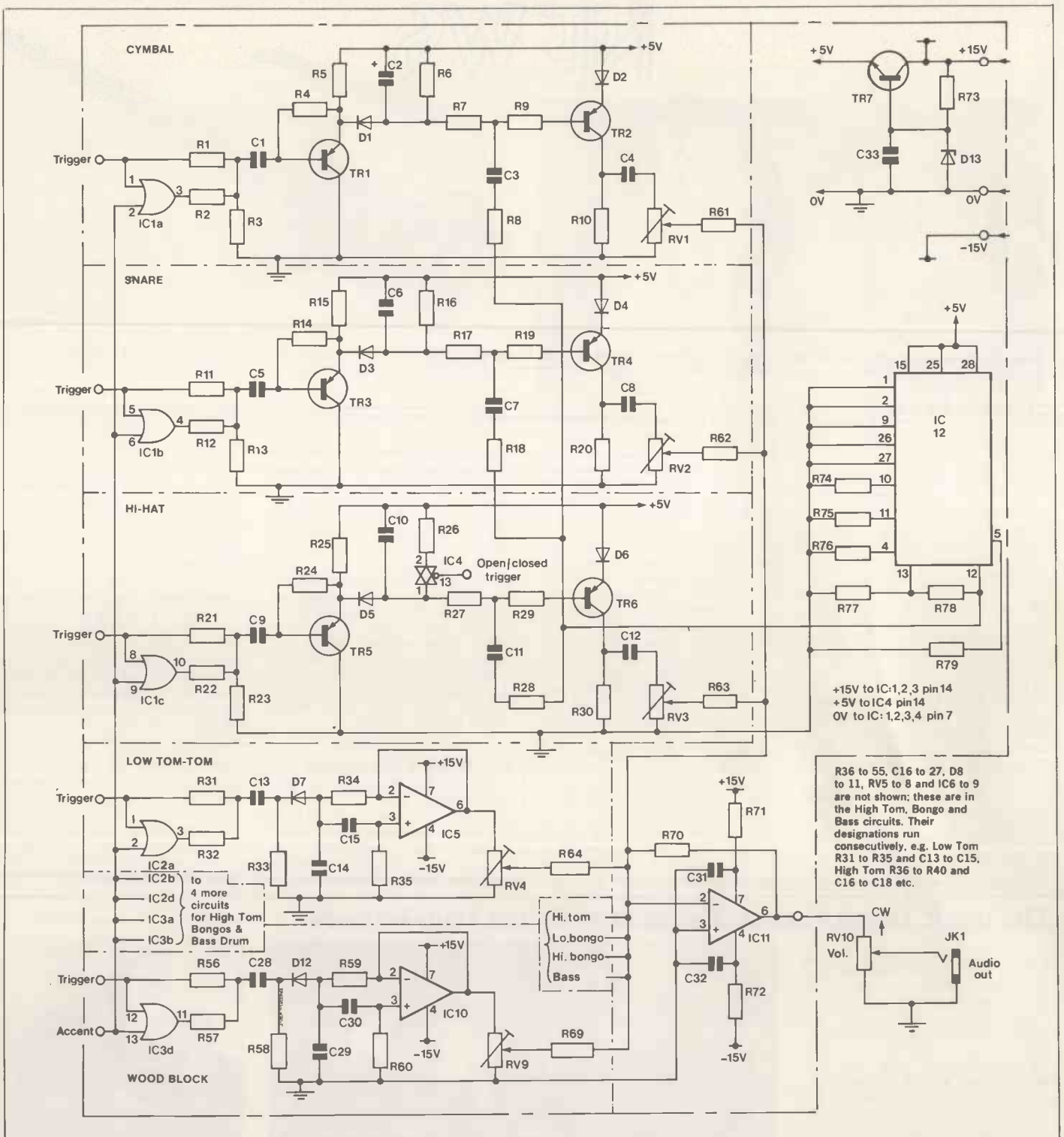

Circuit diagram of the Percussion Sound Generator Board. The circuits for High Tom-Tom, Bongos and Bass Drum are the same as those shown for Block and Low Tom-Tom.

When developing sounds on the PCB, insert Veropins into the holes in that section of the board as continuous desoldering can cause the tracks to lift off.

## The Noise Sounds

Three sounds are provided which are basically noise: Cymbal, Snare and Hi-hat. The SN76477 complex sound generator provides a cheap and reliable digital noise generator. By changing the voltages on its control pins the IC can be made to produce frequency modulated output, and by modifying the board wiring slightly sounds similar to the Syntom can be obtained.

In the cymbal circuit the time constant  $C2 \times R6$  determines the length of the cymbal decay. If C2 is too large, the current required through TR1 is too great and a slow attack results.

E&MM FEBRUARY 1982

The hi-hat is essentially the same as the cymbal, except that a bilateral switch (IC4) is used to discharge C10 rapidly when its gate input goes high. This simulates the operation of the hi-hat foot pedal.

If it is not required to have the hi-hat open facility, the IC4 may be omitted and pin positions 1 and 2 shorted together. Similarly, if the accent feature is not required the three 4071 chips can be omitted. In that case it is recommended that the input resistor in the resonant generators be changed for a value equal to the parallel combination of the input resistor and the accent resistor to obtain maximum dynamic range.

## Construction

A double sided PCB will be available for this circuit — see parts list. This has been laid out so that nearly all the through

connections may be made by soldering component leads on both sides of the board. Only a few through pins are needed, and these are shown in Figure 2.

The output voltage is variable, and the signal is suitable for feeding into an amplifier, PA system, etc. But beware — the bass drum output is very powerful, so start at low volume.

The trigger inputs are negative edge triggered. If you are driving the system from 15V CMOS or other +15V triggers, use  $\pm 15V$  supplies. Note that the hi-hat open/close input should only go between 0V and +5V.

If you connect to TTL levels (e.g. from a microcomputer port) you should drive the board from  $\pm 15V$  supplies. Remove TR7, R73, C33 and D13 and wire the collector and emitter of TR7 together. But be careful not to connect +15V again without reversing the procedure.

E&MM

# NEWS



## WELSON ORGANS

Welson Organs who have been regarded for some time as being in suspended animation are back on the British market. Welson U.K. which is the trading name of Beethoven Ltd, are handling the U.K. concession from the Italian manufacturers. The managing director, Mr John Cowley (right in photograph) has announced that they are conducting a vigorous marketing campaign to promote the Welson brand which has been expanded by many new products.

The quality control, servicing and spare parts for Welson Organs will be handled by Norbury Electronics Ltd, of Manchester.

Part of the marketing campaign was to sign concert artist Jerry Allen (left in photograph) to perform on Welson organs, to provide product development and marketing consultancy.

The following is a list of the new products from Welson which are now available:

**Disco Star:** a portable single keyboard, 49 key model, 15W rms amplification into twin elliptical 5" x 7" speakers, Swing Machine II rhythm unit with eight combinative rhythms.

**Gypsy Star:** as above with 61 keys.

**The Vega:** two manual electronic keyboard, 25W rms amplification into two elliptical speakers, upper and lower manuals 44 keys, bass section pedalboard and rhythm unit with eight combinative rhythms.

**Super Pigalle:** single 61 key home organ, 15W rms output and eight combinative rhythms.

**Super Fiesta:** two manual home organ, 44 keys on each keyboard plus a 13-note pedalboard, 40W rms and the eight rhythm swing unit.

**Monte Carlo L:** twin manual 44 key keyboards, 13-note pedalboard string synthesiser, 16" and 8" pianos, poly synthesiser, new rhythm unit with 10 rhythms and synth bongos, a split mechanical Leslie, twin 40W rms amplifiers into twin 12" speakers and tweeters.

**Festival 2000:** twin manual 37 key keyboard, similar to the Monte Carlo, replacing the Comet.

For prices and further details contact: J.A. Gould on behalf of Beethoven Ltd, 10-12 Cornbrook Park Road, Manchester.



## AWARDS

We've noticed a collection of votes and awards recently which might interest you. GPI Publications in the US publish three well-known magazines for musicians, *Guitar Player*, *Keyboard and Frets*, and every year their readers vote for their fave musicians — a rare example of musicians (mainly) voting for musicians (mainly). What did they choose? All was revealed in the respective December 1981 issues, but of interest to E&MM readers may be the following choices: best overall guitarist was Steve Howe and the best guitar album was DiMeola/McLaughlin/de Lucia's 'Friday Night In San Francisco'. Best keyboard album was voted in as Steve Winwood's 'Arc Of A Diver'; best 'lead synthesist' as Keith Emerson; and top three studio synthesists were Brian Eno, Wendy Carlos and Isao Tomita.

Slightly more obscure is the Industrial Designers' Society of America (IDSA), who in November last awarded Ned Steinberger — President of Steinberger Sound Corporation in Brooklyn, New York — their Industrial Design Excellence Award for Consumer Products for the Steinberger Bass, which Ned claims is a pioneer in all-plastic musical instrument construction. The bass was among three other winners, chosen from over 200 entries in 10 categories.

Lastly, following our American awards theme, JBL have come out top in a survey of monitor speakers used in US studios. In *Billboard* magazine, JBL monitors were found to be located in just over 29 per cent of 691 polled studios, and top the survey for the fifth consecutive year. In the U.K. we suspect smart money might be on Tannoy.

## DESIGNS FOR AUDIO

A new company to us is Designs For Audio, who claim to 'make available to musicians custom-built effects and signal processors, made to the individual requirements of each musician'. Which seems like a good idea, especially when they say

that they'll give you a free quote on your particular effects requirement. The example given is a digital delay line for £90 (including the statutory one year's guarantee). Sounds good?

Quotes for an SAE — write to Designs For Audio, 3 Gordon Avenue, Fleet, Hants GU13 0BA.

## Electronic Organ Festival Weekend at Barton Hall, Torquay

For the second year running Pontins Holiday camps were hosts to 600 organ enthusiasts, many leading organ manufacturers and over a dozen top organists. If you like organs, these weekends are an ideal break for you and your family. Pontins do everything to make you feel welcome and apart from the entertainment, the food is excellent.

There were organ demonstrations all through the day and evening. Brenda Hayward was teaching chording and basic notation in one of the lecture rooms, Brian Hazelby was giving hints and tips on playing techniques, and of course there were organ showcases continuously in the two ballrooms.

Later this year Pontins will be holding residential festivals at Tower Beach, Prestatyn from August 28th to September 4th and at Torquay from December 3rd to 5th. For further details write to Pontins House Electronic Organ Festival Holiday Dept., Bournemouth, BH1 2NT. Telephone 0202 295533.

Dave Snoad, Sales Manager of Maplin shows a fascinated audience the complete electronics circuit board from the Matinée Organ as published in this magazine early last year. Enthusiasts welcomed the chance to hear direct comparisons between the Matinée and latest models from other manufacturers.



A rare opportunity to hear five of Britain's best known organists playing at once! (Left to right) Byron Jones, Brian Sharp, Michael Brent, Brian Hazelby and Trevor Daniels rose with true professionalism to an invitation to perform together completely unrehearsed. Their version of "That's Why The Lady Is A Tramp" was something no one should have missed!



Byron Jones entertains at the Matinée organ. His comments on the organ? "It's great but make it more expensive if you want to sell more!"



Trevor Daniels, managing director of Crumar Ltd, gave some dazzling performances on the keyboards. If you have noticed a distinct resemblance to Paul Daniels it's not surprising — they are brothers!

# NEW PRODUCTS



## NEW DESK TOP MICROCOMPUTER

Comart Ltd have recently launched a North Star desk top micro-computer, the Advantage. The system comprises a Z80A CPU with 65K bytes of user memory, 12" green screen, twin 5" diskette drives which provide a back-up storage of 790K bytes and an 87 key selectric style keyboard with 15 programmable function keys.

The price including business graphics software is just under £2,500. Comart claim that reliability, compatibility and versatility are the three major features of the Advantage.

The new system is compatible with existing software for other North Star systems including word processing, accounting, payroll, and stock control plus other business, scientific and educational packages. The graphics facilities can convert data to bar charts, pie charts, graphs and 3D representation for both screen and printer output.

Further details can be obtained from: Comart Ltd, PO BOX 2, St Neots, Cambs. Tel. 0480 215005, Telex 32514.



## MULTIMETER/ COMPUTER ACCESSORY

Black Star Ltd announce the new Sabtronics digital multimeter, the Model 2020 which has microprocessor interfaces which enable it to be adapted to many microcomputers.

The meter is similar in appearance to the other Sabtronics bench meters with the 3½ digit red LED display. It has a 0.1% DCV accuracy, is capable of measuring AC and DC volts up to 1000V, ohms to 20M and AC and DC current up to 10A.

The capability of driving or supplying a microcomputer with data has a vast number of applications; sample periodic measurements over seconds, minutes, hours or even days to generate statistical data is just one example.

It comes equipped with all cabling and I/O support necessary for either TRS80, Apple, Pet or Atari computers as per customer choice of any one interface included in the price of £165 (plus VAT).

Further details from: Black Star Ltd, 9a Crown Street, St Ives, Huntingdon, Cambs, PE17 4EB. Tel: (0480) 62440.

## CUSTOM GUITAR SHOP

Peter Cook, author of our 'Guitar Workshop' series, has just opened a complete custom guitar shop at 69 Station Road, Hanwell W7, called "PETER COOK GUITARS". In addition to a complete repair and customising service for guitars and amps there is a good selection of new and used instruments for sale.

Peter, who is responsible for the pre-delivery check and set-up on all the new Gibson guitars distributed in the U.K., will be pleased to answer any queries on these instruments during shop hours: Wednesday to Friday 12-7 p.m. and Saturday 11-6 p.m. telephone 01-840 1244.

## FARNELL PLUG-IN DEVICES

Farnell Audio Visual Ltd have released three devices: the Timetouch, Discolite and Pulselite. All three are housed in small cases (5½" x 3¾") with an integral mains socket so that the equipment to be driven can simply be plugged in. Each device plugs into an ordinary mains socket.

The Timetouch is a clock which, by push button command, switches on and off any electrical appliance. Farnell claim that it is a big improvement on the less accurate electro-mechanical time switches.

The Discolite is a lamp flasher with its own built in sound detector. Suitable for use at home discos and also has possible applications as a security device.

The Pulselite regularly provides a current pulse for operating advertising signs and light decorations. The pulse frequency is 40 per minute at 450W max.

All three items are available from radio and electrical dealers at £24.99 inc. VAT for the Timetouch, £17.99 inc. VAT for the Discolite and Pulselite.

In cases of difficulty they are available from the distributors: Farnells, Kenyon Street, Sheffield. (Add £1.00 for post and packing.)

## SUPERCUSSION CATALOGUE

The SuPercussion catalogue and price list for 1982 is available from Musimex who claim that it is almost double the size of last years. It now includes handmade hickory drumsticks, rawhide maracas, kalimbas, rhythm brushes, castanet machine, Brazilian sheckere, square tube shakers and a complete range of chime trees. These are all in addition to a wide range of Indian, Pakistani and South American tabla, dholaks, cuicas, repiniques and surdos; bell trees, reco-recos, agogo bells and berimbau; ganzas, caxixis, afuches and chocalhos; tambourines, rattles, whistles and bags.

To obtain a copy of the catalogue send 50p in stamps to Musimex, 33 Church Crescent, London N20 0JR; they will also supply you with the address of your nearest SuPercussion stockist.

## LASERVISION NEWS

The U.K. launch of the Philips LaserVision video discs which was planned for the end of 1981 was postponed. According to the divisional director, Jimmy Dunkley the delay is due to the fact that insufficient discs would be available to meet consumer requirements.

However, an extensive training program has been conducted over recent months. Three-day service courses with technical instructors and service department heads from Dixons, Rumblelows, Visionhire, Mastercare, Wigfalls and T.A.M.

The Philips LaserVision player is claimed to be simple to operate and easy to service. The latter being due to the use of modular parts for the player.

In addition demonstrations to various trade organisations have been initiated; Boots, Co-op, HMV, Argus, Derwent, Rediffusion, Oxford Press, Vauxhall Motors, The Society of Young Publishers and The National Film Theatre.



## RECHARGEABLE BATTERY SYSTEM

Now available in the UK is the Gould 'Again and Again' rechargeable battery system. The system includes all the popular battery sizes and a universal charger. Gould claim that one 'Again and Again' battery will typically do the job of between 100 and 200 ordinary batteries.

The cost of the charger is less than £10 and it will accommodate all types of battery in the range. A complete set of batteries (one AA/HP7, C/HP11, D/HP2 and an PP3) costs approximately £5. The current consumption of the charger is said to be low and the cost of a recharge cycle a few pence. Up to four round or two 9V PP3 type batteries can be charged at a time. Batteries will recharge overnight but can remain on charge indefinitely without harm.

For further information contact: Gould Battery Division, Raynham Road, Bishop's Stortford, Herts.



## NEW AMPS AT FRANKFURT '82

John Hornby Skewes & Co Ltd will be releasing a new range of seven amplifiers at Frankfurt this year. They cover the whole gamut of applications from a small 5W practice amp to a twin cabinet 100W PA system. Two of these models have been reviewed by us this month, the C50PM and the C20B, the full range is listed below:

CS 5W practice amp	£45
C12 12W practice amp	£69
C20B 20W bass amp with bass equalisation	£105
C25PM 25W amp with Para-Mid	£105
C50PM 50W amp with Para-Mid	£139
C100PM 100W amp with Para-Mid	£299
C100PA 100W PA system	£295
(all prices include VAT)	

For more information contact: John Hornby Skewes & Co Ltd, Salem House, Garforth, Leeds LS25 1PX. Tel: (0532) 865381.

## POWERTRAN KIT SERVICE

The professional electronic company, Circolec, are to provide two services to Powertran customers: to service their complete range of kits and to assemble all kits ensuring that they work properly before despatch.

Kits can be purchased directly from Powertran who will arrange for them to be sent to Circolec, or the complete order can be placed with them direct.

For further information contact John Fell. Tel: 01-767 1233.



## SPEAKER STANDS AND BRACKETS

Audio & Vision Furniture Limited (AVF) have released a range of floor stands and wall brackets. These are available in a variety of configurations, all manufactured in high grade steel and finished in black epoxy or nylon coating with slip-proof neoprene strips and castors where

applicable. The designs facilitate tilt, swivel, height, depth and width adjustment.

Further information available from: Audio & Vision Furniture Limited, Dixon Street, Wolverhampton WV2 2BX. Tel: 0902 53464. Telex 335230.

NOBODY CAN GET NEAR OUR PRICES EXCEPT OUR CUSTOMERS

**NOW IN STOCK**

**THE NEW & EXCITING TRS80 MODEL III**



**48K £599 + VAT**

The Radio Shack TRS-80™ Model III is a ROM-based computer system consisting of:  
 ● A 12-inch screen to display results and other information  
 ● A 65-key console keyboard for inputting programs and data to the Computer  
 ● A Z-80 Microprocessor, the "brains" of the system  
 ● A Real-Time Clock  
 ● Read Only Memory (ROM) containing the Model III BASIC Language (fully compatible with most Model I BASIC programs)  
 ● Random Access Memory (RAM) for storage of programs and data while the Computer is on (amount is expandable from "16K" to "48K", optional extra)  
 ● A Cassette Interface for long-term storage of programs and data (requires a separate cassette recorder, optional/extra)  
 ● A Printer Interface for hard-copy output of programs and data (requires a separate line printer, optional/extra)  
 ● Expansion area for upgrading to a disk-based system (optional/extra)  
 ● Expansion area for an RS-232-C serial communications interface (optional/extra)  
 All these components are contained in a single moulded case, and all are powered via one power cord.

Disc Drives Kit with 2x40 Track Drives — £599 + VAT  
 Disc Drives Kit with 2x80 Track Drives — £729 + VAT  
 Add £25 for Installation

EXTENDED GUARANTEE BY COMPLUCARE

**WE ARE NOW STOCKING THE APPLE II AT REDUCED PRICES-**



**AUTOSTART EURO PLUS**

**48K £599 + VAT**

**Getting Started** APPLE II is faster, smaller, and more powerful than its predecessors. And it's more fun to use too because of built-in features like:  
 ● BASIC.— The Language that Makes Programming Fun.  
 ● High-Resolution Graphics (in a 54,000-Point Array) for Finely-Detailed Displays.  
 ● Sound Capability that Brings Programs to Life.  
 ● Hand Controls for Games and Other Human-Input Applications.  
 ● Internal Memory Capacity of 48K Bytes of RAM, 12K Bytes of ROM; for Big-System Performance in a Small Package.  
 ● Eight Accessory Expansion Slots to let the System Grow With Your Needs.  
 You don't need to be an expert to enjoy APPLE II. It is a complete, ready-to-run computer. Just connect it to a video display and start using programs (or writing your own) the first day. You'll find that its tutorial manuals help you make it your own personal problem solver.

EXTENDED GUARANTEE BY COMPLUCARE

**APPLE DISC II 3.3 Dos**



Disc with Controller  
**£349 + VAT**  
 Additional Drives  
**£299 + VAT**

● Powerful Disk Operating Software Supports up to 6 drives  
 ● Name Access to Files for Ease of Use  
 ● BASIC Program Chaining to Link Software Together  
 ● Random or Sequential File Access to Simplify Programming  
 ● Dynamic Disk Space Allocation for Efficient Storage  
 ● Individual File Write-Protection Eliminates Accidental File Alterations  
 ● Loads an 8K Byte Binary Image in 6.5 sec. (1.2 sec. in Pascal)  
 ● Storage Capacity of 116 Kilobytes (143K Bytes with Pascal) on Standard 5 1/4" Diskettes  
 ● Powered Directly From the APPLE (Up to 6 Drives) for Convenience and High Reliability  
 ● Packaged in Heavy-Duty, Colour-Coordinated Steel Cabinet  
 Colour Monitors for Apple — £295 + VAT

**NEW The PEDIGREE PETS**



RRP £795 for 32K

**32K ONLY £569 + VAT**

Very popular for home & business use. 8K Microsoft Basic in ROM. 32K with new improved keyboard. 12" screen. Cassette Deck £55 extra

EXTENDED GUARANTEE BY COMPLUCARE

**GET YOURSELF A NEW MX70 PRINTER AND SAVE A FORTUNE**



only **£249 + VAT**

● 80 Column, ● Upper & lower case ● Apple dot Graphics  
 ● Centronics Parallel ● Uni-directional. TX80 — £235 + VAT  
 MX80 — from **£349 + VAT** MX80FT **£399 + VAT**

EXTENDED GUARANTEE BY COMPLUCARE

**ACORN ATOM**

**UNIQUE IN CONCEPT — THE HOME COMPUTER THAT GROWS AS YOU DO**



Fully Assembled **£149 + VAT**

Special features include ● Full Sized Keyboard ● Assembler and Basic ● Top Quality Moulded Case ● High Resolution Colour Graphics ● 6502 Microprocessor

EXTENDED GUARANTEE BY COMPLUCARE

**CASIO VL TONE**



EXTENDED GUARANTEE BY COMPLUCARE

**NEW £29.95 + VAT**

It's a new kind of musical instrument. A computer controlled synthesiser that helps you create, play and arrange compositions that normally take years of musical training.

**TV GAME BREAK OUT**

Has got to be one of the world's greatest TV games. You really get hooked. As featured in ETI. Has also 4 other pinball games and lots of options. Good kit for up-grading old amusement games.



**MINI KIT** — PCB, sound & vision modulator, memory chip and de-code chip. Very simple to construct. **£14.90 + VAT**  
**OR PCB £2.90 MAIN LSI £8.50** Both plus VAT

**CENTRONICS 737 DOT MATRIX PRINTER**



only **£369 + VAT** including cables

**Standard Features**  
 ● 80 CPS — Proportional Spaced Mode ● 50 CPS — Monospaced Mode ● Proportional Spacing, Plus 10 CP1 and 16.7 CP1  
 ● N x 9 (Proportional) or 7 x 8 (Monospaced) Dot Matrix ● 7 x 8 Dot Matrix ● 3 Way Paper Handling System ● 96 Character ASCII plus 6 European character sets ● Microprocessor Electronics ● Expanded Print ● Right Margin Justification ● Print Underlining ● 9-Wire Free Flight Print Head ● Bidirectional Stepper Motor Paper Drive ● Full One Line Buffer ● 21 LPM With 80 Columns Printed ● 58 LPM With 20 Columns Printed ● 6 Lines Per inch Vertical Spacing ● Paper Tear Bar ● Centronic Colours and Logo

EXTENDED GUARANTEE BY COMPLUCARE

**TANTEL**



**ONLY £169 + VAT**

Demonstration available at our showroom

**PRESTEL BY TANTEL** The greatest thing since television & telephones. Communications at your fingertips for business & home. 180,000 pages of up-to-date information on travel, news, investment, holidays, hotels etc etc. Ask Prestel a question and you have your answer in seconds in full colour on your own TV. Only requires a telephone jack socket available from the PO.

EXTENDED GUARANTEE BY COMPLUCARE

**NEW**



**MICROLINE 80 £299 + VAT**

● 80 cps Uni-directional ● Small size: 342 (W) x 254 (D) x 108 (H) mm. ● 160 Characters, 96 ASCII and 64 graphics ● 3 Character sizes: 40, 80 or 132 chars/line ● Friction and Pin Feed ● Low noise: 65 dB ● Low weight: 6.5 kg

**MICROLINE 82 £449 + VAT**

● 80 cps Bi-directional logic seeking ● Small size: 360 (W) x 328 (D) x 130 (H) mm. ● 160 characters, 96 ASCII and 64 graphics, with 10 National character-set Variants. ● 4 Character sizes: 40, 66, 80 or 132 chars/line. ● Built-in parallel and serial interfaces. ● Friction and Pin Feed ● Low noise: 65dB ● Low weight: 8kg

**MICROLINE 83 £779 + VAT**

● 120 cps bi-directional logic seeking ● 136 column printing on up to 15in forms ● Small size: 512 (W) x 328 (D) x 130 (H) mm. ● 160 characters, 96 ASCII and 64 graphics with 10 National character-set variants ● 3 Character spacings: 5, 10 and 16.5 Chars/in. ● Built-in parallel and serial Interfaces ● Friction and Pin Feed ● Low noise 65dB ● Low weight: 13 kg

EXTENDED GUARANTEE BY COMPLUCARE

Microline 83 & 82 NOW IN STOCK

**HITACHI PROFESSIONAL MONITORS**



9" — ~~£129~~ **£99.95**  
 12" — ~~£199~~ **£149**

● **Reliability** Solid state circuitry using an IC and silicon transistors ensures high reliability. ● **500 lines horizontal resolution** Horizontal resolution in excess of 500 lines is achieved in picture center. ● **Stable picture** Even played back pictures of VTR can be displayed without jittering. ● **Looping video input** Video input can be looped through with built-in termination switch. ● **External sync operation** (available as option for U and C types) ● **Compact construction** Two monitors are mountable side by side in a standard 19-inch rack.

EXTENDED GUARANTEE BY COMPLUCARE

**THE VIDEO GENIE SYSTEM**

Ideal for small businesses, schools, colleges, homes, etc. Suitable for the experienced, inexperienced, hobbyist, teacher, etc.

**EG3000 Series**



**16K £274.90 + VAT**

**WITH NEW EXTRA KEYS!**

● 16K user RAM plus extended 12K Microsoft BASIC in ROM ● Fully TRS-80 Level II software compatible ● Huge range of software already available ● Self contained, PSU, UHF modulator, and cassette ● Simply plugs into video monitor or UHF TV ● Full expansion to disks and printer ● Absolutely complete — just fit into mains plug.  
 The Video Genie is a complete computer system, requiring only connection to a domestic 625 line TV set to be fully operational; or if required a video monitor can be connected to provide the best quality display. 51 key typewriter style keyboard, which features a 10 key rollover. Supplied with the following accessories: ● BASIC demonstration tape; ● Video lead; ● Second cassette lead; ● Users manual; ● BASIC manual; ● Beginners programming manual. Write useful programs in the BASIC computer language yourself.

EXTENDED GUARANTEE BY COMPLUCARE

**VIDEO GENIE EXPANSION BOX**

Complete with RS232 interface and floppy disc controller. 0 memory. **£225 + VAT**  
 Memory expansion card (S100) 16K **£110** 32K **£159** + VAT

EXTENDED GUARANTEE BY COMPLUCARE

IF IT WASN'T FOR THE LOWEST PRICES, THE BIGGEST CHOICE AND THE BEST AFTER SALES SERVICE, WE JUST WOULDN'T BE COMP SHOP

## YOUR ZX80 IS NOW NO LONGER REDUNDANT

Upgrade your ZX80 to the full animated graphics of the ZX81. (No screen flicker).

FOR ONLY **£12.95** + VAT IN KIT FORM

Works only in conjunction with **NEW 8K ROM** from Sinclair (Not Included).

ZX81 part-exchanges accepted.  
GOOD PRICES OFFERED

## UP GRADE YOUR SINCLAIR TO A 16K RAM PLUS EXPANSION BOARD WITH 3 SLOTS

This Expansion Board is designed for more than just memory - that's why it costs more than others!

**16K £69** + VAT    **4K £49** + VAT

## ATARI CARTRIDGES IN STOCK

Phone for availability

## COMP PRO MIXER

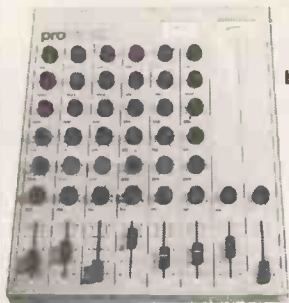

**Professional audio mixer that you can build yourself and save over £100.**

Only **£99.90** plus VAT for complete kit. Plus **FREE** power supply valued at £25.00

## WORD PRO II FOR PET

**£35** + VAT



## TEAC DISK DRIVES

- TEAC FD-50A has 40 tracks giving 125K Bytes unformatted single density capacity.
- The FD-50A can be used in double density recording mode.
- The FD-50A is Shugart SA400 interface compatible.
- Directly compatible with Tandy TRS80 expansion interface.
- Also interfaces with Video Genie, SWTP, TRS80, North Star Horizon, Superbrain, Nascom, etc. etc.
- Address selection for Daisy chaining up to 4 Disks.
- Disks plus power supply housed in an attractive grey case.

**40 TRACK**  
Single Disk Drive **£225** + VAT    Double Disk Drive **£389** + VAT

**77 TRACK**  
Single Disk Drive **£299** + VAT    Double Disk Drive **£499** + VAT

**STOCKTAKE SALE**  
NEVER TO BE REPEATED AT THIS PRICE  
UNTIL STOCKS LAST

★ 6502 based system — best value for money on the market. ★ Powerful 8K Basic — Fastest around ★ Full Qwerty Keyboard ★ 1K RAM Expandable to 8K on board. ★ Power supply and RF Modulator on board. ★ No Extras needed — Plug-in and go ★ Kansas City Tape Interface on board. ★ Free Sampler Tape including powerful Disassembler and Monitor with each Kit. ★ If you want to learn about Micros, but didn't know which machine to buy then this is the machine for you.

## EUROPE'S FASTEST SELLING ONE BOARD COMPUTER

# COMPUKIT UK101



**COMPUKIT WITH ALL THE FEATURES THAT MADE IT THE MOST PROFESSIONAL COMPUTER KIT ON THE MARKET. NOW WITH FREE NEW MONITOR (a saving), which includes Flashing Cursor, Screen Editing, & Save Data on Tape.**

Build, Understand and Program your own Computer for only a small outlay.

KIT ONLY **£99.95** + VAT

Fully Assembled — **£149** + VAT

**NEW MONITOR IN ROM** — available separately at **£7.90** + VAT.  
Improved Basic function — revised GARBAGE routine. Allows correct use of STRING ARRAYS **£4.90**  
This chip can be sold separately to existing CompuKit and Super board users. + VAT

**4K Upgrade Kit**  
**£15.90** + VAT

FOR THE COMPUKIT — Assembler Editor **£14.90**

**GAME PACKS** — 1). Four Games **£5.00**    2). Four Games **£5.00**    3). Three Games 8K only **£5.00**  
Super Space Invaders (8K) **£8.50**    Chequers **£3.00**    Realtime Clock **£3.00**

Case for CompuKit **£29.50**

40 pin Expansion Jumper Cable **£8.50**

All Prices exclusive VAT

## TTL SALE

Minimum Order — **£5**

74LS00	£0.10	74LS86	£0.30	Z80	£4.90
74LS04	£0.10	74LS93	£0.50	ACIA 6850	£1.90
74LS05	£0.15	74LS157	£0.60	OP-AMP	£0.45
74LS10	£0.15	74LS165	£0.90	CA3130	£0.45
74LS32	£0.20	74LS365	£0.40	REG.	
74LS74	£0.25	74LS373	£1.20	7805 5V	£0.75

### Low Profile Sockets

14 PIN	£0.05	18 PIN	£0.10	24 PIN	£0.20
16 PIN	£0.06	20 PIN	£0.15	40 PIN	£0.27

## OUR NEW SUPER LOCATION IN IRELAND

**19 Herbert Street, Dublin 2.**  
**Telephone: Dublin 604165**

## HEAR OUR ADS ON RADIO NOVA 88.1 VHF Stereo

## NEC SPINWRITER

only **£1490** + VAT



NEC's high quality printer uses a print "thimble" that has less diameter and inertia than a daisy wheel, giving a quieter, faster, more reliable printer that can cope with plotting and printing (128 ASCII characters) with up to five copies, friction or tractor fed. The ribbon and thimble can be changed in seconds. 55 characters per second bidirectional printing — with red/black, bold, subscript, superscript, proportional spacing, tabbing, and much, much more.

8MHz Super Quality Modulators	£4.90
6MHz Standard Modulators	£2.90
C12 Computer Grade Cassettes	10 for £4.00
Anadex Printer Paper — 2000 sheets	£15.00
Floppy Discs 5 1/4" Hard and Soft Sector	£2.90
Floppy Disc Library Case 5 1/4"	£3.50
Ribbons	
DP8000	£3.50
DP9500/9501	£12.50

All Prices exclusive VAT

EXTENDED GUARANTEE BY COMPUKARE

## THE ANADEX DP9500 and DP9501 A PROFESSIONAL PRINTER



- Bi-directional printing
- Up to 220 chars/line with 4 print densities
- 500 char buffer
- RS232C and Centronics Parallel interface built in
- Full software control of matrix needles allowing graphics capability
- 200 chars/sec
- Adjustable width tractor feed.

DP9500 — ONLY **£795** + VAT

DP9501 — ONLY **£845** + VAT

## LUXOR COLOUR MONITOR FOR THE APPLE

**£295** + VAT

WE HAVE ONE OF THE LARGEST COLLECTIONS OF COMPUTER BOOKS UNDER ONE ROOF, ALONG WITH RACKS OF SOFTWARE FOR THE GENIE AND TRS80.

EXTENDED GUARANTEE BY COMPUKARE



## SHARP PC1211

**£79.90** + VAT

COMPUTER POWER THAT ONCE FILLED A ROOM CAN NOW BE CARRIED IN YOUR POCKET!  
• Programs in BASIC • "QWERTY" Alphabetic Keyboard • 1.9K Random Access Memory • Long Battery Life.

EXTENDED GUARANTEE BY COMPUKARE

We give a full one year's guarantee on all our products, which normally only carry 3 months guarantee.

A SELECTION OF APPLE INTERFACES ARE NOW AVAILABLE AT OUR EDGWARE ROAD SHOWROOM

Delivery is added at cost. Please make cheques and postal orders payable to **COMP SHOP LTD.**, or phone your order quoting **BARCLAYCARD, ACCESS, DINERS CLUB** or **AMERICAN EXPRESS** number.

### MAIL ORDER AND SHOP:

14 Station Road, New Barnet, Hertfordshire, EN5 1QW (Close to New Barnet BR Station — Moorgate Line).  
Telephone: 01-441 2922 (Sales) 01-449 6596 Telex: 298755 TELCOM G

**OPEN (BARNET) — 10am - 7pm — Monday to Saturday**

### NEW WEST END SHOWROOM

311 Edgware Road, London W2. Telephone: 01-262 0387  
**OPEN (LONDON) — 10am - 6pm — Monday to Saturday**

★ IRELAND: 19 Herbert Street, Dublin 2. Telephone: Dublin 604165

★ COMP SHOP USA, 1348 East Edinger, Santa Ana, California, Zip Code 92705.  
Telephone: 0101 714 5472526

CREDIT FACILITIES ARRANGED — send S.A.E. for application form.

### TELEPHONE SALES

**OPEN 24 hrs. 7 days a week**  
**01-449 6596**



"Europe's Largest Discount Personal Computer Stores"

# NEXT MONTH

In the March issue of E&MM, on sale from the second week of February:

## ★ KLAUS SCHULZE

This famous German synthesist and ex-member of Tangerine Dream started his career on guitar, later became a drummer and made his first album three weeks after changing to keyboards. Read our interview to find out more about his unique approach to music.

## ★ ROBERT SCHRÖDER

A friend and protégé of Klaus Schulze, Robert Schröder builds his own equipment and is much more than just a Schulze clone. Two interviews for the price of one!

## ★ INTERFERENCE SUPPRESSION

Does your mixer pick up the local CB enthusiasts? Does your audio equipment become radio equipment after dark? Our article shows you how to keep those radio waves where they belong.

## ★ REVIEWS

Not only musical instruments, but all equipment relevant to electronic music making is covered in E&MM's extensive review pages.



## ★ LOUDSPEAKER PROJECT

E&MM's 200W high power loudspeakers bring down the price and cabinet size of quality sound. Designed to be equally suitable for the home electro-musician in the studio or on a gig, they can be used for studio monitoring, PA, instrument amplification, disco and many other applications; build a pair for under £200.

## ★ DIGITAL DELAY LINE PROJECT

Full circuit and construction details conclude our description of this big value effects unit.

Plus Guide to Electronic Music Techniques, Advanced Music Synthesis, Electro-Music Engineer and all our regular features and workshop articles which make Electronics and Music Maker the top selling UK music monthly!

## EVENTS

Jan. 13th COMPUTER OPEN DAY EXHIBITION, Polygon Hotel, Southampton, Hants. Demonstrations of software, hardware, etc., with all main exhibitors. Commences 10.00 a.m.-5.00 p.m. For further details phone 01-653 1101.

Jan. 19th-22nd WHICH COMPUTER SHOW, National Exhibition Centre, Birmingham. If computers are what you know or want to know about this is the place to be. Exhibitors include Rank Xerox, Texas, Olympia. Also, the National Computing Centre will be there to give any advice needed. Commences 10.00 a.m.-5.00 p.m. (Friday 22nd 10.00 a.m.-4.00 p.m.). Cost £3.00

Jan. 27th COMPUTER OPEN DAY EXHIBITION, Queens Hotel, Cheltenham, Glos. Demonstrations of software, hardware, etc. Commences 10.00 a.m.-5.00 p.m. For further details phone 01-653 1101.

Feb. 13th-17th INT. TRADE FAIR FOR MUSICAL INSTRUMENTS, Frankfurt Exhibition Centre, Frankfurt, Germany. For all those wanting to obtain comprehensive information on everything involving musical instruments and sheet-music, a visit to the Music Fair Frankfurt is the obvious answer. The opportunity is now offered for amateurs to look around the Fair on the general public day (17th February). Times of opening - 9.00 a.m.-6.00 p.m. For further information telephone 01-734 0543.

March 14th-18th INTERNATIONAL MUSIC SHOW, Wembley Conference Centre, Wembley, London. This is the exhibition to be at in '82! Famous celebrities will be appearing, music and record companies, musical publications (yes, E&MM will be there!) national publications, recording studios, radio stations and many more. Something for everyone! Apart from Sunday, when the show opens from 10.30 a.m. to 11.00 p.m., the week day hours are 10.30 a.m. to 12.00 noon (trade only) and from 12.00 noon to 11.00 p.m. for the public. For more information contact IMS, 26 Kingsland Road, London E2 8DA or tel. 01-729 2666.

April 20th-22nd THE ALL ELECTRONICS/ECIF SHOW, The Barbican Exhibition Centre, London. This will be the largest and most comprehensive display of the electronics industry the capital has seen for many years. So far there are approximately 300 exhibitors to occupy the four halls of the Barbican Centre. Times of opening are 10.00 a.m. to 6.00 p.m. except Thursday when it will close at 5.00 p.m.

For more information contact: Miss Samantha Clarke, The All Electronics/ECIF Show, 34-36 High Street, Saffron Walden, Essex, CB10 1EP. Tel. (0799) 22612. Telex: 81653.

We shall be pleased to publish news of forthcoming electronic and electro-music exhibitions, clubs - also special electronic music concerts.

## BINDERS NOW AVAILABLE

Keep your copies of ELECTRONICS & MUSIC MAKER in this elegant silver binder (holds 12 copies) with our special E&MM logo in blue and red on the cover and spine.

Price £3.95

Please allow 28 days for delivery.

Overseas payments including Republic of Eire should be covered by Bankers draft in pounds sterling — subject to availability.

Send cheque/P.O. to:  
ELECTRONICS & MUSIC MAKER (Binders)  
282 London Road, Westcliff-on-Sea, Essex SSO 7JG.

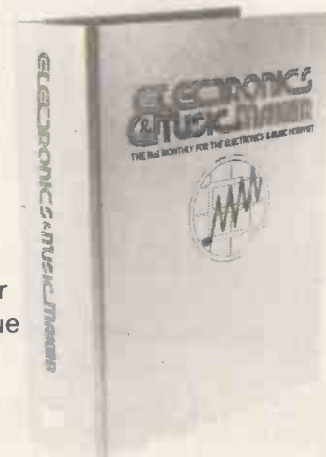



# CLASSIFIEDS

New rates for 1982: Lineage 34p per word (min. 12 words); Box No. 80p extra. Semi-Display: £1.00 extra. Display: £10.00 per single cm. column

All advertisements must be pre-paid. Closing date: 20th of month preceding publication.

Advertisements are accepted subject to the terms and conditions printed on the advertisement rate card (available on request).

Telephone: (0702) 338878/338015. "Classified", E&MM, 282 London Rd, Westcliff-on-Sea, Essex SS0 7JG.

## ACCESSORIES

### ADAM HALL SUPPLIES

Mail Order Services

For all your flight case fittings, coverings & frets.

Celestion speakers, Emilar Drivers & P&N Stands.

Send 30p Post Order/or cheque for illustrated catalogue to:—

### ADAM HALL SUPPLIES

Unit M, Carlton Court  
Grainger Road  
Southend-on-Sea

## BOOKS & CATALOGUES

PARAPHYSICS JOURNAL (Russian translations): Psychotronic Generators, Kirlianography, gravity lasers, telekinesis. Details: s.a.e. 4X9: Paralab, Downton, Wilts.

### HOME ORGANISTS

Teach yourself to play with  
**THE ORGAN MASTER**

by Brenda Hayward (Making Notes)

Two Music Books - Two Theory Books -  
Two Chord Charts in a Boxed Pack

£10 + £1 p&p.

Cheque/P.O./B'Card/Access accepted.

**ORGAN MASTER PUBLICATIONS**

Metfield - Harleston - Norfolk - IP20 0LH.  
Fressingfield (037986) 370

## FOR HIRE



### FOR HIRE AT BUDGET RATES

LEXICON 224 Digital reverb and Prime Time  
EVENTIDE HARMONIZERS ROLAND ECHOS  
DBX COMP/LIMITERS and ANALYSER/  
EQUALIZER

Plus a whole range of studio gadgets

Phone Andy or Louise 01-708 0483

or write for further details:

10 Steedman Street, London SE17 3AF

## FOR SALE

BRAND NEW Powertran Transcendent 2000 synths; built and tested: £300. Dudley 232685.

TRANSCENDENT 2000 assembled board £80; ECHO units graphic equalisers, guitar effects also PCB service. Write to: S. Dulay, 5 Llewellyn Road, Leamington Spa, CV31 2BJ.

OSCILLOSCOPE SE Labs dual trace DC-10MHz with manual, £100. 01-863 4848.

### PUT SOME ZAPP IN YOUR ZX81

Six 1K Games on cassette £2.75 inclusive, M. DUNN, The Pottery, Kingscross, Isle of Arran, Scotland KA27 6RG

### DRUZYC-TAYLOR SOLID STATE ANALOG DELAY/ECHO



with delay, repeat controls in/out foot-switch.

Incorporating 2x SAD 1024 analog delay lines providing delays of up to 300mS. Complete unit as shown including batteries.

**ONLY £55.00 + £1.00 p&p  
SPECIAL BARGAIN OFFER!**

P.C.B. of above unit, fully assembled, tested, complete with I/P O/P jack sockets and controls.

Supplied with operating instructions for an unbeatable £39.00 + £1.00 p&p.

DRUZYC-TAYLOR ELECTRONICS  
148 Coventry Rd, Warwick CU34 5HL  
Tel. (0926) 499300

## PERSONAL

### ATTRACT WOMEN!

A Revolutionary new product, Aeolus 7 will shortly be launched in Europe and the USA. The ultimate male cosmetic spray, its working ingredient Androstenone Pheromone (as recently demonstrated on BBC TV's Tomorrows World) is a powerful female attractant. Clinical tests, press reports and numerous trial users CONFIRM Success! Aeolus 7 is available now (5 months supply) at the special trial price of only £11.95 inclusive (Money Back Guarantee) from Comet Scientific, Dept E&MM, 23 South Bank, Long Ditton, Surrey.

(Or SAE leaflet/Press Reports.)

## RECORDING

### STUDIO HIRE

8 track studio including synthesisers, free tea and a handy musician engineer, £30 per 6-hour session. Ideal for composers, synth players, etc. For full details catch:

Dave on WATFORD 39347

### WEALD SOUND RECORDING LOCATION AND STUDIO RECORDING

**1 to 1 Cassette Production Sound  
Reinforcement**

Collier Street nr. Tonbridge TN12 9RP  
Telephone Collier St (089273) 461

### QU'APPELLE STUDIOS LIMITED

8 track sound recording, colour video recording with edit suite, titling facilities, variable acoustics. Session musicians by arrangement. Audio visual recording £100 per day including tape, audio recording by arrangement.

Tel. Newport, Gwent (0633) 412415

How many times have you thought about controlling your unit from tape?

**NOW YOU CAN!!**

### THE MF 100 SYNC UNIT

The MF 100 will sync rhythm units, sequencers, and most units that require a clock or stop/start control

Three Units available: £40-£250

MAC FISON ELECTRONIC ENGINEERS  
13 Northfalls Road, Canvey Island, Essex  
Telephone: (0268) 685748

## REPAIRS

### ROGER GIFFIN THE LEGEND LIVES ON

SIMPLY THE BEST FOR ALL  
REPAIRS AND CUSTOM BUILT  
GUITARS

Phone: (01) 948 5891

### Peter Cook Guitars

69 Station Rd, Hanwell W.7  
Tel. 01-840 1244

NOT ONLY the ultimate customising and repair service —

**BUT ALSO** a selection of the most playable instruments in the U.K.

OPEN WED TO FRI 12 noon-7 p.m.

SAT 11 a.m.-6 p.m.

BARCLAYCARD — ACCESS — HP — PX  
MAIL ORDER

## SERVICES

CASSETTE duplicating from 38p. 1-1 hi-speed. Simon Stable Promotions, 46 West End, Launton, Oxon OX6 0DG. Tel. 08692 2831.

LUCASSOUND STUDIOS for creative sound effects, transcribing, pulsetones, masters and copies at low negotiable rates. Requirements to: Mr Lucas, Coppi, Mont Cantel, St Helier, Jersey, Channel Islands.

### ZERO ZONE

Synthesiser Information Service, Workshops provided; 4-track mobile recording and mail order.

Phone 074 987 502 for full details or send large s.a.e. to:

THE CHAPEL HOUSE, Perch Hill, Westbury-Sub-Mendip, nr. Wells, Somerset.



MOBILE SOUND MAINTENANCE

- Performance modification rebuilds •
- Emergency 24 hour fault finding •
- New and second-hand equipment evaluation reports •
- Servicing •
- System checks •

Contact us for bookings now

Telephone: 01-948 1331 (24 hours)  
13A Jocelyn Road, Richmond, Surrey



For enquiries on classified space, information and rates, telephone Holly on (0702) 338015 now — don't miss the copy date!!

# DIGISOUND 80 MODULAR SYNTHESISER

A synthesiser for the professional and amateur keyboard player, for education and for the beginner. The DIGISOUND 80 suits all levels of keyboard skill. If you want to know how, then read on.



**BEGINNERS:** A small synthesiser may be assembled at a price comparable with pre-set types. The DIGISOUND 80 has unique facilities and you can learn about electronic music synthesis with the aid of our User's Manual. When you are ready to go beyond the 'mini-synth' stage then simply add more modules to suit your requirements and your purse.

**EDUCATION:** The modular concept is ideal for teaching both music and the physics of sounds. The microprocessor add-on converts it to a project of even wider application.

**KEYBOARD PLAYERS:** The use of the ALPHADAC 16 microprocessor controller allows up to 16 voices in the polyphonic mode as well as providing many other real time keyboard control routines. NEW recording/composing/sequencing programs provide you with the opportunity to create exciting music — imagine playing back a composition with each voice set to a different instrument!

**KEYBOARD SKILL:** The ALPHADAC programs have facilities for composing and recording in both real time and not real time. The latter allows entry of notes at any speed and subsequent playback at the required tempo. The not real time mode is essential to synthesists of limited skill and a boon to the experienced player.

## THE DIGISOUND 80 - IN ANY CONFIGURATION - OFFERS YOU THE BEST PRICE/PERFORMANCE CHARACTERISTICS

Kits supplied ex-stock and ready built modules, or complete synthesisers, are available to order.

NEW IC's from Curtis Electromusic Specialties; NEW modules; NEW users manual plus easy to follow construction notes.

Write or telephone for more information from the ELECTRONIC MUSIC SPECIALISTS:—



**DIGISOUND LIMITED,**  
Dept 2/82, 13 THE BROOKLANDS,  
WREA GREEN, PRESTON,  
LANCS PR4 2NQ. Tel: 0772 683138

# ELECTRO RECORD

Written at the end of 1981 some of the top men in record industry are predicting demise of the record business as it is known (Derek Green of A&M). Band wagon follows band wagon in the desperate efforts of the major companies to strike gold. The Megahype girl Hazel O'Connor's latest single at least utilises the rhythms of a Casio VL-Tone! A record company trying to reduce its overheads?

Vangelis has been putting the finishing touches to his latest opus in his London Nemo Studios. Florian Fricke of Popol Vuh has settled his differences in court with the owner of OHR records. As a consequence some vintage Popol Vuh material will become available again. There are rumours that an English company will re-release the legendary Aguirre. Celestial Harmonies have already released a re-mastered and "cleaned-up" edition of Tantric songs. Sei Stille has been re-recorded by Fricke for Werner Herzog's latest film epic.

Following on the popularity of the European release of Kitaro's Silk Road, Kuckuck are to lease Oasis and Kitaro Live from

Canyon Records in Japan.

Richard Elen of Studio Sound is apparently greatly impressed by the digital sampling facility of the Synclavier II. Francis Monkman (ex-Sky) is already a proud owner and seems very happy to advise anybody else with £20,000 to spend! Those currently enraptured by Synclavier include Pink Floyd. For the ordinary mortal electro musician the Fostex Multitrack brings eight tracks on to a quarter of an inch tape at £1,000+. Critical response seems unanimously enthusiastic. The Fostex puts the production of professional quality masters into the realms of possibility for many electro musicians seeking a wider audience for their work.

Edgar Froese's Macula Transfer and Aqua are available again on import. The Virgin license deal having now expired.

This month's featured shops with a healthy interest in Electro Music are all in Edinburgh. The capital of Scotland is widely recognised as having some of the best record shops in the U.K. Of particular interest to the readers of this journal are Virgin in Princes Street and Listen.

Matthew Gavin **E&MM**

## HAVE YOU RENEWED YOUR SUBSCRIPTION?

to ELECTRONICS & MUSIC MAKER —  
the No. 1 Monthly for the  
Electro-Musician

For 12 issues:

UK ..... £10.75  
Europe & overseas  
(surface) ... £11.65  
Airmail (inc. Eur.)... £25.95

Overseas payments including Republic of Eire should be covered by Bankers draft in pounds sterling.

Subscriptions normally commence from the current issue of E&MM. Back copies can be obtained from E&MM at £1.10 each inc. postage.

E&MM Subscriptions Dept., Maplin Publications  
282 London Road, Westcliff-on-Sea, Essex SS0 7JG

E&MM Subscriptions Dept., Maplin Publications, 282 London Road, Westcliff-on-Sea, Essex SS0 7JG.

Please send me the next 12 issues of Electronics & Music Maker. I enclose a cheque/postal order\* for £10.75/£11.65/£25.95\* made payable to Electronics & Music Maker.

\*DELETE AS APPROPRIATE

PLEASE PRINT

Name .....

Address .....

E&MM/2/82

# THE SHARP MZ-80K HAS GOT IT ALL

STOP PRESS... NOW AVAILABLE  
 BASIC COMPILER  
 PASCAL (CASSETTE BASED)  
 DOUBLE PRECISION DISC BASIC  
 FDOS INCLUDES EDITOR AND  
 Z-80 ASSEMBLER



Since its introduction the Sharp MZ-80K has proved to be one of the most successful and versatile microcomputer systems around.

Sharp now have a comprehensive range of products ready to make the powerful MZ-80K with its Printer and Disc Drives even more adaptable.

Products include: - Universal Interface Card, Machine Language and Z-80 Assembler packages, CP/M\* plus a comprehensive range of software.

You'll find all the help and advice you need about the MZ-80K at your Specialist Sharp Dealer in the list below

\*Trade mark of Digital Research Ltd.

If there is no dealer in your area, or if you require any further information write to: - Computer Division, Sharp Electronics (UK) Ltd., Sharp House, Thorp Road, Newton Heath, Manchester M10 9BE.

## SHARP

*First, and foremost*

**AVON**  
 BCG Computer Systems Ltd.,  
 Bristol. Tel: 0272 425338  
 Decimal Business M/Cs Ltd.,  
 Bristol. Tel: 0272 294591  
 Target Electronics,  
 Bristol. Tel: 0272 421196  
**BERKSHIRE**  
 Computer 100,  
 Bray. Tel: 0628 35619  
 Newbear Computing Store Ltd.,  
 Newbury. Tel: 0635 30505  
**BIRMINGHAM**  
 Camden Electronics,  
 Small Heath. Tel: 021 773 8240  
 Electronic Business Systems Ltd.,  
 Birmingham. Tel: 021 384 2513  
 Jax Rest Ltd.,  
 Birmingham. Tel: 021 350 4555  
 Newbear Computing Store Ltd.,  
 Birmingham B26  
 Tel: 021 707 7170  
**BUCKINGHAMSHIRE**  
 Curry's Microsystems,  
 High Wycombe. Tel: 0494 40262  
 Interface Components Ltd.,  
 Amersham. Tel: 02403 22307  
**CAMBRIDGE**  
 The Avery Computing Co Ltd.,  
 Bar Hill. Tel: 0954 80991  
**CHEESHIRE**  
 Bellard Electronics Ltd.,  
 Chester. Tel: 0244 380123  
 Charlesworth of Crewe Ltd.,  
 Crewe. Tel: 0270 56342  
 Chandos Products,  
 New Mills. Tel: New Mills 44344  
 CR Technical Services,  
 Chester. Tel: 0244 317549  
 Fletcher Worthington Ltd.,  
 Hale. Tel: 061 928 8928

Holdene Limited,  
 Wilmslow. Tel: 0625 529586  
 Newbear Computing Store Ltd.,  
 Stockport. Tel: 061 491 2290  
 Ors Group Ltd.,  
 Warrington. Tel: 0925 67411  
 Sumlock Software,  
 Warrington. Tel: 0925 574593  
**CLEVELAND**  
 Hunting Computer Services Ltd.,  
 Stockton-on-Tees. Tel: 0642 769709  
 Intex Datalog Ltd.,  
 Stockton-on-Tees. Tel: 0642 781193  
**DERBYSHIRE**  
 Malison Electronics Ltd.,  
 Derby. Tel: 0832 38066  
**DEVON**  
 Plymouth Computers,  
 Plymouth. Tel: 0752 23042  
**DURHAM**  
 Necos (DP) Ltd.,  
 Darlington. Tel: 0325 69540  
**ESSEX**  
 Prorole Ltd.,  
 Westcliff-on-Sea. Tel: 0702 335298  
 Wilding Office Equipment,  
 Ilford. Tel: 01 514 1525  
**GLOUCESTERSHIRE**  
 Gloucestershire Shop  
 Equipment Ltd.,  
 Gloucester. Tel: 0452 36012  
 The Computer Shack,  
 Cheltenham. Tel: 0242 584343  
**HAMPSHIRE**  
 Advanced Business Concepts,  
 New Milton. Tel: 0425 618181  
 Xitan Systems Ltd.,  
 Southampton. Tel: 0703 38740  
**HEREFORD**  
 Market Logic Ltd.,  
 Little Dewchurch. Tel: 0432 70279

**HUMBERSIDE**  
 Commercial Systems Ltd.,  
 Hull. Tel: 0482 20022  
 Silicon Chip Centre,  
 Grimsby. Tel: 0472 45353  
**KENT**  
 Technolink Europa Ltd.,  
 Tunbridge Wells. Tel: 0892 32116  
 Video Services (Bromley) Ltd.,  
 Bromley. Tel: 01 460 8833  
**LANCASHIRE**  
 Nelson Computer Services,  
 Rawtenstall. Tel: 0706 229125  
 Sumita Electronics Ltd.,  
 Preston. Tel: 0772 51686  
**LEICESTERSHIRE**  
 Gilbert Computers,  
 Lubenham. Tel: 0858 65894  
 G.W. Cowling Ltd.,  
 Leicester. Tel: 0533 553232  
 Leicester Computing Centre,  
 Leicester. Tel: 0533 556268  
 Mays Hi-Fi,  
 Leicester. Tel: 0533 22212  
**LINCOLNSHIRE**  
 Howes Elect & Autom. Servs.,  
 Lincoln. Tel: 0522 32379  
**Z.R. Business Consultants,**  
 Lincoln. Tel: 0522 31621  
**LONDON**  
 Bridgewater Accounting,  
 Whitehouse. Tel: 01 446 0520  
 Butel-Comco Ltd.,  
 Hendon. Tel: 01 202 0262  
 Central Calculators Ltd.,  
 London EC2. Tel: 01 729 5588  
 Deans,  
 London W8. Tel: 01 937 7896  
 Digital Design and Development,  
 London W1. Tel: 01 387 7388  
 Euro-Calc Ltd.,  
 London EC2. Tel: 01 729 4555

Henry's Radio Ltd.,  
 London W2. Tel: 01 402 6822  
 Lion Computing Shops Ltd.,  
 London W1. Tel: 01 637 1601  
 Scope Ltd.,  
 London EC2. Tel: 01 729 3035  
 Sumlock Bondain Ltd.,  
 London EC1. Tel: 01 253 2447  
**MANCHESTER**  
 The Byte Shop,  
 Manchester M1. Tel: 061 236 4737  
 Electrovalue,  
 Manchester. Tel: 061 432 4945  
 Sumlock Electronic Services Ltd.,  
 Manchester M3. Tel: 061 834 4233  
**MERSEYSIDE**  
 Microdigital Ltd.,  
 Liverpool. Tel: 051 227 2535  
**NORFOLK**  
 Sumlock Bondain (East Anglia)  
 Norwich. Tel: 0603 26259  
**NORTHAMPTONSHIRE**  
 Computer Supermarket,  
 Corby. Tel: 05366 62571  
**H.B. Computers,**  
 Kettering. Tel: 0536 520910  
**NORTHERN IRELAND**  
 Bromac (UK),  
 Co. Antrim. Tel: 023831 3394  
**O & M Systems,**  
 Belfast. Tel: 0232 49440  
**NOTTINGHAMSHIRE**  
 Almarc Business Systems Ltd.,  
 Nottingham. Tel: 0602 62251  
 Mansfield Business M/C Ltd.,  
 Mansfield. Tel: 0623 26610  
**OXFORDSHIRE**  
 Oxford Computer Centre,  
 Oxford. Tel: 0865 45172  
**REPUBLIC OF IRELAND**  
 O'Connor Computers Ltd.,  
 Galway. Tel: 0009 61173

Sharptext,  
 Dublin 2. Tel: 0001 764511  
 Tomorrows World Ltd.,  
 Dublin 2. Tel: 0001 776861  
**SCOTLAND**  
 A & G Knight,  
 Aberdeen. Tel: 0224 630526  
 Business and Electronics M/Cs,  
 Edinburgh. Tel: 031 226 5454,  
 Micro Centre,  
 Edinburgh. Tel: 031 556 7354  
 Micro Change,  
 Glasgow. Tel: 041 554 1462  
 Microforth,  
 Dunfermline. Tel: 0383 32071  
 Moray Instruments Ltd.,  
 Elgin. Tel: 0343 3747  
 Pointer Business Equipment Ltd.,  
 Glasgow. Tel: 041 332 3621  
**SOMERSET**  
 Noret Office Supplies Ltd.,  
 Cheddar. Tel: 0934 742184  
**SUFFOLK**  
 C.J.R. Microtek Co. Ltd.,  
 Ipswich. Tel: 0473 50152  
**SURREY**  
 3D Computers,  
 Surbiton. Tel: 01 337 4317  
 Croydon Micro,  
 Carshalton. Tel: 01 643 4290  
**WILTSHIRE**  
 Datalect,  
 Croydon. Tel: 01 680 3581  
 Datalect,  
 Woking. Tel: 04862 25995  
 Microlines Ltd.,  
 Kingston. Tel: 01 546 9944  
**R.M.B. Ltd.,**  
 Croydon. Tel: 01 684 1134  
 Saradan Electronic Services,  
 Wallington. Tel: 01 669 9483

**SUSSEX**  
 Crown Business Centre,  
 Eastbourne. Tel: 0323 639983  
 Garner,  
 Brighton. Tel: 0273 698424  
 M & H Office Equipment  
 Brighton. Tel: 0273 697231  
**WALES**  
 Limrose Electronics Ltd.,  
 Wrexham. Tel: 097 883 5555  
 Morriston Computer Centre,  
 Swansea. Tel: 0792 795817  
 Sigma Systems Ltd.,  
 Cardiff. Tel: 0222 21515  
 Welsh Computer Centre,  
 Bridgend. Tel: 0656 58481  
**WARWICKSHIRE**  
 Business & Leisure  
 Microcomputers,  
 Kenilworth. Tel: 0926 512127  
**WILTSHIRE**  
 Everyman Computers,  
 Westbury. Tel: 0373 823764  
**YORKSHIRE**  
 Bits & P.C's  
 Wetherby. Tel: 0937 63744  
 Datron Micro-Centre Ltd.,  
 Sheffield. Tel: 0742 585490  
 Huddersfield Computer Centre,  
 Huddersfield. Tel: 0484 20774  
**Leeds Computer Centre,**  
 Leeds. Tel: 0532 458877  
 Omega Systems Ltd.,  
 Leeds. Tel: 0532 704499  
 Ram Computer Services Ltd.,  
 Bradford. Tel: 0274 391166  
 Superior Systems Ltd.,  
 Sheffield. Tel: 0742 755005

Also at selected Lasky and Wildings Office Equipment Branches.

# The creative answer

# EXPANDABILITY

When you buy your first synth, make sure you can create and expand. Roland consider this essential to all design concepts – the ability to interface



**FREE**  
set of Roland  
Stereo Headphones  
with every purchase  
of CSQ 100!

## SH09 – Budget price synth with expandability

Safeguard your investment – compare our features and value for money:

- No modifications necessary – C.V. gate in/out. CSQ 100 sequencer (as shown), 168 step 2 channel, CSQ 600, 600 step 4 channel, DR55 Doctor Rhythm, TR808 Rhythm Composer, CR78 Compurhythm.
- External Input-Guitar or Bass ● Unique delayed modulator ● Sample and hold
- Centre return bender for filter or pitch
- 1 or 2 octave sub oscillator ● Hold – override settings for repetitive percussion effects ● White noise generator ● Envelope inversion
- Variable pulse width combined with sub oscillator ● Full ADSR
- **Interfaceable with 100M system, another SH09, SH2, SH1, SH7, Promars**

Contact your specialist  
Roland dealer today.

 **Roland**

**Roland (UK) Limited**  
Great West Trading Estate,  
983 Great West Road,  
Brentford, Middx., TW8 9DN.

Telephone: 01-568 4578