

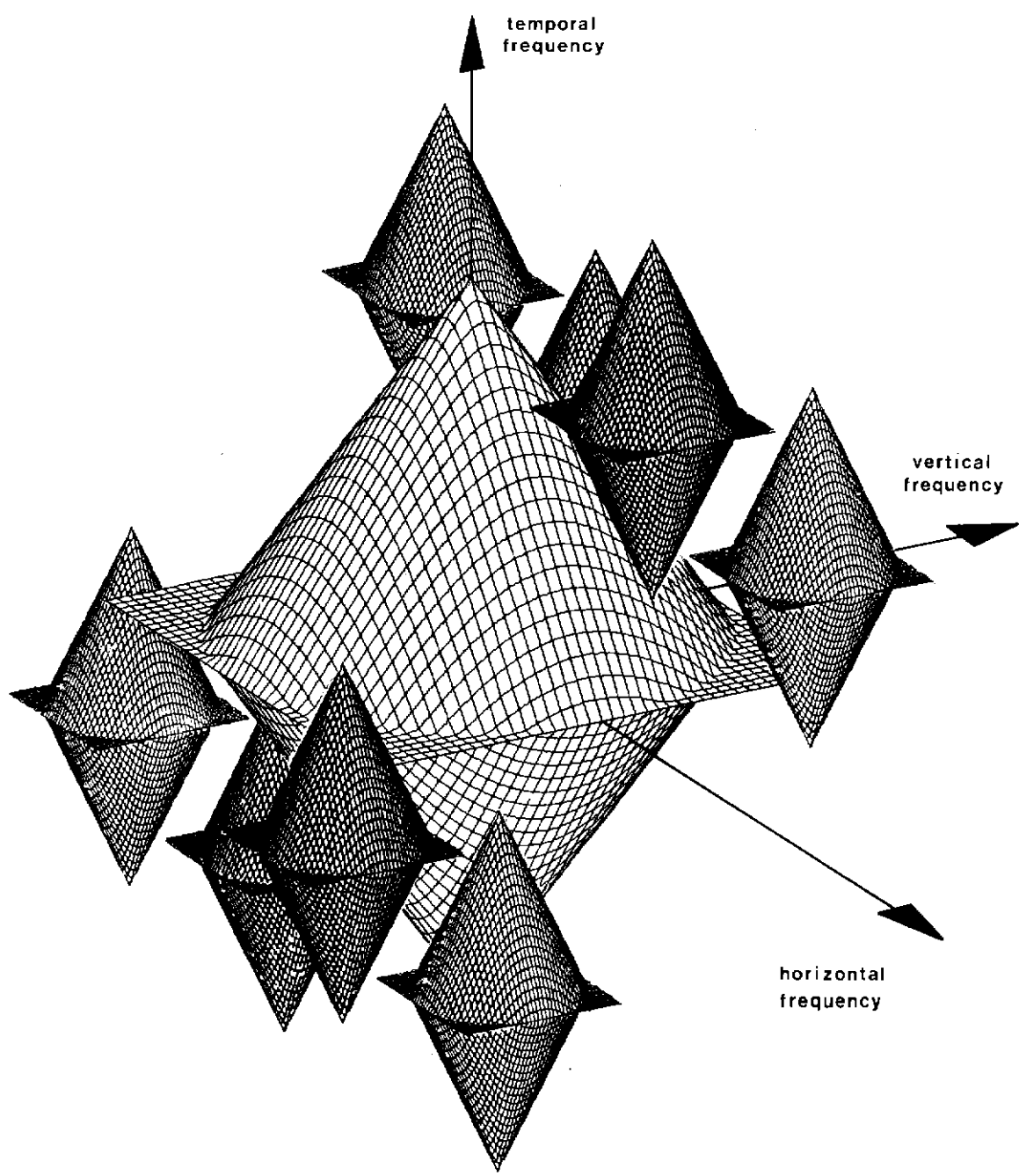
7 R 89/2215

# BBC ENGINEERING

✓  
5.

Number 104

September 1976



# BBC Engineering

including Engineering Division Monographs

A record of BBC technical experience and developments  
in radio and television broadcasting

---

Published approximately four times per year by  
BBC Publications,  
35 Marylebone High Street,  
London W1M 4AA  
ISSN 0308—2369  
ISBN 0 563 17253 3

Edited by  
BBC Engineering Information Department,  
Broadcasting House,  
London W1A 1AA

Printed by  
The Yale Press Ltd,  
London SE25 5LY.

Price  
See note on page 3

Articles are copyright © 1976 by the  
British Broadcasting Corporation  
and may not be reproduced in whole  
or part without written permission.

## Contents

Editorial	2
<b>Principal articles</b>	
New Radio Outside Broadcasts Control Vehicle J. Ford and R. C. Harrison	4
The Filtering of Luminance and Chrominance Signals to Avoid Cross-colour in a PAL Colour System J. O. Drewery	8
<b>Short item</b>	
BBC/Post Office digital satellite-transmission	40
Contributors to this issue	42

The cover illustration is a perspective  
view of the ideal PAL signal spectrum  
as derived in J. O. Drewery's article.

## Editorial

---

In 1934, in a classic paper, Mertz and Gray set out the relationships between the spectral components of a video signal and the spatial frequencies of the information in the corresponding picture. A classic paper is usually one which many have heard of but few have read, but one of the basic findings of this particular paper soon became familiar to television engineers: the bulk of the power in a video signal is concentrated close to the harmonics of the line scanning frequency.

The plausibility of this result could readily be confirmed by considering a video waveform in which every line was the same and invoking Fourier's aid to show that the spectrum could only contain harmonics of the line frequency. Further support was available from anyone who had ever tuned a narrow-band communications receiver which had a video signal connected to its aerial input — the response at each multiple of the line rate was plain for all to see. Although it was somewhat less obvious, it wasn't difficult to accept that the effect of a more useful signal with field synchronisation and with lines which differed from each other would be to add side frequencies to each line harmonic, spaced at intervals of picture frequency. In spite of these extra components, the receiver still demonstrates clearly that there is very much less power midway between the line harmonics than there is in their immediate vicinity.

Movement in the picture, of course, removed the convenient anchor of the repetitive waveform and the normal view was simply that movement 'smudged' the spectral lines — an unfortunate term fostering the misconception that the lines are spread to a degree small compared with the spacing between them.

It was, in fact, all too easy to think of the spectrum of a video signal as a collection of narrow peaks separated by relatively large gaps containing little or no power. Anyone who fell into this trap found it almost impossible to resist the obvious inference that additional signals could be accommodated there without difficulty and without performance penalty. It is unlikely that any of the serious workers in the field were victims of this fallacy, but attempts were certainly made to use these 'gaps' for sundry purposes, including the overlapping of two different television signals.

The NTSC colour specification embodied the first successful application of the principle: the previously-wasted space was used for the chrominance information. The cross-talk which the simple theory allows us to overlook did, of

course, appear but was much less troublesome than cross-talk between separate programmes, partly because of the correlation between the luminance and chrominance. Cross-colour was the term coined to describe the effects of luminance information in the chrominance channel. The associated cross-luminance effect was only avoided by fitting the luminance channel of colour receivers with a notch filter. In many receivers the notch was (and is) sufficiently broad to bring about what is virtually a simple band limiting of the luminance signal to below the chrominance channel. Some of the more sceptical engineers came to regard the claims that the luminance and chrominance shared the same band as at least greatly exaggerated: they were inclined to advocate low-pass filtering of the luminance channel at the studio in order to avoid cross-colour altogether at what they saw as a nominal price in available resolution.

When the PAL system was introduced it halved the frequency spacing between the chrominance and luminance signal components and consequently made more severe the problem of separation by any more elegant method than low-pass filtering of the luminance. It is hardly surprising, therefore, that the generally accepted view was that cross-colour should be avoided as far as possible by encouraging the production staff to choose appropriate designs of set and wardrobe.

It is clear that a receiver cannot possibly keep all luminance components out of its chrominance channel as long as the luminance signal is unprocessed at the studio, i.e. as long as it is allowed to include components at all frequencies. Processing to keep the signals spectrally separate could involve filters using line-period delays to remove components midway between the principal bands at multiples of line frequency: this entails the penalty of reduced vertical definition. More elaborate filters could use field-period delays to remove much of the 'spread' of the picture-frequency-spaced components: in this case the penalty is in the dynamic resolution — the reproduction of moving images.

Until recently, a quantitative treatment of this question has been sadly lacking, but in this issue we publish an article by Drewery which provides just such an approach. Using information published by others about the eye's tolerance of the different limitations, he deduces likely relationships between the needs for the different types of resolution. On this basis he develops an ideal three-dimensional spectrum for a PAL colour signal. He concludes that appropriate filters to

produce such a spectrum would yield a result free of cross-colour and with better effective resolution than is currently obtained: resolution of one type which is better than the eye requires can, in fact, be exchanged for resolution of another type which the eye currently misses. The full benefits would not be achieved without appropriate filtering in the domestic receiver, but appreciable advantages would be available from studio-end processing alone. It is possible, however, that the modest price of the PAL delay line used in modern colour receivers might lead to the use of the line-period delay type of filter in receivers.

**BBC Engineering: increase of price**

This issue, like all its predecessors, costs 40p or \$1, post free. More than six and a half years have elapsed since BBC Engineering was born, and during that time publication and postage costs have risen even faster than most others. As a result, we are no longer able to hold the price at the original figure and so, starting with issue 105, this publication will cost 80p or \$2, post free. The annual subscription rate now becomes £3 or \$8 for four issues.

*We regret the need for this step but hope that our readers will still regard BBC Engineering as good value for money.*

# New Radio Outside Broadcasts Control Vehicle

J. Ford

Operations Manager, Radio Outside Broadcasts

R. C. Harrison

Radio Broadcasting Operations

**Summary:** A comprehensively-equipped sound control and recording vehicle designed and fitted by the BBC has recently gone into service with the Radio Outside Broadcasts Department in London (Radio OBs). It has been developed to cover live and recorded broadcasts in stereo and for general outside broadcast work. This article provides a description of the type of mobile installation which the modern outside broadcasts engineer requires to achieve stereo balance for the varied types of programme common today.

- 1 Introduction
- 2 Design requirements
3. Vehicle specification
- 4 Operational facilities
  - 4.1 Mixing console
  - 4.2 Visual monitoring
  - 4.3 Recording equipment
  - 4.4 Terminations
- 5 Conclusions

## 1 Introduction

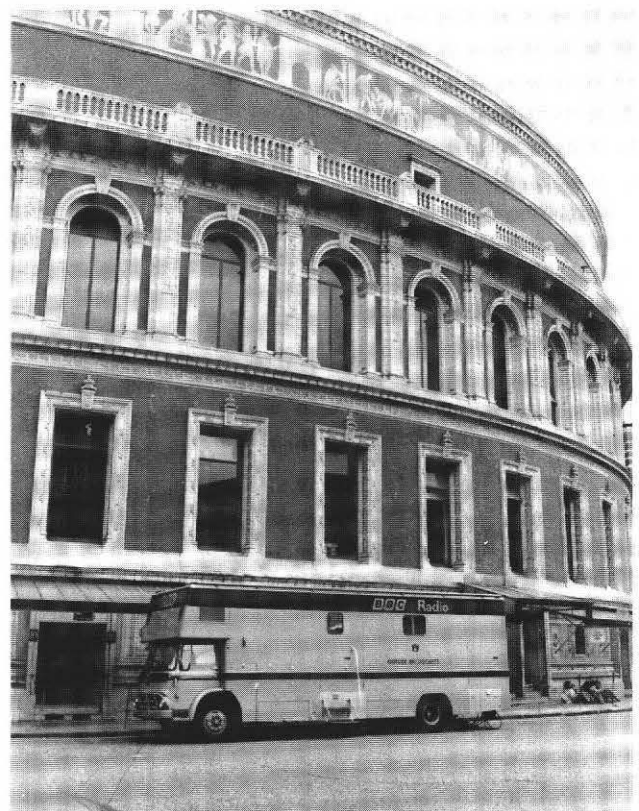
Over the past few years, radio programmes, whether based on live transmissions or on recordings, have grown considerably in complexity. This prompted a complete reassessment of the technical and operational requirements of the wide range of programmes classified as Radio OBs. One clear conclusion emerged from this study: that if the high artistic and technical standards of studio-originated material, particularly in the fields of light and pop music, were to be matched by outside broadcasts, modern studio working conditions would have to be provided. In effect, if the programme could not come to the studio, the studio would have to come to the programme. To achieve this, even partially, before the advent of the vehicle described here, has meant increases in rigging and de-rigging times and unacceptable wear and tear on the equipment itself.

BBC and commercial experience indicated that the only effective way of meeting these requirements without increase in staff effort, and of satisfying technical and financial considerations, was to provide a control and recording vehicle permanently fitted with technical equipment capable of matching the facilities of the best-equipped music studios. Designated SCV-1 (Stereo Control Vehicle 1), the new unit has already been used for many London and Regional commitments, ranging from Promenade Concerts and stereo light music specials to mono church services. It is to be expected that the versatility and operational convenience of the vehicle will keep it almost continuously in use.

## 2 Design requirements

During 1973 a design study was undertaken to produce a specification for a suitable vehicle.

Lengthy consultations were held with experienced Radio OB and Regional Audio Unit staff, Programmes Operations Studio Managers, BBC Transcription Recording Unit engineers (who already had wide experience of stereo and



**Fig. 1** The new vehicle at the Royal Albert Hall, London, for the broadcasts of the BBC Promenade Concerts, 1976

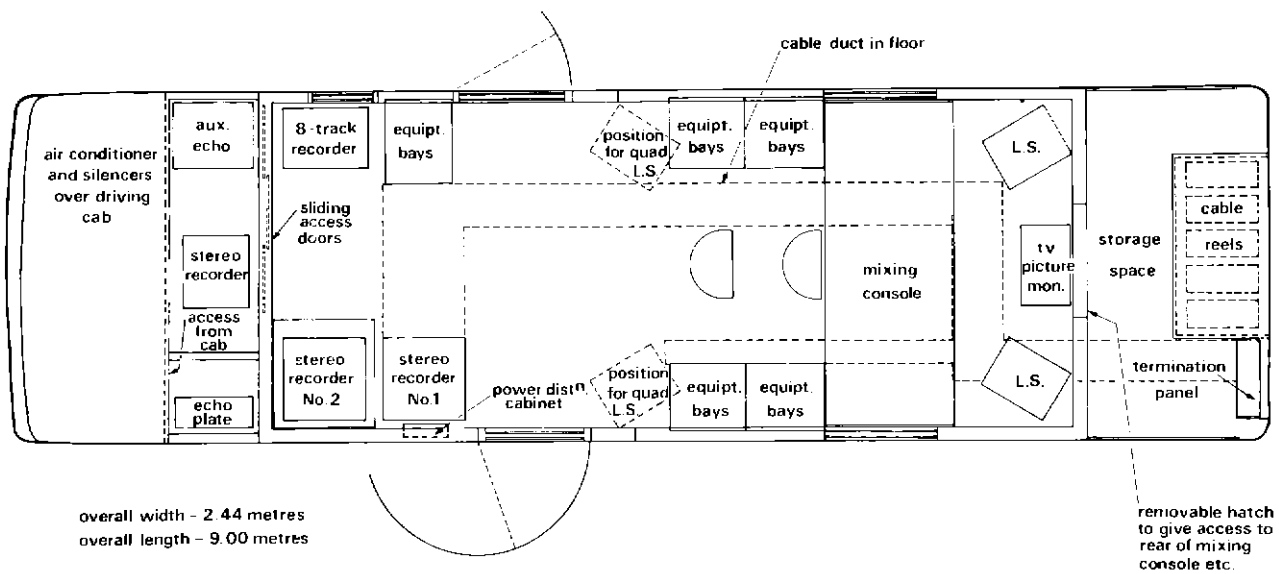


Fig. 2 Plan view of vehicle layout

multi-track recording in semi-fitted acoustically-treated vehicles), and the design and recording engineers associated with several very successful British-based commercial recording vehicles.

The result was the following broad specification:

- (i) The mobile studio should be self-propelled.
- (ii) An acoustically-treated working area of at least 10 square metres should be provided. This area should have a high level of sound isolation from external sources, be capable of comfortably accommodating up to five people for long periods in all weather conditions, and should be readily accessible (even in congested parking conditions) without interruption to operational activities.
- (iii) All technical equipment should travel in an operational condition and be ready for use as soon as the vehicle is parked and powered. To this end, storage of ancillary equipment such as microphones, stands, booms, screens, cables and recording tape must be separate from the main working space.
- (iv) Sufficient storage capacity should be provided to allow the vehicle to carry all the ancillary equipment required for the largest programme commitments and, in addition, sufficient recording tape to record 'on tour' during long periods away from base.

### 3 Vehicle specification

SCV-1 has been designed around a Luton-type body fitted to an 11-ton Bedford chassis which is driven by a six-cylinder diesel engine. In its completed form, the overall dimensions of the unit are: length, 9 metres; width, 2.44 metres. This provides a working area 5.38 metres long and 2.18 metres wide. A requirement for a separate storage compartment necessitated the extension of the chassis to provide a wheel-base of 5.3 metres. Access has been provided to walkways on the roof for rigging purposes. The cab and storage areas have been fitted with audio tie-lines, cue-light circuits, and power points, so that they can be used as announcers'

positions, or to house ancillary equipment such as artificial reverberation devices.

In developing the detailed specification for SCV-1, the valuable experience gained in the building of a new television OB vehicle was drawn upon. Great care was paid to insulation and ventilation and a smooth, broad-band reverberation time of 0.3 seconds and a sound insulation of 30dB have been achieved.

A very effective low-noise air-conditioning system is incorporated, with the ventilation plant resiliently mounted above the cab. Treated air flows to and from the working space through ducts between the inner and outer skins of the roof. In order to achieve a low-velocity air flow for quiet operation, the ducts have large cross-sectional areas, and extend across the full width of the vehicle.

The successful three-skin, high-sound-insulation body construction used in the television mobile control vehicle was also adopted. For maximum sound absorption, the outer cavity is filled with glass fibre. The intermediate skin is of jute-based sound barrier mat having a mass of 7.5 kilograms in each square metre, and the inner skin is of fire-retardant absorbent foam retained by perforated steel plate which forms the inside wall of the vehicle and is covered with an acoustically-porous decorative woven plastic material. All the doors and access panels are constructed in the same way as the main body and sound insulation is completed by double-glazed windows.

### 4 Operational facilities

A plan view of the layout of the vehicle is in figure 2. The working area has been arranged to allow the complete physical and technical separation of the sound-mixing, recording, and engineering activities. It ensures the correct ergonomic setting and proper working environment for broadcasting and recording, and enables sound balance tests and essential engineering line-up operations to be completed simultaneously and without interruption.



Fig. 3 General view of mixing console and monitoring equipment

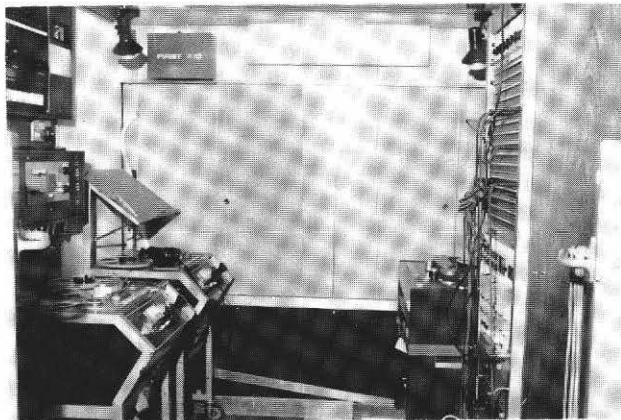


Fig. 4 View of recording area showing two stereo recording machines (left), eight-track recording machine (right-back-ground) and main engineering equipment bay in right foreground. Doors to storage cupboard at rear.

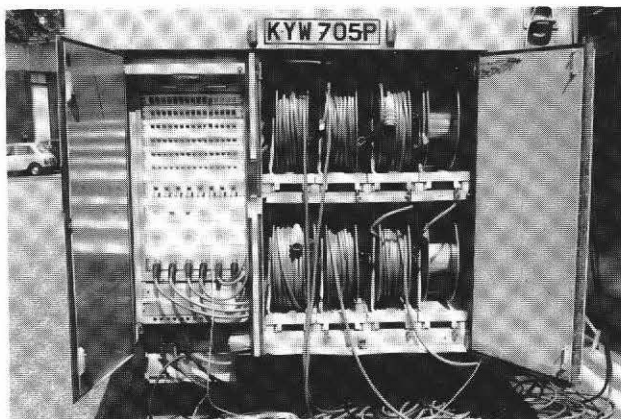


Fig. 5 Termination panel and cable locker at rear of vehicle

#### 4.1 Mixing console

The sound mixing console, figure 3, stretches the whole width of the vehicle and its equipment is based on the Calrec Mark II outside broadcasts mixer which was specifically designed for the BBC. The normal in-line configuration is used, with thirty-two input channels, four stereo groups and an eight-track monitor/mixer which is coupled to an input/output monitor. The modular construction of the units allows for quick extension to forty channels and speedy re-arrangement to suit the working requirements of individual operators. Provision has also been made for the installation of a closed-circuit television (CCTV) system which is sometimes required for complicated productions such as a full-scale opera.

The mixing equipment provides all the facilities normally associated with the most advanced music studio for direct stereo broadcasting, as well as fully-buffered channel and group outputs for multi-track feeding, two-track recording outputs and monitoring inputs, cue-light facilities and comprehensive line-sending amplifier arrangements. For stereo purposes the mixing operator uses two BBC LS3/1 monitor loudspeakers situated above and behind the desk at the full width of the vehicle to obtain the maximum stereo effect within the limitations of the confined space.

All the main programme feeds into and out of the mixing equipment, and the main termination panel are readily accessible on the console's jackfield. This arrangement allows the mixing operator to effect rapid changes in routing and recording feeds, and to insert programme processing equipment into any of the mixing console channel, group, or main output circuits.

#### 4.2 Visual monitoring

In addition to the visual monitoring normally used for stereo by the BBC, which consists of two twin-needle peak programme metres, (PPMs), one displaying A/B (left/right) and the other M/S (sum/difference) signals, a unique multi-track monitoring system has been developed. It consists of eight columns of four indicator lamps (red, amber, green and white), arranged in a compact, clearly-labelled display. Each column is associated with one multi-track machine recording/replay channel.

The uppermost lamp is red, and indicates conditions of modulation likely to lead to distortion, i.e. equivalent to a reading of  $6\frac{1}{2}$  on the PPM or +10dB. The second lamp in each column is amber, indicating correct modulation of the recording track, i.e. equivalent to 1 — 6 on the PPM or -14 to +8dB. The third lamp, green, indicates that the recording feed level is likely to produce undermodulated (noisy) tracks, i.e. corresponding to a PPM indication below 1 (-14 to -16dB). The bottom lamp in each column, white, indicates that the channel is ready to record; when it is off the channel is in the synchronous play-back state.

The switch-off characteristic of each indicator lamp is weighted to avoid distracting flickers. Under normal conditions, both amber and green lamps will remain on. Instant warning of adverse recording conditions is provided by a red-only or green-only indication. This system has proved to

be more satisfactory in operation than meters alone, or other forms of light-column indicators. It has already been used successfully for the production of well-controlled multi-track recordings.

#### 4.3 Recording equipment

The recording equipment, which is arranged close to the engineering position, figure 4, comprises an eight-track master recorder with full facilities for synchronous playback from the recording head and three two-track recorders. These machines feature servo-controlled capstans, and may therefore be powered by a.c. sources having unstable frequency characteristics, such as emergency generators.

A comprehensive monitoring panel allows the tape operator to line up and monitor the recording machines independently of the engineering and sound mixing monitoring.

Aural monitoring for the tape and engineering operators is carried out exclusively using studio-quality headphones fitted with highly effective noise-excluding ear muffs. Two stereo headphone drive amplification systems have been installed, with separate source-selection switches and a programme override control which allows the sound console operator or the producer to communicate quickly with the operators wearing headphones.

A stand-by two-track recorder and two additional echo/reverberation systems are stored in a cupboard adjacent to the engineering bay. This cupboard also provides generous storage space for tape stock, line-up tapes and portable test equipment. The engineering bay has an electronic six-line engineering manual telephone exchange, a multi-input test set providing stereo/mono PPM and aural monitoring, and facilities for recording machine line-up and music/cue-line testing. Also included is a Dolby M16 noise reduction system equipped for eight-channel multi-track working; variable-gain buffer amplifiers for multi-track programme feeds; an r.f. distribution panel for re-routing CCTV feeds to the main monitor outlets in the storage com-

partment and cab, and to external distribution outlets on the main input panel; and a comprehensive jackfield providing access to all recording/replay feeds and incoming/outgoing lines and tie lines.

#### 4.4 Terminations

The terminations of the external programme feeds and the a.c. mains supply are housed in a large cupboard at the tail of the vehicle, figure 5, adjacent to the mains extension cable drums and the multi-way cable drums. The latter, mounted on pull-out platforms, can contain up to six 50-metre 'star quad' multi-way microphone cables providing forty-two circuits connected to the main termination panel via quick-release multi-way plugs and sockets. The cables may be extended to any required length of run by the use of small junction boxes.

In addition to the multi-way cable inlets, up to 40 separate lines may be connected to the termination panel via XLR inlets, and up to 40 XLR outlets are also provided to distribute programme feeds from the vehicle to service other 'on site' requirements. The r.f. inlet/outlet and line connection facilities, 15-amp power inlets and safety-interlocked standby generator inlets are also brought to the termination panel.

All the cables to and from the termination panel are routed beneath a flexible flap at the base of the tail cupboard doors, thus allowing the doors to be locked shut after rigging, for full security.

### 5 Conclusions

Experience so far has shown that the vehicle meets its planned requirements. It has been important that the equipment is based on normal OB equipment which is adaptable and can easily be augmented. This flexibility has allowed changes in the facilities to take account of new developments to be made with relative ease and without major modification.



# The Filtering of Luminance and Chrominance Signals to Avoid Cross-colour in a PAL Colour System

J. O. Drewery, MA, Ph.D.,

Research Department

---

**Summary:** The origins of cross-colour within the PAL system are examined with the aid of one-, two-, and three-dimensional models. Analysis shows where the luminance and chrominance energy is concentrated assuming normal scene content. Filters are then developed, which restrict the luminance and chrominance energies to distinctly separate regions, so minimising cross-colour. These filters range from the simplest to the most complex forms and the degradations so introduced are discussed. Elimination of cross-colour is only obtained at the expense of losing spatial or temporal resolution. The conclusion is reached that with the most complex forms of processing a resolution considerably better than that obtaining at present can be achieved with no cross-colour.

- 1 Introduction
- 2 Basic conditions for separability
- 3 The one-dimensional approach
  - 3.1 The spectrum of unprocessed PAL
  - 3.2 Filters based on line delays
    - 3.2.1 Matched filtering
    - 3.2.2 Filtering at only one end of the system
  - 3.3 Filters based on field delays
- 4 The two-dimensional approach
  - 4.1 The two-dimensional spectrum
  - 4.2 The two-dimensional spectrum of the PAL signal
  - 4.3 Filters based on line delays
    - 4.3.1 Introduction
    - 4.3.2 Variables-separable filters
    - 4.3.3 Isotropic filters
    - 4.3.4 Summary
- 5 The three-dimensional approach
  - 5.1 Introduction
  - 5.2 The three-dimensional spectrum
  - 5.3 The interpretation of movement in the space
  - 5.4 The three-dimensional spectrum of the PAL signal
  - 5.5 Intra-field filters
  - 5.6 A model for the idealised PAL signal
  - 5.7 Possible spatio-temporal filters
  - 5.8 Filtering at only one end of the system
  - 5.9 Summary
- 6 A simplification for the matched system
- 7 Conclusions
- 8 References

## 1 Introduction

The PAL colour system, in common with the NTSC and SECAM systems, compresses luminance and chrominance information into the bandwidth occupied, in a monochrome

system, by the luminance alone. It is therefore inevitable that unless the luminance and chrominance are spectrally shaped before being combined it will be very difficult to separate them without incurring mutual interference. There is thus a choice between cross-colour and loss of spatial or temporal resolution. It is the purpose of this study to examine this choice in more detail and to suggest a possible improvement on the present system.

## 2 Basic conditions for separability

The present method of transmitting luminance and chrominance using system I is shown in figure 1. The corresponding spectra are shown in figure 2. The specification<sup>1</sup> of chrominance bandwidth is fairly lax in that the  $-3\text{dB}$  point must be higher than  $1.3\text{MHz}$  but the  $-20\text{dB}$  point can be as high as  $4\text{MHz}$ . In practice the chrominance is low-pass filtered before modulating the subcarrier at the coder to produce the typical spectrum of figure 2. Because the luminance is usually unfiltered, chrominance and luminance share the same spectral space in the region around subcarrier frequency.

At the decoder, the chrominance path contains a bandpass filter centred on subcarrier frequency. A typical filter has a fairly gentle cut with a bandwidth of  $\pm 1.6\text{MHz}$  at  $-6\text{dB}$ . Thus the chrominance path also accepts the luminance in this region, which gives rise to cross-colour. The luminance path contains a notch filter centred on subcarrier frequency of typical width  $\pm 500\text{kHz}$ . Thus although the subcarrier frequency and some of its sidebands are rejected, the remaining chrominance sidebands are accepted by the luminance circuit and cause cross-luminance. This appears as moving dots on coloured edges.

Assuming that both luminance and chrominance must, between them, occupy the  $5.5\text{MHz}$  band, a way of eliminating these cross-signals is to confine the luminance and chrominance to distinctly separate bands within the total range. They can then be separated at the decoder. Such

a matched coding and decoding system is shown in figure 3.  $F$  is any filter with an ideal spectral characteristic assuming values of zero or infinite attenuation. In the coder the addition of negative luminance to chrominance in all regions where chrominance is passed by the filter gives complementary luminance and chrominance spectra and ensures perfect separation. At the decoder the matched filter passes only the chrominance so that the residue must be pure luminance.

An advantage of the matched, complementary system of figure 3 is that only one filter characterises the system. A disadvantage is that with practical filters there will be a spectral region or regions where the voltage response is a half, giving rise to cross-over points where the luminance and chrominance are attenuated equally by 6dB. After separation at the decoder this means that at these points the cross-signal levels will rise to a minimum attenuation of 12dB.\* The more perfect the filter, the smaller these regions become.

The spectral characteristic of  $F$  may be as simple or as complex as required. For example,  $F$  may be a simple band-pass filter extending from, say, 3.3MHz to 5.5MHz. In this case no luminance whatever above 3.3MHz would be transmitted. Although this would solve the problem of cross-colour, it would be a solution negating the bandsharing philosophy of colour transmission systems. It is the purpose of this study to investigate more complex forms of  $F$ .

It is also of importance to discover the effect of using a filter at only one end of the system. For example, if the filter were costly it might be uneconomic to install it at the decoder. Again, economic considerations for the broadcasting system signal distribution would be different from those for the link from transmitter to domestic receiver.

To discover forms of  $F$  that are likely to be more useful than a simple bandpass filter it is necessary to investigate the spectral structure of the existing, i.e. unfiltered, PAL signal. However, as the form of  $F$  becomes more complex it is increasingly difficult to understand its effect by considering the purely one-dimensional spectrum of the signal. It is for this reason that the concepts of two- and three-dimensional spectra will be introduced. These will give a much clearer picture of what the more complex forms of  $F$  do. The following sections are therefore grouped under the headings of one-, two-, and three-dimensional approaches.

### 3 The one-dimensional approach

#### 3.1 The spectrum of unprocessed PAL

The theory of Mertz and Gray<sup>2</sup> predicts that a spatial frequency having  $m$  cycles/picture width (c/pw) and  $n$

\* If the amplitude characteristic of the filter is  $F(\omega)$ , then that of the overall system for the chrominance is  $F^2(\omega)$  and for the luminance  $[1 - F(\omega)]^2$ . At the decoder the characteristic of the luminance which enters the chrominance path is  $1 - F(\omega)$  and that of the chrominance which enters the luminance path is  $F(\omega)$ . So the cross-colour characteristic is  $[1 - F(\omega)] F(\omega)$  and the cross-luminance characteristic is  $F(\omega) [1 - F(\omega)]$ . Thus the cross-signal characteristics are identical and have a maximum value of  $\frac{1}{4}$  or -12dB.

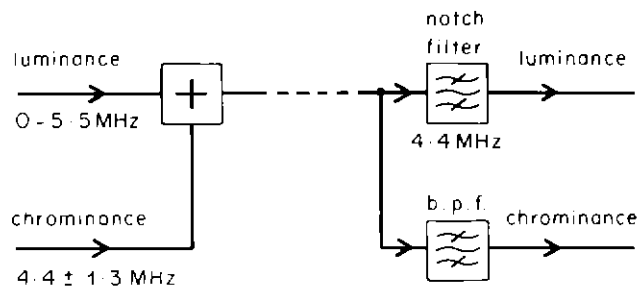


Fig. 1 Present method of transmitting luminance and chrominance in system I

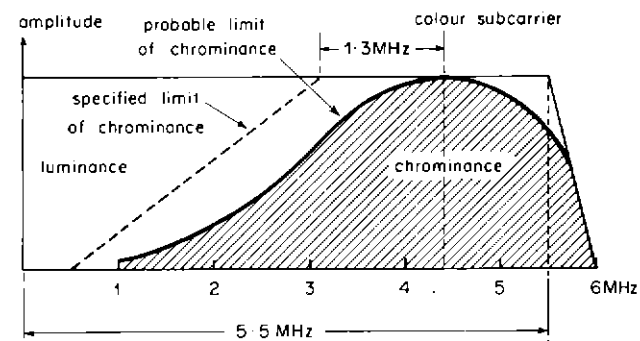


Fig. 2 The spectra of luminance and chrominance transmitted in system I

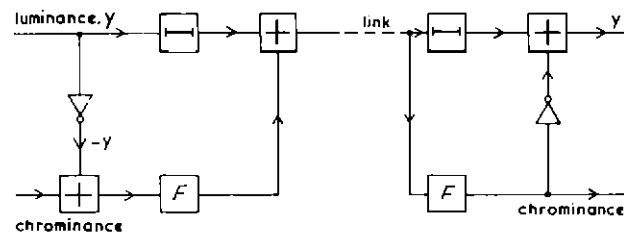


Fig. 3 Matched complementary coding and decoding to eliminate cross-colour

cycles/picture height (c/ph),  $(m, n)$ , corresponds to a signal frequency of  $\nu$ Hz where  $\nu$  is given by

$$\nu = mf_H \pm nf_V \tag{1}$$

(The picture width and height include blanking, which is considered as a black border forming part of the picture.) For a horizontal scanning system  $f_H$  is the line frequency,  $f_L$ , and for a sequential system  $f_V$  is the picture frequency. Then  $f_L = Nf_V$  where the picture is scanned in  $N$  lines. For an interlaced system  $f_V$  is the field frequency and  $f_H = Nf_V/2$  where, as before, a picture contains  $N$  lines. Thus equation (1) becomes

$$\nu = f_L (m - n/N) \tag{2a}$$

for a sequential system and

$$\nu = f_L (m - 2n/N) \tag{2b}$$

for an interlaced system. (The ambiguity of sign has been dropped in favour of a convention relating to the directions of the spatial frequencies and the scanning. For still pictures,  $m$  and  $n$  must be integral.)

The amplitude of the component at frequency  $\nu$  is proportional to the amplitude of the spatial frequency ( $m, n$ ) which it represents. Now statistically the average picture content is such that most of the energy is concentrated in components having long wavelengths, i.e. low values of  $m$  and  $n$ . Thus equation 2a shows that the signal spectral energy for a sequential system is concentrated in bunches centred on line harmonics, the bunches increasing in amplitude towards zero frequency. This is shown in figure 4.

The spatial frequencies ( $m, N/2$ ) correspond to the signal frequencies  $(m - \frac{1}{2})f_L$  which lie midway between line harmonics. Spatial frequencies with values of  $|n|$  greater than  $N/2$  thus transform to frequencies in adjoining bunches and are confused with spatial frequencies having a value of  $m$  differing by one. Now the scanning action, which transforms spatial to signal frequencies, samples the scene vertically at a rate of  $N$  samples per picture height. It is well known from sampling theory that a function must not contain components with frequencies higher than half the sampling frequency if aliasing is to be avoided. Thus the conditions for avoiding vertical aliasing and confusion are identical and are different ways of saying the same thing. Vertical frequencies can be restricted before scanning to values of  $|n|$  below  $N/2$  by optical filtering or suitably shaping the scanning aperture.

For an interlaced system the same general conclusions apply. However, equation 2b shows that the signal frequencies corresponding to successive values of  $n$ , for the same value of  $m$ , are now separated by twice the value that applied to a sequential system. Thus, for the same range of values of  $n$ , the bunches of energy now overlap as shown in figure 5. This overlapping does not, however, cause confusion because the bunches interleave. This is a necessary consequence of the fact that for an interlaced system  $N$  must be odd. Confusion cannot occur until  $n$  reaches  $N/2$  as before.

The spatial frequencies ( $m, N/2 - \frac{1}{2}$ ) correspond to the signal frequencies  $(m - 1 + 1/N)f_L$  which are close to line-frequency harmonics. Thus the region near line harmonics corresponds to both zero and maximum vertical frequency components and the region midway between line harmonics corresponds to the vertical midband of the picture spatial spectrum where alternate field lines are, say, black and white.

The spectrum of the chrominance can be derived by considering  $U$  and  $V$  separately.

The  $U$  component is straightforward. The baseband  $U$  signal modulates the subcarrier using double-sideband suppressed-carrier modulation. The spectrum of the baseband  $U$  signal has the same form as that of the luminance and the modulation process converts it to side frequencies of the subcarrier. As subcarrier frequency is less than 284 times line frequency by about one quarter of line frequency the bunches of  $U$  chrominance are likewise centred on frequencies with the same offset below multiples of line frequency as shown in figure 6.

The spectrum of the  $V$  chrominance is more complex because of the phase alternation. The baseband  $V$  signal is first multiplied by a switching function, which is a square wave of half line-frequency, before modulating the subcarrier. The switching can be considered as double-sideband

suppressed-carrier modulation of the square wave by the baseband  $V$  signal. The spectrum of the square wave consists of lines at odd multiples of half line-frequency with a  $(\sin x)/x$  envelope and each of these lines becomes a carrier for the baseband  $V$  signal. The resulting spectrum is thus bunches of energy centred on odd multiples of half line-frequency. However, because the carrier frequencies are separated by exactly line frequency, bunches belonging to one carrier are exactly confused with bunches belonging to another. Thus the bunch centred on half line-frequency contains contributions from all baseband bunches with differing values of  $m$ . It is therefore not possible to associate a particular signal frequency with a unique pair ( $m, n$ ) but only with a particular value of  $n$ . This confusion is, however, resolved on demodulation. Finally the quadrature subcarrier is double-sideband suppressed-carrier modulated by the switched baseband  $V$  signal producing a set of pairs of side frequencies centred on subcarrier frequency. The spectrum of the  $V$  chrominance thus appears as in figure 7.

The spectrum of the total chrominance signal is the sum of figures 6 and 7. Thus the  $U$  chrominance appears as bunches separated by integral multiples of line frequency from subcarrier frequency whilst the  $V$  chrominance appears as bunches separated by odd multiples of half line-frequency from subcarrier frequency. Therefore the predominant  $U$  chrominance energy lies approximately one quarter of line frequency below line harmonics whereas the  $V$  chrominance lies above. A typical region is shown in figure 8.

For an interlaced system the centres of the  $U$  bunches correspond to both zero and maximum vertical spatial frequencies of  $U$ . The vertical midband of  $U$  corresponds to the region midway between  $U$  bunches, that is at the centres of the  $V$  bunches. Similarly, the centres of the  $V$  bunches correspond to both zero and maximum vertical spatial frequencies of  $V$  and the vertical midband of  $V$  falls at the centres of the  $U$  bunches. There is, however, no confusion between  $U$  and  $V$ . This is because lines within both  $U$  and  $V$  bunches are separated by the field frequency whereas the separation between  $U$  and  $V$  bunch centres is exactly half line-frequency. Half line-frequency is not an integral multiple of field frequency because  $N$  is odd; therefore the  $U$  and  $V$  bunches can overlap and interleave in the same way as the luminance bunches. In fact there can never be any  $U/V$  confusion however great the value of  $n$ . There can, however, be  $U/U$  and  $V/V$  confusion as with luminance unless  $n$  is restricted to values below  $N/2$ .

Further, there is no  $Y/U$  or  $Y/V$  confusion. This is because the luminance energy appears at multiples of picture frequency, every other line belonging to the same energy bunch. However, the  $U$  energy is spaced at integral multiples of picture frequency from subcarrier frequency, that is at the frequencies

$$[(q - \frac{1}{2})N + r]f_p$$

where  $q$  is 284 and  $r$  is any integer. As  $N$  is divisible by 4 with remainder 1 this expression may be written as

$$(s - \frac{1}{2})f_p$$

where  $s$  is any integer.

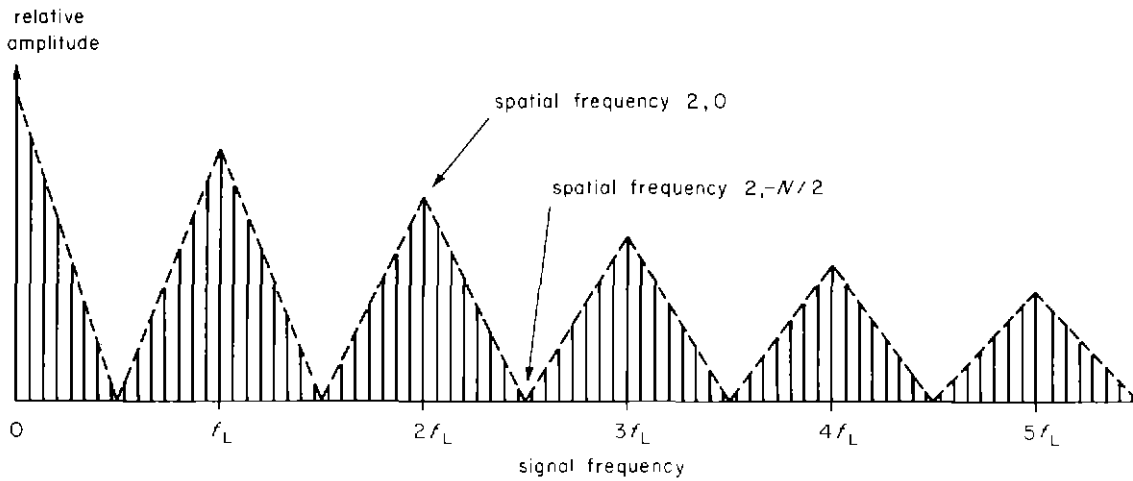


Fig. 4 Luminance spectrum of typical sequentially-scanned still picture

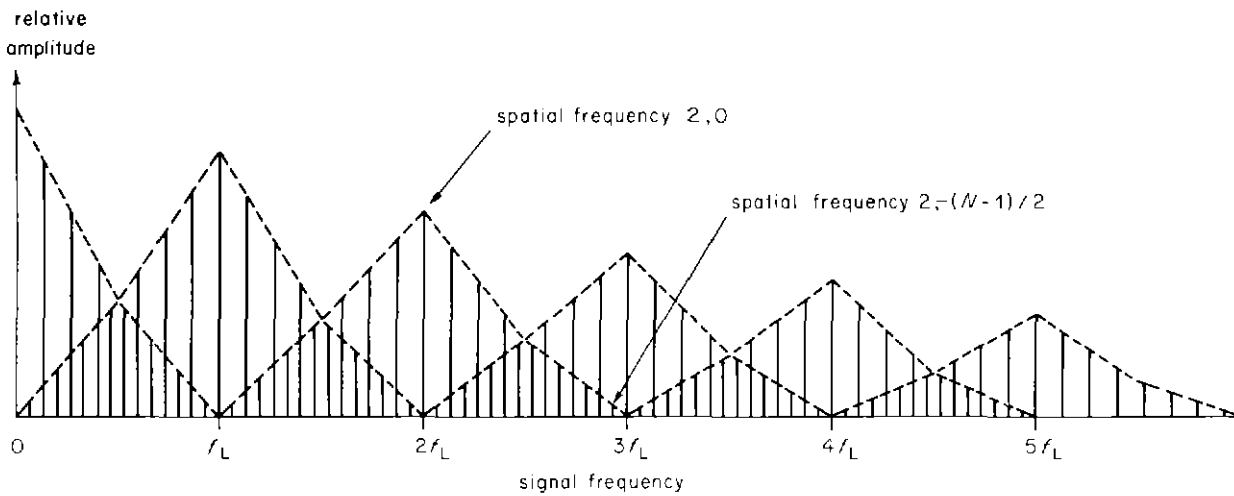


Fig. 5 Luminance spectrum of typical interlaced-scanned still picture

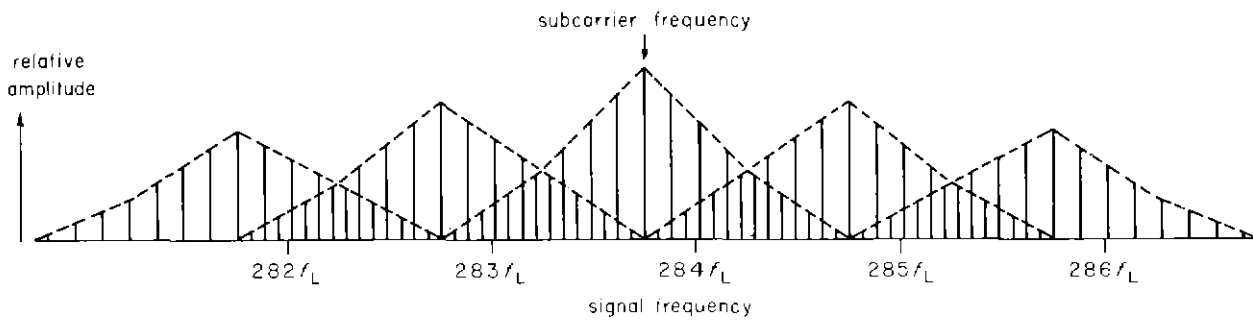


Fig. 6 Spectrum of U chrominance signal

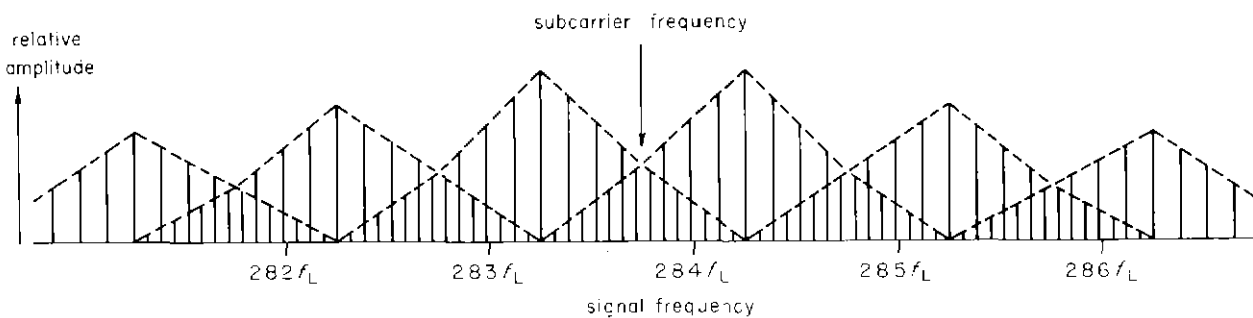


Fig. 7 Spectrum of V chrominance signal

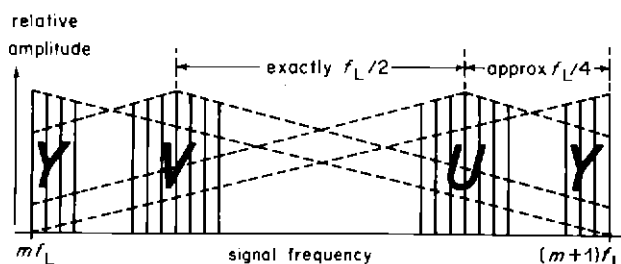


Fig. 8 Typical region of spectrum near subcarrier frequency

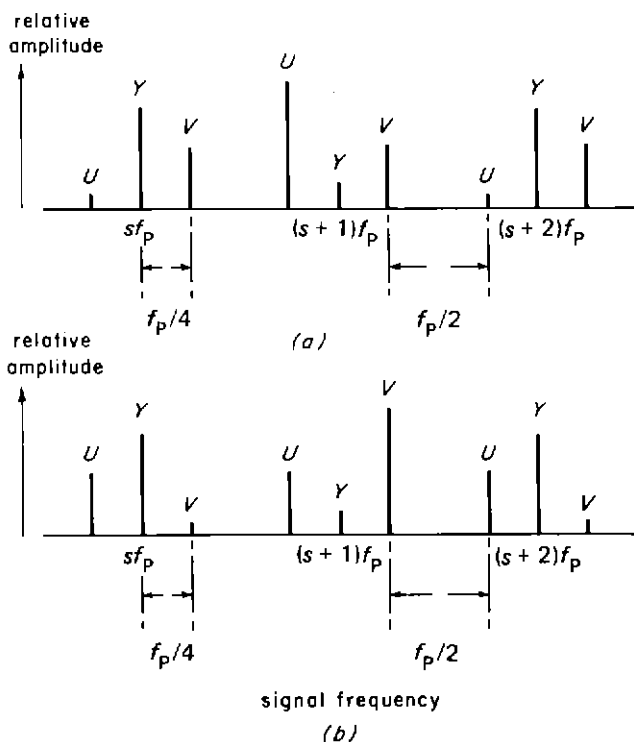


Fig. 9 Magnified portions of figure 8 near the centre of the chrominance spectral bunches  
a. near U b. near V

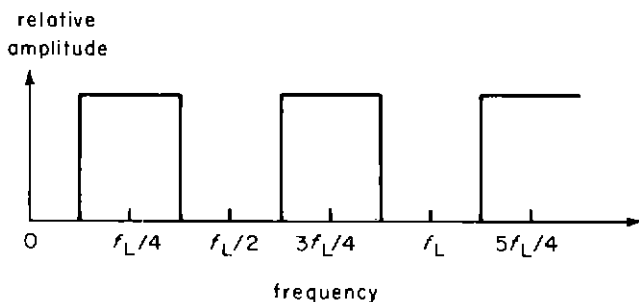


Fig. 10 Transmission of ideal filter for separating luminance and chrominance on a line-frequency scale

The V energy appears at the frequencies

$$[(q+r)N+r]f_p$$

where  $r$  is any integer. This may be written as

$$(s+r)f_p$$

where  $s$  is any integer.

A portion of figure 8 near the centre of a U bunch would therefore appear as in figure 9a. A portion near the centre of a V bunch would appear as in figure 9b. Thus the Y, U, and V lines never interact for stationary scenes and it should be possible to separate the Y, U, and V components completely.

The spectral structure of the signal is seen to exist with two degrees of detail. On a coarse scale the predominant Y, U, and V energy is separated by multiples of  $f_L/4$ . On a fine scale it is separated by multiples of  $f_p/4$ . These two facts give rise to filters based on line and field delays.

### 3.2 Filters based on line delays

#### 3.2.1 Matched filtering

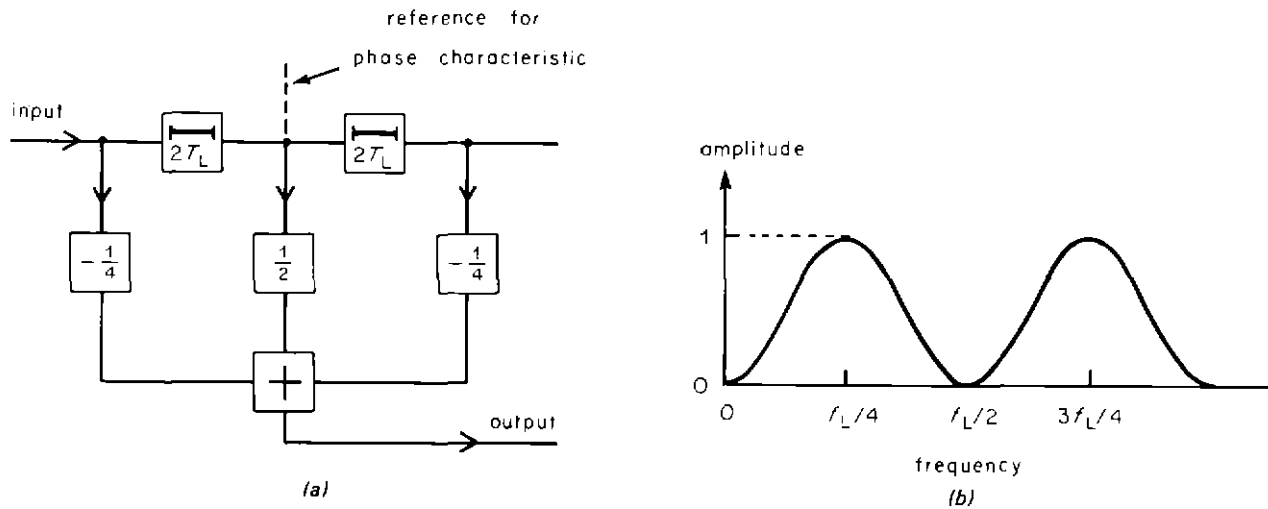
If the filter in figure 3 is to pass the predominant chrominance energy then its spectral characteristic must have maxima at odd multiples of  $f_L/4$ . If, in addition, the system transmits the predominant luminance, then the filter must have minima at integral multiples of  $f_L$  so that the luminance is not cancelled there. The simplest idealised characteristic which satisfies these conditions is shown on a linear scale in figure 10. This characteristic should only apply to the modulated chrominance spectral region and elsewhere should be zero.

The effect of this filter is to restrict the vertical components of the chrominance spatial frequencies to the ranges  $0 - \frac{1}{2}$ ,  $\frac{1}{2} - \frac{3}{4}$ , and  $\frac{3}{4} - 1$  of the theoretical maximum resolution. These ranges are  $0 - 39$ ,  $117 - 195$ , and  $273 - 312$  cycles per picture height. In a delay-line PAL decoder the middle range of vertical frequencies is eliminated by the action of the delay line which separates U from V. The top range of chrominance frequencies would probably not be resolved by the eye at normal viewing distances. It is thus the bottom range which is of primary interest.

The luminance signal components near subcarrier frequency also have their vertical frequencies restricted to the same ranges. As luminance near subcarrier frequency corresponds to high horizontal frequencies it is particular diagonal spatial frequencies having combinations of high horizontal frequency and certain vertical frequencies which are lost.

The horizontal bandwidth of the chrominance and horizontal range over which diagonal luminance resolution is lost is governed by the frequency range over which the characteristic of figure 10 operates. This can be determined by a simple bandpass filter.

The most straightforward way of approaching the characteristic of figure 10 is to use a transversal filter. The essential property of such a filter is that its coefficients are the coefficients of the Fourier series describing the spectral



**Fig. 11** The simplest first-order approximation to the characteristic of figure 10  
a. filter realisation      b. spectral characteristic

characteristic. The idealised square wave of figure 10 clearly has an infinite number of Fourier coefficients and therefore requires a transversal filter of infinite extent.

In practice, truncation of the filter will yield a truncated series which approximates to the square wave. The simplest approximation consists of constant and fundamental terms; this may be called a first-order filter. More complex approximations add further odd harmonics; thus only odd-order filters need be considered.

The periodicity of the characteristic indicates that the filter delay elements are multiples of two line periods. Figure 11 shows the simplest first-order realisation of the filter. Two approaches may be used to determine the coefficient values. One is to make the spectral characteristic maximally flat at multiples of  $f_L/4$  with true maxima and minima there. The coefficients are then solutions of simultaneous linear equations. Otherwise the coefficients can be the Fourier coefficients of the square wave in which case the truncated series does not have overall maxima and minima at multiples of  $f_L/4$  (except for the first-order case) but gives the minimum mean square deviation from the ideal. In either case the characteristic is anti-symmetrical (except for the constant) about the value of  $\frac{1}{2}$ .

As shown in section 2 the matched-system chrominance, luminance, and cross-signal characteristics are  $F^2(\omega)$ ,  $[1-F(\omega)]^2$  and  $F(\omega)[1-F(\omega)]$ . If  $\omega_0$  is the frequency of anti-symmetry, then  $F(\omega_0+\omega)=1-F(\omega_0-\omega)$  and the shapes of the chrominance pass- and stop-bands are identical to those of the luminance. Moreover, the cross-signal characteristics are symmetrical about  $\omega_0$ .

Figure 12 shows the matched-system characteristics of the wanted and cross-signals from the centre of a pass-band to the centre of a stop-band. This range corresponds to a vertical frequency range of 78 cycles per picture height. First-, third-, and fifth-order filters are shown in two series. Series (a) is the maximally flat case and series (b) is the truncated case.

As can be seen, the characteristics of the wanted signal in series (a) always steadily decrease from unity (0dB) so that

the cross-signal level rises steadily towards the cross-over point. Thereafter the cross-signal level falls because of the decoder filter characteristic. The infinite suppression at the ends of the range is unnecessary. In series (b) this infinite suppression is exchanged for a sharpening of the peak at the cross-over coupled with a sharper cut of the wanted signal but with pass-band ripple. As the presence of the cross-signal is likely to be more disturbing than the absence of the wanted signal, it is probable that the characteristics of series (b) would be preferred.

So far the bandpass filter with which the transversal filter is cascaded has been assumed ideal. In practice its spectral characteristic will have a finite rate of cut and in regions where it is other than unity the characteristics of figure 12 will be profoundly modified. Although the effect of the bandpass characteristic on the curves of figure 12 can be deduced, it is difficult to appreciate the significance of the result. This treatment is therefore reserved for the two-dimensional approach.

### 3.2.2 Filtering at only one end of the system

The effect of using a filter at only one end of the system is easiest to appreciate using the ideal characteristic of figure 10 in conjunction with figure 8.

If the filter is used only at the coder, then the transmitted luminance and chrominance have restricted vertical frequencies. At the decoder, however, no further restriction takes place: all the luminance enters the chrominance channel and all the chrominance enters the luminance channel.

The restriction of luminance frequencies means that the coarse cross-colour having vertical frequencies in the range 0 — 39 c/ph (neglecting the other ranges) is eliminated but the fine cross-colour in the range 39 — 117 c/ph remains. For example, the fine cross-colour on the vertical gratings of Test Card F is unaffected because the gratings have no vertical frequency components. Nevertheless, it is the coarse cross-colour which is the more objectionable and so the filter gives a worthwhile improvement.

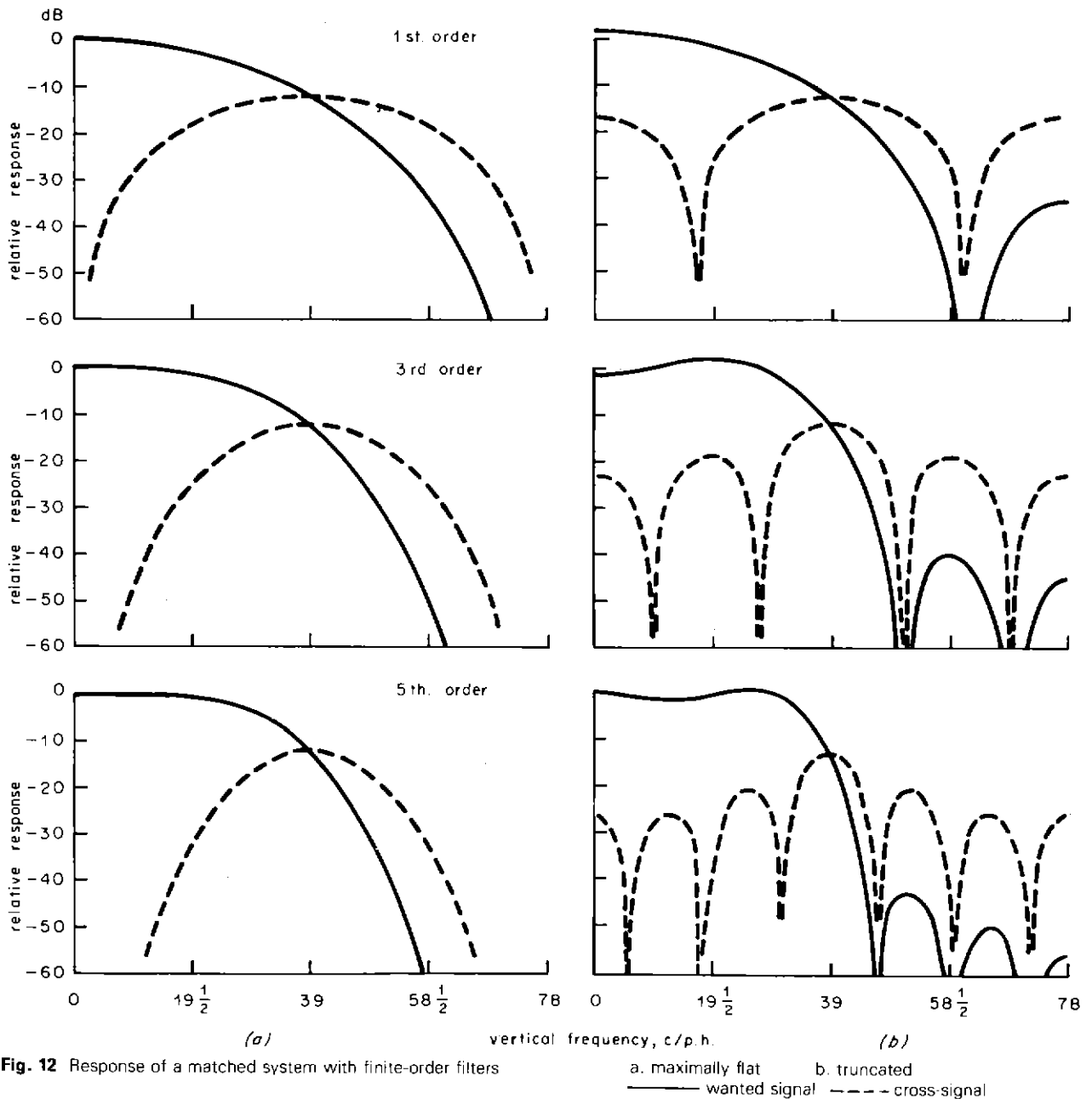


Fig. 12 Response of a matched system with finite-order filters

a. maximally flat      b. truncated  
 ————— wanted signal      - - - - - cross-signal

The restriction of chrominance vertical frequencies means that the cross-luminance with vertical frequencies in the ranges 0 — 39 and 117 — 195 c/ph is eliminated. Because the luminance has a high horizontal frequency component, however, the first range is not particularly coarse. More importantly, the chrominance carrier frequencies are not eliminated because they occur where there is no chrominance detail. Thus plain coloured areas have the full amount of subcarrier patterning which would be completely unacceptable. It is therefore essential that a conventional notch filter must be used in the luminance path of the decoder.

If the filter is used only at the decoder then the transmitted luminance and chrominance have unrestricted vertical bandwidths. But at the decoder the separated chrominance has restricted vertical frequencies and cross-colour of the same

vertical frequency range. Thus the coarse cross-colour remains but the fine cross-colour is eliminated. For example, the cross-colour on the vertical gratings of Test Card F is now eliminated. Although the fine cross-colour is less objectionable than the coarse it can be argued that it occurs more often because verticals are statistically more probable.

The separated luminance at the decoder also has restricted vertical frequencies and cross-luminance of the same vertical frequency range. Thus the cross-luminance of fine vertical frequency is eliminated. In particular the chrominance carrier frequencies are eliminated so that plain coloured areas are free of subcarrier patterning. Therefore a conventional subcarrier notch filter is unnecessary. All the vertical gratings on the test card are now fully resolved.

The effects of the permutation of filter position are summarised in table 1.

### 3.3 Filters based on field delays

Considering the spectral structure of figure 9 it is clear that a filter that separates luminance and chrominance on a picture frequency scale must have maxima at odd multiples of  $f_p/4$  and minima at integral multiples of  $f_p$ . There is also some indication that a field-frequency structure is present.

This is about as far as one can go on the basis of the one-dimensional spectrum. In particular the effect of the filter on movement is difficult to predict. The treatment of filters based on field delays is therefore reserved for the three-dimensional approach.

## 4 The two-dimensional approach

### 4.1 The two-dimensional spectrum

A stationary image is a function of two dimensions and can be represented by a sum of two-dimensional Fourier components. A general Fourier component is a spatial frequency of, say,  $m$  cycles per picture width and  $n$  cycles per picture height and can be visualised as a sloping grating with a sinusoidal variation of brightness. Just as with one-dimensional frequencies, a two-dimensional frequency can be expressed as a sum of two complex frequencies where  $m$  and  $n$  can take negative values. The amplitudes of the complex frequencies plotted with  $m$  and  $n$  as co-ordinates constitute the two-dimensional Fourier spectrum of the image.

The position of any signal frequency in the  $m$ - $n$  plane can be found using equation 2; however only 'picture-locked' frequencies give integral values of  $m$  and  $n$ . Other frequencies are represented by the nearest integral values. Using this representation all the arguments of section 3 can be developed and extended.

For example, vertical aliasing can be considered as follows. For any picture-locked frequency, equation 2 has an infinite number of solutions, that is, pairs of values of  $m$  and  $n$ . These pairs of values are separated by  $(1, N)$  for equation 2a and  $(2, N)$  for equation 2b. This is shown for zero signal frequency in figure 13. As zero frequency lies at the centre of the image spectrum the points in figure 13 mark the centres of the repeated spectra corresponding to the scanned image. Clearly if the spectra are not to overlap, their extent in the  $n$  direction must not exceed  $N$ , that is, the vertical frequencies in the original spectrum must be restricted to less than  $N/2$  cycles/picture height.

This repetition of spectra is fundamental to sampling theory. In one-dimensional terms the spectrum of a sampled function is repeated. In two-dimensional terms the repeat unit has direction as well as magnitude and becomes a vector. The components of the vector are the components of the sampling frequency, in this case  $(1, N)$  or  $(2, N)$ , which describes the scanning action in space.

For an interlaced system the restriction to avoid aliasing is the same as for a sequential system. This is not surprising because a two-dimensional spatial analysis ignores the fact that the fields of a picture occur at different times. But for a filter which operates on the signals of only one field at a time, i.e. intra-field processing, the spatial sampling frequency is twice as coarse and so the spectral characteristic repeats twice as often. Thus the spatial frequency  $(0, 0)$  is treated in

TABLE 1

		CODER	
		No filtering	Filtering
DECODER	No filtering (other than notch)	1	2
	Filtering (but no notch)	3	4

1. Present situation.
2. Reduction of chrominance vertical resolution to  $0 - \frac{1}{2}, \frac{1}{2} - \frac{3}{2}, \frac{3}{2} - 1$  of maximum. Loss of luminance diagonals with same vertical frequencies as above. Reduction of coarse, less-probable cross-colour and cross-luminance.
3. Reduction of chrominance vertical resolution and luminance diagonal resolution as above. Reduction of fine, more-probable cross-colour and cross-luminance.
4. Reduction of chrominance vertical resolution and luminance diagonal resolution as above. No cross-colour or cross-luminance.

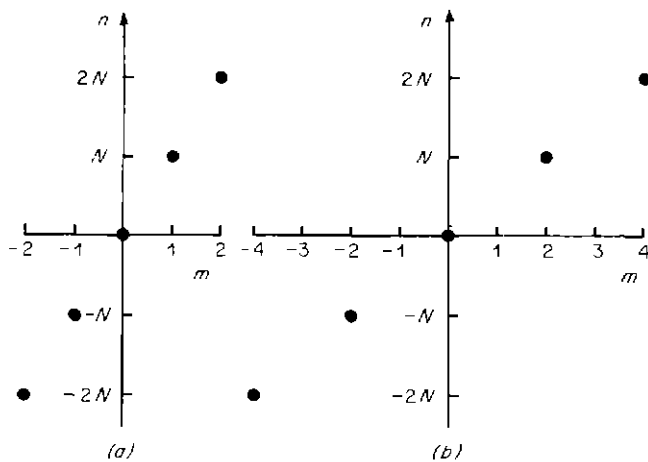


Fig. 13 The two-dimensional spectral interpretations of zero signal frequency  
 a. sequential system      b. interlaced system  
 The horizontal scale is highly magnified

exactly the same way as the frequency  $(1, N/2)$ . It will be recalled that in section 3.1 it was shown that the regions near line-frequency harmonics correspond to both zero and maximum vertical frequencies. Thus a slowly-changing filter characteristic, i.e. one with no field-rate detail, treats both zero and maximum vertical frequencies in the same way. This is confirmation of the repeat unit for intra-field processing from the one-dimensional approach.

### 4.2 The two-dimensional spectrum of the PAL signal

The luminance component is straightforward for stationary images. Taking the two interlaced fields together, the spectrum of the luminance image is simply repeated with the unit



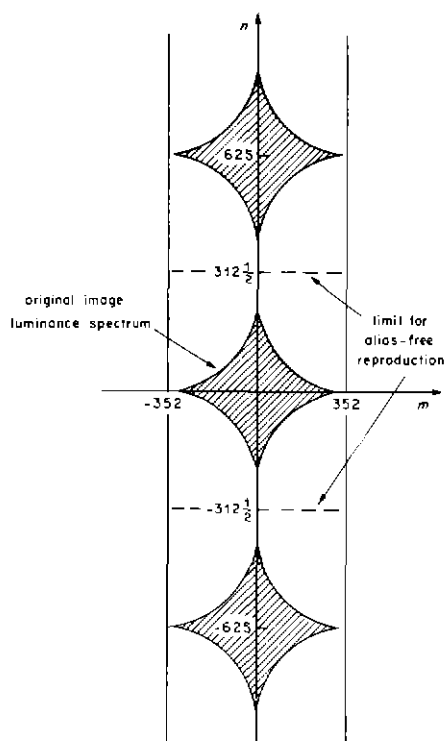


Fig. 14 The two-dimensional spectrum of the luminance signal

(2, 625) which is very nearly along the  $n$  axis. The upper bound on the signal frequency,  $\nu$ , places a bound on the range of values of  $m$  and  $n$  which can be deduced from equation 2b. For system I the maximum value of  $\nu$  is 5.5MHz and  $f_L$  is 15.625kHz so that the bound is

$$(m - 2n/625) \leq 352$$

For all practical purposes this confines  $m$  to less than 352 irrespective of the value of  $n$ . As  $\nu$  is a complex frequency, it has a lower bound of -5.5MHz which imposes a corresponding lower bound on  $m$ . The spectrum of the luminance signal therefore appears as in figure 14.

The two figures of  $\pm 352$  c/pw and  $\pm 312\frac{1}{2}$  c/ph define a rectangle within which the spectrum of alias-free luminance must lie and represent the potentially available spatial resolution of the system. The vertical resolution of  $312\frac{1}{2}$  c/ph is actually greater in absolute terms than the horizontal by a factor of 1.34, taking into account the aspect ratio of the full picture (1.51), i.e. including the black border representing blanking. This fact can be turned to advantage as will be shown later. It is also the reason that the  $m$  and  $n$  axes have been differently scaled in figure 14.

The chrominance component is more difficult to describe because it is modulated on carriers which are not picture-locked. The spatial spectrum of the chrominance has the same meaning as that of the luminance but the modulation translates the spectrum and centres it on the carriers.

The positions of the carriers can be found using equation 2b. The  $U$  chrominance carrier is subcarrier frequency. The nearest solutions having integral values are (284, 78) and (283, -235). The repeat unit of (2, 625) produces an infinite set of further solutions. For all practical purposes these

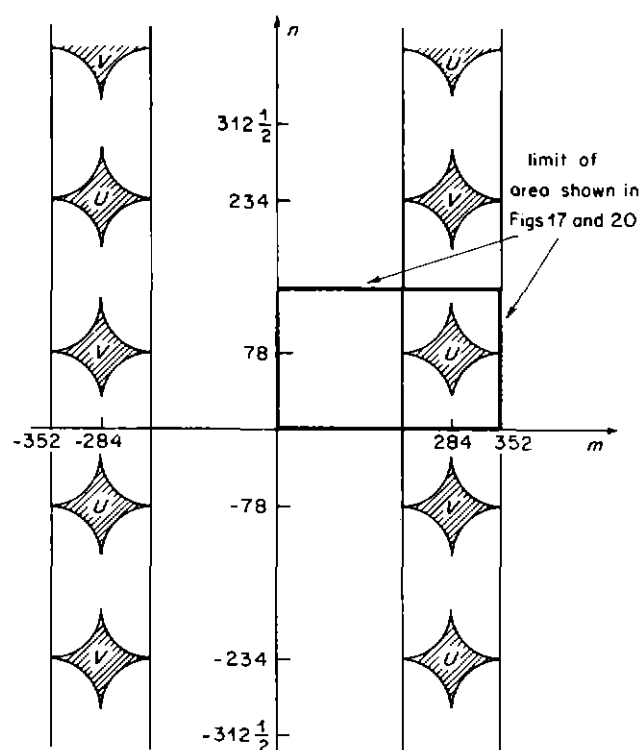


Fig. 15 The positions of the chrominance regions in the two-dimensional spectrum

solutions are in lines parallel to the  $n$  axis and are separated by  $312\frac{1}{2}$  c/ph.

The  $V$  chrominance carrier, as derived in section 3.1, is a set of carriers of decreasing amplitude, offset from sub-carrier frequency by odd multiples of half line frequency. These frequencies give the nearest solutions  $(284 \pm r, 234)$  and  $(283 \pm r, -79)$  where  $r$  is an integer. Further solutions are provided by the repeat unit as before. For all practical purposes these solutions are also in lines parallel to the  $n$  axis and interleave with those for the  $U$  chrominance. The positions of the centres of the chrominance regions therefore appear as in figure 15.

The restriction of baseband-chrominance signal-frequency imposes a limit on  $m$  for the baseband chrominance, as for luminance. Assuming the restriction to be 1.3MHz, this limits  $m$  to 83 c/pw. After modulation the chrominance regions are therefore limited to  $284 \pm 83$  for the value of  $m$ . Taking negative frequencies into account this defines two strips over which chrominance and luminance co-exist, as shown in figure 15.

Using this representation of the PAL signal we can now assess in greater depth the filters considered in section 3.

### 4.3 Filters based on line delays

#### 4.3.1 Introduction

The effect of the simple bandpass filter is to clear away all luminance above, say, 3.3MHz, i.e. for  $m$  greater than 211, and reserve the remaining space for chrominance. The object of the more complex filters is to reclaim some of the luminance at the expense of the chrominance. This

reclamation should take place where the luminance is most useful and the chrominance least useful.

Statistically the incidence of near-vertical edges is higher than that of other inclinations. These edges, having little or no vertical information, consist of almost pure horizontal frequencies which lie near the  $m$  axis in the  $m-n$  plane. Thus the most useful luminance lies here and the filter characteristic should be zero here. Because of the intra-field repeat unit, the characteristic will then also be zero when  $n$  is any multiple of  $312\frac{1}{2}$ .

The regions near the chrominance carriers correspond to the coarsest chrominance spatial frequencies that contribute to large areas of colour. At these points the filter characteristic should be unity.

Now, if the chrominance near the  $m$  axis is deemed less useful than the luminance, it follows that it may also be eliminated in all the regions midway between the carriers, otherwise the chrominance characteristic will be vertically asymmetrical; thus it is possible to reclaim the diagonal luminance midway between carriers, which has vertical frequencies in a range centred on  $156$  c/ph.

Thus an elementary specification for the vertical characteristic of the ideal filter, as shown in figure 16, has been derived. This is essentially the same as that of figure 10 translated into the  $m-n$  plane. In particular, the characteristic repeats vertically with a unit of  $156$  c/ph. Thus it is only necessary to describe it over an area bounded by the  $m$  and  $n$  axes and the lines  $m = 352$  and  $n = 156$ , as shown in figure 16. (Strictly it need only be described over half this range, because it is symmetrical.) The curves of figure 12 can now be plotted as contours and the effect of an imperfect bandpass filter can be included.

#### 4.3.2 Variables-separable filters

The filters developed in section 3.2 take the form of a transversal filter which shapes the vertical frequency response cascaded with a bandpass filter which shapes the horizontal frequency response. Such a behaviour can be termed variables-separable because the shape of the vertical frequency characteristic is simply multiplied by the bandpass characteristic.

The behaviour of the bandpass filter can be quantified by assuming that it, too, is realised in the form of a transversal filter based on element delays. If the element delay corresponds to a sampling frequency of twice subcarrier frequency and the bandwidth (i.e. the normal modulated chrominance bandwidth) is half the subcarrier frequency, then the coefficients have easily-expressed values as

$$A_{hr} = \frac{1}{4}(-1)^r \text{sinc}(r/4)$$

where  $\text{sinc } x = (\sin \pi x) / \pi x$ .

Figure 17 shows the overall matched-system chrominance, luminance and cross-signal characteristics expressed in two-dimensional form over the region described in figure 16. It will be recalled that these are given by  $F^2(1-F)^2$  and  $F(1-F)$  where  $F$  is the filter characteristic. Only the first-, third-, and fifth-order truncated vertical filters of figure 12b are shown, combined with appropriate truncated horizontal filters. The latter are chosen to give horizontal rates of cut ap-

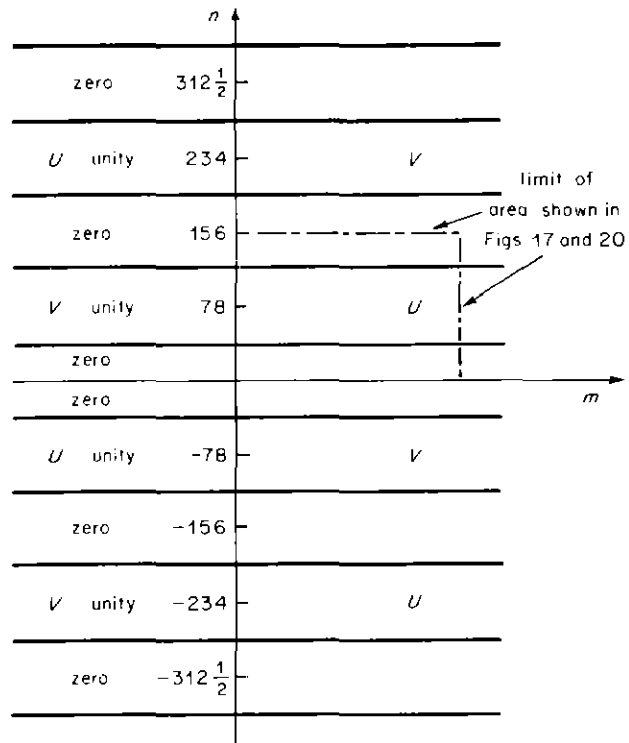


Fig. 16 Elementary two-dimensional specification for the vertical characteristic of the ideal filter

proximately equal to the vertical in absolute terms at the band edge.

The corresponding coefficient arrays are shown in table 2. These are obtained by multiplying together the horizontal and vertical arrays. As the one-dimensional arrays are symmetrical the two-dimensional arrays have four-quadrant symmetry; therefore only one quadrant is shown. It will be noted that alternate rows are zero because the frequency characteristic repeats vertically every  $156$  c/ph; in addition, alternate remaining rows are zero because there are no even harmonic terms in the spectral characteristic. The boundaries mark the different orders of filters used in figure 17.

It will be noted that as the order of the filter rises the area over which the cross-signals are near a level of  $-12$ dB decreases and the characteristics take on an increasingly rectangular shape. This is caused by the variables-separable behaviour of the two cascaded filters. The fact that the shape is nearly square means that the vertical bandwidth ( $\pm\frac{1}{4}$  theoretical maximum) corresponds to the chosen horizontal bandwidth of  $\pm\frac{1}{4}$  subcarrier frequency, i.e.  $\pm 1.108 \dots$  MHz. As the latter quantity is considered an acceptable horizontal chrominance bandwidth the filter merely limits the vertical bandwidth to about the same absolute value in spatial-frequency terms.

#### 4.3.3 Isotropic filters

It may be argued that a simultaneous reduction of horizontal and vertical chrominance bandwidth, as described above, would be unacceptable to the eye. In fact subjective evidence of this is lacking. However, the eye's resolution is almost certainly isotropic, i.e. independent of direction, so that it is

preferable to limit the horizontal and vertical resolution to the same value.

In a delay-line PAL decoder the vertical chrominance bandwidth is limited by the transversal filter formed by the line delay. This limit amounts to a *cosine* amplitude characteristic having a zero at half the theoretical maximum resolution. The equivalent vertical flat bandwidth is  $\pm \frac{1}{4}$  of the theoretical maximum. As the theoretical maximum corresponds to 1.34 times the horizontal resolution (5.5MHz), the equivalent vertical chrominance bandwidth corresponds to about  $\pm 1.84$ MHz. The horizontal chrominance bandwidth is, from figure 2, about  $\pm 1.2$ MHz showing that, with conventional decoders, there is more vertical chrominance resolution than horizontal.

The equivalent isotropic bandwidth, i.e. having the same area in two-dimensional frequency space, is 1.68MHz horizontally or 0.228 times theoretical maximum vertical resolution. Figure 18 shows the relationships between the present equivalent bandwidth area and the equivalent isotropic area. The isotropic area very nearly touches the horizontal axis. If such a filter characteristic were used then luminance spatial frequencies near 284 c/pw would have to be very nearly vertical to avoid rejection.

It may be that the radius of the isotropic area in figure 18 could be reduced without noticeable impairment of the chrominance resolution; subjective tests could confirm this. In addition, the optimum relationship between vertical and horizontal bandwidth might be investigated.

An isotropic filter with a characteristic as shown in figure 18 is not variables-separable and therefore cannot be realised by cascading horizontal and vertical filters. In one-

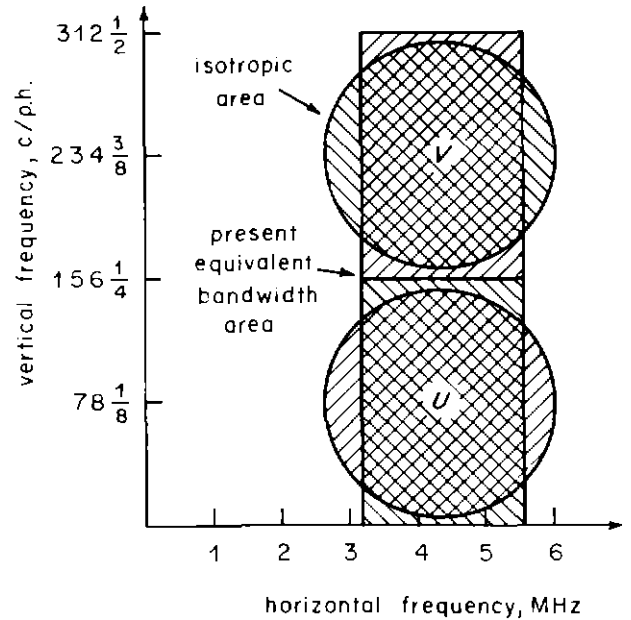


Fig. 18 The relationship between the present equivalent chrominance spectral area and the equivalent isotropic area

TABLE 2

Two-Dimensional Coefficient Array:  
variables-separable filters

-.0159	.0143	-.0101	.0048	.0000	-.0029	.0034	-.0020	.0000	.0016	-.0020	.0019	.0000
.0000	.0000	.0000	.0000	.0000	.0000	.0000	.0000	.0000	.0000	.0000	.0000	.0000
.0000	.0000	.0000	.0000	.0000	.0000	.0000	.0000	.0000	.0000	.0000	.0000	.0000
.0000	.0000	.0000	.0000	.0000	.0000	.0000	.0000	.0000	.0000	.0000	.0000	.0000
.0265	-.0239	.0169	-.0080	.0000	.0048	-.0056	.0034	.0000	-.0027	.0034	-.0022	.0000
.0000	.0000	.0000	.0000	.0000	.0000	.0000	.0000	.0000	.0000	.0000	.0000	.0000
.0000	.0000	.0000	.0000	.0000	.0000	.0000	.0000	.0000	.0000	.0000	.0000	.0000
.0000	.0000	.0000	.0000	.0000	.0000	.0000	.0000	.0000	.0000	.0000	.0000	.0000
-.0796	.0715	-.0507	.0239	.0000	-.0143	.0169	-.0102	.0000	.0080	-.0101	.0065	.0000
.0000	.0000	.0000	.0000	.0000	.0000	.0000	.0000	.0000	.0000	.0000	.0000	.0000
.1250	-.1125	.0796	-.0375	.0000	.0225	-.0265	.0161	.0000	-.0125	.0159	-.0102	.0000

The boundaries (a), (b) and (c) refer to the filters of Fig. 17.

(a)

(b)

(c)

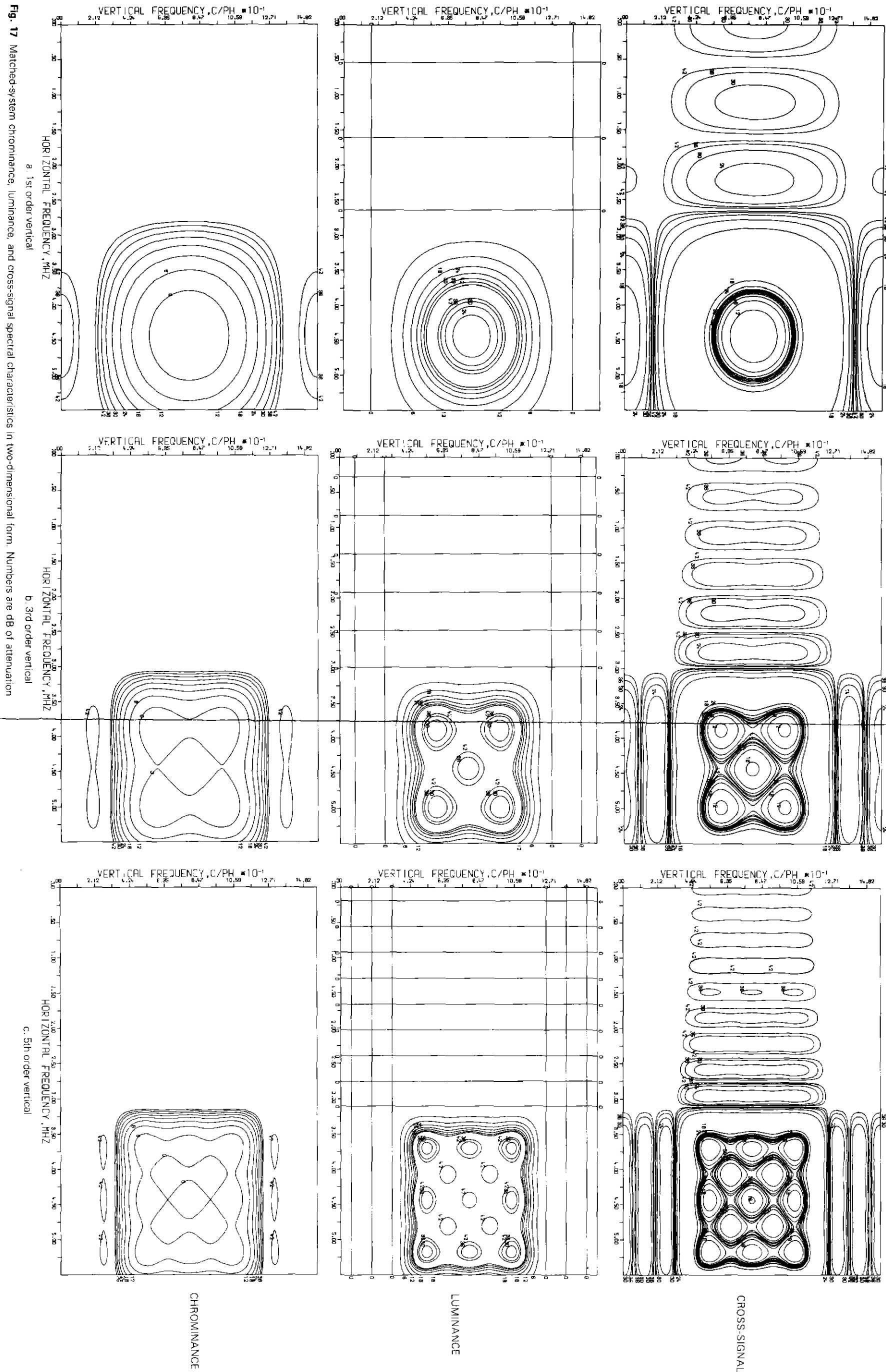


Fig. 17 Matched-system chrominance, luminance, and cross-signal spectral characteristics in two-dimensional form. Numbers are dB of attenuation

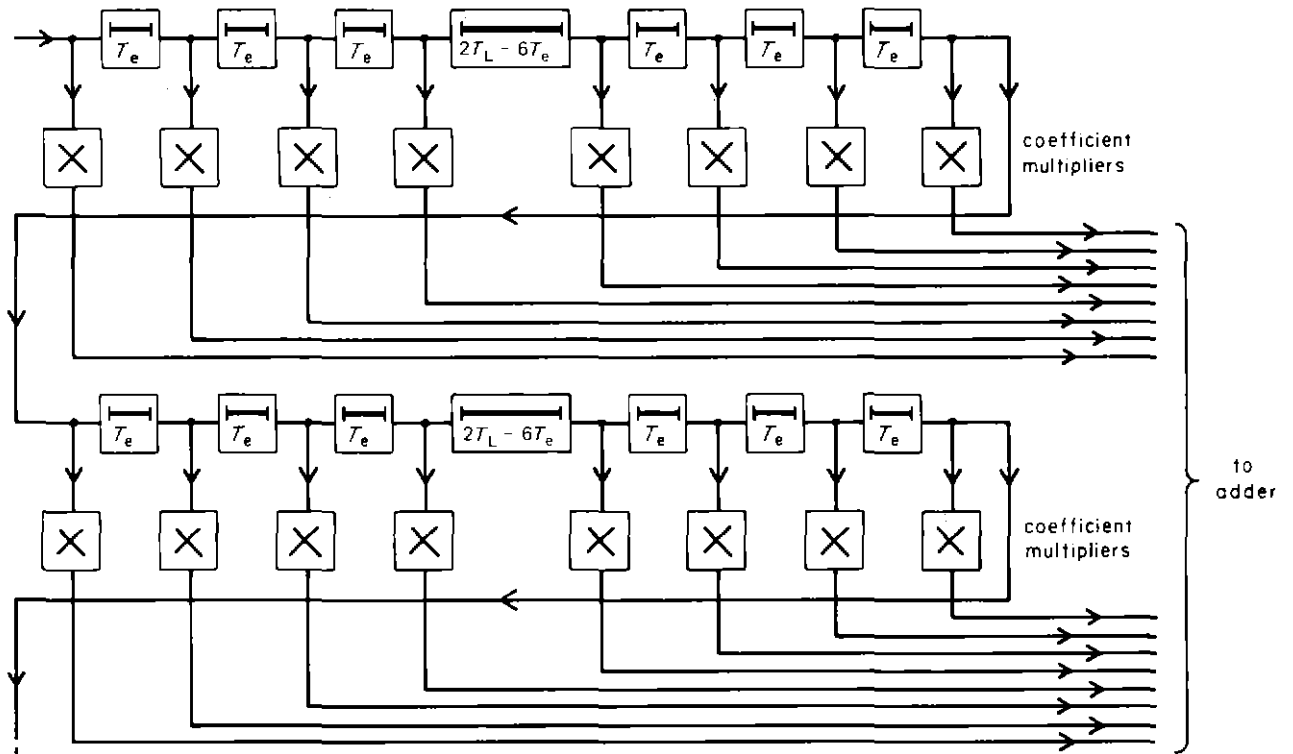


Fig. 19 One form of generalised two-dimensional transversal filter

TABLE 3

Two-Dimensional Coefficient Array:  
isotropic filters

-0.0054	.0056	-.0083	.0070	.0000	.0000	.0000	.0000	.0000	.0000	.0000	.0000	.0000	.0000
.0000	.0000	.0000	.0000	.0000	.0000	.0000	.0000	.0000	.0000	.0000	.0000	.0000	.0000
-.0098	.0100	-.0104	.0103	-.0089	.0055	-.0005	-.0045	.0072	.0000	.0000	.0000	.0000	.0000
.0000	.0000	.0000	.0000	.0000	.0000	.0000	.0000	.0000	.0000	.0000	.0000	.0000	.0000
-.0169	.0168	-.0159	.0129	-.0069	-.0013	.0088	-.0104	.0061	.0015	-.0088	.0000	.0000	.0000
.0000	.0000	.0000	.0000	.0000	.0000	.0000	.0000	.0000	.0000	.0000	.0000	.0000	.0000
-.0309	.0290	-.0221	.0091	.0063	-.0161	.0143	-.0031	-.0079	.0100	-.0030	-.0053	.0000	.0000
.0000	.0000	.0000	.0000	.0000	.0000	.0000	.0000	.0000	.0000	.0000	.0000	.0000	.0000
-.0754	.0552	-.0100	-.0269	.0330	-.0126	-.0105	.0164	-.0053	-.0077	.0096	-.0013	-.0085	.0000
.0000	.0000	.0000	.0000	.0000	.0000	.0000	.0000	.0000	.0000	.0000	.0000	.0000	.0000
.2621	-.2197	.1192	-.0199	-.0308	.0272	.0001	-.0185	.0106	.0043	-.0105	.0040	.0052	.0000

The boundaries (a), (b) and (c) refer to the filters of Fig. 20.

(a)

(b)

(c)

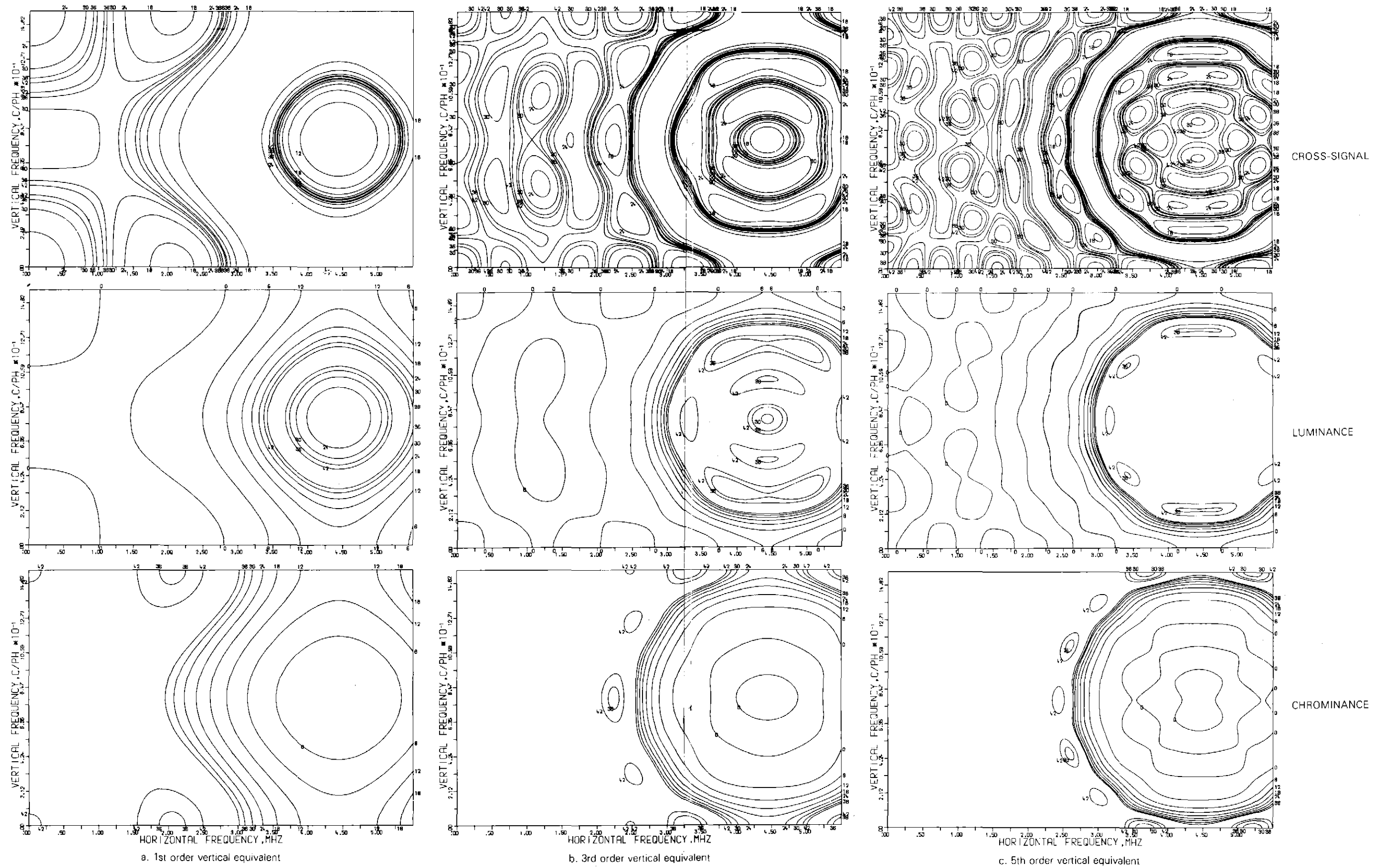


Fig. 20 Matched-system spectral characteristics in two dimensions. Isotropic filters

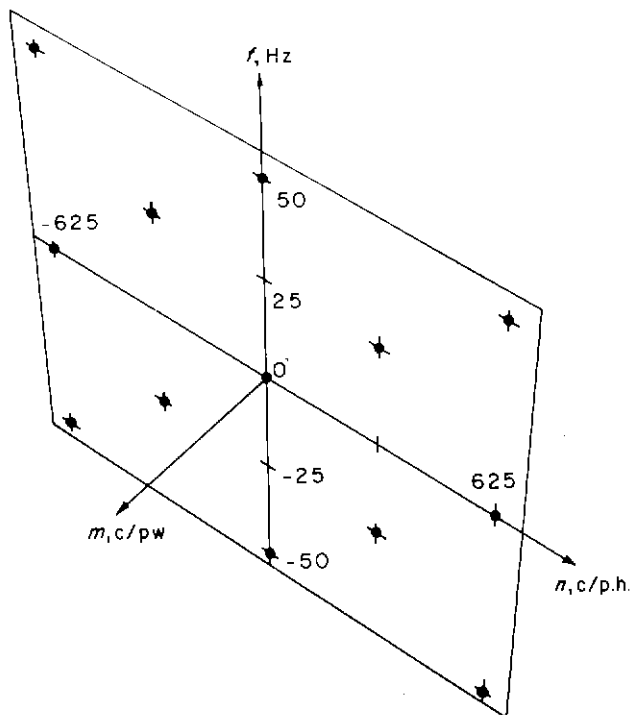


Fig. 21 The three-dimensional spectral interpretations of zero signal frequency for interlaced scanning

dimensional terms the width of the spectral teeth is not now constant at  $f_L/4$  but must vary from zero to a maximum and back to zero across the chrominance band. The coefficients that weight adjacent picture points are the two-dimensional Fourier coefficients of the frequency characteristic. As this is now not variables-separable, neither is the coefficient array. Thus each picture point must be separately accessible and this requires a generalised form of transversal filter based on shortened two-line delays alternating with groups of element delays as shown in figure 19.

An isotropic filter with sharp frequency boundaries would, of course, require an infinite coefficient array; in practice a finite array gives a finite rate of cut in the frequency domain. However, the shape of the frequency characteristics also depends on the way in which the infinite coefficient array is truncated. An isotropic characteristic requires a coefficient array with polar symmetry so that, ideally, the array should be truncated with a circular boundary. With a Cartesian scanning system this can only be approximated.

Figure 20 shows the characteristics obtained by truncating the array with a circular boundary to give approximately the same number of vertical coefficients along the vertical axis as in figure 17. This truncation is reflected in the deviation from circularity of the characteristics.

The corresponding arrays are shown in table 3. Again only one quadrant of the full array is shown. Alternate rows are zero in this case also but no remaining row is zero.

#### 4.3.4 Summary

Firstly, one might assume that the luminance and chrominance vertical bandwidths should be equal and constant over the subcarrier region. This arrangement is easy to

realise using cascaded horizontal and vertical filters but might give unacceptable chrominance vertical resolution. To overcome this, the variables-separable behaviour can be abandoned in favour of an isotropic behaviour yielding about the same total chrominance energy, but better distributed. Isotropic filters would, however, be more difficult to realise because independent access to each picture point would be necessary.

## 5 The three-dimensional approach

### 5.1 Introduction

The two-dimensional intra-field filters developed in section 4 solve the problems of cross-colour and cross-luminance at the expense of severely limiting the chrominance vertical resolution. Isotropic filters may alleviate the problem somewhat, but there is still a serious degradation of resolution. On the other hand, chrominance and luminance can be separated without any degradation for stationary images, but this can be done only at the expense of degrading moving images. It is the purpose of this section to examine the nature of this degradation and develop filters that would produce minimal impairment. For this purpose we need to develop the concept of the three-dimensional spectrum.

### 5.2 The three-dimensional spectrum

A moving image can be described as a summation of 'moving' spatial frequencies. A general moving spatial frequency has, say,  $m$  cycles per picture width and  $n$  cycles per picture height and can be visualised as moving at a speed such that crests pass a fixed point at  $f$ Hz; it can be regarded as an infinite moving grating where the direction of motion is indeterminate (only the sense is determinate). It can be expressed in terms of complex frequencies where  $m$ ,  $n$ , and  $f$  can be negative and the amplitudes (and phases) of the frequencies plotted with  $m$ ,  $n$ , and  $f$  as coordinates constitute the three-dimensional spectrum.

The position of any arbitrary signal frequency in the spectral space can be determined through equation 2 extended to include movement. For interlaced scanning this becomes

$$\nu = (m - 2n/N)f_L + f \quad (3)$$

where  $f$  is positive if the grating appears to move to the left. The inclusion of the extra term means that any signal frequency can be given exact co-ordinates where  $m$  and  $n$  are integers, but  $f$  (in general) is not. The difficulties met in section 4 can now be resolved.

Just as with two-dimensional space, equation 3 has an infinite number of solutions corresponding to any value of  $\nu$ . This means that spectra are repeated but now the repeat unit is a three-dimensional vector. In fact, there are two such vectors whose components are those of the three-dimensional sampling frequencies describing the scanning action. In two dimensions the scanning consists of a set of lines corresponding to the point (2,625) in the  $m$ - $n$  plane. In three dimensions it is the intersection of two sets of planes. One set corresponds to the point (0, 1, 50) in the  $m, n, f$  space: these

planes are very nearly perpendicular to the time axis. The other set corresponds to (1, 313, 25) and intersects the first set to give 312½ lines per picture height, vertically staggered on successive fields according to the interlace pattern. The repetition of spectra based on these two vectors gives a plane lattice in the three-dimensional space which is very nearly parallel to the  $n$ - $f$  plane. This is shown for zero signal frequency in figure 21 where the points mark the centres of the repeated spectra.

The pattern of figure 21 is consistent with the two-dimensional approach. For example, taking the two interlaced fields together is tantamount to excluding all temporal variations. This in turn excludes the existence of spectra outside the  $m$ - $n$  plane. If the spectra (0, 1, 50), (1, 313, 25), etc. are excluded, the lattice collapses to a one-dimensional form which agrees with that developed in section 4. Again, if temporal variations are allowed, the spectra (1, 313, 25) and (1, 312, -25) cancel out to a first order because their sum represents a fine spatial frequency vibrating at 25Hz.

The spatio-temporal sampling lattice of interlace which gives rise to the spectral lattice is shown in figure 22. As can be seen, the parameters in the  $x$ ,  $y$ ,  $t$  space are simply the reciprocals of those in the  $m$ ,  $n$ ,  $f$  space. The two lattices can thus be regarded as reciprocals of each other.

Any filter based on the sampling lattice of figure 22 will have a spectral characteristic which repeats according to the pattern of figure 21. A transversal filter can be described in terms of its coefficients, which weight adjacent samples. These coefficients, arranged in the array of figure 22, are the Fourier coefficients of the two-dimensional series representing the spectral characteristic which repeats with the pattern of figure 21. It should therefore be clear that a purely intra-field filter which takes contributions from points in only one field has a spectral characteristic with no  $f$  variation. According to figure 21 it must therefore repeat in the  $m$ - $n$  plane with half the unit of the spectral lattice. This confirms the observations of previous sections.

### 5.3 The interpretation of movement in the space

When an image moves — or, more specifically, translates — the spatial frequencies which constitute it must move correspondingly. It was pointed out in section 5.2 that the motion of an infinite two-dimensional grating is indeterminate. Only the rate at which crests pass a fixed point can be specified. If this can be found, then the  $f$  component is determined for any spatial frequency ( $m$ ,  $n$ ) for any rate of movement.

To find the rate at which crests pass a fixed point it is simpler to consider a point moving over a fixed grating. Suppose the grating is described by the expression

$$\cos 2\pi(mx/2a + ny/2b)$$

where  $2a$  and  $2b$  are the picture width and height respectively. Suppose the motion of the point is described by

$$x = ut, \quad y = vt$$

where  $u$  and  $v$  are the velocity components. Then substituting for  $x$  and  $y$ , we find that the disturbance at the point is given by

$$\cos 2\pi(mu/2a + nv/2b)t.$$

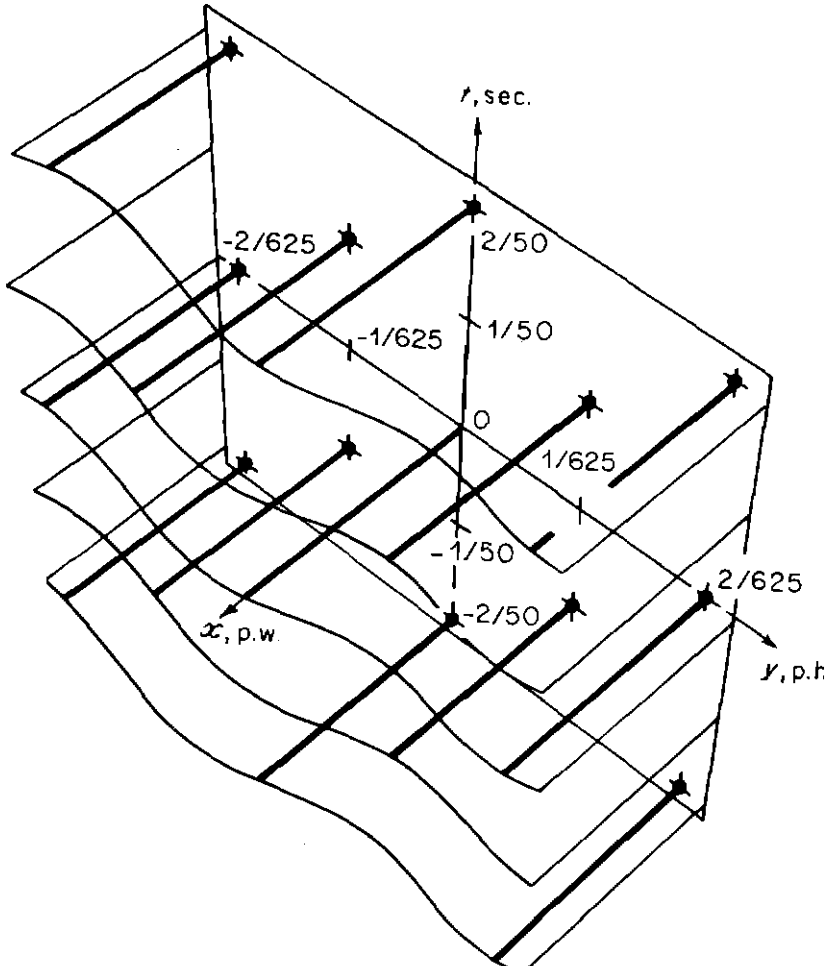


Fig. 22 The sampling lattice of interlaced scanning

Now this describes a temporal variation at frequency  $f$  where  $f$  is given by

$$f = m(u/2a) + n(v/2b).$$

If the velocity components of the point relative to the grating are  $u$  and  $v$ , it follows that the velocity components of the grating relative to the point are  $-u$  and  $-v$ . Thus, for the moving grating,

$$f = -m(u/2a) - n(v/2b). \tag{4}$$

The quantities  $(u/2a)$  and  $(v/2b)$  are simply the grating velocity components expressed in picture widths and picture heights per second. Provided that neither  $m$  nor  $n$  is zero, there is an infinite number of combinations of these components which give the same value of  $f$ . This explains why the grating velocity is indeterminate.

Equation 4 describes a plane in the  $m$ ,  $n$ ,  $f$  space. It passes through the origin and has a gradient of  $[(u/2a)^2 + (v/2b)^2]^{1/2}$  which is the magnitude of the velocity expressed in picture dimensions. The projection of the line of steepest descent on the  $m$ - $n$  plane makes an angle of  $\tan^{-1}(av/bu)$  with the  $m$  axis. This is the direction of the velocity, again modified by the picture dimensions.

This enables an overall picture of the spectrum of an image to be gained. When the image is stationary it lies wholly in the  $m$ - $n$  plane. When the image moves it lies on a tilted plane whose inclination is proportional to the velocity and whose direction of tilt is related to the direction of motion.



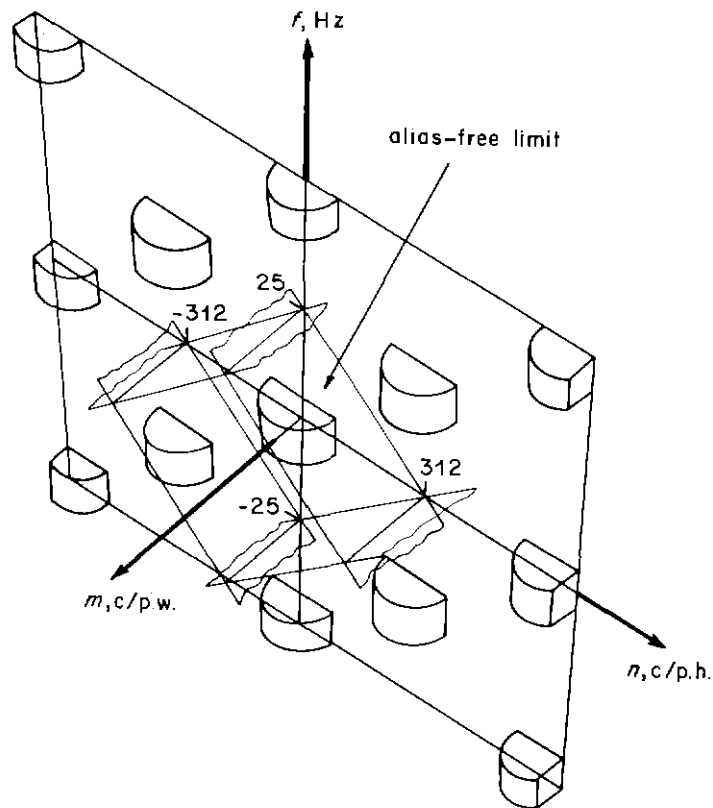


Fig. 23 The three-dimensional spectrum of the luminance signal

#### 5.4 The three-dimensional spectrum of the PAL signal

The arguments are similar to those of section 4.2 except that areas become volumes. The image luminance spectrum, now three-dimensional, is repeated, centred on the points of figure 21. This defines a layer nearly parallel to the  $n$ - $f$  plane as shown in figure 23. As before,  $|m|$  is limited to 352 which limits the layer thickness.

Figure 23 implies that the alias-free luminance volume resembles a rhombic prism because the cross section in the  $n$ - $f$  plane is a rhombus. The cross section in the  $m$ - $n$  plane is a rectangle as observed in section 4.2 and there is an inequality between the  $m$  and  $n$  components. All pure horizontal spatial frequencies, having  $n=0$ , may move at up to 25Hz; but for pure vertical frequencies the maximum temporal frequency depends on the spatial component. Thus, coarse vertical frequencies may move at nearly 25Hz but fine ones can hardly move at all.

This restriction on movement of spatial frequencies for alias-free reproduction can be represented in another way. Instead of describing the limiting temporal frequency for each spatial frequency it is possible to derive the equivalent spatial bandwidth for the moving object; this concept is sometimes referred to as dynamic resolution. To derive the equivalence it is necessary to use the result proved above, that the spectrum of a moving object lies in a tilted plane, and to find where the tilted plane cuts the limiting surface.

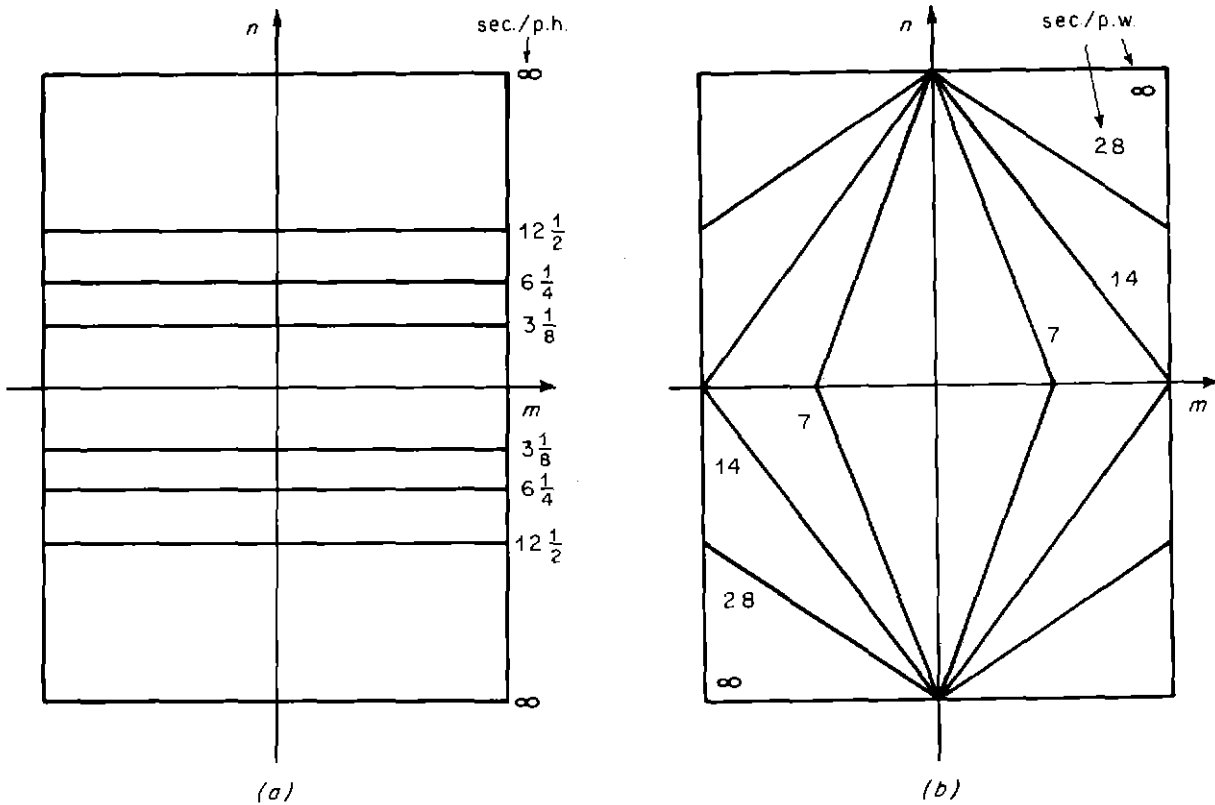
The projection of the intersection on the  $m$ - $n$  plane then gives the spatial bandwidth. This is shown in figure 24 for pure horizontal, pure vertical, and diagonal movement. It is clear that, for alias-free reproduction, horizontal and vertical movement are treated very differently.

Using the concept of dynamic spatial resolution it is possible to describe the action of any three-dimensional filter in a more tangible way.

As in section 4.2 the chrominance components of the PAL signal are centred on their respective carriers and so the positions of these carriers in the three-dimensional space must be determined.

Figure 25a shows the principal interpretations of subcarrier frequency having the lowest values of  $n$  and  $f$ . These points mark the centres of the regions of  $U$  chrominance and their co-ordinates are  $\pm(284, 78, 18\frac{1}{2})$  and  $\pm(283, -235, -6\frac{1}{2})$ ; also shown are the positions of the principal interpretations of the  $V$  chrominance carrier. It will be recalled that these are really a series of carriers whose co-ordinates are  $\pm(283\pm r, -79, -18\frac{1}{2})$  and  $\pm(284\pm r, 234, 6\frac{1}{2})$ .

For clarity a section of figure 25a at a value of  $m$  equal to 284 is shown in figure 25b. The carrier positions are well separated from the origin, i.e. the  $m$  axis. Thus the carrier of coarser vertical frequency has the finer temporal frequency. This is assured by the 25Hz offset of the subcarrier frequency from quarter line-frequency. Without this offset the temporal frequencies of the carriers would be interchanged so that the coarser vertical frequency would be associated with the coarser temporal frequency. This would be undesirable



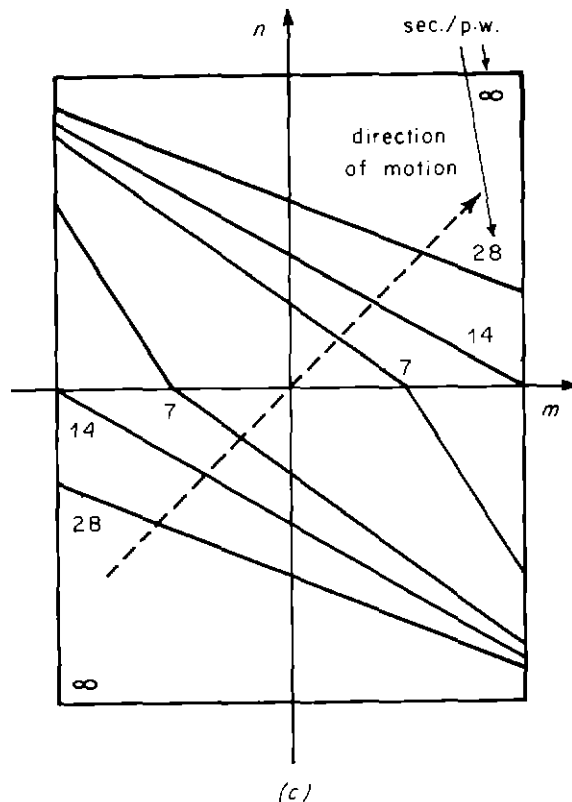
**Fig. 24** The luminance dynamic resolution for alias-free reproduction  
 a. vertical motion      b. horizontal motion  
 c. 45° diagonal motion

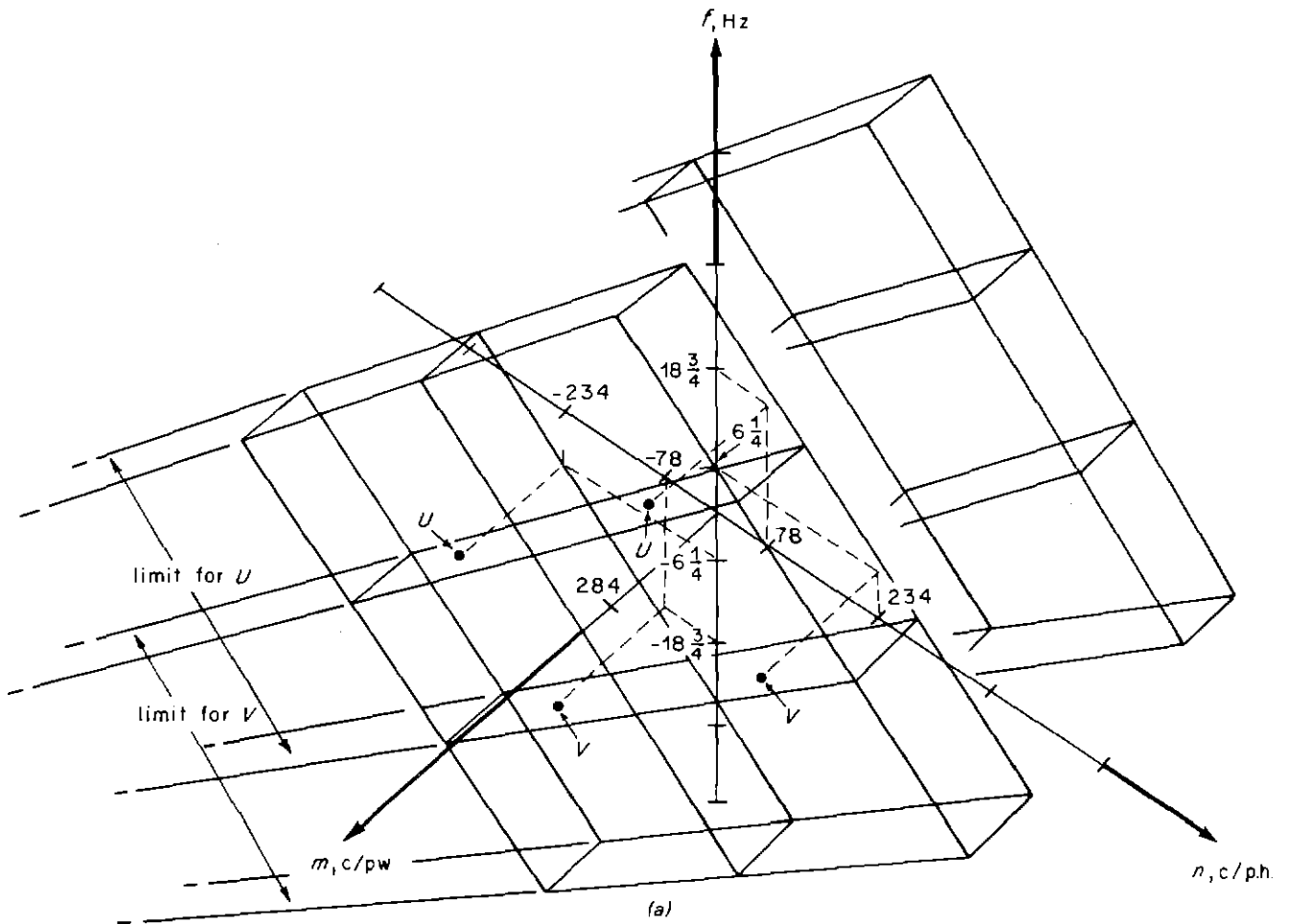
from the point of view of the visibility of cross-colour and cross-luminance.

Figure 25 also shows the alias-free limit of chrominance frequencies that can be handled by the system. Although this limit avoids  $U/U$  or  $V/V$  confusion, it does not take cross-colour into account; to avoid this, further limitation is necessary, as will be seen. The alias-free  $n$ - $f$  cross section is the same as for the luminance, but the limiting of  $|m|$  to, say, 83, means that the alias-free volume for the chrominance is a somewhat thinner rhombic prism. The dynamic resolution is thus the same as in figure 24 except that the horizontal resolution is cut off at a lower limit.

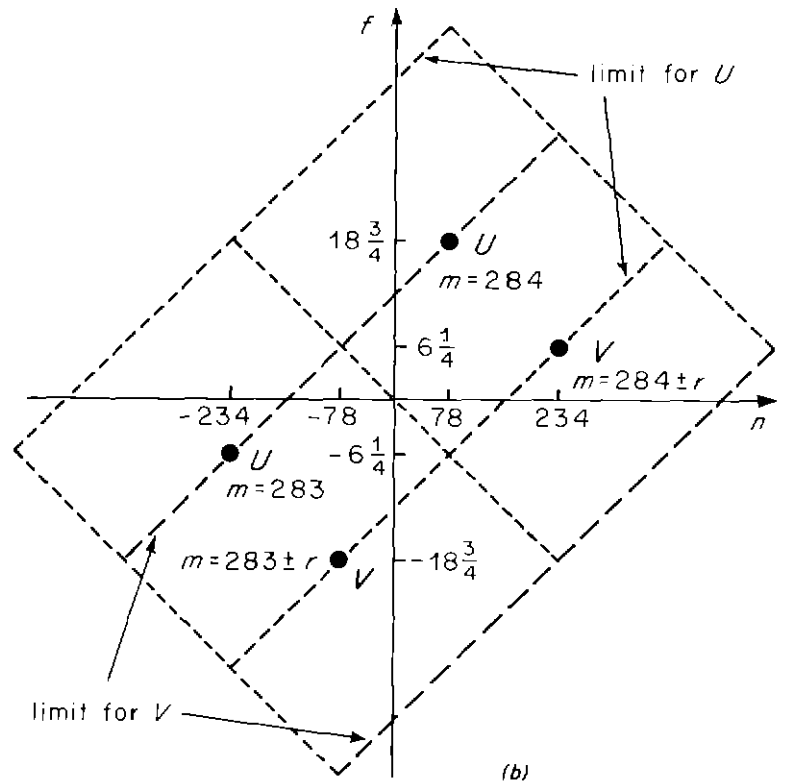
### 5.5 Intra-field filters

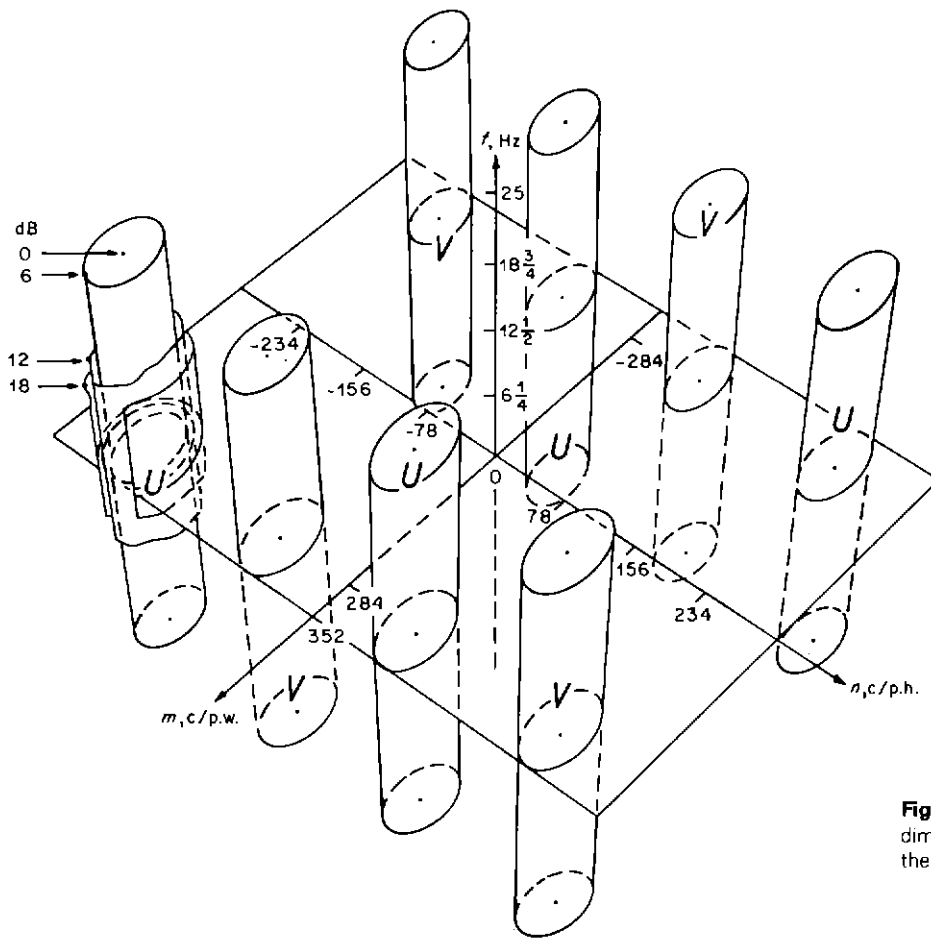
Using the representation of figure 25 it is possible to consider further the effects of the filters developed in section 4. Figure 26 shows the general characteristic of these filters. The diagram shows that because no variation along the  $f$  axis is possible the filter fares badly when trying to select the regions near the chrominance carriers. Its indiscriminate action also selects the stationary luminance with the same spatial co-ordinates as the carriers so that the luminance characteristic (which is the complement) has no components in these areas.



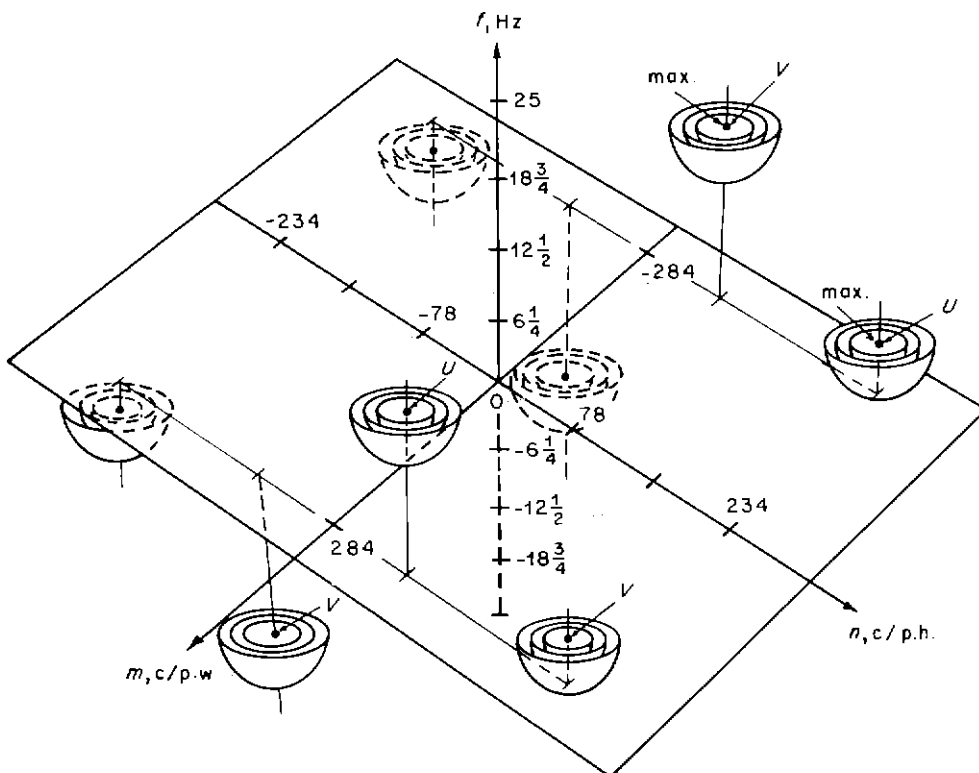


**Fig. 25** The positions of the chrominance regions in the three-dimensional spectrum  
 a. perspective view  
 b. projection perpendicular to  $m$  axis





**Fig. 26** The general three-dimensional characteristic of the intra-field filters



**Fig. 27** An outline of the required three-dimensional filter characteristic

However, the diagram also points the way towards the kind of filter characteristic that would overcome the problem; figure 27 shows an outline of such a characteristic. It varies along the  $f$  axis and thus the filter cannot be purely of an intra-field nature. Before it is possible to define the areas of the maxima and minima, however, it is necessary to know whether such a characteristic is reasonable, and this can be attempted by making assumptions about the eye's characteristics and finding the corresponding representation of the idealised PAL signal.

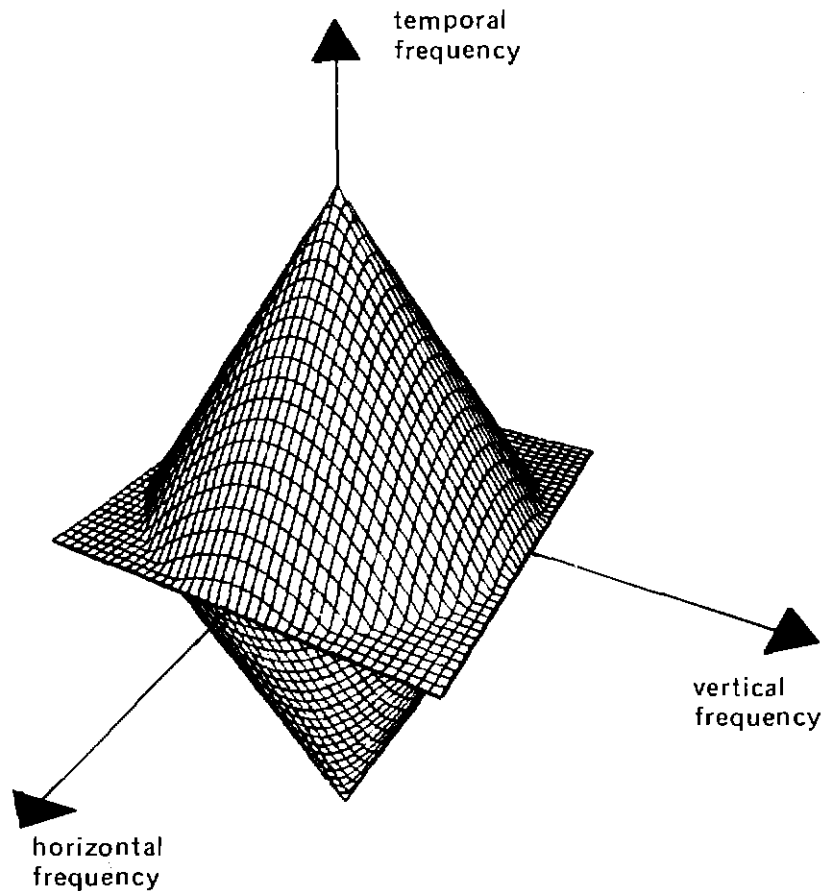
**5.6 A model for the idealised PAL signal**

Suppose, firstly, that the eye's spatial resolution is inversely related to its temporal resolution. This is a reasonable assumption based on known properties of the eye<sup>3,4,5</sup>. A convenient relationship would be a linear decrease of temporal resolution with increasing spatial resolution because this is implicit in the way interlace is assumed to work. As the eye's spatial resolution is very nearly isotropic, the eye's characteristic in three-dimensional frequency space can be assumed to be a surface of the form shown in figure 28; i.e. it can be represented by two cones, base to base. In reality, the eye's characteristic is exceedingly complex, but the surface of figure 28 is a good approximation to a typical surface of constant spatio-temporal response.

Suppose, secondly, that surfaces of this shape represent the characteristic of the eye's response to both luminance and chrominance. The relative dimensions will be different in the two cases; for example, it is known that the eye's spatial resolution for chrominance is much less than that for luminance.

Suppose, then, that the spectrum of the original scene is filtered so that all components beyond the bounds of the surface are eliminated. Then the spectrum of the PAL signal would be bounded by surfaces like that of figure 28, one centred on zero frequency for the luminance and one each centred on the chrominance carriers. A perspective view is shown in figure 29. Moreover, because of the scanning action, the whole structure would repeat according to the pattern of figure 21.

It now only remains to specify reasonable dimensions for the surfaces. It will be recalled that for system I there is potentially more vertical resolution than horizontal. This is not accidental for it has long been known that the full vertical potential cannot be realised due to display imperfections. (A display with a 'box-car' persistence characteristic would be free from these imperfections.) It would seem reasonable, therefore, to limit the required luminance vertical-resolution to the same value, in absolute terms, as the horizontal resolution. Thus the luminance cone radius corresponds to 5.5MHz or 234 c/ph. The maximum tem-



**Fig. 28** A typical surface representing the locus of constant spatio-temporal response of the eye.

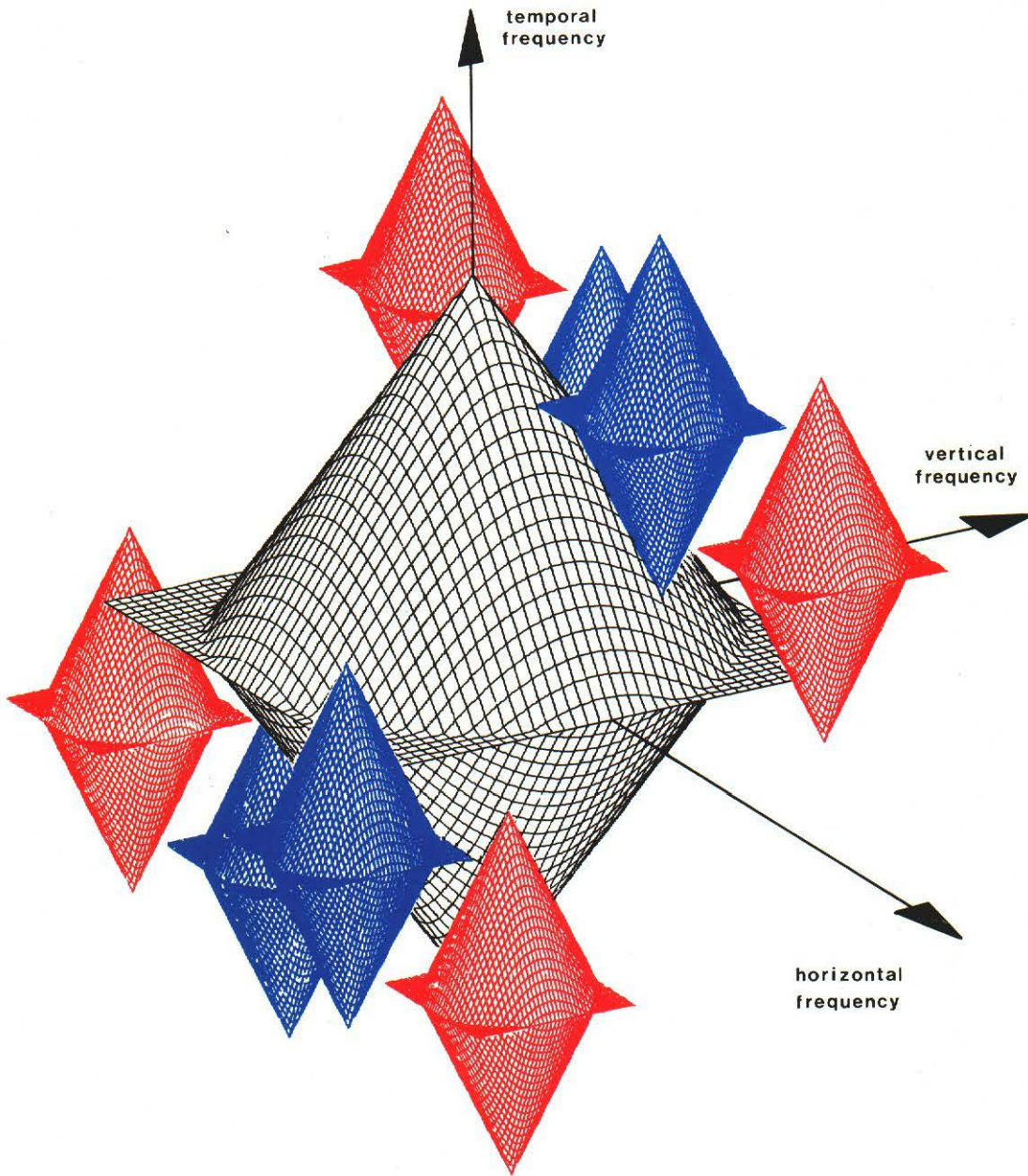


Fig. 29 Perspective view of the ideal PAL signal spectrum

poral resolution, that is, the cone height, can be 25Hz without aliasing.

The chrominance spatial resolution is more open to question. For example, the equivalent present isotropic radius of 1.68MHz derived in section 4.3.3 could be taken. For simplicity, the figure of 1.84MHz will be assumed; this corresponds to 78 c/ph which is one quarter of the theoretical maximum vertical resolution. The maximum temporal resolution of the chrominance cannot be 25Hz because it would then interfere with the luminance. Suppose, therefore, that it is limited to 12.5Hz; this would mean that the chrominance dynamic resolution would still decrease more slowly than the luminance resolution. Both dynamic resolutions are shown in figure 30.

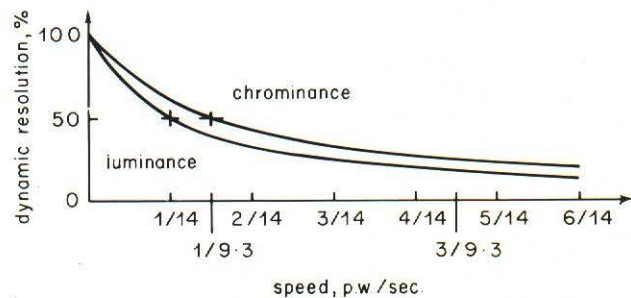


Fig. 30 Relative dynamic resolutions of the luminance and chrominance in the ideal model, as percentages of the static resolution

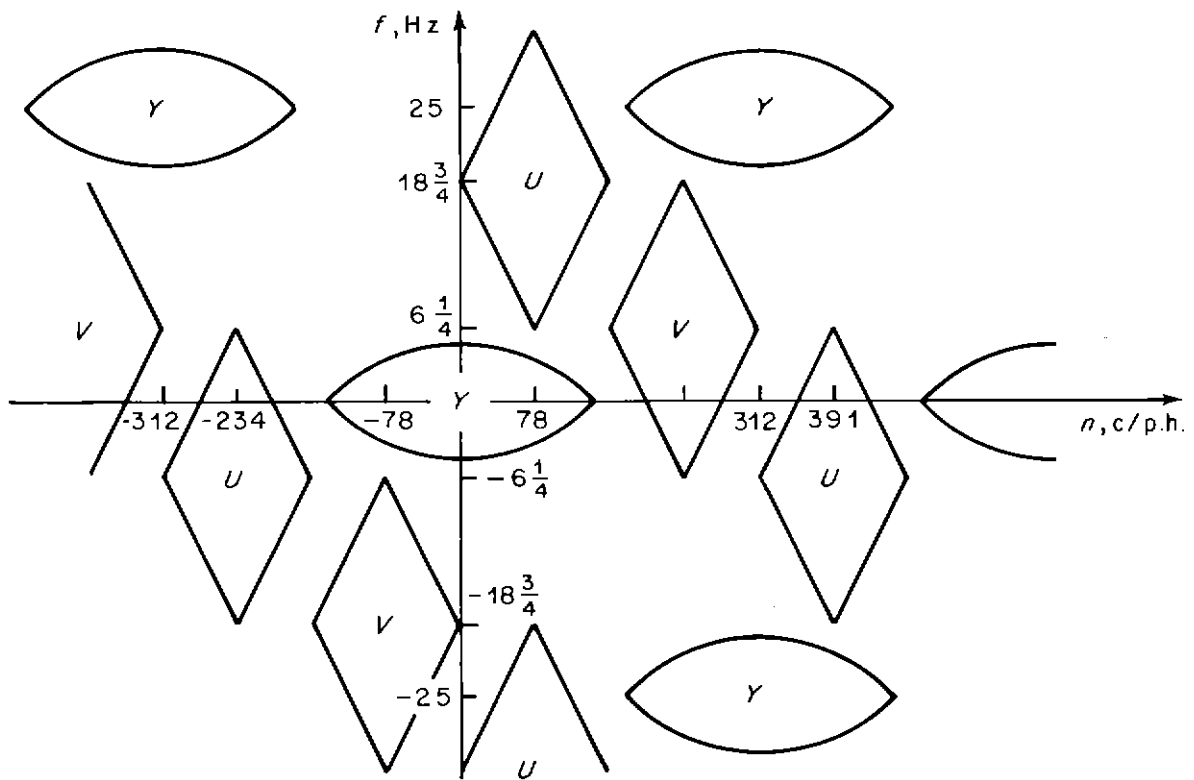


Fig. 31 Section of the PAL spectrum at a value of  $m$  corresponding to 4.43MHz

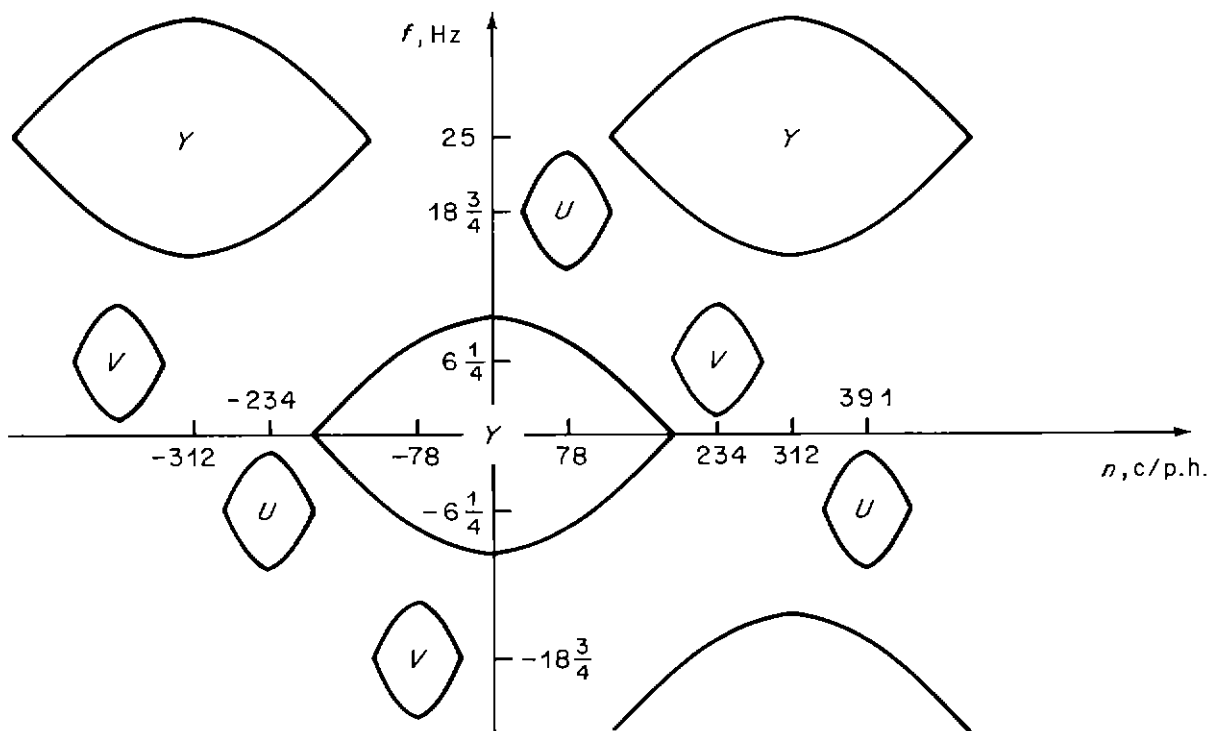


Fig. 32 Section of the PAL spectrum at a value of  $m$  corresponding to 3.3MHz

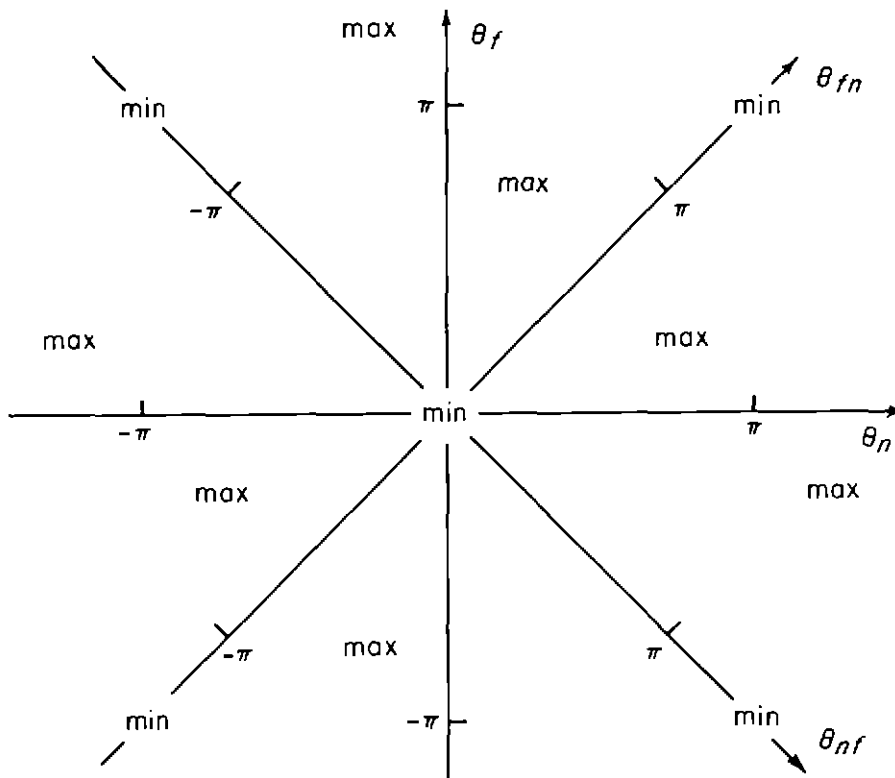


Fig. 33 Section of the three-dimensional characteristic of figure 27 expressed in terms of normalised variables

If the luminance and chrominance surfaces have these dimensions a section of the three-dimensional frequency space perpendicular to the  $m$  axis and centred on the value 284 (roughly 4.43MHz) would appear as in figure 31. With the values shown, the luminance and chrominance areas do not overlap in this plane. Moreover, they do not overlap for other values of  $m$ . As  $m$  decreases, the luminance area grows, showing that faster movement is allowed, but the chrominance areas shrink from their maximum values of figure 31. Figure 32 shows a cross section centred on an  $m$  value of 213 (roughly 3.3MHz); the separation of the luminance and chrominance areas is about the same as in figure 31. These figures illustrate that, in terms of the above assumptions about the visual process, there is ample room, in three-dimensional terms, for the colour spectral energy.

### 5.7 Possible spatio-temporal filters

Only the simplest ones will be discussed here, but it is easy to see how the method of derivation can be extended. Figure 31 defines more precisely the areas of maximum and minimum response at an  $m$  value of 284. The variation with  $m$  can be achieved by cascading the vertical-temporal filter with a horizontal, i.e. simple bandpass, filter. Although this is a variables-separable approach for  $m$ , experience with low-order filters discussed previously suggests that they behave fairly isotropically. But clearly the required  $n$ - $f$  characteristic is not variables-separable and cannot be obtained by cascading vertical and temporal filters.

The required characteristic can be re-defined in terms of normalised variables  $\theta_n$  and  $\theta_f$  as shown in figure 33. These are defined in terms of the vertical-temporal sampling lattice

of the interface system, shown in figure 22. In this treatment the temporal skew of the vertical points is ignored. The definitions of  $\theta_n$  and  $\theta_f$  then become

$$\theta_n = 2\pi n Y$$

$$\theta_f = 2\pi f T$$

where  $Y$  is the vertical pitch of the picture lines measured in picture heights and  $T$  is the field period (for system I these quantities are  $625^{-1}$  and  $50^{-1}$ ).

At first sight the realisation of a function like that of figure 33 appears difficult. The problem can be greatly simplified, however, by rotating the axes through  $45^\circ$  as shown. In terms of the new variables  $\theta_{nf}$  and  $\theta_{fn}$  the ideal function is now considerably easier to express and amounts to the product of square-wave variations in both axes; the period in the  $\theta_{nf}$  direction is, however, half that in the  $\theta_{fn}$  direction. This means that the Fourier coefficients of the filter are spaced twice as far apart in the  $y$ - $t$  direction as they are in the  $t$ - $y$  direction.

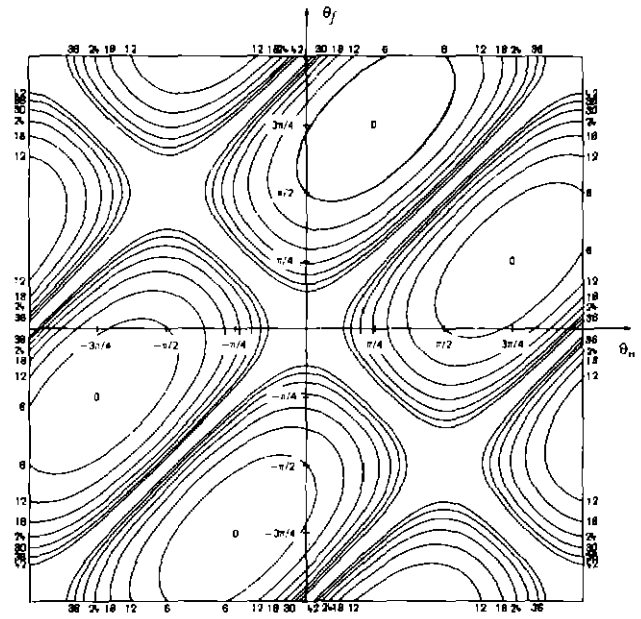
The simplest function that gives a pattern of maxima and minima as shown in figure 33 is the product of cosine variations along both axes, the frequency along  $n$ - $f$  being twice that along  $f$ - $n$ . Mathematically, this is given by

$$\frac{1}{4}(1 - \cos 2\sqrt{2}\theta_{nf})(1 - \cos \sqrt{2}\theta_{fn}).$$

A section of the characteristic is shown in figure 34. Comparing figure 31 and figure 34 it can be seen that the areas of maximum response, corresponding to the chrominance areas, are elongated in the  $\theta_{fn}$  direction and compressed in the  $\theta_{nf}$  direction; this is a natural consequence of trying to filter out the  $U$  and  $V$  areas separately. The pattern of



**Fig. 34** Section of the characteristic of the simplest filter that separates *U*, *V*, and *Y*

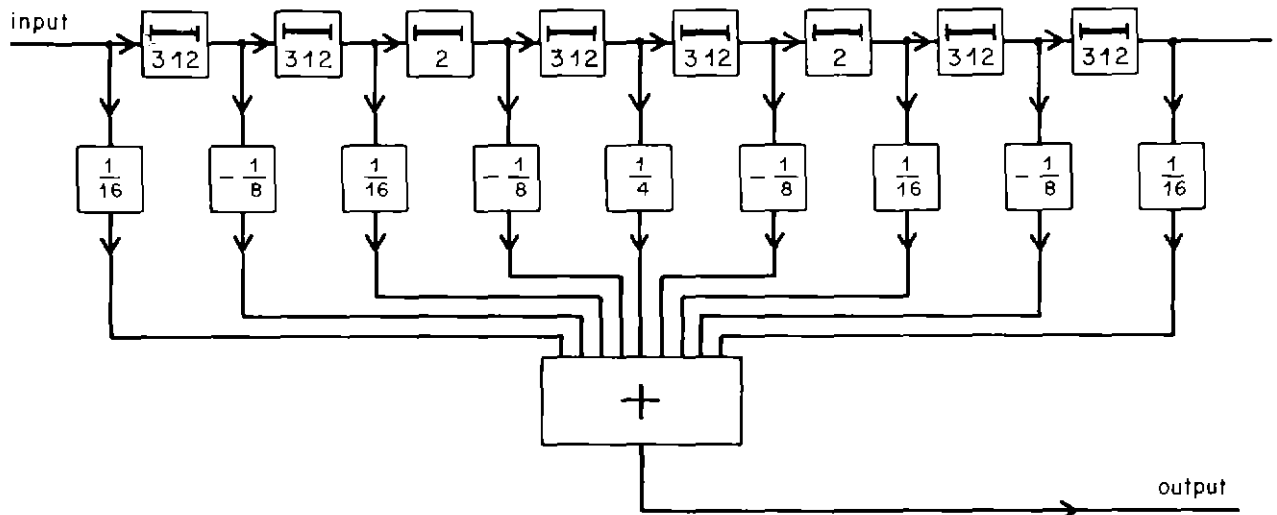


		LINES			
FIELDS	0	1/16	0	0	
	-1/8	0	0		
	1/16	0	-1/8	0	
	0	1/4	0		
	0	-1/8	0	1/16	
	0	0	-1/8		
	0	0	1/16	0	

**TABLE 4** Spatio-Temporal Filter Coefficient Arrays

Separate *U-V* filter

		LINES	
FIELDS	0	-1/4	
	1/2		
	-1/4	0	



**Fig. 35** The realisation of the filter having the characteristic of figure 34. The numbers are amounts of delay in line periods

weighting coefficients corresponding to this filter is shown in table 4. The greater resolution in the  $\theta_{nf}$  direction is reflected in the greater coefficient spacing in the  $y-t$  direction. The pattern extends in time over six field periods and vertically over six picture lines. Such a filter would be realised by the arrangement of figure 35. A compensating delay of 938 lines would be necessary in the arrangement of figure 3.

An even simpler solution is to avoid separating the  $U$  and  $V$  areas at the expense of losing the luminance in the region between them. According to the visual model, the loss of this luminance information is of little consequence. The required filter response is then a continuous maximum band in the  $\theta_{nf}$  direction as shown in figure 36. The simplest function which satisfies this condition is given by  $\frac{1}{2}(1 - \cos\sqrt{2}\theta_{nf})$  and is illustrated in figure 37; the coefficient pattern for the filter is included in table 4. As can be seen, the pattern now extends over only two field periods. The realisation of such a filter is shown in figure 38; a compensating delay of 312 lines would be necessary.

The matched-system chrominance, luminance, and cross-signal characteristics using this filter are shown in figure 39. Compared with the intra-field filters it can be seen that these characteristics represent a considerable improvement. For example, the stationary chrominance vertical-bandwidth down to the 12dB points is now plus or minus one half the theoretical maximum compared with the plus or minus one eighth for the intra-field filters.

Compared with the idealised model of the PAL signal, exemplified in figure 31, the characteristic of this filter is generous. For example, the channel of unity response in the  $\theta_{nf}$  direction means that pure upward vertical motion of  $12\frac{1}{2}$  sec/ph is not spatially filtered at all.

The dynamic resolution of the luminance down to the  $-12$ dB level for various motions is shown in figure 40. This should be compared with figure 24 which is plotted over the same range. The dotted areas show the dynamic resolution corresponding to the ideal model. Assuming an ideal band-pass filter of, say,  $\pm 1.3$  MHz, the resolution is, of course, unaffected below  $3.1$  MHz. Above  $3.1$  MHz certain spatial frequencies are lost or attenuated, the pattern of loss depending on the amount and direction of movement. Stationary pictures have a resolution which is nearer the isotropic ideal than that given by the intra-field filters. Pure upward motion increases the vertical resolution at first; pure downward motion decreases it. Pure horizontal motion gives a skew sinusoidal pattern of attenuation. For fast horizontal motion the striations of the pattern become nearly perpendicular to the  $m$  axis.

The dynamic resolution of the demodulated chrominance is shown in figure 41 over the vertical range  $\pm 312\frac{1}{2}$  c/ph. The behaviour is generally the same as for the luminance except that it is centred on the origin. Stationary pictures have a rectangular resolution characteristic with a vertical limit of  $\pm 156\frac{1}{2}$  c/ph at the  $-12$ dB points. Pure upward motion increases the limit at first, pure downward motion decreases it, and pure horizontal motion gives a skew pattern as before. Severe motion causes the spectrum to break up into bands.

The subjective effect of this dynamic resolution is uncertain. However, it can be confidently stated that with the visual model of section 5.6 as a guide, the subjective impair-

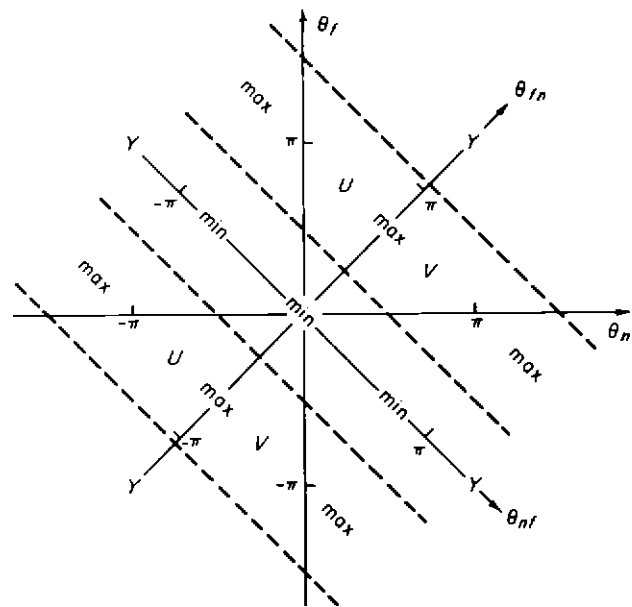


Fig. 36 Outline of filter characteristic which separates  $U$  and  $V$  from  $Y$

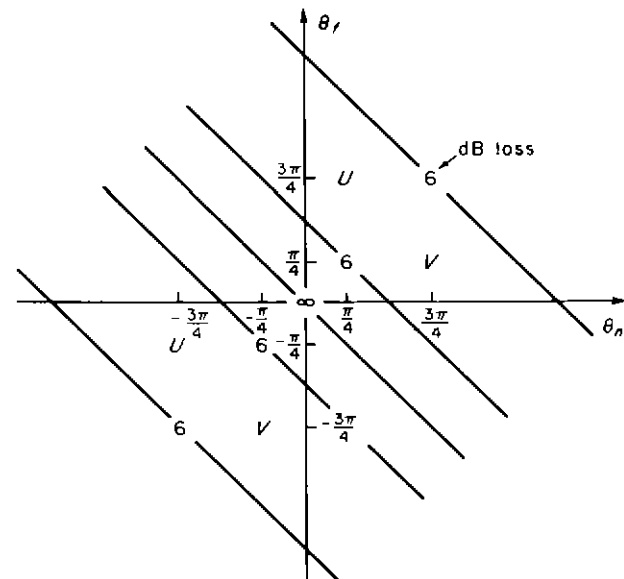


Fig. 37 Section of the characteristic of the simplest filter which separates  $U$  and  $V$  from  $Y$

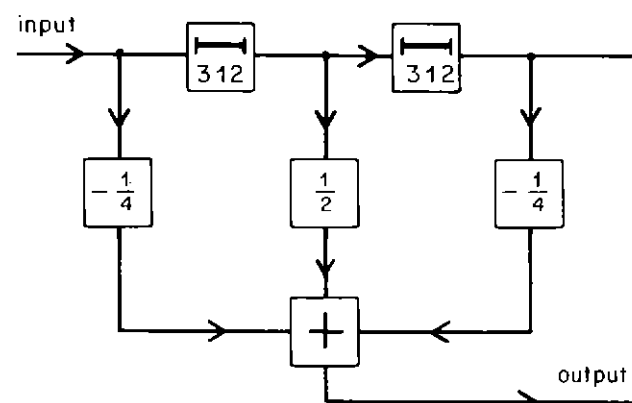
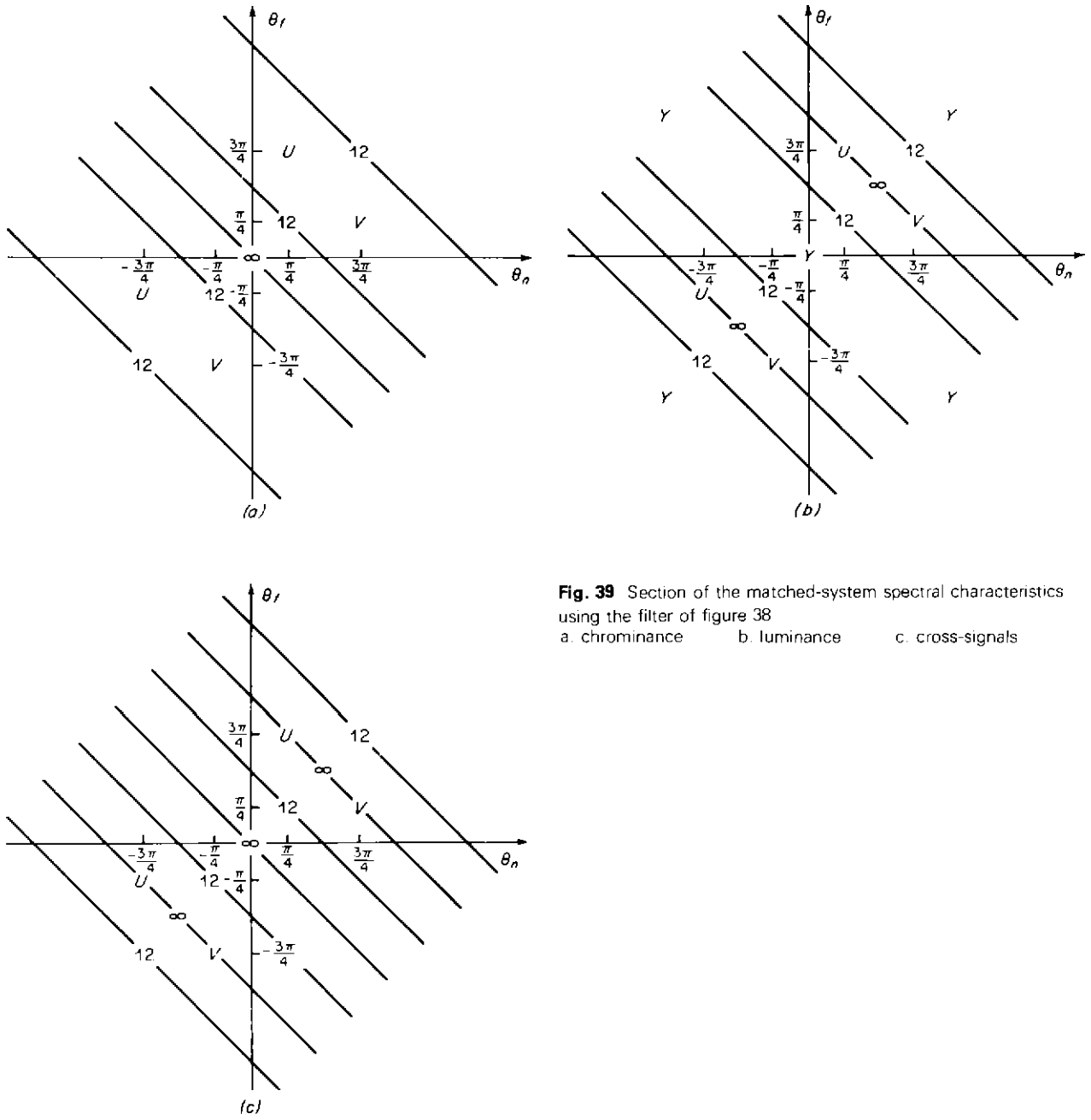
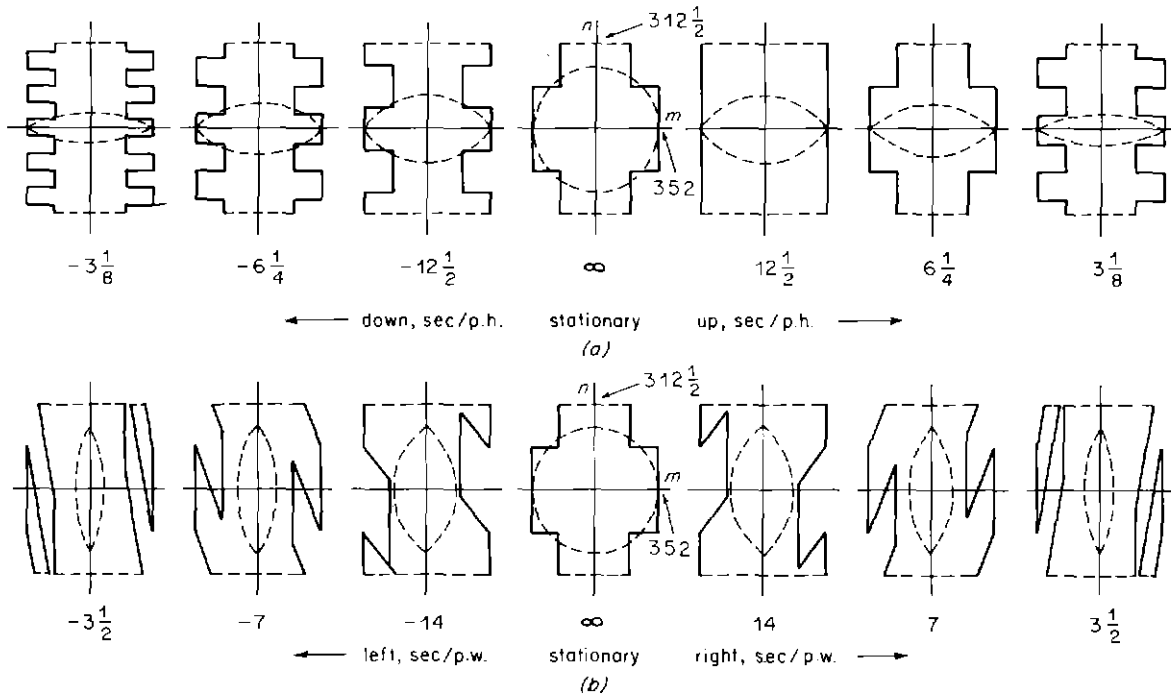


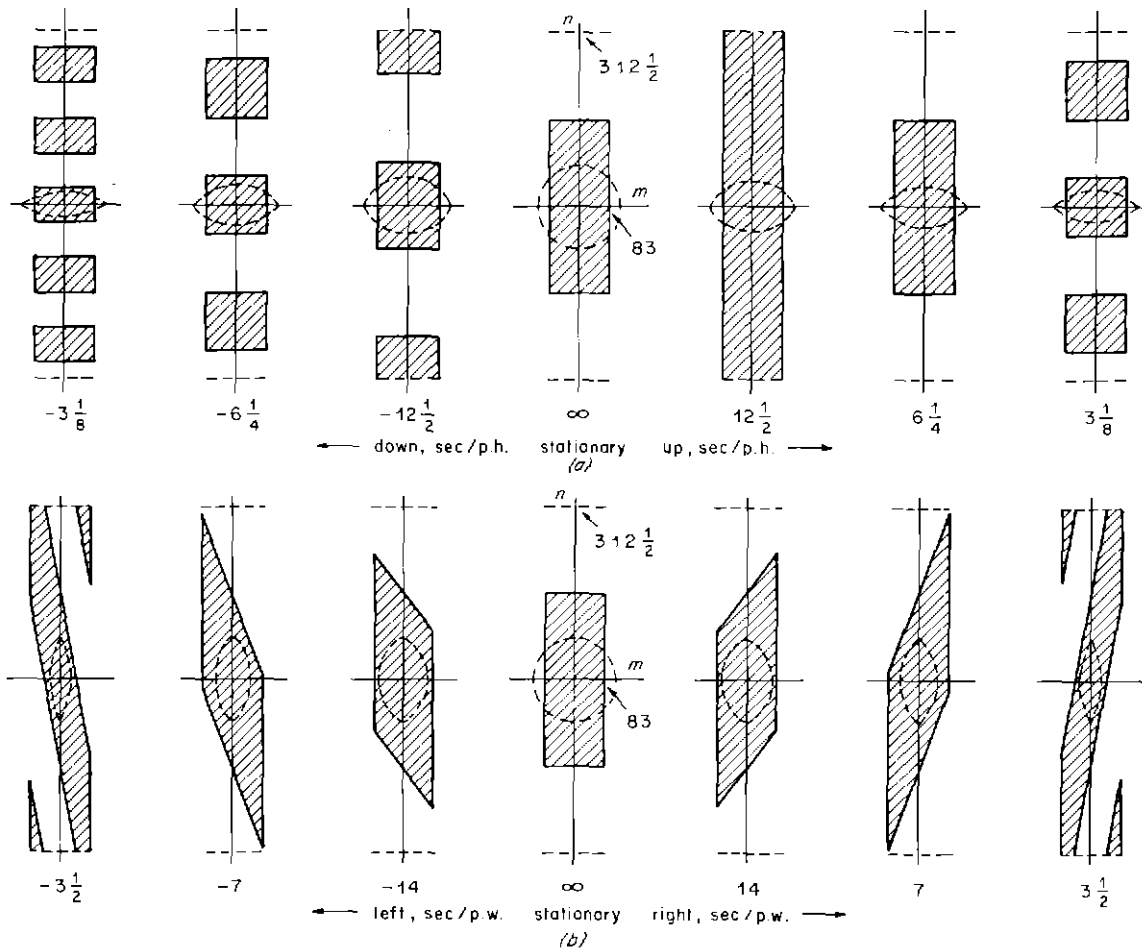
Fig. 38 The realisation of the filter having the characteristic of figure 37



**Fig. 39** Section of the matched-system spectral characteristics using the filter of figure 38  
 a. chrominance      b. luminance      c. cross-signals



**Fig. 40** Dynamic luminance resolution of the matched system down to  $-12\text{dB}$  using the filter of figure 38 in conjunction with an ideal bandpass filter  
 a. vertical motion      b. horizontal motion



**Fig. 41** Dynamic chrominance resolution of the matched system under the same conditions as in figure 40  
 a. vertical motion      b. horizontal motion

ment will be minimal. The curious effects will be outweighed by the eye's loss of dynamic resolution.

### 5.8 Filtering at only one end of the system

If such a filter is used only at the coder, then the decoder chrominance circuits will accept signals from all the spectral space, and cross-colour will be produced by the residual luminance. The luminance removed at the coder will be that which causes the slow-moving cross-colour on stationary pictures, since it lies near the chrominance carriers; however, the fast-moving cross-colour will remain. With moving pictures in which the movement is such that it would have caused slow-moving cross-colour, then the cross-colour is removed.

Equally, the decoder luminance circuits will accept all signals so that cross-luminance will be produced by the residual chrominance. The chrominance removed at the coder will be that which causes the coarse vertical-frequency, slow-moving cross-luminance. But the fast-moving and fine vertical-frequency components remain. In particular the chrominance carriers themselves are present so that, as with the intra-field filters, a conventional notch filter must be included in the decoder luminance path.

If the filter is used only at the decoder then it is the fast-moving components that are eliminated. Thus the slow-moving cross-colour and slow-moving coarse cross-luminance remain. In particular, the chrominance carriers are rejected so that a luminance notch filter is unnecessary.

The effects of the permutations of filter position are shown in table 5.

TABLE 5

		CODER	
		No filtering	Filtering
DECODER	No filtering (other than notch filter)	1	2
	Filtering	3	4

1. Present situation.
2. Satisfactory luminance diagonal and chrominance vertical resolution on stationary pictures. Slow-moving cross-colour eliminated. Fast-moving cross-colour and cross-luminance of high probability remains on stationary pictures. (Thus subcarrier luminance patterning is present in full amplitude unless an additional luminance notch is present in the decoder.) Certain forms of movement have reduced spatial resolution.
3. Satisfactory luminance diagonal and chrominance vertical resolution on stationary pictures. Fast-moving cross-colour eliminated. Slow-moving cross-colour and cross-luminance of low probability remain on stationary pictures. Certain forms of movement have reduced spatial resolution.
4. Satisfactory luminance diagonal and chrominance vertical resolution on stationary pictures. No cross-colour. Certain forms of movement have reduced spatial resolution.

### 5.9 Summary

With the aid of a three-dimensional spectral model a form of filter has been derived which, when used in a matched system, conveys the maximum amount of information in the luminance and chrominance channels without interaction. For stationary pictures the luminance resolution is somewhat better than with the intra-field filters and the

chrominance resolution is considerably better. For moving pictures the loss of resolution is thought to be significantly less than that occurring in the eye.

## 6 A simplification for the matched system

A certain simplification is possible, within the confines of a matched system like that of figure 3, if the filters used are first-order, that is, having a  $\cos^2$  frequency characteristic. This is simply to assume that the  $\cos^2$  function describes the overall characteristic rather than that of the individual filters. This means that the individual filters have a cosine characteristic which can be realised by taking equal weights across a single delay element. On this basis, a system using two-dimensional filters becomes as shown in figure 42a, whilst one using three-dimensional filters becomes as shown in figure 42b; not only is the filter delay halved but also the large wideband compensating delay at the decoder is unnecessary.

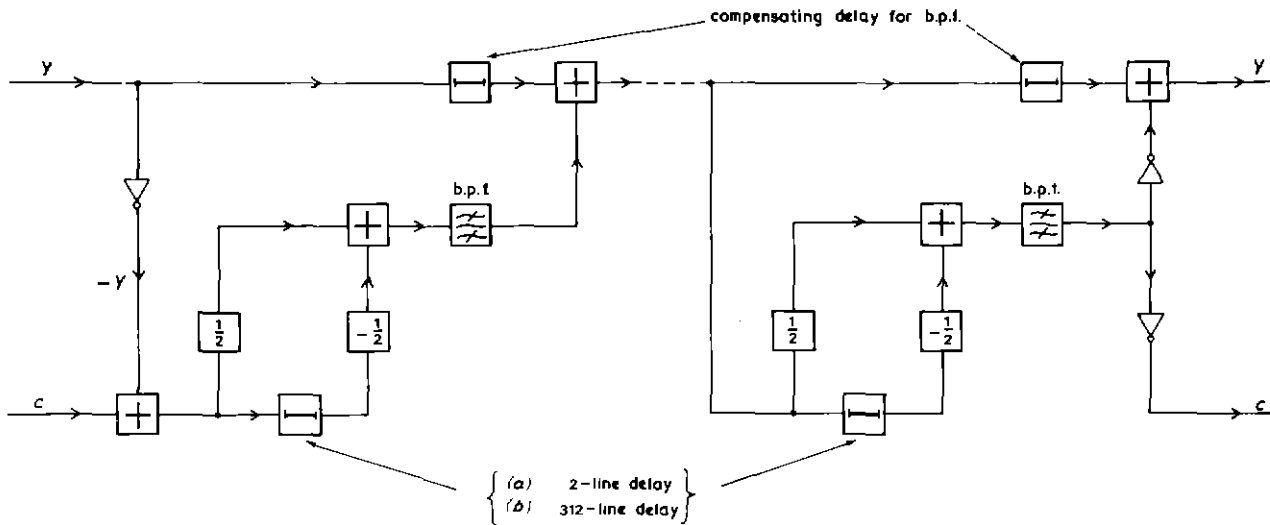
The difficulty with this type of filter is that it is not phase-corrected because the group delay of the filter corresponds to a point that lies vertically midway between the scanning lines. However, when two such filters are cascaded the resultant is phase-corrected. Thus the filter can be used provided that it is acceptable to have a non-phase-corrected signal at the coder-decoder interface. The wideband delay at the coder ensures that the overall vertical registration is preserved. Further, the cross-signal level has a maximum amplitude of  $-6\text{dB}$  instead of  $-12\text{dB}$ . The potential cost-saving using a filter such as that shown in figure 42b would, of course, be considerable when compared with those outlined in figures 35 and 38.

## 7 Conclusions

The present methods of coding and decoding the PAL signal are not as effective as they could be in combining and separating the luminance and chrominance signals. As a result, mutual interference occurs which can be very objectionable for certain scenes. This article has studied methods whereby luminance and chrominance are confined to distinctly separate frequency bands before being combined, and are separated by suitable filters so that interference cannot occur. The filters which characterise these methods can be based on line stores (intra-field processing) or field stores (inter-field processing).

Using intra-field filters it is possible to obtain an increased horizontal chrominance bandwidth compared with that obtained at present and still preserve high-frequency luminance information; the conventional decoder notch filter is replaced by a more selective bandstop filter. The price paid is an additional loss of vertical chrominance resolution, but it is argued that such resolution is excessive at present, and the loss would be noticed only on test signals containing synthetic vertical detail.

Using inter-field filters it is possible to obtain a further increase in chrominance bandwidth and to preserve yet more of the luminance information at the expense of limitations on the spatial spectra of moving objects which are determined by the velocities with which the objects move. From published information on the characteristics of human



**Fig. 42** Simplified form of matched system using non-phase-corrected filters  
 a. two-dimensional      b. three-dimensional

vision, these limitations do not appear to be serious; nevertheless such information should be interpreted with some caution.

Although the potential advantages of the proposed methods rely upon the use of special filters at both the coder and decoder, some benefit would nevertheless be obtained by the use of a filter at only the coder. It is, however, possible that a relatively cheap solution based on simplified intra-field filters, could be used at both the coder and decoder. In this case the characteristics of the coder filter would be such that compatibility with existing decoders would need to be investigated.

The potential advantages of the proposed methods are immediately relevant to the transcoding of PAL to other colour standards; this, of course, would involve the incorporation of special filters in all PAL coders. Further, the introduction of more complex techniques, such as sub-Nyquist sampling

for digital coding, might benefit greatly from the more rigid spectral specification which the inter-field method implies.

### 8 References

1. Specification of television standards for 625-line system I transmissions. BBC and IBA, Jan. 1971.
2. MERTZ, P. and GRAY, F. A theory of scanning and its relation to the characteristics of the transmitted signal in telephotography and television. Bell Syst. Tech. J., 1934, Vol. 13, 3, pp 464-515.
3. ROBSON, J.J. Spatial and temporal contrast-sensitivity functions of the visual system. J. Opt. Soc. Am., 1966, Vol. 56, pp 1141-1142.
4. KELLY, D.H. Adaptation effects on spatio-temporal sine-wave thresholds. Vision Res., 1972, Vol. 12, pp 89-101.
5. BUDRIKIS, Z.L. Model approximations to visual spatio-temporal sine-wave threshold data. Bell Syst. Tech. J., 1973, Vol. 52, 9, pp 1643-1667.

## BBC/Post Office Digital Satellite-Transmissions

After ground tests in April 1976, the BBC and the United Kingdom Post Office successfully transmitted high-quality digital colour television and sound signals through an INTELSAT IV satellite in May 1976. This is believed to be the first time that System-I PAL television pictures have been transmitted digitally through a satellite. The pictures used included colour transparencies currently being considered as possible test pictures by the European Broadcasting Union, and BBC network pictures. The picture signals were transmitted from BBC Designs Department, London, in analogue form to the Post Office Earth Station at Goonhilly Downs and back, over Post Office s.h.f. permanent links.

The Post Office and the INTELSAT Manager agreed with the BBC that such transmissions would be worthwhile to investigate technical requirements and possible problems, particularly those associated with interfacing, interference, and synchronisation, relevant to possible operational digital transmissions in the future.

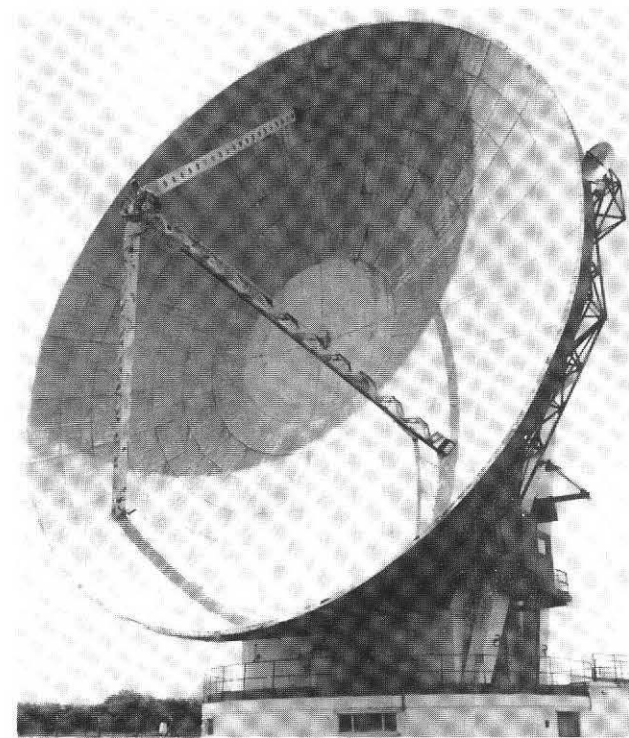


Fig. 2 Aerial I pointing at the INTELSAT IV (Flight 1) Indian Ocean satellite; elevation 5 degrees

A 60 Mbit/s multiplex signal was transmitted; it was generated in experimental equipment built in BBC Research Department. The signal was split into two 30 Mbit/s parallel streams plus a clock signal before being fed to the BBC/Post Office interface at the input to a differentially encoded quadrature-phase-shift keying (QPSK) modulator built by Post Office Telecommunications Development Department. The 70 MHz i.f. output from the QPSK modulator was up-converted to s.h.f., amplified, and transmitted through Aerial I to the Indian Ocean INTELSAT IV (Flight 1) satellite and back again, using a 'full-bandwidth' transponder with a 36 MHz r.f. bandwidth.

The 60 Mbit/s signal comprised one video-audio 'package'; two of these had been interleaved in the BBC/Post Office 120 Mbit/s cable-transmission experiments reported in 'BBC Engineering' No. 102. The 60 Mbit/s package consisted of a multiplex of one digital PAL colour video signal with a nominal bit-rate of optionally 44.3 or 53.2 Mbit/s, and one 2048 kbit/s multiplex signal for sound channels. The two signals in the 60 Mbit/s multiplex were not synchronised, i.e. their precise bit-rates were independent of each other and also of the resultant 60 Mbit/s bit-rate.

The video channel employed sub-Nyquist sampling at a rate equal to twice the colour subcarrier frequency of the PAL signal (i.e. at about 8.9MHz). After quantising with eight bits per sample, the bit-rate was reduced optionally to five or six bits per sample, using a form of differential pulse-code modulation. The resultant bit-rate was 53.2 Mbit/s (a dummy sixth bit being used in the five-bit option) which, after the application of Wyner-Ash convolutional error-correction coding, was increased to 56.8 Mbit/s.

To facilitate reliable recovery of the QPSK carrier signal in the demodulator (developed for the Post Office by Marconi Research Laboratories), in which only 36 MHz r.f. bandwidth was being used for the 60 Mbit/s baseband signal, the digital video bits were 'scrambled' using a self-synchronising scrambling technique. The scrambling and unscrambling were done before and after error-correction coding and decoding, respectively, thereby eliminating unacceptable effects of bit-error extension.

The sound channels of 15kHz bandwidth were coded using a 'near-instantaneous' digital companding technique to enable six such channels to be fitted into a bit-rate of 2048 kbit/s, which is the bit-rate of the first-order multiplex in the new digital communications network under development by



**Fig. 4** 60 Mbit/s digital video and audio satellite-transmission experimental equipment. The Post Office four-phase modulator and demodulator is on the left. The BBC baseband equipment is at the centre and on the right.

the Post Office. For the field trials, two of the six sound channels were equipped.

The elevation of the aerial beam above the horizon was necessarily small, namely about five degrees, which is about the smallest elevation for satisfactory analogue or digital transmission. Consequently, careful adjustment of parameters such as group-delay equalisation of filters was needed. When this was done a bit-error rate of about 1 in  $10^6$  was attained, which was adequate, using error correction, for high-quality picture transmission.

Informal subjective assessments of the picture and sound quality obtained during the experiments suggested the long-term possibility of attaining slightly higher quality using

digital techniques rather than analogue f.m. techniques, without requiring additional r.f. bandwidth or incurring unacceptable interference between channels. This possibility will be studied further in the broader context of efficient use of satellite channels having usable r.f. bandwidths both narrower and wider than the 36 MHz used in these experiments. However, the current use of equipment employing f.m. transmission techniques, which provides a service even under degraded propagation conditions or in reduced bandwidth situations such as two television channels per 36 MHz transponder, makes it unlikely that analogue f.m. will be superseded by digital techniques in the near future.



## Contributors to this issue



**J. O. Drewery** graduated at Cambridge and afterwards took a Ph.D. in Electronic Engineering at the same University. He entered the BBC Research Department in 1968 and was involved with the field store standards converter and the digital line standards converter. Since 1972 he has been with Image Scanning Section and his main interest has been in the field of image enhancement using digital techniques.



**John Ford** joined the BBC as a Youth-in-Training at the Exeter low-power transmitting station in 1945 and in the same year he moved to London Outside Broadcasts. For 12 years he was an engineer in the OB Unit and in 1958 he was placed in charge of OB planning and allocations. In 1969 he was appointed Operations Manager, Radio OBs.



**R. C. Harrison** joined the BBC in 1963 and, after a short training period in the Central Maintenance Unit, was attached to the Transcription Recording Unit of the BBC Transcription Services. Later as a Recording Engineer and then Senior Recording Engineer in the unit, he was involved in all the operational and technical aspects of a wide cross-section of Transcription Service's studio and mobile programme originations.

In 1973 he was made responsible for stereo radio output engineering and in 1975 he was given a wide-ranging brief to provide specialist assistance to Programme, Programme Operations and technical departments in the application of new or unusual programme-origination techniques.