

FULL-SIZE PLAN of the AMAZING "WIZARD"

Read our
**BEGINNERS'
COURSE**

Amateur Wireless

and
Radiovision

Every
Thursday

3^d

Vol. XXI. No. 537

Saturday, September 24, 1932

The
WIZARD
SIMPLE TO BUILD

Another
FREE
Supplement

wireless
MADE EASY

PERCY HARRIS'S
BUILD AS YOU LEARN

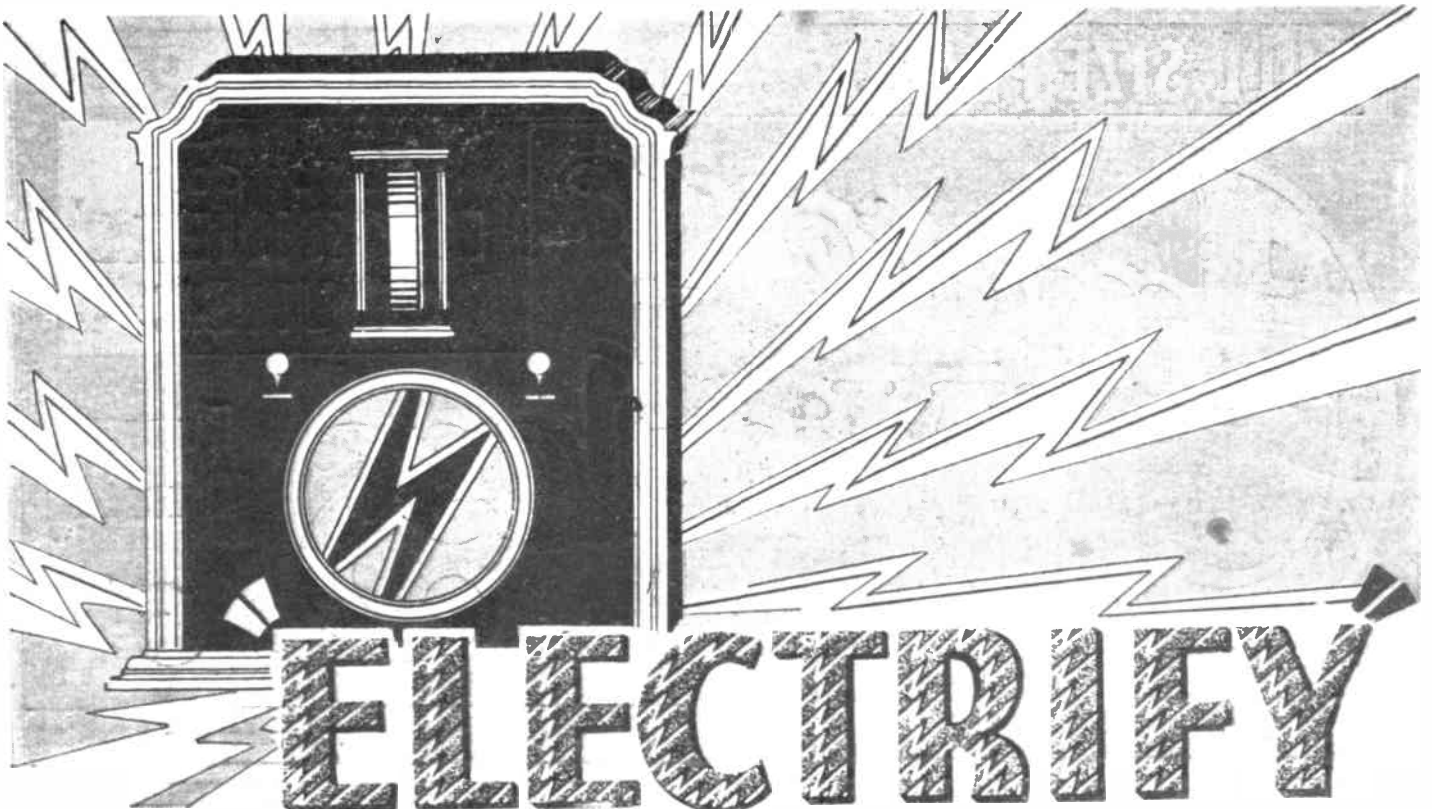

ELECTRIFY

YOUR SET WITH

PERTRIX

TRADE MARK

DRY BATTERIES AND ACCUMULATORS

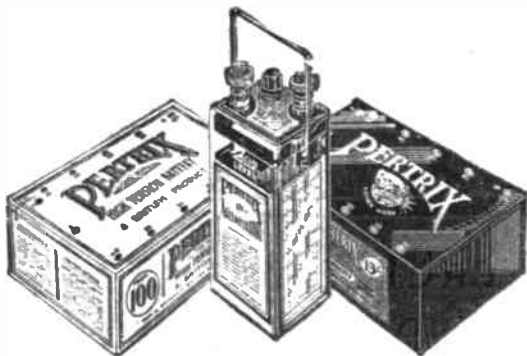

They will put new life into your set—new power to get stations that you have never heard clearly before—and they'll last longer; definitely longer, for they are made by a patent process which provides a recuperative quality unknown to other batteries. "Electrify" your set by Pertrix Power.

H.T. Batteries from 5/6

L.T. Accumulators from 4/6

Advt. of Britannia Batteries Ltd., 233, Shaftesbury Avenue, London, W.C.2. Telephone: Temple Bar 7971 (5 lines)
BRANCHES: Manchester, Bristol, Glasgow, Dublin, etc. Works: REDDITCH (Worcs.)

Advertisers Appreciate Mention of "A.W." with Your Order

NOW CONVERT YOUR SET TO A RADIOGRAM

Transform your Set to a thing of beauty with this Modern Walnut Cabinet that is the craftsman's last word in style and appearance. Decorated with carefully matched inlaid walnut veneers of contrasting colour. Hand french polished to reveal the hidden beauty of grain only to be found in the finest Walnut, while bringing to perfection the acoustic properties of the correctly proportioned speaker compartment. **Gives a new and better tone to your Set; adds beauty to your home at minimum cost.**

1933 ADAPTAGRAM

This 3 Guinea Cabinet makes your Set look worth 30 Guineas

MODEL A Never before such a clever and conveniently designed Cabinet for the instant conversion of your existing Set to a Radiogram. Comes to you with Vignotted front as illustrated and motor board, ready to take your own Set, Gramophone Motor and Pickup. No skill or expensive tools are required to transform your Radio into a combination instrument, presenting the professionally finished appearance of the most luxurious Radio Gramophone money can buy. Suitable for all popular Sets such as the Olympus Four, S.T.300, etc., etc., etc., described in "Popular Wireless," "Wireless Constructor," "Modern Wireless," and all other leading technical journals.

Dimensions: Height, 30 1/2 in.; width, 21 1/2 in.; depth, 15 1/2 in.; panel size: 18 x 8 in.; baseboard depth, 14 in. Speaker Compartment, 17 x 19 1/2 in.; Clearance between motor board and underside of lid, 4 in. Ready fitted with back. Baffle Board 3/8 extra if required.

- Designed by Peto-Scott—foremost for Cabinets since 1919—originators of the "Adaptagram Principle" in 1928.
- With Standard Vignette and shelf taking any Set of panel size not exceeding 18 in. wide, 8 in. high and baseboard 14 in. deep.
- Generous accommodation for Super H.T. and L.T. Batteries or full mains equipment.
- Constructed with room for mounting any type of Speaker behind the modern silk-covered fret.

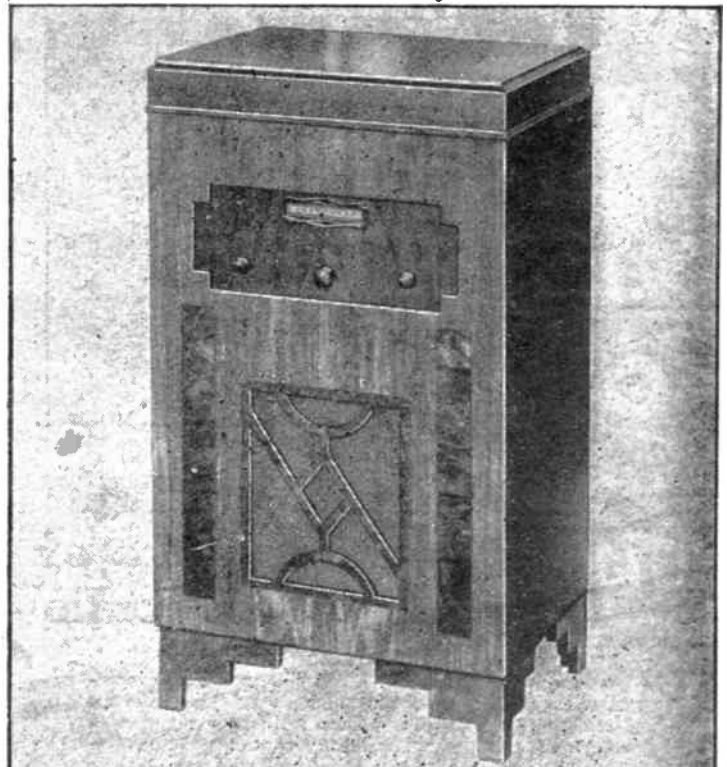

BUILT LIKE A FINE PIANO

**IT COMES TO YOU
DIRECT from our FACTORY**

Carriage and Packing 2/6 extra England and Wales.

MODEL "A"

63/-

CASH or C.O.D.

or 12 monthly payments of **5/9**

IMMEDIATE DELIVERY

PETO-SCOTT CO. LTD. 77, CITY RD. LONDON, E.C.1

Dear Sirs, Please send me CASH, C.O.D. or H.P.

1933 ADAPTAGRAM { Model A 63/-, Model B 6 Guineas, Model C 7 Guineas.

for which I enclose £ s. d. Cash/Deposit

Name _____

Address _____

A.W. 24/0/32.

MODEL B SPRING MOTOR

Standard 1933 ADAPTAGRAM ● Garrard Double Spring Motor ● 12" Plush covered Turntable ● Automatic Stop ● B.T.H. Tone-Arm with Pick-up, and Volume Control complete ● Automatic Needle Cup that delivers new needles one at a time to your finger tips ●

Model B

Fitted as described above—ready to convert your existing Set to a Radiogram.

Cash or C.O.D. **6 Guineas** or 12 monthly payments of

12/-

MODEL C ELECTRIC MOTOR

Standard 1933 ADAPTAGRAM CABINET ● Collaro Induction Electric Motor with Tone-Arm, Pick-up and Volume Control in one Unit ● 12" Plush covered Turntable ● Automatic Stop ● Automatic Needle Cup that delivers NEW needles one at a time to your finger tips ●

Model C (For A.C. Mains 100-130 and 200-260 volts 25-100 cycles.) Fitted as described above—ready to convert your existing Set to a Radiogram. Details of D.C. Model on application.

Cash or C.O.D. **7 Guineas** or 12 monthly payments of

13/9

GRAMO FITTINGS FITTED FREE

1933's GREATEST RADIO ADVANCE

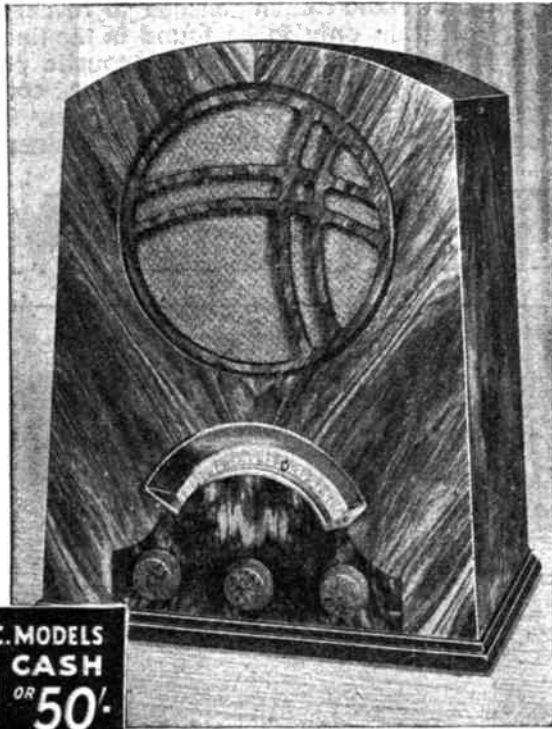

A.C. & D.C. MODELS
10 CASH OR **50** DOWN
 GNS. GNS.

BATTERY MODEL
6/10 CASH OR **40** DOWN
 (Less Batteries)

The "ATLAS TWO" starts new era of Tone-True Radio

♦ ♦ ♦ The "ATLAS TWO" now brings a completely new thrill to every music-lover: catching the very personality of the artist: with a brilliance and sparkle that seems to put you in the front row at every entertainment. You're actually there with the "ATLAS TWO."

The specification includes "ATLAS" Moving-coil Speaker, One-knob Tuning, provision for Pick-up and Extra Speaker, Westinghouse Rectifier in A.C. Model, Mains Aerial in both A.C. and D.C. Models.

See, hear, and test it for yourself. Ask your dealer for a demonstration and insist on the "ATLAS TWO." Post the coupon to-day for full details.

CLARKE'S "ATLAS

H. CLARKE & CO., (M/CR) LTD.
PATRICROFT, MANCHESTER
London Offices: BUSH HOUSE, W.C.2

TWO" ®

POST THIS COUPON NOW

Messrs. H. CLARKE & CO. (M/CR), LTD.,
GEORGE STREET, PATRICROFT, MANCHESTER.

Please send me full details of the new "ATLAS TWO" Receivers.

Name (in capital)

Address

29/24/32

APART FROM LOW PRICE

THERE ARE

6

QUALITY REASONS

Why you should choose DUBILIER DRY ELECTROLYTIC CONDENSERS

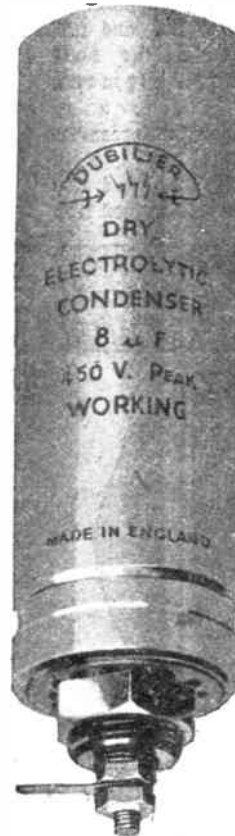

QUALITY POINT No. 1

LOW POWER FACTOR

The power factor of these condensers is about 8%, which is less than half that of the "aqueous" types.

NOTE THESE PRICES

4μf. . . .	4/6
6μf. . . .	5/-
8μf. . . .	5/6

These Condensers are designed for a Maximum Peak Voltage of 450 (D.C. + A.C.)

Have you seen the new Dubilier Component booklet, "Choosing your Condensers and Resistances"? Ask your dealer for a copy or write to us.

DUBILIER CONDENSER CO. (1925) LTD.
Ducon Works, Victoria Road, North Acton, W.3

Advertisers Appreciate Mention of "A.W." with Your Order



IMPERIAL AIRWAYS



trust to

MARCONI VALVES

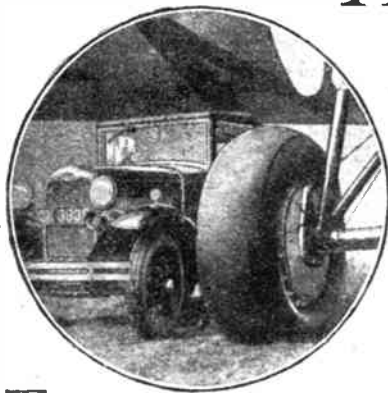

This is "HELENA," the largest and probably the safest air liner in the world (note the height of its wheels compared with that of a car). From the moment of taking off the pilots are in constant communication with their air ports. Flags track their movement on control room maps at Croydon, Le Bouget and Brussels; they are told what weather to expect en route, and when visibility is bad this 2,200 h.p. monster is even directed by wireless. Its wireless gear *must* be reliable—so much depends on it—that is why "HELENA," like other Imperial Air-

ways machines, and like the air traffic of almost every nation, trusts to Marconi valves. *When lives depend on a valve they choose Marconi.*

THERE IS A MARCONI VALVE FOR EVERY PURPOSE

Ask your local dealer, or write direct to The Marconiphone Co., 210/212, Tottenham Court Road, London, W.1, for the Marconi valve folder which gives curves, facts and figures for all types.

THIS IS THE TWO VOLT RANGE

VS.2.	Variable-Mu Screen Grid	16/6
S.22.	Screen Grid (Single stages)	16/6
S.21.	Screen Grid (Multi stages)	16/6
H.2.	High Magnification	7/-
HL.2.	Medium Magnification	7/-
HL.210.	Medium Magnification	7/-
LP.2.	Power	8/9
P.2.	Super Power	12/-
PT.2.	Pentode	17/6
DG.2.	Double Grid	20/-

VS.2. A NEW 2-volt VARIABLE-Mu

VS.2 is the latest Marconi development, providing the user of a battery-operated receiver with the enhanced selectivity, purer tone and perfect control of volume which only a Variable-Mu Valve can give. It is comparable in range and sensitivity to its famous A.C. counterpart, the VMS.4, and offers definitely improved performance to almost every user of a 2-volt S.G. Receiver.

Price 16/6

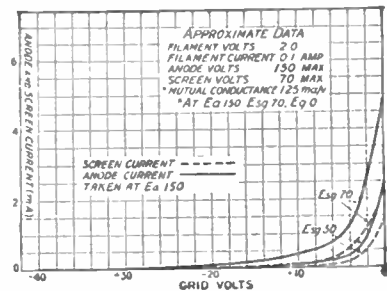

To Ensure Speedy Delivery, Mention "A.W." to Advertisers

What Amazing Value!!! What Unequalled Results!!!

FARRAND 12 POLE INDUCTOR

42% OF ALL RADIO STORES



To all Discriminating Radio Enthusiasts we now offer without fear of comparison the Undy 12-pole Farrand Inductor which has gained the most recent and unstinted approbation of experts on scientific acoustical research. Never before have you heard music and speech so truthfully and perfectly reproduced as by this new Undy product—undoubtedly the world's best speaker—and which at the low price of 42 - is within the reach of everyone. Both the 12-pole and the Undy Ultra Minor are so constructed that they are adjustable to all types of valve.

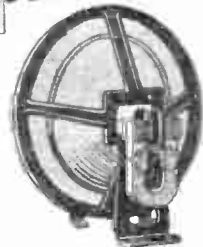

Undy 4 pole Farrand Inductor, Model : Ultra-Minor

UNDY unique Trader Service

Every Undy Farrand Inductor is GUARANTEED for 12 MONTHS whilst every stockist has at call the UNDY Information and Service Dept., where technical information and a fully qualified staff are available.

29%

Go to your dealer, hear the best, then listen to the Undy Farrand Inductor

J. HEMELIK

8 Cullingworth Rd., London, N.W.10. Telephone : Gladstone 3033

The famous BRITISH GENERAL TUNING UNIT

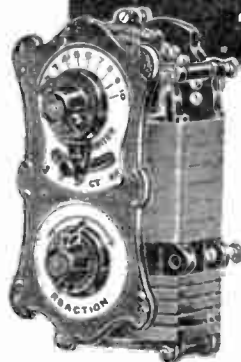

now reduced to 10'6

By reason of increased demand and enlarged production we are able this season to offer our well-known Tuning Unit at 10/6 instead of 14/6 as before. This Unit effectively replaces plug-in coils and covers the entire wave-band, from 200-2,000 metres. Easy fixing; simple tuning. Full instructions supplied with every model.

Write for Full List of B.G. GUARANTEED COMPONENTS POST FREE.

From all dealers or direct from the manufacturers—

BRITISH GENERAL MANUFACTURING CO., LTD. Brockley Works, London, S.E.4

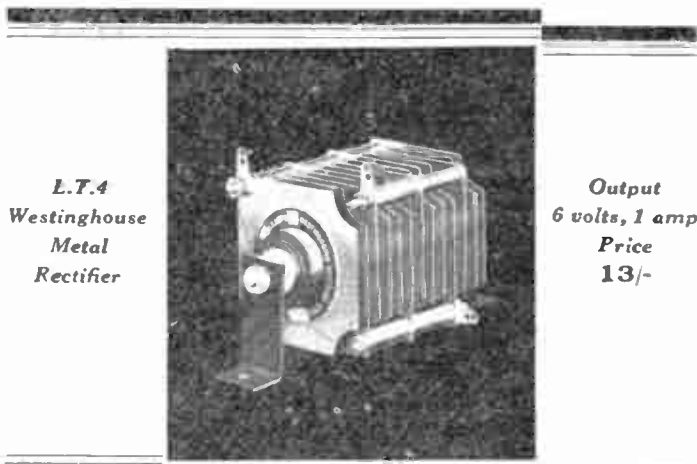

L.T.4 Westinghouse Metal Rectifier

Output 6 volts, 1 amp Price 13/-

BUILD your trickle-charger with a Westinghouse Metal Rectifier and keep your batteries up to scratch always. A rectifier, transformer and resistance are all that is necessary to charge from A.C. mains, and the total cost should not exceed 30-. Full details, circuits and prices are given in the new and enlarged 1933 edition of "The All-Metal Way." The attached coupon and 3d. in stamps will bring you a copy.

WE ARE EXHIBITING AT STAND 73, MANCHESTER RADIO SHOW. THE WESTINGHOUSE BRAKE & SAXBY SIGNAL CO., LTD. 82 York Road, King's Cross, London, N.1.

COUPON Westinghouse Publicity, 82 York Road, King's Cross, London, N.1. Please send me a copy of the 1933 edition of "THE ALL-METAL WAY," for which I enclose 3d. in stamps.

NAME ADDRESS

When the higher notes are missing RECTATONE restores them

YOU NEED IT NOW

Rectatone—the Varley component that restores to their true value the all-important higher notes. It is by deliberately cutting off these higher notes that to-day's Superhets and ultra-sharp tuned circuits achieve their selectivity. Now comes Rectatone to put them back again . . . and millions know they need it.

VARIABLE COMPENSATION

The degree of compensation may be suited to the particular tuned circuits in use or employed to correct deficiencies due to the loud-speaker or to the acoustics of the room.

RECTATONE

- 1 Has a rising response curve from 1,000 to 4,500 cycles.
- 2 Balances any form of sound reproduction.
- 3 Restores a weakened treble to its correct value.
- 4 Gives a variable compensation and, therefore, complete control of tone correction.
- 5 Gives the required tone correction without an extra L.F. stage.
- 6 Becomes at will and instantly a normal straight-line transformer.
- 7 The ideal L.F. coupling for selective sets.
- 8 Particularly useful where the same L.F. amplifier is used for radio and gramophone reproduction.

THE NEW
RECTATONE
L. F. TRANSFORMER



Ratio 7-1 List No. D.P. 33

Compensation is controlled by a variable resistance of about 5,000 ohms connected externally between the terminals H.T. + and RES. With a pentode output valve a 2,000 ohm fixed resistance may be connected in series with the variable resistance in order to prevent excessive amplification of high frequencies with consequent liability to self-oscillation.

Suitable Resistances for use with Rectatone are :

- Varley C.P.157 5,000 ohm Wire-Wound 5/6
- Varley C.P.123 2,000 ohm Spaghetti 9d.



To Messrs. Varley, Kingsway House, 103 Kingsway, London, W.C.2.

Please send me, free and post free, the

“BOOK OF THE RECTATONE”

Date.....

Name.....

Address.....

A.W.4.

"RADIO ENTHUSIASTS CAN PURCHASE THEM WITH EVERY CONFIDENCE"

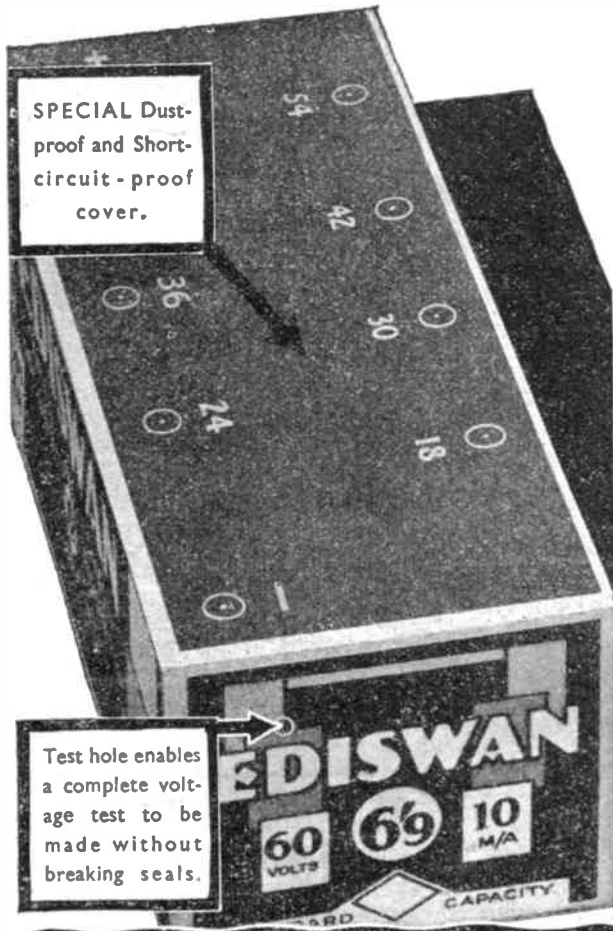

The Ediswan Batteries are giving the first-class service expected of them. Radio enthusiasts can purchase them with every confidence. Their outputs are above the average and they give a clean, steady output . . .

says the Technical Editor of "Popular Wireless"

Settle the H.T. Battery problem once and for all—take no more risks buying batteries "on spec."—It is unnecessary, for Ediswan H.T. Batteries are now GUARANTEED against failure to give completely satisfactory service. Every single cell in every Ediswan Battery must successfully pass four tests before it leaves the factory, and special precautions are taken to ensure perfect internal insulation between cells.



Standard Capacity. Where the anode current required does not exceed 10 M/A these batteries will give highly satisfactory service. If super-power valves are used, the super-capacity type should be used.

Super Capacity. These batteries have twice the capacity of the standard type, and, owing to their large reserve of power, last nearly three times as long when used as replacements to standard capacity batteries.

Look for the Ediswan Authorised Dealer sign when you buy!

Send for your FREE copy of "How to get the most out of your H.T. Battery." Full of useful data, hints and tips.

Guarantee

The Edison Swan Electric Co. Ltd. guarantee that Ediswan Batteries are of full voltage and capacity. Should any Ediswan Battery fail to give satisfactory service, we undertake to deal with the customer's complaint within 24 hours of receipt of the defective battery.

EDISWAN Guaranteed RADIO H.T. BATTERIES

THE EDISON SWAN ELECTRIC CO. LTD.



PONDERS END, MIDDLESEX

B.174

A THIEF— a silent... sneaky thief



Valve deterioration is a slinking silent fellow creeping on you un-awares, robbing your wireless of its tone value, its clarity and even its selectivity. Valve deterioration robs you cunningly—just a little at a time, so little that you scarcely notice it

until one day you realise that you are not hearing the wireless programmes as well, or as clearly, as you used to. The real enjoyment has—somehow—gone.

The fault is not in your set but in your valves. Twelve months work—or even less with some receivers—is as much as you should expect from your valves. After that efficiency is much lowered and running costs are much increased. A new set of ETA valves will restore the original purity and crispness of your reception. ETA valves will make your set as good as ever it was or even better. ETA valves give and maintain the highest possible standard of reproduction.

**YOU NEED NEW VALVES
GOOD VALVES — ETA VALVES**



ETA

THE INTERNATIONAL VALVE

PRICES FROM
5/6

SERVICE COUPON

To the ELECTRICAL TRADING ASSOCIATION LTD.,
Aldwych House, Aldwych, London, W.C.2.

A. Please let me know the correct type of ETA valves to replace my present valves which are as under

1..... 2..... 3..... 4..... 5.....
(Insert type letters and number)

B. Please advise me which ETA valves to use for the following receiver or circuit.

Specify Type No. and Name

Name.....

Address.....

A.W. 24.9.32

Something **NEW** for
Amateur and Expert



**PART
ONE
NOW ON
SALE**

FREE INSIDE

Design Chart for making a
Double-Cone Portable Set.

Why You Should Buy this Work

- Because it explains the theory of wireless in a way you can understand.
- Because it contains many new designs by the best designers.
- Because it is authoritative yet easy to understand.
- Because it gives you the expert advice of wireless specialists.
- Because when completed it will be worth much more than it has cost you.

PART 2 READY FRIDAY, SEPT. 23

NEWNES COMPLETE WIRELESS

Obtainable at all Newsagents and Bookstalls or by post 1/2i from
George Newnes, Ltd., 8-11, Southampton Street, Strand,
London, W.C.2.

IN ABOUT 24 WEEKLY PARTS



Geo. Newnes, Ltd.

FOR EVERY SET — there's a PILOT AUTHOR KIT

CASH — C.O.D. — or H.P.

EVERYTHING RADIO
IMMEDIATE DELIVERY—
CASH, C.O.D., or H.P.

CARRIAGE PAID TO YOUR DOOR

- COSSOR MELODY MAKER.** Model 335. Send 10/-
Complete with valves, speaker and cabinet. Cash Price, £7/17/6. Carriage Paid. Balance in 11 monthly payments of 14/10. only
- COSSOR ALL-ELECTRIC MELODY MAKER.** Model 336. Send 21/7
Complete with valves, cabinet and speaker. Cash Price, £11/15/0. Carriage Paid. Balance in 11 monthly payments of 21/7. only
- SLEKTUN SCOUT S.G.3.**—S.G., Detector and Power. Pilot Author Kit "A" (less valves and cabinet). Cash or C.O.D., £4/8/6. Carriage paid. Send 8/1
Balance in 11 monthly payments of 8/1. only
- R & A "VICTOR" PERMANENT-MAGNET MOVING-COIL SPEAKER DE LUXE.** With 6-ratio input transformer and protecting grill. Cash Price £3/10/0. Carriage Paid. Send 6/5
Balance in 11 monthly payments of 6/5. order
- EPOCH "20 C" PERMANENT MAGNET MOVING-COIL SPEAKER.** (New Edition). With 3-ratio input transformer. Cash Price £1/15/0. Carriage Paid. Send 6/6
Balance in 5 monthly payments of 6/6. only
- W.B. PERMANENT-MAGNET MOVING-COIL SPEAKER.** Type PM4. Complete with transformer. Cash Price £2/2/0. Carriage Paid. Send 5/9
Balance in 7 monthly payments of 5/9. only

THIS YEAR'S WINNER

LISSEN "SKYSCRAPER 3." Send 8/3
Chassis model with (Lissen) S.G., Detector and Pentode valves. Cash Price £4/9/6. Carriage paid. only
Balance in 11 monthly payments of 8/3.

BLUE SPOT SPEAKER UNIT AND CHASSIS. Send 5/5
TYPE 1000. Cash Price £1/10/6. Carriage Paid. only
Balance in 7 monthly payments of 5/5.

ATLAS ELIMINATOR. Type A.C.244. Three Send 5/6
tappings, S.G., detector and power. Output: 120 volts at 20 m/a. Cash Price £2/19/6. Carriage Paid. only
Balance in 11 monthly payments of 5/6.

GARRARD INDUCTION GRAMOPHONE MOTOR. For A.C. mains. Model 202. Send 4/7
Mounted on 12-inch nickel motor plate with fully automatic electric starting and stopping switch. Cash Price £2/10/0. Carriage Paid. only
Balance in 11 monthly payments of 4/7.

REGENTONE W.I.F. H.T. ELIMINATOR for A.C. mains, tapped S.G., detector and 120/150 v. at 12 m/a. Cash Price £2/15/0. Carriage Paid. Send 5/1
Balance in 11 monthly payments of 5/1. only

COLLARO INDUCTION MOTOR WITH PICK-UP. For A.C. mains. 12-in. turntable, moulded pick-up, volume control and automatic stop. Cash Price £4/0/0. Carriage Paid. Send 7/4
Balance in 11 monthly payments of 7/4. only

PILOT BAND-PASS UNIT

Whether your set is Main or Battery operated, the **PILOT BAND-PASS UNIT** cuts out programme interference effectively and sharpens tuning to needle-point selectivity. It is simple to attach and can be operated by anyone without technical knowledge. No valves or extras required.

Instantly converts any Set to Band-pass Tuning with Needle-sharp Selectivity.



25/- CASH or C.O.D. or 6 monthly payments of 4/6.

WIZARD

KIT "A"

As described in last week's issue. Author's Kit of specified parts, including ready-drilled panel, less valves and cabinet.

CASH OR C.O.D. DELIVERY FROM STOCK CARRIAGE PAID

Or 12 monthly payments of 7/4. Carriage paid.

80/-

KIT 'B' Kit "A" as above, WITH VALVES but less cabinet. CASH or C.O.D. Carriage Paid **£5-12-3**

Or 12 monthly payments of 10/4. Carriage paid.

KIT 'C' Author's Complete Kit, with valves, cabinet and ready drilled panel. CASH or C.O.D. Carriage Paid **£6-12-3**

Or 12 monthly payments of 12/2. Carriage paid.

FINISHED INSTRUMENT Fully Assembled WIZARD. Aerial Tested. Complete with Valves and Cabinet, excluding batteries. CASH or C.O.D. **£8-0-0** Carriage paid. Or 12 monthly payments of 14/9.

IMPORTANT.—Parts, Kits, Miscellaneous Components, Finished Receivers or Accessories for Cash, C.O.D. or H.P. on our own system of Easy Payments. Send us a list of your wants. We will quote you by return. C.O.D. orders value over 10/- sent carriage and post charges paid.

THESE ARE THE PARTS THE AUTHOR USED.

1 Red Triangle ebonite panel, 14 in. by 7 in., ready drilled	4 6
1 Peto Scott base-board, 14 in. by 9 in.	1 6
2 Ready Rad "Mecatog" .0005-mfd. condensers	7 0
2 Readi-Rad slow-motion disc drives	8 0
1 Lissen 2-mfd. fixed coil unit and switch	17 6
1 Lissen .0005-mfd. variable reaction condenser	6 6
2 Telsen 1-mfd. fixed condensers	4 6
1 Telsen 2-mfd. fixed condenser	3 9
1 Dubilier .00005-mfd. fixed condenser, type 070	1 0
2 Lissen .0002-mfd. fixed condensers	1 0
1 Dubilier 2-megohm grid leak with wire ends	1 0
1 Trowell 30,000-ohm spaghetti resistance	1 4
1 Weatco screened high-frequency choke	3 6
1 Sektun standard high-frequency choke	4 0
3 W.B. 4-pin valve holders	1 6
1 Belgin "Senator" resistance-fed transformer	6 9
2 Terminal strips	6 6
1 Severign .0003-mfd. pre-set series aerial condenser	1 3
2 Belling-Lee terminals, marked "Pick-up"	1 5
1 Readi-Rad radiogram change-over switch	2 0
6 Belling-Lee wander plugs, marked	1 0
2 Belling-Lee spade terminals, marked: L, T, I, L, T.	6
6 Yards thin flex, connecting wire, sleeving, length flexible tubing, screws and 1 terminal strip 5 in. by 2 in.	1 8
KIT "A" Cash or C.O.D.	4 0 0
1 Peto-Scott Special Cabinet	£1 0 0
Specified Valves	£1 12 3

BUILD IT YOURSELF — it's easier with a PILOT RADIO ENVELOPE



AN AMAZING GO STATION SET

The Selective Family 3

YOU CAN BUILD THIS SET IN AN EVENING with this PILOT RADIO ENVELOPE

THIS SET WILL PRINT 3 PROGRAMS AND 3 COMPLETE SETS OF PARTS AND COMPLETE INSTRUCTIONS IN EVERY ENVELOPE

Complete

GET YOUR COPY TO-DAY POST FREE

PILOT RADIO ENVELOPE No. 1. Buy this and build a city-station 3-valve battery set. Blueprint, photographs and complete assembly and operating instructions in every envelope

PILOT RADIO ENVELOPE No. 2. Tells you how to build an amazing 5-valve super-het. Contains point-to-point wiring, assembling and operating instructions.

1/- 1/-

WITH FULL SIZE BLUEPRINTS



PILOT RADIO ENVELOPE No. 3

ADVENTURER 5-VALVE SUPER HETERODYNE

Build it Yourself!

COMPLETE PILOT AUTHOR KIT PRICES FOR THESE TWO AMAZING BATTERY RECEIVERS

SELECTIVE FAMILY THREE

Kit of parts in sealed carton as specified by Maxamp, the Designer, for building a wonderfully selective GO-station 3-valve receiver. Includes necessary Pilot Radio Envelope, but excludes valves and cabinet.

Cash or C.O.D. **65/-** Carriage Paid.

Or 12 monthly payments of 5/11. Carriage paid.

ADVENTURER 5-VALVE SUPER-HET

Kit of parts in sealed carton as specified by Maxamp, the Designer. This is a wonderfully selective and powerful set with built-in moving-coil speaker. Includes necessary Pilot Radio Envelope but excludes valves, cabinet and speaker.

Cash or C.O.D. **£6 10** Carriage Paid.

Or 12 monthly payments of 11/11. Carriage paid.

BACKED BY PETO-SCOTT—ORIGINATORS OF CONSTRUCTOR KITS IN 1919

BUY ALL YOUR RADIO FROM PETO-SCOTT

PETO-SCOTT CO. LTD. 77 City Rd. London, E.C.1. Telephone: Clerkenwell 94007

West End Showrooms: 62 High Holborn, London, W.C.2.

Dear Sirs, Please send me CASH/C.O.D./H.P. for which I enclose £.....s.d. CASH, H.P. Deposit. Also send your FREE 1933 Radio Catalogue.

NAME

ADDRESS

A.W. 24/1/32

Buy by Post — it's Quicker

Get YOUR FREE COPY of this Book to-day!



Thousands have literally snapped it up—and are making this outstanding set

Every day more thousands send for this free book of the "Scout S.G.3." Thousands who own average receivers are now making this sensational set. Those who have made it are enthusiastic in their reports of its performance, simplicity and moderate cost.

Most definitely there has never before been such a cleverly designed home constructor's set—for the "Scout S.G.3" is the result of a united effort by leading component manufacturers to design a specialist's set that even a novice can construct—at a cost that brings it within reach of the most modest purse.

The set is a sensation. It has created a sensation. The tremendous demand for the Free Book and Blueprint proves how outstanding it is. Get your copy to-day.

The

SLEKTUN SCOUT S.G.3

Take the coupon below to your dealer for the Free Book and Blueprint of the "Scout S.G.3," or, if more convenient, post it to us with a 1½d. stamp affixed.

- One-knob tuning—fifty stations at full loud-speaker strength.
- Extreme selectivity. "The Broadcaster" says: "Even with a large aerial at ten miles from Brookmans Park, the local stations were easily separated."
- "Simplicity is one of the outstanding features—"
- "The constructional details are very explicit, and we can imagine no difficulties."

Messrs. SLEKTUN PRODUCTS LTD.,
21, Douglas Street, WESTMINSTER, S.W.1

Please send me the FREE illustrated Book of the SCOUT S.G.3, together with the full-size Blueprint. I enclose 1½d. stamp to cover cost of postage.

Name.....
Address.....
A.W.3.....

SLEKTUN PRODUCTS LTD., 21 DOUGLAS STREET, WESTMINSTER, S.W.1

National

Advertisers Appreciate Mention of "A.W." with Your Order



**BRITAIN'S LEADING RADIO WEEKLY
FOR CONSTRUCTOR, LISTENER & EXPERIMENTER**

EDITOR:
BERNARD E. JONES

TECHNICAL EDITOR:
J. H. REYNER, B.Sc. AM.I.E.E.

RESEARCH CONSULTANT:
W. JAMES

ASSISTANT EDITOR:
H. CORBISHLEY

NEWS & GOSSIP OF THE WEEK

OUR FREE SUPPLEMENT

INCLUDED in this issue is the second of the "A.W." Special Supplements for beginners. It is an eight-page feature brimful of interesting topics for all readers, and it gives everybody a chance to brush up his technical knowledge. You will find this supplement in the centre pages of the issue. The "Wizard" is a big feature this week, too. The construction of this fine set is described in simple, illustrated stages. It is really something new in sets.

GIVING THE EMPIRE WHAT IT WANTS

BACK from their holidays, Sir John Reith, Director-General, and Mr. Cecil Graves, the new Empire Broadcasting Director, have been planning the make-up of the Empire programmes to be broadcast from the new stations nearing completion at Daventry. The Empire is to have just what it wants. *Not what the B.B.C. thinks it ought to want!* If the cry goes up for vaudeville, it shall be given. If overseas listeners like their humour "broad," they shall have it—but there will be nothing vulgar! A big demand for light entertainment is expected—hence the bustle to augment the programme staff with revue

producers who will be ready for home or Empire work.

SPARING NO EXPENSE

ALTHOUGH no contributions to the Empire Service are as yet forthcoming from overseas, the B.B.C. is determined to make use of its best material. It is recognised that the programmes must be "robust" to catch the ear of the colonial. The very best artistes of every department of the B.B.C. will be engaged in this Empire work.

FEEDING THE FIVE ZONES

ONE of the difficulties of this Empire broadcasting is the time differences between the various countries, and even between one part of a country and another. At first, Mr. Graves will be satisfied if he can feed each of the five zones with programmes between 8 and 10 p.m. local time, extending the period later from 6 p.m. to 12 midnight local time.

BOTTLING PROGRAMMES FOR LATER USE

GREATLY improved quality is being obtained from three Blattnerphone machines of a new type now being tested at the B.B.C.'s Research Laboratory at

In this issue :

Free wiring plan of the "Wizard."

The A.B.C. of Mains Working. Practical Hints and Tips.

Some Developments in Low-frequency Amplification.

Our Second Special 8-Page Supplement, "Wireless Made Easy."

Nightingale Lane, Clapham. These new recording machines will enable the B.B.C. to "bottle" programmes sent out from the studios in the normal way, so that later wax-disc impressions can be taken for distribution to the Empire.

FIRST EMPIRE RECORDING

CURIOSLY enough, the first recording for Empire distribution made by the B.B.C. is a Maux programme, lasting half an hour and comprising folk music and a comic song. There may be difficulty in finding material for this scheme, as we hear that several authors are unwilling to sell their "Empire rights."

DANCE MUSIC FOR OCTOBER

HENRY HALL will be back in the Thursday evening dance-music period during the month of October, and bands from the Dorchester, Monseigneur, Savoy, and Mayfair will be relayed on other evenings. It is interesting to note that Maurice Winnick will also be playing from the Carlton on three nights of the month. Bertini will take a well-earned holiday, being on the air only once.



Practising for the outside broadcast of the speedway racing at the Wembley Stadium. The engineers are trying microphone positions during motorcycle testing.

NEXT WEEK: A NEW USE FOR YOUR OLD SPEAKER

NEWS & GOSSIP OF THE WEEK —Continued

STUART HIBBERD BACK

LISTENERS have probably noticed that the B.B.C.'s Chief Announcer, Mr. Hibberd, is now back at the microphone. He is in fine voice after spending several weeks down in Devonshire, where Mr. King-Bull is now recuperating and seeking inspiration in a coast-guard cottage on a cliff!

PLYMOUTH PROGRAMMES TROUBLES

ALTHOUGH the Plymouth relay station has been successfully synchronised with Scottish National on a wavelength of 288.5 metres, it is feared that after night-fall it will be impossible for the relay to send out a programme different from the National. This will mean the scrapping of the local children's hour. Although great disappointment is anticipated, the B.B.C. points out that such a move would be inevitable next spring, when West National is also synchronised on 288.5 metres.

VARIETY IN THE LUNCH-TIME MUSIC

BY the policy of pooling the lunch-time music resources of Midland, Scottish, and North Regional stations the B.B.C. believes that listeners are gaining a greater variety of broadcasting. Anyway, the policy is to be continued.

A TELEVISION SCOOP

ALL credit for "televising" Jim Mollison and Amy Johnson is due to Eustace Robb, the enthusiastic television producer recently taken on by the B.B.C. His waking hours are one long round of auditions, rehearsals, and transmissions, and he is certainly "delivering the goods." Ventriloquists, conjurers, cartoonists, Yo-Yo players, a sea-lion and a cat have already figured in the programmes! Sir Joseph

Duveen came to the studio to discuss the best methods of televising works of art. He was followed by a Jap who was wanted to discover whether ju-jitsu would be a television success!

B.B.C.'s CONTRIBUTION TO CRISIS

THIS year the B.B.C. is handing over £150,000 of listeners' money to the Treasury as a contribution to the nation's

begins. For seven days the Midland Regional programme will be flavoured with the history, music, literature and customs of Worcestershire. During the week the Prince of Wales will be heard opening a new bridge in the county town.

ANOTHER 'MUSIC HALL' FROM NO. 10

JOHN SHARMAN and John Watt, in double harness once again, will produce

ANOTHER SPECIAL SUPPLEMENT NEXT WEEK!

Next week's issue will contain another special eight-page supplement of outstanding interest to beginners in wireless, and those who want to brush up their technical knowledge.

PERCY W. HARRIS describes another interesting addition to the special receiver of the **BUILD AS YOU LEARN** series.

J. H. REYNER continues his fascinating **ELEMENTARY WIRELESS COURSE FOR BEGINNERS**.

The Supplement will also be full of helpful hints and tips for set-users, and for those who are curious to know just "how it works."

ANOTHER BUMPER NUMBER.

ORDER YOUR COPY NOW.

needs in these difficult times. Next year, as the result of discussions now ended, a larger sum will be handed over. Listeners need not fear that the programmes will suffer, although development work is likely to be somewhat checked.

WIRELESS ON TRAINS

Differences Between First and Third!

WHILE third-class travellers availing themselves of the wireless earphone service on L.N.E.R. trains prefer jazz it seems that the first-class occupants plump for symphonic music! Radio-grams, as fitted on the Scottish expresses, are now installed in the London-Leeds train—which was the pioneer of travelling radio in this country. Alternative programmes can be supplied with these instruments. The charge has now been reduced to 10d. The pages who hand round the phones appreciate the change!

NOT SO HIGH-BROW!

CHARLES SIEPMANN, the new Talks Director of the B.B.C., has produced a programme of talks that promises good listening. In doing so he has managed to confound the critics who expected a highbrow "bias." Some talks are quite human!

MIDLANDS COUNTY WEEK

ON October 18 the first of the Midland Regional County Weeks

a Music Hall bill on October 1, in studio No. 10. The programme is not complete, but if the artistes are available the bill will include Lily Morris, Clarice Mayne, Walter Williams, and Billy Bennett—a galaxy of stars! The concert studio in Broadcasting House is in constant use for musical programmes, and it is doubtful whether it will be used again for vaudeville. The Productions Department has not entirely abandoned hope about using this studio, and feeling at the moment is running rather high between the contestants.

BETTER RELATIONS!

LADY SNOWDEN and Dr. Adrian Boulton are to be congratulated upon the better relations existing between the B.B.C. and the musical world. At least six Philharmonic concerts will be relayed during the season, starting on September 29. Sir Thomas Beecham himself will conduct several performances. A series of operatic relays from the Carl Rosa tour begins with an excerpt from Bristol in the week of September 26.

A. J. ALAN AGAIN

THAT ever-popular broadcaster, A. J. Alan, will make his first appearance in the Children's Hour with a story called "Percy the Prawn." He has also promised to tell his evening audience another story. Both of these broadcasts will take place in October.

POETRY READINGS!

A new experiment in the reading of poetry and prose is to be tried during the autumn and winter months. Every evening of the week for a period of five minutes (except on Wednesdays, when the period will be extended to fifteen minutes) a reading of poetry or prose will be broadcast immediately before dance music begins at the end of each day's programme.



"You know, Alf, this 'ere wireless is like the rows me and the missus 'ave!"
 "'Ow's that, Bill?"
 "Words over nothin', Alf!"

SEVENTEEN STATIONS IN DAY-LIGHT DURING A SHORT TEST OF THIS AMAZING SET

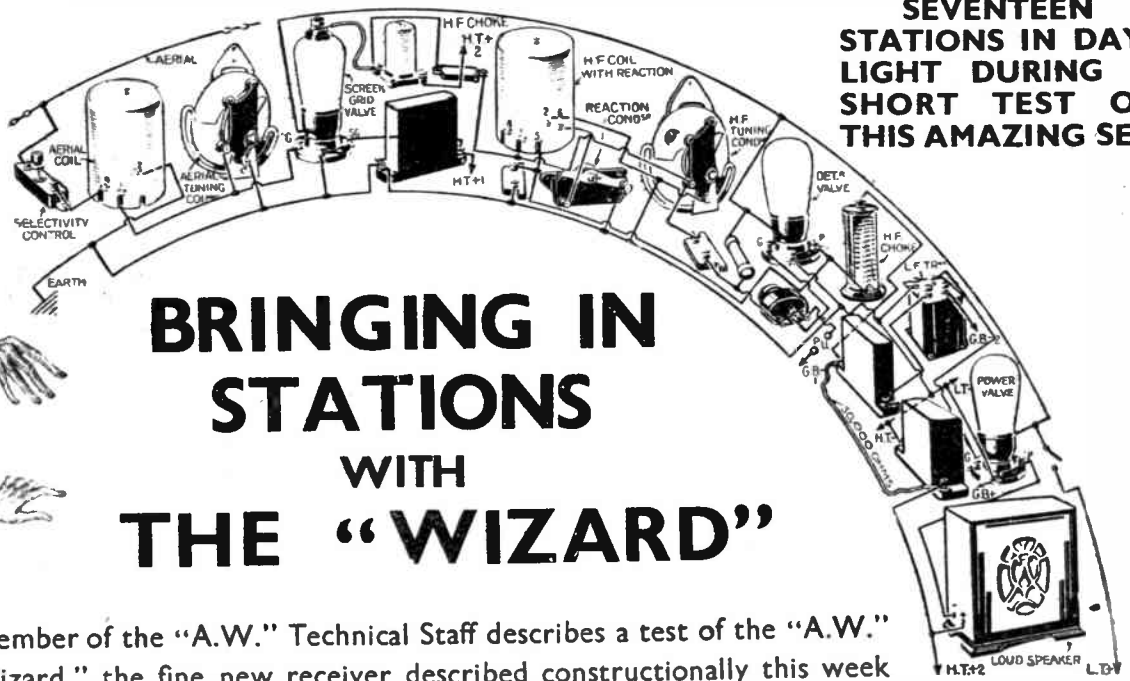

BRINGING IN STATIONS WITH THE "WIZARD"

A member of the "A.W." Technical Staff describes a test of the "A.W." "Wizard," the fine new receiver described constructionally this week

I WONDER why many of us go to the expense of buying large, costly receivers when one can listen to over fifty stations on an efficient three-valve receiver, costing only a moderate sum.

I tested the "Wizard" on a Saturday afternoon and evening at Letchworth, about 30 miles, "as the crow flies," from Brookman's Park. Using an aerial of about 38 ft. in length, and the specified valves, batteries, etc., the results obtained were really remarkable considering the simplicity of the apparatus.

In the Daytime

The receiver was connected up round about 3 o'clock to see that it was in good working order. As I idly tuned the receiver, I was struck by the liveliness and the smooth reaction, so I decided to see just how many stations could be received during daylight.

Tuning to the top end of the long-wave scale, Hilversum was received at good strength, giving a Trio Concert; only

6 degrees lower Radio Paris came in, with reaction practically at zero, giving an introductory gramophone record prior to starting the afternoon programme. At approximately 83 degrees Berlin was heard at fair strength, but not for long, as Daventry started up a few minutes later, interfering badly.

Although Eiffel Tower could be separated from 5XX, care had to be taken in adjusting the aerial condenser to do this completely. The carrier wave of Kalundborg was received together with a faint signal, but it was not of sufficient strength to be of entertainment value.

Croydon was very interesting for a few minutes. I listened to a conversation between a 'plane going to Cologne and the operator at the Control Tower giving a weather forecast and bearings.

On Medium Waves

The medium waveband is not usually very much used in daylight except for the local stations, but the long-wave stations

being so very good, I decided to try and see just what could be obtained.

The North Regional was quite a strong signal but it was inclined to fade a little, but Langenberg, only 1 degree lower, came in quite clearly and free from interference. This, in my opinion, was a double achievement: firstly, to receive this station at all in daylight, and, secondly, to be perfectly clear from the North Regional.

On 200 Metres!

The London Regional was far too strong for comfort, and, even with the reaction condenser at zero was still rather too loud. Huizen was giving a splendid concert and could be received quite easily without having to force reaction in the least.

After 5 o'clock Brussels No. 1 at 91 degrees came in very strongly, as did its sister station, Brussels No. 2, on 66.5 and 61.5.

The Midland Regional can be received nearly everywhere in the country, so the reception of this station is not of much interest, but the North National, relaying dance music, came in at practically the same strength, and, at the same time, did not jam Huizen. Lille, only a minor station of 1½ kilowatts, nevertheless came in on the speaker at good strength, when the London National allowed. As the two stations were less than 1 degree apart, this is not to be wondered at.

Finally, Fécamp, which nearly everyone seems to want to obtain, came in at 38 and 32, showing that the receiver is not only very sensitive, but is capable of tuning down to well under 200 metres. This, incidentally, should be of interest to Newcastle and Aberdeen readers who have trouble in this respect.

Seventeen stations in daylight is certainly a "bag" to be proud of and I was very keen on trying again later in the day. I decided to give the receiver a thorough test that evening as the conditions seemed quite good, and there was a com-

(Continued at foot of next page).

A FINE FAMILY SET!



The "Wizard" at home! As the test report on this page shows, it is an ideal station-getter; nevertheless it is a good set for family use, being easy to operate and economical to work



THE average wireless enthusiast, if asked to check the condition of his low-tension accumulator, would simply put his voltmeter across the terminals and answer quite glibly, "Oh, it's fully charged; reading 2 volts now—look." And he would be quite satisfied. Unfortunately, however, a reading of 2 volts per cell is not always an indication that the accumulator is in good condition and the knowing battery user never relies upon voltmeter readings alone.

In the first place, many radio fans fail to realise that the popular "2-volt accumu-

lator" has a voltage when fully charged of something like 2.3 volts and that a cell that is to all intents and purposes worn out may yet read nearly 2 volts on open circuit.

Secondly, it must be remembered that a voltage test should never be taken on open circuit, but only when the battery is under load, i.e., actually discharging. Readings taken in this manner (while the radio is working) are, for the most part, reliable, but open-circuit voltages may be very misleading.

A Hydrometer Provides the Best Test

A good hydrometer gives a far better idea of the condition of a battery than does any voltmeter. Notice that a *good* hydrometer is specified. That is, one which has an accurately graduated float to indicate the actual strengths of the acid, as shown by the photograph. Hydrometers of the "floating-ball" type, or those with floats marked "charged," "half charged," and so on may not give sufficient warning when the electrolyte is too strong or too weak.

Watch the Acid Strength

For example, a cell with this type of hydrometer would read "fully charged" if the specific gravity of the electrolyte was 1.250 or more. Now supposing that the acid strength were fifty points in excess of that recommended by the battery makers (a regrettably frequent occurrence when an inefficient charging station has been patronised) the "floating ball" hydrometer would give no indication of this and the battery plates would soon be ruined.

Don't, therefore, begrudge an extra shilling or so when buying your hydro-

meter. A "cheap" instrument is seldom an economical proposition, whereas a good hydrometer will last a lifetime—always provided that it is not knocked off the table too frequently. Incidentally, a cardboard "collar," cut as shown by the diagram and slipped round the hydrometer will curb the instrument's tendency to roll and, perhaps, prevent a regrettable accident.

Leaking Floats

Of course, there are times when even the best hydrometer appears to be "playing tricks." The writer has vivid recollections of a time when the specific gravity of the electrolyte in his batteries obstinately refused to rise above the 1.230 mark. But the trouble in that case was ultimately

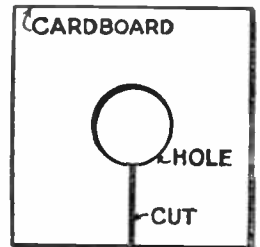

A piece of cardboard cut as this and slipped over the hydrometer may prevent accidents

traced to a microscopic crack in the hydrometer float. A little acid had found its way inside the float, thereby increasing the weight of the latter and causing inaccurate readings.

There are additional causes for variation in hydrometer readings. For instance, if distilled water has been added to an accumulator and not thoroughly mixed with the original electrolyte, false readings may be obtained. Similarly, if the acid level in one cell of a battery is allowed to fall much below normal, a higher specific gravity will be registered in that particular cell than in those at the correct level. This is because a considerable volume of water has evaporated and left concentrated acid behind in the cell.

"BRINGING IN STATIONS WITH THE WIZARD."

(Continued from preceding page)

plete absence of atmospherics.

The first thing I did was to adjust the pre-set condenser in the aerial until I obtained a sufficient degree of selectivity, because, as it was now quite dark, stations were coming in at greatly increased strength and additional selectivity was required.

On the long waves all the main stations came in without any trouble, including Lahti on 1,796 metres; this is quite an achievement, as this station is received very rarely. Berlin was interfered with to a certain extent by 5XX, but probably in a more favourable area (I am less than thirty miles from 5XX) this would not be the case. Several other stations were obtained at varying strength, but as they were not identified, were not included in the log.

It was on the medium waves that I had a pleasant surprise. Over forty stations were received during the evening; more than thirty of them sufficiently loud and free from interference to be worth listening to for a

whole evening's entertainment. Thirty alternative programmes on three valves!

Perhaps an idea as to how these stations were received will make quite sure that new constructors will be able to duplicate these results.

The Ideal Set FOR BEGINNERS AND EXPERTS THE "A.W." "WIZARD."

As the receiver is fitted with 25-1-ratio dials, little difficulty will be experienced in obtaining a very slow movement of the condensers, and the reaction being quite smooth the receiver does not go into oscillation with a "plop." The set could be left in its most sensitive condition (that is, nearly oscillating) when searching for your stations, the volume being adjusted when a station has been received satisfactorily.

The long-wave tuning hardly requires any description, as all the main stations could be received without any trouble by referring to the dial readings or by checking

the call signs. It will be noticed, however, that the pre-set condenser in the aerial will have to be screwed further down than when used on the medium waves.

On this band reception is not quite so simple. The stations are not only very close together, but in many cases the languages are very similar, so that one's log of stations has to be compiled carefully.

One or two stations of little consequence were to be found between zero and 37 degrees, but the first station to come in at all well was Cork on 37.5 and 32 degrees. Just above this was Picamp, broadcasting a programme for English listeners. Belfast and Trieste came next, followed by Hörby, which in most cases will be interfered with by the London National, for listeners who are within 30 miles or so of this station. Lille will also be interfered with to a certain extent by this same station, but as it is an excellent daylight station the Sunday morning programmes provided will be of considerable interest.

Heilsberg is a tremendous signal at 53 and 50 degrees and it is quite free from interference from the National. Between this reading and the London Regional over

(Continued on page 642)



How the A.C. mains can be used to replace the batteries of the wireless set is simply explained in this practical contribution by a designer of mains wireless apparatus

IN one article it is not possible to give anything more than a general idea of how the mains are used to supply the wireless set with its power. Let us see what we have in a mains supply and what we want in the receiver. The mains give

The low-tension is much more simply obtained, by stepping down the voltage of the mains to the 4 volts at which the filaments have to be heated. This needs only a transformer, or more usually an extra winding on the high-tension transformer.

doubler metal-rectifier circuits the secondary has to be centre-tapped. So has the filament secondary, unless two resistances are connected in series across the winding to provide an artificial centre tap.

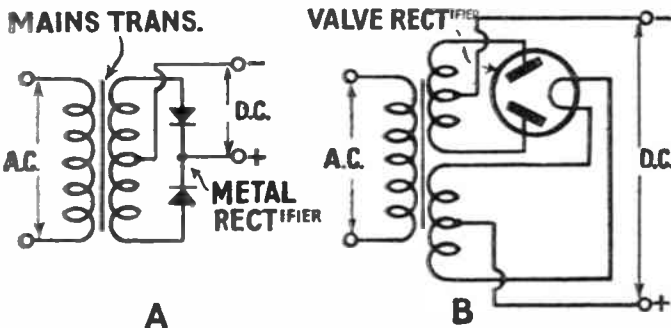

Circuits for mains rectification. At A is a centre-tap circuit for use with a metal rectifier and at B the standard circuit for a double-wave valve rectifier is shown

us an almost unlimited amount of power at a fixed voltage, usually 200 or 230 volts. The set needs three distinct voltages—high-tension for the anodes of the valves, low-tension for their filaments and grid-bias for their grids. The job in mains working is to obtain these various potentials from the fixed voltage of the mains.

The high-tension is obtained from a sequence of components consisting firstly of a transformer, then a rectifier, then a smoother and finally a potential divider.

many designs for transformers. The final choice depends on the rectifier to be used and on the amount of high tension wanted. There is a primary winding connected across the mains, with tapplings for the different voltages of supply. Then there is a number of secondaries, usually two, one for the high-tension rectifier and the other for the filaments.

The function of the transformer is *not* to transform but to alter the voltage of the mains to whatever voltage is needed for the rectifier and the filaments. As a rule, the rectifier voltage is higher than the mains voltage, so more turns are put on the secondary than on the primary. For the filaments only 4 volts is wanted, so a very much smaller secondary winding is provided.

With some types of metal rectifier a simple high-tension secondary is sufficient, but generally with valve and voltage

Of which more later.

The grid-bias is obtained in quite a subtle way. It does not need any special components. Grid-bias is, to use a common term, "pinched" from the high-tension. Some of the voltage that would have gone on the anodes is diverted to the grids.

TRANSFORMERS

FOR mains working there are many designs for transformers. The final choice depends on the rectifier to be used and on the amount of high tension wanted.

RECTIFIERS

WHAT you have inevitably to decide is whether you will use a valve or a metal rectifier. Some form of rectifier is essential, for the current passed on by the transformer is of its original nature, flowing backwards and forwards, usually 50 times a second. This is of no use for the anode supply, which must be smooth direct current, otherwise there will be a humming noise in the loud-speaker.

The modern valve rectifier has the advantage that the smoothing after it does not have to be very extensive. On the other hand, most of the new metal rectifiers provide a direct-current output that can quite easily be smoothed, with the additional advantage that the metal rectifier is practically everlasting. The valve should give at least a thousand hours service and may last considerably longer.

The valve rectifier consists of two half-wave rectifiers inside one bulb, with

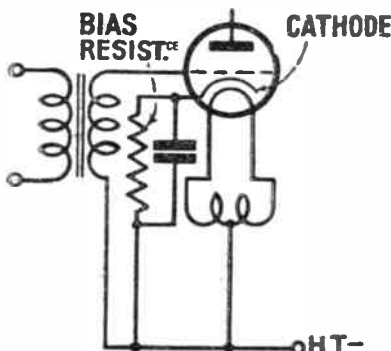

Grid-bias circuit for an output power valve using an indirectly heated mains valve. Note that a bias resistance is connected between the cathode and high-tension negative. This has the effect of making the cathode positive with respect to the grid, which is the same as making the grid negative

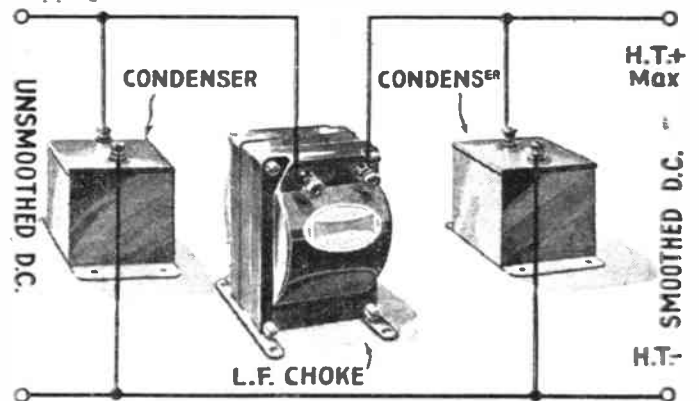

The essentials of a smoothing circuit are shown here. There is firstly a reservoir condenser, then a choke and finally an output condenser. The condensers store up the voltage while the choke tends to oppose any change in the current producing this voltage, so the effect is to smooth the output

separate anodes but a common filament. The transformer for such a rectifier has to provide a secondary for heating the filament and a centre-tapped high-voltage secondary for the anodes.

With metal rectifiers one secondary (Continued at foot of next page)

WHY NOT FADE OUT THE APPLAUSE?

Asks WHITAKER WILSON

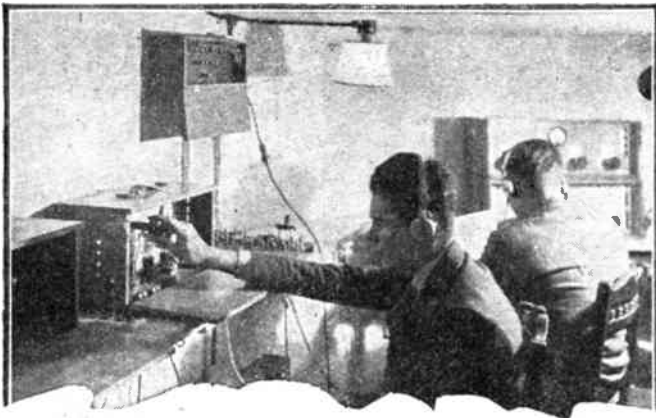

If you look amongst the published correspondence of the B.B.C. you will find an occasional outburst from some enraged listener protesting against the applause at Queen's Hall during the Proms and symphony concerts. Often these letters have been protests against applause as such, generally casting aspersions at the mentality of those who applaud. That sort of criticism is hardly worth while writing; it is certainly not worth reading.

On the other hand, I am inclined to think there is something in the point of view if modified into reason. Unfortunately, the broadcast effect of people clapping is not good. If allowed to transmit for three or four minutes, as is often the case, it certainly becomes a nuisance.

On the other hand, if you are in the hall it is entirely another matter. The reason is simple. You can see the artiste you have thus approved; you can see him (or her) acknowledge your approbation; you can see Sir Henry Wood bowing, the

orchestra rising and the various other movements and actions. That makes all the difference.

At home you see nothing of this. You have heard the music, but that is the only experience common to you and the people in the hall. Everything else is their gain and your loss.

The stimulus to applaud comes from being in a place crowded with people. You will applaud vigorously when two thousand people applaud with you, but if you happen to be in a theatre or concert hall where, for some reason, there is but a handful of people you are almost afraid to applaud. Surely it is not unreasonable to suggest that in the privacy of your drawing-room you have no desire to applaud at all?

On the other hand, it is not reasonable to argue that because you are not a member of what may be called the primary audience you are justified in objecting to their clapping and cheering, but it may be argued that the effect of applause immediately a work has finished is inartistic and even unpleasant under ordinary listening conditions.

Even if a work ends brilliantly, with crashing chords, or a long note held by the

full orchestra, a sudden outburst of clapping is by no means good in effect, but if a work ends like a breath—as, for instance, does the *Pathetic Symphony* of Tchaikovsky, which ends so softly that it is difficult to be sure when it really has ceased—then the effect of tumultuous clapping jars the nerves of any keen listener.

I have just been making an experiment with my watch. At the conclusion of a symphony in a Prom I switched round into silence for ten seconds. I then faded in the applause with considerable effect. Looking at it as though it had been done for me, I am bound to state I felt the benefit of the ten seconds complete silence.

I should like the controller to try the experiment one evening of cutting off for ten seconds, then allowing the applause to fade up to a good strength for half a minute, fading out a second time for the announcement of the next item, and finally fading in the end of the applause. The arrangement could be variable; there is no need to make any hard and fast rules.

Until television is established everything broadcast must be thought of and viewed as something heard but not seen. We are all better listeners than we were ten years ago—even a year ago. We are getting used to appreciating music and plays by means of the ear alone.

'THE A.B.C. OF MAINS WORKING'

(Continued from preceding page)

voltage for the high tension is sufficient, and with either the bridge circuit or the voltage-doubler circuit the secondary voltage does not have to be very much greater—and is sometimes less—than the required output voltage.

SMOOTHING

AFTER the mains current has passed through the rectifier, whether metal or valve, it is "one-way" current, but by no means smooth enough to be applied to sensitive anode circuits. Between the final output of the mains equipment and the rectifier we therefore insert smoothing devices.

There are smoothing condensers and smoothing chokes. The condensers store up the voltage applied to them and thus tend to maintain the output at a constant level. The chokes oppose changes in the value of the current flowing through them and thus also help to keep the output smooth. There is more in smoothing than this, of course, but you have the general idea.

Usually, enough smoothing is obtained with two condensers and a choke between them. The important point about the condensers is not so much their capacity, though this is, of course, taken into consideration, but their working voltage.

Condensers consist of metal plates sepa-

rated by an insulating material called the dielectric. The better the dielectric the greater the voltage you can safely apply to the condenser. It costs money to put in

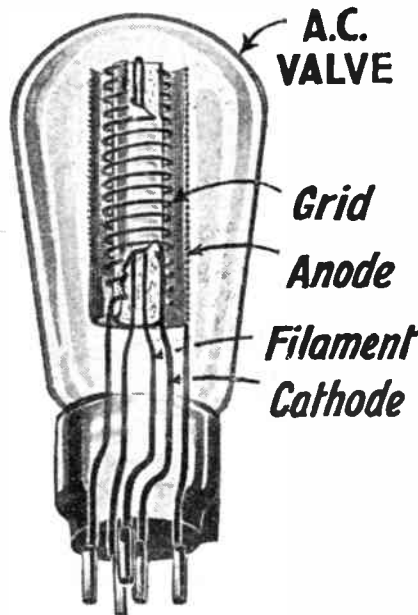

A typical mains-valve construction. The heater or filament is fed with the raw A.C. at 4 volts and this heat is communicated to the cathode, which is insulated from the heater. The cathode is the electron emitter, and corresponds to the negative side of the filament of a battery valve

dielectrics to stand up to high voltages, and your job is to choose a condenser with just the right dielectric for your applied voltage.

Smoothing condensers are now generally sold on their working voltage, which is less than half the test voltage.

The choice of the choke depends on how much current the mains supply is delivering. A choke of not less than 30 henries inductance is needed. The inductance varies with the current flowing through it, so do not be guided by the inductance figure alone. Take it with a current figure—such as 30 henries at 40 milliamperes, to give a typical example.

The condenser immediately connected to the rectifier—called the reservoir—should have a capacity of 4 microfarads. This value must not be exceeded with a valve or serious damage may be done. After the choke is another condenser, which may be anything from 4 to 8 microfarads. In this output position it is now possible to use an electrolytic condenser.

VOLTAGE DIVIDERS

AFTER the smoothing has been done we have a fixed voltage providing direct current. For the output power valve this voltage may be suitable as it stands, but for the preceding valve stages, such as the screen-grid and detector valves, a reduction in the voltage must be made.

This reducing is done with potential

(Continued on page 645)

A SIMPLE DISCOVERY—

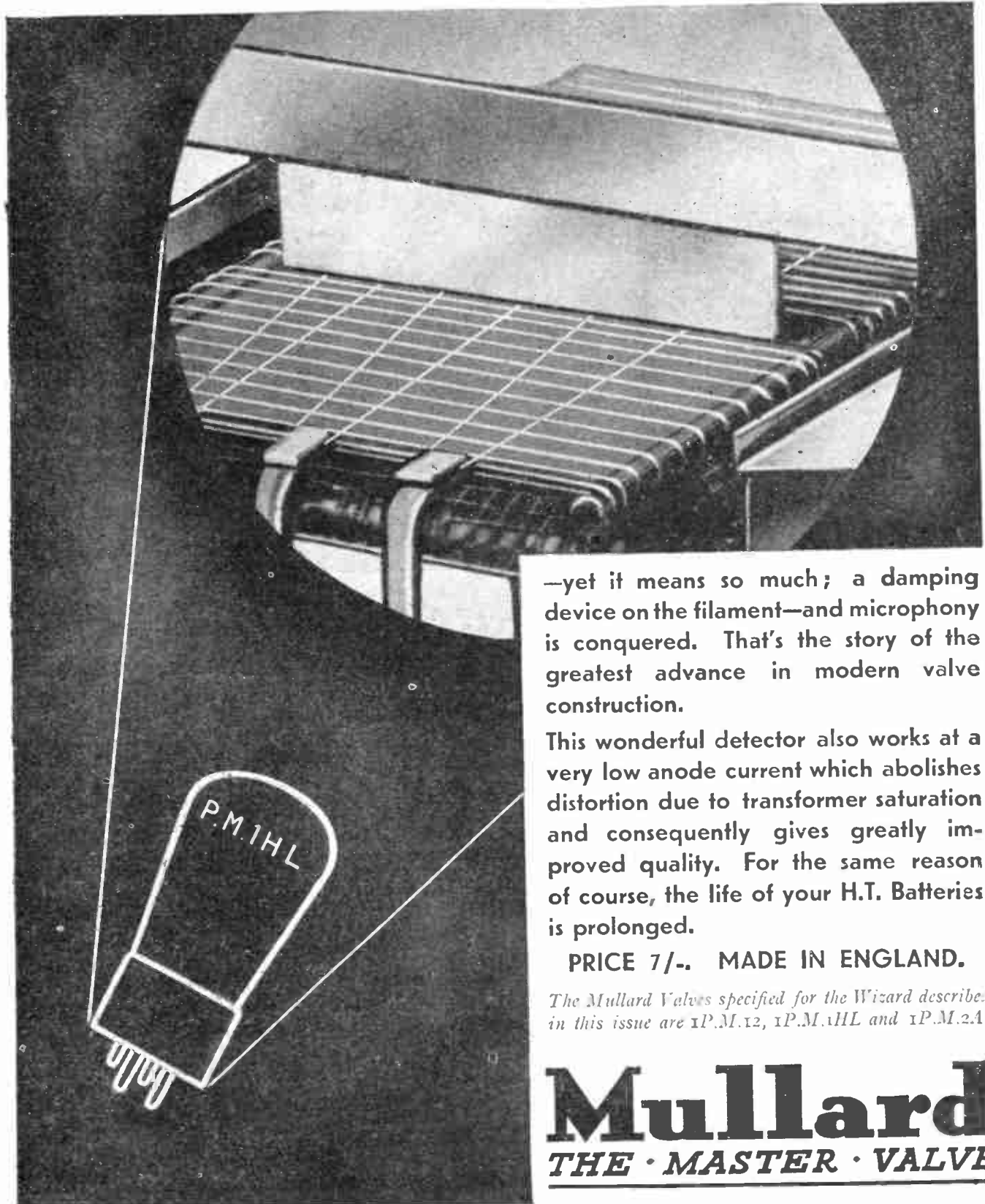

—yet it means so much; a damping device on the filament—and microphony is conquered. That's the story of the greatest advance in modern valve construction.

This wonderful detector also works at a very low anode current which abolishes distortion due to transformer saturation and consequently gives greatly improved quality. For the same reason of course, the life of your H.T. Batteries is prolonged.

PRICE 7/-. MADE IN ENGLAND.

The Mullard Valves specified for the Wizard described in this issue are 1P.M.12, 1P.M.1HL and 1P.M.2A.

Mullard

THE · MASTER · VALVE

Advt. The Mullard Wireless Service Co., Ltd., Mullard House, Charing Cross Road, London, W.C.2. ARKS

Please Mention "A.W." When Corresponding with Advertisers



“ not that I’m necessarily thinking of a set that’ll bring in Timbuctoo and Pernambuco. Let me get the really worth-while programmes sounding good. That’s the main thing — *sounding good*. Can’t do without records, though—must be able to choose my own stuff when I want to. There’s an H.M.V. radio-gramophone at thirty-nine guineas. It’d look fine, over there under the little window”



“TRUE TO LIFE”

THE MOST FAMOUS RADIO-GRAMPHONE IN THE WORLD — MODEL 521 — IS 39 GUINEAS ; WITH AUTOMATIC RECORD-CHANGING DEVICE, FOR 8 RECORDS, 46 GUINEAS.

Photographic catalogue fully describing 22 models gladly sent on request. “His Master’s Voice,” 367a Oxford Street, London, W.1.

His Master’s Voice

INSTRUMENTS FOR RADIO AND RECORDS

On Your Wavelength!

MY MISTAKE!

IF ever one's pen slips in AMATEUR WIRELESS, plenty of readers are always sure to spot the lapse and to write in about it with chuckles. I was guilty of a funny mistake a week or two back when I wrote that broadcasting would not celebrate its ninth birthday until November next. Here is how it happened. I turned up the reference, just to make sure, in the 1923 Whitaker's Almanack, in which I read that broadcasting had begun in November. Stupidly enough, it didn't occur to me that this meant November, 1922; though, of course, I knew it perfectly well if only I had thought for a moment.



"... not a sound could be coaxed from the set!"

Yes, broadcasting is just on ten years old, right enough; and ten jolly eventful years they have been.

PACKED YEARS

IHAVE before me as I write a copy of the first popular book on wireless ever published in this country—published, too, under the auspices of the Editor of "A.W.", though this paper was not then born. The first edition of the book appeared some time before broadcasting began. It deals with coherers and all kinds of funny old apparatus. The carborundum and crystal detectors it knows, but it does not get as far as the valve! Then there's another book which appeared in the very early days of broadcasting. This was quite a revelation in its time, for it not only dealt with the theory of the valve, but also showed how to make a five-valve set. You couldn't buy many components in those days; so full instructions were given for making the variable condensers, low-frequency transformers, and fixed condensers, as well as the tuning coils. The five valves were all of the general-purpose type; so you can just imagine what the distortion was like when this set got going. There was, of course, no negative grid-bias anywhere.

SOME EVENING!

ISHALL never forget the evening when I gave my first more or less formal wireless demonstration. This must have been in the late summer of 1922, and the show took place after a dinner party to which guests had been specially invited to see and hear the new wonder. The set was a unit affair with two H.F., a detector, and two L.F. stages (all

G.P. valves) connected to the original Brown type "H" loud-speaker. Old hands will remember this speaker well enough.

THE THRILL OF IT

IT grieves me to have to say it, but not a sound could be coaxed from the set until after Writtle had closed down. Whilst I was engaged in trying to discover the fault, my accomplice endeavoured to keep the audience interested by telling them of the wonderful things that were shortly to happen. When, at long last, I discovered that the grid leak had died on me and replaced it with the line of Indian ink drawn on paper that we so often used for the purpose in those days, I was overjoyed to find that several amateurs were hard at work transmitting. One of these was sending out a Harry Lauder record and, by stupendous feats of tuning, I got the transmission up to loud-speaker strength. Positive thunders of applause greeted what we should now regard as an appalling performance. A few more amateurs were picked up, and the evening closed with a world tour, which consisted in tuning in long-wave morse signals. My audience listened to those pings and pipings from far-away places with more interest than a present-day audience would display in the perfect and powerful reproduction of some outstanding musical programme from Budapest or Madrid. Those were the days!

SAD BUT TRUE

WITH the autumn increase in signal strength that we are experiencing just now, heterodynes are becoming far more marked. Actually, the growing number of heterodyne whistles is due not only to seasonal effects, but also to the fact that so many Continental stations have increased their power and are therefore more capable of producing "action at a distance." This is a very serious problem for all wireless folk. It is quite clear that where powerful transmitting stations are concerned as wavelength neighbours, a 9-kilocycle separation is about as much use as the proverbial sick headache.

With a selective receiver you can separate the two stations easily enough, but you cannot get rid of the heterodyne whistle which accompanies either. We shall, I think, have to make more use of filter cir-

cuits to obviate this nuisance. Since the general separation of stations is 9 kilocycles, the frequency of the heterodyne is well defined, and it is not difficult to design a filter for it. The use of such a filter means, of course, that this particular frequency is strained out, whether it occurs as a whistle or as a musical note. In theory, this might seem a fatal objection, but in practice it does not make a great deal of difference.

OLD AGE IN LOUD-SPEAKERS

IHAVE had so many letters recently from correspondents who have found old or oldish loud-speakers developing various annoying habits, that I think I had better mention again the hints that I gave in these columns a year or two back. All loud-speakers of the balanced-armature type and the majority of moving-coil loud-speakers made to-day incorporate permanent magnets. The trouble is that, like permanent waves, permanent magnets are not everlasting. There is no greater enemy of the permanent magnet than vibration, and this must come the way of those which form part of loud-speakers. As time goes on, the magnet slowly loses strength. The instrument then overloads more and more easily and the quality suffers badly. There are several firms which carry on re-magnetizing, and the process is not at all an expensive one. I have had several loud-speakers treated in this way and it has invariably produced beneficial results.

ERRATIC FADING

WHEN a set plays the old soldier's game of gradually "fading away," it is generally because one of the batteries has run down, specially



J. A. Mollison making one of his numerous appearances before the "mike." On his return he was asked to broadcast, with Mrs. Mollison, during a late-night television transmission

On Your Wavelength! (continued)

the L.T. But there are fading symptoms of a more erratic kind. For instance, not long ago I was called in to "vet" a set which worked quite normally for a couple of minutes, and then fell off nearly to nothing. After a while, the signals came back only to go off again, and so on. Now this kind of thing is usually due to grid trouble—either the leak resistance is too high or else it is open-circuited—so that the grid voltage gradually builds up until it paralyses the valve by shutting-off the plate current. After a while the excess voltage manages to find some path of escape, possibly across the base of the holder, and the valve starts to function properly. But not for long, because the same defect soon causes it to choke up again. If the set works all right so long as you keep your fingers on the faulty grid terminal, you can be pretty certain you have found the cause of the trouble.

"DATING" VALVES

A PROPOS of a recent paragraph in which I commented on the long and faithful service given by the average valve before "passing out," I find that, as usual, there is another side to the story. In fact, judging by recent correspondence it rather looks as if the mains-driven valve is more prone to give up the ghost at an early stage than the battery-driven type. This, of course, is not as it should be, but I notice that the evidence as to length of service is not always very convincing. Personally I think it is a very sound plan, whenever one has to put in a new valve, to stick on it a small label plainly marked with the date of purchase. One can then at least be certain exactly how long it has been in operation, without having to strain one's memory and possibly do the valve manufacturer something less than full justice.

WHAT'S IN A NAME

THE first time I saw the term humbucking coil in print I thought it was a rather amusing misprint. But in point of fact it is used, quite aptly, to describe a special coil used for cutting-out "hum" from a moving-coil speaker energised from the mains. I think the term "bucking circuit" was first used in America to describe a coupling which introduced reverse reaction, i.e. one tending to cut down any tendency to self-oscillation. Hence a humbucking device is one which helps to eliminate hum. Another interesting bit of radio slang is the word "wow," used by the B.B.C. engineers as a snappy way of referring to the otherwise indescribable effect produced, when transmitting from a gramophone record, by a momentary alteration in the speed of the turntable carrying the disc. One can, of course, get the same effect by altering the speed on an ordinary gramophone, but I don't think you could find a terser way of describing it.

KEEPING A CHECK

THERE is a very useful way of keeping a check on the condition of loud-speaker and other magnets. To a piece of iron, attach by threads one of those little paper cups in which ices are sold. Place the iron against the magnet, as near the pole pieces as you can, and go on placing pennies in the cup until you find the greatest number that it will support. Three pennies go to an ounce. Scratch the number of pennies on the magnet, and there you are. If you make this test first of all when the magnet is new you can always try it out at any time to see whether it is remaining in good form. A more exact measurement can be made by using small shot instead of pennies and subsequently weighing the contents of the cup.

A PENTODE YEAR

IT is really amazing to find what numbers of ready-made sets nowadays incorporate pentode valves, whether designed for mains or for battery operation. As I prophesied some time that it would, the pentode has come into its own. It has shown that, given a chance, it can be a wonderful performer. The trouble in the past was that we did not give the poor thing a chance, for too often the loud-speaker was not properly matched to its impedance by means of the right kind of output filter or transformer. Or, again, no corrector circuit was used with the pentode, with the result that reproduction was apt to be thin and shrill. You won't find these faults in the well-designed pentode sets of to-day.

REFORMED!

FROM another point of view, the pentode is a reformed valve. It used to be horribly greedy in the matter of high-tension current, and this made its use in battery sets almost impossible unless super-capacity H.T.B.'s were

"HOOK-UP" CONDENSERS

Experimental circuits may be tried out on a baseboard without using any proper panel. The condensers should be mounted right at the edge, so that the knobs are

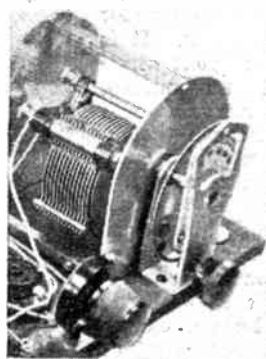

accessible and scales should be provided, so that you do not have to guess at the dial readings.

employed. Most of the early pentodes required the best part of 20 milliamperes all to themselves. I remember testing the H.T. current drain of a four-valve pentode portable worked from a standard-capacity battery which appeared on the market a few years ago. This turned out to be 28 milliamperes, and the set was therefore just a little expensive to run. The modern battery pentode really is economical, for there are several types which require not more than 5 milliamperes and yet provide an undistorted output of a very respectable fraction of a watt.

SINGLE-WAVE TELEVISION

HITHERTO, the "sight" portion of a television transmission has always been sent on one wavelength and the "sound" portion on another. The drawbacks of such a system are obvious: two transmitters and two receivers are required, and the combined transmissions monopolise two of the limited number of wavelengths available. A very ingenious new system has just been tried out successfully from the well-known American short-wave station W2XAB. The wavelength used was 107 metres, and both sight and sound were transmitted upon it. So successful were the first tests that transmissions are now being made daily, except on Saturdays and Sundays. In case any short-wave enthusiast wants to try for the transmissions, the programme begins at 1 a.m. British Summer Time and continues for two hours.

HOW IT IS DONE

THE method employed is exceedingly clever. To begin with, the sound waves occurring in the studio are used to modulate a feeble carrier with a frequency of 45 kilocycles. No actual transmission at 45 kilocycles is, however, made. The modulation due to television consists of frequencies up to 40 kilocycles. This and the afore-mentioned 45 kilocycles are impressed upon the main carrier and radiated as a single transmission. At the receiving end only one set is required. Frequencies up to 40 kilocycles are passed to the neon tube, but a filter keeps out the higher frequencies, which thus cause no interference with the reception of the picture. The second detector, tuned to 45 kilocycles, takes charge of the speech part of the transmission.

The system appears to be very promising and it is working well on the short waves. It could not, however, be used on the long waves, for the simple reason that the channel required by a broadcasting station for such a transmission is 45 plus 45, or 90 kilocycles in width. This is equivalent to ten of the 9-kilocycle channels at present employed under the Prague Plan. This means that ten single-wave television transmitters operating in different parts of the Old World would completely cover the whole of the "broadcast" band. There is heaps of room on the short waves. But the broadcast band is already very much overcrowded.

THERMION.

Whatever set you possess, an Ever Ready Battery will power it most economically, most satisfactorily and for a longer time; Ever Ready Batteries are made to fit and power exactly every wireless set made. And every Ever Ready Battery is guaranteed satisfactory by the makers of batteries for the past 30 years.

**CHEAPER TO USE
BETTER QUALITY
GREATER VOLUME
LONGER LIFE**



EVER

**WIRELESS
DRY
BATTERIES**

READY

THE BATTERY YOU WILL ULTIMATELY USE

THE EVER READY CO. (Great Britain) Ltd. HERCULES PLACE HOLLOWAY, LONDON, N.7.

Mention of "Amateur Wireless" to Advertisers will Ensure Prompt Attention

LOOK FOR "EDDY" IN YOUR DEALER'S WINDOW

Full-sized constructional models (Battery or A.C. Mains) of the "Sunday Express" S.G.2 Radiogram, specifying Mazda Radio Valves, are obtainable at W. H. Smith's bookstalls and radio dealers, price 1/-



FACTS YOU SHOULD KNOW.. ABOUT THE MAZDA PENTODES



The output stage in portable battery-driven receivers has always presented a problem to the designer on account of the limited H.T. supply available.

THE MAZDA PEN 220 has solved this problem as, owing to its extreme sensitivity, ample volume can be obtained with only 4 M/a anode consumption. The Pen 220 has, in addition, rapidly gained favour in the case of standard battery-operated receivers where economical H.T. consumption is an important consideration.

THE PEN 220A is a high-power output pentode suitable for driving a large moving-coil speaker. It should be used in conjunction with an eliminator.

THE PEN 425 for receivers operating on anode voltages above 150.

THE AC/PEN, the finest all-mains power pentode, sensitive enough to operate a loud speaker direct from aerial input.

Full details of these and other useful Mazda types will be found in the Mazda catalogue, sent FREE on request.

Mazda valves are fitted by all the leading receiver manufacturers. All good radio dealers stock them.

The amazing

MAZDA THE BRITISH VALVES

EDISWAN RADIO
100% BRITISH—Designed by British Engineers

The Edison Swan Electric Co. Ltd

Mazda Radio Valves are manufactured for The British



155 Charing Cross Rd. London. W.C.2

Thomson-Houston Co. Ltd., London and Rugby.

V.167

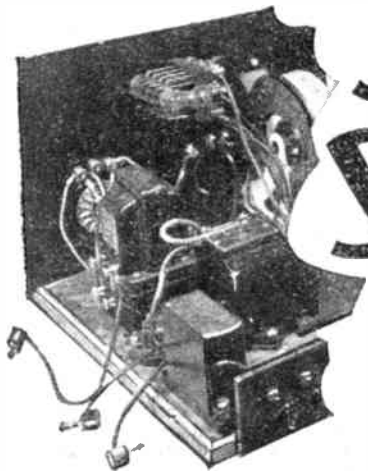

J.H. REYNER EXPLAINS SOME DEVELOPMENTS IN L.F. AMPLIFICATION

A Forecast of Some Interesting Possibilities
in Low-Frequency Amplification

IT is a long time since there was any marked change in the methods adopted for amplifying the low-frequency signals after the detector stage. In fact, one can say that the introduction of grid bias was the last really important development in this field. There have been numer-

ous changes in the form of the device used to couple one valve to the next, but all the systems hitherto employed operated on the common principle that the grid swing permissible ranged between the

point where the characteristic starts to curve at one side and the point where grid current begins to flow on the other. This latter point usually occurs round about zero grid bias (see Fig. 1); so that it has been the practice to apply negative grid bias to the valve of a value approximately half that at which the characteristic first begins to curve, and we operate over the straight-line portion of the characteristic and so obtain distortionless amplification.

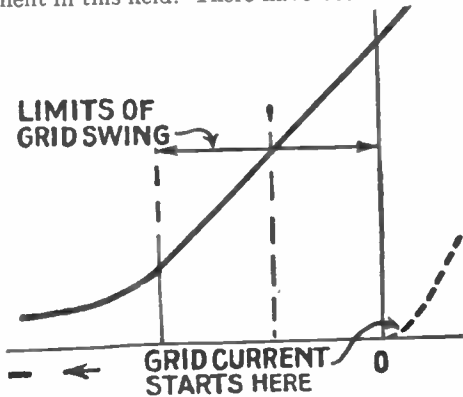

Fig. 1. Under normal operating conditions the grid voltage swings over the straight portion of the curve

ous changes in the form of the device used to couple one valve to the next, but all the systems hitherto employed operated on the common principle that the grid swing permissible ranged between the

A Matter of Grid Swing

This leaves all the characteristic to the right of the zero grid-bias line unused and imposes a serious limitation on the power output obtainable from a given valve. In general, the principles just outlined remain unaltered even in the case of the power valve which supplies the loud-speaker, and the output obtainable is very largely dependent on the grid swing which is possible without overshooting the two limits already stated. If we could, in some way, extend the characteristic so that without altering anything else we could put, say, 50 per cent. more grid swing into the valve we should obtain over twice the power output.

Attempts are now being made to do this. It is not practicable to run over the

curved portion of the characteristic, so that the direction in which attention has been turned is that of extending the swing on the positive side of the characteristic. This means that grid current flows during all or part of the time. So far we have regarded such a state of

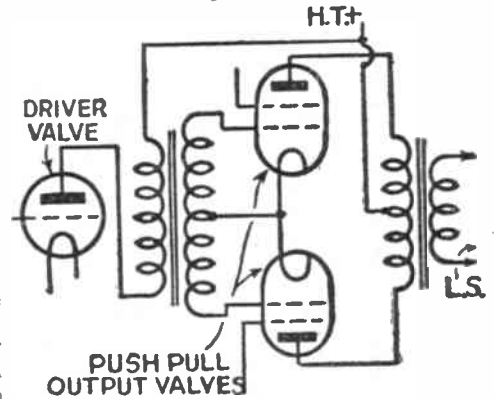

Fig. 2. Circuit of grid-current push-pull amplifier. The driver valve is designed to work as a power amplifier

affairs as one to be avoided at any cost, but it now appears likely that under proper control it may not prove such a bugbear as was anticipated.

Various methods are being tried out, most of which, unfortunately, require special valves, but I hope in future articles to give details of some experiments which can be carried out with existing valves under suitable operating conditions so that those who are interested can try the various effects for themselves. For the present, reference will be made to two systems either of which may be widely used in the future.

New Systems

The first of these is the triple-twin tube. This is a two-valve arrangement which is put on the market in the one bulb and behaves, as far as external connections are concerned, as if it were a single valve. The main part of this valve is an ordinary power valve normally operating with zero grid bias. A negative voltage applied to the grid causes the anode current to decrease in the normal manner and operates over what we term

(Continued on page 644)

GETTING BUSY AT MADRID



Some of the delegates in the Senate Palace at Madrid, where the big International Congress is taking up the time of 600 members from the leading European countries. The B.B.C. is represented by Sir Charles Carpendale Mr. Noel Ashbridge, and Mr. Hayes

PRACTICAL HINTS AND TIPS

Useful advice for set-builders and users. These hints and tips will enable you to get better results, and make for simpler and safer set-operation

FITTING A FUSE

IN a portable set there is sometimes a chance that the low-tension wiring may be pulled loose and a short circuit will result, which may burn the wiring insulation. The best prevention is a fuse fitted close up to the accumulator terminals. Many types of fuse for inter-lead connection are now on the market, but in emergencies a short length of thin fuse wire of the electric-light type can be

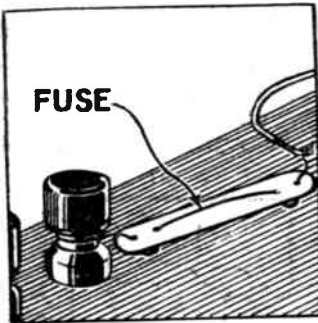

How to fit a fuse in a portable set

used and this should be connected quite close to one of the terminals.

EARTHING A TRANSFORMER

SOME transformers are shielded in a metal case but are not provided with an earthing terminal. To prevent spread of the magnetic field it is sometimes necessary to earth the base and core, and it is a good plan to scrape away a little of the insulation underneath the base of the transformer and to clamp it down on a wire (making good electrical contact), which can be connected to negative low-tension, thus earthing and stabilising the transformer. This can safely be done with low-frequency transformers, but is not a wise precaution with mains transformers as the casing may not be well insulated from the core.

A SHORT-WAVE COIL

IF you wind a short-wave aerial coil with a reaction winding on the same former you can in most cases easily convert your set to short-wave working. A piece of ribbed ebonite tubing should be used as the former and bare wire should be wound on it so that you can make the connections to the coil at suitable points. On a former of about 3 in. diameter wind on 15 or 20 turns of No. 24 bare copper wire and space the turns about 1/4 in. apart. Small nicks may be cut in

the ebonite ribs of the former to keep the turns in position. Brass clips known as "crocodile" clips should be used to take the tappings to the coils, but a rough test may be made by twisting the coil connections around the bare wire turns. The reaction winding should consist of 5-8 turns of wire and if the right number of turns is found for the local set conditions there is no need to have this winding tapped.

PARALLEL-FEED

IF you have a small transformer which is easily upset by the steady direct current of the anode circuit flowing through its windings, it can generally be made to give better results by putting it in a parallel-feed circuit. This is quite easily arranged. Leaving the secondary winding in its original position in the circuit, remove the primary winding connections and substitute a fixed resistance of 30,000 ohms. Connect one end of the primary winding to a 1-microfarad condenser connected on its other side to the join point of this fixed resistance and the high-frequency choke in the anode circuit. The other end of the primary winding is connected to earth through the negative low-tension wiring. When you scheme this out you will see that it is on similar lines to the arrangement of a choke output circuit, the secondary winding of the transformer being connected as usual to grid and grid bias.

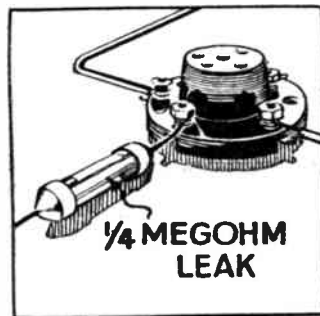

A good idea to prevent motor-boating—a leak in the low-frequency grid circuit

FITTING A LEAK

IF your set motor-boats, and gives rise to threshold howl, even though the detector stage is decoupled, try fitting a grid-leak of about 1/4-megohm in the wiring to the grid of the valve following the detector. The leak

should be put in series with the existing wire going to the grid terminal and not placed from grid to negative low-tension. This will stop high-frequency instability.

LABEL YOUR VALVES

VALVES have a long length of life nowadays but it is worth while keeping a record when each new valve is put into the set. The B.B.C. always does this. All the amplifiers in the control rooms have the valves ticketed with an indication of the tested emission when new and of the date of insertion. Stick a piece of stamp paper on your valves and make a note when each valve is bought.

ADDING COIL TURNS

SOMETIMES it is necessary to add a winding to a coil, as for example when an aperiodic winding is required to improve the selectivity. This is a tip worth noting. There is no need to scrap the coil or to move the main winding in order to get winding space for the additional turns. The winding can be put over the main turns, using covered wire kept away from the body of the coil with small strips of ebonite, or even pieces of matchwood if the wire is well insulated. In this way the selectivity of a coil can often be improved. Put an additional winding outside it of 15 or 20 turns of wire of not too thin a gauge. Connect one end of this additional winding to earth, remove the aerial lead from the

condenser chassis at a number of positions and which are variable in height. The sets of feet must match for otherwise there will be a constant strain on the chassis which will upset the ganging.

A WIRING HINT

A SIMPLE tip, but one which makes a great difference to the neatness and trouble-free nature of the wiring in a set; when baring flex or battery

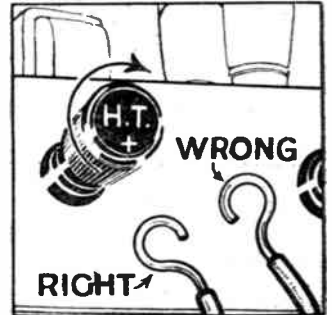

How do you wire up? The correct and incorrect methods of making a terminal connection are shown

connections, take care that only the rubber is cut and that the wire is not nicked; also when the wire ends have been bared, twist the strands tightly together and make a loop in a clockwise direction. If the loop is made in the other direction the strands will tend to unravel as the terminal head is tightened.

NOISY PIGTAILS!

NOISY tuning in a short-wave set can often be traced to the pigtail connection rubbing against some part of the condenser frame. When working down on 15 metres and thereabouts, the rubbing of the pigtail turns against themselves will sometimes even cause a scraping noise. Keep the pigtail connection as short as possible and spaced away from the condenser frame.

VARY THE H.T.

IT is important to vary the high-tension in a short-wave set to get smooth reaction. Smooth descension into oscillation is much more important in a short-wave set than it is on the long waves. Try altering the H.T. to the detector valve for you will probably find that this makes a great difference to reaction control. A lower H.T. value than normal for broadcast-band working is frequently an advantage as it enables smoother oscillation to be obtained at the risk of reducing the handling power of the detector.

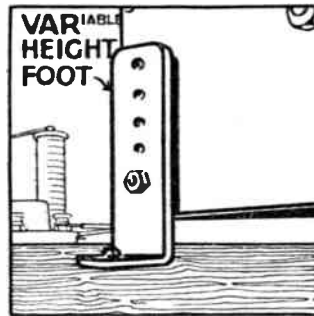

You should watch this point when fixing ganged condensers. The foot shown is adjustable for height

coil and take it to the other end of the added winding.

GANG CONDENSER MOUNTING

SOME ganging condensers are provided with L-section feet, which can be clamped on to the

YOU SHOULD BUILD THE "WIZARD"

Direct Radio

THE "WIZARD"

159 BORO HIGH STREET

	£	s.	d.
1 Ebonite panel, 14 in. by 7 in.	4	0	0
1 Baseboard, 14 in. by 9 in.	1	0	0
2 Readl-Rad .0005-mfd. solid dielectric variable condensers, "Minclog"	7	0	0
2 Readl-Rad S.M. disc drives	8	0	0
1 Lissen 2-gang shielded coil unit and combined filament switch...	17	6	0
1 Readl-Rad .0005-mfd. variable reaction condenser	2	6	0
3 T.C.C. fixed condensers—(2) 1 mfd. and (1) 2 mfd.	6	0	0
1 T.C.C. .0005-mfd. fixed condenser, type 8	1	3	0
2 T.C.C. .0002-mfd. fixed condensers, type 8	2	6	0
1 Dubiller 2-megohm grid leak with wire ends	1	0	0
1 Lewcos 30,900-ohm spaghetti	1	6	0
1 Wearite screened H.F. choke, H.F.P.	3	6	0
1 Readl-Rad standard H.F. choke	1	6	0
3 4-pin valve holders	1	6	0
1 R.I. resistance-fed transformer, Parafed	8	6	0
2 Terminal blocks, Aerial, Earth, L.S.+, L.S.—	1	0	0
1 Sovereign pre-set series aerial condenser, .00003-.00025 mfd.	1	3	0
1 Drilled ebonite strip, 3 in. by 2 in.	6	0	0
2 Belling Lee terminals, Pick-up... ..	5	0	0
1 Readl-Rad radiogram e/o switch	2	9	0
6 Belling Lee wander plugs: H.T.—	1	0	0
H.T.+1, H.T.+2, G.B.+1, G.B.—2	1	0	0
2 Belling Lee spade terminals: L.T.+1, L.T.—	6	0	0
6 Yards Lewcoflex, Glazite, shielded flexible tubing, screws, etc.	1	7	0
3 Mullard valves: PM12A, PM11H, PM2A	1	12	3
1 Special "159" cabinet	1	0	0
Total	£6	10	0



The special "159" Cabinet, in hand polished walnut

- Kit No. 1** (Less Valves and Cabinet) **£3 : 17 : 9**
 or 7/- down and 11 monthly payments of 7/-
- Kit No. 2** (With Valves less Cabinet) **£5 : 10 : 0**
 or 10/- down and 11 monthly payments of 10/-
- Kit No. 3** (With Valves and Cabinet) **£6 : 10 : 0**
 or 12/- down and 11 monthly payments of 12/-

ACCESSORIES

	£	s.	d.
1 Siemens 120-volt H.T. battery	15	6	0
1 Siemens 9-volt G.B. battery	1	0	0
1 Oldham 050 2-volt accumulator	9	0	0
1 Epoch Twentieth Century speaker	1	15	0
1 Atlas H.T. mains unit, A.C.244	2	19	6

	£	s.	d.
Mains Units			
Atlas A.C.244	2	19	6
H.T. only			
Atlas A.K.260	4	10	0
H.T. and L.T.			
Atlas D.C.15/25	1	19	6
H.T. only			
Pick-up			
Bowyer-Lowe A.E.D. Mark III	1	10	0
Pick-up Volume Control			
Bowyer-Lowe A.E.D. log law	8	6	0
Moving-coil Speakers			
R. & A. "Bantam"	1	7	6
R. & A. "Challenger"	1	15	0
R. & A. "Victor"	3	10	0
All including input transformers. Our special "Soundex" Speaker Cabinet in polished veneered Walnut can be supplied at £1/5/0 extra.			
Gramo motor, Collaro spring type B.30	1	12	0
Gramo motor, Collaro induction type	2	10	0
Oldham H.T. accumulator, 120 volts 5,500 m.A. hour capacity, £4/1/0, or 7/6 down and 11 monthly payments of 7/6.			

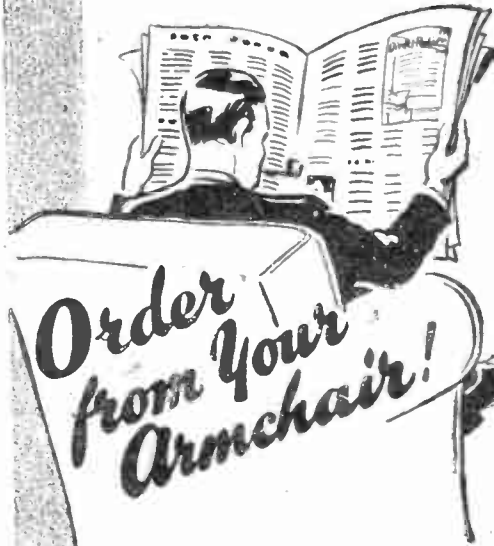

CASH, C.O.D. AND EASY PAYMENT ORDER FORM
 To: Direct Radio, Ltd., 159 Borough High Street, London, S.E.1.

Please dispatch to me at once the following goods.....

for which (a) I enclose
 (b) I will pay on delivery { cross out line }
 (c) I enclose first deposit of { not applicable }

NAME

ADDRESS

A.W. 24/9 32

TO OVERSEAS CUSTOMERS. We specialise in Radio for Export. Goods to your exact specification are very carefully packed and insured, all charges forward. Terms: Cash with order, or deposit one-third with order, balance C.O.D.

FULL-SIZE PLAN

and

WIRING GUIDE

A Simple-to-build

Ultra-modern "Three"

Amateur Wireless

THE WIZARD

GRAMO-RADIO SWITCH

BLUEPRINT
NO A.W. 360

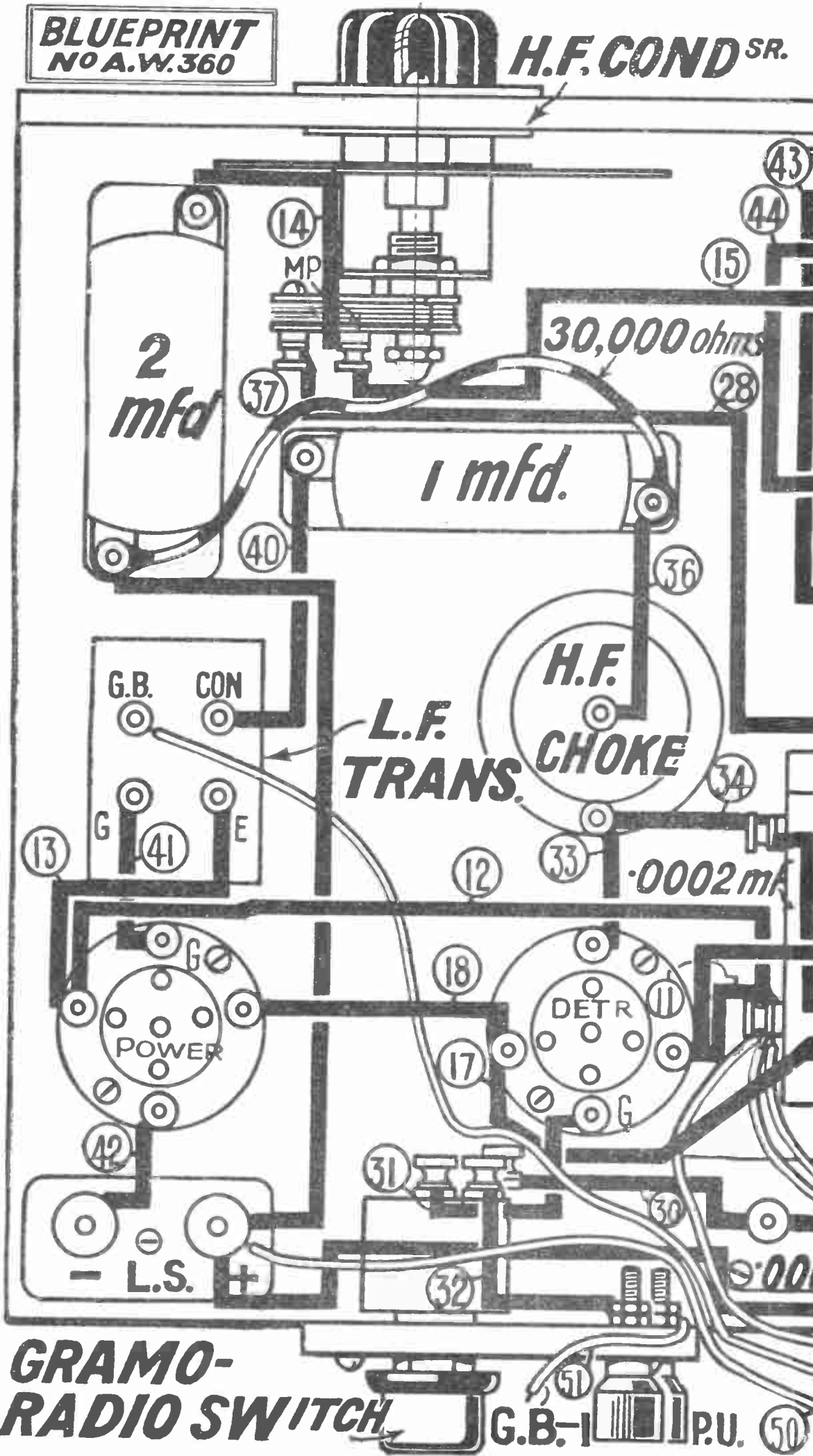

H.F. COND SR.

2 mfd

1 mfd.

L.F. TRANS.

H.F. CHOKE

G.B. CON

.0002 mfd

POWER

DET R

L.S.

G.B. I

P.U.

REACTION COND. AERIAL COND.

PANEL 14x7

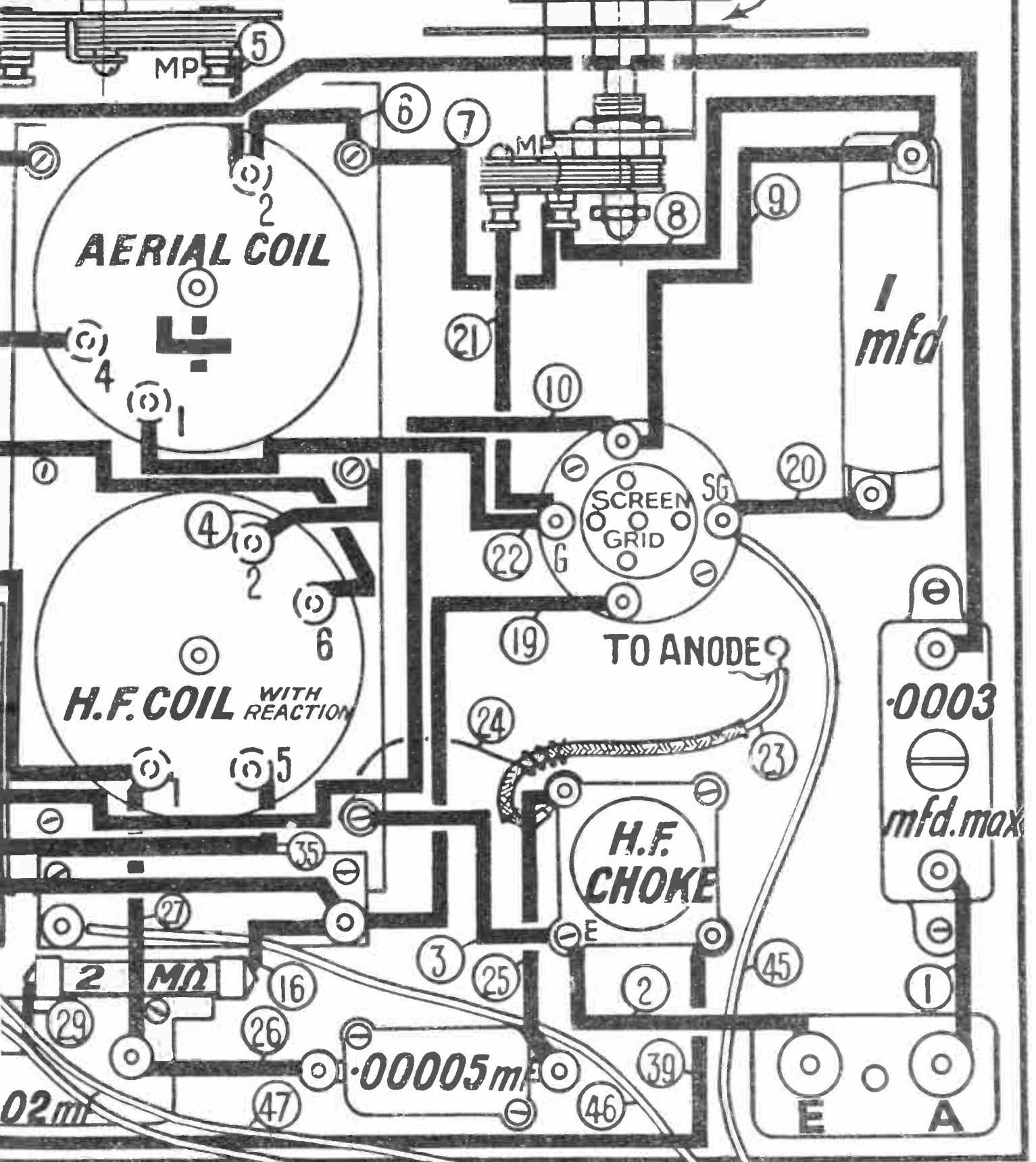

BASEBOARD 14"x9"

G.B.+ 48 L.T.- H.T.- H.T.+1
 G.B.-2 49 H.T.+2 L.T.+

THE "A.W. Wizard," the set which forms the subject of the free full-size wiring plan on pages 624 and 629, can be built in a couple of hours.

It is one of the easiest sets to build which has ever been described in a wireless journal. There is no metal in the construction, no complicated screening, nor any under-baseboard wiring.

A few parts are mounted on the panel and some screwed to the baseboard. The minimum number of wires are connected in place, and the "Wizard" is ready to conjure in the stations.

There is no soldering in the whole set.

Why is the construction so simple? Well, the photographs show you that there are separate tuning condensers, and so no special ganged component has to be positioned in the set. The separate condensers used are of a very easy-to-mount type.

The two coils in this set are bought ready mounted on a metal sub-chassis and are ganged together with a combined wave-change and on-off switch. This coil assembly forms the central component of the set and is a rough-and-ready guide to the positions of the other parts.

Even if you have never built a wireless set before, you will have no difficulty in making up the "Wizard" and getting it to work properly.

The full-size wiring plan in this issue is an exact guide to the positions of the parts and it shows you just where to connect up the few wires needed in the construction.

If you are an experienced set builder you will be better able to appreciate how simplification has been effected in the "Wizard" and how, on the score of simple

BUILDING YOUR



construction and easy working, the "Wizard" is an outstanding set.

THE FIVE STAGES

There are five stages in the construction of the "Wizard." These are as follows. The selection of the parts from the accompanying components list, which gives all the components you will need, and a list of recommended accessories; the arrangement of these parts on the panel and baseboard, preparatory to mounting, in order to ascertain from the wiring plan the exact mount-

BUILD THIS SET IN TWO HOURS

ing centres of each component; the mounting of the parts on the baseboard, the drilling of the panel, and the fixing together of panel and baseboard; wiring up and, last of all, checking.

THE KIT OF PARTS

The first stage is easy, for the components list saves you the bother of selecting parts. The components are grouped in this list under the various headings, such as "ebonite," "coils," "low-frequency transformer," and so on. In practically every case alternatives are given, so that if the first-mentioned parts are not available you will know which other makes to order from your dealer.

Owners of existing sets may find that some of their parts can be transferred to the "Wizard." Take care; don't experiment with parts of different values from those specified. The components list should be your safe guide.

The next stage is to check your kit of parts with the components list, making sure that you have everything at hand.

The full-size wiring plan on pages 624 and 629 should be detached complete from the issue, without tearing. This is of great assistance in the first job you will have to

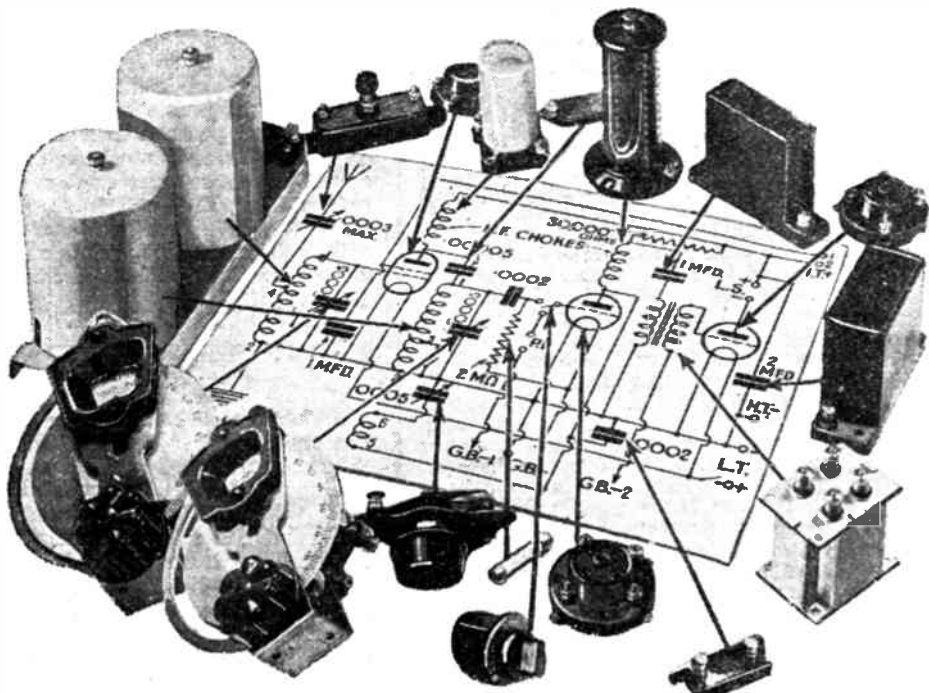

A composite picture which will help you to understand the circuit diagram. The positions of the actual components are clearly indicated and you can find the corresponding positions on the layout plan on pages 624 and 629

WIZARD

Here is a full constructional description of the fine new "A.W." set which is the subject of the free full-size wiring plan in this issue. The "Wizard" is a three-valver with an amazing performance and can be built in a couple of hours.



undertake in the actual construction, the plotting out of the mounting centres on the baseboard and the marking for the holes in the panel.

If you prefer to work from one of the professional-type full-size actual blueprints, as produced in connection with every "A.W." receiver, then write for a blueprint of the "Wizard" set, enclosing a postal order for one shilling, to the Blueprint Department, AMATEUR WIRELESS, 58-61 Fetter Lane, London, E.C.4.

HOW TO USE THE FREE WIRING PLAN

The wiring plan should be put flat down on the plywood baseboard. Take some sharp tool, such as a bradawl, and prick through on to the wood the screw holes of each of the components shown. If one of the parts used is not of a make first specified in the components list, then the mounting centres may be different from those shown on the print.

Do not move the print while the holes are being marked through or you will find that some of the screw holes are out of true.

Now for a slightly more difficult job, the marking of the panel. The wiring plan or blueprint is again used to show the centres and the panel is marked on its reverse side, so that the marking lines do not show.

Put the print flat down on the back of the panel and for safety's sake temporarily attach it at each of the four corners with spots of adhesive. This will prevent it moving while you mark the centres. A small punch is best used for marking centres on the ebonite or the sharp point of a bradawl can be pushed through the paper against the ebonite. In either case take care not to crack the panel. Only light taps should be given on the punch to make a small indentation in the ebonite. On the baseboard it is sufficient to mark the centres with the point of the bradawl, but on the panel a more definite mark is needed not only to show the drilling centre, but to give the

point of the drill a start, so that it does not slip on the panel surface.

DRILLING THE PANEL

Holes need to be marked for the two condenser shafts, for the reaction condenser, for the wave-change switch, and for the three wood screws along the bottom edge of the panel. In addition there are the two windows to be cut for the tuning condenser scales.

Drill the condenser wave-change switch and screw holes with an ordinary brace and bit, drilling through from the reverse side of the panel to the front. *Put the panel on some sheets of newspaper so that it does not get scratched.*

There are two good ways of cutting the condenser-scale windows. The most professional way, of course, is with a fretsaw. An easier way for the man who is not adept with tools is to drill a number of small holes around the outline of each window and then lightly to tap out the centre piece of ebonite. The edges of the holes thus formed can be smoothed down with a file. Don't forget the two small holes on each window for the small bolts which hold the escutcheon plates in position.

When the holes are drilled, screw the panel firmly to the baseboard, making sure that they are at right angles.

HOW TO MOUNT THE PARTS

Everything is now in order for mounting all the components. The panel parts should be mounted first, and then, of the

**SEE THE TEST REPORT
ON PAGE 611
and be convinced of the real
worth of the "Wizard"**

baseboard components, the ganged coil assembly. Do not screw all the parts down firmly at this stage, for you must check up to see that you have components such as the valve holders and the low-frequency transformer the right way round. When you are satisfied that this is O.K., the parts should be screwed down, leaving only the one special wood screw of the screened high-frequency choke, for this screw clamps an earthing wire to the screen and cannot, therefore, be tightened down until the wiring is started.

The small ebonite strip carrying the gramophone switch and pick-up terminals is easily drilled and the switch and two terminals should be mounted on it. Do not screw the strip to the back of the



THE SIMPLE - TO - BUILD MODERN THREE (Continued from preceding page)

baseboard, though, until some of the wiring to the switch has been done, otherwise you will find it awkward to manipulate the pliers.

The coil unit it will be noted, is mounted on a strip of plywood, so that it is raised higher from the baseboard and leaves more room for the operation of the wave-change knob.

WIRING UP

Many listeners may have previously fought shy of making a wireless set because they have believed that the wiring is difficult. This is true of some complicated sets, but the "Wizard" is as simple as A B C.

As there is no soldering, the whole job of wiring can be done with a pair of pliers. The leads are best made with bare copper wire enclosed in insulated sleeving. This is a trifle easier to carry out than wiring with insulated wire, the ends of the insulation having to be removed in order to make terminal connections.

Use the blueprint as your guide and cut each length of the bare copper wire to run conveniently from point to point. About half an inch should be allowed at each end to make the looped connection underneath the terminal head. Cut each length of the insulated sleeving to the exact length required to run from terminal to terminal.

When putting each lead in place, loop one end under the terminal and clamp it down. Slip on the insulated covering and then make the second looped connection. One or two wires in the "Wizard" are so short that no insulated covering is needed. Terminal 2 of the coil nearer the panel is taken to one of the fixing screws, thus earthing it. The grid leak (one end of which

COMPONENTS FOR THE "WIZARD"

EBONITE
 1—Ebonite panel, 14 by 7 in. (Lissen, Becol, Goltone, Peto-Scott).
 2—Terminal blocks, marked Aerial, Earth, L.S.+, L.S.— (Lissen).
 1—Ebonite strip, 3 by 2 in. (Becol, Goltone, Peto-Scott, Lissen).

CONDENSERS, VARIABLE
 2—.0005-mfd. solid dielectric (Ready Radio "Micalog," Lissen, Telsen, Peto-Scott, Polar, Utility).
 1—.0005-mfd. variable reaction (Lissen, Ready Radio, Telsen, Peto-Scott, Polar, Utility).
 1—Pre-set series aerial condenser, .00003 mfd. to .00025 mfd. (Sovereign, Lissen, Telsen, Formo, Igranic, Goltone).

COIL
 1—Two-gang shielded coil unit and combined filament switch (Lissen).

CONDENSERS, FIXED
 2—1-mfd. (Telsen, Lissen, Dubilier, Igranic, T.C.C., Formo).
 1—2-mfd. (Telsen, Lissen, Dubilier, Igranic, T.C.C., Formo).
 1—.00005-mfd. (Dubilier, type 670; T.C.C., Ormond, Formo).
 2—.0002-mfd. (Lissen, Telsen, T.C.C., Dubilier, Goltone, Formo, Sovereign).

CHOKES, HIGH-FREQUENCY
 1—Screened high-frequency choke (Wearite, Bulgin).
 1—Standard high-frequency choke (Slektun, Lissen, Tunewell, Telsen, Wearite, Goltone, Igranic, Varley, Climax, Sovereign, Watmel, Ready Radio).

RESISTANCES, FIXED
 1—2-megohm grid leak with wire ends (Dubilier, Lissen, Igranic).
 1—30,000-ohm spaghetti resistance (Tunewell, Lewcos, Ready Radio, Lissen, Varley, Goltone, Bulgin, Sovereign, Telsen, Igranic).

HOLDERS, VALVE
 3—Four-pin valve holders (W.B., Lissen, Lotus, Telsen, Junit, Benjamin, Clix, Wearite).

TRANSFORMER, LOW-FREQUENCY
 1—Resistance-fed transformer (Bulgin "Scuator" R.1., Igranic "Parvo," Varley).

SWITCH
 1—Radiogram change-over switch (Ready Radio, Bulgin, Tunewell).

SUNDRIES
 1—Baseboard, 14 by 9 in. (Peto-Scott, Camco).
 2—Slow-motion disc drives (Ready Radio, Lissen, Utility, Lotus, Telsen, J.B.).
 6—Wander plugs, marked H.T.—, H.T.+1, H.T.+2 G.B.+1, G.B.—1, G.B.—2 (Belling-Lee, Clix, Ealex).
 2—Spade terminals, marked L.T.+1, L.T.— (Belling-Lee, Clix, Ealex).
 2—Terminals, marked Pick-up (2) (Belling-Lee, Clix, Ealex).
 Six yards thin flex (Lewcoflex).
 Connecting wire and sleeving (Lewcos).
 Length of shielded flexible tubing (Goltone, Lewcos).

ACCESSORIES

BATTERIES
 1—120-volt high-tension (Lissen, Pertrix, D Oldham, Ever Ready).
 1—9-volt grid-bias (Lissen, Pertrix).
 1—2-volt accumulator (Lissen, Exids, C.A.V. hau).

CABINET
 1—Special cabinet (Peto-Scott).

LOUD-SPEAKER
 1—Motor "York," Blue Spot, R. & A., Lanc Epoch.

MAINS H.T. UNIT
 1—Atlas, A.C. 244; Ekco; Tunewell H.R. 1 Regentone, Lissen, Clinax.

you will see is connected to the switch on the end of the coil chassis) is also supported in the set by the two short wires, which are ready soldered to the caps of the leak.

The major part of the set wiring is done with the bare wire in the insulated sleeving, but the battery flexes for high tension, low tension, and grid bias also form part of the

set wiring and are taken direct from the various terminals. These battery flexes are clearly seen from the wiring plan. They can be of any convenient length to join up the set with the batteries or mains eliminator and should not be twisted together until the connections have been properly made and until wander plugs and spade tags have been attached.

There is one spaghetti resistance in the "Wizard," and this is connected directly between the terminals shown on the wiring plan. The spaghetti resistance is fitted with spade tags, so that it clamps easily underneath the terminals.

Take particular note of the lead going to the top terminal of the screen-grid valve. It is of metal-sheathed wire, and a thin wire is twisted round this sheathing and connected to the coil base.

When the wires have been connected to the grammo-radio switch and the two pick-up terminals, the small ebonite strip carrying these parts can be screwed at right angles to the baseboard.

Under some of the terminals more than one wire is clamped. Be sure to see that all of them make good contact and that the wire does not loop out from underneath the terminal as the head is tightened down.

The last stage in getting your "Wizard" ready to work is checking. It is impossible to over-emphasize the importance of making sure that each lead is in its right place. A wrongly connected wire may mean burnt-out wires and quickly run-down batteries. A few minutes spent in comparing your set with the wiring plan may save you a great deal of expense and worry.

In next week's issue a special illustrated article will describe the operation of the "Wizard" and will give you many practical hints and tips on bringing in the stations.

ALL THE GOOD POINTS A SIMPLE SET SHOULD HAVE

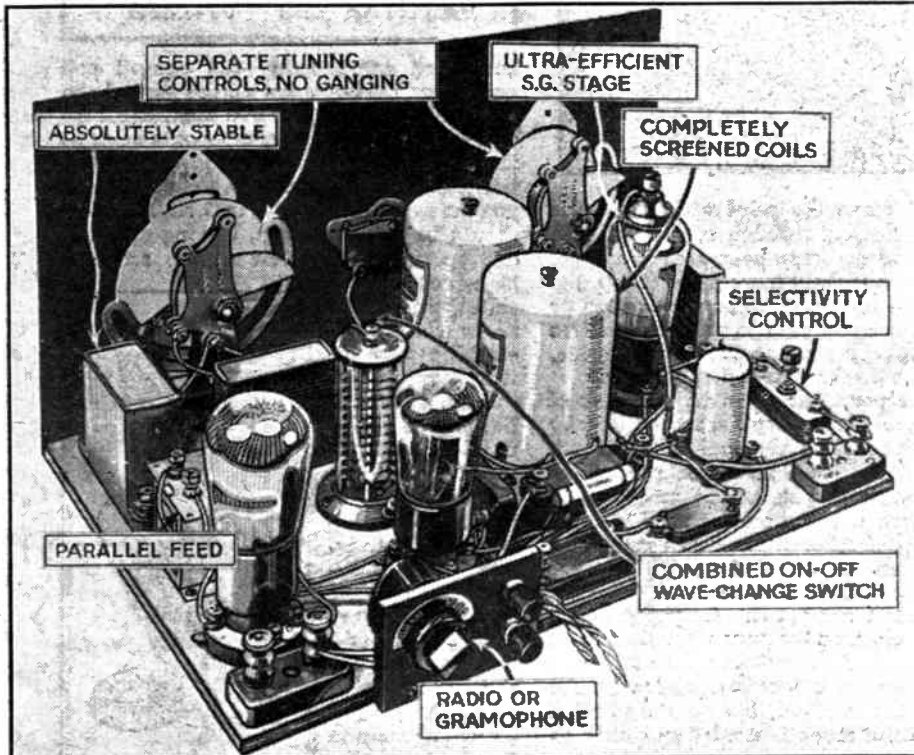

A test report of the "Wizard" appears on page 611. If your set will not put up a performance equally as good, then you should build this

OUR BROADCAST CRITIC

ON A POOR SHOW



EVELYN SCOTNEY,
who made such a success of Delibes Bell Song

HIL-AIR-ITY. That is what they called it in the programme, but nothing was said about *our* being hilarious as a result of it. Personally, I was almost reduced to tears. I was intensely sorry for those who took part in that show because they must have been under the impression that it was a good show. It was a very bad show, but not altogether the fault of those who played in it. *The material was not there.* One line—I noticed many of the kind—was a statement that “an extra large depression had arrived from Iceland by parcel post.”

It seems to me that unless the book and lyrics of this type of show are really brilliant it is just as well to engage a number of artistes and let them do what they like. The result would be much more satisfactory, even if it only amounted to a kind of vaudeville. I think the idea of varying vaudeville is so good that I am doubly disappointed when I hear a transmission of this nature with no sense in it from beginning to end.

I noted that the music was by Billy Mayerl. I only hope his admirers enjoyed his part of the business. I thought his imitation of a cinema organ on the piano very poor. It was nothing like a cinema organ. But then—what is, except another cinema organ? Why try to imitate one?

The Bach Prom.

The Bach concert seems to have been a record in attendance, hundreds being turned away. There were two thousand people standing in the Prom. that night. Popular fellow, Bach!

In some respects it was an outstanding concert, even unique. I do not remember seeing five pianists sit down to play at one concert before. I wonder what Bach himself would have thought had he been suddenly transported into Queen's Hall last Wednesday. I think he might well have been proud of his audience and the reception his music received. If he had thought of the tiny clavichords for which he wrote his concertos, and then looked at the three enormous grands on the platform he might have been forgiven had he remarked that he wrote for three *pianos*, not *pantechonics*.

Those concertos made fine broadcasting. Bach's lucid way of dealing with two or three pianos just marks the difference between music properly written for the instruments and the rubbish for two pianos often played in the vaudeville programmes.

The one blemish in the programme that night was the slow speed at which Maria Basilides sang the *Agnus Dei* from the Mass. It is admittedly a slow aria, but the rhythm is on the crotchets; she made it on the

quavers and converted the song into a very funeral affair.

I hope you heard Val Gielgud's *Exiles*. Unfortunately I could not hear it, but I am told it was a great play.

Evelyn Scotney scored a great success in the “Bell Song” of Delibes in the Saturday night Prom. Her high C sharp was a wonderful note. I was surprised that the audience was not more enthusiastic about her.

It would be interesting to know how many sets were switched off during “Nights in the Gardens of Spain,” played by Harriet Cohen (piano) with the orchestra. A work not worth playing, in my opinion. I have rarely heard any of de Falla's works and liked them, but that was one I found very distasteful. I thought the piano sounded rather silly, to be quite candid. If those

are the sort of nights they have in gardens in Spain I think I shall stay in my own.

I listened to Strauss' *Don Juan* with increasing pleasure—every bar. I remember that work when it was first played in England many years ago. I also remember I thought myself very modern—and therefore superior—because I liked it on first hearing, but the criticisms at the time were very hot. Yet, as I listened to it last Saturday, I wondered why I ever thought it modern at all. That just shows how we have become accustomed to dissonances. At all events, Sir Henry brought the house down with it.

Dr. Alcock gave an organ recital from Queen's Hall on Sunday morning. I do not think the Queen's Hall organ particularly good for solo purposes, but I enjoyed his clear phrasing and refined way of playing.

The sonata recital (violin and piano) by Licco Amar and Philip Jarnach was a bit dull. They chose the wrong works. They finished with the dullest chamber work Schubert ever wrote. No amount of pleasing tone will ever make up for a dull programme. It is exactly the same thing as writing dull libretti and lyrics for a light show. No comedian will ever pull a show together if the lines he has to deliver are weak. These chamber music recitals *should* be acceptable to many listeners if only on the grounds that they transmit so well. Chamber music is going to be served a bad turn every time artistes choose dull works. Cut off from seeing the players—which is really a large percentage of the enjoyment—we are left very high and dry when what we hear seems bereft of inspiration.

The 5.30 recital on Sunday afternoon by Arthur Cranmer proved the point I have just tried to make. He chose the right material, but I still quarrel with singers who persist in singing Schubert in German. Why not make good translations for broadcasting purposes? At a recital in Wigmore Hall (where one has only to study a few enthusiasts), to sing in German is all very well; but broadcasting is too general. I am sure that English is best for romantic songs of the classical period.

Incidentally, I never heard any section of the B.B.C. Orchestra play more out of tune than they did through the whole of this particular concert. The intonation during the Rameau suite was a disgrace to the B.B.C. The sooner it is realised that some of us have ears, the better.

WHITAKER-WILSON.

PROGRAMME POINTERS

There have been too many “shows” recently of which the actual matter has been distinctly poor. I have already pointed to one this week. Surely something ought to be done about the quality of libretti, of what is evidently intended to amuse and to entertain in a light manner? The same thing applies to the lyrics of light songs often broadcast in vaudeville. Light songs have a proper place in broadcast programmes. It would be hard on a good many listeners were they excluded, but there must be some sort of standard set with regard to the words. I have listened to far too many songs recently whose words are sheer rubbish, an insult to any intelligent person. Can there not be a committee at Broadcasting House specially for this sort of thing? Somebody is allowing anything to pass, no matter how insensate. Unless something definite is done before long the lighter side of broadcasting will come into disrepute. That would be serious because it seems to be a fact that the greater part of the total revenue from licences accrues from subscriptions from those who look to the programmes as a light entertainment only. The whole aspect of light broadcasting needs tightening up. Whoever is responsible for these songs and libretti going through as they are is evidently not awake to facts

TUNING A SHORT-WAVE RECEIVER

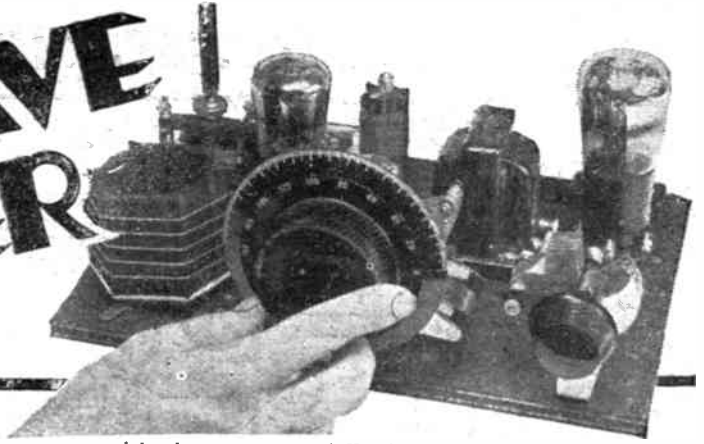

Although with a really good receiver, tuning on short waves need be by no means difficult, to some extent short-wave tuning is an art to be acquired only by sufficient practice, helped along by plenty of patience. Helpful hints are given here by MANDER BARNETT

AFTER having acquired a short-wave receiving outfit, whether this may consist of a complete receiver or merely a short-wave adaptor or convertor, the first thing that the newcomer to the short waves will learn is that the actual tuning of a short-wave receiver differs in many respects from that of a normal broadcast receiver.

The greatest mistake which many beginners appear to make is that they believe that all they have to do is to turn the receiver or adaptor dial in a similar manner to that of the broadcast receiver, then manipulate the volume control and in comes Pittsburgh, or something like that.

Many beginners have probably found that after even several hours' trial of a short-wave receiver they have heard nothing probably more than a few ear-

splitting code telegraph stations, which naturally enough convey no meaning at all to them, and thus they gain their first—and perhaps last—impression of short-wave work in general. Not a very helpful one, certainly, but one which is probably fifty per cent. their own fault. Let us state then, that tuning a short-wave receiver is a vastly different procedure to that of tuning a medium- or long-wave receiver.

First Impressions

The first impression which the beginner will probably gain is the fact that tuning on the short waves appears to be abnormally sharp and this sharpness of tuning is often mistaken for that factor which is known as "selectivity" in a normal broadcast receiver. This is quite wrong, for the average short-wave receiver of to-day is a notoriously unselective affair, although at first glance this might certainly seem otherwise.

Where there are a number of stations working comparatively closely together on the short waveband, we may find a number of these stations coming in within a few degrees on the dial. For instance, take the cluster of stations operating between 30 and 32 metres, or taken more practically, between Madrid EAQ on 30.4 metres and Rabat on 32.26 metres. These two stations will come in on the dial within only a few degrees and the tuning of each single carrier will appear to be exceedingly sharp. Between these two stations, however, we have a frequency separation of 569 kilo-cycles! Supposing we were to operate a number of new stations here and separate them by our minimum frequency

separation of 6 kilocycles, which we use to-day in our normal tuning bands, there would be room for no less than sixty-three stations between 30.4 and 32.26 metres! And if you have had any experience at all of a short-wave receiver you may be well sure that you could not, with our present-day standard of selectivity, tune in all these stations without mutual interference! When referring to selectivity, then, we have to think more in terms of frequency, or kilocycles, than in metres, or wavelength, as the respective characteristics vary in each separate set of wavebands which we have in use to-day.

A Large Frequency Separation

In view of these considerations, therefore, the short-wave listeners of to-day should be thankful that the short-wave stations now in existence are still able to keep to such a large frequency separation. What will happen when further short-wave stations arrive, remains to be seen, but we shall certainly have to devote more thought to short-wave selectivity.

Now for some practical considerations of what the above remarks hold for us in our short-wave receiver. Tuning undoubtedly is sharp and we keep our condenser capacity as low as is practicable—generally using a capacity of .00025 microfarad—exactly half of that used for the average broadcast receiver. This isn't really anything like low enough for sensible tuning, but we have to use this figure in order to avoid further coil complications.

Tune Slowly

See, therefore, that your receiver is equipped with a really good vernier dial, the higher the ratio the better, and acquire the habit right at once of tuning this dial, extremely slowly. It is quite possible entirely to miss a whole station by turning the dial too quickly.

Another bugbear with which we have to contend to-day is that in many short-wave receivers the reaction control itself has a very large effect on tuning. You tune a carrier in on the main dial, then adjust the reaction condenser to bring it nearer the edge of oscillation and phwit! the carrier has gone. Therefore, it is now necessary to again adjust the main dial until the carrier is once more in tune and to keep up this process until the edge of oscillation is

(Continued on page 652)

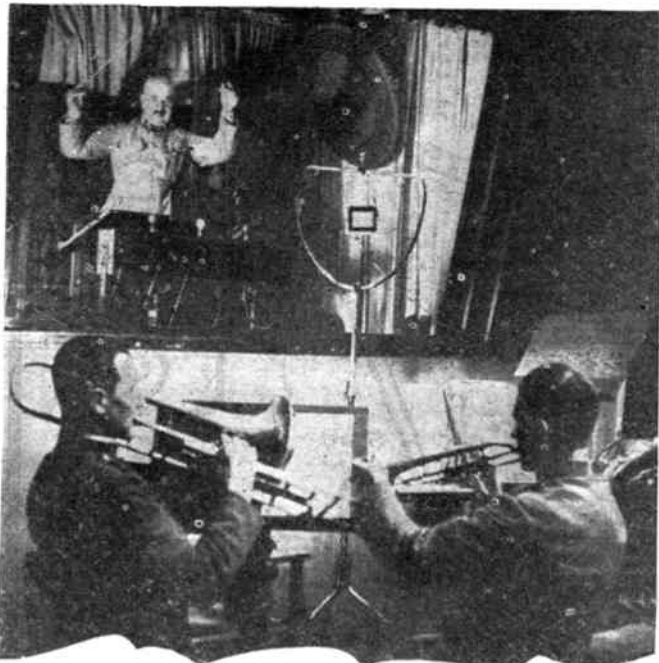

Radio Budapest is trying a new way of broadcasting orchestral concerts, in which the conductor is in a soundproof asbestos-lined cabinet. He hears the orchestra's playing through a pilot loud-speaker. Signal lights are used so that the conductor can give orders. It is claimed that in this way the conductor can judge the playing in the same way as wireless listeners



HOW STUDIO
SOUNDS ARE
PRODUCED

The wind is rustling the tree-tops!

What wonderfully expressive things are trees—their swaying branches, their rustling leaves make Nature's music in accompaniment of Nature's moods . . . and yet the Effects Studio produces all the characteristic sounds of gale force wind or gentle zephyr breeze by merely rustling torn pieces of paper in a bowler hat. The result is realism itself. . . . Realism too that you can retain in your reproduction by using the pure power of the Lissen High Tension Battery in your set. There is a process used *exclusively* in this Lissen Battery which produces power of remarkable purity; power so sustained that over prolonged periods of time it remains steady, noiseless and abundant always. Every radio dealer sells the Lissen High Tension Battery; ask for it firmly by name.

LISSEN H.T. BATTERY

lasts longest and provides a pure high tension current
that will give stage realism to your radio drama!

You will Help Yourself and Help Us by Mentioning "A.W." to Advertisers



The ATLAS A.C.2.

SETS OF THE SEASON

WHAT more do you want for local-station reception than a two-valver? Even if you want an occasional tour round the chief Continental stations the well-designed "two" of to-day will still serve quite well, especially if you are prepared to make critical adjustments with the reaction knob.

Here, then, is just the set for local reception—the "Atlas Two-valver," with a built-in moving-coil giving pleasing quality. I have just tried out the A.C. model and can recommend it as being a bright little set at a reasonable price.

THE ATLAS A.C.2 IN BRIEF

Makers.—H. Clarke & Co. (Manchester), Ltd.

Circuit.—Power-grid detector (Cossor 41MH), coupled by the parallel-feed transformer system to a power output valve (Cossor 41MP), which is connected to the energised moving-coil through an output transformer. Metal rectification for the mains.

Controls.—Four: Tuning, operating condenser and pointer over large fixed scale; wave-change switch for medium and long; reaction control; and, at the back, a mains on-off switch.

Type.—Table set in attractive walnut cabinet, containing set, power pack, and moving-coil speaker.

External Connections.—Extra loud-speaker sockets, pick-up sockets, mains-aerial connection, and mains plug for wall or lamp fitting.

Remarks.—A bright little two-valver for pleasing reproduction of the local stations.

There are many little points about this set that will please the amateur who "knows his stuff." The tuning coil, for example, comprises a large solenoid for the medium waves, and it is wound with stranded wire. A real low-loss looking coil—which on test shows just how much we are losing with the modern screened coil as used in the big sets.

I ought to add, in fairness to other designers, that only in the two-valver, with its single tuning circuit, can we make use of really low-loss coils, because the large field produced by a massive winding, while of no great consequence in a small set, would cause untold trouble in a set having several tuning circuits.

Next I was struck with the metal rectifier used for converting the A.C. mains

supply into D.C. for the anodes of the detector and power valves. I can assure you that there is no mains hum with this set, as the smoothing after the metal rectifier is more than adequate.

A Straightforward Circuit

The two-valve circuit is quite straightforward. The low-loss tuning circuit precedes a power-grid detector, with a .0001-microfarad grid condenser and a .25-megohm grid leak. The detector is paralleled to the power valve. Which means that the anode current passes through a resistance and not through the primary of the transformer.

The filaments of both valves are heated by 4-volt A.C. obtained from the mains transformer, an artificial centre tap on a small secondary winding being obtained with a resistance. Bias is obtained for the power valve as part of the high-tension output from the metal rectifier and not with a cathode resistance as is normally employed.

The moving coil is also fed from the metal rectifier, and is both sensitive and excellent in frequency response. It has an incorporated output transformer, which tests prove matches up extremely well with the power valve.

On test my impressions were immediately favourable, especially in regard to the amount of undistorted output that could be obtained. I was frankly amazed to find that in so small a cabinet there was absolutely no "boom." The tone is a pleasant change

from the "woofy" quality that we hear so often, even in quite expensive sets these days.

There appears to be more high-note reproduction than usual, giving an exceptional clarity to speech and a brilliant incisiveness to the music that more than compensates for the inevitable heterodynes heard on some of the foreign stations. You cannot have it all ways!

Simple Operation

Operation is just as simple as you would expect. I will say that reaction is as smooth as I should make it myself! And don't forget this: smooth reaction means sensitivity on foreign stations; which I certainly got.

London National at 25 degrees on the wide and easy-to-read tuning scale and London Regional at 45 degrees were absolutely clear of interference. On long waves Radio Paris came in at quite good strength, as did Hilversum. Naturally, Daventry was very strong. The two aerial terminals provide a choice of coupling to suit most aerial lengths.

On the mains-aerial connection, at twenty miles from Brookmans Park, I got both London stations at good strength. There was no appreciable increase in mains hum, but I found the earth essential.

There is enough power in reserve, thanks to the good tuning coil and the efficient reaction, to justify the use of an indoor aerial with this set. High praise indeed!

SET TESTER.

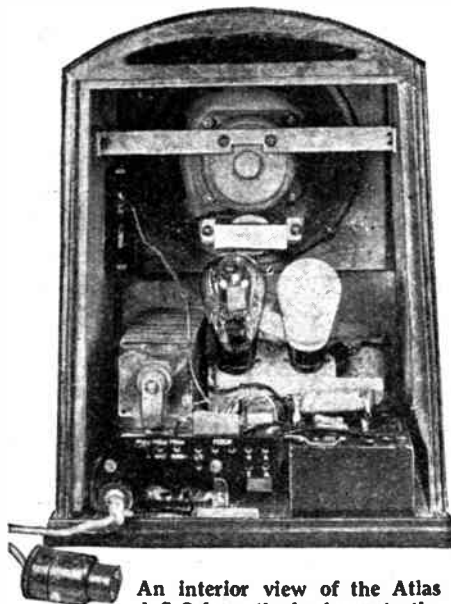

An interior view of the Atlas A.C.2 from the back: note the rectifier unit on the left and the ample spacing of the components and speaker

Those Four Chaps—Bobbie Comber, Paul England, Claude Hulbert, and Arthur Clay—will be heard in a National vaudeville programme on September 27.

A repetition of "Great Grandfather's Song Book," a collection of popular songs of 1770, will be heard by Midland Regional listeners on October 3.

A play, "Full Tide," will be broadcast from Birmingham studios on October 5 with Gladys Joiner and Herbert Lees among the artistes.

The first performance in Birmingham of Vaughan Williams' Ballet Music "Job," will be a feature of the first Symphony Concert of the season to be given by the City of Birmingham Orchestra on October 6.

Muriel Richardson will give a pianoforte recital in the Leeds studio on September 26.

The two young musicians, who spent the summer wandering about the South with a piano, a barrow and a donkey, will be the artistes at the second Manchester Tuesday Mid-day Society's concert on September 27.

The 2 Gang Coil for the A.W. WIZARD

INCORPORATING
WAVECHANGE
AND FILAMENT
SWITCHES

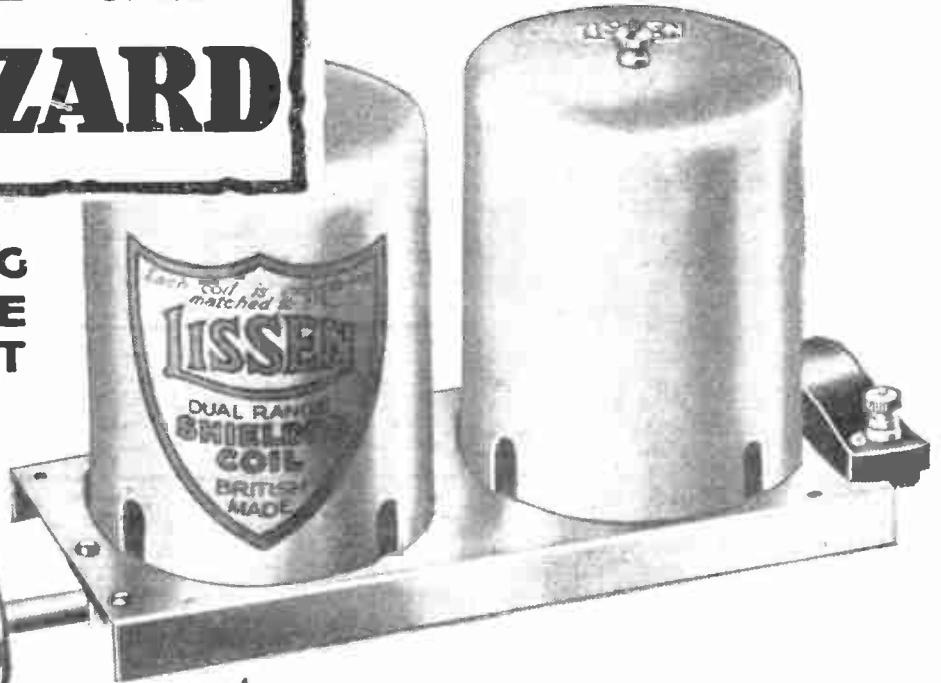

LISSEN SHIELDED

DUAL RANGE COILS

LISSEN SHIELDED COILS

3 GANG 26¹/₂ COILS

SINGLE 66¹/₂ EACH COILS

You are going to use a Lissen 2-gang Shielded Coil Unit in your "A.W." "Wizard"! It is a simple set to build—because of these Lissen Coils. It is an easy set to handle—because of the perfect matching of these Lissen Coils. Its advanced yet simplified circuit design is made possible only by the Lissen Coils. Its high selectivity depends upon them, its attractive appearance even is enhanced by the combined wave-change and filament switch incorporated in this Lissen 2-gang Coil Unit.

Break-through on the long wave-band is almost entirely eliminated. Damping losses are exceptionally low. Shielding is particularly complete. All Lissen Shielded Coils are matched in inductance to within 1 per cent. Price of 2-gang Coil Unit complete with inbuilt wave-change and filament switches

17¹/₆



What Our Readers Think

The Editor does not necessarily agree with the views expressed by readers and does not accept responsibility for the letters published. Letters cannot be published which do not bear the sender's full name and address.

An "Amateur Wireless" Lead

SIR,—To my mind, the most outstanding feature of the Radio Show was the number of super-hets shown, proving that AMATEUR WIRELESS was on the right track when it startled British listeners with the achievement of Mr. James' "Century" and other super-hets. The next most important feature is the wholesale adoption of the multi-mu valve and here, I presume, we must give the Americans their due, because it is their invention.

"Thermion" is tilting a broken lance at them when he keeps on about the inclusion of the rectifying valve in the number of a set's valves, because most of the British manufacturers have copied that reprehensible habit too. But for "Thermion's" agitation in your columns, I am afraid the British valve makers would have been still slower in adopting the multi-mu. Now, he might use his powerful pen in inducing them to make a multi-mu pentode, so as to save Mr. James one valve in the I.F. stage of the next super-het—which I for one am ready for—otherwise, in spite of "Thermion's" warning, I shall have to buy a British-built four- (or shall we say five-) valve super-het with American multi-mu pentode in the first stage.

My experience with British components is very much like "Thermion's" with that American set. Out of one kit I recently had to return faulty:

1. Tuning condenser and S.M. dial,
2. L.F. transformer,
3. Valve socket,
4. Fixed condenser,

which did not leave much of the kit on my bench to get on with, and that in spite of the multiple tests the firm in question claim to pass their components to in the various stages of manufacture. True, the parts were all in rotation replaced, with profound apologies, but it only goes to show that radio manufacturers in this country are in as great a hurry to make money as their colleagues across the pond.

T. M. B. (London, W.1).

The Editor invites letters from readers on all interesting radio subjects. For the most interesting letter published each week a general-purpose valve or other component to the same value will be given

The Loud-speaker Nuisance

SIR,—In a recent issue of AMATEUR WIRELESS reference was made to the action of the St. Pancras Borough Council in making it an offence against the housing estate regulations to operate a loud-speaker after 11 p.m., and the writer of the paragraph holds the opinion that the Council is making an attempt to interfere with the rights of listeners.

May I be allowed to raise a point which appears to have been overlooked? The housing estate is presumably for the benefit of working-class tenants, and there are numbers who are compelled by force of circumstance to rise in the early hours, no doubt, and the Council, by its action, is merely safeguarding the resting hours of such tenants. Consequently, instead of the Council's action being depreciated, it should be applauded.

Anyone who has had experience of a loud-speaker disseminating distorted dance music until the early hours of the morning can appreciate the point. Sleep under such

circumstances is well nigh impossible for adults and out of the question for children; I have had sufficient experience of neighbours' receivers to speak with authority.

Furthermore, I venture to offer a suggestion which may well be adopted with advantage by the loud-speaker fiends. It is this: If you must listen after 11 or 12 at night, cut out the speaker and put 'phones into circuit, they cost very little and by so doing the neighbours are considered and no one can, therefore, raise any objection. I might add that this practice is invariably adopted by myself.

E. C. (Hounslow).

Super-het Design

SIR,—Of late I have been experimenting with a super-het circuit which has not such refinements as the factory-matched oscillator and I.F.T.'s which figure in the excellent designs based on this circuit. A few points, practical and theoretical, which arose, may be of interest to you.

I am using a detector-oscillator arrangement based on the Autodyne system. (This is, apparently, against your principles, by the way, as the only "super" you have ever published without a separate oscillator valve was the "W.M." "Home Super.") The oscillator unit is one-wave, consisting of two plug-in coils, one being connected in the anode circuit of the "mixer." This reaction coil was wound generously, and the coupling between it and the grid coil varied by rotating the former on one screw until most satisfactory reaction was obtained. The I.F.T. coils are actually 300 turns of 36 d.s.c. on a 1½-in. former—this, with a .001 semi-variable, tuning to about 2,000 metres. I considered that 150 kilocycles was a satisfactory intermediate frequency, although 126 kilocycles was more usual; and this for the following reason, one which I have never seen exploited in favour of a longer I.F.

With a very low I.F. of, say, 50 kilocycles, consider the settings of the aerial and oscillator condensers for any stations—take Midland Regional on 398.9. This is a frequency of 752 kilocycles. The oscillator reading will, therefore, be 752+50 kilocycles. Taking it as 752+50, this is equal to 802 kilocycles. Interpreted in metres, this is approximately 375 metres. Now, unless the aerial circuit is exceptionally selective, the local oscillations will "bridge" that small frequency gap and cause the aerial to radiate, causing interference. But with an I.F. of nearly three times that, the oscillations are proportionately prevented from radiating, so that, although less amplification is obtainable on the lower frequency, the higher permits of the use of an open aerial with a much larger input.

C. G. B. (Bedford).

A WIRELESS PIANO



NEW USE FOR OSCILLATING VALVES!

One of the interesting features of the recent German Wireless Exhibition was a wireless piano with which a wide range of tones was obtained by means of oscillating valves controlled from the keyboard seen here

New Tone for Old Sets — Better Tone for New Sets —

BY ADDING A

LISSEN INTER-VALVE TONE CONTROL

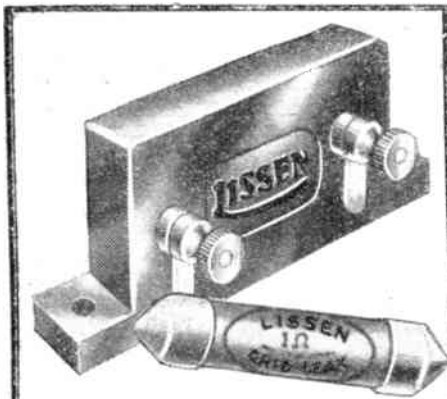

Here is a component which opens up new possibilities of quality reproduction—the Lissen Inter-valve Tone Control. Hitherto the best you could do in the control of tone was to attempt to correct in the output stage those faults of quality inherent in the receiver itself. Now the Lissen Inter-valve Tone Control gives you **SCIENTIFIC CONTROL OF TONE IN THE HEART OF THE RECEIVER.** By rotation of the special potentiometer (which is fitted to the front panel of the receiver) you get real variable control, so that for any particular item you can bring out deep bass or obtain brilliant high-note response just as your ear demands.

The illustration shows the Lissen Inter-valve Tone Control used in conjunction with a Lissen Hypernik Transformer. It can be used successfully with any transformer, and gives real control of tone. But, if possible, use a Lissen Hypernik Transformer, which will give you magnificent amplification over the whole band of audible frequencies and in conjunction with this new Lissen Intervalve Tone Control will make every item natural and true.

PRICE COMPLETE WITH SPECIAL POTENTIOMETER - - **10/-**

LISSEN
HYPERNIK
TRANSFORMER

If you want absolute truth of tone, use the Lissen Hypernik Transformer, as all the foremost set designers are doing. You cannot get such a good response curve—such fine quality reproduction—from any other transformer at anything like this price.

With a primary inductance of fully 100 henries, the Lissen Hypernik Transformer yet operates perfectly when passing currents up to 5 mA or more. Its step ratio is 4 to 1 and a stage amplification of more than 100 is obtained. PRICE **12/6**

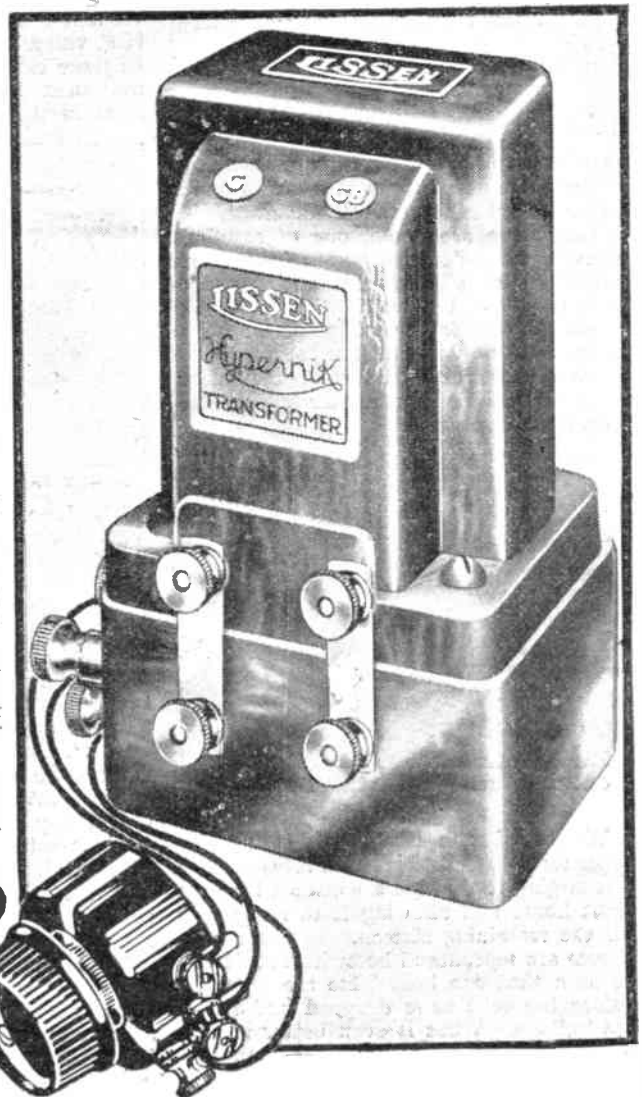

LISSEN
FIXED
CONDENSER

The only full-size Condenser selling at

6^D

LISSEN
FIXED
GRID LEAK

Exactly the same Grid Leaks for which you were previously paying 1/-.

6^D

LISSEN LTD., WORPLE ROAD, ISLEWORTH, MIDDLESEX

Please Mention "A.W." When Corresponding with Advertisers



A weekly review of new components and tests of apparatus conducted by J. H. Reyner, B.Sc., A.M.I.E.E.

EDISWAN H.T. BATTERY

A NEW battery of considerable merit has recently been placed on the market by the Edison Swan Electric Co. These new batteries utilise the modified process of manufacture which not only

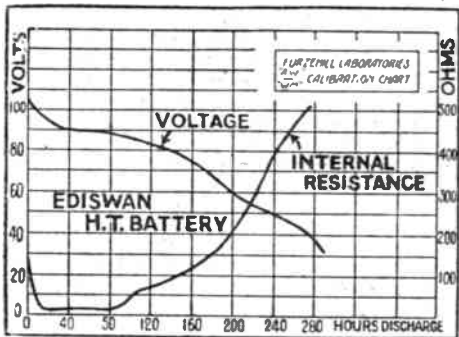

These voltage and internal resistance curves for the Ediswan battery tested show its useful life

enables them to be made considerably more cheaply but also results in a performance which is decidedly above the average.

Two types are made, one of standard capacity intended to give a maximum output of 10 milliamperes and a super-capacity type for which the maximum current rating is 20 milliamperes. The prices for a 60-volt unit are 6s. 9d. in the standard size and 12s. 6d. in the super size, and correspondingly more for higher voltages up to 120 volts.



One of the range of Ediswan batteries—a 120-volt job

We tested one of the single-capacity types for voltage and internal resistance by discharging it through a constant load for eight hours and allowing it to recuperate for the remaining sixteen. The discharge curves are reproduced herewith and it will be seen that 250 hours' life are obtained before the cells have dropped under half the voltage. What is even better is that the internal resistance remains very low during the greater part of this discharge

period. Indeed, at the end of the useful life the resistance is only in the neighbourhood of 500 ohms. The actual capacity is 1,760 milliampere-hours, which is over 40 per cent. better than the value which we usually consider standard for the single-capacity cell.

These new batteries are really good and can be confidently recommended.

A NEW LEWCOS "POT"

HIGH-RESISTANCE potentiometers are used to a very large extent in modern radio construction. For example, volume control these days is usually arranged by a high-resistance potentiometer connected in the grid circuit of a variable- μ valve, the screen circuit of an H.F. valve, or even across the aerial itself. In these circumstances it is not surprising that there has been considerable development in these components quite recently.

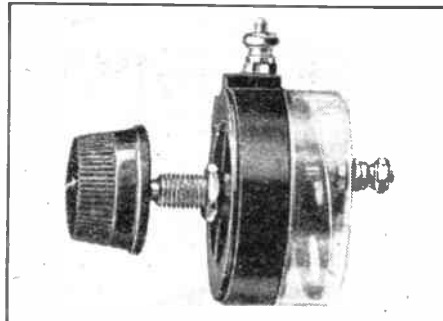

A new Lewcos wire-wound potentiometer

The Lewcos people have just put on the market a very ingenious and inexpensive arrangement. A wire-wound resistance is used, the winding being carried on flat strips of fibre in the usual way and housed inside a bakelite moulding. Instead of making contact with this resistance wire by means of a rotating or sliding contact, however, a flat disc is used which is mounted at a slight angle to the spindle. This disc rests on the element at one point, and if the spindle is rotated the disc rolls round the element so that its point of contact is continually changing.

This produces smooth and even variation of the resistance without any rubbing contact at all, as the disc only exerts a light pressure on the resistance wire and there is no friction between the two at any point.

With ordinary uniform variation of resistance the component sells at the remarkably low price of 3s. Graded types are available at 4s. 6d. and 5s. respectively, depending upon the type of grading required. All the usual values are obtainable

and, indeed, it is possible to obtain the component in values up to 250,000 ohms. Altogether the device is a most effective one and should appeal to the constructor.

TUNEWELL MATCHED COILS

An interesting set of tuning coils which we have tested recently are those marketed by Messrs. Tunewell Radio, Ltd.

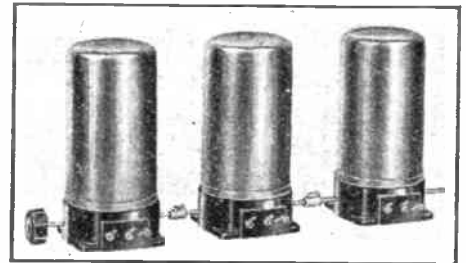

The Tunewell triple coil set described in the accompanying paragraph

There are three coils in this set, two being designated respectively A.1 and A.2 and forming a dual-capacity-coupled band-pass filter, and the third, G.1, the intervalve coil. The coils are wound on ribbed ebonite former, the overall diameter being 1 1/2 in. They are mounted on moulded bakelite bases, which house the switching mechanism and carry the necessary connecting terminals. Each coil is provided with a copper screening can and a copper base plate.

The coupling condenser recommended for use at the low-potential end of the coils is .05 microfarad, but there is also a small capacity coupling between the high potential ends of the coils, this being included in the base of the coil A.2. As the capacity required here is exceedingly small, this condenser consists merely of two small copper plates spaced about 1/4 in. apart.

Tested with a three-valve receiver, the coils gave excellent results, the signal strength being very good, while the selectivity was adequate for all normal purposes.

The high-frequency resistance of the coils was measured and at 400 metres was found to be 6.5 ohms, while at 1,600 metres the figure obtained was 41 ohms. Both these figures are good, as one would expect from the signal strength obtained.

The coils are turned out accurately matched to within one half per cent., and no difficulty should be experienced with ganging, assuming that a good three-gang condenser is employed. The overall dimensions of the coils are 3 in. diameter and 6 1/2 in. in height.

They can be recommended.

Use your own hands, save pounds & get a better set!

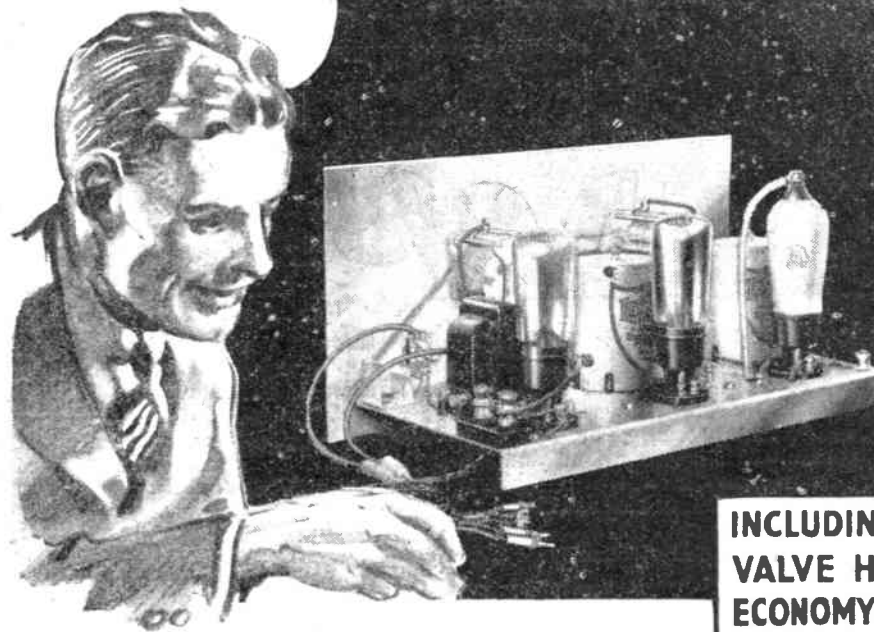

YOU CANT GO WRONG - YOU ARE TOLD WHAT TO DO WITH EVERY SINGLE NUT & SCREW!

INCLUDING METALLISED S.G VALVE HIGH MU DETECTOR & ECONOMY POWER PENTODE

89%

This is the only kit you can build yourself employing such HIGH POWER VALVES

There never has been the equal of this set within the range of the home constructor—this new Lissen Skyscraper is the only one on the market that you can build yourself, employing Metallised Screened Grid, High Mu Detector and Economy Power Pentode Valves. No factory—however well-equipped—can build a better receiver. No manufacturer, however large, can produce a receiver whose results will surpass those you will get from the Lissen Skyscraper you build yourself. It is the only battery set that can deliver such power—yet the H.T. current consumption is far less than that of the average commercially designed 3-valve set.

INCLUDING VALVES CABINET AND LOUDSPEAKER

£6.5



Yet the Lissen Skyscraper is made simple for you to build. Elaborate care has been taken to ensure your success by giving—in the Skyscraper Constructional Chart—such detailed instructions and such profuse illustrations that everybody, with no technical knowledge or skill at all can build it quickly and with complete certainty of success.

You buy the Lissen Skyscraper Kit complete with valves—a Lissen Metallised S.G., a High-mu Detector, and a Lissen Economy Power Pentode Valve—and the price is only 89 6. Or you can buy the Lissen Walnut Console Skyscraper Cabinet and Loud-speaker combined as illustrated. It holds all batteries, and accumulator and loud-speaker as well. It makes everything self-contained. A special Pentode Matched Balanced-armature Loud-speaker of great power is supplied with the cabinet and the price of the Skyscraper Kit complete with valves and this cabinet and loud-speaker is only £6 5s.

LISSEN COMPLETE CONSTRUCTIONAL CHART - FREE TO AMATEUR WIRELESS READERS

Photographs and instructions make every detail easy and clear—NO SKILL REQUIRED! Send Coupon below for your copy of FREE CHART!

To LISSEN, LTD., Dept. A.W.3, Wexple Road, Isleworth, Md.lx. Please send me FREE copy of your L. Skyscraper Chart. Name Address

LISSEN

SKYSCRAPER KIT 3

A description of the new Marconi system by means of which television tests are made between a beam station at Chelmsford and the Sydney wireless station in Australia



TELEVISION to Australia! The Marconi people, by using the beam system, have set a long-distance record for television transmissions.

They have, however, done much more than set up a mileage record. They have perfected a new television system which transmits news and verbal messages from characters printed on a moving tape. The receiver used in these tests is of the broadcast type and uses a mirror drum.

The beam station G2BS at Chelmsford was used, the receiving point on the Australian side being at Sydney. Our ordinary 25-metre short-waver 5SW also played a part in the tests.

A "Tape Scan" Set

The television signals were received by means of a simple type of receiver designed to have a very broad frequency response curve. This set consists of one stage of high-frequency magnification, anode-bend detection, and one stage of low-frequency amplification. The output from this receiver was taken to a power amplifier for use in the 15-line tape scan receiver.

The 15-line receiver gives a picture on a ground glass screen 25 in. by 3 in. A sodium tube of the dumbbell type is mounted close to an aperture, the modulated light being projected on to the screen by means of a mirror wheel, driven by a synchronous motor and giving a horizontal scan. The speed of the mirror wheel is 1,200 r.p.m., and gives 20 pictures per second. Synchronism is effected by a synchronising amplifier, A.C. mains operated, and consisting of two valves with large power output. This amplifier is connected to follow the second stage in the television signal amplifier.

The 50-line receiver gives a picture on a ground glass screen 8 in. by 8 in. A

similar sodium tube is used as on the 15-line receiver, the light is projected on to the screen by means of a mirror wheel driven by a synchronous motor and giving a horizontal scan. The speed of the mirror wheel is 900 r.p.m., and gives 15 pictures per second. Synchronism is effected by the same amplifier used for the 15-line receiver.

The 50-line "Projection" receiver gives a picture on a white screen 4 ft. by 4 ft. The light source is an arc modulated from a Kerr Cell, and is projected on to the screen by a mirror wheel driven by a synchronous motor giving a horizontal scan. The speed of the mirror wheel is 900 r.p.m., and gives 15 pictures per second. Synchronism for this motor is effected by another synchronising amplifier similar to that used for the sodium receiver, and is connected to follow the second stage in the amplifier modulating the Kerr Cell.

The 15-line transmitter, which was in operation at Chelmsford, is designed to modulate any high-class transmitter in such a way that images of characters printed on a semi-transparent tape can be received. The tape on which the characters are printed may be set in motion at the transmitter and the resultant image at the receiver will then consist of a series of letters moving from right to left at the receiver screen.

A Narrow Frequency Band

The frequency band occupied by transmissions of this nature can be made narrower than that needed for transmission of "head-and-shoulders" pictures, and in the present case is, in fact, very little wider than is necessary for good telephone transmission.

The characters on the tape are printed in a single line and the tape is fed forward

through the transmitter in a continuous manner at speeds which may correspond to from 60 to 120 five-letter words per minute.

The minimum number of scan lines needed for good detail is fixed by the
(Continued on page 640)

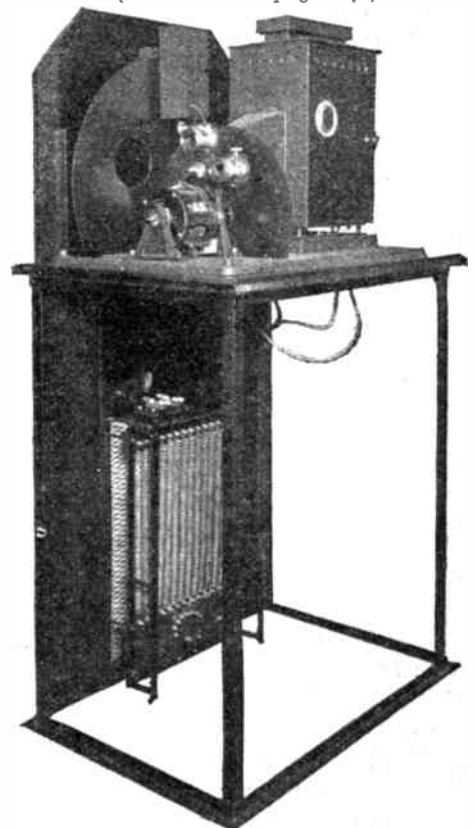

The scanner of the broadcast type transmitter. The photo shows the disc, arc, lens arrangement and synchro motor

DO YOU KNOW—

THAT if crackling noises are caused when a dual or triple condenser is rotated, all sections should be disconnected and the two or three wires put back one at a time? This will make it obvious which section is short-circuiting, very possibly owing to dust between the vanes or a bent vane.

THAT when adding a pick-up, the return lead on the negative side should not be taken to L.T.—, but to 1½ or 3 volts on the G.B. battery? In a mains set a dropping resistance shunted by a condenser should be put in circuit to provide about the same value of negative bias.

THAT difficult tuning will result if there is any end play or loose movement in the bearings of a solid dielectric reaction condenser? The slightest movement of the knob up or down will affect the capacity before one has a chance to turn the knob.

“MICALOG” Tuning Chosen for the “WIZARD”

“Micalog” tuning opens a new era in radio! “Micalog” condensers employ an entirely new type of di-electric and combine all the advantages of a solid di-electric condenser with the efficiency of the air-spaced type.

Invented by Mr. G. P. Kendall, the famous radio scientist, who incorporates “Micalog” tuning in all his well-known set designs. Its adoption by “Amateur Wireless” for the “Wizard” is sure proof that “Micalog” tuning is the tuning system of the future.

Capacities .0003 and .0005 mfd.

3/6

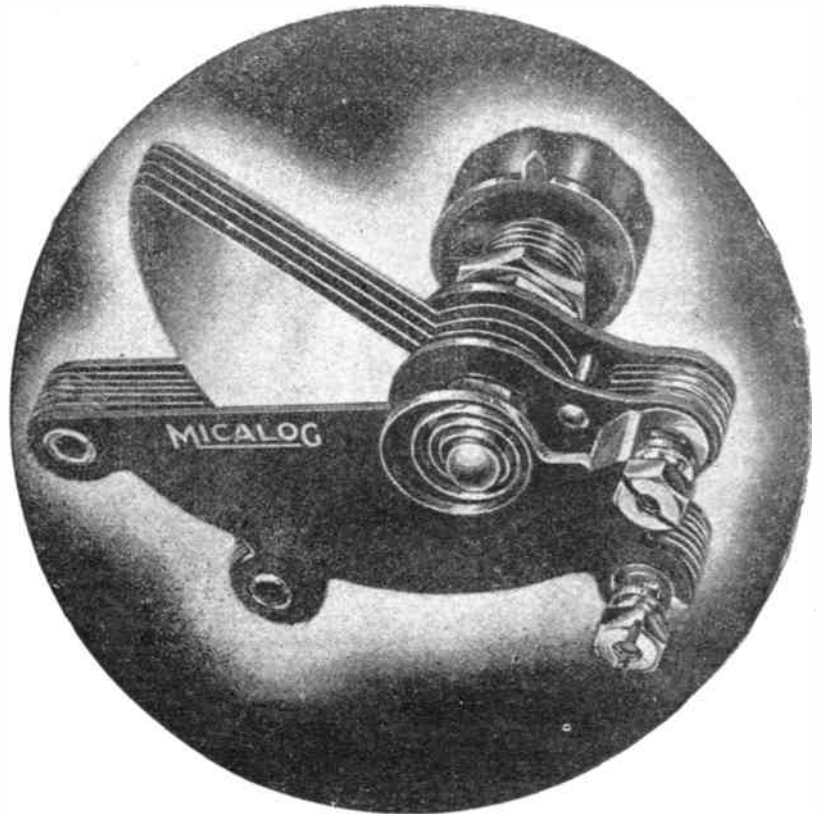

READY RADIO SLOW MOTION DISC DRIVE

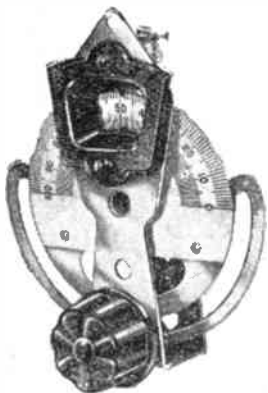

Specified for the
“Wizard”

A Robust Slow Motion Disc Drive having a Ratio of 25-1. Ideally suited for use with Micalog Condensers.

4/

READY RADIO

Advt. of READY RADIO, LTD., Eastnor House, Blackheath, S.E.3

Free

Mr. G. P. Kendall, B.Sc., the designer of many famous sets, and his assistant Mr. H. D. Price, the famous short-wave experimenter, have written a book containing complete instructions, photographs and diagrams of ten modern circuits, both battery and mains operated. It shows you how, at a cost of a few shillings, you can bring your present set right up to date. At its published price of 1s. it represents remarkable value for money.

Full-sized dimensioned Blueprints of these ten wonder circuits are also available at the exceptionally low price of 1s. for the set of ten. Send 1s. in stamps with coupon below and we will also send you a FREE copy of the “Kendall-Price” Book. Post coupon now!

To: **READY RADIO, LTD. (Book Department), Eastnor House, Blackheath, S.E.3.**
I enclose 1/- for the ten full-sized blueprints. Will you also send me—FREE—a copy of the Kendall-Price Book of Ten Circuits.

Name

Address

A.W.5

Mention of “Amateur Wireless” to Advertisers will Ensure Prompt Attention

"TELEVISION TO AUSTRALIA"*(Continued from page 638)*

character of the type. If capitals are employed, consisting mainly of arrangements of horizontal and vertical lines, each letter requires to be cut up into at least seven horizontal strips to ensure reasonable reproduction at the receiver.

In the present case, the number of scan lines covering the complete picture width has been chosen as 15, and while this enables sufficient detail to be transmitted, only a comparatively narrow band of frequencies is utilised. Scanning is accomplished by means of a rotating lens drum, and the 15 lenses are arranged round a spiral on the periphery of the drum.

The lamp house is of the standard type and is mounted at right angles to the main chassis of the transmitter. The light source is a standard 1,000-watt gas-filled metal filament projection lamp mounted vertically

with reflector behind it. A spherical condensing lens system is mounted in the lamp-

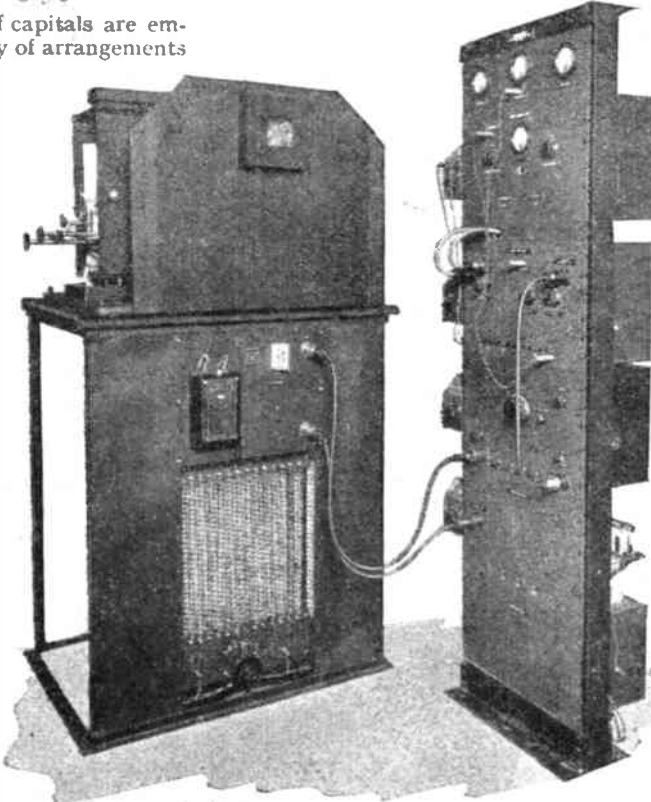

The new Marconi broadcast-type television transmitter connected to the first stage amplifier. The arc controls can just be seen, while a regulating resistance is below

house and a carrier in front of the lamp-house contains an aperture, a cylindrical lens and reflecting prism so arranged that the emergent light just covers the area of the lens system on the lens drum. The lenses in the drum focus sharp images of the apertures on to the tape. The tape is carried vertically between two rollers, the bottom one of which is driven by the same motor that drives the lens drum through suitable gearing.

Calcium Cells

Behind the tape is mounted the photo cell and photo-cell amplifier, both of which are contained in a single shielded unit slung by springs on an angle iron framework. The photo-cell receives its light from the transmission of the aperture image through the tape. One large-sized photo-cell is employed, with an aperture size of 8 in. by 1½ in. The light-sensitive material used is Caesium and the cell is gas-filled. The photo-cell amplifier consists of two stages of screen-grid valves which are resistance-capacity coupled. A screened lead is taken from this amplifier to the line amplifier.

The motor driving the disc is kept running at constant speed by means of an electrically driven fork, the output of which is fed into the A.C. windings of the motor.

An important talk will be heard at 7.35 p.m. on September 27, when the North Regional Director will tell listeners all about "Northern Programmes for the Autumn."

COLVERN

-T.D.COIL

AN UP-TO-DATE COIL WITH
UP-TO-DATE FEATURES

TYPE T.D., an entirely new COLVERN COIL, designed to give super selectivity on both long and broadcast wave-bands.

The coil is completely screened, giving a very neat appearance, and incorporates tapped aerial coupling and reaction, while the four alternative aerial tappings are arranged as sockets with a wander plug.

The first two tappings give aerial couplings similar to those normally employed, but with greatly increased selectivity.

Nos. 4 and 5 give a high degree of selectivity with weak aerial coupling—suitable for use in a "swamp" area.

A most important feature of this coil is that there is no break through on the long wave-band from B.B.C. stations.

This coil is specified for the "MULTI-MAG 3" described in "Wireless Magazine," and many other modern receivers.

Our 1933 Booklet Radio List No. 10 is now available and free on request.

COLVERN LIMITED

MAWNEYS ROAD, ROMFORD, ESSEX

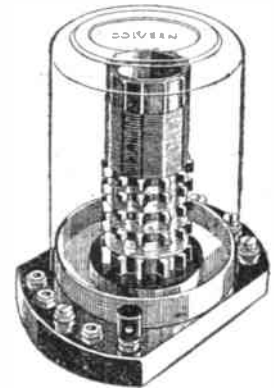
**TYPE T.D.**

PRICE
8/6



Pick-ups.



DISTINCTIVE IMPROVEMENTS KEEP HARLIE PICK-UPS ALWAYS IN THE LEAD

Other manufacturers have taken the Harlie as the model of perfection and have tried to make their quality and output the same as the Harlie, but Harlie Pick-ups are always "a Season ahead" because the improvements are our own and not released until the Olympia Exhibition. Therefore, by our specialising we offer the finest Pick-up obtainable.

EXCLUSIVE HARLIE FEATURES

1. The original Harlie knife-edge bearing has been improved.
2. Free and highly sensitive stylus movements.
3. 35 per cent. of cobalt magnet.
4. Pole pieces of special high permeability alloy.
5. Spring counter-balance — ensures correct weight on record.
6. Ball-bearing base allows free swing over record.
7. Remarkable frequency response range giving uniform tone quality.
8. Unusual tone volume for reproduction from screen-grid Receivers.
9. Is triple tested for frequency output by the finest precision instruments.
10. Individually tested for tone accuracy.

The new Harlie Electric Pick-ups will successfully deliver all the quality that the Engineer and Manufacturer built in the Radio Receiver, Amplifier and Speaker Unit.

2/6 DOWN Further 2/6 in 7 days and 5 monthly payments of 5/-.
(Cash Price, 27/6.) Complete with Fixing and Connecting Instructions.

Harlie

HARLIE LTD.,
Cambridge Arterial Rd.,
Enfield, Middlesex.

The New Harlie Pick-up Booklet TELLS HOW TO BRING YOUR RECORDS TO LIFE

Tells you how to play records with superb realism and brilliant distinction through your Radio Set, with only a few minutes' alteration; how to eliminate needle-scratch; how to double the playing life of your records; how to obtain volume control . . . It tells you all about how a Pick-up works, and much more besides. It is written in the simplest way so that you don't get a headache over technicalities and is bang up-to-date.

Post coupon below for your
FREE copy now.



TONE SELECTOR and SCRATCH FILTER

Definitely improves reproduction of radio or gramophone records—gives different tones—normal, brilliant, bright, mellow, deep. When used in conjunction with a gramophone pick-up it eliminates all needle scratch. Obtainable for 1/- and further 1/- in 7 days, and 2 monthly payments of 1/6. (Cash Price, 4/6).

All Harlie Products are obtainable on our Hire Purchase scheme through our registered Dealers.

Please forward :—
Free Booklet
De Luxe Pick-up } Cross out items not wanted.
Tone Selector }
for which I enclose P.O. value. (No stamps.)

Name

Address

A.W.6.

THE NORTHERN NATIONAL RADIO EXHIBITION

City Hall, Deansgate, Manchester: September 28 to October 8

NEXT Wednesday, September 28, the Ninth Northern National Radio Exhibition opens at the City Hall, Deansgate, Manchester.

Everything points to it being a better Show than ever before, and Midland and Northern readers who were not able to see the new developments at Olympia last month will welcome this fine opportunity to see, at Manchester, the latest in radio.

The Northern National Exhibition runs from Wednesday, September 28, to Saturday, October 8—ten days packed with interest for all radio enthusiasts.

While, of course, not so vast as the National Radio Exhibition at Olympia, the Northern Show is nevertheless similarly planned, and the Exhibition is organised by the Radio Manufacturers' Association in conjunction with Provincial Exhibitions, Ltd. The stall arrangements are similar to those at Olympia, and during the ten days of the Radio Show the main hall of the City Hall (with a bridge over the central aisle), the Tonman Hall, New Hall and galleries will be a brilliantly illuminated display of new sets and components. The Stands are varied, but a uniform scheme of stand-fitting is adopted for the bridge over the main hall. There are eight Stands on the bridge, and, of course, many others in the rest of the gallery.

In next week's issue a full account of the Exhibition will be given, together with floor plans, a full list of the exhibitors and a detailed description of the new developments on show.

"A.W." is, of course, represented, and all visitors to the Northern Radio Exhibition should take this opportunity of seeing the new AMATEUR WIRELESS and *Wireless Magazine* sets, including the "Wizard" described this week. The "A.W." Stand is No. 34 in the Tonman Hall, in a very convenient position in the Exhibition.

COIL MOUNTING



Tuning coils having the axis parallel with the baseboard should not be mounted flat down against the wood, but should be supported at least $\frac{1}{4}$ -in. away. The best way of doing this is to slip $\frac{1}{4}$ -in. lengths of ebonite tubing over the mounting screws to form small supports.

"BRINGING IN STATIONS WITH THE 'WIZARD'"

(Continued from page 612)

eight stations were received at full loud-speaker strength without any trouble, and no doubt if I had been more used to the receiver, I could have increased this number considerably. Barcelona was badly swamped by London Regional together with Muhlacker, but the Scottish Regional came in well. Above this an unknown station was received at enormous strength, but I could not identify it; it was probably Lvov relaying Warsaw. The Midland Regional, at 76.5 and 75, is a little too close to Sötten to be pleasant, but between this reading and the North Regional at least eight stations were received at full loud-speaker strength. Here again many more would have been received if sufficient time had been taken to log them.

Prague is always a reliable station and in this instance it was no exception, giving a recital of Maurice Chevalier's records, to which I listened for over half an hour. Brussels came in louder than the North Regional and, if anything, at better quality.

Between 91 and 100 degrees six or seven stations were received, but only Vienna, Munich and Budapest were definitely identified.

Readers will probably wonder why this receiver should be so sensitive. I think the most important reason is that independent tuning obviates the necessity for careful ganging, and the use of closely matched coils, so the utmost efficiency is obtained from the receiver.

PIONEERS & LEADERS ALWAYS

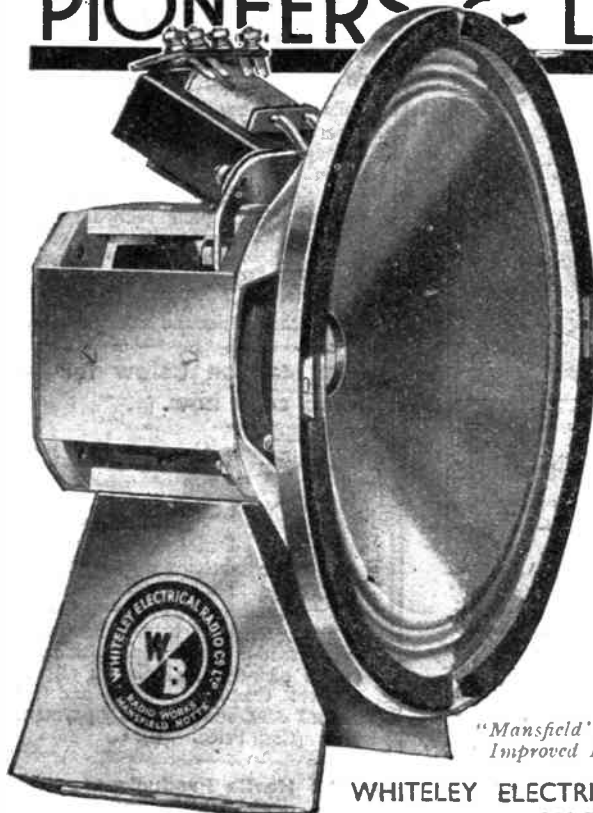

Get our new art booklet "Speaking of Speakers"—write for it NOW. It gives full information on all the new "W.B." productions—"Undoubtedly the leaders in their price class"—and

The "MANSFIELD" new PERMANENT MAGNET Moving-Coil Speakers

"Mansfield" Senior Improved P.M.4.

"Mansfield" Senior P.M.4. 42/- complete

"Mansfield" Junior P.M.5. 27/6 complete

WHITELEY ELECTRICAL RADIO CO. LTD., Radio Works, Mansfield, Notts.

Irish Free State distributors: Kelly & Shiel Ltd. 47 Fleet Street, Dublin.

RADIOPAK

TRADE MARK
THE ONLY COMPLETE BAND-PASS TUNER

MATCHED PERFECTION

REVOLUTIONISING SET CONSTRUCTION

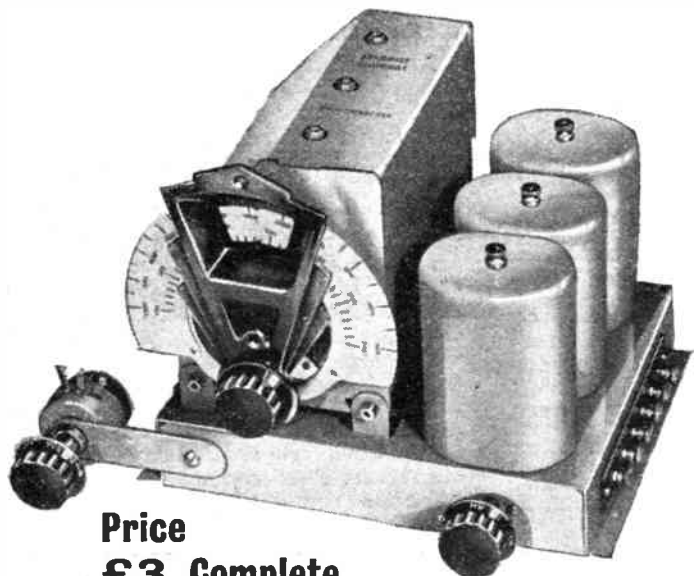

**Price
£3 Complete**

The British Radiophone Radiopak unit has been specially produced to bring perfect Band-pass tuning within reach of all constructors.

The unit consists of the necessary coils; the gang condenser with illuminated slow-motion escutcheon and disc drive calibrated in wavelengths; a wave-change switch; and a wire-wound volume control complete with on-off Q.M.B. power switch. The switching arrangement is the best yet devised for any radio component, and the combined volume control and switch is one of the famous Radiophone standard types needing no further recommendation. Owing to the high degree of accuracy in the matching of the coils and condensers, this unit will REVOLUTIONISE modern set construction. Write for full descriptive particulars to Dept. A.W.

**THE BRITISH RADIOPHONE LTD.
ALDWYCH HOUSE, ALDWYCH, W.C. 2**

Telephone: HOLBORN 6744



The "ATLAS" A.C.244 SPECIFIED AGAIN

MODEL A.C.244.
59/6 Cash.
1 Tapping 60/80v. (Max. & Min.)
1 Tapping 50/90v. (Max., Med., & Min.)
1 Tapping 120/150v. Output 20 mA at 120v.
MODEL A.K.260.
With L.T. Trickle Charger for 2-, 4-, and 6-volt Accumulators.
90/- Cash.
Westinghouse Rectifiers Guaranteed 12 months.

... Yet again "ATLAS" is the designer's choice and definitely specified to ensure the finest possible reception from the "Wizard" Receiver described in this number.

Make sure of getting the best in value and performance by insisting on "ATLAS," winners of the Olympia Ballots in 1930 and 1931.

Ask your dealer for a demonstration and post the coupon to-day for your FREE Folder.

"CLARKE'S" "ATLAS" MAINS UNITS

H. CLARKE & CO. (M/CR.), LTD.
Patricroft, Manchester

LONDON OFFICES: Bush House, W.C.2
SCOTTISH DISTRIBUTORS:
G.E.S. Co. Ltd., 38 Oswald St., Glasgow

POST THIS COUPON TO-DAY:

H. CLARKE & CO. (M/CR.) LTD., George St., Patricroft, M/cr.
Please send FREE copy of Folder No. 68.

NAME _____

ADDRESS _____
29/24/9

"DEVELOPMENTS IN L.F. AMPLIFICATION"

(Continued from page 621.)

the straight part of the characteristic. A positive voltage causes the anode current to increase and operates over the positive portion of the characteristic.

In doing so, grid current flows so long as the grid is positive, which means that the grid-filament path of the valve has quite a low resistance. Under normal conditions this would short-circuit the preceding transformer or resistance and cause the amplification to drop off considerably, so that there would be an unequal amplification of the two halves of the wave with very serious distortion in consequence. To overcome this, the valve is fed from a driver which is another valve designed to operate normally when the grid of the power valve is negative, but to give an increased amplification when the power-valve grid is positive. This effect is obtained by a special design of the characteristics of the driver valve, and the net result is an undistorted amplification, the short-circuiting effect of the grid current in the output valve being compensated for by the increased amplification from the driver valve.

It will be clear that this arrangement allows twice the normal grid swing on the output valve and therefore *four times the power output*, while the anode current has only been increased to about twice the normal value so that the arrangement is considerable more efficient. As against this there is the necessity for the driver

valve which must be allowed for even when it is included within the same bulb.

The second system is a form of push-pull arrangement shown in Fig. 2. The two push-pull valves are of the screen-grid or pentode type so designed that the anode current is practically zero with no grid bias. Each half wave, therefore, one of the valves swings over its characteristic, which is all on the positive side, while the other valve is idle. During the whole time each valve is operative, grid current is flowing so that there is a permanent load across the transformer feeding the valves. This is an easier condition to contend with than the last, for provided the load is reasonably constant, we can design the preceding stage to give undistorted amplification.

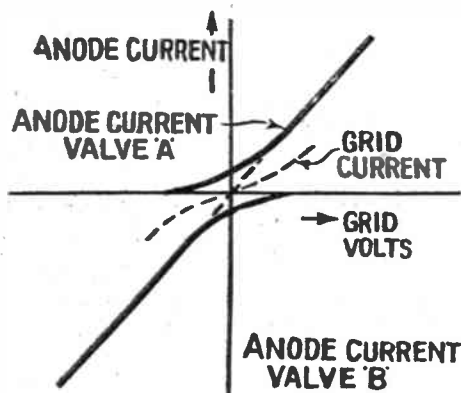

Fig. 3.—The valves are designed so that the anode current is practically zero with no grid bias

The case, indeed, is very similar to the design of the output circuit at present, where the power valve has to feed into the load imposed by the loud-speaker. The first valve therefore is arranged to operate as a power amplifier and delivers undistorted voltage to the grids of the push-pull valves.

Due to the fact that there is no grid current limitation the grid swing of these valves can again be extended and considerably increased power output is obtainable, at the expense of the driver valve, as before (Fig. 3). On the other hand, the two push-pull valves take practically no anode current when they are not working, which means considerable economy in H.T. consumption.

A typical valve just marketed in America delivers 3½ watts output with 180 volts H.T. This is for two such valves in push-pull as just described, the total anode current for both valves with no signal being only 4 milliamperes. One valve by itself used as a normal amplifier only gives an output of 200 milliwatts.

I should add that these figures are taken on trust. I have not yet had an opportunity of verifying them, but they do indicate the considerably greater power output which can be obtained. Some valve designers claim that they can get just as good results with straight methods of amplification if they are given sufficient rein. Time will show, but there is no doubt that these new methods are going to cause considerable thought in the immediate future.

"NEW RADIOS FOR OLD"

RADIALADDIN EXCHANGE SERVICE THE SUCCESS OF OLYMPIA

(All orders placed at the Radio Exhibition are being dealt with in strict rotation.)

In purchasing by mail order, it is essential that the supplier's dealings, methods and bona fides should be subject to the strictest scrutiny, and it is therefore with pleasure that we have compiled a pamphlet illustrating numerous satisfactory experiences of those who have dealt with us—and also the Press. It will pay you to write for particulars of our amazing exchange offer, enclosing 1½d. stamp, naming your old set which we buy, and the new set you fancy. A free quotation will follow. Balance payable in cash or hire-purchase.

FREE Wireless Set to introduce the Radialaddin Club.

Please forward this INQUIRY FORM (without obligation)

Please quote me free your allowance for this new set:

Make..... Model and list price.....

My Present Set is: Make..... Batteries or Mains.....

Date of Purchase..... Original Cost of Set.....

Balance of purchase price would be payable by me as follows:

Plan A. Whole of balance in cash.

Plan B. Whole of balance over six, nine, twelve * months.

*Delete unwanted words.

NAME (in full).....

ADDRESS.....

RADIALADDIN, Limited

THE LARGEST RADIO EXCHANGE IN THE UNITED KINGDOM. (Dept. A.W.), 47-48 Berners Street, London, W.1. Museum 1821.



British Made

THE RELIABLE BECOL EBONITE FORMER which has stood the TEST OF TIME and tested before despatch. Prices LOW.

EFFICIENCY COUNTS!!!

LOOK FOR TRADE-MARK. SOLE MAKERS

THE BRITISH EBONITE CO., LTD. HANWELL, W.7

HERE IT IS EXACTLY WHAT YOU REQUIRE FOR SHORT WAVES



FOR THIS SPLENDID NEW 1933 "BLUE SPOT" SPEAKER

NEW 1933 PERMANENT MAGNET SPEAKER No. 50PM.

The new "Blue Spot" Speaker 100U is ideal for the amateur constructor. Mounted to chassis and needs no matching transformer. Send 2/6 for 7 days' trial. If satisfied, pay further 3/6, then 6 monthly payments of 5/-.

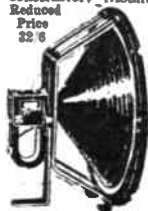

The chassis is an outstanding example of first-class workmanship and the unit, with its heavy permanent magnet containing a high percentage of cobalt, is wonderfully sensitive. From any set this new "Blue Spot" Speaker will reproduce every detail of speech or music to perfection. Send only 2/6 deposit for 7 days' trial. If satisfied, pay further 3/6 at once, then 6 monthly payments of 5/6. (Cash in 7 days, 50/6). Leaflet discussing this and other "Blue Spot" Speakers post free on request.

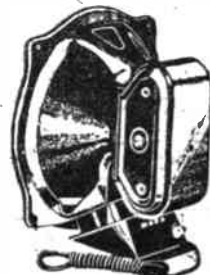

E. J. HERAUD LTD., DEPT. A.W.11, NUMBER ONE, EDMONTON LONDON. N.13

and at Tottenham Walthamstow, and Enfield Wash. Estab 33 years.

"THE A.B.C. OF MAINS WORKING"

(Continued from page 614)

networks, either potentiometers, as for screen-grid stages, or as series resistances, as for the detector anode.

To work out the required resistance in series between the maximum output and the anode of the valve is quite easy when you know the anode current of the valve. It involves a simple application of Ohm's Law. You subtract the voltage required from the voltage you have: This gives the voltage to be dropped. Then you divide this voltage by the valve's anode current in milliamperes and the answer, when multiplied by 1,000, will be the resistance in ohms required.

LOW-TENSION SUPPLY

As already indicated, the problem of the low-tension supply for heating the filaments from the A.C. mains is simply solved by means of a 4-volt secondary on the high-tension transformer. The 4 volts delivered by this small secondary is, of course, A.C., which even in its "raw" state can be applied directly to the cathodes of the valves.

The variations in the heating effect of the alternating current passing through the heater elements never reaches the actual filament—never affects the real electron emitter, called the cathode, and corresponding in circuit connection to low-tension negative of a battery set.

GRID BIAS

When the high tension is obtained from the mains the grid bias is automatically derived by means of resistances in the cathode leads. The anode currents flow through these resistances, and thus cause voltage drops across them determined by the value of the currents and the value of the resistances.

What we do is to find out how many volts grid bias is needed for each stage, measure the anode current of each stage and then apply Ohm's Law to find what the resistance value should be to cause the wanted voltage drop.

Example: We might want to bias the detector valve, say, 2 volts negative for using it as a gramophone amplifier, and the anode current of the valve might be 4 milliamperes. The value of the resistance needed to give 4 volts drop across it when the current flowing through it was 4 milliamperes would be found by dividing the voltage drop, that is 2 volts, by the current in milliamperes, that is 4, and multiplying the answer by 1,000; which, in this example, works out to 500. A 500-ohm cathode resistance would therefore give the required grid bias of 2 volts.

It is important to note that this voltage gained for the grid bias is voltage lost for the anode of the valve. Potentials are measured with respect to the cathode.

The point is that when we get negative bias by making the cathode more positive we obviously make this cathode less negative with respect to the anode, or in other words we make the anode less positive with respect to the cathode.

In modern mains sets cathode-bias resistances are used for each valve, so that different bias voltages can be obtained quite easily, especially as a wide variety of resistance sizes is now available.

**Why
throw away
2½ worth of H.T.
— when your H.T.
Battery runs down?**



When you throw away an old H.T. Battery there is still power left in it—power you cannot use—its voltage is too low to work your set. You are compelled to waste this energy—energy for which you have already paid.

The Lively 'O' H.T. Accumulator eliminates waste. It is full of life and vitality right up to the time when it is ready for recharging (3 or 4 times a year). Its "air-spaced" cells are proof against electrical leakage. Its voltage is constant. Get the best out of your set with the smooth, unvarying H.T. supply ensured by the Lively 'O'. Your Dealer stocks it.

TWO TYPES:

Standard 10 volt unit capacity 2,750 milliamps **5/6**

Extra large capacity 5,500 milliamps (10 volt unit) **6/9**

The

Lively 'O'

H.T. ACCUMULATOR

PUT THE LIVELY 'O' INTO YOUR RADIO

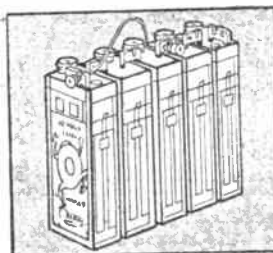

Oldham & Son Ltd.,
Denton, Manchester.
Est. 1865, and at
London, Glasgow,
Belfast and Dublin.

IN MY WIRELESS DEN

WEEKLY HINTS —

CONSTRUCTIONAL



& THEORETICAL

By

W. JAMES

HOW M.C.'S DIFFER

If you tested a number of moving-coil speakers of the same make you might be surprised at the slight differences in the results.

This may be traced to various small faults. Sometimes the cones are not quite right. The centre holding pieces do not always have the same flexibility and the distance between the front of the magnet and the beginning of the winding of the speech coil is not always equal.

You might find slight scratching sounds. Some overload and give bad quality or rattle before others. Naturally, if you have one speaker, as most of us have, it is difficult to detect slight faults in the reproduction, but scratchy noises and overloading will be noted. It is possible that the fixing might be loose and this should be seen to.

To clear filings or other material, lay the speaker unit upon its face and pass a strong signal through it; at the same time gently bump the face of the unit against the table. This treatment will usually clear away the particles of foreign matter lodged in the gap.

If the coil is rubbing against the poles,

slightly loose the fixing screw holding the centreing piece and adjust very carefully.

I have noted that a fault may be produced by fastening the unit carelessly. The screws used to hold the unit to the cabinet or board may not be tightened evenly, and this might twist the frame slightly.

See to this, therefore, when fitting the unit. A moving-coil speaker should be dealt with carefully and reasonably and if it is exposed it is a good idea to fit a bag of cotton or silk over the back of the unit, the silk covering the fret protecting the front.

LOSING VOLUME BY CHANGING

— TONE —

A FORM of tone correction is usually employed by all of us. We usually do our best in the low-frequency side to make the sounds from our loud-speaker as natural as possible.

If top is lacking we try a transformer having a rising characteristic, and when there is too much top we cut it down by using a resistance-condenser filter. It is difficult to make a set having very sharp tuning circuits which cut the top notes and low-frequency circuits which correct faithfully for this.

The detector plays a part and must be carefully arranged. A satisfactory detector would have a straight-line characteristic, and this generally means that the input must be adjusted within limits to work only on the straight part. A detector of this class, such as a properly set up "power grid" type, distorts very little itself.

It is interesting to note that a correcting circuit usually works by taking away rather than by adding to the signal. This is why two low-frequency stages are sometimes needed instead of one stage.

WHAT'S THE RATIO ?

THE ratio of a transformer is reckoned as the number of turns of wire in the secondary divided by the number in the primary.

Thus, if, for example, the turns are 16,000 and 4,000, the ratio is said to be 4 : 1. Now it is possible that if you connect a 7 : 1 transformer to your set the magnification may be no greater than when a 3 : 1 is used.

The frequency characteristics will probably be quite different and the most uniform results may be obtained with the 3 : 1. Much depends upon the valve to which the primary is connected. The valve may have an impedance of 20,000 ohms, when the normal 3 : 1 transformer would be satisfactory. A transformer of higher ratio would only spoil the results. There would probably be a reduction in the bass notes and perhaps the higher notes would be weakened in comparison with the valve and 3 : 1 ratio combination.

A VOLTMETER OF FIRST GRADE ACCURACY

is essential to all radio builders

FERRANTI METERS

are of accuracy guaranteed within the limits of the British Standard Specification No. 89, for first-grade Moving Coil Instruments.

A wide open scale (110°—2½ inches) ensures accurate readings in all ranges. Particularly useful instruments for normal purposes are the **Types 16P and 17P**. For measurements in very high resistance circuits, the following are recommended.

TYPE 25P - - - £3 : 8 : 6
Ranges 7½—30—150 volts.

TYPE 26P - - - £3 : 14 : 6
Ranges 10—50—250 volts.

Resistance, 1,000 ohms per volt.

TYPE 16P - - - £2 : 12 : 6
Range 7½—30—150 volts.

TYPE 17P - - - £3 : 0 : 0
Range 10—50—250 volts.

Resistance, 200 ohms per volt.

Clearly divided scale
Absolutely dead
beat Accuracy
within 1%

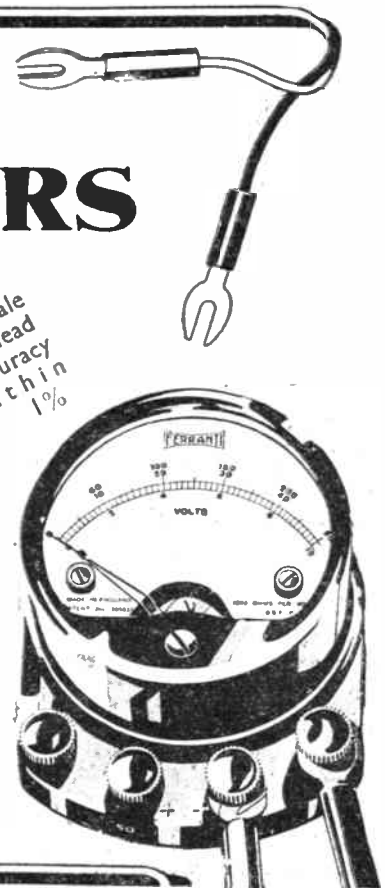

NO BETTER INSTRUMENTS ARE AVAILABLE AT ANY PRICE

Ferranti have been famous for instruments since 1882

FERRANTI LTD., Head Office and Works, HOLLINWOOD, LANCASHIRE.

LONDON: Bush House, Aldwych, W.C.2

The point here is that the valve and transformer work together and cannot be considered separately. If the valve were replaced with another of 10,000 ohms the results would probably be quite different. With a good 7:1 transformer the results might be much better than with the 3:1.

Then again, the output valve plays a part. This valve has capacity which is across the transformer, and being across the secondary, has much more effect than an equal capacity joined across the primary.

A 7:1 transformer may, therefore, not be as good as a component having a lower ratio, but if the impedance of the valve joined to the primary is low the high-ratio transformer may be worth while.

IS IT EARTHED ?

A POWER transformer or choke mounted upon a metal chassis is automatically earthed in many cases. The fixing feet or perhaps the metal core make contact with the chassis. To avoid this when the practice results in hum it is necessary to insulate the parts.

A piece of cardboard may be used beneath the component affected. The effect is to introduce a short gap between the cone and the chassis, which is often of steel, plated to preserve it.

The earthing may not be important by itself, but hum is sometimes introduced by the core resting against the surface of the chassis.

Earthing is sometimes more important than is usually thought, and it may be much more satisfactory to earth the parts by taking wires to the earthing terminal instead of relying upon contacts with the chassis itself.

'WARE HIGH TENSION!

A PROTECTING terminal ought to be used for the top of a metallised screen-grid valve. If an ordinary wire connection is used there is always the chance that it might touch the metal covering of the bulb and cause damage.

The metal coating is earthed through the low tension or cathode, and if the high-tension wire going to the anode should by chance touch it there will be practically a short circuit.

The metal covering will be damaged, but the valve is usually not harmed apart from this. With a proper terminal fitted to the stem at the top of the bulb this cannot happen.

New Times Sales Co

MANUFACTURERS' KITS

LISSEN "SKYSCRAPER 3" Chassis With
model with Lissen S.G., Detector 8/3
and Pentode valves. Cash price
£4/9 6 Carriage Paid. order
Balance in 11 monthly payments of
8 3.

COSSOR MELODY MAKER MODEL With
335. Complete with valves, speaker 10/-
and cabinet. Employs Cossor variable- order
mu S.G., H.F. stage, detector and
power valves. Cash price, £7/17 6.
Balance in 11 monthly payments of
14/10. Carriage Paid.

SLEKTUN SCOUT S.G.3.—S.G., With
Detector and Power. Pilot Auth r 8/1
Kit "A" (less valves and cabinet). order
Cash or C.O.D., £4/8 6. Carriage Paid.
Balance in 11 monthly payments of
8 1.

ACCESSORIES

GARRARD INDUCTION GRAMO- With
PHONE MOTOR. For A.C. mains. 4/7
Model 202. Mounted on 12-inch order
nickel motor plate with fully automatic
electric starting and stopping switch.
Cash price £2/10 0. Carriage Paid.
Balance in 11 monthly payments of 4 7.

B.T.H. SENIOR PICK-UP with arm With
and base. Cash price £2/2/- 3/10
Balance in 11 monthly payments of order
3/10. Carriage Paid.

COLLARO INDUCTION MOTOR WITH With
PICK-UP. For A.C. mains. 12 inch 7/4
turntable, moulded pick-up, volume order
control and automatic stop.
Cash price £4 0 0. Carriage Paid.
Balance in 11 monthly payments of
7 4.

**FIRST WITH
EASY TERMS
in 1924 and
Still leading
BIGGEST STOCKS**

**NEW 1933
RADIO
ON EASIEST OF
EASY TERMS
QUICKEST DELIVERY**

Strictest Privacy Guaranteed

- R. & A. "VICTOR" PERMANENT MAGNET MOVING-COIL SPEAKER DE LUXE with 6-ratio input transformer and protecting grille. Cash or C.O.D., £3 10/- Carriage Paid. Balance in 11 monthly payments of 6 5
- R. & A. "BANTAM" PERMANENT - MAGNET MOVING - COIL SPEAKER with 3-ratio input transformer. Cash price £1/7 6. Carr. Paid. Balance in 5 monthly payments of 5/-
- W.B. PERMANENT MAGNET MOVING-COIL SPEAKER. Type P.M.4. With transformer. Cash price £2/2/- Balance in 7 monthly payments of 5/9
- BLUE SPOT SPEAKER UNIT AND CHASSIS, TYPE 100U. With 5/5
- Cash price £1/19 6. Carriage Paid. Balance in 7 monthly payments of 5/5
- ATLAS ELIMINATOR, Type A.C.244. Three tappings, S.G., detector and power. Output, 120 volts at 20 m/A. Cash price, £2/19 6. Carriage Paid. Balance in 11 monthly payments of 5/3
- EPOCH "SUPER JUNIOR" Type M.V. Permanent Magnet Moving-Coil Speaker with 5-ratio transformer. Cash or C.O.D. £1/7 6. Carriage Paid. Balance in 5 monthly payments of 5/-
- EPOCH "20 C" PERMANENT MAGNET MOVING-COIL SPEAKER. With 3-ratio input transformer. This speaker will handle up to 5 watts. Cash price, £1/15 6. Carriage Paid. Balance in 5 monthly payments of 6 6
- EKOK H.T. UNIT, Type A.C.25. For multi-valve sets requiring up to 25 m/a. 3 tappings, S.G., detector and 120/150 volts. For A.C. mains. Cash price, £3/17 6. Carriage Paid. Balance in 11 monthly payments of 7/1

Any items advertised in this Journal sent C.O.D. if value over 10/- sent all C.O.D. charges paid.

To NEW TIMES SALES CO., 37, Ludgate Hill, London, E.C.4
Please send me (a) 1933 Lists,
(b)..... for which I enclose
first payment of £.....s.....d.....
Name.....
Address.....
A.W. 24/9/32

Miscellaneous Components. Accessories, etc., etc., supplied CASH, C.O.D. or H.P. on our own Private System of Easy Payments.

**IN THE
WIZARD**

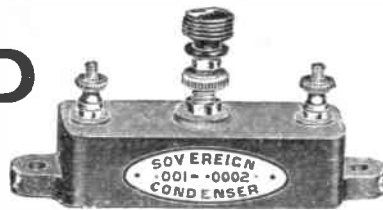

**A
SOVEREIGN COMPRESSION TYPE
CONDENSER TYPE J IS SPECIFIED**

1/3

We are pleased to announce publication of the Third (1932) Edition of our famous Components Catalogue which will be forwarded (free) together with our latest Blueprint for building the Sovereign Ambassador and Plessey Receivers upon receipt of a postcard to Dept. A.W.

Sovereign Components may be obtained from all good Dealers. Use them as much as you can in building the Wizard.

SOVEREIGN PRODUCTS, LTD. SOVEREIGN HOUSE, ROSEBERY AV. E.C.1

**OUR
BLUEPRINT
SERVICE**

Constructors of receivers described in this Journal should make full use of our Blueprint Service and avoid all risk of failure.

A 6d Insurance Policy

Ask for Genuine "Competa" Green Top Fuses. The only reliable make which fuse instantly on 50% overload.

TRADE MARK
COMPETA
THE WORLD'S SELECTED

Adv. of A. F. BULGIN & Co. Ltd., Abbey Rd., Barking

RADIO SUPPLIES

Send your list of Radio needs for our quotation. Kits, Parts, Sets, etc. Everything in Radio stocked. Prompt delivery; seven days' approval. Catalogue free. Taylor and Standard Wet H.T. replacements stocked.

G. TAYLOR, 87 STUDLEY ROAD, STOCKWELL, LONDON

OUR QUERY DEPARTMENT?

The attention of readers is directed to the rules printed below. Replies are sent by post, only a selection of queries of general interest are printed here.

Using an Absorption Wavemeter

SIR,—I have been presented with what I have been told is an absorption wavemeter. It contains a variable tuning condenser connected to a coil-holder and mounted on a simple panel and baseboard arrangement. There are several plug-in coils for use with the gadget. Can you explain to me how I may use this instrument?
F. W. (London).

The wavemeter is not of much use unless it is calibrated. You do not say whether you have any calibration curves with the instrument, but we will assume you have these. The meter should be arranged near to the receiver so that its tuning coil is close to, and parallel with, the plane of the aerial tuning coil in your set. If you tune in a station and want to find out its wavelength, you adjust the tuning condenser of the wavemeter until you find a position on its condenser scale where signals from your actual receiver fade away. This is the absorption spot and a reference to the condenser setting on your meter calibration curve will indicate the wavelength of the station. It is best not to place the meter near to the tuning coil of the receiver until after a station has been tuned in, as absorption effects in the meter may affect the tuning of the receiver.

Advantages of H.F. Stage in Short-wave Sets

SIR,—I have often heard it remarked that a high-frequency stage in a short-wave set is virtually a passenger, but this does not explain much to me. Is it a fact that there are no advantages gained when incorporating a high-frequency amplifying valve before the detector in a short-wave set, and, if so, why do so many designers put in such a stage of amplification?
R. D. (Belfast).

It is not quite true to say that an H.F. stage in a short-wave set is a passenger. It is not possible to gain much pre-detector amplification from such a stage when working on wavelengths below about 30 metres, but there is a great advantage in using an H.F. stage on these low wavelengths and this is, it stabilises the whole receiver, makes detector-circuit reaction extremely smooth, and permits elimination of much of the mush usually experienced when a plain detector with reaction on to the aerial is used. Above about 30 metres it is common to expect a good H.F. amplification stage gain, and it often makes all the difference between just hearing a station and receiving it at full speaker strength.

Obtaining a Transmitting Permit

SIR,—I am very interested in short-wave work and wish to take up transmission experiments. Other short-wave enthusiasts with whom I have spoken on the subject have stated their willingness to report upon my work. I should therefore be pleased to learn how I should go about applying for a licence for a transmitter and

what other steps I should take to qualify for it.
W. R. (Middlesbrough).

It is necessary, first, that you be able to transmit and receive morse code signals at twelve words a minute. Next, you must be able to satisfy the authorities regarding your ability to operate a transmitting station in a proper manner. You must also be prepared to sit for an examination with regard to these two subjects, if called upon. A letter to the Secretary of the P.M.G. will bring to you the necessary application forms and these should be filled in to the best of your ability. A circuit of the transmitter you will be using, together with brief details of the type of experiments you intend to conduct, should be included with the licence application forms when returned to the authorities. You would gain much practical assistance in the matter by joining a well-informed radio society.

THE BRIGHTON RADIO EXHIBITION

AN event in which South Coast listeners will be interested is now in course of preparation and will be officially opened by the Mayor of Brighton at 3 p.m. on Monday, October 3, at the Georgian Room of the Regent Cinema, North Street, Brighton.

The Brighton Radio Exhibition is a united effort by most of the radio manufacturers and the leading radio traders of Brighton, Hove, and Portslade, and upon thirty-one stands practically all of the new designs shown at Olympia will be displayed and demonstrated. The Exhibition will be open daily from 3 to 10 p.m., October 3 to 8 inclusive, admission 6d.

Captain C. B. Graves, who described his journey from England to New Zealand in a Liverpool Barque in a talk last June, will on September 27 give an account of the return journey.

WHEN SUBMITTING QUERIES

Please write concisely, giving essential particulars. A Fee of One Shilling (postal order), a stamped addressed envelope, and the coupon on the last page must accompany all letters. The following points should be noted.

Not more than two questions should be sent with any one letter.

The designing of apparatus or receivers cannot be undertaken.

Modifications of a straightforward nature can be made to blueprints, but we reserve to ourselves the right to determine the extent of an alteration to come within the scope of a query. Modifications to proprietary receivers and designs published by contemporary journals cannot be undertaken.

Readers' sets and components cannot be tested at this office. Readers desiring specific information upon any problem should not ask for it to be published in a forthcoming issue, as only queries of general interest are published and these only at our discretion. Queries cannot be answered by telephone or personally.

Readers ordering blueprints and requiring technical information in addition, should address a separate letter to the Query Department and conform with the rules.

P.P.M. SOUNDEX 27/6 INCLUDING TRANSFORMER

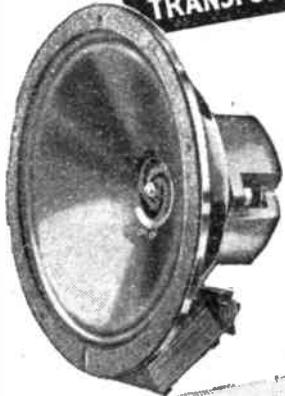

PPM 69



P.P.M. SOUNDEX CHASSIS
Have you heard Celestion's latest chassis speaker? You will be amazed that such a small speaker can produce such wonderful tone and volume. Incorporating the famous Hyflex diaphragm. Price, including universal tapped transformer, 27/8.

P.P.M. 69 (CABINET)
The most outstanding achievement of the year. A wonderful magnet giving extraordinary sensitivity and a large Hyflex diaphragm combine to make this speaker really amazing. Housed in a dignified cabinet that will fit in with any style of furniture. Prices: 85/- Oak; 90/- Mahogany and Walnut.

CELESTION
The Very Soul of Music

Celestion Ltd., London Rd., Kingston-on-Thames
London Showroom: 108, Victoria Street, &W.



Go over your set with an "All-in-One" Radiometer and quickly trace the true source of any trouble. You can't go wrong in radio

with this wonderful little instrument to guide you.

Its never-failing aid enables you to track down a fault instantly. Wherever it may be—valves, batteries, transformer, circuit, or other component—an "All-in-One" Radiometer gets to the root of the matter and registers it at once.

There is no other instrument like it. Ask to see it demonstrated at your radio dealer's or electrician's. If in any difficulty, write direct to

PIFCO, Ltd., High Street, Manchester.

Standard Model "All-in-One" Radiometer for Battery Sets only, as shown here.

Price 12/6



De Luxe Model, for Battery Sets, Electric Receivers and Mains Units.

Price £2/2/0

Φ F

PIFCO ALL IN ONE RADIOMETER



Here is your Opportunity—Make Wireless Batteries—It is a Paying Proposition!

WHETHER you are a Wireless Enthusiast or not, you know what an enormous demand there is for Wireless Batteries—a demand which is ever increasing by leaps and bounds. If you are a Wireless Enthusiast you know also that you and millions of others are constantly on the look out for BETTER Batteries.

Here is a way in which you can meet the demand for BETTER Batteries and Profit Financially—make them yourself in your Spare time by means of our Patented Method and Formula. By making your own Batteries you can SAVE money—by supplying your friends and others you can MAKE MONEY—and you may make up to £300 a year per licence!

ANYBODY CAN DO IT!
YOU Can Do this : It has probably never crossed your mind before. You have thought of batteries as "Technical" things—always regarded them as something "mysterious."

The exact opposite is the case. Study the pictures on the left and you will see how really simple it is.

You will need no expensive "plant" or machinery—only a few simple tools and hand presses. You need have no special accommodation—a start can be made upon your present Kitchen Table. The Children can help you.



WE WILL TELL YOU HOW

You may know nothing about Wireless or Electricity—it does not matter in the slightest. We will tell you how to do it—FREE. After receiving our instructions you can start right away to Manufacture! And the work is intensely interesting as well as easy—more fascinating than making your own Wireless Set! The saving is huge—an average worker can complete a 60 roll H.T. Battery in 2 hours at a cost of 2/3 approximately. Compare this with Shop Prices!

Make your Friends' Wireless Batteries and MAKE MONEY.

Consider what this means to you. Not only can you SAVE Money on your own Batteries—and get BETTER Results—but directly your friends know of them they will want some, too! Thus you can begin to build up a profitable Spare-time Business and reap a Golden Harvest from the Wireless and Electrical Market. Many men are already making comfortable EXTRA incomes in this Pleasant, Easy Way.

There's MONEY in it—big money if you are energetic and anxious to get out of the rut! What could you do with £300 a year?

PROFITS GUARANTEED.

Your market is unrestricted—it can never be overcrowded—you sell where you like and when you like. If necessary, we will purchase sufficient of your output to guarantee you a weekly Profit, providing it reaches the required standard of efficiency, which is easily attainable. We will continue your training FREE until you reach that standard—that's fair, isn't it?

Don't hesitate—if you have never seen a Battery before you can MAKE money this way. Let us explain this GILT-EDGED, HONEST PROPOSITION fully. Write at ONCE! Make your SPARE Hours—GOLDEN Hours.

SEND THIS FORM FOR FREE INSTRUCTIONS HOW TO START

COUPON

To Mr. V. ENGLAND-RICHARDS, The ENGLAND-RICHARDS Co., Ltd., 1, 222 King's Lynn, Norfolk.

Sir,—Please send me at once, and FREE, full details as to how I can Make Wireless Batteries and Make Money at Home in my spare time. I enclose 2d. stamps for postage.

Print your name and address boldly in capital letters on a plain sheet of paper and pin this coupon to it.

"Amateur Wireless," Sept. 24, 1932

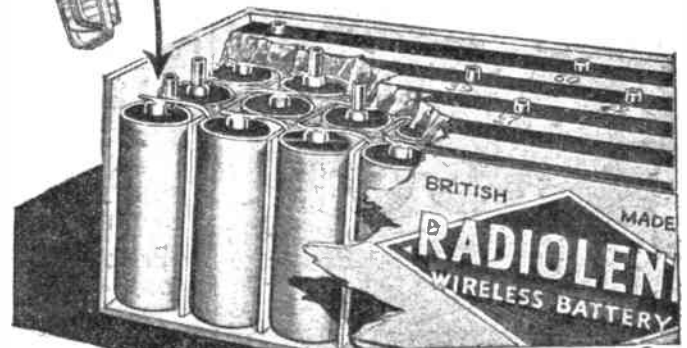

CLIX "MASTER" PLUG

Test this against all others—we are confident you will choose 'CLIX'

The technical press congratulates 'Clix' on the design and efficiency of the 'Clix' "Master" Plug.

POPULAR WIRELESS

Radio enthusiasts who have experienced trouble from soft pronged or too rigid plugs and tapered H.T. Battery sockets will welcome the 'Clix' "Master" Plug.

METAL TO METAL CONTACT. FIRM GRIP. FULL SURFACE CONTACT WITH ANY H.T. OR G.B. BATTERY SOCKETS.

Full range of markings.

Send for Illustrated Folder 'A' of all 'Clix' products.

1 D. 1/2

Supplied with long or short shanks and insulators.



Cheapest PERFECT CONTACT

Lectro Linx Ltd., 254, Vauxhall Bridge Road, S.W.1

7 vital radio accessories in 1

I get stations you've never heard before!
I cut out atmospheric!

A well-made super-efficient LEAD-IN that incorporates a perfect lightning arrester and a tubular variable condenser, so providing volume and selectivity control, a static eliminator, and an ideal aerial cut-out. The Cop cannot fail to improve vastly the performance of any set with an outdoor aerial. And—it carries a \$100 FREE Insurance Policy. From your local radio dealer, or send P.O. for 2/6 direct to the manufacturers:

CLIFFORD A. PRESSLAND (SALES), LTD., 84 Eden Street, Kingston-on-Thames.

PRESSLAND AERIAL CONTROL

COP



Scientific

BROADCASTING STATIONS

Broadcasting Stations classified in order of wavelengths. For the purpose of better comparison, the power indicated is that of the carrier wave.

Kilo-Metres cycles	Station and Call Sign	Power (Kw.)	Kilo-Metres cycles	Station and Call Sign	Power (Kw.)	Kilo-Metres cycles	Station and Call Sign	Power (Kw.)	
19.737	15,200 Zeesen (DJB) ...	8.0	288.5	1,040 Scottish National	50.0	472.4	635 Langenberg	60.0	
25.4	11,810 Rome (2KO).....	15.0	288.5	1,040 Swansea	0.12	476	630.2 Sebastopol	10.0	
25.53	11,755 Chelmsford (G5SW)	16.0	291	1,031 Tampere	1.0	480	625 North Regional	50.0	
31.25	9,598 Lisbon (CTIAA) ...	2.0	293	1,022 Vapuri	13.0	488.6	614 Prague	120.0	
31.51	9,520 Skamleback.....	0.5	293.7	1,021.5 Limoges (PTT)...	2.5	493.4	608 Trondheim	1.2	
31.38	9,560 Zeesen (DJA) ...	8.0	298.1	1,013 Huizen	8.5	500.8	599 Florence (Firenze)	20.0	
32.28	9,300 Rabat	0.5	298.1	1,004 Tallinn	1.0	502.4	579 Nijni Novgorod	10.0	
33.0	9,090 L.L. Paris.....	0.5	301.5	995 North National	50.0	509	590 Brussels (No. 1)	15.0	
43.75	6,865 Vitus/Paris	0.5	304.9	984 Bordeaux (PTT)	13.0	518.8	578.9 Vienna	15.0	
50.0	6,000 Moscow	20.0	306.5	977 Radio Vitus	1.0	also testing on 1,254 m. from 7.0 p.m. (Mon., Wed., Sat.)			
58	5,172 Prague	0.5	307	977 Zagreb (Agrain)	0.75	525	572 Riga	15.0	
198.5	1,510 Riga (test).....	18.0	307.1	976 Falun	0.5	527	519.8 Palermo	3.0	
206	1,460 Antwerp	0.3	309.9	968 Cardiff	1.0	532.9	563 Munich	15.0	
207.3	1,447 Franchinont	0.2	312.8	959 Cracow	1.5	542	554 Sundsvall	10.0	
208.5	1,438.5 Budapest (2).....	3.0	312.8	959 Genoa (Genova)	10.0	550	545 Budapest (1)	18.5	
210	1,430 Magyarovar	1.5	315	950 Marseilles	1.6	559.7	536 Kaiserslautern	1.5	
211.3	1,420 Newcastle	1.0	318.8	941 Naples (Napoli)	1.5	559.7	536 Augsburg	0.3	
214.3	1,400 Aberdeen	1.0	(Rodno Radio)			1.0	503	531 Wilno	16.0
214.3	1,400 Warsaw (2).....	1.9	319.7	946 Dresden	0.25	506	530 Hanover	0.3	
215.4	1,392.5 Bruxelles Conference	0.2	321.9	932 Göteborg	10.0	509.1	527.1 Grenoble (PTT)	2.0	
217.1	1,382 Königsberg	0.9	325	923 Breslau	60.0	509.3	527 Freiburg	0.25	
218	1,373 Salzburg	0.5	328.2	914 Poste Parisien	60.0	574.7	522 Ljubljana	5.2	
220	1,363.2 Béziers	0.5	332.2	902.8 Milan	7.0	644	465.8 Kazan (RV17)	10.0	
222.0	1,344.6 Cork (6CK)	1.2	335	896 Poznan	1.9	720	416.6 Moscow (PTT)	20.0	
226.1	1,327.5 Fécamp	10.0	334.2	888 Brussels (No. 2)	15.0	740	401 Ostersund	0.6	
227.4	1,319 Flensburg	0.5	341.7	879 Brunn (Brno)	35.0	825	395 Geneva	1.25	
230.6	1,301 Malmö	1.2	345.2	868 Strasbourg (PTT)	11.5	848.7	373.5 Sverdlovsk (RV5)	50.0	
233.4	1,292 Kiel	0.25	348.8	860 Barcelona (EAJ1)	8.0	882	370 Saratov	20.0	
235	1,283 Lodz	2.2	351	855.5 Leningrad (RV70)	20.0	937.5	370 Khar'kov (RV4)	25.0	
235.5	1,274 Kristiansand	0.5	352.1	852 Graz	7.0	967.7	310 Alma Ata	10.0	
237.2	1,265 Bordeaux-Sud-Ouest	2.0	355.8	843 London Regional	50.0	1,000	300 Leningrad	100.0	
238	1,260 Nimes	0.5	358	838 Moscow (Exp.)	15.0	1,035	290 Kiev	100.0	
238.9	1,256 Nürnberg	2.0	360.5	832 Muhlacker	60.0	1,071.2	280 Tbilis (RV7)	100.0	
239.5	1,258 Binche	0.3	363.3	825.3 Algiers (PTT)	16.0	1,071.4	280 Scheveuingen	10.0	
240.0	1,247 Stavanger	0.5	364	824 Bergen	1.0	Haven			
242	1,238 Belfast	1.0	367.0	816 Fredriksstad	0.7	1,083	277 Oslo	60.0	
244.1	1,229 Basle	0.65	368.1	815 Bolzano	10.0	1,106	271.2 Minsk (RV10)	35.0	
245.9	1,220 Berne	0.5	368.1	815 Helsinki	13.2	1,116	268.5 Moscow Popoff	75.0	
245.9	1,220 Cassel	0.25	369.3	815 Seville (EAJ5)	1.5	1,153.8	260 Kalundborg	7.5	
245.9	1,220 Linz	0.5	also on 33 m. (900 Kcs.)			1,171.6	256 Tashkent	25.0	
247.7	1,211 Trieste	10.0	372.2	806 Hamburg	1.5	1,200	250 Istanbul	5.0	
249	1,205 Prague (Strasice)	5.0	376.4	797 Scottish Regional	50.0	1,200	250 Reykjavik	21.0	
250	1,200 Radio Schaerbeek	0.3	380.7	788 Lvov	16.0	1,229.5	244 Boden	0.6	
251.1	1,195 Juan-les-Pins	0.5	385	779 Radio Toulouse	60.0	1,280	237 Novosibirsk	4.0	
253.8	1,180 Barcelona (EAJ15)	3.0	385	779 Stalino (RV26)	15.0	1,275	235.3 Luxemburg	200.0	
253.4	1,183 Gleiwitz	5.0	389.6	770 Archangel	10.0	1,304	230 Moscow (Trades Unions)	165.0	
255	1,175 Toulouse (PTT)	1.0	389.6	770 Leipzig	120.0	1,348	222.5 Motala	30.0	
257	1,166 Hörby	10.0	394	761 Bucharest	12.0	1,380	217.4 Bakou	100.0	
259.3	1,157 Frankfurt-a-M	17.0	398.9	752 Midland Regional	25.0	1,411.8	212.5 Warsaw	120.0	
261.0	1,147 London National	50.0	403	743 Sottens	25.0	1,445.7	207.5 Eiffel Tower	13.5	
263.8	1,137 Moravska-Ostrava	11.0	408	734 Katowice	12.0	1,481.5	202.5 Moscow RV1	100.0	
265.4	1,130 Lille (PTT)	1.3	411.4	729.1 Madrid (EAJ7)	2.0	1,538	195 Ankara	7.0	
268.8	1,124.5 Valencia	6.0	413	725 Athlone (tests)	0.0	1,554.4	193 Daventry (Nat.)	30.0	
267.0	1,120.9 Breinen	0.2	416.4	725 Dublin	1.2	1,600	287.5 Irkutsk	10.0	
269.4	1,112 Bari	20.0	419	716 Radio Marce (Rabat)	6.0	1,620	185 Norddeich KVA	10.0	
271.4	1,105 Rennes	1.3	424.3	707 Berlin	1.5	1,634.9	183.5 Zeesen	60.0	
273.7	1,096 Turin (Torino)	7.0	430.4	697 Madrid (Espana)	2.0	1,725	174 Radio Paris	75.0	
276.5	1,085 Heilsberg	60.0	435.4	697 Stockholm	55.0	1,796	167 Lahti	54.0	
279.5	1,073.5 Bratislava	14.0	441	680 Rome (Roma)	60.0	1,875	160 Hiversum	8.5	
281	1,067 Copenhagen	0.75	447.1	671 Paris (PTT)	0.5	1,935	155 Kaunas	7.0	
282.2	1,063 Lisbon (CTIAA)	2.0	453.2	662 Danzig	0.5	2,525	119.3 Königs-wuster-Hausen (press)	15.0	
283	1,058 Innsbruck	0.5	453.2	662 Klagenfurt	0.5	2,900	103.5 Königs-wuster-Hausen (press)	15.0	
283.6	1,058 Berlin (E)	0.5	455	650 Radio Agen	0.5	4,000	75 Königs-wuster-Hausen (press)	15.0	
283.6	1,058 Magdeburg	0.5	456.0	557 San Sebastian	0.5				
288	1,049 Montpellier	0.8	450.4	653 Beromuenster	60.0				
287.1	1,045 Radio Lyons	10.0	405.8	644 Lyons (PTT)	1.5				
288.5	1,040 Bournemouth	1.0	405.8	644 Tartu	0.5				
288.5	1,040 Plymouth	0.12							

Get your Copy of the

WIRELESS MAGAZINE

Now on Sale Price - 1/-

The New "LANGMORE" No. GI

RADIO-GRAMOPHONE CABINETS IN FIGURED OAK Size overall, 3 ft. 6 in. high by 21 in. wide by 15 in. deep. THE TOP SECTION. Size, 4 1/2 in. high by 18 in. wide by 14 in. deep.

THE CENTRE SECTION. Size 10 in. high by 18 in. wide by 14 in. deep, to take a panel either 18 in. by 7 in. or 18 in. by 8 in.

THE BOTTOM SECTION. Size, 16 in. high by 18 in. wide by 13 1/2 in. deep. With "GALLEON," as illustrated, or "CATHEDRAL" Fret Fronts.

Wooden panels to fit, with oval aperture, 12 in. by 5 1/2 in., 2/- extra.

The whole of the back is enclosed by double doors, so that all parts are easily accessible. ALL are fitted with hinged top, heavy platform to take a 12-in. turntable for the Gramophone, and a substantial baseboard for the Wireless Set.

Beautifully Finished Jacobean Oak NEW ILLUSTRATED CATALOGUE FREE

THE MISCELLANEOUS TRADING CO. LTD. 13 & 17, NEW OXFORD ST., London, W.C.1. Phone: Holborn 4894. Trade Inquiries Invited



PRICE 49/6 each Packed FREE and sent Carriage Paid to any address in Great Britain.

The Ideal Set FOR BEGINNERS AND EXPERTS—THE "A.W." "WIZARD."

FREE!

CALCULATION RESISTANCE CHART!

This is without doubt one of the most valuable charts yet published, as it can quickly give you the four following factors: 1, Current; 2, Watts; 3, Volts; 4, Ohms. Drop us a line and we will send you a copy. If you are thinking of constructing a set at the present time, consider using WATMEL Components—"They get the best out of any set," and we have three specialties at the present moment—Potentiometers, Resistances and Coils.

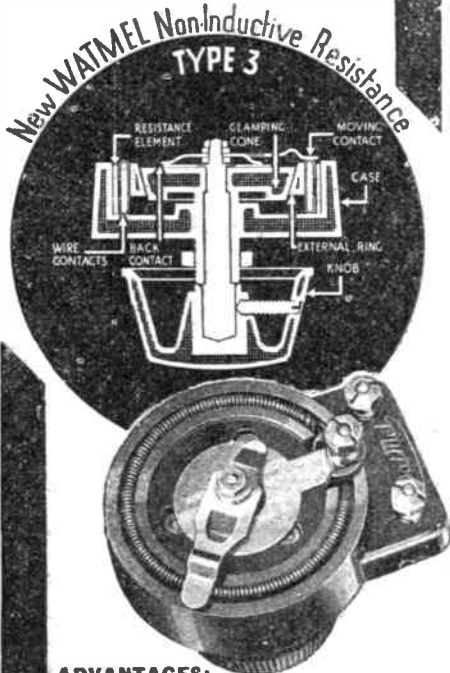

ADVANTAGES:

1. NON-INDUCTIVE. This is because the resistance element is not wire.
2. Furthermore, the wire contacts shown make contact with the resistance element so that the moving contact does not wear out the element. This guarantees true and true contact always.
3. The extremely firm and even contact with element. This is obtained by a new patented clamping cone which directly it is screwed down forces the sprung external ring against the wire band. The pressure is so great that perfect all-round contact is made with the element which will not vary under any circumstances.
4. Self-cleaning wiping contacts—this ensures perfectly clean contact always.
5. Silent in operation.
6. Price **4/6**

We recommend this resistance (Type 3) only for values above 50,000 ohms where wire-wound potentiometers are not required. Patents for this new resistance have been applied for.

If you have any difficulty in obtaining Watmel Components, WRITE DIRECT TO US.

TRADE ENQUIRIES INVITED



Watmel Wireless Co., Ltd., Imperial Works, High Street, Edgware.
Telephone: Edgware 0323. W.C.72

POSTCARD RADIO LITERATURE

GET THESE CATALOGUES FREE Here "Observer" reviews the latest booklets in folders issued by well-known manufacturers. If you want copies of any or all of them FREE OF CHARGE, just send a postcard giving the index numbers of the catalogues required (shown at the end of each paragraph) to "Postcard Radio Literature," "AMATEUR WIRELESS," 58/61, Fetter Lane, E.C.4. "Observer" will see that you get all the literature you desire. Please write your name and address in block letters.

K.B.'s Latest

TAKE my tip and get the new pocket folder of Kolster Brandes' sets and radio-grams. There are some "stars" such as a six-valve mains-driven super-het. and the new inexpensive Cobra three-valver. Copies of this pocket folder can be obtained free on request. **842**

Automatic Tuning

Automatic tuning has been introduced on the Zetavox eight-valve super-het. Automatic volume control in combination with automatic tuning means that once the control is set, any one of the stations on the automatic dial can be brought in at the same strength, and with practical elimination of fading. The Zetavox chassis is described in a new booklet, a copy of which I have just received. **843**

The Telnor

When building your new set, why not try the new Telsen Telnor, which will enable you to get a very neat panel layout with all the controls grouped together on one escutcheon plate? The Telnor is one of the new components described in the latest Telsen catalogue. **844**

Becker Switches

Some very well made moulded switches are in the new Becker range. These are suitable for mains switching and for many wireless jobs, such as radiogram change-over. Some of them are of the one-hole fixing type suitable for panel mounting. Get the new Becker folder and see the range for yourself. OBSERVER. **845**

ELECTRADIX BARGAINS

SEE
SEPT.-OCT.
SALE LIST

ELECTRADIX RADIOS,
218, Upper Thames St., E.C.4
Phone: City 0191.

QUICK EASY PAYMENT SERVICE

We supply all good quality Radio Receivers, and Accessories on deferred terms. Large stocks are carried and orders are executed promptly. Send list of requirements and a quotation will be sent by return of post. Price List free on request.

MANUFACTURERS' KITS

NEW COSSOR MELODY MAKER, Model 335 (just released). Complete Kit of Parts, Valves, and Loud-speaker and Cabinet. Cash Price, £7 17/6. And 11 monthly payments of 14 10. With order **10/-**

NEW TELSEN JUPITER S.G.3. KIT. Complete set of Components less Valves. Cash Price, £3 17/-. And 11 monthly payments of 7/-. With order **7/-**

NEW LISSEN "SKY SCRAPER" KIT, including Valves. Cash price £4/9/6. And 11 monthly payments of 8/3. With order **8/3**

NEW TELSEN AJAX 3. Complete Set of parts for Det.; 2 L.F. Receiver, less Valves. Cash Price, £3 1/6. And 11 monthly payments of 5/8. With order **5/8**

READY RADIO "METEOR" S.G.3 KIT, including cabinet, valves, and moving coil unit. Cash Price, £8/17/6. And 11 monthly payments of 16/8. This Receiver tunes to Ultra-short Waves. With order **11/-**

READY RADIO 303 KIT. Cabinet Model, including moving-coil unit and valves. Cash Price, £6/17/6. And 11 monthly payments of 12/9. With order **10/-**

ACCESSORIES

NEW ORMOND PERM. MAGNET MOVING-COIL L.S. UNIT. (just released) Cash Price £1 18/6. And 7 monthly payments of 5/4. With order **5/4**

ATLAS ELIMINATOR, A.C.244. 3 H.T. Tappings. 20 A. output. Cash Price, £2 19/6. And 11 monthly payments of 5/6. With order **5/-**

NEW R. & A. "CHALLENGER" PERM. MAGNET MOVING-COIL UNIT. Cash Price, £1 15/-. And 6 monthly payments of 5/8. With order **5/-**

NEW EPOCH 20c PERMANENT MAGNET MOVING-COIL UNIT. Cash Price, £1 15/-. And 6 monthly payments of 5/7. With order **5/7**

NEW BLUE SPOT 99 P.M. MOVING-COIL UNIT. The finest of the new Permanent Magnet Units. Cash Price, £2/19/6. And 11 monthly payments of 5/6. With order **5/-**

NEW R. & A. "VICTOR" PERM. MAG. MOVING-COIL REPRODUCER DE-LUXE. With 6 Ratio Transformer and Cadmium plated Grill. Cash Price, £3/10/-. And 11 monthly payments of 6/5. With order **6/5**

BLUE SPOT 100U. INDUCTOR UNIT. Cash Price, £1/12/6. And 6 monthly payments of 5/2. With order **5/-**

To avoid delay, will customers kindly send first payment with order. All above carriage paid.

The LONDON RADIO SUPPLY COMPANY ESTD 1925
11, Oat Lane, Noble St., LONDON, E.C.2
Phone NATIONAL 1977

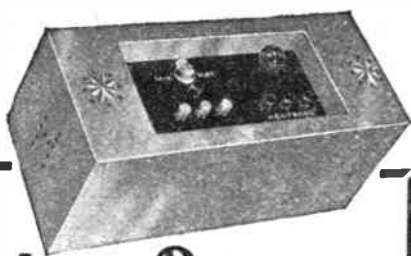

Mains Power for your Radio

Here is a Mains Unit that will run a 3- or 4-valve Receiver from A.C. Mains. High Tension and raw A.C. supply for A.C. Valves solves your H.T. and L.T. problems. Scrap your batteries and accumulators now and increase the range and selectivity of your Radio set.

HEYBERD MAINS UNIT, MODEL M.W.1.
Alternative Outputs: 50 m/A. at 200 volts, or 30 m/A. at 150 volts. L.T., 4 volts 5 amps for A.C. valves.

Tappings: 60/120 volts var. S.G., 180 volts and 200 volts fixed.

Incorporating Heayberd sterling components and Westinghouse Rectifier. Complete in neat metal case—ready to switch on. Fully Guaranteed. Price, £6 7s. 6d.

Models at all prices to suit all types of receivers, for A.C. or D.C., are dealt with fully in the New Handbook.



Post Coupon for Heayberd handbook on Mains Working

I enclose 3d stamps for New Handbook of Mains Equipment. Packed with Technical Tips, Service Hints and diagrams

Mr. _____
Address _____

F.C. HEYBERD & Co.,
10 FINSBURY STREET, LONDON, E.C.2
One minute from Moorgate Stn

The ACME of CRAFTSMANSHIP High Grade RADIO GRAMOPHONE CABINET

of exclusive modern design, with record wells, handmade and polished, on Queen Anne legs.
Figured Oak... 27 13 8
Figured Walnut or Mahogany... 29 9 0
(Carriage Paid.)
Illustrated Catalogue Free. Cabinets made to order a speciality.

GILBERT
Cabinet Maker, SWINDON
Estimates Free. Estd. 1866.



MATERIALS SUPPLIED FREE

in Profitable Spare Time Employment making Leather Matting at Home

Finished Work Bought at Fixed Rates.
Write for particulars, Dept. D420.

ARNOLDS (Wellingborough) Ltd., Wellingborough.

LET "A.W." SOLVE YOUR WIRELESS PROBLEMS

"TUNING A SHORT-WAVE RECEIVER"

(Continued from page 630)

reached with the carrier satisfactorily in tune.

If your short-wave receiver or adaptor is equipped with a variable aerial coupling device, make this coupling about 50 per cent. "in," whether it be by means of a variable condenser or a movable coil. Making the coupling too tight will, no doubt, increase signal strength to some extent, but it will also introduce many further troubles and the receiver will probably become "live"; that is to say, the tuning will alter when your hand comes near to any metal part of the set. If your receiver uses a high-frequency valve in front of the detector, however, this effect will probably not be noticed at all. The above remarks apply in general to all receivers or adaptors of the straight type which do not work on the super-heterodyne principle.

Therefore, we now step to the super-heterodyne type of outfit, which may, of course, consist of either a complete super-heterodyne receiver or an ordinary receiver used in conjunction with a convertor. This type of outfit is undoubtedly the easiest to tune, and this, perhaps, adds largely to its general effectiveness, as the results obtained do not rely to such a great extent on the skill of the operator.

Assume we are using a convertor in conjunction with an average type of screen-grid three-valve receiver. The most important thing to remember is that volume is not controlled by the reaction condenser on the convertor. Volume is,

instead, controlled entirely by the normal reaction condenser on the receiver itself and the convertor must be in a state of continuous oscillation all the time. Only when both the convertor and the receiver or second detector are oscillating will you be able to hear any carrier waves. Once a carrier wave is found, slacken off the receiver reaction control and generally, without further adjustment, you will now hear the required station.

Thus with an outfit of this type, it is possible to set the receiver just under the oscillation point and the whole outfit will now remain just under this point, while you can tune in all the stations on the adaptor itself without hearing a single whistle. So it is not necessary to be continually "following up" the short-wave dial every time the reaction condenser is adjusted—at least this might happen to some exceedingly slight degree, but the effect will be hardly noticeable.

The general procedure for tuning a complete super-heterodyne receiver is generally the same as that outlined above, but controls may vary slightly in type on individual receivers. Remember that you probably won't have absolute success the first time "out" with your short-wave receiver and a few nights' practice will certainly be well spent. You will probably gather the impression that the short-wave world is full of code and telegraph stations, but a few hours spent in careful searching will (provided atmospheric conditions are reasonably good) prove that this is not correct and that there are quite a number of really interesting stations to be tuned in below 100 metres.

FUSE HOLDERS AND FUSES

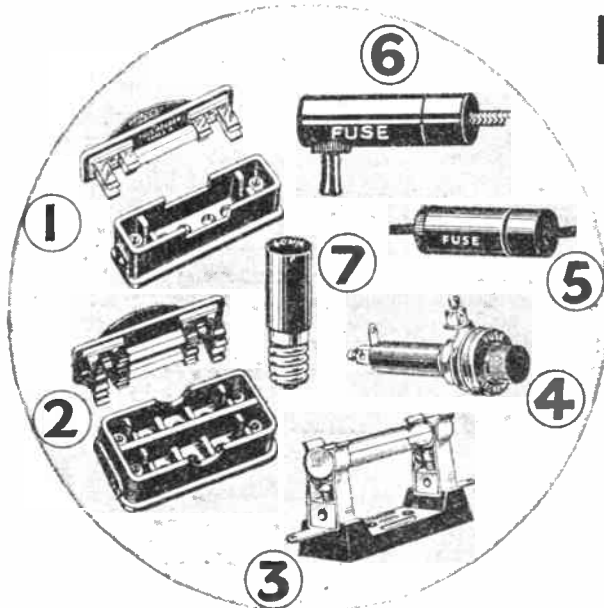

- 1 SINGLE SAFETY BASE BOARD FUSE-HOLDER. Fuse carried on lid, making shocks impossible. Complete with 1 amp. fuse 1/6
- 2 TWIN SAFETY BASE BOARD FUSE-HOLDER. Fuses carried on lid, rendering shocks impossible. Complete with two 1 amp. fuses. 2/6
- 3 SINGLE OPEN FUSE-HOLDER. With 1 amp. fuse 9d.
- 4 PANEL FUSE-HOLDER. For panel mounting. With 1 amp. fuse .. 1/6
- 5 FLEX FUSE-HOLDER. With 1 amp. fuse .. 1/-
- 6 WANDERFUSE. With 150 m.a. fuse 1/-
- 7 "SCRUFUSE," Not bulb, not cartridge, yet both! .. 6d.

SPARE FUSES, LONG FUSE. 60, 150, 250, 500, 750 m/a., 1, 2, or 3 amp. SHORT FUSE for wanderfuse only, 60 and 150 m.a.

Each rating a different colour, avoiding possibility of error.

5 different colour-coded ratings 60 to 750 m.a.

BELLING-LEE

Advert. of Belling & Lee, Ltd., Cambridge Arterial Road, Enfield, Middlesex

Dealers will fit other ratings in any of these holders at the time of purchase.

DARIO PRICE REDUCTIONS & NEW RANGE

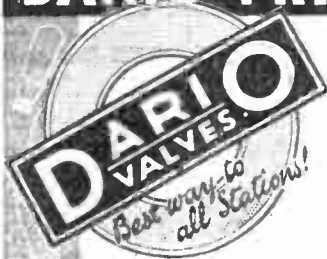

Fit Dario Valves in your receiver and its sensitivity, range, and volume will increase enormously. Do not tolerate valve deterioration. Why let those worn-out valves spoil your reception when, at such a little cost, you can restore the original sensitivity and purity of your set with Dario Valves. You will be amazed at the improvement.

FREE—Write to us now and we will send you free the Dario Booklet, which illustrates the full Dario range of valves, together with slopes and all technical information. If you are in doubt as to the valves you should be using in your receiver, write to us for a Free Valve Inquiry Coupon and we shall be pleased to tell you the correct valves for your set.

DARIO 2-VOLT VALVES	
DARIO Screenodion Bivolt	12/6
DARIO Screenodion Variable Mu	13/6
DARIO Universal Bivolt, reduced to ..	5/-
DARIO Super H/f Bivolt, reduced to ..	5/-
DARIO Detector Bivolt (non microphonic) to	5/-
DARIO Super Detector Bivolt reduced	
from 6/6 to ..	5/-
DARIO Super Power Bivolt reduced to ..	6/6
DARIO Hyper Power Bivolt reduced to ..	7/-
DARIO Polyodion (Multi-grid)	12/6

DARIO A.C. MAINS VALVES (I.H.)	
DARIO A.C. Screenodion	13/6
DARIO A.C. Super Screenodion (Steep slope)	13/6
DARIO A.C. Variable Mu Screenodion ..	13/6
DARIO A.C. Super Detector reduced to ..	9/6
DARIO A.C. Super H.F. reduced to ..	9/6
DARIO A.C. Super Power	10/-
DARIO A.C. Polyodion (Multi-grid) ..	13/6

DARIO D.C. MAINS VALVE 20-VOLT (I.H.)	
DARIO D.C. Screenodion	15/-
DARIO D.C. Super Detector	11/6
DARIO D.C. Super Power	12/6
DARIO D.C. Polyodion (Multi-grid) ..	15/6

FULL WAVE RECTIFYING TUBES (4 VOLT A.C.)	
DARIO F.W.1 (2x250 v-60 m.a.)	9/-
DARIO F.W.2 (2x350 v-120 m.a.)	11/-
DARIO F.W.3 (2v500 v-120 m.a.)	14/-

Also the usual 4-volt Battery range.

IMPEX ELECTRICAL LTD., 538 High Road, Leytonstone, London, E.11

DARIO VALVES FOR-PROGRESS, EFFICIENCY, ECONOMY

STENIBAC



RADIO CABINETS
 "First in Their Class"
 MODEL V26. Beautiful Radiogram Cabinet. 3 ft. 2 in. high, 1 ft. 10 in. wide, 1 ft. 4 in. deep. Accommodates any type of Gramophone Motor and set with Baseboard, 18 in. by 14 in. or smaller. Hand polished.

OAK	£3 15 0	(All Models)
MAROGANY ..	£4 0 0	Carriage
WALNUT	£4 5 0	Forward

Write for Free Catalogue of Latest Models Post Free.
STAND 80 (Gallery) Northern National Radio Exhibition City Hall, Manchester Sept. 28—Oct. 8

STENIBAC Ltd. DEPT. A.W. 303, ESSEX ROAD, ISLINGTON, LONDON, N.1.

PROTECT YOUR VALVES FROM ACCIDENTAL SHORT-CIRCUITING



BY FITTING THE "BUSCO" FUSE SWITCH

All "BUSCO" Switches have Self-cleaning Contacts and "Set Cracking" is safeguarded through the Vice-like Grip at Contact Points.

3/- EACH Post Free Complete with Fuse Bulb

BUSBY & Co. Ltd, Price St., BIRMINGHAM

Tunewell All-Purpose H.F. Choke.
 Wound on hollow-cored moulding. Capacity reduced to absolute minimum. Resistance unequalled by any other. Range 20/2,000 metres, 3/6.

Tunewell Volume Control.
 Increases power of reception. Expenses much less than with ordinary types. Logarithmically wound with double silk-covered wire. Paper-aid between windings. Type V. All sizes up to 50,000 ohms, 5/6. From 50,000 to 100,000 ohms, 7/6. Type F. Variable Resistance or Potentiometer. Equal resistance between studs. Max. Dissipation 3 watts, 5/6.



"Guide to SUPER RADIO" with 8 BLUE PRINTS FREE!

This interesting Guide has already shown many thousands the way to Super Radio—at lower cost. It incorporates 8 Blueprints (Bandpass All Mains 3, S.G.3, S.W.3, Kit Eliminator, etc.) and details of the New Tunewell

Super-Radio Components. Whatever the set, Tunewell Components will give you better results. Get this Guide now—FREE.

FILL IN AND POST THIS—NOW!

To Tunewell Radio Ltd., 54, Station Rd., London, N.11. Send me "Guide to Super-Radio" to:

Name

Address

My nearest dealer is

A.W.7

Post in unsealed envelope, half-penny stamped.
 to—TUNEWELL RADIO, LTD. 54 Station Road, London, N.11.

TUNEWELL

SET EXPERTS ARE SET ON IGRANIC

PREPAID ADVERTISEMENTS

Advertisements under this head are charged THREEPENCE PER WORD, minimum charge THREE SHILLINGS. DEPOSIT SYSTEM.

As the publishers cannot accept responsibility for the bona fides of advertisers in this publication, they have introduced a system of deposit which it is recommended should be adopted by readers when dealing with persons with whom they are unacquainted.

The amount of the Deposit and Fee must be remitted by Postal Order or Registered Letter (Cheques cannot be accepted), addressed to "AMATEUR WIRELESS", ADVERTISEMENT DEPARTMENT, 58/61 FETTER LANE, LONDON, E.C.4

ENGINEERS.—Sit down and think this over. We believe that our 200-page handbook, "ENGINEERING OPPORTUNITIES" will show you the way to well-paid, permanent, and progressive employment. In any case, the handbook costs nothing, and it will at least show you various surprising possibilities about which at present you know nothing.

RYALL'S RADIO, 83 Chancery Lane, London, W.C.2. New, surplus, and tested used radio components at very reasonable prices. Write for free list or inspect our display personally.

BRUCE PRODUCTS.—Grade "A" quality Mains Transformers and L.F. Constant Inductance Smoothing and Output Chokes. Recommended and tested by "Amateur Wireless".

MAINS TRANSFORMER REPAIRS.—If you have a faulty or burnt-out mains transformer, we can rewind to your requirements at very moderate charges.

REVELATION! By fitting a "Vita" Wizard Tuning Coil in any two- or three-valve (straight) receiver. Marvellous results. Fitted in ten minutes. Satisfaction guaranteed.

EXPERIMENTERS' SURPLUS. Transformers, Coils, Headphones, etc., 6/- parcels. Postage paid.—Hodgson Radio, Mareham-le-Fen, Boston, Lincs.

RADIO CABINET SPECIALISTS.—Redrup & Son (A.W. Dept.), 178 Albert Road, Southsea. Send 2d. stamp for Illustrated Catalogue.

VALVES.—PM1LF, Tungram LG210, 6d. each; PM2, PM6, 9d. each; PM2DX, Six Sixty 217D, 1/- each. Emission passable, filament continuity guaranteed.—Below.

LOUD-SPEAKERS.—Amplion Wall Cones, 10/-; Senior Horn type, 4/-; Junior ditto, 3/6.—Below.

L.F. TRANSFORMERS.—5-1 ratio, shrouded, 1/9. Four-pin Anti-micro. Valve Holders, 3d. each. Above subject unsold, per C.O.D.—Tonge, 10 West Crescent, St. Annes.

POUNDS SAVED on kits, components, batteries. Quotations given. Write Childs, 29 Moray Road, London, N.4.

MODERN RADIO GRAMOPHONE CABINETS.—The most wonderful bargains ever offered. Made by skilled craftsmen and hand polished. Finished figured walnut, mahogany, and oak, 70/-. Satisfaction guaranteed.

OAK CABINETS.—Beautifully finished, hinged lid. 14 in. by 7 in. by 10 in., 7/6; 16 in. by 7 in. or 8 in., and 18 in. by 7 in. by 10 in., 8/-; 21 in. by 7 in. by 10 in., 9/6; Baseboards, 6d. Refused unsatisfied. 18 in. by 7 in. by 10 in. cabinet, Permeol panel and baseboard, 14/6 C.F. Other sizes stocked. Quick dispatch. Fret fronts. Baffles. Speaker cabinets from 8/6. Trade supplied. All kinds of Radio apparatus. Send for "Guide to Wireless," 1/-.—F. S. Gibson, 99 Burnley Road, Ainsdale, Lincs.

BANKRUPT BARGAINS.—List free with 3-valve diagram. Three-valve Kit, 22/6; S.T. 300, 42/-; Century Super Kit, 75/-. Meter 3, 40/-. Any kit supplied. Part exchange. Let me know what you have for disposal and what you require. Transformers from 2/9. Dual Coils, 3/6. Panels, polished, 2/3. Fixed Condensers, 5d. Valve Holders and Switches, 4d. Telsen Ace, 4/9; Radiogram, 6/-; Speaker Units from 2/6. D.C. M.C., 18/6. P.M. M.C., 22/6. Eliminators, D.C. and A.C., cheap. S.M. type air-spaced, 0005, with dials, 3/6. Mica, 0005, 10d. Differentials, good quality, 1/9. H.F. Chokes from 1/-. Tungrams from 4/6. Polar 3-gang, 7/-. Complete Speakers from 7/6. Accumulators from 2/9. Headphones, 3/9. Cabinets, oak, from 6/-. All goods of decent quality. Advice free.—Dutlin, 143b Preston Road, Brighton.

RADIO AT LESS THAN COST! Kits and Components. Send list of requirements. Twenty to 80 per cent. saving on any circuit guaranteed now. "This week's special," comprising limited stock, quality components below cost (Dubilier, Burndett, etc.): L.F. Transformers, 1/3; Binocular H.F. Chokes, 8d.; Speaker Units, 1/11; v-condensers (0005, 0003), 11d.; f-condensers, v-holders, 3d.; g-leaks, 4d.; Valves, guaranteed, 2/11. Kits (with diagrams), 3-v. S.G., 18/6; 3-v., 10/6; 2-v., 8/6. Over 10,000 sent C.O.D.—(City Radio Surplus Suppl. s, 14 Currier Street, E.C.4.

"Amateur Wireless and Radiovision." Price Threepence. Published on Thursdays and bearing the date of Saturday immediately following. Post free to any part of the world; 3 months, 4s. 6d.; 6 months, 8s. 9d.; 12 months, 17s. 6d. Postal Orders, Post Office Orders, or Cheques should be made payable to "Bernard Jones Publications, Ltd."

General Correspondence is to be brief and written on one side of the paper only. All sketches and drawings to be on separate sheets. Contributions are always welcome, will be promptly considered, and if used will be paid for. Communications should be addressed, according to their nature, to The Editor, The Advertisement Manager, or The Publisher, "Amateur Wireless," 58-61 Fetter Lane, London, E.C.4.

THE MOST POPULAR RADIO-GRAM CABINET ON THE MARKET

Reduced 39/6 Carriage to Paid!!! Quality Guaranteed Improved Soundly constructed in select oak etc., and hand polished. SPECIFICATION.—3' 3" high, 1'10" wide, 1'6" deep. To take panels up to 18" x 7". Panel opening to suit set. These cabinets allow ample room for the following:—Pick-up, Motor, Speaker, Batteries, etc., all for the reduced price of 39/6.



Catalogue Post Free. From one of the Largest Mail Order Works in England: W. S. WILKIN, Cabinet Manufacturer, 12-26 Nelson Mews, Southend-on-Sea, Essex. Guaranty Depot: Messrs. Leale Ltd., 7, Bondage, Guernsey.

SHORT-WAVE BARGAIN!

SHORT-WAVE PLUG-IN COILS, Nos. 2-3 TURNS

8D EACH Usual Price 1/6 AIR DIELECTRIC STANDARD SIZE 4 for 2/4, 8 for 4/6, all Post Paid. The set of eight covers whole S.W. range. Base-board Coil Holders 4d.



SCIENTIFIC SUPPLY STORES, DEPT. A.W., 126, NEWINGTON CAUSEWAY, SOUTHWARK, LONDON, S.E. Phone: Hop 4177.

DESIGNS FOR APPARATUS FOR ANY RADIO PURPOSE, INCLUDING TRANSMISSION. OVERSEAS ENQUIRIES INVITED: ANY APPARATUS SUPPLIED. CONSTRUCTIONAL WORK UNDERTAKEN.

We undertake to solve your problems, including obtaining Amateur Transmitting Licence. Whatever your difficulty, write us. Charge: 3/- per query, four or more, 2/6 each, with diagrams. Radio Technical Agency, (Dept. A.W.), 2, Westgate Chambers, Newport, Mon.

10,000 Gramo-motors from Stock. Big Cash Discount Allowed! Make a Gramophone or Radiogram. Order loose kits and assemble them at home. Get for 3d. our new 64-page catalogue with scale drawings and instructions how to make cabinets, gramophones or radiograms, and what parts to choose. We sell motors from 7/8, tone-arms, soundboxes, 1/6, pick-ups, big volume horns, loud-speakers, radi kits, complete receiving sets, gramophones, radiograms and parts. Established 1903.—The Regent Fittings Co., A.W., 120 Old Street, London E.C.

REPAIRS to Loudspeakers 4/-. Blue Spots 5/-. Transformers 4/-. Moving Coils, etc. quoted for. Prompt service. 12 months guarantee. Trade Invited. Stratham 6618. Loud-speaker Repair Co., 2 SHIPKAY ROAD, Balham, London

TAYLEX WET H.T. BATTERIES Give long service, improved volume and tone. Very economical. Replacements for Taylex or Standard batteries at low prices details post free. Also Bargain List; Radio Kits and parts at lowest prices. A. TAYLOR, 57 STUDLEY ROAD, STOCKWELL, LONDON

FULL-SIZE BLUEPRINTS

When ordering, please send Postal Order, NOT STAMPS.

CRYSTAL SET (6d.)

- 1931 Crystal Set AW308
ONE-VALVE SETS (1s. each)
Easy to Build One AW304
Short-wave One valver AW327
B.B.C. One valver AW344
Portable Short-wave One AW354

TWO-VALVE SETS (1s. each)

- Two Star 2 (D, Pen) AW315
The 25/- Two (D, Trans) AW330
Ten-Station Two (D, Trans) AW336
Inexpensive A.C.2 (D, Trans) AW346
Midget Two (D, RC.) AW348
Mascot Two (D, Trans) AW353
Ideal Regional 2 (D, Trans) AW357
Music Lover's Two (D, Trans) WM260
New Economy Two (D, Trans) WM265
Family Two (D, Trans) WM278
Screen-grid Two (SG, Trans) WM289
Economy A.C. Two (D, Trans) WM286
A Two for 7 Metres (D, Trans) WM295

THREE-VALVE SETS (1s. each)

- 1932 Ether Searcher (SG, D, Pen) AW325
Wide World Short-wave Three (D, RC, Trans) AW332
New Favourite Three (D, RC, Trans) AW334
Home-Lover's All-electric 3 (SG, D, Trans) AW335
The P.W.H. ("Mascot" D, RC, Trans) AW337
Home-Lover's Battery 3 (SG, D, Trans) AW341
8 Radiogram (SG, D, Trans) AW343
New Regional Three (D, RC, Trans) AW349
World-Ranger Short-wave Three (D, RC, Trans) AW355
The Wizard (SG, D, Trans) AW360
Ether Marshal (SG, D, Trans) WM247
Five-advantage Three (D, RC, Trans) WM257
Everybody's A.C. Radiogram (SG, D, Trans) WM258
Double Band-pass Three (SG, D, Trans) WM259
Everybody's A.C. Radiogram (with automatic G.B.) WM262
New Economy Three (SG, D, Trans) WM263
New Plug-in Coil Three (D, 2 Trans) WM270
Transportable Three (SG, D, Trans) WM271
Multi-Mag Three (D, 2 Trans) WM288
Percy Harris A.C. Radiogram (D, RC, Trans) WM294
The Prosperity Three for Batteries (SG, D, Trans) WM296
The Prosperity Three for A.C. Mains WM297
The Prosperity Three for D.C. Mains WM298

FOUR-VALVE SETS (1s. 6d. each)

- Four Star 4 (SG, D, RC, Trans) AW318
50/- Four (SG, D, RC, Trans) AW331
Advance Four (2 SG, Trans) AW356
Your Home Radiogram (SG, D, RC, Trans) AW358
Brookman's Three-plus-one (SG, D, RC, Trans) WM233
Ether Rover (SG, D, RC, Trans) WM266
Quadryne (2 SG, D, Pen) WM273
Double Band-pass Four (SG, D, RC, Trans) WM274
Everybody's Radiogram (SG, D, RC, Trans) WM276
A.C. Quadryne (2 SG, D, Pen) WM279
Ideal A.C. Home Super (Super-het) WM290
Gold Coaster (A.C. Short-waver) WM292
Triple-tune Four (2 SG, D, Trans) WM293

FIVE-VALVE SETS (1s. 6d. each)

- James Short-wave Super (Super-het) AW328
Simple Super (Super-het) AW340
Ideal Home Super (Super-het) WM280
Easytune 60 (Super-het) WM284

SIX-VALVE SETS (1s. 6d. each)

- Century Super (Super-het) AW287
A.C. "Century Super" (Super-het) AW295
Mains Unit (1/-) AW295A
Super 60 (Super-het) WM229
Super 60 (with Wearite base) WM249
Super 60 (with Lewcos base) WM251
1932 Super 60 (Super-het) WM269
1932 A.C. Super 60 (A.C. Super-het) WM272

SEVEN-VALVE SETS (1s. 6d. each)

- Super Senior (Super-het) WM256
Super Senior (Wearite base and Lewcos coils) WM261

PORTABLES (1s. 6d. each)

- Hiker's Two (D, Trans) (1/-) AW345
General-purpose Portable (SG, D, RC, Trans) AW351
Town and Country Four (SG, D, RC, Trans) WM283
Everybody's Portable (5-valve super-het) WM291

AMPLIFIERS (1s. each)

- Universal Push-pull Amplifier AW300
"A.W." Record Player (L.F. Push-pull) AW319
Quality Amplifier (D.C.), 1/6 WM264
A-P-A (Power, Amplifier for A.C. Mains) WM275
A-P-A Radio Unit (SG, D.) WM281
Economy Gramophone Amplifier WM277

MISCELLANEOUS (1s. each)

- Short-wave Plug-in Adaptor (6d.) AW326
Short-wave Super-het Adaptor (6d.) AW329
Ether Searcher Radio-gramophone Motor Board AW333
"A.W." Short-wave Adaptor AW339
"Mascot" Mains Unit AW350
"A.W." Trickle Charger AW352
An Add-on Band-pass Unit AW359
"W.M." Linen Diaphragm Loud-speaker WM235
Super 60 A.C. Unit WM248
A Simple Mains Unit WM283
Short-wave Director (6d.) (wavemeter) WM285
Voltage Regulator WM287

Copies of the "Wireless Magazine" and of "Amateur Wireless" containing descriptions of most of these sets can be obtained at 1s. 3d. and 4d. respectively, post free Index letters "A.W." refer to "Amateur Wireless" sets and "W.M." to "Wireless Magazine." Address letters:

Amateur Wireless Blueprints Dept., 58-61 Fetter Lane London, E.C.4

Amateur Wireless INFORMATION BUREAU COUPON Available until Saturday OCTOBER 1, 1932 FEE 1/-

What a difference!



100D NOW **52/6**

All Blue Spot Products may be purchased by instalments.
Send for Catalogue A.W. 52.S.

EVERYBODY who hears Blue Spot 100D makes this remark. Old speakers, other speakers, seem muffled and indistinct. You wonder how you could possibly have enjoyed, yes actually enjoyed, listening to their wheezy mumbling or raucous roaring.

Afterwards, when you've got over your first surprise, you can appreciate the quality of the reproduction 100D gives you. You can sit and listen for those half-hidden notes (those that were really hidden on other speakers), and you will actually hear them, just as they should be. You will listen to lecturers and find them friends. Singers become human beings instead of disembodied voices. Dance bands seem to regain the "pep" you thought they'd lost.

100D has, of course, 100U unit inside its handsome oak cabinet, and 100U gives as good a performance as a really good moving-coil speaker. It is sensitive

to very small inputs and needs no matching transformer for Pentode valves. You will find it hard indeed to discover a better speaker, especially for the smaller sets—whether mains or battery driven.

Make your Gramophone into a Radio-Gram

Fit a Blue Spot Pick-Up on your gramophone and link it up with your set. You will hear your records in a new way, with all the hidden beauty of the original developed and reproduced to perfection. Price with self-contained volume control, 63/-



SEE ALSO
ADVERTISEMENT
ON PAGE 644

THE BRITISH BLUE SPOT COMPANY LTD.
BLUE SPOT HOUSE · 94, 96 ROSOMAN STREET · ROSEBERY AVENUE · LONDON · EC1

Telephone: Clerkenwell 3570. Telegrams: "Bluspot, Isling, London."
Distributors for Northern England, Scotland and Wales: H. C. RAWSON (Sheffield and London), Ltd., 100, London Road, Sheffield; 22, St. Mary's Parsonage, Manchester; 44-46, High Bridge, Newcastle; 37, 38, 39, Clyde Place, Glasgow.

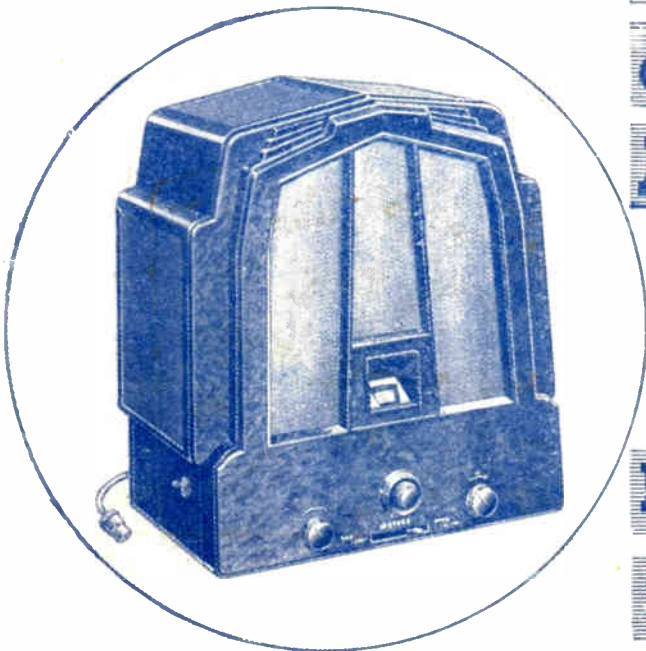

**The GREATEST
of all 1933 3-valve
All-Electric Sets**

**FLAWLESS Quality
Selectivity Sensitivity**

PRICE **17** GUINEAS
or 12 monthly payments of
32/9

THE NUMBER OF VALVES stated in descriptions of EKCO receivers signifies the actual number of RADIO RECEIVING STAGES. Rectifying stages in A.C. models are not included. With one exception, all EKCO receivers, etc., employ the Westinghouse patent Metal Rectifier, which is of a definitely permanent character.

**10 DOMINATING FEATURES OF
THE EKCO CONSOLETTA M.23**

1. Very latest type of three-valve circuit (Screen Grid, Detector and Pentode).
2. Wide choice of stations from home and abroad at full loud-speaker strength.
3. Can be used without an aerial or earth if desired.
4. Simplicity itself—single knob tuning with illuminated dial calibrated in wavelengths.
5. Latest type of moving-coil speaker.
6. Selectivity and volume control.
7. Connections for gramophone pick-up and additional speaker.
8. Figured walnut bakelite cabinet.
9. Westinghouse Metal Rectifier in A.C. Model.
10. All-electric—just plug in to your electric supply and switch on—that's all.

Consult your dealer or post coupon now

To : E. K. Cole, Ltd., Dept. K.20,
EKCO Works, Southend-on-Sea.
Please send me full details of EKCO Consolettes, Radiograms,
Consoles and Power Units.

Name

Address



ALL - ELECTRIC RADIO



Wireless MADE EASY



THE WAVE-CHANGE SWITCH

ON practically every set there is a little knob called the wave-change switch. Do you know why this is needed? Because in Europe broadcasting is done on two distinct wavelength bands, known as the medium waveband and the long waveband. The medium waveband extends from about 200 metres to 550 metres. The long waveband from 1,000 to 2,000 metres.

It is impossible, with one coil and one tuning condenser to vary the wavelength continuously from 200 to 2,000 metres. What we do is to provide two distinct rotations of the condenser.

At one setting of the wave-change switch the variation of the tuning condenser takes us from 200 to 550 metres, and at the other setting of the switch this same condenser takes us from 1,000 to 2,000 metres.

Between the two rotations, though, we have to move the wave-change switch. This switch brings the tuning condenser into contact with either the medium-wave coil windings or the long-wave coil windings.

WHAT'S INSIDE THE VALVE?

ASK a friend for one of his old valves and take it to bits—you will be amazed at the construction. Wrap the bulb inside a handkerchief and gently tap with a hammer. The glass will break away.

Hold the bakelite base of the valve. What is that little circle of metal tacked on to the main structure? It was only used when the valve was being made. On it was placed a small piece of magnesium. After the bulb had been sealed as much air as possible was pumped out. The magnesium was "fired."

CONTENTS FOR THIS SUPPLEMENT

PERCY HARRIS'S "BUILD AS YOU LEARN."

A unique constructional feature that will appeal alike to the seasoned amateur and the newcomer to wireless. Simple practical experiments that will teach you theory without tears.

Pages 2, 3 and 6

ELEMENTARY WIRELESS COURSE FOR BEGINNERS.

Prepared by J. H. Reyner and the staff of "Amateur Wireless," this brilliant series of articles explains the theory of wireless in a vivid and interesting way.

Pages 4, 5 and 7

AND NINE OTHER SIMPLE ARTICLES

The magnesium, in burning, used up all the remaining gases and air in the bulb, thus making the vacuum almost perfect. The silver coating you noted on the inside of the bulb was magnesium oxide.

Now look at the metal structure. It is supported in a glass "pinch" by several stout wires. These supports, or some of

the filament, and a grid formation coming between the shell and the filament, which is called the grid.

Note that the grid is nearer to the filament than to the plate or anode. There is a very good reason for this.

The filament, when heated by a current sent through its two ends, shoots off tiny particles

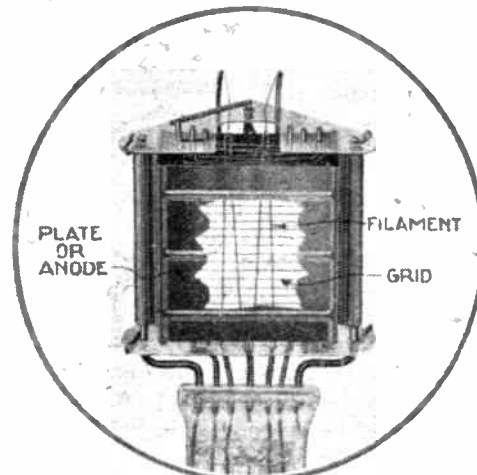

This valve has been taken to bits in a way that shows you the main construction. There is a central filament, surrounded by a wire grid that comes between the filament and the outer metal shell or anode

them, are joined to the pins of the valve base by wires embedded in the pinch.

In a battery valve there are four such wires. One is for the metal shell of the valve structure. Another is for the grid wire. The two other wires are both for the thin thread of wire at the centre.

Continue your destruction of the valve and you will find that inside the metal shell, which we call the anode or plate, is a very thin wire, which we call

of electricity, called electrons. These pass right through the meshes of the surrounding grid wire on their way to the anode.

Why should they go to the anode? Because we apply a very powerful inducement. The anode or plate is charged up with a high voltage, and this is the attraction for the electrons.

Why the grid in between? Well, to this grid we apply the wireless signal, and it interrupts the flow of the electrons going from the filament to the anode.

DO YOU SPEAK OF WAVELENGTHS OR FREQUENCIES?

IN most of the published lists of stations the wavelength is given beside a somewhat mysterious figure called the frequency.

Note that there is a simple connection between the wavelength of a station and its frequency. The connecting link is the velocity or speed with which the waves travel through space.

All wireless waves, no matter what their wavelength may be, travel through the ether of space with a speed of 186,000 miles per second, or roughly 300,000,000 metres per second.

If the wavelength of the signal were 300,000,000 metres the frequency with which it would pass a given point in a second would obviously be one. If the wavelength were 300 metres the frequency would be 1,000,000.

How did you arrive at these figures? Simply by dividing the velocity or speed of the waves per second by the wavelength, which gave the frequency or number of waves per second.

That is all there is in frequency—the number of waves passing a given point in a second. With the speed constant for all waves you can find the frequency by dividing the speed by the wavelength.

On looking up any list you will always find that the long-wave stations have much lower frequency figures than the short-wave stations. The wavelength of 300 metres corresponds to a frequency of 1,000,000 cycles per second, whereas a wavelength of 3,000 metres corresponds to a frequency of only 100,000 cycles.

You can easily find the wavelength if you know the frequency of the waves, since you also know the speed of the waves. Simply divide the speed by the frequency and the answer will be the wavelength.



PERCY W. HARRIS'S BUILD AS YOU LEARN

IN last week's lesson we assembled our complete, although simple, two-valve receiver, and I hope that by this time it will be working satisfactorily. Before we go any further I want you to ask yourself the following questions which doubtless by now you will be able to answer.

1. What is the effect on (a) selectivity, (b) strength, of varying the clip position on the tapings?
2. What is the effect of varying the compression condenser with the clip connected to the top of the coil?
3. Does the position of a station on the tuning dial vary with (a) different positions of the clip on the coil, (b) different positions of the compression condenser knob?
4. Which clip position on the coil gives you the best results on your local station when the compression condenser is out of circuit—that is to say, when the lead from the aerial terminal goes straight to the clip?
5. With the clip on the top of the coil (the lead which goes to the fixed plates on the variable condenser) what kind of setting on the compression condenser gives you best results (screwed right down, screwed right up, or an intermediate position)?

Do as much experimenting as you can in this direction until you "get the hang" of the set. I do not want to give you the answers to these questions in the present issue, as we can discuss the results later.

When you have tried these various experiments and have become clear in your mind as to what happens with the different settings, I want to take you one step further and teach you the

fundamental points regarding reaction circuits. For this and the next lesson we want one or two more parts. We want, for example, a piece of cardboard, another bracket, and a small condenser known as a .0003 microfarad differential reaction condenser. We do not need any more wire as we have plenty over on our 1/4-pound reel.

This week Mr. Harris adds a reaction coil and condenser to the simple two-valver he introduced to beginners in last week's supplement. For the benefit of those who built the original version we give the wiring alterations needed to bring the set up to the present stage:—

Remove wire No. 11 from terminal "P" of low-frequency transformer and connect to one end of the reaction coil.

Remove wire No. 12 from the set entirely.

Connect a new wire, marked No. 27 in this week's layout, between terminal "P" on low-frequency transformer and right-hand terminal of .0003-microfarad differential reaction condenser (looking from the back).

Connect remaining wire from reaction coil to the same terminal of the above reaction condenser—wire No. 26.

Connect a new wire (No. 12) between the centre terminal of the reaction condenser and the terminal of the .0003-microfarad condenser to which wires No. 5 and No. 6 are already connected.

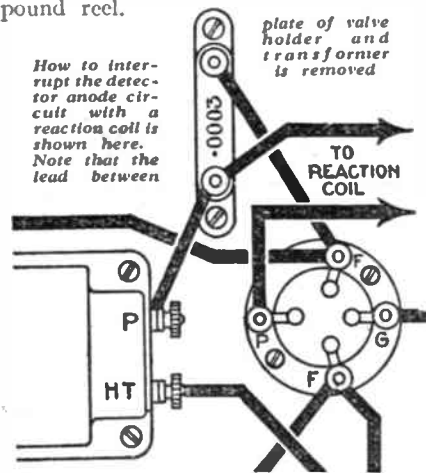

The first thing to do is to take the piece of cardboard and draw on it a circle of the same diameter as the coil

former, leaving a piece of projecting cardboard to act as a handle, so that it looks like a frying pan or a ping-pong bat. Now cut out seven slots about a quarter of an inch wide as shown in the drawing and pierce two holes near the handle.

Leaving about a foot of wire to start, wind a coil of wire in and out as indicated by the diagram, the wire going down through the first slot, up through the next, down through the next and so on till we have made a complete circle. Owing to the odd number of slots the coil will appear wound in basket fashion, and I want you to wind on twenty-five turns until you come to

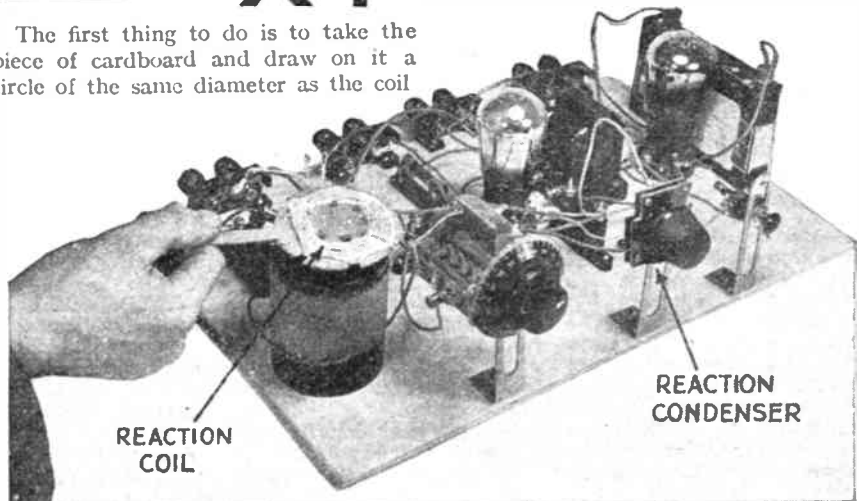

Applying reaction to the set by bringing the reaction coil close to the tuning coil, as shown by this picture and explained in the text

SIMPLE REACTION EXPERIMENTS

the end, when, leaving another foot of wire for connection, you thread it through the second hole.

As the set stood last week the signal currents set up in the coil are applied directly to the valve through the detector condenser and on being rectified are magnified in the low-frequency end. I want to show you how we can bring back some of the signal current from the plate side of the valve and re-magnify it, thus adding considerably to our signal strength.

Altering the Leads

All we have to do to make the change is to disconnect the lead which goes from the plate terminal of the valve to the plate terminal of the low-frequency transformer and that which goes from the plate of the valve to the .0003 by-pass condenser.

Before you make these changes pull out the positive plug from the high-tension battery in case you have an accident, and do not replace it until the new leads are made. Now connect one of the free wires from your new reaction coil to the plate terminal of the valve and the other to the plate terminal of the low frequency transformer, taking a further lead from this last terminal to the .0003 fixed condenser. (See small sketch).

You will see now that the currents from the valve, instead of going straight to the low-frequency transformer have to come through the reaction coil, and if you take this coil in your hand and gradually bring it down on top of the tuning coil, one of two things will happen—either when you get near the coil you will suddenly hear a rushing sound, indicating the set has gone into oscillation or else nothing whatever will happen! If

the latter is the case, turn the coil over and repeat the experiment, when you will get the rushing noise.

As the set is oscillating when the rushing sound occurs, and is liable to cause interference with your neighbours, try this part of the experiment some time out of broadcasting hours, such as on a Sunday morning. You will find after a little practice that as the reaction coil approaches the tuning coil so will the set oscillate. You can stop it oscillating either by holding it a little distance away from the coil or else by laying it on top of the coil and sliding it sideways so that, so to speak, it overhangs.

Practise a good deal and find a position where the set will just not oscillate at any position of the tuning condenser when the reaction coil is laid on top of the coil. This will probably be when it is about half overhanging the side.

When, out of broadcasting hours, you have found this position, switch on the

set during broadcasting hours and (Cont. n.d. on pag. six)

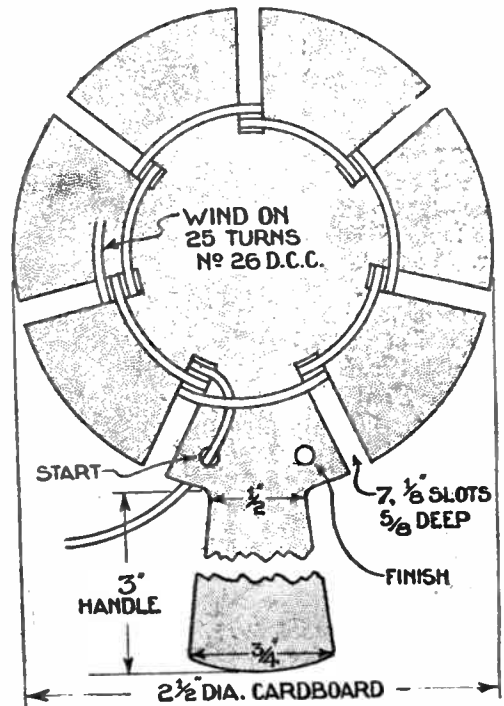

This is a sketch of the cardboard former on which you must wind the reaction coil. Trace this sketch—it can be used as a template for marking out the former

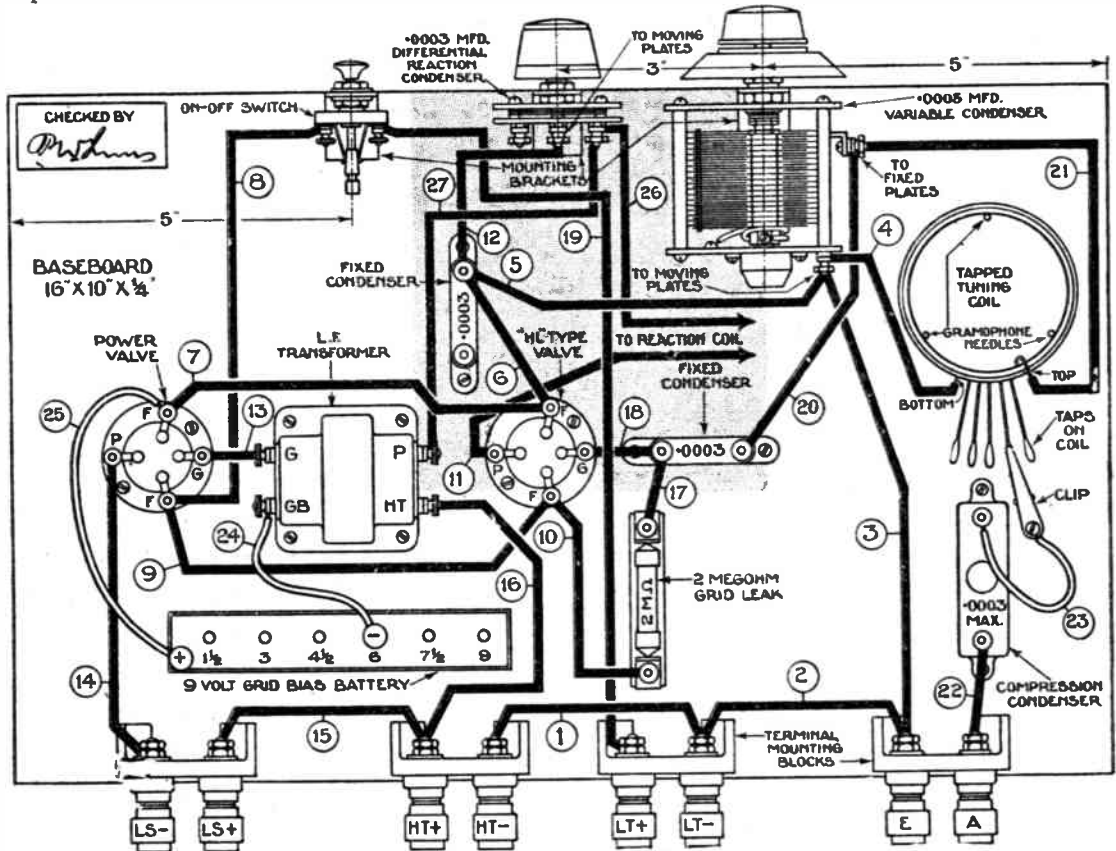

From this layout you can see how the components are wired together. The shaded portion indicates the area in which alterations have been made on the original layout given in last week's supplement. Compare this with the list of alterations on the preceding page. Note that the home-made reaction coil has to be connected to the two leads marked "to reaction coil." Note also the fixing of the reaction condenser on a bracket, and that one terminal of this component is not used this week—it will be next week!

STEP 2. THE CONDENSER: WHAT IT IS AND WHAT IT DOES

JUST consider this component here—it is called the tuning condenser. You will see there is one for each coil. There are two sets of plates, assembled parallel to one another. One set is fixed and the other set can be rotated with this knob so as to interleave with the fixed plates. (See Fig. 1.)

What are they used for?

To adjust the currents in the coils. Each coil has to be connected to a condenser.

One end of the coil goes to the fixed plates and the other to the moving plates (see Fig. 2). Let us assume for simplicity that there is only one pair of plates, one being fixed and the other moving.

We can do this because the action is exactly the same for two plates as for two sets of plates. Now assume that there is an electro-motive force in the coil. As we saw last week, this will try to produce a stream of electrons which will flow through the wire. I also pointed out that the electrons must have somewhere to go. In other words, there must be a *circuit*.

With a condenser by itself, as at Fig. 1, we have no complete circuit. In between the two plates connected to the ends of the coil is a layer of insulating material—in this condenser it is the air. Therefore, no direct current can flow but there can be a momentary current.

As I said last week, the electrons in the insulating material—the *dielectric*—between the plates will “side-slip,” and there will be a corresponding motion of electrons through the whole circuit. This will result in a piling up of spare electrons on one plate. (See Fig. 3.)

What is more important, this general shifting of the electrons through the wire will leave the other plate with less electricity than it should have.

Do you mean that electricity has been transferred from one plate to another?



ELEMENTARY WIRELESS COURSE FOR BEGINNERS

Precisely! We say that the condenser is charged, and it will remain like this as long as the electro-motive force continues to be applied.

You will now want to know how much electricity there is in this charge on the condenser. That depends. The movement of electrons from one plate to another corresponds exactly to the displacement in the dielectric. This in turn depends on the dielectric itself.

If we can produce a greater side-slip of the electrons in the dielectric, we obtain a larger current. This effect can be obtained with a stronger electro-motive force. In fact, the charge on the condenser is directly proportional to the electro-motive force, but it is also dependent upon the amount of dielectric between the plates.

If the plates are large and close together, the e.m.f. can produce a large movement of electrons in the dielectric between them, but if we reduce the area or move the plates farther apart, the capacity is reduced.

What do you mean by capacity?

Exactly what I say!—the capacity the condenser has for storing electrons under good conditions. With a tuning condenser the capacity is variable, because the overlap of the fixed and moving plates can be altered. (See Fig. 4)

If the plates do not overlap, the condenser has very little capacity for storing electrons, because there is practically no dielectric between the plates. With one set of plates completely overlapping the other we have the maximum capacity and we can get any intermediate capacity by rotating the moving plates.

The idea of having a number of plates is to increase the capacity. If we connect another fixed plate on the other side of the moving plate, we are able to produce displacement currents on both sides of the moving plate and thus obtain twice the capacity.

For wireless purpose we cannot obtain enough capacity with one pair of plates

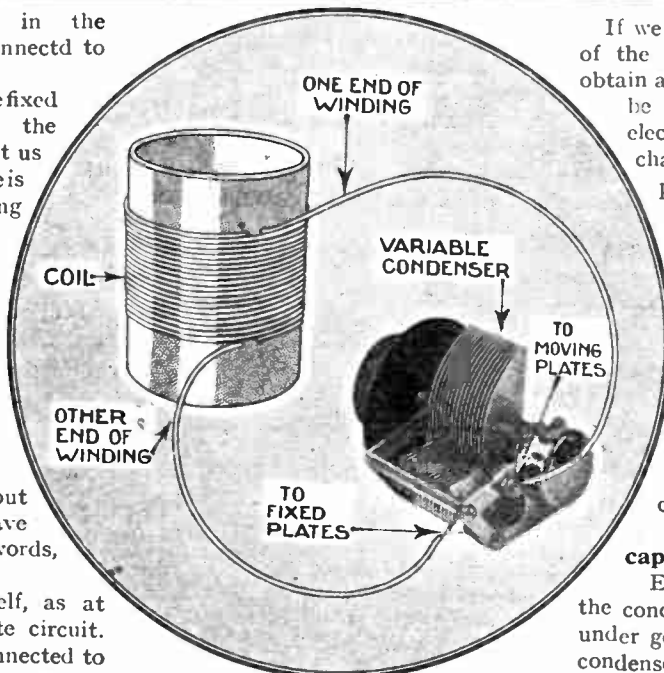

Fig. 2. How the ends of the tuning condenser are connected to the ends of the tuning coil to complete the electrical circuit. In every tuning circuit there is a coil and a condenser

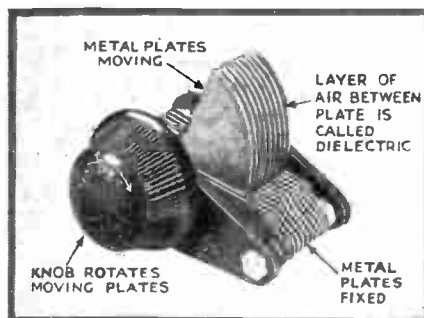

Fig. 1. The essential construction of a variable condenser. The plates connected to the control knob are the moving and the other plates are the fixed. The dielectric in this condenser is the layer of air between each plate and its neighbours

By J. H. REYNER

AND STAFF OF "AMATEUR WIRELESS"

alone, and we have to use something like ten or a dozen plates, as you can see.

Then is the purpose of this condenser to store up the current picked up on the aerial ?

Momentarily, yes. You will remember that I said the condenser would only remain charged as long as the applied electro-motive force continues. In wireless reception, we receive from the aerial a very rapid succession of small impulses. Each one of these forces a charge into the condenser and then retires from the scene. The condenser accepts the charge, but then discharges again.

Discharging means that the electrons return to their original state. Once we remove the external force, there is nothing to hold the electrons in the plates, and they resume their normal positions. (See Fig. 5.)

A condenser will not remain charged ?

It will if you remove any circuit which may be connected across it. Suppose, for example, we charge the condenser by connecting a battery across it and then remove the battery. There will still be an excess of electrons on one plate and the condenser will remain charged until we connect a piece of wire across the two plates, when the electrons will return to their normal positions.

But is there not a coil connected across the condenser in this wireless set all the time ?

Yes—and that is why the condenser discharges as soon as the electro-motive force has disappeared. As a matter of fact, it is the rather peculiar method which the condenser adopts in discharging itself which is the basis of

wireless tuning. I will try to explain this to you now.

Assume that the condenser has been charged so that one plate is holding a store of electrons. As soon as we release them they will rush back to the other plate through the coil and give us a momentary discharge current.

This current flows through the coil. When a current flows through a coil it produces a magnetic field. Now, here is the point. Last week I likened the coil to a cup of tea in which the liquid had been stirred round rapidly with a spoon. If I stop stirring the tea will settle down again, but not immediately. *It will go on spinning round for some time before it finally settles down.*

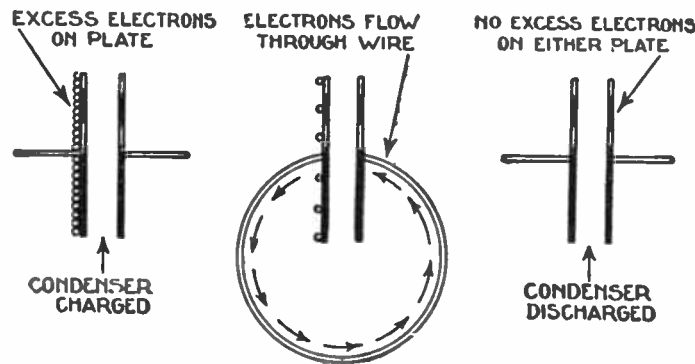

Fig. 5. Illustrating how a condenser with one plate charged will discharge itself as a flow of currents between the two plates

You get just the same effect with a magnetic field. Once you have "twisted up" the atoms in the neighbourhood of the coil, they take a little time to disentangle themselves, and while they are doing that they try to keep the current flowing.

If you are stirring a cup of tea, and

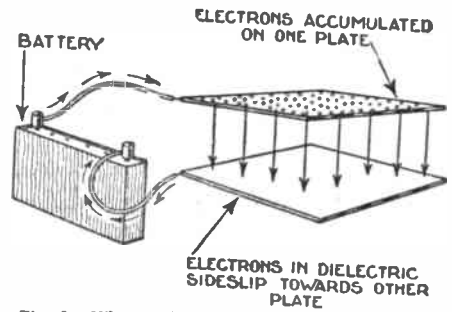

Fig. 3. When a force is applied to a condenser's plates, as here, the electrons in the dielectric—the air between the plates—will side-slip and cause a piling up of electrons on one of the plates

you suddenly stop stirring, without removing the spoon, you will find that the liquid tries to carry the spoon round with it; in fact, if you want to hold the spoon still, you have to exert quite an appreciable force. (Fig. 6 on page 7.)

So a magnetic field tries to carry the current along with it ?

That is the idea! If you withdraw the force which initially started the current, the magnetic field itself will supply a force of its own, tending to keep the current flowing.

You mean the current flows on indefinitely ?

No! The force is not sufficient for that, but it is strong enough to prolong the current appreciably.

This is a very important effect, which is often found in electricity. Let us see (Continued on page seven)

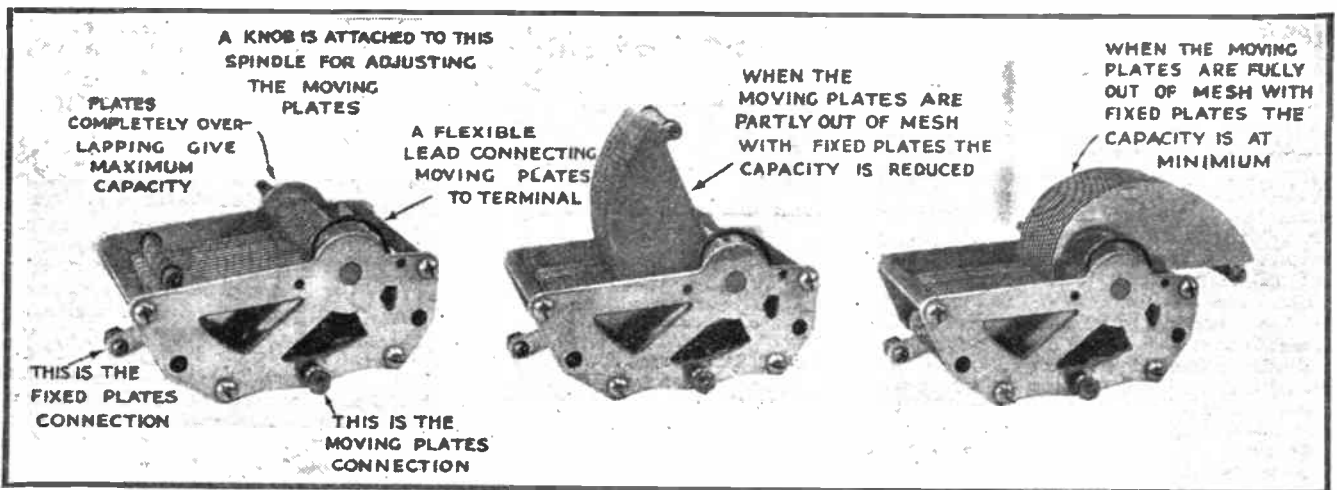

Fig. 4. All you need to know about the construction of a variable tuning condenser is told by these three diagrams. On the left the plates are totally in mesh and the capacity is at its maximum. At the centre, with the plates partially out of mesh, the capacity is reduced, and on the right, with the plates entirely out of mesh, the capacity is at its minimum.

PERCY W. HARRIS'S BUILD AS YOU LEARN

(Continued from page three)

re-tune and you will find there is a tremendous increase in signal strength, and you may be able to get in several distant stations. Be careful in your adjustment of the coil so that the set does not oscillate during broadcasting hours.

You will now find that the reaction coil position to some extent governs the strength of reception. The nearer the set is to oscillation, the stronger the signal. Be careful, however, in the setting, and if you hear squeals and whistles when you tune the set, alter the reaction setting at once, as the set will be oscillating and causing interference.

The next experiment is still more interesting. Set up the third bracket and make the connections shown by the shaded

Do scrape water pipes clean and bright before clamping down the earthing connection. Dirty pipes will mean high resistance, and that will mean a bad earth. Do try to install the best possible earth, and go in for a buried earth plate or tube if at all possible.

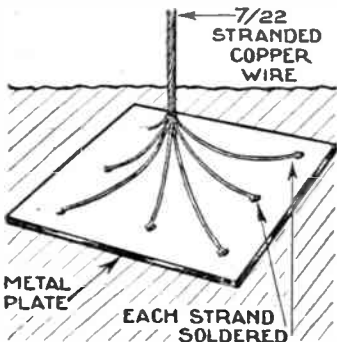

Two efficient arrangements for the earth connection are shown above. On the left is a buried plate, with stranded wire connection lead. On the right is a water-pipe connection, with a clamping piece to make good contact

Don't under any circumstances "earth" to a gas pipe.

Gas pipes are not really dangerous, but they are very inefficient, because of their white-lead joints—and white lead has a high resistance.

Don't forget that the connection of a stranded wire to a buried plate provides a very low-resistance earth. But you must solder each strand to a different part of the plate.

Don't just wind the wire

round an earth tube in the garden, but make sure the wire is well soldered. Otherwise corrosion and oxidation due to the atmosphere will quickly make the connection high resistance.

Don't worry unduly if you have to use a fairly long earth

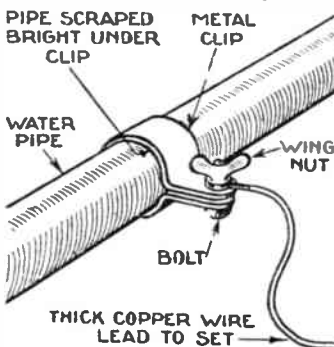

lead to join to set to a really good contact, but make quite sure the wire is thick, or the total resistance will be high.

Don't forget to earth the aerial when you finish listening at night. The earth, when connected to the aerial outside the house, will effectively drain away any static charges that may accumulate on the aerial and will act as a protection against the remote possibility of lightning.

STARTING UP A NEW SET

BEFORE attempting to make a new set do its job of picking up wireless programmes you should carefully read the makers' instruction book.

Read how to connect up the batteries, or to adjust the set to the voltage of your mains supply; read how to insert the valves in their correct order; how to plug in the aerial lead in the correct socket; or how to prepare the set for mains-aerial reception.

If the dials and knobs are not marked, read which is which, so that you know which is for tuning, which for volume, and which for changing the wavelength.

While you are at it, read the wording of your guarantee, which may be for six months or for a year. Note that although the maker will readily undertake to make good faults in the material and possibly in the assembly, he cannot be held responsible for faulty valves.

Also, in this guarantee, note that the undertaking is usually to replace the faulty material. You may have to pay quite an appreciable sum for the replacement of a faulty component—not for the material, but for the repairer's time.

If the set is not a portable, some form of external aerial system will be needed, even with the most ornate instrument, such as a super-hetero-radio gramophone. The question you will have to decide is how long the aerial shall be and whether it shall be indoors or outdoors.

The answer will depend on your locality and on the power of the set. If it is a small set use a good outside aerial of not less than 70 feet total length. If this set is very close to a regional centre the length may have to be reduced to give complete separation of the programmes.

With a large set, whether near or far from a regional centre, a big outdoor aerial is neither necessary nor desirable. A total of 50 feet should be ample, and often it will not be necessary to erect it outdoors.

With all new sets, big or small, near or far from regionals, the earth is of first importance, and should be made as efficient as possible. With mains sets, bad earths often cause an unpleasant background humming noise.

Remember that when a mains set is first switched on you will not immediately hear anything, as the indirectly-heated filaments of the valves take about half a minute to warm up and operate. This applies whenever the set is switched on.

COMPONENTS NEEDED

Baseboard, 18 in. by 10 in. Four terminals blocks, each to take two terminals. Eight terminals, one each marked A., E., L.T.—, L.T.—, H.T.—, H.T.—, L.S.—, L.S.—. Compression condenser, .0003 microfarad max. Coil former, 3 in. by 2 1/2 in. 1 lb. No. 26 D.C.C. wire. Crocodile clip. Flexible wire for connections. Three brackets (made specially by Peto-Scott for this set). .0003 microfarad variable condenser with one-hot spring. On-off switch. Two valve holders. Two fixed condensers .0003 microfarad, 1/2 in. lead, 2 megohms, and holder. Low-frequency transformer. .0003 differential condenser. Piece of card-board for reaction coil. 120-volt high-tension battery. 2-volt accumulator and 9-volt grid-bias battery, with appropriate wadding plugs and tags. Note.—With the exception of the brackets, which are special for this set, the components may be of any reputable make. As a safeguard, use only branded products. You can rely on 'A.W.' advertisers.

portion of this week's layout reproduction. Try again out of broadcasting hours and you will now find that if you lay the reaction coil flat on top of the tuning coil and turn the knob of the reaction condenser one way or the other, you will have a perfect control of reaction and oscillation. After a little practice try it in broadcasting hours, and increase your range!

YOUR WIRELESS EARTH Do's and Don't's for the Beginner

A good earth is a low-resistance earth. Low resistance means the minimum opposition to the flow of the wireless waves coming in on the aerial and going to earth via the earth contact. The lower the resistance the more efficiently will the earth connection act.

Do, if you possibly can, see that the earth lead is short. If it is unavoidably long do see that it is made of thick wire. That known as 7/22 stranded-copper will serve fine.

Do make sure that, if you use a water-pipe earth, the pipe is on the main supply, and not just a cistern pipe.

BATTERY OR MAINS?

BEGINNERS often want to know whether a mains set is entirely different from the battery-operated type of set. The answer is that all sets are much the same in their general action. The difference between the battery and the mains types of set lies in the power supply alone.

The mains set has no batteries at all. It derives all its current and voltage from the electric-light supply. Before this supply can be used to feed the wireless set it has to be converted, altered, or modified in some way. The electric-light supply is too "raw" for the delicate valves of the set.

With A.C. mains sets there are three distinct processes before the domestic supply can be used in the set. First, the voltage has to be "stepped up." This is done with a transformer, which has a winding connected across the mains and another

larger winding connected to the rest of the apparatus.

The next step is the conversion of the alternating current of the mains into direct current. This is done with a rectifier, which can be either a valve or a metal device. This rectifier makes the electricity go all the same way, instead of shooting backwards and forwards.

Although it is a one-way current when it gets past the rectifier the electricity from the mains is still far from suitable for the set. It has to be "smoothed" by several devices after the rectifier.

The "raw" stuff can be used for heating the valve filaments, just as it can be used for the lighting of the bulbs in the house.

There is no magic in the mains set—just a greater convenience of maintenance and an ability to give more volume because of the more robust power available.

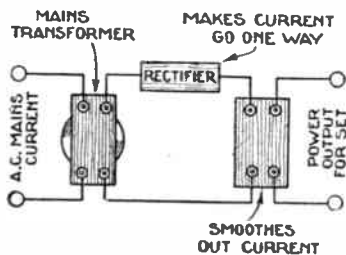

The three essential parts of a mains unit—the transformer, the rectifier and the smoother

ELEMENTARY WIRELESS COURSE FOR BEGINNERS

(Continued from page five)

what it means. The electrons in the condenser have rushed out of one plate into the other so that the condenser is now discharged and the dielectric is in a normal condition.

We have produced a current in the coil, however, which has set up a magnetic field, and because of the time required for this field to collapse, the current goes on flowing after the condenser has been discharged. Consequently we pile up electrons on the other plate, and this goes on until the magnetic field has died away. (See Fig. 7.)

You mean that the condenser will charge again?

Yes. This time in the opposite direction, with the electrons on the other set of plates.

Then how long does this oscillating go on?

Probably 50 to 100 times in normal circuits. It does not go on for ever because of the *resistance* in the circuit.

Resistance is a form of electrical *friction*. When we have electrons moving between the atoms of the material in a haphazard fashion there are bound to be crashes! If two electrons collide they cease to be useful in providing current, so that gradually the various electrons "knock out" each other and the current becomes smaller and smaller.

We call this tendency of electrons to collide the *resistance* of the material. In some materials, like copper, the number of collisions is relatively small, so that with a given electro-motive



Fig. 6. When you suddenly stop stirring a cup of tea the force tends to carry the spoon along. So with a magnetic field, for when you stop the current the magnetic field of force tends to keep the current flowing

we deal in wireless. The oscillations take place at a tremendous rate, hundreds of thousands of times a second, and it is really due to their extraordinary rapidity that wireless waves are produced.

I don't quite see the connection between these currents and wireless.

We shall come to that next week. Perhaps I can give you some idea by telling you that every one of these oscillations produces a wireless wave. Just what that means you will discover in due course.

Here is another thing. The speed or frequency of these vibrations depends on the capacity of the condenser. That is why we make the capacity variable on our wireless set, so that we can adjust the frequency of the oscillations to correspond with the various wireless waves.

Is that what you call tuning?

Yes. When you rotate the knob you are making the oscillations in your set correspond with the wireless waves from the particular transmitter you are receiving. Next week I will explain this process of tuning more carefully and will show you a mechanical analogy which I think will make it perfectly clear.

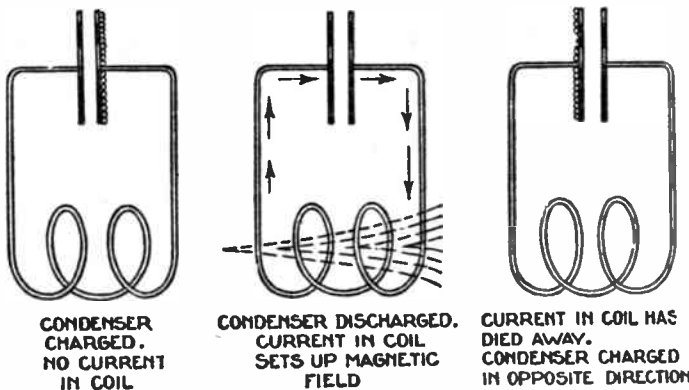

Fig. 7. These three diagrams show how a charge on a condenser will discharge itself as a current through a coil connected to it, and then this current will charge up the other side of the condenser, leaving no current in the coil

More or less as we were before?

Wait! When the coil has finished forcing electrons into the condenser, it starts to discharge again, and a current rushes through the coil once more. Exactly the same thing happens and we have a continual rush of electrons out of one plate into the other and then back again.

We say that the current is *oscillating* and it is the effects produced by these oscillating currents that are responsible for wireless.

force we obtain a large current. With a high resistance, on the other hand, the "casualties" are enormous and only a relatively small proportion of the electrons is able to travel on its way unhindered. Different metals have different resistances as you will see later.

All you need worry about at the moment is that this oscillating current rushing in and out of the condenser sooner or later dies away because of these casualties.

That is the form of current with which

SOME SIMPLE WIRELESS SYMBOLS EVERYBODY SHOULD MEMORISE

<p>EARTH</p> <p>The earth lead, shown in symbol on the left, and as a water-pipe connection on the right</p>	<p>JOINED WIRES</p> <p>WIRES CROSSING</p> <p>POSITIVE (RED)</p> <p>NEGATIVE (BLACK)</p>	<p>FIXED CONDENSER</p> <p>The condenser symbol is on the left. This is for a fixed condenser, such as that on the right</p>	<p>AERIAL</p> <p>The symbol for the aerial is shown on the left and a typical horizontal aerial erection on the right</p>
---	---	---	---

SOME POINTS ON PORTABLES

THE portable set is the only type of set that does not need either an externally-connected aerial or earth. The aerial in a portable is wound in the form of a frame—it is nothing more than a large

rather restricted in both tone and volume.

Lately the moving-coil type of loud-speaker has found its way into the portable, which can therefore give more realistic performance.

Probably the biggest drawback of the portable—even today, with so many excellent models available—is the limitations in volume imposed by the small batteries carried in the portable cabinet

To overcome this trouble as much as possible, many portables now use what is known as a pentode output valve, which for a given amount of battery energy provides more power to the loud

speaker than can be supplied by the ordinary type of power valve.

Weight in a portable, while irksome during transport, should never be utterly condemned, because this weight is probably due to the inclusion of large batteries capable of providing ample volume.

One last point in favour of the portable. Its frame aerial, though so limited in its ability to pick up signals, has the great advantage that it will pick up signals only in one direction at a time.

If two signals are causing interference and are coming from different directions the portable will usually separate them more easily than will a set with an ordinary aerial, because the frame aerial in the portable will respond much more energetically to the station in whose direction it is pointing than to stations in all other directions.

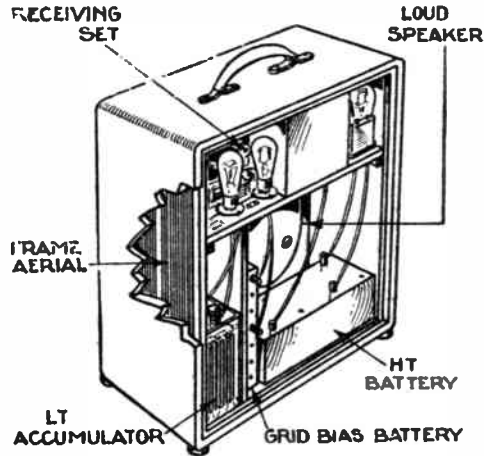

How a modern portable set is constructed

tuning coil some 1½ feet or more in diameter.

Due to the limited pick-up of energy obtained with this frame aerial, the portable set has to employ several amplifying valves to give good loud-speaker strength. Owing to the very great amplification obtained from the latest valves, it is now possible to overcome the drawback of the frame aerial with as few as four valves.

The great advantage of the portable set is that it will work entirely on its own, and it is therefore of great value to travellers and to those living in restricted dwellings, such as flats and tenements.

Besides the frame aerial, the cabinet of the portable contains the set, the batteries, and the loud-speaker. Until recently the limitation in the space has meant that only a cheap type of loud-speaker could be used, and the quality has been, therefore,

HOW LONG OUGHT YOUR BATTERIES TO LAST ?

MOST newcomers to wireless want to know how long the batteries will last. It is quite simple to work out how long the low-tension battery—sometimes called the accumulator—will last before it wants re-charging, but it is not so easy to say how long the high-tension battery will last before requiring renewal.

Let us take a simple example to illustrate the accumulator problem. We might have what is called a 20-ampere hour

accumulator working a three-valve set, which might take a total filament current of .4 ampere. If we divide the capacity of the accumulator, as represented by the ampere-hours, by the current we are taking from the accumulator in an hour, which is the total filament current in amperes, we shall find the number of hours the accumulator can be used.

In this simple example 20 is divided by .4, and the result, 50, is the number of hours we can

expect the accumulator to work.

It is unwise to allow an accumulator to stand for any length of time in a totally discharged state so we should deduct say 5 hours from this service, thus ensuring that when the accumulator goes to the charging station it will not come to harm through standing uncharged for a day or so.

The high-tension battery also has capacity, but is not so readily worked out. The current drain upon the high-tension is small, being a matter of thousandths of an ampere—milliamperes—but then the cells inside the battery are also small, and will quickly become exhausted if over-run.

The capacity of high-tension

batteries is arbitrarily divided into standard, double, and treble, according to the size of the cells. In general, when worked to the maximum limit, these batteries will last from two months upwards, according to the amount of use.

For maximum anode current not exceeding 7 milliamperes a standard battery can be used. For anything up to 10 or 12 milliamperes a double-capacity high-tension is needed. For currents over this a treble capacity is essential.

If attempts are made to run a set needing, say, 15 milliamperes from a standard battery the life of the battery is very short—perhaps not more than six weeks.

HOW THE MOVING-COIL WORKS

DO you know how the modern loud-speaker works? It is quite a simple idea. In the latest popular type of loud-speaker, called the moving-coil, the action depends on the movement of a small coil of wire.

What makes this coil move ?

The currents flowing through the coil.

What currents ?

The currents in the output circuit of the power valve—currents bearing the low-frequency signals corresponding to audible sounds of speech and music.

Tuning coils have currents flowing through them—how is it they do not move ?

Because they are not arranged like the moving-coil of a loud-speaker.

Then how is this moving-coil arranged ?

In a very powerful magnetic field, set up by lines of force travelling across the poles of a large field magnet, which may be permanently magnetised or magnetised by applying current from the mains.

It is the current flowing through the little coil that causes the coil to move, because in passing through the coil the current disturbs the lines of force. Something has to go—it is the little coil—backwards and forwards.

Attached to this little coil is a conical-shaped diaphragm, which vibrates in sympathy with the movements of the coil attached to its centre.

The air is set in motion around the cone, and sound waves are set up corresponding to the currents flowing through the coil. These currents are electrical transcriptions, so to speak, of the sounds originated in the studio.

The moving-coil has the great advantage of responding very faithfully to all the audible frequencies. It works on a theoretically perfect idea, and only the imperfections of assembly prevent it giving perfect reproduction. As it is, it gives better reproduction than any other known type of loud-speaker mechanism.

The coil and cone mechanism are delicately balanced, and it

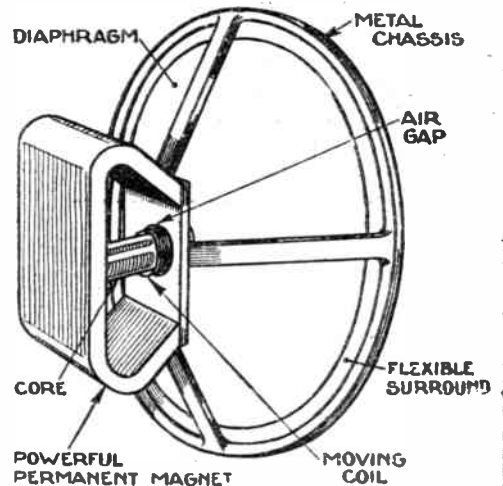

Working details of the moving-coil loud-speaker. Note the coil is in a strong magnetic field of force

is a great mistake to tamper with them in the hope of getting better results.

The moving-coil has a certain resistance or impedance, which must be accurately matched to the impedance of the power valve in the set if the maximum power and the most faithful reproduction are to be obtained.