

OUR SUPER SET

**- WITH -
CONSTRUCTOR'S
PICTORIAL
GUIDE -**

Amateur Wireless

and
Radiovision

Every
Thursday

3^d

Vol. XVIII. No. 434

Saturday, May 2, 1931

Building "The CENTURY SUPER"

**Daily Mail SAYS THIS SET "WILL PROVE
A BOON TO THOUSANDS OF LISTENERS"**

B.B.C.'S NEW TELEVISION DEVELOPMENT

RANGE THE WORLD

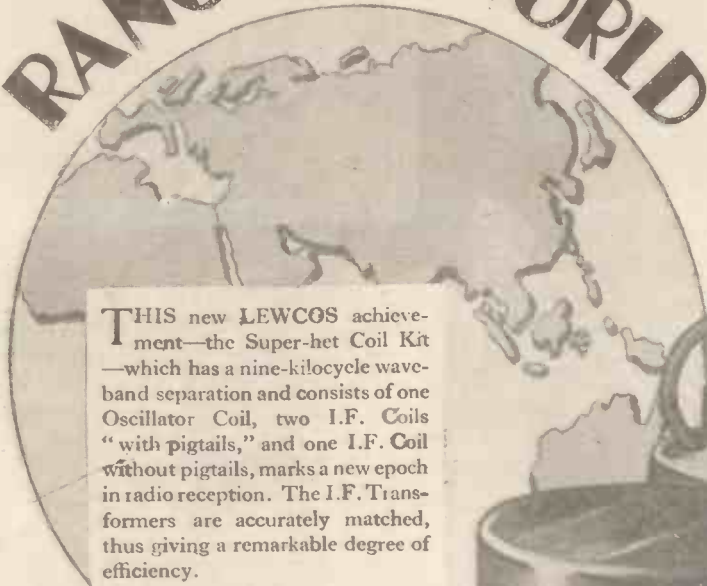

THIS new LEWCOS achievement—the Super-het Coil Kit—which has a nine-kilocycle wave-band separation and consists of one Oscillator Coil, two I.F. Coils “with pigtails,” and one I.F. Coil without pigtails, marks a new epoch in radio reception. The I.F. Transformers are accurately matched, thus giving a remarkable degree of efficiency.

This Kit, which is recommended for the “Century Super,” can also be fitted with extraordinary ease in any set of similar design and the results will be truly astounding!

The small space available is completely inadequate to give even a short description of these wonderful new LEWCOS Coils, and you are invited to write for an illustrated explanatory leaflet.

with
The

LEWCOS

(Regd)



SUPER-HET COIL KIT

(Patent Pending)

which is recommended
for the
“CENTURY SUPER”
receiver described
in this issue.

Price 50/-

BRITISH THROUGHOUT

GREEN

BLACK

RED

WHITE

BLUE

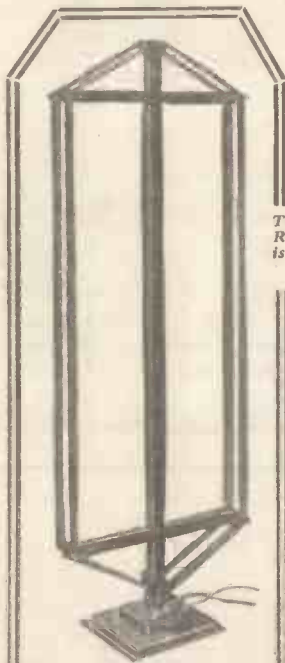

This is a photograph of the LEWCOS Dual Range Centre-Tapped Frame Aerial which is recommended for the “Century Super.”

PRICE 32/6

LEWCOS “Spaghetti Resistances” of 15,000 and 20,000 ohms each
PRICE 1/6 each
are specified for the
“Century Super”

A COMPLETE KIT OF PARTS FOR THE “CENTURY SUPER,” WHICH INCLUDES THE LEWCOS SUPER-HET COIL KIT AND THE FRAME AERIAL, CAN BE OBTAINED FROM

READY RADIO LIMITED

H. & B. RADIO COMPANY

PETO-SCOTT CO., LTD.

—See separate advertisements in this issue—



LEWCOS RADIO PRODUCTS FOR BETTER RECEPTION

THE LONDON ELECTRIC WIRE COMPANY AND SMITHS LIMITED, CHURCH ROAD, LEYTON, LONDON, E.10

You Will Help Yourself and Help Us by Mentioning “A.W.” to Advertisers

A set so good deserves the best loud-speaker . . .



Amateur Wireless

"Century Super"
and the century's
super cone speaker

To make sure of the best results you must have the best H.T. Battery — Ask your dealer for the "new process"

EDISWAN

2-60 volt 20 M/A **15/6** each
or

120 volt 20 M/A **31/-** "

LONG LIFE — CONSTANT POWER
ALL BRITISH

The **B.T.H. CONE**

"Amateur Wireless" engineers—discriminating critics of loud-speaker performance—use and recommend the B.T.H. Cone for use in conjunction with the "Century Super."

Brilliant reproduction, with an attractive appearance, are the outstanding features of this Ediswan product. Ample bass, sparkling treble and a warm radio brown finish that will harmonise with any decorative scheme—see and hear it for yourself. Any good radio dealer can demonstrate it to you.

Price 50/=



THE EDISON SWAN ELECTRIC CO. LTD.
Radio Division
155 Charing Cross Road, London, W.C.2
Showrooms in all the Principal Towns

EDISWAN

W.147

Mention of "Amateur Wireless" to Advertisers will Ensure Prompt Attention



HERE are the valves that are making radio history—ETA. They demonstrate conclusively that highest efficiency can be combined with reasonable economy. Fit ETA Valves and know the satisfaction of wonderfully improved reception. Prices from 7/-

Ask your Radio dealer for particulars of the ETA Valve to suit your set.

ETA VALVES

The Electrical Trading Association Ltd., Aldwych House, Aldwych, W.C.2.
Telegrams: Eltradox, Strand, London. Telephone: Holborn 8139.

Recommended for the 'CENTURY SUPER'

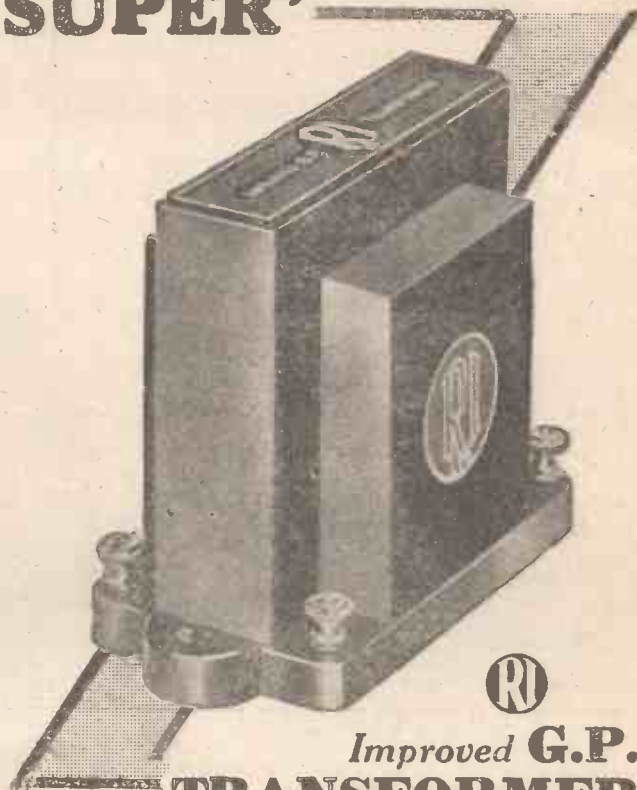

RI
Improved G.P.
TRANSFORMER
gives definitely the best performance of any transformer at its price.

A new, larger "general purpose" transformer for use where considerations of space do not arise. Fitted in a beautiful green bakelite case with an improved iron core, its electrical characteristics show a vast advance on the original G.P. model. It is the lowest priced transformer with such high primary inductance.

Resistance Primary D.C. 1,050 ohms.
Resistance Secondary D.C. 6,600 ohms.
Inductance Primary 35/40 henries.
Ratio 3½ : 1. Weight 1 lb. 2 ozs.
Overall dimensions 3½" x 1½" x 2½" high.

10'6

The latest edition of the R.I. Catalogue is the most comprehensive and useful component reference obtainable. Ask your dealer—or us—for a free copy.

The HYPERMU NIKALLOY CORE TRANSFORMER

Without doubt the world's best transformer. Gives the highest and most uniform amplification of any commercial transformer in existence. 25 to 7,000 cycles. Primary inductance 85 henries. Ratio 4 to 1 **21/-**



The DUAL ASTATIC H.F. CHOKE

The only choke giving perfect amplification from screened-grid valves at all broadcasting wavelengths. Ensures freedom from resonant peaks and blind spots. Resistance D.C. 650 ohms. Inductance 60,000 microhenries **7/6**

R.I. Ltd., Madrigal Works, Purley Way, Croydon
Phone: Thornton Heath 3212

Please mention "A.W." when Corresponding with Advertisers

H & B GUARANTEED KITS

for

The "CENTURY SUPER"

MARVELLOUS VALUE
100% EFFICIENCY
SIMPLE TO BUILD
ONLY TWO TUNING CONTROLS
NO OUTDOOR AERIAL
NO EARTH

With the H & B Frame Aerial the stations log exactly as described in "A.W."

H & B CABINET

In OAK with polished Oak Panel and Base-board ... **15/-**
Hand Polished Mahogany ... **£1.3.6**

H & B DUAL RANGE FRAME AERIAL

Complete with Turntable, Rubber flex, three plugs and three ebonite spacers **20/-**

H & B DUAL RANGE FRAME AERIAL fitted with WAVE-CHANGE SWITCH

Complete as illustrated below. The switch gives immediate change-over without having to disconnect any leads ... **25/6**

H & B GUARANTEED STANDARD KIT

| | £ | s. | d. |
|--|----|----|----|
| 2 .0005 variable condensers with slow motion (J.B. "Tiny") | 17 | 0 | |
| 1 50,000 ohm wire wound Potentiometer (Colvern) | 5 | 6 | |
| 1 Three point shorting switch | 1 | 3 | |
| 1 Set of 4 superhet coils (Lewcos or Wearite) | 2 | 10 | 0 |
| 6 Valve holders (Telsen) | 6 | 0 | |
| 1 Triple coil base (H. & B.) | 2 | 0 | |
| 5 1 mfd. fixed condensers (Dubilier) | 12 | 6 | |
| 2 .001 fixed condensers (T.C.C.) | 3 | 8 | |
| 1 .0002 fixed condenser (Formo) | 6 | | |
| 1 Grid leak holder (Lissen) | 6 | | |
| 1 1 meg. grid leak (Telsen) | 1 | 0 | |
| 1 L.F. transformer (Telsen "Ace") | 8 | 6 | |
| 1 Terminal strip with three terminals for baseboard mounting (H. & B.) | 8 | | |
| 1 15,000 and one 20,000 Spaghetti resistance (Lewcos) | 3 | 0 | |
| 1 Fuse holder and fuse (Bulgin) | 1 | 3 | |
| 5 Yards of thin flex (Lewcos) | 7 | | |
| 6 Wander plugs, engraved (Belling Lee) | 1 | 0 | |
| 2 Spade terminals, engraved (Belling Lee) | 8 | | |
| Connecting wire and sleeving (H. & B.) | 1 | 3 | |

CASH PRICE **£5-16-10**

H & B GUARANTEED SPECIAL KIT

| | £ | s. | d. |
|--|----|----|----|
| 2 Variable condensers .0005 with slow motion (Polar "Ideal") | 1 | 5 | 0 |
| 1 Potentiometer, wire wound (Electrad) | 6 | 0 | |
| 1 Three point shorting switch (W.B.) | 1 | 3 | |
| 1 Set of 4 superheterodyne coils (Lewcos) | 2 | 10 | 0 |
| 6 Valve holders (W.B.) | 6 | 0 | |
| 1 Triple coil base (H. & B.) | 2 | 0 | |
| 5 1 mfd. fixed condensers (Dubilier) | 12 | 6 | |
| 2 .001 mfd. fixed condensers (T.C.C.) | 3 | 8 | |
| 1 .0002 mfd. fixed condenser (Formo) | 6 | | |
| 1 Grid leak holder (Dubilier) | 1 | 0 | |
| 1 1 meg. grid leak (Dubilier) | 1 | 8 | |
| 1 L.F. transformer (Lewcos) | 17 | 6 | |
| 1 Terminal strip with three terminals (H. & B.) | 8 | | |
| 1 15,000 Spaghetti resistance (Lewcos) | 1 | 6 | |
| 1 20,000 Spaghetti resistance (Lewcos) | 1 | 6 | |
| 1 Fuse holder and fuse (Bulgin) | 1 | 3 | |
| 5 Yards of Lewcoflex | 7 | | |
| 6 Engraved wander plugs (Belling Lee) | 1 | 0 | |
| 2 Spade ends (Belling Lee) | 8 | | |
| Connecting wire and sleeving (H. & B.) | 1 | 3 | |

CASH PRICE **£6-15-6**

KITS NOW READY FOR IMMEDIATE DISPATCH. No delay the H & B Way

TERMS: Carriage Paid on all Cash Orders. C.O.D. charges paid on orders over £1.

TRADE SUPPLIED

RECOMMENDED ACCESSORIES:

| | |
|--|---------|
| 2 Siemens Double Capacity 60-volt H.T. Batteries | 27/- |
| 1 Siemens 9-volt Grid Bias Battery | 1/6 |
| 1 Exide 2-volt 100 amp Accumulator | 14/6 |
| 1 Ormond Loudspeaker in Cabinet | 27/6 |
| 6 Mullard Valves (as specified) | £3 16 0 |

LEWCOS C/T Frame Aerials in Stock **£1 - 12 - 6**

To meet the wishes of our clients we have a built "CENTURY SUPER" on show in our offices, you are welcome to inspect it without any obligation.

H & B RADIO CO.

34, 36, 38

BEAK STREET,
REGENT STREET
LONDON, W.1

Telephone: Gerrard 2834



National Physical Laboratory Tests self-capacity of Marconi MS4!

PRICE
25/-



MARCONI VALVE M.S.4

- Filament Volts ————— 4.0
- Filament Current ————— 1.0 amp.
- Anode Volts ————— 200 max.
- Screen Grid Volts ————— 70 max.
- * Amplification Factor ————— 550
- * Impedance ————— 500,000 ohms.
- * Mutual Conductance ————— 1.1 MA/volt

*Taken at anode volts 100 and grid volts zero.

Six standard MS4 A.C. indirectly heated screen grid valves have just been tested by the National Physical Laboratory; their average self-capacity was found to be only .0019 MICRO-MICRO FARAD!

The practical efficiency of any screen grid valve is, of course, dependent mainly on this inter-electrode capacity. Its measurement is, however, extremely difficult; for this reason, Marconi Engineers realised that an accurately certified figure was long overdue. Their enterprise is rewarded by this decisive tribute to Marconi superiority.

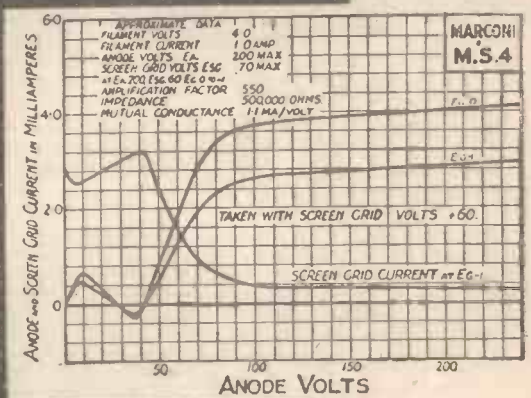

9 Marconi

THE VALVES THE EXPERTS USE

THE MARCONIPHONE COMPANY LIMITED, 210-212 TOTTENHAM COURT ROAD, W.1

Mention of "Amateur Wireless" to Advertisers will Ensure Prompt Attention

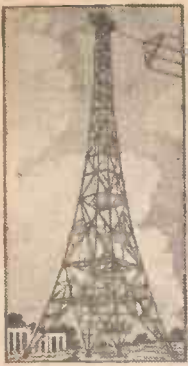

Amateur Wireless

and
Radiovision



EDITOR:
BERNARD E. JONES.

TECHNICAL EDITOR:
J. H. REYNER, B.Sc., A.M.I.E.E.

**THE LEADING RADIO WEEKLY FOR THE
CONSTRUCTOR, LISTENER & EXPERIMENTER.**

RESEARCH CONSULTANT:
W. JAMES.

ASSISTANT EDITOR:
H. CORBISHLEY.

NEWS · & · GOSSIP · OF THE · WEEK

THE HUNDRED-STATION SET

IMMENSE public interest has been aroused by our introduction of the new "Century" set. This is the first home-built set for which an honest claim of hundred-station reception has been made, and, naturally, as this is such an important factor (taking into account the selectivity which it implies), even the national "dailies" have described the new "Century" system. Further details of this amazing set, together with a large size constructor's guide, will be found in this issue.

SAVOY BAND BROADCASTS

LISTENERS to Howard Jacobs' Dance Band on April 17 or April 21 must have wondered why the relay was not made from the Savoy ballroom. Actually, the band was playing in the Lincoln Room at the Savoy. B.B.C. engineers have tried hard to overcome the difficulties in relaying dance music from the Savoy ballroom, but so far it has been found impossible to eliminate the considerable degree of background noises under such conditions. Howard Jacobs' band was, as a matter of fact,

engaged by the B.B.C. when it was performing at Claridges, and it was through the courtesy of the Savoy management that the Lincoln Room was placed at the B.B.C.'s disposal for the two final broadcasts of the band's engagement.

ANNOUNCERS ARE HUMAN!

IT is refreshing in these days of rigid anonymity among B.B.C. announcers to come across an incident proving that they still remain human in spite of their calling, or should we say announcing. The other night, during a reading of the debate on the Sunday Cinema Bill, the chief announcer at Savoy Hill had to read out a remark to the effect that there appeared to be no objection to Sunday broadcasts involving B.B.C. engineers and announcers. As an aside to listening millions the announcer said, "I did not know that was coming!"

THE "ETHER SEARCHER" COMPETITION

AS we go to press the final stage of judging the great competition of 1931 "Ether Searchers" is in progress, and

PRINCIPAL CONTENTS

| | PAGE |
|--|------|
| News and Gossip | 697 |
| The Regional Suppressor | 699 |
| What the "Daily Mail" says about the "Century Super" | 700 |
| "—taking You over to Covent Garden" | 701 |
| Coils Have Many Uses | 702 |
| On Your Wavelength | 705 |
| Amazing Results with the "Century Super" | 707 |
| Broadcast Artistes in Picture | 708 |
| A Portable Television Transmitter for the B.B.C. | 709 |
| Without Fear or Favour | 711 |
| Building the "Century Super" | 712 |
| Records of the Month's Broadcast Music | 716 |
| In My Wireless Den | 718 |
| The Catesby Orbit Radio-Gramophone | 720 |
| Readers Ideas and Questions | 722 |

it is hoped that in next week's issue it will be possible to give the full list of winners. The task of selecting entries and of testing each of the sets received has entailed a huge amount of work. Each set has been carefully tested and allotted marks for various good points. Even at this stage it is possible to say that the general standard of construction has proved even higher than was ever anticipated, and this has naturally made the judging a difficult and somewhat lengthy business.

MIDLAND REGIONAL

WHEN we remarked to the B.B.C. that complaints had been received in our post bag to the effect that the wavelength change of Midland Regional is giving trouble to many London listeners wanting to hear Midland Regional clear of London Regional, we were told that such complaints did not greatly worry the B.B.C. "After all," said an official, "such listeners are eavesdropping; they are not intended to listen to Midland Regional." And a few days ago the Chief Engineer remarked to journalists at the visit to Moorside Edge that the B.B.C. must put the reception of British stations first. While the B.B.C. thus disclaims any responsibility or indeed

M.P.'S RADIO TURN



Did you hear the broadcast of sea shanties by a quartet which included Sir James Sexton and Mr. Ben Tillett, the two well-known M.P.'s? Here they are (in the centre of the group) before the microphone.

THE "CENTURY SUPER" — FURTHER DETAILS NEXT WEEK

NEWS & GOSSIP OF THE WEEK —Continued

any interest in reception beyond the local station or stations, there is no doubt that a very great number of B.B.C. subscribers buy their sets for rather more than the reception of the local B.B.C. station.

VERY MUCH ALIVE!

AN old superstition is going to be killed this year. There are people who will tell you that radio is "no good" in summer,



Broadcasting House's designer—Lt.-Col. G. Val Myer, F.R.I.B.A. He is responsible for the wonderful new B.B.C. building which is now rapidly growing in Portland Place, and has worked in co-operation with Mr. M. T. Tudsbery, Civil Engineer to the B.B.C.

and that when the foreign stations are difficult to pick up because of summer-time conditions; gardening is preferable to grid leaks, and antirrhinums to aerials! With old sets they may have been right, but this year they will be *wrong*! The new efficient sets such as the "Ether Searcher" and the "Century Super" are pulling in the stations despite the long, light days. So, be prepared for a good wireless summer!

SÖTTENS INTERFERENCE

WE understand that the strength of Midland Regional with its new aerial system is well maintained in its service area. But there is undoubtedly greater interference from foreign stations than before. Söttens, the high-powered Swiss station, immediately above Midland Regional's wavelength, is making rather a nuisance of itself to Midland listeners, such as Müh-lacker is to London listeners.

SHEFFIELD IS WORRIED

IN spite of the fact that field strength measurements in Sheffield show that a signal of 20 millivolts per metre is possible in that district from the 479-meter North Regional transmitter, there is quite an agitation going on at the moment for the retention of the Sheffield relay. We expect

the B.B.C. is rather sorry it ever promised to consult Sheffield representatives about closing down the relay, as it did some time ago. At present the B.B.C. has come to an agreement with these representatives that Sheffield shall be closed down during the reception tests of Moorside Edge. When they are concluded another meeting will be held to decide the final fate of this relay station.

BROADCASTING HOUSE

ALTHOUGH the staff at Savoy Hill is loth to forecast the date of its wholesale removal to Broadcasting House at Portland Place, there is a feeling in the air that a start will be made during August or at the latest in September. At all events, the staff appears to be preparing for early summer holidays.

FIRE! FIRE! FIRE!

NOT long ago the drummer of Jack Payne's band had a fire at his home in St. John's Wood, London. Unfortunately, he raised the alarm rather prematurely, for by the time the brigade arrived the fire was out. This naturally upset the brigade, who hated to be done out of a job of work. A bargain was struck; and the sequel was a very special request item during Jack Payne's 5.30 programme a few days later. "The number we have just played was Fire! Fire! Fire! and this is at the request of a certain fire brigade." Perhaps listeners will understand now why the band guffawed at this announcement.

ANOTHER RADIO CENSUS

AS a result of a canvass of the agricultural population by a French newspaper, it has been revealed that farmers prefer sports programmes. Next in order come popular songs, military marches, and concertina music. The nightly market reports broadcast by several stations are also eagerly looked forward to. So it is said: we wonder if the same appreciation of the Fat Stock prices is given by our farmers!

A POLITICAL SERIES

A SERIES of political talks has been arranged to take place. The subject will be: "The Effect of Tariffs on Employment," and representatives of the three political parties will speak as follows: Monday, May 4, 9.20 to 9.40 p.m., the Right Hon. David Lloyd George, representing the Liberal Party; Monday, May 11, 9.20 to 9.40 p.m., the Right Hon. William Graham, representing the Labour Party; Wednesday, May 20, 9.20 to 9.40 p.m., the Right Hon. Neville Chamberlain, representing the Conservative Party. This series is worth hearing.

SIR JOHN TO LECTURE

SIR JOHN REITH is going to New York next month to attend a conference on radio in education. The title of Sir John's address will be: "What Europe's experience in educational broadcasting can offer to America." Well, he should know!

PHILIP RIDGEWAY TESTS THE "CENTURY!"

□ □

Philip Ridgeway, creator of the famous "Parades," has been trying out the 'Century Super,' and in next week's issue his experiences with this set will be described. Listening also to the set is Beatrice Galleway, the new broadcast star of the "Parades"

□ □



THE REGIONAL SUPPRESSOR

A Simple Device for Cutting-out the Local Station—By J. H. Reyner, B.Sc., A.M.I.E.E.



The "Suppressor" complete

NOW that the North Regional programmes are commencing from Moor-side Edge, some readers will be sure to be experiencing difficulty with selectivity. Foreign stations which they were wont to receive before will now be blotted out by the powerful local transmission. If one does not wish to go to the trouble of building a special receiver to meet the new conditions, one of the simplest remedies which can be adopted is the inclusion of a wavetrap or similar device in the aerial circuit.

The "Regional Suppressor" is a device which has been specially produced for the North Regional listeners. In circuits of this type experience shows that the simplest and most straightforward methods are usually the most effective. The principle adopted in the present instance, therefore, is the well-tried one of the absorption circuit, coupled in a suitable manner to the aerial. This circuit is tuned to the interfering station and its effect is to absorb a large percentage of energy from the aerial and thus prevent it from being passed on to the set.

The object of a wavetrap is not to blot out the local station, but to reduce the effect thereof to a reasonable amount, so that when one mistunes the receiver and adjusts it to some other station, serious interference is not experienced. A simple circuit such as that shown by Fig. 1a would entirely blot out the local station even at quite close distances, but it would have a

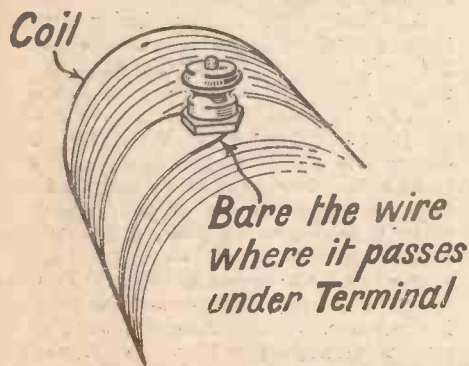

Fig. 2—Showing method of reversing winding and taking tapping at centre point

very wide absorption band. It would not only absorb energy at the frequency of the interfering signals, but for a considerable range on either side.

In order to make effective use of the principle the aerial is best coupled to the absorbing circuit in a manner such as shown in Fig. 1b. This acts much in the same way as a coupled aerial circuit does in an ordinary receiver. We all know that if the aerial is connected straight across the coil the strength is fairly good, but the tuning is very flat. It is the almost invariable practice nowadays to couple the aerial

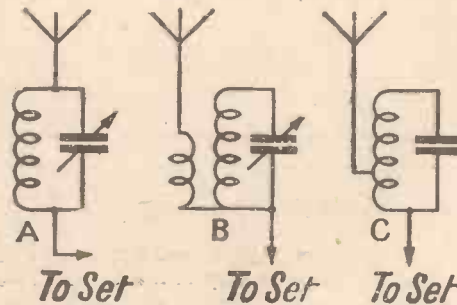

Fig. 1—Three forms of absorption trap

to the tuned circuit either by means of a separate coil or by taking a tapping thereon, and this enables us to get appreciably sharper tuning. In our wavetrap we adopt the same method, either coupling the aerial with a separate winding or taking a tapping as shown in Fig. 1c.

A further point of importance in a wavetrap is the question of the interaction between wavetrap and tuning circuit. The wavetrap circuit absorbs energy from the local station, and hence under operating conditions there is a large circulating current in this circuit. If this is placed near to the remainder of the receiver, the advantage derived from its use will largely be lost because the energy will be reintroduced into the circuit through the ordinary inductive effects existing between coils. Therefore, it is advisable to keep the wavetrap a little distance away from the receiver, or to arrange that the coil is of an astatic character so that it will not radiate appreciably. In the present instance this latter alternative has been adopted, the coil being wound in two sections in opposition to each other, so that the coil does not radiate energy to a serious extent.

The "Regional Suppressor" is very easily constructed. First of all take a piece of

2 1/2-in. Paxolin, ebonite, or other suitable material. Starting a little way from one end, wind on 40 turns of 30 s.w.g. double-silk-covered wire. Now drill a hole about a 1/4 in. away from the end of the winding and insert a small nut and bolt from the inside of the former. The wire should be bared and passed round the bolt, being held in place by the nut. This serves to hold the wire and also to serve as a contact point. A further 40 turns should now be wound on, this time in the opposite direction. The two sections should be kept apart, a separation of 1/2 in. in the centre being desirable (Fig. 2). In the second section a tapping should be taken at 20 turns.

Connections

The winding is now finished off and the connections are taken to the various terminals. The beginning and end of the winding are connected to two terminals at the bottom of the coil former. The tapping in the centre of the second section of the winding is brought out to a third terminal, also at the bottom of the former, but a little further round. A connection to the centre tap has already been made during the process of winding the coil. The bolt should be pushed through from the inside of the former, the nut going over the wire.

It only remains to insert a small block of wood at the bottom of the coil in order to screw it down to a baseboard and to mount on the same baseboard a pre-set condenser.

(Continued at foot of next page)

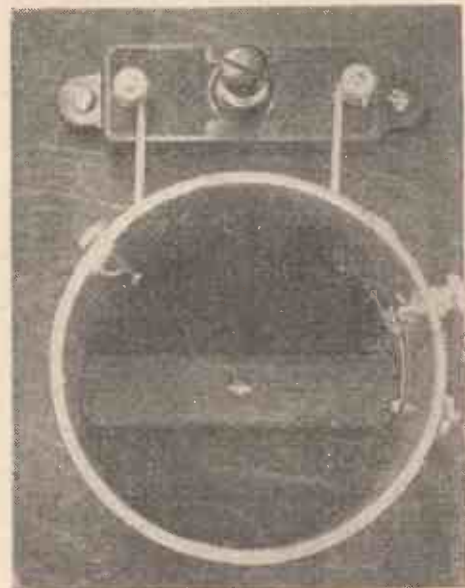

A plan view of the "Suppressor"

The "Century Super"

Many of our readers will no doubt already have seen the comments on the "Century Super" which recently appeared in the "Daily Mail." For the interest of those of our readers who did not, we give below an extract from the "Daily Mail" of April 17, which has special reference to this amazing receiver.

SELECTIVITY BOGEY CONQUERED :: SECRET IN THE COILS :: LOW COST

B RITISH wireless engineers have taken an important step towards solving the problem of the crowded and chaotic state of the ether.

As foreshadowed in the *Daily Mail*, this has been done by greatly increasing the selectivity of the receiving set, and not by long international talks between the broadcasting countries.

A set is shortly to be put on the market on which more than 120 stations can be received with perfect clarity. Its price will be only about £10 10s.

This set, which will prove a boon to thousands of listeners, has been produced by the experts of *Amateur Wireless*. They worked in their laboratories for a year until this triumph rewarded their efforts.

The secret lies in greatly improved coils, which are now to be manufactured in this country, so that the set will be entirely of British manufacture.

BATTERY OR MAINS

The set, which is a super-heterodyne with special band-pass tuning of the intermediate high-frequency stages, has six 2-volt valves in a cabinet which is little larger than the ordinary portable gramophone. There is a frame aerial, and batteries are used, although the set can be adapted to "mains" use.

There are two tuning dials, and some idea of the selectivity can be gained from the fact that London National and London Regional stations can be cut out within one degree. Mühlacker can be heard without a trace of London.

Recently one of the best-known experts in the country took the set to Eastbourne to test it. He has signed a document to the effect that he obtained, and checked a second time, 115 European stations and 8 American stations. It is claimed that the manipulation of the tuning is extremely simple and can be mastered even by the inexpert in a few minutes.

ELIMINATOR VOLTAGE

T HE rectified voltage across the terminals of an A.C. eliminator depends upon the amount of current used. For instance, where an eliminator is rated to give 25 milliamps at 120 volts, the voltage will rise if the set takes less current than that specified, and vice versa. On open circuit, i.e., when there is no load, the secondary winding acts simply as a choking coil, the back E.M.F. being equal to the primary voltage, except for the small magnetising-current. When the secondary circuit is closed through the potentiometer and valves, the rectifier, which has a high internal resistance, comes into circuit. The voltage drop across the rectifier obviously depends upon the amount of current drawn off, so that the remaining or available voltage is always greater for a small load current than for a large. M. B.

The B.B.C. Gaelic is not meeting with altogether complete approval. Every broadcast in the tongue of the North Brings abusive as well as appreciative messages. It is a matter of some difficulty to decide upon a standard, regarding Gaelic pronunciation.

The U.S.A. Federal Radio Commission has ordered all full-time broadcasting stations to be on the air a minimum of twelve hours each broadcasting day, as from May 1.

Work on the new 75-kilowatt Königswusterhausen transmitter has been completed and the station will broadcast on this power within the next few days.

"THE REGIONAL SUPPRESSOR"

(Continued from preceding page)

This condenser is connected across the whole coil and serves to tune it to the wavelength to be suppressed. The instrument is then ready for use.

Connect the aerial terminal of the set to the bottom end of the coil, that is to say to the left-hand terminal of the pre-set condenser, looking at the arrangement with this component facing one. The aerial itself is connected either to the tapping point or to the centre point of the coil (Fig. 3). In most cases the former connection will be found suitable, this being equivalent to tapping the aerial across one quarter of the whole circuit. Now tune in the receiver to the local station. Leaving the receiver set, carefully adjust the pre-set condenser in the following manner. Screw the operating knob right down to where some resistance is felt to the motion. This is the position at which the plates are compressed to their fullest extent. Now gradually unscrew the knob a little at a time. At one particular point (two or three turns back) the strength of the local station will be found to diminish. Find the setting which gives the minimum volume.

On retuning the receiver it will now be found that the local station tunes out in a comparatively short space, instead of occupying a large part of the dial as hitherto. It is not desirable to readjust the "Suppressor" when one is tuned to a distant station. Although this may

momentarily give an increase in the reception, it will be found to be a purely passing effect, and the adjustment for the other stations will be usually found to be worse than before.

Always adjust the "Suppressor" with the receiver tuned in to the station which

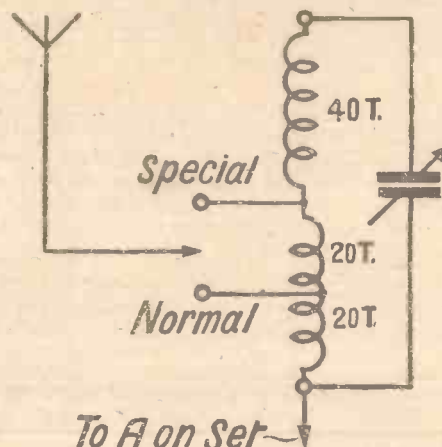

Fig. 3—Connections of the "Suppressor"

is to be cut out. Under these conditions it will not be possible to reduce the strength of the local station absolutely to zero, but only to a minimum value. Actually this minimum should be of just the right strength to be listened to in comfort, because, of course, this is the setting which one will use for listening to the local pro-

grammes and, therefore, the strength must not be reduced to an absolute whisper.

The second terminal—that connected to the actual centre tapping on the coil—has been marked "Special." This is for use where the reader is situated very close to a regional station. Here some rather greater measure of absorption is necessary and, therefore, the aerial circuit is connected across half the coil instead of only one quarter, as in the previous case. The absorption band with this setting is of necessity somewhat wider and, therefore, it is not desirable to use this except in special cases. In my own case, situated five miles from Brookmans Park, I found the quarter tapping sufficient to enable me to tune in stations 50 metres away, even using a full outside aerial.

One final point. This particular trap has been specially designed for the North Regional station. For this purpose the pre-set condenser employed should be the type "G" Formodenser, tuning from .0002 up to .001 microfarad. With this condenser the device will tune from 400 to 800 metres. It thus tunes to Slaithwaite at towards the minimum of the condenser, while it may also be used, if desired, by those readers situated in coastal districts, where it may be tuned to 600 metres, with the object of reducing some of the shipping interference. If any reader wishes to use it on a wavelength less than 400 metres, the Formodenser, type "F," should be used. This will enable a wavelength range of 200 to 400 metres to be covered.



"Taking You Over to Covent Garden"

Notes on the B.B.C.'s relays during the grand opera season that opened on April 27 at Covent Garden, London

BY this time *Der Rosenkavalier* will have opened the Covent Garden opera season and listeners will probably have heard Margit Angerer, leading soprano of the Berlin State Opera, as the Rose Baron. Once again B.B.C. listeners can, in imagination, take part in the splendour only fully appreciated by a visit to Covent Garden.

Perhaps it is a little curious that grand opera, in which spectacle is so intimate a part, should find such a wide appeal among the audience that only hears and does not see; yet the B.B.C. assures me that Covent Garden opera relays are among the best appreciated "O.B.'s."

No doubt the very fine acoustics of the vast stage enable the relays to achieve a certain spaciousness impossible in even the largest studio; but we must not overlook the fact that the very vastness of Covent Garden—and the elaborate disposition of the singers and scenery in the operas—entails considerable difficulties for the relay engineers. Since the first days of broadcasting, Covent Garden has figured in B.B.C. relays, so that present technique is the result of many experiments in the dispositioning of the microphones.

To-day the single microphone of early relays has been replaced by no less than four—one in the footlights, one at each side of the proscenium, and one on the rail of the orchestra pit. Sometimes the B.B.C. uses a fifth microphone—one that can "wander," in order to catch the more out-of-the-way excerpts. Thus the Dragon in *Siegfried* has his own microphone and so does the Emperor of China when perched up on his screen in *Turandot*.

Connected with these four or five microphones is what the B.B.C. calls a fade unit, worked by an engineer with an eye on the score of the opera being relayed. In this way that most dreaded of broadcast calamities, a "blast," is effectively avoided.

Apart from the avoidance of blast, the fade unit has a large bearing on the general balance of the relay, fading in and out the different microphones as the action moves from one part of the stage to the other.

The question is often asked as to what is a Covent Garden audience. It is divided, perhaps, between those in the stalls who really pay for the performance and those in the gallery who claim to be the only part of the audience that really appreciates the opera! What of the broadcast audience?

An interior view of Covent Garden Opera House with which many listeners will be familiar



Does that consist merely of opera fans subscribing to the next best thing to an attendance at Covent Garden—no one could pretend that broadcasting puts over the glamour and excitement of an actual

attendance—or does the relay of opera serve to recruit a new audience from among those who normally have neither inclination towards opera nor opportunities to see it?

From conversations with Savoy Hill programme compilers I should say that the general impression is that broadcast opera appeals considerably to listeners not primarily interested in opera. At all events, the programme is compiled so that the opera relays form, as far as possible, an aesthetic contrast to the programme on the alternative wavelength.

It may be news to some readers that the B.B.C. regards the differences in the various operas available for broadcasting as so much light and shade for programme builders—especially when attempting to fit in contrasts for regional stations.

One of the difficulties about these opera broadcasts is the B.B.C.'s inability to state very far ahead which particular opera excerpt is to be broadcast. But we may trust the discrimination of the programme compilers to give us a good selection of the German and Italian operas of the Covent Garden season. In addition to such old favourites as *The Ring*, *Tristan and Isolde*, and *Lohengrin*, the season is notable for several new Italian productions.

The usually dazzling array of singers from all parts of Europe have assembled at Covent Garden, including Lotte Lehmann, Anna Tibell, from Stockholm, and the Danish contralto, Maria Olczewska.

A. S. H.

VARIABLE AMPLIFICATION

IN general the amplification factor of a high-frequency valve shows up better on the shorter wavelengths than on the long, so that, apart from fading, stronger signals can be secured on 250 metres than higher up the scale. Where a set is designed

to receive over a range of from 200-2,000 metres, this, of course, means that its efficiency falls off as the wavelength is increased. One way of preventing this, and securing a better average response, is to use a "constant coupling" combination of inductance and capacity. The effect of the capacity on the short waves is then offset by the magnetic coupling on the long waves, giving a uniform amplification over the whole tuning range. M. B.

YOUR NEW SET MUST BE "THE CENTURY SUPER"

THE HOW AND WHY OF RADIO

XXXIV—COILS HAVE MANY USES

If you are a beginner in wireless, now is your chance to gain a clear conception of its theory and practice. In this series of articles, specially prepared for the beginner, no previous knowledge of wireless is assumed. It is intended to deal with every aspect of the subject and the whole series will endow the beginner with sufficient knowledge to enable him to derive the greatest possible interest from the fascinating hobby of wireless

BEGINNERS evidently appreciated the recent article in this series on the different uses of the condenser, as explained in the April 18 issue of AMATEUR WIRELESS. So this week I am treating coils in a similar way, by showing the different uses of coils in the same two-valve circuit used to explain condensers. Readers will see that the outlines of the different coils are shown in pictorial form whereas the rest of the circuit is symbolised.

We may as well start at the aerial end of the circuit. First of all we have the aerial tuning coil shown at A. This is shown connected across a .0005-microfarad variable condenser. The two components from what is known as an oscillatory circuit. When its frequency is adjusted by means of the variable condenser to the frequency of

The coil shown at B is not used for tuning, but for introducing reaction into the aerial tuning circuit, by handing back the oscillating high-frequency current flowing in the anode circuit of the detector valve. The size of coil B and its distance from coil A determine the degree of coupling between them. As this coupling is fixed we usually choose a coil just sufficiently big to provide reaction over the entire wavelength range covered by the aerial tuner. Of course, the amount of high-frequency anode current flowing through coil B is regulated by the variable condenser connected in series between coil B and earth.

Now we come to coil C, which is actually a high-frequency choke. Here again we have an untuned winding helping to provide reaction in the aerial circuit. When

low, otherwise we should have in effect a fixed condenser across the choke coil; in other words a capacity to earth only via the wrong route! Apart from low self-capacity in choke coil C we must insist upon a very high inductance value. For however low we may keep the self-capacity of the choke coil C it is obvious that whatever capacity is present will serve to form with the winding an oscillatory circuit.

If this has a frequency within the wavelength range used for broadcasting the choke acts as a tuned circuit and all sorts of queer things happen, such as uncontrollable oscillation. So in practice choke coils for the position shown at C are designed to have an inductance well above the value likely to produce a peak in the broadcasting range of wavelengths between 1,000 and 2,000 metres.

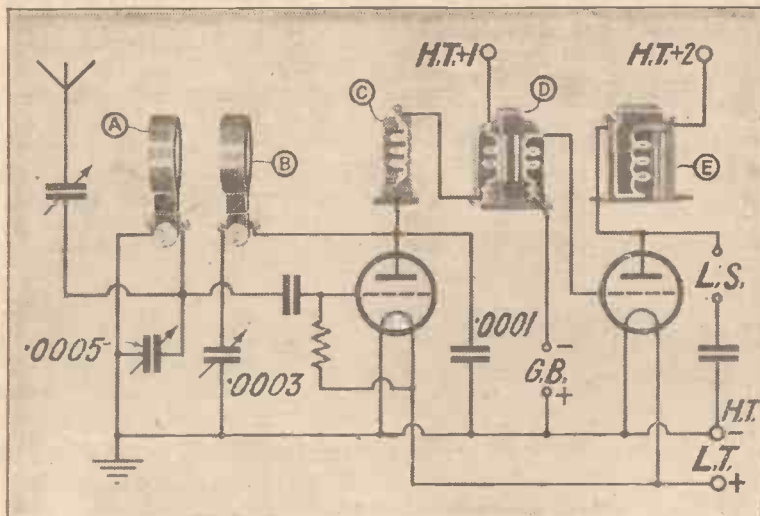

This pictorial diagram shows tuning and reaction coils in their relation to the high-frequency choke coil. Note also the low-frequency coils of the transformer and output choke

L.F. Stage

In the low-frequency transformer, coupling together the detector and power valves, are two coils, one the primary winding and the other the secondary winding. These coils at D differ from those at A, B, and C, in having considerably greater inductance. The primary is usually wound so that its inductance offers an impedance to low-frequency signals comparable with the impedance of the detector valve. The secondary winding has two or three times as many turns as the primary winding, so that a step-up ratio is obtained. Thus a signal voltage of 2 flowing in the primary winding would appear in the secondary winding as the signal voltage of 6, assuming a 3-to-1 ratio.

Finally, we have coil E, which is a low-frequency choke as distinct from the high-frequency choke at C. Broadly speaking, the functions of coil C and E are the same, in that both serve to act as a barrier to current wanted in another direction. Thus the low-frequency signals flowing in the anode circuit of the power valve are prevented from flowing through coil E owing to its very high impedance value, whereas similar low-frequency signals on a smaller scale, flowing in the anode circuit of the detector valve, have no difficulty in passing through coil C.

This point of difference between the actions of coils C and E is important. If we want to divert high-frequency current a very much smaller coil will serve than for the diversion of low-frequency current. Incidentally, the choke coil E offers no barrier to direct current of the anode supply of the power valve, nor does coil C prevent direct current flowing in the detector anode circuit.

HOTSPOT.

the incoming signal, the phenomenon of resonance causes a considerable current to be developed. The extent of this current depends largely upon the type of coil A. If it has a low resistance the current will rise to a greater maximum at the point of resonance than it would with a high-resistance coil.

Between adjacent turns of coil A exists a small capacity, negligible as such but quite appreciable when added to all the other small capacities formed by adjacent turns. The sum total of these inter-turn capacities is called the self-capacity of the coil. Now it happens that capacity formed by turns of wire separated by the insulated covering of the wire is an inefficient form of capacity, very much more inefficient than the capacity formed by the air-spaced plates of the tuning condenser across the coil. For this reason tuning coils such as that shown at A need to be designed so that the self capacity is low.

the high-frequency anode current reaches the anode end of the choke coil C, it is prevented from passing on due to the very high inductance value of the winding. Actually this high-frequency current is diverted through coil B and so through the .0003-microfarad reaction condenser to earth. Or if the reaction condenser is at minimum capacity this current finds a way to earth easily enough through the .0001-microfarad fixed condenser connected between the anode and earth.

The efficiency of the choke coil C must be of a high order. Its self-capacity must be

THE MOST UP-TO-DATE SET
FOR RANGE, POWER, AND
PURITY — "THE CENTURY
SUPER"

PILOT KIT SCORES

ALL OVER THE COUNTRY WITH CENTURY SUPER-HET

HERE IS WHY

- Q CHEAPER than any other Kit.
- Q EVERY component guaranteed.
- Q INCLUDES Peto-Scott Frame Aerial as used by "A.W." experts and Daily Mail to receive over 120 stations.
- Q LIST of Dial readings, specially calibrated for Peto-Scott Condensers by our technical staff.
- Q DRILLED panel in Oak or ebonite.
- Q FREE Konecterkit containing connecting wire, screws and bolts, together with wiring diagram and instructions.

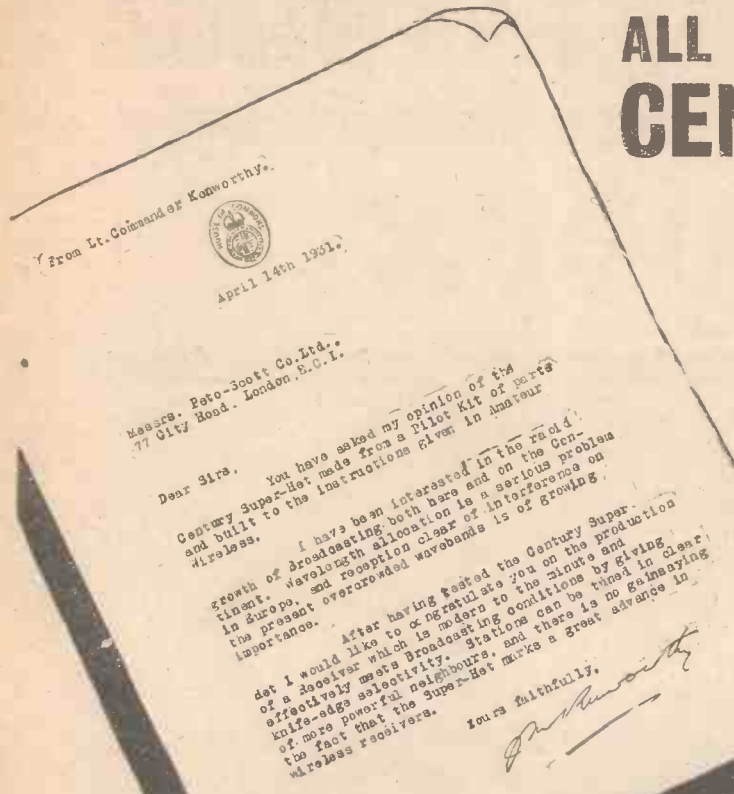

SIX MORE OUTSTANDING REASONS

EACH STRAND OF WIRE ENAMELLED AND COVERED OVERALL

ACCURATELY SPACED LOW-LOSS INSULATED WINDING SUPPORTS

POSITIVE ACTION WAVECHANGE SWITCH

TRIPLE LOW-CAPACITY AERIAL LEAD FITTED SIX SPACER BARS

IMPROVED PETO-SCOTT CONDENSERS WITH SLOW MOTION

SPECIALY MATCHED KNOBS IN HANDSOME OAK MOTTLED EFFECT TONING WITH PANEL

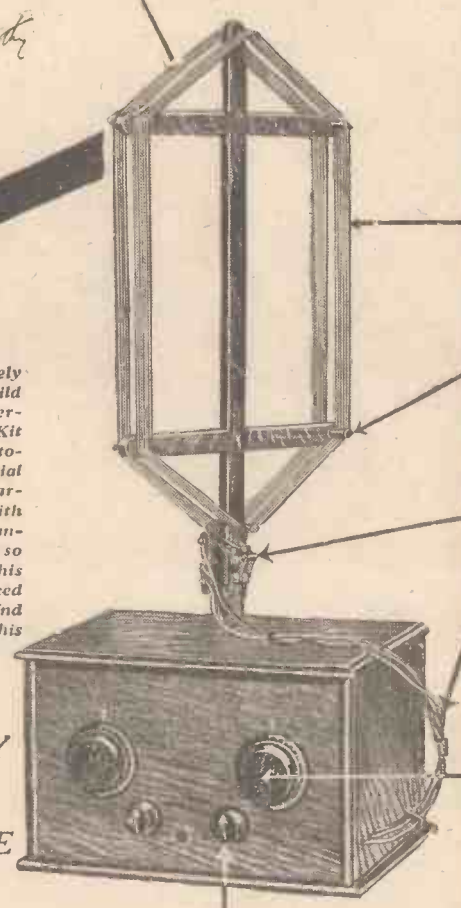

It is absolutely essential to build the Century Super-Het with a Pilot Kit of Parts with Peto-Scott Frame Aerial to ensure the marvellous results with which Lt.-Commander Kenworthy is so enthusiastic in his letter reproduced by his very kind permission in this announcement.

DELIVERY TO THE MINUTE

KIT "A"

Complete Kit less Cabinet, Valves and Frame Aerial

£5 - 6 - 6

or 12 monthly payments of 9/9

With Frame Aerial £6 - 6 - 6

or 12 monthly payments of 11/7

For other prices SEE PAGE 721

3-WAY PLAN

IN selecting the House from whom to purchase your CENTURY SUPER-HET remember that PETO-SCOTT supply on their famous 3-WAY PLAN conveniently arranged to suit your pocket. C.O.D.—Pay the Postman; it costs you no more. EASY WAY—Twelve equal monthly payments. CASH—Send money with your order. See page 721 for detailed list of parts, etc. It will pay you.

ESTABLISHED in 1920

PETO-SCOTT CO. LTD.

77 CITY ROAD, LONDON, E.C.1: Clerkenwell 9406; 62 HIGH HOLBORN, LONDON, W.C.1 Chancery 8266; MANCHESTER: 33 WHITELOW ROAD, CHORLTON-CUM-HARDY. Phone: Chorlton-cum-Hardy 2028; NEWCASTLE, STAFFS: 7 ALBANY ROAD. Phone: 67190

To Ensure Speedy Delivery, Mention "A.W." to Advertisers

We're pleased that you're pleased
with your **Drydex**



The supreme new dry battery by the
makers of the world famous **Exide**

| RED TRIANGLE | GREEN TRIANGLE | ORANGE TRIANGLE | BLUE TRIANGLE |
|--------------------------------|--------------------------------|---------------------------------|----------------------------------|
| 60 volts 7/- • 66 volts 7/6 | 60 volts 9/6 • 66 volts 10/6 | Triple Capacity • 60 volts 14/- | For portable sets • 63 volts 9/- |
| 99 volts 11/6 • 120 volts 14/- | 99 volts 15/6 • 120 volts 18/6 | 105 volts 24/6 • 120 volts 27/- | 99 volts - 14/- • 108 volts 15/6 |

For Grid Bias: *Red Triangle*. 9 volts—1/4. 16.5 volts—2/3. *Green Triangle*. 9 volts—1/9. 16.5 volts—2/9.
Unit Cells for Torches: *Green Triangle*. 1.5 volts—4d. Batteries for Pocket Lamps: *Blue Triangle*. 4.5 volts—6d.

Obtainable everywhere from all good dealers. Ask for Leaflet DB104.

Exide Batteries, Clifton Junction, near Manchester. Branches at London, Manchester, Birmingham, Bristol, Glasgow, Dublin and Belfast.

Dr. 20.

You will Help Yourself and Help Us by Mentioning "A.W." to Advertisers

On Your Wavelength!

CHANGING CONDITIONS

THE introduction of summer time usually marks a change for the worse in receiving conditions, particularly as regards the more distant stations. However, I do not think we shall run short of a reasonable choice of programmes from the Continent this year; so many of the "foreigners" have increased their power, that summer conditions should have very little effect. Actually, a little toning-down of the field strength, say from Müh-lacker, would come as a boon and a blessing to many of us, especially on those occasions when one wants to hear the London Regional programme without a German background.

SKIP-DISTANCE

ON the other hand, one can sometimes get an odd station or two better in summer than in winter. It all depends, I suppose, on "skip distance," which, in turn, is governed by the height of the Heaviside layer. The longer hours of sunshine, and possibly the extra intensity of the ultra-violet rays, combine to shift the layer to a higher average level during the summer months. This may result in bringing the reflected waves from a far-off station down to earth at a point that is more favourable for reception than usual. Of course, I am speaking of cases where the earthbound component of the signal is already too attenuated for direct reception. Strictly speaking, "skip distance" is measured between the point where the earthbound component is wiped out, and the point where the space waves come back again to earth after deflection from the Heaviside "ceiling."

MERE WORDS

I SEE that the B.B.C. Advisory Committee on English "as she is spoke" has issued another list covering the pronunciation of some of those words on which we are all liable, at times, to feel a little shaky. The Committee includes several eminent authorities—amongst others Mr. G. B. Shaw and Sir J. Forbes-Robertson—so that I suppose one ought to do one's best to follow the lead they give. Accordingly, please note that the stress should come on the first syllable of "aristocrat," instead of on the second. I used to think otherwise, so that the next time (if ever) I have to use this particular word, I shall probably "foozle" it horribly. Incidentally, should you at any time be moved to refer to the other fellow's bad temper as "choler," mind you pronounce it "coller," or you'll lose the full effect.

BY THE WAY

ALL this careful attention to pronunciation reminds me of an old story that may be worth reviving. On a certain American railway there is a small mountain station situated at one of the highest points along the line. It is called Urelia. Although there is nothing very remarkable in

the name, it sticks in the memory of most of those who pass through simply because of a long-standing feud between the station-master and the guard as to the way in which it should be pronounced. As the train slows up on arrival, the guard passes along the corridors announcing: "You're a liar! You're a liar! You're a liar!" Before the passengers can recover from their astonishment, the station-master on the platform caps the insult by shouting out in stentorian tones: "You reely are! You reely are! You reely are!"

GRAMOPHONE MOTORS

THE new squirrel-cage of inductor motor for driving a gramophone turntable from A.C. mains is a decided improvement on the commutator type adapted to be run either from a D.C. or A.C. supply. The latter model is liable to be noisy, especially when used with a pick-up and amplifier, owing to the difficulty of preventing sparking at the brushes. Even with shunt condensers across both terminals and a centre tapping to earth, it is not easy to cut out the trouble entirely. In the inductor model this difficulty disappears with the brushes, giving a perfectly silent drive. One should, however, be careful to see that the "regulator" is always set for the correct mains voltage. I mention this because, the other day, after I had carried out some "spring-cleaning" operations, this "gadget" must have worked loose on its shaft, and connected up some of the field windings in parallel instead of in series. The first thing I noticed was that the "tempo" seemed to be altogether too fast. Then I happened to touch the motor-body and found it was distinctly "hot." I promptly switched off, and soon located the trouble.

THOSE SHOCKS!

I CAME across a friend of mine the other day playing with an L.F. choke. He was apparently trying to measure the current through the choke with a milliammeter, and I noticed that every time he took the meter off he gave a jump. I asked him what the matter was, and he told me that he was rather troubled because every time he removed the meter he got a shock. I investigated the matter, and found that he was passing something like 20 milliamps through the choke, and that in consequence he was setting up quite an appreciable magnetic field.

As I explained to him, every time he broke the circuit he was getting an appreciable kick off the winding, and as he had hold of the connection in a particular way which always left him connected across the choke, he got the full benefit of this kick; hence the shock! My friend objected to this explanation, however. He said that he had only 50 volts in the circuit anyhow, and that he was not so feeble as to get a shock off 50 volts. I had to explain to him that whenever one breaks a magnetic field

a very large voltage is set up. This voltage actually tries to keep the field going by tending to pass a current in the same direction it was flowing in before the circuit was broken. Obviously it is unable to do this, as otherwise we should have a current flowing without any circuit; but, nevertheless, the voltage is set up, and this may rise to several hundred volts. I pointed out to him that it was this E.M.F. of self-induction, as it is called (hence the name inductance) that was causing the unexpected shock.

As a matter of fact, in some of the many-henried chokes which are available on the market to-day this problem is quite an appreciable one, and I daresay many of my readers will have experienced the same trouble when disconnecting chokes or transformers with high primary inductances. The anode current through a valve is sufficient to produce a magnetic field, which if broken will produce quite a healthy shock.

ANOTHER GOOD MARK

MORE than once I've pointed out that, unlike the great majority of scientific inventions, wireless shows a record consisting almost entirely of benefits to the human race. There can be little doubt that no invention of modern times has saved so many lives or done so much to increase the general happiness. An instance of the beneficent work of wireless occurred during the recent turmoil in Spain, when King Alfonso was obliged to leave his throne. Had there been no broadcasting stations there would undoubtedly have been serious rioting and bloodshed, for people would have thronged the streets to find out what was happening, and that is how riots start at such times. As it was, they found that they could learn more of current events by staying at home, and anxiety was allayed by frequent news bulletins summing up the position of the moment.

GLORIOUS DEVON

RECENTLY I have been making a stay in Devonshire and have toured about a good deal in the adjoining counties. Naturally, I was very keen to see what progress wireless had made as a popular hobby in the West of England, where the greater part of the country lies far outside the service area of any home station. The nearest B.B.C. main stations are Bournemouth, far away to the east, and Cardiff, far to the north. In addition, there is the tiny Plymouth relay, whose service area has not more than about a ten-mile radius. Things will, of course, be better when the Bristol H.P. twin transmitter gets going; but what does the West Country find to listen to now? I was agreeably surprised to find how well 5XX (or the Daventry National, to give him his up-to-date official name) is received down there. In the very south of Devon he comes in at excellent loud-speaker strength with a trio of valves.,

On Your Wavelength! (continued)

This is really the only reliable home station, for the high-powered medium wavers mostly fade very badly. I could get hardly a sound of "Noisy Nat" with four good valves!

COMPENSATIONS

CURIOSLY enough, when allowed to twiddle the controls of several sets in the West I found that Moorside Edge on 479 metres was often the most powerful of the home transmissions. He is of course, more distant than the others; but he has a longer wavelength, and therefore does not suffer so badly from fading. Quite possibly, too, this part of the world is outside his fading area—medium-wave stations, you know, are sometimes better received at three or four hundred miles than they are at a shorter distance. If the home stations are not too good, dwellers in Devon, Cornwall, and Somerset have some compensations in the splendid reception that is obtainable from Radio-Paris, the Eiffel Tower, Huizen, and other long-wave stations. On the medium band, too, French, Spanish, and some German stations usually come through remarkably well.

SURPRISING INDEED

SINCE the home-made programmes are so poorly received, except from the distant 5XX, a visitor might expect to find very little interest taken in wireless in the West. This, however, is very far from being the case. Except in a few places, you don't, of course, see the forests of aerial masts that meet the eye in Midland towns and villages. But, all things considered, the number of wireless sets in use, even in remote hamlets, is remarkable. They may not get the morning papers till tea time, but they have had the important items of the news the evening before by means of the headphones or the loud-speaker. There is one rather interesting aspect of wireless in the West Country, which the Big Wigs of the B.B.C. and of the wireless trade might well take to heart. It is the exception to find anything like a modern receiving set or loud-speaker in any but the wealthiest houses.

AN OLD FRIEND

WHAT did interest me very much was to come across still in use an AMATEUR WIRELESS "Ideal Unit Set." I designed that set when "A.W." was a good deal less than a year old, and a very good set it was in its day, though I sez so myself as shouldn't. But I didn't think that there was one still in action till I took tea at a country rectory. There it was, though, and still going strong. Its owner had modernised the L.F. department, but the H.F. side was in its primitive form, except that he had added a few knobs and switches to the original number, which was by no means inconsiderable. I counted eleven knobs and nine switches, but I may have missed a few! The old set was giving a jolly good account of itself, anyhow, and pulled in the foreigners like anything.

OPPORTUNITY WAITS

ONE thing is quite certain, and that is that as soon as Bristol gets going there will be a very big market for up-to-date wireless components, sets, and loud-speakers in the West. The B.B.C. would do well to speed up work on the Bristol station, and the wireless manufacturers should note that if they go the right way about it they will have a tremendous call for their wares. Even as things are, I think that there is plenty to be done in the West Country by making people realise that, though Bristol is not yet in existence as a high-powered twin transmitting station, a good modern set will bring in a wonderful number of programmes.

HOW DO YOU LIKE IT?

NOW that 5GB—or the Midland Regional, if you so prefer it—is down on 398.9 metres, quite a few readers in an area extending from the Midlands to the northern suburbs of London will be having a spot of bother with their sets unless these are up-to-date and pretty selective. The Daventry medium-wave station has a pretty big range and his field strength is considerable at distances up to fifty miles away or more. "Raucous Reg" is even more powerful, and the result is that many people are now finding duets from the two stations in progress when they switch on. Should you be one of those so troubled I'd suggest that you try out one tip before doing anything else. I have often found that if one changes from an outdoor to an indoor aerial there is a comparatively small drop in signal strength, but a big increase in selectivity. Therefore, try the indoor wire before you start pulling the set to bits and making elaborate changes in it. When the strength of B.P. and 5GB is really greater than you need with the outdoor aerial, you have something to play with, and changing to the indoor collector will probably still leave ample strength.

MIXING ACCUMULATOR ACID

When you put new electrolyte into the accumulator it must, of course, be sulphuric acid diluted to the correct specific gravity. Remember to add the



acid to the water, and not the water to the acid. This is most important, for the water will spray out in a dangerous fashion if poured into the acid.

DON'T FORGET THIS

TAKING indoor aerials all round, the best I have used is a plain single wire suspended round three sides of a room. Keep it about a foot from the walls and the same distance below the ceiling. But remember one thing. The efficiency of an indoor aerial is largely dependent on the smallness of its capacity. If you hang the wire too near walls or ceiling—I have seen aerials only an inch or so from both—or if you have rather a long down lead arranged near (or, worse still, fixed to) a wall, the capacity may become pretty considerable; the selectivity and signal strength are then both likely to suffer. You can easily see how the capacity of the indoor aerial compares with that of the outdoor by making a note of the reading of the first tuning condenser when the latter is in use and seeing what happens when you change over. With the indoor collector the reading of this condenser should be higher than with the other, since the first tuned circuit should now have a smaller amount of parallel capacity, due to the aerial-earth system.

A WORD IN SEASON

IF we haven't yet got summer-time we have, at any rate, summer time! The season of the year is now approaching during which accumulators, both H.T. and L.T., receive their worst doses of unintentional ill-treatment. Most people go out of doors more in the evenings, and therefore don't make so much use of their sets. Others go away for longish periods and forget all about their poor batteries. Make it a rule this summer that you will have yours charged regularly, even if your listening hours are less and they appear to last longer. Nothing harms a battery more than to stand idle in a run-down or semi-run-down condition. If you're wise, you'll arrange with the charging station to give yours a boost up and, if necessary, a top-up with distilled water once a month. The best way is to fix a date beforehand—say, the first Monday in each month.

WARE POWER CABLES!

IN my newspaper this morning I read a paragraph which, if read by the layman, would be likely to cause some doubts concerning the safety of wireless in the home. The paragraph was headed: "Wireless Aerial Causes Electrocutation." Now, this is only a half-truth. An aerial, which had been erected for some time and was being dismantled, came into contact with some power cables above which it was erected. The person doing the dismantling and holding the aerial wire received the full energy of the power cables through his body to earth, with fatal results. May I again emphasise the printed rules laid down by the authorities that it is not permitted to erect an aerial wire above power or telegraph cables. Should any listener be unfortunate enough to have such cables running over his property, he should erect a single-wire vertical aerial as far away as possible.

THERMION.

AMAZING RESULTS With The "CENTURY SUPER"



An account of a test by the well-known authority on continental reception—
J. GODCHAUX ABRAHAM.

IN its time AMATEUR WIRELESS has submitted to its readers a large number of wireless receivers, but I doubt whether any of them can compare with the new six-valve super-het which was sent to me for an independent test. It is far in advance of any radio receiver it has been my privilege to operate and when, on the first evening I coupled it up to its batteries, I enjoyed myself thoroughly. I append a log of 115 stations, all tuned in through a loud-speaker as, of course, the enormous power of the majority of signals heard precludes the use of headphones; as a matter of fact, it would be dangerous to use them for in most instances the volume at which certain transmissions were received, even from low-power stations, called for a generous use of the potentiometer control.

With this receiver, so to speak, you have Europe at your elbow; you may run around the dials with the certainty of capturing any station you set yourself out to bag. It will pick up almost any whisper on the ether and I experienced no difficulty in pulling in individual concerts from such lesser-heard stations as Nice-Juan-les-Pins, Riga, Zagreb, Naples, Kosice, Reykjavik and Istanbul at good loud-speaker strength.

On the first evening I logged over sixty-five long- and medium-wave transmissions; in three days I had increased this total to 115 and had checked and re-checked the condenser readings of those of which I was in some doubt. Every station in the log has been individually identified.

But just one word of caution: it is useless to twist the dials at random. If you do so you will miss all but the most powerful transmissions. The receiver is so selective that you will find no difficulty in cleanly separating London Regional from Graz or Mühlacker, Warsaw from Eiffel Tower, Istanbul from Reykjavik, London National from Leipzig and Moravská-Ostrava, Marseilles from Wilno, and so on. But the adjustment of the oscillator condenser must be carried out delicately, for one-quarter of a degree either way will spell success or failure. And yet, after a few hours practice you should tune in one transmission after another with the utmost ease.

As regards the American transmissions, I have no doubt that I could have logged many more, but I only devoted a period of three hours to that side of the game. Staying up after midnight after a long day's work does not appeal to me, but even in that short time I had ample proof that the happy owner of a "Century" can increase materially the log I have put forward.

And notwithstanding its exceptional selectivity and excellent DX qualities the "Century" gives you clear-cut signals and almost perfect purity of tone. For the reception of musical transmissions it is all that can be desired.

Personally, I could not wish for a better receiver; it did all I wanted it to do and, believe me, I am hard to please.

J. GODCHAUX ABRAHAM.

| MEDIUM WAVES | | | | LONG WAVES | | | | |
|--------------|---|-----------------------------------|---------|-----------------------------------|-------------|---------|---------------------------------------|-----------|
| Wave-length | Station | Dial Readings Frame Oscillator | Station | Dial Readings Frame Oscillator | Wave-length | Station | Dial Readings Frame Oscillator | |
| 217 | Koenigsberg | 13 .. 28 | 306 | Zagreb | 36 .. 49½ | 455 | San Sebastian (EAJ8) | 66 .. 78 |
| 218 | Flensburg | 13½ .. 28½ | 310 | Cardiff | 37½ .. 49½ | 459 | Beromuenster (Switzerland) | 67 .. 79 |
| 221 | Helsinki | 13¾ .. 28¾ | 312 | Wilno | 38 .. 49½ | 466 | Lyons PTT | 69 .. 80½ |
| 223 | Fecamp (Normandy) | 14 .. 29 | 315 | Marseilles PTT | 38½ .. 49½ | 473 | Langenberg | 70 .. 81 |
| 225 | Cork | 14 .. 29½ | 321 | Goeteborg | 39 .. 50½ | | (Manchester faint) | 71 .. 82 |
| 227 | Cologne | 16 .. 30 | 325 | Breslau | 39½ .. 50½ | 479 | Northern Regional (full loud-speaker) | 71 .. 82 |
| 230 | Malmö | 16½ .. 30½ | 328 | Grenoble, PTT | 40 .. 51 | 487 | Prague | 72 .. 84 |
| 232.5 | Kiel | 17 .. 31½ | 332 | Naples | 41 .. 53 | 501 | Milan | 76 .. 87 |
| 234 | Lodz | 18 .. 32 | 338 | Poznan | 42 .. 54 | 509 | Brussels No. 1 | 76 .. 88 |
| 239 | Nürnberg | 18 .. 33 | 339 | Velthem (Brussels No. 2) | 43 .. 54 | 517 | Vienna | 78 .. 89 |
| 240.6 | Kristianssand (Norway) | 19 .. 34 | 342 | Brno | 43½ .. 56 | 525 | Riga | 79 .. 89½ |
| 242 | Belfast | 20 .. 35 | 345 | Strasbourg | 44½ .. 57½ | 533 | Munich | 81 .. 91 |
| 244 | Cracow | 20½ .. 35½ | 348.6 | WABC New York | 45 .. 58 | 541 | Sundsvall | 83 .. 93 |
| 249 | Nice Juan-les-Pins | 21 .. 36 | 349 | Barcelona EAJ1 | 45½ .. 58 | 550 | Budapest | 84 .. 95 |
| 253 | Gleiwitz | 22 .. 36½ | 352 | Graz | 46½ .. 59 | 560 | Kaiserslautern-Augsburg | 86 .. 96 |
| 255 | PTT Toulouse | 22½ .. 36½ | 356 | London Regional | 47 .. 59½ | 566 | Hanover | 88 .. 96½ |
| 257 | Hoerby | 23 .. 37 | 360 | Mühlacker | 47½ .. 60 | 577 | Ljubljana | 89½ .. 98 |
| 259 | Leipzig | 23½ .. 37½ | 364 | Bergen | 48½ .. 60½ | | | |
| 261.3 | London National | 24 .. 38 | 365 | Algiers | 49 .. 61 | | | |
| 263 | Moravská-Ostrava | 25 .. 38½ | 368 | Seville (EAJ5) | 49½ .. 61 | | | |
| 265 | Lille PTT | 26 .. 39 | 372 | Hamburg | 50 .. 61 | | | |
| 272 | Rennes PTT | 27 .. 40½ | 376.4 | Glasgow | 50½ .. 62 | | | |
| 273.6 | WPG Atlantic City, N.J. | 27½ .. 41 | 379 | WGY Schenectady | 51 .. 62 | | | |
| 276 | Heilsberg | 28 .. 42 | 381 | Lvov | 51½ .. 62 | | | |
| 279 | Bratislava | 29 .. 42½ | 384 | Radio Toulouse | 52 .. 64 | | | |
| 281 | Copenhagen | 29½ .. 42½ | 390 | Frankfurt-on-Main | 53 .. 65 | | | |
| 282.8 | U.S.A. Station, believed to be WTIC Hartford, Conn. | 30 .. 43 | 394 | Bucarest | 54 .. 67 | | | |
| 283 | Berlin (Common Wave) | 30 .. 43 | — | WJZ Boundbrook | 54½ .. 67 | | | |
| 286 | Montpellier PTT | 31 .. 43½ | 399 | Midland Regional | 55 .. 68½ | | | |
| 289 | British relays | 32 .. 44 | 403 | Sötzens (Switzerland) | 56 .. 69 | | | |
| 293 | Kosice | 33 .. 45 | 408 | Katowice | 57 .. 70 | | | |
| 295 | Limoges PTT | 33½ .. 47 | 413 | Dublin | 58 .. 70½ | | | |
| 296 | Turin | 34 .. 47½ | 416 | Rabat (Morocco) | 59 .. 71 | | | |
| 298.8 | Hilversum | 34 .. 48 | 418 | Berlin-Witzleben | 59½ .. 71 | | | |
| 301 | Aberdeen | 34 .. 48½ | 424 | Madrid (EAJ7) | 60 .. 72 | | | |
| 303 | WBZ Springfield (Mass.) | 34½ .. 49 | 430 | Belgrade | 60 .. 73 | | | |
| 304 | Bordeaux-Lafayette | 35 .. 49 | 436 | Stockholm | 61 .. 74 | | | |
| 305 | KDKA E. Pittsburgh | 35 .. 49½ | 441 | Rome | 63 .. 75½ | | | |
| | | | 447 | Paris PTT | 65 .. 77½ | | | |
| | | | 454.3 | WEAF New York | 66 .. 78 | | | |

BROADCAST ARTISTES IN PICTURE



PAUL BEARD.—Leader and first violin of the Unity Quartet, recently relayed from the Royal Society of Artists Gallery, Birmingham



MARJORIE PARRY.—One of the younger singers of the B.N.O.C., Miss Parry has become one of the foremost of our operatic singers



MISS CECIL LUCAS.—Heard on April 16 through the London Regional station, Miss Lucas sang with W. L. Trytel and his Octet



OSMOND DAVIS.—One of our best known tenors and one of the earliest of the concert-hall singers to broadcast. Mr. Davis made his debut at the Queen's Hall in 1919



HERMIONE GINGOLD.—One of the charming principals in "The Ridgeway Parades"



JACK PAYNE.—Leader and conductor of the B.B.C. Dance Band



GWYNETH EDWARDS.—A charming young soprano who sang recently through the London Regional station with the William Mathews Octet



BEATRICE GALLOWAY.—Another member of "The Ridgeway Parades." Listeners do not need reminding of the charm of her work



MAJOR YEATS BROWN.—A most interesting speaker, he is now commencing a new series of talks on Eastern subjects



PHILIP RIDGEWAY.—Actor, author, composer and singer. The producer of the now famous "Ridgeway Parades"



BERT COPLEY.—A popular entertainer and singer. He took part in a special programme on April 16 from Manchester



NOEL EADIE.—A famous member of the B.N.O.C., and heard frequently from the studios as well



CHARLES HEDGES.—Has had a wide concert-hall experience; his most recent broadcast was on April 16 through the Midland Regional

A PORTABLE TELEVISION TRANSMITTER FOR THE B.B.C.

*Some interesting details of a new development
by H. J. Barton Chapple, Wh. Sch., A.M.I.E.E.*

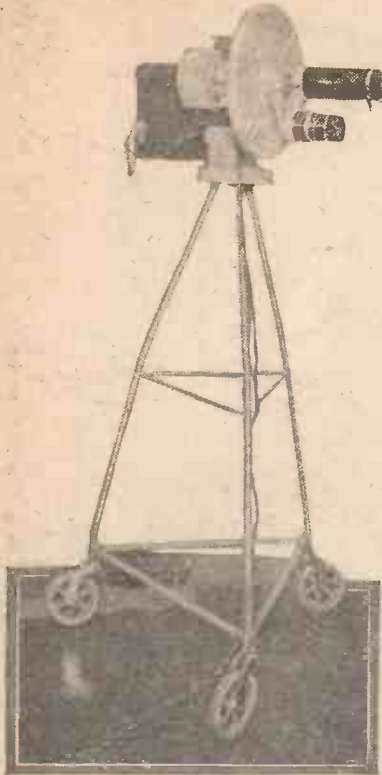

The new portable television transmitter installed at the B.B.C. No. 10 studio

A PORTABLE television transmitter has been supplied by the Baird Television Company to the B.B.C. This transmitter has been installed in No. 10 Studio and it is hoped that very shortly some of the well-known B.B.C. artistes will be televised while broadcasting.

Actually this portable transmitter was delivered to the B.B.C. on April 13 and, although it had not been made public, television transmissions by wireless had previously taken place from the Baird studios by means of this portable transmitter.

In a sense the standard apparatus shown by the accompanying photograph, working on the spotlight principle, is mobile, but obviously could not come within the designation of the word portable. This last-named term, however, can be truly applied to the latest form shown in the heading.

Truly Portable

For wireless purposes the name "portable" is applied to receiving sets the weight of which is such that except for the possibility of movement from room to room they are essentially fixtures. The present form of Baird portable transmitter now with the

B.B.C. is certainly not a piece of apparatus which can be moved from pillar to post with impunity, but its design is such that the engineers in charge can cater for reasonable subject movement of the persons being televised and furthermore it can be set up easily in any desired position.

The basic transmitting mechanism is supported on a tubular tripod framework having pivoted rubber-tyred wheels. The supporting plate is so arranged that the disc, arc, lenses, etc., can be moved round in a horizontal plane, while, in addition, a movement in vertical elevation can be effected. The handle whereby these manipulations are carried out is seen on the extreme left of the arc casing.

Vertical Scanning

The disc is made for vertical scanning with the usual thirty holes arranged in the form of a spiral. It is completely enclosed in a casing to make it quite dustproof, while in addition the inclusion of the cover makes it almost noiseless in action. Driving the disc is a universal motor with provision made for the accurate maintenance of the correct running speed. As a source of light there is an arc lamp working with an automatic feed, the black casing surrounding this being visible at the back of the disc cover.

A particularly interesting feature of the apparatus is the provision of two lenses. These are carried on a casting pivoted at the centre and with the aid of registering pins dropping into positioned slots it is possible to bring either one or the other into action. The longer of these lenses has a focal length such that "close ups" (that is, head and shoulders) of a particular person can be televised, although the individual concerned may be several feet away. If a change is then effected to the shorter of the lenses the full length of the same individual is available to be televised. Furthermore, the lens with the shorter focal length covers those situations where a head and shoulders image of a person is required when that individual is fairly close to the transmitting mechanism. The whole apparatus is perfectly

balanced and therefore can be run in any position.

The "auxiliary" equipment is not shown in the illustration, but consists of the photoelectric cells and initial stages of the cell amplifier housed and balanced on a pivoted stand; these can be positioned where desired to bring about the condition of best reflected light pick-up from the televised subjects. In this way reasonable movement of the artiste is catered for, the individual position change being followed closely by the engineer in charge in much the same way as the spotlight operator keeps his "beam" on stage artistes.

Quite separate there is the main amplifier and power supplies. The results of the tests will be awaited with interest.

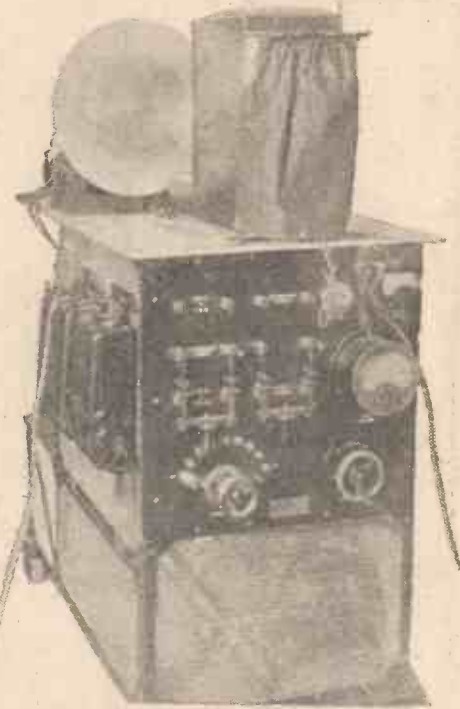

This is the standard type of transmitter which has been used until recently

SCREENING

CONSTRUCTORS do not always realise that it is just as necessary to screen condensers as well as all coils on the high-frequency side of a set. The potential variations on the vanes of a tuning-condenser set up spreading fields of static force, which are just as liable to give rise to back-coupling and instability as the magnetic flux from a high-frequency coil. This

liability to electro-static interaction between different circuits is, of course, greatly increased when several condensers are "ganged" together in close proximity to each other, so that care should always be taken to see that they are adequately screened from each other. B. A. R.

BUILD THE "CENTURY SUPER"

The Westinghouse Company recently requested from the Federal Radio Commission four relay wavelengths for the purpose of sending sponsored programmes over W8XK, auxiliary of KDKA of Pittsburgh, with the object of advertising American products, particularly radio gear, to stimulate their sales abroad. Plans included special programmes to appeal to the particular countries intended to be reached. The application has been refused.

COSTS NO MORE THAN A HIGH-CLASS THREE-VALVE SET

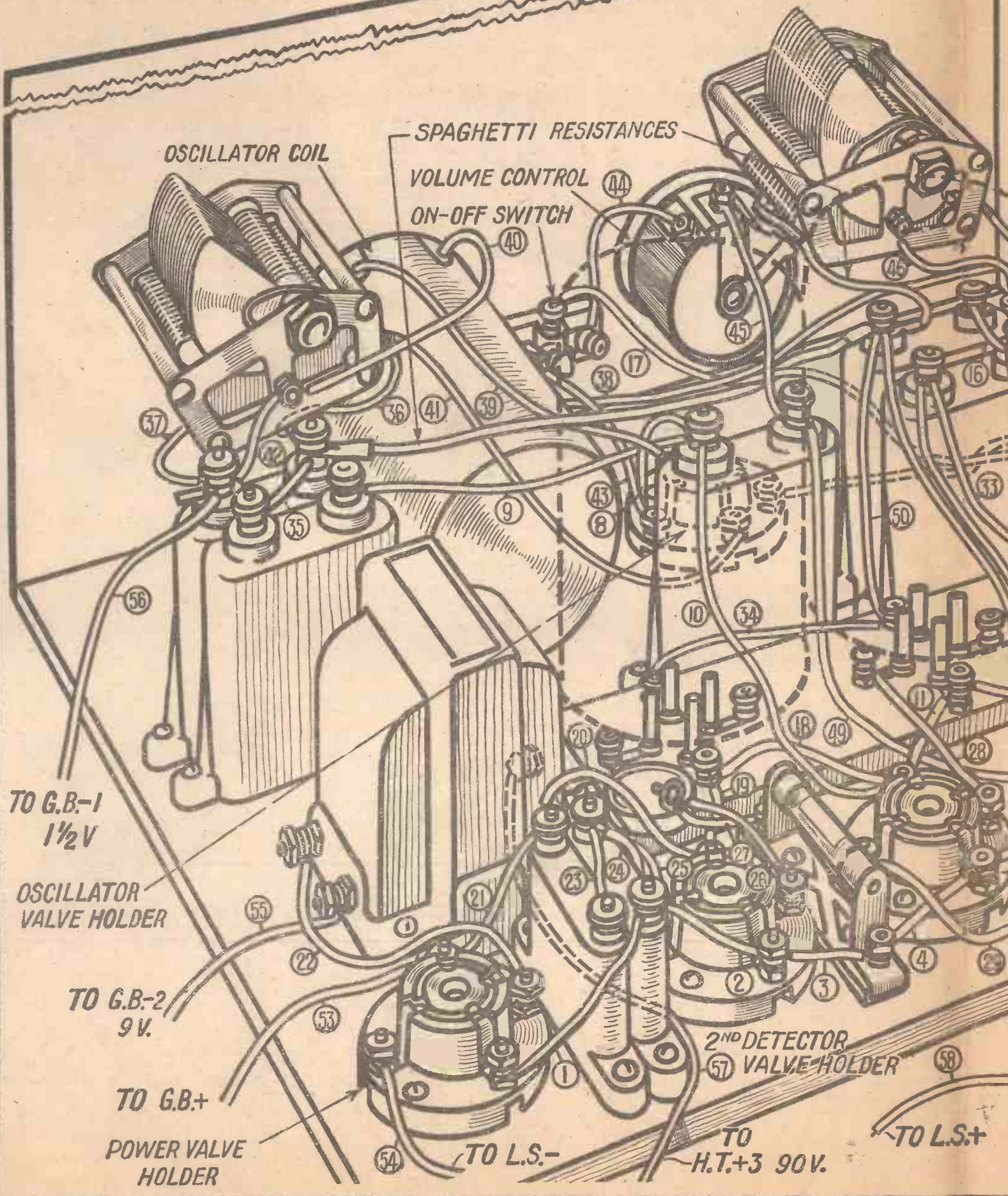

THE "CENTURY SUPER"

DESIGNED BY W. JAMES

Constructor's Pictorial Guide and List of Components

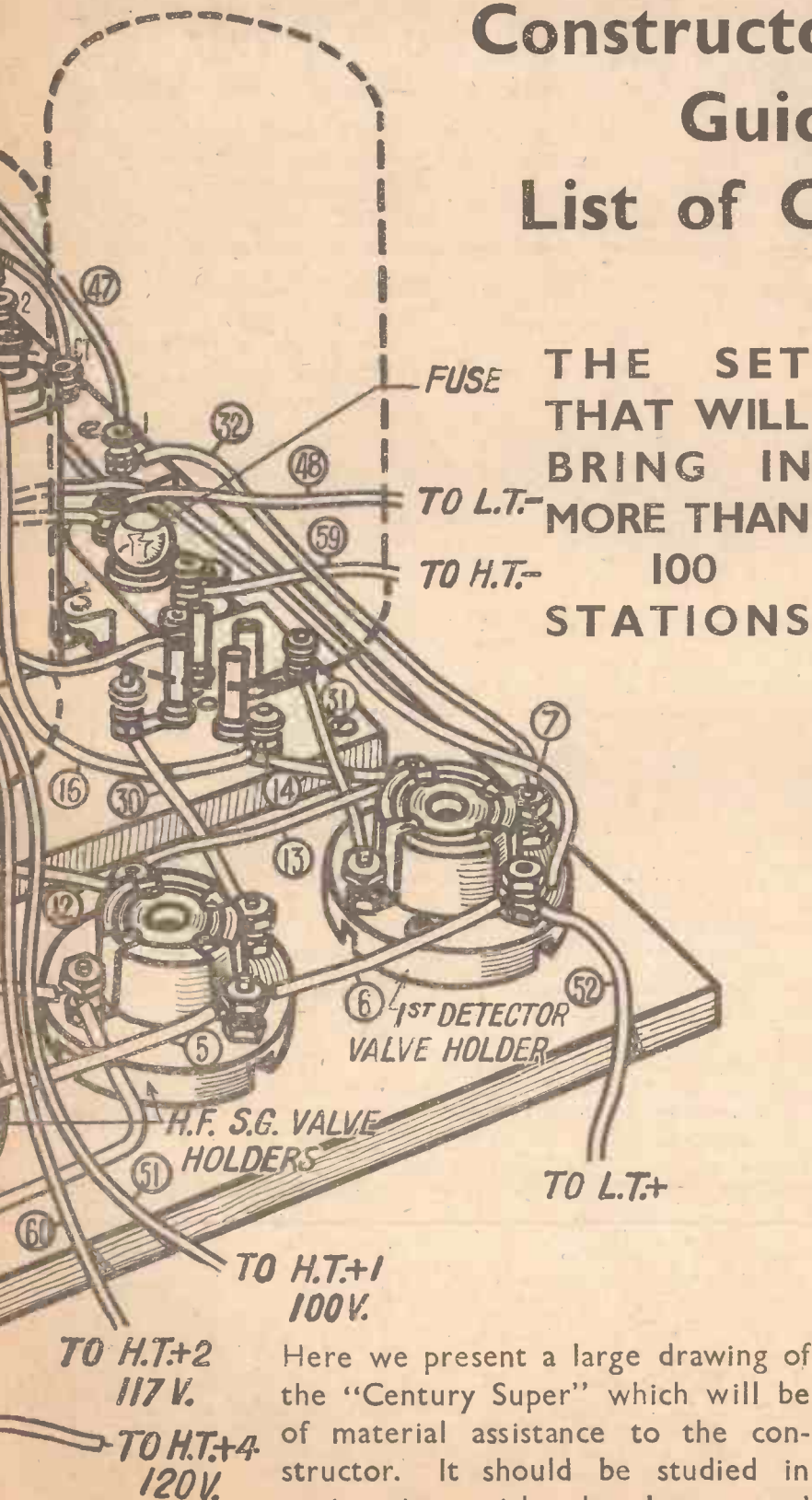

COMPONENTS REQUIRED for the "CENTURY SUPER"

Special cabinet and baseboard, and wooden panel (Camco, Peto-Scott, H. & B.).

Two .0005-mfd. variable condensers with slow-motion movement (J.B. "Tiny No. 2," Peto-Scott, Lissen, Ormond, Read-Rad, Cyldon).

50,000-ohm wire-wound potentiometer (Colvern, Sovereign, Regentstat, Rotor).

Three-point shorting switch (Read-Rad, Wearite, Bulgin, H.B., Benjamin, Lissen, Junit).

Set of super-heterodyne coils (Wearite, Lewcos).

Six valve holders (Telsen, Wearite, Lissen, Lotus, Benjamin, W.B., Clix).

Triple coil base (Peto-Scott, Wearite).

Five 1-mfd. fixed condensers (Dubilier, Lissen, T.C.C.).

Two .001-mfd. fixed condensers (T.C.C., Lissen, Telsen, Dubilier, Formo).

.0002-mfd. fixed condenser (Formo, Lissen, T.C.C., Dubilier, Read-Rad, Graham Farish).

Grid-leak holder (Read-Rad, Wearite, Lissen, Bulgin, Dubilier, Formo).

1-meg. grid-leak (Lissen, Dubilier, Telsen, Graham-Farish).

Low-frequency transformer (Telsen "Ace," Lissen, Varley, Ferranti, Burton, Lewcos, R.I., Voltron).

Terminal strip with three small terminals for baseboard mounting (Peto-Scott).

15,000 and 20,000-ohm spaghetti resistances (Lewcos, Bulgin, Read-Rad, Turner, Graham-Farish).

Fuse-holder and fuse (Bulgin, Read-Rad).

Five yards of thin flex (Lewcos).

Eight wander plugs marked: H.T.—, H.T.+1, H.T.+2, H.T.+3, H.T.+4, G.B.—, G.B.—1, G.B.—2 (Belling-Lee, Clix, Eelex).

Two spade terminals marked: L.T.—, L.T.— (Belling-Lee, Clix, Eelex).

Connecting wire and sleeving (Jifilinx, Read-Rad).

Frame aerial (Peto-Scott, Lewcos, Wearite).

ACCESSORIES

One cone speaker (B.T.H., Amplion, Mullard, Ormond, Blue-Spot).

One double capacity 120-volt H.T. battery (Ever-Ready, Pertrix, Drydex, Lissen, Fuller).

One grid-bias battery, 9 volts (Ever-Ready, Pertrix, Drydex, Lissen, Fuller).

One 2-volt accumulator (C.A.V., Exide, Pertrix).

Valves: One Mullard PM1LF, one Mullard PM2, two Mullard PM1HF, two Mullard PM12.

Instructions for building this amazing set are given on pages 712, 713 and 714

Here we present a large drawing of the "Century Super" which will be of material assistance to the constructor. It should be studied in conjunction with the layout and wiring diagram on page 714.

THE coils used in the "Century Super," of which preliminary details were given last week, are of rather special construction. That is why I am not giving details of the numbers of turns and winding details.

The three long-wavelength transformers used in the beat-frequency amplifier are alike as regards their internal construction, but two of them have flexible leads coming out of the top of the metal pots for convenience in connecting to the screen-grid valves.

Inside each metal pot is a transformer having both windings separately tuned. Thus there are the usual primary and secondary windings, which are spaced by a certain amount to provide a suitable degree of coupling. Then there is a condenser connected across the primary and a further one joined across the secondary.

The Coils

These condensers are not in the usual form of copper or foil electrodes with mica insulating pieces. They are composed of a pair of wires twisted together. During manufacture, therefore, the primary and secondary coils are wound to a certain inductance, and the condensers are also wound. Afterwards, the values are most accurately adjusted in a testing appliance and finally the coils are tuned to a given wavelength.

The transformers do not tune sharply to a given frequency, but are designed to have a fairly flat topped resonance curve. This is a most important matter. The whole performance of the set depends upon the accuracy with which the coils are prepared according to the specification.

There are the three coils in the long wavelength, or, as some would call it, the beat-frequency, amplifier. If one of the coils is out, the magnification will be lower than normal and the tuning would be broader than necessary.

With these carefully matched coils the selectivity is good and the magnification is ample for the reception of the most distant stations. If you pull off the cover from one of the coils you will see that the coils have been very carefully made. They are treated in order that the tuning should remain constant. This was a fault with older super-heterodyne coils. They were so constructed and finished that the tuning did not hold over a period.

In these coils great care has been taken to ensure extreme accuracy and constancy. In the older types of coils, as no doubt some readers will remember, it was usual to provide trimming condensers in order that the user could match up the circuits.

If the present-day super-heterodyne coils had to be adjusted in this manner, I should have left them alone, as experience has shown that consistently good results cannot be obtained unless the coils are tuned to a definite wavelength and will remain tuned to that wavelength for an indefinite period of time.

There are no trimming condensers in the circuit, therefore, because none are needed. You simply plug in the coils, knowing full well that they are accurately matched by the makers to the

Building the "C"

THE SET
THAT GIVES
AMAZING
RESULTS
AND IS EASY
TO BUILD AND
MAINTAIN

By W. JAMES



wavelength of the beat-frequency amplifier. The layout is chosen bearing this in mind, and the most careful tests on every part have failed to discover any lack of balance in the circuits.

It is here that we gain over the usual ganged tuning circuit, for the circuits must be properly tuned. This is easy enough for experienced amateurs, but is a great trouble to those who have not had much to do with the tuning of several circuits. In this set, therefore, the beat-frequency amplifier, which includes the two screen-grid valves, the second detector and the power valve, requires no tuning at all.

Component Positions

The parts are merely fixed in the positions given on the diagram on pages 670 and 675 in last week's issue and are bound to tune correctly and to magnify properly.

We have only the two circuits to tune,

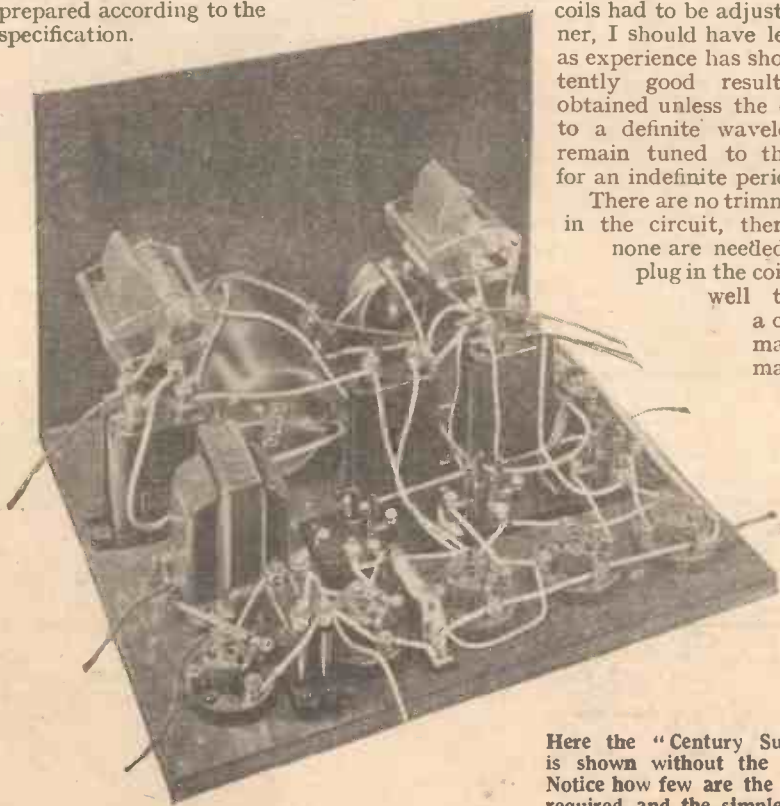

Here the "Century Super" is shown without the coils. Notice how few are the parts required, and the simple construction

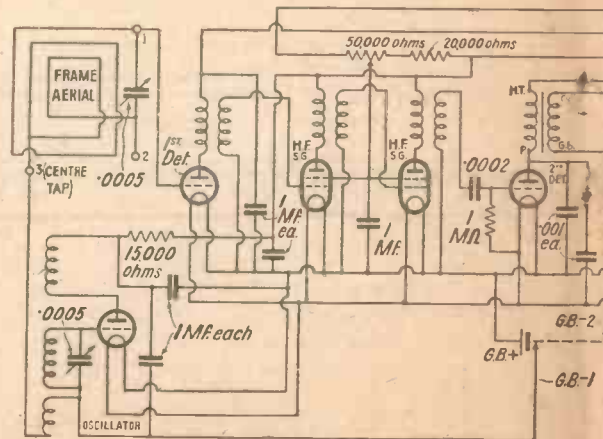

CENTURY SUPER



SIX-VALVE RESULTS AT THREE-VALVE COST

one being the frame-aerial circuit and the other the oscillator. If you looked inside the oscillator unit you

would see a switch and the tuning coils. There is nothing much here although the coils must be fairly accurately made in order to tune over the wavelength ranges with the .0005 microfarad tuning condenser. The shield is, of course, essential, or we should have a coupling with the frame aerial which would be undesirable and cause an amount of trouble.

The Oscillator

The oscillator is connected to about the centre point of the frame aerial, and you will notice that both sides of the frame-aerial tuning condenser are at a high-frequency potential to the filament circuits. Therefore, a metal panel cannot be used unless the parts are provided with ebonite bushes.

The construction is so easy and straightforward that there is little to be said about it. With the special three-point valve holder strip, used for the three beat-frequency amplifying coils, these coils are automatically suitably spaced, and the screen-grid anode leads come out in the right positions for the valves.

Some amateurs may want to make the frame aerial connecting strip themselves, and this is easy enough, as it comprises only a piece of

ebonite or paxolin having three small terminals. These are for the two ends of the frame and the centre tap. The strip measures $2\frac{3}{4}$ in. by $\frac{7}{8}$ in. and has two fixing holes as well as the three for the terminals. It is advisable to countersink the underneath sides of the holes for the terminals.

Detection

At the second detector we use a .0002-microfarad condenser and a 1-megohm grid-leak. These are smaller values than usual. But we have to preserve the quality and these values are better from this point of view than the more usual .0003-microfarad

and 2-megohms. A detector of the grid-leak type always tends to reduce the relative strength of the higher notes, we avoid this so far as possible by using a little lower value grid-leak and condenser.

Good by-passing in the anode circuit being essential, there are two fixed condensers. One is connected from the anode to the negative side of the filament in the usual way and the other goes from the anode to the positive side. You will notice that the connections here are very short, which is as it should be. These two fixed condensers are fitted between the second detector and power valve holders.

It is not necessary to connect the core of the transformer to the filament circuit, using the transformer indicated, but you should always try this with other makes.

I have found the results to be the same from both the Wright & Weaire and the Lewcos sets of coils; they are in fact interchangeable. Actually, the Lewcos coils have a different internal construction from the Wright & Weaire coils, but they both

tune to the same wavelength and are very well manufactured and tested.

This testing is an important item and any other old coils that you might have should on no account be used. I myself have several old patterns, having pre-set type condensers fitted to them which are not at all satisfactory. The great magnification is obtained in two ways: First, there is the straightforward amplification of the beat frequency amplifier. Being on a longer wavelength than any broadcast wavelength with the amplification with stability is of course, greater, which is one of the reasons for the choice of the particular wavelength used.

Then there is the effect of the oscillator and the first anode-bend "detector."

If you were to experiment with oscillators of different strengths, you would find that, starting with a weak oscillation

the signals from distant stations are also weak. As the oscillator is strengthened, thus increasing the strength of the oscillations in the grid circuit of the first "detector," the signals are brought up. A point is reached, however, where no further increase in the strength of the signals is brought about by adjusting the amplitude of the

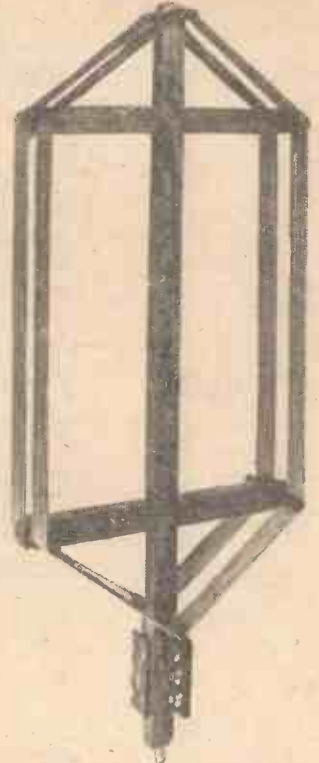

Another advantage of the "Century Super" is that an outside aerial is not required. This picture shows the frame aerial used.

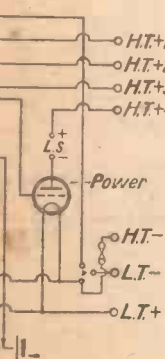

The circuit

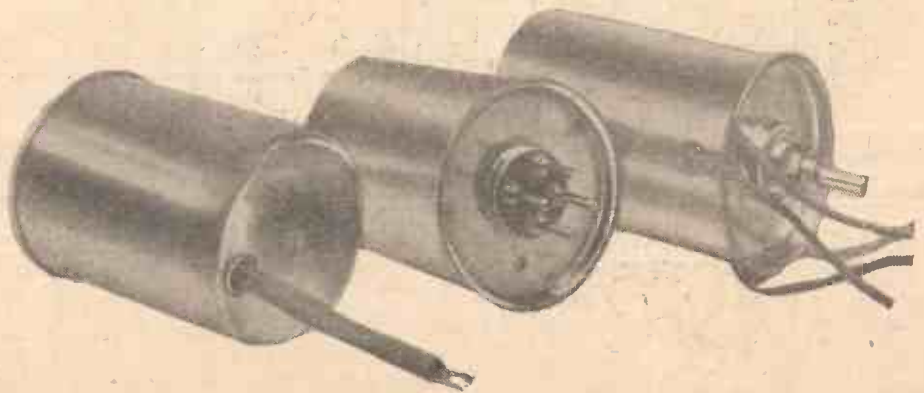

These are the intermediate-frequency coils which are an important feature of the set

A Weekly Programme Criticism—By SYDNEY MOSELEY.

Without Fear or Favour



A POPULAR CONDUCTOR

AT SAVOY HILL

SOMETHING near what a debate should be was that between my old colleague, S. P. B. Mais and Ivor Brown. They spoke on holidays, "Beaten Track v. Quietude," and, strangely enough, both scored heavily. It was a good "hammer and tongs" debate, and there must have been a lot of rehearsing.

Mais was, perhaps, a wee bit too downright; but the whole thing was first class and I congratulate them both.

Alfred Coates had an amazing reception at the Queen's Hall the other night. He has a way with him: is full of the joys of spring and enjoys robust health. After seeing him at the Queen's Hall I went to studio No. 10, and he seemed to wink and smile at each member of the orchestra in turn. No wonder he is popular.

All is not well at Savoy Hill, I understand. The clique of young, "modern," pseudo-intellectuals—we used to call them in the war, "swankpots"—are getting the upper hand.

I have had more criticism about the programmes lately than for a long time. What is wanted is a strong policy.

When I was up north recently they were trying to show me that they had the cream of singers. Some of them *are* the cream but I had my doubt about the others.

Listening to "Memories," a programme of old favourites the other day, I thought: Well, what is there better than these good old tunes? I admit, however, that some of the modern ones are catchy. For instance, "You're Driving Me Crazy" is rather clever.

The idea of getting vocal accompaniment to "More Melodious Memories" was good, although it shows up here and there the scrappiness of these dove-tail pieces.

I listened to Cyril Smith playing the piano on Sunday. He is, of course, the television pianist. An earnest young man, keen on his work, I think he should go far. His transmission from Savoy Hill revealed great ability.

I switched on for a moment to the

Children's Hour the other day and heard the line, "You shall die to-night." I suppose that is something to give the children to go to bed with.

Some of us were discussing "The Ridgeway Parade" the other day. One or two of my colleagues were very downright about it. But I found a little improvement

DESCRIBED ON PAGES
712 TO 714—THE
CENTURY SUPER—
THE SET FOR YOU

in the last transmission, although I fear Mr. Ridgeway himself as "Mr. Ramsbottom" didn't quite get over.

I have had no bricks, curiously enough, following my broadcast talk on films recently. The fact is, the talk was rather rushed on me and I was extremely busy at

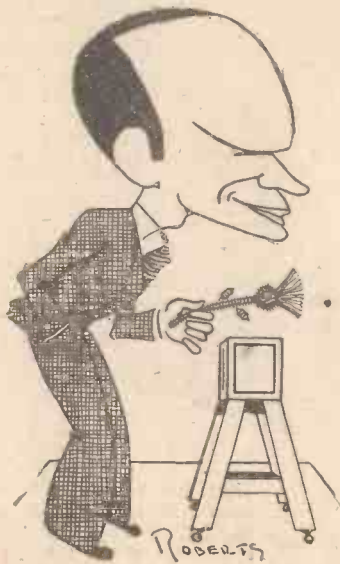

An impression of Sandy Rowan,
the popular Scotch comedian

THE TALKS DEPARTMENT

STUDIO APPLAUSE

the time. I was very surprised, therefore, to hear from a friend at Savoy Hill that it went over fairly well. One day I may make an interesting exposure about the extraordinary muddle of these films talk in which, curiously enough, I myself figure.

The talks department has suffered by lack of direction. The director herself is away and to my own knowledge three different people have had a hand. People outside have no idea of the chaos that prevails in a department that ought to be the easiest of all to organise.

The Wagner concert must have pleased everybody, and I am quite certain that those who didn't care very much for the master before have come to love him. What more beautiful song is there than the Death Song from *Tristan and Isolde*? Stop, you lowbrows, dare to tell me I am highbrow! I have a pile of letters bullying me for having said we get too much Bach cantata on Sundays. Perhaps you prefer Bach.

I see that a talk down by Ruth Maschwitz entitled, "Seeing is Believing," was changed for the more commonplace one of "The Antique Chair." Why on earth does the B.B.C. still ban that interesting subject, television? Miss Maschwitz would have been ideal for this subject.

"Requests" programme from the Midland Regional contained some obviously popular items as the *Adante Cantabile*, by Tchaikowsky, and *Fantasy on Grieg* and, so far as the songs are concerned, "The Admiral's Broom," "Until," and "Nirvana." I am not so certain whether the other items of the programme could be universally regarded as "requests."

The talk on the opening of the cricket season, by Mr. Howard Marshall, sounded rather sombre. He promised to go to the opening match at the Oval. It sounded as if he were going to his aunt's funeral.

In regard to studio applause, why doesn't the B.B.C. institute more generally the rule that some of us observe when we go to No. 10 studio on Sundays? That is, to wait until the red light is off before offering polite applause.

BUILDING THE "CENTURY SUPER" (Continued from preceding page)

oscillations. When an oscillator is tuned to different wavelengths the strength of the oscillations applied to the grid of the "detector" varies, sometimes over wide limits.

To reduce this effect so far as possible, the oscillator is connected to the high-tension supply through a fixed resistance and a bypass condenser, this acting also as a filter. The resistance used is 15,000 ohms and the condenser is 1 microfarad. This resistance acts to level the current taken by the oscillator over its range. If the current tends to increase, the voltage drop in the resistance rises and so tends to lower the voltage applied to the anode circuit. When, on the other hand, the current tends to fall off, the voltage drop is less and so a greater voltage is applied to the circuit, thus strengthening the oscillations.

If we had an adjustable resistance in the circuit we could vary the strength of the oscillations to suit all conditions, but this is not necessary in practice, the single fixed resistance being of such a value that good average results are obtained over all wavelengths.

A further fixed resistance, actually of 20,000 ohms, is included in series with the

(Continued on page 726)

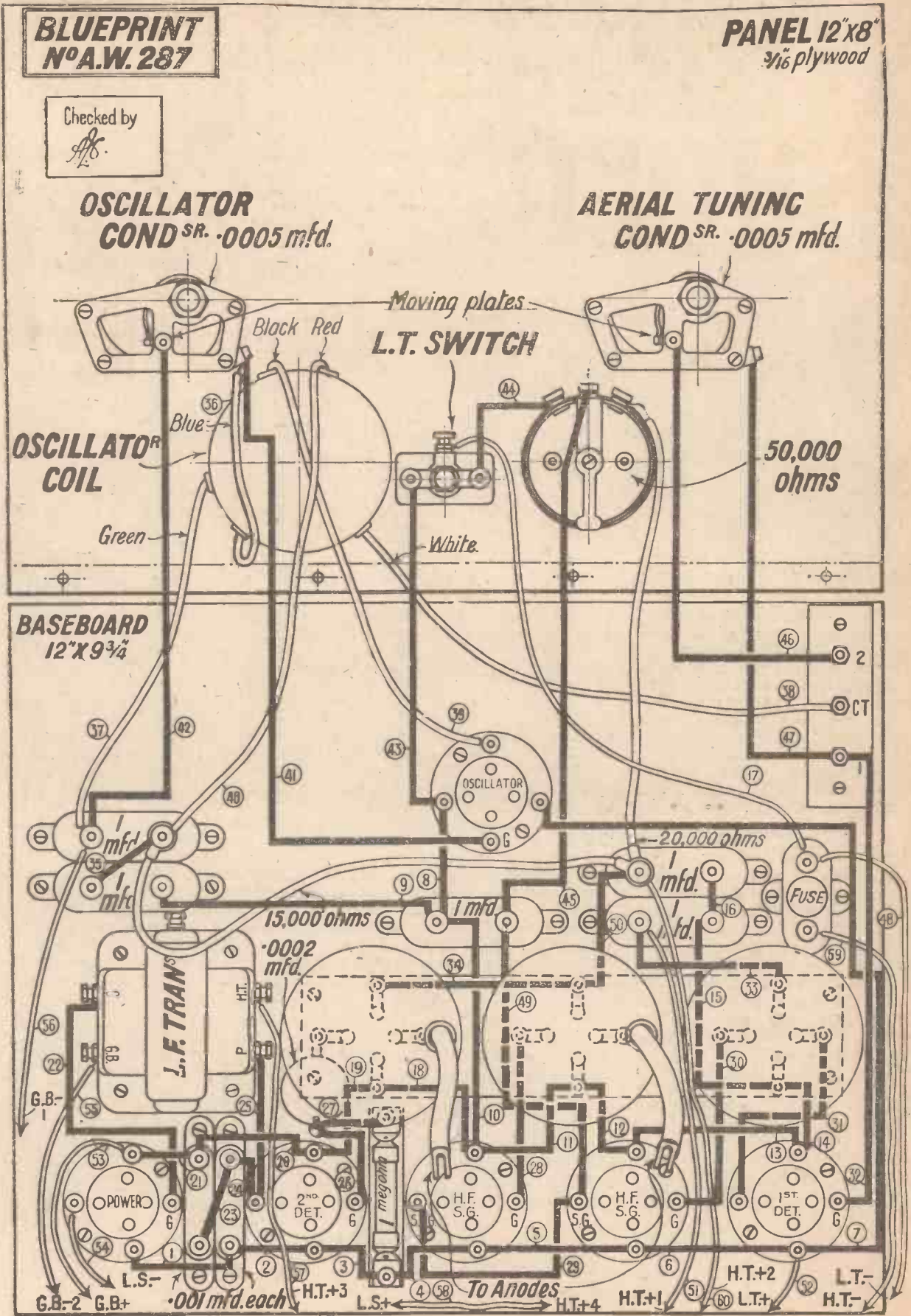

The layout and wiring diagram.

A full-size plan was included in last week's issue, and a full-size blueprint of the above is available, price 1/6

RECORDS of the MONTH'S BROADCAST MUSIC

LISTEN TO THE
BEST ITEMS
AGAIN!

The following notes are intended to link up current wireless programmes with the gramophone and assist readers to select permanent records of the most pleasing features. In every case the most suitable presentation of a particular item will be recommended and the name, make and number of the record given

A Fine Modern Suite

ON April 9, from London Regional, was played Eric Coates' "Four Ways." Here is a straightforward theme, each movement typifying an orthodox conception of lands and peoples to "Northwards," "Southwards," etc. They are orthodox in the sense that the tyro could readily name each piece if he did not know the title, but this is not to say that their presentation is in any way hackneyed. "Northwards," for instance, is a most virile inspiring march which tells its story in no uncertain manner. The whole suite is excellently played and superbly recorded by Columbia on two 12-in. records (DB9756-7). The performers are the Regal Cinema Orchestra. "Four Ways" is a most pleasing English work, which will delight again and again.

A Beautiful Serenade

Toselli's—played on a saxophone on April 25! A dreadful lapse, which we hasten to forget. Here is a most delicate artistry—a thing of great beauty. Its acquisition in the form I do most wholeheartedly commend is expensive, but worth the 6s. Renée Chemet's performance on H.M.V. DA955 is enchanting—it is one of the best violin solos recorded. It is doubtful if one would ever tire of this beautiful melody.

Two Delightful Songs

Here are two songs, given on April 5 and April 9 respectively, which will appeal to those who like ballads of sentiment—"Just because the Violets" and "A Song of Sleep." Both are sung by Walter Glynn, the first on H.M.V. B2372 and the second on H.M.V. B2723. Each will probably be derided by modernists, but the latter song achieved considerable fame in its day, although its theme is somewhat sombre.

Continental Light Music

There is a German talkie with the quaint title, "Three at a Petrol Station" from whose wealth of very good tunes the dance bands have been drawing lately. Further delving into the work of the German composers who are responsible for such music provides a heartening substitute for the American dance music "plugged" week after week. Let readers who want "something better" try Columbia DW2041, "Ein Freund, ein guter Freund," and H.M.V. EG2001, "Good Night." The first is a six-eight played by the Columbia Dance Orchestra, and the second a waltz by Marck Weber and his Orchestra. (On the back of the Columbia disc is a very delightful march-song, "Adieu, mein Kleiner Gardeoffizier," a number which the famous Taube has sung.) Yes, "Three at a Petrol Station" has done well by modern dancers. I believe foreign records of this type

do not command a very great sale in England. This can only be for the reason that dealers will not stock and play them to their customers. They are definitely superior to many of the better-known tunes.

Round the Programmes

A few items, just as reminders to readers: "The Belle of New York," newly revived and newly recorded by Zonophone (5822). A short selection this, unfortunately. Easthope Martin's "Fairings" and "Come to the Fair" (each on different dates). Both are on H.M.V., by Percy Heming, C1482. Drdla's Serenade. Hear Marjorie Hayward (violin) on H.M.V. B2140. This is a charming thing. "The Gipsy Princess," a jolly selection, is on the new Phonycord P117.

"The Midnight Review." Get Columbia DB9874 and enjoy Norman Allin's magnificent rendering. Finally, Strauss's "Ständchen," by Claire Dux (soprano), on Polydor 70690.

More New Records

Recent issues include some very pleasing items especially amongst the less expensive records. There appear to be signs of a tendency to forsake the boring duplication of jazz pieces for the more satisfying production of "straight" music.

Light Music

H.M.V. C2116 (4s. 6d.), "The Clock and Dresden China Figures," by Ketelby, is a novelty piece which should prove popular. A better musical study in horology than "The Clock is Playing" of recent fame. On the reverse Marck Weber's Orchestra plays "The Skater's Waltz" with customary ability.

Radio 1462, "La Fille de Mme. Angot." Here is a very pleasing selection from Lecocq's work of some generations ago. Gilbert and Sullivan enthusiasts should buy this excellent little disc.

The eternal "Blue Danube" reappears twice. Nevertheless, to Piccadilly 721 I would affix a V.H.C. card. Here, by Schomberg's Viennese Orchestra it is played as it should be (but in abridged form). Thanks, Piccadilly! To mention its performance by the Black Diamonds Band may smack of heresy, but on Zono 5849 one may hear a brass band play it with very proper restraint and sense of propriety. There are two re-issues of old favourites by the same company worthy of commendation: Zono 5822 and 5832 respectively, allotted to "Floradora" and "Belle of New York," and, secondly, "Nights of Gladness" and "Valse Septembre." The latter pair are completely equipped with zylphone, concertina, and the implements of musical modernity. One must notice the very satis-

factory fare provided by Phonycord under this head. P109, "Waltzes of the World," is good—performance and tone are excellent. These gaily-coloured flexible records are a most interesting and convenient contribution to recorded music. It is a pity that they can be played only with the special Phonycord needle, however, two are presented with each record. "Saschinka," a Russian medley, is played finely by Marek Weber's Orchestra on H.M.V. C2100. This record may have a somewhat limited appeal, but is interesting and attractive.

Songs

First of all comes Piccadilly 700, "The Toymakers' Song," from the "Toymakers of Nuremberg." It is sung by Bernard Dudley with a delightful baritone voice and perfect enunciation. Everybody should buy this record.

Sanderson's Songs are happily drawn on for Edison Bell Winner L5233. The vocal parts of Morlais Morgan and Gladys Knight are really well done, but the accompanying Scala Concert Orchestra should not imitate a massed band organisation.

Terance O'Neill sings the "Snowy Breasted Pearl" on Radio 1468. A charming little ballad, well rendered and recorded.

Orchestral Music

"The Bronze Horse" overture (H.M.V. C1997). I mention this with qualifications. It has a vogue: somebody described it as a "bustling" piece. Whilst it is not wholly satisfying, it is worth hearing. The performance and recording are excellent, however.

"Le Chasseur Maudit" (Fränck) demands mention, so good a performance is it. The music is too uncanny to be really popular, but it is worth while to learn how music can tell a story. Get a synopsis of this and let the composition interpret it to you on H.M.V. C2016-7.

"William Tell" Overture (Winner 5240-1). A straightforward and well-balanced production by the Vienna Symphony Orchestra.

Instrumental

The Paderewski Minuet and Mendelssohn's "Rondo Capriccioso" are played (concerto fashion) by a very able pianist, Yenovitch, on Broadcast 5216.

More Hawaiian guitar music. An excellent performance is that of "Aloma" on Sterno 629. The performers are The Pagan Three.

Humour

One of Leslie Sarony's attractive absurdities is recorded on Imperial 2417 (Icicle Joe), with a very competent orchestral accompaniment, whilst Broadcast are responsible for an excellent version of "Seven Veils," by Bob and Alf Pearson (3002).

WHAT DOES KENDALL THINK OF THE "CENTURY SUPER"?



Coombe Cottage,
Oaklands Avenue,
Esher,
Surrey.
22nd. April, 1931.

The Managing Director,
Messrs. Ready Radio,
159, Boro' High St.,
London Bridge,
S.E.1.

Dear Sir,

I have had the pleasure of witnessing your demonstration of the extremely interesting possibilities of the "Century Super" receiver made up from a "Ready Radio" kit of parts.

I was greatly impressed with the results obtained in the course of the demonstration, so much so, that I later took an opportunity of handling the receiver myself and applying some severe tests.

As a result of these tests I came to the definite conclusion that this receiver sets a higher standard of selectivity, range and power than has been forthcoming from any Superhet which I have previously handled. I am confident that the instrument must prove irresistible to every listener who requires a set capable of dealing with the difficult modern conditions, with real ease and certainty.

A point which is of greater importance than usual in a receiver of this sensitive, high power type, is the fact that the use of a properly Matched Kit of components can play a great part in determining the results obtained.

Yours truly,

G. P. Kendall

Mr. G. P. Kendall, B.Sc. For 8 years with "Modern Wireless" and "Popular Wireless," as Assistant Editor and also as Chief of Research Department, heard the "Century Super" demonstrated at the Ready Radio Showrooms and was immediately impressed by its wonderful performance. Read what he says!

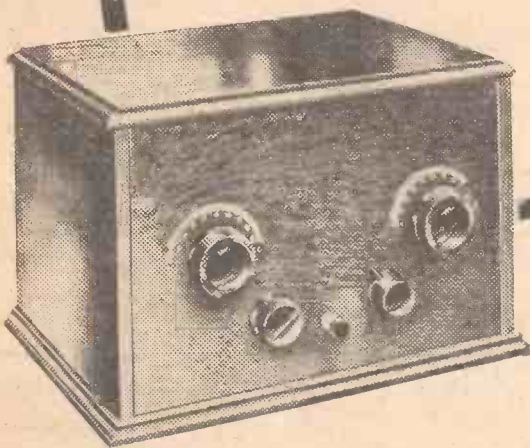

Come and hear the "Century Super" demonstrated at our Showrooms!

Ready Radio

159, BOROUGH HIGH STREET,
LONDON BRIDGE, S.E.1.

Telephone: HOP 5555 (Private Exchange) Telegrams: READIRAD, SEDIST.

Price Lists and Order Form on Page 719

Mention of "Amateur Wireless" to Advertisers will Ensure Prompt Attention

IN MY WIRELESS DEN



WEEKLY TIPS—
CONSTRUCTIONAL AND THEORETICAL

By W. JAMES.

“Slow” Mains Valves

I WONDER whether the valve manufacturers will ever be able to shorten the time now taken for a mains valve to reach its operating condition from cold.

The waiting time is a disadvantage and if it can be reduced all users would be grateful. No doubt the bulk of the cathode, or should one say of the insulating material upon which the cathode is carried, is responsible for the time taken.

There are American A.C. valves, I see, in which the construction has been specially arranged to make the heating time as short as possible. If this can be carried out with our own valves, without increasing the hum or noise, then something ought to be done about it!

The recently introduced metal-coated valves, which have a metal coating sprayed on to the bulbs, are a marked improvement. Being connected to the cathode pin of the holder in the case of indirectly heated valves, the coating forms a metal shield and is of value in reducing pick-up and improving the performance of screen-grid valves. More quiet operation is, therefore, to be expected and a gain in stability, which is all to the good. The valves, I understand, are not to cost more than the ordinary types.

Tracing a Hum

It is sometimes rather difficult to trace what is producing a hum in a mains set. There are so many possible faults, such as poor smoothing, centre tap out of position, and so on.

One fault that sometimes crops up is a poor contact of the grid pin of a valve with its socket in the holder. If this should be the detector valve a hum will in all probability be heard.

The grid circuit of a detector valve is extraordinarily sensitive. A poor contact will nearly always produce a hum or noise. Care should, therefore, always be taken that the valve pin makes a good contact and when a hum is heard it is as well to go over the valves.

Now Summer is Here

Summer time being here now, I expect we shall all notice a falling off in the number of stations received during the evening.

This is, therefore, a particularly good time to build a real long-distance set. It is surprising how few sets will bring in, say, a dozen stations during the hours of daylight, but a good super-heterodyne will do it.

We rely upon the long-wavelength stations partly, of course, as they are

always fairly easily received. Personally, I like working during the hours of daylight, for if a set brings in stations then, I know that when it is dark any number will be heard.

Stray H.F.'s

In an endeavour to prevent trouble through high-frequency currents passing through low-frequency circuits and perhaps reaching the speaker, fixed resistances are often included in the grid leads to the low-frequency valves.

These resistances act to reduce the voltage of the high-frequency currents applied across the grid-filament path of the valves. So far as the H.F. currents are concerned, we have a resistance in series with a condenser, made up of the working

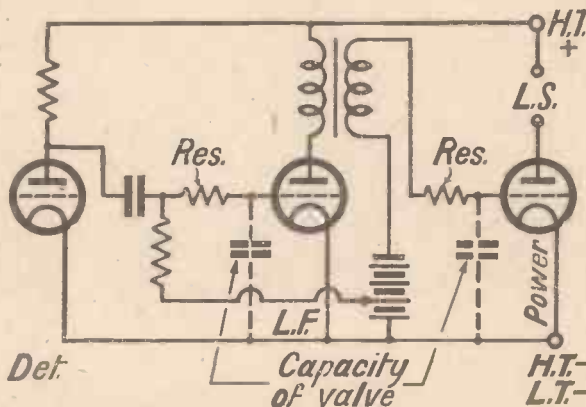

This idea for cutting out stray H.F. currents is described in the accompanying paragraph by W. James

capacity of the valve. If, therefore, the impedance of the resistance unit is large compared with that of the capacity, the greater part of the voltage is set up across the resistance.

In the accompanying diagram I show the resistance and capacity from which this point will be clear. We have low-frequency voltages in the circuit, however, and these reach the grid through the resistance. If the resistance is high, therefore, or the capacity is relatively large, the tendency will be for the higher audio frequencies to be weakened. This must be guarded against by not using a larger resistance than necessary. For one stage a 100,000-ohm resistance is often used, but values of 50,000 ohms will usually be satisfactory for two stages.

Use a Pilot Light

A pilot or dial light fitted to an A.C. set costs very little to run, but now and again I have letters complaining that the bulbs

soon burn out. This is because the wrong type bulbs are used.

The filament or heater circuit has a voltage of 4, so a 4-volt bulb should be used. When a bright light is not needed, the bulb may have a higher voltage rating with advantage. A current of .1 ampere is usually enough, but much depends upon the arrangement of the set itself. Perhaps a bulb taking a heavier current is needed properly to light up the dial.

High H.T.

There is much to be said in favour of using a voltage of, say, 160 on the anode of the power valve of a battery set. The usual voltage of 100 to 120 (when the battery is new) is not enough for some purposes, although I know that many listeners are satisfied with the results obtained when the battery is of this order of voltage.

With the higher voltage and suitable grid bias, the volume will be much greater before overloading sets in and usually the quality will be better, as when the lower voltage is used the last stage is usually overworked.

A point to note, however, is that the current is fairly high when the voltage is of the order of 160, and the battery may not be suitable for supplying this relatively heavy current. Before investing in the extra battery, therefore, you should examine the valve maker's curves of the particular power valve used and find what the current is likely to be if the voltage is increased.

One part of the battery will, of course, be carrying the full current of the set and the other part a smaller current, as the anode circuits will be tapped off different points in the battery. If you raise the anode voltage of all the valves the total current will go up considerably.

Matching with the Speaker

The best way of dealing with speakers of very different impedances which it is desired to connect to a set is to fit separate output circuits.

One may well be connected through a choke-condenser filter, and the other may best be supplied through a transformer. It depends upon the characteristics of the loud-speakers, of course. A low-resistance loud-speaker must have its transformer coupling and a high-resistance one may be best connected through a 1-1 ratio transformer or a filter circuit.

GET IT FROM READY RADIO

THE CENTURY SUPER

IMMEDIATE DESPATCH

Avoid delay and disappointment and the offer of unsatisfactory substitutes by ordering a complete kit of specified components from Ready Radio.

KIT A

(Less Valves and Cabinet, but including Wound Frame Aerial.) **£6 : 18 : 6**
or 12 equal monthly instalments of **12/8**

KIT B

(Including Valves, Wound Frame Aerial, but less Cabinet.) **£10 : 14 : 6**
or 12 equal monthly instalments of **19/8**

KIT C

(Including Valves, Cabinet and Wound Frame Aerial.) **£11 : 9 : 6**
or 12 equal monthly instalments of **21/-**

| | £ | s. | d. |
|---|------------|----------|----------|
| 1 Cabinet complete with wooden panel 12 in. by 6 in. and baseboard 12 in. by 10 in. ... | 15 | 0 | |
| 1 Frame aerial wound to specification ... | 1 | 0 | 0 |
| 2 Jackson .0005 mfd. variable condensers, Tiny No. 2 ... | 17 | 0 | |
| 1 Colvern 50,000 ohm potentiometer ... | 5 | 6 | |
| 1 Readi Rad 3-point shorting switch ... | 1 | 6 | |
| 1 Set Wearite or Lewcos Super Heterodyne coils ... | 2 | 10 | 0 |
| 6 Telsen 4-pin valve holders ... | 6 | 0 | |
| 1 Triple coil base ... | 2 | 9 | |
| 5 T.C.C. 1 mfd. fixed condensers ... | 14 | 2 | |
| 2 Telsen .001 mfd. fixed condensers ... | 2 | 0 | |
| 1 Formo .0002 mfd. "Mikadenser" ... | 1 | 4 | |
| 1 Readi Rad 1-megohm grid leak and holder ... | 1 | 4 | |
| 1 Telsen "Ace" L.F. transformer ... | 8 | 6 | |
| 1 Terminal strip fitted 3 6-B.A. terminals ... | 1 | 3 | |
| 1 Readi Rad 15,000 ohm. link resistance ... | 1 | 3 | |
| 1 Readi Rad 20,000 ohm. link resistance ... | 1 | 3 | |
| 1 Readi Rad fuse and holder ... | 1 | 4 | |
| 8 Belling Lee wander plugs ... | 1 | 4 | |
| 2 Spade terminals, red and black ... | 3 | | |
| 1 Packet Readi Rad "Jiffilinx" for wiring ... | 2 | 6 | |
| 6 Valves to specification, 2 S.G., 2 H.F., L.F. and Power ... | 3 | 16 | 0 |
| 5 Yards thin flex, screws, etc. ... | 11 | | |
| Total (including Valves, Cabinet and Wound Frame Aerial) ... | £11 | 9 | 6 |

RECOMMENDED ACCESSORIES

| | | | |
|--|----|----|---|
| 2 Fuller 60-volt "Super" capacity H.T. batteries ... | 1 | 7 | 0 |
| 1 Fuller 9-volt grid bias battery ... | 1 | 6 | |
| 1 Fuller (S.W.X.9) 2-v. 40 80 amp. L.T. accum. ... | 12 | 9 | |
| 1 Celestion D.10 loudspeaker ... | 3 | 0 | 0 |
| or 1 Amplion cone loudspeaker A.C. 21 ... | 1 | 19 | 6 |

Any Component can be supplied separately.

THE CENTURY SUPER

Completely assembled with valves, cabinet and wound frame aerial, ready for use and aerial tested. **Price ... £14:10:0**
or 12 monthly payments of 26/6.

ORDER NOW
STRICTLY PRIVATE
EASY PAYMENTS

TO INLAND CUSTOMERS.
Your Orders are sent Post Free or Carriage Paid.
TO OVERSEAS CUSTOMERS.
All Overseas Customers Orders are carefully packed for export and insured to nearest port, charges forward.

ORDER NOW
IT COSTS NO MORE
PAY ON DELIVERY

IMMEDIATE DESPATCH ORDER FORM

To: Ready Radio (R.R. Ltd.), 159 Borough High St., London Bridge, S.E.1

CASH ORDER. Please despatch to me at once the goods specified for which I enclose payment in full of £

C.O.D. ORDER. Please despatch to me at once the goods specified for which I will pay in full the sum of £

HIRE PURCHASE ORDER. Please despatch my Hire Purchase order for the goods specified for which I enclose first deposit of £

Cross out whichever does not apply.

Name

Address

KIT REQUIRED

You will Help Yourself and Help Us by Mentioning "A.W." to Advertisers



The CATESBY ORBIT

RADIO-GRAMOPHONE

SETS OF DISTINCTION

Makers : Catesby's.

Price : £18 10s. (for the complete instrument)



MOST of the sets I test, although differing in many details, conform to what has become a standard method of construction and design. Here is something different; the Catesby convertible gramophone, three-valve radio set or radio-gramophone.

By an ingenious system of assembly, it is possible for the listener to start with a simple gramophone and by easy stages (easy payments, too, if necessary!) to convert it into a complete radio-gramophone. Or one can start with a three-valve console set and convert it later on into a radio-gramophone.

Plenty of scope is allowed for individual tastes, for the set can be either battery-driven or supplied with a Regentone mains unit for the high-tension current, in which

with all desirable gadgets, such as automatic stop.

Mounted in the correct position near the turntable I noted an Ultra gramophone pick-up. Convenient cups to take old and new needles are also fitted.

In the lower front part of the cabinet I found the loud-speaker, which is an Ultra double-linen-diaphragm type, capable of giving excellent results with a normal three-valver.

The three-valver, fitted into a suitable compartment immediately above the loud-speaker, is built up as a compact metal chassis. The layout of the components is somewhat unorthodox, but my tests show that this layout is justified by the entirely satisfactory radio reception. The chief component is a two-gang condenser, comprising two bakelite dielectric condenser units and an admirable slow-motion dial reading from 0 to 100 degrees.

As an auxiliary to the main tuning knob is a small knob for trimming the two condenser units. The layout of the panel controls is quite straightforward and all the knobs are notable for their ease of operation.

As already stated, the tuner occupies the centre of the panel. There are four other control knobs, two on the left and two on the right. The top left-hand knob controls the switch, providing gramophone reproduction or radio reception. For the radio side the circuit comprises a screen-grid valve, a detector and a transformer-coupled power valve, but for the gramophone side the high-frequency valve is not used.

Near this switch is the radio volume control, which, during tests, worked admirably. This control is of great use when receiving nearby powerful stations. To the right at the top of the panel is another switch knob providing medium and long-wave tuning. There is also a centre "off" position. Near this switch knob is the reaction control and this is, of course, essential when receiving most of the distant stations capable of being heard on this set.

As the chassis is designed for use as a gramophone amplifier in addition to its function as a three-valve radio set, the makers have quite rightly emphasised the need for amplification from the detector

valve onwards. For this reason a 7-to-1 ratio low-frequency transformer is used to couple together the detector and power valves.

I am quite satisfied with the way in which this convertible instrument fulfils the makers' claims. Certainly the results are remarkable in view of the low price of the complete job. Quality of reproduction, probably due to the linen diaphragm loud-speaker, is above the average for an inexpensive console. Of course, a lot depends upon the power supply and on the last valve.

The radio side is quite easy to operate and works well in London with the frame aerial. By the way, this frame is directional, and for this reason the cabinet door in which it is fitted can be readily moved through a wide angle.

Very complete instructions are issued with the Orbit radio-gramophone and these are well worth a perusal by all readers of AMATEUR WIRELESS interested in this account.

SET TESTER.

TELEVISION FOR AVIATORS

AN American inventor has devised an ingenious television system for helping an aircraft pilot to land his machine safely during foggy weather, or at night, when it is not possible to get a direct view of the aerodrome. The approaching aeroplane is first picked up by direction-finding aerials installed at the aerodrome, and its subsequent movements are followed by electrical repeaters and projected as a moving spot of light on to a contour map showing the landing-field and its immediate surroundings. The map is then transmitted by television apparatus to the approaching machine, where it is thrown on to a viewing-screen on the instrument board, so that the pilot is able to follow his own course through the air by observing the spot of light as it moves across the background of the televised map.

B. A. R.

Bordeaux-Sud-ouest (France) transmits a special late musical programme every Tuesday until midnight G.M.T.

The Compagnie Francaise de Radiophonie (Paris) officially states that the new Radio Toulouse transmitter now under construction will be so planned that its power can be rapidly increased from 60 to 150 kilowatts in the aerial.

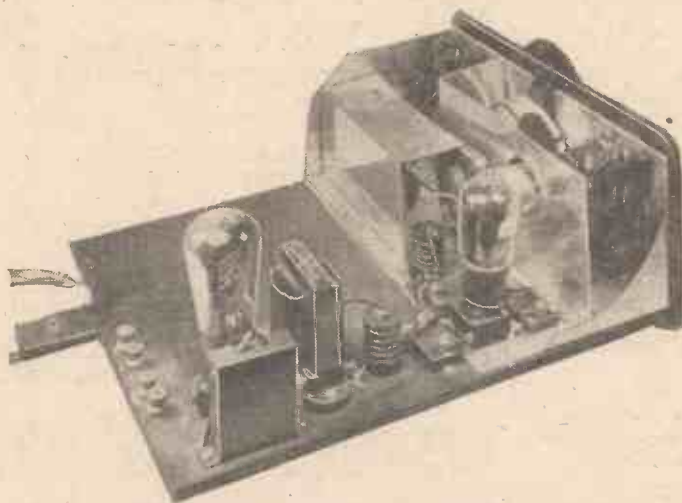

The chassis of the Catesby Orbit radio-gramophone

case a trickle charger is used to keep up the low-tension accumulator.

Among the gramophone accessories one has a choice of a Collaro spring turntable motor or an electric motor.

The cabinet of the Catesby Orbit instrument, which makes these conversion ideas practicable, comprises a removable motor-board and suitable space to accommodate the necessary batteries, gramophone horn or loud-speaker, pick-up or tone arm; and there is still ample space left for gramophone records. In the door of the cabinet is fitted a frame aerial, so that the instrument can be used as an entirely self-contained radio-gramophone if necessary.

I was recently supplied with a completely assembled Orbit radio-gramophone for battery operation. On the motor-board is mounted a Collaro motor with a winder brought out to the side of the cabinet. This motor is a very good job and is fitted

C.O.D

Pay the Postman—it costs no more
—We pay all charges on all orders
over 10/-



Strict Privacy Guaranteed
on all H.P. Orders

CASH

with order—Carriage Paid

PILOT KITS

—Everybody's buying them for the
CENTURY SUPER-HET
because they include the specified
Peto-Scott Frame Aerial on which
"A.W." obtained amazing results



SENT C.O.D. PETO-SCOTT CENTURY FRAME AERIAL

As illustrated, in polished
Oak or Mahogany—Pay
the Postman. **20/-**

Supplied with accurate-fitting bearing bush, wave-change switch, 3-way leads and six spacers. Each strand of wire is enamelled and covered overall, which ensures maximum results. Correct centre-tapped. This is a new type frame aerial designed at the request of "A.W." by Peto-Scott himself. No substitute will do. Beware of imitations. You must have a Peto-Scott Century Frame Aerial to ensure results obtained by "A.W." and Daily Mail. If desired we can supply Leveco's Frame Aerial 32/6.

CABINET. Specification: Handsome Polished Oak, 12" x 8" x 10" deep. Fitted with figured oak panel, polished and drilled; also 12" x 10" 6-ply baseboard. Oak or Mahogany **15/-**

The Components Included in every PILOT KIT are guaranteed against manufacturing fault. Faulty parts replaced.

ALSO SEND FOR THESE SPECIAL PARTS, C.O.D. Pay the Postman:

Wearite Super-Het Coils. Set of 4 coils. As used by the designers and included in Pilot Radio Kits. **£2-10-0**

6 Mullard Valves for Century Super-Het
1 P.M.1.L.F.; 2 P.M.1.H.F.;
1 P.M.2; 2 P.M.12. **£3-16-0**

● KIT "A" Less Valves, Cabinet and Frame Aerial. **£5.6.6**

Or 12 monthly payments of 9/9
KIT "A" with Frame Aerial, **£6.6.6**, or 12 monthly payments of 11/7

KIT "B" £9.2.6 **KIT "C" £10.17.6**

As above with valves but less Cabinet and Frame Aerial
or 12 monthly payments of 16/9
KIT "B" with Frame Aerial **£10-2-6**
or 12 monthly payments of 18/7

Complete with Valves, Cabinet and Baseboard, Panel and Frame Aerial.
or 12 monthly payments of **£1.0.0**

Kit of parts as approved by A.W.

| | £ | s. | d. |
|--|----|----|---------------|
| 2 .0005-mfd. Variable Condensers with slow-motion movement. Peto-Scott Sovereign | 12 | 0 | |
| 1 50,000-ohm. wire-wound potentiometer. | 4 | 6 | |
| 1 Three-point starting switch. Ready Radio | 1 | 6 | |
| 1 Set of Super-het coils. Wearite or Leveco's | 2 | 10 | 0 |
| 6 Valve holders. Telsen | 6 | 0 | |
| 1 Triple-coil base. Peto-Scott | 2 | 9 | |
| 3 1-mfd. fixed condensers. Franklin | 10 | 10 | |
| 2 .001-mfd. fixed condensers. Graham Parish | 2 | 0 | |
| 1 .0002-mfd. fixed condenser. Formo or Ormond | 6 | | |
| 1 Grid leak holder | 1 | 0 | |
| 1 1-meg. grid leak. Telsen | 1 | 0 | |
| 1 Low-frequency transformer. Telsen "Ace" | 8 | 6 | |
| 2 Spaghetti resistances, 15,000 and 20,000-ohm. Keystone or Leveco's | 3 | 0 | |
| 1 Fuse holder and fuse. Ready Radio or Dunlop | 1 | 3 | |
| 8 Wauder plugs marked: H.T.—, H.T.—, 1. H.T.—3, H.T.—3, H.T.—4, G.B.—, G.B.—1, G.B.—2, Belling-Len | 2 | 0 | |
| 2 Spade terminals, L.T.—, L.T.—, Peto-Scott | 3 | | |
| Konecterkit. Terminal strip with three small terminals for baseboard mounting (Peto-Scott) 5 yards of thin flex, glazed connecting wire, fixing screws, bolts and nuts, etc. | | | GRATIS |

Customers ordering this Kit are supplied with matched knobs in mottled oak effect to tone with the polished oak panel. Black knobs supplied with Ebonite Panel. Also Dial Reading Chart supplied specially calibrated on Peto-Scott Condensers by our Technical Staff.
★ Fitted with J.B. "Tiny" Condensers 5/- extra

SPECIFIED ACCESSORIES

| | £ | s. | d. |
|---|----|----|----|
| Handsome Polished Oak or Mahogany Cabinet with figured oak panel 12" x 8" ready drilled and 6 ply baseboard 12" x 10" | 15 | 0 | |
| CENTURY SUPER FRAME AERIAL READY WOUND WITH SWITCH | 1 | 0 | 0 |
| Oak panel polished and drilled 12" x 8" | 2 | 0 | |
| 6 ply baseboard | 1 | 0 | |
| Ebonite panel 12" x 8" x 3/8" drilled | 4 | 6 | |
| 1 Green Triangle 120V. H.T. Battery, Drydex | 18 | 6 | |
| 1 Grid Bias 9V Battery, Drydex | 1 | 4 | |
| 1 20/40 Accumulator. Exide | 9 | 6 | |
| 6 Mullard Valves, 1 P.M.1.L.F.; 2 P.M.1.H.F.; 1 P.M.2; 2 P.M.12 | 3 | 16 | 0 |

ANY PARTS SUPPLIED SEPARATELY If value over 10/- sent C.O.D.

FREE with every Kit a Konecterkit containing all screws, nuts, bolts, etc., terminal strips, 5 yds. flex and glazed connecting wire.

FREE to every purchaser of the CENTURY, a full sized diagram and copy of "Amateur Wireless" containing constructional details.

FREE Every CENTURY owner becomes entitled to free technical advice and assistance.

FINISHED INSTRUMENT

Fitted with Valves, Cabinet and Frame Aerial **£12.7.6**
Royalties extra **£1.10.0**
Or deposit **£3.17.6** and 11 monthly payments of **£1.**
NOTE: Batteries extra.

Peto-Scott Cabinet
Handsome French-Polished Oak Cabinet with Drilled Panel and Baseboard. **15/-**

EXPRESS ORDER FORM

To PETO-SCOTT CO. LTD.
Please send me **C.O.D./CASH/H.P.**

for which I enclose Cash / H.P. Deposit
£ s. d.

Name

Address

A.W. 2/5/31

PETO-SCOTT CO. LTD.

77 CITY ROAD, LONDON, E.C.1: Clerkenwell 9406. 62 HIGH HOLBORN, LONDON, W.C.1
Chancery 8266. MANCHESTER: 33 WHITELOW ROAD, CHORLTON-CUM-HARDY. Phone:
Chorlton-cum-Hardy 2028. NEWCASTLE, STAFFS: 7 ALBANY ROAD. Phone: 67190.



Mains Hum

SIR,—In a note in a recent issue of *AMATEUR WIRELESS*, under the heading "An All-mains Weakness," "Thermion" quotes a friend whose set develops a hum in the morning.

The explanation is, of course, perfectly correct. I have experienced the same trouble ever since I installed an A.C. radio-gramophone. Not only is the radio part of the set inclined to hum in the morning, but interference from the gramophone motor, practically inaudible at night, is often very bad. This morning I have just tried to play a record, but the interference was so appalling that I had to stop it.

I may add that I have gone to a good deal of trouble in the way of scratch filters and tone controls to obtain the really good reproduction which I get in the evening. I often wonder whether H.T. accumulators combined with indirectly heated A.C. valves would be worth while trying.

C. M. S. (Fareham).

Penny-in-the-Slot Wireless

SIR,—You might be interested and amused to know that I have had a penny-in-the-slot fitting attached to my set for some time. Its average takings are 1s. 9d. weekly. By the time new batteries are required we have the necessary cash! The on-off switch on the panel is not used, anyone wishing to listen-in simply puts a penny in the slot and away it goes. I should be pleased to know if you have heard of a similar novelty of this kind.

A. J. (Sheffield).

Adding H.F. Valve

SIR,—I recently added an ordinary H.F. unit to my existing three-valve receiver, thinking to increase the receiving range. Contrary to expectation, this unit has decreased my range and also the power of stations that are received. Can you account for this?

K. M. (Bath).

Your original set probably had reaction coupled into the aerial system, and this enabled you to overcome the effects of resistance in your aerial and earth system. Now that you have added an H.F. unit, you have, no doubt, cut off the reaction from the aerial and the aerial-earth resistance is causing you poor reception. By attending to the aerial and earth, reducing resistance as far as possible you should be able to improve your reception. Another thing, your H.T. battery may have been suitable for the working of a three-valve set, but is not capable of working four valves. If you are using a standard-capacity dry-cell H.T. battery for your four valves, replace it with a double- or triple-capacity dry-cell H.T. battery. In this way you will ensure that all valves get sufficient current for efficient working.—Ed.

The "1931 Ether Searcher"

SIR,—I have just completed the above wonderful set and arranged it to work entirely from A.C. mains with great success. The only modification was to use a differential aerial series condenser so as to use it more as a volume control and a similar condenser for reaction. This was found necessary for stability.

Indirectly-heated valves were used throughout and the volume was sufficient fully to load the Mazda AC/Pr. H.T. and L.T. were fed from a combined transformer, the former feeding a H.T.7 Westinghouse rectifier. All circuits were generously decoupled and a variable H.T. feed was arranged for the detector as well as S.G. The detector was not at all critical as to its H.T., so a 30,000-ohm fixed resistance was put in circuit for simplicity.

The grid bias was arranged with variable resistances in the cathode leads, with, of course, the usual shunt condenser.

The set works admirably—splendid tone and very selective.

W. E. R. B. (Guildford).

Accumulator Charging

SIR,—I have been extremely interested in the recent discussion on accumulators, as it is my job to charge a number of these at the local garage. If "Thermion" could see some of the sulphated things that are sometimes brought in to be charged, his sympathy would be on my side.

With regard to the question of buying a low-tension accumulator, I should choose a glass cell with separators. Plates that are kept in position by flanges moulded in the case come to an untimely end by buckling, not necessarily due to ill treatment of any kind, but by reason of the fact that the positive plates expand; and as the glass holds the edges of the plates tightly, they cannot expand outwards, and buckling takes place.

It seems rather funny that, although the B.B.C. told us that the idea of the regional scheme was to give us alternative programmes on crystal sets and other simple apparatus, it is now necessary to have a six-valve super-het to obtain good results.

V. D. (Sidcup).

Faulty Variable Condenser

SIR,—I have built up a simple receiver consisting of a detector and two low-frequency valves, and although I receive the local station, the tuning condenser appears to make no difference to tuning.

L. L. (Alperton)

The fault appears to be in your tuning condenser. You should test it by arranging a battery and a measuring instrument between the terminal of the condenser and the plates to which the terminal is connected. With either

the fixed plates or the moving plates you may detect a disconnection between the plates themselves and the actual terminal to which the plates should be connected.—Ed.

Wavelengths and Frequencies

SIR,—As a technical inexactitude we wish to draw your attention to the first paragraph of the article "Introducing W. James' 'Century Super'," in the April 18, 1931, issue of *AMATEUR WIRELESS*.

Your contributor, Mr. A. Hunter, appears to have made a mistake in that he has confused frequency with wavelength. Since London Regional operates on 842kc. and Mühlacker on 833kc., it will be seen that the latter transmission is 9kc. below the London frequency.

From the point of wavelength, Mühlacker is above London Regional, being 360 against 356 metres of the latter.

Our reason for bringing the matter to your notice is one which affects all prospective constructors of super-heterodyne receivers, particularly as the use of "kilocycles" enables certain peculiarities common to these receivers to be explained. For instance, a number of constructors, having built the "Super 60" receiver, are puzzled as to the reception of Mühlacker when endeavouring to receive Warsaw on 212.5kc. (1,411 metres), both the frame aerial and oscillator switch being set for the high-wave reception.

A similar cycle of events is true for other powerful stations operating on the medium waveband, and explains the reason for their reception on the long waves.

Applying the same facts to the reception of medium-wave stations, and taking into account harmonics, which can only be multiples of a fundamental, it will be noted that the second and third "points" would occur below the lowest "point" on the tuning dials and in the neighbourhood of 2,000kc. (150 metres).

In the circumstances, it is easy to see why stations on the medium waveband are practically free from interferences from harmonics, and explains why the Americans so studiously avoid long-wave reception. Fortunately, the difficulties are not a fraction of what they appear on paper, because though harmonics are annoying, yet they can be taken in "one's stride" if it is remembered most of the "image" interference occurs on frequencies between those employed by the various long-wave stations.

The subject is a vast one and cannot be covered by a letter of this nature. Nevertheless, we believe the above notes if brought to your readers' notice are sufficient to show the immense value of computing wavelengths in kilocycles, and especially in dealing with super-hets.

WRIGHT & WEAIRE, LTD. (London).

TINY No 2 scores in the CENTURY SUPER

Over a hundred programmes separated with ease by the J.B. "Tiny No.2." . . . Last week's test report of the "Century Super" shows 115 stations tuned in on the loud-speaker, including 8 Americans! Hear them yourself by using the condensers specified—"Tiny No 2"—typical examples of J.B. precision. The slow-motion mechanism is housed in the bottom bearing, taking no extra space. It is smooth in action, free from backlash, and controlled by a large knob. Super-hardened brass end plates and hard aluminium vanes give absolute rigidity and accuracy. One-hole fixing; ball-bearing centre spindle; pigtail to rotor. See this excellent condenser at your dealers. It is compact, light, and rigid—ideal for portables or confined spaces. Price, complete with knob, pointer, and scale: .0005, 8/6

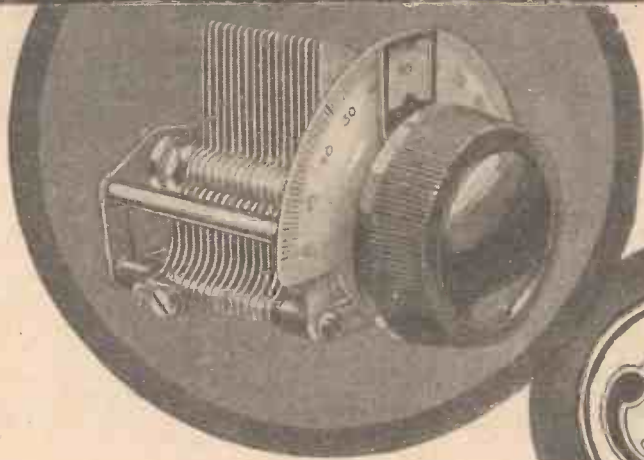

J.B. "TINY No. 2."
USED AND
SPECIFIED in
the CENTURY SUPER

**PRECISION
INSTRUMENTS**

IMMEDIATE DELIVERIES

Advertisement of Jackson Bros., 72 St. Thomas' Street, London, S.E.1

Telephone: Hop. 1837

Modern valves demand MAMMOTH PLATES

The modern wireless valve is a most complex instrument. So sensitive is its reaction to every influence that the old type of accumulator is much too clumsy a power unit to link with it. A wireless accumulator to-day must give a power output which is constant, as level and smooth as a billiard table. Fuller's discovered that "Mammoth Plates" were the secret of this even, unvarying power.

Fuller Accumulators have other unique features; micro-porous paste, patent double grease-cup terminals and a patent non-slip metal handle folding out of the way when not in use. Fit a Fuller and your valves will sing its praises.

Ask your dealer to show you the L.D.G.—2 v. 60 a.h. Price 9/6. Full list of H.T. Dry Batteries and L.T. and H.T. Accumulators on request.

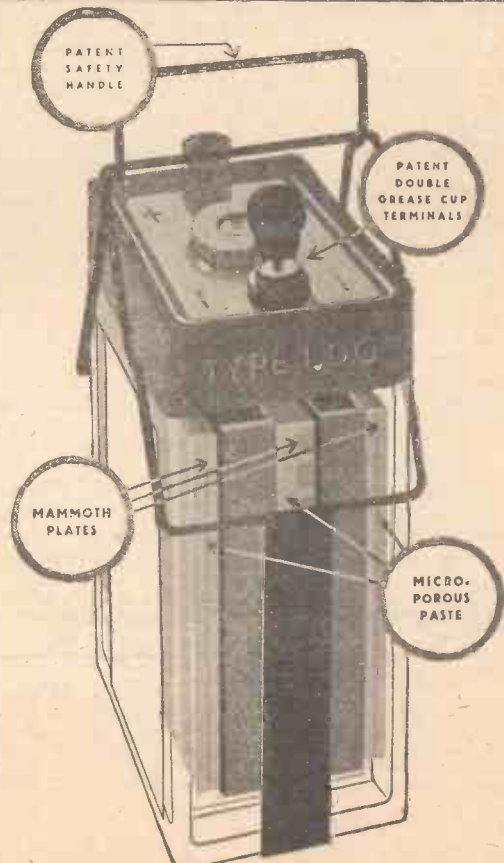

FULLER SUPER BATTERIES

Obtainable through Fuller Service Agents or any reputable dealer. Full list of sizes and types post free.

DRY H.T. BATTERIES

For portables the Fuller W.O.P. 100 is supreme. Despite the limited space it gives them the power they need—guaranteeing emission up to 20 milliamps, 100 volts (reads 108 volts), 10" x 5" x 3", 15/- . Complete range of standard, super power and grid bias batteries available.

CAR BATTERIES

Patent double grease-cup terminals to eliminate risk of acid creep and subsequent corrosion. Strong, durable ebonite containers, micro-porous paste. There is a type for every car—ask for lists 104a and 105a.

FULLER ACCUMULATOR CO. (1926), LTD.
CHADWELL HEATH, ESSEX.

Advertisers Appreciate Mention of "A.W." with Your Order

WE TEST FOR YOU

A weekly review of new components



and tests of apparatus.

Conducted by J. H. REYNER, B.Sc., A.M.I.E.E.

Wufa 60-pole Speaker

WE have this week tested a Wufa 60-pole speaker. One is a little intrigued by this designation at first, expecting to find a somewhat revolutionary magnet system. It transpires, however, that the magnet poles are laminated, there being a 4-pole system, each containing fifteen laminations.

As a matter of fact, it is the rest of the construction rather than this particular feature which interested us more. The movement is of the balanced-armature type, a long horseshoe magnet being employed to provide the necessary permanent magnetic field. This magnet carries the laminations, one set on each pole, and by means of a lever operating a cam, the two poles of the magnet can be sprung apart slightly, thereby varying the air gap. The farther the poles are apart the greater the vibration permissible before the armature touches the pole pieces, although, of course, the sensitivity will be somewhat reduced. Therefore, the speaker can be adjusted according to the input with which it is to be supplied.

A large diaphragm, some 15 in. in diameter, is driven by the mechanism. This diaphragm is housed in a metal stamping, so that the whole unit forms one complete assembly, which can be built into a cabinet or set without any difficulty. Another interesting point is that there are six tappings on the winding, intended to match the speaker to different types of output valves having impedances of 250, 500, 1,250, 1,500, 2,500, and 3,000 ohms respectively.

We measured the impedance at 400

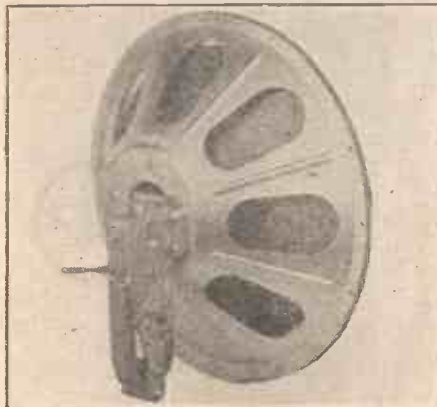

The new Wufa 60-pole speaker

cycles on each of these tappings and found them to be as shown in the accompanying table. It will be seen, therefore, that most of

the values are approximately twice those of the recommended valve, which is of the right order for best matching. Valves having impedances as low as 250 and 500 ohms are not in everyday use, but we presume that these taps have been included to allow those readers who possess step-down transformers to make use of them.

We chose the tapping which gave the best matching to our own amplifier and tested the speaker out on signals. The results were good, the sensitivity being of a high order and the quality also above the average. If anything, there was a slight loss in the upper frequencies, but we did not notice any marked resonances in any part of the scale. The instrument will handle a large power and can be recommended.

| Valve impedance quoted. | Impedance at 400 cycles. |
|-------------------------|--------------------------|
| 250 | 500 |
| 500 | 810 |
| 1,250 | 1,400 |
| 1,500 | 2,700 |
| 2,500 | 4,250 |
| 3,000 | 6,500 |

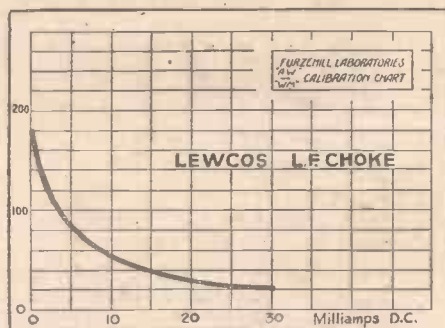

Characteristic curve of the Lewcos L.F. choke

Lewcos L.F. Choke

THE Lewcos L.F. choke which we have tested this week is built on the same generous lines as the L.F. T.5 transformer, which, by the way, has just been reduced in price. The same iron circuit is employed, so that one expects to find a large inductance, together with good current-carrying capacity. When we tested the instrument we were not disappointed, as the curve accompanying this test report will show. The inductance with no D.C. flowing was 220 henries, this value falling off somewhat rapidly as the polarising current increased. The inductance, however, is well maintained, being still 20 henries when 30 milliamperes steady current is flowing through the choke.

The dimensions of the instrument are 2 3/4 in. by 2 3/4 in. by 3 3/4 in. high. It is housed in the familiar blue metal case and is a useful addition to the range of Lewcos products.

Grosvenor Red-line H.T. Battery

THE Grosvenor Red-line battery which is reported on this week is well up to the standard which we should expect. Grosvenor batteries have been marketed for some time now and have achieved a



One of the new Grosvenor High-test H.T. batteries

reputation for reliability. The present model, although relatively small in size, measuring 9 3/4 in. by 3 3/4 in. by 2 3/4 in., gave a good performance. The voltage is 66, tappings being taken every 6 volts. The battery was discharged through a constant resistance, the discharge commencing at 7 milliamperes and continuing until the voltage fell to half the initial value. This did not occur until after 264 hours, giving a discharge of nearly 1,400 milliampere hours. This is a high figure even for the modern battery, so that the results must be considered above the average.

Constancy of voltage during the useful

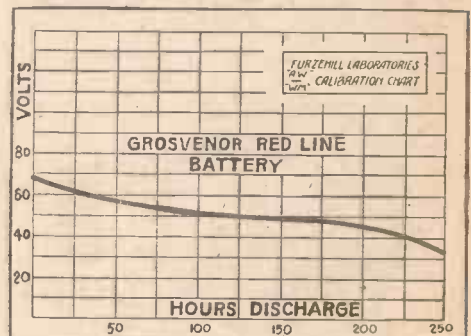

The good performance curve of the Grosvenor H.T. battery

life is one of the claims made for this battery. The curve given herewith shows the manner in which the voltage falls during the discharge period.

FOR THE "CENTURY SUPER"

AN outstanding receiver such as the "CENTURY SUPER" is worthy of a good battery—that is probably the reason the designers used a C.A.V. in their inside and outside tests.

With a receiver of this class, the H.T. battery always plays an important part: thus finest results will be obtained by using C.A.V. H.T. rechargeable accumulators. This ensures complete freedom from background noises that emanate from mains units or dry batteries.

Full details and dimensions of all C.A.V. Radio Accumulators are given in our free Catalogue.

Obtainable from our Depots and Battery Agents throughout the country and from all Radio Dealers.



Nothing smaller than the 2AG9 48 amp. capacity should be used:

Price: 13/-



RADIO BATTERIES

* Have you had a copy of "The Care and Maintenance of H.T. and L.T. Accumulators"? Free on request to Dept. I.4

C.A.V. Vandervell & Co. Ltd.
ACTON, LONDON, W. 3.

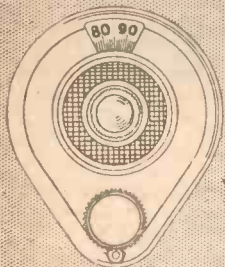

VERNIER DIAL 3/6

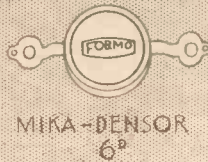

MIKA-DENSOR 6^p

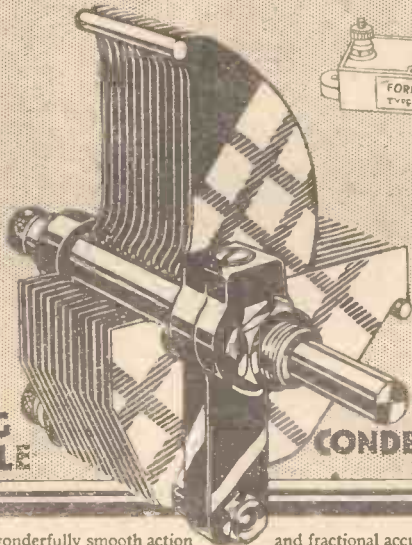

MID LOG VARIABLE CONDENSER 4/6

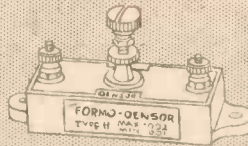

FORMO-DENSOR 1/6

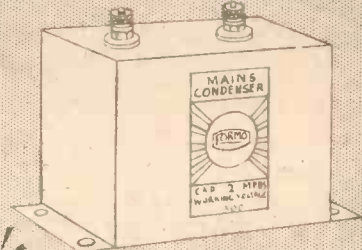

MAINS CONDENSER CAP 235

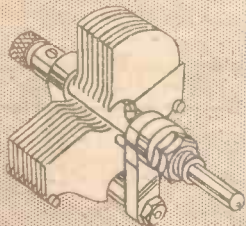

MIDGET CONDENSER 2/9

THE wonderfully smooth action and fractional accuracy of the Formo Vernier Dial used in conjunction with Formo variable condensers makes tuning of close stations a simple operation with the certainty of clear-cut reception. The scientific thoroughness of Formo condenser construction is your assurance of the best possible results from any set. High performance is further assisted by the enclosed and protected pigtail within the shaft and minimum eddy current losses. In 4 capacities.
Catalogue of the complete range of Formo components sent on request.
ARTHUR PREEN & CO., LTD.,
GOLDEN SQUARE, PICCADILLY CIRCUS, LONDON, W.1.
Factory: Crown Works, Southampton.



DUAL RANGE COIL 12/6

Don't Forget to Say That You Saw it in "A.W."

"THE 'CENTURY SUPER'"

(Continued from page 714)

potentiometer. This has its sliding contact taken to the screens of both screen-grid valves, so that the voltage of both screens can be adjusted. The fixed resistance prevents the application of too high a voltage and so safeguards the valves.

In order to avoid a steady flow of current from the high-tension supply, one end of the potentiometer passes to a switch contact and so the circuit is disconnected when the set is "off." A smooth control of the volume is obtained by adjusting the potentiometer, as this varies the characteristics of the screen-grid valves. At the same time the directional effect of the frame aerial must not be overlooked.

I have not found the frame aerial to be too directional, but there is a well defined minimum point. As you turn the frame you will notice that at first the signals do not vary much in strength, but presently a point is reached where they fall off rapidly and soon will disappear with a good frame.

This property of a frame aerial is hardly needed in tuning, but the point is that if the frame happens to be in quite the wrong direction for a given station, nothing of it will be heard. The directional properties of the frame are not needed in order to separate the London station from Muhlacker, for instance, the tuning of the set being good enough for this.

As a test of selectivity this is about as severe as one could wish for, as both stations are powerful and the frequency separation

is 9 kilocycles. Even closer tuning is possible, however, so that it must be considered exceptionally sharp.

There are two separate windings on the frame aerial, one for the long waves and the other for the medium waves. Stranded wires are used. Solid wire is not so good, both electrically and mechanically. Tuning is a little sharper with a good frame and the strength is greater.

The frame windings can be used separ-

THE "SUPER" ON VIEW

Why not see the "Century Super" before you start the constructional work? Models are on view in London at Selfridge's, W.1; Ready Radio, 159 Borough High Street; Peto-Scott, 77 City Road and 62 High Holborn; H. & B. Radio, 34/8 Beak Street, W.; and in Manchester at Lewis's, Ltd.

ately, on the medium wave one can be connected in parallel with the long-wave winding, using a simple switch. When the coils are to be used in parallel only one centre tap is needed.

A large frame is not needed. Actually, the signals are strengthened by using a larger frame, but we do not want the frame to be so large that it is unwieldy. A fair

sized frame collects signals of ample strength and is easily handled.

The connecting wires between the frame and the set ought not to be too long, as they are part of the tuned circuit. If, therefore, the wires are free to move about easily the tuning is upset. A few ebonite spacers may be used with advantage to hold the wires and to avoid this.

Next week I shall describe the operation of the set and give a few hints regarding the valves as well as the wiring. Actually, the adjustment of the set is easy, but there are a few points of interest.

The Federal Radio Commission in the U.S. has adopted the recommendation of the recent television engineering conference regarding the re-allocation of the assignments of the nineteen experimental stations so as to afford greater geographical separations and eliminate interference on the short-wave channels.

It should be noted that the price of Sovereign compression-type condensers was given incorrectly in Messrs. Sovereign Products Ltd. announcement in last week's issue. The price of these handy little components is, of course, 1s. 6d.

A Mullard development is the use of a sprayed metal coating on the bulbs of new valves, this thin metallic film acting as a screen for H.F. "Strays." These new valves are thus more stable in working, although the natural efficient characteristics are not impaired.

THE ORBIT WONDER RADIO GRAM-

MAHOGANY OR OAK:- £18/10/0 COMPLETE.

Dear Sirs,
The "Orbit" Radio Gram arrived quite safe and I am more than delighted with it. I know nothing about wireless but after following the instructions I fixed it up and got Station after Station. The Tone is Perfect and as clear as a Bell. I will recommend it to all I know. Thanking you for same
I remain,
Yours truly,
E. Sweetman!

J. Hill Street,
Bacup,
Lancs.

To Catesbys Ld.s.
London, W.1.

EASY TERMS
SEND AT ONCE FOR FREE INTERESTING LISTS GIVING COMPLETE DETAILS

THE AMAZING ORBIT can only be got from CATESBYS FAMOUS RADIO STORES TOTTENHAM CT.RD. LONDON - W.1.

VOLTRON INGENUITY COMBINES LUXURY WITH EFFICIENCY

THE PERFECT FRAME FOR THE "CENTURY SUPER"



Patent applied for
Registration applied for

63/-

OAK OR MAHOGANY FINISH

Note these points:-

- 1 Ultra low loss windings.
- 2 Integral wave change switch—out of sight.
- 3 Direction of each station can be logged.
- 4 Frame rotation controlled by dial.
- 5 Hides the unsightly frame itself.
- 6 Provides a convenient table for the set.
- 7 ALL BRITISH.

FRAME

VOLTRON

AERIAL

If your dealer cannot supply, send your order with remittance direct to the manufacturers. No extra charge.

VOLTRON ELECTRIC, LTD., Queensway, Ponders End

SPECIFIED FOR THE "CENTURY SUPER"

ADDITIONAL WEARITE COMPONENTS FOR THE "CENTURY SUPER"



WEARITE DUAL-RANGE FRAME AERIAL

Entirely new in design and embodying exclusive features which give extremely high efficiency. The windings are of Litzendraht wire, carefully wound at even tension throughout, in order to maintain the accuracy of spacing. The winding is centre-tapped and provided with the necessary three terminals for connection to set. The change from short to long waves is affected by means of a switch at the base: no other alterations to connections are necessary. The frame aerial swings through 180 degrees and is mounted on a polished mahogany base. It is of particular-

ly handsome appearance. PRICE **42/-**



WEARITE THREE-POINT SHORTING SWITCH

Push-pull action. Sound self-cleaning contact. With insulated spindle. PRICE **1/6**

WEARITE GRID-LEAK HOLDER



Has new type contact spring clips. Fits any size grid leak. PRICE **6d.**



WEARITE VALVE HOLDER

Robust construction. Sprung sockets ensure good contact. Fitted with terminals and soldering tags. PRICE **1/3**

The Coils chosen by Mr. W. James for his "Century Super" are made specially by Wright & Weaire Ltd., the oldest established firm in the Wireless Components Industry

The outstanding performance of this receiver is only made possible by the use of Wearite SUPER-HET COILS.

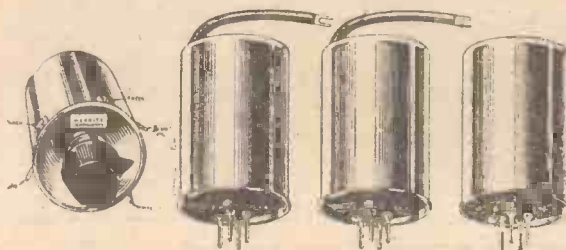

The Oscillator Coil is designed for panel mounting and is fitted with flexible connecting leads. The three long-wave coil units are fitted with standard valve pin bases so that they may be mounted in ordinary 4-pin valve holders.

Price of complete set of coils **50/-**

(Illustrated descriptive leaflet explaining the unique construction of these coils will be sent on request.)



TRIPLE COIL BASE

Base for above coils, complete with terminals and tags. Coil sockets are sprung similar to valve holders. PRICE **2/9**

Send for Free Illustrated Lists

WEARITE COMPONENTS

WRIGHT & WEAIRE LTD.

740, HIGH ROAD, TOTTENHAM, N.17

Telephone : Tottenham 3847-8-9

Advertisers Appreciate Mention of "A.W." with Your Order

A "CENTURY SUPER" ON THE ROAD

BECAUSE the "Century" is a set of the transportable variety, the only parts outside the cabinet being the batteries and speaker, it is very well suited for out-of-door use, especially in the car. It is easy to make the "Century" in a self-contained cabinet, but as shown here by this set which is made up from a kit of Peto-Scott "Pilot" parts, the standard "Century" is quite a portable affair and well suited to out-door use.

"Century" builders will be interested to know that a set made with a "Pilot" kit has given the following very satisfactory and lengthy list of stations. These, it will

be seen, are obtained with 180-degree dials and it is interesting to compare these readings with those obtained on a set having 100-degree dials.

| Station | Frame | Oscillator |
|-----------------|-------|------------|
| Nurnberg | 36 | 71 |
| Gleiwitz | 44 | 79 |
| Horbj | 46 | 81 |
| London National | 50 | 83 |
| Heilsberg | 57 | 90 |
| Bratislava | 59 | 91 |
| Copenhagen | 60 | 92 |
| Huizen | 68 | 100 |
| Goteburg | 78 | 109 |
| Breslau | 79 | 111 |
| Barcelona | 89 | 119 |

| | | |
|-----------------|-----|-----|
| London Regional | 93 | 123 |
| Algiers | 96 | 126 |
| Hamburg | 99 | 128 |
| Lvov | 103 | 131 |
| Toulouse | 104 | 133 |
| Frankfurt | 106 | 134 |
| Katowice | 112 | 141 |
| Berlin | 116 | 144 |
| Belgrade | 120 | 148 |
| Rome | 124 | 152 |
| Beromunster | 131 | 157 |
| Langenberg | 135 | 160 |
| North Regional | 137 | 162 |
| Milan | 144 | 169 |
| Vienna | 152 | 174 |
| Munich | 155 | 178 |
| Leningrad | 89 | 102 |
| Oslo | 97 | 110 |
| Kalundborg | 110 | 123 |
| Moscow | 128 | 140 |
| Motala | 133 | 144 |
| Warsaw | 138 | 148 |
| Eiffel Tower | 143 | 152 |
| Daventry | 153 | 160 |
| Zeesen | 163 | 168 |
| Radio Paris | 172 | 172 |



A "Century Super" built with a "Pilot" kit, being tried out on the road

Messrs. Peto-Scott have submitted to us a "Century Super" set built from a "Pilot" kit. In general appearance it very closely resembles our own models, and follows the specification given in AMATEUR WIRELESS, with the exception of some small details of no particular importance. The coils and other chief components are, of course, as specified by us. We submitted a built-up kit to test, and have pleasure in saying that its performance is quite satisfactory.

SOVEREIGN IN THE CENTURY

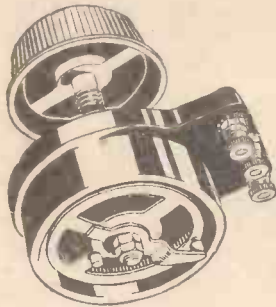

50,000, 100,000 and 500,000 ohms. 1 and 2 megohms. Each 4/6

The famous SOVEREIGN VOLUME CONTROL (50,000 ohms) is recommended in most famous of sets, the CENTURY SUPER. Complete with Bakelite knob, 3 terminals totally enclosed movement, its smooth silky action controls volume to a fine degree. Use this and other Sovereign components in this super set.

USE THESE SOVEREIGN COMPONENTS TOO

If it is difficult to obtain these and other Sovereign components write direct (also for full lists) to

SOVEREIGN PRODUCTS LTD. 52-54, Rosebery Avenue, LONDON, E.C.1

IN THE CENTURY, 2 SOVEREIGN Fixed Condensers (.001 mfd., 1/3 each; .0002 mfd., 10d.); 1 meg. Grid Leak, (10d.); 2 Spaghetti Resistances (15,000 and 20,000 ohms, 1/3 each), etc., etc.



High-Grade RADIO GRAMPHONE CABINET

of exclusive modern design, hand made and polished, on Queen Anne legs. Figured Oak £5-19-3 Figured Walnut or Mahogany £6-17-3 Carriage paid.

THE ACME OF CRAFTSMANSHIP. Radio-Gram Cabinets from £3-19-6 to £21 Wireless Cabinets - - - from £2 Photographs and 30-page illustrated catalogue free.

Cabinets made to order a speciality. Furniture at Maker's prices.

GILBERT, CABINET MAKER, SWINDON.

Estimates free.

Estd. 1865

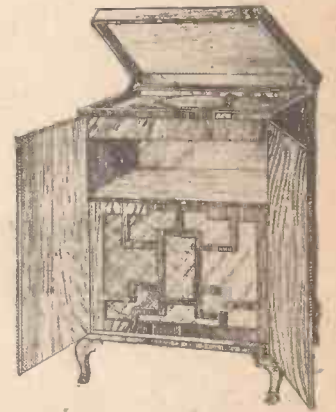

You MUST have the "Wireless Magazine" Every Month Price 1/-



SPEECHES by Lord Brentford and Lord Moynihan, at a dinner given in connection with National "Safety First" Week, will be relayed from Leeds on May 13, in the National programme.

London Regional listeners are to hear a relay from Bournemouth on May 23 of a concert by the Bournemouth Municipal Orchestra, conducted by Sir Dan Godfrey.

Arthur Young is an example of the youthful British composer who has "made good" in foreign lands. Berlin dances nightly to his dance rhythms and jazz tunes. On May 4 in the National programme and May 7 in the Regional programme, listeners to B.B.C. vaudeville will hear his music as a link between items which are to be provided by Gillie Potter, Greta Keller, and Mischa de la Motte. The programme will also include a sketch, *Crocus*, by Reginald Beckwith.

Stanford Robinson will conduct the B.B.C. Symphony Orchestra in a performance of "The Dream of Gerontius," by Sir Edward Elgar, in the Queen's Hall, London, on May 18.

A full-length play for broadcasting in the National programme on May 15 is *The Forest*, by John Galsworthy. With Dulcinea Glasby as adapter and Howard Rose as producer, the B.B.C. is providing the strongest combination at its command to ensure a thrilling broadcast.

A mystery of the sea, based upon a true story, forms the theme of L. du Garde Peach's play, *The Mary Celeste*, which is to be broadcast on May 7 and 8. The broadcast version is by L. du Garde Peach himself. Listeners will get plenty of thrills from the broadcast, which will have a cast of thirty artistes.

Speeches by the Lord Mayor of Hull and Mr. John Drinkwater will be heard by North Regional listeners on May 5, when a banquet is held to celebrate the six hundredth anniversary of the granting of a charter by King Edward III to Hull.

The Three Valleys Festival will be held in the Pavilion, Mountain Ash, from May 9 to 16 inclusive. This is the second annual festival and the National Orchestra of Wales will again take part. Three concerts will be relayed to Cardiff listeners.

The Abbey Players, on their next monthly visit to the Belfast studio, which occurs on May 4, will present two plays, *Spring*, a play in one act by T. C. Murray, and *Meadowsweet*, a pastoral comedy in one act, by Seamus O'Kelly. Incidental music will be provided by the Radio Septet.

In order to escape from interference caused by the transmissions of the Trades Unions' station at Moscow-Stchelkovo,

Motala (Sweden) has altered its wavelength to 1,352 metres (221.7 kilocycles).

The city of Nidaros (Norway), formerly Trondhjem, has been re-christened Trondheim, and the call from the broadcasting station has been altered in accordance.

In addition to the 150-kilowatt high-power transmitter to be built at Lahkihegy for the Hungarian broadcasting authorities, it is also proposed to instal a 5-kilowatt station at Nyiregy-Naza, close to the Romanian border and to open smaller relays at Miscolec, Magyarovar, and Pees.

The construction of the new Radio Paris transmitter is rapidly nearing completion and tests are to be expected very shortly. The plant has been so planned that the power, when desired, can be increased to 120 kilowatts (aerial).

Radio Lyon (France) will relay foreign stations on the first and third Saturdays in May, June, and July. These transmissions are to be extended to midnight B.S.T.

THE MOST UP-TO-DATE SET FOR 1931—"A. W's." NEW CENTURY SUPER

J3DE, the only short-wave amateur station in Wakayama Prefecture, Japan, exchanged communications with an amateur station in Madrid recently.

The only radio journal in Europe to have three successive morning editions—daily except Monday—is the journal broadcast by station EAJ7, Union-Radio, Madrid. The first edition is broadcast at 8 a.m. every day, the second at 8.20 a.m., and the third at 8.40 a.m. The radio journal begins every edition with a few gramophone notes of Rossini's opera, *William Tell*. The announcer is a woman and the news she broadcasts is nearly the same for all three editions. The journal is called *La Palabra*, meaning "the word."

The new French Government station, Bordeaux-Lafayette, recently underwent its final tests. Its transmissions are unusually clear. It will be used chiefly for communication with overseas colonies and for Press communications for North and South America.

With the hope of improving acoustics in the Law Courts, an experiment was made in the Divorce Division with two microphones, one placed in front of Lord Merrivale, on the bench, and another in the witness box, with loud-speakers suitably placed.

ELLISON GUARANTEED MAINS TRANSFORMERS & CHOKES

All standard types are carried in stock, and will be despatched by return; and any special windings can be despatched within 24 hours—every one is guaranteed for three years.



What others say

"Eliminator has been running 4 to 5 hours daily and has not given the slightest trouble." B.W.N.

"Thank you for the efficient manner in which the repair was carried out." J.H.B.

"The Transformer for filament, heating is A1, and not a bit of hum comes through from mains." M.H.

We supply all transformers and components as described in "Amateur Wireless." Let us have your enquiries! (All transformers value £1 or over may be obtained on easy payment terms).

We can quickly and economically carry out repairs to any make of mains transformer.

MAINS TRANSFORMERS

| Type | Outputs | Price |
|------|--|-------|
| E69a | 4V. 3 amps C.T. | 11/8 |
| E74 | 250-0-250 60 m.a. 4V. 1a C.T. | 32/8 |
| E76 | 250-0-250/120 m.a. 4V. 2a C.T. 4V. 5a C.T. | 42/- |

MAINS & L.F. CHOKES

| Type | Max. Current | Price |
|------|---------------|-------|
| EC11 | 50/75 30 m.a. | 7/6 |
| EC14 | 30 60 m.a. | 15/- |
| EC15 | 40 120 m.a. | 23/8 |

ELLISON MANUFACTURING Co. (Dept. A) DRAGON WORKS, HARROGATE

NOW! this new simple way of cabinet - making —"BYLDURONE"

A Byldurone Cabinet! So easy to construct—only a screwdriver required. Supplied complete, ready to put together. Handsome, yet sturdily built—Byldurone—build-your-own—Cabinets will give an added charm to your radio. Their distinctive coverings can be supplied in an extensive range to suit individual taste, and to harmonise with furniture style, and colour schemes.

When building your new receiver, house it in a Byldurone Cabinet and add good looks to high efficiency.

Write for List J15

J. J. EASTICK & SONS EELEX HOUSE

118 BUNHILL ROW, LONDON, E.C. Telephone: Metropolitan 0314/5/6

ESSENTIAL FOR EVERY LINEN SPEAKER (single or double)



WEEDON'S SELF-CENTRING DRIVING ROD improves tone and volume 50 per cent.

All side stress and chatter is eliminated and the unit is automatically adjusted to true dead-centre by the ingenious driving rod.

Greater toning and therefore greater tonal beauty and volume are instantly accomplished merely by tightening up one nut.

Get one now and build or reconstruct the finest speaker you have ever heard.

Finest DOPE obtainable
Weedon's Golden Tautening Dope improves the tone of your speaker as it matures. Bleaches out—easily applied. Sold in airtight tins. Price 1/- per tin.

WEEDON & CO.
26a LISLE ST., LONDON, W.C.2

TUNEWELL



THE CLARION COIL

TUNEWELL CLARION COILS AERIAL or ANODE 7/9. (6 pin base 2/-) PANEL MOUNTING 10/6. (3 pt. switch 1/3). SHORT WAVES 3/11.

Present-day conditions call for greatly increased selectivity. Modernise your unselective set with the new Tunewell Clarion Coil. It gives greatly improved range and sharper tuning to any straight or S.G. circuits. Specified for the "Ultra Selective Straight 3," it is also suitable, and gives greatly improved results, with the "Mullard Master 3," "Favourite 3" and similar circuits.

TUNEWELL ALL-BRITISH SPAGHETTI RESISTANCES, 10,000 and 15,000 ohms, 1/-, 20,000, 25,000 and 30,000 ohms, 1/4, 40,000, 50,000 and 60,000 ohms, 1/6. Send for Lists

TURNER & CO., '54, Station Road, London, N.11.

MIKES FOR HOME RECORDING

Pulpit Pedestal, 12/6, Pedestal Broadcaster, as illustrated, 18/6, Microphones with handle, 15/-, powerful Public Address models 55/- and 65/-, Transformers 4/6, Couplers 15/-, Valve Amplifiers 55/-, for Band Repeater or Public Address work, Home Recorder for Gramo.



ELECTRADIX RADIOS
218 Upper Thames Street, London, E.C.4
CITY 0191.

BROADCAST TELEPHONY

Broadcasting Stations classified by country and in order of wavelengths. For the purpose of better comparison, the power indicated is *aerial energy*.

| Kilo-Metres | Kilo-cycles | Station and Call Sign | Power (Kw.) | Kilo-Metres | Kilo-cycles | Station and Call Sign | Power (Kw.) | Kilo-Metres | Kilo-cycles | Station and Call Sign | Power (Kw.) | | | | |
|---|-------------|---------------------------|-------------|--|-------------|---------------------------|-------------|------------------|-------------|------------------------|----------------|--|--|--|--|
| GREAT BRITAIN | | | | | | | | | | | | | | | |
| 25.53 | 11,751 | Chelmsford (G5SW) | 15.0 | 294.1 | 1,020 | Limoges (PTT) | 0.5 | 416 | 721 | Radio Maroc (Rabat) | 10.0 | | | | |
| 200 | 1,500 | Leeds | 0.10 | 307.6 | 975.2 | Bordeaux (PTT) | 35.0 | 1,250 | 240 | Tunis Kasbah | 0.0 | | | | |
| 242 | 1,238 | Belfast | 1.2 | 317.3 | 945.4 | Marseilles (PTT) | 1.5 | NORWAY | | | | | | | |
| 261.3 | 1,148 | London Nat. | 08.0 | 327.5 | 916 | Grenoble (PTT) | 3.0 | 235.5 | 1,275 | Kristiansand | 0.5 | | | | |
| 288.5 | 1,040 | Newcastle | 1.2 | 329.5 | 910.3 | Poste Parisien | 1.2 | 240 | 1,250 | Stavanger | 0.5 | | | | |
| 288.5 | 1,040 | Swansea | 0.10 | 345.2 | 869 | Strasbourg (PTT) | 15.0 | 364 | 824 | Bergen | 1.0 | | | | |
| 288.5 | 1,040 | Stoke-on-Trent | 0.16 | 370 | 810.5 | Radio LL (Paris) | 0.5 | 366.2 | 819.2 | Frederiksstad | 0.7 | | | | |
| 288.5 | 1,040 | Sheffield | 0.18 | 385 | 779 | Radio Toulouse | 8.0 | 453.2 | 662 | Porsgrund | 1.5 | | | | |
| 288.5 | 1,040 | Plymouth | 0.16 | 447 | 671 | Paris (PTT) | 2.0 | 493.4 | 608 | Trondheim | 1.2 | | | | |
| 288.5 | 1,040 | Liverpool | 0.16 | 466 | 644 | Lyons (PTT) | 2.3 | 580.3 | 517 | Hamar | 0.8 | | | | |
| 288.5 | 1,040 | Hull | 0.16 | 1,445.7 | 207.5 | Eiffel Tower | 15.0 | 1,071 | 280 | Oslo | 75.0 | | | | |
| 288.5 | 1,040 | Edinburgh | 0.4 | 1,725 | 174 | Radio Paris | 17.0 | POLAND | | | | | | | |
| 288.5 | 1,040 | Dundee | 0.16 | 1,725 | 174 | " | 85.0 | 214.2 | 1,400 | Warsaw (2) | 14.0 | | | | |
| 288.5 | 1,040 | Bournemouth | 1.2 | (testing shortly) | | | | 234 | 1,283 | Lodz | 2.2 | | | | |
| 288.5 | 1,040 | Bradford | 0.16 | GERMANY | | | | 312.8 | 959 | Cracow | 1.5 | | | | |
| 301 | 995 | Aberdeen | 1.2 | 31.38 | 9,560 | Zeesen | 15.0 | 335 | 806 | Poznan | 1.9 | | | | |
| 309.9 | 968 | Cardiff | 1.2 | 217 | 1,383 | Königsberg | 1.7 | 368.1 | 815 | Wilno | 20.0 | | | | |
| 356.3 | 842 | London Reg. | 70.0 | 219 | 1,369.7 | Flensburg | 0.6 | 381 | 788 | Lyov | 21.0 | | | | |
| 376.4 | 797 | Glasgow | 1.2 | 227 | 1,319 | Cologne | 1.7 | 408 | 734 | Katowice | 16.0 | | | | |
| 398.9 | 752 | Midland Reg. | 38.0 | 227 | 1,319 | Münster | 0.6 | PORTUGAL | | | | | | | |
| 479.2 | 626 | Manchester (temp) | 1.2 | 227 | 1,319 | Aachen | 0.3 | 240 | 1,250 | Oporto (Teatro Apollo) | 0.25 | | | | |
| 479.2 | 626 | North Regional | 70.0 | 232.2 | 1,292 | Kiel | 0.31 | 284.7 | 1,053.6 | Lisbon (CI/IA) | 0.25 | | | | |
| also testing on about 1,100 m. | | | | 239 | 1,256 | Nürnberg | 2.3 | ROMANIA | | | | | | | |
| 1,554.4 | 193 | Daventry (Nat.) | 35.0 | 246.4 | 1,217.2 | Cassel | 0.3 | 304 | 767 | Bucharest | 16.0 | | | | |
| AUSTRIA | | | | | | | | | | | | | | | |
| 219 | 1,370 | Salzburg | 0.6 | 253.4 | 1,184 | Gleiwitz | 5.6 | RUSSIA | | | | | | | |
| 246 | 1,220 | Linz | 0.6 | 259.3 | 1,157 | Leipzig | 2.3 | 497 | 702.5 | Khar'kov | 4.0 | | | | |
| 283.0 | 1,050 | Innsbruck | 0.6 | 269.8 | 1,112 | Bremen | 0.3 | 720 | 416.6 | Moscow (PTT) | 20.0 | | | | |
| 351.7 | 853 | Graz | 9.5 | 276.5 | 1,085 | Heilsberg | 75.0 | 800 | 375 | Kiev | 20.0 | | | | |
| 453 | 666 | Klagenfurt | 0.6 | 283.0 | 1,058 | Magdeburg | 0.6 | 824 | 364 | Sverdlovsk | 25.0 | | | | |
| 517 | 581 | Vienna | 20.0 | 283.6 | 1,058 | Berlin (E) | 0.6 | 937.5 | 320 | Khar'kov (RV20) | 25.0 | | | | |
| BELGIUM | | | | | | | | | | | | | | | |
| 206 | 1,456 | Antwerp | 0.4 | 318.8 | 941 | Dresden | 0.3 | 1,000 | 300 | Leningrad | 100.0 | | | | |
| 215.5 | 1,392 | Chatelneau | 0.25 | 325 | 923 | Breslau | 1.7 | 1,080 | 283 | Tiflis | 15.0 | | | | |
| 216 | 1,391 | Radio Conference Brussels | 0.25 | 360 | 833 | Mühlacker | 75.0 | 1,103 | 272 | Moscow Popoff | 40.0 | | | | |
| 245.1 | 1,223.7 | Schaerbeek | 0.5 | 372 | 806 | Hamburg | 1.7 | 1,200 | 250 | Khar'kov (RV4) | 25.0 | | | | |
| 338.2 | 887 | Brussels (No. 2) | 20.0 | 390 | 770 | Frankfurt | 1.7 | 1,301 | 230 | Moscow (Trades Unions) | 165.0 | | | | |
| 509 | 590 | Brussels (No. 1) | 20.0 | 418 | 716 | Berlin | 1.7 | 1,380 | 277.5 | Bakou | 10.0 | | | | |
| BULGARIA | | | | | | | | | | | | | | | |
| 319 | 941 | Sofia (Rodno Radio) | 1.0 | 452.1 | 662 | Danzig | 0.2 | 1,481 | 202.5 | Moscow (Kom) | 20.0 | | | | |
| CZECHO-SLOVAKIA | | | | | | | | | | | | | | | |
| 203 | 1,139 | Moravska-Ostava | 11.0 | 473 | 635 | Langenberg | 17.0 | SPAIN | | | | | | | |
| 279 | 1,076 | Bratislava | 14.0 | 533 | 563 | Munich | 1.7 | 253.5 | 1,188 | Barcelona (EAJ15) | 1.0 | | | | |
| 298 | 1,022 | Kosice | 2.5 | 559.7 | 536 | Kaiserslautern | 1.0 | 268 | 1,212 | Valencia (EAJ15) | 8.0 | | | | |
| 341.7 | 878 | Brunn (Brno) | 22.0 | 559.7 | 536 | Augsburg | 0.3 | 349 | 860 | Barcelona (EAJ1) | 8.0 | | | | |
| 487 | 617 | Prague (Praha) | 5.5 | 566 | 530 | Hanover | 0.3 | 338 | 815 | Seville (EAJ5) | 1.5 | | | | |
| 487 | 617 | Cesky Brod | 75.0 | 570 | 527 | Freiburg | 0.35 | 424 | 707 | Madrid (EAJ7) | 2.0 | | | | |
| DENMARK | | | | | | | | | | | | | | | |
| 281 | 1,067 | Copenhagen | 1.0 | 1,035 | 833.5 | Zeesen Norddeich | 10.0 | 453 | 662.2 | San Sebastian (EAJ8) | 0.6 | | | | |
| 1,153 | 260 | Kalundborg | 10.0 | HOLLAND | | | | | | | | | | | |
| ESTONIA | | | | | | | | | | | | | | | |
| 296.1 | 1,073 | Tallinn | 0.7 | 31.28 | 9,599 | Eindhoven (PCJ) | 30.0 | HUNGARY | | | | | | | |
| 403 | 648 | Tartu | 0.5 | 299 | 1,004 | Hilversum | 8.5 | 550 | 545 | Budapest | 23.0 | | | | |
| FINLAND | | | | | | | | | | | | | | | |
| 221 | 1,355 | Helsinki | 15.0 | 299 | 1,004 | Radio Idzerda (The Hague) | 3.0 | 1,200 | 250 | Reykjavik | 21.0 | | | | |
| 291.5 | 1,029 | Tampere | 1.0 | IRISH FREE STATE | | | | | | | | | | | |
| 1,790 | 167 | Lahti | 54.0 | 224.4 | 1,337 | Cork (IFS) | 1.5 | 224.4 | 1,337 | Dublin (2RN) | 1.5 | | | | |
| FRANCE | | | | | | | | | | | | | | | |
| 219.3 | 1,368 | Béziers | 0.6 | 413 | 725 | Dublin (2RN) | 1.5 | ITALY | | | | | | | |
| 222.9 | 1,346 | Fécamp | 1.0 | 25.4 | and 80 | Rome (IRO) | 9.0 | 296.8 | 1,022.2 | Turin (Torino) | 8.5 | | | | |
| 235.1 | 1,275 | Nîmes | 1.0 | 312.8 | 959 | Genoa (Genova)* | 1.5 | 332 | 905 | Naples (Napoli) | 1.5 | | | | |
| 237.2 | 1,263 | Bordeaux-Sud-Ouest | 2.9 | 441 | 680 | Rome (Roma) | 75.0 | 453 | 662 | Bolzano (IBZ) | 0.2 | | | | |
| 249 | 1,205 | Juan-les-Pins | 0.5 | 501 | 599 | Milan (Milano) | 8.5 | LATVIA | | | | | | | |
| 256 | 1,172 | Toulouse (PTT) | 1.0 | *testing on 525 m. | | | | | | | | | | | |
| 265 | 1,130 | Lille (PTT) | 15.0 | 525 | 572 | Riga | 13.0 | LITHUANIA | | | | | | | |
| 272 | 1,103 | Rennes | 1.2 | YUGOSLAVIA | | | | | | | | | | | |
| 285.4 | 1,051 | Montpellier | 2.0 | 303.4 | 825.3 | Algiers (PTT) | 13.0 | 305.1 | 983 | Zagreb (Agram) | 0.7 | | | | |
| 287.1 | 1,045.1 | Radio Lyons | 0.5 | TURKEY | | | | | | | | | | | |
| NETHERLANDS | | | | | | | | | | | | | | | |
| 294.1 | 1,020 | Limoges (PTT) | 0.5 | 1,216.2 | 246.6 | Istanbul | 5.0 | 1,538 | 195 | Ankara | 7.0 | | | | |
| 307.6 | 975.2 | Bordeaux (PTT) | 35.0 | SWITZERLAND | | | | | | | | | | | |
| 313.8 | 956.8 | Natan-Vitus (Paris) | 0.5 | 244.1 | 1,229 | Basle | 0.65 | 245.9 | 1,220 | Berne | 1.1 | | | | |
| 317.3 | 945.4 | Marseilles (PTT) | 1.5 | 452.5 | 743 | Sottens | 25.0 | 452.2 | 653 | Beromunster | (testing) 60.0 | | | | |
| 327.5 | 916 | Grenoble (PTT) | 3.0 | 680 | 442 | Lausanne | 0.6 | 790 | 395 | Geneva | 1.5 | | | | |
| 329.5 | 910.3 | Poste Parisien | 1.2 | YUGOSLAVIA | | | | | | | | | | | |
| 345.2 | 869 | Strasbourg (PTT) | 15.0 | 430.6 | 696 | Belgrade | 3.0 | 574.7 | 522 | Ljubljana | 2.8 | | | | |
| 370 | 810.5 | Radio LL (Paris) | 0.5 | OTHER STATIONS | | | | | | | | | | | |
| 385 | 779 | Radio Toulouse | 8.0 | length scale. For instance, beam signals sent on wavelengths between 15 and 30 metres can be received at good strength 10,000 miles away during the day, though they have a comparatively small range at night. The explanation lies in the change of altitude in the Heaviside layer as the sun rises and sets. | | | | | | | | | | | |
| 447 | 671 | Paris (PTT) | 2.0 | M. A. L. | | | | | | | | | | | |
| 466 | 644 | Lyons (PTT) | 2.3 | WHEN SUBMITTING QUERIES | | | | | | | | | | | |
| 1,445.7 | 207.5 | Eiffel Tower | 15.0 | Please write concisely, giving essential particulars. A Fee of One Shilling (postal order), a stamped addressed envelope, and the coupon on the last page must accompany all letters. The following points should be noted. | | | | | | | | | | | |
| 1,725 | 174 | Radio Paris | 17.0 | Not more than two questions should be sent with any one letter. | | | | | | | | | | | |
| The designing of apparatus or receivers cannot be undertaken. | | | | | | | | | | | | | | | |
| Modifications of a straightforward nature can be made to blueprints, but we reserve to ourselves the right to determine the extent of an alteration to come within the scope of a query. Modifications to proprietary receivers and designs published by contemporary journals cannot be undertaken. | | | | | | | | | | | | | | | |
| Readers' sets and components cannot be tested at this office. Readers desiring specific information upon any problem should not ask for it to be published in a forthcoming issue, as only queries of general interest are published and these only at our discretion. Queries cannot be answered by telephone or personally. | | | | | | | | | | | | | | | |
| Readers ordering blueprints and requiring technical information in addition, should address a separate letter to the Query Department and conform with the rules. | | | | | | | | | | | | | | | |

DAY AND NIGHT RANGES
BROADCAST programmes on 200 metres or over generally come in best at night. Even long-wave commercial stations, which have a range of 3,000 miles or more at night, drop to 300 or 400 miles during the daylight hours. The reverse holds if one goes far enough down the wave-

length scale. For instance, beam signals sent on wavelengths between 15 and 30 metres can be received at good strength 10,000 miles away during the day, though they have a comparatively small range at night. The explanation lies in the change of altitude in the Heaviside layer as the sun rises and sets.

WHEN SUBMITTING QUERIES

Please write concisely, giving essential particulars. A Fee of One Shilling (postal order), a stamped addressed envelope, and the coupon on the last page must accompany all letters. The following points should be noted. Not more than two questions should be sent with any one letter. The designing of apparatus or receivers cannot be undertaken. Modifications of a straightforward nature can be made to blueprints, but we reserve to ourselves the right to determine the extent of an alteration to come within the scope of a query. Modifications

to proprietary receivers and designs published by contemporary journals cannot be undertaken. Readers' sets and components cannot be tested at this office. Readers desiring specific information upon any problem should not ask for it to be published in a forthcoming issue, as only queries of general interest are published and these only at our discretion. Queries cannot be answered by telephone or personally. Readers ordering blueprints and requiring technical information in addition, should address a separate letter to the Query Department and conform with the rules.

OUR LISTENING POST

By Jay Coote

HAVE you noticed that for the past week or so a slight alteration has been made in the call put out by the Copenhagen station? As the short-wave transmitter has been transferred to Skamleback, the name of Lyngby drops out of the announcement, which now reads: "København, Kalundborg og (and) Danmarks kortbølgesender" (short-wave transmitter). Up to the present the Dane has not used an interval signal, but when gaps existed in the programme he has satisfied his listeners with a gramophone record or so. Imitation, however, being the sincerest form of flattery, Copenhagen, in future, intends to take a leaf out of Oslo's book of words and has decided to adopt a similar signal, namely, a few notes from the theme of a Danish folk song.

What the "Super" Will Do

In passing, I must add that one advantage I have reaped from the use of a "Century Super" is the steady reception at good loud-speaker strength of announcements made by the lady of Reykjavik. Although previously I had a slight doubt regarding the call, I can now give it in full; it is, "Utuvarpsstoed Islands i Reykjavik" (phon.: Ray-kee-yar-veek), and when signing off her last words are *Goda natt*. It differs slightly from the greeting sent from Denmark, Norway, and Sweden.

The transfer of Midland Regional to 398.9 metres, I fear, in some instances, may render the reception of Söttnens and Katowice somewhat difficult on all but selective receivers. (By the way, I can separate them perfectly with the "Super" and frame aerial.) It is a pity, as I know that from Geneva and Lausanne there are frequently excellent programmes to be picked up and they should not be missed. However, the close proximity of such powerful stations was bound to upset the apple-cart. For the time being Langenberg is being received at better strength. Later, in December, when the new 75-kilowatt station is launched on the ether, with Northern Regional as its immediate neighbour, we may, I take it, expect further trouble. As it is rumoured that the Cologne plant is to be transferred to Treves and that Muenster and Aachen are to close down, some less fortunate listeners may have to erase the "Westdeutsche" concerts from their daily log.

In Spain

Out of sheer curiosity, on the eventful April 14, I turned my frame aerial towards Spain; I was anxious to ascertain whether and in what manner the advent of a republic would affect the programmes. As luck would have it, I tuned in to Madrid at the exact moment of an announcement to the effect that a message would be broadcast by Alcalá Zamora, the President of the Provisional Government. So far as I could ascertain, it was relayed by all the Union Radio net. Later I found Madrid, Barcelona, and San Sebastian broadcasting their usual musical and dance programmes as if nothing special had happened.

British Summer Time, this year was adopted by France, Spain, and Belgium on the same date; Holland, as usual, did not come in with us, but changes over on May 15. Bear in mind, therefore, that until that date Dutch time will be forty minutes behind B.S.T. and afterwards, as hitherto, namely, twenty minutes in advance. It makes all the difference between hearing a concert from Hilversum—or missing it. B.S.T. now brings us on a level with most of the Continental states, at least, all those working to Central European time. Make a note, however, that Algiers and Rabat (Morocco) do not alter, but retain Greenwich mean time. Russia, I understand, has advanced its clocks one hour.

Postcard Radiō Literature

GET THESE CATALOGUES FREE

Here "Observer" reviews the latest booklets and folders issued by well-known manufacturers. If you want copies of any or all of them FREE OF CHARGE, just send a postcard giving the index numbers of the catalogues required (shown at the end of each paragraph) to "Postcard Radio Literature," "AMATEUR WIRELESS," 58/61, Fetter Lane, E.C.4. "Observer" will see that you get all the literature you desire. Please write your name and address in block letters.

Triotron Valves

FROM Triotron comes an interesting little folder, complete with curves and characteristics of Triotron screen-grid valves. I confess I did not know that such a complete range of screen-grid valves is available in this make, both for battery and mains operation. You should certainly get this folder. **236**

Ever Ready Batteries

Nowadays most of us use a dry battery of some kind, even if it is only for grid bias or in a pocket torch. For that reason I think everyone should have the new Ever Ready catalogue which describes and gives full details of practically every type of Ever Ready battery, accumulator and accessory. **237**

The Ferranti Console

I advise everyone in search of a really high-quality set to write through my free catalogue service for a fine illustrated folder, which tells the whole story of the Ferranti rexine-covered console set. This is an all-electric three-valver, with one screen-grid stage and fitted with a magnodynamic speaker in the top part of the cabinet. Useful technical information is given in the leaflet. **238**

A New Portable

Electrical & Radio Products, Ltd., have brought out a fine screen-grid four-valver made up in a portable type cabinet. A special feature is the low H.T. consumption, the demand from the battery being only six milliamperes. Full details are given in a free folder. **239**

The New PM254

The well-known Mullard PM254 super-power valve has always been a firm favourite and I see that rather than change this type concurrent with new valve developments, Mullards have wisely decided to retain this valve but to embody certain improvements in it. You can get, free, a folder giving details of the new and improved characteristics of the PM254 which is now truly a super super-power valve. **240**

For Selectivity

As the working of Moorside Edge has produced a new need for selectivity, the General Electric Company, Ltd., have reduced the price of the Gecophone wave-trap.—OBSERVER. **241**

EASY TERMS

We supply all good quality Radio Receivers, Components and Accessories on deferred terms. We carry adequate stocks and can give prompt delivery
NEW HEYBERD A.C. ELIMINATOR KIT C.150.—Complete Kit of Parts for building an H.T. Eliminator, including steel case. Output, 25 m.a., 150 volts, 3 H.T. Tappings, one variable.

Cash Price, £3/16/-
or 7/6 with order and 11 monthly payments of 7/-
12 EXIDE W.H. HIGH-TENSION ACCUMULATORS (120 volts, 5,000 m.a.). Higher voltages if desired.

Cash Price, £3/15/-
or 6/6 with order and 11 monthly payments of 7/-
Carriage charged on all orders from Scotland.

N.K. FARRAND INDUCTOR LOUD-SPEAKER UNIT.—Quality of reproduction almost equal to a moving-coil speaker.

Cash Price, £3/10/-
or 5/6 with order and 11 monthly payments of 6/6
B.T.H. PICK-UP AND TONE ARM.—One of the best pick-ups available.

Cash Price, 45/-
or 5/- with order and 9 monthly payments of 5/-
NEW BLUE SPOT 66R UNIT.—The finest balanced-armature movement on the market. Complete with large Cone and Chassis.

Cash Price, £2/10/-
or 5/- with order and 10 monthly payments of 5/-
Send list of requirements and quotation will be sent by return.

LONDON RADIO SUPPLY CO.

11 OAT LANE, NOBLE STREET

LONDON, E.C.2

Telephone: National 1977

"RED DIAMOND" DETECTOR

As specified for 'A.W.' Tapped Coil Crystal Receiver.

RD40
2/-

By insured Post 2/3 or 2/9 with shield.



Can be mounted on brackets or through panel. Once set always ready. Not affected by vibration. Each one is tested on broadcast before dispatch.

Of all high-class Radio Dealers or Sole Makers:

JEWEL PEN CO., LTD.

(Radio Dept. 45), 21-22, Great Sutton Street, LONDON, E.C.1

DX THE STANDARD PLUG-IN COIL

Sold everywhere from 1/-

DX COILS Ltd, London, E.8

For YOUR SET or RADIO-GRAM



Radio Furniture de luxe! Gives style to the home. Nothing cheap or shoddy. Advantages also of PIANO-TONE baffle enables BETTER REPRODUCTION (3,000 clients and Leading Experts.) DIRECT from makers. APPROVAL

10/- monthly Photographs FREE. PICKETTS, Radio Furniture Works (A.M.) Albion Road, Bezzleyheath, Kent

ROLA MOVING COIL

SPEAKERS

Highly efficient, latest, for mains or batteries, tested; guaranteed, 2,000 to clear immediately, 39/6 each. Cash order, seven days approval.

A. F. POLLOCK & Co., 50 Alric Avenue, New Malden, Surrey.

THE HALL MARK OF BETTER RADIO



TAYLEX WET H.T. BATTERIES—New Prices: Jars 1/3. Sacs 1/2. Zincs 1 Od. Sample doz. 18 Volts complete with bands and electrolyte 4/1 post 9d. Sample unit 6d. Illus. booklet free. Bargain list free. AMPLIFIERS, 30/- 3 VALVE ALL-STATION SET £5. A. TAYLOR, 57, Studley Road, Stockwell, LONDON.

PREPAID ADVERTISEMENTS

Advertisements under this head are charged THREEPENCE PER WORD, minimum charge THREE SHILLINGS. DEPOSIT SYSTEM As the Publishers cannot accept responsibility for the bona fides of advertisers in this publication, they have introduced a system of deposit which it is recommended should be adopted by readers when dealing with persons with whom they are unacquainted. It is here explained. Intending purchasers should forward to the Publishers the amount of the purchase money of the article advertised. This will be acknowledged to both the Depositor and the Vendor, whose names and addresses must necessarily be given. The deposit is retained until advice is received of the completion of the purchase, or of the article having been returned to and accepted by the Vendor. In addition to the amount of the Deposit, a Fee of 6d. for sums of £1 and under, and 1s. for amounts in excess of £1, to cover postage, etc., must be remitted at the same time. In cases of persons not resident within the United Kingdom, double fees are charged.

The amount of the Deposit and Fee must be remitted by Postal Order or Registered Letter (Cheques cannot be accepted), addressed to

"AMATEUR WIRELESS" ADVERTISEMENT DEPARTMENT, 58/61 FETTER LANE, LONDON, E.C.4

PHOENIX THREE-VALVE kits complete with cabinet, £1/17/6. Ditto with valves, £2/15/-. Ditto with H.T. and L.T. batteries and speaker, £4/19/6. H.P. terms on kit: 5/- deposit, 2/7 per week.—Phoenix, 314 High Road, Lee, S.E.13.

PATENTS.—Trade Marks, Advice Handbook free.—B. T. King, Regd. Patent Agent, 146a Queen Victoria Street, London.

PERSONS WANTED as manufacturing agents, new and interesting industry. Regular work supplied, cash paid weekly. Write E. 87, "Everlast" Leather Matting Co., Wellingborough.

CHARGE YOUR H.T. FROM YOUR L.T. AT HOME. Wonderful discovery. Fox's Recharger will trickle-charge H.T. accumulators. Ratio, 4 amp. Set can be on or off switch. Fitted 2 minutes. Guaranteed, 6/6 (diagram only, 1/6).—Fox, 188 Camberwell Grove, S.E.5.

A.C. H.T. ELIMINATORS, from 65/-, or 12 monthly payments of 6/-. A.C. H.T. Eliminator Kits from 43/- to 62/6; cash or monthly terms. Cabinet Speakers, 12/6 each, worth double. Cash or C.O.D.—Servwell Wireless Supplies (Dept. M.O.), 74 Gough Street, London, E.14.

AGENTS WANTED to sell well-known H.T. Units, etc., for cash or easy terms. Prices are very competitive and good commission is offered.—Brookman Rapid Radio Service, 105 Spencer Street, Birmingham. Wireless and Cycle Factors. Specialists in Radio Cabinet Work.

TRICKLE CHARGERS, A.C. mains for 2- and 4-volt accumulators, 0.5 amp., no upkeep, 18/6, carriage paid.—A. Benoit, 4 Manor Gardens, Gunnersbury Avenue, London, W.3.

"BEST BY 3" radiogram in cabinet, all parts new, including Lewcos coils, valves and Ekco H.T. mains unit, Blue Spot speaker and pick-up. Set never completed through owner travelling north England. What offers —Box No. 33, "Amateur Wireless," 58 Fetter Lane, E.C.

COLUMBIA 16-gn. portable, as new, £8 8s. cash.—Dunn and Duncan, 87 Chancery Lane, W.C.

FREE TELSEN RADIOGRAND TRANSFORMER to every purchaser of a Wates 8-pole Star Unit. Send 25/- plus 1/- postage and take advantage of this offer now. Details of other bargains on request.—John Strait, 18 Mitcham Road, East Ham, London.

"BROOKMANS 4."—Coils and other components selling half-price.—"Chaufeur," Southbar, Rentfree.

BARGAINS.—Shop-soiled and partly used components, sets, speakers, etc., all Guaranteed perfect electrical condition. Supplied on seven days approval against cash. Send list your requirements.—Bostock & Stonnill, 1 Westbourne Terrace, S.E.23.

SALE.—Ferranti A.F.5 (c), O.P.M.2 (c); Lewcos binocular coils, new (offers); also experimenter's surplus. Stamp particulars.—H. Hobbs, Bucknell, Salop.

MOORSIDE EDGE.—Special device to cut out new station within three degrees. Results guaranteed or money returned. Price 5/6, postage 3d, extra.—Wainwrights, Wireless Engineers, Wakefield Road, Ossett. Telephone 16.

A MAGNIFICENT SET.—The National and Regional Three, absolutely complete, including Tungram valves, 2-volt accumulator, 100-volt H.T. battery, B.T.H. 45/- loud-speaker. Perfect reception from home and foreign stations. Guaranteed 12 months. Amazing value, £4, inclusive.—H. Panagakis, Radio Manufacturer, 91 Dale Street, Liverpool.

ENGINEERS, CAN'T WE GET TOGETHER?—All we ask is the chance to prove that you can earn £300, £400, and even £1,000 per year and more. Other men are doing it and you can do the same. If you wish for something more than a "bread and butter" job, you owe it to yourself to investigate our service. Our new handbook, "Engineering Opportunities," contains, amongst other intensely interesting matter, details of B.Sc., A.M.I.C.E., A.M.I. Mech. E., A.M.I.E.E., A.M.I.A.E., A.M.I. Struct. E., M.R.San L., I.I.B.O., F.S.I., G.P.O. C. & G., etc. Exams., outlines courses in all branches of Civil, Mechanical, Electrical, Motor, Wireless, Aeronautical, and Tackle Engineering, and explains the unique advantages of our Appointments Department. We alone guarantee "No pass—no fee." This is your opportunity. Send for our new handbook to-day. State subject or exam. of most interest (free and post free).—British Institute of Engineering Technology, 109 Shakespeare House, 29-31 Oxford Street, London.

BANKRUPT BARGAINS.—List free with 3-v. diagram. .0005 variable, 2/6; differentials, 2/6; S.M. dials, 1/6; dual coils, 5/- and 8/6; H.F. chokes, 1/6; transformers, 2/9; Telsen A.C.E., 6/6; Radiogram, 9/6; valves, speaker units, eliminators, etc. 3-v. kits, 35/-; 2-v., 24/-, with cabinets.—Butlin, 143b Preston Road, Brighton.

It is understood that a new main cable has just been constructed from Manchester to Liverpool with special screened conductors, for the B.B.C.

Broadcasts from the Vatican (Rome) short-wave station are now taking place regularly at the following times: on 19.84 metres from 10.0 to 10.30 a.m. B.S.T. and on 50.26 metres from 7.0 to 7.30 p.m. B.S.T. Transmissions in telegraphy follow the telephony broadcasts.

From statistics issued by the German Ministry of Posts and Telegraphs it is computed that of the total number of sets used only 16 per cent. are now crystal sets.

The B.B.C. is inaugurating an important new series of orchestral concerts in the big studio at the Edinburgh station. A Scottish orchestra of about forty players has been assembled, and the series will be continued throughout the summer months.

An effort is being made to extend the usefulness of the Wireless League in Scotland. The League has appointed Mr. Andrew Aitken, 8 Fortrose Street, Glasgow, as the honorary secretary for Scotland.

"Amateur Wireless and Radiovision." Price Threepence. Published on Thursdays and bearing the date of Saturday immediately following. Post free to any part of the world: 3 months, 4s. 6d.; 6 months, 8s. 9d.; 12 months, 17s. 6d. Postal Orders, Post Office Orders, or Cheques should be made payable to "Bernard Jones Publications, Ltd." General Correspondence is to be brief and written on one side of the paper only. All sketches and drawings to be on separate sheets. Contributions are always welcome, will be promptly considered, and if used will be paid for. Communications should be addressed, according to their nature, to The Editor, The Advertisement Manager, or The Publisher, "Amateur Wireless," 58-61 Fetter Lane, London, E.C.4.

YOU CAN BUILD A £40 GRAMOPHONE WITH OUR SCALE DRAWINGS FOR 40/- Book of instructions 3d. Catalogue of Motors, Tonearms, Soundboxes, latest internal amplifiers, Gramophones and Cabinets Free. Cash or Terms. W. BURT, 185 High St., Deptford.

KONDUCTITE (Prov. Patent 481731) METALLIC PAPER Konductite consists of a thin sheet of aluminium mounted on a comparatively stiff backing paper and has all the advantages of sheet metal. It is very easy to work with and infinitely superior to tin or copper foil. It is now specified in all leading circuits. For Covering Baseboards : Back of Panels : Linings of Cabinets and all Screening purposes. In sheets measuring 30" x 20" 2/- Postage and packing 6d. extra. Free sample on receipt of stamped addressed envelope. GRAMMO-RADIO AMPLIFIERS LTD., 11 NEW LONDON ST., E.C.3 Phone: Royal 4300

MAKE OR BUY A GRAMOPHONE AT a quarter shop prices. Or buy Cabinets for Wireless. British double spring motor, 12 in. velvet turntable, swan arm, metal sound-box, amplifier, needle cups, for £4-16-0 p.p., and build your own Cabinet. Portable Gramophones from 15/6, postage 1/6. Motors from 7/6. Lists free. 64 pp. 1931 Catalogue No. 220 with Reduced Prices, Drawing and How to Make Gramos, 3d. Established 27 years. Regent Fittings Co., A.W., 120 Old St., London, E.C.1

FULL-SIZE BLUEPRINTS

When ordering, please send Postal Order, NOT STAMPS. CRYSTAL SET (6d.) B.B.C. Crystal Set AW284 ONE-VALVE SETS (1s. each) One Control One AW267 Regional Ultra-selective One AW280 B.B.C. One AW280 Hartley One WM198 TWO-VALVE SETS (1s. each) Talisman Two (D, Trans) AW194 No-battery A.C. Mains Two (D, Trans) AW230 No-battery Gramo-radio 2 (D, Trans) AW238 1930 Talisman 2 (D, Trans) AW245 Searcher Two (D, Trans) AW245 Arrow Two (D, Trans) AW249 Forty-five-shilling Two (D, Trans) AW250 Searcher Short-wave 2 (D, Trans) AW259 Challenge Two (D, Trans) AW261 Loftin-White Two (A.C. Mains) AW263 Everybody's All-in 2 (D, Trans) AW273 Twenty-Shilling Two (D, Trans) AW274 Brookman's Two (D, Trans) WM168 Gleaner Two (D, Trans) WM201 Music Monitor (D, Trans) WM208 Merlin Two (A.C. Set) WM213 Five-Point Two (D, Trans) WM220 Brookman's A.C. Two (D, Trans) WM225 Aladdin Two (D, Trans) WM231 THREE-VALVE SETS (1s. each) 1930 Clarion Three (SG, D, Trans) AW223 Beginner's Regional Three (D, 2LF) AW233 The "A.W." Exhibition 3 AW247 Push-Pull "Two" (D, Push-Pull) AW270 1931 Ether Searcher (SG, D, Trans) AW271 1931 Ether Searcher (A.C. model) AW276 Mains Unit AW277 Ultra-Selective Straight Three (SG, D, Trans) AW282 1931 Ether Searcher (D.C. model) AW284 Mains Unit AW285 Fanfare Three (D, 2 Trans) WM157 Brookman's Three (SG, D, Trans) WM161 Brookman's Push-Pull Three (SG, D, Trans) 1/6 WM170 Inceptordyne (SG, D, Pentode) WM179 Music Marshal (D, 2 Trans) WM190 Concert Three (D, 2 Trans) WM199 De-Luxe Three (D, RC, Trans) WM209 Five-Point Three (SG, D, Trans) WM212 Falcon Three (A.C. Set) WM217 New Brookman's Three (SG, D, Trans) WM218 Five-point Short-waver (D, RC, Trans) WM223 Baffle-Board Three (D, RC, Trans) WM226 Plug-in-Coil Three (D, 2 Trans) WM232 Regional Three (SG, D, Trans) WM236 Gramo-radio A.C. Three (SG, D, Trans) WM237 FOUR-VALVE SETS (1s. 6d. each) Horizon Four (SG, D, 2 Trans) AW237 Challenge Radio Gramophone (SG, D, RC, Trans) AW265 Lodestone Four (HF, D, RC, Trans) WM193 Searcher's Four (SG, D, RC, Trans) WM194 Regional Band-pass Four (SG, D, RC, Trans) WM211 Five-Point Four (SG, D, RC, Trans) WM216 Regional A.C. Four (SG, D, RC, Trans) WM222 Supertone Four (SG, D, Push-pull) WM227 Brookman's Three-Plus-One (SG, D, RC, Trans) WM233 FIVE-VALVE SETS (1s. 6d. each) James Quality Five (2SG, D, RC, Trans) AW227 Companion Portable (2HF, D, RC, Trans) AW279 1930 Five (2HF, D, RC, Trans) WM171 Radio-Record Five (SG, D, Trans-parallel) WM188 Overseas Five (3SG, D, Trans) WM191 Regional A.C. Five (3SG, D, Trans) WM224 SIX-VALVE SETS (1s. 6d. each) Century Super (Super-het) AW287 Hyperdyne Receiver WM221 Super 60 (Super-het) WM229 AMPLIFIERS (1s. each) "A.W." Gramophone Amplifier AW205 Two-valve Amplifier AW216 Simple Gramophone Amplifier AW257 High Quality Amplifier for A.C. Mains AW275 2-Watt Amplifier for A.C. Mains AW283 Radio-Record Amplifier (DC Mains) WM183 Selecto Amplifier (HF, Unit) WM212 MISCELLANEOUS (1s. each) Simple Tester Unit (6d) AW246 "A.W." Improved Linton-diaphragm Speaker AW248 Handy L.T. and G.B. Unit for A.C. Mains AW254 Our H.T. Unit for A.C. Mains AW262 Gramophone Tone Control AW264 Short-wave Super-het Adaptor AW268 H.T. Unit and Trickle Charger for D.C. Mains AW272 Booster Speaker AW286 "W.M." Standard A.C. Unit WM214 "W.M." Standard D.C. Unit WM215 Falcon A.C. Unit WM219 Hyperdyne Short-wave Adaptor WM228 Big H.T. Unit for A.C. Mains WM235 PORTABLE SETS Continental Portable (SG, D, Trans) AW241 1/- Companion Portable (2HF, D, RC, Trans) AW279 1/6 Pedlar Portable Two (D, Trans) WM195 1/- Pedlar Portable Three (D, 2 Trans) WM197 1/- Super 60 Portable (Super-het) WM238 1/6 Copies of the "Wireless Magazine" and of "Amateur Wireless" containing descriptions of any of these sets can be obtained at 1s. 3d. and 4d. respectively, post free. Index letters "A.W." refer to "Amateur Wireless" sets and "W.M." to "Wireless Magazine." Address letters: Amateur Wireless Blueprints Dept., 58-61 Fetter Lane London, E.C.4.

Amateur Wireless Available until Saturday MAY 9, 1931

460,000

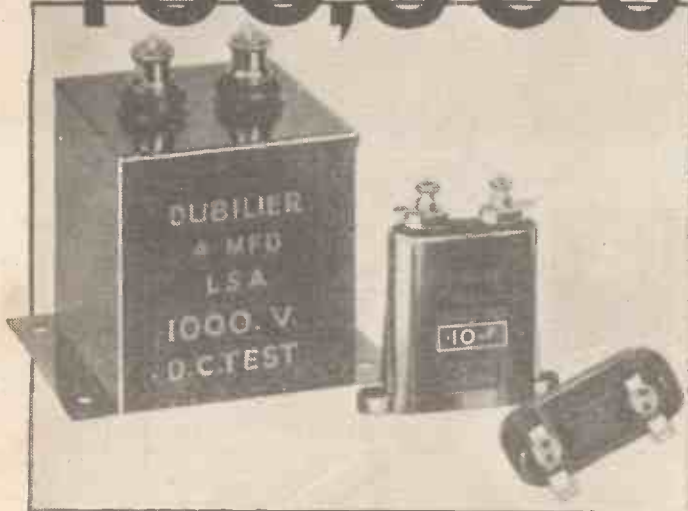

DUBILIER CONDENSERS

CHOSEN ON MERIT

A well-known firm of Set manufacturers has recently placed with us a contract for this huge number of condensers.

Competent engineers on their staff subjected samples of our Condensers to rigorous tests together with other makes and Dubilier Condensers came out on top.

This manufacturer entrusted his reputation to Dubilier—can there be better testimony to Dubilier quality? Ask for Dubilier and be sure.

DUBILIER CONDENSER CO. (1925), LTD.
 Ducun Works, Victoria Road, N. Acton,
 London, W.3.

DUBILIER CONDENSERS

THE GREATEST PLEASURE



"Although there were about 25 Speakers of all makes tested, my "Wufa" was found to be the winner."

Beware of imitations. The genuine Wufa has RED Magnets

Receive the congratulations of your friends when they hear the amazing fidelity of reproduction given by your "Wufa."

Read this extract:—

"At a meeting of our local Radio Society . . . The members were amazed at the fidelity of its reproduction and afterwards a lecture was given on its merits."

Now ask your Local Dealer to demonstrate a "Wufa" to you
 If your Dealer cannot supply, we will send you a "Wufa," carriage paid for 40/-

Southall Mdx.

40/- Complete with chassis 27/6 Unit only

(Trade Supplied)

WUFA

PEARL & PEARL
 190 Bishopsgate, London, E.C.2

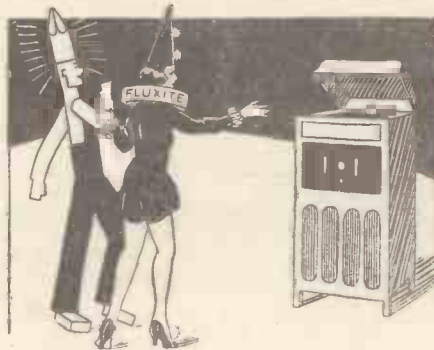

We're Fluxite and Solder. The reliable pair, Famous for soldering—Known everywhere! You've trouble with wireless Well, don't get put out—We'll SOLDER the connections, That's the trouble, no doubt!

See that Fluxite and Solder are always by you—in the house, garage, workshop—anywhere where simple, speedy, soldering is needed. They cost so little, but will make scores of everyday articles last years longer! For Pots, Pans, Silver, and Brassware; RADIO; odd jobs in the garage—there's always something useful for Fluxite and Solder to do.

All Hardware and Ironmongery Stores sell Fluxite in tins, 8d., 1/4 and 2/8.

ANOTHER USE FOR FLUXITE
 Hardening Tools and Case Hardening.
 Ask for Leaflet on improved method.

NEW "JUNIOR" SIZE, 4d per tin
FLUXITE SOLDERING SET

Simple to use and lasts for years in constant use. Contains special "small-space" soldering iron with non-heating metal handle; pocket blow-lamp, Fluxite, Solder, etc.; and full instructions.

COMPLETE, 7/6, or LAMP only, 2/3.
 FLUXITE, LTD.

(Dept. 326)
 ROTHERHITHE, S.E.16

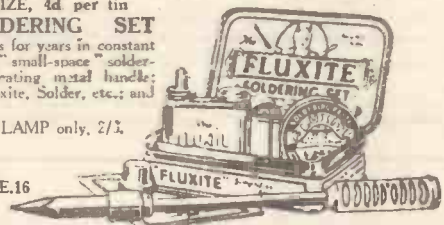

ALL MECHANICS WILL HAVE

FLUXITE

 IT SIMPLIFIES ALL SOLDERING

To Ensure Speedy Delivery, Mention "A.W." to Advertisers

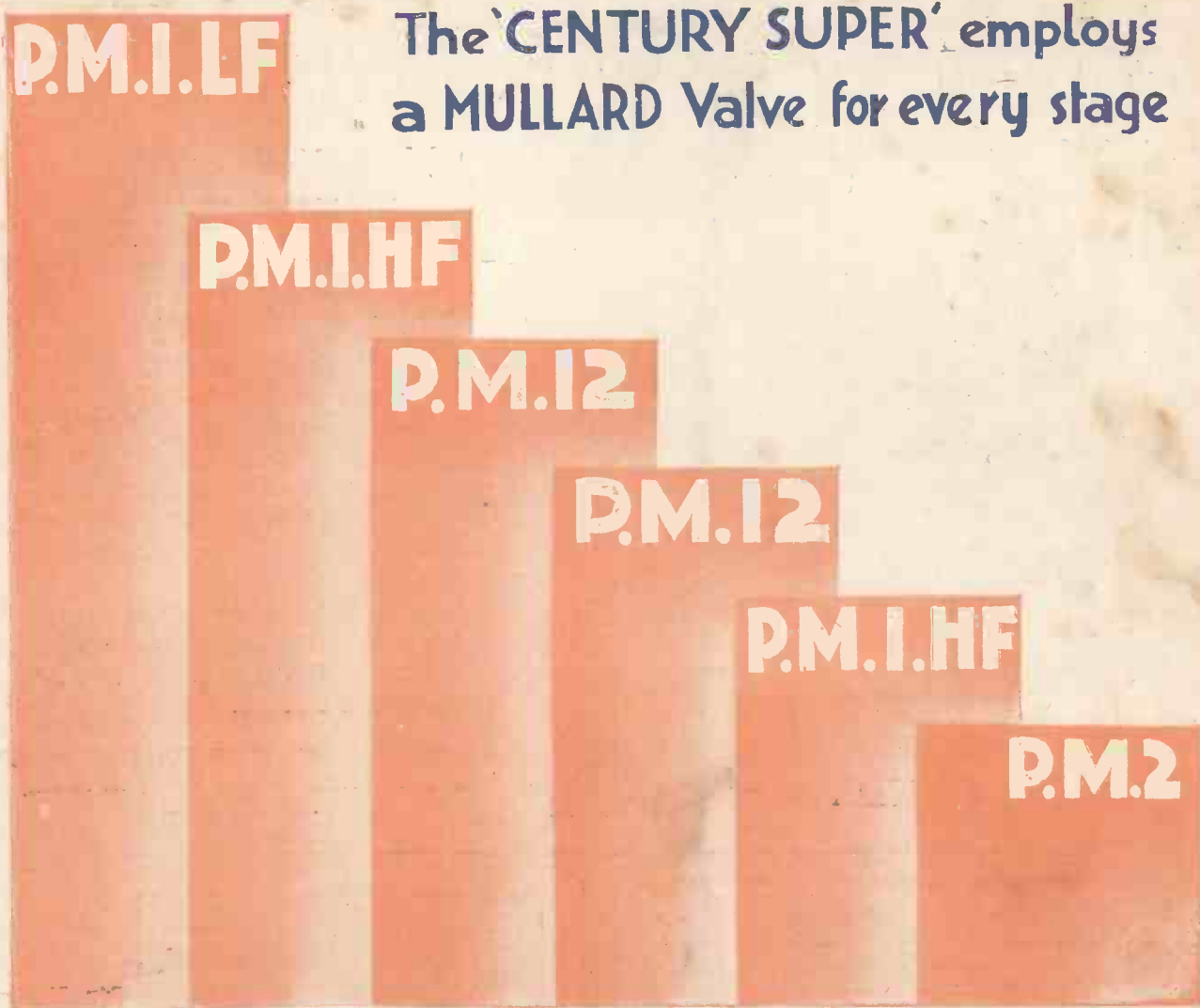

The 'CENTURY SUPER' employs a MULLARD Valve for every stage

OSCILLATOR 1ST DETECTOR SCR.GRID SCR.GRID 2ND DETECTOR OUTPUT

The designer of the Century Super could not afford to take chances with his valves. He chose Mullard. Mullard because of unsurpassed performance. Mullard because of unfailing reliability. Mullard because of economy. Your own radio dealer can supply you with the necessary Mullard types for this great new receiver.

P.M.1LF 8'6. P.M.1HF 8'6. P.M.12 20'-. P.M.12 20'-. P.M.1HL 8'6. P.M.2 10 6.

Mullard

THE MASTER VALVE

Advt. The Mullard Wireless Service Co., Ltd., Mullard House, Charing Cross Road., London, W.C.2

Arks

Printed in England. Published by Bernard Jones Publications, Ltd., 58/61 Fetter Lane, London, E.C.4.
 Sole Agents for South Africa: CENTRAL NEWS AGENCY, LIMITED. Sole Agents for Australasia: GORDON & GOTCH, LIMITED. Saturday, May 2, 1931