

OUR SPECIAL "SUPER-HET" NUMBER

AN EIGHT-VALVE SUPER-HETERODYNE

Amateur Wireless And Electrics

Vol. VI. No. 151.

SATURDAY, APRIL 25, 1925

Price 3d

PRINCIPAL CONTENTS

A TUNING-COIL RE-
FINEMENT

A SIMPLE 3-VALVE
SUPER-HETERODYNE
RECEIVER

THE CRYSTAL DE-
TECTOR IN THEORY
AND PRACTICE

LOUD-SPEAKER EX-
TENSION LEADS

OSCILLATORS FOR
SUPER-HETERODYNE
RECEIVERS

TRANSMISSION STEP
BY STEP

SUPER-HETERODYNE
TRANSFORMERS

FREE REPLIES TO
READERS' QUES-
TIONS

WELL ILLUSTRATED

Registered at G.P.O. as a Newspaper.

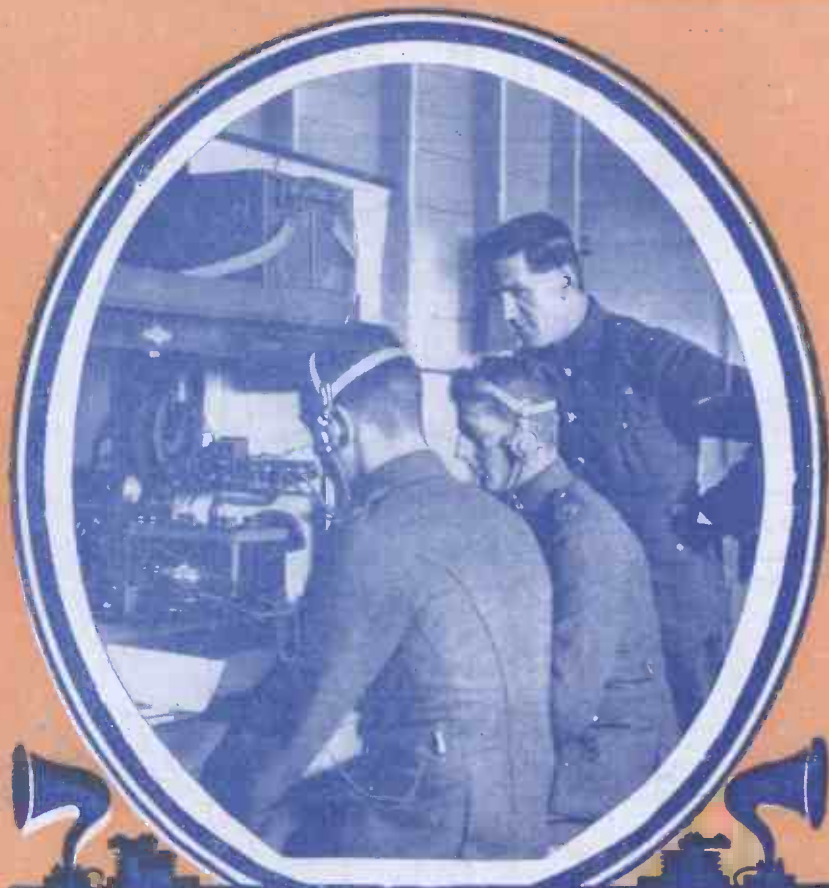

TRAINING WIRELESS OPERATORS FOR THE ARMY

At work in the 120-watt training station at Haresfield, where wireless operators are trained for the Royal Signals.

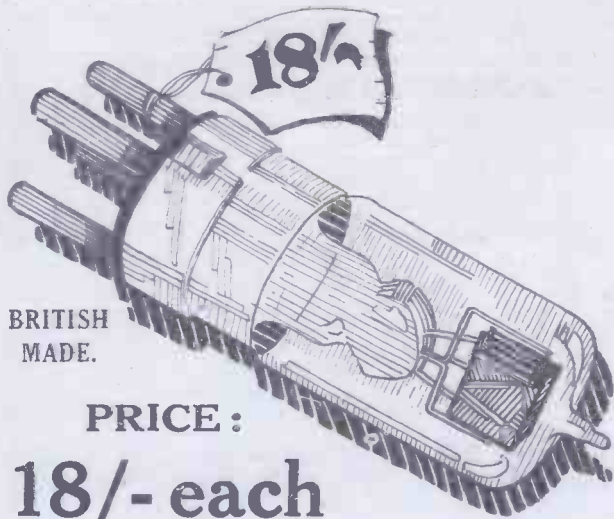

BRITISH
MADE.

PRICE:
18/- each

On a low-loss short wave Receiver, KDKA (68 metres) was brought in at comfortable headphone strength on one valve (Amateur Wireless, Apr. 4th.)

The valve has an unusually high filament efficiency, and, as can be gathered from our tables, gave excellent results, on all tests. (Wireless World.)

The new type Dextraudion Valves were used in the 4-valve portable and gave excellent results. Their low current consumption has solved the difficulty of portable sets for the motorist. (The Motor.)

The actual consumption of the Dextraudion Valve is only .051 amps. (Wireless World.)

AN ASTOUNDING OFFER!

A Brand New Pair of Brown's Featherweight 'Phones given away to "Dextraudion" Users, for One Week Only

We believe that the new .06 DEXTRAUDION VALVE is the best dull emitter in the world to-day, and we want everyone else to know it. In order to encourage readers of *Amateur Wireless* to try them and prove our statement we are making this unique offer for one week only. To every retail purchaser of 3 Dextraudion Valves who sends or brings this advertisement we will present a pair of the World's Best 'phones—BROWN'S FEATHERWEIGHT, value 20/-, brand new, in sealed boxes. The valves must be purchased from us direct, within 7 days from the publishing date of this advertisement.

We are confident that when you have tried these valves you will never use any others. The voltage is 2½ to 3, consumption .06 amp., and the anode potential 45-75 volts. Each valve is carefully tested and packed in sealed boxes of special construction. We guarantee safe delivery.

Economic Electric Ltd

10 FITZROY SQUARE, LONDON, W.1
SHOWROOMS: 503 EUSTON ROAD, and
64 LONDON ROAD, TWICKENHA M. Also at Bush House

TUNGSTALITE'S TRIUMPH

2 L O HEARD FROM LIVERPOOL
on
TUNGSTALITE GOLD LABEL



3, Forbes Place, Orell,
Bootle (nr. Liverpool).
Messrs. Tungstalite, Ltd. April 2nd, 1925.

Dear Sirs,—No doubt you will be glad to hear that I receive splendid results with your GOLD LABEL CRYSTAL. Liverpool (3 miles) and Manchester (32 miles) come in splendid on a Crystal Set, and on Monday evening I listened to the test from LONDON STATION, and I attach below details of what I heard from 2 L O.

I may say that I have tried several Crystals during the last twelve months, and while some have been very good, your TUNGSTALITE is the only one which has brought in London.

Yours faithfully,
FRANK G. URMSTON.

IT IS ABSOLUTELY
THE FINEST CRYSTAL
IN EXISTENCE.

post 2/- free

Ask your dealer for it, or send 2/- to
TUNGSTALITE LTD.,
47, FARRINGTON ROAD, LONDON, E.C.1
Phone: Holborn 2557. Grams: Tungstlamp Smith.

**DON'T ASK FOR CRYSTAL
—ASK FOR TUNGSTALITE**

*This PAD makes all the
difference in the world*



The "Kumfi" de Luxe Ear Pad is a veritable boon to listeners. Instead of the hard surface of the headphone earpieces pressing continuously on your ears, you have instead a soft, luxurious pad that relieves pressure and prevents all discomfort.

The "Kumfi" de Luxe Ear Pad is the only scientifically prepared pad. It is hygienic and absorbent, and shuts out exterior noises. Try a pair and add greatly to your comfort; they are easy to fix and easy to remove.

**'KUMFI'
De Luxe
EAR PAD**

Patent applied for. ©2

1/3d per pair

Sold by Wireless Dealers,
or post free from the
makers, on receipt of 1/3.

A. De ST. DALMAS
and Co., Limited,
LEICESTER.



Amateur Wireless

and Electrics

Vol. VI. No. 151

April 25, 1925

THE SUPER-HETERODYNE

A SIMPLE EXPLANATION

AS the supersonic heterodyne receiver is becoming very popular, a simple explanation of the principles of this very interesting type will be acceptable. The theory of the supersonic heterodyne is really quite simple and will be readily understood by reference to Fig. 1. Here at A we have a set of waves of a certain wavelength, say the waves picked up by your aerial from a broadcast station. At B is another set of waves of a wavelength slightly different, such as might be produced by a local valve oscillator coupled to the aerial-tuning coils; and tuned to a slightly different wavelength (say a metre or so different).

The Heterodyne Effect

Now imagine these two sets of waves combining.

We shall see that, if we arrange so that the peak or crest of the first wave of A corresponds with the first crest of B, these two crests will join together, both being positive crests. The next two crests will not coincide exactly, and in the third, the crests will be still further out. Progressing thus, we see that a time will come when a crest of A will coincide with a hollow or trough of the B set—that is, they will neutralise one another, or nearly so.

The result is shown graphically at C, and it will be readily seen that the distance of x to y will depend on the difference between the wavelength of A and B. If this difference of wavelength is made less, the distance x-y will increase, until when A and B are of the same wavelength, the distance x-y is infinite.

However, let us look a little closer at the result C, which we obtain by combining A and B. If C is passed through a detector and rectified we shall see that the result will be D, and it requires no very great stretch of imagination to see that D consists of a new set of

waves of a wavelength much higher than that of either of the original sets, but varying according to the wavelength difference between the original sets.

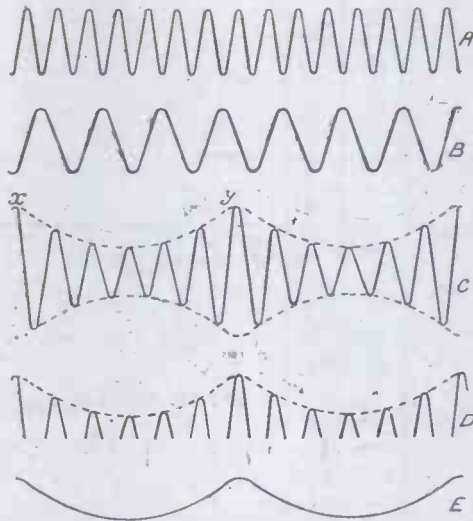

Fig. 1—Diagrams Explaining the Principle of the Super-heterodyne Receiver.

As a matter of fact, this new wave is formed of a series of minute impulses all in the same direction, but these impulses

or "beat" wavelength correspond with the highest wavelength used for wireless. If we now arrange a second detector for this new wavelength we can rectify the "beat" oscillations and obtain speech and music from them as we might have done from the original oscillations from the broadcast station. This is the principle used in the supersonic heterodyne.

The Oscillator

A local oscillator (a valve) is made to generate oscillations which combine with the incoming oscillations from the aerial. The result is rectified by a second valve, in the anode circuit of which is connected the primary of a long-wave transformer (tuned to, say, 8,000 metres). The secondary of this transformer is connected to a series of H.F. amplifying valves and, lastly, a second detector valve. In the anode circuit of this valve are connected the telephones.

To operate the circuit the aerial is tuned to the wavelength of the station to be received, and the heterodyne circuit which generates the local oscillations is adjusted so that the resulting "beat" oscillations occur on the wavelength to which the long-wave H.F. amplifier of the receiver is tuned.

Thus it will be seen that, even if as many as ten high-frequency valves are used on the long-wave amplifier, only two tuning controls will still be needed. This is one advantage of the super-heterodyne receiver, as it means extreme simplicity of operation.

Another advantage lies in the fact that the wavelength is first changed from the low wave to the high wave before it is amplified at radio

frequency. This means that a great number of H.F. valves can be used without any instability.

(Concluded at bottom of third column on next page)

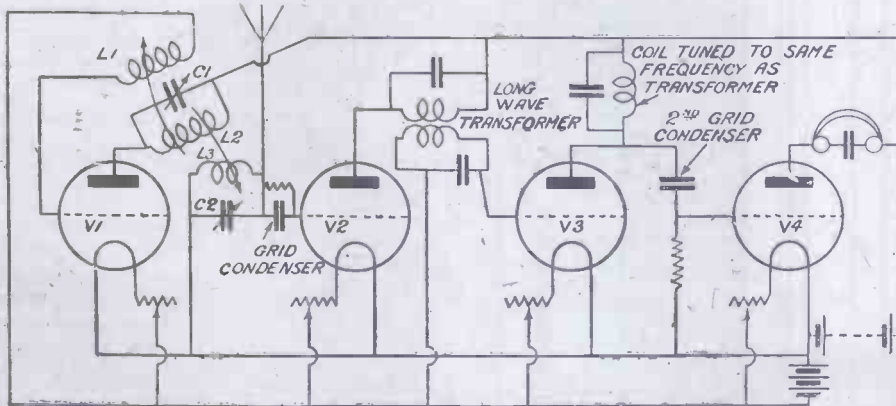

Typical Super-heterodyne Circuit.

can be ignored, as their total effect is what counts, and this is shown at E.

By suitably adjusting the wavelength of B oscillations, we can make the resulting

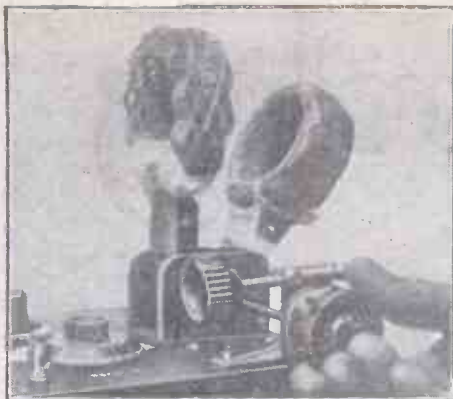

A TUNING-COIL REFINEMENT

TO obtain a fine adjustment of the tuning coils on one of my valve sets, I recently made and fitted the device illustrated by the photographs. As far as I know it is quite original in design, although the main principle introduced—namely, a friction coupling between the two movements, the coarse and the fine—is well known to clockmakers. It is used in setting the hands of a clock. When the hands are forcibly moved they must be freed from the gear-mechanism, otherwise turning the hands round would damage the works.

In adapting this time-honoured scheme to the present purpose (see Figs. 1 and 2), the vernier gear is loose and is only connected to the disc fixed on the spindle by the friction provided by pressing the two parts together with a spring washer. It will also be noted that when the device is used, no other friction arrangement is required to maintain the coils in position.

Furthermore, this device can be made as an entirely separate unit and be "tied on" anywhere to the spindle moving the coils between the handle and the holder, though it must, of course, be connected to some fixed part of the set. The spindle

can be of any desired length. The two actions are permanently coupled together by the same amount of friction as is necessary to support the coils in position. The parts of the device are few. A

gear wheel and cut the worm to suit it out of brass bar, solid, with the "vernier" spindle. The fixed collar (Fig. 3) can also be a Meccano fitment. The bracket (Fig. 4) was made out of odd casting, but any thick sheet-brass can be used. Its exact shape depends on how it is to be supported on the panel or the case somewhere near to the extremity of the coil-holder spindle.

The friction disc (Fig. 5) should be fixed to the shaft and bear on the gear wheel—which is loose on the spindle—at the periphery only. All the centre should be recessed so that it does not touch the gearwheel there. This ensures that the grip between the two parts is exerted only at the greatest distance from the spindle. The gearwheel has to drive the spindle when the vernier is being used. The spring washer should be of the ordinary double type.

In assembling, a spring washer may also be placed between the worm and its bearing to take up any back-lash, and the holes in the bracket for the bearings (Fig. 4) of this worm should be slightly oval so that the bearing can be adjusted. They should be capable of being tapped down when nearly tightened up to bring the worm into perfect mesh with the gear-wheel and then finally secured.

HENRY GREENLY.

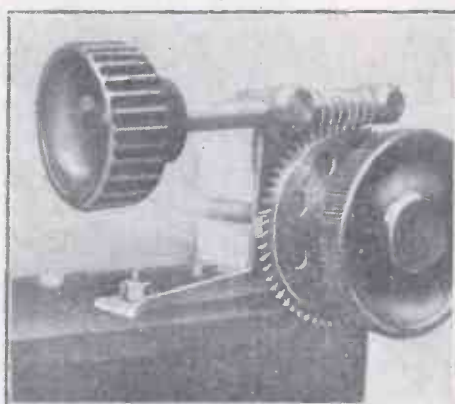

View of Gear.

suitable worm-and-gear wheel is essential. These can be made, retrieved from an old clock, or the gears supplied with construction toys can be pressed into service. For my own set I used a Meccano 1½-in.

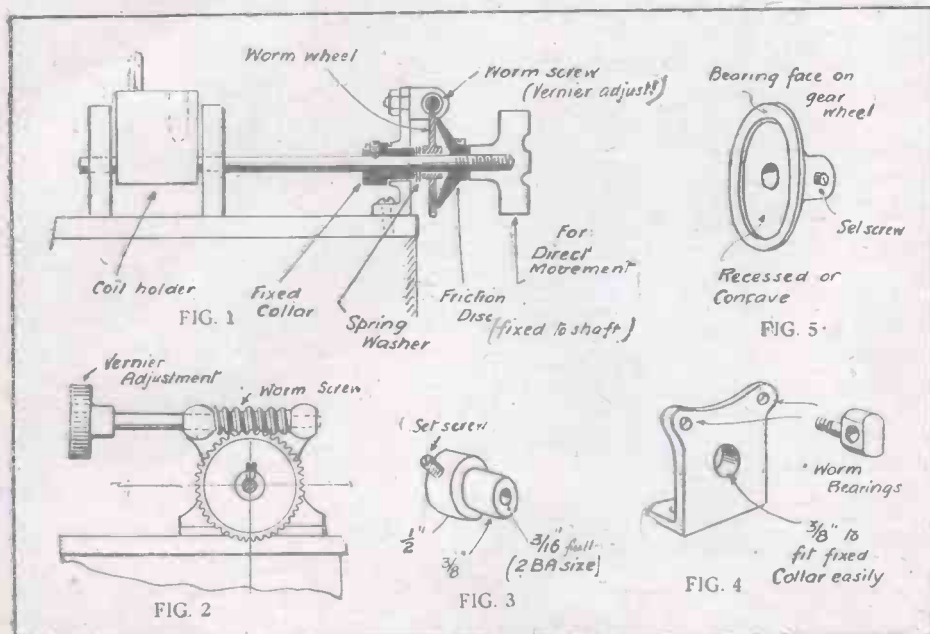

Figs. 1 and 2.—Section and Elevation of Adjuster. Fig. 3.—Collar. Fig. 4.—Bracket. Fig. 5.—Friction Disc.

"THE SUPER-HETERODYNE" (continued from preceding page)

The third and very important advantage lies in the fact that the first valve (the short-wave detector) will respond readily to very minute impulses from the aerial, due to the fact that its grid circuit is kept in a state of continuous oscillation.

The circuit (Fig. 2) is a typical super-sonic-heterodyne circuit, consisting of V₁ the oscillation valve, V₂ the short-wave detector, and V₃ and V₄ the amplifier and detector for the "beat" oscillations.

Only one H.F. amplifier is shown here for clearness, though more can be, and generally are, used.

M. C. P.

Broadcasting will begin this month in Peru. The first station will be at Lima, and will be a duplicate of the station formerly used for 2 L O at Marconi House.

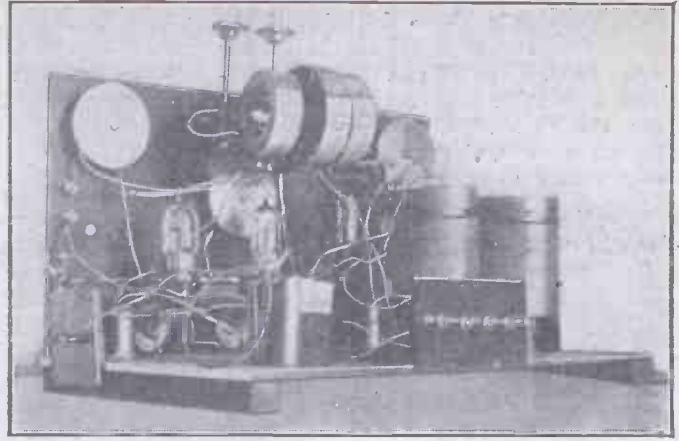
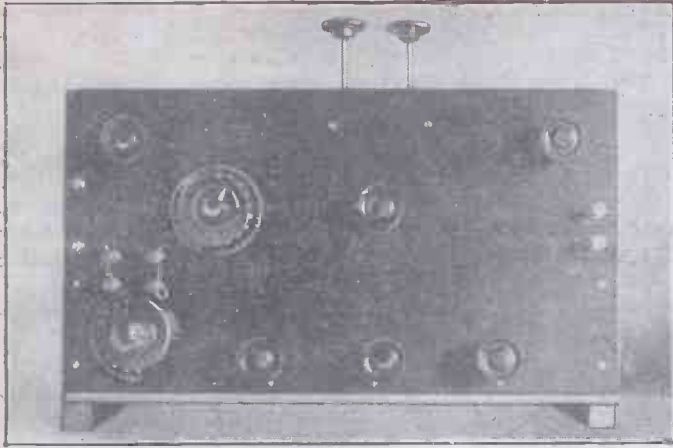

Front and Rear Views of Panel of Experimental Super-heterodyne Receiver.

A SIMPLE 3-VALVE "SUPER-HET"

Details of a Super-heterodyne Receiver which is low in first cost and economical in working.

It is not within the means of every amateur to indulge in a seven- or eight-valve super-heterodyne receiver as it is rather an expensive matter to purchase the parts for such an instrument. On this account, therefore, the writer designed the simple experimental receiver illustrated in the photographs, the objects kept in mind being (a) the production of a super-heterodyne set suitable for operating a loud-speaker on a frame aerial up to a range of twelve miles from a British broadcasting station, and (b) a set to enable the amateur who is not vested with a great amount of wealth to investigate the possibilities of super-heterodyne reception. Before going any further it might be stated that both objects appear to have been achieved, for the set produces extremely clear loud-speaker reception at ten

miles from 2 L O with a small frame aerial and one stage of note magnification. For the amateur experimenter the set provides a means of investigating all the properties of the "super-het." It must be noted, however, that the set contains only one stage of high-frequency amplification, so that it is not super-sensitive to weak signals, the term super-heterodyne not being synonymous with super-regenerative. The super-heterodyne circuit merely provides an efficient means of using H.F. amplification on short waves and is extremely stable in operation, besides being selective.

The Components

At the moment there are not many components on the market which are suitable for use with a multi-valve super-het., and

therefore the experimenter would be well advised to make his own. Standard oscillator coils, transformers and tuning coils for super-heterodyne receivers may, however, be obtained from some of the advertisers in this journal.

The parts embodied in the present set consist of the following:

Two No. 1250 Igranic coils (for loose-coupled transformer); one No. 300 Igranic coil (for detector reaction coil); two 60-volt H.T. batteries; two pocket flashlight batteries (for grid-biasing unit); three .0005-microfarad Baty condensers; one .001-microfarad condenser with vernier; one .0005-microfarad variable condenser with vernier; one .001-microfarad blocking condenser; one .5-microfarad blocking condenser; one .0003-microfarad grid condenser; one three-way coil holder; three filament rheostats; three valve holders; 6 in. of 4-in. ebonite tube; 6 in. of 3-in. ebonite tube; one 1.5-megohm grid leak; ½ lb. No. 20 d.c.c. wire; ebonite panel, 1 ft. 6 in. by 10 in. by ¼ in.; ebonite valve stage, 1 ft. by 3 in. by ¼ in.; fifteen terminals; wood for making a suitable base to hold the coils, etc., 1 ft. by 1 ft. 6 in.

The Coils

The aerial coil L1 (Fig. 1) is aperiodic or untuned, and consists of six turns of No. 20 d.c.c. wire on the 4-in. former. The coil L2, the major portion of the tuned secondary, consists of 68 turns of No. 20 d.c.c. wire on the same 4-in. former. Coil L3, the minor portion of the tuned secondary, which is coupled to the coil L4, consists of 8 turns of the wire on the 3-in. former. Coil L4, the oscillator coil, consists of 46 turns of No. 20 d.c.c. wire, tapped at the twenty-third turn, on the 3-in. former. The space between coils L1 and L2 should be about ¼ in. and between coils L3 and L4 about ½ in.

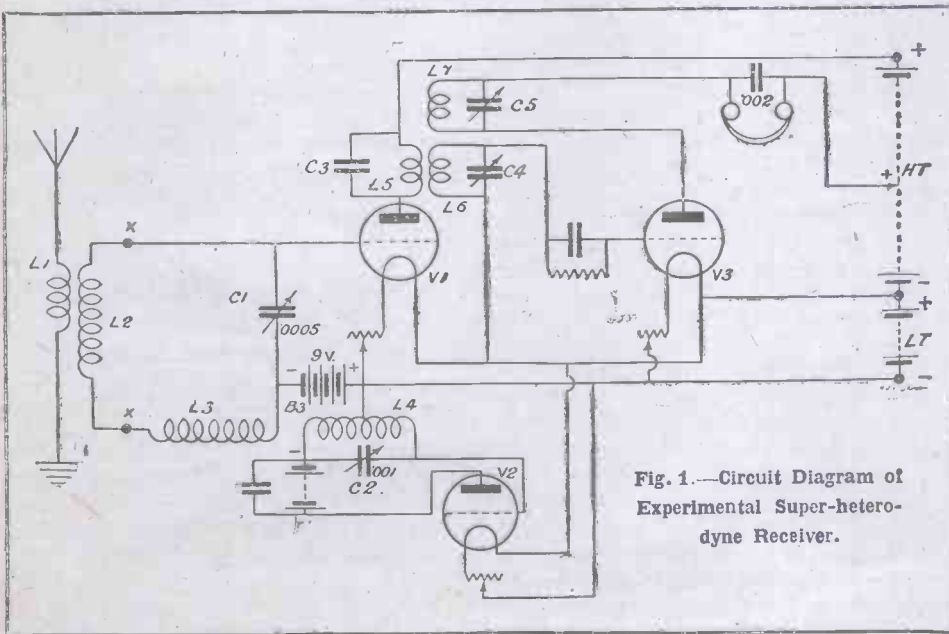

Fig. 1.—Circuit Diagram of Experimental Super-heterodyne Receiver.

The Panel

The panel should be drilled and the components mounted as shown in the photographs. The diagram Fig. 2 illustrates a suitable layout when using the Baty condensers. Should rotating-vane condensers be used the layout will have to be varied to suit the extra depth of condenser involved.

Use of Frame Aerial Only

If it is proposed to use only a frame aerial for the receiver, coils L1 and L2 may

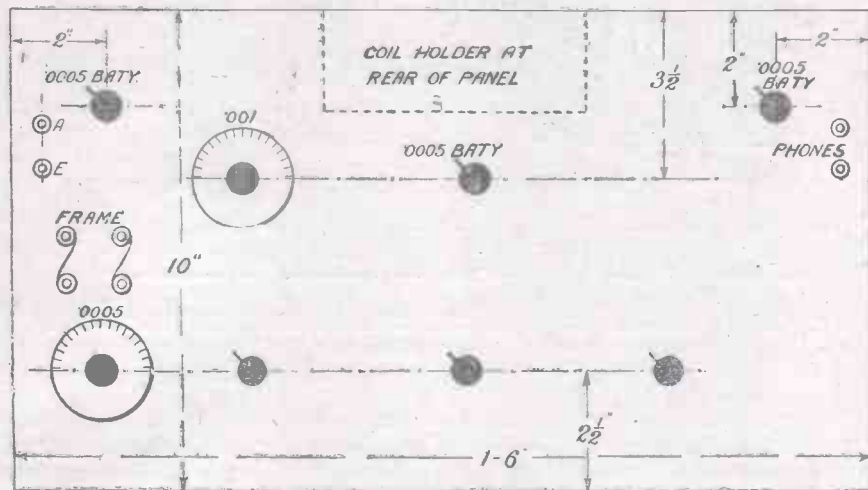

Fig. 2.—Layout of Panel.

be entirely omitted. It is suggested, however, that they should be put in for experimental purposes. If it is not desired to experiment on the open aerial, all that is required is coil L3 (8 turns of No. 20 d.c.c. on the 3-in. former) and the oscillator coil on the same former. The frame aerial used by the writer had sides 1 ft. 6 in. long and was wound with 14 turns of No. 20 enamelled wire.

Radio-frequency Transformer

The radio-frequency transformer L5-6, which amplifies at a wavelength of approximately 4,000 metres, is made up from two Igranic No. 1250 coils, the coupling being variable to ensure selectivity. For this purpose and for the mounting of the reaction coil, the three-way coil holder is required. The coil L7 is the reaction coil, the size of which depends to a great extent upon the make of detector valve and H.T. potential employed. An Igranic No. 300 is, however, about the right value to adopt, but experiments may be advantageously carried out with different sizes of coil and settings of the condenser C5. It is possible to dispense with the condenser if the coil is of a suitable value.

The Valves

The valves used are Cossor valves. The writer found, however, that a V24 valve functioned particularly well in the position indicated as v1. A negative potential of 9 volts (battery B3) was necessary in order to get maximum results. Valve v2 is the oscillator valve, and any good valve can be used in this position. A Cossor ordinary proved as good as any.

Valve v3 is the detector. Any good detector can be used, but soft Dutch valves do not appear to be particularly desirable in this position. An ordinary Cossor P1 valve performed very well.

The Valve Stage and Baseboard

The piece of ebonite 1 ft. by 3 in. is trued up and fitted with valve sockets and the grid leak and condenser mounted on it. Should it be desired to work a loud-speaker for broadcast reception, a fourth note-magnifying valve may be added in the

usual manner, and provision should be made for the valve on the stage. The note-magnifying valve is added in the usual manner. It will be necessary to wire up the under side of the valve stage before screwing it to the wooden baseboard, leaving enough wire to attach to the various components in the circuits. Two empty wire bobbins are used to space the valve stage from the wooden baseboard and long screws are passed through the stage and the hole in the centre of the bobbins to the baseboard. The panel is also mounted on the baseboard at the edge by means of suitable iron or brass brackets. The photograph clearly illustrates the arrangement.

General

When mounting the gear the oscillator coil L4 and the coils on the 4-in. former L1 and L2 should be kept well spaced from each other and the leads kept as short as possible in the tuned circuit. Right-angle kinks in the wire at bends should be avoided, the bends being smooth easy sweeps. Soldering should also be avoided, the experimenter relying entirely upon metal-to-metal contacts between stout nuts and washers. Keep the H.F. stage as efficient as it is possible to make it and use well-built tuning condensers. It is of no use expecting to use tuning condensers without a vernier attachment, as tuning is very critical. The two Baty condensers C3 and C4 are merely used to balance up the Igranic coils which form the transformer in case there is any difference in their inductance values. In any case the wiring of the set is bound to make one side

of the transformer of a slightly different capacity from the other. The Baty condenser C5 may very easily be dispensed with except for experimental purposes.

Additions

The super-het. described possesses all the essentials of a large multi-valve set. Should the experimenter desire fresh fields to conquer, he can readily add a number of stages of H.F. amplification without difficulty or unnecessary complication. It is recommended that three stages of resistance-capacity coupled amplification should be added, as by so doing the matching of transformers, etc., is avoided, besides keeping the circuit noiseless and stable.

Operation

The operation of the three-valve set is extremely simple, although a little experimenting is entailed in obtaining results. With the condenser C2 10 degrees "in," the condenser C1 is operated until signals are heard, the reaction coil having first been removed and the coil holder shorted. Should no signals be heard, the condenser C2 is moved up slightly and the condenser C1 again adjusted. A faint hissing will be heard when the settings are correct, and signals may then be received. Should signals still be absent, slight variations of the condensers C3 and C4 should be tried and the process repeated. Adjustments should also be made to the filament of the oscillator valve, as this is somewhat critical.

When once signals have been obtained the condensers C3 and C4 should be adjusted for best results, and probably they will not be required to be moved again. The reaction coil may now be inserted in its holder and brought into play. For frame-aerial reception four terminals are provided on the front of the panel and these are shorted in pairs when receiving on the open aerial. When receiving on the frame the shorting bridges are removed and the frame aerial attached to the two which are indicated as X in the circuit diagram.

Advantages

The advantages derived from the use of the super-heterodyne circuit will be clearly demonstrated with the three-valve set described. Clear telephony signals are obtainable without interference, and the receiver is extremely critical in its tuning. Almost any number of H.F. stages may be used with a minimum of controlling devices, and, moreover, the valves will be stable in operation and function more efficiently than they would if used in the ordinary way.

A. J. C.

Experimenters will be interested to know that an A.R.R.L. weekly bulletin of instructions is sent out at 12.30 every Monday morning. Various American amateurs take it in turn to send out this message. The wavelength is about 80 metres, and high power is used.

THE CRYSTAL DETECTOR IN THEORY AND PRACTICE

Theory

ONE of the most difficult aspects of wireless, to the novice, is that which deals with the problem of rectification. A crystal, he is told, rectifies the incoming signals. A valve, when used in a certain way, performs a similar function. Without some means of rectification signals cannot be heard. Fifty amplifying valves may not produce a single intelligible sound in the telephones unless they are augmented by a rectifying valve or by some other form of rectifier. In order to grasp the importance of this essential part of every wireless receiver it is necessary to understand one or two simple facts in connection with the transmission of wireless messages.

Oscillations

When a broadcasting station is about to send out a message, the aerial of the station is oscillated at a certain frequency. These oscillations produce waves in the ether. There is thus a continuous stream of waves radiating from the aerial before the speaker begins to address himself to

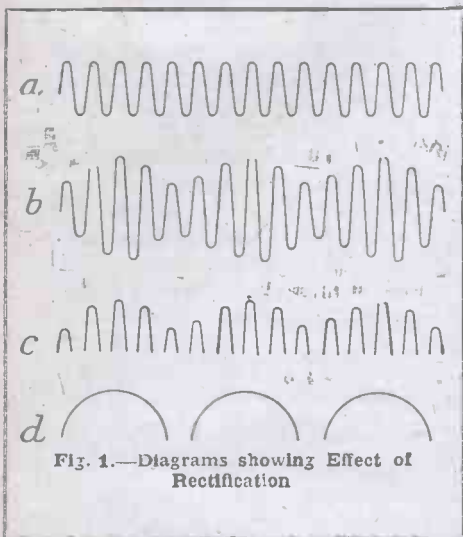

the microphone in the broadcasting studio. These waves have a very high frequency, in the neighbourhood of about one million per second. Their form is quite regular and continuous, as shown at *a* in Fig. 1. The height of the wave at any point represents its strength, and it will be seen that they vary regularly from a definite maximum in one direction to a definite maximum in the opposite direction.

As soon as the speaker in the studio begins to transmit, the shape of this wave stream changes considerably. The height

of the wave changes in a curious way. At *b* is shown how the transmitted wave is affected by the sound waves that strike the microphone in the studio. It will be seen that the actual frequency of the original waves is not affected; the change takes place in the height of certain waves. This causes a peculiar grouping of the waves. Three groups of waves of varying height are shown at *b*.

Two Frequencies

There are thus two distinct frequencies involved. In the first place there is the frequency of the waves themselves, which remains the same as before. Secondly, there is the frequency of the groups, which depends upon the frequency of the transmitting voice. These groups in the original steady stream of waves occur at the same frequency as the sound waves that strike upon the microphone in the broadcasting studio. If the sound waves are produced by a musical instrument, the groups will vary a good deal in frequency, becoming very frequent when a high note is played and comparatively infrequent when a low note is played. If the sound waves in the studio are produced by a speaking voice, the group frequency will not, of course, vary so much.

The Group Frequency

This group frequency is, therefore, the factor that concerns us particularly when we come to the question of receiving the broadcast song or speech. We require some kind of instrument which will respond to the group frequency, and produce mechanical vibrations of the same frequency as those which actuate the microphone in the broadcasting studio. The problem is complicated by the fact that the waves—and therefore the currents in the receiving aerial—change their direction so rapidly; that is, at the rate of a million changes per second. It would be much easier if we could wipe out a half of each wave before it strikes the aerial, so that all the currents produced in the aerial would flow in the same direction. The form of the wave would then be as shown

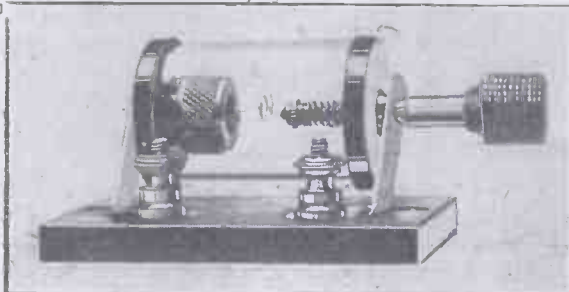

at *c* in Fig. 1. Alternatively, the same result would be achieved if we could devise some means of wiping out half the currents produced in the aerial, after the latter has been struck by the waves.

This is what the crystal actually does. It was found by experiment that there were certain crystals through which electricity would flow only in one direction. When the currents from a receiving aerial are passed through such a crystal, therefore, only a half of each oscillation succeeds in penetrating the latter, and we get a series of groups of unidirectional currents, which can be represented as shown at *c* in Fig. 1. These little unidirectional pulses of current follow one another so quickly that, in effect, each group is equal to one large pulse of current. This effect is illustrated at *d*. We have now at our disposal single pulses of current, which occur at the same frequency as the sound waves in the broadcasting studio, and it is these unidirectional pulses of current that cause the telephones

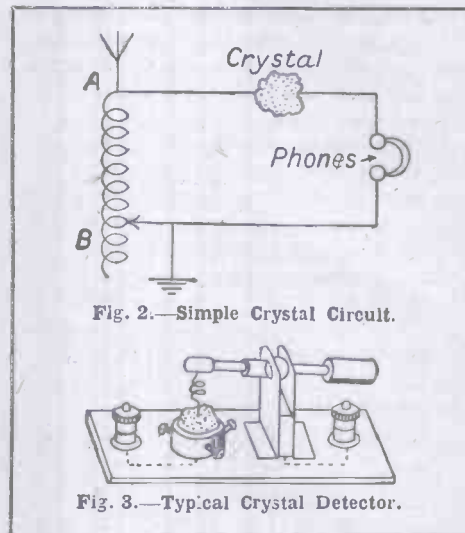

to vibrate and produce identical sound waves at the receiving station.

Practice

The purpose of the crystal is to act as a kind of filter, through which the aerial currents are passed on their way to the telephones. Fig. 2 shows how a crystal can be used for this purpose. AB is a variable tuning coil, by means of which the aerial can be tuned to the frequency of the waves sent out from the broadcasting station. When signals are being received,

(Concluded at bottom of next page)

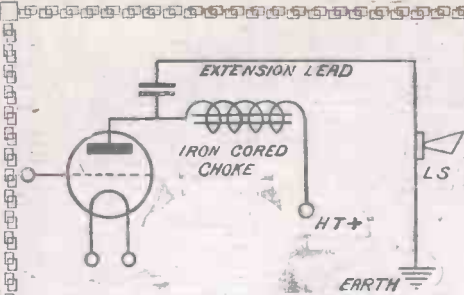

Fig. 1.—Circuit with Choke.

LOUD-SPEAKER EXTENSION LEADS

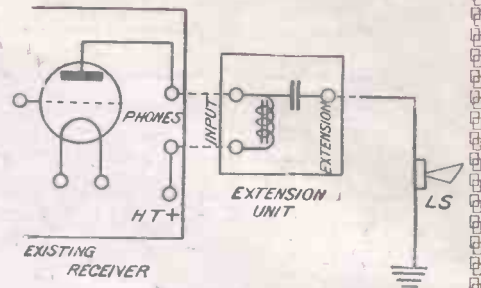

Fig. 2.—Arrangement of Extension.

THERE are probably many experimenters who on occasion wish to operate a loud-speaker in another part of the house. The usual method of accomplishing this is to connect a length of twin lighting flex to the phone terminals as an extended telephone lead.

This procedure is quite unsatisfactory in the majority of cases. It may be argued that as the extension lead is only required to carry a few milliamperes of current with an applied E.M.F. of perhaps 90 or 100 volts, the few ohms resistance of the flex can be ignored. But as serious losses occur and, not infrequently, bad distortion, it is necessary to look elsewhere for an explanation.

The assumption that the only factor to be considered is the ohmic resistance of the lead leaves out of consideration the

fact that the plate of the valve is at a rapidly fluctuating potential above earth. This being the case, it is obvious that extending the plate circuit of the last valve will result in a serious capacity loss to earth.

It is, however, possible to make use of this phenomenon. If an iron-cored choke coil is included in the plate circuit of the last valve, a lead may be taken via a large capacity condenser through the loud-speaker to earth (Fig. 1).

The advantages of this method are that there is no loss of signal strength, that the signals at the end of the extension are of the same quality as at the set itself, and that none of the H.T. battery current passes through the loud-speaker, and therefore there is no risk of demagnetisation or of burning out the windings.

Neither the inductance value of the choke nor the capacity of the condenser seems critical provided they are large enough. For the choke, the windings of an L.F. transformer connected in series is ideal, but a series of two or more of the choke coils from army telephone switchboards, obtainable from dealers in surplus Government stores, will be satisfactory. It is not recommended that the condenser should be much below .05 microfarad, but the writer has obtained satisfactory results with a "surplus" condenser rated at .03 microfarad, and little improvement was noticed with two or three condensers in parallel. The capacity usually recommended is .25 or .5 microfarad. This principle may be applied to existing sets by means of a unit as indicated in Fig. 2.

T. V. G.

"THE CRYSTAL DETECTOR IN THEORY AND PRACTICE" (continued from preceding page)

therefore, there is a high-frequency oscillating current (a current that changes its direction very rapidly) flowing in this coil. These currents can be drained off, as it were, into the telephones by connecting the latter across the coil. But in order to convert the received oscillating currents into unidirectional pulses of current (as is necessary in order to operate the telephones), we must connect a crystal in the circuit. Thus in passing from the aerial to the telephones the high-frequency oscillating currents are rectified into low-frequency pulses of unidirectional current.

For facility in operation it is found convenient to fix the crystal in a small metal cup, the latter being mounted on an ebonite board. This cup is connected by a wire to a terminal on the board. The wire is brought underneath the ebonite base-board, the latter being grooved to receive it. (See Fig. 3, in which the wires that run under the base are shown as dotted lines.) The crystal can be held firmly in the cup by means of two or three small screws, which pierce the side of the latter, as shown in Fig. 3; or it may be soldered in the cup with a special preparation known as Wood's metal. Ordinary solder must not be used,

because it is liable to damage the crystal, owing to the heat developed in applying it.

Characteristics

Crystals vary a good deal, not only with



WIRELESS FOR THE INJURED

Messrs. Burndep, Ltd., hearing of the plight of a London hawker lying in hospital severely injured as the result of a traffic accident, kindly provided an Ethophone-Duplex loud-speaker set for his entertainment.

one another, but in regard to their internal constitution. That is to say, an individual crystal may have quite a considerable number of blind spots, or insensitive areas, on its surface; and if connection be made with one of these spots the crystal will not fulfil its function of rectifying the oscillating currents that are tapped off from the aerial. It is, therefore, necessary in practice to employ some means of searching for blind spots with one of the connecting wires. This is usually achieved by means of an adjustable metal arm, one end of which carries a thin wire. The arm is pivoted on a metal pillar, which stands on the ebonite base, and this pillar is connected to the second terminal with which the base is fitted. The arm can be moved backwards or forwards horizontally through the pillar which supports it, and, by its pivotal action, it can also be raised or lowered at its contact end. Thus the tip of the small wire can be brought into contact with any point on the surface of the crystal.

Contact Pressure

The pressure with which the contact wire rests on the crystal is an important factor, which sometimes affects the sensitivity of the latter.

M. E.

SIEMENS HIGH-TENSION RADIO BATTERIES

NEW TYPE—LARGE CAPACITY

THE H.T. BATTERIES DE LUXE.



TYPE R.B. 1



TYPE R.B. 3



TYPE R.B. 2

Type	E.M.F. Volts.	No. of cells	Terminal connections at Volts.	Dimensions overall	Weight approx.	Price			
				approximate including covers		Inches.	lbs.	£	s.
R.B. 1	18	12	0-3-9-15-18 (+)	8 3/4 x 3 1/4 x 3 7/8 high	3 3/4			7	6
R.B. 2	36	24	0-24-27-30-36 (+)	8 3/4 x 6 x 3 7/8 high	7 1/4			14	0
R.B. 3	72	48	0-24-30-54-60-72 (+)	17 1/4 x 6 1/4 x 4 high	15	1	7	6	

Each battery is fitted with a substantial lid, and with a strong paper band as seal.

Every endeavour has been made to produce an article embodying all the improvements which experience can suggest as being essential to provide an efficient and reliable H.T. battery. In particular, the question of insulation has received special attention. Paraffin wax of the highest quality obtainable is used throughout, and every unit is embedded solidly in this substance with adequate spacing between units.

All three sizes are capable of giving excellent service on wireless receiving apparatus where the normal anode current does not exceed 10 milliamperes. They are therefore suitable for supplying plate current to multi-valve receiving sets, including one or two small power valves. It is very desirable, however, where a high anode potential is impressed on amplifying valves, that a suitable negative grid bias be provided; otherwise economical results cannot be expected from the H.T. battery. Valve manufacturers publish data from which suitable values of H.T. and negative grid bias can be determined for particular types of valves. Details of batteries suitable for grid bias purposes are given in our Leaflet 645.



OLD STANDARD.

A direct comparison between the small unit hitherto used and the large type which is now adopted as the standard is given in the illustrations.



NEW STANDARD.

AMPLE SUPPLIES ARE AVAILABLE AT THE MOMENT, BUT IT IS VERY DESIRABLE TO PLACE AN ORDER WITH YOUR DEALER NOW

Leaflet 645 will be sent on application

SIEMENS BROTHERS & CO., LTD., WOOLWICH, LONDON, S.E.18

TO RETAILERS.—An attractive cut-out showcard in colours may be obtained direct from us, or from any of our Home Branches

Now on Sale

Over 60 Separate
Features
and 160 Photographs,
Diagrams and Drawings

SPECIAL
HOME-CONSTRUCTOR SETS
IN THIS ISSUE

**AN ARMSTRONG SUPER-GENERATIVE
ONE-VALVE SET**

("All England on a Frame Aerial with One Valve!") A Blueprint Panel-drilling Template and a Coloured Wiring Diagram Given Free.

**CRYSTAL-SET CONSTRUCTION IN
SUCCESSIVE STAGES**

BUILDING A POWER AMPLIFIER

**A LOUD-SPEAKER THREE-VALVER FOR
THE FAMILY**

A Coloured Wiring Diagram Given Free.

**THE LONG-DISTANCE EXPERIMENTER'S
CRYSTAL SET**

The Wireless Magazine

Cassell's Publishers London



FOR MAY

1/-
net



FREE BLUEPRINT AND WIRING DIAGRAM

Special Features

The New Stations
by CAPT. P. P. ECKERSLEY

Radio and the Rustic
by F. W. THOMAS

Stories of Early Broadcasts
by WILLIAM 'LE QUEUX

How to Receive America
by F. L. HOGG

Broadcast Music of the Month
WITH 23 PHOTOGRAPHS

Get Your Copy TO-DAY



World famous **RAULAND** Transformers

*Chosen by experts for the 8-valve
supersonic receiver described in this issue*

Chosen on account of the precision methods employed in their manufacture—on account of their proved reliability—on account of their capability to bring out to the utmost the theoretical possibilities of the super-heterodyne receiver.

R.110. Long Wave Transformer (Intermediate Frequency). Range 4,000-20,000 metres. 75-15 Kilocycles.

If, in this stage broad-tuned Transformers are used, the almost inevitable danger of distortion by imperfect matching is avoided. The curve of Type R.110, although having its peak at 30 kilocycles, falls off so rapidly that at under

10,000 kilocycles there is an attenuation rather than an amplification of noise currents. This perfection in design allows every transformer to be perfectly matched, resulting in unequalled efficiency. Price **30/-** each.

Type A.120. 10,000 metres (30 Kilocycles). Tuned Transformers (Filter or Input Transformer).

It is necessary for this Transformer in the super-heterodyne receiver to be sharply tuned to the chosen wave-length. With the R.120, frequencies from about 26 to 34 kilocycles are passed with high amplification, while frequencies

above and below this figure are very effectively excluded. Special windings and high-grade condensers, mounted integral, with the instrument, account for this superiority. Contained in a neat bakelite case. Price **30/-** each.

Gaston E. Marbaix

27-29, Anning Street, E.C.2, and 169, High Street, Shoreditch, London.

Phone: BISHOPSGATE 1294.

THERE'S A RAULAND FOR EVERY CIRCUIT

THE NEW RADIO KEY BOOK
By E. N. RAULAND
Is now ready.
Full of up-to-date information and diagrams of the latest circuits, including Reflex Neurodyne, and Super-Heterodyne. Photographic blue print sent with each book, upon receipt of 1/- in stamps.

THE PANEL DE LUXE



THE advantage that a Radion Panel confers on a Receiving Set is much more than merely adding a gold case to a watch. Rather, is it comparable to the addition of that delicate compensating balance wheel mechanism which ensures split-second accuracy. If you aim at 100 per cent. efficiency for your Set you'll naturally start with a Radion Panel. With dials to match.

Radion is available in 21 different sizes in black and mahogany. Radion can also be supplied in any special size. Black 1d. per square inch, mahogany 1 1/2d. per square inch.

RADION

American Hard Rubber Company (Britain) Ltd.

Head Office: 13a Fore Street, London, E.C.2
Depots: 120 Wellington Street, Glasgow.
116 Snow Hill, Birmingham.
Irish Agents: 8 Corporation Street, Belfast.

Gilbert Ad. 2730



PRICE, complete
with 6ohms Rheostat, 6/6
" 10 " " 7/-
" 30 " " 7/6

The Woodhall Valve Unit combines Rheostat, Valve Holder, Bracket and Window in one compact fitting . . . And you need to drill two holes only.

This newest addition to the Woodhall Range of Components fills a definite need of many "Home Constructors." It gives the popular "back-of-panel" fitting for the valve, occupies a minimum of space, and is highly efficient in use. Consists of Woodhall Valve Holder, on rigid bracket with nickel-plated valve window and Woodhall Vernier Rheostat (see below).

The **WOODHALL** Vernier Rheostat



Patent No. 213,030

Combined plunger and rotary movement. Push-pull movement for coarse setting; rotary for vernier. Wonderfully smooth movement; best ebonite former; one-hole fixing. 6 ohms, 2/6; 10 or 12 ohms, 3/-; 30 ohms, 3/6.

WOODHALL

Guaranteed Components

Sold by all the best Radio Dealers.

Woodhall Wireless Manfg. Co., Ltd.—London Show Rooms, 21 Garrick St., (Tube Station: Leicester Square.) Sole Distributors: Pressland Electric Supplies, Ltd., Hampton-on-Thames

Phone: MOLESEY 22





Only the Wuncell gives that bell-like tone.

If you are already using Dull Emitter Valves and obtaining disappointing results from your Loud Speaker do not blame your Set without first testing the Valves. Remember that the secret of Cossor success lies in the correct use being made of the electron stream given off by the filament. In the Wuncell the filament is arched and almost totally enclosed by the hood-shaped anode and Grid. Practically no portion of the electron emission can escape. But, on the other hand, any Valve with a long, straight filament and tubular anode permits a wasteful leakage of the electron stream at each end of the anode.

Obviously such a design means inefficient operation — and inefficient operation means loss of sensitiveness and distortion. If you are already a user of Cossor Bright Emitters we need only remind you that when you decide to take advantage of the economies of Dull Emitters, you will find the Wuncell W. 1 and W. 2 are an exact match of the famous P. 1 and P. 2.

Technical Data:
 Filament voltage, 1.2 to 1.8
 Fil. consumption, .3 amps.
 Plate voltage, 20 to 80

Prices:
 W. 1 For Detector or L.F. Amplifier
 W. 2 (With red top) for long distance reception
 18/- each

*W.R. 1 Corresponding to W. 1
 *W.R. 2 Corresponding to W. 2
 20/- each

*Fitted with internal resistance so that Valve can be used with 2, 4, or 6-volt Accumulator without alteration to Set.



Tracking microphonic noises to their lair!

WHILE bright valves were universal we rarely heard much about microphonic noises. To-day, now that so many wireless enthusiasts are awake to the economies of the Dull Emitter, the elimination of microphonic noises is quite a problem.

* * * * *

Various ingenious methods are suggested. Valve holders sprung on rubber bases or on coiled springs are already available. Some technical writers even advocate the mounting of valves on rubber insulated platforms. But these are only makeshifts to make the best of a bad job. Obviously the best way to overcome microphonic noises is to go to the root of the trouble within the valve itself.

* * * * *

Microphonic noises are due to external vibration. Usually the cause lies in the use of an extremely fragile filament. Sometimes it is due to lack of rigidity of the grid. To overcome such noises, therefore, these elements must be so robust in design that movement is practically impossible.

* * * * *

This was the problem that had to be faced when the Cossor Wuncell was designed. Microphonic noises were not accepted as inevitable, we knew that they could be eliminated. First of all we tracked down the causes. The worst culprit was the valve with the long, straight and extremely fragile filament. A filament so delicate that the slightest touch on the glass would set it a-quivering. Such valves on occasion have even been known to set up microphonic noises when the mouth of the Loud Speaker is turned towards them!

* * * * *

Another fruitful cause of microphonic noises lies in the use of a Grid insecurely mounted on its electrode. Most Grids are merely spirals of wires secured to upright nickel supports. And so our experiments drew us more and more to the conclusion that the standard Cossor construction which had definitely produced the finest Bright Emitter should be used for the Wuncell.

* * * * *

Owing to its unique filament construction—an arch with a third supporting electrode at its centre—all possibility of vibration is eliminated. Its Grid, too, is wonderfully rigid. It is built up on a stout metal Grid band and each turn of the wire is securely anchored in three distinct places. Thus in the Wuncell microphonic noises are tracked to their source and completely eliminated. Even if the table on which the Receiver stands is struck there will be no answering discord from the Loud Speaker. Can any other Dull Emitter survive such a drastic test? And thoughtful valve users are realising that such rigidity and strength—particularly in the filament—means a considerable increase in life for the Wuncell.

Cossor Wuncell Valves

THE ONLY DULL-EMITTER VALVES SOLD IN SEALED BOXES

Advertisement of A. C. Cossor Ltd., Highbury Grove, N. 5.

On Your Wavelength!

Why, Oh Why?

WHY is it, I wonder, that professional demonstrations of wireless reception are usually so appallingly bad? You have only to wander round the showrooms and the "listening-in parlours" of the shops to see how true this is. The people who operate the sets seem to be obsessed with the idea that loudness is the one and only criterion of merit. For this reason they boost things up to the last notch by tightening the reaction coupling, brightening the filaments and pushing up the H.T. voltage. And the results? On music, "cracking" and buzzing on high notes and loud passages, tinniness, absence of tone, confused noise when the bass instruments come in, and a general bad gramophony quality. On speech, indistinctness, woolliness and a weird effect which makes the voice sound as though the speaker were being throttled.

If only demonstrators would work sets well within their power we should find a far smaller number of people who, having once or twice heard wireless, maintain that the receiving set is quite incapable of faithful reproduction.

Your Set?

The faults I have just mentioned are not confined to ready-made sets operated for demonstration purposes. I have heard results every bit as bad from sets made in the home workshop and tuned by people who know quite a lot about wireless. As a general rule one may say that if distortion of any kind does take place, the fault lies in the receiving set; the transmissions are usually not to blame in any way. I must, however, say that with 2 L O's new plant and aerial I have to employ far more correcting devices than on any other transmission. It does seem that here we have a certain harshness that is due to the transmission and not really to the receiving set. I could amplify the old 2 L O until he was loud at a hundred yards without the least trace of unpleasantness; but the new one, using one valve less on the receiver, is apt to be a little rough at times even if one reduces the volume to something quite small.

Some Tips

Apart from the question of the over-application of reaction, I think that the majority of bad reception is due to a cause that is not generally recognised. This is oscillation in the rectifying valve. Many a man who has a multi-valve set will touch the grids of his high-frequency valves to show you that his set is perfectly stable; but it does not occur to him to apply the same test to the rectifier. As often as not, if you put a finger on the grid leg of

the rectifying valve of a set containing one or more high-frequency stages there will be a "plock" or even a scream in the telephones or loud-speaker. If this condition obtains, distortion is almost sure to be present to a greater or less degree.

Now, to stifle oscillation in the rectifier is at times rather a difficult business. It will not as a rule suffice to lower the plate or the filament potential. Something may be done by using a grid leak of smaller resistance value, but this is not getting at the root of the matter. Oscillation in the rectifier is caused generally by high-frequency impulses which somehow or other have no ready escape to earth. Very important it is to shunt the H.T. battery with a big condenser—and if there are several high-tension positive leads there must be a condenser of at least one microfarad between each and H.T. minus. But most important of all there must be a condenser across the primary of each low-frequency transformer to by-pass the high-frequency waves that leak through the valves.

If the provision of these condensers, whose value will generally be between .001 and .002 microfarad, does not make reception perfect, then try shunting the secondary of each transformer with a variable resistance. You may lose a little in the matter of signal strength, but you will get it all back in the increased purity of your signals.

Beam or Broadcast?

I see that New Zealand is opposing the installation of a long-distance beam station on the ground that there is a wide diversity of opinion on the merits of the various systems of transmission. Anyone who doubts the efficacy of the short waves as compared with the medium can easily test things out for himself on one of the lighter nights that are now with us. Let him try first of all to tune in KDKA on his higher wavelength. This is becoming increasingly more difficult as the summer draws on. Then if he fails, let him test the short-wave transmission, which is usually receivable even under poor conditions. On most nights KDKA on the short wavelength is easily twice as strong in this country as on the longer. The beam system is, of course, applicable only to very short waves, and as these are on the whole more constant than the longer ones, it would seem that it would certainly pay for long-distance transmissions where reception at all times is essential. In recent beam tests over very long distances reception was possible during forty-seven out of forty-eight hours of continuous working.

The Difference

There is one point as regards Australian and, I believe, New Zealand official wireless that is not always appreciated in this country. Over there reception is done with a soft valve, which makes an immense difference to range. Ever since the early numbers of AMATEUR WIRELESS I have advocated strenuously that manufacturers should put on the market in this country a soft valve suitable for amateur use at a reasonable price. So far none of them has done it. In the Antipodes, a soft valve is used, and most often official reception is done on single-valve sets, with or without the addition of note-magnifying stages. Sooner or later—sooner, let us hope—the vast advantages of the soft valve as a rectifier will be recognised in this country, and then we shall thereby witness an enormous improvement in the range and the signal strength of small receiving sets. To show what the soft valve can do, I will guarantee at any time to obtain on the loud-speaker with a single valve of this kind reception at thirty miles from 2 L O audible in any part of an average room. At night time I can do the same thing with Radio-Paris. With the standard hard valve I can obtain good telephone strength and no more.

"That Tired Feeling"

I've felt it coming on for a good many programmes. I expect you all know the symptoms, too. You shirk switching on "the juice," don't mind if a valve "goes west," and go to sleep in the middle. A friend of mine—one I hadn't borrowed any valves from—diagnosed my case yesterday. "What station have you been listening-in to, old man?" "Oh, the usual," I said, meekly; "2 L O and a spot of Chelmsford." He nodded triumphantly. "Indigestion. Musical indigestion, I mean," he added hastily. "I know, you get that Debussy feeling up the back of your neck, and Scriabin down your left arm. I've had it myself."

Lighter Fare

Of course this educational stunt is all very well, and it's excellent music; but when you've been chasing the almighty dollar through its various rates of exchange all day, you want something on the lighter side, you know, than the permutations and combinations of Bach, Brahms and Beethoven. Mind you, I'm not asking for a constant menu of jazz, or songs of the type of "two verses with no meaning, and one verse with two."

Foreign Relays

The successful relaying of foreign broadcast stations by the B.B.C. does

:: :: *On Your Wavelength! (continued)* :: ::

really seem to present a problem impossible of solution. I have at one time or another commented upon the interference which inevitably seems to crop up on the very occasion these relays are to be carried out. It happened when American stations were being received; it happened when Radio-Paris was being received.

It is becoming more and more obvious every day that really adequate measures must be taken if the ether is not to become so overcrowded as to make decent reception an impossibility. The policy at present pursued of endeavouring to cram on the power of the local station and drown out interference from other sources is suicidal and quite contrary to the fundamental purpose of wireless as a science. It may work as a temporary measure, designed to ensure that every area is decently served by its local station, but when it comes to a question of inter-communication over vast distances the result is obvious.

Northolt Again

Readers will no doubt remember references I have made to the interference caused by Northolt. They will remember that when the Transatlantic tests were carried out all the interference came from this side. There was none in the States. Something must be done, if not now, then it will become a national matter. I am not going to say that it is a problem devoid of difficulty, but there is no possible doubt that with proper reference to sharpness of tuning and selection of wavelength, all the stations at present operating in Europe could be worked without inter-interference.

As time goes on and more stations are erected we shall have to find some other method, and perhaps the directive system of beam transmission will help greatly to reduce interference. But what puzzles me is the fact that all these long-distance stations can usually be brought in quite easily and with a minimum of interference until the very night when someone attempts a relay or an important test.

The Short Waves

The really short waves are coming into their own slowly. I have heard many amateurs recently working on wavelengths as low as twenty metres and, in isolated instances, as low as five metres. I was somewhat startled on one occasion to hear one hardy annual appealing for someone to help him carry out tests below fifty metres. There must have been many besides myself who heard his appeal, yet he apparently found only one who could go below fifty metres on a receiver. It all goes to show that the practice of building transmitters and receivers which are definitely limited in their tuning range

is a poor one. I could never understand why anyone should do this at all, since it is not necessary. An all-wave receiver can be built easily to tune down to thirty-odd metres, and a transmitter can be built to work as low as twenty metres without any special gadgets being used. When I think of the expense that some experimenters must be put to my head whirls. I doubt if my annual income would cover the cost of their H.T. condensers.

A Curious Adventure

A friend came running round to my house the other night in a terrible state of mind, having, as he informed me, just burnt out at one fell blow five perfectly good valves. He was completely at a loss to understand how the accident could have occurred, and begged me to go round and investigate. On looking at the set I found that the valves certainly appeared to have cashed in their cheques, though the voltmeter showed that the accumulator was up to the mark, and nothing happened when the rheostats were moved. Asking for an account of the way in which the holocaust had occurred, I learnt that five new valves had been placed in the holders, that the rheostats had been turned on, and that within quite a short time one after the other ceased to glow. I pulled out one of the valves and examined it, finding that the filament appeared to be intact.

A trial with a flashlamp battery proved that it was, and my friend almost wept with relief. As a result of further tests, we found that none of them had been destroyed. It was obvious that there must be a disconnection somewhere in the low-tension circuits, but nothing could be seen from an inspection of the wiring. "By the way," I asked, "what rheostats are these?" He told me that they were of no particular make, but that he had bought them a week or two before. He intended originally to use .06 valves and had therefore fitted 50-ohm rheostats. Then he had decided to use bright-emitters of the type which take rather a lot of current. Now these 50-ohm rheostats, even if they are of really good make, are designed to carry only about one-sixth of an ampere. If you go and put the best part of an ampere through them you stand a very good chance of burning them out, and this is exactly what he had done.

High-resistance rheostats, which have been wound with fine wire may stand up, for a time at any rate, to the current required by the less greedy bright-emitters, but it is most unwise to use them with these valves, for the windings will become very hot and it is quite possible that considerable damage may be done to the set. The current that the rheostat has to bear should always be considered. Not long ago I saw a three-valve note magnifier provided with a single rheostat. Two of

the valves were of the general-purpose variety drawing .75 ampere apiece, whilst the third was a power valve taking a little more than an ampere. The rheostat used was designed for a maximum load of 1 ampere, and when we took off the panel and let the valves run with the resistance coil exposed to view we found that it was working at a dull-red heat! Luckily the resistance coil was *not* wound on a former of ebonite or other inflammable material.

Searching Hints

When working with an unknown set I always go for a strong signal of known wavelength which is easy to tune in. In this part of the world the required signal is provided by 2 L.O. This gives one a known wavelength from which to work. Now suppose that it is desired to find Newcastle. Turn the aerial tuning condenser to what you guess will be about the right reading—experience makes this almost instinctive, but anyhow the tuning of the primary is never very critical. Do the same with the closed circuit condenser and then work with the left hand on the knob controlling the coupling between primary and secondary coils and the right on the anode condenser.

By varying the coupling one can search over quite a wide band of wavelengths. Directly a faint signal is heard, leave the coils where they are and bring it up by means of the anode condenser and the secondary condenser. The aerial tuning condenser may be adjusted if necessary, but provided that its setting is approximately correct the secondary condenser will usually do most of the necessary work. As soon as a second station has been tuned in and identified you can discover the condenser reading required for its wavelength, and it will provide a fresh jumping-off point.

Another Way

Another method of searching which answers very well is to set the aerial and anode condensers approximately and then to move the secondary condenser very slowly through a small number of degrees. In this case the coupling should be kept fairly loose and the potentiometer, if there is one, should be so adjusted that the set is just stabilised. The great thing to remember in searching is not to turn the controls too fast. On weak or distant signals tuning may be so critical that a movement of a fraction of a degree of the secondary or anode dials may suffice to pass over them altogether.

The better your set is made and the more efficient the inductances used with it, the sharper will be the tuning and the greater will be the need for very small movements of the controls in searching. Where a tune-stand-by switch is provided the controls can be reduced to two with its help.

THERMION.

OSCILLATORS FOR SUPER-HETERODYNE RECEIVERS

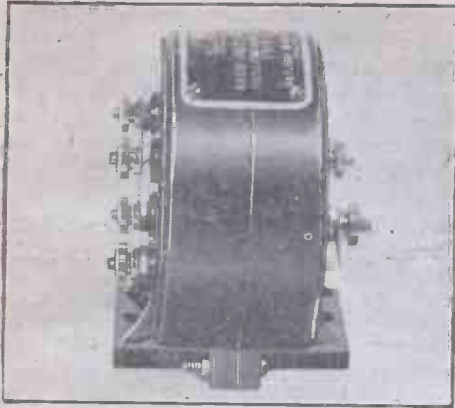

Rauland Oscillator and Coupler.

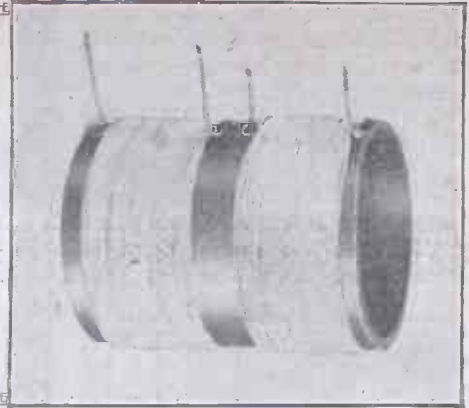

Home-made Oscillator.

THE design and construction of a suitable oscillator for supersonic heterodyne work is not as simple as it appears. The mere fact that a valve will generate high-frequency oscillations when connected to a tightly-coupled grid and plate coil with a variable condenser in parallel is not sufficient. It must be remembered that a great deal of energy is absorbed from the oscillator when the receiving circuit is in tune with it.

Although, theoretically, the receiving and oscillating circuits should never be tuned to the same frequency, in practice it is certain that during tuning operations the two frequencies will be identical, and if at this point the energy demanded from the oscillator is in excess of that which it is able to supply, the oscillations will suddenly cease. This will be indicated in the phones by a sound that can only be described as a "plonk." It is very perplexing to try and tune-in signals on a super-het when all that is heard is a series of plonks and clicks.

In order to avoid this cessation of the operation of the oscillator it is essential to have a sufficient amount of reaction between the grid and plate coils of the oscillator valve so that it is able to generate the necessary oscillations throughout its entire frequency range, no matter what energy is demanded from it by the receiver.

How the Oscillations are Produced

Referring to the circuit diagram (Fig. 1),

here is shown a simple circuit for the production of oscillations. Across the grid and filament of the valve is connected a coil L_1 , tuned by a variable condenser connected in parallel. In the plate circuit of the valve a coil L_2 is connected. This coil may either be tuned with a variable condenser in parallel, as in the case of the grid coil, or else it may be aperiodic.

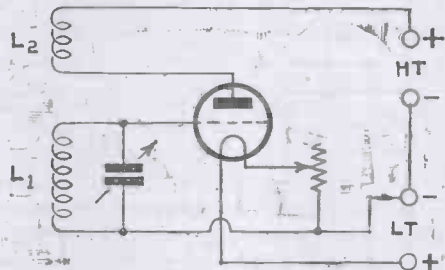

Fig. 1.—Simple Oscillator Circuit.

The H.T. and L.T. batteries are shown connected in the usual manner.

If, say, the incoming wave of a transmitting station sets up oscillations in the grid coil and condenser, they would eventually die out (assuming for the moment the plate coil to be short-circuited). If, however, the plate coil L_2 is now brought into circuit, the oscillations in the coil L_1 are first of all amplified by the action of the valve itself and thus oscillations of the same frequency but of larger amplitude are produced in the plate coil L_2 . If this coil is now coupled to the grid coil, the amplified oscillations are fed back from the plate coil to the grid coil and greatly strengthen the oscillations already present in the latter coil.

Provided that the energy thus transferred from the plate coil to the grid coil is sufficiently strong, the oscillations will continue indefinitely and the valve will oscillate of its own accord.

Correct Connections of the Plate Coil

There is one important point to notice. If the plate coil L_2 is coupled the right way round, the grid will be given a much stronger positive potential at the exact moment it is already at a small positive potential given by the original oscillations. Similarly the grid is given a

stronger negative potential when it is, by reason of the original oscillations, already slightly negative.

It is important, therefore, in all super-hets to see that the plate coil of the oscillator valve is connected the right way round. This, of course, is a matter for experiment.

Types of Oscillators

It is intended to describe in the remainder of this article a few of the various types of oscillators used in supersonic heterodyne circuits. All of these oscillators are well known and may be relied upon to function properly.

The Hartley Oscillator

The Hartley oscillator, the circuit diagram of which is given in Fig. 2, is very efficient. The coupling between the grid and plate in this case is obtained by the .0005-microfarad variable condenser only. There is no magnetic coupling between the grid and plate coils L_2 and L_3 respectively, the coupling being purely static.

The oscillations produced by this method are fed into the receiving valve by means of the "pick-up" coil L_1 . All the coils L_1 , L_2 and L_3 may be of the well-known honeycomb type, and for broadcast wavelengths they should be Nos. 25, 75 and 50 respectively.

The two coils L_1 and L_2 are coupled together in a fixed manner and may be mounted on two fixed single-coil holders,

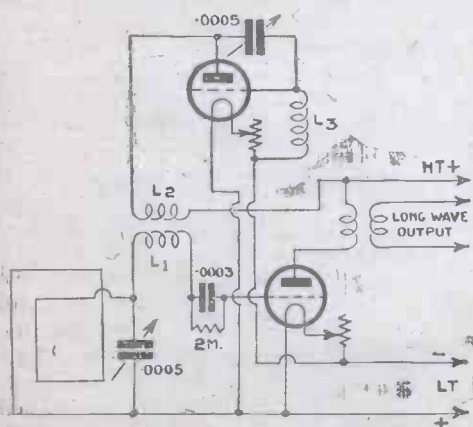

Fig. 2.—Circuit Diagram of Hartley Oscillator.

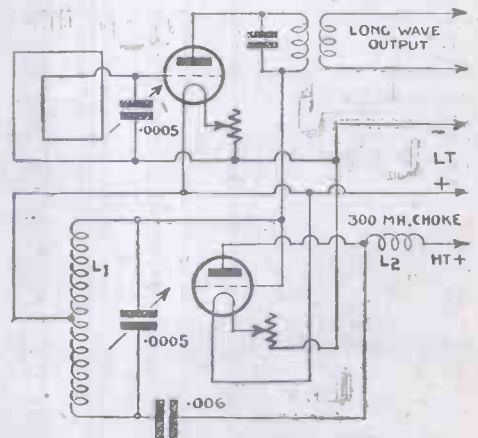

Fig. 3.—Circuit Diagram of Ultradyn Oscillator.

mounted side by side. The third coil L₃ is fixed so that no magnetic coupling exists between itself and the other coils and may be mounted on a single coil holder.

The "Ultradyné" Oscillator

An out-of-the-ordinary type of oscillator has been invented by Mr. Robert LeCault, which is incorporated in what he calls the "Ultradyné"—a special form of super-heterodyne. As will be seen from Fig. 3,

in one continuous coil with a centre tapping. Fifty-seven turns of No. 22 d.c.c. copper wire wound on a 3-in. diameter tube and tapped at the centre turn completes the coil L₁. The coil L₂ is an H.F. choke and has a value of about 200 microhenries.

A Good and Simple Oscillator

Fig. 4 shows how to wind the coils and how to connect up a very efficient oscilla-

Doing Away with the Local Oscillator

A method whereby the local oscillator valve is dispensed with is shown in Fig. 5. Here the oscillator and tuning circuits are connected together, thus avoiding the necessity of a separate valve. The two circuits, however, are made independent of one another by connecting the tuning circuit to a "nodal" point of the oscillator circuit. This nodal point is the middle turn of the oscillator grid coil.

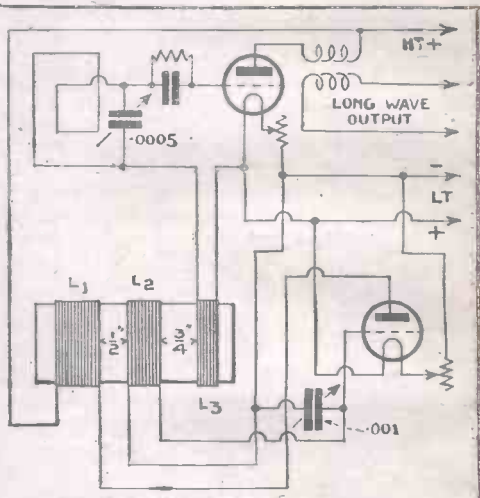
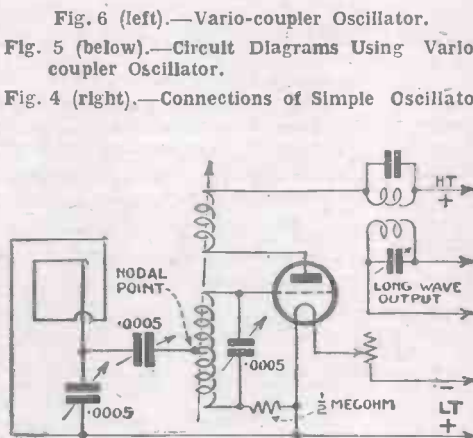

the plate of the first detector is not connected to +H.T., but operates with an alternating-current supply in the form of high-frequency oscillations. In this manner the frequencies of the incoming signal and of the oscillator are imposed one on the other in the plate circuit of the first valve, giving the resultant intermediate frequency.

The grid and plate coils L₁ are wound

tor which is simple to make. The coils are wound on a 3-in. diameter ebonite tube 4½ in. long. The writer recommends this oscillator in place of the usual honey-comb coils. The plate coil L₁ consists of 45 turns of No. 22 d.c.c. copper wire; L₂ of 26 turns of the same gauge and type of wire; L₃ of 10 turns of No. 18 d.c.c. wire. All the coils are wound in the same direction.

The two coils L₁ and L₂ may be constructed in the form of a vario-coupler, the stator of which is 3 in. in diameter and 3 in. long, and the rotor 2 in. in diameter and 2 in. long. The stator is wound with 50 turns of No. 26 d.c.c. wire tapped at the twenty-fifth turn, while the rotor is wound with 25 turns.

A photograph of this form of coupler is shown in Fig. 6. D. C. R.

ENCLOSED SETS—A WARNING

A SET was made up recently on two shelves of a cabinet, the accumulators and batteries being on a third shelf and the whole being enclosed by a door. As the oak used was known to be at least 150 years old (from an old beam) no panel was used, and only the aerial terminal was bushed. The L.T. leads were soldered to bolts through the shelf above and the H.T. positive leads took the form of square rod passing through small holes in the wood. After a month the lead from H.T. positive to the last valve was almost eaten through, copper sulphate and another product being formed, while the bolts carrying the L.T. through the wood were badly blackened. Where H.T. leads passed through the top shelf away from the accumulator no corrosion had taken place. A valve holder stood on the shelf above the accumulator, and here the ends of the legs (not in contact with the wood, but close to it) were covered with sulphate. The factors to be considered are gases from the accumulator, direct current in

the leads, and chemicals in the wood. Any two of these, or even the third alone, might in time produce corrosion, but not in a month—all three must have operated. The accumulator has been removed from the cabinet, and where a lead has to pass through the wood the hole has been burnt and vaselined and the lead fitted with rubber insulation. It was surprising to find such old oak in a dangerous state, though it must be recognised that a great deal of oak of more recent origin sold for cabinet-making has been submitted to a process which may well leave a quantity of sulphur in it, and this must be guarded against, for the fumes of an accumulator may easily start a chemical or electrolytic action. R. E. T.

**"Wireless Telegraphy
and Telephony"**

The most Practical Handbook for the
Amateur. The price is 1/6 net.

From all Newsagents and Booksellers, or post
free by return for 1/9 from the Editor of
Amateur Wireless

Cassell & Co., Ltd., La Belle Sauvage, London, E.C.4

A FEW VALVE MEMS.

- REMEMBER that the filaments of valves are brittle and will not stand much vibration.
- Remember that your H.T. battery is not intended for lighting the filaments of your valves.
- Remember that low-capacity valves should always be used in H.F. circuits.
- Remember that valves do not give best results if overloaded.
- Remember that it is always advisable to use a power valve in the last stage of L.F. amplification.
- Remember that soft valves work best with low plate voltages.
- Remember that the grid circuit of a valve should be carefully insulated, as here the impulses are weakest.
- Remember that a false slip in inserting a valve into a holder may result in a burnt-out filament if the H.T. battery is connected.
- Remember that a soft valve is best as a detector.
- Remember that blue glow in the valve is detrimental to the life of the filament.

WARNING!

LETTERS PATENT No. 143583

WE hereby give notice that we are the owners of the above Letters Patent which is the basic patent covering the double detection or "Supersonic" method of wireless reception and apparatus and circuit arrangements therefor.

The Trade and Public are hereby warned against any or all infringements of this patent, whether resulting from the manufacture, sale or use of Wireless Sets embodying this invention in this country, or the sale and use of such Sets imported from abroad.

Traders and the Public must bear in mind that the sale or use in this country of one of these infringing Sets renders the seller or user liable to action equally with the unlicensed manufacturer and importer.

We are, however, prepared to grant licenses on reasonable terms to bona fide Manufacturers and Amateur constructors.

By arrangement, such licenses can be obtained from us or from Marconi's Wireless Telegraph Company, Limited.

For the information of the Trade and the Public we wish to draw attention to the fact that a Wireless Receiving Set embodying the Supersonic principle cannot be constructed without also infringing other patents of Marconi's Wireless Telegraph Company, Limited.

Western Electric Company Limited.

Connaught House, Aldwych, London, W.C.2

Telephone : CENTRAL 7345 (9 lines).



*Hot registering
Cool figuring*

The bearings of our National Cash Register ran hot one day last week dealing with the enormous demand for Super-Heterodyne sets.

We are not complaining; we don't mind if they melt.

THE SUPER-HETERODYNE SET

is a Masterpiece of sensitivity and selectivity; so selective is the Super-Heterodyne set that, while 2LO is being received and distributed in our Show-rooms with an ordinary 4-valve set, WE CAN GET ANY OF THE STATIONS IN THE UNITED KINGDOM loud-speaker strength at the same time.

America will also come in freely and easily on this set, loud-speaker strength; a great feature being that the new Heterodyne entirely eliminates interference from ships and other spark stations.

THE WHOLE set of these parts to make a Six-valve Tropadyne Set is now on Sale for £15 11s. 2d., or with Cabinet and Baseboard £1 9s. 6d. extra.

CHART and Full Book of Instructions for Making this Wonderful Receiver, 3s. post free, 3s. 3d.

FREE. Send for Special List of Super-Heterodyne Receiving Sets.

The demand for these Sets amongst the leading enthusiasts has been phenomenal and orders can only be dealt with in strict rotation. Remember no Outside Aerial is needed. The great results we are obtaining in our Show-room are from a small frame aerial 2½ ft. square:

POST YOUR ORDER TO-DAY

mentioning "Amateur Wireless" to

**DAYZITE LTD., 19, Lisle St.,
Leicester Square, London, W.C.2**

'Phone :
Regent, 4577.

Telegrams :
"Titles," Westrand, London.



REDUCED
PRICE

25/-

Carriage Paid, ready
for mounting.

Clearer Speech and Music

with the



**TWIN-COIL L.F.
INTER VALVE
TRANSFORMER**

ONE amateur enthusiast writes: "Your transformers are definitely superior in quality of production of speech and music." Another says: "The greatly improved reception since fitting these transformers is indeed amazing."

These opinions, arriving daily, confirm our own tests. With the M-L transformer you get both speech and music clearer. There is a complete absence of distortion, greater amplification and a longer range.

Stoutly built and well finished, it is dust and damp-proof. The coils are completely enclosed. Insulation has received special attention, and there is no danger of burning out. Primary to secondary ratio, 1-4.

To get the best from your set use an M-L transformer.



The **M-L** **ANODE
CONVERTER**

A PERMANENT substitute for the high-tension battery. Ideal for power amplifier work. Worked from the ordinary 6-volt accumulator, the consumption is low—1.15 amperes. Perfectly smooth reception. Continuous adjustment of H.T. voltage and not by steps.

Supplied in the following standard voltage ranges:

Type B 6-120 volts £11 5 0

Type C 12-300 volts £13 10 0

Type D 12-500 volts £18 0 0

For two stage power amplification

For low power transmission work.

We invite applications from traders for terms. Write for details.

The M-L Magneto Synd., Ltd.,
Wireless Dept.,
Victoria Works, Coventry.



A LOW-LOSS CRYSTAL RECEIVER

THE tuning coil of this receiver consists of 1 lb. of No. 16 enamelled copper wire, wound upon a former made up of eight 1/2-in. beech dowel rods, supported by a 5-in. by 3/8-in. hard-wood cheek at each end, and reinforced in the centre by a wooden disc 3 in. in diameter and 1/2 in. in thickness.

Holes are drilled in these end pieces as shown in Fig. 1, and the rods when adjusted are fixed by means of screws. The centre disc is held in position by 3/4-in. panel pins driven through the rods.

This disc is essential in order to prevent the rods bending when the wire is wound on. The overall length of this former when finished is 12 in. The rods are 12 1/2 in. long, and each one is grooved seventy-one times with a triangular file. The grooves should be the same depth as the thickness of the wire, so as to prevent any chance of the wire slipping. Marking off should be commenced 3/4 in. from the left-hand end of each rod, the scale being fourteen markings in every 2 1/8 in. Working on these lines, seventy-one grooves will occupy a space of 10 3/4 in. It will be seen from Fig. 2 that the rods must be slightly staggered to the right so that the first groove of rod No. 8 (B) comes directly under the second groove of rod No. 1 (C); thus the first groove of rod No. 2 is slightly to the right of No. 1 and so on, and a spiral formation of the winding is the result.

When all the rods have been adjusted and screwed in position there will be

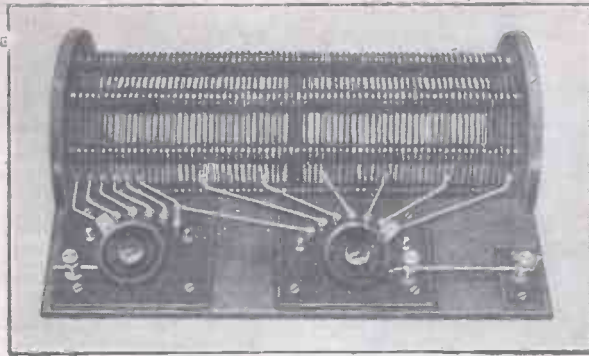

The Receiver without Case.

small projections varying in length on the outside of the cheeks. When these have been sawn off flush the centre disc should be fixed in place. The rods should be polished or treated with shellac.

Winding is commenced at the first groove in rod No. 1, Fig. 2 (A), by making a loop as in Fig. 3 (A), and finished off in a similar way when all the turns have been completed.

Tappings are taken as follows (see photograph): First just above the starting loop, then at every other turn until the 11th, after that at every 10th turn until the end of the former is reached. The tappings are taken in a straight line above rod No. 1 in each case. For this purpose 1/8-in. square section tinned-copper wire is used (and also for all other connections).

Fig. 3 (D) shows the method of attaching the tap to the coil, the tapping wire being slit with a fine saw and forked; it is then soldered.

The contact studs can either be slotted, Fig. 3 (B), or drilled through the centre to take the square wire (C), and the wire soldered in. In order to avoid overheat-

ing the ebonite panels two wooden templates are made and screwed in position with the studs attached to them. When the soldering has been finished, these templates are removed, leaving the studs in their proper position, and they are then replaced by the ebonite panels.

The baseboard to which these panels are fixed is shown in Figs. 1 and 4. The necessary clearances in the wood, which is 1/4 in. thick, are also indicated. A brass strip,

Fig. 1 (E), forms a bracket to secure the panel in position. In Fig. 1, at A, one of the tapping leads is shown. At B is a small condenser bush, drilled and tapped through one side to take a 4-B.A. screw (C). The nut D is used to screw the collar, or bush, in its right position, and the screw C is then tightened up.

Fig. 5 shows the connections. The brass bush under the control knob is drilled to the depth of 1/8 in. (A) and the square wire is then soldered to it. A loading coil, if required, may be connected between the terminals C and E, the bar D being removed. The detector and phone terminals are not indicated.

Fig. 6 is a section of the cabinet with the lid hinged at B and a glass panel inserted at A. At C a supporting strip of wood is fixed.

The tuner is very efficient, and is not difficult to make if the method suggested is carefully followed out. L. S. P.

A Liverpool Radio Retailers' Association has been formed to facilitate co-operative efforts to stabilise the wireless trade.

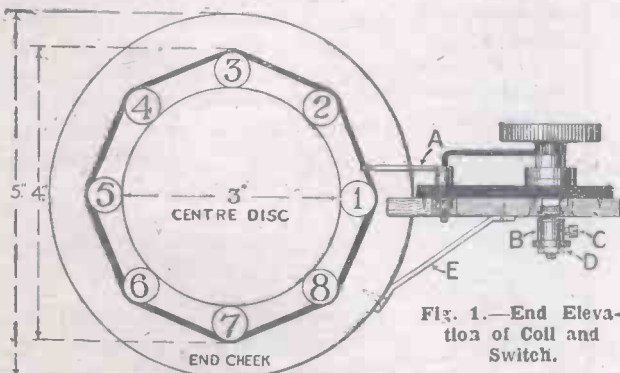

Fig. 1.—End Elevation of Coil and Switch.

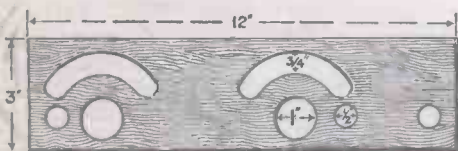

Fig. 4.—Layout of Base.

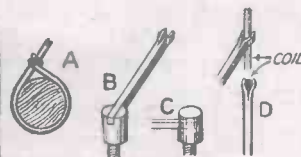

Fig. 3.—Joints.

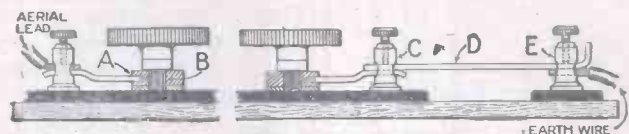

Fig. 5.—Details of Connections.

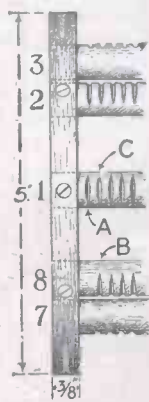

Fig. 4.—Detail of Former.

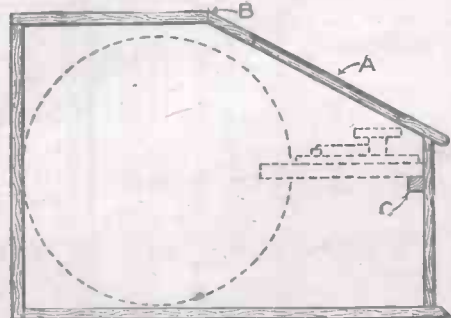

Fig. 6.—End Elevation of Case.

WHAT THE "I.F." TRANSFORMER DOES!

Readers of "A.W." know what the H.F. (high-frequency) and the L.F. (low-frequency) transformers are, but in the "super-het" there is another, the I.F. or intermediate-frequency transformer.

THE super-heterodyne receiver, to give it its full title, may be divided into five parts. As the first unit there is the receiver, or tuner, after which comes the frequency or wavelength changer, next the intermediate amplifier, then the second detector, and last of all the low-frequency amplifier. This is shown in diagrammatic form in Fig. 1. It is the intermediate amplifier with which this article will deal.

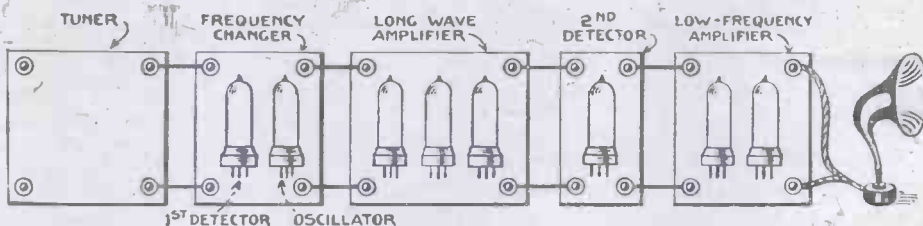

Fig. 1.—Super-heterodyne Receiver shown in Diagrammatic Form.

Every broadcasting station transmits on a certain wavelength, which, for example, may be 350 metres. This wavelength is then changed by means of the frequency changer, comprising a detector and an

To take a concrete example, suppose a station is transmitting at a frequency of 1,000 kilocycles and an intermediate frequency of 30 kilocycles (10,000 metres) is decided upon. It will be necessary to tune the oscillator so that it will generate a frequency of either 970 or 1,030 kilocycles. The combination of the oscillator and received frequencies will produce the 30-kilocycle frequency desired. This 30-kilocycle frequency may now be amplified through as many stages as desired with little or no tendency on the part of the amplifier to howl.

Another disadvantage in the use of an air-cored transformer is its uneven amplification of the "sideband." Without going into explanations of the side-band frequencies, let it be sufficient that all H.F. amplifiers for broadcast wavelengths must amplify equally all frequencies from 4,000 less than the carrier-wave frequency up to 4,000 cycles above it. If we reduce the carrier-wave frequency to 30,000 cycles (30 kilocycles) intermediate frequency, the 4,000 cycle side-band extends well down from the peak of the sharp resonance curve of an air-core transformer, causing distortion. This will be seen on glancing at Figs. 2 and 3, which are resonance curves

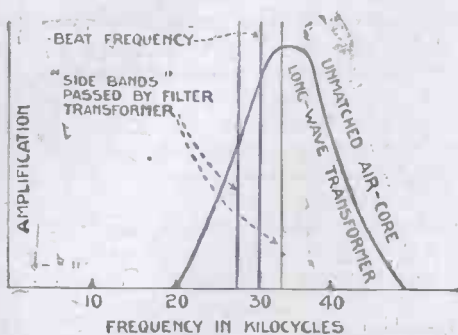

Fig. 2.—Resonance Curve of Unmatched Air-Core Transformer.

Tuned Air-core Transformers

Up to the present time, especially in this country, long-wave air-core transformers have been popular as intermediate transformers for the reason that if an iron-core transformer is used its amplification curve must slope down very steeply as we come from the beat frequency down to the audible frequencies, otherwise the set would be very noisy. Air-core transformers, of course, get over this difficulty, but, on the other hand, if two or three stages of air-core transformer are used a certain amount of distortion is very likely to result from the imperfect matching of such instruments and from the interaction of each transformer on the others, a tendency to which these transformers are very prone. Each transformer may be tuned with a variable condenser, but this would necessarily introduce complications in the number of controls.

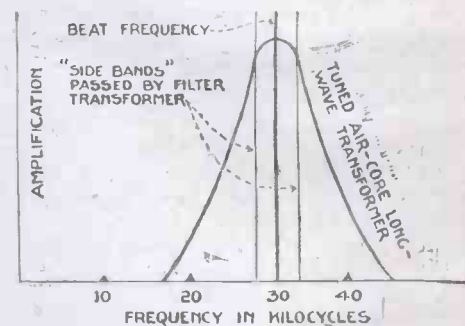

Fig. 3.—Resonance Curve of Tuned Air-core Transformer.

oscillator valve, to a much longer wavelength still above audible frequency. This intermediate wavelength may vary in different super-heterodyne designs between 2,500 and 10,000 metres, the amplification of which necessitates a special form of transformer—a subject of many recent designs.

The first thing to determine, then, is the intermediate wavelength or frequency which we shall use. It must be remembered that the higher the wavelength for which a high-frequency amplifier is used, the more stable it becomes. On the other hand, however, it would be foolish to design an intermediate transformer for, say, 7,000 metres when a high-power station is working in the vicinity on or near 7,000 metres. Serious interference would be a natural consequence, for the amplifier itself would pick up this station and by the time it had passed through one or two stages of L.F. amplification the interference would be intolerable.

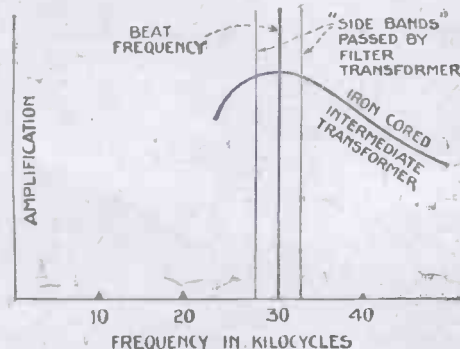

Fig. 4.—Resonance Curve of Matched Iron-core Transformer.

of air-core transformers. Fig. 2 shows the curve of a fixed air-core transformer not perfectly matched with the first "filter," or first stage of long-wave amplification. Fig. 2 shows a similar curve of a similar transformer correctly tuned by a condenser. It will be noticed that the resonance peak is too sharp.

Iron-cored Transformers

Using a well-designed iron-cored transformer having a fairly flat resonance peak this difficulty of evenly amplifying the side-bands disappears. Another trouble, though, as already pointed out, may arise. Should the curve be too flat, then the transformer will amplify currents of audible frequencies present in the beat frequency. The curve in this case should drop sharply before it comes down to 10,000 cycles. A diagram of a resonance curve of a good iron-cored intermediate transformer is shown in Fig. 4. This shows clearly how the side-band frequencies are evenly amplified. D. C. R.

PRACTICAL ODDS AND ENDS

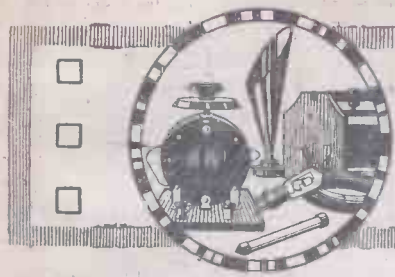

The Sagging Filament

WHEN valves are fixed horizontally in a set it will be found that the filaments tend to sag downwards until they touch the grids. In order to prevent this, it is convenient to make a little gadget for

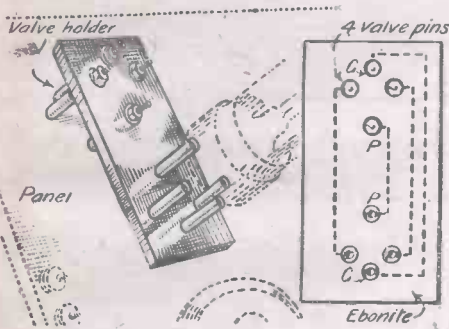

Mounting the Valves.

reversing the position of the valve, as shown in the diagram.

The materials necessary are few: a strip of ebonite 2½ in. by 1½ in. by ¼ in., four valve pins, four valve legs, and short lengths of insulated copper wire.

The construction of the socket is shown quite clearly in the diagram, and the use of such a device will prevent many a valve from becoming useless owing to the filament sagging on to the grid. J. H. P.

Reversible Coils

WHEN high-frequency amplification is switched out it is necessary, if reaction is used on the A.T.I., to reverse

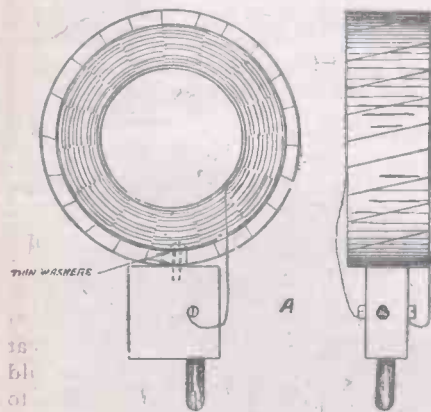

Reversible Coil.

the coil and also on many other occasions when experimenting. Here is a suggestion for mounting coils so that they can be

quickly changed without disconnecting any wires.

Honeycomb coils are made in the usual way, and it is advisable to gum a strip of empire cloth round the coil before the spokes are removed from the former.

A piece of cardboard tube is next cut the same width as the coil and made a little larger in diameter than the coil. Empire cloth is wound round the tube as shown and a small hole is made in the centre.

A hole is next made in the centre of an ordinary coil block, the tube is screwed to it as shown, the coil pressed into it and the ends connected, leaving enough wire to allow for turning. A. E.

Crystal Detectors

IN any crystal set it is a good plan to employ two detectors arranged so that by means of a single-pole double-throw switch either may be brought into action. It is possible to make a comparison of reception by this means, and the set is more reliable. U.

Capacity Effects

THE method described here and shown in the sketches overcomes capacity effects and allows the full range of control to be obtained with ease. The alteration can easily be carried out.

The condenser knob *a* is removed from the spindle and a drill of the correct tapping size passed through the undrilled portion of the nut in the centre. The newly drilled portion of the hole is tapped the same size thread as the remainder of the hole, drilling and tapping being done from the under side.

For the handle *b*, take a piece of ebonite ¾ in. by ¼ in. by 6 in., and at a suitable distance from one end, according to the size of the condenser knob, drill a clearance hole for the screw *c*, which is used to secure the handle to the knob, the screw being of the same size as the condenser spindle occupying the other end of the tapped hole.

After trimming the handle to the shape desired, a small clearance should be filed away as shown in the diagram to allow of the handle bearing only on the outer rim of the condenser knob when the screw *c* is screwed tightly against the end of the spindle *d*, the clearance providing the necessary "spring" for the friction drive now existing between the handle and knob. In use it will be found that when the limit

of travel of the extension handle is reached this can readily be set back to its starting-point or where required by holding

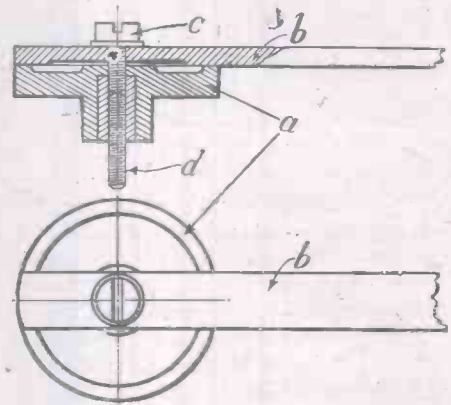

Details of the Control Arm.

momentarily the knob, although this action is only necessary when working the condenser from zero to 180 degrees. C. F.

An Aerial Switch

WHEN the ordinary type of double-pole double-throw switch is used for earthing the aerial a loss of signal strength is often encountered owing to corrosion between the switch arm and contacts.

The diagram shows a very simple method of preventing any bad contact caused by the action of the weather.

Short lengths of wire are soldered on to the leads to the switch points, so that there is no loss between, say, the earth lead

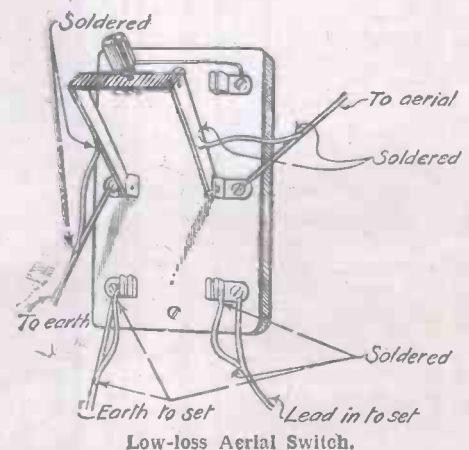

Low-loss Aerial Switch.

and the switch contact connected to earth. The diagram shows how the various wires are connected. A. B. K.

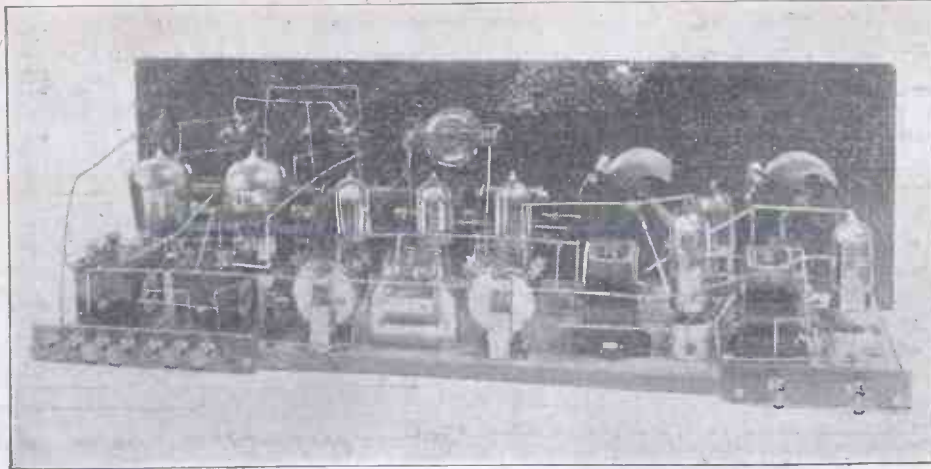

View of Back of Panel showing Components.

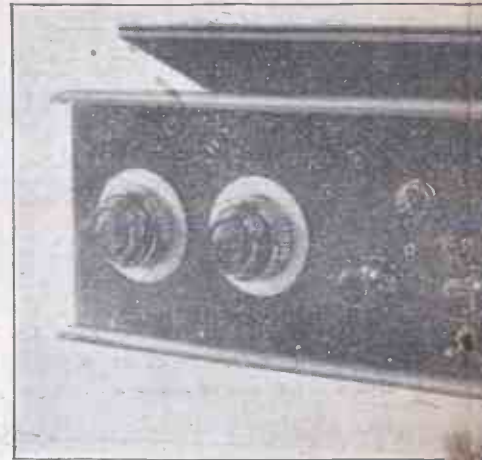

The Complete 8-valve Super

IN America the "super-het" is perhaps the most popular of all receivers, and undoubtedly amateurs in this country are now beginning to look upon it as a really good type that has come to stay.

The super-heterodyne reigns supreme as the most sensitive and most selective of receivers, and, contrary to the general opinion, it is extremely simple to operate. Very great progress has been made since the first appearance of the super-heterodyne in that the number of controls has been reduced to a minimum. Although great care is essential in wiring up, the building of such a receiver is no longer a risky and adventurous proceeding.

The Theory of the Circuit Used

Every amateur who has constructed a high-frequency amplifier using one or two stages will have noticed a tendency of the receiver to self-oscillation. The elimination of this tendency has been the subject of many recent inventions, especially with reference to the super-heterodyne. In the case of this type of receiver the trouble has been overcome in the following manner:

The high-frequency oscillations in the aerial circuit of the receiver received from the transmitting station are in the first instance reduced to a much lower frequency, a frequency which has previously been determined. This lower frequency, while eliminating any tendency to self-oscillation, is still above audible limits. When once reduced to this frequency the signals are amplified through as many stages as desired, each of which is as effective and far more stable than any high-frequency low-wavelength amplifier. The fundamental principle of the super-

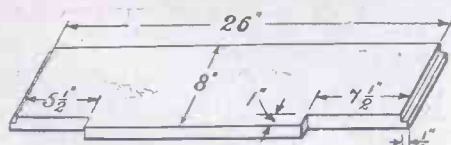

Fig. 6.—Detail of Back of Cabinet.

OUR SUPER-HETERODYNE

THE LAST WORD

heterodyne is therefore the reduction of frequencies between 550 and 1,350 kilocycles to an intermediate frequency between 30 and 50 kilocycles. The frequency reduction is brought about by the combination of oscillations of a fixed frequency generated by a "local oscillator," as it is called, and the frequencies of the incoming oscillation, thus producing the "beat" frequency it is desired to amplify.

Referring to the circuit diagram (Fig. 2), it will be seen that the valve V1 acts as a detector, while the valve V2 acts as a generator of high-frequency oscillations. These oscillations are picked up by the coupling coil (marked 1, 2) in the grid circuit of the detector valve V1. The combination of the two frequencies present in the grid circuit of the valve V1 oscillations having a frequency of 30 kilocycles, or 10,000 metres, by means of the special air-cored transformer, known as the filter transformer, has an amplification peak which is steep-sided for selectivity but which is well rounded off at the top of the peak so that the beat frequency and the "side bands" are able to pass without distortion. Further amplification of the beat frequencies is effected

by the valves V3, V4 and V5, using special intermediate-frequency coupling transformers. The valve V6 is the second de-

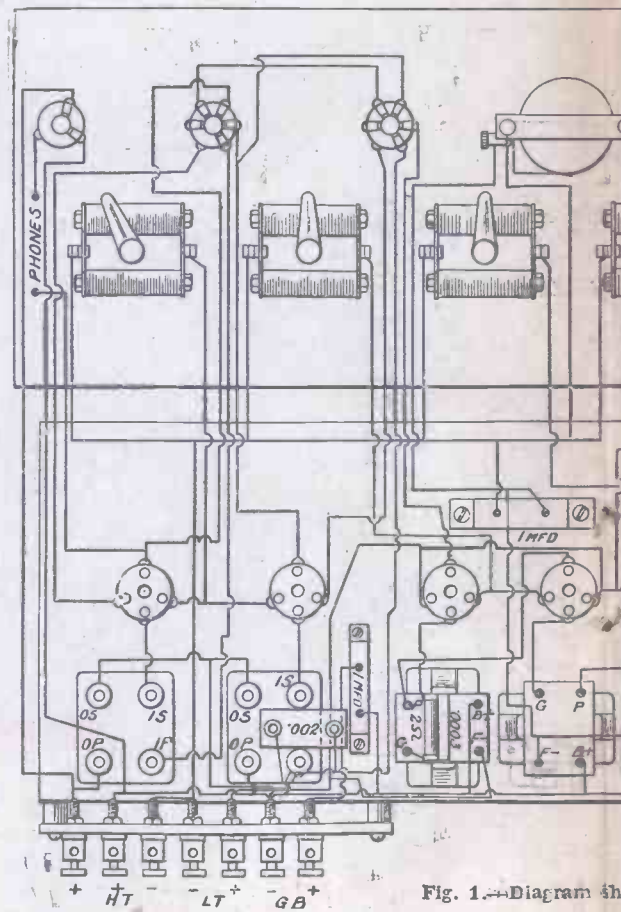
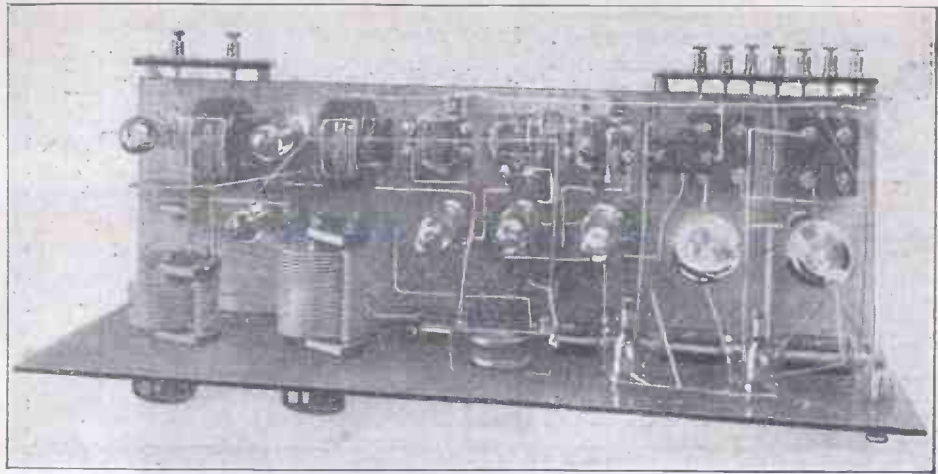

Fig. 1.—Diagram of the Receiver



Super-heterodyne Receiver.



Plan View of Receiver

HYPER-HETERODYNE EIGHT-VALVER

IN RECEIVERS

Detector and the last two valves, V7 and V8, are ordinary low-frequency amplifiers, one or both of which may be cut out

at will by means of two "push-pull" switches which are shown at the top left-hand corner of Fig. 1.

Component Parts Required

One Radion ebonite panel, 26 in. by 8 in. by $\frac{3}{8}$ in. thick (American Hard Rubber Co., Ltd.); four filament rheostats, dual type (Radio Instruments); one potentiometer (Igranic); two six-point push-pull switches (Lissen); one three-point push-pull switch (Lissen); one variable condenser, .0005 microfarad, square law (Wates Bros.); two condenser dials (Accuratune type, Gaston E. Marbaix); one super-heterodyne outfit, including three matched intermediate transformers, one filter transformer and one oscillator unit (Rauland Superfine Kit, Gaston E. Marbaix); eight valve holders (Athol Engineering Co.); two L.F. transformers, ratios 2.5 to 1 and 6 to 1 (Fullers United Electric Co.); two 1-microfarad fixed condensers (Ediswan); two .0003-microfarad fixed condensers with grid leaks (Dubilier); one .002-microfarad fixed condenser; nine terminals; two plugs and sockets (Belling Lee); two ebonite terminal strips 5 in. by 1 in. and 7 in. by 1 in.; one oak cabinet to suit (Carrington Manufacturing Co., Ltd.).

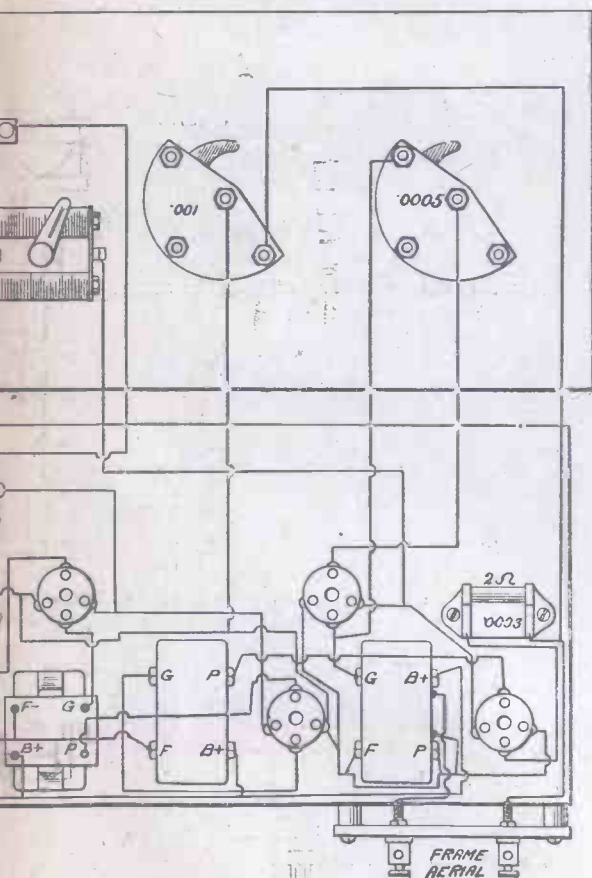

Fig. 1.—Arrangement of Components and Wiring.

The Cabinet

It is considered sufficient for those amateurs who care to make their own cabinets to give a dimensioned sketch (Fig. 4). A very suitable and well-made cabinet has been made for us by the Carrington Manufacturing Co., Ltd., 18-20, Norman's Buildings, Mitchell Street, London, E.C.1, from whom an identical case may be obtained at the price of thirty-seven shillings and sixpence in oak, and forty-two shillings in mahogany. Two slots are cut at the back of the cabinet to allow the two ebonite terminal strips mounted on the edge of the baseboard to fit flush with the back of the cabinet. Untidy battery connections to terminals on the panel front are thus avoided.

The Panel and Baseboard

The panel is a standard size of the American Hard Rubber Co., Ltd., and if obtained from this firm a lot of trouble and time will be saved in cutting and truing-up. A drilling diagram showing the positions and dimensions of all holes to be drilled is given in Fig. 3. After the panel has been drilled the variable condensers, filament rheostats, potentiometer and switches should be mounted and put on one side.

The next matter is the baseboard. An idea of the disposition of the components will be obtained from the wiring diagram, Fig. 1, and the photographs. The baseboard itself measures 25 in. by 8 in. by $\frac{1}{2}$ in. thick and is supplied with the cabinet by the makers. This baseboard forms a convenient shelf behind the panel for mounting most of the apparatus. The dimensions of this board are given in Fig. 5.

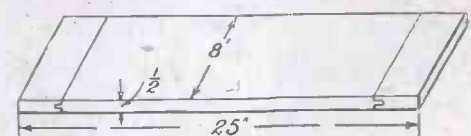

Fig. 5.—Dimensioned Sketch of Baseboard.

Wiring Up

The eight valve holders are of a type specially designed for baseboard mounting; each is fixed by means of one screw. Having mounted the valve holders, it is advisable to solder short pieces of wire

controlled by one rheostat must be both dull-emitters or both bright-emitters.

Using the Super-het

After finally checking over the wiring the set may be tested. Connect the frame

but its entire range for each setting of the oscillator condenser. A whistling sound may indicate the existence of a carrier wave. The whistling sound, if any, is eliminated by adjusting the potentiometer. It is advisable to readjust the tuning and oscillator condensers after adjusting the potentiometer. With a little practice stations can be easily tuned in. The dial settings of every station received should be recorded so that at any future time when it is desired to tune in the same station again the dials can be set at the proper positions.

Condenser Settings

An important point to notice is that the same station can be received at two different settings of the oscillator condenser. This is characteristic of all super-heterodyne sets. Should any interference be experienced at one setting it is a simple matter to turn the oscillator dial to the other setting, where it will be found that the same interference will not be heard.

When tuning in a distant station that requires critical adjustment and body capacity effects are noticeable the special vernier controls on the two large dials will be found invaluable.

When neither stage of L.F. amplification is used the "push-pull" switch on the extreme right of the panel must be placed in such a position that the H.T. potential on the plate of the second detector valve is lower than that on the plates of the other valves. When one L.F. is in circuit the extra H.T. potential will need suitably adjusting.

Test Report

An eight-valve supersonic heterodyne receiver of this type will, in favourable circumstances, bring in any signal which reaches the aerial in sufficient strength to be distinguishable from small atmospheric disturbances.

The set was tested out on a frame aerial (3 ft. sides) and the sensitivity and selectivity was extremely good. All the main broadcasting stations were heard, Radio-Paris, Madrid, Brussels, L'Ecole Supérieure and Hamburg were easily tuned in. In most cases it was found that

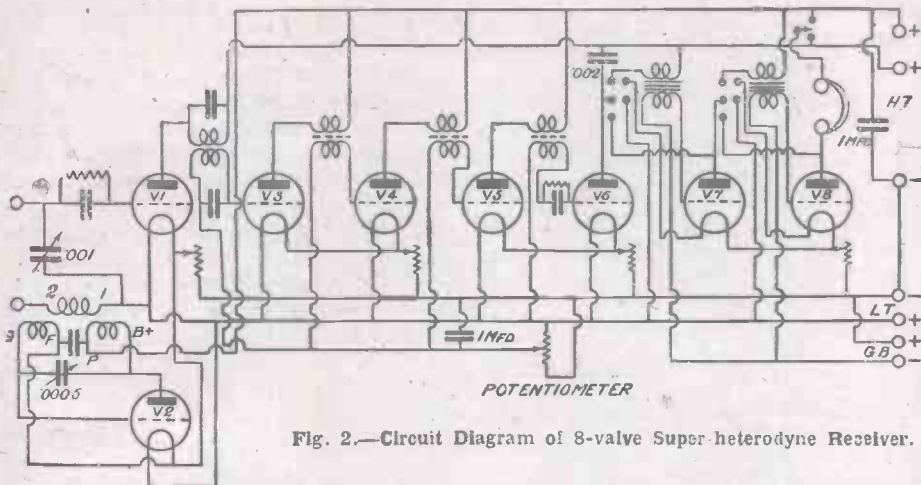

Fig. 2.—Circuit Diagram of 8-valve Super-heterodyne Receiver.

to the valve-holder terminal screws, otherwise it will be found nearly impossible to do this after the panel has been fixed to the baseboard. In fact a good plan is to wire up as much of each component as is possible before mounting the next. A little trouble may be experienced in wiring up the American instruments, in that the conventional signs on the terminals are different from the English signs. The four terminals on each of the intermediate transformers are marked P, B+, G and F-. The English equivalents are P, H.T.+, G and L.T.- respectively, P and G standing for plate and grid.

aerial to the two terminals on the right of the baseboard looking at the back of the panel. The H.T., L.T. and grid-bias batteries are connected to the terminals on the left.

Tuning is accomplished by the two large

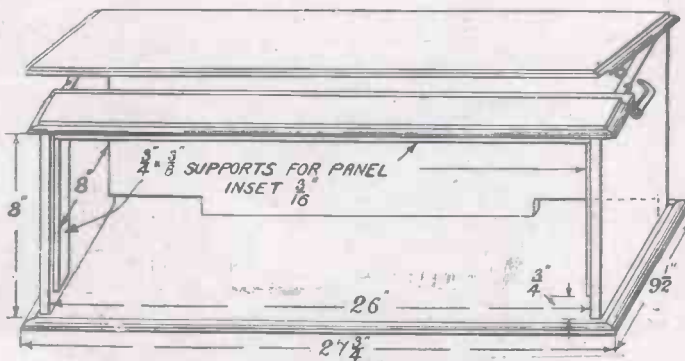

Fig. 4.—Details of Cabinet.

When wiring up a multi-valve set of this description continual reference should be made to the wiring diagram and the photographs. Care should be taken to space the plate and grid leads and to see that the H.T. and L.T. leads cannot possibly so short-circuit that the valve filaments are in danger of being burnt out.

dials on the left of the panel (the tuning and oscillator condensers) and the potentiometer. These three controls are the only critical controls on the set. The frame aerial, which should be free to rotate,

Valves

On testing the actual receiver we used six Cossor valves and two Mullard power valves, type DFA1. The power valves are used in the two stages of L.F. amplification. Using these valves results were excellent, and we strongly recommend their use in this receiver. While on the subject of valves, we would point out that there are four filament rheostats controlling eight valves. The filament rheostats are of the dual type, suitable for bright or dull-emitters, and each rheostat controls two valves. It is essential, therefore, that the two valves of any pair con-

must be turned to point in the direction of the station it is desired to receive. Turn the oscillator condenser (the extreme left dial) two degrees at a time and the tuning condenser slowly through-

the second stage of L.F. amplification was unnecessary except for loud-speaker work.

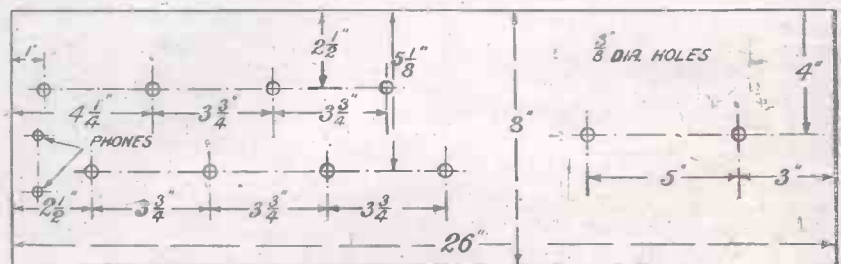

Fig. 3.—Lay-out of Panel.

Ask "A.W." for List of Technical Books

TRANSMISSION STEP BY STEP.—III

THE ARTIFICIAL AERIAL

It is strange that more experimenters have not availed themselves of the artificial aerial, for a licence for the use of this device is easy to obtain, costs nothing, and will often result in the acquisition of much knowledge of transmitting circuits and valves or other components under actual transmitting conditions. The artificial aerial licence carries with it a call-sign and certain restrictions, the chief of which is that the aerial is to be as non-radiating as possible.

Non-radiating Aerial

An artificial aerial is a non-radiating aerial and not a frame aerial, which latter, although comparatively non-radiating, does, in effect, radiate sufficient high-frequency energy to carry a fair distance under favourable conditions.

The question which immediately arises is how, then, can one have an aerial which is neither an open aerial nor a frame aerial? The answer is that, when experimenting with transmitters and transmitter circuits it is necessary to produce so far as possible the actual conditions under which the valve oscillator or spark transmitter will be called upon to operate.

We know that an aerial oscillatory circuit consists of inductance, capacity, and resistance, and we have, therefore, to arrange such properties in dummy form. This is, of course, not a difficult matter, but due regard has to be paid to the conditions pertaining at the time of transmission, that is, wavelength and power

used. We will, therefore, consider that the experimenter desires to investigate the possibilities of a 10-watt transmitter designed to operate on a 200-metre wavelength and test the different methods of modulation and various components such as chokes, valves, condensers and the like.

The circuit diagram, Fig. 1, illustrates the circuit to be adopted. That portion contained in the area of the dotted square

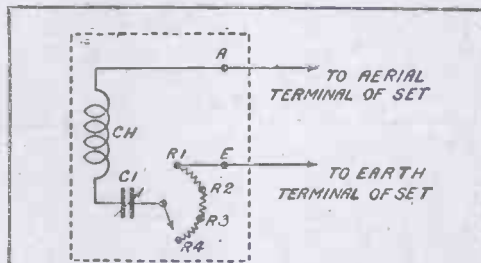

Fig. 1.—Circuit Diagram of Dummy Aerial.

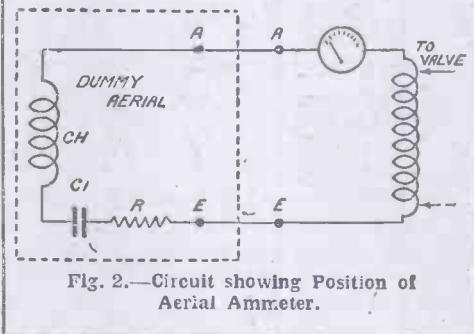
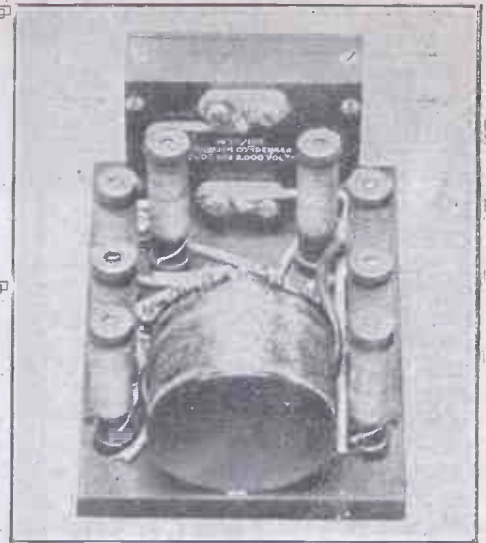

Fig. 2.—Circuit showing Position of Aerial Ammeter.

constitutes the dummy aerial portion of the apparatus. The condenser C1 is a variable condenser of a value of .0002 to .00025 microfarad capacity. This covers the capacities which are likely to be obtained with an average P.M.G. aerial; .0002 will be sufficient, and the plates should be well spaced.

Alternatively a fixed condenser of a value of .0002 might be used, but this should be of air dielectric, or the mica dielectric should be of the very best quality ruby mica. The air-dielectric fixed condensers recently placed on the market by Messrs. Bowyer-Lowe at 1s. 6d. each are suitable for the purpose. The resistances R1, R2, R3, and R4 are wound non-inductively on fireproof material, such as a mica former composed of strip mica or on small porcelain insulators. These porcelain bobbins are often ready wound to a suitable resistance with resistance wire, but if they are inductively wound the wire



Under Side of Panel of R.A.F. Dummy Aerial.

should be removed and wound non-inductively, as explained hereunder.

In order to ascertain whether or not a resistance is non-inductive, it should be placed in a tuned circuit whilst receiving broadcast. If inductive, the tuning will be markedly altered; if not, no variation in tuning will be noticeable. It will be observed that the resistance increases in four steps of 5 ohms each to 20 ohms, and four spools are required, each wound to a resistance of 5 ohms. A quarter of a pound of No. 22 Eureka resistance wire will be required, and each spool will be wound with 4 1/2 yd. of wire.

To wind the spool non-inductively the required length of wire is first measured off and then bent double at the centre. The winding is then commenced at one end with the doubled length and the turns wound on the former, the two free ends being together at the other end.

The Choke

The choke or artificial inductance has next to be built up. This is composed of 25 turns of No. 18 d.c.c. wound on an ebonite cylindrical former 3 in. in diameter by 2 1/2 in. long. The aerial is now wired up as outlined in the circuit diagram.

The photographs on this page illustrate an ex-Air Force dummy aerial which may be converted to meet the present requirements. The instruments are obtainable at 17s. 6d. each from dealers in ex-Government apparatus.

Should there be any fear of the small amount of current radiating from the aerial interfering with your next-door neighbour's reception on low wavelengths, the instrument should be placed in a tin case, such as a biscuit-box, and this case earthed to the nearest convenient point. The aerial described is suitable for tests on or about 200 metres; if it is desired to test on wavelengths lower than about 100 metres, suitable values of inductance and capacity will have to be designed for the

(Continued at bottom of next page)

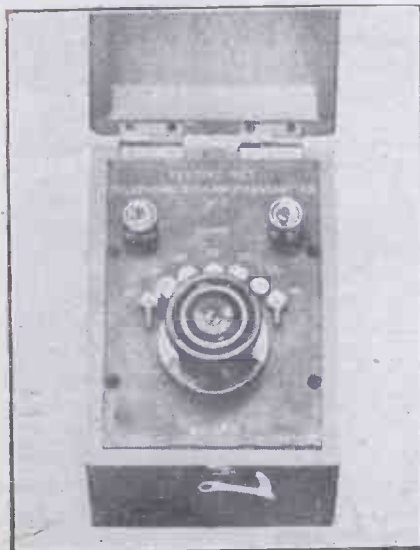

R.A.F. Dummy Aerial.

MAKING A COIL-WINDER.—II (CONCLUSION)

A SERIES of ebonite discs, of $\frac{1}{8}$ -in. material, respectively $3\frac{1}{4}$ in., $3\frac{3}{4}$ in., $4\frac{1}{4}$ and $4\frac{3}{4}$ in. in diameter, are turned in the lathe, bored a push fit to the saddle and grooved with a V-parting tool about $\frac{1}{8}$ in. deep. As an alternative a stepped drum of ebonite or hard wood may be used.

The reel or former to be wound is mounted on the spindle A1 and driven by means of the small gear, being connected by any means most convenient to the constructor, as, for example, by boring out the gear and fitting it to a thin brass tube which will revolve freely on the spindle.

Having mounted the reel or former on the spindle, the screwed rod should be adjusted so that each of the grooves in the drum in turn can be moved laterally (left and right) about $\frac{1}{8}$ in. clear of the inner face of each of the flanges of the

reel so as to cover the whole winding surface of the reel.

To operate the winder the drum should be revolved until the smallest diameter groove lies slightly to the right of the inner face of the right-hand flange of the reel or former. Anchor the wire in a suitable manner and pass it over the top side of the drum in the groove. Controlling the wire with the thumb and first finger of the left hand, and turning the handle of the gear wheel with the right, the wire will wind on the reel, the drum moving slowly to the left.

The drum should have a slight lag giving the wire a lead so that it will wind closely and not be spaced. If it tends to move too rapidly, the movement can be slowed down by a slight pressure of the second finger of the left hand.

When the first layer has been completed the wire should be lifted from the drum, the drum revolved a few turns to the left, so as to bring the groove slightly to the left of the inner face of the left-hand flange of the reel, the wire brought round the end of the threaded spindle and underneath the drum into the same groove, but on the lower side. When the spindle A1 is revolved, still in the same direction, the drum will revolve in a reverse direction and so travel to the right.

At the end of the second layer the wire is again brought to the top, the drum revolved a few turns to the right, the wire placed in the groove as in the case of the first layer, and the winding proceeded with.

As the layers increase, the diameter of the former on which the wire is wound increases, and each complete turn of wire becomes longer, thereby causing the drum to revolve (and so to move laterally) more rapidly. When this becomes too rapid to be controlled by the braking effect of the finger the wire should be lifted—at the end of a layer—into the second groove. At successive stages the third and fourth grooves may be used.

It will be found, with a little experience and turning the handle at about 100-150 revolutions a minute (the reel or former revolving at 300-500), that the winding is almost automatic, needing very little supervision except to take care that the wire does not mount the preceding coils on the reel.

The winder is provisionally patented (No. 16,194/24), but if any reader desires to construct one and to obtain a rod and saddle, the writer will be very pleased to arrange for the supply. H. C. H.



Photo: Foulsham & Banfield Ltd., 49 Old Bond St., W.

"UNCLE ARTHUR"

Mr. A. E. Burrows has resigned from his position of assistant director and controller of programmes of the B.B.C. An international broadcasting bureau has been set up at Geneva, following a conference of European wireless firms, and Mr. Burrows has been appointed manager of the new organisation. (See interview with Mr. Burrows on p. 694.)

"TRANSMISSION STEP BY STEP" (continued from preceding page)

purpose, the capacity and the inductance being reduced slightly.

As to the use of the aerial, it is connected to the aerial and earth terminals of the transmitter with the radiation meter or tuning lamp in circuit, as illustrated in Fig. 4. It will be found that increasing the value of the resistance in circuit will result in large decreases of the H.F. current in the aerial circuit. Practically all adjustments which may be made on a transmitter connected to an open aerial may be tried out on this apparatus, the only difference being that the amateur is not allowed to call another station, and must rely upon his own personal observations for his working data. This, however, is often more reliable than reports furnished by other stations, and there is, of course, no chance of interference.

A. J. C.

NEW EDISWAN VALVES

WORTHY ADDITIONS TO A FAMOUS SERIES

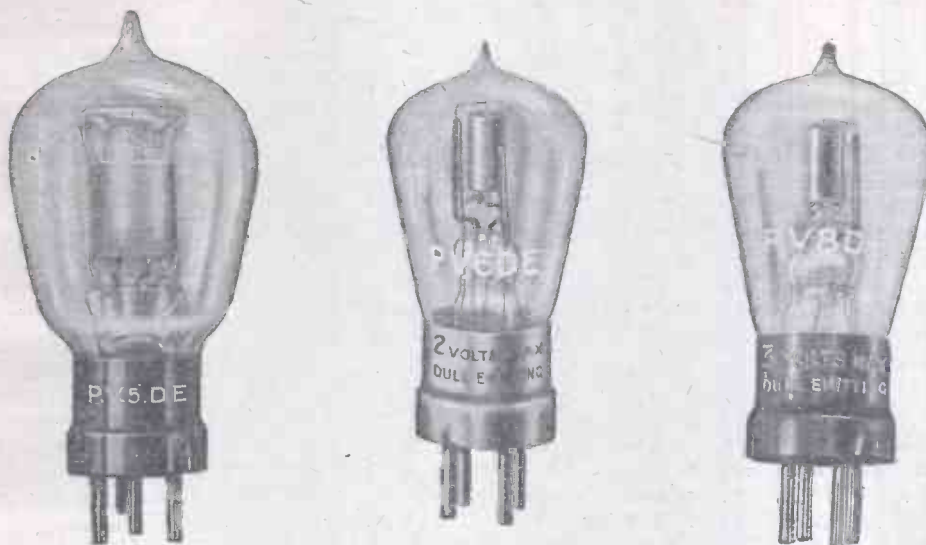

Volume without distortion

To secure volume free from distortion you must use the right valves in the L.F. stage. This new series of Ediswan Power Valves is the result of much experimental work resulting in the valves being perfect before being offered to the public.



TYPE ARDE
HF and LF

P.V.5 D.E.

Fil. volts, 5.
" amps, 0.25
Plate volts, 50-150
Impedance, 8,500

Price 30/-

P.V.6 D.E.

Fil. volts, 2.0
" amps, 0.4
Plate volts, 60-120
Impedance, 12,500

Price 22/6

P.V.8 D.E.

Fil. volts, 3.
" amps, 0.12
Plate volts, 60-120
Impedance, 12,000

Price 30/-

Valves for H.F. and L.F. Ediswan Dull Emitter Valves, types ARDE and AR.06 are now especially made for H.F. and L.F. work. They are distinguished by Red (H.F.) and Green (L.F.) lines. Prices, ARDE 18/-, AR.06 21/-.

THE EDISON SWAN ELECTRIC CO., LTD.,
123-5, Queen Victoria Street, E.C.4.



TYPE AR.06
HF and LF

If your dealer does not yet stock EDISWAN POWER VALVES or VALVES for HF and LF - write to us for full particulars and name of nearest agent

AROUND THE SHOWROOMS

S.W.C. Terminals

JACK terminals of any type have always appeared to me to be very satisfactory. It seems so simple just to plug-in the contact point to obtain perfect electrical and mechanical contact.

The S.W.C. jack terminal, manufactured by S. Wilding Cole, of 116, Snow Hill, Birmingham, has proved itself to be a useful little gadget worthy of insertion in any amateur's set.

The plug is of the phone-tag type, heavily nickel-plated. The jack is also nickelled, and presents a very attractive appearance on the face of the panel. Coloured washers are provided in red and black in order to denote the polarity of the connections. The jack is fixed by means of a large nut, so that it is only necessary to drill one hole.

Slotted tags are provided so that the accumulator, aerial and other leads can be inserted and soldered, thus providing permanent tags in all cases.

Oldham Accumulators

OLDHAM accumulators have long been known as the best in their class for reliability and economy. The Oldham wireless accumulator is in fact essentially the same as the miner's lamp accumulator which Messrs. Oldham and Son, Ltd., of Denton, Manchester, have developed for special use in coal mines.

By means of a special activation process applied to the plates, the life and strength



Oldham Accumulator.

of the battery is greatly increased. The raised dome-shaped top of the container prevents corrosion of the terminals that might be caused by spraying of the acid.

From the photograph of a typical Oldham accumulator the sturdy construction will be evident.

Accuratune Dials

VERNIER adjustment devices for condensers are quite good, provided that troublesome

hand capacity effects, are not noticeable, as is only too often the case.

A very efficient vernier control, known as the Accuratune dial, is supplied by Gaston and Marbaix, of 27-28, Anning Street, E.C.2. This dial is very massive in construction, and consists of two large

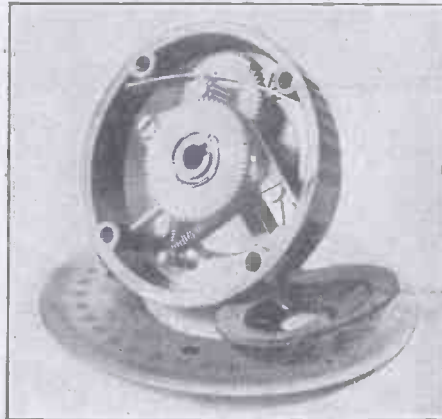

Accuratune Dial.

concentric knobs, one of which carries an aluminium scale graduated in degrees from 0 degrees to 180 degrees.

The larger of the two knobs is fixed to the condenser shaft by means of a set screw, the other being connected through a train of gears at a ratio of 80 to 1, in order to obtain fine adjustment.

Songster Loud-speaker

I HAVE often wondered how many of the listeners who decry the loud-speaker do so more on the grounds of expense than on the bad quality of reproduction.

The Superlamp Co., Ltd., of 94, Paul Street, E.C.2, have removed all objections by producing the Songster loud-speaker at a price cheaper than a pair of phones.

The Songster de luxe is highly finished in chocolate brown, has a handsome curved horn eleven inches high, and a neat base. The phone part of the loud-speaker seems very good, for the tone is loud and mellow and there is no apparent distortion.

Ediswan Variometer

MESSRS. EDISON SWAN ELECTRIC CO., LTD., of Queen Victoria Street, E.C.4, manufacture a particularly interesting variometer. The rotor windings are wound on a spherical moulded former and the stator windings are on the inside of a bakelite cylinder. The windings are brought out to separate terminals so that they can be connected either in series or parallel by means of metal bridges or strips. By this method the wavelength range is increased considerably.

On actual test with a P.M.G. aerial

with the windings in series the wavelength range was found to be 277 to 634 metres, and the whole range with the windings in series and parallel was 205 to 634 metres. With the windings in parallel, however, the range is only 205 to 359 metres.

The variometer is of the one-hole fixing type, so that only one hole, $\frac{3}{8}$ in. in diameter, need be drilled into the panel. It is supplied complete with knob and dial.

Peto-Scott Condenser

FOR making fine tuning adjustments and for ease in tuning in long-distance stations it is necessary to have a condenser which is an instrument of precision, preferably of the square-law type.

A very efficient condenser is manufactured by the Peto-Scott Co., Ltd., of 77, City Road, E.C.2. The appearance of this condenser is distinctly pleasing, the end plates being of solid turned ebonite and the vanes of heavy-gauge aluminium. Three substantial supports are fitted so that there is not the slightest possibility of the alignment of the plates getting out of order.

The square-law effect is obtained by means of the curiously-shaped piece cut out from the centre of the fixed plates. The moving vanes are not altered in shape, so that there is less chance of them being damaged.



Peto-Scott Condenser.

Connection is made to the moving plates by a springy helical strip of phosphor bronze, and a felt washer between the bush and the plates makes the "feel" of the condenser exceedingly smooth. A stop is provided to prevent the moving plates from being turned too far and injuring the flexible connection.

VANGUARD.

Ask "A.W." for List of Technical Books

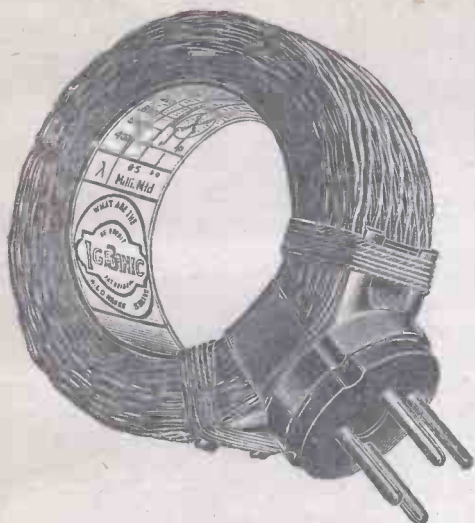

IGRANIC High Frequency Transformer.



IGRANIC "E" Type Audio-frequency Transformer.



IGRANIC Unitune Fixed Coupler.

The secret of their fine performance —is in the windings

In the case of both the Igranic High Frequency Transformer and the Igranic Unitune Coupler the world famous De Forest method of Honeycomb Duolateral winding is employed.

In the transformer this results in a highly inductive coupling being obtained, and self-capacity being kept at a minimum—thus the maximum transference of anode potential fluctuations to the grid of the succeeding valve is assured with the minimum of distortion. The Igranic H.F. Transformer is made in four sizes : 250 to 500 metres, 8s. ; 450 to 880 metres, 9/6 ; 800 to 1,700 metres, 11/- ; and 1,500 to 3,000 metres, 12/6.

The De Forest method is of particular advantage in the Unitune Coupler—a device specially designed for transatlantic and short-wave reception—because minimum self-capacity in the coupler is so essential when high-frequencies, such as occur in short wavelengths, are involved. The Igranic Unitune Coupler combines the advantages of both direct and loosely coupled methods of tuning without their

attendant disadvantages. It is made in two sizes : minor, for 75 to 180 metres, 7/6 ; and major, for 300 to 600 metres, 9/-.

The Igranic E. Type Audio-Frequency Transformer has a coil wound by a patent cotton interweave process and the primary and secondary windings are so disposed with relation to the iron circuit that distortion is avoided. Windings are of ample cross-section, and have a current carrying capacity of 20 milliamperes. Each transformer is subjected to a flash test of 2,500 volts alternating potential between windings and between windings and frame, and is suitable for anode potentials up to 150 volts. The audio-frequency transformer is obtainable in 1 : 5 ratio for first stage of amplification, 21/- ; and 1 : 3 ratio for second and subsequent stages, 19/6.

Only the finest material can stand the tests to which Igranic Components are put before leaving the works, and it is therefore not to be wondered at that you will build a better set with Igranic Radio Devices.

IGRANIC RADIO DEVICES

include Honeycomb Duolateral Coils, Fixed and Variable Condensers, Filament Rheostats, Intervale Transformers, Variometers, Vario-Couplers, Bi-plug Coil Holders, Tri-plug Coil Holders, Battery Potentiometers, Vernier Friction Pencils, etc.

All carry the IGRANIC guarantee.

Write for List Z490.



149, Queen Victoria St., London.

Works : BEDFORD.

BRANCHES :

BIRMINGHAM : 73-74, Exchange Buildings.
 CARDIFF : Western Mail Chambers.
 GLASGOW : 50, Wellington Street.
 LEEDS : Standard Buildings, City Square.
 MANCHESTER : 30, Cross Street.
 NEWCASTLE : 90, Pilgrim Street.

These give the "finishing touches" to the better set



IGRANIC Knob and Dial.

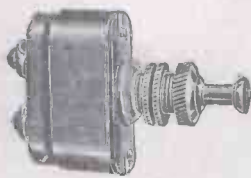

IGRANIC Radio Switch.

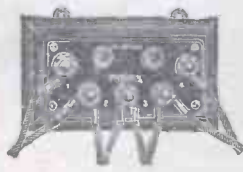

IGRANIC Telephone Connector.

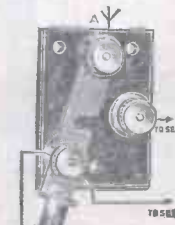

IGRANIC Earthing Switch.



IGRANIC Vernob.



RULES.—Please write distinctly and keep to the point. We reply promptly by post. Please give all necessary details. Ask one question at a time to ensure a prompt reply, and please put sketches, lay-outs, diagrams, etc., on separate sheets containing your name and address. Always send stamped, addressed envelope and attach Coupon (p. 695).

Wire for Potentiometer

Q.—What kind and how much wire shall I need to make a potentiometer to control the first valve of a four-valve set (H.F., det., 2 L.F.)?—P. H. D. (Glasgow).

A.—Use 25 yards of No. 36 s.w.g. Eureka enamelled wire.—J. F. J.

Wet H.T. Battery

Q.—Could forty Leclanché cells, such as are used for bells, be used as an H.T. battery?—S. K. (Oldham).

A.—Certainly. They will take up a lot of space and need some attention, but will last very much longer than the usual dry H.T. battery. Be careful adequately to insulate the cells from each other and from earth.—J. F. J.

Interference from Magneto

Q.—A neighbour has a petrol engine with magneto ignition which greatly interferes with my reception when it is running, which it is nearly always doing in the evening. He has promised to do anything in reason to reduce the trouble. What steps can I request him to take?—P. F. L. (S.W.4.)

A.—It may help matters if he earths the magneto carcass. He might also replace the lead to the sparking plug by a metal-covered cable and earth this sheathing.—J. F. J.

Filament Rheostats

Q.—It appears that filament rheostats are now being sold having various resistance values from five to fifty ohms. Can you tell me of a rough-and-ready rule for finding the correct resistance for any particular valve?—C. S. (Pontypool).

A.—As a rough rule the total resistance of the rheostat should be of the same order as that of the valve filament. To find the resistance of the filament, divide the makers' figures for filament volts by their figures for the filament current. The result will be the resistance of the filament in ohms.—J. F. J.

Improving Loud-speaker Tone

Q.—I have noticed the tone of a loud-speaker can often be improved by connecting a fixed condenser across its terminals. Will you please explain exactly what this condenser does?—S. M. (Sheffield).

A.—The usual tendency of an L.F. amplifier is to cause distortion by accentuating the higher frequencies, and the condenser tends to correct such distortion. As it is in parallel with the loud-speaker windings, of course the condenser by-passes some of the signal energy. The reactance of a condenser decreases with an increase of frequency, and so the higher frequencies are diverted from the speaker in a greater proportion than are the lower ones. Also the condenser lowers the natural frequency of the windings, and so gives greater prominence to the lower frequencies by reason of resonance.—J. F. J.

Accumulators and Dull-emitters

Q.—I am using a 4-volt 60-ampere (actual) accumulator to light the filaments of two .06 D.E. valves. Using the set for, say, thirty hours a week, the usual calculation would seem to indicate that the accumulator would

only require charging about every six months. Would the battery really retain its charge so long?—F. P. M. (Cardiff).

A.—It is always as well, when an accumulator is being very lightly used, to have it recharged every two months at the outside, to prevent sulphating and to keep it in good condition.—J. F. J.

Repairing Dull-emitters

Q.—I have three D.E. valves, but the emission has fallen off. I am told that it is possible to cure this by processes known as "cooking" or "flashing." Please explain the meaning of these terms, and say whether I am likely to cure the trouble in this way.—P. D. (Bedford).

A.—A failing emission can often be restored by "cooking." This means burning the filament at its usual temperature for half an hour or so with the H.T. disconnected. "Flashing" is a more desperate remedy and should only be attempted as a last resort, as if clumsily carried out, it may destroy the filament altogether. Connect a wire from one side of the H.T. battery to one of the filament legs and lightly brush the other filament leg with a wire from the other side of the battery. The duration of the contact should be as brief as possible. It is advisable not to use more than about 30 volts for the purpose.—J. F. J.

Extension Leads

Q.—It is desired to add long extension leads to a two-valve and crystal reflex set to work a loud-speaker in another part of the house. So that they shall not be unsightly, the wires have been hidden underneath the linoleum. The set howls terribly when the extension is connected, though it works perfectly with phones or L.S. connected directly to the set. All the usual remedies have been tried without success.—M. L. (N.W.3.)

A.—If it is necessary to place the leads where they may have a large capacity to a wall, floor, etc., it will be advisable to connect the primary of a 1 to 1 ratio telephone transformer to the phone terminals of the set and to connect the extension leads to the secondary of this transformer.—J. F. J.

Charging Accumulators

Q.—Please explain the simplest possible method by which I can charge my accumulators from the house-lighting supply which is 110 volts D.C.—J. M. (Glos.)

A.—The simplest method is merely to connect the mains to your accumulators through a resistance which will just pass the required charging current. If 110-volt carbon filament lamps are used as the resistance, about 4 watts may be reckoned per candle-power. Thus if the normal charging rate of the accumulator is 2½ amperes, two 32 c.p. 110 volt carbon filament lamps may be connected in parallel with each other, and used in series with the mains. During the charging process the batteries should be well insulated from earth.—J. F. J.

Indoor Aerial

Q.—When it is impossible to erect an outdoor aerial, is it better to use a frame aerial or an aerial of normal type but erected inside the house?—S. P. (Bolton).

A.—Everything depends upon the type of set you possess and the purpose for which it is to be used. As the types of aerial you mention are designed for entirely different purposes their relative efficiency cannot very well be compared. With practically all "straight" circuits the normal type of aerial will usually give far better results than a frame, and the latter should only, as a rule, be used when it is distinctly intended to utilise its directional properties, though some type of "super" circuits will only work on a frame.—J. F. J.

Earthing the L.T.

Q.—In a direct-coupled circuit is it better to connect the positive or the negative of the L.T. battery to earth?—W. C. F. (York).

A.—If the first valve is a detector and the grid leak is connected across the grid condenser the L.T. positive should be connected to earth so as to apply the positive bias which will cause the small grid current necessary for rectification to flow to the detector grid. If the first valve is an H.F. amplifier the L.T. negative should be earthed for good amplification. In the latter case a positive bias will certainly reduce the tendency to self-oscillation but will also have less desirable effects due to damping.—J. F. J.

Carborundum Detectors

Q.—I have heard a lot lately with regard to the merits of carborundum as a detector. Is it really more sensitive than the prepared galena type?—M. D. (Swansea).

A.—The great advantage of carborundum is that best results are obtained when considerable pressure is applied at the contact point so that the setting is not easily disturbed by vibration. Although a good specimen of carborundum can give excellent results, the prepared galena type is more sensitive and does not require a battery and potentiometer.—J. F. J.

Directional Effect

Q.—Is it worth while trying to utilise the directional effect of an L aerial of P.M.G. size so as to obtain maximum results from a particular station?—J. C. M. (Lancs.).

A.—The directional effect of such an aerial is only marked when the length of the flat top is very great compared with its height above earth. If you are fortunate enough to be able to erect aerials of equal efficiency in whichever direction you wish, point the free end directly away from the station you desire to receive. However, the directional effect of a broadcast aerial is so slight, and the usual listener is usually so restricted with regard to positions for his aerial that, in general, it is best to erect the best possible aerial in the circumstances, irrespective of its direction.—J. F. J.

Manufacturing Sets

Q.—Is there any reason why I cannot manufacture wireless sets and sell them to friends?—A. N. (Halifax).

A.—There is no reason why you should not manufacture wireless components and receivers, although, of course, the question of patents requires consideration.—U.



THE new 10-kilowatt broadcasting station is to be opened in Munich in June next, when the wireless exhibition will take place.

The Portuguese Bureau of Posts and Telegraphs has requested the Government to withdraw the concessions which have been temporarily granted to foreign broadcasting companies, and to inaugurate a national service worked by the home industries.

It is proposed to erect in Jugo-Slavia wireless telegraphy and telephony stations for the broadcasting of concerts at Agram, Laibach, Neusatz, Spalato, Uskub and Podgoritza.

The theory that signals on a wavelength of 20 metres cannot travel at night time is contradicted by a Glasgow amateur, who reports picking up 1 X A M, working on 21 metres, at 11.30 p.m. recently—an hour when it would be dark right across the Atlantic. It is also stated that transmission on or about this wave cannot be heard at a less distance than 300 or 400 miles from the source.

The growing popularity of short-wave work is emphasised by complaints of much jamming between 20 and 40 metres. It promises to be as bad on this band as formerly was the case on 200 metres, and later on 100 metres.

An "Old Times" or "Veterans" programme, consisting entirely of music-hall items of days gone by, will be given on May 6.

The Derby will be broadcast by the B.B.C. if the necessary permission can be obtained. By means of microphones at the winning post, in one of the enclosures and at Tattenham Corner, the excitement of the race will be transmitted to stay-at-home enthusiasts. Even the thud of the horses' hoofs will be heard.

The Minister of Railways at Prague is proposing to attach to express trains on certain Czecho-Slovak lines cars specially equipped for cinema and wireless entertainments.

A popular programme will be broadcast on May 7, the vocalists being Miss Elsie Hulme (contralto), Mr. Sydney Coltham (tenor), Jack Hellier (actor-entertainer), and a new wireless personality, "The Radio O'Rymer," whose quips and cranks in verse will be quite a novelty. In addition the wireless orchestra will contribute items. The last half-hour from 10.30 p.m. till 11 p.m. will be filled by excerpts from

three of the musical comedies at present running so successfully in town, *No, No, Nanette*, *Katja the Dancer*, and *Rose Marie*.

That the advent of the Nottingham relay station had adversely affected the study of music was a striking statement made recently at the annual invitation concert of the Nottingham centre of the London College of Music.

A renewed effort is to be made to convey the thunder of Niagara Falls to British listeners.

Negotiations are proceeding to enable the British Broadcasting Company to establish a second station in London, and to arrange programmes for various tastes.

A dance evening will be given on May 2, and from 8 p.m. to 9 p.m. the Selma Four will play in the 2 L O studio. From 9 p.m. till 11 p.m. speeches will be relayed from the R.A. dinner, and the weather forecast and news will follow. From 11.15 p.m. till 12 the Savoy bands will be relayed as in the ordinary way.

The Postmaster-General states that the high-power wireless station in course of erection at Rugby is expected to be completed by November next. Beam stations for communication with Canada and South Africa are due to be completed early in October, and beam stations for communication with India and Australia should be completed within nine months of the approval of sites which had been submitted.

The organ recital from the Armitage Hall on the afternoon of May 3 is by Mr. H. G. Newell, one of the first blind organists to broadcast. He is giving a varied programme, which will include an arrangement of the largo from the Dvorak *New World* symphony.

The Prague Municipal Council has issued an order prohibiting the erection of private aerials.

On Thursday, April 9, Mrs. Haldane, the mother of Viscount Haldane, celebrated her hundredth birthday, and at her home at Cloan, Auchterarder, Perthshire, she received by wireless a special message of congratulation from the British Broadcasting Company.

The band of H.M. Scots Guards, under Lieut. F. W. Wood, will provide the main portion of the programme on May 4. Songs by Miss Dorothy Bennett and Mr. A. Bell-Walker and Earle Spicer will also be broadcast.

In connection with a scheme to provide receiving sets in childrens' hospitals in the city, Glasgow Radio Circle held a bazaar with the object of raising some £20 or £30. So great was the public interest that the hall in which the function took place was found to be far too small, and it is estimated that some fifteen hundred people had to be turned away. The promoters believe that at least £300 will reward their efforts.

Mr. Dan Godfrey will conduct the S.B. Symphony concert on May 5. Lovers of Bach will be delighted to know that the Brandenburg Concerto No. 2 will open the programme.

A new broadcasting station is to be erected at Weimar (Germany), and owing to the increased number of listeners in the Hanover district a 5-kilowatt transmitter will be installed in that city.

In view of the interference caused in the reception of Chelmsford (5 XX) in Paris, the Eiffel Tower authorities are now making test transmissions on 1,980 metres, and it is proposed to abandon the use of the 1,500-metre wavelength.

The Berlin Vox Haus broadcasting station have now made all arrangements to broadcast every Sunday afternoon classical dramatic performances in which all the parts are taken by children.

Listeners should not express undue surprise if, when picking up a transmission in the neighbourhood of 3,200 metres, they hear the following announcement, "Hallo! Hallo! Eto Goworyt moskowskaja zentralnaja radio telephonia stantsia imeni Kominterna." This is simply the call from the Moscow central station.

The chamber music for April 30 is provided by the Philharmonic Trio (Albert Fransella (flute), Leon Goossens (oboe) and Francesco Ticciati (pianoforte), assisted by Miss Sidonie Goossens, the popular harpist at 2 L O, and Miss Elsie Suddaby (soprano). The instrumentalists are providing a very interesting and unusual type of programme, which includes old and modern French and English items.

Many Constantinople cinemas are now fitted with loud-speakers in order to allow the audiences to hear concerts broadcast from Prague, Rome and Moscow.

The programme for May 1 consists almost entirely of novelties. Among the artistes are Pete Mandell (the principal banjoist to the Savoy bands, Nitza Codolban (cymbalist), A. J. Coles, and the London Trombone Quartet.

The Barcelona theatre managers have issued a joint circular to their subscribers requesting them to withdraw their support from "Radio-Barcelona," the local broadcasting station, in order to protest against the installation of microphones in places of amusement.

The first wireless station in Persia was opened at Teheran on March 26 last.



Mexican Transmissions

SIR,—In reply to a report of reception I sent Mexican 1 N, he tells me he is only using 20 watts input and that my report is the first he has received from Europe. I received him on detector and L.F.

He wishes British amateurs to know he is working between 00.00 and 02.00 G.M.T., and is very glad to receive any reports.

His system is C.W. (A.C.) and his wave-length about 90 metres. All reports should be sent to: Manuel Medina, Box 2295, Mexico City, Mexico.—T. A. S. (Harrow).

"Eddy-current Control"

SIR,—With reference to the special one-valve circuit stowed away in an odd corner of your recent article on "Eddy-current Control," why such an astounding circuit has not been made a special feature I cannot understand. (No. 147.)

I made the hook-up from odd junk and tried it out last night. The results were simply wonderful. I tuned in twenty-three stations on the 35 Igranic coil. Every station came in as clear as could be desired, every word in each case being perfect.

Distance seems to be no obstacle, as you may guess, to be able to tune in such a string of stations clearly.

This circuit is selective and almost fool-proof.—F. C. L. (Rayleigh).

"An Experiment by Train"

SIR,—I made here some months ago a trial, similar to that reported in No. 148, of telephonic reception on a train in motion.

The instrument was a Marconiphone two-valve set, the aerial 60 ft. of electron fixed round the outside edge of the roof of the carriage and the earth the iron work of the carriage. The trip was made over a run of about 100 miles, on a slow goods train, and the results were similar to those reported by your contributor, all usual stations, Madrid, Bournemouth, Rome, etc., being received at ordinary strength on two sets of phones. There were, however, certain differences in the results. Passing through or over iron bridges produced fading, and reception was weaker in tunnels and cuttings, possibly due to increase in capacity, as noted by your contributor. The principal interruptions, however, were due to more or less perfect contact with rails and of couplings and buffers. When the carriage was coupled directly to the locomotive, the tuning was completely altered. I may add that the railway is 200 miles from Madrid and 1,000 miles from the B.B.C. stations.—G. L. B. (Aguilas).

Pliotron Valves

SIR,—You recently published a report of the test of the Pliotron SS4 dull-emitter .06 valve.

I should like to report that I have been using a valve of this type for a few weeks, and have received the following stations: Hamburg, Breslau, Barcelona, Madrid, practically all B.B.C. stations, WGY, WGZ, WJZ, Paris and Brussels. The circuit used was a one-valve reflex.

My aerial is 24 ft. high and usual regulation length; water-tap earth.

I consider these to be excellent results, especially as the continental stations were heard during broad daylight.—S. F. R. (St. Albans).

Other Correspondence Summarised

A. D. K. L. (Tonbridge) has received 2 L O on a crystal set without amplification.

N. H. (Lancashire) wishes to make known the generous treatment which he has received from Messrs. A. C. Cossor, Ltd. They changed two faulty valves without asking any questions.

A. G. G. (Peckham Rye) wishes to make known the generous treatment which he has received from Messrs. Lissen, Ltd. Having damaged one of their H.F. reactances, he sent it back for repairs, but the firm forwarded him a new one without any charge being made.

"HEARING IS BELIEVING"

April 28th

WE with other Wireless Manufacturers and Traders are providing a special CONCERT to be broadcasted on APRIL 28th.

To get it at its best and purest requires a

"COSMOS"
UNIVERSAL VALVE SET

Obtainable from all Dealers. Ask for a Demonstration.

—"Hearing is Believing"—

METRO-VICK SUPPLIES LTD.,
4, Central Buildings, Westminster, S.W.1.

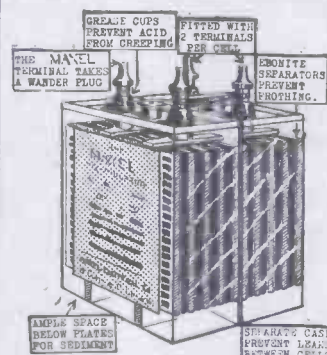

The New MAXEL Accumulator

Specially Designed for Wireless GUARANTEED TWELVE MONTHS
If you live too far away to call and see the Battery Mail your Order to us for the size you want. We will willingly return your money if you are disappointed.

	AMPS.			
	40	60	80	110
4 VOLT ..	15/-	18/6	22/-	25/6
6 VOLT ..	—	27/6	32/6	37/6

Special: 2v. 60a. for D.E. VALVES 9/-
Packing 1/- extra per battery.
N.B.—Repairs to any make of battery in 24 hours.

MAXEL ELECTRICAL CO., 28, Clipstone Street, Great Portland Street, W.1.
Telephone MUSEUM 7084

Prov. Patent No. 11016/24.

EVERYBODY NEEDS The RADIO BEAD

Every Radio enthusiast is troubled by the twisting and kinking of the flex leads of his headphones, loudspeaker, or batteries and the consequent damage resulting in inferior reception. But now there is a remedy.

THE RADIO BEAD

Is a simple accessory which clamps on to your flex leads (no disconnecting necessary) and enables you to instantly remove kinks and prevent their recurrence. Light in weight and small in cost, it prevents that frequent and often unknown cause of loss of signal strength which is so difficult to trace. Approved by leading radio experts.

SATISFACTION GUARANTEED.
Essential to you. Have enquiries invited. Got one now.

WIN PATENTS.
Lidgeway House, HAMMERSMITH, LONDON, W.6
Obtainable from all Dealers. Tel.: Rive-side 3463.

1/- EACH

CHIEF EVENTS OF THE WEEK

		SUNDAY, April 26	
London	4.0	Springtime Programme.	
London	9.0	De Groot and the Piccadilly Orchestra.	
Glasgow	4.0	Popular Orchestral Programme.	
		MONDAY	
London	8.0	"London."	
Newcastle	8.0	"Ships."	
Belfast	7.30	Opera—Poetry—Drama.	
		TUESDAY	
London	8.0	Concert by the N.A.R.M.	
5 X X	8.0	Carmin (Bizet).	
		WEDNESDAY	
London	8.0	"From the Land of the Midnight Sun."	
London	10.40	John Goss and Hubert Foss with the Cathedral Male Voice Quartet.	
Newcastle	9.0	Opera and Drama.	
Glasgow	8.0	Beethoven Symphonies.	
		THURSDAY	
London	8.0	Chamber Music Evening.	
London	9.45	A "Speciality" Interlude.	
Bournemouth	8.0	"With Hounds."	
Manchester	8.0	The "Minnehaha" Amateur Minstrels.	
Aberdeen	8.0	Operatic Night.	
Belfast	7.30	The Whirligig of Time.	
Nottingham	8.0	Inaugural Community Singing Concert.	
		FRIDAY	
London	8.0	Novelty Night.	
Bournemouth	8.0	May Day Revel.	
Cardiff	8.0	Gems from Opera.	
Manchester	8.0	The "Crystal Set" Concert Party.	
Glasgow	8.0	"May Day."	
Edinburgh	8.0	Birthday Programme.	

RECORDING BROADCAST

SELECTED items from radiated programmes can now be permanently recorded by means of an apparatus which operates on much the same lines as the well-known magnetic detector used by Marconi in the early days of wireless. The scientific principle involved is, perhaps, best illustrated by the text-book experiment of writing one's name with a magnet on a steel surface, such as the blade of a saw. If iron filings are then sprinkled on the blade they will adhere to the tracing, proving that the steel has been definitely magnetised at these points and at no other.

The inventor of the Poulsen arc was the first to apply this magnetic phenomenon to the storing or recording of human speech. In the Poulsen "telegraphone" speech currents are led round a permanent magnet, but the resultant variations in flux, instead of being used to vibrate a diaphragm as in the ordinary telephone receiver, are directed on to a thin wire, which is made to move past the magnet poles at a steady rate.

A magnetic record or "image" of the speech frequencies is in this way impressed upon the wire, which is then wound up on a bobbin and stored away. The speech can be reproduced when required by re-passing the wire across the poles of a second electromagnet, the variable currents thus induced being utilised to vibrate the diaphragm of a telephone or loud-speaker. M. A. L.

Ask "A.W." for List of Practical Money-making Books

JUNIOR with Loud Speakers SENIOR performance



On this page are illustrated two of the most popular models of AMPLIONS, the "New" Junior Type AR. 111, at £2 10 0, and the "New" Junior-de-Luxe Type AR. 114, at £3 5 0.

THEY incorporate all the patented — and therefore *exclusive* — features embodied in the design and construction of the AMPLION Standard "Dragon" model, and by experience and tests against much larger and more expensive models of other makes, they have been proved supreme in every respect.

Handy in size, highly finished in appearance, and superlative in performance, they uphold to the full the world-wide reputation of the

The World's Standard

AMPLION

Wireless Loud Speaker

For Better Radio Reproduction



Obtainable from AMPLION Stockists and Wireless Dealers everywhere.

Patentees and Manufacturers:
ALFRED GRAHAM & CO. (E. A. GRAHAM),
St. Andrew's Works, Crofton Park,
LONDON, S.E.4.

Demonstrations gladly given during broadcasting hours at the AMPLION Showrooms:—
25-26, SAVILE ROW, W.1,
and 79-82, High Street, Clapham, S.W.4.

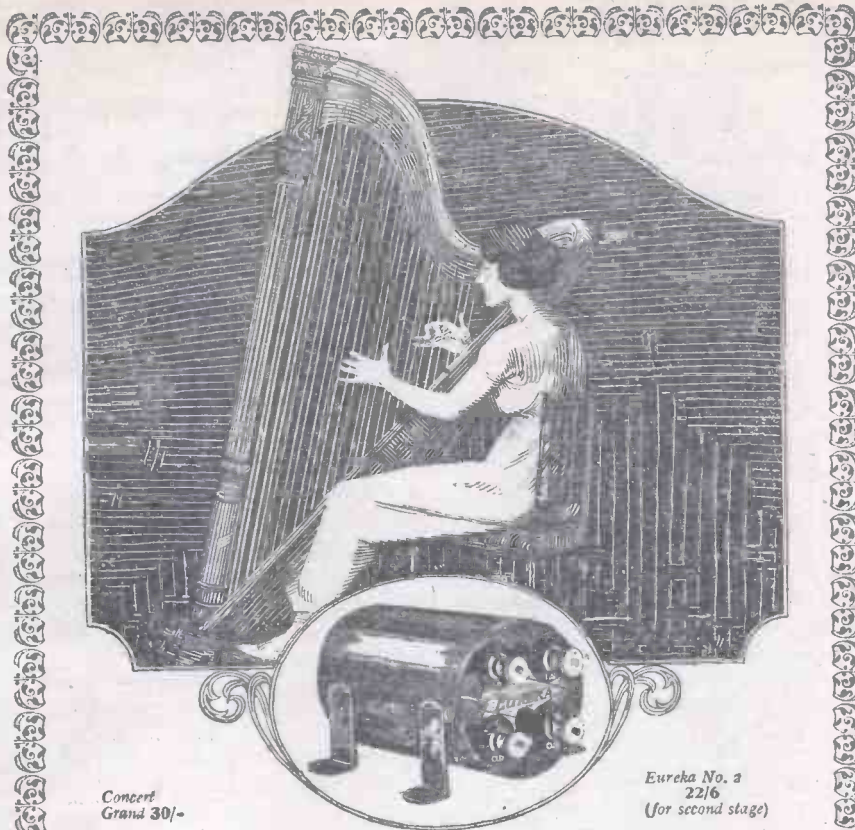

Concert
Grand 30/-

Eureka No. 2
22/6
(for second stage)

The new idea in Set-building

A REMARKABLE change has occurred in Wireless. A year or so ago those who bought expensive components were considered foolish and extravagant—to-day every Dealer will tell you that cheap parts are a drug on the market. "A Transformer is only one small component in a Receiving Set," the average man used to say to himself. "If I can save ten shillings here no one can possibly tell the difference."

But now thousands of Wireless enthusiasts who previously bought on price are wishing they had bought on quality.

Back of every Eureka Transformer is the experience only acquired by the most laborious and costly methods—there are no short cuts. Eureka was the first Transformer to be made with very large primary and secondary windings. Eureka was the first Transformer to be sold in a steel case to avoid interaction. Eureka was the first Transformer to be hermetically sealed to prevent possible breakdown through dampness.

Eureka set a new standard for quality of performance, and naturally most of the features that Eureka originated have been imitated. We don't mind that—no imitation has ever been found as good as the genuine article.

EUREKA

BRITAIN'S FINEST TRANSFORMER

Manufactured only by

Portable Utilities Co. Ltd., Fisher Street, London, W.C.1

Gilbert Ad. 27/6



NOTE.—In the following list of transmissions these abbreviations are observed: *con.* for concert; *lec.* for lecture; *orch.* for orchestral concert; *irr.* for irregular; *m.* for metres; and *sig.* for signal.

GREAT BRITAIN

The times given are according to Greenwich Mean Time.

London (2LO), 365 m. 1-2 p.m., con. (not daily); 4-5 p.m., con.; 6.0-6.35 p.m., children; 6.40 p.m., light music; 7-7.30 p.m., time sig., news, talk; 8.0-10 p.m., music; 10.0-10.30 p.m., time sig., news, talk; 10.30-11.0 p.m., music. Tues. and Thurs. the Savoy Bands are relayed until 11.0 p.m., and on Sat. until midnight.

Abdeen (2BD), 495 m. Belfast (2BE), 435 m. Birmingham (5IT), 475 m. Bournemouth (6BM), 385 m. Cardiff (5WA), 351 m. Glasgow (5SC), 420 m. Manchester (2ZY), 375 m. Newcastle (5NO), 400 m. Much the same as London times.

Bradford (2LS), 310 m. Dundee (2DE), 331 m. Edinburgh (2EH), 328 m. Hull (6KH), 335 m. Leeds (2LS), 346 m. Liverpool (6LV), 315 m. Nottingham (5NG), 326 m. Plymouth (5PY), 335 m. Sheffield (6FL), 301 m. Stoke-on-Trent (6ST), 306 m. Swansea (5SX), 481 m.

Chelmsford (high-power station), 1,600 m.

Experimental transmission every Monday at 10.30 p.m. from one or other main or relay station.

CONTINENT

The times are according to the Continental system; for example, 16.30 is 4.30 p.m., and 08.00 is 8 a.m. (B.S.T.).

AUSTRIA.

Vienna (Radio Wien), 530 m. (1 kw.). 09.00, markets (exc. Sun.); 11.00, con. (Tues., Thurs., Sat., Sun.); 13.05, time sig., weather; 15.30, Stock Ex. (exc. Sun.), news, con.; 17.10, children, women (Wed.); 18.10, children (Mon.), lec. (Thurs.), con. (Sun.); 19.00, lec. (Fri.); 19.30, news, weather, time sig., con., lec., news; 19.45, Engl. (Mon., Wed., Fri.); 22.00, dance (Wed., Sat.).

Graz (Radio-Hekaphon), 404 m. (500 w.). 13.30, 18.30, con. and tests.

BELGIUM.

Brussels, 265 m. (1½ kw.). 17.00, orch., children (Wed. and Thurs.); dance (Tues. and Sat.); 18.00, news; 20.00, lec., con., news (opera, Mon. and Wed.).

Haeren (BAV) (250 w.), 1,100 m. (250 w.). 13.00, 14.00, 16.50, 18.50, weather.

CZECHO-SLOVAKIA.

Prague (Strasnice), 570 m. (1 kw.). 10.00, Stock Ex. (weekdays); 11.00, con. (Sun.); 11.30, Stock Ex. (weekdays); 17.00, Stock Ex., con. (Wed., Sat.); 18.00, Stock Ex. (weekdays); 19.15, con. or lec., weather, news, children (Sat.); 20.00, con., dance.

Brünn (OKB), 1,800 m. (1 kw.). 10.00, con. (Sun.); 14.00, Stock Ex., news; 19.00, lec. or con. or dance.

DENMARK.

Copenhagen (Kjobenhavns Radiofoni station), 775 m. (1 kw.). 19.35, notices, lec., con.* (Tues., Thurs., Sat.); 21.30, Esperanto (Wed.).

* This con. is also relayed by the Aalborghus ship station on 445 m. Sun.: Copenhagen only.

Lyngby (OXE), 2,400 m. (2½ kw.). Week-days: 19.20, news, Stock Ex.; 21.00 and 22.00, news, weather, time sig. Sundays: 16.00 and 21.00, news.

Ryvang, 1,190 m. (1 kw.). 20.00, con., news (almost daily).

FRANCE.

Eiffel Tower, 2,650 m. (6 kw.). 06.40, weather (exc. Sun.); 11.00, markets (exc. Sun. and Mon.); 11.15, time sig., weather; 14.45, 15.35, 16.30, Stock Ex. (exc. Sun. and Mon.); 18.15, con.; 19.00 and 22.10, weather; 20.30, con. (on 2,200 m.), Wed., Sun. (temp.).

Radio-Paris (CFR), 1,750 m. (about 5 kw.). Sundays: 12.45, con., news; 16.30, Stock Ex.; 20.15, news, Esperanto, con. or dance. Week-days: 12.30, con., markets, weather, news; 20.15, news, con. or dance.

Le Matin, Paris, provides a special con. every 2nd and 4th Sat. in the month at 21.00. CFR frequently relays 5XX after 22.00.

L'Ecole Sup. des Postes et Télégraphes (PTT), Paris, 458 m. (800 w.). 14.00, lec. relayed from Sorbonne University (Thurs.); 15.00, outside relay (Sat., irr.); 15.45 and 17.00, lec. relayed from Sorbonne (Wed.); 16.00, outside relay (irr.); 20.00, Engl. talk (Tues.), children (Thurs.); 20.30, lec. or con., almost daily.

Le Petit Parisien, 345 m. (500 w.). 21.30, con. (Sun., Tues., Thurs.), dance (Sat.).

Lyon (Radio Sud-Est), 340 m. 21.00, con. (Tues. and Fri.).

Radio-Lyon, 387 m. (temp.). 12.30, news, con., etc.; 20.30, news; 21.00, con. (exc. Tues. and Fri.); 22.00, dance (Tues. and Fri.).

GERMANY.

Berlin (Vox Haus), 505 m. (1½ kw.). 09.00, sacred con. (Sun.); 10.00, markets, news, weather; 11.00, con. and tests; 12.00, educ. hour (Sun.); 12.15, Stock Ex.; 12.55, time sig., news, weather; 14.15, Stock Ex.; 15.00, educ. hour (Sun.), markets, time sig.; 15.30, children (Sun., Wed.); 15.35, Esperanto (Sat.); 16.30, orch.; 18.20, educ. lec., women; 19.00, French (Mon.), lec.; 20.00, theatre news (Tues.); 20.30, con., weather, news, time sig.; 22.30, chess (Mon), French (Tues.), dance (Thurs., Sat.).

* If operatic transmission, at 19.15. Will be increased to 81.10 kw.

Königswusterhausen (LP), 2,450 m. (5 kw.). Wolff's Buro Press Service; 07.30-21.00. 1,500 m. (6 kw.): 11.30, con., Esperanto (Sun.). 3,150 m.: Telegraphen Union: 07.45-19.45, news. 4,000 m. (10 kw.): 07.00-21.00, news.

Berlin (Witzleben), about 500 m. (10 kw.). Testing shortly.

Eberswalde (Lorenz Co.), 280 m. Testing, daily about 22.30.

Bremen, 330 m. (1 kw.). Relay from Hamburg. 13.45, own con. (Sun.), 16.30 (daily).

Breslau, 418 m. (1½ kw.). 11.15, Stock Ex., weather; 12.00, con. (daily); 12.55, time sig. (Sun.), weather, Stock Ex.; 12.35, time sig. (weekdays), news, weather; 15.00, news; 16.00, children (Sun.); 17.00, con.; 19.00, lec.; 19.30, lec. (Sun.), Engl. (Mon.), shorthand (Wed.), Italian (Thurs.); 20.30, con., weather, time sig., news; 22.00, dance (Mon.), cabaret (Tues.).

Cassel, 288 m. (1½ kw.). Relay from Frankfurt.

Dresden, 280 m. (1½ kw.). Relay from Leipzig.

Frankfort-on-Main, 470 m. (1½ kw.). 08.30, sacred con. (Sun.); 10.45, Stock Ex.; 11.55, time sig., news; 12.55, Nauen time sig.; 15.00, Stock Ex., markets; 16.00, children (Sun.), markets, news; 16.30, con., children (Wed.); 17.00, con. lec. (Sun.); 18.00, markets, lec.; 18.30, shorthand (Thurs.), 19.00, Esperanto

(Continued on next page.)

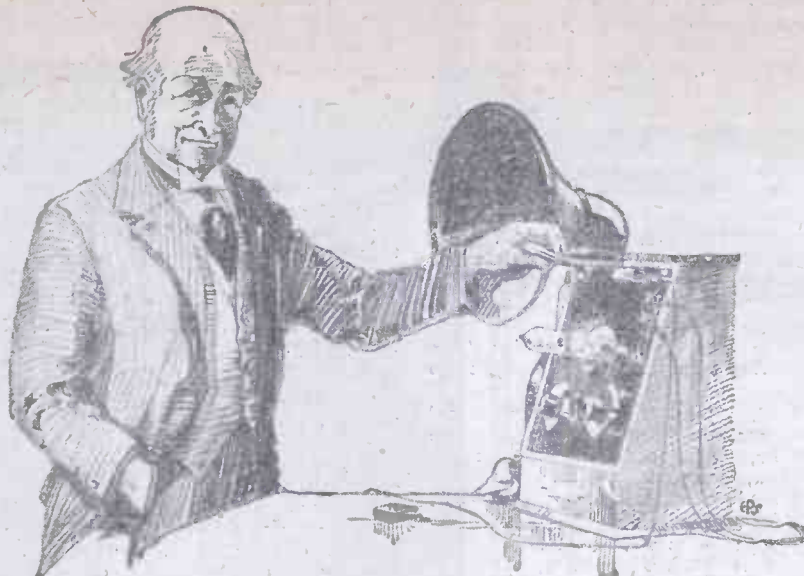

A coil you can handle

It may sound strange to lay stress on this especial quality of Fellows Coils, seeing that a coil, of all things, must necessarily be handled at frequent intervals.

But coils are fragile things, and their delicate windings must be protected carefully if they are to render you constant and efficient service.

For this reason we enclose the windings of Fellows Coils in a strong crystalate case. This means that if by accident you drop the coil no harm will be done.

Another advantage is the fact that when plugging the coil in to your set, or taking it out, you can catch hold of any part of the coil without risk of breaking the connection between the windings and the non-reversible pin contacts.

In fact, the Fellows Coil is a thoroughly strong, workmanlike and well-finished job, made to be used and capable of withstanding more hard knocks than it is ever likely to receive, which, after all, is no disadvantage, as the extra strength does not involve extra cost. On examination you will find the Fellows Coil rather cheaper than the average coil and therefore much more worth the money you pay for it.

Ask your local dealer for Fellows Coils.

Muel Fellows

Yeates Ltd., 20, Store Street, Tottenham Court Road, London, W.C. Well-equipped Sales and Demonstration Offices for Fellows Wireless Products.



"Fellows Coils." Standard Non-reversible Pin Contacts

Prices: 4/3 to 10/-.

FELLOWS WIRELESS

Advt. of the Fellows Magneto Co., Ltd., Park Royal, London, N.W.10.

E.P.S. 142

'BROADCAST TELEPHONY' (cont. from page 689) (Fri.); 20.00, lec., con., news, weather, Engl. (Mon.); 22.00, con. or dance (almost daily).

Hamburg, 395 m. (1 kw.). Sundays: 08.55, time sig., weather, news, lec., women; 11.15, sacred con.; 12.15, chess; 13.15, lec.; 14.30, chess; 17.00, children, con.; 19.15, Engl., sport, weather; 20.00, con. or opera, news (in English), dance. Weekdays: 07.25, time sig., news, weather, markets; 08.30, theatre news; 12.15, markets; 12.55, Nauen time sig., shipping news; 14.45, markets, police news; 16.10, women; 18.00, children (Mon., Tues.); 19.00, lec.; 19.30, English (Tues., Fri.), Spanish (Thurs.); 20.00, con. or opera; 22.00, markets, news (in English), dance.

Hanover, 296 m. (1 1/2 kw.). Relay from Hamburg. Also own con., 13.45 (Sun.), 16.30 (weekdays).

Königsberg, 463 m. (1 kw.). 09.00, sacred con. (Sun.), markets (Wed., Sat.); 12.55, time sig., weather, news; 16.00, markets; 16.30, con. (children, Mon.); 19.30, lec., Esperanto (Wed. and Sat.); 20.00, con. or opera, weather, news, dance (irr.).

Leipzig, 454 m. (700 w.). 08.30, sacred con. (Sun.); 10.00, markets, news; 11.00, educ. hour (Sun.); 12.00, con. (daily); 12.55, Nauen time sig., Stock Ex., news; 16.00, con. (Sun.), markets; 16.30, con. (weekdays), children (Wed.); 17.30, lec.; 18.00, markets, Stock Ex., lec.; 18.30, wireless talk (Sat.); 19.00, Engl.; 20.15, con. or opera, weather, news; 22.00, con., cabaret or dance (not daily).

A.W., 1/4/25. Will be increased to 6 kw.

Münich, 485 m. (1 kw.). 11.30, lec., con. (Sun.); 12.55, Nauen time sig., news, weather; 15.30, markets; 16.00, orch. (Sun.), children (Wed.); 16.30, con. (weekdays); 17.00, lec. (Sun.); 18.00, con. (Sun.); 18.30, lec., chess (Tues.), Engl. (Fri.); 19.15, Italian (Tues.); 20.30, con., news, weather, time sig.; 22.15, late con. (irr.).

Munster, 410 m. (2 1/2 kw.). 12.00, con.,

news (Sun.); 12.30, news (weekdays); 12.55, Nauen time sig.; 15.30, news, time sig.; 16.00, con., children (Mon.); 19.00, Italian (Tues., Sat.), Esperanto (Wed.); 19.40, news; weather, time sig., lec.; 20.25, women (Mon.); 20.30, con.; 22.00, Engl. (Tues., Fri.).

Nuremberg, 340 m. (800 w.). Relay from Munich.

Stuttgart, 443 m. (1 1/2 kw.). 11.30, con. (Sun.); 17.00, con. (Sun.), children (Wed., Sat.); 18.30, time sig., news; 19.00, lec.; 19.30, Esperanto (Thurs.); 20.00, con. (daily); 21.15, time sig., late con. or cabaret.

FINLAND.

Helsingfors (Helsinki), 380 m. Testing 18.00, daily.

HOLLAND.

Amsterdam (PCFF), 2,125 m. (1 kw.). Daily: 08.35-16.50 (exc. Mon. and Sat., when 10.50-11.50), news, Stock Ex. (PX9), 1,070 m. (400 w.), 21.20, con. (Mon.). (PA5), 1,050 m., 20.20, con. (Wed.).

Hilversum (HDO), 1,060 m. (2 1/2 kw.). 12.20, news; 14.50, con. (Sat. and Sun.); 18.20, children (Mon.); 20.20, con. or lec. (Wed., Fri.), relay of Mandelberg con., Amsterdam (Thurs.), opera or con. (Sat.).

Vossegat (Bé), 1,050 m. 12.50 and 20.20, weather.

Soesterberg (STB), 1,050 m. 20.06, weather.

Bloemendaal, 345 m. 10.20 and 17.20, divine service (Sun.).

HUNGARY.

Buda-Pesth, 950 m. (2 kw.). 07.45, news, tests at irr. times.

ITALY.

Rome (IRO), 425 m. (2 1/2 kw.). 10.45, sacred service (Sun.); 13.00, news (irr.); 16.45, children, Stock Ex., orch. relayed from Hotel di Russia, news; 20.45, con., news, dance; 21.15, Esperanto (Mon.).

Milan (about 650 m.). Testing shortly.

Radio Club Italiano (IRC), Milan. 320 m. 21.00, con. (irr.).

JUGO-SLAVIA.

Belgrade, 1,650 m. (2 kw.). 18.30, con., news, weather (Tues., Thurs., Sat.), weather, news only (Mon., Wed., Fri.).

NORWAY.

Oslo, 380 m. (500 w.). Testing, daily, about 20.30.

POLAND.

Warsaw (Radiopoi), 385 m. (1/2 kw.). 18.00, tests.

RUSSIA.

Moscow (Central Wireless Station), 1,450 m. Sundays: 13.45, lec.; 16.30, news and con. Weekdays: 14.00, markets; 16.30, news or con.

(Sokolniki Station), 1,010 m. Sundays: 15.30, con.; 18.00, lec. and con. (Tues., Thurs., Fri.).

(Trades Union Council Station), 450 m. 18.00, con. (Mon., Wed.).

Reval, 350 m. Testing.

SPAIN.

Madrid (R1), 392 m. (3 kw.). Sundays: 19.00, time sig., con., lec. Weekdays: 13.30, news, lec.; 19.00, *La Libertad* con. (Tues., Thurs., Sat.); 23.00-01.00, Radio-Madrid con., time sig., lec. (Mon., Wed., Fri.).

Barcelona (EAJ1), 325 m. (600 w.). 18.30, lec., markets, Stock Ex., con.

Bilbao (Radio Vizcaya), 415 m. 19.00, con., news.

Seville (EAJ5), 350 m. (1 kw.). 19.30, con., news, weather.

SWEDEN.

Stockholm (SASA), 427 m. (500 w.). Sundays: 10.55, sacred service; 17.00, children; 18.00, sacred service; 20.00, con.; 21.00, news, con., weather. Weekdays: 12.30, weather, Stock Ex., time sig. (12.55); 20.00, lec. (irr.), then same as Sun.; 22.00, dance (Wed., Sat.).

(Continued on page 692)



Chosen by experts and used in the 8-valve Supersonic Receiver described in this issue.

Chosen because of the 80-1 gear which makes precision tuning a matter of ease. Be guided by the expert's experience and fit "Accuratune" to your receiver now.

—for
infinitely close tuning

Learn what a revelation in fine tuning the "Accuratune" is. You can change from ordinary dials to this micrometer control in an instant—no set alterations necessary. Get one to-day.

Dominating Accuratune Features.

1. No Back Lash. A new principle takes up all back lash and produces a very smooth-operating instrument.
2. Long centre bushing eliminates all dial wobble and takes all strain.
3. Gear Mesh and alignment perfected to the same degree of accuracy as the mechanism of a watch. Ratio 80 to 1.

dard condenser shafts. Permits dial mounting flush with panel.

From your dealer **17/6** or send direct.

WRITE FOR A DESCRIPTIVE FOLDER.

MYDAR RADIO COMPANY,

European Manager:

GASTON E. MARBAIX, 169, High Street, Shoreditch, and 27-29, Anning Street, London, E.C.2.

ACCURATUNE
MICROMETER CONTROLS



BUY "F.A.R." THE BEST

The "FAR" L.F. TRANSFORMER

(SHROUDED) Ratio 5-1. **15/-**

Ratio 1-1 ...	13s. 3d. each
Ratio 3-1 ...	14s. 3d. each
Ratio 10-1 ...	16s. each

Acknowledged to be the finest on the Market.

Sole Agent: **M. BOBIN,** 21, Warwick Lane, London, E.C.4.

OF ALL DEALERS. Telephone: CENTRAL 4872.



The **BRETWOOD GRID LEAK** with the N.P.L. Report Patent No. 224,295/23. PRICE **3/-**

Another Guaranteed BRETWOOD Speciality is our Improved **ANODE RESISTANCE** which gives accurate readings consistently from 10,000 ohms to over 100,000 ohms. It is constructed on the same principles that have made BRETWOOD Components famous, and, of course, it carries the BRETWOOD Guarantee. Patent No. 224,295/23. Obtainable from all wireless dealers. Price 3/-; or by post, 3/3

BRETWOOD, Ltd., 12-18 London Mews, Maple St., London, W.



The Latest **Wattmel** Improvement

The new contact! By means of an ingenious bronze spring (shown in the enlarged illustration) any slackness between the bush and adjusting screw is automatically rectified and perfect electrical contact maintained at all times. Other features worthy of special mention are:—Continuously variable, silent in operation, dust and damp-proof and constant in any temperature.

VARIABLE GRID LEAK. Black Knob 5 to 5 megohms 2/6

VARIABLE ANODE RESISTANCE. Red Knob 50,000 to 100,000 ohms 3/6

Send P.C. for Descriptive Folder.

THE WATMEL WIRELESS CO., Ltd. 332a, Goswell Rd., London, E.O.1. Tel.: Clerkenwell 7900.

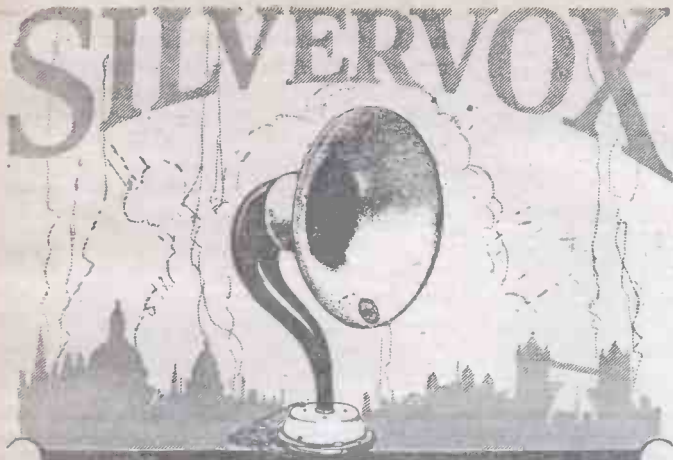

The Silvertown "Silvervox" Loud-Speaker will reproduce both speech and music without the loss of its original tone and quality. Coils wound to either 120 or 2,000 ohms. The tone arm is a heavy aluminium casting. Total height 20 inches. Size of trumpet $12\frac{1}{2}$ inches diameter.

PRICE £3 10 0 each.

Silvertown Window-Pane Insulators.
(Patent Applied for)

Made of best quality enamel-coated ebonite, these insulators take advantage of the excellent insulating properties of glass, and at the same time avoid losses by keeping the lead-in well away from walls. Rubber rings form a watertight joint against the pane. The cone keeps a portion of the insulator dry in wet weather. PRICE 4/- each. A special drill with instructions for making hole in glass supplied with each insulator.

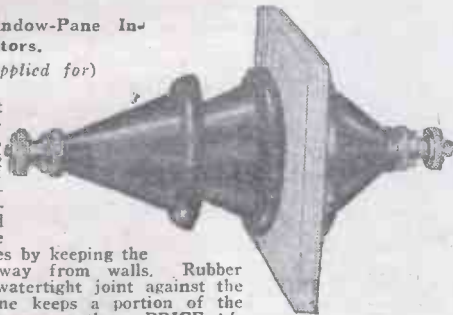

Silvertown Cone Lead-in Insulators.
(Patent Applied for)

Another effective form of insulation, using the cone insulators in conjunction with an ebonite tube passing through a window frame or wall.

Electrical efficiency assured.
PRICES from 4/6 each.

MAKERS:
THE SILVERTOWN COMPANY,
106, CANNON STREET, LONDON, E.C.4.

Works: SILVERTOWN, LONDON, E.16.

- | | |
|--|---------------------------------------|
| BELFAST: 75, Ann Street. | LIVERPOOL: 54, Castle St. |
| BIRMINGHAM: 15, Martineau Street. | LONDON: 100 and 102, Cannon Street. |
| BRISTOL: 4, Victoria Street. | MANCHESTER: 16, John Dalton Street. |
| CARDIFF: Pier Head Chambers, Bute Docks. | NEWCASTLE ON TYNE: 59, Westgate Road. |
| DUBLIN: 70, Middle Abbey St. | PORTSMOUTH: 49, High St. |
| GLASGOW: 15, Royal Exchange Square. | SHEFFIELD: 88-90, Queen St. |
| LEEDS: 1, New York Road. | |

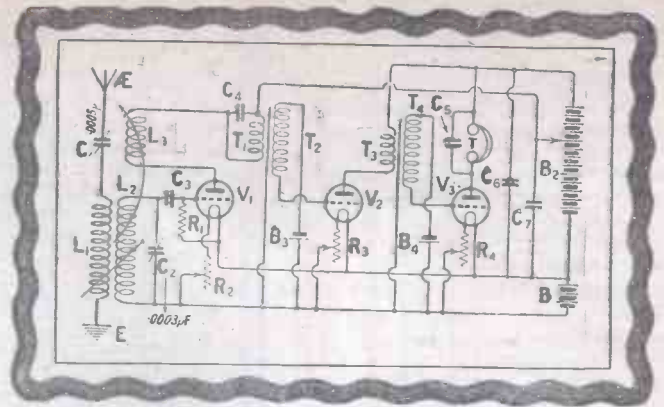

This circuit is simple if you make it with

GLAZITE

THE NEW COLOURED CONNECTING WIRE

With "Glazite"—the new coloured connecting wire—you can easily make complicated circuits like the above without any chance of short circuits, or any difficulty in connecting up.

"Glazite" is made in four colours, Red, Blue, Yellow and Black, so that you can see at a glance the different parts of your circuit.

"Glazite" Connecting Wire consists of a tinned copper wire covered with cotton and then with a film of heavy insulating material which is flame-proof and impervious to moisture. It has a high di-electric strength and is flexible. Send P.C. for "Glazite" leaflet and the name of nearest dealer with stock.

Price **1/6** per coil.
(Length 10 feet)



The LONDON ELECTRIC WIRE CO. AND SMITHS LTD.

(Makers of Electric Wire for over forty years)

Playhouse Yard, Golden Lane, London, E.C.1

Telegrams: Electric, London. Telephone: Clerkenwell 1388, 1389, 1390, 1391

"BROADCAST TELEPHONY" (cont. from page 690)
Gothenburg * (SASB), 290 m. (500 w.). 10.55, sacred con. (Sun.). From 12.30 onwards S.B. from Stockholm.
Malmö * (SASC), 270 m. (500 w.). As Gothenburg.
Sundsvall * (SASD), 545 m. (500 w.). As Gothenburg.
Boden * (SASE), 2,500 m. (500 w.). As Gothenburg.
Falun (SMZK), 370 m. (250 w.). 20.00, S.B. from Stockholm thrice weekly.
Joenkoepping (SMZD), 265 m. (250 w.). See Falun.

* Local programmes are also broadcast at times.

SWITZERLAND.

Lausanne (HB2), 850 m. (500 w.). 08.05, weather; 13.30, weather, markets, time sig.,

news; 17.00, children (Wed.); 18.55, weather, news; 21.15, con. (exc. Wed.), dance (Thurs. and Sat.).

Zurich (Högg), 515 m. (500 w.). 12.00, weather; 12.55, time sig., weather, news, Stock Ex.; 16.00, con. (exc. Sun.); 18.15, children (Mon., Wed., Thurs., Sat.); 19.00, weather, news (exc. Sun.); 20.15, lec., con., dance (Fri.); 21.45, news.

Geneva (HB1), 1,100 m. (temp.). New station shortly testing.

Basle (500 w.). New station under construction.

One of the questions which will have to be tackled soon is the possibility of the increased use of wireless for international propaganda.

Plastered Walls are frequently damaged by blows from the backs of chairs and other hard articles, and an article describing how these damages may be made good appears in the current issue of "The Amateur Mechanic and Work" (3d.). Other articles appearing in the same number are: "A Labour-saving Kitchen Cabinet," "A Water-colour Box for Artists," "Cleaning a Motor-car," "Boxing Separate Batteries for the H.T.," "A Simply-made Detector," "A Short Aerial," "Improving Crystals," "Safety Valves: Good and Bad," "How to Repair a Side-board," "Buying a Second-hand Camera," "Magneto Troubles of Motor-cycles," "Non-stop Spinning Tops."

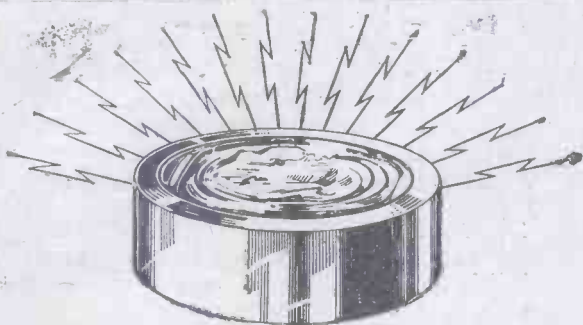

"TIP-TOP" CRYSTALS

Registered

are consistently used and recommended by the largest manufacturers—an appreciation that is warmly endorsed by such world experts as

DE FOREST, HARKNESS and PRIESS

Distance! Volume! Clearer Tone! That's what the "TIP-TOP" will give you. Every piece is firmly mounted in a circular cup, ensuring perfect contact. Just slip it in your detector and learn how good crystal reception can be.

2/-

Mounted in the circular cup ..
 Dealers write for generous trade terms.

At your Dealer—otherwise send 2/- direct and you will be supplied post free

Gaston E. Marbaix

27-29 Anning St., E.C.2, and 169 High St., Shoreditch

Phone: Bishopsgate 1294

"K" Variable Square Law Condensers

Help you to get that difficult Station

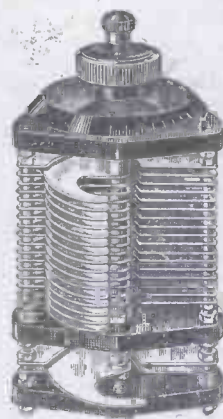

The Square Law Principle is designed to improve the selectivity of your set.

"K" Condensers are very sturdily constructed with vanes double the usual thickness—they eliminate the usual condenser troubles.

Very smooth movement—supplied with or without Vernier attachment.

Capacity	PRICES	
	Without Vernier	With Vernier
0.001	10/-	12/6
0.0005	8/3	11/6
0.0003	7/9	10/6
0.0002	7/3	
0.0001	6/6	

"Kingsway" Variable Condensers

The accurate assembly of these condensers coupled with the quality and finish of components are responsible for maximum efficiency.

The following prices are remarkably low in comparison, and exceptional value

0.00	8/-	0.00075	7/-	0.0005	6/-
0.0003	5/6	0.0002	4/6	0.0001	4/-

Send for our latest free catalogue. 3 plate Vernier 3/9
 Wates Products are sold by all discriminating Radio Dealers, who will willingly demonstrate. We can supply carriage paid, but your Dealer's name must be enclosed with order.

WATES BROS. LTD.

Head Office: 12-14, Gt. Queen St., London, W.C.2.

Phone: Gerrard 575-576.

Grams: Zywtacseng, Westcent.

Works: London, Birmingham and Westcliff.

20 CIRCUITS ON ONE PANEL!

WITHOUT A SINGLE SWITCH, AND NO KNOWLEDGE OF WIRELESS WANTED!

The "P.P." Experimental Panel is the amateur's "long felt want." By following simple instructions contained in 20 charts, anything from a simple crystal to a powerful loud speaker circuit can be hooked up or changed in a few minutes.

RADIO PLAN No. 5 explains everything in lucid text and comprehensive pictorial diagrams. Wireless is made easier than it has ever been made before.

**RADIO PLAN No. 5
 PRICE 2 SHILLINGS**

**PRESS EXCLUSIVES, 2, Wine Office Court,
 Fleet Street, London, E.C.4.**

**WE REPAIR BY OUR PATENT PROCESS
 ALL STANDARD TYPES of VALVES**

(Except Dull Emitters.)

Up to 3 valves send by letter post.

6/6
 Carr. Paid.

Remittance must be enclosed with valves.

GUARANTEE: Equal to new or better—Return in seven days—Satisfaction.

THE Eclat Electric Manufacturing Co., Limited.
 Spencer Works, Spencer Hill Road, Wimbledon, London, S.W.

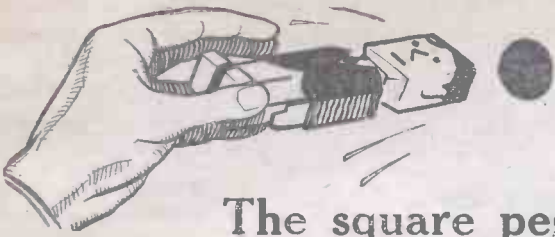

The square peg in the round hole

Everywhere you find them, these unhappy square pegs. Often indeed you must have been conscious of occupying their uneasy situation yourself. And oftener still their rank incompetence must have harassed and perplexed you.

In one thing at least in this life they need have no place. You can banish them for ever from your radio set (where commonly their name is legion) by using the CLIX Plug-socket and Adapter.

The plug of one CLIX smoothly slips into the socket of the next CLIX, or CLIX Adapter—and there is firmly held, with full surface contact. That's the CLIX secret. Simple? But it's withheld from every kind of switch plug or terminal but CLIX.

- Retail Prices:**
- CLIX with Locknut 3d.
 - CLIX Adapter with Locknut 2d.
 - CLIX Insulators (6 colours) 1d. each.
 - CLIX Bushes (6 colours) 1d. pair.



AUTOVEYORS LTD., 84 VICTORIA STREET, LONDON, S.W.1

LEAVE IT TO FLUXITE



An un-soldered wireless set is a breeding ground for those little devils of distortion and bad reception. They thrive on the delicate currents that pass through the circuit. Each un-soldered joint is a trap. One spot alone is sufficient to lower the receptive qualities of your set, so just think what is missed if all the joints are left unsoldered. FLUXITE chases away all soldering worries, and makes

possible the perfect soldered joint; making your circuit one whole solid piece of wiring instead of twenty or thirty odd patchy lengths. Make up your mind and solder your wiring now. It is so simple. Leave it to FLUXITE.

Ask your Ironmonger or Hardware Dealer to show you the neat little

FLUXITE SOLDERING SET

It is perfectly simple to use, and will last for years in constant use. It contains a special "small-space" Soldering Iron with non-heating metal handle, a Pocket Blow-lamp, FLUXITE, Solder, etc., and full instructions. Price 7/6. Write to us should you be unable to obtain it.

FLUXITE
SIMPLIFIES SOLDERING

All Hardware and Ironmongery Stores sell FLUXITE in tins, price 8d., 1/4, and 2/8.

Buy a Tin To-day.
FLUXITE, LTD., (Dept. 326), West Lane Works, Rotherhithe, S.E.16.



ANOTHER USE FOR FLUXITE.
Hardening Tools and Case Hardening
ASK for LEAFLET on improved methods.

Dispense with that second L.F. stage!



I am easily able to dispense with the second stage of L.F. amplification which I used for loud speaker. There is no noticeable loss whatever in the volume with two "Six Sixty" Valves working (Detector and 1 L.F.) as against three bright emitters (Detector and 2 L.F.), but there is certainly a most remarkable gain in clarity.

R. C. P.

VOLUME, clarity and economy—"Six Sixty" Valve combines these qualities in a measure far surpassing any other standard radio valve, bright or dull emitter.

Its superlative efficiency is due to an important scientific discovery in filament manufacture.

The "Six Sixty" is the only valve embodying a Molybdenum Thorium Covered Filament, which, prepared by our patented processes, gives an emission of electrons so much in excess of the ordinary tungsten filament that volume approximately 50% greater than a standard bright emitter is achieved with crystal clarity.

Not to test the "Six Sixty" on your set is to miss the most notable advance in practical radio valves. One that will assuredly give you infinitely better results, and with economy, for one accumulator charge lasts at least ten times as long with a "Six Sixty." Make sure your next valve purchase is a "Six Sixty."

BRITISH MADE
B.B.C. STAMPED

FILAMENT VOLTS
1.5 to 2.

FILAMENT CURRENT
.3 amps.

18/-

If your local dealer cannot supply, communicate with us. Please give dealer's name and address.

DEALERS.

Test this Valve—you will find it an indispensable line. Send a postcard to-day for full details.

THE
ELECTRON
CO. LTD.

TRIUMPH HOUSE,
189, REGENT STREET,
LONDON, W.1.

Phone: Regent 5336.

Six Sixty

The Best Dull Emitter.

A CHAT WITH MR. BURROWS

AS I pushed open the door of his office, I literally found the director of programmes up to his neck in work. "Busy?" I inquired.

"See for yourself," answered Mr. Burrows. "I'm effecting a general clearance preparatory to my departure for Geneva this week."

"Tell me all about it," I said.

"Well, the new organisation—so far as it has been decided—will be called La Société Internationale de Radio-Téléphonie—"

"An international concern?"

"Yes; to which delegates from all the European broadcasting companies will be appointed. The Geneva Bureau has been established to deal with all matters of international interest to the broadcasting world. I shall be acting in the capacity of director, and certain definite powers have been entrusted to me.

"One of our main duties concerns the question of interference as between stations, and all complaints on this score will be dealt with by the Geneva Bureau. This will save considerable time, as direct negotiations between individual stations have proved to be a lengthy matter. The international bureau will be empowered to allot wavelengths, and as all the information will be centred at Geneva an impartial judgment on the various cases can be relied upon."

"And as regards new stations?" I interrupted.

"Their wavelengths will also definitely be fixed, but it is quite possible that they may be given a choice of two or three different positions in the broadcasting wave-band."

"What about morse interference from Government stations?"

"We cannot deal with these matters, but only with those which concern broadcast telephony.

"The Bureau will also make all necessary arrangements for the relay of concerts and entertainments of international interest, and its duties generally will tend to further the progress of broadcasting for the common benefit of all European nations."

To Mr. Burrows every minute was precious, so, wishing him the best of luck, I beat a hasty retreat. JAY COOTE.

A Dextraudion Valve Offer.—We refer readers to a very interesting offer made by the Economic Electric Co., Ltd., of 10, Fitzroy Square, London, W.1, in their announcement on page ii of the cover of this issue. The company is offering to every retail purchaser of three of their Dextraudion valves an absolutely new pair of Brown phones. We think the company makes a just claim when it says that this is a unique offer, and we are certain that AMATEUR WIRELESS readers will jump to take advantage of it.

WIRELESS IN PARLIAMENT



From Our Own Correspondent.

IN reply to further questions put on April 6 by Lieut.-Commr. Kenworthy, the Prime Minister stated that the whole question of broadcasting would have to be examined in anticipation of the expiration of the existing agreement with the British Broadcasting Company on December 31, 1926. The Government, he thought, would have to begin to reconsider the matter in the course of the coming winter. The question of the broadcasting of the proceedings of Parliament was one of the things which would have to be considered when the whole question was discussed.

CALIBRATION SIGNALS

AMATEURS who are interested in transmissions on the lower wavelengths will find the following signals of use to them for the calibration of their receivers.

I NO (Signor Franco Marietti, Corso Dante, 8, Turin, Italy) sends out calibration waves every Monday at the following times:

22.00 B.S.T.	on	110 metres,	letter	A.
22.10	"	100	"	B.
22.20	"	90	"	C.
22.30	"	80	"	D.
22.40	"	70	"	F.
22.50	"	60	"	G.

Each signal lasts three minutes, followed by a long dash for calibration purposes.

A further transmission which can be picked up and which is also very helpful is one given by 8AÉ, France, every Friday, at 22.00 B.S.T., as follows:

22.00-22.05	—Series of T's on 200 metres.
22.10-22.15	" A's " 175 "
22.20-22.25	" U's " 150 "
22.30-22.35	" V's " 125 "
22.40-22.45	" W's " 100 "

At 22.50 corrected wavelengths are advised. J. G. A.

The Supersonic Patent.—Readers' attention may be directed to the announcement on another page of this issue relating to Patent No. 143,583, which was taken out in the year 1918, and under which the Western Electric Company, Ltd., claim to own all rights in the double-detection or supersonic method. We may comment upon the final paragraph of the announcement, in which reference is made "to the fact that wireless receiving sets embodying the supersonic principle cannot be constructed without also infringing other patents of Marconi's Wireless Telegraph Co., Ltd." Well over two years ago the Marconi Co. intimated publicly that amateurs could avail themselves of Marconi patents in constructing experimental apparatus for their own amateur use.

The Jack Terminal with 101 Uses

EQUIP your receiver throughout with S.W.C. Jack Terminals. They look well, work well, and cost but 4½d. each. Just press home the telephone terminal-tag and perfect connexion is instantly made.

Use them for 'phones, for your aerial, for every external lead on your receiver. All bright parts nickelled and every terminal provided with distinguishing black or red washer.

(Slotted tags are provided so that accumulator, aerial and other leads can be inserted and soldered, thus providing permanent tags in all cases.)

The S.W.C. JACK TERMINALS

Prov. Appl. No. 3352.

From your local dealer or, if any difficulty, send remittance (with 2d. extra postage) direct to sole manufacturer and patentee:

S. WILDING COLE,
116, Snow Hill, Birmingham.

2/3

FOR SIX.

Also sold in boxes of 12 for 4s. Complete with red and black celluloid washers for positive and negative terminals.

Trade Enquiries Invited.

LOOKS LIKE THIS ON THE PANEL

BOWYER-LOWE TESTED PARTS



MATCHED H.F. TRANSFORMERS

Every one in a range matches every other perfectly. All terminals clearly marked. All ranges from 150 to 3,000 metres supplied. These transformers cost less. They give better service because the matching guarantee means extra care in manufacture. All ranges same price. Order direct or from your dealer ... **7/-**

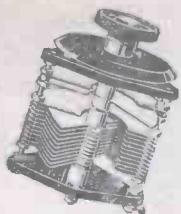

SELECTIVE

Designed with moving plates smaller than those in ordinary condensers, the Bowyer-Lowe Square Law Condenser has lowest losses yet obtained. Richer music, greater wavelength range and selectivity are given to any set in which it is installed. Test it in the instrument you are making. Ask for it by name at your dealers or order direct.

Bowyer-Lowe Square Law CONDENSERS

HOW TO MAKE A SEVEN VALVE SUPER-HET.

Circuit diagrams, progressive wiring photographs and full instructions for building a new super Heterodyne Receiver with all English components and Bowyer-Lowe Intermediate Wavelength Transformers. Send for this book or get it from your dealer to-day. Price **6d**

MAKE SUCCESSFUL SETS

Bowyer-Lowe Co. Ltd., Radio Works, Letchworth



B.W.R. COIL HOLDERS

Fit into any part of Cabinet. Made of best pure polished Ebonite. No surface leakage. Permanent tight-fitting shaft.

Prices: 2-way 4/6. 3-way 7/6 each.

Sent to any address post free on receipt of remittance.

BURGE, WARREN & RIDGLEY, LTD., 91 & 92, Great Saffron Hill, London, E.C.1

Ebonite work of any kind undertaken. Sheets, rods or tubes cut to any size.

To remind you

that for the moderate sum of 7/6 you can buy the "Brownie Wireless"—the crystal set of big results.

Excellent results are obtained at a distance of 25-30 miles from a broadcasting station, or with loading coil attached, up to 120 miles from Chelmsford. Complete with solid moulded ebonite cap, high grade nickel fittings, glass protected detector, D.L.5 Crystal and "Palladium" Catwhisker.

Chelmsford Coil 1/6

An attractively finished Ebonite Base can also be obtained, 1/6

The Brownie Wireless Co. (of Great Britain) Ltd.,
Incorporating the J.W.B. Wireless Company,
310-312a, Euston Road, N.W.1
(Facing Warren Street Tube Station)



7/6

From Your Dealer.

ELECTRADIX RADIOS

Electrical Instrument Bargains for the Radio Expert and the Novice.

We have the finest Stock of Panel and Laboratory Precision, Standard and Radio Instruments ever seen. Full details in our New Illustrated Catalogue 1925 Spring Edition, just out. Full of interesting details of Receiving and Transmitting gear and accessories. Price 4d.



BATTERY CHARGES

220 A.C. to 6v. 6 amp. D.C. Very cheap to use. **£4 10**

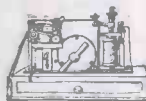

MORSE RECORDERS

Fine Instruments. **£7 10**



ALTERNATORS WITH EXCITER

200 watts. **£3 10**



WAVEMETERS

£3 to £7 10



H.T. VOLTMETERS

G.E.C. 2 range, 1000 volts and 2000 volts. **£5**



4 RANGE PANEL

Weston 24 m/a 120 m/a 6 amp. 240 mil. volts. 45/- 1 range 0.5 m/a 30/-



MIDGET M.C. CELL

Tester, 2 range, 28/6



H.T. & L.T. POCKET VOLTMETER

15/-



MIDGET M.C.

0-10 m/a, 28/6



PORTABLE SUB-STANDARDS

Volts & m/a A.C. and D.C., 45/-



TESTING SILVER-TOWN GALVOS.

15/-



SULLIVAN LAB. CONDENSERS

Stand 2000v., 55/-



DISTANT SWITCHES

for valves. 15/-



MIRROR MICRO-AMMETERS

Small £3 10. Large £4

LOW LOSS "C" OSRAM VALVES

Clips, 1/- Adaptors, 4-leg, 1/-. The cheapest high-frequency, low-capacity detector-amplifier ever offered. You can get KDKA with these when others fail. "C" Dull Emitters, 15/-



5/-

- 200 3-valve Portable Aircraft Mark II Receiving Sets complete, 300/500 metres, 12 x 7 x 4. Very compact 3-valve enclosed sets, complete with 3 Dull Emitters and 4-volt. accumulator, £4 15 0.
- 150 2-valve Mark III Receivers. This well-known Trench Receiver is a bargain at £5 10 0. With D.E. valves and accumulator.
- 320 Famous R.A.F. "10" Aircraft 5-valve Receivers, 2 H.F., 4 D.E.T., 2 L.F. The smallest 5-valve "attache case" set ever offered for 200/600 metres. Work Loud Speaker. Cost £40, sold elsewhere £10. Bargain price with valves, £5 15 0.
- 250 Transmitters, Wilson 1-valve C.W. Trench Sets, with H.T. Unit, £4 10 0.
- 300 Transmitters, 2-valve Aircraft C.W., and Telephony. £3 10 0.
- 50 Transmitters, 2-valve, 60-watt C.W., Variometer Tuning, £5 10 0.
- 100 Marconi combined Trench Transmitter and Receiver Sets in Mahogany case, £4 10 0.
- 2 tons, 22 Gauge H.C. Copper Magnet Wire, one coat enamel and bottom, Government quality for Instrument or Coils, 1/4 per lb.
- 10 miles 7/22 Stranded H.D. Admiralty Aerial Wire, Enamelled, 3/- per 100 ft.
- 100 Townsend Broadcast Wavemeters, Ex. W.D., each £3 10 0.

SPECIAL ATTENTION TO EXPORT ORDERS

Call if you are in London and inspect our wonderful stock.

LESLIE DIXON & CO.

9, COLONIAL AVENUE, MINORIES, E 1

On Bus Route. Telephone—Avenue 4166.

Near Aldgate Met. Rly. Station. Telegrams—Electradix. Ad.

TRADE NOTES AND CATALOGUES

FROM the Eagle Engineering Co., Ltd., of 8, Great Russell Street, W.C.1, we have received an interesting leaflet published in connection with the No. 7-type valve-receiving set which this company manufactures.

In order to facilitate the selection of valves when required, all Marconi valve cartons now have a coloured distinguishing label pasted on before they leave the Osram Lamp Works. Each type of valve has a different colour. In addition, to facilitate identification when Marconi valve cartons are stocked on their sides, a narrow coloured label, which corresponds with that on the side of the carton, is attached to the bottom. This new method of distinguishing valve types not only saves time, but it will assist the retailer in checking his stock.

We are informed by the Mead Co., of Fallows Rd., Sparkbrook, Birmingham, that they intend to take up the sale of complete crystal and valve sets in order to feature the sale of this class of instrument on a cash and credit mail-order method of trading.

It is interesting to note that, in the interests of the public and the wireless trade, a certificate is now being issued by the Wireless Retailers' Association, of 70, Finsbury Pavement, E.C.2, to reputable dealers. In its decision to issue the certificate the association has been partly influenced by the need that the public feel for some means of distinguishing those dealers on whom they can rely as to quality of apparatus, adequate service and scientific knowledge, on all of which matters the association encourages a high standard amongst its members.

The Edison Swan Electric Co. Ltd. have recently received back from one of their customers one of their AR valves. Although this well-known type of valve is only intended for use as a receiving valve, this particular one has been in constant use as a transmitting valve with 500 volts on the plate, and frequently up to as much as 7 volts on the filament. Under these conditions it gave better results than could be obtained with a 15- or 30-watt transmitting valve. At a very conservative estimate the valve has had a life of not less than 350 hours. The valve was not specially selected, but was bought out of stock over the counter in the usual way, and its owner, resident in the Birmingham area, states that it was used regularly on two-way telephony with Aberdeen.

The only station that has a licence to broadcast in Japan is one in Tokyo, and its licence has been held up pending reconstruction of its temporary broadcasting station.

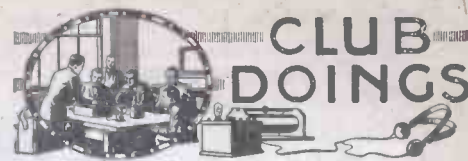

Hackney and District Radio Society

Hon. Sec.—MR. G. E. SANDY, 114, Parnell Road, E.3. ON April 6 Mr. Van Colle demonstrated the new seven-valve receiver. Afterwards the evening was devoted to the answering of queries.

Radio Association: Paddington and District Branch

Hon. Sec.—MR. H. J. WOOD, 5, Senior Street, Paddington, W.2.

THE monthly meeting took place on April 22 at The Manor House, 38, Westbourne Terrace North, W.2, at 8 p.m., when a lecture by Mr. A. Turner on "Grid Trap Circuits for Short-wave Work" was given.

North Middlesex Wireless Club

Hon. Sec.—MR. H. A. GREEN, 100, Pellatt Grove, Wood Green, N.22.

ON April 1 Mr. W. Gartland gave a lecture on "A Universal Meter." He demonstrated that the one instrument, suitably mounted, could, with the addition of two or three resistances, be used to measure current over practically any range and also voltage and resistance.

Coventry and District Co-operative Radio Society

Hon. Sec.—MR. A. CURTIS, West Orchard, Coventry. AT the meeting held on April 1 Mr. R. Burt, the society's librarian, gave an excellent lecture on "Wireless," technicalities being avoided for the benefit of the layman.

Barnet and District Radio Society

Hon. Sec.—MR. J. NOKES, Sunnyside, Stapylton Road, Barnet.

AT the last monthly meeting sets and components made by members were exhibited and demonstrated. A paper on "Selenium" was read and some experiments were conducted.

Dublin Wireless Club

Hon. Sec.—MR. A. C. BRIDLE, 29, Sth. Anne Street, Dublin.

A MEETING was held on April 2, with Mr. J. C. Mangan in the chair. Mr. Jackson delivered a lecture on "The Construction of a One-valve Set," and demonstrated a one-valve which incorporated a novel method of introducing reaction.

Kensington Radio Society

Hon. Sec.—MR. H. JOHNSON, 81, Cromwell Road, Wimbledon, S.W.19.

MR. J. REEVES, M.A., M.B.E., and Mr. J. McMillan gave a lecture on the new cylindrical low-loss coils for short wavelengths with which they have been experimenting for some time.

"Modulation Amplifier." Owing to a draughtsman's error the circuit diagram of a modulation amplifier shown in the Information Bureau page in No. 148 included no high-tension supply. A high-voltage battery should, of course, be connected between the lead to the primaries of the intervalve transformers and the negative L.T. terminal in the usual way—negative H.T. to negative L.T., and positive H.T. to the primaries of the transformers.

ANNOUNCEMENTS

"Amateur Wireless and Electric." Edited by Bernard E. Jones. Price Threepence. Published on Thursdays and bearing the date of Saturday immediately following. It will be sent post free to any part of the world—3 months, 4s. 6d.; 6 months, 8s. 9d.; 12 months, 17s. 6d. Postal Orders, Post Office Orders, or Cheques should be made payable to the Proprietors, Cassell & Co., Ltd.

General Correspondence is to be brief and written on one side of the paper only. All sketches and drawings to be on separate sheets.

Contributions are always welcome, will be promptly considered, and if used will be paid for.

Queries should be addressed to the Editor, and the conditions printed at the head of "Our Information Bureau" should be closely observed.

Communications should be addressed, according to their nature, to The Editor, The Advertisement Manager, or The Publisher, "Amateur Wireless," La Belle Sauvage, London, E.C.4.

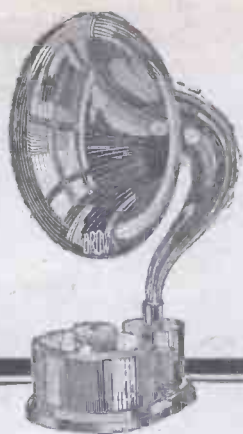

It works from a Crystal Set

FOR the man who is fortunate to live within a few miles of a B.B.C. Station there is no more economical means of enjoying Broadcasting than by using a Crystavox—the only Loud Speaker that will work direct from a Crystal Receiver.

And the cost of such pleasure is absurdly small when one realises that there are no valves to buy—no accumulators to recharge—no additional expenses of any kind. But not every Crystal Set will work a Crystavox—try out the test given below. If you are successful see your Dealer about one-to-day.

£6:15:0

The TEST

Hold the phones 12 inches from the ear and if the transmission can still be distinctly heard the set is sufficiently sensitive to operate a Crystavox satisfactorily.

S. G. BROWN LIMITED
Victoria Road, N. Acton, W.3

Showrooms:

19 MORTIMER STREET, W.1
15 MOORFIELDS, LIVERPOOL
67 HIGH ST., SOUTHAMPTON

Brown

Gilbert Ad. 2714

Amateur Wireless

COUPON
Available until Saturday,
May 2nd, 1925

Saves you pounds

43 pages of illustrations. Lowest prices in London for highest grade Radio Apparatus. Send 3d. at once. Large illustrated Folders describing Unit System, interchangeable Unets and Pilot Receivers, sent free.

3d

PETO-SCOTT, LTD.
Head Office: 77, City Rd., E.C.1

Branches—
London—62, High Holborn, W.C.1.
Walthamstow—230, Wood Street.
Liverpool—4, Manchester Street.
Cardiff—91, Queen Street.
Plymouth—Near Derry's Clock.

Peto-Scott's Catalogue 2720

Cabinets you want!
For Radio Perfection

PICKETTS are used for Finest Sets. Insulated Against Surface Leakage—an Important Point for Tone Purity & Strongest Signal Strength. Estimates Per Return Post.



Send for Cabinet Designs & Lists Free. CABINET (A.M.) WORKS, BEXLEY HEATH, S.E.

A BOOK BARGAIN

THE HOME RADIO. How to make and use it. By Verill. For those interested in improving their sets or installing more efficient ones. Published 3/6. Offered, new, for 1/9, post free.

Quota offer 104.

FOYLES, 121, Charing Cross Road, London.

ACCUMULATOR BARGAINS

C.A.V. & Fuller's, soiled, but guaranteed 12 months. Sent on approval next cash.

2v-40a .. 9/6	4v-80a .. 27/6	6v-100a .. 37/6
4v-40a .. 17/-	4v-100a .. 32/6	6v-80a .. 40/-
4v-80a .. 21/9	6v-40a .. 25/-	6v-100a .. 46/-

MAUDE RUBBER CO., 59, FRAED STREET, W.

BROWN A2 Adjustable Reed Type Earpieces, 21/- each, or complete with headphones and cords, 42/- per pair. These are brand new Not Ex. W.D. and are the best for

A.W. PLEATED PAPER LOUDSPEAKER

(as described in "A.W.," October 25th, 1924.)
3-in. Length **Ro2** to screw in Reed with nut to lock. 7d. Ditto 6-in. for cone shaped Loudspeaker, 1/-.
Adjustable centre bushes and discs, 2/3 (does away with the unsatisfactory cork and makes a neat and easy job). Paper, 391 by 6, 2/3. 391 by 6 1/2, 2/6. We have tested this paper thoroughly and consider it the best, it does not require proofing. Not Parchment substitute.
12-in. Plated Frames, give a very finished appearance, 5/6 per pair. 12-in. Wood Frames with clamp, 2/6, post 4d.
Brass back stays to fit earpiece to frame. These obviate drilling your cap and make a very firm and neat job. 2/- per set of three.

"GOODMAN'S"

G STATION ROAD, HARROW, MDDX.

IF YOU ARE IN THE CITY VISIT SPENCER'S STORES, LTD.

4-5, MASON'S AV., COLEMAN ST., E.C. 2
Telephone: London Wall, 2292

F VALVE RENEWALS ALL TYPES
O KENITE PANELS ANY SIZE
R BEST PHONES from 10/9
INDIVIDUAL ATTENTION AND ADVICE

SOMETHING NEW

Extreme Simplicity, Remarkable Efficiency and No Soldering—These are the outstanding features of The F.S. 2 Loud Speaker Set. Even if you have no wireless experience at all you can build it as easily and well as an expert and save pounds. The F.S. 2 Envelope contains explicit non-technical instructions and unique full-sized drawings which can be understood by all. Post free 1/6. P.O.'s payable to: H. J. E. Butler.

THE FLEET STUDIO, 68 FLEET ST E.C.4



Many Handicrafts Easily Acquired!

Cassell's Amateur Mechanic Handbooks

Lavishly illustrated and written by experts in straight forward and lucid manner, each of these famous manuals gives the essential information to enable even the veriest amateur to become proficient. Purchase one and begin work at once. There is money in it for you.

Each 1/6 net

- Basket Making.
- Beehives and Beekeepers' Appliances.
- Bent Iron Work.
- Bookbinding.
- Building Model Boats.
- Camera Making.
- Conjuring Apparatus and How to Make It.
- Cycle Repairing and Adjusting.
- Domestic Jobbing.
- Dynamo and Electric-Motor.
- Dynamo and Motor Erection and Management.
- Electric Accumulators.
- Electric Bells and Telephones.
- Electric Lighting.
- Electric Primary Batteries.
- Electro-Plating.
- Fishing Rods and Tackle.
- Furniture Repairing.
- Glass Writing, Embossing and Fascia Work.
- Gramophones and Phonographs.
- Handyman's 1,000 Practical Receipts, The
- House Painting and Decorating.
- Household Repairs.
- Incubators and Chicken Rearing.
- Induction Coils.
- Magneto Repairs and Adjustment.
- Metal Turning Made Easy.
- Miniature Electric Light.
- Model Aeroplanes.
- Motor Cycles and Side-Cars.
- Oxy-Acetylene Welding.
- Photography Simplified.
- Pianos.
- Poultry Houses and Appliances.
- Pumps and Hydraulic Rams.
- Rustic Carpentry.
- Simple Lathie and Its Accessories.
- Small Electric Apparatus.
- Small Lathes: Making and Using.
- Small Workshop Appliances.
- Soldering, Brazing and Welding.
- Stage Illusions and Entertainments.
- Toy Making.
- Violin Making and Repairing.
- Watch Cleaning and Repairing.
- Workshop Hints for Metal Workers.

Of all Newsagents and Bookstalls, 1/6 net or direct from the Publishers 1/9 post free

Cassell's Publishers London

PREPAID ADVERTISEMENTS.

Advertisements under this head are charged FOURPENCE PER WORD, minimum charge FOUR SHILLINGS.

DEPOSIT SYSTEM.

As the Publishers cannot accept responsibility for the bona fides of Advertisers in this publication they have introduced a system of deposit which it is recommended should be adopted by readers when dealing with persons with whom they are unacquainted. It is here explained.

Intending purchasers should forward to the Publishers the amount of the purchase money of the article advertised. This will be acknowledged to both the Depositor and the Vendor, whose names and addresses must necessarily be given. The Deposit is retained until advice is received of the completion of the purchase, or of the article having been returned to and accepted by the Vendor. In addition to the amount of the Deposit, a Fee of 6d. for sums of £1 and under, and 1s. for amounts in excess of £1, to cover postage, etc., must be remitted at the same time. In cases of persons not resident within the United Kingdom, double fees are charged.

The amount of the Deposit and Fee must be remitted by Postal Order or Registered Letter (Cheques cannot be accepted), addressed to

"AMATEUR WIRELESS,"

ADVERTISEMENT DEPARTMENT,
LA BELLE SAUVAGE, LONDON, E.C.4

GOLD OR SILVER TREATED DIAPHRAGMS. Ready for use. splendid results. 12 in. diam., 1s. 6d.; 16 in. diam., 2s. 6d.—Ernest Murray, 39, Princes Parade, Binsley, N.32

PATENTS. Trade Marks, Inventions, Advice Handbook and Consultations free.—B. T. King, Regd. Patent Agent, 140a, Queen Victoria Street, London, E.C.4

PLUG-IN COILS. Set of 4 Broadest Wavelengths, 12s. 6d.; 3 Chalmers, 21s. Every coil tested. Headphones, 9s. pair. Money returned if not satisfied. Postage free.—Whitworth, Dudwell, Halifax.

THE VALVELESS AMPLIFIER

A boon for Deaf people. No Valves, Accumulators, H.T. Batteries required. Simply fix to crystal set. Price £2 10. Send for particulars, but we prefer you to give us a personal call during broadcasting hours. THE VALVELESS AMPLIFIER CO., (1st Floor), Dept. B, 1, ST. JAMES-WALK, Clerkenwell Green, E.C.1.

TELEPHONES RE-WOUND

to 4,000 ohms. Guaranteed. All makes 5/-, except Brown 3 1/2 and Sullivan Wax filled, 10/- per pair. Ex. 3000 converted to high resistance 2/6 each complete. Re magnetism 9/-, per earpiece. Postage extra 6d. per pair. Write for prospectus

JOHN W. MILLER, (1 Farringdon St., E.C.1) (2nd and 3rd floors). Phone: CENTRAL 1950



PROMPT REPAIRS

TO HEADPHONES TO LOUDSPEAKERS

Rewound to any resistance, remagnetized and made equal to new. Prices quoted on receipt of instruments. First class workmanship only.

Established 27 Years

THE VARLEY MAGNET CO.,
Phone: 11 00, 11 883, Woolwich, S.E. 18.

Notable Contributions to the Perfection of Wireless



LOUD SPEAKERS TRANSFORMERS ACCUMULATORS

Folders on request.

C.A. Vandervell & Co. Ltd.
ACTON VALE, LONDON, W. 3.

RETAIN THEIR CHARGE LONGEST—

A.F.A. SPECIAL DUROS ACCUMULATORS
ESTD 1887
of all Wireless Dealers

Trade, A.F.A. DIANA PLACE, EUSTON RD, LONDON, N.W.1.

LISSENIUM

A delightful condenser to use—

A SQUARE law condenser is a necessity for laboratory work where painstaking accuracy is essential, and if a receiver were to be used on one small band of wavelengths it would be possible to select a suitable square law condenser which would be satisfactory within its limits. The difficulty is, however, that a square law condenser which is suitable for short wave work is hopelessly inadequate for longer wavelengths, and, conversely, a square law condenser which is suitable for high wavelengths is totally unsuitable for short wave work. With the numerous stations in this country and all over the world now transmitting on widely separated wavelengths, we consider it highly desirable that one condenser should be equally appropriate to all wavelengths. We have therefore aimed to produce a condenser which has almost the accurate characteristics of a square law condenser, but which is much easier to tune with, provides a negligible minimum capacity at one extreme of the scale, while at the other extreme it provides a high maximum. In this condenser there has been found one which **FOR ORDINARY WORK OUTSIDE A LABORATORY IS A GREAT IMPROVEMENT ON ANY SQUARE LAW CONDENSER.** The **ONE CONDENSER COMBINES ALL TUNING CAPACITIES—AND IT IS ESSENTIALLY A LOW LOSS CONDENSER.**

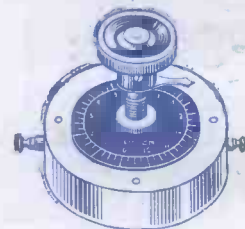

TUNING ON SHORT WAVE WORK IS DELIGHTFULLY EASY—LONG DISTANCE WORK—IS IMMENSELY IMPROVED.

The pointer of this condenser makes two revolutions—when small changes of capacity are required you work on the first revolution, and on the second revolution when more critical changes of capacity are desired—one knob control, too. With a negligible minimum capacity, its maximum is rated at .001, but actually is higher.

THIS LISSEN MARK II MICA VARIABLE CONDENSER (pats. pending) IS WORTH ITS PRICE OF ... **17/6**

LISSEN ONE-HOLE FIXING, OF COURSE—table or panel mounting without alteration.

With this LISSEN CONDENSER and LISSENAGON (pronounced LISSEN-AGON) coils a receiver is fitted with the best tuning combination it is possible to have. Ask for them if you are out for ease and distance.

A delightful condenser to use—and improves long distance work immensely

Parts that pull together— When you know that every vital part in your receiver is pulling strongly with each other, you know that you have a receiver which is the best you can ever get. With all LISSEN Parts you will get results which would never be possible with mixed parts.

Delivers all its stored up energy—

IT is worth while fitting LISSEN FIXED CONDENSERS, too—made with scrupulous care—they are accurate to 6 per cent.—they never vary—never leak—**THEY DELIVER ALL THEIR STORED UP ENERGY, ALL the TIME.**



Capacities—.0001 to .0009 ... 2/-
 „ .001 to .003 ... 2/6
 „ .004 to .006 ... 3/-

Don't mix your parts—there is a LISSEN Part for every vital place.

LISSEN LIMITED

Telephones: Riverside 3380, 3381, 3382, 1072.
 Telegrams: "Lissenium London."

16-20 Woodger Road, Goldhawk Road, Shepherd's Bush, London, W.12

PARTS WITH HIDDEN POWER—BUILD WITH THEM