

WITH FREE BOOK "WIRELESS QUESTIONS ANSWERED"

THE "A.W." ULTRA-SELECTIVE FOUR-VALVER

Amateur Wireless

And Electrics

Vol. VI. No. 142.

SATURDAY, FEBRUARY 21, 1925

Price 3d

PRINCIPAL CONTENTS

ANALYSING THE
CIRCUIT DIAGRAM

TESTING YOUR
EBONITE

AERIAL TYPES

A HOME-MADE
WAVEMETER

TIPS ABOUT TER-
MINALS

INDUCTANCES—
THEORY AND
PRACTICE

AN EXPERIMENTAL
PANEL

TRANSMISSION STEP
BY STEP

CRYSTAL SET WITH
LORENZ TUNER

SHORT WAVE HINTS

WELL ILLUSTRATED

Registered at G.P.O. as a Newspaper

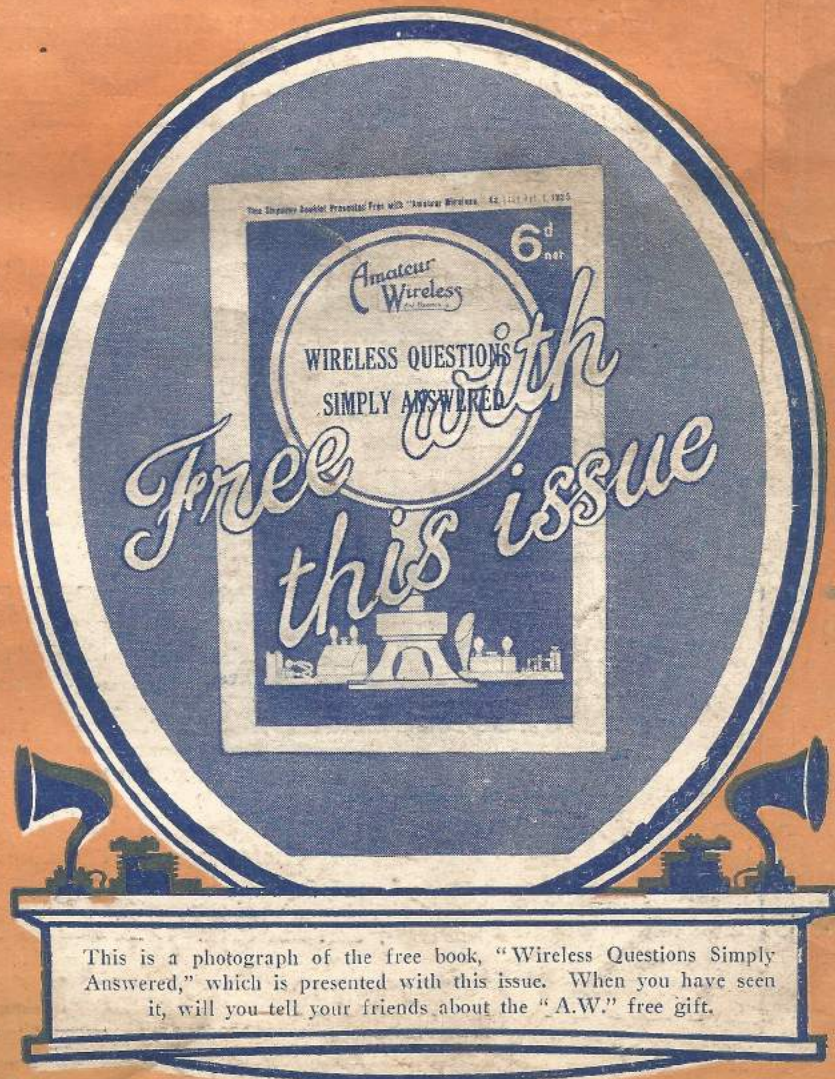

This is a photograph of the free book, "Wireless Questions Simply Answered," which is presented with this issue. When you have seen it, will you tell your friends about the "A.W." free gift.

GREAT CRYSTAL DISCOVERY

BROADCAST RECEPTION PERFECTED

IMPORTANT ANNOUNCEMENT



Twelve months of untiring research and scientific investigation has found its reward in the production, on a commercial scale, of the most perfect and ideal crystal rectifier yet known.



This new product, to be known henceforward as

GOLD 2/- TUNGSTALITE LABEL 2/-
 Regd. Trade Mark 447149

is a synthetic crystal of entirely British manufacture. It is distinguished by a very fine crystalline structure, and its peculiar molecular architecture is such as to secure complete electrical uniformity, thus enabling the manufacturers to give the following remarkable **WRITTEN GUARANTEE** with every specimen, namely that **ANY and EVERY POINT of CONTACT WILL GIVE PERFECT 100% RECEPTION**

TUNGSTALITE (GOLD LABEL). Is packed in specially constructed glass-covered boxes, each of which contains an identification number and written guarantee. These precautions are calculated to render fraudulent imitations almost impossible.

TUNGSTALITE (GOLD LABEL). possesses an exceptional range and a remarkable capacity for receiving MORSE and distant signals undetected by other crystals. **It is unaffected by heat, by handling, or by exposure to the atmosphere.**

Try a specimen of **TUNGSTALITE** (Gold Label). Make a thousand different contacts on a thousand different points—**AND SECURE PERFECT 100% RECEPTION EVERY TIME.**



OBTAINABLE FROM ALL DEALERS AND FROM

LONDON : 47 Farringdon Road, E.C. **TUNGSTALITE, LTD.** YORKSHIRE : 41 Call Lane, LEEDS
 'PHONE : HOLBORN 2557.

LONDON : Messrs. Brown Bros., Ltd., Gt. Eastern Street ; Messrs. Houghtons, Ltd., 88, High Holborn. MANCHESTER : Messrs. Franks (Wholesale), Ltd., 3, South King Street. NEWCASTLE-ON-TYNE : Messrs. Payne & Hornsby, Ltd., 6, St. Andrew's Buildings, Gallowgate. SCOTLAND : Messrs. Robb Bros. (Glasgow), Ltd., 69a, West Nile Street. NORTHERN IRELAND : Messrs D. H. Macleay, 7, Howard Street, Belfast.

SECURE YOUR GOLD LABEL TO-DAY



Dubilier Grid Leak Resistances 0.5, 1, 2, 3, 4, 5 Megohms. 2/6 each. Grid Leak clips, per pair 6d. each.

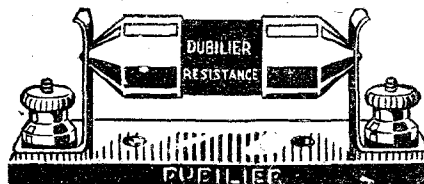

Dubilier Anode Resistances complete with holder as illustrated, from twenty thousand to one hundred thousand ohms. 5/6 each.



LITTLE THINGS THAT COUNT.

A lost collar stud, a broken shoe lace. You know how often the bigger issues in life depend upon the attention paid to detail.

It is just the same with your wireless set ; if you want to make sure of good results, pay attention to details.

An uncertain grid leak will ruin the reception of an otherwise carefully constructed set. We realize the importance of having a grid leak which can be relied upon to remain constant in action under widely varying conditions of service. That is why all Dubilier Grid Leaks are carefully tested on 100 volts D.C. before they are offered to you.

Similarly, Anode Resistances are tested on 200 volts D.C., and will carry the Anode current of a valve indefinitely without altering in resistance. Here, as with all other products, we do our best to ensure that the name Dubilier shall enable you to feel entire confidence as to results. Eighty per cent. of complete-set manufacturers in Britain, as well as thousands of experimenters, fit Dubilier products as standard in their sets. They have to pay slightly more for them, but they very wisely place reliable working before the saving of a few pence, and they know that if reliable components could be made cheaper, Dubilier would be making them.

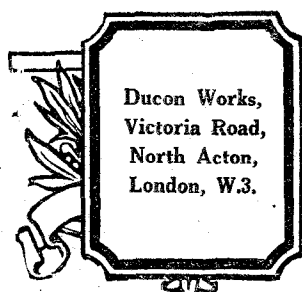

Ducon Works,
Victoria Road,
North Acton,
London, W.3.

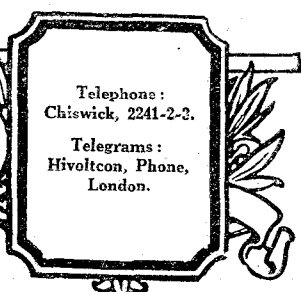

Telephone:
Chiswick, 2241-2-3.
Telegrams:
Hivoltcon, Phone,
London.

Amateur Wireless

and Electrics

Vol. VI. No. 142

February 21, 1925

ANALYSING THE CIRCUIT DIAGRAM

THE beginner who wishes to know how his set works usually has little difficulty in understanding the action of the single-valve circuit, where the valve works either as an amplifier (Fig. 1) or as a detector (Fig. 2). In either case a direct current from the H.T. battery passes through the valve from anode to cathode, the amplitude of this current at any instant depending upon the potential of the grid with respect to the other two electrodes between which it is situated.

In Fig. 1 the signals to be amplified are applied between grid and filament, causing the potential of the former to vary with respect to the latter so that variations of the anode current take place which correspond exactly to the original signals but are of greater amplitude.

In Fig. 2 the action is slightly more complicated. By the insertion of a leaky condenser one-half of the H.F. oscillations is made to affect the plate current to a much greater extent than the other half does, and owing to the effect of the used half-cycles being cumulative, the anode current is affected by each train of waves as a whole.

What really happens is that, owing to the unilateral conductivity of the valve, the signals are rectified between filament and grid, and as the accumulating nega-

valve followed by a three-electrode valve acting as a direct-coupled L.F. amplifier.

When studying the action of the valve the filament current, of course, may be



ignored, as this plays no part in the actual working of the valve beyond merely raising the temperature of the filament to a point at which it will emit sufficient electrons.

The "Straight" Circuit

The straight single-valve circuit is really so simple that its action can be readily understood by the veriest novice, but having reached this point the interested student naturally wishes to proceed further, but the next step, he finds, is a very big one. He finds himself confronted by a formidable array of three-, four- and five-valve circuits in which it is difficult to see how the principles which he has already mastered can apply. Instead of the two simple circuits with which he has been concerned, he now has to deal with an intricate maze of conductors, circuits and parts of circuits, not isolated so that he can study the action of each one separately, but interconnected and superimposed one upon the other until it seems hopeless to try to understand the actual working of the complicated whole.

To show how such a multi-valve circuit diagram can be resolved into its component circuits so that the action of each one can be studied separately is the purpose of this article. Perhaps the best way of explaining how the present-day com-

plicated circuit can be analysed and its constituents separated is to reverse the process and follow the evolution of the intricate modern circuit from the mere collection of simple circuits which was its prototype.

Fig. 3 shows diagrammatically the connections of a three-valve receiver as actually used in the early days of the three-electrode valve. The valves act respectively as an H.F. amplifier, a detector and a note magnifier. As the various stages are entirely separated one from the other the student will have no difficulty in following the action of each. However, we will follow this out in detail. For greater clearness the nature of the current flowing in each circuit is indicated by an initial placed near that circuit. The meaning of these initials is as follows:

H, high-frequency currents; AH, amplified H.F. currents; R, rectified currents; L, low-frequency currents; AL, amplified L.F. currents; D, direct current.

Referring to Fig. 3, the H.F. currents in the aerial induce H.F. currents in the secondary circuit, which is the grid circuit of the first valve, and therefore an amplified reproduction of the original oscillations is superimposed upon the direct current flowing from the H.T. battery through the valve. Although the current in the primary of the H.F. transformer is really

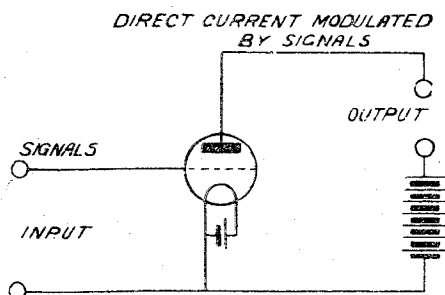

Fig. 1.—The Valve as an Amplifier.

tive charge on the grid side of the condenser can only escape slowly via the grid leak, the potential of the grid is materially reduced by each train of oscillations. The arrangement shown by Fig. 2 is really equal to a two-electrode

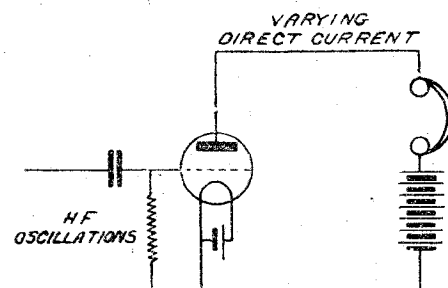
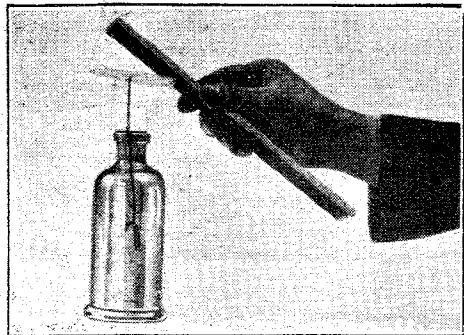

Fig. 2.—The Valve as a Detector.

a fluctuating D.C. current, only the H.F. component, of course, produces any effect in the secondary of the transformer by which the amplified H.F. currents are applied to the grid and filament of the

(Concluded at bottom of next page)



TEST YOUR EBONITE

pression as to the relative insulating properties of materials.

Construct a simple form of the gold-leaf electroscope, as shown in the photograph. All that it consists of is a bottle, a piece of wire bent as shown (to the top of which is soldered a circular disc of metal) and a piece of gold leaf. The gold leaf is attached by means of a little gum to the bottom end of the wire.

Charge the electroscope by flicking the disc with a piece of dry fur or flannel. The leaves will diverge, the instrument being charged and ready for the test.

(Note.—The leaves will more readily diverge if the instrument is placed a few feet from the fire for a short time.)

Now take hold of, say, a piece of ebonite and touch the disc with it. If the surface

is non-conducting the leaves will remain apart, but if leakage is taking place the static charges residing on the leaves will leak to earth through the body and the leaves will slowly collapse. In turn present other materials—three-ply wood, oak, etc.—to the electroscope and note the results; the rate of collapse of the leaves will indicate the quality of the insulation of the material.

The experiment will prove that most materials, ebonite excepted, used for panels leak electrically, and consequently the efficiency of sets built upon them will be greatly impaired.

Such an experiment is convincing, and amateurs will feel amply repaid having made another incursion into the realm of experiment. C. L. R.

CONSTRUCTORS of wireless sets often falsely economise by buying cheap ebonite.

Most amateurs have not the necessary apparatus to test for current leakage across an insulating surface, nor have they seen an experiment conducted which would visibly impress them that leakage does take place.

The following is an interesting experiment which can be carried out in a few minutes and will leave an indelible im-

"ANALYSING THE CIRCUIT DIAGRAM" (continued from preceding page)

detector valve. Owing to the action of the grid condenser and leak a decrease of plate current is produced by each group of

The arrangement shown in Fig. 3 suffers from the obvious disadvantage that separate H.T. and L.T. batteries are required for each valve. It was soon discovered that a common H.T. battery could

be used and such a circuit is shown in Fig. 4. Comparing this with Fig. 3, the student should have no difficulty in seeing that the use of a single H.T. battery does not modify the previously explained action in any way.

Fig. 5 shows the modern arrangement. This is materially the same as Fig. 4, the only alterations being that the filament of each of the three valves is heated by current drawn from the same accumulator and that it is not found necessary to tune both windings of the H.F. transformer.

The student should carefully follow out the evolution of the very common type of circuit with which we have just dealt until

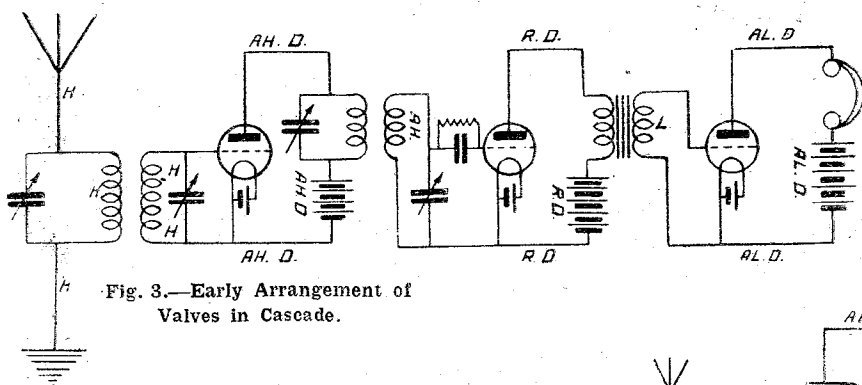

Fig. 3.—Early Arrangement of Valves in Cascade.

waves and so the current flowing in the plate circuit of the detector valve consists of a direct current modulated at speech frequencies. As before, only the fluctuating component induces a corresponding current in the secondary of the transformer, which causes the potential of the grid of the last valve to fluctuate and vary the direct current through the phones so that the telephone diaphragm produces audible signals.

Fig. 4.—Valves in Cascade with Common H.T. Battery.

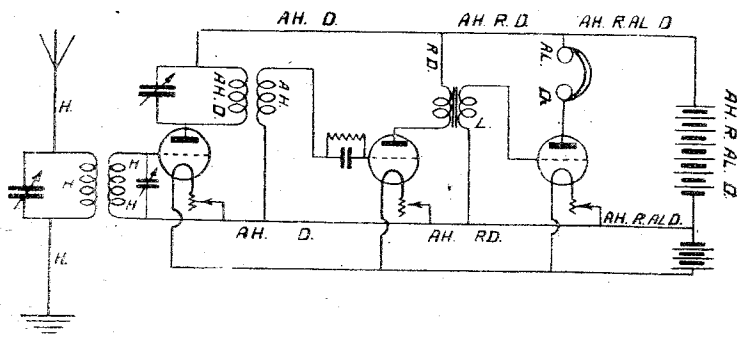
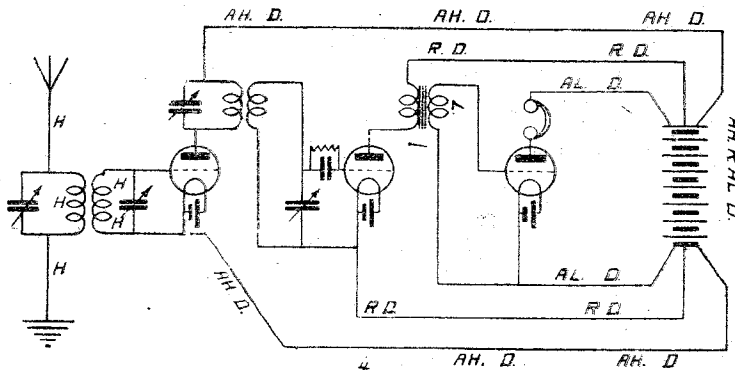

Fig. 5.—Modern Arrangement of 3-valve Circuit.

he is quite confident that he thoroughly understands each step, and then he should apply the same principle to the various other types of circuit, all of which can be resolved into their fundamental constituents in exactly the same way.

The writer is well aware that the above explanation can be criticised on the grounds of incompleteness, but considers that the introduction of unimportant details would serve no useful purpose at this stage and would only confuse the beginner. The explanation is accurate so far as it goes. J. F. JOHNSTON.

A HOME-MADE WAVEMETER

The wavemeter is not appreciated at its true value; this article tells you what it does and how it may be made.

A WAVEMETER is one of the most useful things that any wireless enthusiast can possess. With its help the process of searching for distant stations, so long as their wavelength is known and they are within the range of the receiving set, becomes quite simple. Further, it is the greatest help to either the valve or the crystal man as a means of testing his set. With the aid of its buzzer the crystal user can find the sensitive spot without delay, whilst both he and the valve man will find it a help in time of trouble.

If you are getting either weak signals or no signals at all, set your wavemeter to the wavelength to which you have tuned or desire to tune, start it buzzing, and place it near the A.T.I. Then tune in its note as loudly as you can. If it comes in at its usual strength, then probably there is nothing wrong with the receiving set

the battery through the coil and the buzzer back to the positive pole. During the brief instant whilst current is flowing energy is stored up in the magnetic field formed round the windings of the coil. When the blade springs away the current is broken. The stored up energy is given back and goes to charge up the condenser, which discharges in a series of swings to and fro, producing an oscillating current.

By suitable values of inductance and capacity we can make the rate of the condenser's discharge, or the frequency, what we will. Thus the oscillatory circuit, consisting of the coil and the condenser, can be set to any wavelength, and when the instrument is brought near a receiving set tuned to the same wavelength, the note of the buzzer will be heard in the telephones or loud-speaker, since the wavemeter circuit and the tuned circuit of the receiving set are in resonance.

Calibration

We can calibrate the wavemeter in two ways. The first is to use an ordinary dial graduated into degrees on the condenser, and to make a chart showing the wavelength to which any condenser reading in conjunction with a given coil corresponds. Or in place of the ordinary dial we may make use of one marked off into wavelengths instead of degrees. In this case the chart is not required, and we have what is called a direct-reading wavemeter.

For very great accuracy, especially upon the ultra-short waves, the heterodyne wavemeter is superior to that using the buzzer. There are, however, certain objections to the use of the heterodyne wavemeter; it requires, for example, a valve of its own, and for the best results it should not be worked from the same batteries as the receiving set. Further, it must be calibrated for one particular valve, which must always be run at the same filament temperature and with the same plate voltage. The substitution of a valve of a different type, or even of another of the same type as that originally used, may alter its performances considerably.

Method of Using

Actually, a buzzer wavemeter made on the lines described will be found to give extraordinarily accurate and sharp wavelength readings, especially if care is taken to place it always at some distance from the A.T.I. of the receiving set. If the distance between the two is small, close readings cannot be taken, for the note of the buzzer may be audible over a fairly broad band of wavelengths, and it takes a very acute ear to decide upon the exact point of

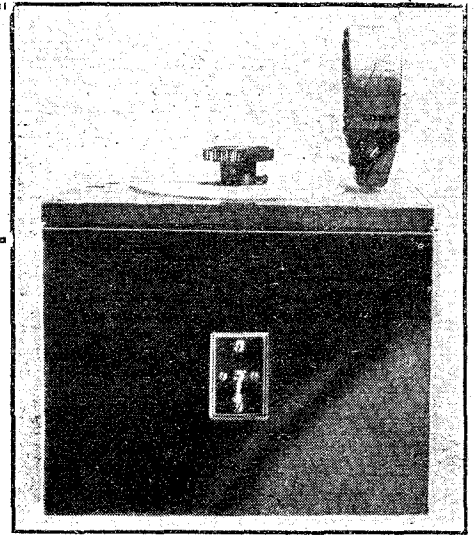

The Complete Wavemeter.

tuning at which the sound is loudest. When, however, the buzzer is placed at some distance from the set, matters are very much easier. The best position for the wavemeter is that which makes the buzzer note just comfortably audible when there is perfect resonance between the wavemeter and the receiving set. Personally I generally place the wavemeter about 6 ft. from the set.

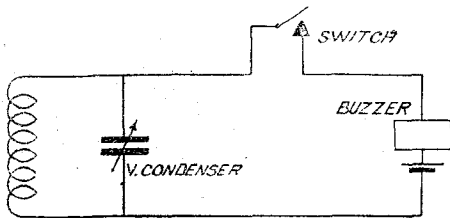

Fig. 1.—Circuit Diagram.

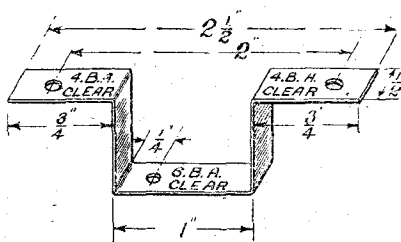

Fig. 3.—Buzzer Bracket.

itself, and you must look for the trouble in the aerial or earth.

Again, should a signal which is usually strong come in weakly on a certain night apply the wavemeter test. If its note is as powerful as ever in the receivers, then probably the transmitting station is using less power or receiving conditions are particularly bad.

The simple wavemeter consists of no more than a buzzer, a variable condenser, an inductance coil, a switch, and a single dry cell to supply the current required to work the buzzer. The circuit is shown in Fig. 1. What happens when the wavemeter is working is this: The blade of the buzzer alternately makes and breaks contact. When it makes contact there is a path for current from the negative pole of

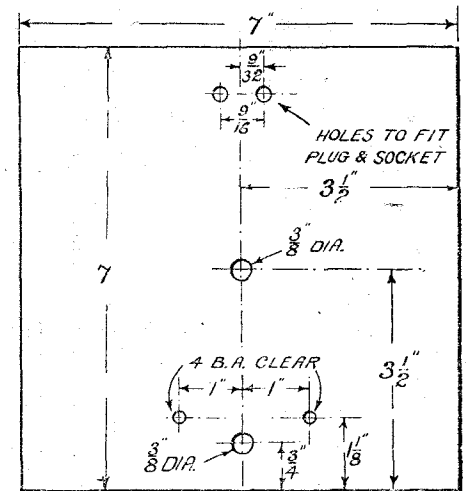

Fig. 2.—Lay-out of Panel.

The buzzer wavemeter is delightfully simple to use either for picking up a desired transmission or for identifying one which has been tuned in, but whose call sign has not been heard. Here is the *modus operandi*: Suppose that we wish to tune the set to the wavelength of 5 S.C. We set the wavemeter to 420 metres and switch on the buzzer. We then adjust the controls of the receiving set until its note is heard as loudly and as clearly as possible. Provided that the wavemeter has been carefully calibrated, Glasgow, if within range of the receiver, should be heard when the wavemeter is silenced. To identify an unknown station we set the wavemeter going, adjusting its condenser until resonance is obtained. We then read off the wavelength recorded, and refer-

ence to the lists of home and foreign stations published in AMATEUR WIRELESS enables us to determine with fair certainty where the transmission comes from.

The materials required for constructing the home-made wavemeter are few and inexpensive. The variable condenser should be of the square-law type, whose advantages for wavemeter purposes are very great, as we shall see in a moment. The most suitable capacity is .0005 microfarad. The buzzer must be of a type capable of being tuned to a high singing note, reminiscent of that of the mosquito. An excellent type can be obtained from the Silver-town Manufacturing Co. quite cheaply. To operate it we require a single small dry cell, such as one of those used in an Ever-Ready No. 15 flashlamp battery. A piece of 1/4-in. ebonite 7 in. square, a flush mounting plug and socket, and a small on-and-off switch complete our requirements.

The way in which the panel is laid out and drilled is shown in Fig. 2. The size of the holes made for the plug and socket will depend upon the type used. That in the middle of the panel for the spindle of the condenser will in most cases be

3/8 in. in diameter. At the end opposite the position of the plug and socket two 4 B.A. holes are made, as shown, to carry the bracket which supports the buzzer, and

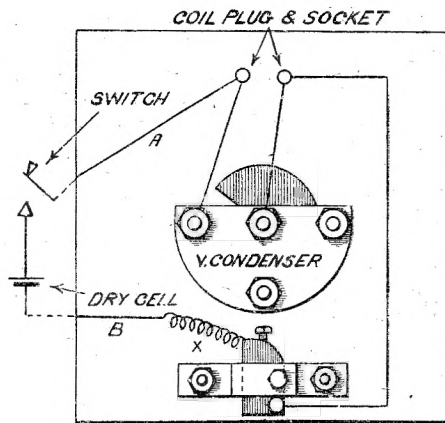

Fig. 4.—Wiring Diagram.

there is a hole 3/8 in. in diameter, which will come immediately over the contact screw of the buzzer, allowing it to be tuned readily with a small screwdriver.

The bracket which holds the little buzzer in place is made as shown in Fig. 3

from a piece of sheet brass 4 in. in length and 1/2 in. wide. A 4 B.A. clearance hole is drilled in each of the arms of the bracket to coincide with those made in the panel for the fixing screws. In the bottom of the bracket is drilled a clearance hole for a single small screw, by which the buzzer will be attached. The coil plug and socket and the condenser can now be mounted upon the panel, the buzzer being firmly fixed to its bracket and also mounted.

Fig. 4 shows the wiring connections. All except those marked A and B should be made with stiff bare wire, each joint being well soldered. A and B are the leads which run to the switch and the dry cell. These should be of good flex, and they should be made long enough to allow the panel to be removed from its cabinet, so that when necessary the buzzer may be got at quite easily. The switch, which may be of any well-designed type, is mounted, as shown in the photograph, upon one side of the cabinet, and the dry cell, which will last for months without renewing, may be placed inside in a small box. The fine wire X is best soldered to a screw driven through the panel. J. H. R.

(To be concluded)

TIPS ABOUT TERMINALS

MANY successful wireless enthusiasts never dream of soldering connecting wires to terminals; if you ask them why, they would probably tell you that it is hardly worth bothering about unless you are going in for a "fixed-circuit" receiver. This is true, for once a cluster of wires are soldered to the shank of a terminal, then usually that terminal is doomed to remain for all time in its original position.

Useful Hints

The accompanying sketches illustrate a few little dodges which may interest the experimenter. At A an ordinary telephone terminal is fitted to the panel in an inverted position, and the hexagon nuts are replaced with two milled nuts taken from an ordinary terminal. The ends of the under-panel connecting wires are clamped in the lower terminal in the usual way. The same idea is embodied in the arrangements shown at B and C. At B a stout brass bush is drilled as shown in the upper sketch to take any convenient number of connecting wires. Tapped diagonal holes in the edge of the bush are provided with small thumb-screws so that it represents a multiple terminal. In the centre of the bush is drilled a hole which is larger than the diameter of the terminal shank, and over this is soldered a brass nut which clamps the terminal to the panel in the usual manner.

At C a number of small terminals are clamped to a small brass strip, which is bent as shown and attached under the ter-

minal nut. D shows two terminals fitted in opposite positions and connected together by means of a small link of copper

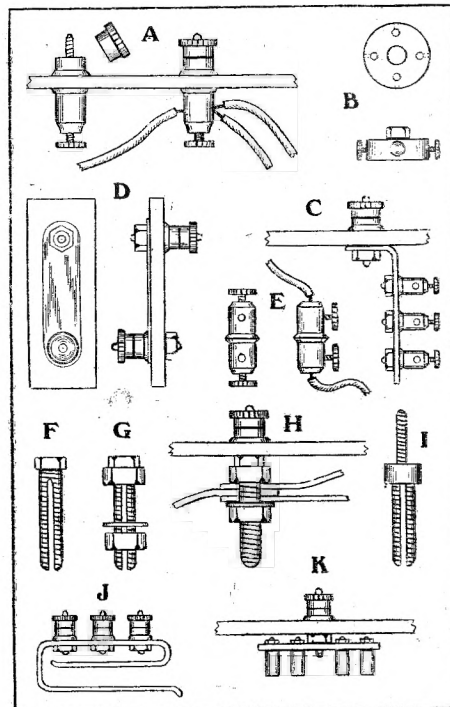

Some Terminal Tips.

foil. Such an arrangement is useful for lead-in wires, etc.

How a simple connector for fairly heavy-gauge wires may be made from a pair

of large telephone terminals is shown at E. The shanks are sawn off, the bases of the terminals then being filed smooth and sweated together. An easily-made multiple terminal for square-section wire consists of a short length of threaded brass rod which is slotted and soldered at one end to the terminal nut in the manner shown at F. The slotted rod is provided with a washer and two nuts as shown at G, and then screwed over the shortened terminal shank in the manner indicated at H. Readers who possess a lathe should turn the two shanks and the collar in one piece as shown at I.

A few extra terminals are often required on the experimental panel. J shows an emergency terminal block which can be very quickly clipped over the edge of a panel, this consisting of a strip of spring brass which is fitted with a number of small terminals and then bent as shown to form a spring clip.

Plugs and Sockets

Readers who favour the plug-and-socket system of connections will find a simple and inexpensive suggestion at K. Here a number of ordinary valve sockets are clamped to a strip of sheet brass, which is then attached to the terminal shank in any convenient manner.

Several manufacturers are now supplying various types of multiple terminals. One fairly well-known type embodies the principle outlined at B; another is a modification of the idea shown at C. O. T. R.



All Brandes products carry our official money-back guarantee, enabling you to return them within 10 days if dissatisfied. This really means a free trial.

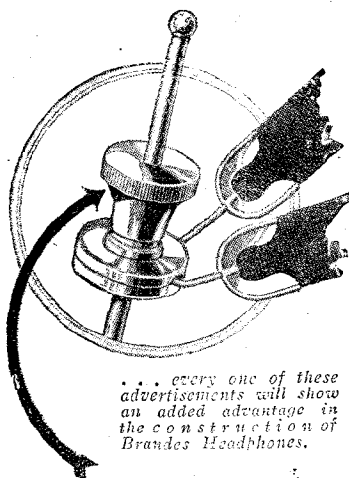

... every one of these advertisements will show an added advantage in the construction of Brandes Headphones.

The lock-nut on the receiver yoke is a clutch that tightens and holds the receivers firmly in place when satisfactory adjustment has been obtained. This point prevents the receivers from slipping, keeps the headphones in correct balance without possibility of working askew, and makes the headband follow the natural line of the head. The whole family can wear the headphones with comfort.

British Manufacture.
(B.B.C. STAMPED.)

Matched Tone means a technical improvement in telephone construction which should at once grip your attention. If you are intent on better broadcast reception, if you wish to gather the more distant signals with increased strength and clarity, then Brandes Superior *Matched Tone* Headphones are certainly what you want. Matched by ear, the two receivers or ordinary headphones cannot gain an exactly similar degree in tone and volume by a margin of eighty degrees. Brandes, matched by special apparatus, obtain corresponding sensitivity and volume in each receiver to within five degrees and a consequent increase of tone purity, accuracy, and strength. For just home stations or trans-atlantic and trans-continental telephony, get Brandes *Matched Tone* Headphones. Ask your Dealer for Brandes.

The *Table Talker* is another Brandes quality product at moderate price. Designed to meet the need for a simple radio loud-speaking device to entertain a group of people in an average size room, its full round tones are wonderfully clear and pleasing. It is matched to the unit so that air resistance produced will exactly balance the mechanical power of the diaphragm. This means beautiful sound-balance. Gracefully simple of line, it is finished a shade of neutral brown.

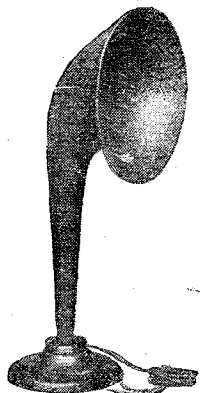

Brandes

The Name to know in Radio

"The same sound in both ears."



Superior "Matched Tone" Headphones

TRADE MARK

HULLO EVERYBODY!!

ALL THESE GOODS SENT POST FREE (U.K. ONLY) EXCEPT WHERE MARKED. FOREIGN POST EXTRA. ORDERS DESPATCHED IN STRICT ROTATION AT EARLIEST POSSIBLE MOMENT.

- AERIAL 7/22 100 ft. 3/-
- Copper Strip 3/-
- Allen Var. Grid Leak 1/9
- BURNDIPT Detector 4/6
- Basket Holders 1/3, 1/6
- Battery Links, doz. 1/2
- Bushes, Ebonite 1/3
- CRYSTALS each, 1/6, Neutron, Gilray, Permantite, Blue Label, Tungstalte
- COIL STANDS 2-Way
 - Vernier 4/6, 5/-, 5/6
 - Gearred 5/11 Polar 4/6
 - Shipton Vernier 6/-
 - "Baby" Ordinary 3/6
 - With ex. handles 3/3
 - Nickel 4/3
 - Baby 3-way 4/3
 - Nickel 5/6
 - Vernier 3-way 6/6
 - Shipton V. 8/-

- COILS D.C.C.
 - For Chelmsford 1/11
 - With Adapter 2/8
 - 200/2000 SET of 5 2/6
 - (Air Spaced Waxless)
 - Extra Large Air-Spaced Set of 5 Duplex D.C.C. Coils, 25, 35, 50, 75, 100 2/9
 - Coil Plugs, Wedge, pr. 2/9
 - Edison Bell 2 for 2/6
 - Plugs with Fibre 1/-

- DETECTORS (Enclosed)
 - Micrometer 2/6
 - Nickel, Large 2/6
 - Brass 2/-
 - Burndept 4/6
 - Mic. Met. 6/-

- EDISON BELL
 - Fixed Condensers.
 - .001 to .0005 each 1/3
 - .002 to .006 each 2/-
 - Grid Leaks and Clips 1/6
 - Dubilier .001 to .006 ea. 3/6
 - .0001 to .0005 each 2/6
 - Grid Leak, 2 meg. 2/6
 - .01 for L.S. 7/6
 - Anode Resistance on stand, 70,000, 80,000, or 100,000 each 5/6
 - McMichael's 2-meg. Leak and Clips 2/6
 - 100,000-ohm Res. 2/6
 - RAYMOND (Ebonite Base)
 - .001 to .0005 each 1/3
 - .002 to .006 each 1/3
 - .01 or .02 each 1/9

- TERMINALS
 - Phone or W.O. doz. 1/9
 - Pillar Large doz. 1/9
 - Pillar Medium doz. 1/3
 - Nickel 6d. doz. extra. (All with nuts.)

- GOSWELL QUALITY
 - Valve Legs, Set 4 1/3
 - Valve Holder 1/9
 - 2-way Cam Vernier 9/-
 - 3-way Cam Vernier 12/6
 - 3-way Ordinary 7/6
 - 2-way Panel 3/-
 - 3-way Panel 5/-
 - Basket Holders 1/4

- H.F. TRANSFORMERS
 - McMichael's 300/600 10/-
 - 1100/3000 10/-
 - Energ, 250/700 3/11
 - 450/1200 4/3
 - 900/2000 4/6
 - Raymond E.B.C. 2/9
 - 5 X X 2/9
 - IGRANIC-Rheostat 4/6
 - 30 ohms 7/-
 - Potentiometer 7/6
 - Variometer 10/6

- COILS (all numbers)
 - 25 5/- 35 5/-
 - 50 5/2 75 5/6
 - 100 7/- 150 7/10
 - 200 8/8 250 9/-
 - 300 9/5 400 10/6
 - 500 10/6

- LISSEN-Minor 3/6
- Stat 7/6
- Universal 10/6
- Switch 2-way 2/9
- Series Parallel 3/9
- Anode Res. 2/6
- Var. Grid Leak 2/6
- Choke 10/6
- L.F. T.1 30/-
- T.2 25/-
- L.F. T.3 16/6
- Coils—
 - 25 4/10 35, 40, 4/10
 - 50 5/- 60 5/4
 - 75 5/4 100 6/9
 - 150 7/- 200 8/5

- LOUD SPEAKERS
 - C.A.V. Tom Tit 30/-
 - C.A.V. Junior 55/-
 - Sterling Baby 55/-
 - Sterling Dinkie 30/-
 - Amplion Junior 27/6
 - Amplion Dragonfly 25/-
 - Becco 52/6

- POLAR CONDENSERS
 - .001, .0005 or .0003 10/6
 - Micrometer 5/6
 - 2-way Junior 6/-

- RHEOSTATS
 - One hole fixing 1/6
 - C. & S. do. 1/5
 - De Luxe and Dial 2/6
 - Burndept 4/6
 - McMichael Dual 7/6
 - Shipton Strip
 - 7 ohm (with fuse) 3/6
 - 30 or 60 ohm 3/6

- SWITCHES
 - Panel DPDT 1/6
 - Panel SPDT 1/4
 - Ebonite DPDT 2/6
 - Ebonite SPDT 1/9
 - Simplex Lead in 1/9
 - Sq. Bus Bar 1/-
 - Switch Arms 1/6

- ENERGO L.F. TRANSFORMER. For supreme Results, Efficiency, Finish, and Permanent Reliability, For 1st stage. 15/-

- THE MIC-MET SUPER CRYSTAL DETECTOR 6/-

- TRANSFORMERS, L.F.
 - Ferranti 17/6
 - Igranic 21/-
 - Ormond 14/-
 - G.R.C. 83 15/-
 - Super Success 21/-
 - Standard Success 16/-
 - Brunet Shrouded 13/6
 - Formo Shrouded 18/-
 - Formo open 12/6
 - French 9/3

- VALVE HOLDERS
 - Murray Anticap 1/3
 - Legless Anticap 1/3
 - Bretwood 1/9
 - H.T.C. UN PANEL 1/9
 - Solid Rod Standard 1/3
 - Goswell 1/6

- VALVES
 - Myers Universal 11/-
 - French "R" 7/6
 - Dutch Detector 5/6
 - Dutch "R" 5/11
 - Metal '06 13/11
 - Radio Micro '06 13/11

- VALVES (continued)
 - Bright Emitter B.T.H. "R", Ediswan A.R., Marconi Osram "R" or "R5", Mullard ORA, Cossor L.F. P1, Cossor H.F. P2, Mullard H.F., Mullard L.F. 11/-
 - Dull Emitter B.T.H. B3, Ediswan A.R.D.E., Marconi D.E.R., Myers, each 18/-
 - Dull Emitters B.T.H. B5, Ediswan A.R. "06", Mullard D.F. ORA 21/-
 - D.E. Power Valves Marconi D.E. 6 22/6
 - Power Valves (for '06) B.T.H. B8 30/-
 - Marconi D.E. 4 26/-
 - Mullard D.F.A. 26/e
 - Power Valves for B.E. B.T.H. B4, Marconi, Mullard 30/-

- WATMEL
 - Var. gd. Leak 2/6
 - Anode Res. 3/6

- WATES MICROSTAT
 - New Improved Model. 2/9

- BRETWOOD
 - New Model, variable grid leak 3/-
 - Anode Resistance 3/-
 - Anti-Cap Switch 5/-
 - TELEPHONE DISTRIBUTION BLOCKS, Table Pattern, takes 4 pairs of 'phones 3/6

- ORMOND CONDENSERS with Vernier, one-hole fixing, .0005. Price 7/6 Post free.

- PANEL SWITCHES. On and Off. Connecticut Nickel. Post Free 1/6

- EASIFIX. Eliminates all ugly, loose wiring and minimises the risk of burning out valves. Each conductor is distinctively coloured and enclosed within an outer-braiding. Complete with Wander Plugs 3/-

- OLDHAM PORTABLE ACCUMULATOR
 - For .06 Valves, 2-in. series will run 6 weeks on one charge. Recharging costs a few pence only. 2v. 10 amp. continuous 12/6. Will go in your waistcoat pocket.

- BRETWOOD
 - Valve Holder 1/9
 - 100 p.c. Efficiency Eliminates poor reception. No soldering stop over or under panel.

HEADPHONES

ERICSSON CONTINENTAL.
Your Favourite 'phones. Entirely NEW MODEL. Most beautifully finished, exquisite tone. Ridiculous Price, per pair (4000 ohms) 13/11

BRUNET
New Model "TYPE D." Hygienic Horn Headbands. Nickel-plated Stirrup. Black and White Cord. Each receiver stamped with trade mark. 4000 ohms. per pair 16/6
For the MAGIC HOUR! When Fairyland becomes reality, Let the kiddies wear Featherweight 'phones.

BROWN'S "F" TYPE.
4000 ohms. 25/- pair

N and K LATEST MODEL. 4000 ohms. Ideal for Crystal reception. Price in AMERICA, £2.
All Stamped N and K. Price here. 17/6
Limited number of old models stamped N and K. 4000 ohms. 12/11 pair Post 6d. pair

TELEFUNKEN (GENUINE). Adjustable. 4000 ohms. Price 17/11

SUPER L.F. (5-1) TRANSFORMER
Windings have insulated layers of 6 sections each, wonderful for amplification. Made in France, by the World's foremost firm. SPECIAL PRICE 10/-

Genuine BRUNET L.F. TRANSFORMER (Shrouded)
5-1: 5,000 Primary turns, 25,000 Secondary turns. Post free 13/6

PERFECT RHEOSTATS

- Shipton New Type Strip Rheostat, 7 ohms (with fuse) 3/-
- Shipton New Type Strip Rheostat, 30 ohms 3/-
- Shipton New Type Strip Rheostat, 60 ohms 3/-
- Shipton Potentiometer, 600 ohms 4/6

A specially designed spindle gives one-hole fixing and incorporates a tension spring which ensures perfect electrical contact at all times; terminal connections are provided. The 7 ohm Model is fitted with a fuse, which little device may save you the cost of an expensive valve. In operation they are noise free—quite an important consideration.

- "UTILITY" SWITCHES
 - 2 Pole c/o Knob 4/-
 - 2 Pole c/o Lever 5/-
 - 4 Pole c/o Knob 6/-
 - 4 Pole c/o Lever 7/6

TELEFUNKEN TYPE
So near to Originals. You can scarcely tell the difference except not adjustable. 4000 ohms. Pair 10/9

£50 REWARD! given if the DR. NESPER PHONES SOLD HERE ARE NOT GENUINE! BEWARE OF FRAUDULENT IMITATIONS!!

(Injunctions obtained)
Adjustable diaphragm, detachable receivers, double leather-covered head-springs long flexible cords, nickel plated parts. Very comfortable fitting to the head. Per Pair, 12/11. Post 3d. pair

BRANDES
Matched Tone, 25/- pair. 4000 ohms

STERLING Latest Model. 4000 ohms. Wonderful Tone. 25/- pair

G. R. C. 4000 ohms. 20/- pair.

SIEMENS. 4000 ohms 25/- pair.

B. T. H. Simply cannot be equalled 4000 ohms. 25/-

PERFECTION and Quality. Weight negligible.

QUALITY (GOSWELL) RADIO COILS
Far more efficient than honeycomb or any other type of coil. Exceedingly strong and rigid, mounted on standard ebonite plugs. Brown finish, no wax or shellac used. MOUNTED

- 25 ... 1/6
- 35 ... 1/9
- 50 ... 2/0
- 75 ... 2/3
- 100 ... 2/9
- 150 ... 3/0
- 175 ... 3/6
- 200 ... 3/9

MANSBRIDGE CONDENSERS

- Octopus, Tested at 350v D.C.
 - .01 ... 2/3
 - .25 ... 3/-
 - 1 mfd. 3/8
 - 2 mfd. 4/6



"WONDER" Aerial Wire
49 Strands Special Alloy Phosphor Bronze. For Frame, Indoor, or Outdoor Aerial.

Each strand is a separate conducting surface, is non-corroding, maintains its wonderful results all the time. 110 feet 3/9 post free. BEWARE of spurious imitations. This is the finest quality.

"HOVIMO" CRYSTAL VALVE. Replaces the old-fashioned detector. Cat's-whiskerless, Batteryless, Worryless, Fuss and Bothersome Wireless 3/6





ACCUMULATORS FOR CALLERS ONLY at present.



Rheostat, with Dial, extra value, 2/6

Bretwood Valve-holder 1/9

Manchester "Powquip" 1/6

Ormond 14/6

Siemens "Powquip" 18/-

Standard "Powquip" 14/6



"R.I." NEW MODEL IN SEALED BOX
Doz't Buy Otherwise. Post 25/- Free

FERRANTI L.F. BETTER THAN THE BEST 17/6

IMPORTANT NOTICE
TRADE COUNTER OPEN
will oblige you with any lines in stock, less 20% on Proprietary articles.
NO POST ORDERS TRADE.

EBONITE PANELS
3x6 ... 1/8 10x8 ... 3/6
7x5 ... 1/8 12x9 ... 5/-
3x6 ... 2/6 12x12 ... 5/9
3x6 ... 2/9 14x10 ... 5/9

CRITERION CONCERT COILS.
Low Self Capacity. Every turn and layer airspaced. Perfect for Reaction. Mounted on Plug.
25 ... 2/- 50 ... 2/6
30 ... 2/3 60 ... 2/9
35 ... 2/3 75 ... 2/9
40 ... 2/6 100 ... 3/-
SET OF 5 (25, 35, 50, 75, 100) 10/- Post 3d.

K. RAYMOND

WIRELESS DEPOT

27, LISLE STREET, W.C.2

PHONE: GERRARD 4637

RIGHT OPPOSITE
DALY'S
GALLERY DOOR

HOURS OF BUSINESS:
DAILY - 9 to 7.45
SUNDAYS - 10 to 1

No responsibility accepted on post orders unless cheques and postal orders are crossed and made payable to the firm. Money sent must be registered

HULLO EVERYBODY!!

REVOLUTION
IN VARIABLE CONDENSERS
SQUARE - LAW LOW - LOSS
(SQUARE-LO-LOSS) with **VERNIER**.

CALLERS! THESE 4 COLUMNS FOR YOU
NO POST ORDERS FROM SAME

Warning! Note name **RAYMOND** on windows. You will not be able to buy these goods otherwise. Nearest Tube Leicester Square. This address is at the back of Daly's Theatre. Open Weekdays 9 to 8, Saturdays 9 to 8.45, Sundays 10 to 1.

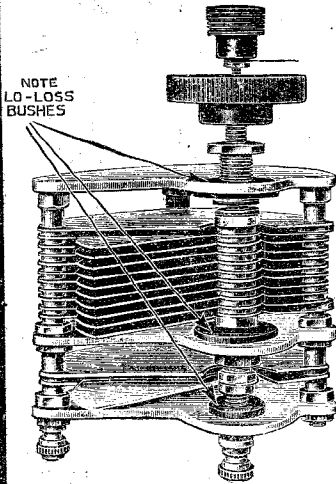

The only Condenser with the Low-Loss Bushes. Electrical losses reduced to a minimum. Full capacity as rated. Exceptional Low Capacity.

The Condenser for short wave-lengths. Why buy a Condenser without Vernier when one WITH costs no more.

*001 - - 8/9
*0005 - 7/9
*0003 - 7/-
Post 6d. Set.

SQUARE LAW with VERNIER
Including Knob and Dial.
Ebonite Ends 1/- extra. **TRADE SUPPLIED.**

"DE LUXE" MODEL
As shown, with Dial, Knob and Bush

*001 6/11	*0003 5/-
*0005 ... 5/6	*0002 4/9

POST 6d. SET.
Unsurpassed for Fine Tuning.

"NEW MODEL"
Startling Reductions

ORDINARY	SQUARE LAW
Aluminium Ends, Ebonite bushes	Aluminium Ends, Ebonite bushes
*001 6/6	*001 7/6
*0005 5/-	*0005 5/9
*0003 4/6	*0003 5/3

Ebonite Ends 1/- extra. All Complete with Knob and Dial. Post 6d. Set (3 Sets 6d.).

LONDON'S LARGEST STOCKIST OF JACKSON BROS. "J.B." VARIABLE CONDENSERS
Complete with Knob

SQUARE LAW	STANDARD
*001 9/6	*001 8/6
*0005 8/-	*0005 7/-
*0003 6/9	*0003 5/9
*0002 5/6	*0002 5/-

Other sizes as advertised by "J.B." Post 4d.

ACCUMULATORS
2 v. 40 amps. 9/6
4 v. 40 amps. 16/6
4 v. 60 amps. 18/6
4 v. 80 amps. 23/6
6 v. 60 amps. 27/6
6 v. 80 amps. 33/-
6 v. 105 amps. 38/6
Hart's Stocked. All High Quality.

EBONITE, 3/16 in.
Stock Sizes.
Cut to size 1/4 sq. in.
6 x 6 1/4
7 x 5 1/4
8 x 6 1/4
9 x 6 2/-
10 x 8 3/-
12 x 9 3/-
12 x 9 4/3
12 x 12 5/6
14 x 10 5/6
1/2 in. also Stocked.

Switch Arm, 12 Studs, 12 Nuts, 12 Washers. Lot 10/4d.

TAPPED INDUCTANCE COIL
for Chelmsford. A Real Bargain 1/6

WEDGE COIL PLUGS
Fitted Fibre 7d.
Various 7d., 8d., 9d.
Edison Bell 11d.
Plaincoil Plugs 4/d.
Also 5d., 6d., 7d. each.
Fibre Strip 2d.
(36 in. by 1 in.).
Empire Tape, doz. yds. 6d.

RAYMOND FIXED CONDENSERS
.001, .0001 to .0005 ... 10d.
.002, .003, .004 1/-
.006, 1/3; .01, 1/9; .02, 1-9
Ebonite Base Terminals.

DETECTORS
(Enclosed).
Micrometer 1/6
Hall Opal 1/-
Small Brass 8d.
Large Brass 1/-, 1/3
Nickel 10d. to 1/6
Burndept 4/-
Crystals Stocked, Neutron, Blue Tung-stalite, Permantite
Shaw's Genuine Hertzite 10d.
Uralium 1/-
All known makes.
4 Whiskers (1 gold) ... 2d.
Gold and Silver do. 2d.
7 Waxed Coils 1/8
5 Waxless Coils 1/3
For B.B.C.

SPECIAL!
Vernier 2-way Coil
Stands 3/6
Geared do. 5/3

BOXES from 1/11
7 x 5 9 x 6 12 x 9 14 x 10
8 x 6 10 x 8 12 x 10 etc.

H.T. BATTERIES
60 v. 7/6
30 v. 4/6
60 B.B.C. 8/11
30 B.B.C. 5/6
9 v. B.B.C. 2/6
1.5 (D.E.) 1/9
Eveready 66 v., 36 v., 108 v. stocked.

D.C.C. WIRE
per 1/2 lb.
18 or 20 g. 9d.
22 g. 10d.
24 g. 1/-
26 g. 1 1
28 g. 1/3
30 g. 1/6

BASKET COILS
Chelmsford 11d.
Also at 1/-, 1/3, 1/9
B.B.C. Duplex Wax-
less set of 5 1/9
Extra air space, 1/2 in.
(25, 35, 50, 75, 100).
Wave-lengths given.

SWITCHES
DPDT, china base 1/4
SPDT 10/4d.
Panel DPDT 1/-
SPDT 10/4d
Ebonite DPDT 2/3
SPDT 1/3
Tumbler 1/-
On and off 10/4d.

VALVE HOLDERS
Legless 10/4d.
Solid Rod 1/-
Climax 1/6
Murray 1/3
Under Panel 1/3
Templates 1/4d.

NEUTRODYNE CONDENSERS
Ormond 2/-
Colvern 3/6
Success 3/6
Vernier (Colvern) ... 2/6

SPECIAL!
VARIABLE CONDENSERS
Square Law with Knob and Dial
*0003 4/11
*0005 5/6
Callers' Price

SPECIAL!
Leatherette Boxes with Lid 2/3 and 2/11
Re-echo Crystal Sets 13/11

SPECIAL!
Fine Crystal Set, sloping leatherette Cabinet. Fitted for Chelmsford and B.B.C. Wonderful value 9/11
Variometer, Impregnated Board 1/6
With Clips 2/3
Formers from 4d.
(Impregnated)
Variometers, inside winding, Ebonite former, similar to Fallon, etc. 6/11

VALVES
Dutch Detectors 4/9
"R" type 4/9
.06 11/-
Phillips "R" 6/11
French "R" 5/11

RADIO MICRO .06
THE WONDER VALVE
H.T., L.T., or D.
3 volts 12/6

METAL .05
Be sure "METAL" is Stamped on Valve and avoid imitations.
One to each Customer at **10/11**
Regular Price 12/6

ALL VALVES REDUCED
(Marconi, Ediswan, Mullard, Cossor, Myers, etc.)

VARIOMETERS
Very Special 200/650 metres. All ebonite. Double silk wound callers only 4/-

TERMINALS (Complete)
W.O., Pillar, Phone, brass, 1d. each; nickel, 2d. each; stop and valve Pins, 1d.; nuts, various, 6 a 1d.
Valve Sockets 1d., 1 1/2d.
Flush Panel do. 1d.
Spade Tags 6 a 1d.
Do. Terminals 2 for 1 1/2d
Do. Pins 2 for 1 1/2d.
Screws and nuts 2 a 1d.
Switch arms 7d.
Nickel arms 10/4d.
Studs, complete 2 a 1d.
Phone connectors 1d.
2 B.A. Rod ft. 2d.
4 B.B. Rod ft. 2d.
Valve windows 4d.
Washers 12 a 1d.
Shorting plug and socket 3/6
Shellac 5d.

H.F. TRANSFORMERS
For Chelmsford 2/9
For B.B.C. range 2/6
Energo, McMichael, Bowyer-Lowe stocked.

MANSBRIDGE FIXED T.T.C. GREEN
.25 2/9
1 mfd. 3/6
2 mfd. 4/6

CONCERT COILS
Set of 5: 25, 35, 50, 75, 100, 10/- set.

Var. gd. Leaks 1/-
Fixed 2 meg. 9d.
Battery Links 3 for 2d.
Ins. Hooks 2 for 1 1/2d.
Egg Insulators 1d.
Reel 2 for 1 1/2d.
Ins. Staples 5 a 1d.
6 ft. phone cords 1/- 1/6
Sleeving 3 yards 9d.
Tinned Copper 18 g. 5d.
Bus bar, hank 6d.
Knobs, 2 B.A. 2d
Wander Plugs 1 1/2d.
Strip Aerial, 100 ft. 2/-
7/22 Heavy, 100 ft. 1/11

COIL STANDS
Ebonite 2-way 1/9
With ex. handles 2/3
Nickel 2/8
3-way from 3/11
Basket Holders 8d.
Best quality 1/-
Basket Spikes 7d., 9d.
Anti cap. handles 9d.
Lead-in Tubes 6d.
Sorbo Ear Caps pr. 1/3

FLEX
2-colour doz. yards 1/6
Lighting doz. yards 1/6
Twin silk doz. yards 1/-
Lead-in, thick, yd. 3d.
Do., good, 10 yds. 1/-

Rheostats 1/-
Ormond 1/9
Ebonite Former 1/6
With dial 1/11
Shipton, Iganic, Burndept, McMichael, etc., etc., etc.

SPECIAL!
Customers purchasing 20/- worth of our own goods (at full prices only) are allowed to buy a first-class pair of phones for 5/-, 4,000 ohms, as an advertisement. One pair to each customer. This offer must be taken advantage of at time of purchase.

CRYSTAL SETS
For 5XX and 7/11 B.B.C.

K. RAYMOND WIRELESS DEPOT

27, LISLE STREET, W.C.2
PHONE: GERRARD 4637

RIGHT OPPOSITE
DALY'S
GALLERY DOOR

HOURS OF BUSINESS:
DAILY - - 9 to 7.45
SUNDAYS - 10 to 1

No responsibility accepted on post orders unless cheques and postal orders are crossed and made payable to the firm. Money sent must be registered

Sensitive?

HERE'S PROOF

Lisbon.

You may be interested to know that one of our customers has heard Chelmsford, 5XX, here on a crystal set using your 'phones, and he states that he could hear nothing with a pair of adjustable 'phones of well-known English make.

Mascarenhas & Co.

Comfortable?

READ THIS

Sutton St. James.

I think them the most perfect and comfortable 'phones on the market. I have tried nearly a dozen different makes, most of them dearer to buy, but believe me, General Radiophones beat the lot.

J.—, H.—, B.—.



Weight 7 ozs. with cords. The finest Headphones at any price.

20/-

GENERAL RADIOPHONES

FAMOUS FOR EFFICIENCY



ISSUED BY THE PUBLICITY DEPARTMENT OF THE GENERAL RADIO COMPANY LTD., RADIO HOUSE, 235, REGENT STREET, W.1.

PHONES, 4,000 OHMS

Special Line	7/9
Telefunken	8/6
Lightweight adjustable diaphragms	18/3
Telefunken Featherweight	12/6

NESPER (Pattern)

Foth (Nesper Pattern) adjustable diaphragms	10/6
Dr. Nesper	12/6

LOUDSPEAKERS

Telefunken Jewel	18/6
Telefunken Pearl	32/6

On 3 days' Trial. Money returned in full if dissatisfied.

VALVES

Dutch	3/11
Radio Force	4/3
Marconi	11/-
Cossor	11/-
Phillips	7/6
Radio Micro	10/6

All valves on post at purchaser's risk.

Square Law Condenser .0005	7/6
----------------------------	-----

Variometers	2/6, 2/11, 3/6
Voltmeter	5/-
Combined Voltmeter and Ammeters	6/-

AERIAL WIRE

Ribbon Aerial, 100 ft. K Brand	2/3
7/22 Hard Copper	2/3
5/26 " "	1/11
Electron Wire	1/8

CRYSTALS

Tungstalite	1/6
Hertzite	1/-
Neutron	1/6

Special Lightning Switch	1/3
--------------------------	-----

H.T. Batteries, 60 Volt	6/9
Pocket Batteries, doz.	4/6
Cases to take 14 Batteries	5/6

Fluxite 8d. Outfits	7/6
---------------------	-----

Rawplug Outfits	3/6, 5/-
-----------------	----------

LOUDSPEAKERS

Ultra	27/6
C.A.V. Tom-tit	30/-
Amplion Junior	27/6

Chelmsford Coils	1/9
Sets Basket Coils	1/9 1/11
	2/3 3/6

Mounts for same, each 10d.

TRANSFORMERS

Croix, 12/6; Igranic,	21/-
R.I.	25/-

Grid Leaks	2/-
Lissen Grid Leak	2/6
Phone Cords	1/6

Phone Terminals, with nuts	1d.
Terminals, with nuts	1d.
Extra Large, with nuts	1 1/2d.
Crystal Cups	2 for 1 1/2d.
Crystal Cups, Improved	1 1/2d.
Shellac Varnish	9d.
Valve Legs, with nuts	1d.
Valve Sockets, with nuts	1d.
Spade or Pin Terminals	1d.
Switch Arms	7d.
Studs, with nuts	doz. 6d.
Stops 2 1d. Wander Plugs	4d.
Twin Flex	yard 2d.
Lead-in Wire	2 1/2d.
Earth Wire	2d.
Adhesive Tape	3d.
Insulated Hooks	each 1d.
Insulated Staples	doz. 3d.
Panel Transfers	sheet 4 1/2d.
Sleeving yd. 3d. Rheostat	1/10
Solder for Panels	stick 3d.
1/8 Square Panel Wire,	doz. 1/6

ORDERS OVER 2/- CARRIAGE PAID.

TELEPHONE:
NORTH 2351

HENRY KENNETT

11, LIVERPOOL ROAD, ISLINGTON, N.

ESTABLISHED
1861

On Your Wavelength!

2 L O

HAS anyone noticed how much louder 2 L O has become lately and how much more difficult to tune out on an ordinary set within fifteen miles of the transmitter? Whether the power has been increased or not I do not know, but lately I have been getting reception quite comfortably at loud-speaker strength with a detector valve—without reaction—followed by one note magnifier, whereas I invariably used to use two note magnifiers.

Incidentally, the quality of reception seems to have improved. I have been noticing some curious effects when long extension leads are used for loud-speakers. Assuming a loud-speaker is being used in the room where the set is and then one is plugged in downstairs the result is, of course, to throw the aerial tuning out and necessitate retuning. This is not unusual. But I have noticed lately that if the speaker with the long lead is taken out of circuit and the one in the room put back, the tuning does not, as might be expected, return to its original constants. It remains as it became when the long lead was plugged in. In other words, by using the long extension you have put up the wavelength of the receiving circuit *permanently* and the removal of the long lead does not put it down again. To return the receiving circuit to its normal wavelength value it is necessary to cut off for a moment and then switch on again. I am going to try some experiments on this when I find the time.

Amateurs' Splendid Work

Hardly a week passes without our seeing in the newspapers an account of a marvellous feat of transmission and reception accomplished by some amateur wireless enthusiast. To-day, for instance, I see it recorded that Mr. Simmonds has added to his laurels by accomplishing telephonic working with an Australian amateur, Mr. Howden, whose station is near Melbourne, 10,000 miles away. This is not the first time that the spoken word has been conveyed by wireless between this country and the Antipodes, for some time ago Senator Marconi was heard in Australia when he was conducting experiments from Carnarvon with his beam system of transmission. It is, I believe, the first time that the thing has been accomplished by the ordinary broadcast form of transmission and with the tiny power that amateurs are permitted to use. Another well-known amateur, Mr. Marcuse, has succeeded in establishing communication with the wireless operator of the scientific expedition which is now far from civilisation in the wilds of South America. Some

of the finest work in wireless has, as a matter of fact, been done by the amateur. The restrictions imposed upon him have made it essential for him to obtain the utmost efficiency in order to get results with his small outfit.

Good Conditions

Conditions for American reception have been extremely good of late, as I dare say many of you have noticed. Sitting up the other night I was able to pick up no less than five stations, getting K D K A, W B Z and W G Y all at very fair strength on the loud-speaker. There was so little interference from atmospheric, mush or spark signals that the transmissions came through quite as well as those of our own more distant broadcasting stations usually do. One of the best American stations, I think, is W H A Z, but he is unfortunately not an everyday transmitter, and I never can remember which is his particular night. The result is that if I do pick him up I generally do so by accident. His wavelength is 380 metres, which is the same as that of W G Y, so that one cannot get him well unless the latter station happens not to be working at the time.

No Need to Stay Up Late

Though, as I say, I made a night of it, it is often possible to hear quite a lot of American broadcasting without staying up very late. W B Z, whose wavelength is 337 metres, gives a concert at 11 p.m. Greenwich time, and K D K A, 9 metres lower down the scale, opens his musical programme a quarter of an hour later. W O R, on 405 metres, starts at the same time as K D K A, but W G Y is not usually to be heard until a quarter to one in the morning. On a dark overcast night, provided that atmospheric are not bad, one can often pick up American stations as soon as our own close down. Conditions generally improve as time goes on, the best period being often that between 2 and 3.30 in the morning. It is very curious to notice how the strength of these transmissions as received in this country varies from night to night. When conditions are really good many of them come in so strongly that they are as easy to tune in at my station as Aberdeen, Belfast or Hamburg. On these nights the loud-speaker can be brought into use, and sometimes it has to be toned down in order to avoid waking the rest of the household. On other nights I cannot get beyond telephones, and when conditions are really bad one hears either nothing at all or sounds so faint that they are only just identifiable as those of speech or music. Sometimes, too, fading is so pronounced,

especially with W G Y, that signals are roaring in at one moment and at the next they begin to die away, becoming finally quite inaudible.

Although I have received the American stations scores of times I always feel the same thrill of wonder when I manage to pick one of them up and hear what is being said. The other night one station—I forget which it was, but I think it was W G Y—was relaying part of a play acted in New York, and I realised that I was hearing words spoken upon the stage before they reached the ears of members of the audience sitting in the second row of the stalls.

Those Reflex Circuits

I got into very serious trouble a few months ago for speaking disparagingly of reflex circuits. I was inundated with correspondence, and one fiery gentleman in the Midlands challenged me to demonstrate that two reflex circuits side by side on outdoor aerials would not cause interference. I should like him to spend an evening or two with me and I could demonstrate that one such circuit at least is causing a great deal of disturbance in the ether in that little corner of the earth wherein I eat, sleep, write and listen-in. Every time that this particular aversion of mine adjusts his catwhisker I get the full blast of what sounds like a couple of watts of H.F. current from his aerial. His catwhisker is particularly troublesome, at least so it appears, and the whole evening is cut up into a series of horrible screams, growls and grunts from his nasty receiver. I learned quite recently that his set will not work without 120 volts H.T. being applied to the anodes of his valves, and I quite believe that he is speaking the truth! One of our well-known amateur transmitters has transmitted over a distance of 250 miles using such a plate voltage—two miles to a volt.

Canadian Transmissions

The Canadian station C N R A reached England. It is surprising that she did. The usual battery of oscillators, hundreds of morse stations, and Northolt's mush did their best to prevent any reception. One amateur telephonist even chose the exact wavelength of C N R A to discuss problems of modulation. But can anyone tell me why, if any special test is to be carried out, Heaven knows how many morse stations should suddenly appear on the wavelength of the station testing? They are not there normally. Really the problem is becoming acute. Something must be done to restrain both professionals and amateurs from doing their worst in this manner.

On Your Wavelength! (continued)

On normal occasions several U.S.A. stations can be brought in with ease, but when anything like a test is being carried out, the ether becomes one bedlam of noise, every possible source appearing to combine to render the test a failure. If wireless is ever to be anything other than an academic experiment, then something must be done to make stations more selective and to prevent indiscriminate transmitting on any wavelength the operator wishes to use. It is not impossible to keep stations so sharply tuned that no interference is caused.

Northolt

The recent letter from E. W. W. (Coventry), published in the correspondence columns of this paper, is interesting inasmuch as it substantiates the statements I have made from time to time regarding the interference occasioned by Northolt. There is, of course, no doubt that E. W. W. is correct in his statement that Northolt can be heard right down the broadcast band. He may be interested to know, as, no doubt, will many others, that already considerable improvement has been effected in this interference and that the Post Office have promised to look into the matter. It really is a matter of national pride that our stations should not be behind those of every other country. Commercial stations in England do not cause so much interference as do the Post Office stations, and it is time the latter were brought up to a reasonable standard. If publicity can effect this—and it certainly has some influence—we should not be long before we see a change.

The Amateurs

The ether is remarkably clear on the band of wavelengths from 150 to 200 metres nowadays, and I suppose that many people who are not "in the know" have concluded that the amateur has become as extinct as the proverbial "dodo." One evening I did hear 2XR and 2QQ carrying on in their usual breezy fashion somewhere about 200 metres; 5DY and 6YG were also busy. For two hours these were the only amateur stations it was possible to pick up on this (one time) congested wavelength. An examination of the transoceanic wavelength (93 metres and upwards) also failed to bring to light any "brass pounders," so that I concluded that they were all in bed preparing for the early morning tests. This reminds me that I called upon one transoceanic enthusiast a week or so ago about three o'clock in the afternoon, but I found him in bed, getting ready for an "all-night sitting."

The amateur transmitter is not extinct; he has merely hibernated, and when all hope of getting across the Herring Pond vanishes with the arrival of the longer

days we shall find him once again perched on the old 200-metre wavelength.

On "Perching"

By this sub-title you will perhaps think that your THERMION has turned his attentions to fields of labour other than wireless, but "perching" is not in this case connected with an aquarium. "Perching" is an offence in the transmitting world, and it is a word coined by the amateur when referring to calculated jamming. I remember that in the good old days of "brass and sparks" that "perching" was often resorted to when it was desired to quieten an unruly station or one which was taking up more than his fair share of ether. The offended station would then change his wavelength to that of the offender, and he would "perch" himself beside him on that wavelength until the other was forced to desist and give his fellow transmitter a little time for transmission.

Needless to say that the tuning of spark transmissions at that time was so flat that it was not necessary to "perch" very close to a station in order to make his signals unreadable, and it was an effective method of preventing a "hog" station from taking more than his fair share of the time available for experiments.

With the advent of sharply tuned valve transmitters "perching" is extremely difficult and unnecessary. The expensive upkeep of a transmitting valve in accumulator "juice" is generally a limiting factor that cannot be altogether disregarded even by the most selfish of transmitters. Thus "the old order changeth—"

The "Squeak" Method

A writer in a daily newspaper has advised readers to tune in distant stations by the "squeak" method; that is, to couple up the coils sufficiently tight as to produce oscillation and then to search for the carrier of the wanted station. The article was headed "Shooting Stations," and if the writer himself has been pursuing the practice advocated it is rather surprising that some person or persons have not "shot" his station long ere this. To search for a station in this manner is an extremely selfish procedure, and, moreover, the terms of the listener's licence forbid him to do so. So, dear reader, please leave the "squeak method" alone and try something less offensive.

DX Work

It has long been my opinion that some of the extraordinary results that have been achieved in long-distance reception during the winter have been due more to an unusual state of the atmosphere than to any marked improvement in apparatus, either receiving or transmitting. Certainly it has

seemed that the improvement in results has more than kept pace with the improvement in apparatus. However, I wonder if my recent experiences with Transatlantic broadcasting have been shared by other listeners. I have found during the past few days that reception in England of U.S.A. stations has completely altered in character, much as it did some months back when a station like KDKA, working on the short wave, could not be heard at all over a considerable period. The strength of the carrier wave seems still as good as ever on KDKA and WGY, and also atmospherics do not seem too greatly in evidence, yet somehow the modulated signals are not coming in as they should. KDKA on her 60-odd metre wave is the worst offender. A background effect is audible which has completely spoiled my reception of this station for some days past. It consists of a vibrating noise much like that made by an express train passing over the joints in the lines. Very nearly every electrical fitting in my house has received attention, but the noise still persists. It does not appear to emanate from either my receiver or anything connected with the locality.

To make things worse this particular station is again receiving the attention of an experimenter with a supersonic heterodyne receiver, with the result that a pleasant wailing noise of rather high pitch is assisting the original transmitted wave to vary up and down the scale rather like the rectified A.C. waves of some experimenting transmitters.

I have an idea that the recent exceptional conditions have come to an end. The future may prove me wrong—I hope it does—but I am inclined to think that the days of American reception on one valve are done with for a time at least.

The Same with a Difference

What is the difference between a musical comedy and a comedy with music? This is not a cross-word puzzle and no prizes are offered, but I think the answer will be found to-morrow night at the Leeds-Bradford station when *The Maid of the Inn* is to be performed. Written by Mr. Cecil Moon, pianist and director of the Harrogate Royal Baths Quartet, it possesses a real plot; and that is the answer.

Talks Unlimited

There are too many talks in the B.B.C. but to-morrow Sir Francis Younghusband, the famous explorer, is going to tell Nottingham some of our tasks in India, and we can stand much from the man who really knows his subject. If only we could dispense with some of those afternoon feminine boxes at 2 L O a revolution in wireless interest would be made.

THERMION.

INDUCTANCES—IN THEORY AND PRACTICE

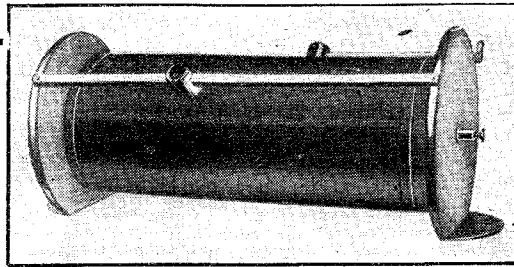

WHEN a direct current of electricity flows through a wire the only factor that affects the current is the resistance of the wire. Certain kinds of wire are much more *resistive* to electricity than others. Moreover, the resistance of any particular kind of wire depends upon its length and thickness; the longer the wire the higher its resistance, and the thicker the wire the lower its resistance. When an alternating, or oscillating, current is passed through a coiled wire, however, a new factor is brought into play—to wit, "inductance."

By an alternating current we mean a current which changes its direction at a definite number of times per second—or, as we say, at a definite frequency. An oscillating current is merely an alternating current which does this at a high frequency. (For this reason we sometimes distinguish between oscillating and alternating currents by describing them as "high-frequency" and "low-frequency" currents. What follows applies equally to both kinds.)

Oscillating Current

Now, when an oscillating current of a certain frequency flows in a circuit, it may, or may not, experience some difficulty in changing its direction *at that frequency*. It may be oscillating too quickly, or too slowly, for the particular circuit in which it flows. In quite a different circuit, on the other hand, it may experience no difficulty whatever in oscillating at its ordinary frequency. What is it that makes one circuit suitable and another unsuitable for a current of a given frequency? The answer is: *the inductance of the circuit*. The facility with which a current of a given frequency can oscillate in a circuit depends upon the inductance of that circuit.

Natural Frequency

Let us look at the matter from another point of view. When an oscillatory current flows through a wire, we say that that wire is oscillating. Now, every wire tends to oscillate at a certain "natural" frequency of its own. A long wire has a natural tendency to oscillate at a low frequency, and a short wire has a natural tendency to oscillate at a high frequency—just as a long piano wire has a natural tendency to *vibrate* at a low frequency, whilst a short piano wire has a natural tendency to vibrate at a high frequency. When we want to oscillate a wire, therefore, at a given frequency, we cut the wire to such a length that its own natural frequency will be the same as the frequency of the electrical oscillations we are going

to pass through it. In this way we make it as easy as possible for the oscillations to take place in the wire, and thus prevent any undue waste of energy. There is always energy wasted in trying to make a wire oscillate at any frequency other than its own natural frequency.

frequency equal to the frequency of the received waves. If it possesses less, or more, than this amount of wire, some of the energy of the received waves will be wasted in trying to make it oscillate at an *unnatural* frequency, and signals will be proportionately weaker. The ideal aerial, therefore, will be one which can be made

longer or shorter at will and with a minimum amount of trouble. In practice this ideal is achieved by the simple method of attaching a coil of wire to the lower end of the aerial—the end that enters the house—and connecting the two together in such a way that any desired amount of the coil can be added to the aerial by the operation of a small switch.

The Inductance in Practice

The process of altering the length of an aerial so that its natural frequency is made equal to the frequency of the waves which strike it is called "tuning." This, as has been stated, is effected by means of a coil of wire, and such a coil is known variously as a "tuner," an "inductance," a "tuning coil," a "variable inductance," a "variable tuner," etc. There are several kinds of these coils, and many ingenious devices have been invented for the purpose of making them "variable."

An ordinary aerial, before it can receive signals, must be connected to earth. The tuning coil must therefore be inserted in the aerial wire at some point along the latter before it reaches the earth. Fig. 1 shows one method of connecting a variable tuning coil to an aerial. Several turns of wire are wound on a cardboard cylinder, and a connecting wire is taken from some turn to a metal stud, several of which are fitted on the panel in a semicircle. A revolving switch *S* can be brought into contact with any of the studs, and in this way variable quantities of the coil can be added to the aerial. For instance, when the arm of the switch rests on stud No. 4, five turns of the coil are connected up to the aerial. The currents received in the aerial flow down the latter to No. 1 stud, through the first five turns of the coil to stud No. 4, along the metal arm of the switch, and thence to earth. It is always desirable that the tuning coil should be inserted as close as possible to the lower end of the aerial. In other words, the wire that connects the switch to earth—the "earth lead," as it is usually called—should be as short as possible. A coil of this description is known as a "tapped" coil. Although there are many minor ways in which its form may be modified, the principle on which it works is the same.

(Continued at bottom of next page)

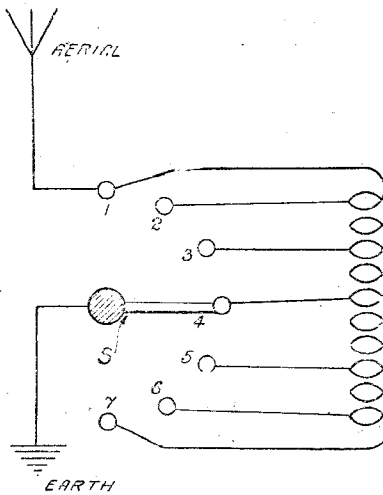

Fig. 1.—Diagram of Variable Inductance Connected to Aerial.

When we consider this elementary fact in relation to aerials it becomes obvious at once that if an aerial is to receive waves of a certain frequency it must possess a certain amount of inductance—or, if we like to regard it from the other point of

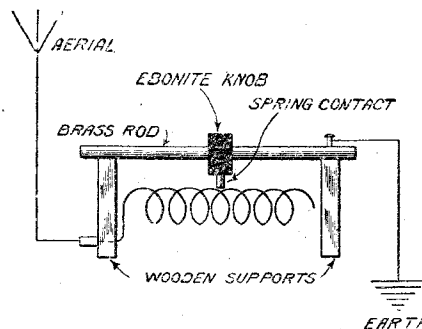

Fig. 2.—Diagram of Slider Inductance Connected to Aerial.

view, it must contain a certain amount of wire. In order that there shall be no unnecessary waste of energy a receiving aerial must contain just that amount of wire which will make its own natural fre-

AN EXPERIMENTAL PANEL

VERY few amateurs who make up their own sets are satisfied with their first results, so it is a wise plan to first construct an experimental panel of wood upon which to try various circuits.

he can fall back upon his experimental panel, and by purchasing very few extra parts, try various circuits without altering to any serious extent the finished set.

Figs. 1 and 2 show a suggested experi-

two wires from condensers to coils and the wire from rheostats, which it will not be necessary to change.

Fig. 3 is a method of making valve-holders which will enable the wires to be

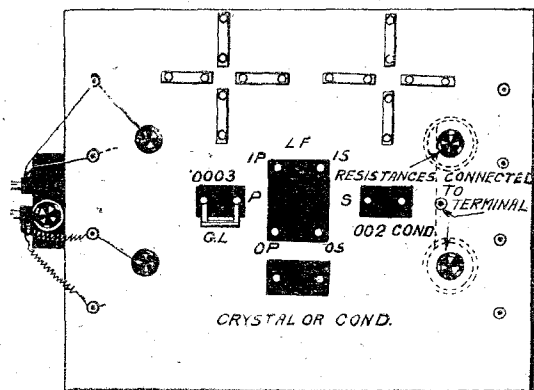

FIG. 2

In this way money will not be wasted, but the experimenter, after deciding upon the best circuit, will be able to make up a neat and efficient set with an ebonite panel.

Again, should the craving for experimenting return, which it assuredly will,

mental panel with the necessary components to wire up practically any one- or two-valve circuit, and there should be plenty of room should any other part be required.

The panel is 1 ft. 3 in. by 1 ft., and the wiring is all upon the surface, except the

Fig. 1.—Elevation of Panel.

Fig. 2.—Plan of Panel showing Position of Components.

Fig. 3.—Simple Valve Holder.

Fig. 4.—Another Valve Holder.

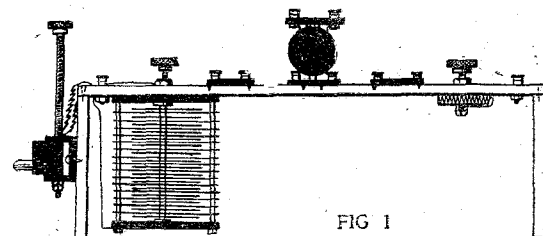

FIG. 1

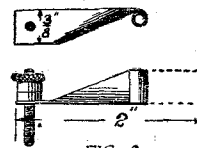

FIG. 3

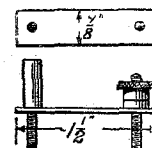

FIG. 4

easily and quickly changed. It consists of a piece of sheet-metal twisted and bent round at the end and firmly held by the terminal.

An alternative way is shown in Fig. 4, which is self-explanatory. A. L. E.

"INDUCTANCES—IN THEORY AND PRACTICE" (continued from preceding page)

Another simple form of variable tuner is that known as the "slider" coil. The principle on which this type of coil operates is shown in Fig. 2. A coil of wire is fixed between two upright wooden supports. A brass bar stretches from one support to the other at a distance of about 1/4 in. above the coil. An ebonite knob rides on this bar, and a small spring contact, which protrudes from the bottom of the knob, presses down on the wire of the coil. A coil of this kind is usually wound with enamelled wire, the purpose of the enamel being to prevent the turns of the coil from making (electrical) contact with one another. The enamel, however, is scraped off the top surface of the wire so as to allow the spring contact to make electrical connection with it at any point.

The spring contact, it should be mentioned, also presses against the brass rod inside the ebonite knob. When the knob is pushed into any position along the rod, therefore, the spring contact connects the latter with the turn of the coil upon which the contact rests. But the brass rod, as shown in the diagram, is connected to earth, whilst the left-hand end of the coil is connected (through one of the wooden supports) to the aerial. Thus any desired amount of the coil can be inserted between the aerial and earth by sliding the ebonite knob along the brass rod. A

typical design of such a coil is shown in the photograph.

The inductance of a wire, it may be added, depends upon its shape as well as upon its length. Equal lengths of wire, when wound on drums of different shape, have different inductance values. M. E.

CRYSTAL MEMS

REMEMBER that crystals do not function well if covered with dust and dirt. Remember that most crystals should have a light springy contact.

Remember that carborundum may be used where a stable detector is desired.

Remember that perikon detectors are not suitable in many reflex sets.

Remember that carborundum needs an applied potential for best working.

Remember that crystals should not be handled with the fingers.

Remember that it is not essential to use a large crystal for loud signals.

Remember that a flat silver strip should be used in conjunction with molybdenite.

Remember that carborundum-silicon is an excellent combination of crystals.

Remember that a crystal does not detect

well if preceded by many H.F. amplifiers.

Remember that good contact between the crystal and the cup is essential.

Remember that solder is not suitable for fixing crystals.

Remember that a clean catwhisker is essential for best results.

Remember that crystals are affected by heat.

Remember that it is always preferable to use a catwhisker of some metal which does not oxidise readily.

Remember that insulation in the crystal detector is important.

DISTORTION IN LOUD-SPEAKERS

SOME loud-speakers are inclined to reinforce or accentuate certain notes or tones above others, thus ruining otherwise perfectly good reception, and it is sometimes thought that this distortion must always be associated with the horn type of loud-speaker. Such, however, is not the case. The way to avoid or at least diminish this trouble is to pierce holes the length of the horn at the half-way point, the quarter and the eighth distance from the direction of the narrow part. This will tend to reduce resonance in the horn, and the usual gramophonic type of distortion will be greatly reduced. S. S.

T. W. THOMPSON & CO.

Government Surplus Depot

39-43 LONDON STREET, GREENWICH, S.E.10

Telephone—Greenwich 1259.

Agents for Brighton District: A. J. HILL & CO., 8, YORK HILL, BRIGHTON

We are open to accept offers for large quantities of these goods.

THIRD CLEARANCE SALE owing to Expiration of Lease of Stores

(500 Hydrometers, to clear, 2/- each, post 3d.) (200 Pairs Prismatic Binoculars, all best makes, 30/- a pair, post 1/-.) (250 Pairs Field Glasses, cost £4, to clear, 20/- each, post 1/-.) (100 Gunsight Telescopes, 10/- each, post 1/6.) (10 Austin Twin Petrol Electric Generating Sets, 2½ k.w. 110 Volts 23 Amp., in new condition, £40 each.) (500 T.V.T. High Tension Units, Input 6 Volts, Output 1,000 Volts, complete with Transformer and Condensers, etc., 15/- each, post 1/3.) (2,000 Telephone Cords, Various Colours, 6-8 ft. long, 6 complete cords, 1/-, post 6d.) (Special Offer, 1,000 Brand New Fuller Block Accumulators, 2 Volt 120 Amps., all under guarantee, 15/- each; 4 Volt 120 amps., 30 -; 6 volt 120 amps., 42/- each.) (150 Pairs 4,000 ohm Headphones, brand new, 8/- pair, post 9d.) (500 Chloride Accumulators, 2 volt 20 amps., brand new, 4/6 each; 4 volt 20 amps., 9/-; 6 volt 20 amps., 13/-, post 6d., 9d., and 1/-.) (100 2-Valve Transmitting Sets, complete with condensers, wound leak tuning coils, etc., etc., 25/- each, post 1/-.) (500 New High Tension Batteries, 60 volts, all guaranteed, 7/6 each, post 1/3.) (2 Tons Wireless Scrap material, consisting of odd receivers, Ebonite, Terminals, Coils, Wire, Damaged Instruments, Meters, etc., etc. Useful to all amateurs for experimenting, 9 lb. 6/6, post 1/-.) (200 Mk.III. 2-Valve Receiving Sets, high grade instruments, wavelength 100-1,800 metres. The finest set the government used, guaranteed to receive all British and Continental Broadcasting, to clear, £4 10 each; 2 valves given away free with each, pass. train 2/6.) (50 Brand New M.IV. 3-Valve Amplifiers, complete with 3 Intervale Transformers, 1 Telephone Transformer, Condenser, Stud Switch, etc., etc., £3 each, post 1/3.) (300 Brand New Intervale Transformers, the very best to be obtained, 12/6 each, post 6d.) (2,000 Dewar Switches, 2/- each, post 3d.) (400 Brand New I.M.F. Condensers, 2/- each, post 3d.) (400 Worm Geared Potentiometers, 400 ohm, all new panel mounting, 4/- each, post 6d.) (2,000 Single Earphones, all tested, perfect to clear, 1/3 each, post 3d.) (500 Choke Coils, 500 ohm iron wire enclosed core, 2/6 each, post 3d.) (1,000 7-Piece Terminals, 4 B.A., all new, 2/- per doz., post 4d.) (200 Weston Super Sensitive Relays for recording Morse, etc., 12/6 each, post 1/-.) (4,000 yds. Heavy Flex, useful for long extensions, etc., without loss of signal strength, all new, 2/- per doz. yds., post 4d.) (2,000 yds. Lead-in Wire, heavy vulcanised copper, 2/- per doz. yds., post 4d.) (2 Mile Single Tinned Copper Wire, rubber covered, as used for wiring ex-government wireless sets, 1/6 per doz. yds. new, post 3d.) (10 Mile Bare Copper Earth Wire, 6d. per doz. yds., post 2d.) (600 50-ft. Lengths 7 Strand Aerial Wire, 1/- per length, post 3d.) (600 lb. Copper Pyrites Crystal, to clear, at 1/- lb., post 6d.) (2,000 yds. Positive and Negative Coloured Flex, 2/- per doz. yds., post 3d.) (200 Microphone and Telephone Transformers, ¾-lb. silk wire on each, 3/- each, post 6d.) (200 Copper Earth Mats, 20 ft. x 2 ft., a perfect earth, 12/6, post 1/6.) (500 Heavy Morse Practise Keys, cost 20/- to clear, 2/- each, post 3d.) (3,000 Brand New Ebonite Earcaps, 2/- per doz., post 6d.) (400 R.A.F. Spark Transmitters, complete with Tuning Helix, 100-600 meters, 1-in. Sterling Spark Coil, Condensers, Spark Cap, Ebonite Panels, etc., cost £12, to clear, in new condition, 12/6 each, post 1/6.) (50 Moving Coil-Mirror Reflecting Voltmeters, 0-1,000, 70/- each.) (100 Voltmeters, 0-25 Mirror Reflecting Laboratory Instruments, 35/- each.) (300 H.F. Aerial Ammeters, 0-1.5, 7/6, post 1/6.) (500 Oak Valve Boxes, to hold 3 Valve, all padded, 9d. each, post 6d.) (20 Paul's Station Tester Wavemeters, range 100-3,500 meters, £5 each.) (2,000 Loud Speaker Bobbins, all wound to 2,000 ohms, all tested, 6d. each.) (4,000 Egg and Shell Insulators, 1/- per doz., 8/- per gross.) (400 R.A.F. Tuners, complete with variable condensers, 6/- each, post 9d.) (600 Brand New French R. Valves, a fine amplifier to clear, 6/6 each, post 6d.) (500 M.III. Star Tuning Coils, Tapped 100-700 Meters, Ebonite former, 4/- each, post 6d.) (100 M.III. Star Crystal Sets, the finest selective tuner to be obtained, cost £40, to clear, 70/- each, pass. train, 3/6.) (1,000 Condensers, .025 Mica Dielectric, 2/- per doz., post 3d.) (100 G.R.C. Variometers, range 100-700 meters, brand new, list price, 17/6, to clear, 8/- each, post 6d.) (1,000 Standard Telephone Plugs, to clear 1/- each.) (400 Newton Voltage Regulators, 2/6 each, post 6d.) (30 Power Buzzer Transmitters for transmitting via earth, complete with condensers, key, H.F. Ammeter Buzzer, etc., etc., 25/- each, carriage 2/-.) (25 Slightly Damaged Naval Crystal Sets, to clear 20/- each.) (100 Telephone Hand Generators, useful for testing, etc., 5/- each, post 9d.), etc., etc., etc.

ORDERS FROM ABROAD MUST BE ACCOMPANIED BY EXTRA POSTAGE

"BELLING-LEE" Indicating Terminals

Heads cannot screw off.

Grips a spade tag for flex.

Standard 4 B.A. Stem.

Brass, 3/8d. each.
Nickel, 4/2d. each.

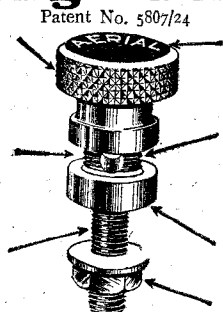

Tops engraved in White on Black. 16 Indications.

Hole to Grip a phone tag or solid wire.

Serrated bottom prevents working loose.

Complete with nut and washer.

"BELLING-LEE" Plug & Socket Terminals

Recessed to take end of flex covering.

Internal all-metal 4-jaw chuck to grip any wire from 14 S.W.G., to 40 S.W.G.

Dome-shape indicating discs in red and black. 16 engravings.

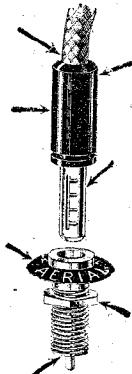

Shock-proof insulation handle in red and black.

Transverse spring tongues pressing outwards, ensuring definite contact at many points.

Complete with fixing nut.

Soldering lug.

Price 7d. per set.

M.K. Pat. No. 205090 & 28743/24.

Your dealer can supply you. In case of difficulty, write direct to—

BELLING and LEE, Ltd., Queensway Works, Ponders End.

HULLO!! C.Q., WILL DAY CALLING

TO-DAY GO TO DAY—IT WILL PAY

TANDCO BASKET COILS (100 to 4,500 metres.)
Duplex wound, 25 gauge D.C.C. wire, sewn supports unwaxed, very firm and strong, recognised as the finest type Coils yet made.

Size	1. 2 in., approximately	250 to 400	350 to 550	450 to 650	600 to 750	700 to 1,000	950 to 1,350	1,300 to 1,750	1,700 to 2,600
No. 1.	5d. each.	6d. "	7d. "	8 1/2d. "	10d. "	1 2 "	1 4 1/2 "	1 8 "	2/- "
Enamelled	2. 5d. each	3. 6d. "	4. 7d. "	5. 8d. "	6. 9d. "	7. 10d. "	8. 1/- "	9. 1/2 "	10. 1/4 "
	11. 1/6 "	12. 1/8 "							

COIL HOLDERS, 1/6 each

The new "Dayzite" Variable Condensers fitted with Aluminium End Plates, and both sets of Vanes adjustable. .001, 7/9 each; .0005, 5/8 each; .0003, 5/1 each; .0002, 4/7 each; Vernier 3/11 each. Postage 6d. each extra.

IF YOU WOULD SECURE IMMUNITY FROM LEAKAGE IN YOUR SET HAVE YOUR PANELS CUT TO YOUR SIZE FROM OUR FAMOUS EBONITE, ORDINARY FINISH, 4/6 PER LB., MATT FINISH, 5/- PER LB. AMERICA EASY ON ONE VALVE.

MAKE NO MISTAKE IN YOUR SELECTION. Do not keep wasting money on crystals of unknown repute. GET A CRYSTAL THAT HAS STOOD THE TEST OF TIME.

DAYZITE REGD.

Sold only boxed with Silver Cat's-whisker, 2s. 6d. each, postage 3d. extra. Makes excellent contact with Zincite for a Perikon Detector.

We had a call from a delighted customer recently who stated he received 2 L O at Brussels quite distinctly on a DAYZITE crystal.

Write at once for our new catalogue, post free by mentioning "Amateur Wireless."

WILL DAY, LTD.,

19, LISLE STREET, Leicester Square, LONDON, W.C.2
Phone: Regent 4577. Telegrams: "Titles, Westrand, London."



Contact Immediate - Perfect and Permanent

CERTAIN reception with as many headphones as you wish. Experimental circuits wired-up, tried and re-wired in no time. No more need for the messy soldering-iron.

These are the advantages you get with Newey Snap Terminals; although their adaptation is simplicity itself, their efficiency is proved.

- Contents of Complete Set**
- 8 Terminal Studs,
 - 6 Multi-Connectors,
 - 4 Coloured Connectors,
 - 8 Discs (Black, Red and Blue),
 - Phones + High Tension + Low Tension + Earth
 - Phones - High Tension - Low Tension - Aerial
 - Complete with Instructions
 - Price 2/-

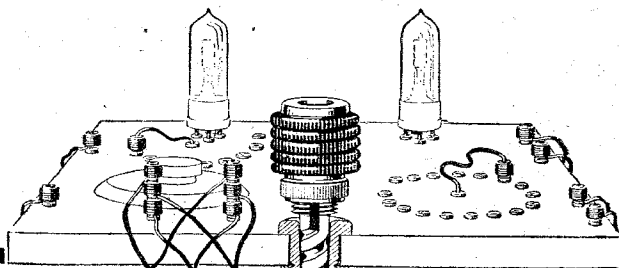

Solder all connections, Where you can't - Use CLIX!

CLIX PROVIDES AN IDEAL POINT FOR SOLDERING

Perfect contact—instantaneously—everywhere.

The tapered design of CLIX plugsocket ensures full surface contact in every one of its countless applications.

That's why CLIX, the Electro-Link with 159 Uses, supersedes all forms of Plugs, Terminals and Switches, and has standardised the wiring of all radio circuits.

Retail Prices

- CLIX with Locknut 3d.
- CLIX Insulators (6 colours) 1d. each
- CLIX Bushes (6 colours) 1d. pair

Obtainable from all Wireless Dealers or direct from the Patentees and Manufacturers:

AUTOVEYORS, LTD.

Radio Engineers and Contractors

84 VICTORIA STREET, LONDON, S.W.1

THE BIG THREE

MAKE WIRELESS WORTH WHILE!

RADIO-PLAN No. 1. Two Shillings. EVENING TRIPS TO AMERICA BY THE "P.P.V.2" ROUTE.

This Radio-Plan tells you how to build the most simple, powerful and successful long range set in the world. A Two Valve Wonder. Works loud speaker or carries 29 pairs of headphones within 30 miles. Receives all B.B.C., European and Continental Stations and
AMERICA EVERY NIGHT.

RADIO-PLAN No. 2. Two Shillings. YOUR OWN WIRELESS ORCHESTRA! A Bard in Your Home!

This Radio-Plan explains the building of the Big Super Set The "P.P.V.4." *Atlantic Volume of Perfect Melody.*

No Distortion. No Blare. No Rattle.

The "P.P.V.4" is the last word in Wireless. Receives all European Stations on loud speaker and at least one American programme at fair loud speaker strength. One, two, three or four valves can be used at will. Just a few very simple parts. No complicated wiring. Quite easy for any amateur to build.

No Crystal. No H.F. Nothing to Puzzle. The "P.P.V.4" is the Queen of all Circuits

RADIO-PLAN No. 3. Two Shillings. AMERICA ON ONE VALVE!

This Radio-Plan details the easy construction of "P.P.V.1" the simple super circuit, and the "T.C.1" the most simple and powerful regenerative circuit ever to have been designed.

With either you can tune-in all European and one American programme nearly every night. Both are as powerful as most two-valve circuits. Both require only a few parts costing a few shillings. One variable and a few fixed condensers wired in a certain way. Result—Miracles.

Either or all of the above sent direct by return post on receipt of remittance.

The Big Three Make Wireless Worth While

PRESS EXCLUSIVES (Wireless Publishers)
2 Wine Office Court, Fleet St., London, E.C.4

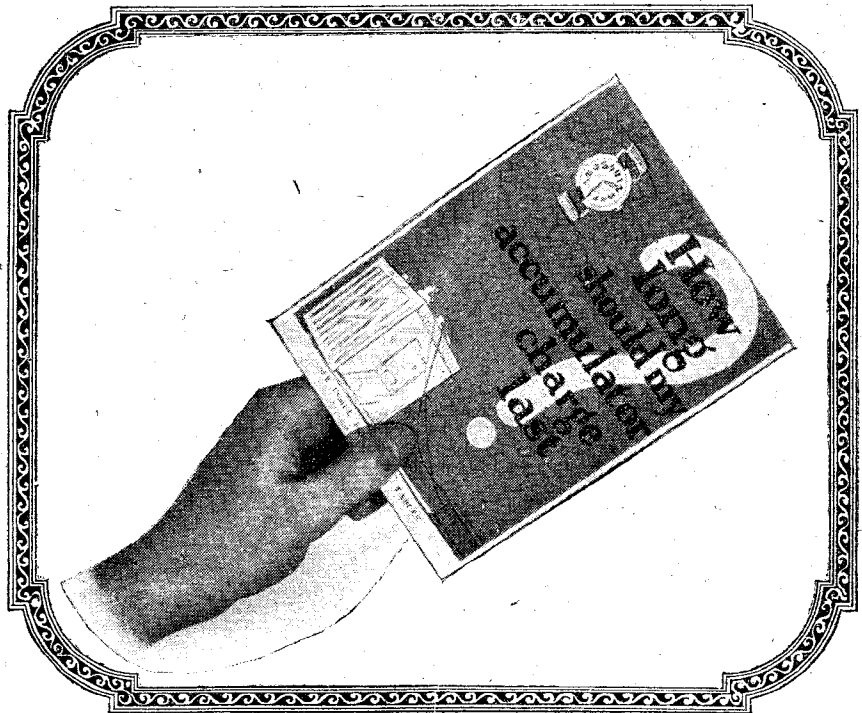

Send for this Useful Booklet

Send a postcard for this useful booklet. Gives number of hours your accumulator charge should last for various types of valves, also characteristic curves and particulars of valve repairs. Every amateur wants to know these things. Send a postcard at once, and we will send you this useful booklet free.

RADION VALVES Prices Reduced.

Radion D.E. .06

Filament, 3 volt .06 amp.
Anode, 20-100. One of the best valves of the very dull emitter class ever designed ... each **20/-**

Radion D.E. .34

Filament, 2 volt .34 amp.
Anode, 20-100. A very fine 2-volt type dull emitter ... each **17/-**

THE CURVES WILL CONVINCE YOU.

Radion G.P.

The economical bright emitter. Filament, 4 volt .48 amp. (Price unaltered) ... each **10/-**

RADIONS LIMITED Bollington, Macclesfield



Adv. of RADIONS LIMITED, BOLLINGTON, Nr. MACCLESFIELD.

THIS IMPROVED Athol MEANS INSULATION

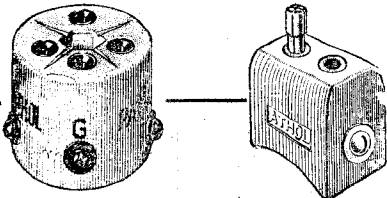

REVERSIBLE VALVE HOLDER PORCELAIN COIL MOUNT

The only single hole fixing holder that fits any set.

With the perfect plug. Will fit any coil.

1/3 each

1/- each

For mounting front or back of panels, or on base boards.

LISTS FREE.

We will send goods post free if you mention dealer's name

ATHOL ENGINEERING CO.
Cornet Street, Hr. BROUGHTON, Manchester

SALE AMATEURS' OPPORTUNITY

TUNERS, AMPLIFIERS, UNITS, PANELS, VALVE RECEIVERS, HEADPHONES, CASES, LOUDSPEAKERS, USEFUL COMPONENTS.

Termination of Lease compels THE

MARCONI SCIENTIFIC INSTRUMENT Co., Ltd.

To sell the above at prices regardless of cost.

FOR A FEW DAYS ONLY

**MARCONI SCIENTIFIC INSTRUMENT CO. LTD.,
40 DEAN STREET, SOHO, W.1.**



GUARANTEED COMPONENTS STUDY OUR PRICES!

HIGH-GRADE ACCUMULATORS :

2 volt. 40 amp. ign. **9/6** 2 volt. 60 amp. ign. **11/9** 4 volt. 40 amp. ign. **18/-**
4 " 60 " " **23/-** 6 " 40 " " **27/-** 6 " 80 " " **43/-**
Carriage 1/- extra.

H.T. Batteries, 60 volt. Best quality, with plugs **8/-**
Headphones, adjustable, 4,000 ohms ... **15/6**
Transformer, L.F., Ratio 5 : 1, Laminated core ... **15/6**

Square-Law Variable Condensers, with Vernier.

.001, 11/6; .0005, 9/6; .00025, 8/6.
All the above are sent carriage paid.

BROOK & LENARD
LONDON DEPOT : 178, NELSON RD., HORNSEY, N.8.
Works : ANCLADA, SOUTH HEATH, GT. MISSENDEN, BUCKS.



ECONOMY —real and false

Wuncell exclusive advantages featured:
No. 1

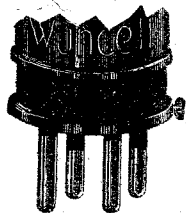

THE man with a multi-valve Set using bright emitters can replace his valves one by one as they become useless by Wuncells W.R.1 and W.R.2. These are the only dull emitters on the market that can be used with a 2-volt, 4-volt or 6-volt accumulator without any alteration to the Set.

Every W.R. type of Wuncell has incorporated in its base a special resistance which can be short-circuited when not required by the screw shown above. When all the bright valves have been replaced by Wuncells these resistances can be short-circuited and the accumulator altered to give 2 volts with a greatly increased capacity. Full instructions for this simple alteration are supplied with every Wuncell valve:

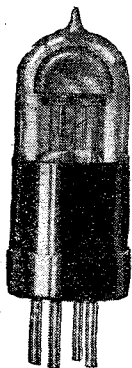

Prices:
W.1 For Detector or L.F. Amplifier
W.2 (With red top) for long distance reception
18/- each

*W.R.1 Corresponding to W.1
*W.R.2 Corresponding to W.2
20/- each

* Fitted with internal resistance as above.

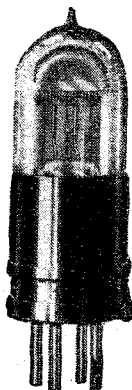

THE point is just this: Can you afford *not* to use Wuncell Dull Emitters.

Or, let us put it in another way. You own, perhaps, a 3-valve Set. Now the average bright emitter valve consumes about .7 of an ampere every hour. Three of them, therefore, will consume 2.1 amps. every hour you are using them. If your accumulator is rated at 6 volts 30 amp. hours (that is a good average size) you will get about 15 hours' use from it on a charge.

The cost for this may be anything up to 2/-. Eight shillings for a month's broadcasting—practically £5 per year. Not much when compared with the pleasure you obtain, but still quite an appreciable item in the family exchequer.

* * * * *

Now let us see what you would be paying if you used Wuncells. First of all you would re-connect your accumulator to give 2 volts only by connecting all the cells in parallel instead of series. This will triple its capacity and give you 2 volts 90 amp. hours, but the charging cost won't be any higher.

Wuncell Valves function best at 1.8 volts and consume .3 of an amp. per hour—your 3-valve Set, therefore, will consume .9 amp. per hour, and your accumulator will last six weeks on one charge.

In other words, you get 5 weeks' broadcasting for nothing every time you get your accumulator charged if you are using Wuncells. And they will save their cost in a couple of months or so.

* * * * *

That is not all. The filament of a bright valve is naturally incandescent. It glows at a white heat and becomes brittle. No matter how careful you are, sooner or later the filament breaks and your valve is useless . . .

But see the Wuncell working. You'll have to look pretty hard before you will realise that the filament is glowing. In daylight it is almost invisible. In fact, it is the nearest approach to the cold valve yet produced.

Isn't it obvious that such a low temperature must mean an exceptionally long life? And to make the Wuncell even stronger, we have inserted a centre support to the filament. No wonder *Amateur Wireless* reported that its filament "is practically unbreakable."

* * * * *

So you'll readily admit that not only do you save quite a considerable amount in running costs, but you get a valve that is likely to last at least three times as long as the ordinary bright emitter. Surely this is real economy.

Cossor Wuncell Valves

THE ONLY DULL-EMITTER VALVES SOLD IN SEALED BOXES

AERIAL TYPES

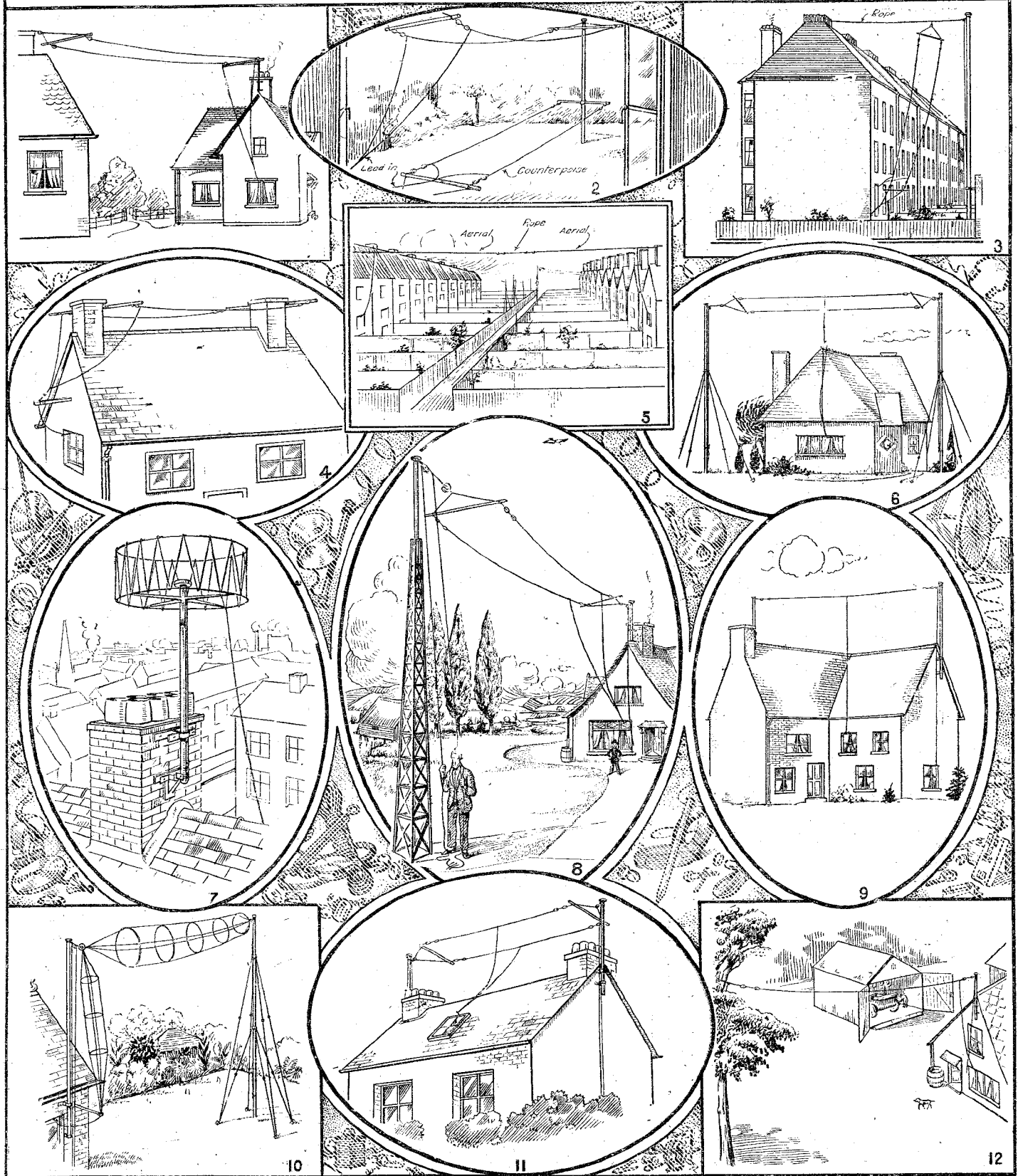

1.—Two-wire inverted L-type Aerial. 2.—Counterpoise Earth. 3.—Aerial for Use in Restricted Spaces. 4.—Simply-erected Two-wire Aerial. 5.—Dispensing with the Aerial Mast. 6.—Double-wire T-type Aerial. 7.—“Birdcage” Aerial. 8.—An Imposing Aerial Layout. 9.—Single-wire T-type Aerial. 10.—Efficient Cage Aerial. 11.—Simple Double-wire T-type Aerial. 12.—Plain Single-wire Aerial.

SHORT-WAVE HINTS

I HAVE been given a difficult task. I am to discuss some of the methods and apparatus required for short-wave reception in such a way as to assist those who have some experience of wireless in general and who wish to investigate the possibilities of the lower waveband.

My space is very definitely limited. This is a vast subject: In the first place there is short-wave reception and short-wave reception. The reception of amateurs on short waves differs distinctly from the reception of broadcasting stations on the same wave-band. Why this should be so I cannot say, but the fact is there.

Again, there are different categories of short waves. You have 150 metres up to

and P is for the fine tuning of reaction. The suggested value of this and the aerial-tuning condenser is .0005 microfarad.

A few additional points may be mentioned. First this receiver will not function with anything like perfection until considerable experience has been gained in its operation. The wavelength range is approximately from 110 metres to 300. Stages of radio-frequency amplification can be added if desired; this was conclusively proved by the Radio Institute of America during experiments with standard apparatus carried out with this object in view.

The Many Circuits

It would be impossible to list even a tenth of the circuits available for work on this higher band of short waves. As a general rule it may be stated simply that a single valve connected through a grid condenser and leak should be used and experiments carried out as to the best way of inducing reaction direct into the aerial circuit. In almost all these receivers home-wound coils are necessary and should be wound continuously on a tube, the break being made afterwards where indicated.

Now to get down to the medium band of short waves, which includes the operating wavelength of KDKA at Pittsburg.

It seems from practical experiments that considerable latitude exists here as to the type of receiver employable. Modifications of the Reinartz receiver are used with varying degrees of success, but, speaking quite personally, I am not inclined to recommend them. The method of winding coils on a tube is detrimental to success, and even where basket coils are used losses occur which cannot be compensated where only one valve is in use.

Immense Distances

There is no doubt that immense distances can be covered with an efficient one-valve receiver on these wavelengths, and the experimenter is not advised to ignore the method by any means. If he does attempt the single-valver the greatest trouble he will have will be centered in his coils. They will have to be low-loss coils and wound with exceptional care even before he commences the tricky task of fitting them into the set.

Another point to watch here is the variable condenser. The nearest available to an American low-loss instrument will work the best. If I had the space available I would discuss low-loss condensers here, for they do not receive their due share of attention in England.

But I think the best system to work on with this band of frequencies is to admit

the necessity of losses occurring and effect a compromise, accepting the losses and compensating for them by the use of high-frequency amplification. A Reinartz or modified Reinartz receiver, with a one- or two-stage high-frequency amplifier added, would not work as low as 50 metres, though it is quite feasible on waves of 200 metres. The amplifier would have to be built specially as a short-wave amplifier and balancing of constants would cause serious trouble.

The best results can be obtained as low as 50 metres by sacrificing some of the features of the sensitive single-valve circuit and returning to the straight circuit, which, though taken valve for valve can-

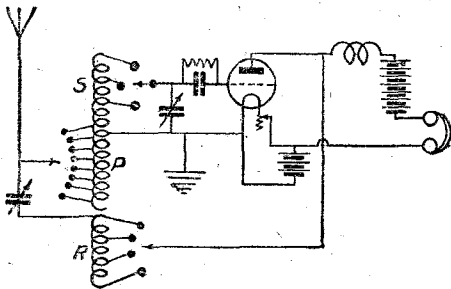

Fig. 1.—Circuit Diagram of Reinartz Receiver.

250—the amateur band. Then comes 90 to 150—another amateur band. Below that the broadcast test band, 50 to 100 metres, and, below that again, freak work on 15 to 50 metres.

I think I can with certainty say that each of these bands requires, for really efficient work, a different receiver.

Let us subdivide these short waves into three bands—high, medium and low. The low—fifty downwards—scarcely comes within our scope at the moment.

The Reinartz

Taking first the high band, we find several excellent receivers of standard design. The best of these for amateur reception is probably the Reinartz or one of its several modifications.

Short-wave work is one of the objects of this type of receiver, and it was designed to give good amplification of weak signals. It has a detector valve with reaction, and should not be used during broadcast hours on an outside aerial. A main point in the Reinartz receiver is the choke coil in the plate circuit, which is for the purpose of ensuring that the H.F. currents pass to the reaction coil and not via the capacity of the telephone windings to earth.

Fig. 1 illustrates one form of this receiver. The coil marked R is the reaction coil and the condenser between R

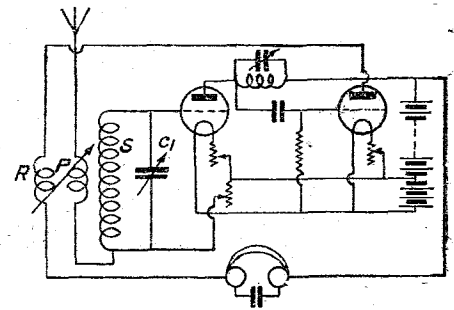

Fig. 2.—Suggested Circuit for Short-wave Receiver.

not compare with the detector with reaction for sensitivity, will allow you to use several valves and thereby get better results.

Fig. 2 is a circuit which I suggest for short-wave work. I have not yet had the opportunity of thoroughly testing it, though it appears to be promising. The primary and secondary should be wound on one low-loss former, preferably one upon the other, though loose coupling might be tried for greater selectivity. The reaction coil is wound separately and coupled variably to the primary. The earth connection has not been shown since in many cases it does not appear to be necessary.

Eight turns make the primary, twenty-four the secondary, and four the reaction coil, though these figures require altering in individual cases and must be established by experiment.

Using a basket coil tapped at the twenty-fourth turn out of thirty-two and another for the reaction, KDKA at Pittsburg has been easily heard. E. C. D.

Although he is screened by mountains on all sides, Signor Franco Pugliesi, the Italian amateur, is heard all over Europe and is well known to English amateurs. The Finnish station 2MN has received his signals on two valves.

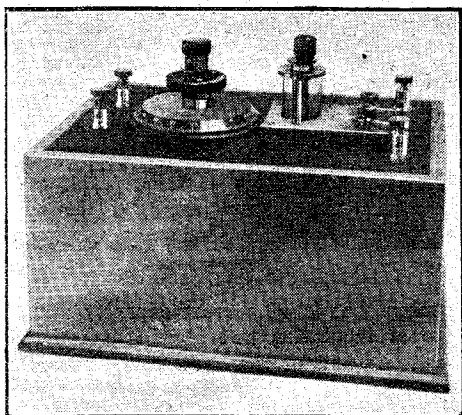

The Complete Set.

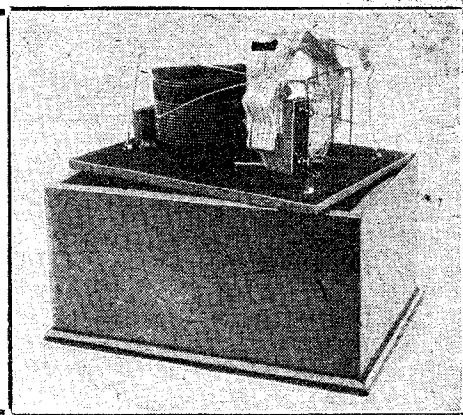

Under Side of Panel.

CRYSTAL SET WITH LORENZ TUNER

It should always be remembered when constructing crystal sets that there is no means of amplification possible, and strong signals will only be heard in the phones if every care is taken to put the received energy to good use.

The aerial coil is the first item that calls for attention, as it is quite possible to lose fifty per cent. of the signal strength if a poorly designed or constructed inductance is used. Low-loss coils are, however, extremely simple to wind provided that a little care is taken. The Lorenz type of low-loss tuning coil is employed in the crystal set described below, which has been specially designed by members of the AMATEUR WIRELESS technical staff.

Components

The following are the components required: One ebonite panel 9 in. by 6 in.; one Dubilier "Vanicon" condenser, .0005 microfarad (with vernier); one .0002 microfarad fixed condenser (Lissen); one .002 microfarad fixed condenser (Lissen); one crystal detector (R.I.); four terminals (Refty); 1/4 lb. No. 24 d.c.c. copper wire; 6 ft. of No. 18 gauge tinned-copper wire.

The construction of the coil will be described first, as it is the item of chief interest in the receiver. A piece of ebonite or hard wood, 6 in. by 6 in., is used as the mounting for the former while winding, and on this a circle 4 in. in diameter is marked. Nine evenly-spaced 2 B.A. rods are mounted therein, secured in a vertical position by means of 2 B.A. nuts. These form the temporary supports for the coil during the winding. The wire is then twisted round one rod, leaving a length of a few inches for making connection when the coil is finished.

Winding the Inductance

Winding may now be commenced. The wire is wound from corner to corner, each alternate rod being missed; since there are an odd number of rods, a coil having linear sides will result, as seen in the photograph. Thirty-two turns are required, and when these have all been wound on, short lengths of wire (or string) may be used for binding the "corners" of the coil together.

The rods can now be unscrewed and slipped out, when the coil will be found to be self-supporting. The method of mounting the coil on the panel can be clearly seen in the photograph.

The connection is firmly soldered to its terminal, for it is most annoying if a connection should break free owing to a slight jar or knock. A clean, well-tinned iron is the secret of successful soldering.

It will be seen that the constant aerial tuning system is employed, the small .0002 microfarad fixed condenser in the aerial lead rendering the circuit more or less aperiodic. This arrangement will be found very useful under experimental conditions because, although sharp tuning is obtainable by the use of the condenser, tuning is practically unaffected by the length of the aerial. It is not necessary to use a short aerial for low-wave reception—in fact the tuning will remain the same even if the aerial is disconnected. Signal strength will, of course, suffer.

Tuning on this set is extremely sharp owing to the low losses in the aerial coil, and it should thus be possible to eliminate much of the interference and jamming sometimes heard on crystal receivers.

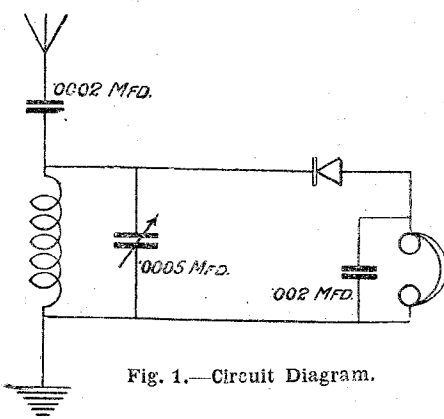

Fig. 1.—Circuit Diagram.

Wiring is carried out with No. 18 tinned-copper wire according to the circuit diagram shown in Fig. 1. A wiring diagram is shown in Fig. 2 for those who

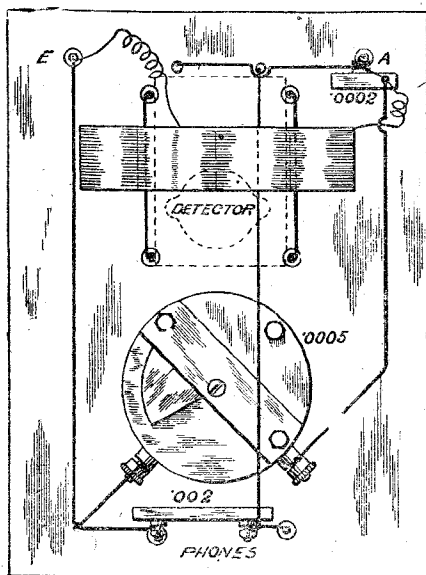

Fig. 2.—Under Side of Panel and Wiring.

prefer to make an exact copy of the original set. The connections are simple and should present no difficulties.

It is important to see that each con-

EDUCATIONAL BROADCASTING

THE B.B.C. is of the opinion that the educational side of broadcasting could be much further developed, and despite the somewhat poor results that have rewarded experiments in this direction, a further attempt is being made to introduce wireless as a serious aid to education.

A programme and syllabus of talks and lectures has been issued, and will be sent on request, we understand, to any schoolmaster. The table of lectures was reproduced on page 120 in AMATEUR WIRELESS No. 137, and it will be seen that a very extensive field of subjects is covered.

There is no doubt that the lectures and interesting talks will be of great use, for scores of appreciative letters from teachers have proved conclusively that *under favourable conditions* children grasp and retain the instruction conveyed by wireless lessons.

The whole success of educational broadcasting depends upon the satisfactory reception in the schools, and for this purpose highly efficient loud-speaker apparatus is required.

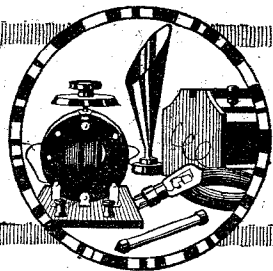

PRACTICAL ODDS AND ENDS

Glass Detectors

IT may happen through an accident that the glass cover of a crystal detector gets broken, and as most detectors are held together by the glass cover it will be impossible to continue reception.

A temporary substitute for the glass cover may be made by rolling up a strip of thin ebonite sheet, presspahn or similar material. The detector can be reassembled in the ordinary way. B. A.

Potentiometers

EXPERIMENTERS who use a potentiometer, either for controlling the potential applied to a carborundum crystal or in the grid circuit of a high-frequency amplifier, should remember that current is flowing all the time the potentiometer is connected across the battery or accumulator.

It is advisable, therefore, to employ a switch to disconnect the potentiometer and the accumulator when the set is not being used.

When the potentiometer is used for applying a potential to a carborundum crystal a dry cell is sufficient to supply the necessary current provided that a switch is fitted to relieve the battery of strain when the set is not in use. K.

Improved Basket Coils

FOR rigidity and efficiency the basket coil wound on a disc with nine slots is very hard to beat, but it can be further improved by increasing the air spacing as shown in the diagram. The writer found

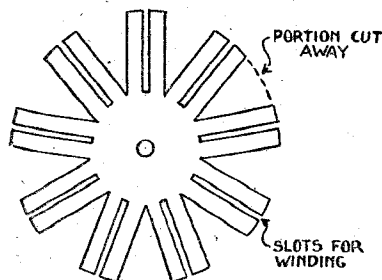

Details of the Coil Former.

a slight increase in signal strength of the local B.B.C. station, but on long-distance reception the further the station the greater the increase in volume. Breslau on a two-valve set came in at twice the strength of that obtained with solid formers. A. W.

Coil Clips

IT is often required to add a condenser or alter a tuning condenser during various tests without materially altering the original wiring.

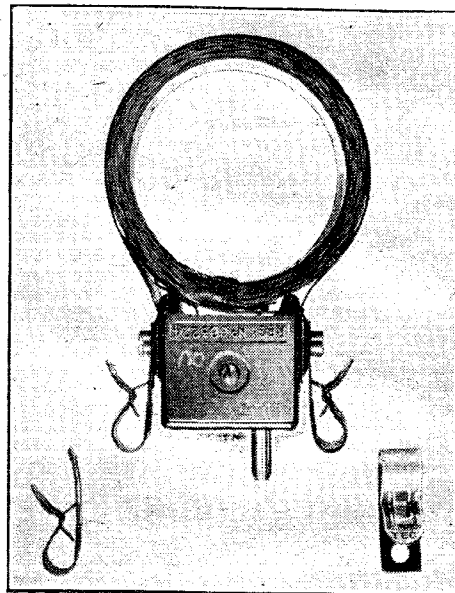

Clips Mounted on Coil Base.

The following idea will be found very useful where quick changes of the connections are required, and if necessary the arrangement may be made permanent.

The spring-clip terminals illustrated may be bought from several dealers advertising in "A.W." for a few pence a dozen, and, if mounted as shown on the coil holders, are always handy and ready for any addition or alteration required. W. B.

Faulty Grid Leaks

A FAULTY grid leak or grid condenser may be easily detected, but without measuring instruments it is not always easy to find out which of the two is wrong.

If the value of the grid leak is too high or the value of the condenser in this circuit too low, it will be found that when the reaction is coupled up instead of the set oscillating properly it tends to produce popping sounds. This is a sign of an insulated grid or a wrong value of grid leak. The usual values that work best together in the circuit are a .0003 fixed condenser and a 2-megohm leak. Buy good components (not necessarily expensive ones) and make sure of getting a con-

denser that is of correct capacity and of proper insulation and a grid leak that is constant and of the resistance stated. A variable grid leak can be used if desired, but a good fixed one is quite as good as the best variable and infinitely preferable to some cheap variable leaks, which are neither quiet nor constant. In addition, of course, a fixed grid leak makes the operation of the set far more simple, since it makes one less adjustment to be considered. C. D.

Home-made Loud-speaker Tip

MANY would-be makers of loud-speakers find no difficulty in either making or obtaining a suitable horn, but they do find difficulty in attaching the horn to the earpiece.

To overcome this difficulty, obtain a rubber motor horn bulb and cut a round hole about $\frac{3}{8}$ in. smaller in diameter than that of the earpiece to be used in the bulb. Force the other end on to the horn and wrap it round tightly with adhesive tape. On the top of this wire may be wound to hold it more securely.

This arrangement allows quick and easy detachment of the earpiece and makes a sound-tight joint. A. D.

Frame Aerials

THE winding of a frame aerial should always be kept tight and evenly spaced or the natural wavelength of the whole aerial will suffer. Insulation of the windings, too, is just as important as the insulation of an outside aerial. Slotted ebonite strips may be employed for insulating and supporting the turns. The so-

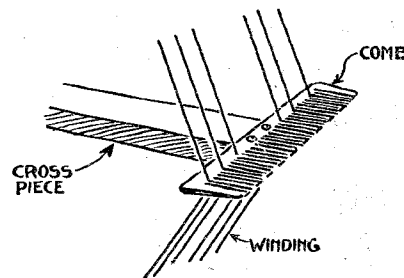

Comb Insulator.

called "ebony" combs are quite good insulators and may be screwed on the edge of the wooden cross-pieces as shown in the diagram. The spacing of the wires is easily determined by this arrangement, as the number of spacing slots may be varied at will. U.

TRANSMISSION STEP BY STEP.—I

A short series of practical articles describing and illustrating the actual apparatus used for amateur transmission.



PROBABLY the reader is familiar with the ordinary type of buzzer wavemeter which is used for the calibration of receivers. A circuit diagram illustrating the connections of such a piece of apparatus is shown by Fig. 1. When the buzzer A is energised by current from the battery B by closing the switch S, oscillations of a high frequency are set up in the circuit formed by the condenser C1 and the inductance L1. These oscillations may be increased or decreased in periodicity by effecting variations in the capacity of the condenser C1. If, then, the buzzer wavemeter is put into operation near a valve or crystal receiver and the receiver is in tune with or set to the same wavelength as the wavemeter, the rectified H.F. oscillations can be heard in the telephones of the receiver.

Now it is well known that a closed circuit such as is formed by the inductance L1 and the condenser C1 is a good oscillator but a poor radiator of high-frequency current, and correspondingly an open circuit is a comparatively poor oscillator but a good radiator. We can therefore utilise these facts in building up a piece of elementary transmitting apparatus which will have an effective transmission range of two to three miles under favourable conditions. The schematic drawing Fig. 2 and the theoretical diagram Fig. 3 illustrates such an arrangement. The buzzer A should be of a robust design and fitted with an adjustable armature or vibrator. Surplus Army buzzers of various types are avail-

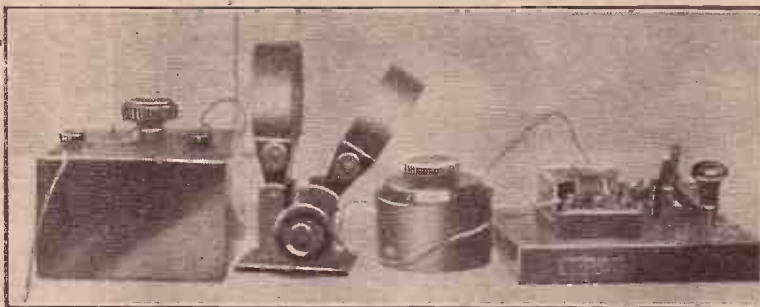

A Simple Buzzer Transmitter.

able and the power buzzer is a good model to obtain, the only drawback being that they require more current to operate them

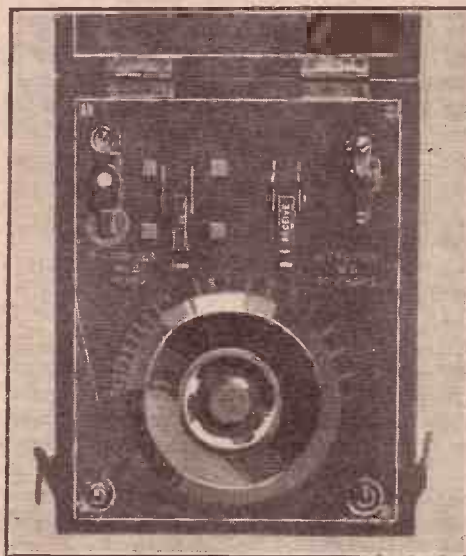

Wavemeter.

than the lighter types. The type illustrated in the photograph will work well on a 6-volt accumulator or dry battery.

The operating key K takes the place of the switch S in the wavemeter and the variable condenser C1 has a value of .0005 microfarad. The aerial tuning condenser C2 has a value of about .001 microfarad.

As regards the tuning coils, these have to be of a suitable value of inductance, and as spark transmission is forbidden on the low wavelengths of 150 to 200 metres (the gear described is of the nature of a spark transmitter), the amateur must confine his attention to the 440-metre wave outside of broadcasting hours. Therefore the inductances L1 and L2 may consist of two coils normally used for the reception of broadcast. Nos. 50 and 75 Igranic coils are suitable.

To use the transmitter the armature of the buzzer is screwed up until a depression of the key causes it to give out a regular high-pitched note and the dots and dashes of the morse code are certain and well defined. The aerial should be disconnected during this operation, and then, after re-connecting, the inductances L1 and L2 are tuned by the condenser to the required 440-metre wavelength. Care should always be taken to see that the tuning is sharp, and this may be effected by keeping the coils loosely coupled, although by so doing less energy is put into the aerial. This is compensated for by the fact that your transmission is less liable to interference by other stations and is therefore easier to receive at the receiving end.

As comparatively little energy is put (Concluded at bottom of third column of page 314)

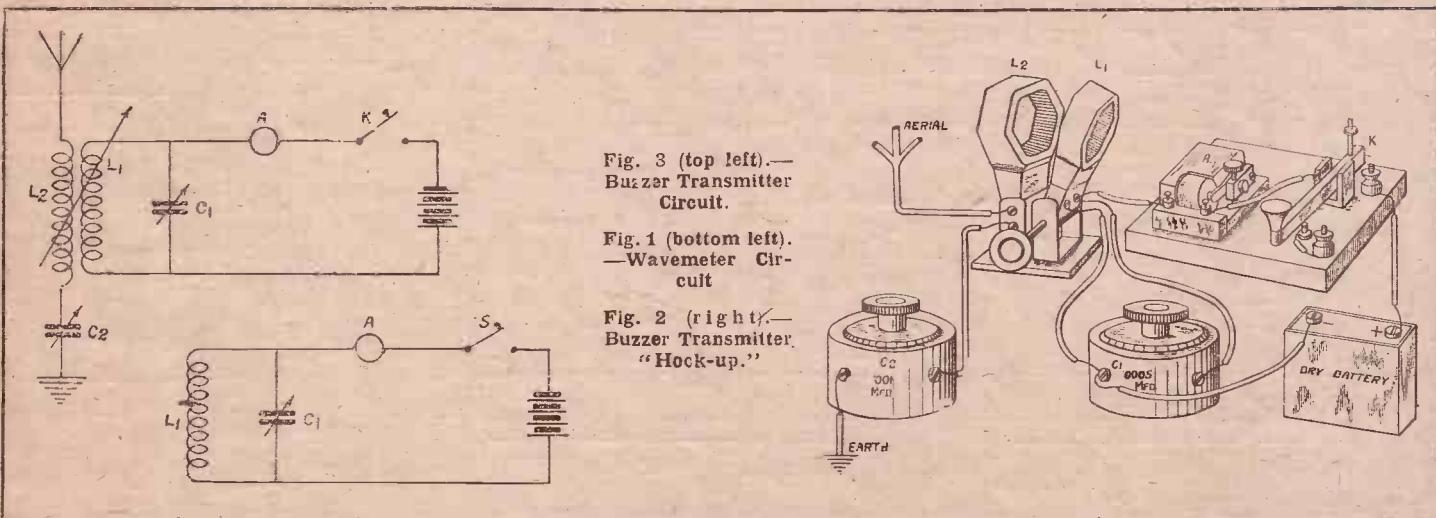

Fig. 3 (top left).—Buzzer Transmitter Circuit.

Fig. 1 (bottom left).—Wavemeter Circuit

Fig. 2 (right).—Buzzer Transmitter "Hook-up."

A.W." SELECTIVE VALVER

Double H.F. transformer, and ease of control.



Four-valve Receiver.

plug. By tapping off a suitable voltage from the *negative* end of the H.T. battery with this wander-plug the correct grid bias will be applied to the grids of the L.F. valves.

List of Component Parts Required

For the benefit of those who would like to construct a set identical to the original receiver shown in the photographs a list of the components used is given. At the

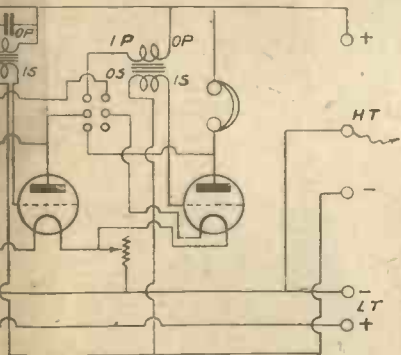

Circuit Diagram.

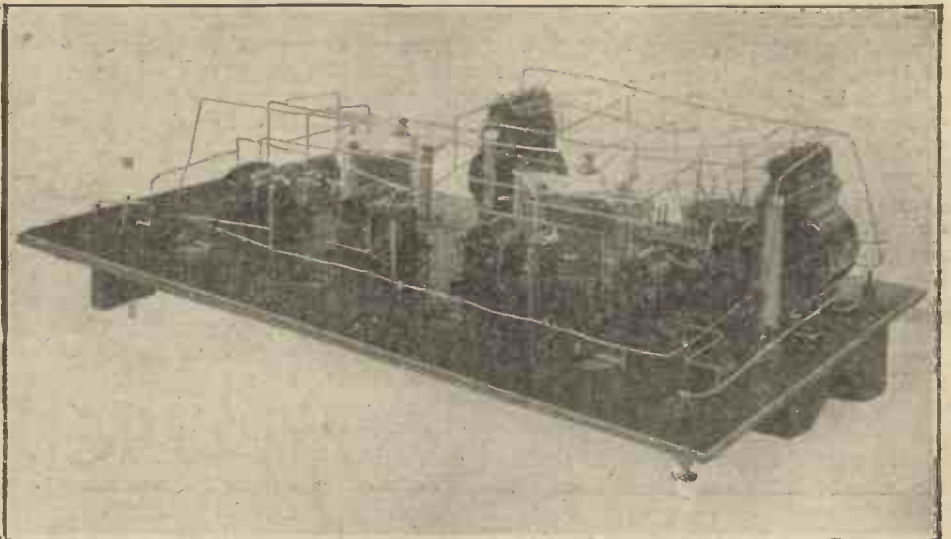

Another View of Under Side of Panel.

side of each item the maker's name appears, but it should be understood that other well-known reliable makes having the same electrical values may be substituted.

One Radion "Mahoganite" panel, size 12 in. by 21 in., for cutting to 11 $\frac{1}{4}$ in. by 20 in. (American Hard Rubber Co.).

Two valve sockets for H.F. transformers. Four special valve holders (Aermonic). Four valve windows (A. F. Bulgin). Three filament rheostats (Enterprise Manufacturing Co.).

Two double-pole double-throw lever switches (Wilkins and Wright, "Utility" lever type).

Two .0005 microfarad square-law variable condensers, with vernier (Wilkins and Wright).

Two L.F. transformers, first and second stages (Igranic).

Two matched H.F. transformers (Igranic).

One "Unitune Major" aperiodic aerial coupler, 300-600 metres (Igranic).

One Igranic concert coil, C3. One two-way left-hand coil holder (Burne-Jones).

One .0003-microfarad grid condenser and 2-megohm grid leak (Dubilier).

One .001-microfarad fixed condenser (Lissen).

Seven Refty terminals.

One mahogany cabinet to suit panel (Pickett Bros.).

The Cabinet

Instead of buying the cabinet ready-made it can be constructed at home from $\frac{3}{8}$ -in. thick mahogany. The dimensions are as follows: Base, 8 in. by 20 $\frac{3}{4}$ in.; back, 14 $\frac{1}{2}$ in. by 20 in.; top, 4 $\frac{3}{4}$ in. by 21 in.; sides, 20 in. high, 8 in. wide at the bottom, 4 in. wide at the top.

The back should be made removable so that easy access to the valves is possible. A dark mahogany polish on the finished cabinet, together with the mahoganite panel, will give a pleasing effect. Wooden cleats should be screwed round the open-

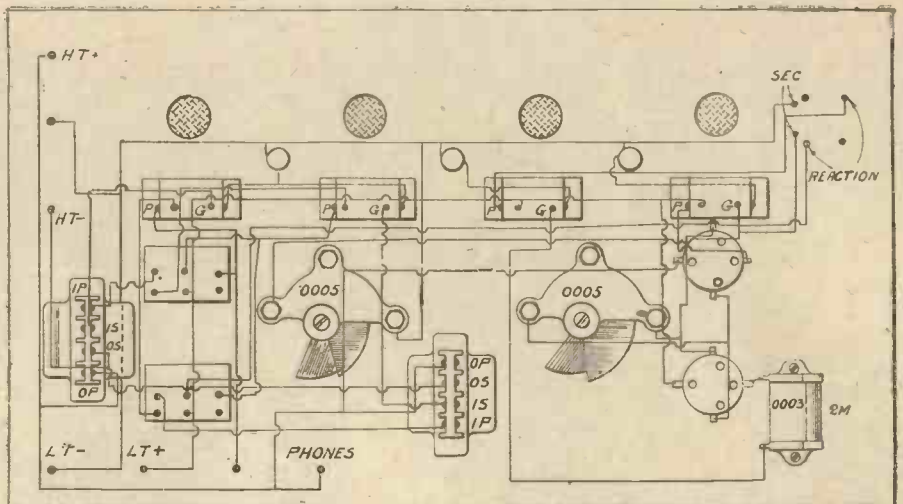

Fig. 3.—Wiring on Under Side of Panel.

ing for the panel $\frac{1}{16}$ in. from the edges so that the panel will fit in flush with the sides of the cabinet.

The Panel

This should be of good quality. Too much stress cannot be laid on the necessity of using high-grade ebonite for insulating panels. The writer has actually known cases where a set has refused to work owing to the fact that the highest resistance between two near points on the panel was 2 megohms! The American Hard Rubber Co., Ltd., 13a, Fore Street, London, E.C.4, keep in stock a suitable panel measuring 12 in. by 21 in. This panel will have to be cut to the size indicated, $11\frac{1}{4}$ in. by 20 in. A panel-drilling layout is given in Fig. 2, and with this there should be no difficulty in marking out the holes. The components are mounted as shown in the photographs and in the wiring diagram, Fig. 3.

It may be found that the condenser dials stand out from the panel, spoiling the appearance of the set. This may be remedied by inserting an ebonite distance-

piece between the condenser and the under side of the panel, thus lessening the length of the one-hole fixing screw sticking up through the panel.

Provided that thick copper wire is used for wiring up there is no necessity to screw down the fixed condensers. The wire should be stiff enough to keep them in place.

No aerial and earth terminals are mounted on the panel. The aerial and earth wires are connected to the two terminals on the Igranac "Unitune" coil. The two-coil holder is mounted on the top left-hand corner in such a manner that the reaction coil swings out to the left—away from the set.

On the right-hand side, looking at the front of the panel, are seen the two switches for cutting out the L.F. valves. Great care should be taken to wire these switches up exactly as shown in the wiring diagram, Fig. 3.

Operating the Set

When all the wiring has been finished and carefully checked so that there is no

possibility of burning out the valves, the H.T. and L.T. batteries and phones should be connected up to the proper terminals. An Igranac Unitune Major is plugged into the fixed arm of the two-coil holder and the concert coil into the moving arm. As already stated, the aerial and earth are connected to the two terminals on the Unitune Major. Plug the two H.F. transformers and the valves into their sockets and, keeping the reaction and aerial coils well away from one another, rotate slowly the two condenser dials until signals are heard. Now bring the reaction coil closer to the aerial coil, thereby strengthening the signals considerably. If no strengthening effect is noticed, reverse the wires connected to the reaction coil.

With regard to the valves, either bright or dull-emitters may be used. The carbon rheostats are suitable for either type of valve.

The selectivity of the receiver may be realised by the fact that during a short test on an aerial within sight of 2 L.O., this station could be cut right out and Birmingham tuned-in.



Success Transformer.

L.F. Transformer

LATELY I have been testing a Super Success transformer made by Beard and Fitch, Ltd., of 34-36, Aylesbury Street, E.C.1. As will be seen from the photograph, this is of a somewhat unconventional design.

Actually the transformer is of the hedgehog type with the core in a vertical position, the whole being enclosed by a japanned brass tube with ebonite end pieces. It was tried on a two-valve set (detector and L.F.); the signals were remarkably free from distortion and amplification good.

The construction of the Super Success transformer is such that it will stand a good deal of hard usage. It is an instrument that I can thoroughly recommend. The price is 21s.

"Wireless Ear"

SOME clever people have found a new disease that they call "wireless ear." Listeners will not worry themselves much about this, but it must be admitted that

AROUND THE SHOWROOMS

there are phones not any too comfortable to wear for long periods.

In this connection I have been interested in the Macondo pneumatic ear pads sold by McLeod and McLeod, of 320, High Holborn, W.C.

These pads are attractive in appearance and have only to be stretched to fit tightly over the earcaps. Their corrugated surface, part of an air cushion, allows of a free passage of air and prevents perspiration. I have found the pads to be particularly comfortable in use.

Tungstallite Gold Label

THERE seems to be no end to the number of new crystals that make their appearance on the market, and it speaks well for the trade generally that they are nearly all satisfactory in use.

A new-comer among crystals is the Gold Label brand made by Tungstallite, Ltd., of 47, Farringdon Road, E.C.1. I have tested this and found it sensitive over the entire surface.

The crystal is sold with a special silver catwhisker, and results with this were certainly better than with an ordinary copper contact.

Each crystal is packed in a glass-topped airtight container and is accompanied by a numbered guarantee. If you find a piece of Tungstallite that is defective the guarantee entitles you to a new specimen, or you can have your money back.

Tungstallite Gold Label should be of special use in reflex sets, for, owing to its fine grain, the catwhisker has little chance of slipping off.

Super-heterodyne Sets

FEW amateurs in this country have yet tackled the construction of super-heterodyne receivers, mostly because of the difficulty of obtaining the necessary transformers.

Many firms in the states sell complete kits of transformers, and I see that these kits are now being sold in this country. For instance, Gaston E. Barbaix, of 27-29, Anning Street, E.C.2, are importing a set of five Rauland transformers for building super-heterodyne receivers.

VANGUARD.

"TRANSMISSION STEP BY STEP.—I" (continued from page 311)

into the aerial by means of this apparatus an extremely sensitive and expensive hot-wire meter or thermo-couple would be required to indicate such energy, so that it will be necessary to rely upon a valve receiver placed at a distance (say immediately beneath the aerial) in order to ascertain whether the aerial is being energised. Having once confirmed that the tuning and radiation are O.K., a note should be made of the coil and condenser settings for future reference.

The apparatus described will prove extremely interesting to the beginner and will afford a working knowledge of the behaviour of a loose-coupled transmitter and its advantages and also provide a means of practising the morse code under actual working conditions before investigating the simple spark transmitter to be described in a subsequent article.

A. J. C.

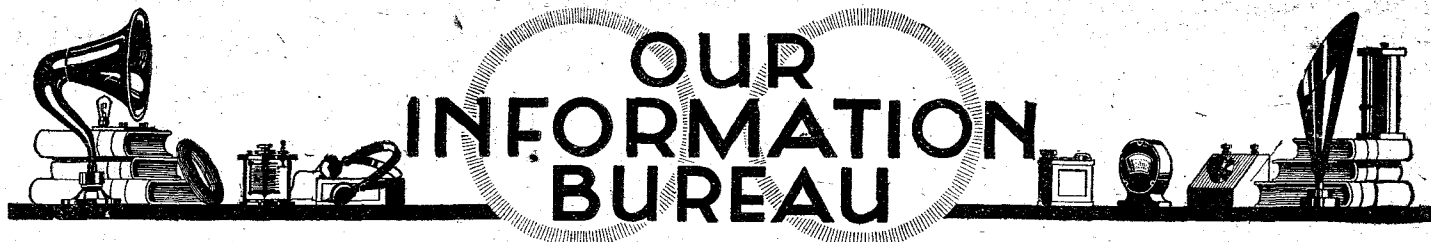

RULES.—Please write distinctly and keep to the point. We reply promptly by post. Please give all necessary details. Ask one question at a time to ensure a prompt reply, and please put sketches, lay-outs, diagrams, etc., on separate sheets containing your name and address. Always send stamped, addressed envelope and attach Coupon (p. 336).

Night Effects

Q.—Are signals stronger by day or by night?
A.—By night, because the light of day absorbs some of the energy of wireless waves.—U.

Accuracy of D.F.

Q.—Can a ship's position be found accurately by wireless?—M. B. (Wimbledon).
A.—Yes; best results should be correct to within half a geographical degree.—K.

Crystals

Q.—Please give the chemical formula of bornite, carborundum and copper pyrites.—A. G. (Bromley).
A.—Bornite $Cu_2 S_2 Fe S_2$, carborundum SiC_1 , copper pyrites $3 Cu_2 S_3 Fe_2 S_3$ —U.

Call Signs

Q.—Is there a central office for controlling call-letters everywhere?—B. T. (Hove).
A.—Yes, the Bureau of the International Radio-Telegraphic Convention at Berne.—K.

L.F. Amplification

Q.—Which method of low-frequency amplification gives the least distortion—a microphone amplifier or a valve note magnifier?
A.—We do not think there is much to choose between the two methods of low-frequency amplification provided each is properly designed. The question of cost should be considered.—U.

Oscillation and Radiation

Q.—Is it correct to assume that there is no radiation from the aerial when telephony is received without distortion, using a circuit employing reaction?
A.—Reaction effects may easily take place which cause radiation from the aerial even though no noticeable distortion is introduced into the received speech. There is not, however, likely to be radiation if turning the tuning condensers does not produce any squeals or howls.—U.

Frame Aerials for Broadcasting

Q.—What is a suitable size of frame aerial for the reception of broadcasting?
A.—If the frame is 3 ft. square you will require ten turns of wire spaced $\frac{1}{2}$ in. apart.
 The aerial should be tuned by means of a small variable condenser in parallel with it, having a capacity not greater than .0005 microfarad. No aerial tuning inductance in the apparatus will, of course, be necessary.—U.

Accumulator Charging

Q.—How can I prevent the danger of overcharging when charging my accumulator?
A.—You need not fear any danger from overcharging, provided that the charging rate itself is not too high. Towards the completion of a charge the cells will "gas," and this should be allowed to continue for an hour or so before switching off.—U.

Joining the B.B.C.

Q.—What formalities are to be complied with for a manufacturer to become a member of the B.B.C.?—B. H. (Portsmouth).
A.—We understand that any *bonâ-fide* manufacturer may become a member of the B.B.C., and we suggest you communicate with the secretary for further particulars.—U.

Fixed Condenser Plates

Q.—Is there any advantage in using copper-foil instead of tinfoil for fixed condensers?
A.—Both are electrically sound, but copper-foil may be found easier to cut and press to shape. This foil, too, is not so liable to have pin-holes, and is probably better in high voltage circuits.—K.

Reflex Receivers

Q.—Please give a circuit of a simple reflex single-valve circuit without an L.F. transformer.—P. O. (Cardiff).
A.—The circuit required is shown here and it will be seen that an aperiodic H.F. trans-

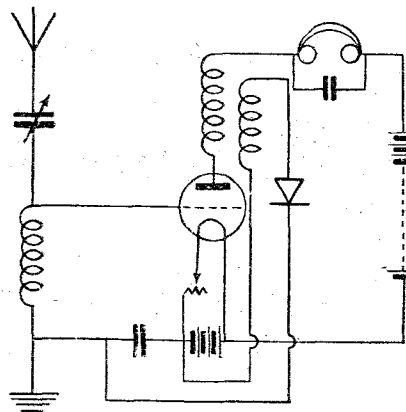

Circuit of One-valve Reflex Set.

former is employed. This makes the circuit more simple, but better results would be obtained if either the primary or the secondary winding be tuned by means of a small condenser.—U.

Frame Aerial Efficiency

Q.—What is the efficiency of a frame aerial as compared with the ordinary type of outdoor aerial?
A.—The frame aerial will probably only have from 5 to 10 per cent of the efficiency of the elevated outdoor type. Considerable amplification is necessary in order to make the results obtainable on a frame compare with those obtained in the ordinary way.—U.

Radio or Audio Frequency?

Q.—Is high-frequency amplification better than low-frequency?
A.—This all depends on what is desired. Low-frequency amplification will amplify anything that is rectified by the detector so that a large volume of sound is to be had. High-frequency amplifies the signals before they reach the detector, thus bringing in signals that would not otherwise be heard

with the detector and low-frequency amplification alone.—K. U.

The Vernier Condenser

Q.—What is the vernier condenser and what is its use?
A.—The word vernier is being very carelessly used nowadays in connection with almost every piece of wireless apparatus which affords a particularly exact adjustment. A better name would be "fine-tuning" condenser. Such a condenser is simply a small variable condenser, comprising only three or, at the most, five plates, so that a considerable movement of the knob gives only a small change in capacity.
 By connecting a condenser of this description in parallel with a large variable condenser, the preliminary adjustments are made upon the large condenser, and then the fine tuning condenser is brought into action to effect the final accurate adjustment.—K.

Outdoor or Indoor Aerials?

Q.—Is it necessary to have an outside aerial with a simple type of apparatus or can an indoor aerial be used?
A.—Indoor aerials, when used by an experienced operator in conjunction with good apparatus, can be made to give quite satisfactory results, but for a beginner a regulation outside aerial is much to be preferred.—U.

Oscillating and Heterodyning

Q.—Is the oscillation of a valve during the reception of C.W. necessarily radiating energy from the aerial, or is one creating a nuisance only on the occasions when too tight a coupling causes a hooting audible in one's own phones?
A.—Interference is being caused all the time that the valve is in a state of oscillation. Howling caused by too tight coupling of the coils must never be allowed as it will considerably shorten the life of the valve. Really pure clean speech can never be obtained while the set is in a state of oscillation, and only a slight coupling of the reaction coil should be employed.—U.

Interference

Q.—I am very much troubled by certain rushing noises which are located quite definitely on fixed wavelengths, one of the most troublesome being a band between about 420 and 440 metres. I have tried the wavelength frequently with a wavemeter, and find it approximately constant.
A.—There is no need to suspect the set, since the trouble is almost certainly that irritating form of interference known as "mush." This is a rather peculiar form of harmonic frequently radiated by high-powered arc stations, among which certain post office installations are notorious.
 There unfortunately appears to be no remedy as far as receiving apparatus is concerned other than the use of really selective circuits, and even these do not appear to give very much relief.
 Fortunately the particular bad band referred to does not cover one of the B.B.C. stations.—K.

TRANSMITTING STATION 2 K T

Of all the amateur wireless stations in Great Britain, probably 2 K T is one of the best known. The station dates back to pre-war days, when, of course, it was known by a different call sign. Since those exciting days of "sparks and crystals" many changes have taken place in its arrangement and equipment. The

tucked away in Snaresbrook, Essex, and the general climatic conditions are generally such as to be what the weather forecaster would term "some mist and fog." Consequently at certain seasons of the year moisture permeates everything.

The little megger generator is driven by a $\frac{1}{2}$ -h.p. motor which is fed from the

this capacity. The wavemeter and other instruments may be readily identified.

A great deal of the success achieved by 2 K T must in part be due to the efficient aerial and earthing systems. The aerial is well insulated and the twin wires are spaced about 10 ft. apart. The earth system is a perfect network of heavy copper bar and wire. The roof of the wireless room, which is covered with lead-sheet, is also utilised and tuned to earth so as to form a small counterpoise.

The station is spread over two rooms. In one is housed the motors, generator and a petrol engine with the house-lighting accumulators, and in the other are the actual transmitter, receiver and sundry tools and appliances.

Mr. Nickless is mindful of the assistance and reports he has received from time to time from many old wireless friends, including 2 F K, 2 O M, 2 N M, 2 F Q, 2 P X, 5 Q V, 5 P Z, and many others too numerous to mention. A. J. C.

GRID CONNECTIONS

THE grid of a high-frequency amplifier is usually connected to the negative pole of the filament battery, the rheostat wire being inserted between this pole and the moving arm or pointer connected directly to one of the filament terminals. With this arrangement the positive end of the filament is plus 4 volts (if a 4-volt accumulator is used), whilst the negative end of the filament is higher than zero by the amount of the voltage drop across the rheostat resistance. The filament as a whole is thus kept at a higher potential than the negative pole of the filament battery.

As the grid is connected directly to the L.T. negative terminal it is therefore automatically set at a lower potential than any point on the filament. This ensures (a) that the valve is working on the straight-line part of its characteristic curve, and (b) that there is no grid current flowing to damp the aerial circuit and lessen sensitivity.

If the rheostat resistance is changed over so as to come between the positive pole of the battery and one filament terminal, the result will be to decrease the potential difference between grid and filament. The grid is sometimes connected to L.T. positive instead of L.T. negative in order to reduce any tendency to self-oscillation. The grid, being at a positive potential, allows grid current to flow. Altering the grid connection in this way will often stabilise a noisy reflex circuit, although the change-over involves a certain loss in selectivity.

M. A. L.

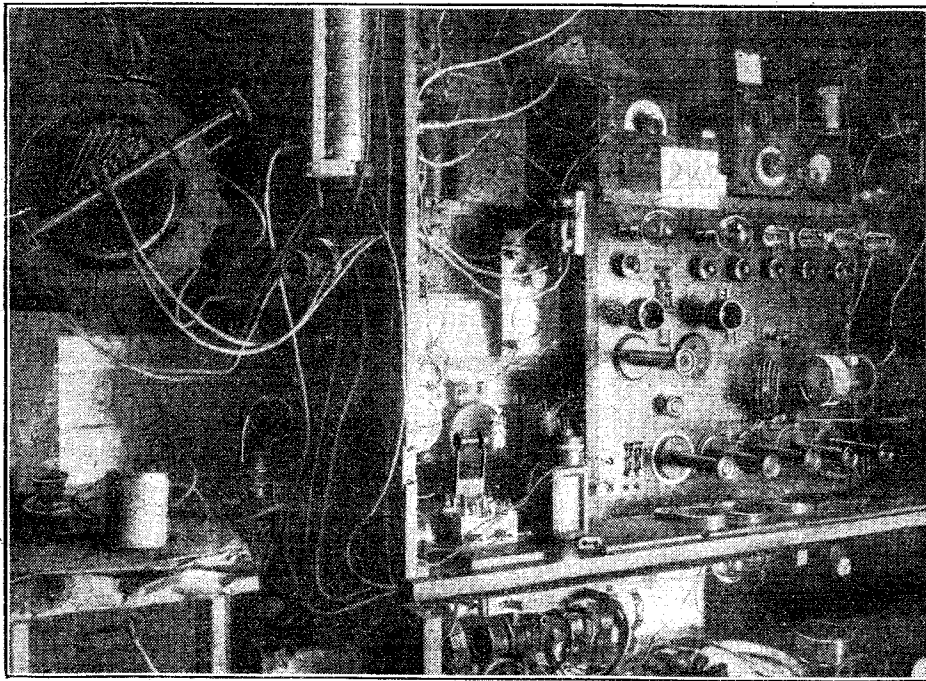

Mr. Nickless' Station—2 K T.

enthusiasm of the owner and operator, Mr. J. E. Nickless, M.I.E.E., has, however, not changed with the passing of time. Besides being an extremely energetic experimenter, Mr. Nickless is also president of the South Woodford Radio Society, president of the Ilford Radio Society, and a committee member of the Transmitting and Relay Section of the Radio Society of Great Britain.

In view of the great calls upon his time by the holding of such offices one would naturally expect that his voice would not often be heard in the ether, but, to the contrary, he can be heard almost any night of the week and every Sunday morning. Reports of the reception of his station have been received from over the whole of the British Isles and from the Continent; also certain American stations have reported receiving him, but up to the time of writing these reports have not been confirmed.

These results are perhaps all the more surprising when one knows the unsatisfactory conditions under which the station is worked. The aerial, 50 ft. high by 60 ft. long, is in a dip between two hills,

50-volt house-lighting accumulators. This supplies the plate current for a Mullard 0-150 valve and also, when occasion demands it, for choke-control purposes, a Marconi A.T. 40 valve. When using the Mullard 0-150 valve as an oscillator and working on a wavelength of 200 metres the aerial ammeter shows a reading of 1 ampere.

Modulation

Few who have heard the speech from 2 K T would recognise that he mainly uses the grid-control method of modulation, yet such is the case. Morse keying is effected in the grid circuit of the transmitter.

The photograph illustrates a portion of the wireless room. The six-valve receiver panel may be seen to the right-hand centre of the picture. The circuit employed is a "straight" circuit comprising two H.F., rectifier and three L.F. valves, with suitable switch-gear to select any number of valves from these.

To the left-hand side of the picture can be seen an old spark "jigger" converted for short-wave transmission work (50 metres upward), and it serves very well in

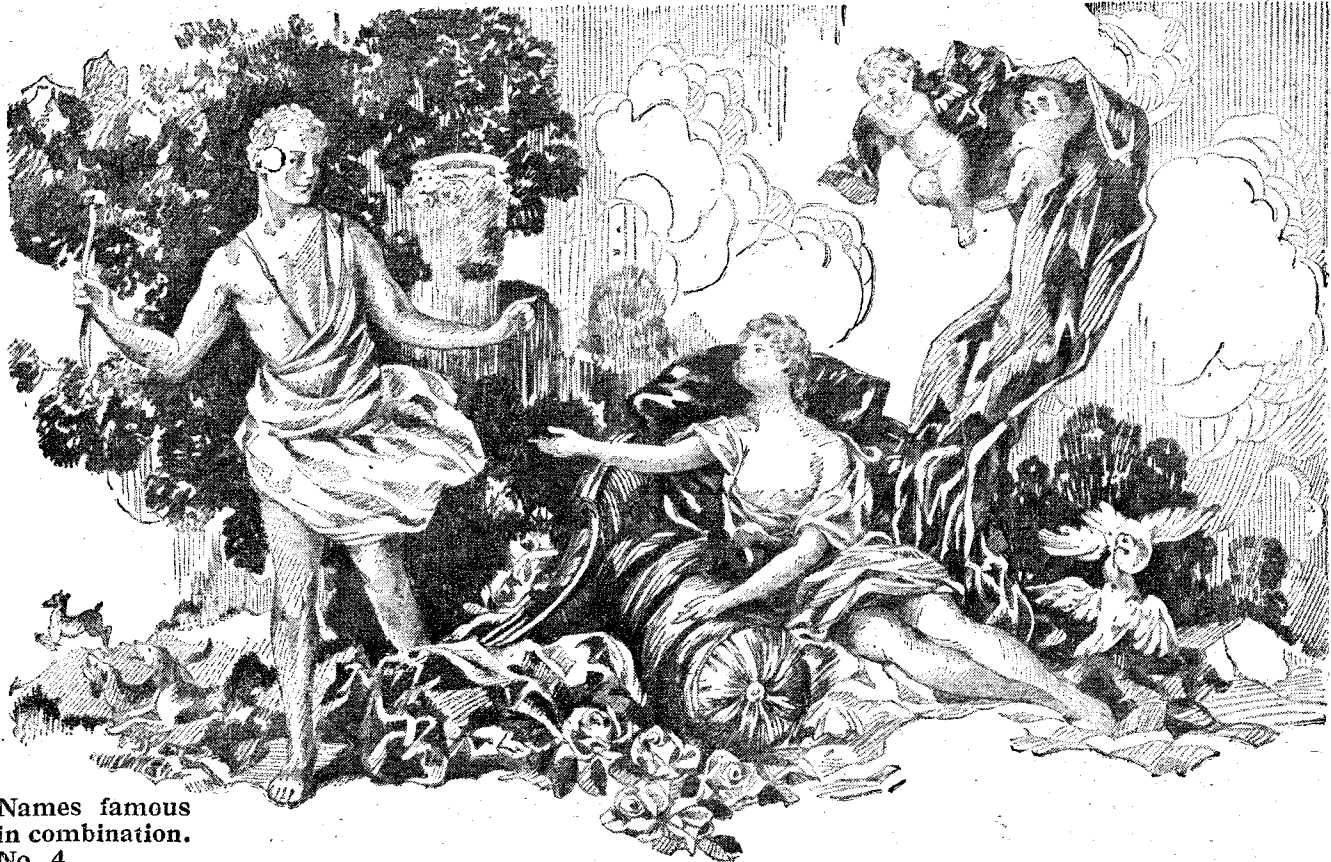

Names famous in combination. No. 4.

Venus and Adonis

FROM the idealised figures of mythology to affairs of modern interest is perhaps a far cry; yet certain names famous in combination are conceded their due renown whatever the period of conjunction.

To-day the association of the two celebrated names, MARCONI and OSRAM, has resulted in the splendid outcome of their joint effort—"The Valve in the Purple Box."

Read the 40-page wireless book, The Book of MOV. Free from your dealer or the M.O. Valve Co., Ltd., Hammersmith, London, W.6.

NEW REDUCED PRICES.		
For 2-volt Accumulators.		
Purpose.	Type.	Price.
†G.P.	D.E.R.	18/-
†L.S.	D.E.6.	22/6
For 4-volt Accumulators.		
G.P.	R.	11/-
G.P.	*D.E.3.	21/-
L.S.	D.E.4.	26/-
For 6-volt Accumulators.		
G.P.	R.5.V.	11/-
L.S.	D.E.5.	30/-
L.S.	*D.E.5b.	30/-
L.S.	L.S.5.	50/-
†G.P.=General Purpose.		
†L.S.=Specially suitable for low frequency amplification for Loud Speakers.		
*Can be used with Dry Batteries.		
∴ For Resistance-capacity Amplification.		

MARCONI VALVES

MADE AT THE OSRAM LAMP WORKS

Sold by Wireless & Electrical Dealers, Stores, etc.

ANNOUNCEMENT OF THE M.O. VALVE CO. LTD.

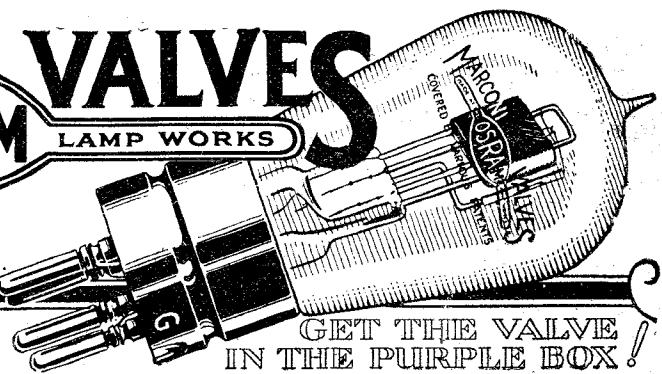

GET THE VALVE IN THE PURPLE BOX!

PROGRESS AND INVENTION

Earth Tubes

THE provision of an efficient earth system always presents a problem to the amateur. The water-pipe, unless it has only a very short run before it reaches the earth, is highly inefficient. In many cases also it is not easily accessible and a long stretch of wire has to be employed, which still further reduces the efficiency.

A direct connection to earth is preferable, but the difficulty then has to be solved of selecting a suitable earth plate or connection.

A very neat type of earth connection is described in Patent No. 226,869/23 (Henry Quartermaine, Woking, Surrey).

It will be seen in the diagram that this earth consists of a length of metallic tubing, pointed at one end to facilitate the insertion of the tube into the earth, and having a terminal at the other extremity for connection to the set. Holes may be provided in the length of the tube so that water, if poured down the open end, can damp the surrounding earth.

An improved type of cap is described in the specification to prevent damage to the tube when it is hammered in. An earth of this description has the disadvan-

tage that it has not a very great superficial area for contact with the ground, but a number of earth tubes can, of course, be used in series.

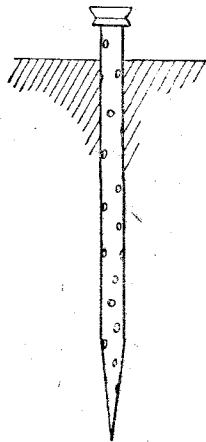

(Earth Tube (226,867/23))

For receiving purposes a single tube of this description should be sufficient, provided that the surrounding earth is a good conductor, but for transmission it would be advisable to use more than one tube.

Dull-emitters

DULL-EMITTER and low-consumption valves have been so developed that the filament has nearly reached the ideal "cold" stage,

Naturally, a filament which can emit electrons when only sixty milliamps are passed through it is very thin and fragile. This, indeed, is the weak point of all low-consumption valves.

An invention of Dr. Leonard Angelo Levy (Shoot-up-hill, Cricklewood, Middlesex), described in Patent No. 226,654/24, should be successful in producing a less fragile dull-emitter. Instead of using a solid metal conductor as the filament, it is proposed to use a core of some insulating material, such as fused silica, coated with the metal.

Platinum may be used for coating, or some oxide of barium or strontium having a high electronic emission may be used.

Metallic thorium can also be used for coating the fused silica, and it is suggested that this should be deposited in the form of thorium chloride. The chloride may then be reduced in hydrogen at a suitable temperature, and the pure metallic coating remains.

— components that make successful sets

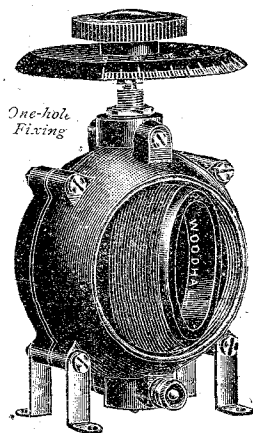

The **WOODHALL** No. 1 Variometer.

The spindles of the Rotor are moulded in, in perfectly true alignment. They cannot come loose. The coupling between Rotor and internally wound Stator is closer than in any other Variometer. The spindle has a metal bearing. All connections internal; two terminals; one-hole fixing. Wavelength 250 to 750 metres on 100ft. aerial.

12/6



The **WOODHALL** Vernier

Rheostat (Pat. No. 213,030). Combined plunger and rotary movement. Push-pull movement for coarse setting; rotary for vernier. Wonderfully smooth movement; best carbon former; one-hole fixing.

6 ohms **2/6**
10 or 12 ohms **3/-**
30 ohms **3/6**

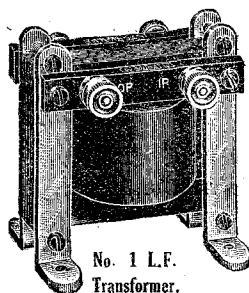

No. 1 L.F. Transformer.

Wound with 42 gauge wire simultaneously with fine SILK. Even on 200 or 300 volts pressure gives no trace of distortion, and its amplification factor is decidedly above the average of other good-class transformers. Specially recommended for circuits of the "reflex" type.

23/6

WOODHALL
GUARANTEED COMPONENTS
Sole Distributors:

Pressland Electric Supplies, Ltd., Hampton-on-Thames

Phone: Molesley 22

ON MAINTAINING A REPUTATION

A REPUTATION is infinitely easier to make than to maintain. Many years ago the "Daily Graphic" made a reputation for clean news, broad editorial outlook, good pictures and convenient make-up. To-day these qualities are just the same, and the reputation of the "Daily Graphic" is not only maintained but enhanced. For your home, for the boy and girl at school, for holiday time, for a railway journey, it is the best daily illustrated paper you can buy—and the price is only One Penny.

Your newsagent has many readers of the "Daily Graphic" among his customers. He will be pleased to add your name to his list. Send him an order to-day.

DAILY GRAPHIC
ONE PENNY

They tried 19 makes

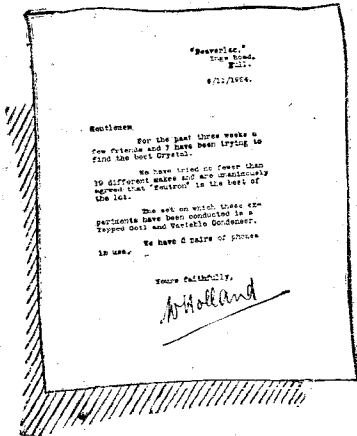
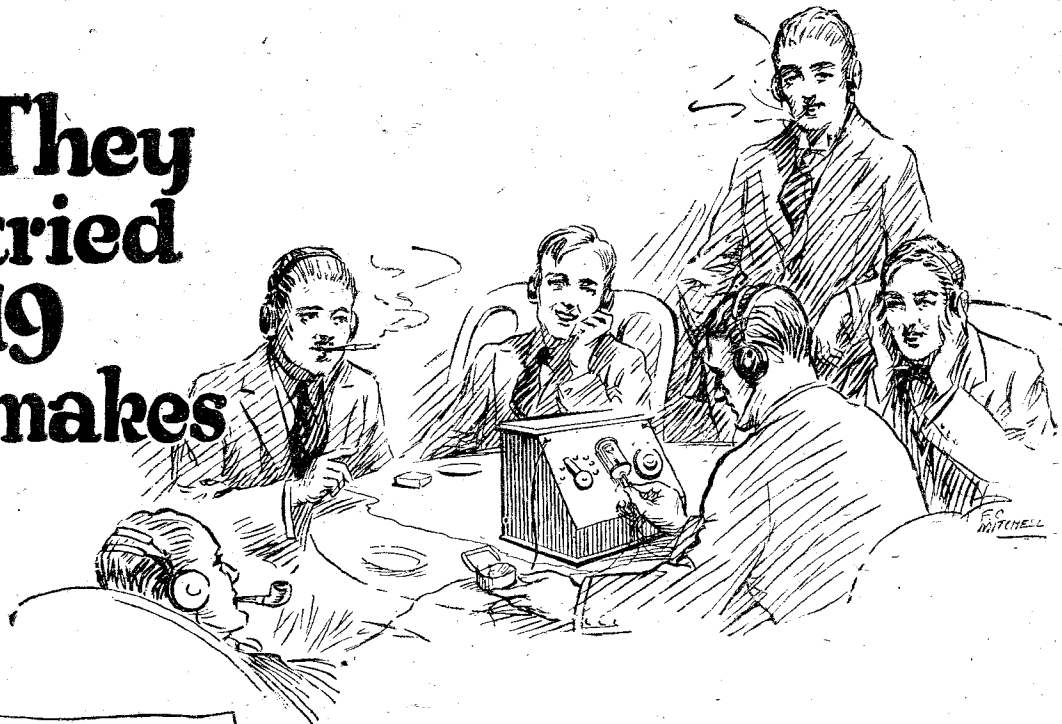

Here is another remarkable letter of testimony, one of several received in the same mail. It is photographically reproduced on the left, and reads :—

"For the past three weeks a few friends and I have been trying to find the best crystal. We have tried no fewer than 19 different makes, and are unanimously agreed that 'Neutron' is the best of the lot. The set on which these experiments have been conducted is a Tapped Coil and Variable Condenser. We have 6 pairs of phones in use."... and did you notice the last sentence ?—

"We have Six Pairs of Phones in Use."

Sooner or later, you will use Neutron, and then stop searching for better results. You may secure a good crystal by just asking for "a crystal"; but you may also try twenty or thirty first. On the other hand, if you ask for Neutron, in the black-and-yellow tin, you will inevitably secure optimum re-

sults *at once*—and save the expense of further tests. The reason why you can depend on Neutron is that each Neutron is carefully tested and selected, and before ever it reaches your crystal-cup it has been proved at maximum efficiency, for loudness, clearness and complete sensitiveness.

and **NEUTRON** was the best of the lot

Stocked by the Best Radio Dealers. Packed in tin, with silver cats-whisker. Insist on Neutron, in the Black and Yellow Tin, **1/6**

Long-distance Circuit Diagram FREE

Ask your Dealer for Free Diagram (given on request to every purchaser of a Neutron) of the circuit used by 5 BT in receiving Brussels from Chiswick on a Neutron. We send one direct with sample Neutron if you enclose stamped envelope and 1/6 with Dealer's name.

Sole Distributors for U.K. :—V. Zeilin & Sons, 144, Theobald's Rd., London, W.C.1. Phones : Museum 3795 & 6841.

Produced by :—Neutron Ltd., Sicilian House, Southampton Row, London, W.C.1. Phone : Museum 2677.

District Agents:

- Scotland : R. F. Miller & Co., 22, York Place, Edinburgh.
- Plymouth : Mumford & Sons, 68, Mutley Plain, Plymouth.
- B'ham : Cooke & Whitfield Wireless Ltd., St. Paul's Buildings, 24, St. Paul's Square, Birmingham.

- North-East Yorks : Smith & Jordan, The Arcade, Redcar, Yorks.
- Manchester : Garnett's, Islington Grove Works, Salford, Manchester.
- Ireland : Pettigrew & Merriman Ltd., 8, Corporation Street, Belfast.
- N. Staffs : H. W. Teeton, Foundry St., Hanley.

The Concert-Tested and Guaranteed Radio Crystal





UP to the present over 20,000 would-be broadcast artistes have been given auditions by the B.B.C.

Of the million-odd licence holders in Great Britain to-day approximately 65 per cent. are crystal users.

Mr. Godfrey Isaacs, who had to resign from the Marconi Co. because of his health, is now very much better.

Another of the popular "query" programmes will be given on February 28.

A suggestion that proceedings of the Liverpool City Council of exceptional public interest should be broadcast is to be put before the Lord Mayor by the British Broadcasting Company.

The growth of the use of wireless in Canada is shown by the fact that the total receiving licences registered in the Department of Marine is now over 78,000.

Broadcasting failed at Sheffield recently owing to mice having eaten some cotton-wool of the microphone equipment.

The B.B.C. has picked up a message from KDKA, the well-known American station, embodying an appeal on behalf of St. Paul's Cathedral.

The P.M.G. has promised to see what

steps can be taken to protect homing and wild pigeons from damage by wireless aeriials.

The staff at 2 L O have formed a Rugby team.

The B.B.C. are still carrying out experiments with regard to echo effects and reverberation in studios.

The Glasgow Education Authority, in conjunction with the Scottish engineering staff of the B.B.C., has designed a receiving set, which is being demonstrated as the standard set for schools. It comprises a crystal detector with a two-valve power amplifier.

Primarily for the benefit of miners on late-shift work in the west of Scotland coalfields, the Glasgow station is to start forenoon transmissions. These will be given from 11.30 a.m. to 12.30 p.m. two days per week.

A chamber music programme will be given on Thursday, February 19.

Items by Miss Ruby Holder, Mr. Ronald Courley and Miss Joan Hastings will be broadcast on February 20.

A popular programme will be given on February 21, and will include items by the Band of H.M. Scots Guards.

During the whole of the perilous journey of the French motor expedition which is crossing the Sahara communication with Paris by wireless is being established.

There are ten wireless amateurs at Maderia, two of them owning low-power transmitters.

Mr. R. L. Royle, of Palmer's Green, London, effected two-way communication with 3 B Q, Australia, on January 30.

Australia already possesses four broadcasting stations: Sydney (2 F C), 1,100 metres (5 kilowatts); Sydney (2 B L), 350 metres; Perth (6 W F), 1,250 metres; Melbourne (3 L O), 1,720 metres.

A new record for transmission on short waves was made when Mr. J. L. Reinartz succeeded in exchanging messages with another amateur across the American continent on a wavelength of only 21 metres.

2 L O had an unusual experience recently when they received an urgent request to find someone to broadcast an address opening a bazaar at Birmingham. The B.B.C. secured the services of Viscount Curzon, who spoke from 2 L O direct to Birmingham Town Hall, where loud-speakers were installed.

Experiments which the French broadcasting station, Radio Sud-Est, at Lyons, has made in transmitting its concerts simultaneously upon wavelengths of 87 and 440 metres have met with great success.

The Crosley Radio Corporation, U.S.A., are just completing the installation of their new transmitter some thirty miles from Cincinnati. It is definitely decided

(Continued on page 322)

"BECO"

Hornless Loud Speaker.

AN ORNAMENT IN ANY HOME.
RICH IN MELODY—CLEAR AS A
CRYSTAL. VOLUME EQUAL TO
ANY STANDARD TYPE OF LOUD
SPEAKER, BUT FAR SUPERIOR
IN PURITY OF TONE.

British Made.

YOU MUST HAVE ONE! **WHY NOT NOW?**

OBTAINABLE FROM ALL DEALERS OR FROM

The British Electrical Sales Organization,

PHONE : CITY 7665.

623, AUSTRALIA HOUSE,
STRAND, LONDON, W.C.2.

Works—PUTNEY, LONDON, S.W.15

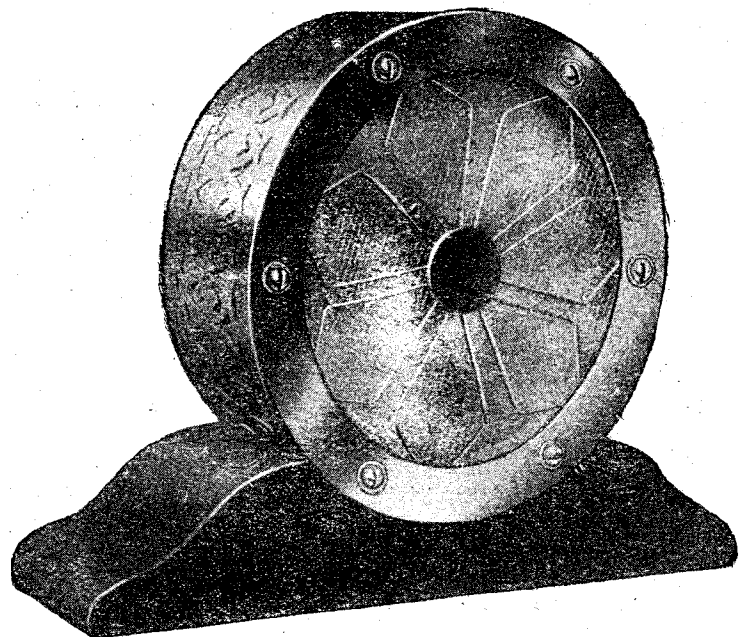

Silver or Copper
Oxyd. 55/-.

RICH IN MELODY

NICKEL PLATED

6" high,
5" dia.,
2" thick.

52/6

POST FREE.

"WIRELESS" SUCCESS

Mr. E. J. BARNARD, Welling, Kent, writes:

"I think I ought to tell you how much I value 'THE AMATEUR MECHANIC.' It has proved of great assistance in a variety of jobs, and especially as to the article on Wireless Telegraphy. I constructed an instrument entirely according to the instructions, and was rewarded with success on the first trial, as I succeeded in picking up the telephonic message from London to Geneva at 9.40 a.m. Considering that my aerial is only 42 feet long and 18 feet high, I think these are grounds for self-congratulation. I may add that until I became interested in the article in your 'Amateur Mechanic,' I had not the slightest elementary knowledge of Wireless Telegraphy."

You can do the same with The AMATEUR MECHANIC

Edited by BERNARD E. JONES

Written in Language you can Understand
supplemented by over 6,000 Illustrations

Apart from the up-to-date chapters on the fascinating study of Wireless Telegraphy the AMATEUR MECHANIC teaches you to do all those home jobs that cost so much to get done elsewhere. You can save its cost in a few weeks, besides finding pleasurable employment for an empty evening.

**Here are a few of the 400 Subjects it
Teaches in a Practical Way**

How to Build Your Own Sheds, Outhouses, Poultry Houses, etc.—How to Cure Damp Walls, Leaky Roofs, and Smoky Chimneys—How to Make Garden Frames, Garden Furniture, and Garden Paths—How to Mend Windows, and to Make, Mend, and Strengthen Locks and Bolts—To Clean, Overhaul, and Repair Motors and Motor-Cycles—To Install Wireless Telegraphy, Electric Light, etc.—To work in every kind of Metal—To Etch on Brass—To Write on Glass—To Make Hectographs—To Build a Boat, a Canoe, a Canvas Canoe, etc.—To paint and paper a room—To sole and heel and patch boots and shoes—To make a pair of hand-sewn boots—To restore colour to old brown shoes—to make household furniture—To re-seat chairs—To upholster sofas, etc.—To install a speaking-tube—To clean a stove—To repair bicycles—To work in metal—To colour metals—To repair water taps—To varnish a violin—To remedy damp walls, etc. etc.

Mr. A. C. Forster, Kensington, Liverpool.
"I am very well pleased with these books. They give plenty of scope for the amateur as well as for the practical tradesman."

SEND FOR FREE BOOKLET AT ONCE

(Send this Form in unsealed envelope, with halfpenny stamp.)

To THE WAVERLEY BOOK CO., Ltd.
(A. W. N. Dept.), 96, Farringdon St., London, E.C.4.

Please send me, without charge or obligation to order, your Free Descriptive Booklet, explaining contents, etc., of "THE AMATEUR MECHANIC," with specimen pages and pictures, and particulars as to your terms for small monthly payments beginning thirty days after

Name
Address
A.W.N., 1925.

*The Electrical Wonder Book
for Wireless Workers*

ELECTRICAL ENGINEERING

The Book that tells you all about Wireless Telegraphy

By Harold H. Simmons, M.I.E.E.,
and Alfred H. Avery, A.M.I.E.E.

An up-to-date work dealing with the whole field of
Electrical Engineering, design, and workshop practice

Profusely Illustrated

with over 1,000 Diagrams, Plans, Photographs, etc.

ELECTRICAL ENGINEERING deals with the whole Science of Electricity and describes every practical application in the Commerce and Industry of to-day. It explains all the elementary principles, and shows their practical application in the design, construction, and operation of every electrical appliance in modern practice—power, light, traction, etc.

It explains everything in Electrical Science that is difficult to explain in the simplest language. It has been written by practical men for practical men. That is one reason why it is the best book of its kind. Another reason is that it is practical. It tells you the why and how of everything. It includes everything in Electricity.

IT IS THE BOOK THAT IS INDISPENSABLE
TO EVERYONE INTERESTED IN
THE LATEST WONDERS OF ELECTRICITY

**It treats fully and Practically with all
the elements of Wireless Telegraphy :**

All about Aerials, Wave-lengths and Tuning. All about Transmitters and Transmitting Systems. Detectors, Receiving Systems, Syntony, etc. Thermionic Valves, Generators, Dynamos, Motors, Transformers, Balancers, Boosters, Testing Instruments, Armatures, Commutators, Winding Schemes, Brush Gears, Controls, Resistances, Switchboards, Accumulators, Lighting, Heating, Power, Telegraphy, Signalling, Telephony, Wireless, etc. etc.

**WRITTEN IN SIMPLE
UNDERSTANDABLE LANGUAGE**

**Send for Free Booklet giving full details
regarding price and terms of payment**

(Send this Form in unsealed envelope, with halfpenny stamp.)

To THE WAVERLEY BOOK CO., Ltd.
(A. W. E. Dept.), 96 Farringdon St., London, E.C.4.

Please send me, free of charge or obligation, your Free Descriptive Booklet explaining contents, etc., of "ELECTRICAL ENGINEERING," with specimen pages and pictures and particulars as to your terms for small monthly payments, beginning thirty days after delivery.

Name
Address
A.W.E., 1925.

RADIOGRAMS (continued from page 320) to use the new artificial language "Ido" for all the transmissions.

The wavelength of the Nottingham broadcasting station has been altered from 322 metres to 326 metres.

Inquiries are being made by the B.B.C. in reference to a proposal to provide land-lines for broadcasting purposes between the Swansea relay station and various local churches.

Major H. Lefroy, M.P., who was prominently associated with army wireless during the war, has been appointed a director of Marconi's Wireless Telegraph Co., Ltd.

Announcements from W K A Q, the San Juan broadcasting station, Porto Rico, are made in English as well as Spanish.

So far 28,000 licences have been issued from Leeds post offices, and as there are about 112,000 inhabited houses wireless installations may be found in one of every four residences.

A programme of vocal and instrumental music will be broadcast on February 23.

The S.B. programme to be given on February 24 includes items by Miss Gladys Palmer and Mr. Dale Smith. A shortened version of *The Beggar's Opera* will also be broadcast.

Broadcasting may be expected shortly from a new station which the Norwegian

Broadcasting Company is now constructing, and which should be ready to begin transmissions some time in the latter part of February. The station will be equipped with a 1,500-watt Marconi transmitter.

Mr. Ramsay MacDonald has promised to broadcast a lecture from 2 L O on "The Meaning and Limitations of Open Diplomacy."

The proprietors of several American hotels and apartment houses are now supplying wireless sets in every room.

A new broadcasting station has been erected at Moscow, to work upon a wavelength of 1,200 metres.

Wireless amateurs in Batavia, in the Dutch East Indies, are attempting to have the ban on wireless sets removed.

There is a good deal of speculation among crystal-users just now with regard to the possibilities of some material increase in the transmission power of 5 P Y.

The wireless programme broadcast recently from Moncton, New Brunswick, by the Canadian National Railway was heard well in Liverpool and the south of England, but was very indistinct in London.

Mr. S. K. Lewer (6 L J), of West Hampstead, states that he has recently been receiving signals from many of the 1st District American amateurs at midday.

Two new broadcasting stations are to be

erected at Bilbao and at Cadiz. Both stations will transmit with a power of 500 watts.

There are only four receiving sets in Bulgaria, and to each of the amateur owners a special government authority has been given. Authority is being sought by a Bulgarian company to broadcast, but it is stated that permission will only be given to broadcast agricultural subjects.

The wavelengths of the two great French military stations at Lyons (La Doua) and Bordeaux (Croix d'Hins) have been increased from 15,200 metres to 15,400 and from 19,100 to 19,500 metres respectively.

The changing of the wavelength of Radio-Paris from 1,780 metres to 1,125 metres is being considered by the French Post Office because of interference by the Dutch station at Schweningen.

Grumbles from Edinburgh people about too many programmes being sent on from Glasgow to their relay station have culminated in a ballot being organised by a trader in the Scottish capital. The figures obtained were significant, being as follows: For the London programmes, 477; for Glasgow, 46; no change, 49.

A wireless telephone service between ships and the shore, which may be linked up with the General Post Office land telephone lines, is now undergoing experiment at Southampton.

America — on one valve, with Reactone Coils

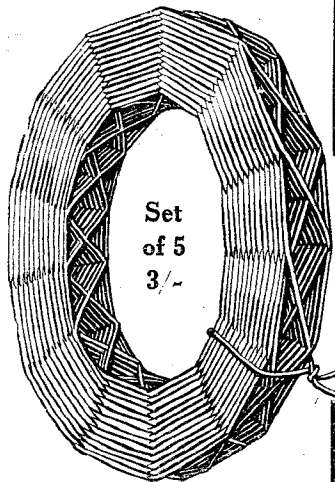

Set of 5 3/-

A.G.E., Maidenhead, writes: "Using Reactone Coils and One Valve only, W.G.Y. and W.B.Z. came in quite loud on the Phones. With three valves, using Reactone coil for H.F. Anode tuning, volume was so great on the loud speaker that it could be heard all over the house. I have tried many makes of coils but have never been able to get satisfactory long distance reception before, neither have I had such sharp tuning."

It is in the reception of the distant stations that the higher efficiency of Reactone Tension-Wound Inductances is most apparent. It is then that the sharp tuning of Reactone Coils counts—and the unique construction that gives without shellac or wax a highly efficient, rigid and uniform inductance.

Supplied in sets of 5 (Nos. 25, 35, 50, 75, and 100), and each set is boxed. Be sure to see the name "Reactone."

3/-

No. 150 (Chelmsford), Price 1/9.
No. 200 ... 2/3.



Reactone TENSION-WOUND Inductance Coils

Ask your Wireless Dealer: In case of difficulty send P.O. (adding 3d. for postage) with your Dealer's name and address, to The Manufacturers:

LEWIS HARFORTH & CO.,
88-90, Chancery Lane, London, W.C.2.
Phone: Holborn 2213.

Wholesale from V. Zeitlin and Sons,
144, Theobald's Rd., London, W.C.1.
Agents wanted in all Broadcasting Centres.

A. MUNDAY, Ltd.,

Electrical and Wireless Engineers,
59, WATLING STREET, E.C.4.

TEL., CITY 2972
(One door from Queen Victoria St. and Queen St.)
AND AT

45, EASTCHEAP, E.C.3.
ROYAL 4632

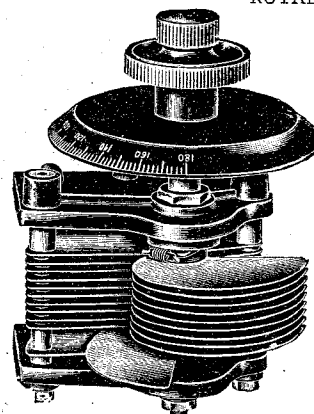

We are Stockists of
STERLING SQUARE-LAW CONDENSERS
BOWYER-LOWE SQUARE-LAW CONDENSERS
POLAR CONDENSERS
ORMOND JACKSON & FORMO CONDENSERS
TRANSFORMER, 10/- SPECIAL.

Accumulators in Stock Charged,
6 volt 60 amp., 26/6

ALL MAKES OF EVERYTHING FOR WIRELESS

WIRELESS ON EASY TERMS

GAMAGES have now extended their easy payment system to Wireless, and you may now secure on payment of first deposit Wireless Sets and Apparatus from £5 upwards, balance being payable in monthly instalments. Write for details to Wireless Dept.

GAMAGES FOR WIRELESS VALUE!

Our Stocks are comprehensive and always fully up-to-date, our assistants are Wireless Experts, always ready to offer sound technical advice and the **VALUE** offered is unrivalled.

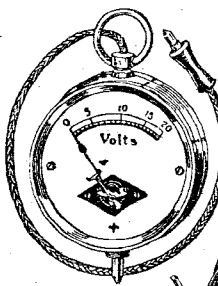

**Special Line
VOLTMETERS**

Dead-beat Type, very reliable, nicely made and finished. Readings 0.3, 0.6, 0.12, 0.15, 0.20 volts. Post 6d.
5/-
Price each

POST ORDERS
and Enquiries receive prompt attention and speedy dispatch, and should you have any cause for dissatisfaction, we willingly put it right or refund your money in full.

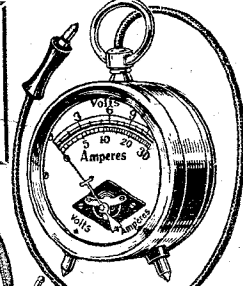

**Combined Dead-Beat
VOLT-AMMETERS**

Watch Type in Nickelled Brass Case. Readings 0-15 volts; 0-30 amps. Of Gamages usual high quality.
7/6
Post 6d. Price

ALL makes of Values, Batteries, Loud Speakers, 'Phones, etc., are included in our Stocks. Come and see them!

TELEPHONES
Special Line of high-class 'phones, 4,000 ohms. Fully guaranteed and very comfortable to wear. Nicely made and finished.
12/6
Price per Pair

BOOKS on Wireless in stock dealing with every conceivable problem, written by Wireless Experts and nicely bound

GAMAGES SUPER CRYSTAL DETECTOR
with the new REVOLVING CRYSTAL, which enables all spots to be used without removing Crystal. Supplied complete with a piece of our famous "PERMANITE" Crystal and Silver Cat's Whisker.
Price for Panel Mounting. **4/6**
Post 4d.



SOMETHING NEW!

The "Duo-Lateral" COIL HOLDER.
No Loose or Dangling Wires; Direct Connection on Underside of Panel; Reversible Pins; Anti-Capacity Handies

With the Gamage Duo-Lateral Coil Holder, there are no loose or dangling wires; it is electrically connected (through the stout metal brackets) to the underside of the panel by screws and nuts provided for the purpose. Insulated parts are made of best ebonite and metal parts of Nickel-plated Brass.

Price for Two Way **5/-** Post 3d. Price for Three Way **6/6** Post 3d.

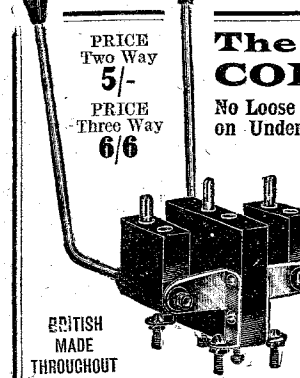

For Table Panel Mounting. **5/6**
Post 4d.

PRICE Two Way **5/-**
PRICE Three Way **6/6**

BRITISH MADE THROUGHOUT

GAMAGES, HOLBORN, LONDON, E.C.1

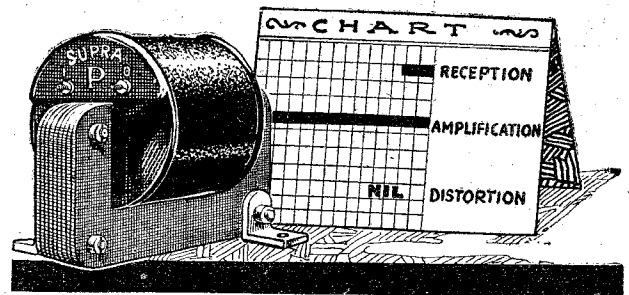

THIS illustrated chart tells the story of the SUPRA transformer, which, briefly stated, is, *volume free from distortion.*

These desirable qualities are chiefly attributable to the sectional windings. You need pay no more than twelve-and-six!

This claim is substantially supported by our offer to refund your money if the SUPRA transformer is not entirely satisfactory.

12'6

Ratio 5 : 1

If your local dealer doesn't stock, send to us direct.

Write, 'phone or call for our new catalogue just published.

WATKES
BROS., LTD.

12-14, Gt. Queen St., Kingway, W.C.2.
'Phone : Gerrard 573/6.

CRINOLINES AND CANNON BALLS

belong to the past; they are replaced by up-to-date articles giving better service. Nobody uses a crinoline or a cannon ball now, and for the same reason the valve user goes for the very latest production. Hence the phenomenal sale of the C. & S. DULL EMITTER, which received

NEW ZEALAND
on one valve.

PRICE
12/-
2 volt 0.2 amp.
(also made 0.06 amp.)
15/- each.



CRAIK & SMITH
ALLEN ST., E.C.1
Showcards Now Ready.

WHY PAY MORE?



THAN **11/6** PAIR

4,000 ohms Double Headbands
TRIED, TESTED & TRUE

Hundreds of thousands of wireless enthusiasts are buying Headphones daily.

DO THEY KNOW WHAT THEY ARE PAYING FOR?

If they only stopped to think and compared values, would they pay twice as much for practically the same article?

WOULD THEY?

We should think not! And we cannot too strongly advise you to

TAKE WARNING

and insist on being shown the
I.M.I.

"Astoria" HEADPHONES

Handle them, screw off the cap and examine the inside, try them on and note the comfort over your head and the close fitting at the ears, and you will realize what satisfaction means at a small cost only.

Obtainable from all dealers.

IMPERIAL MOTOR INDUSTRIES, LTD.,

Wireless Dept.,

Denmark St., W.C.2.

Tel. 3347-8 Gerrard.

BROADCASTING DEVELOPMENTS IN AUSTRIA

ALTHOUGH the Vienna broadcasting service was only officially inaugurated in October last, wireless has taken such a hold on the Austrian capital that over 100,000 receiving licences have been issued to date.

In view of this initial success the broadcasting company has decided to increase the length of its transmissions by about four hours daily and to include in its programmes features which have found favour in other countries. English lessons are in great request. A new studio is planned and will be built on the lines of those used by the B.B.C. The relaying of concerts from the local halls is already an accomplished fact. An exchange of correspondence between the director of Radio-Wien and the B.B.C. has, according to information received from Vienna, brought about excellent results. Herr Oskar Czejka, the director, recently stated that good material for the broadcasting of plays had been put at his disposal by 2 L O, and negotiations in progress with the London station raised hopes regarding the relaying of concerts from 2 L O in Vienna and those in the Austrian capital for London listeners.

The local Union of Musicians and

Artistes has declared open war on broadcasting. In view of the excellent concerts transmitted to listeners, many of the hotels and restaurants have discharged their orchestras and replaced them with loud-speakers. Since Radio-Wien has included relays of programmes from the principal halls, competition has been acutely felt, and protests have been lodged with the authorities.

The alternative put forward by the Union is that no broadcasting should take place during theatre hours—that is, between 7 and 11 p.m. Should this proposal not be accepted, musicians, composers and artistes threaten to boycott the studio, in which case the broadcasting company may find some difficulty in compiling its programmes. According to a Vienna correspondent the position has reached a critical point.

The Municipality of Vienna is also insisting on the payment of an amusement tax.
J. G. A.

"Wireless Telegraphy and Telephony"

The most Practical Handbook for the Amateur. The price is **1/6** net.

From all Newsagents and Booksellers, or post free by return for 1/9 from the Editor of *Amateur Wireless*

Cassell & Co., Ltd., La Fells Sauvage, London, E.C.4

With Every Copy of This Week's "Amateur Wireless" we present a 36-page Sixpenny Booklet

"WIRELESS QUESTIONS SIMPLY ANSWERED"

THERE must be a very strong point of view and a very special object in going to the enormous expense of producing at least 200,000 copies of the booklet which we present with this issue. We are giving that booklet away! We are doing our best week by week to make "Amateur Wireless" meet the needs of the amateur public. A very large number of that public know of our efforts and loyally support us, but there is a further number that knows us not. Now, the publication of this free booklet gives us a chance of an introduction to them, and that is absolutely the whole of the object we had in mind in going to this expense and trouble—except, of course, we know that our enterprise will give our regular readers a certain amount of definite pleasure.

We much appreciate the fact that we have an enormous number of regular readers week by week. Many of them

write to us, send us their queries, criticise us and occasionally give us a word of appreciation. But we expect that a very large number of wireless people will see "A.W." for the first time this week, and it is to them that we make our special appeal. Will they do us the favour of ordering "Amateur Wireless" to be sent them every week? By filling in the form given at the foot of this announcement they will be adopting the easiest possible way of seeing that "Amateur Wireless" reaches them regularly. The greater the number of our regular readers the more generally useful we can be to everybody, and we sincerely trust that old readers and new ones alike will combine on this occasion to speak a kindly word for us with the object of extending our already immense circulation.

Here is an order form. Will new friends fill it in at once?

ORDER FORM

To (Newsagent)

Please supply me every week, until further notice, with "Amateur Wireless," published by Cassell's.

(Signed).....

(Address).....

FILAMENT SAFETY AND VERNIER CONTROL

The Efesca Vernistat makes your valves safe against an accidental burn-out through too rapid switching-on, because three complete revolutions of the knob are required to bring in or out the whole 5 ohms resistance. The Vernistat provides the most delicate filament control yet invented and should be used wherever a separate rheostat is employed for H.F. and detector valves. Ask your wireless dealer to show you the complete series of

EFESCA

ONE HOLE FIXING COMPONENTS

WHOLESALE ONLY:
FALK STADELMANN & CO., Ltd.

Efesca Electrical Works,

83, 85, 87, Farringdon Road, London, E.C.1.
And at Glasgow, Manchester and Birmingham.

EFESCA VERNISTAT (Patent)

Unique Construction. Smooth and silent in operation. Resistance 5 ohms, 6/- each, as illustrated.

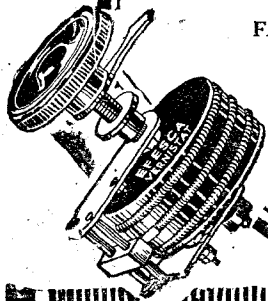

The "CHASEWAY" JUNIOR HOME BATTERY CHARGING

FOR

(FOR DIRECT CURRENT ONLY)

SAFE, RELIABLE, PRACTICAL, EFFICIENT

The greatest JUNIOR on the market. Recharges your accumulators FREE whilst you are using current in any part of the house for other purposes.

LOOK FOR THE CHINA FUSE BOX—YOUR SAFEGUARD

Larger Models No. 1, 25/-; No. 2, for lower voltages, 35/- and 40/-; No. 3 (Multiple) Model, for recharging depots, £4. *Send for full particulars.*

Look out for "CHASEWAY" Alternating Current Charger—Ready Shortly.

"CHASEWAY" VARIABLE GRID LEAK

001 - 20 meg. s.

10/6 postage 9d.

The greatest advance in grid leak manufacture. A really scientific instrument. The nerves of your set. Give extraordinary results in sensitivity and range. **RELIABLE FOR ALL TIME.** One-hole fixing and the end of your Grid troubles.

Send stamp for Illustrated Catalogue of "CHASEWAY" Novel Necessities.

CHASE ELECTRICAL MFG. Co., Ltd.
184a, Fleet St., LONDON, E.C.4.

4!

Phone: Central 1539.



Prov. Pats.

V. Pethick—Advertising—London.

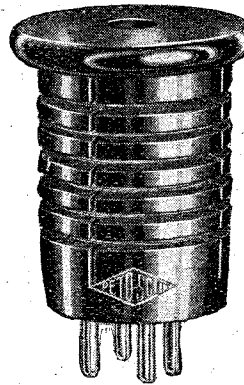

Plug-in H.F. or Neutrodyne Transformers

The latest Peto-Scott H.F. Transformer with windings in six slots. Very selective tuning and particularly efficient for long-distance work. Only the highest grade ebonite used in its construction.

300 to 600 metres - each 7/6
Chelmsford and Radiola - each
Matched in pairs at no extra cost.

Similar type but wound specially to Mr. Harris's Specification for use in the Six Valve Anglo-American Six and matched.

7/6 each.

21/6 set of three.

Slow Motion Coil Holder (3 coil).

For Panel mounting or Cabinet mounting. Knob gives vernier movement. Essential for accurate tuning. Superior workmanship ... 15/6 Two Coil Holder, 10/6

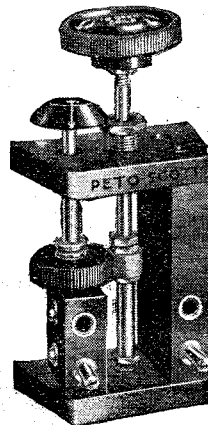
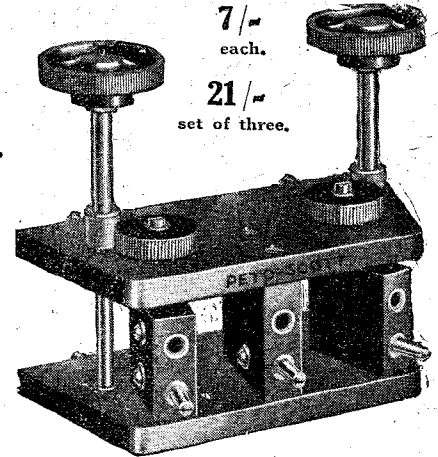

Back of Panel Coil Holder

As used by Mr. Percy Harris, Mr. Barber and other authorities. The only satisfactory method of mounting coils at rear of panel. Friction drive gives vernier movement. Indication in front of panel shows position of moving coil. Price 12/6

Neutrodyne Condenser

Essential for providing the very low capacity required for tuning neutrodyne transformers. One-hole fixing. Price 5/6

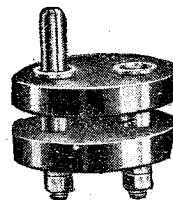

Coil Holder

For panel mounting. Very neat. Complete with nuts. 1/2

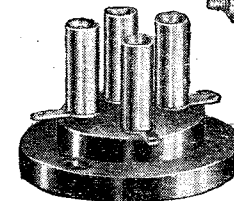

Valve Holder

For American-type Sets where components are mounted on baseboard. Complete with soldering lugs 1/3

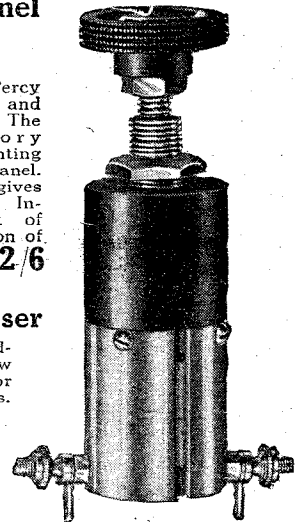

EXPERIMENTERS :

Send 3d. for a copy of our Pilot Chart. 32 pages describing all the famous Pilot Sets including the S.T.100, the Transatlantic V, the All-Concert de Luxe and many others. Catalogue of Components fully illustrated 3d. post free. Peto-Scott's Wireless Book post free 1/5.

PETO-SCOTT CO. LTD.

Registered Offices ;

77, CITY ROAD, E.C.1 (For all Mail Orders.)

Branches:—LONDON: 62, High Holborn, W.C.1; and 230, Wood Street, Walthamstow. CARDIFF: 94, Queen Street. LIVERPOOL: 4, Manchester St. PLYMOUTH: Near Derry's Clock. P.S.2288



NOTE.—In the following list of transmissions these abbreviations are observed: con. for concert; lec. for lecture; orch. for orchestral concert; irr. for irregular; m. for metres; and sig. for signal.

GREAT BRITAIN

The times given are according to Greenwich Mean Time.

London (2LO), 365 m. 1-2 p.m., con.; 3-15-3-45 p.m., lec.; 4-5 p.m., con.; 5-30-6-15 p.m., children; 6-40 p.m. talk; 7-7-30 p.m., time sig., news, talk; 7-30-9-30 p.m., music; 9-30-10-0 p.m., time sig., news, talk; 10-0-10-30 p.m., music. Mon. and Wed. the Savoy Bands are relayed until 11-0 p.m., and on Sat. until midnight. Sat. only, 4-5-30 p.m., con.

Aberdeen (2BD), 495 m. Belfast (2BE), 435 m. Birmingham (5IT), 475 m. Bournemouth (6BM), 385 m. Cardiff (5WA), 351 m. Glasgow (5SC), 420 m. Manchester (2ZY), 375 m. Newcastle (5NO), 400 m. Much the same as London times.

Bradford (2LS), 310 m. Dundee (2DE), 331 m. Edinburgh (2EH), 328 m. Hull (6KH), 335 m. Leeds (2LS), 346 m. Liverpool (6LV), 315 m. Nottingham (5NG), 322 m. Plymouth (5PY), 335 m. Sheffield (6FL), 301 m. Stoke-on-Trent (6ST), 306 m. Swansea (5SX), 481 m.

CONTINENT

The times are according to the Continental system; for example, 16.30 is 4.30 p.m., and 08.00 is 8 a.m. (G.M.T.).

AUSTRIA.

Vienna (Ravag), 530 m. (1 kw.). Daily:

08.00, markets (exc. Sun.); 10.00, con.; 12.05, time sig.; 12.20, weather; 14.30, Stock Ex. (exc. Sun.); 15.00, news, con.; 15.10, children (Wed.); 17.10, lec. (Wed., Thurs., Sat.), children (Mon., Fri.), women (Tues.); 18.30, news, weather; 19.00, time sig., con., news; 21.00, dance (Wed., Sat.).

Graz (relay), 700 m. Testing.
Innsbruck (relay station). Under construction.

BELGIUM.

Brussels (SBR), 265 m. (1½ kw.). 17.00, orch., children (Wed. and Thurs.); dance (Tues. and Sat.); 18.00, news; 20.15, lec., con., news (opera, Mon. and Wed.).

Haeren (BAV), 1,100 m. 13.00, 14.00, 16.50, 18.50, weather.

CZECHO-SLOVAKIA.

Kbely (OKP), 1,160 m. (1 kw.). Weekdays: 09.00, 10.30, 12.30, 16.00 and 17.00, con. (Wed. and Sat.); 18.30, lec., news, weather, con. (time sig., 19.00), daily; 10.00, con. (Sun.).

Komarov (OKB), 1,800 m. (1 kw.). Weekdays: 13.00, Stock Ex., weather, news; 17.30, con. (Thurs.); 09.00, con. (Sun.), also testing on 1,180 m.

Strasnice (430 m.). Testing shortly.

DENMARK.

Copenhagen (Kjobenhavns Radiofoni station), 475 m. (1 kw.). 18.35, notices, lec., con.* (Tues., Thurs., Sat.). *This con. is also relayed by the Aalborg station on 510 m.

Lyngby (OXE), 2,400 m. and 2,700 m. Weekdays: 18.20, news, Stock Ex. (2,700 m.); 20.00 and 21.00, news, weather, time sig. (2,400 m.). Sundays: 15.00 and 20.00, news (2,400 m.).

Ryvang, 1,190 m. Concert, 14.00 (Wed.), 15.00 (Sun.), 19.00 (Fri.), 19.30 (Tues.).

FRANCE.

Eiffel Tower, 2,600 m. (6 kw.). 06.40, weather (exc. Sun.); 11.00, markets (exc. Sun. and Mon.); 11.15, time sig., weather; 14.45, 15.35, 16.30,* Stock Ex. (exc. Sun and Mon.);

18.00, con. (not daily); 18.45, Paris fashions (in English)—temp—(Wed. and Sat.); 19.00, weather; 20.30, con. relayed from PTT (Fri.); 22.10, weather (exc. Sun.).

* On 1st and 15th of each month at 16.45.

Radio-Paris (SFR), 1,780 m. (2 kw.). Sundays: 12.45, orch.; 13.45, news; 16.45, con.; 20.30, news, &c.; 21.00, dance music. Weekdays: 12.30, orch., Stock Ex., news; 16.30, markets, Stock Ex., con.; 17.45, Stock Ex., news, women; 20.30, lec., news, con.; 21.00, dance (Thurs.). Frequent relays of 5 XX after 22.00. *Le Matin*, Paris, provides a special concert every 2nd and 4th Saturday in the month at 21.00 or 22.00 G.M.T.

L'Ecole Sup. des Postes et Télégraphes (PTT), Paris, 450 m. (400 w.). 14.00, lec. relayed from Sorbonne University (Thurs.); 15.00, outside relay (Sat., irr.); 15.45 and 17.00, lec. relayed from Sorbonne (Wed.); 16.00, outside relay (irr.); 20.00, Eng. talk (Tues.); 20.30, lec. or con., almost daily, con. relayed by F. L. (Fri.); 20.45, lec. (Sun.), organ recital 3rd Sun. each month; 21.30, con. (Sun.). Power will be shortly increased.

"Le Petit Parisien", 345 m. (500 w.). 21.30, con. (Sun., Tues., Thurs.), dance (Sat.).

Lyons-la-Doua, 550 m., 10.30, gramophone con.; news, etc. (irr.).

Radio-Lyon, 287 m. (2 kw.). 12.00, 17-15, 20.30, news; con. (irr.).

Toulouse Aerodrome (MKD), 1,525 m. 09-42, 19-42, weather.

GERMANY.

*Berlin (2), 305 m. (1½ kw.). 08.00, sacred con. (Sun.); 09.00, markets, news, weather; 10.00, factory con. and tests; 10.30, educat. hour (Sun.); 11.15, Stock Ex.; 12.00, time sig., news, weather; 13.15, Stock Ex.; 14.00, lec. (Sun.), markets; 14.30, children (Sun., Wed.); 15.00, Esperanto (Sat.); 15.30, orch., French (Tues.); 17.30, lec., women; 18.00, French (Mon.), lec. (Tues.); 18.30, lec., Engl.

(Concluded on page 328)

The New Coloured Connecting Wire

GLAZITE

Don't risk burning out an expensive Valve !

"Glazite" makes that back-of-panel "short" an impossibility. Made of tinned copper wire with a special glazed covering, "Glazite" possesses exceptional insulating qualities, which enable you to entirely dispense with insulating sleeving. Damp-proof and flame-proof "Glazite" will not deteriorate in use.

Ask your radio dealer for "Glazite." It is made up in neat coils 10 feet in length in four different colours—red, blue, yellow and black. Price 1/6 per coil.

Send a postcard for "Glazite" Leaflet and name of nearest radio dealer carrying stock.



THE LONDON ELECTRIC WIRE CO. & SMITHS, LTD.

(Makers of Electric Wire for over forty years.)

Playhouse Yard, Golden Lane, London, E.C.1.

Telegrams: Electric, London. Telephone: Clerkenwell, 1388, 1389, 1390, 1391.

THE MOST EFFICIENT VALVE HOLDER

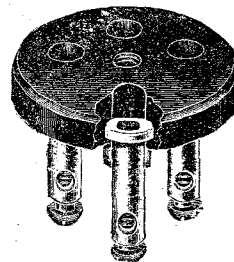

"MURRAY"
VALVE HOLDERS

1/3

Postage on 1 or 2, 2d. 3 or more Post Free.

EXPORT ENQUIRIES INVITED

From all Dealers, or in case of difficulty, write to the Patentees.

MURRAY, SON AND CO.,
387a, HIGH ROAD, TOTTENHAM, N.17.

Phone:—TOTTENHAM 178.

The "MURRAY" Valve Holder is a revolution. Scientifically designed, and in construction mathematically perfect, it provides absolute safety, besides being neat in appearance. It has a particularly high finish, but extremely low self-capacity, and is the holder par excellence for the experimenter as well as the amateur.

COUNTER-SUNK SOCKETS SAFETY-FIRST

The cap, made of finest EBONITE, serves as the drilling template, and sockets being counter-sunk ensure absolute safety. The "MURRAY" Valve Holder is easily fixed either above or below the panel.

Each one is mounted on a card, with the very simple instructions necessary for fixing.

No. 2 of this
superb New Magazine
 on sale February 25

Order your Copy **NOW**



More than 50
 Separate Features

including

BROADCASTING : TO-DAY, AND TO-MORROW

A Special article by CAPT. P. P. ECKERSLEY

A SPECIAL REINARTZ TWO-VALVER

Designed and built by "The Wireless Magazine"

A SELECTIVE ONE-VALVE SET

A CRYSTAL SET FOR MANY PHONES

JOKING APART : TIPS FOR TYROS

By F. W. THOMAS

SELENIUM : A KEY TO TELEVISION

By E. E. FOURNIER D'ALBE

AT 2, SAVOY HILL, W.C.2

A Page Contributed by the B.B.C.

KEEPING THE HOME FIRES BURNING

By E. V. KNOX ("Evoc" of "Punch")

MY FIVE-VALVE RECEIVER

By A Boy of Fifteen

WHAT I THINK OF BROADCAST TALKS

By J. C. STOBART, Director of Education, B.B.C.

OUR CROSS-WORD THREE-VALVER

SOME "REFLEX" MYSTERIES SOLVED

THE EVOLUTION OF THE CRYSTAL SET

Free

COLOUR PLATE
 and **TWO BLUEPRINTS**

constituting coloured wiring diagrams and full size panel-drilling templates for two notable wireless sets—a selective one-valver and a special Reinartz two-valver.

Over 200,000 Copies of No. 1
 were sold on day of publication

Make sure of your Copy of
No. 2 by giving an order to
 your **Newsagent TO-DAY**

1/- net
 monthly

CASELLS
 Publishers
 LONDON



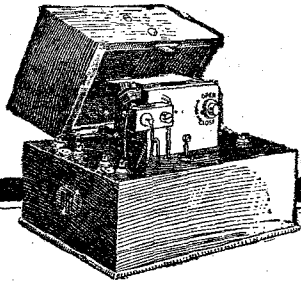

Amplification without valves

**THE BROWN Micro-
phone Amplifier is
available in two types:**
**Type C. For attachment
to any Crystal Set as an
amplifier to operate a
large number of pairs
of Headphones. For
Hospitals, Institutes and
Clubs there is no more
economical method than
to use a BROWN
Microphone Amplifier
and a simple little 6-volt
dry battery. No Valves to
buy, no accumulators to
recharge—costs practi-
cally nothing to run.**

**Type V. To take the place
of a 2-Valve amplifier.
Can be used with any
one-Valve Receiver to
work a Loud Speaker.
Gives very powerful and
undistorted signals with-
out the expense of
Valves or accumulators.
Supplied by any Dealer
or direct.**

Type C.	
4000 ohms input	£6:0:0
2000 ohms output	
Type V.	
120 ohms input	£5:5:0
120 ohms output	
2000 ohms input	£5:8:6
120 ohms output	
2000 ohms input	£5:13:6
2000 ohms output	

S. G. BROWN LIMITED
Victoria Road, N. Acton, W.3

Showrooms:
19 MORTIMER STREET, W.1
15 MOORFIELDS, LIVERPOOL
67 HIGH ST., SOUTHAMPTON

Brown

Wireless Apparatus

Gilbert Ad. 2268

"BROADCAST TELEPHONY" (cont. from page 326)
(Thurs.), theatre news (Tues.); 19.30, * con.,
weather, news, time sig.; 21.30, chess (Mon.),
dance until 23.00 (Thurs., Sat., Sun.). * If
opera relayed, at 18.30.

Berlin (Telefunken Co.), 290 m. Tests.

Königswusterhausen (LP), 2,450 m. (5 kw.).
Wolff's Buro. Press Service: 06.00, 20.00,
2,800 m. (5 kw.): 10.30, con. (Sun.), Esperanto
lec. 3,150 m.: Telegraphen Union, 06.45-18.45,
news, con. (Fri., irr.). 4,000 m. (10 kw.):
Express News Service, 06.00-20.00 (daily); lec.
(Tues. and Fri., time irr.).

Bremen, 330 m. (1 kw.). Relay from Ham-
burg.

Breslau, 418 m. (1½ kw.). 10.15, Stock Ex.,
weather; 11.00, factory con. (weekdays),
sacred con. (Sun.); 11.55 (Sun.), time sig.,
weather, Stock Ex.; 14.00, news (weekdays);
15.00, children (Sun.); 16.00, orch., children
(Fri.); 16.45, con. (Sat.); 17.00, shorthand
(Sat.), Mah Jongg (Wed.); 18.00, Esperanto
(Mon.), Engl. (Thurs.), lec. (other days); 19.00,
con., weather, time sig., news; 20.30, dance
(Sun.); 21.15 (Mon.).

Cassel, 228 m. (1½ kw.). Relay from
Frankfort.

Dresden, 280 m. (1½ kw.). Relay from
Leipzig.

Frankfort-on-Main, 470 m. (1½ kw.). 07.30,
sacred con. (Sun.); 10.10, Stock Ex.; 10.55,
time sig., news; 15.00, children (Sun.), Stock
Ex. (weekdays); 15.30, con., women; 16.00,
con. (Sun.); 17.00, markets, lec., children
(Wed.); 18.00, lec. (daily), shorthand (Wed.),
Esperanto (Fri.); 18.30, educat. hour; 19.00,
lec., Engl. (Mon.); 19.30, con. (daily), jazz
band (Fri.); 20.30, time sig., weather, news;
21.00, dance or late con. (not daily).

Gleiwitz (relay station). Under construction.

Hamburg, 395 m. (1½ kw.). Sunday: 07.55,
time sig., weather, news, lec., women; 10.00,
sacred con., chess; 12.00, con., lec.; 16.00,
children; 17.00, con.; 18.00, Engl. conv.; 19.00,
sport, weather, news, con. or opera; 21.00 on-
wards, as weekdays. Weekdays: 06.25, time
sig., news; 07.30, theatre news; 11.55, time
sig.; 12.20, Engl. (Wed.); 14.00, political news,
markets; 15.00, women; 15.30, lec., Esperanto;
16.05, orch., 17.00, con., lec.; 18.25, lec.,
Engl. conv. (Tues. and Fri.), Spanish (Mon.
and Thur.); 19.00, weather, con. or opera;
21.00, weather, markets, news; 21.50, news (in
English), dance (not daily). Will shortly be
increased to 5 kw.

Hanover, 296 m. (1½ kw.). Relay from
Hamburg. Will shortly become a main station.

Königsberg, 463 m. (1½ kw.). 08.00, sacred
con. (Sun.); 10.15, markets; 11.55, time sig.,
weather; 13.15 and 15.00, markets; 15.30,
children (Tues., Wed., Sat.), orch.; 18.30, lec.,
Esperanto (Thurs., Sat.); 19.00, con. or opera;
20.00, orch., lec., weather, news, dance (Thurs.,
Sun.).

Leipzig, 454 m. (1½ kw.). 07.30, sacred
con. (Sun.); 10.00, educat. hour (Sun.); 11.00,
markets, orch., time sig.; 15.00, markets;
15.30, orch., children (Wed.); 16.30, lec.
(Tues.); 17.30, lec. (Tues.), experimenters (Wed.
and Sat.); 18.00, lec.; 19.00, lec. (irr.); 19.15,
con. or opera, weather, news; 21.00, con. (not
daily). Will shortly be increased to 5 kw.

Münich, 485 m. (1½ kw.). 10.30, lec., con.;
13.00, news, weather, time sig., snow forecast;
14.00, con., lec. (Sun.); 15.30, orch. (16.00
Sun.), children (Wed.); 17.00, agric. talk
(Mon.), con.; 18.00, lec., Engl. (Mon. and Fri.),
Italian (Tues.), Russian (Sat.), Esperanto
(Thurs.); 19.30, con.; 20.30, news, weather,
time sig.; 21.00, late con. (Sun.), lec. (Tues.),
dance (Sat.).

Munster, 410 m. (1½ kw.). 11.00, sacred
con., news (Sun.); 11.30, news (other days);
11.55, time sig.; 14.30, markets; 15.30,
children (Sun.), lec. (weekdays); 18.40, weather,
lec., time sig.; 19.20, women, con. or opera,
news, dance (Sat.); 21.00, English, Spanish or
Esperanto, news, dance (Sat.).

Nuremberg, 340 m. Relay from Munich.

Stuttgart, 443 m. (1½ kw.). 06.30, time
sig., weather (weekdays); 10.30, con. (Sun.);

15.00, time sig., con., news (Sun), children
(Sat.); 16.45, children (Wed.); 18.30, lec.
(weekdays); 19.00, con. (daily); 20.15, time
sig.; 22.00, weather, news, dance (Sun.).

FINLAND.

Haelsiikki, 400 m. (temporary w.l.). Testing
daily.

HOLLAND.

Amsterdam (PCFF), 2,000 m. Daily: 07.55-
16.10 (exc. Mon. and Sat., when 10.10-11.10),
news, Stock Ex., time sig., 09.55 and 16.10
(PX9), 1,050 m.: con., 20.40, con. or organ
recital (Mon.).

Hilversum (HDO), 1,060 m. (1½ kw.). 17.40,
children (Mon.); 19.40, lec. (Fri.); 19.40, con.
(Sun.), relay of Mendelberg orch. (Thurs.);
con. (Sun.); 19.55, Radio talk (Wed.); 21.40,
lec. (Sun.).

Vossegat (Bé), 1,050 m. 12.10 and 19.40,
weather.

Soesterberg, 1,050 m. 19.26, weather.

Bloemendaal, about 200 m. 09.40 and 16.40,
sacred service (Sun.).

HUNGARY.

Buda-Pesth. New broadcasting station will
be opened in March.

ITALY.

Rome (IRO), 425 m. (2 kw.). 14.15, con.
(not Sun.); 15.45, time sig., news, Stock Ex.;
19.30, news, con.; 21.25, weather, dance.

Centocelle (ICD), 1,800 m. (6 kw.). 15.00
and 19.30, news, con.

JUGO-SLAVIA.

Belgrade, 1,650 m. (2 kw.). 17.30, con.,
news, weather (Tues., Thurs., Sat.), weather,
news only (Mon., Wed., Fri.).

NORWAY.

Christiania, 340 m. (500 w.). Testing, daily,
about 19.30.

PORTUGAL.

Lisbon (Aero-Lisboa), 375-410 m. 21.30,
tests, music, speech (Wed. and Fri., irr.).

Montesanto (CTV), 2,450 m. (1½ kw.). Tests
music (irr.); 13.00 and 23.00, weather.

RUSSIA.

Central Wireless Station, 1,450 m. Sundays:
12.45, lec.; 15.30, news; 16.15, con. Week-
days: 13.00, markets; 15.30, news or con.

Sokolniki Station, 1,010 m. Sundays: 09.00,
lec.; 10.00, radio talk; 13.30, lec.; 14.30, con.;
17.00, lec. and con. (Tues., Thurs., Fri.).

Trades Union Council Station, 750 m. 17.00,
con. (Mon., Wed.).

SPAIN.

Madrid (Radio-Iberica), 392 m. 21.00,
weather, Stock Ex., time sig., con., news;

(Continued on page 330)

THE NATURAL CRYSTAL

ETHITA

Trade Mark
IS SECOND TO NONE
Sample post free 1s. Please send local dealer's name, etc.
Proprietors: THE BRIGHT CO. LONDON, N.8.

Sole Wholesale Agent for London & Home Counties only
A. J. CONWAY, 86, GREENWOOD ROAD, LONDON, E.8
Phone: Clissold 4976.

WORLD FAMOUS RAULAND TRANS-FORMERS
Pioneers in the Industry.

There is a "Rauland" for every circuit. Whatever your
requirements—H.F. or L.F.—you can be certain that
you will find in the complete "Rauland" line the exact
instrument you want. Each one carries with it a positive
guarantee of reliability. From all Good Dealers. :: ::

GASTO & MARBA X.
27-8, Anning Street, London, E.C.

**TO MAKE YOUR AMPLION JUNIOR EQUAL TO A
£5 5s. MODEL SEND POST CARD FOR PARTICULARS
COMPLETE "ALLWOOD-ORN" & AMPLION SPEAKER 45/-**
Wood horn, aluminium casting and 2,000 ohms the cheapest and
best loud speaker with wood horn. Wood Bells, horns and
flares made to fit your speaker, state your requirements
fully. WOOD BELLS and GOOSE NECK CASTINGS
supplied. Ditto to take GRAMOPHONE ATTACHMENTS
**H. MADDISON, 2a, Ronalds Rd., Holloway Rd.,
Nr. Highbury.** Manufacturer of 54" wood horns as
displayed by "Amplion" at Wembley—Trade supplied
customary terms (cash with order)

Megger evidence

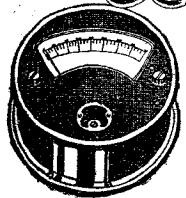

YOU can't tell how good—or how bad—a piece of ebonite is by looking at it. Even its surface appearance can belie its actual efficiency. But to build it into a set—particularly if you are using a stage of High Frequency amplification and you will soon find out whether its quality is good. Now obviously, you don't want to go to the trouble and expense of building a good Set only to find that the signals are weak—or that the Set howls—or even that not a sound is obtainable.

What is the remedy? Use a Red Triangle guaranteed Panel and success is assured. Every sheet of Red Triangle ebonite before being cut into panels is tested on the Megger—a wonderfully sensitive electrical instrument which instantly detects leaks. Nothing can escape its eagle eye and any ebonite that does not come up to the Red Triangle standard of quality is ruthlessly cast out.

Each panel is cut dead square and is supplied with a velvet matt surface carefully packed under our own label.

If your local Dealer cannot supply send direct to us. Delivery per return post.

12 Stock Sizes :

6 x 8	3/-	7 x 10	4/3	8 x 12	6/-	12 x 14	10/6
6 x 18	8/-	8 x 6	3/-	10 x 12	7/6	12 x 16	12/-
7 x 5	2/3	8 x 10	5/-	10 x 24	15/-	12 x 18	13/6

All 1/4-in. Thick. Sold in Scaled Envelopes.

Special Sizes :

All Concert-de-Luxe, 16 x 8 x 1/4	8/-	Resistoflex, 12 x 8 x 1/4	6/-
Transatlantic V., 22 x 11 x 1/4	15/-	Anglo-American, 36 x 9 x 1/4	20/-
All Britain, 16 x 9 x 1/4	9/-	Neutrodyne Tuner, 12 x 10 x 1/4	7/6
S.T. 100, 12 1/2 x 9 1/2 x 1/4	7/-	Neutrodyne Receiver, 12 x 10 x 1/4	7/6
Puriflex, 14 x 10 1/2 x 1/4	9/2	3-Valve Dual, 24 x 10 x 1/4	15/-
Transatlantic IV., 16 x 8 x 1/4	8/-	Harris Crystal Set, 9 x 5 1/2 x 1/4	4/4

Any Special Size Cut per return at 3d. per Square inch.

Use



Red Triangle Ebonite

PETO-SCOTT Co., Ltd.,

Registered Offices, Mail Order and Showroom,
77, CITY ROAD, LONDON, E.C.1.

BRANCHES:

LONDON:—62, High Holborn, W.C.1.
WALTHAMSTOW:—230, Wood Street.
PLYMOUTH:—4, Bank of England Place.
LIVERPOOL:—4, Manchester Street.
CARDIFF:—94, Queen Street.

P.S. 2292

GUARANTEED VERY BEST DUTCH DETECTOR AND AMPLIFIER VALVES

Tubular Type, Fil. 3.5-4.0, Plate 30-80, Amps. 0.5 4/9 each.
"R" Type, Fil. 3.5-4.0, Plate 30-80, Amps. 0.5 4/9 each.

Both these valves give first-class results either as Amplifiers or Detectors.
Dull Emitters, Fil. 1.6-2.0, Plate 20-100, Amps. 0.06 12/6 each.

Liberal Trade Discounts.

We Guarantee all Valves, but do not undertake to exchange any Valve of which the Filament does not light up. All Valves are carefully packed and tested before leaving our premises

Don't Delay—Buy Direct from the Importers.

BISHOPSGATE ELECTRIC SUPPLY (1924) CO.,
DEPT. A.W.

1st floor, 180, Bishopsgate, London, E.C.2.

Phone:—CENTRAL 7361.

Please include sufficient postage.

PROFIT BY THE EXPERIENCE OF OTHERS—

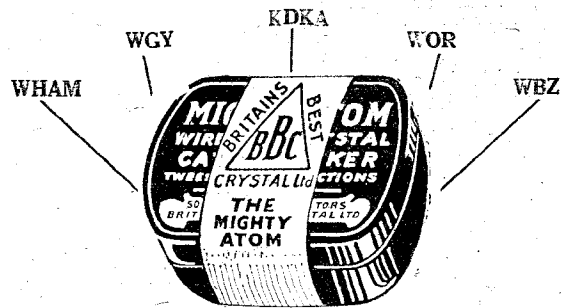

PROOF

TAUNTON.

"With your Crystal and a One-valve home-made Amplifier I get these American stations direct. They are quite loud on 'Phones."

THAT'S ALL YOU NEED KNOW ABOUT CRYSTALS!

SPECIAL CATSWHISKER in TUBE, TWEEZERS, SIGNED SLIP DIRECTIONS
OF ALL DEALERS 1/6 OR POST FREE

Any reader desiring to receive particulars of the aerial, circuit, etc., on which the above results are obtained can have same by return if self-addressed stamped envelope is enclosed.

BRITAIN'S BEST CRYSTAL, LTD.,
234, 5, SALISBURY HOUSE, LONDON WALL, E.C.2.

The Crystal for the Connoisseur



RUSSELL'S HERTZITE

THERE are, literally, hundreds of different crystals—all will give you results—of a sort. But only one will give you maximum signal strength and purity of tone. The Russell Laboratories have found that one—by constant research and experiment. It is offered to you in the little sealed boxes bearing the name Russell—the guarantee of 100 per cent. crystal purity. Try Russell's Hertzite in your set to-day—you will never go back to the "doubtful others."

THE L. G. RUSSELL
LABORATORIES
1-7, Hill Street, BIRMINGHAM
(Opposite Empire Theatre)



Retail Price Per Box 1/- of all good dealers

AN INNOVATION IN VALVE DESIGN

WITHIN the past year very considerable alterations have been made in valve design, both as regards internal and external arrangements. Now comes another innovation which is a distinct step forward. This is a valve produced by Cossors which has been specially designed to avoid capacity effects. The mounting of the valve is composition (a feature which is to be embodied in all Cossor valves in the future); this, of course, is not unusual, but where the novelty lies is in the fact that the composition is hollow, and if the valve is viewed from the end of the base it is possible to see into the interior. The leads from the legs simply pass into the valve through the hollow shell mounting, only one of them being enclosed in a glass tube. Such an arrangement will obviously reduce capacity to a minimum—in fact the actual capacity is hardly measurable—a feature which will make the valve of great value for short-wave work. In our next issue we hope to give a sectional sketch of this valve:

The Government of India has offered to grant a licence to the Indian Radio Telegraph Company to operate a beam wireless station in India for communication with the United Kingdom.

"BROADCAST TELEPHONY" (cont. from page 328)
22.00, *La Libertad* con. (Tue. and Fri.). Sunday: 16.30, con.

Barcelona (EAJ1), 325 m. 17.30 or 18.00, lec., Stock Ex. markets, con. or relay of opera; 20.30, news and con.

Seville (EAJ5), 350 m. 18.30, lec., con., news.

SWEDEN.

Stockholm (SASA), 430 m. (500 w.). Sundays: 09.55, sacred service; 16.00, children; 17.00, sacred service; 19.00, con.; 20.30, news, weather. Weekdays: 11.30, weather, Stock Ex., time sig. (11.55); 18.00, lec. (irr.); 19.00, con., lec., news, weather.

Gothenburg (SASB), 290 m. (500 w.), also 700 m. 10.00, fishery reports (700 m.); 11.55, time sig.; 19.00,* programme s.b. from Stockholm.

Malmö (SASC), 270 m. 11.00, weather; 19.00,* programme s.b. from Stockholm.

Boden (SASE), 2,500 m. 18.00, con. (Tues., Fri., Sun.)—temp

* Local programmes are also broadcast at times.

Sundsvall (SASD), 680 m. (500 w.). To open about March.

Falun (SMZK). Tests. Occasional relay of 5XX.

SWITZERLAND.

Geneva (HB1), 1,100 m. (500 w.). 13.15, lec. No Sun. transmissions.

Lausanne (HB2), 850 m. (500 w.). 07.05, weather; 12.30, weather, markets, time sig., news; 16.00, children (Wed.); 17.55, weather, news; 20.15, con. (exc. Wed.), dance (Thurs. and Sat.).

Zurich (Höngg), 515 m. (W.L. not definitely fixed) (500 w.). 11.00, weather; 11.55, time sig., weather, news, Stock Ex.; 15.00, con.; 17.15, children (Mon., Wed., Fri.); 18.00, weather, news; 19.15, lec., con., dance (Fri.); 21.00, news. Sundays: 15.00 and 19.15, con., news, weather.

AGRICULTURAL MARKET INTELLIGENCE

THE B.B.C., in conjunction with the Ministry of Agriculture and Fisheries, have arranged each Thursday evening from 6.35 to 6.40 to broadcast a bulletin giving the latest foodstuffs market information.

The bulletin will include such items as current prices of agricultural produce, wheat, oats, potatoes and cattle-feeding stuffs.

While the bulletin will be intended primarily for farmers and agriculturists, it will probably be of general interest to large numbers of the community.

The SHIPTON New Type Strip Rheostat and Potentiometer

THE MOST PERFECT RHEOSTAT YET INTRODUCED

Ask for it by the name—the SHIPTON. Mechanically, well designed and constructed; electrically, free of noise in operation, evenly spaced resistance wire, and a specially designed spindle which allows one-hole fixing and enables the provision of a compression spring which assures good contact of the rotating arm. Use a wire Rheostat.

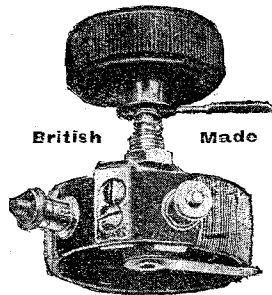

- SHIPTON New Type STRIP RHEOSTAT 7 ohm (with safety fuse) - - - 3/-
- SHIPTON New Type STRIP RHEOSTAT 30 ohm - 3/-
- SHIPTON New Type STRIP RHEOSTAT 60 ohm - 3/-
- SHIPTON POTENTIOMETER - 600 ohm 4/6

Packed in neat linen-tie boxes.

SHIPTON VERNIER COIL HOLDER

- 2-way coil holder ... 4/-
- 3- " " " ... 7/6
- Nickel-Plated 2-way ... 4/6
- 3- " " " ... 8/-

SHIPTON NEW TYPE VARIABLE GRID LEAK

Silent in operation; constant under different settings; can be calibrated accurately. Faraday House Test Report No. T/252/H. "The resistance varied continuously from 0.5 megohms to 6.5 megohms."

Price 3/-

SHIPTON Products are obtainable from all dealers or direct, when kindly give your dealer's name and address.

E. SHIPTON & Co. Ltd.

37, 10TH L STREET, WESTM NSTER, S.W.
Telephone—VICTORIA 3171. Telegrams—RENTFONES, PARL.
Also at 14, King Street, Covent Garden, W.C.

The Importance of Low Losses

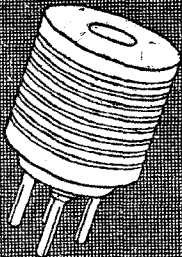

Every Bowyer-Lowe H.F. Transformer is guaranteed to match perfectly every other in its range. All ranges from 150 to 3,000 metres and up to a uniform price of

7/-

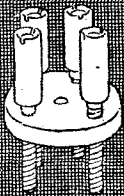

Bowyer-Lowe Anti-Capacity Valve Holders give greatly increased efficiency, especially on short wave-lengths. No nuts required for fixing. Price complete

1/2

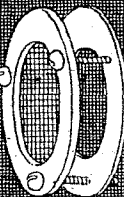

Bowyer-Lowe lated Valve Windows, with rounded bezel, impart a fine appearance to your set. Sold complete with gauze, back plate, and all nuts and screws. Each

9d.

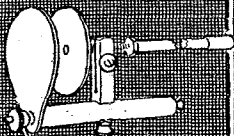

The Neutrodyne Condenser for efficient tuning of neutralizing circuits. Minimum capacity practically zero. One screw fixing with additional 1/8-inch hole for operating spindle. Price

5/-

"Losses" is the name given to electrical energy which is wasted during its passage through the parts of which a wireless set is made. Poorly designed and carelessly assembled components may seem cheap in the first instance, but they are so full of these tiny leakage points, that they are dearly paid for in poor reception.

It is the first duty of a Wireless Manufacturer to so design the parts he makes that all their losses are reduced to a minimum. "Low Loss" components mean highly responsive sets.

Amateurs and experts everywhere realize that the greatest recommendation of every component made by Bowyer-Lowe is in the knowledge that it has been tested for losses and carries a full guarantee of excellence in this respect.

Fit Bowyer-Lowe Parts in every set you make and prove their quality by the richness and volume of your reception.

Bowyer-Lowe TESTED Radio Parts

New Catalogue Free

Thirty-six pages of valuable and helpful information about Bowyer-Lowe Tested Components and their uses are yours for the asking. Send your name and address with 1½d. stamp for postage, and you will receive our Complete Price List by return. It fits the pocket and contains blank pages for your own notes.

Send for it To-day

BOWYER-LOWE CO., LTD., LETCHWORTH

Write for List Z 405

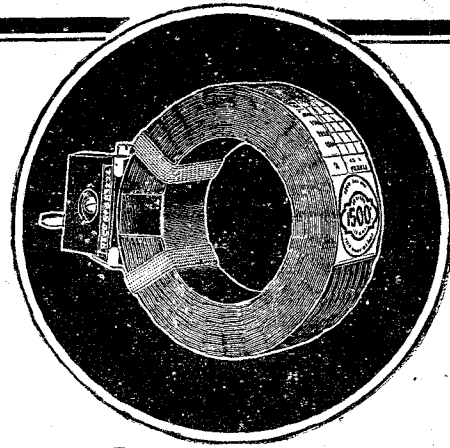

IGRANIC Honeycomb Duolateral COIL

Aerial characteristics often demand an intermediate Coil

That is why you can obtain Igranice-Honeycomb Duolateral Coils in nineteen sizes, with wave-length ranges of from 100 to 23,000 metres. If you find that your 25, 35, 50, 75 or other "popular" sized coil does not give that critical tuning for which you aim, plug in one of the intermediate Igranice Coils of say 30, 40 or 50 turns as the case may be, and you will plug-in a sure way to better tuning.

IGRANIC RADIO DEVICES include:

Honeycomb Coils, Fixed Condensers, Filament Rheostats, Intervolve Transformers, Variometers, Vario-couplers, Bi-plug Coil Holders, Tri-plug Coil Holders, Battery Potentiometers, Vernier Friction Pencils, etc., etc.

All carry a six months' guarantee and are stocked by all reputable dealers.

Write for List Z405

Birmingham
Cardiff
Glasgow



Leeds
Manchester
Newcastle

149, Queen Victoria Street,
London.

Works: BEDFORD.

DATA AND PRICES OF "IGRANIC" PLUG TYPE HONEY-COMB DUOLATERAL INDUCTANCE COILS.

Coil No.	Self Capacity micro-mfds.	Natural Wave length metres.	Wave length in metres when shunted by				Price
			.0001 mfds.	.0003 mfds.	.0005 mfds.	.001 mfds.	
25	25	53	117	190	243	336	5/-
30	32	72	147	233	294	411	5/-
35	37	90	174	272	344	477	5/-
40	32	104	216	335	424	590	5/2
50	38	133	252	395	498	693	5/2
60	39	157	298	464	585	814	5/4
75	38	170	326	511	644	895	5/6
100	24	220	504	815	1036	1445	7/-
150	25	333	738	1190	1520	2110	7/10
200	23	420	976	1580	2015	2820	8/8
250	24	538	1215	1960	2490	3480	9/-
300	20	608	1470	2400	3010	4280	9/5
400	16	810	2175	3585	4580	6430	10/3
500	18	956	2470	4050	5170	7240	10/6
600	18	1140	2905	4770	6100	8800	11/-
750	19	1450	3720	5950	7650	10620	11/10
1000	18	1900	4920	8090	10320	14470	12/8
1250	17	2380	6280	10320	13180	18500	14/-
1500	21	3200	7720	12580	16000	22400	15/-



Cutting Out the H.F. Valve

SIR,—Readers who propose fitting a switch to cut off the H.F. valve should take certain precautions, otherwise they are likely to short both batteries.

When in the "off" position of the H.F. switch the top end of the aerial inductance is connected via the plate of the H.F. valve to the grid condenser of the detector valve. Both batteries are then shorted through the A.T.I. and anode coil.

I myself get over the difficulty by fitting a three-pole double-throw switch, in which one pole switches the aerial connection from the H.F. grid to detector grid, the second pole makes and breaks contact between H.T. + and anode coil, and the third pole makes and breaks the filament circuit of the valve.

One is apt to be forgetful to remove the anode coil before switching off or even to switch off the rheostat, so that in switches for L.F. valves it is a good plan to make use of a D.P.D.T. switch.

I should like to say how much I appreciate almost all the articles in "A.W."—P. S. B. (Newcastle, Staffs.).

Other Correspondence Summarised

L. N. C. (Lancs.) has received six

B.B.C. stations and Brussels on his home-made crystal set.

K. G. (Ashton-under-Lyne), referring to the letter of 2 A Y F (Southsea) in No. 140, writes us that he quite easily picked up W B Z, Springfield, when his aerial and earth were disconnected.

S. G. (Glasgow) wishes to make known the fact that he has received very valuable advice in the use of their instruments from the General Radio Co., with the result that he is now able to bring in the main American stations on their one- and two-valve sets.

C. B. (30, Charleston Street, Walworth, S.E.17) has about thirty back numbers to which other readers are welcome, if they will forward the necessary postage.

[Owing to pressure upon our space it has been necessary to hold over many letters.—ED.]

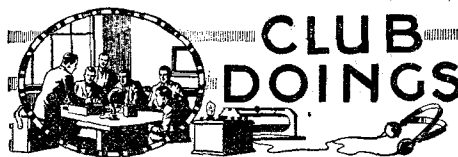

Inland Revenue Radio Society

Hon. Sec.—MR. J. O. CLAXTON, 570, Salisbury House, London Wall, E.C.2.
The second ordinary meeting was held on February 6, and opened with morse practice. Mr. D. G. Dync, B.Sc., gave a paper on "Thermionics in Relation to the Valve," and Mr. M. A. Beetzstone, M.I.E.E., spoke on the subject of "Elementary Electricity."

Dublin Wireless Club

Hon. Sec.—MR. A. C. BRIDLE, Hillsdene, Portmarnock, Dublin.
A MEETING was held on February 5 with Mr. H. J.

Dunear in the chair. Mr. T. H. Lurring delivered a lecture on "The Care and Maintenance of Accumulators," in which he described the construction of accumulators, and explained how to keep them in good condition.

Barnet and District Radio Society

Hon. Sec.—MR. J. NOKES, Sunnyside, Stapylton Road, Barnet.

At the annual general meeting held on January 20 it was decided to utilise part of the balance left for the provision of additional books for the library and some apparatus to enable the experimental part of the work to be carried on in a progressive manner. It was also decided that instead of forming a separate section for juniors, young people under the age of 17 should be admitted to full membership at an annual subscription of 2s. 6d. instead of 5s. It was arranged that instead of meeting twice a month as heretofore, the society should have a regular meeting on the third Thursday in each month. The president then conducted a number of experiments on light and sound waves and gave a short talk on the relation between the waves created by sound, light and radio.

Ilford and District Radio Society

Hon. Sec.—MR. F. W. GEDGE, 157, High Road, Ilford.

MR. E. G. DENNIS lectured on February 3 on "How It Was Done in the Navy." He is an ex-C.P.O. and was able to speak with authority upon the development of wireless in the Navy.

ANNOUNCEMENTS

"Amateur Wireless and Electric." Edited by Bernard E. Jones. Price Threepence. Published on Thursdays and bearing the date of Saturday immediately following. It will be sent post free to any part of the world—3 months, 4s. 6d.; 6 months, 8s. 9d.; 12 months, 17s. 6d. Postal Orders, Post Office Orders, or Cheques should be made payable to the Proprietors, Cassell & Co., Ltd.

General Correspondence is to be brief and written on one side of the paper only. All sketches and drawings to be on separate sheets.

Contributions are always welcome, will be promptly considered, and if used will be paid for.

Queries should be addressed to the Editor, and the conditions printed at the head of "Our Information Bureau" should be closely observed.

Communications should be addressed, according to their nature, to The Editor, The Advertisement Manager, or The Publisher, "Amateur Wireless," La Belle Sauvage, London, E.C.4.

VALVES REPAIRED

Please Send us your Burnt Out Valves. We Undertake to Return them

AS GOOD AS NEW

Bright Valves, from 5/6
Dull Emitter, „ 9/-

All valves thoroughly tested before being sent back.

H. SLOOG, 45 Gt. Marlborough St. London, W.1



H.F. Plug-in TRANSFORMERS

A series of H.F. plug-in transformers in six ranges of wavelength. They are made of our highly-pollished non-loss chrome. The windings are carried in staggered slots, well protected, ensuring low self-capacity and high efficiency. Each and every transformer is tested to a standard oscillator, and any not coming within very narrow limits are rejected. Perfect matching is thus ensured.

No. 00.	80 to 150 m.	10/-
No. 0.	150 to 300 m.	10/-
No. 1.	300 to 600 m.	10/-
No. 2.	450 to 1,200 m.	10/-
No. 3.	1,100 to 3,000 m.	10/-
No. 4.	2,500 to 7,000 m.	10/-
Complete Set (Nos. 00 to 4),		55/-
No. A6 (Neutrodyne unit), each		10/-

Can be supplied in matched pairs at NO extra charge if requested at time of ordering.

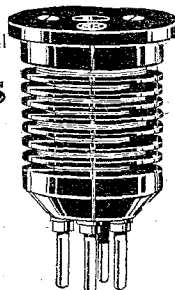

Constructors who are out for fame. Remember M.H. is the name.

L.M. MICHAEL LTD

Manufacturers of Wireless and Scientific Apparatus.

179, STRAND, LONDON, W.C.2.

Convert your 'phones

into a **LOUD SPEAKER**

with "THE **GRAMAPHIX**"

A most efficient device to which ordinary headphones are clipped by simple pressure on the spring clips.

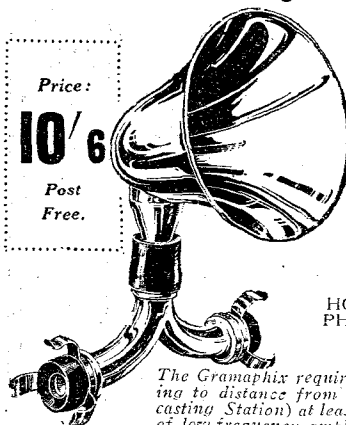

HORNS TO MOUNT ON GRAMAPHIX: Straight Horn (Bell 10 in.), 6/-; Swan-necked Horn (Bell 11 1/2 in.), 15/-; Small Curved Horn (Bell 8 1/2 in.), 7/6. Post 9d. extra.

The Gramaphix requires (according to distance from the Broadcasting Station) at least one stage of low-frequency amplification to give satisfactory volume.

TOOLS

Make your own **Wireless Sets**

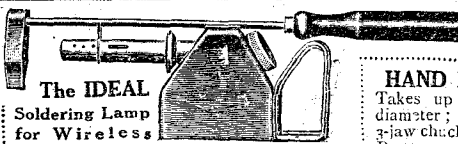

The **IDEAL Soldering Lamp for Wireless Amateurs**

5/-
Postage 6d. extra

Straight or hatched shaped Soldering Irons to use with above, 1/- extra. Postage 3d. extra.

HAND DRILL

Takes up to 1 in. diameter; powerful 3-jaw chuck.

Postage 5/9
Set of Six Twist Drills 2/-
Post Free



WIRELESS LIST "E" SENT POST FREE
RICHARD MELHUISE, LTD.,
Tool, Machine and Electrical Experts. Established 1888
50, 51 & 84, FETTER LANE, Holborn Circus, London, E.C.1



Guaranteed for 12 Months

The Only British Telephones with this Warranty.

THE guarantee on Revco Headphones is like the hall mark on Silver or "Sheffield" on steel. It's the outward sign of inward worth. Unsurpassed for sensitivity and clarity—whether on broadcast or morse reception.

No nipping, no heavy head pressure, just a gentle lightness hardly felt. Can be worn for hours. Just the telephone for the feminine listeners-in of your family. At all good agents. If unobtainable locally send us your nearest dealer's name.

Let us send you illustrated and informative literature descriptive of our loud-speakers, sets, crystal and valve amplifiers, etc.

21/-

Cable Accessories Co., Ltd.,
Tividale, Tipton, Staffs.

A worthy contemporary of Revco Headphones — the Revco Loudspeaker in three sizes, Senior, Junior and Baby: 80/-, 48/-, 30/- respectively. Like the telephones are guaranteed for 12 months.

"Revco"

Regd.

The Name for Perfect Radio



Portmanteau Words

I'm afraid I must confess a distinct weakness for Portmanteau Words; chiefly, I suppose, on account of their descriptive convenience. They always seem to mean exactly what they say, and, except perhaps in a rare case such as that of the immortal "Brugglesmith," their meaning is evident at sight.

Take, for instance, the word Volutone. No doubt can rest in anyone's mind as to what that means.

Volume and Tone—the two essentials of a first-class Loud Speaker. Full Volume and Perfect Tone, a joy to listen to and a treasure to possess.

But even this all-embracing word fails to convey its handsome appearance. The instruments' pleasing lines have a beauty rarely found in something that hitherto has usually been regarded purely as a piece of mechanism.

Go and have a look at a Volutone. Your local retailer is almost certain to have one in stock.

And when you have satisfied yourself as to its appearance, make a point of hearing it as well.

I think you'll agree then that I was quite right when I coined that essentially accurate word—VOLUTONE.

Muell's Fellows

**YEATES Ltd., 20, Store Street
Tottenham Court Road, LONDON, W.C.1**

*Well equipped demonstration and sales offices of
Fellows Wireless Products. Wholesale and Retail*

FELLOWS WIRELESS

The VOLUTONE LOUD SPEAKER gives really large volume without sacrificing the quality of reproduction. The diaphragm is adjustable.
PRICE:
£4 : 10 : 0

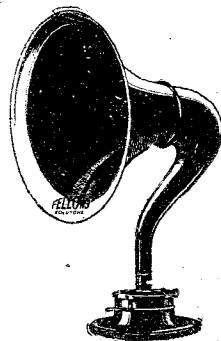

CHIEF EVENTS OF THE WEEK

SUNDAY, February 22nd.

London and 5 X X	3.0	Oratorio: "The Creation" (Haydn)
London and 5 X X	9.0	Casano's Octet.
Birmingham	3.0	Chamber Music Programme.
Bournemouth	3.0	Band of 2nd Batt. The Argyle and Sutherland Highlanders.
Cardiff	9.0	Handel Programme.

MONDAY

London and 5 X X	7.30	Barnardo's Musical Boys.
	8.15	D'Erlanger Programme.
Bournemouth	7.30	With Hounds, The Country Side, and Comic Opera.
Newcastle	7.30	Grand Variety Concert.
Glasgow	7.30	The J. H. Squire Celeste Octet.
Belfast	7.30	Handel Programme.

TUESDAY

5 X X	7.30	Popular Orchestral Programme.
ALL STATIONS except 5 X X	7.30	Programme of Old English Music.
	8.25	A Shortened Version of <i>The Beggar's Opera</i> .

WEDNESDAY

Birmingham	7.30	Coleridge-Taylor Programme.
Bournemouth	7.30	The Morality Play <i>Everyman</i> .
Manchester	7.30	Symphony Concert.
Newcastle	7.30	Selections from Opera, and the J. H. Squire Celeste Octet.
Glasgow	7.30	Popular Night.

THURSDAY

London	7.35	Light All-British Concert.
Manchester	7.35	Light Programme.

FRIDAY

Birmingham	7.30	First English Production of <i>Boris Godunov</i> .
Cardiff	7.30	A Popular Programme.
Manchester	7.30	Dramatic Night.
Aberdeen	7.30	Music and Drama— <i>A Tale of Two Cities</i> .
Glasgow	7.30	Melody in the Western Isles.
Belfast	7.30	Light British Music.

London	7.30	Sixth Query Programme.
Bournemouth	7.30	"A Mixed Menu."
Birmingham	7.30	Popular Instrumental Programme.
Cardiff	7.30	In Honour of Saint David.
Manchester and 5 X X	7.30	Grand Opera, <i>Samson and Delilah</i> .
Belfast	7.30	Band of 1st Batt. The Highland Light Infantry.

WIRELESS IN PARLIAMENT



From Our Own Correspondent.

SIR WM. MITCHELL-THOMSON, the Postmaster-General, introduced in the House of Commons last week his promised Bill to "re-enact and amend the law relating to wireless telegraphy, and to make provision with respect to visual and sound signalling and the use of etheric waves for the transmission of energy." The measure was read a first time.

In reply to Sir H. Brittain, Sir Wm. Mitchell-Thomson said that the sites for the Canadian and South African "beam" stations had been selected and terms of purchase agreed. It was hoped that legal arrangements for the purchase of the various properties concerned would be sufficiently advanced to enable the sites to be placed at the disposal of the contractors before the end of the present month. The sites were near Bodmin (Cornwall) and Bridgwater (Somerset).

"Making a Brooder for 50 Chicks" is the title of an illustrated article appearing in the current issue of "The Amateur Mechanic and Work" (3d.), and should be of interest to many readers. Other articles and features appearing in the same number are: "House Repairs: Badly-fitting Doors," "Setting Slide Valves of Engines," "Motor-cycle Practicalities," "Do You Get Good Crystal Results?" "Wire Ropes for Aerials: How to Splice and Fix the Ends," "Resistance Attachment for Dull-emitter Valves," "How to Construct a Recess Cupboard," "Simple Terra-cotta Work," "Lock for Electric Lamps," "Hints on Using Rawl-plugs," "Our Small Car Page," "Fitting New Springs to Cycle Lamps."

A new motor lifeboat, equipped with wireless, has been built for the Cunard Line. The boat, which has accommodation for thirty people besides the crew, has just completed her trials successfully at Southampton.

A miscellaneous light programme of music will be given on February 22.

ETHITA

For PERFECT Reception

EASY BUILDING—SURE SUCCESS

can be obtained by all readers who write now for full details of Radiax range of sets, for home construction. Also, free descriptive booklet with instructions and diagrams:—

"How to Build Your Radio Station"

RADIAX UNIVERSAL RECEIVERS

are powerful regenerative sets which will deal efficiently with all wavelengths and embody detail refinements which few other sets, however expensive, can boast. They are wonderful for distant reception. Supplied complete with plan, diagram, fully drilled and engraved panel, and every detail required.

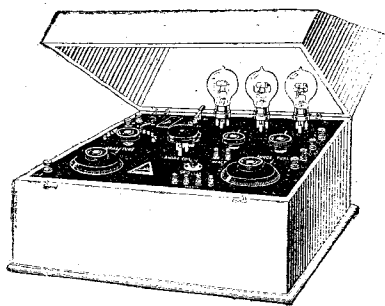

The following is a small selection:—

Constructors Sets.	Completed and Tested
Valve Units from 17/6.	sets, Valve Units from 27/6
No. 31 P 1 Valve Reflex ..	£4 15 0 £6 12 6
No. 24 P 2 Valve Set	£4 15 0 £6 12 6
No. 26 P 3 Valve Set	£7 5 0 £10 17 6
No. 28 P 4 Valve Set	£9 15 0 £15 0 0
No. 30 P 4 Valve Set	£9 7 6 £15 0 0

(Plus Marconi Royalty, 12/6 per valve.)

In addition to the above free literature, send 3d. stamps for Complete Components Catalogue.



RADIAX Ltd., 20, Radio House, Percy Street, Tottenham Court Road, London, W.1.

3 min. from Tottenham Crt. Rd. & Goodge St. Tube Stations. Phone: Museum 490

IMMEDIATE SUCCESS OF THE "LOTUS" Vernier Coil Holders

CUT GEARED
Prov. Pat.

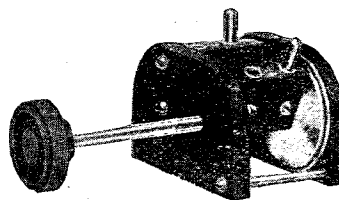

3 important reasons why you will fit a "LOTUS" to your Set.

1. It does not matter what position the "LOTUS" is fitted, the moving Coil cannot fall.
2. The "LOTUS" has an easy Vernier movement of 8 to 1.
3. It provides the finest and most delicate tuning.

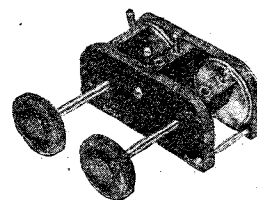

Two-way - Price - 7/-
Three-way - ,, - 10/6

Manufactured by—
GARNETT, WHITELEY & CO., LIMITED
Lotus Works, Broadgreen Road, Liverpool.

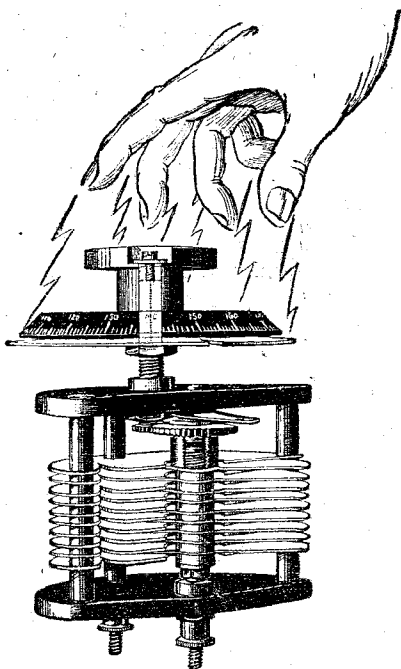

Perfect Tuning GREATER CLARITY

THE new "Fulstop" Square Law Condenser is so designed that it will allow twice the degree of accuracy obtainable with the ordinary type of variable condenser. It is full of valuable detail improvements and shows a great advancement in modern design.

The dial of this instrument is graduated over the complete circumference and is geared at two to one in relation to the moving plates. This allows for perfect tuning and enables individual stations to be selected with exceptional ease. The "Fulstop" Condenser is also guaranteed to abolish all hand capacity effects, thereby greatly improving reception and giving better tone. It has been strongly recommended by the Wireless Press for use in situations where hand capacity effects are troublesome.

PRICES: { .001 ... 13/6 | .0003 ... 10/3
 { .0005 ... 11/3 | .0002 ... 9/6

Stocked by Most Wireless Dealers, but if you have any difficulty write to:

J. H. NAYLOR, Ltd., WIGAN



TEST WITH THE BEST OF THE REST
and you'll know why

"CLARKE'S ATLAS"
LOW LOSS COILS
Patent No. 215053.

are the natural choice of the expert!

They conserve those minute particles of energy received on your Aerial. Give you

Distance Selectivity
and
Volume.

Are sound in design and mechanically strong.

Offer the **LEAST POSSIBLE RESISTANCE TO HIGH FREQUENCY CURRENTS**, and consequently are **THE MOST EFFICIENT COILS EXTANT.**





Clarke's "ATLAS" "C.E.B." 'Phones.

The 'Phone de Luxe

These headphones, which are designed to give you every comfort in use, are specially sensitive, and have a total resistance of 4,000 ohms. The 'Phones, which have double-leather Headbands, are supplied with adjustable Diaphragms and long flexible cords, and the metal parts are nickel-plated. Eminently suitable for Crystal or Valve Sets.

Price **15/-** per pair

Say "ATLAS" and be safe.

SOLE MANUFACTURERS
H. CLARKE & CO. (Manchester) Ltd.
RADIO ENGINEERS
Atlas Works, Old Trafford, Manchester.
'Phones: 683 & 793 Trafford Park. 'Grams: "Pirtold, Manchester."

ATLAS

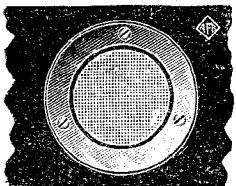

TRADE MARK
DECKO
A few
coppers
Only?

And what a difference to the appearance of your set!!!

Whether you are building a one or six valve set, go to your dealer and ask and insist upon being shown. The "DECKO" Valve Window. Made from heavy gauge metal, recessed at the back, bevelled edges and finished in the highest possible manner they will appeal to you at once. Avoid imitations.

IN SEALED PACKETS ONLY

HIGHLY NICKEL PLATED OR Pol. Lacq. BRASS 6^D EACH

From all dealers or in case of difficulty write to the manufacturers
A. F. BULGIN & Co., 9-11, CURSITOR ST., CHANCERY LANE, Tel. Holborn 2072 E.C.4

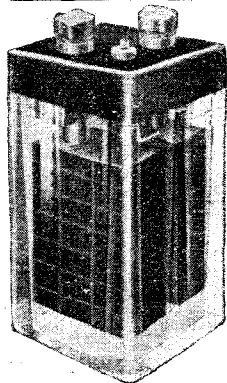

Exide
the long-life Battery.
Type D.F.G.
in glass boxes.

For D.E. valves, capacity 45 amp. hours, on slow intermittent discharge.

PRICE 10/-

219/229, Shaftesbury Ave. W.C.2.

07 VALVES for 13/3

Equal in performance to any '06 or '07 obtainable. Send for the concert-tested PLOTIRON S. S. post free with makers' instructions for use.

24 Hours' Approval upon receipt of cash order. Max. con. '07, fil. volts 2 3/4; anode 40-80. English "R" Valves, fil. volts 4 1/2; anode 45-100, 3/6. Concert tested, post free, 24 hours' approval.

Responsibility for all postal damage accepted if damaged valve is returned within 24 hours of receipt. **ANELOY PRODUCTS (Dept. A. 25);** Eton Works, Upland Road, London, S.E.22

ACCUMULATORS

C.A.V. Fuller's, etc. Guaranteed brand new and perfect but slightly soiled. We return cash with carriage both ways if returned within 7 days.

2V-4Ca	8/6	2V-60a	11/6
1V-40a	17/-	6V-40a	25/-
4V-60a	21/9	6V-60a	32/6
4V-80a	27/6	6V-80a	40/-
4V-100a	32/6	6V-100a	47/6

Special Line. C.A.V., 2V-100a (actual) 27/6.

MAUDE RUBBER CO., 58, Praed St., W.2.

ETHITA
FULL of GOOD POINTS

CABINETS for Wireless Constructors

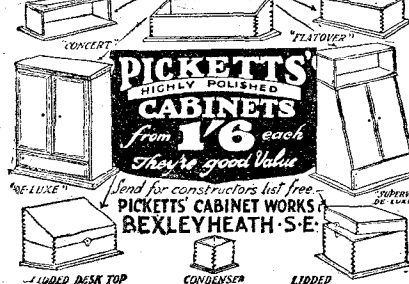

PICKETT'S
HIGHLY POLISHED
CABINETS
from 1/6 each
They're good Value

Send for constructor's list free
PICKETT'S CABINET WORKS
BEXLEYHEATH S.E.

Send for Constructor's List (A.M.) FREE

To Wireless Traders, Electricians, Dealers and others,

31, CAMDEN STREET, CAMDEN TOWN, N.W.

VERYARD & YATES, F.A.I.,

will SELL by AUCTION on Thursday, March 5th, large quantities ex-Government wireless electrical, telephone, and general surplus stores: 4,000 pairs Sullivan Headphones (4,000 ohms), 10,000 L.F. Choke Coils (500 and 1,000 ohms), 500 Coils New V.I.R. Lighting Cable, 100 3-Valve Amplifiers, 40 New 1/2 and 1 kw. Transformers, 20 cwt. 0 and 1 B.A. Brass Terminals, 8 1/2 New 2-Valve Mark, 4 Receiving Sets, 2,000 Single Phones, 1,500 Microphones, 1,000 2 M.F. Condensers, 300 Spark Coils, 250 Marconi Variable Condensers, 12 cwt. Sheet and Rod Ebonite, 40 Large New Distribution Boards, 5,000 Fuller's Leclanché Cells, 100 Jar Condensers, 250 Transmitting Sets, 4 Electric Motors (1/2 and 1 h.p., 220 volt), 400 New and S.H. Accumulators, 40 Ships' Liquid Compasses, 10 Marconi Ships' Wireless Sets, 300 Radiation Meters, 3,500 Ebonite Earcaps, 2,500 Terminal Blocks, 200 Road Measures, 100 kilowatt Meters, 60 Galvanometers, 5,000 Wound 1,000-ohm Telephone Bobbins, 500 Gross Brass Screws, 250 Wireless Cabinets, 2,000 Variometers, Portable Telephones, Switches, Cable, Resistances, Insulators, Barographs, Telescopes, Crystal and Valve Sets, and Wireless Equipment and Spares of all kinds; also 60 Mechanical Calculators, 1,500 Sheets Roofing Glass, 250 Cycle Foot Pumps, Kettle Drums, Tools, New Hinges, 300 Pairs Rubber Trolley Wheels, Acetylene Flares, Scrap and Ebonite, etc., etc. Catalogues from the Auctioneers, 365, Norwood Road, S.E.27. (Phone; 346 Streatham.)

SAFETY  **FIRST**

'LIBERTY' SAFETY PLUG

Passes sufficient current to supply CIRCUIT but not enough to damage them, even if wrongly connected.

80% of burnt Valves is caused by connecting H.T. battery across filament.

No fuses or bulbs to renew.

Only ONE plug required for circuit.

PRICE **2/6**
For Dull Emitter **3/-**

A PERMANENT SAFEGUARD AGAINST UNTIMELY VALVE DESTRUCTION.

Stocked by all wireless dealers, or direct post free, from—**SOLE PATENTEES AND MANUFACTURERS RADI-ARC ELECTRICAL CO., LTD. BENNETT STREET, CHISWICK, LONDON, W.4.**

.06 DULL EMITTER Valves 12/6 POST FREE

Fil. volts—3-3 1/2. Guaranteed. Trade supplied

Star Wireless Supplies
Biggleswade

PARIS AND OTHER STATIONS

Clearly heard on Loud Speaker Nr. London, using the "MIRACLE" MASTER 2 Valve Set £3 12 6 plus Royalties. 1, 2, 3, & 4 Valves.

Trade supplied. Send stamp for particulars.

WORLD'S WIRELESS STORES, WALLINGTON

THE ORIGINAL HOUSE SPECIALISING IN TRANSFORMER REPAIRS

We Repair, Rewind or Reconstruct to any Ratio, NOISY or BROKEN DOWN TRANSFORMERS of Any Make. Efficiency Guaranteed equal to New. 5/- Cash with Order. Postage paid. DELIVERY 3 DAYS

We supply Transformer Bobbins of any dimensions (Limit Core 1" Diameter) wound to any Ratio and any number of turns, up to 24,000. 5/9 Post Paid

TRANSFORMER REPAIR CO. HAY STREET, PORTSMOUTH

PREPAID ADVERTISEMENTS.

Advertisements under this head are charged FOURPENCE PER WORD, minimum charge FOUR SHILLINGS.

PATENTS and Trade Marks obtained.—H. T. P. Gee, Patent Agent, Member R.S.G.D., 51, 52, Chancery Lane, London, W.C.2. Phone, Holborn 1525.

HEADPHONE REPAIRS.—Rewound, re-magnetised and readjusted. Lowest prices quoted on receipt of telephones, delivery three days.—The Varley Magnet Co., London, S.E.18.

HEADPHONES, Loud Speakers, rewound, remagnetised, adjusted, any make. 5s. Remagnetised, adjusted only, 1s. 6d. Postage 6d. Returned in 24 hours.—Magnetico Service Co., 4, Newington Causeway, S.E. Hop 2577. 122 F

L.F. Transformers Re-wound, any ratio, guaranteed 6 months returned tested 4 days, 6s. 6d. Radio Instruments, 7s. 6d., post free. Old transformers bought, 2s. 6d.—Cannon, 15, Jervis Road, Fulham. 119 F

WIRELESS INVENTORS.—Patents and Trade Marks. Advice, Handbook, and Consultations free.—B. T. King, Regd. Patent Agents, 146A Queen Victoria Street, London. Phone, 682 Central.

3-WAY TRANSFORMERS.—30—50—80. Guaranteed. 10s. 6d. High Ratio.—Gould, 25, Adolphus Road, N.4.

AGENT WANTED for Australia by one of the largest Wireless Component Manufacturers in this country. Applicants must be firms of good standing and have a live connection in Australia. The Agency would include the whole of Australia and would be a Buying Agency. Box No. 17, Ashburners Advertising Agency, 10, Fiacidilly, Manchester, England.

SINGULAR TELEPHONES, 2,000 ohms, tested and guaranteed, 3s. each, post 3d. Transformers, 5:1 Ratio, guaranteed, 8s. 6d. each, post 6d.—Home, 67, Little Heath, Charlton, S.E.7.

ACCUMULATORS 1—Send for FREE LIST.—Reg. Houghton, "The Radio Specialist," Blackwood, Mon. 126 F

AGENTS WANTED.—Wireless valve repair business. Deal with the actual repairers. Lowest trade terms. All types repaired. A hard vacuum guaranteed. Old valves bought for cash, 6d. each. Standard British types only.—M. & G., 60, Churchfield Road, Acton, W.3. Telephone—Chiswick 2981.

ACCUMULATORS.—Guaranteed low or high tension batteries.—Accumulators (Market Harboro'), Ltd., Dairy Yard, High Street, Market Harboro'. 127 F

RADIO "CROXSONIA" PANELS

See Croxsonia seal on all panels

Black matt finish, insulation perfect, rigid without being brittle, drills, cuts and taps perfect.—7" x 5", 4"; 8" x 5", 1/2"; 10" x 6", 1/3"; 9" x 6", 1/7"; 10" x 8", 2/1"; 11" x 8", 2/3"; 10" x 9", 2/4"; 12" x 8", 2/6"; 11" x 9", 2/7"; 12" x 9", 2/10"; 12" x 10", 3"; 14" x 10", 3 1/2"; 14" x 12", 4"; 1 1/2" thick. Post free. Callers, cut any size, and quote by Post. **Exceptional Terms, sample and prices post free to the Trade.** To sole Manufacturers: **CROXSONIA COMPANY, 10 South St., MOORGATE, E.O.2.**

FREE AS AN ADVERTISEMENT FREE

We will make you a 1-4 Valve Set **ABSOLUTELY FREE OF CHARGE**

FREE Write for Full Particulars **FREE**

SELHURST RADIO CO., 89, Selhurst Rd., S. Norwood, S.E.25

TELEPHONES RE-WOUND

to 4,000 ohms. Guaranteed. All makes 5/-, except Brown "A" 6/- and Selhurst 12/6. 10/6 per pair. Ex-army converted to 100 ohm resistance, 2/6 each earpiece. Re-magnetising 5d. per earpiece. Postage extra 6d. per pair.

JOHN W. MILLER, 68 Farringdon ST., E.C.4 (2nd and 3rd Floors). Phone: CENTRAL 1950.

BROWN A² Adjustable reed type earpieces, 21/- each or 42/- per pair, complete with headbands and cords. Undoubtedly the best type you can use for

A.W. PLEATED PAPER LOUDSPEAKER

(as described in "A.W." October 25th, 1924), also for **LOUDSPEAKER AS INCORPORATED IN PORTABLE SET** (See "A.W." February 7th, 1925) and **FIDDLE LOUDSPEAKER** (as fully described in "The Wireless Magazine," February, 1925). 3" length rod to screw in reed with nut to lock, 7d. post free.

PAPER for "A.W." Pleated Paper Loudspeaker, in sheets 42 x 6 1/2. Ready proofed. The best obtainable for the purpose. 2 3 per sheet.

12in. FRAMES with Clamp, 2/6, post 4d.

GRAMAVOX JUNIOR Loudspeaker, 12/6. Convert: any gramophone or horn into a first-class Loud speaker in a few seconds. Complete in box with instructions. Flexible 6 ft. connection. 2,000 ohms. Money back Guarantee on every box.

GRAMAVOX SENIOR, 30/-. A larger instrument, full volume and fine tone.

SPECIAL CLEARANCE LINES AT BARGAIN PRICES.

CRYSTAL SETS in solid Mahogany sloping Cabinets. Enclosed glass detector. Variometer tuned, 15/- each.

COMPLETE SET OF PARTS for above, panels ready drilled, 10/6.

"PHONE" Crystal Sets, 5/9 (usual price) 7/6

DULL EMITTER BATTERIES

Will outlast several dry batteries and have been thoroughly tested for use with dull Emitter Valves and proved excellent. In ebonite cases 2 1/2 x 5 1/2, weight 7 1/2 lbs. 15 volts each. Unused W.D. Cost at least double to make. 3/9 each, postage 1/- 1/2 dozen lots post free. Shell Insulators 10d. per dozen, post free. Condenser Knobs and Dials, 1/-

Everything "GOODMAN'S" Prompt Dispatch.

75, PENCER RD., WEALDSTONE, MDDX.

CAIN WAS A TILLER OF THE GROUND

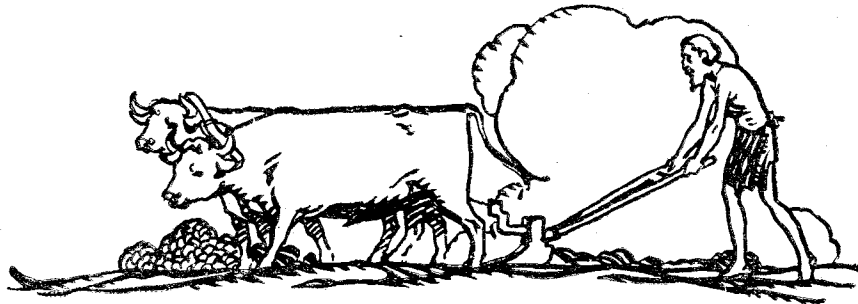

Name ?

Something that was bestowed on you at your christening to identify you from your neighbour. Later, you possibly had another, but that was a nickname; and again on attaining an age of responsibility or the right of a pay envelope, you had a title of courtesy, but nothing to define your utility to man . . . as . . .

Cain was a tiller of the ground.

Mullard . . . a maker of valves.

Mullard . . . THE maker of valves

Mullard . . . THE maker of MASTER valves.

A Master Valve for every wireless circuit.

Obtainable from all dealers.

Mullard
VALVE

LISSENIUM TYPES OF MAGNETIC CONCENTRATION

With many types of coils the magnetic field is mostly concentrated in the centre of the coil, and the field does not extend to any appreciable degree. The characteristics of the magnetic field in such coils are closely analogous to the ordinary solenoid inductance.

In the case of LISSENIUM (pronounced LISSEN-AGON) coils, however, the magnetic field, in addition to being very strong in the centre of the coil, is also distributed on each side of the coil. This accounts for the remarkably strong magnetic linkage obtained with LISSENIUM coils in reaction circuits, and SO FOR THE PECULIAR EFFICIENCY OF THE COILS WITH EDDY CURRENT TUNING.

LISSENIUM TUNING CHART. Note the Intermediate Coils 30, 40, and 60.

TABLE I Wave-length range when used as Primary Coils with Standard P.M.G. Aerial and .001 mfd. condenser in parallel.			TABLE II Wave-length range when used as Secondary Coils with .001 mfd. condenser in parallel.		
No. of Coil.	Minimum Wave-length.	Maximum Wave-length.	Minimum Wave-length.	Maximum Wave-length.	PRICE.
25	185	350	100	325	4 10
30	235	440	130	425	4 10
35	285	530	160	490	4 10
40	360	675	200	635	4 10
50	480	850	250	800	5 10
60	500	950	295	900	5 10
75	600	1,300	360	1,100	6 10
100	820	1,700	500	1,550	9
150	965	2,300	700	2,150	12
200	1,885	3,200	925	3,000	18
250	2,300	3,800	1,100	3,600	24
300	2,500	4,600	1,400	4,300	30

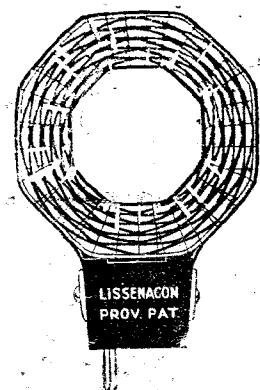

IF YOU WANT COILS WHICH SIMPLIFY TUNING—USE LISSENIUM COILS.

SIGNALS ARE ALWAYS STRONGER—

when capacity is low and inductance is high. If, where, say, a No. 35 coil is ordinarily used with added capacity to tune it to a given wave-length, a No. 60 coil can be used, AND WITHOUT ADDED CAPACITY, other things being equal, it follows that signals would be stronger.

In the new LISSENIUM CRYSTAL SET a form of tuning has been introduced which permits of a No. 60 LISSENIUM (pronounced LISSEN-AGON) coil being used, and dispenses with the need of added capacity to tune it. A big signal voltage is built up. But, apart from its high inductance efficiency, too, there are other considerations which place this receiver far above all other crystal sets, NO MATTER WHAT THE PRICE.

THERE IS AN UNDISTURBED ELECTRICAL CIRCUIT, for instance. The only moving part is the metal plate, and although this is entirely unconnected with the electrical circuit, its influence on the inductance is effectively applied through the medium of the magnetic field created.

In conjunction with the principle of EDDY CURRENT TUNING employed in this new LISSENIUM CRYSTAL SET, LISSENIUM COILS ARE PECULIARLY EFFICIENT. No other coils give the same results.

By fitting the appropriate LISSENIUM (pronounced LISSEN-AGON) coil, the LISSENIUM CRYSTAL SET can be used for any station within range. Two coils would be needed for London and Chelmsford, for instance—to change over from one station to the other, take one LISSENIUM coil out, and plug the other one in.

On long aerials it would be possible to use a coil one size larger in each case, e.g., No. 40 instead of 50; 50 instead of 60; 60 instead of 75; 75 instead of 250.

NOTE.—One LISSENIUM CRYSTAL SET must be ordered with each set of LISSENIUM coils. It will not be sold without a LISSENIUM coil because the use of the latter ensures very high efficiency.

No paper—no cardboard—no loose wires—connections are stamped—receiver is an instrument through which you receive the MOST EFFICIENT CRYSTAL SIGNALS AND THE MOST EFFICIENT INDUCTANCE.

LISSENIUM L