

DON'T MISS FREE MAP WITH CALL SIGNS NEXT WEEK

Amateur Wireless And Electrics

Next Week
**SPECIAL
BROAD-
CASTING
NUMBER**
(See page 64)

Vol. II, No. 33

SATURDAY, JANUARY 20, 1923

Price 3d.

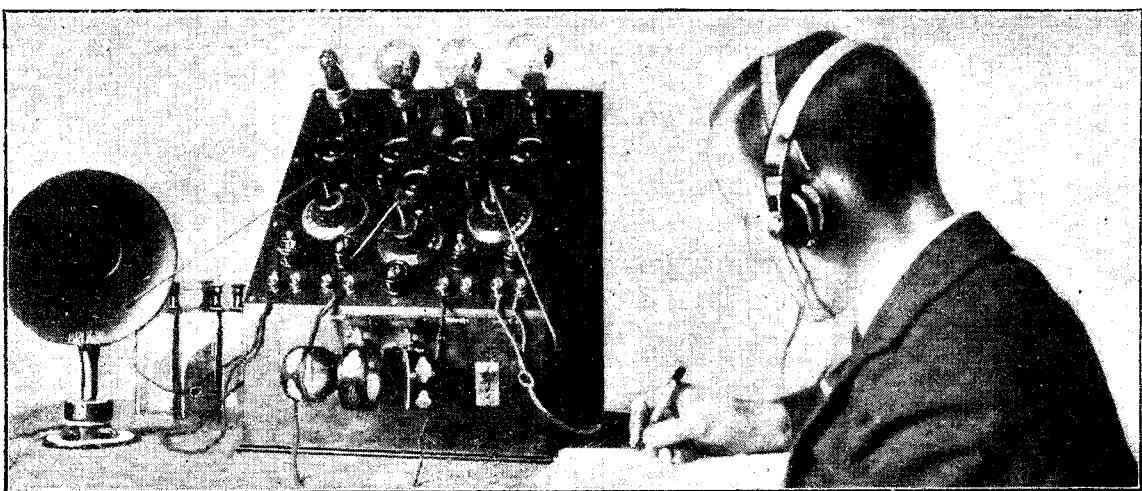

AN AMATEUR'S (Mr. W. S. HUTTON'S) FOUR-VALVE SET THAT HAS GIVEN EXCELLENT RESULTS

THIS WEEK'S FEATURES

What Causes Fading?
More About Vario-couplers
Loud-speaker for Eight Shillings
Repairing a Low-frequency Transformer
Notes for the Novice—Some Simple Definitions
High-frequency Amplifiers
A Variable Grid-leak

5 L P: An Amateur-equipped Transmitting and Receiving Station
Cigar-box Valve Panels
A Simple Series-parallel Device
Loose-coupler with Dead-end Switch
Re-radiation
Radiograms, Information Bureau, Correspondence, Broadcast Telephony, etc.

THERE IS A SPECIAL ANNOUNCEMENT ON PAGE 64

ECONOMIC ELECTRIC LTD.

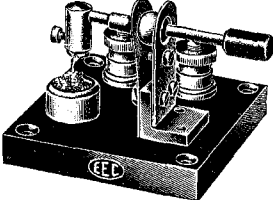

CRYSTAL DETECTORS, 5/6



**HEAD RECEIVERS
From 12/6**

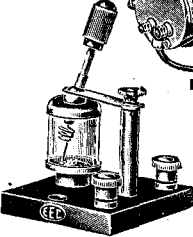

**ENCLOSED
CRYSTAL
DETECTOR, 12/6**

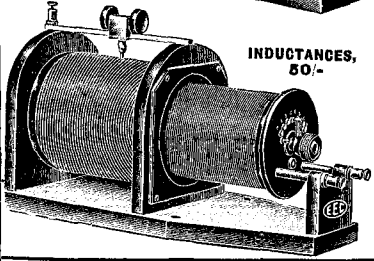

**INDUCTANCES,
50/-**

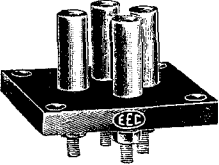

VALVE HOLDERS, 1/9

Write
To-day for 40-
Page WIRELESS
List Post Free
4d.
250 Illustrations.

Showrooms:
303, EUSTON ROAD, N.W.1.

Telephone:
MUSEUM 1055

Branch Showrooms & Works:
TWICKENHAM

Head Office **10, FITZROY SQUARE, LONDON, W.1.**

BEGINNER'S GUIDE TO WIRELESS

Explains in plain, everyday language, everything beginners wish to know about Wireless Telegraphy.

HOW TO ERECT, CONNECT, AND MAKE

all the apparatus required for reception of telephony or Morse, and full instructions and diagrams for making coils, tuners, and complete valve and crystal sets. 112 pages, price 1/- post free.

SAXON RADIO CO. (Dept. 12), South Shore, BLACKPOOL

32 page Catalogue of Wireless Apparatus. 2d. post free.

HAMMOND and KING, Wireless Specialists, 51, BERWICK STREET, W.1.

Aerials Erected, Apparatus Manufactured and Installed.

A Crystal Set for 15/- **KING'S FOR VALUE** A Crystal set for 15/-

SETS OF PARTS:
"Brunet" telephones 4,000 ohms with cords, **£1 1s.**, post 1s.; 12 x 4 Inductance 24 E.S.W.G. **3s.**, post 1s.; 0 x 31 inductance 24 E.S.W.G. **2s. 6d.**, post 1s.; Mahogany Polished grooved ends per pair, large, **1s. 8d.**, post 6d.; Ditto, small, **1s. 6d.**, post 6d.; Mahogany Polished Base, large, **2s. 9d.**, post 6d.; Ditto, small, **2s. 6d.**, post 6d.; Slides rod drilled with terminal fitted per pair, **10d.**, post 6d.; Knob and Plunger, per pair, **1s.**, post 3d.; Crystal detectors, upright type, **3s. 6d.**, post 6d.; Blocking condensers, ebonite, 8 x 2, **2s.**, post 3d.; Filament resistances, **2s. 4d.**, post 6d.; Condenser boxes, polished mahogany, 4 x 4 x 3 1/2, **2s. 6d.**, post 6d.; Aerial Wire 7/25 Base copper 100 ft., **2s. 10d.**, post 3d.; 1 Valve panel detector, complete set of parts with box, **15s.**, post 1s. 6d.; 1 Amp. Unit with box, **£1 10s.**, post 1s. 6d.

"HERE'S REAL RADIO SERVICE"

Telephones, best French, adjustable earpieces, 4,000 ohms	... £1 0s. 0d.
" " genuine "Brunet" steel Headbands, 4,000 ohms	... £1 2s. 6d.
" " single earpiece with cords and handle, 4,000 ohms	... 11s. 0d.
Crystal Detectors, mounted on Ebonite, ball socket joint	... 2s. 6d.
Hertzite Crystals	... 1s. 6d. and 2s. 0d.
Wound Inductance, 12 in. x 4 in. wound with 22 enamel wire	... 3s. 6d.
Brass Rod and Slider, complete with plunger (13 in. rod)	... 10d.
Rheostat, remarkable value	... 2s. 6d.
Valve Holders, each 9d. with screwed legs and nuts	... 1s. 3d.
Batteries, 4-5 volts, suitable for H.T.	... per doz. 5s. 0d.
Phosphor Bronze Aerial Wire, 1/18, 100 ft. coils	... 2s. 0d.
Insulators, Roel 2, Large Egg, 6d.; Shell	... 6d. and 8d.
Enamelled Aerial Wire, 7/23, stranded, 100 ft.	... 4s. 6d.
Terminals, War Office type, with nuts, per doz.	... 1s. 6d.
Aluminium Pulleys, ex-Government, each	... 1s. 0d.
Leading-in Cable, heavily rubber-covered wire, per yard	... 6d.

Coils with Tappings, Loose Couplers, etc. wound to order, Cardboard Cylinders, Enamel, Silk and Cotton-covered Wires

WATERLOO ELECTRIC CO., Electrical and Wireless Engineers,
129, WATERLOO ROAD (1 minute Waterloo Station)
Phone: HOP 5649. **PRICE LISTS FREE.**

MITCHELFONES

Are not a spasmodic production to meet a sudden demand, but have been on the market for over three months, and during this period 27,000 have been distributed to the trade, and consequently we have not been able to offer them direct to the retail buyer.

1,000 per week are now available, and we announce

DELIVERY FROM STOCK

You post your order, or call at our premises and get them at once. Think what this means to you—you, perhaps, who have been waiting and are still waiting.

Standard resistance 4,000 ohms, double headgear with double headstraps, comfortable, highly efficient, and foolproof

25/- per pair.

Special Terms to Traders and deliveries that will surprise you.

MITCHELLS Electrical & Wireless Ltd.,

Postal Address: McDermott Road, Peckham, S.E.15.
Retail Address: 188, Rye Lane, Peckham, S.E.15.

Phones: New Cross 1540/1541.

GREAT BRITAIN'S GREATEST WIRELESS STORE

Headphones



4,000 ohms total Resistance.
Double Headband.

Guaranteed highly efficient. Complete with Cords. Ball and socket joints; highly polished nickel cases; best Tungsten steel magnets.

Splendid Crystal Detector

Mounted on Ebonite.

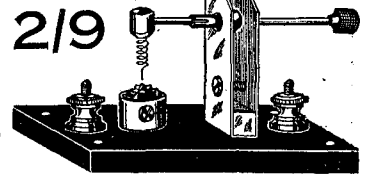

Beaver Complete Crystal Sets

No. 1 unassembled ... 15/-
No. 2 unassembled ... 20/-
No. 3 assembled, ready for use ... 24/-

Intervolve Transformers 15/-

Ratio 5 to 1. Excellent Value.

ALL GOODS SENT POST FREE

BEAVER ELECTRICAL SUPPLY CO.
109, REGENT STREET, LONDON, W.1

Telephone: GERRARD 1900



Special Terms to Trade. All Cheques and Postal orders to be crossed London Joint City and Midland Bank.

Amateur Wireless

and Electrics

Vol. II, No. 33

January 20, 1923

WHAT CAUSES FADING?

THE problem of fading is of great interest, and though no solution has as yet been arrived at, some little progress has been made by recent investigations.

Tests

Amateur tests carried out in a district some 200 miles from the nearest broadcasting station seem to make it clear that no blame for the trouble can be laid at the door of the transmitting stations, and the theories involving that link in the chain of broadcasting communication must therefore be ruled out. This leaves the two alternatives—the receiving apparatus and the medium through which the waves travel in their passage from the transmitting acrials.

The tests were made within a radius of four miles, and it was found that, while none of the experimenters reported perfect reception of the whole programme, there was no similarity in the experiences regarding fading. An item would be heard excellently at one point, and serious fading trouble would be met with at another point in respect of the same item, while a few minutes later the position would be quite reversed. On one or two occasions the

fading occurred synchronously at all the stations.

Two of the stations where the tests were made were, however, only a few hundred yards from each other, yet there was a considerable difference in the reports by the operators. While apparently absolving the transmitter, the tests cannot be said to have helped much in pointing the way to a solution.

Theories

In some quarters it has been argued that the phenomena is due to the blocking of the grid condenser, caused by the use of grid leaks of insufficient value, the idea being that an overcharge, such as atmospheric, paralyses the valve for the time being, and the leak can only work away to gradually relieve it. A variable condenser and leak has been tried, also shorting of the grid condenser when fading takes place, and potentiometer control of the leak, but these expedients have not been found to improve matters.

Adherents to the belief that the atmospheric conditions are to blame are numerous, and one of the most popular suppositions is that clouds of moisture

passing backwards and forwards over a district may take away part of the energy of the transmitting station. It is only right to point out, however, that in aeroplanes wireless reception from the ground has been much better when the aeroplane was above the clouds than when below them. In addition, during the amateur tests mentioned above a white mist lay on the ground at some of the receiving stations, while at the others the conditions were clear. The results did not bear out that the mist had any effect.

Are Our Neighbours to Blame?

A rather interesting speculation is that fading is due to the behaviour of near-by receiving stations—those who offend in the matter of oscillations. If such a station at a very short distance be oscillating, it is conceivable that its wave will come in practically as strong as the carrier wave of the broadcasting station. Before long a point is bound to be reached when these two waves will neutralise each other, so far as listeners-in on the particular sets which are receiving both are concerned; that neutralising would cause fading—at any rate, that is the theory. G. A. F.



Radio Mac II Converted Set.

CONVERTED APPARATUS

THESE self-contained sets are ex-Government instruments modified so as to be suitable for broadcast reception. That on the left was originally a B Mark II detector-amplifier, but the wavelength range is now from 300 to 1,000 metres. A variable condenser is provided for fine tuning, and duolateral coils can be plugged in.

The other photograph shows what was formerly a C.W. Mark III transmitting set which is now a two-valve receiving set. The coils remain exactly as before. A variable condenser has been added, so that the range of wavelength is from 300 to 1,500 metres. A variometer is embodied to render very close tuning possible.

The instruments are retailed by Leslie MacMichael, Ltd., and were exhibited at the "Model Engineer" Exhibition.



C.W. Mark III Set after Conversion.

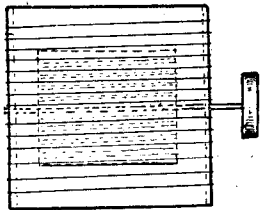
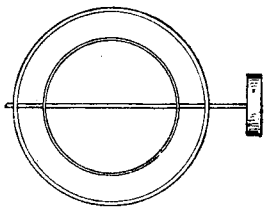

Fig. 1.—Ordinary Type of Vario-coupler.

More About Vario-couplers

Types :: Uses :: Construction

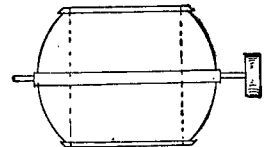
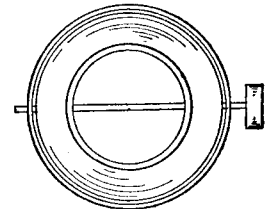

Fig. 3.—Ball-type Rotor (Constant Capacity).

IN this article it is intended to deal only with those arrangements which have a secondary or reaction coil rotating inside the primary coil.

The most usual type is where the axis on which the coil turns passes through the centre of the windings (Fig. 1). It is necessary with this arrangement to leave a space between the turns for the spindle to pass through, which means a loss of efficiency since the continuity of the coil is broken. This can be overcome by adopting the following method of pivoting the inner coil. The axis is fixed to opposite points on opposite circumferences of the smaller coil, and rotates in bearings at similar points on the larger coil. (This will be clearly understood from the illustration, Fig. 2.)

It is obvious that the continuity of the winding is unaffected since the axis does not pass through the turns on either coil. Further, the control knob has to be turned through half a revolution (180 deg.) to change the coupling from maximum to minimum—from tight to loose. This 2 to 1 ratio is especially valuable when the degree of coupling has to be very exactly defined, as is the case with the reception of telephony. Suitable sizes for the coils (for short wave work) are:

Outer or primary coil, 3½ in. outside diameter by 2½ in. long.

Inner or secondary coil, 2½ in. outside diameter by 2 in. long.

* These sizes give a maximum degree of coupling which is not too tight to cause self oscillation, an important consideration where broadcast reception is concerned. The illustration, Fig. 2, shows a convenient way of mounting these coils with a switch for varying the primary inductance on top of the containing cabinet.

If the coils are to be used as an aerial tuning inductance and closed circuit inductance, the "ball" type of inner coil is more suitable for two reasons. Firstly, the degree of coupling can be made much greater than with other arrangements, a desirable feature since there are no ill effects arising from tight coupling in this

case. Also the shape of the rotating part inside the A.T.I. is such that the capacity effect it has on the outer coil is constant. Hence a variation in coupling does not affect the tuning of the aerial circuit.

This type of former can be readily turned out of any hard wood and mounted on two short spindles or one continuous spindle (Fig. 3).

It is not advisable to use the spindle as the connections for the coil, for however

ing must be put on in two parts and joined at the centre, as it is only possible to wind "up the hill." The winding should be started at each end and continued upwards (inwards), and the two ends then soldered together and tucked inside.

H. R.

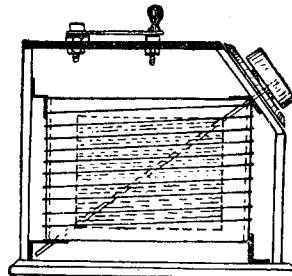

Fig. 2.—Fine-coupling Device.

carefully the rubbing contacts are made noises are produced on turning the control knobs.

Since the coil need only rotate through 90 deg., connections can be established by flexible wires (covered) soldered to the ends of the winding.

It is advisable to note that the wind-

Dielectric Constant of Mica

IN an article in the "Physical Review," J. R. Weeks, Jr. states that for samples of mica, without visible air films, the dielectric constant ranged from 6.4 to 9.3. For sheets having air films the values were from 2.9 to 5.6. Sheets split from the sample which had given the value 2.9 were measured and the results varied from 6.6 to 8.4. Similar experiments confirm the belief that the low results are to be attributed to the presence of air. This probably explains the reason for the wide divergence between values of the dielectric constant of mica given in handbooks.

A Loud-speaker for Eight Shillings

WHY do loud-speakers cost so much? I have just constructed an instrument, for the modest sum of eight shillings, which gives results quite equal to those obtained from factory-built loud-speakers costing three or four pounds. The basis of the apparatus is an ex-army loud-speaker which was purchased from an advertiser in AMATEUR WIRELESS for the sum of seven shillings and sixpence.* This is an ear-piece with extra large diaphragm, and came, I fancy, from a trench-set. It is of 200 ohms resistance. The horn, purchased at a second-hand store for three-pence, is an ordinary tulip-shape aluminium horn from an old phonograph.

The fixing of the horn to the ear-piece presented some difficulties. It is essential that there should be an air-tight connection, because the action of a loud-speaker depends on setting in motion the column of air between the diaphragm and that

portion of the horn where it begins to widen out. After several trials—soldering of two aluminium surfaces being thought out of the question—a piece of rubber tube of sufficient size was slipped over the end of the horn and then rubber and horn and ear-piece were tightly bound together with bare copper wire. The result is not beautiful to look at, but it answers. With three stages of note magnification Paris time signals can be heard all over the house, and London, Paris, Birmingham and Manchester broadcasting really do "flood the room with music." There is very little distortion, which is probably due to the good design of the horn. Of course there must always be some distortion in a loud-speaker, apart altogether from that due to the note-magnifiers, because as the sound-waves broaden out in the horn they themselves are distorted. This is reduced by good design.

ERNEST LANGMEAD.

Repairing a Low-frequency Transformer

HOW many amateurs have thrown away low-frequency transformers as useless after they have given out!

One day whilst working on three valves, one H.F. and one L.F., I was interrupted by a scratching noise which rapidly grew in volume, succeeded by a loud final click and—silence. In fact, my L.F. transformer had ceased to function. At first I had visions of another £1 going on a new transformer, but I thought that I would have a look inside first just to see what could be done. First I connected the secondary of the transformer in series with a 1.5 volt battery and a pair of phones. A click was heard in the phones and another upon disconnecting, so, I thought,

the secondary is O.K. I repeated the test with the primary, but no loud click. Subsequently I found that the primary windings had gone where the wire was started next to the iron core. As the wire is finer than hair I did not see how I could find the break, so with a small penknife I scraped away a little insulation from the visible portion of the wire nearest to the core, and with resin-cored solder soldered a length of fine copper wire on. I then tested with the phones and battery once more, using the new piece of wire as one terminal and the outside lead of the primary as the other. A welcome click was heard, which proved that I had established connection again, despite the fact

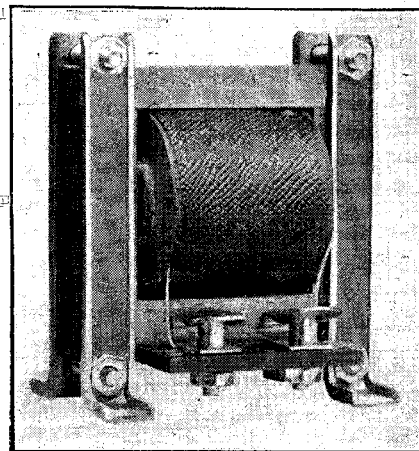

Low-frequency Transformer.
(Igranic Electric Co., Ltd.)

that there were probably several dozen turns lying idle. The next thing to see was—would it work. I connected up as usual and switched on. In came the signals with a roar and rattle. A. G. W.

IN the last article mention was made of the rate at which electrical vibrations are set up in a transmitting aerial. This is commonly referred to as the "frequency" of the vibrations, or of the wave which they produce. This wave travels through space at the same velocity as light. There is, in fact, a great deal in common between wireless waves and light waves, although you can "see" one and not the other. One thing, for instance, which they have in common is their speed. They both travel at the enormous speed of about 186,000 miles per second! Moreover, that speed does not vary for different kinds of light waves (giving rise to the sensation of "red" or "blue" or "green," for instance), or for different kinds of wireless waves—"long" or "short" waves as they are called.

"Vibrating" the Aerial

Now it is not a very difficult thing to imagine this wave motion being set up in the space surrounding a transmitting aerial. We know what a wave on the sea looks like: a series of hills and hollows, ups and downs, and we can depict a wireless wave similarly. If you make a point on a sheet of paper with a pencil, and then from it draw a "waggly" line across the page, you may make these represent the transmitting aerial and the wireless wave set up by it when it is vibrated electrically. Now the hills or crests of this wavy line must be a certain distance apart, and this distance is usually called the wave-length. It may be defined as the distance between any two successive crests.

If the aerial is vibrated very quickly the successive crests of the resulting wave

will be very close together—that is, the wave-length will be small. If the aerial is vibrated more slowly the crests will follow each other at longer intervals—that is, the wave-length will be longer. In other words, the greater the frequency the smaller the wave-length. This can be demonstrated quite easily. Assume that the wavy line runs from the pencil point to the edge of the paper and that there are 1,000 wave crests in this distance. If, now, you superpose on this another wavy line having only 500 crests extending over the same distance, it will be obvious that the distance between the latter crests must be twice the distance between the former. That is, when you halve the frequency you double the wave-length. Similarly, if you double the frequency you halve the wave-length, and so on.

Wave-length and Frequency

Suppose you want to set up a wireless wave having a wave-length of one mile. Well, since the wave, whatever its length, will travel at a speed of 186,000 miles per second, it follows that you will have to vibrate your aerial at a rate of 186,000 times per second in order to do so. Or, again, if you want to transmit on a wave of half a mile length you will have to vibrate your aerial at twice the former rate, that is, at 372,000 times per second. This can be expressed as a general law by saying that frequency = $\frac{186,000}{\text{wave-length}}$.

Notes for the Novice.—III

Some Simple Definitions

In working this as a formula, of course, the wavelength must be expressed in miles. In practice, however, it is more customary to calculate wavelengths in metres or feet.

It is also customary in practice to speak of "oscillations" instead of "vibrations." Instead of saying that you "vibrate" the aerial at a certain "rate," the phraseology of wireless ordains that you should say that you "oscillate" it at a certain "frequency."

Maintaining Oscillations

When you vibrate, or oscillate, an ordinary violin string you must take care that it doesn't come into contact with anything. If you touch it with a stick, or a book, or your finger, it will cease to oscillate. You must protect or shield it from anything which would tend to prevent it from oscillating. The same is true with respect to an aerial in which you want to maintain oscillations; it must be shielded from anything which might prevent it from oscillating also. This is usually referred to as "insulating" the aerial. "OLD HAND."

Whilst listening-in to an American broadcasting station, Mr. J. E. Samuel, of Aberystwyth, distinctly heard the clapping of hands of people in the room when an orchestral item was encored.

The directing of aircraft by ordinary wireless means is said to be giving better results than the system of transmitting signals from a cable laid along the line of route.

High-frequency Amplifiers

Transformer-coupled :: Resistance-coupled :: Reactance-capacity Coupled

THE object of using a high-frequency amplifier in a receiver is usually to increase the range and not the signal strength, although it does do the latter to some extent. Very weak signals may not have enough energy to make a rectifier

fix into valve holders so that they may be changed easily and quickly when listening-in.

Owing to the number of transformers required for receiving on all wavelengths this type is expensive to buy and trouble-

the anode circuit. In the resistance-coupled type these currents do leak away a little, and if the resistance is raised there is not sufficient voltage on the anode for the valve to function properly. The inductance, however, has a fairly small direct-current resistance.

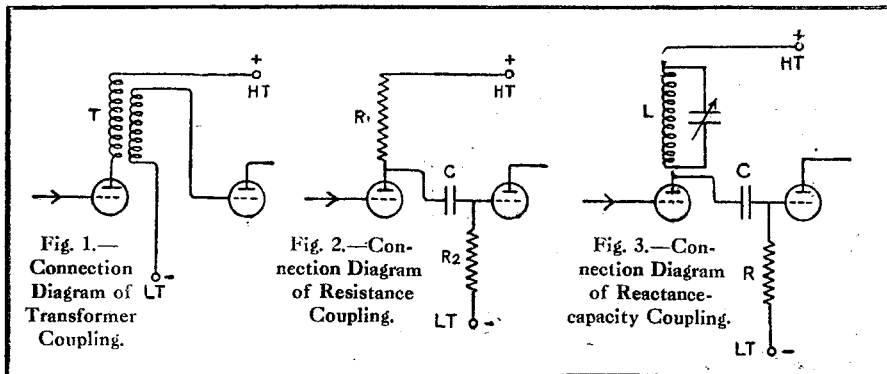

function, and so they are not heard at all. If by means of a high-frequency amplifier these signals are magnified before reaching the rectifier, then they will have enough energy to make themselves audible.

Types

There are three types of high-frequency amplifiers in common use: (1) transformer-coupled, (2) resistance-coupled, and (3) reactance-capacity-coupled. They all magnify signals before they are rectified, and it will therefore be understood that the magnification takes place at the frequency which corresponds to their wavelength. This is why they are sometimes called "radio-frequency amplifiers," to distinguish them from amplifiers of rectified signals called "audio frequency amplifiers" or "note magnifiers."

Transformer Coupling

In the first type the magnified radio-frequency impulses are conveyed to the next valve, which may be another high-frequency valve or a rectifier, by means of a transformer. This is connected up in the same way as a low-frequency transformer and is shown in Fig. 1. These high-frequency transformers have no iron core.

As the frequencies of incoming signals vary so greatly over even a small band of wavelengths, one transformer will only be suitable for receiving signals between certain limits of wave-length. It is therefore necessary to have a set of transformers, each wound with different amounts of wire, for receiving over a large range. They are usually made to

some to make. When properly designed, however, they give very good results. If wound with resistance wire the transformers cover a slightly larger band of wavelengths, and signal strength is nearly as good. Some experimenters say that these transformers do not "transform" at all, but have an entirely different action.

Resistance Coupling

The second type makes use of a resistance in the anode circuit, as shown in Fig. 2. This resistance should be as large as possible for the H.T. voltage and is usually about 50,000 ohms. The condenser may be of about .0002 mfd. capacity and R₂ about 2 megohms. This type is not quite as efficient as the transformer-coupled type, and is of no use on wavelengths below about 1,000 metres.

Reactance-capacity Coupling

The reactance-capacity type is the most efficient and the most popular with experimenters. The connections are shown in Fig. 3. The inductance L is tuned to the exact wave-length of the incoming signals. The grid coupling condenser may be .0002 mfd. and R about 2 megohms. The advantage of this type is that a reactance from the rectifier may be coupled to the inductance L to produce beats for C.W. reception, without radiation.

The principle upon which it works is as follows: Although any inductance has some resistance, when tuned to a certain wavelength it has an infinitely high resistance to currents at that frequency, and in the case of an amplifier all the amplified impulses pass to the grid-coupling condenser and do not leak away through

Oscillation

All types of high-frequency amplifiers are liable to self-oscillation and howling, due to an excessive negative charge on the grid or grids. This can be overcome by connecting all the grids in parallel and taking a lead to a potentiometer, so that they may all be given a small positive charge if necessary. The potentiometer is placed across the accumulator. The inductance for a reactance-capacity type amplifier may be a basket-type coil, with a tuning condenser of not more than .0003 mfd. capacity. As with the transformer type, different coils will be needed for different wavelengths, but they are easier and cheaper to make than transformers. RADION.

Variable Grid-leak

THE accompanying sketch shows an idea for a variable grid leak which works very well. As will be seen, it consists merely of a circular base which may be ebonite or fibre, on which is mounted a switch arm that is connected to one of the

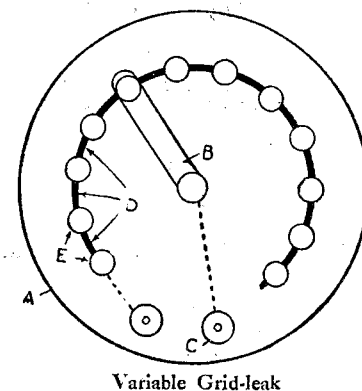

terminals C. The leak D is an indian inl line and contact is made to it by the contact studs E which are screwed down tight. The farther round the switch arm is placed the longer leak is placed in circuit. The first contact stud, of course, is connected to the other terminal. H. R.

Ask "Amateur Wireless" to send you a list of practical books. Sent gratis and post free.

It Speaks for itself—

and in no uncertain voice

THE WORLD'S STANDARD LOUD SPEAKER

AMPLION

WIRELESS
LOUD
SOUNDING
RECEIVERS
are supplied in
a series of

Ten Models

Suitable for
every service:

**The Home,
Laboratory
and the
Concert Hall**



At Prices

ranging from
£2 : 10 : 0
to
£15 : 15 : 0

**DAILY
DEMONSTRATIONS**
at the
**GRAHAM
SHOWROOMS**
The ALGRAPHONE
SALON
25-26, Savile Row,
Regent Street, W.1
Phone: Regent 1075

"MUSIC MASTER" HORN

Type AR 13, 120 ohms ... **£8 : 0 : 0**
Type AR 15, 2,000 ohms ... **£6 : 2 : 6**

"Graham" Wireless Pro-
ductions include "High
Efficiency" Telephone
Headsets of improved
design and construction.
The "Graham" is the
best Head Gear money
can buy.

*Full particulars forwarded upon
request. Ask for Folder A. W.*

Patentees and Manufacturers :

ALFRED GRAHAM AND COMPANY

St. Andrew's Works, Crofton Park
LONDON - - - S.E.4

Phone: Sydenham 952. Grams: Navahada, Brock, London

SCOTLAND :

Mr. F. M. Milligan,
25, Renfrew Street,
GLASGOW.

IRELAND :

Mr. Alex. R. Munday,
41, Chichester St.,
BELFAST.

HULLO

Do YOU Know Us? If not, why not?

COMPLETE SETS of PARTS for MAKING VARIABLE CONDENSERS

**EVERYTHING READY to ASSEMBLE and
CONSISTS of the FOLLOWING:**

Accurate Aluminium Fixed and Moving Vanes, Large and Small Spacer Washers, Centre Square Spindle (Screwed Ends, 2 B.A.), 3 Side Rods, 13 Nuts and 13 Brass Washers (2 B.A.), Pointer-scale 0-180, Terminals 3 bushes, Spring Coil Washers, Best Quality Knob with 2 B.A. Nut in Centre.

ALL HIGHEST QUALITY GOODS

REVISED PRICES, WITHOUT EBONITE

Approximate Capacity in Microfarads	No. of Plates	Price
.0015	85	9/-
.001	57	6/6
.00075	43	5/6
.0005	29	4/6
.0003	19	3/-
.0002	13	2/3
.0001	7	2/-
Vernier	3	1/9

DRILLED EBONITE ENDS - 1/- pair

Postage and Packing: 1 set, 1/-; 2 sets, 1/3; 3 sets, 1/6

If more than 3 sets kindly include ample for packing and carriage, as the value given does not permit of my paying same.

No Connection With Any Other Advertiser

HEADPHONES

Genuine
"BRUNET"
(FRENCH)

A Simply Splendid Phone for Radio
DOUBLE RECEIVERS

Complete with Cords

25/- pair
Post Free

SEE YOU GET THE GOODS!

*I Sell these on MERIT
and RECOMMENDATION*

BRITISH PHONES

4,000 ohms. Approved P.M.G.
Stamped B.B.C.

21/- 22/6 25/-
(Double) Post 1/-

BRITISH PHONES

(Single) 4,000 ohms
Approved P.M.G. Stamped B.B.C.
Complete with Cord and Handle

12/6

ASSEMBLED CONDENSERS

(Circular Discs.) Complete Sets.

.001 - - - **12/6**
.0005 - - - **8/6.**

Post and Packing, 1/3 Set

RIGHT OPPOSITE
DALY'S
GALLERY DOOR

M. RAYMOND

27, LISLE STREET, W.C.2

'Phone: **GERRARD 4637**

To avoid mistakes,
this address is close
to Charing X Road
and Leicester
Square Tube

EVERYBODY

We do not offer you "something for nothing," nor is this advertisement a catchpenny one. Goods supplied are value for money, both as to quality and price. We leave our customers to be the best judges. 'Nuff said!

IMPORTANT NOTICE.

Owing to the enormous demand for goods, and the difficulty in obtaining sufficient supplies at the moment for postal supplies, I ask your kind indulgence *re same*.

ALL ORDERS DESPATCHED AT THE EARLIEST POSSIBLE DATE.

All Articles Sent on Approval.

No Catalogues Issued.

ALL FOLLOWING GOODS POST FREE AT THE SPECIAL POST PRICES ATTACHED

Aerial Wire. Genuine 7/22 bare copper stranded. 100 ft. hanks, daily market prices (postal supplies uncertain at present).

Switches. Not common rubbish on fibre, but a real good article, brass on ebonite. S.P.S.T., 1/6 (by post, 2/6); S.P.D.T., 2/6 (by post, 2/6); D.P.S.T., 2/6 (by post, 3/6); D.P.D.T., 3/6 (by post, 3/6).

Filament Resistances. I have 3 types, all highest quality. For 1 valve, 2/6 (by post, 3/3); for 2 valves, 3/6 (by post, 3/6); and for 3 valves, 3/6.

Insulators, green or white, egg type, 2d, each (not sent by post).

Lead-in Tubes. Ebonite, with brass ends. Best quality. 6 in., 1/6; 9 in., 1/2; 12 in., 1/4 (not sent by post).

Crystal Detectors on Ebonite. Well made, two designs. 2/6 (by post, 3/3) and 3/3 (by post, 3/9). And they are worth it!

Crystal Detector. Dust proof, glass covered, horizontal type. Very handsome design; our own pattern. 4/6 (by post, 5/3).

Detector for Two Crystals. Horizontal type, thoroughly well made. (Some people ask 10/6 for the same design!) I am sure you will be satisfied to pay 4/6 (by post, 4/9).

Grid Leak and Condenser. .0003. Absolutely perfect in design and quality. It is not cheap, but does the work. Price 3/9 (by post, 4/3).

Our 5-piece **Terminals** beat the world. 1d. each (no post orders at present).

Terminals, with hole for telephone leads. Beautifully finished, complete with nut and washer. 2d. each (not less than 1 doz. sent by post, price 2/6).

Ebonite Valve Holders, with 8 nuts. 1st quality, 1/3 (by post, 1/8); 2nd quality, 1/1 (by post, 1/5).

W.O. Terminals. Highly finished and polished, suit highest class set. With nut and washer. 2d. each (not less than 1 doz. sent by post, price 2/6).

Terminals. Extra good quality, small size, 4 B.A., W.O. pattern. 8 for 1/6 (by post, 1/4).

Terminals. 4 B.A. Small, round pattern, pretty design, with nut and washer. 8 for 1/6 (by post, 1/4).

Very Large Terminals. Superb quality. 2 B.A. Complete with 2 nuts and 2 washers. 2 for 8d. (by post, 1/6).

I can supply you with Terminals, various designs, all really good and cheap. No rubbish supplied.

Intervalve Transformers, low frequency, 5-1. On approval. 14/6 (by post, 15/6).

Ebonite Dials. 0-180. Bored in centre. 1/6 each (by post, 1/6).

Knobs. Bushed 2 B.A., specially good quality, 4 1/2d. each (by post, 7d.).

Switch Arms. 3 designs. All complete with laminated arm, bushes, nuts, washers, etc. Prices, 1/6 (by post, 1/6), 1/6 (by post, 2/6), 2/6 (by post, 2/6).

Fixed Condensers. First-class value, .0003, .0005, .001, .002, .003. Scientifically constructed. 1/3 each (by post, 1/6); also .004, 1/6 (by post, 1/9). These are with terminals on ebonite.

Slider Knobs and Plunger. 4d. (by post, 7d.). Slider, knob and plunger, with 13 in. brass rod. The lot, 7d. No post orders accepted.

Oojah Basket Coils. 7 in set, 5/6 (postal supplies uncertain at present).

H.T. Batteries. 30 volt, 6/6 (by post, 7/6).

H.T. Batteries. 60 volt, 12/6 (by post, 13/6).

UNSOLICITED TESTIMONIALS.

<p>H. S. PETTITT, 37, Robertson Road, BRIGHTON. 10/1/23.</p> <p>"Received Condenser parts to-day, and they surpass all my expectations."</p>	<p>SAMUEL LOWE, 23, Noble Terrace, GATESHEAD-ON-TYNE. 30/12/22.</p> <p>"The Condensers received by me were first class and people would not believe me when I told them the price."</p>	<p>R. H. FEUSTER-RUSSELL, 21, Hadlow Road, TONBRIDGE, Kent. 11/1/23.</p> <p>"... I consider them the most remarkable Condenser value on the market."</p>
---	--	---

To CALLERS: We Sell All Component Parts CHEAP!

BRASS RODS, NUTS, WASHERS, SCREWS, VALVE SOCKETS, VALVE PINS, STOP PINS, LARGE SPACERS, SMALL SPACERS, BUSHES, etc., AT WHOLESALE PRICES. ANY QUANTITY SUPPLIED.

It is impossible to advertise everything, but you can rest assured that you cannot get quality or prices obtainable here, at any other establishment

M. RAYMOND

27, LISLE STREET, W.C.2

Phone: GERRARD 4637

RIGHT OPPOSITE
DALY'S
GALLERY DOOR

To avoid mistakes,
this address is close
to Charing X Road
and Leicester
Square Tube

On Your Wavelength!

**Broadcast
Opera**

**Amateur
Telephony**

Short Waves

country. The most surprising point at first sight is that these messages had never been heard until about two months ago; then one observer who was working on short waves in the small hours was amazed at hearing items of a broadcast programme from Newark, New Jersey. Almost at once other wireless men began to announce that they were able to hear Transatlantic transmissions, and now they are picked up quite regularly by dozens of people. The truth is that until the possibility of hearing Uncle Sam's wireless voice was known not one owner of a wireless set in a thousand ever thought of tuning in the short wavelength at 2 ak emma. There is a certain amount of commercial and shipping work on 300 metres, but otherwise there is nothing to hear. Then until last summer the number of valve receiving sets in use in this country was a very small one indeed. It grew rapidly as the summer waned, and with the departure of the hot weather, atmospherics, which are particularly bad in America, ceased their usual spoil-sport antics. Winter nights are especially favourable for wonderful results.

* * *

But there is another point which is most remarkable—the more aeri-als there are in use for reception the better is our chance of picking up faint and distant transmissions. Even when the set is so perfectly controlled that it causes interference with no one else it is radiating weak waves which exactly correspond to the oscillations that it is receiving. Hence if two sets are working on the same wavelength within a fairly short radius their aeri-als will influence one another just as do the secondary and reaction coils of the set, each “boosting up” the signals received by the other. This “aerial reaction,” as we may call it, may become one of the most important factors in wireless, for in the future stations may be designed to take full advantage of the interaction of twin or triple aeri-als.

* * *

Amateurs, though eclipsed to some extent by the prevalence of broadcasting, are by no means so silent as some correspondents imagine. If you care to tune down to about 200 metres you will find

REPORTS continue to come in that telephonic transmissions from America are being picked up by amateurs in all parts of the

that all our old friends are still very much in evidence; 2 J Z, 2 L Z, 2 O D and 2 O N, for instance, transmit on most evenings, and they are by no means the only ones.

* * *

It used to be thought that short waves travelled badly, but now that telephony has crossed the Herring Pond on a carrier-wave of 360 metres, we must revise our ideas a little. Most of the London amateurs are heard regularly in Paris on quite small receiving sets, and many of them are picked up in places as far afield as Berne, Nice and Cadiz. The lower wavelengths are coming into their own, and many enthusiasts hold that the future of wireless lies largely with them.

* * *

A correspondent asks whether by connecting a potentiometer directly across the accumulator he will not be practically “shorting” it. Many people seem to have a similar doubt, and certainly the little coil of wire does look as if it would give the L.T. battery a fairly free passage for its current. Ohm's Law shows that the current passed is equal to the voltage divided by the resistance. Hence if a 200-ohm potentiometer is shunted across a 60-volt accumulator the current passing is only 6/200th of an ampere, or 30 milli-ampere, which is so small that we need not worry about it. At the same time a switch should be provided to cut out the battery, otherwise much of its “juice” will eventually leak away.

* * *

The President of the Sheffield Wireless Association, one of the most go-ahead in the North, has been bringing home to the members the iniquity of condition No 2 of the broadcast licence. Admittedly the new P.M.G. takes a wide view and grants experimental licences to most of the serious applicants for them; still this does not alter the fact that a monopoly has been established, and monopolies are seldom satisfactory things except for those that own them. Mr. Lloyd, in his address, pointed out that when 1,000,000 wireless sets were in use the Broadcasting Company would have a revenue of £250,000 a year from licences alone, to say nothing of the royalties charged on complete sets and on parts. The whole position is unsatisfactory and calls for united and decided action on the part of wireless associations.

* * *

It is to be hoped that we shall see ere long the promised improvement in the quality of broadcast programmes. 2 L O's

orchestra, now, we believe, a permanent feature, is most pleasant to listen to, but some of its items do not seem well suited for broadcasting purposes. An occasional lecture on wireless subjects by an expert would be welcomed by thousands of enthusiasts. The gramophone and the pianola should be barred out as wireless “turns.”

* * *

As I write it seems as if these pious aspirations are likely to be fulfilled, for the loud-speaker in the next room is delivering in the most delightful manner Mozart's “Magic Flute,” transmitted direct from the Royal Opera House, Covent Garden. There was a slight delay in starting, then 2 L O announced “switching over to Covent Garden.” Came a rather indistinct sound of the scraping of fiddles mingled with toots on the flute and with other more or less pleasant noises. It was the orchestra tuning up. (This, by the way, was the only part of grand opera that appealed to the late Shah of Persia.) A sudden silence, then an outburst of applause as the conductor took his place, and next moment the overture was in full swing. The effect of a salvo of hand-claps is most extraordinary if you are close to the instrument or have the phones on your head, sounding rather like strong atmospherics, but at a little distance you can almost imagine yourself in the theatre and you can hardly resist adding your own enthusiastic applause. The solos and the choruses are coming through to perfection. There was a little fading at the very outset, but no such effect is now noticed. The signal strength is only a trifle less than that of 2 L O's own transmissions, which, considering the size of the Covent Garden stage, is remarkable. The success of this experiment in broadcasting (and it is a very real success) marks the opening of an entirely new era in wireless. The B.B.C. has promised us future operatic programmes, and there is little doubt that in the future we shall be able to hear plays from the theatres, services from the great churches, and even speeches made in both Upper and Lower Houses of Parliament.

* * *

The telephone girl was listening-in for the first time. “Hello! Hello! Hello!” called the headphones. “Number engaged,” she said automatically, then relapsed into blushing confusion.

THEMION.

**Potentiometers
and the
L.T. Battery**

**Licence Clause
No. 2**

The Hello Girl

illustrated description of amateur-equipped transmitting and receiving station that of Mr. L. W. Pullman, Golders Green, London, N.W.

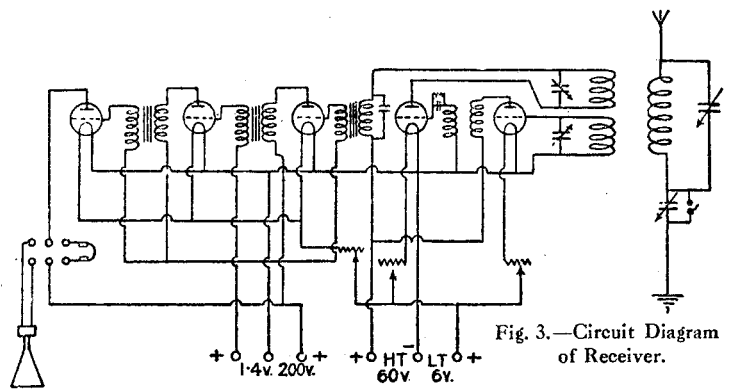

Fig. 3.—Circuit Diagram of Receiver.

be seen on the left of the switch, places the experimental artificial aerial in circuit. The round box just above contains the lightning arrester.

Receiver

The receiver is a 5-valve set, having one



Photograph of the Apparatus

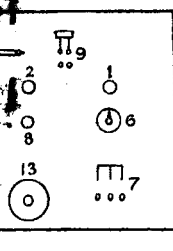

REFERENCES

- 14.—Voltage variations on H.F. and D.
- 15.—Armstrong control switch.
- 16.—Filament resistance for L.F. valves.
- 17.—Reactance-variometer condenser.
- 18.—Wavelength changing switch.
- 19.—Secondary variometer.
- 20.—Change-over switch to enable outside tuner to be used.
- 21.—Plugs for outside tuner.

Disposition of Receiving Units.

H.F., one detector, and three L.F. valves. The last three valves, by an arrangement of switches, can be converted into the Armstrong super-regenerative receiver, from which excellent results are obtained.

Receiving Valves

From right to left on the panel there is the H.F. valve with a H.F. variable-range transformer, and under this is the tuning condenser. The next valve is the detector, and above it and slightly to the right a double-pole switch is fitted which enables various values of grid-leaks to be used. Below the detector valve there is another variable condenser, and on the right there is a 5-way switch which controls the tapings on the first low-frequency transformer input.

Main tuning-Condenser

The main-tuning condenser is in a box on the right front of the panel, and this is arranged so that it can be operated in conjunction with two vernier condensers to enable two telephony stations to be tuned. By the manipulation of the switch, shown in the centre, either station can be listened to without re-tuning; even though there may be a difference of 100 metres in their wavelengths.

Wavemeter

On the top of the receiver and at the extreme left of the wavemeter is to be seen, which is of the well-known Townsend type. In the glass-topped case, to be seen on the left in the photographs, is a stand-by set, which ordinarily is never used, being merely kept as a standard for reference.

All the wiring is carried out with 16-gauge wire, and all condensers are sheathed in metal cases with the latter earthed. Panels are coated on the back with tinfoil, the foil being cut away where necessary to clear parts; the tinfoil is also earthed. The same system is carried out with the low-frequency transformers; all these being placed in metal cases and earthed. The diagram (Fig. 2) with its accompanying references will make the disposition of the apparatus clear. A circuit diagram of the receiver is shown by Fig. 3.

Mr. Pullman considers method and neatness to be essential for really successful results to be obtained.

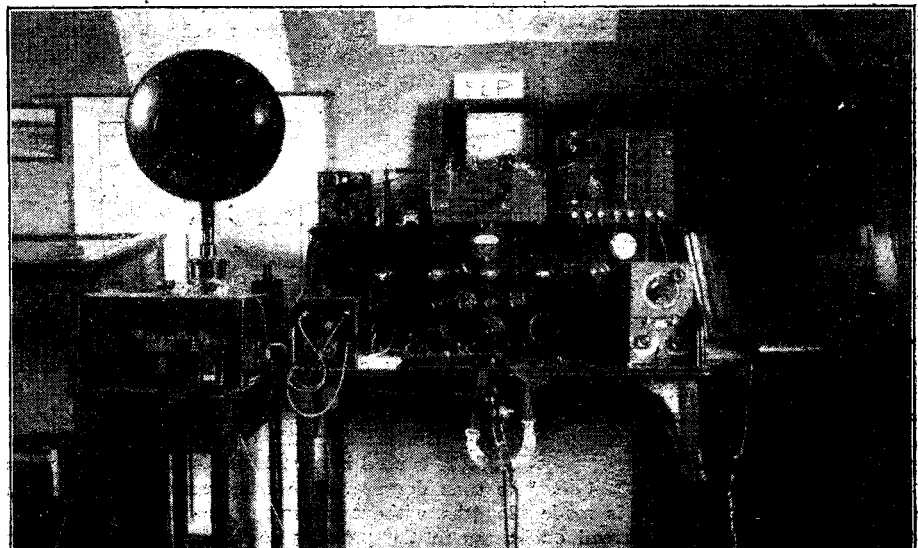

Another Photograph of the Apparatus.

Cigar-box Valve Panels

THE advantages of a three- or four-valve cabinet set are compactness and appearance, but against these there is the disadvantage of not being able to alter the connections to enable another circuit to be used.

The writer has made, and is using with great success, a series of small one-valve panels made from cigar-boxes which can be connected together, providing both high- and (or) low-frequency amplification.

A number of cigar-boxes are obtained, the "50" size being very convenient for the purpose, having dimensions of, roughly, 9 in. by 5 in. Soak off the paper with warm water, taking care that the

heating it over a gas flame or lamp. It has to be done very carefully, as the fibre easily breaks. Bend the rod to make a semicircle of about 2 in. diameter, and then near each end make a 6 B.A. clearance hole. File one side of the rod flat and wind the grooves with about No. 24 resistance wire, securing each end to a 6 B.A. brass bolt $\frac{1}{2}$ in. long. Cut out a piece of $\frac{1}{8}$ -in. ebonite about $3\frac{1}{2}$ in. by $2\frac{1}{2}$ in., and in the centre drill a hole just large enough to take a piece of brass tube having an inside diameter large enough to take a 2 B.A. brass rod easily. A piece of this tube $\frac{1}{8}$ in. long should be pressed into the hole in the ebonite and its edges

close to the other side of the ebonite. Brass or copper washers should be placed on the rod on each side of the ebonite to ensure easy working. Connection to the moving arm is made by soldering a strip of copper foil (about 3 in. long by $\frac{1}{8}$ in. wide) to the end of the brass rod; wind a couple of turns of the foil round the rod, and solder the free end to a piece of stout copper wire, which is held down to the ebonite by a 6 B.A. bolt. This makes a positive connection.

The rheostat is secured to the supports by 6 B.A. bolts as in Fig. 3, taking care that the rod does not bind in the hole in the ebonite panel. A small knurled knob

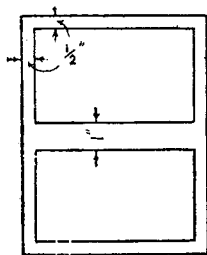

Fig. 1.—Lid of Box Cut Out.

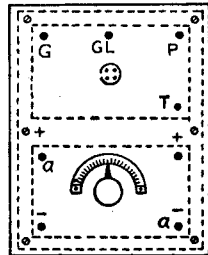

Fig. 2.—Box with Ebonite Panels Fitted.

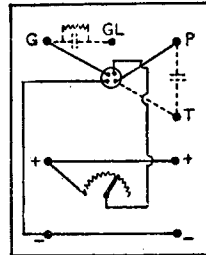

Fig. 4.—Wiring Diagram.

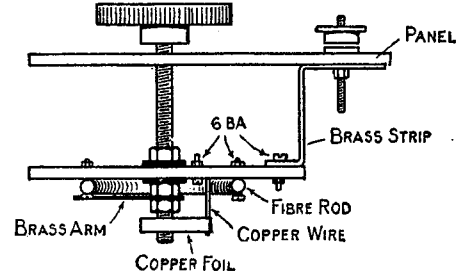

Fig. 3.—Enlarged Detail of Filament Rheostat.

boxes are weighted during drying to prevent warping, and with a fretsaw cut out the lids as shown in Fig. 1. Small brass hinges (if not already fitted) should be obtained and the lids carefully hinged.

Panels

A sheet of ebonite $\frac{1}{8}$ in. thick should be obtained, and a piece $\frac{1}{2}$ in. longer and $\frac{1}{4}$ in. wider than the box lid cut out. This is secured by small brass wood screws at each corner and the middle of each side as shown in Fig. 2. Holes are now drilled to take the valve socket, terminals, and for the filament rheostat rod (this should be 2 B.A. clearance). The terminals marked are the same for all panels, with the exception of the two marked GL and T. For the rectifying valve panel the terminal GL must be put in, as this is to be connected to a grid-leak and condenser which is placed across terminals GL and G. If desired, the grid-leak and condenser may be cut out by connecting direct to G instead of GL. The panel to which the phones are to be connected must have a terminal T and a small blocking condenser connected across P and T.

Rheostat

The filament rheostat (Fig. 3) is made by putting a $\frac{1}{4}$ -in. Whitworth thread on a piece of $\frac{1}{4}$ -in. round fibre rod (red fibre is better than the black, as it is not so brittle) and bending the threaded rod by

burred over to hold it securely. This is to make a brass bush for the rod, which otherwise would very quickly wear the ebonite. Mount the resistance coil, flat side uppermost, on to the piece of ebonite, securing it by the two 6 B.A. bolts. Firmly fix a small strip of strong, springy brass about $1\frac{1}{2}$ in. long on to a piece of brass rod, screwed 2 B.A. and about 2 in. long, by means of two nuts. Put this through the bushed hole so that the brass strip makes contact with the resistance wire. Secure this rod by means of another nut

should now be fixed on the projecting rod, and as an additional refinement a pointer and scale may be fitted.

Connections

General connections are shown in Fig. 4. It will be noted that in the diagram the plate lead is connected to the lower terminal marked T in Fig. 2, and the H.T. phones to the upper terminal. By having all connections brought out it is apparent that any number of circuits can be tried at will.

E. A. E.

A Simple Series-parallel Device

IT is surprising to find how few people realise the advantages of wiring the aerial-tuning condenser in series for the reception of short-wave telephony. If a condenser of .001 microfarads, which is about the most usual capacity for the A.T.C., is used in parallel, it is impossible to tune down even to broadcasting wavelengths without reducing the number of turns in the primary coils of the aerial-tuning inductance to something very small indeed; and matters become worse when it is desired to listen to amateur transmis-

sions on round about 180 metres. The introduction of a large capacity in parallel means that weak signals and indistinct speech come in, whilst tuning has often to be so finely done that it is most difficult to keep the set from oscillating. Even when dealing with the longer waves it will often be found an improvement to throw the condenser into series and to use a larger coil. I find, for example, that when this is done both Lympne and Le Bourget come in well enough to be heard on three valves (1 H.F., 1 R., 1 L.F.) with a loud-

speaker; whilst if the condenser is in parallel a second L.F. valve must be used to make their speech plainly audible.

One of the strongest reasons for fitting some device which enables one to change over quickly from parallel to series is that it enormously increases the range of basket, slab, or honeycomb inductances.

A.T.C. itself, and it costs next to nothing to make. Also, it is a job that anyone can do in little more than half an hour.

Between the existing terminals on the ebonite top of the condenser fit two more *a* and *b* (Fig. 1), placing them so that the four are evenly spaced. Now take three straps of the shape shown in Fig. 2, using

thereby permitting a much better tuning arrangement with increased volume of sound. By opening the single-pole knife switch, indicated in the drawing, the unused portion of the primary coil from the aerial circuit is disconnected.

With a coil of this kind any desired wave range may be obtained from 200 to 2,000 metres by simply varying the number of turns of wire out into the circuit with the circular disc switch. The minimum number of turns to be wound on the coil prior to tapping in the single pole switch would be fifty-five. This permits the reception of signals from transmitting stations of 400 metres and less. For reception of signals of over 400 metres wavelength, the minimum number of turns should be 150. Taps should be taken from the remainder of the coil at intervals of turns, and fastened securely to the contact points of the circular disc switch.—Radio News.

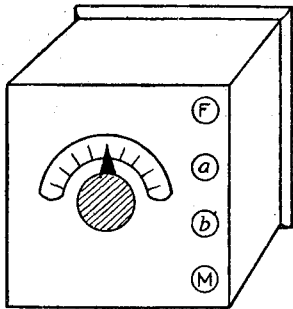

Fig. 1.—The A.T.C. with Extra Terminals Fitted.

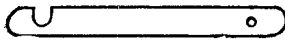

Fig. 2.—Connecting Hook.

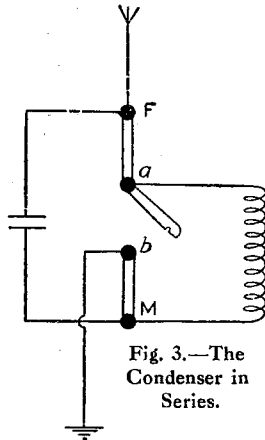

Fig. 3.—The Condenser in Series.

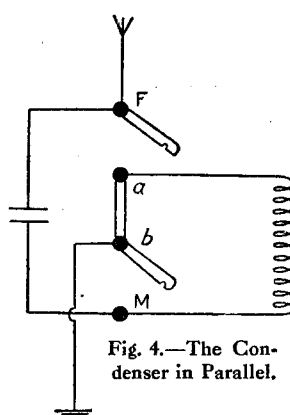

Fig. 4.—The Condenser in Parallel.

If a coil will tune from 1,000 to 2,000 metres with the condenser in parallel, its range with the condenser in series may be something like 500 to 900 metres. This means that with one small gap a single coil can be made to cover all wavelengths from 500 to 2,000 metres. The size of the gap between series and parallel depends largely upon the capacity of the aerial. The thinner its wires and the less there are of them the smaller the "dead spot" will be. In any case, it is nothing very great, and it can be done away with altogether if a small vernier condenser is kept permanently wired in parallel.

The commonest way of making a series-parallel change device is to use a double-pole double-throw switch of some kind. This is a perfectly satisfactory arrangement, but the means outlined here of accomplishing the desired end will be found still better. It is mounted on the

sheet brass, or even tin if brass is not available. Their length will depend on the distance between the terminals.

The lead-in is taken directly to the terminal connected with the fixed plates *r* (Fig. 1), the earth wire goes to *b*, and the primary coil is wired to the moving-plate terminal *M* and to *a*.

A glance at Figs. 3 and 4 will show how the hooked straps are operated. If the middle one is connected up whilst the upper and lower ones are free, the condenser will be wired in series; the reverse of this arrangement puts it in parallel.

This change can be made in a moment, for the primary coil need not be disconnected. The vernier condenser, if one is used, should be connected to terminals *r* and *M*. Its use will be found to facilitate considerably the critical adjustments necessary for very short-wave reception.

R. W. H.

Radiograms

SOME alterations have been effected in the aerial of the London broadcasting station which have considerably increased its range. Amateurs whose apparatus has heretofore been just beyond the range of 2 L O may now be able to get some results.

It is hoped that Cardiff broadcasting station will be ready to start work by the time this issue of AMATEUR WIRELESS is in the readers' hands. The Glasgow station, we learn, ought to be completed by Jan. 25.

We hear from the Sterling Telephone and Electric Company, Limited, that this firm has opened a branch at 14, St. Peter's Square, Manchester, for dealing with orders from Lancashire, Yorkshire, Cheshire, and Derbyshire. Facilities have been provided for daily demonstrations of wireless apparatus.

The call sign of the Birmingham broadcasting station has been altered from 2 W P. to 5 I T.

Whilst a film was being shown in America explaining the working of the three-electrode valve a lecturer accompanied the film with a running commentary on it. Soon the audience discovered that the lecturer was sitting silent among them, and it was then explained that he had delivered the same lecture in New York several days before, his words being recorded by an electrical device.

Loose-coupler with Dead-end Switch

THERE is a certain amount of current in the unused balance of the primary coil of a loose-coupler which is not in

circuit and signals in the receiver. By means of the dead-end switch, as shown in the accompanying sketch, any portion of the

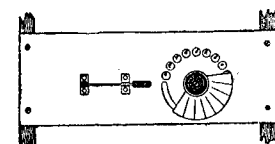
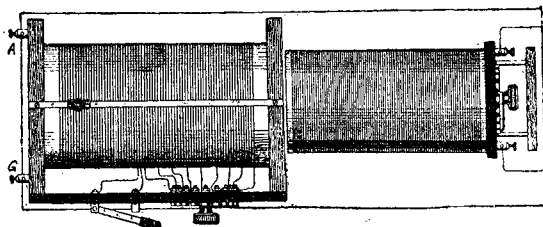

Details of Loose-coupler with Dead-end Switch.

resonance with the aerial, that is not only a total loss in the secondary circuit, but which acts to retard the secondary cir-

cuit. The unused turns are short-circuited by means of the circular disc switch,

A very successful innovation was the broadcasting of selections of the "Magic Flute," grand opera, on the night of Jan. 8. The selections were sent from Covent Garden by means of a special cable and microphone placed in front of the orchestra, to Marconi House, from whence it was broadcast.

The deputation of the Empire Press Union which waited out the P.M.G. on Jan. 8 were unable to get much satisfaction regarding the Empire wireless system. The P.M.G. was able to state that the Government were reconsidering the whole question, but it had not been decided where the money for the new station was to come from, or what size it was to be.

The Canadian Marconi Company have decided to build a new station in Vancouver, the cost of which, when completed, is expected to be in the neighbourhood of 2,000,000 dollars.

The staff of the Metropolitan Water Board have decided to form a wireless club, and have planned to install a 6-valve receiving set.

A group of medium-power wireless stations employing valve transmitters has been erected by Marconi's Wireless Telegraphy Company, Limited, at North Weald, near Ongar, Essex, for the purpose of conducting commercial wireless services with France, Switzerland, and Spain.

These stations have been brought to a high state of efficiency. Although only designed for European communication one of them has been carrying on a Transatlantic service to Canada. One of the other stations (G L O), which is used for communication with Madrid, a distance of about 720 miles, can be heard at Bandoeng, Java, 7,500 miles distant.

An amplifier, using a 60-cycle A.C. supply for anodes and filaments, has been developed by the Bureau of Standards, U.S.A. It has three stages of H.F. amplification, a crystal rectifier, and two note magnifiers.

Dr. Franklin Leroy Satterlee, an American X-ray specialist, has invented a non-regenerative set, which makes one detecting valve do the work of two stages of high-frequency amplification.

With a two-valve set Manchester telephony has been heard so clearly in Glasgow that the indrawing of the announcer's breath was quite audible, also the opening and closing of switches at the transmitting station.

The Italian-American Association gave a reception in Rome to Senator Marconi on Dec. 28, the twentieth anniversary of wireless telegraphy.

An American (Nebraska) is suing for an injunction to break up an alleged monopoly of the ether by the American wireless companies.

One of the latest American productions is a receiver comprising a 2-valve set,

A Gift with Next Week's
— ISSUE OF —
"Amateur Wireless"

"WIRELESS TRANSMITTING STATIONS AND THEIR CALL SIGNALS"

is the title of a sheet which we shall present gratis with next week's "Amateur Wireless." You will get your copy of "Amateur Wireless"—a **Special Broadcasting Number** by the way, containing many extra pages—and with it you will receive this special presentation sheet, **all for the usual price of three-pence.** The sheet alone is worth twice the amount.

"Wireless Transmitting Stations and their Call Signs" will be printed in two colours on special paper; the paper has been specially chosen so as to ensure permanency, the idea being that the sheet can be hung up on the wall alongside the receiver. The sheet has two great features: one, **a Map showing the Positions of Most of the Transmitting Stations in England, and the other the fullest possible List of Transmitting Stations—amateur and otherwise—that it has been possible to compile.** The printed portion of the sheet measures no less than 22 in. by 22½ in., and readers can be a sure of the extraordinary value which we have packed tight within those limits.

Editorially, next week's "Amateur Wireless" will appeal to the many thousands of people attracted by the new broadcasting and desirous of becoming wireless amateurs. The articles have been specially written to help and encourage them. Practical, informative, up-to-date, well illustrated, we promise our readers that the **Special Broadcasting Number of "Amateur Wireless,"** to be published next week, will give them unstinted pleasure.

Will amateurs generally pass the good word along? Will they explain to any friends who contemplate becoming either amateurs or merely "listeners-in" that their **best possible guide is "Amateur Wireless"?** Next week's issue will be a splendid one for the new reader to start with. We trust that we can rely upon the kindness of the constantly growing number of our readers to put in a good word for us between now and next week. Newsagents and bookstalls will be carrying extra supplies of "Amateur Wireless." (We apologise, by the way, for any trouble there has been in recent weeks in obtaining copies of this paper. Twice we have been quite out of print.) Will all our readers register their orders with their newsagent or bookstall for a regular weekly copy, and will they, in addition, **do us the great favour of suggesting to their friends that they also become regular subscribers.**

frame aerial, batteries, and loud-speaker, which is all contained in a suit-case, and can be operated anywhere.

CORRESPONDENCE.

Minus the H.T. Battery

SIR,—On January 4th I received the 2 L O concert on the detector valve (Mullard "Ora") with 3.5 volts L.T. and without any high-tension supply. Is this unusual? My set is a 4-valver made to your specifications—1 detector, 1 tuned

anode, and 2 L.F. with short-wave loose-coupler tuner.—A. T. N. (Thornton Heath).

A Seven-hours' Concert and French Transmissions

SIR,—Of course seven hours of unjammed and uninterfered-with reception is not possible every night of the week; but your correspondent G. T. (Bromley) must be very unlucky if the sample of a night he gives in the issue of January 13 is usual with him, as he seems to suggest it is. Perhaps his set is not nearly so selective as regards its tuning arrangements as it might be. It may be said that since the article which G. T. refers to was written the writer has beaten its record with almost untroubled receptions of nine and ten hours on a Sunday, starting with Radiola at 2 p.m. and ending with the amateurs when the broadcasting stations had closed down.

By the way, the correspondent who wishes to know what French transmissions he has been listening to can see by reference to your list of regular transmissions. The occasional 5 p.m. to 6 p.m. transmission is from Concerts Radiola, Paris. The one that ends at seven o'clock is from Eiffel Tower on 2,600 metres. Radiola always works from 9.45 p.m. to 10 p.m. or just after, and Eiffel Tower is sometimes on in the evening as well. Radiola is on 1,500 metres. If Radiola or Eiffel Tower are jammed or accompanied by much crackling, try cutting out reactance if it is being used.—E. L. (Pirbright).

Re-radiation

SIR,—Almost every evening one hears 2 L O repeat complaints from various districts regarding the misuse of reaction and other annoyances. Suffering very much from this disease myself, I have been working on the matter for some time. Result: Living about six miles from the Strand, I have received 2 L O each evening for the last month with a single valve and a frame aerial 13 in. square. A two-valve amplifier is attached and can be switched in if required, but the second valve of the amplifier has never been necessary. Writtle can be heard right through, and Birmingham is audible with the second amplifier valve. Users of outside aerials do not realize what pleasure it is to receive the news and concerts without the usual accompaniment of scratches, screams, etc. If any fellow sufferer is interested and can construct his own tuner I shall be very pleased to send you details. There is nothing more serious to make than a single-layer coil, so almost anyone can construct the instrument and rid themselves of the nuisances caused by the many ignorant knob twisters.—F. T. C. (Streatham).

[We shall be glad to have the particulars offered.—ED.]

A taxi-cab company in Paris has applied for permission to fit its vehicles with receiving apparatus.

Practical Wireless Valve Circuits
by John Scott-Taggart

Reaction which will pass the P.M.C

CONTENTS

1. Crystal Detector Circuits
2. Single-Valve Circuits
3. Two-Valve Circuits
4. Three-Valve Circuits
5. Four-Valve Circuits
6. Five-Valve Circuits
7. Local Oscillators for Heterodyne Reception of CW
8. Valve Transmitter and Radio Phone Circuits

2/6
or 2/8; post free from publishers

THE use of Reaction gives almost the additional strength of another Valve, but carelessly used it is a source of great annoyance to all other receiving stations within two or three miles. Therefore the P.M.C. has rightly banned all reaction coupled to Aerial Circuits on broadcast wave-lengths.

No need to cut it out altogether though, for in this new book by John Scott-Taggart—that eminent authority on Thermionic Valves—several circuits are shown for the first time which permit the fullest use of Reaction which cannot cause oscillation in the Aerial circuit.

If you are not now using Reaction, get this book and see how easily you can alter your wiring to obtain that maximum of efficiency so essential if you are to pick up those long distance broadcasting Stations.

Every diagram is clearly drawn, all necessary condenser values are given—further you have the assurance that every circuit has been tried and tested, that they are not mere "paper circuits." You'll need this book to understand your Set better. Get it to-day.

Radio Press, Ltd.
PUBLISHERS OF AUTHORITATIVE WIRELESS LITERATURE
DEVEREUX COURT, STRAND, W.C.2.



The sign of dependable information

ACCUMULATORS

4 volt 20 amp. ...	14/-	6 volt 20 amp. ...	22/-
4 " 40 " ...	19/-	6 " 40 " ...	27/6
4 " 60 " ...	27/-	6 " 60 " ...	37/6
4 " 80 " ...	33/-	6 " 80 " ...	52/-

(Carriage Paid) (Carriage Paid)

These accumulators are brand new, guaranteed and specially recommended. Terms Cash with Order.
BASTONES, 228, PENTONVILLE RD., KING'S CROSS, LONDON. N.1.

SCIENTIFIC APPLIANCES (Dale & Hollins). Electrical, Magnetic, Optical and **ALL RADIO WIRELESS PARTS** and Materials at Lowest Prices. Call and see our immense stock or write for Information and Prices. In Centre of London, Top of Kingsway.
SCIENTIFIC APPLIANCES,
11 and 29, Sicilian Avenue, London, W.C.1.

PORTLAND'S PARTS BY POST
"EBONITE"

	s.	d.		£	s.	d.
8 x 1 ...	7		12 x 10 ...	7	6	
4 x 4 ...	1	3	17 1/2 x 8 1/2 ...	9	6	
17 x 5 1/2 ...	6	8	18 x 18 ...	12	10	
10 x 6 ...	3	9	36 x 18 ...	1	3	0
7 x 5 ...	2	8	7 lb. ...	1	3	0

QUARTER, MAT. BRITISH
Postage Free—Any Size Cut

JAMES PORTLAND,
39, SINCLAIR ROAD, OLYMPIA, W.14
N.B.—Mr. Portland Stocks 200 Wireless Parts

JUST PUBLISHED

THE "READY" METHOD OF MEMORISING MORSE.

whole Alphabet can be memorised permanently in **5 MINUTES**

Price 6d., or by post 6 1/2 d.

R. F. ROBERTS, 3 George St., Croydon,
Wholesale: Percival Marshall & Co., 66, Farringdon St., F.C.

AT
HALL'S
PRICES THAT SPEAK FOR THEMSELVES

BRITISH HEADPHONES
4,000 ohms. Very Light. Beautifully Finished. Stalloy Diaphragms. Complete with Cords. Adjustable Earpieces.
(Sold elsewhere almost exclusively at 35/-.)
19/6 Postage 9d.

THE WELL-KNOWN
French "Brunet" Headphones
22/6 POSTAGE 9d.
French "Siderp" Headphones
21/- POSTAGE 9d.

GUARANTEED GOODS DESPATCHED BY RETURN

VARIABLE CONDENSERS:

Capacity.	Parts Complete.	Assembled for Panel Mounting.
.001 ...	7/-	12/6
.0075 ...	5/9	12/-
.0005 ...	5/-	10/6
.0003 ...	3/3	7/6
.0002 ...	2/3	6/-
.0001 ...	2/-	4/9

Top and Bottom Circular Drilled Ebonite Plate, 1/8 extra. Vernier, 3/4, assembled.

Interval Transformers, Ratio 4 to 1, finest manufacture ... 12/9; 5 to 1 14/6

Crystal Sets ... from 15/- to 23

"Royal Phone" Loud Speakers, 4,000 ohms resistance, ebonite horn, giving clarity of tone and freedom from distortion. each 30/-
Orders in strict rotation.

Aluminium Condenser Vanes, fixed and moving, 22/24 gauge ... pair 1d.

Spacers, true to .001. Small, doz. 2d.; large doz. ... 3d.

Ebonite Knobs, tapped 2 B.A. with brass nut—1st quality, 4d.; 2nd quality ... 2d.

Aerial Wire, 7/22 hard drawn copper, in 100 ft. lengths ... 2/3

Valve Legs, with nuts and washers, 1d. each; doz. ... 9d.

Two Coil Holders, solid ebonite mounted on mahogany ... 4/9

Three Coil Holders, solid ebonite, with long arms to avoid capacity effects ... 9/6

Crystal Detectors, adjustable in every way ditto, ditto, enclosed in glass case ... 2/6

Engraved Ivorine Scales, 0-180 ... 43d.

Filament Resistances, extraordinary value, velvet action ... 2/6 and 3/6

Switch Arms, complete with knob, collar, washers, bush nuts, etc. 1st quality, 1/6; 2nd quality ... 1/-

Valve Holders, turned ebonite, complete with nuts, 1/3; 2nd quality ... 9d.

Crystal Cups. Plain 1d.; one, two, or three screw ... 3d.

Large Terminals, complete with nut and washer 1d.

Basket Coils, set of 7 ... 5/-

Contact Studs, 1/2 in. by 1/2 in., complete with nut and washer ... doz. 6d.

Insulators, 2-in. reels—1d. each; white egg, 3d.; green egg, 4d.; green shell ... each 4d.

Brass Nuts, 2, 3, 4, 5, 6 B.A., doz. 3d. Washers, doz. ... 2d.

Ebonite Sheet, 1/8, 1/4, 3/8 ... lb. 4/-

Fixed Condensers, any capacity ... each 1/3

Grid Leak and Condensers combined ... each 3/6

Slider Plunger, complete ... each 4d.

Slider Rods, 12-in. or 13-in. 1/4-in. square brass, drilled both ends ... 4d.

Hertzite, 1/8. Borzite, Carborundum, Galena 4d.

Screwed Brass Lengths, 12-in. 2 or 4 B.A. each inductances, wound 22/24 enamelled wire, each 3d.

Orders under 30/- kindly remit ample postage. Balance refunded if excess sent.

Send for Free Catalogue

TRADE HALL'S DISPATCH SUPPLIED BY RETURN
'PHONE: REGENT 1282
71, 71a, Beak St., Regent St., London, W.1
Between Piccadilly Circus and Oxford Circus
Buses 3, 6, 12, 13, 15, 32, 51, 53, 55 and 88 pass

OUR INFORMATION BUREAU

Expert Replies to Readers' Questions. Hundreds of Replies are sent by Post.

TO ENSURE A PROMPT REPLY PLEASE OBSERVE THE FOLLOWING RULES

Write distinctly, give all necessary details and keep to the point. Ask one Question at a time—never more than two. Send a Stamped and Addressed Envelope. Send the Coupon cut from page 68.

Making a Rectifier.

Q.—Please tell me if I can make a vibrating rectifier for 100 volts 50 cycles from steel strip as sample enclosed.—D.H.B.M.C.C. (Leicester) (4,606).

A.—The writer cannot recommend the use of the vibrating type of rectifier; it is an article that is gradually going out of use owing to its various unsatisfactory features. Not only is it difficult to get the vibrating tongue to oscillate in true synchronism with the frequency of the circuit, but the interruptions must be timed to occur at definite intervals before and after the zero points on the voltage wave, or the accumulators will discharge as rapidly as they are charged up. The chemical rectifier or Nodon valve possesses no such disqualifications and is cheap in first cost and upkeep. Directions for its

construction and a diagram of its connections are to be found in No. 29. Other means of electrification are the tungar valve and the motor generator.—A. H. A.

Direct and Loose Coupling

Q.—Will you please explain the advantages and disadvantages of direct- and loose-coupled tuners?—S. W. S. (Cambridge).

A.—With a direct-coupled tuner signals reaching the aerial have a direct path to earth. Any signal from a near-by station, even if "out of tune" with the receiving aerial, will probably force its path through the receiver to earth and so be a cause of interference. If a loose-coupled tuner be used, however, the signals will still force through the circuit, and, being out of tune or resonance with the tuned aerial circuit, will be heavily damped, and

therefore incapable of causing a large inductive effect in any inductively-coupled circuit. By loosening the coupling between primary and secondary coils the damped signals will not be induced with any great force into the secondary coil, whereas tuned signals will still be induced into this coil and good results obtained. By employing a loose-coupled tuner, signals may be very slightly decreased in strength, but the selectivity of reception will repay any small loss. When tuning a loose-coupler, care should be taken that the secondary has at least twice the number of turns in use as those on the primary. This is to give a transformer "step-up" effect to obtain signals at the maximum strength. Tuning of the secondary should be effected by means of a small variable condenser.—I. C.

BROADCAST TELEPHONY

Some of these transmissions are commercial or official. Wave-lengths and times are liable to alteration without notice.

London B.B.C. Station (2 L O), 369 metres. Daily, 5 p.m. to 5.30 p.m., children's stories; 6.30 p.m. to 10 p.m., concert and news.

Manchester B.B.C. Station (2 Z Y), 385 metres. Daily, 4.30 p.m. to 5 p.m., concert; 6 p.m. and 6.15 p.m., kiddies' corner; 6.30 p.m. to 7 p.m., reproducing-piano recital; 7 p.m., news bulletin; 8 p.m. to 9.10 p.m., concert; 9.15 p.m., second news bulletin; 9.30 p.m. to 10 p.m., miscellaneous concert.

Birmingham B.B.C. Station (5 I T), 420 metres. Weekdays: 6.30 p.m., children's stories; 7 p.m., concert; 7.30 p.m., news bulletin; 8.30 p.m. to 9 p.m., interval; 9 p.m., concert; 9.45 p.m., second news bulletin; 10 p.m., final announcements. Sundays: 8 p.m., news bulletin; 8.10 p.m. to 9.45 p.m., concert; 9.45 p.m., second news bulletin; 10 p.m., final announcements.

Newcastle B.B.C. Station (5 N O), 400 metres. Daily, usually 6.30 p.m. to 8 p.m.

Croydon (G. E. D), 900 metres. Daily, Writtle (2 M T), 400 metres. Tuesdays, 8 p.m.

Eiffel Tower (F L), 2,600 metres. Daily, 6.20 p.m. to 7 p.m. and 10.10 p.m. to 10.20 p.m. (weekdays only).

The Hague (P. C. G. G), 1,085 metres. Sundays, 3 p.m. to 5 p.m.

Paris, Concerts Radiola, 1,506 metres. Daily, 5 p.m. to 6 p.m., concert. Sundays, 2 p.m. to 5 p.m., concert.

Rome (I. C. D), 3,200 metres. Daily, 10 a.m. **Königswusterhausen** (L P), 2,800 metres. Daily, 4 p.m. to 5.30 p.m.

Amsterdam (P. C. A), 1,800 metres. Daily, 1.10 p.m.

Haren (O P V H), 900 metres. Daily, every hour from 11.20 a.m. to 4.20 p.m.

A film entitled "Via Radio" has been produced by the *Scientific American* in conjunction with the Educational Films Corporation. It explains to the layman all about broadcasting and the working of the radio compass amongst other things.

The National Association of Radio Manufacturers

AN association has recently been formed under the title of The National Association of Radio Manufacturers. The association has been brought into being for the avowed purpose of preventing those chaotic conditions which might arise in a new industry if the solution of all problems is left to individual effort.

It is stated that the association will not attempt to control the selling prices of the instruments marketed by its members, but that its main objects are to establish such fair and equitable conditions of trading as are essential to the well-being of a new industry, and to take up from time to time any question of common interest to the trade upon which united action appears to be desirable. A condition of membership is that the applicant must be a *bona-fide* British manufacturer of wireless apparatus, and must be eligible for membership of the British Broadcasting Company, Limited.

We are informed that the wireless section of the *Daily Mail* Ideal Home Exhibition, to be held at Olympia from March 1 to 24 (inclusive), will be under the control of this association. Intimations have recently been issued to members, and potential members, inviting applications for stands.

Messrs. Derbyshire and Co., chartered accountants, of 4, Southampton Row, London, W.C.1, are acting as secretaries to the newly formed organisation, and will be pleased to furnish further particulars to any duly qualified British manufacturers who would like to consider the question of membership.

Care and Management of Primary Batteries

is the title of an article which will be of interest to wireless enthusiasts in the current issue of "Work" (3d.). Other articles include: "A Self-feeding Table Fountain," "Two Accessories for the Gramophone," "Practical Upholstery," "Making a Table for Table-tennis," "Using Gas Economically," "Piano Tuning and Repair," "Silver Work for Amateurs," "Cleats for Use in Cleaning Joints," "American Notes Illustrated."

We have received a handsome little catalogue from Radio Instruments, Limited, 12, Hyde Street, London, W.C.1, dealing exclusively with broadcast cabinet receivers, ranging from a small 4-valve set for table use to a handsome 7-valve Chippendale cabinet set. A copy may be obtained on request.

When the captain of the American ss. *Hatteras* died during the voyage to New York, the burial service was wirelessed from the ss. *President Adams*, 250 miles away, as the *Hatteras* had no clergyman on board.

The transmission of pictures by wireless has reached the stage that it is now possible to transmit and reproduce coloured drawings.

H. G. COPPER INSTRUMENT WIRES

Enamd.	24	28	30	32	36	40	48 s.w.g.
S.C.C.	2/5	3/3	3/6	3/11	4/6	6/6	8/- lb.
S.S.C.	2/11	3/10	4/6	—	—	—	— lb.
S.S.C.	3/7	5/-	6/3	7/3	9/9	15/6	20/- lb.

H.D. Aerial, 7/22 plain. 4/-; enamd., 5/- 100 ft.
Terms:—Cash with Order. Postage extra.
HORROCKS & ASPIN, 12, Schwabe St., Rhodes, Manchester.

In replying to Advertisers, please make a strong point of mentioning "Amateur Wireless."

The Universal Electric Supply Co. Ltd.

4 BROWN STREET
ONE DOOR FROM MARKET ST
MANCHESTER
G.P.O. Box No. 519. Established 1892.



OUR SINGLE VALVE PANEL AT 70/-

Gives Remarkably Good Results.
Full particulars, together with other sizes, will be found in our "Claphorn" Pamphlet, post free on request.

FILAMENT RHEOSTAT.

Reliable quality, ready for mounting.
4/-, post free.
Superior quality, 6/-, Post free.

Double Head RECEIVERS.
British Made. Complete with cords, 4,000 ohms, 28/-, post 1/-.

Make Your Own H.T. BATTERIES.
Terminals, which can be easily and securely attached to Pocket Lamp Batteries in a few minutes, 2/- each, post free in doz. lots. Broadcasting Fee 6d. extra.

LARGE ILLUSTRATED CATALOGUE POST FREE 6d.

Expert knowledge will make your Set twice as sensitive

- CONSTRUCTION OF WIRELESS APPARATUS** 1/6
Shows how to make every component necessary without the aid of special tools.
- WIRELESS VALVES SIMPLY EXPLAINED** 2/6
Over 130 pages of sound explanation telling exactly how the Valve works and how to get the best results from it.
- RADIO PRESS DIRECTORY** 2/6
20,000 Call signs with names of Stations (commercial and amateur).
- WIRELESS FOR ALL** 6d.
Read this before buying your Set. Tells you exactly what Radio is and the Set you'll need.
- SIMPLIFIED WIRELESS** 1/-
A practical Book showing how to build Crystal Sets, and explaining full theory of Radio in everyday language.

KNOW how it works and you can easily correct any faults and tune it up to a high state of efficiency. The requisite knowledge for this can be gained from books issued by the Radio Press. Here are some of them—all can be relied upon for dependable information. From all Booksellers or direct from the Publishers.

Radio Press, Ltd.
PUBLISHERS OF AUTHORITATIVE WIRELESS LITERATURE
DEVEREUX COURT, STRAND, W.C.2.



VARIABLE CONDENSERS

0005 for panel mounting complete with knob, scale and pointer 8/-, in cabinet 15/-. Rectifying Crystals. Chry-stagad, the super Hertzite, 2/-. Hertzite, 1/3. Box of 6 Crystals, 1/-.

WEATHERALL & CO.
ESTABLISHED 25 YEARS
28, Woodbridge Street, LONDON, E.C.1

SOLID EBONITE

1' Sheet—18"×18", 12/-; 12"×12", 5/6; 12"×9", 4/-; 9"×6", 3/4; 4"×4", 10d. ANY SIZE CUT.
Knobs, 2 B.A., 4d. each; Valve Holders and 8 Nuts, 1/- each; Coil Holders, 1/3 each; Rod and Tube, 1' and 1/2 Sheet; Cheap Accumulators: Phons; H.T. Batteries; Loud Speakers.
CARRIAGE PAID OVER 10/-

BAILEY & ROBINSON
9, Esplanade, REDCAR

RADIO COMPONENTS

All Component Parts offered by the Cheapest Firm in England.

Condensers for Panel Mounting.

Capacity	Assembled	Unassembled
.001 ..	14/-	10/6
.0005 ..	9/-	6/-
.0003 ..	8/3	5/-
.0001 ..	6/6	3/6
Vernier ..	5/-	2/-

Ebonite plates 2/- pair.

WRITE FOR OUR LISTS.

BOWER ELECTRIC LTD.
15, Grape Street, Shaftesbury Avenue,
Phone: Reg. 3636.
Also at 15, Kingston Road, Wimbledon, S.W.19.
Phone: Wimbledon 1030.

Exide BATTERIES

H.T. Batteries for Valve Sets

24v. 28v. 32v.
Type B.K.



Owing to the demand for these batteries, all orders will be dealt with in strict rotation. Prices approximately one shilling a volt.
:: Ask for Leaflet 4030 ::

THE Chloride ELECTRICAL STORAGE COMPANY LIMITED.

CLIFTON JUNCTION, N^o MANCHESTER.

219/229, SHAFTESBURY AVENUE, W.C.2.

PRICES AND PARTICULARS ON APPLICATION.

CLUB DOINGS

Leeds and District Amateur Wireless Society.

Hon. Sec.—D. E. PETTIGREW, 37, Mesborough Avenue, Chapeltown Road, Leeds.
On Jan. 5 the chairman called upon Mr. T. Brown Thomson to lecture upon the "Transmission of Photographs by Wireless." The lecturer sketched the methods that have been used since 1847, paying particular attention to the efforts of Knudsen in 1908. Mr. Thomson expressed his belief that it would soon prove to be possible to transmit an ordinary negative without the use of special plates, and advocated the use of undamped waves for such a transmission. Various methods of transmission, using spark, arc or valve, were briefly considered, and arrangements of receiving apparatus examined. The great problem of synchronisation between the transmitter and receiver was closely considered.

Wandsworth Wireless Society.

Hon. Sec.—F. V. COPPERWHEAT, 9, Birdhurst Rd., Wandsworth, S.W.18.
By the courtesy of Captain E. S. Davis members of the above society were accorded an interesting evening on Wednesday, Dec. 20, at "The Pavilion," Marble Arch, better known probably as 2 B.Z. On arrival the party were ushered into the private theatre and several films of an educational character were shown, these being interspersed with broadcast music. During the changing of one of the films the opportunity was taken of recording wireless telephony and music on a dictaphone, and the reproduction was amazing for its clarity. The announcement that loud-speakers could be made out of tooth-powder tins caused no small comment, but upon producing the instrument so named and subjecting it to severe working conditions those present had to admit that this was possible where 2 K.L. was concerned. After partaking of some refreshment kindly provided by the host, the party proceeded to the power house. This was a very extensive one with several generators, main distribution panels, air compressors and battery rooms.

Battersea and District Radio Society.

Hon. Sec.—F. J. LISNEY, 66, Newland Terrace, Queen's Road, S.W.8.
ALL amateurs in the district are invited to join the above society. Particulars can be obtained from the secretary.

Tottenham Wireless Society

Hon. Sec.—R. A. BARKER, 22, Broadwater Road, Bruce Grove, Tottenham, N.17.
On Jan. 3 Mr. H. Winter gave a very excellent lecture, his subject being "Telephone Receivers." All persons interested in the above society should apply immediately to the secretary for particulars.

Bournemouth Radio and Electrical Society.

Hon. Sec.—L. O. SPARKS, "Maradon," 3, Cotlands Road, Bournemouth.
The above society has now been formed, and all those interested in wireless or any electrical matters are invited to communicate with the secretary, who will be pleased to supply them with any information required.

Croydon Wireless and Physical Society.

Hon. Sec.—B. CLAPP, Meadmoor, Brighton Road, Purley.
A MEETING of the Croydon Wireless and Physical Society was held on Jan. 6, at which Lieut. D. Sinclair delivered a lecture entitled "The Signals Organisation of Our Airways." Lieut. Sinclair explained very fully the methods by which the machines on the air routes are controlled and their positions determined by wireless telephony. He said that the wavelength of 900 metres was now used exclusively for communication with aircraft. Any messages required to be sent from one aerodrome to another are transmitted either by wireless telegraphy via the Air Ministry (G.F.A.) on a wavelength of 1,400 metres or by private landing, whilst weather reports are sent by the Air Ministry on a 1,680 wavelength. Some very excellent lantern slides were shown illustrating the aerials and apparatus at the W.T. stations* at several of the aerodromes in England.

Ipswich and District Wireless Club.

Hon. Sec.—H. E. BARBROOK, 46, Foundation Street, Ipswich.
On Jan. 8 a very successful and interesting evening was spent, when a good number enjoyed what will be known as the first demonstration of broadcasting grand opera by wireless. The club set was used on this occasion, with the addition of a two-valve note magnifier, a microphone amplifier and loud-speaker, thus enabling all present to "listen-in" without the trouble of headphones. Mr. Bird was the operator for the evening, and having tuned in 2 I.O. was picked up, the reception being very clear. The opera transmitted was the "Magic Flute," and the tuning of the orchestra was clearly heard, as was also the tapping of the conductor's baton. The music and singing came through with very little distortion, although the words of the singers were rather difficult to follow.

Stoke-on-Trent Wireless and Experimental Society.

Hon. Sec.—F. T. JONES, 360, Cobridge Road, Hanley.
A MEETING of the above society was held on Jan. 4, a lecture being delivered by Mr. R. W. Steel on "Sources of Electrical Current." In the opening portion of his address he explained the nature of electricity by means of the electron theory. He then went on to describe the various methods of producing electricity, classifying them under four main headings—electrical, chemical, thermal and dynamical.

Thames Valley Radio and Physical Association.

Hon. Sec.—E. A. ROGERS, 17, Leinster Avenue, East Sheen, S.W.14.
On Jan. 4 Mr. Jocelyn lectured on "Induction." With a series of experiments and liberal blackboard sketches the lecturer proved both interesting and instructive.

ANNOUNCEMENTS

"Amateur Wireless and Electrics." Edited by Bernard E. Jones. Price Threepence. Published on Thursdays and bearing the date of Saturday immediately following. It will be sent post free to any part of the world—3 months, 4s. 6d.; 6 months, 7s. 9d.; 12 months, 12s. 6d. Postal Orders, Post Office Orders, or Cheques should be made payable to the Proprietors, Cassell & Co. Ltd.

General Correspondence is to be brief and written on one side of the paper only. All sketches and drawings to be on separate sheets.

Contributions are always welcome, will be promptly considered, and if used will be paid for.

Communications should be addressed, according to their nature, to The Editor, The Advertisement Manager or The Publisher, "Amateur Wireless," La Belle Sauvage, London, E.C.4.

Amateur Wireless and Electrics

Querist's Coupon Available until
Saturday, Jan. 27, 1923

IMPORTANT

WE HAVE OPENED VERY COMMODIOUS PREMISES AT

54, Gracechurch Street, E.C.3

for the demonstration and sale of all types of Wireless Receiving Sets and "Claritone" Loud Speakers.

Amateurs and Experimenters will be able to obtain every part required for any type of Set including:

Transformers, L.F. and H.F.	Valves, M.O. and Mullard's
Headphones, all types, all resistances	Brass W.O. and Telephone type Terminals,
Condensers, variable and fixed, all capacities	Nuts, Washers, Contact Studs and all other parts
Vario-couplers and Variometers	Accumulators
Coil-holders and Coils	Dry Batteries
Anti-capacity Switches, all types	Aerial Wire
Rheostats, all types	Insulators
Radial Switches, 5-, 10- and 15-way	Hertzite and Galena Crystals
Ebonite Valve Holders, Dials, Scales, other parts and in sheet	Cotton and other Tubings, all colours
	Etc. etc.

PRICE LIST FREE ON APPLICATION

PETTIGREW & MERRIMAN, Ltd., 122-124, Tooley Street, London, S.E.1

Note: Gracechurch Street is a few minutes from Monument, Eastcheap, Bank, Cannon Street & London Bridge

TELE.: HOP 134

BROADCASTING RECEPTION SETS

One-Valve Set Complete for Working, £7 10s.

Passed for
Broadcasting
Licence G.F.O.
No. 1038.

SEND FOR
CATALOGUE
Agents
Wanted.

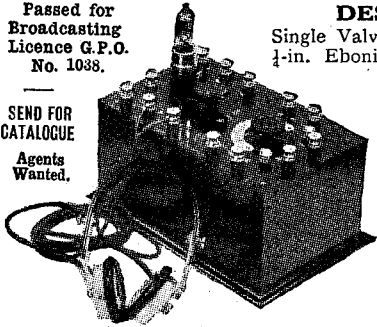

DESCRIPTION:
Single Valve, mounted on polished 1/4-in. Ebonite Panel with Variable Condenser, smooth acting resistance, grid leak and condenser and all terminals clearly engraved in white, in a Mahogany Polished Cabinet 9 in. by 5 in. by 5 in. **£3 15 0**

A TAPPED COIL for wave-lengths up to 900 metres with 2 terminals for coils for any higher wave-lengths.

The coil is enclosed and the tappings are brought out to an 8-way switch mounted in the front of the cabinet.

ACCESSORIES INCLUDED:

Siemens' 54-volt high-tension Battery with plugs for altering the voltage	15 0
4-volt 50-amp.-hour low-tension Accumulator in case with carrying strap	1 4 0
One pair of Sensitive Headphones of 4,000 ohms resistance	1 1 0
One Detecting Valve	15 0
Total	£7 10 0

Plus B.B.C. Royalties.

WIRELESS INSTALLATIONS Ltd.
15, Aldersgate St., London, E.C.

We are now in the position to supply

EDISWAN A.R. 6 volt VALVES

from Stock at

FULL MAKERS' DISCOUNT

WIRELESS INSTALLATIONS Ltd.
15, Aldersgate St., London, E.C.

DO YOU READ PRACTICAL BOOKS?

See Cassell's List of Technical, Practical and Money-saving Books. A p.c. will ensure your receiving it.

CASSELL & Co., La Belle Sauvage, LONDON, E.C.4.

METROPOLE GARAGE, WIRELESS SHOWROOMS,
Opposite HOTEL METROPOLE, **BLACKPOOL.**
FOR ALL RADIO REQUISITES

Ask for Our List. We Can Save You Pounds.
The Finest Stock of Quality Wireless Accessories in the North. Astounding Prices & Real Service.

SHEET EBONITE, 1/4 in. & 1/8 in. ... 3/9 per lb.!!

WATES' CRYSTAL RECEIVING SET Costs but £5—Receives Broadcasting within 30 miles.

SUPPLIES up to three headphones with music or speech from a Broadcasting station 30 miles away.

The movement of one switch arm will enable to receive Telephony or Telegraphy with remarkable clarity.

Dimensions 9 in. by 9 in. and 8 1/2 in. high.

Complete in highly polished mahogany case, with Sterling Headphones, 100 ft. 7/22 Aerial, 2 Econ Aerol Insulators, 1 Aluminium Pulley.

Price £5 - 0 - 0

including all Royalties and Taxes.
NO EXTRAS.

First cost is all—no batteries to need recharging.

Send at once for list or call for demonstration.

We supply complete Receiving Sets (Crystal or Valve) also all component parts, of which the following is an abbreviated list:

"Ideal" Valve Accumulator, 4 volt 50 amp. (Carriage, 2/-)	24/- per set
"Ideal" Valve Accumulator, 6 volt 50 amp. (Carriage, 3/-)	35/- per set
Filament Resistances of Variable Condensers (of various capacities) from	5/- each
Fixed Condensers, from Pyramid H.T. Battery, 15 volt	2 6 each
Pyramid H.T. Battery, 30 volt with variable plug connection	3 6 each
Three-coil Holder, complete unit	7/- each
	20/- each

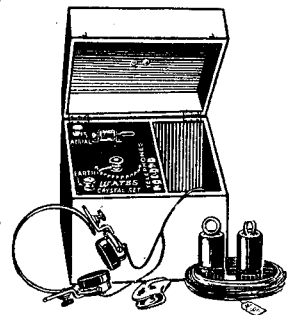

Wates Bros. 13/14, Great Queen Street, KINGSWAY, LONDON, W.C.2.

The "BROWN" LOUD SPEAKERS

with new improved Curved Horns

THE requisites of a Loud Speaker are pure tone, clear articulation, and good volume of sound. The BROWN Loud Speaker possesses all these qualities in a marked degree. Type H. 2 has been designed to meet home requirements, both as to volume of sound and price.

PRICES

H. 2 (Small), Low Resistance. 120 ohms, height 12 in. **£3 0 0**

H. 1 (Large), Low Resistance. 120 ohms, height 21 in. **£6 5 0**
(High Resistances for either size, 2/6 to 5/- extra.)

THE BROWN MICROPHONE AMPLIFIER.

This amplifier gives a magnification much greater than that obtained from a two-valve amplifier.

Prices

Low Resistance (120 ohms input), **£8 0 0**
High Resistance (2,000 ohms input), **£6 2 5**

Our apparatus can be obtained from all wireless dealers.

Sole Manufacturers:

S. G. BROWN, LTD.

London Showrooms:

19, MORTIMER STREET, LONDON, W.1.

Head Office and Works: Victoria Road, North Acton, W.3

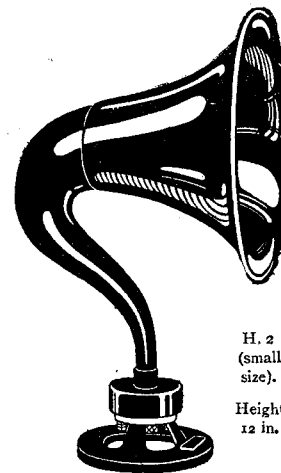

H. 2 (small size).
Height 12 in.

Illustrated Catalogue of Headphones, Loud Speakers and Amplifiers, post free.

T. O. BUSS

SCIENTIFIC INSTRUMENT MAKER

77, CLERKENWELL ROAD, LONDON, E.C.1.

ESTABLISHED 1850. Exhibition Awards—London, 1862. Sydney, 1879. Melbourne, 1880.

HEADPHONES

Genuine French Telephones, most sensitive obtainable, 6 Tungsten poles in each earpiece. 4,000 ohms with cords (Double Receivers) ... post free

19/6

French "Brunet" Headphones 4,000 ohms 22/6 POSTAGE 9d.

Variable Condensers

CONDENSERS. Complete Sets of Parts.			Assembled Complete for Cabinet Mounting.	
Approx. Capacity Microfds.	No. of Plates.	Price.	Approx. Capacity Microfds.	Price.
0001	57	7/6	001	16/-
00075	43	6/9	0005	12/8
0005	30	5/6	0003	11/8
0003	19	4/6	0001	5/6
0002	13	3/6		
0001	7	3/-		

Postage 1/- per set extra.

WIRELESS PARTS AND ACCESSORIES

Aerial Wire, 7/22 bare copper, stranded. Price per 100 ft., 3/-. By post, 4/6.

Aluminium Vanes, 2 doz., 1/-. By post, 1/6. 5/- gross, by post, 6/-.
Basket Coils, 7 in set, 5/- set. By post, 5/6.

Brass Washers, 2, 3, 4 or 5 B.A. ... dozen 2d.
" Nuts, 2, 3, 4 or 5 B.A. ... dozen 4d.
Brass Rod (screwed)—
 2 B.A., in 12-in. lengths ... each 5d.
 3 B.A., in 12-in. lengths ... each 4½d.
 4 B.A., in 12-in. lengths ... each 4d.
 5 B.A., in 12-in. lengths ... each 3½d.

Copper Foil Sheets, uniform thickness, 12 in. by 3 in. ... each 3d.

Crystal Detectors on Ebonite. Each 2/6. By post, 3/-. Also 3/3; by post, 3/9.

Crystal Detector, cup enclosed with glass cover, dust proof, 4/6. By post, 5/3.

Ebonite Dials, with engraved scale 0.180, 1/- each. By post, 1/6.

Egg Insulators, 4 for 11d.; 2/6 per doz. By post, 3/6 doz.

Filament Resistances. Each 2/6 and 3/6. By post, 3/- and 4/-.

Filament Resistance.—Suitable for one, two or three valve sets 4/-. By post, 4/6.

Fixed Condensers, with terminals on ebonite, .0003, .0005, .001, .002, .003, 1/6; by post, 1/9; 004, 1/9; by post, 2/-.

Grid Leak and Condenser, .0003, high quality, 3/9. By post, 4/3.

Inductance Coils Wound Enamel Wire, 12 by 4, 3/-. By post, 5/-.

1½ Insulating Sleeving, 6 yds. for 2/2. By post, 2/6. 12 yds. for 4/-. By post, 4/6.

Intervalve Transformers (low frequency), tested and guaranteed 5-1, 14/- each. By post, 15/-.

Knobs, with brass nut (2 B.A.), 4½d. each. By post, 7d., 6 for 2/- By post, 2/6.

Large Spacer Washers, 3 doz., 9d. By post, 1/-.

Lead-in Tubes, ebonite with brass terminals, 9 in., 1/2. By post, 1/6. 12 in., 1/4. By post, 1/8.

Reel Insulators, 1d. each. By post, 2/- doz.

Slider and Plunger, 5d. By post, 7d.

Small Knob, Plunger and 13 in. rod, 8d. the set. Cannot be sent by post.

Small Spacer Washers, 6 doz., 1/-. By post, 1/4.

Switch Arms, with polished knob, bushed 2 B.A. nut, laminated blade, spring coil washer, nuts and bush, 1/-, 1/6, 2/- each. By post, 1/3, 1/9, 2/-.

Terminals, telephone, with nut and washer, 2/- doz. By post, 2/6.

Terminals (large), aerial and earth, complete with 2 nuts and 2 washers (2 B.A.), 2 for 8d. By post, 1/-.

Tin Foil, free from lead, Sheets 26 in. by 13 in. ... each 4d.

War Office Pattern Terminals, with nut and washer, 2/- doz. By post, 2/6.

"EBONITE"

Postage Free. Any Size cut.

1" thick	2" thick	3" thick	4" thick	5" thick	6" thick	7" thick	8" thick	9" thick	10" thick	11" thick	12" thick	13" thick	14" thick	15" thick	16" thick	17" thick	18" thick	19" thick	20" thick
8 x 1	4 x 4	7 x 5½	10 x 6	17 x 5	12 x 10	17½ x 8½	18 x 18	36 x 18	7 lb.	s. d.	£ s. d.	7 6	9 6	12 10	1 3 0	1 3 0	1 3 0	1 3 0	1 3 0

Instrument Wires

British Made Copper Wires.		Per lb.																	
S.W.G.	Per lb.	yds.	ohms	per 1,000	S.C.C.	D.C.C.	S.S.C.	D.S.C.	D.S.C.	Enmld.									
22	140	39	2/9	3/-	4/-	5/-	2/7												
24	230	63	3/-	3/6	4/6	6/-	2/8												
26	340	95	3/7	4/1	5/-	8/-	3/2												
28	530	140	4/4	4/8	6/-	9/-	3/6												
30	716	200	5/-	5/6	7/-	10/-	3/10												
32	950	262	6/-	7/3	8/-	12/6	4/2												
34	1,300	362	7/-	8/3	9/-	13/6	4/4												
36	2,000	530	8/8	10/-	12/-	15/6	4/8												

Wireless Crystals

"Hertzite" 1s. 6d	Carborundum 6d
Zincite 6d	Molybdenite 6d
Silicon 6d	Iron Pyrites 6d
Bornite 6d	Galena 6d
Copper Pyrites 6d	Graphite 6d
Wood's Metal 2s.	Tellurium 2s 6d

— Post free —

Intervalve Transformers

Ratio 5 to 1 ... 15/- Post Free.

Celluloid Accumulators

We are introducing a new model consisting of individual two volt units. This MODEL to be known as T.9 has an actual capacity of 18 ampere hours, and an intermittent capacity of 34 ampere hours.

PRICE AS FOLLOWS

2 volt	6/- each
4 volt	11/9 "
6 volt	17/6 "

H.T. Batteries, 30 volt, 6/- (by post, 7/6).
H.T. Batteries, 60 volt, 12/- (by post, 13/6).

Inductance Tubes

Cardboard

12 in. by 4 in., 8d each. Post 2d.

Mahogany Boxes

Polished 4½ x 4½ x 3½ in.	3/-	Post 3d
4½ x 4½ x 5 in.	3/6	6d
6½ x 6½ x 4 in.	4/8	1/-
13 x 6½ x 4 in.	8/-	1/-

Notice to Advertisers

ADVERTISEMENT INSTRUCTIONS and copy for "Amateur Wireless" should be at the office by First Post on FRIDAY morning at the latest.

PREPAID ADVERTISEMENTS.

B.A. Screws, Nuts, and Washers, assorted gross, 2s.; list, 2d.—J. H. Bennett, Station Road, Willesden Junction.

Working Drawings for wiring sketches supplied.—Puckle, Buckhurst Hill, Essex. Telephone, Woodford 400.

Wireless Goods Cheap.—Ex-Army transmitters, 15s.; 1 in. spark coils, 8s.; 80-metre sets, transmitting, 10s.; mine exploder dynamo, 17s. 6d.—Below.

New Goods.—Low-frequency intervalve transformers, 16s.; filament resistance, 2s. 6d.; valve-holders, 1s.; crystal detectors, 2s. 6d.; switch arms, 1s. 9d.; contact studs, 9d. doz.; terminals, 1d. and 2d. each; block condensers, 1s. 6d. each; variable condensers, .0003, 7s. 6d.; .0005, 9s.; .001, 12s.; vernier, .00005, 5s.; inspect showrooms. Three pairs' approval against cash.—E. J. Galpin, 16, Loampit Hill, Lewisham, S.E.13, London.

Potentiometers.—Invaluable for grid control and crystals, adapt an ex-naval rheostat, 260 ohms, 16 stud. Price, 1s. 6d., post free; excellent value.—Monk, 4 Alma Road, Plymouth.

"Work" Short Wave Receiver, £2. Two-slide coil. Perikon, 9s. Or exchange valve accessories.—14, Scoutbottom, Mytholmroyd.

Telephone Receivers Rewound up to 1,000 ohms, 5s.; 2,000 ohms, 7s. 6d.; cash with order.—M. E. Hampshire, 139, Sydenham Road, S.E.26.

Trafford No. 2 Crystal Set, without phones, £2.—Kerr, 62, Farleigh Road, Stoke Newington.

EASY TERMS OR CASH

Startling Advertisement Offer, for fourteen days only. Complete Single Valve Set of parts for 99/-. 33/- with order, balance 11/- a fortnight.

Specification:—Ebonite Panel 10 x 8 drilled, Mullard Ora Valve, Variable Condenser .0005, Filament Resistance, Grid Leak and Condenser, Two Honeycomb Coils No. 35 and 50 and Holders, Variable H. T. Battery 30 volt, Accumulator 4 volt 30 amps, One pair Mullard's Double Headphones 4,000 ohms, 100 ft. Aerial Wire, Lead in Tube, 4 Insulators, Wire for wiring and sleeving, Terminals, Valve-holder and diagram. Delivered Carriage Paid. Money returned in full, if you are not completely satisfied, within seven days after delivery; full allowance made for parts not required.

G. BUSH, 119, Sutherland Avenue, London, W.9.

POST ORDERS OUR SPECIALITY

Satisfaction Guaranteed or Money Refunded

PRICE LIST SENT POST FREE

AERIAL WIRE, 100 ft. 7/22 Copper ... 2/9

HERTZITE CRYSTAL DETECTOR, complete 3/9

BASKET COILS, Seven in Set ... 4/9

CRYSTAL RECEIVING SET. Entirely enclosed in Mahogany Cabinet. B.B.C. Royalty paid. Fully Tested and Guaranteed. Carriage paid ... 32/6

HEADPHONES, Accumulators, Resistances, Insulators, Vanes, Terminals, Ebonite Parts. Many Other Accessories

CARRIAGE PAID ON 20/- ORDERS

DE LUXE COMMODITIES

151A, OXFORD STREET, LONDON, W.1

ELECTRADIX RADIOS.

IMMEDIATE DELIVERY FROM OUR HUGE STOCKS

Everything from a Recorder to an Earth Clip.

The best equipped City depot.

COME AND SEE US

9, COLONIAL AVENUE is first opening on left in the Minorities, nr. Aldgate Station, Metropolitan Railway.

LESLIE DIXON & CO., 9, COLONIAL AVENUE, MINORITIES, E.1.

Let the Frame Aerial solve the Problem

Use a stage or two of H.F. with a Frame Aerial and you'll get the long-distance Stations just as well.

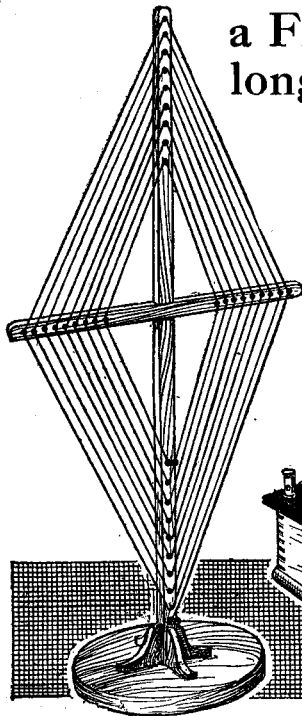

The man who cannot erect an outside Aerial or who wants to move his Set from room to room need not despair. A good Frame Aerial of the type illustrated will give loud and clear telephony when used with sufficient H.F. amplification from all Stations within a wide area. Further, because it is directional, it cuts out a lot of interference from near-by Stations together with most of the atmospherics.

The Peto-Scott standardised Unit System provides the only sensible way of adding just as many stages of H.F. as you need at the least possible expense. Our illustrated Booklet, "Radio," describes the whole System and shows how each Unit is built up—price 6d., post free.

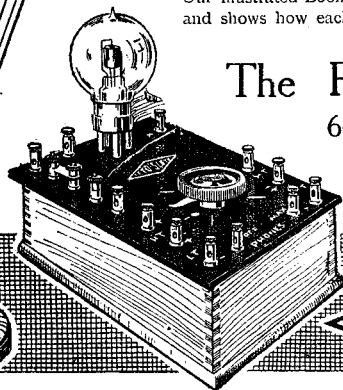

The PETO-SCOTT Co.,
64, HIGH HOLBORN,
W.C.1

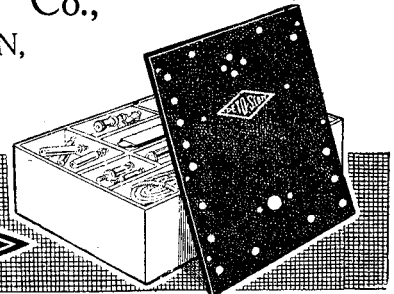

PRICE LIST of Sets of Parts

- No. 1. Tuner Unit **27/6**
- No. 2. Condenser Unit **42/-**
- No. 3. H.F. Amp. Unit **13/6**
- No. 4. Detector Unit **17/6**
- No. 5. L.F. Amp. Unit **33/6**

Mahogany Cabinets to fit Nos. 1, 3, 4 and 5, **3/6**.
To fit No. 2, **7/-**.

Postage 9d. per unit extra, but paid on all orders over £2.

Wireless is attracting all men. The Amateur is entering the field in great numbers, and he wants to know all about it. He will require Materials, Parts, Tools. He will also want to sell surplus material.

"AMATEUR WIRELESS"

is out to cater for this class of reader, who will be eager for knowledge and bargains. To meet him, use the Sale and Exchange columns, which he is sure to search. Rate 3d. per word, 3s. minimum, prepaid. Latest date Friday mornings.

Address: The Advertisement Manager,
"Amateur Wireless,"
La Belle Sauvage,
Ludgate Hill, London, E.C.4.

GENTS' RADIO FITMENTS

STURDY, SOUND AND RELIABLE

SEND for LATEST PRICES OF Gents' "TANGENT" Filament Rheostat
Gents' "TANGENT" L.F. Transformer
Gents' "DISCOL" H.F. Transformer and other fitments.

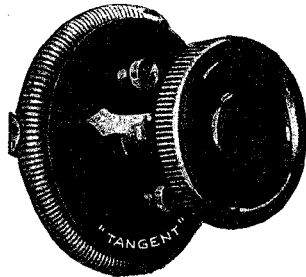

GENT & CO., LTD., Radio Dept., "FARADAY WORKS," LEICESTER

LONDON: 25, VICTORIA ST., S.W.1.
NEWCASTLE-ON-TYNE: "TANGENT HOUSE," BLAOKETT ST.

RADIO ESSENTIALS

PHENOMENAL VALUE

TRANSFORMERS—Telephone, 15/-; L.F. Interval, £1
H.F. INTERVAL TRANSFORMERS—

Wave Length	Terminal Type	Phi Type	Unmounted Slab	Unmounted Basket
300—700 M.	... 3/9	... 4/6	... 1/3	... 1/3
600—1300 M.	... 4/-	... 4/6	... 1/6	... 1/6
900—1900 M.	... 5/-	... 5/6	... 2/-	... 2/6
1800—3500 M.	... 5/6	... 6/-	... 2/6	... 3/-
3000—5000 M.	... 6/6	... 7/-	... 3/6	... 4/-

FILAMENT RESISTANCES—Specially good quality, 2/6
CONDENSERS FIXED—All Capacities, 1/6
GRID LEAKS, 1/-
GRID LEAK AND CONDENSER—Best quality, 3/9
VALVE HOLDERS, 1/-
ENAMELLED AERIAL WIRE—Per 100 ft., 4/9

Charge your own Accumulators from A.C. Mains—NO DANGER! NO VALVES! HIGH EFFICIENCY!

OUR ECONOMICAL ROTARY BATTERY CHARGER RECTIFIES A.C. TO D.C.
 Complete with Starting Switch and Auto Transformer to run off 100/250 volt 50/60 cycle single phase mains. Output—8/15 volts 3 amps.
Special Price £7 0 0

COMPLETE LIST of all Radio Essentials in preparation. Meanwhile let us have your inquiries. Nothing too small; nothing too large!
Orders of £1 and over post paid; below include postage
 All Post Orders: Dept. A, 10, MANOR GARDENS, PURLEY, Surrey

OFFICES
 10, MANOR GARDENS,
 BRIGHTON ROAD,
 PURLEY

HALL AND BRENARD

TELEPHONE
 CROYDON:
 973



No. R. 1238.
Manufactured under Brown's
Patent No. 13433/13 by
Sole Licence.

Write for literature and
prices of these instruments
and of the wide range of
other radio apparatus
which we offer.

DEPENDABLE HEAD 'PHONES

YOU can always hear well with Sterling Head 'Phones. They are constructed on highly scientific principles and embody the very best workmanship and finish.

The ear pieces have swivel and trunnion movement, which provides a comfortable fit to the ear of the user.

The Ladies' Hand 'Phone illustrated has been designed to give the greatest ease and convenience and enables ladies to listen-in without disarranging their coiffure.

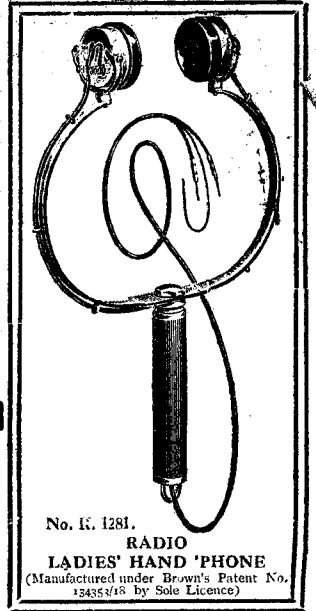

No. L. 1281.
RADIO
LADIES' HAND 'PHONE
(Manufactured under Brown's Patent No.
13435/16 by Sole Licence)

To be obtained from all Dealers or direct from:

STERLING TELEPHONE & ELECTRIC CO. LTD.

Telephone House,

210-212, TOTTENHAM COURT ROAD, LONDON, W.1

Telephone: Museum 4144 (7 lines).

Telegrams: "Cucumis, Wesdo, London."

MANCHESTER:
14, St. Peter's Square

CARDIFF:
8, Park Place

NEWCASTLE-ON-TYNE:
9, Clavering Place

WORKS:
Dagenham, Essex.

We guarantee that all Broadcast Radio Apparatus sold by us conforms with the conditions of the broadcaster's licence issued by the Postmaster-General.

wireless - without an aerial

The "Ducon" does away with the Aerial. Plug one into an ordinary electric lamp holder or wall socket, connect to your wireless receiver and you will receive the broadcasting perfectly.

The "Ducon" can be used with complete safety—each one is tested to 2,500 volts, it consumes no current, and does not affect the electric light in any way.

The DUCON 10/-

is obtainable from leading wireless dealers, electrical contractors and stores, or direct from the makers.

Over 50,000 in use.

Dealers not yet stocking are invited to write for trade terms.

THE DUBILIER CONDENSER CO. (1921) LTD.,
Ducon Works, Goldhawk Rd., Shepherd's Bush, London.

Telephone:
Hammersmith 1084.

Telegrams:
Hivoltcon, Phone London.

