

CDC's Kicksorter -- see cover story page 5.

electronics and communications

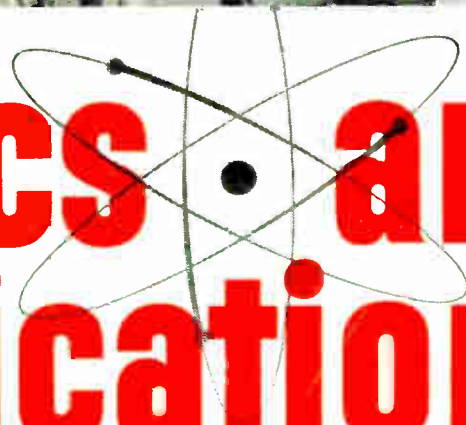

New Kicksorter Circuitry	21
I.F. Modules	26
Square Wave Phase Shifter	34



an age publication
NOVEMBER 1961

MR F W PREZIOSI
8 EASTGATE CRES
SCARBOROUGH ONT

CREATIVE CONTROVERSY IN INERTIAL GUIDANCE

Behind the inertial package you see here is the instructive history of a creative controversy.

It's the history of how the ingenious rebuttals of some Litton Systems people won an engineering debate by overcoming certain obstacles that had been roadblocking progress in airborne inertial navigation.

The equipment shown is the stable-platform unit of a Litton LN-3 navaid system, first to furnish operational aircraft with inertial navigation information to an accuracy within 1.5 nautical miles for each hour of varied flight maneuvers.

The debate: It had been known that an inertial platform could be

built around two two-degree-of-freedom gyros in place of the three one-degree-of-freedom gyros that were the standard concept. And that such a change would offer a number of important advantages including high gyro angular momentum in a compact platform, better servo response characteristics, and freedom from air-bubble problems achieved through the use of low-viscosity damping fluid.

Many inertial engineers felt strongly that the difficulties encountered in trying to manufacture two-degree-of-freedom gyros would more than offset the promised benefits. The difficulty regarded with the most superstitious awe was the problem

of adjusting the center of gravity, center of buoyancy and total weight of the float containing the gyro to achieve neutral buoyancy at a specified temperature and zero torque about all three axes, within extremely narrow tolerances.

The additional restriction, that the weights placed on the float for balancing shall fall between a minimum and a maximum allowable size, increases the complexity of the actual balance procedure, placing it in the "linear programming" category from a computer standpoint. The problem was solved by being programmed for solution on a digital computer in order to provide an efficient and reliable balancing process in production. The success of this approach is demonstrated by the world-wide operation of the Litton LN-3 aircraft navigation system, a proven lightweight system of high accuracy that uses two-degree-of-freedom gyros.

The same approach is being used to expedite the development of even more advanced systems, which will assure Litton's dominant position in the field. They include the Litton Doppler-Inertial System for the P3V anti-submarine patrol aircraft and the P-300 inertial platform of the Air Force Flight Data System for orbital and sub-orbital vehicles.

Attractive openings are available for electronics engineers and mechanical technicians with several years assembly experience in any of the following fields—inertial platforms, gyros, accelerometers, servo mechanisms or similar precision mechanical equipment. These are permanent positions in a long term programme. To apply, write to Personnel Manager, Litton Systems (Canada) Limited, 123 Rexdale Blvd., Rexdale, Ontario.

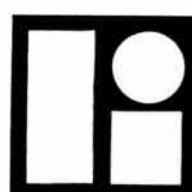
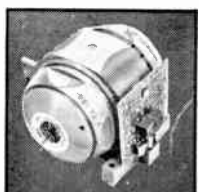
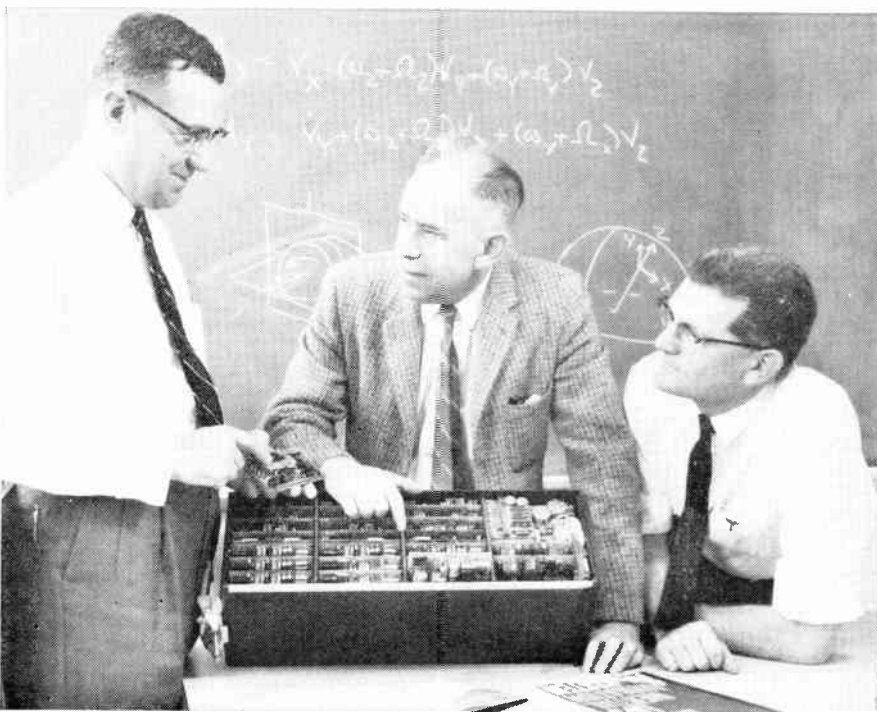

**LITTON SYSTEMS
(CANADA) LIMITED**
Rexdale, Ontario

DIVISION OF LITTON INDUSTRIES
BEVERLY HILLS, CALIFORNIA



MARCONI TUBES OFFER EXTRAS THAT COUNT

Extras above and beyond the call of business — personal, helpful service . . . a sincere interest in your problems . . . speedy delivery when you're in a jam. These are the extra benefits you get when you specify Marconi Radiotrons. As well, you get the famous Marconi quality — rigid manufacturing standards . . . finest components . . . expert craftsmanship . . . careful testing. When next you order, remember the extras that count. Insist on Marconi Tubes.

ELECTRONIC TUBE AND COMPONENT DIVISION

CANADIAN **Marconi** COMPANY

1830 BAYVIEW AVENUE, TORONTO 17, ONTARIO

Branches: Vancouver • Winnipeg • Montreal • Halifax



IN ELECTRICAL CONNECTORS, TOO



Craftsmanship produces enduring quality

For over three centuries, the Stradivarius has provided unmatched violin quality, reflecting the integrity of its maker. Similarly, companies today achieve their goals—or fall short—through varying degrees of quality and integrity.

Bendix® Electrical Connectors, made by the Scintilla Division, are recognized by their users as products of the highest quality—with no premium in cost. If connector quality interests you, write us at Sidney, N. Y.

Scintilla Division



Canadian Affiliate: Aviation Electric, Ltd., 200 Laurentien Blvd., Montreal 9, Quebec. Export Sales & Service: Bendix International, 205 E. 42nd St., New York 17, N. Y.

For complete details check No. 8 on handy card, page 63



an age publication

Arthur E. Maine, P.Eng., editor
R. C. Poulter, P.Eng., associate editor
Ron Wood, assistant editor
William Bowers, art editor
Jerry Davey, photo editor

H. E. Dallyn, manager
Derek Reynolds, advertising manager
Nevill A. Campling, production manager
Diana King, asst. production manager
Rudy Lengerer, circulation manager

L. R. Kingsland, president
K. E. Gould, executive vice-president
Paul A. Irwin, secretary-treasurer

Published by
AGE PUBLICATIONS LIMITED
450 Alliance Avenue, Toronto 9, Ontario
Telephone RO. 2-7225

Publishers of
Beverage Alcohol Reporter
Restaurants and Institutions
Automatic Heating/Plumbing/Air Conditioning
Food Service Equipment Supplier
Canadian Gas Journal

MONTREAL
J. R. "Tom" Graham
Suite 616-1
1500 Stanley St.
Montreal 25, Que.
Telephone VI 4-6782

WEST COAST
Dillenbeck-Galavan, Inc.
266 South Alexandria Avenue,
Los Angeles 4, California

U.K. and EUROPEAN REPRESENTATIVE
Norman F. Keenan
Regency House,
1 Warwick Street,
London, W.1, England

Indexed in the Canadian Business and
Technical Index of the Toronto Public Library.

Subscription Rates: Canada, British Possessions
and United States: 1 year — \$5.00; 2 years — \$9.00;
3 years — \$12.00. Foreign: 1 year — \$10.00.

Member Canadian Circulations Audit Board

Authorized as second class mail by the
Post Office Department, Ottawa and
for payment of postage in cash.



PRINTED IN CANADA

60

electronics and communications

Canada's pioneer journal in the field of
electronics and communications engineering

contents **NOVEMBER, 1961** Vol. 9, No. 11

- 21 Kicksorter uses new high-speed analog to digital converter
by Wladyslaw F. Korczynski
- 26 The IF Circuit Module — a new type of component
by G. G. Armitage and B. Tennent
- 31 The Chargistor — a new class of semiconductor devices
by Dr. Hwa N. Yu
- 34 A novel square-wave phase shifter
by A. E. Maine
- 37 Tiny digital computer uses "solid-circuits"
- 38 Engineering in Canada
The CSA Testing Laboratory
- 41 A new 450 Mc/s communications system
by R. B. Purser and G. H. Bennett
- 45 Automatic exchange has no moving parts
by J. W. Paddon
- 46 Ceramic filters permit direct coupled IF amplifiers

departments

- | | |
|---|--------------------------------|
| 9 EIA news | 55 International scene |
| 14 Industry's business | 57 Engineer's bookcase |
| 17 CRTPB newsletter | 60 Product panorama |
| 48 Defense industry barometer | 63 Technical literature briefs |
| 50 Close-up | 68 Forthcoming meetings |
| 53 Engineer's file folder | 70 Opportunities |
| <i>No. 3 Some transistor terms
defined by D. H. Lewis</i> | |
| | 72 Editorial |

COVER STORY

Technician adjusts new style kicksorter at the plant of Computing Devices of Canada, Ottawa, Ontario. See article on page 21.

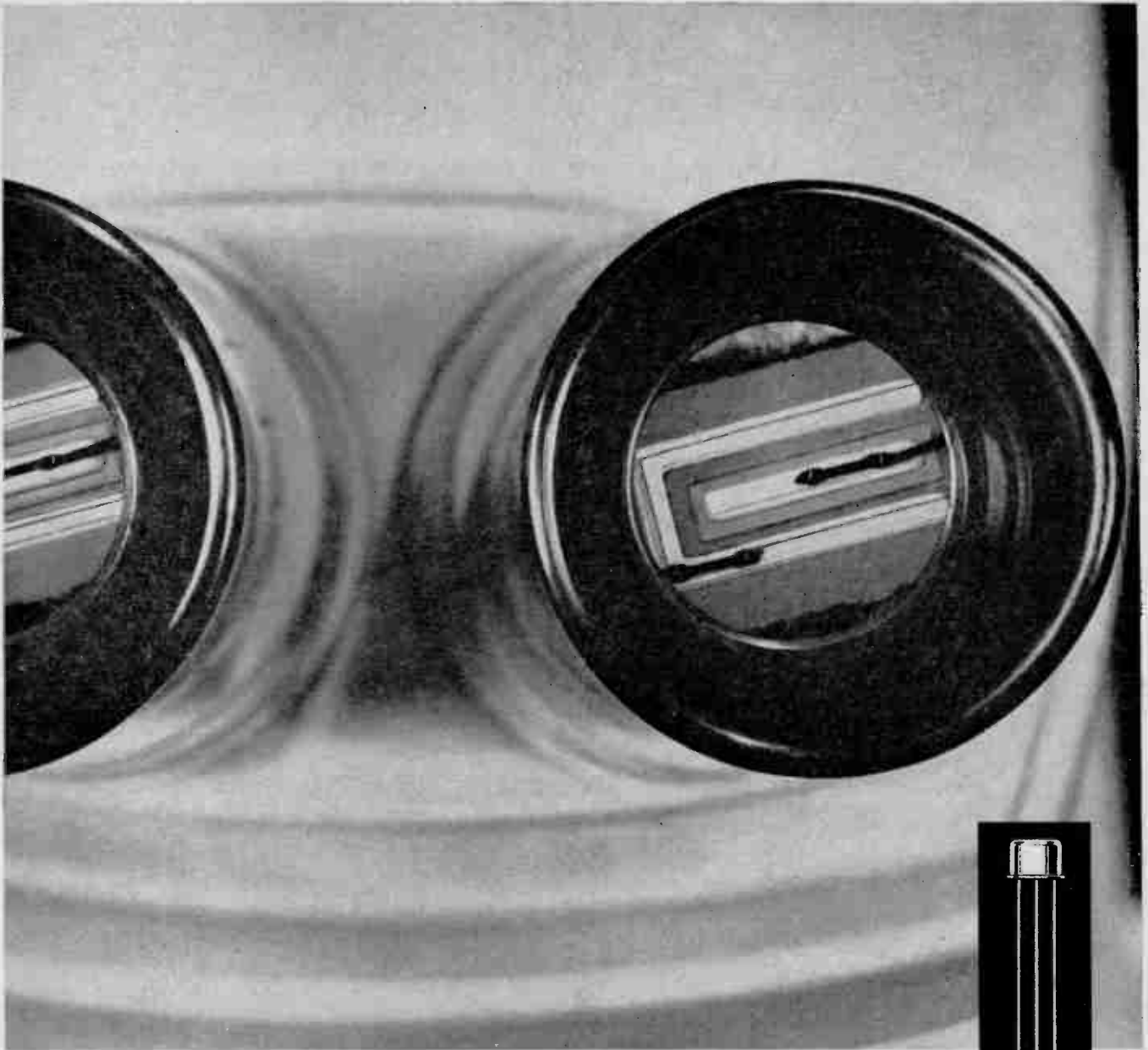

Intricate "machining" of junctions is inspected under powerful microscopes

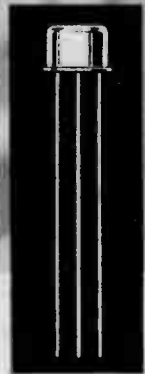

even miniaturization remains **MANAGEABLE...**

"Precision in small things" best sums up the General Instrument technique—however small the device, however demanding the ultimate application.

Precision and *miniaturization* may seem contradictory aims since the human eye falls somewhat short as a manufacturing tool, below certain size limitations.

At General Instrument *Semiconductor*, where the most intricate "machining" processes are carried out as routine, this is solved by working under a magnification

of 600X... thus representing each millimeter as nearly two feet!

Only by doing this can the pure gold welds of silicon and germanium wafers to hermetic leads be perfected without risk of microscopic burrs or discrepancies in formation.

Such micro-manipulation typifies our approach to the business of producing semiconductors... at General Instrument *there is no limit to the means when reliability is the end.*



GENERAL INSTRUMENT SEMICONDUCTOR
 DIVISION OF GENERAL INSTRUMENT
 F. W. SICKLES OF CANADA LIMITED
 151 Weber Street South, Waterloo, Ontario

GERMANIUM — SILICON — SELENIUM
 TRANSISTORS • DIODES • RECTIFIERS
 "ZENERS" • THERMOELECTRICS
 SEMICONDUCTOR CIRCUIT MODULES

For complete details check No. 19 on handy card, page 63

Resistors?

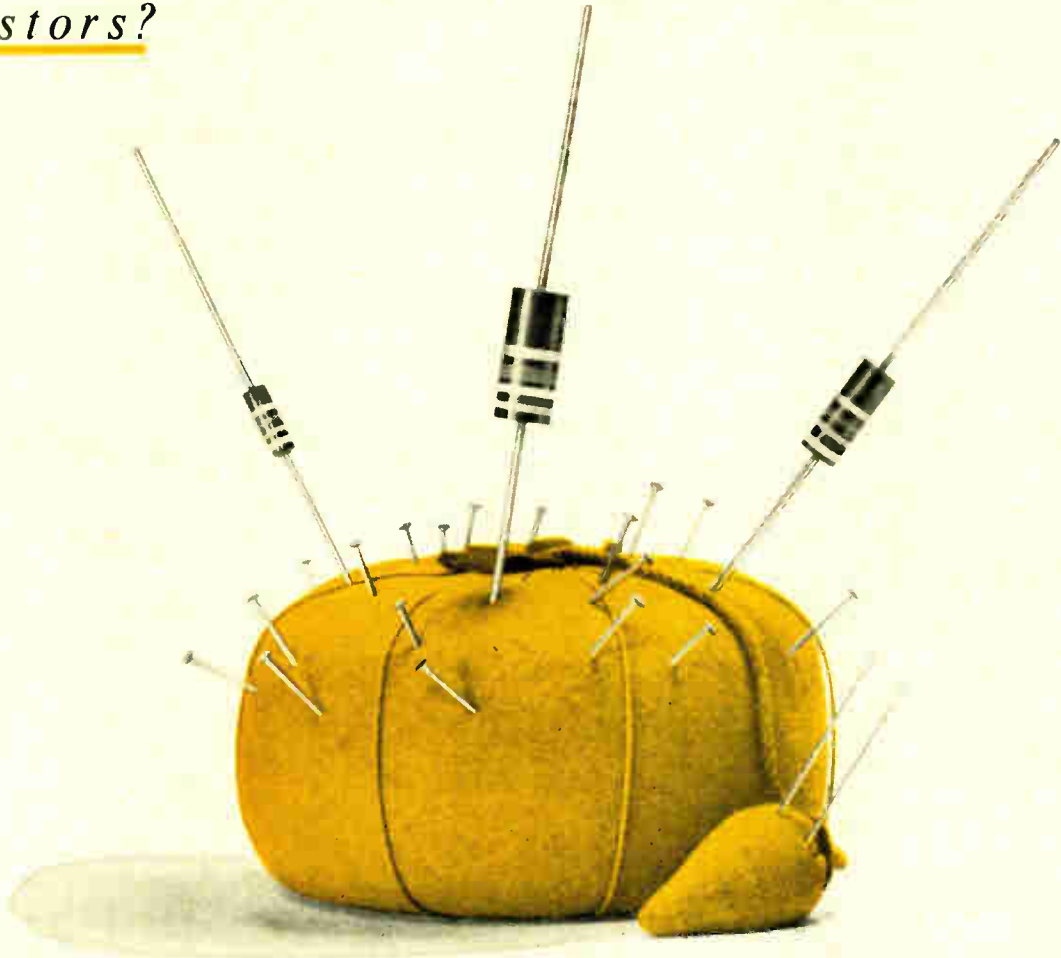

Stick with **STACKPOLE**

It's a known business axiom that getting with—and sticking with—a single, dependable source of supply can reap handsome dividends. When you purchase Coldite 70+ Resistors from Stackpole you provide yourself with an *extra* cushion of dependability and quality. That's because Coldite 70+ Resistors are not only designed to exceed MIL-R-11 requirements in every respect . . . but they are also tops in load life, humidity and moisture tests.

What's more—no other resistors can match Coldite 70+ for production line efficiency because they are far and away the easiest to solder by any method . . .

dip or iron. Leads stay tarnish-free and solderable even after months of storage thanks to the exclusive Stackpole extra solder coating applied after the usual tin dipping.

Coldite 70+ Resistors are available in Type RC-20 (½-watt); Type RC-32 (1-watt); and Type RC-42 (2-watts) . . . in all standard resistance values and at regular resistor prices. Write for Stackpole Resistor Bulletin giving complete specs on Coldite 70+ Resistors for MIL as well as commercial uses.

CANADIAN STACKPOLE LIMITED

550 Evans Avenue, Toronto 14, Ontario
Telephone: CLifford 5-2373



CERAMAG® FERRITE CORES • VARIABLE COMPOSITION RESISTORS • SLIDE & SNAP SWITCHES • CERAMAGNET® CERAMIC MAGNETS • FIXED COMPOSITION CAPACITORS • BRUSHES FOR ALL ROTATING ELECTRICAL EQUIPMENT ELECTRICAL CONTACTS • GRAPHITE BEARINGS, SEAL RINGS, ANODES • HUNDREDS OF RELATED CARBON & GRAPHITE PRODUCTS.

For complete details check No. 10 on handy card, page 63

ELECTRONICS AND COMMUNICATIONS. November, 1961

a *Genie at your command—*

the **CALL** director



The 30-button CALL director helps secretaries handle more calls, streamlines office operation.

From Northern Electric comes a new-style genie . . . the CALL director telephone. It's the versatile virtuoso of modern business communications. To reach many inter-office extensions—just press a button. To hold a telephone conference—just press a button. To connect outside calls to others—just press a button. The CALL director is available with 12, 18 or 30 buttons and many features to save precious business time.

The CALL director telephone is another step forward in the science of business communications by Northern Electric, who design and manufacture most of Canada's telephones and related equipment.



Northern's extensive experience in this field, along with their creative engineering and design personnel and modern manufacturing facilities are at your command. Branches are strategically located across Canada to serve you.

Northern Electric

COMPANY LIMITED

SERVES YOU BEST

by R. T. O'Brien



Reorganizing Top Level Committee

The Government Liaison Committee, the top policy committee on all matters affecting the Association's contact with Federal Government Departments, is undergoing reorganization.

The new structure will have President John D. Houlding, R.C.A. Victor Company, as its Chairman with two senior company executives from each of the three Divisions as members. These will be named at the next quarterly Division meetings.

New Export Committee Helping Newcomers to Export Field

Discussions have disclosed certain areas which could be problematical to new entrants in the export field. The newly formed Export Committee is calling upon members interested in getting into the field that they should call upon the Committee for assistance.

The Committee says it is generally agreed that the Canadian Electronics Industry must export and thereby widen its sales area if it is to be healthy. This is partly due to the exploitation of the Canadian domestic market by foreign manufacturers. They feel that the expansion of Canadian industry into world markets is considered a better way of counteracting this competition than trying to remain secure behind tariff walls.

Promote Color TV and FM Stereo Broadcasting

The Color TV and UHF Committee is developing a plan for the promotion of color TV telecasting in Canada on a time scale of about two years. The committee believes that color technological developments south of the border will start to accelerate rapidly now that the bulk of the major manufacturers in the U.S.A. have entered the TV market and that this color position can be expected to change within the next year and a half to two years.

The Committee says that the Canadian industry cannot afford to remain passive since if nothing is done about color then no one else can be expected to help the industry after the development has taken place. The Committee has decided that an active approach will probably be the most important point in trying to develop local broadcasting in Canada on a time scale that will neither harm the industry nor be so late as to enable imports to take over this segment of our industry.

At the same time there is a widespread feeling that EIA should do something about the education of dealers and the general public on all the facets of the new FM Stereo Broadcasting. The Publicity and Public Relations Committee is investigating ways and means of promoting this potential bonanza market.

Canadians to Display at Seattle Exposition

"Canadian Science and Industry Servicing Mankind" is the theme of Canada's display at the Seattle Universal and International Exhibition from April 21 to October 21, 1962. The Honorable George Hees, Minister of Trade and Commerce, announced last spring that Glen Bannerman, Director of the Canadian Government Exhibition Commission, had been named Commissioner General for Canada at Seattle.

Mr. Bannerman indicated the purpose of Canada's presentation is to emphasize the fact that Canadian scientific achievements have made a significant contribution to the knowledge of science and its practical uses throughout the world. It is expected that 10 million persons will visit the exhibition and that a large proportion of these will examine the Canadian display.

Continued on page 67

DELEVAN SETS THE PACE



- Each terminal has two rigid tabs for circuit connections.
- Completely safe as terminal is insulated from coil form by a fiberglass collar.
- Coil winding connections are made to base of terminal leaving tabs clean and free for attachments.
- Solder connections are easily made on the "Y" type terminal tabs.

Delevan offers a broad range of Variable Inductors as well as many standard coil forms. In either case we can provide you with the exact coil or coil form from stock or will be pleased to wind to your specifications.

Represented by A. T. R. Armstrong Ltd.
700 Weston Rd., Toronto 9, Canada

DELEVAN
ELECTRONICS
CORPORATION

77-C11 OLEAN RD. • EAST AURORA, N.Y.

For complete details check No. 15

*a completely
self-contained*

**FREQUENCY
MEASURING
INSTRUMENT**

*employing
a new
principle !*

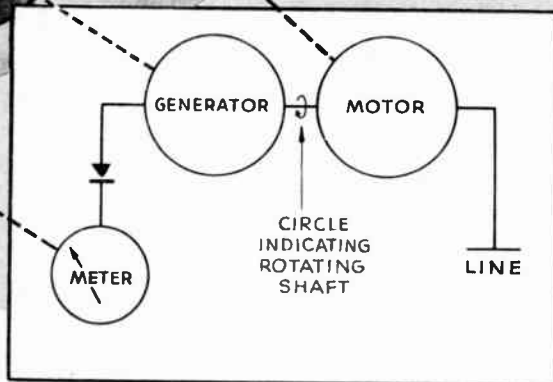
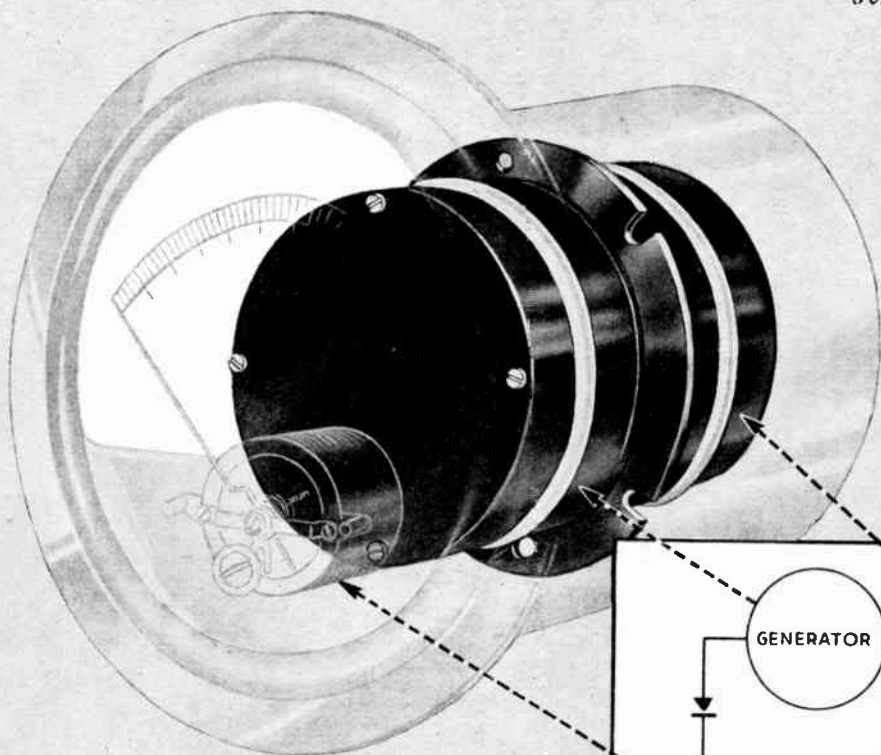

The Bach-Simpson **FREQUENCY METER**

Simple in principle, revolutionary in design, the Bach-Simpson Frequency Meter offers these advantages:

★ **INDICATION INDEPENDENT OF VOLTAGE:**

On 110 volt models, for example, input voltage fluctuation between 20 and 200 volts produces no change in indication.

★ **INDEPENDENCE OF WAVE-FORM VARIATION:**

The change from pure sine-wave to square-wave is barely detectable.

★ **COMPACTNESS:**

The miniaturised Motor-Generator which is the heart of the instrument allows a remarkably shallow self-contained unit, with simple two-terminal connection.

★ **LOW POWER INPUT:**

Less than one-half the power input necessary for most pointer type frequency meters is required.

★ **LONG TERM ACCURACY:**

The requirements of the A.S.A. Specification for Grade I Frequency Meters will be met and exceeded throughout the life of the instrument, which, under normal conditions, will be in excess of ten years of continuous operation.

★ **ECONOMY**

Extremely competitive pricing derives from the simplicity of design, and from the elimination of costly and cumbersome accessories.

How does it work? The input voltage drives a synchronous AC Motor and Generator on a common shaft, and the resulting output voltage, proportional to input frequency, is read out on a suppressed zero linearly-scaled meter.

Simple? You can say it in ten seconds. But literally thousands of hours of Canadian Design and Engineering have gone into making this one more of the quality products which Canadian Industry has come to expect from Bach-Simpson Limited.

Your inquiries are invited.



K1570

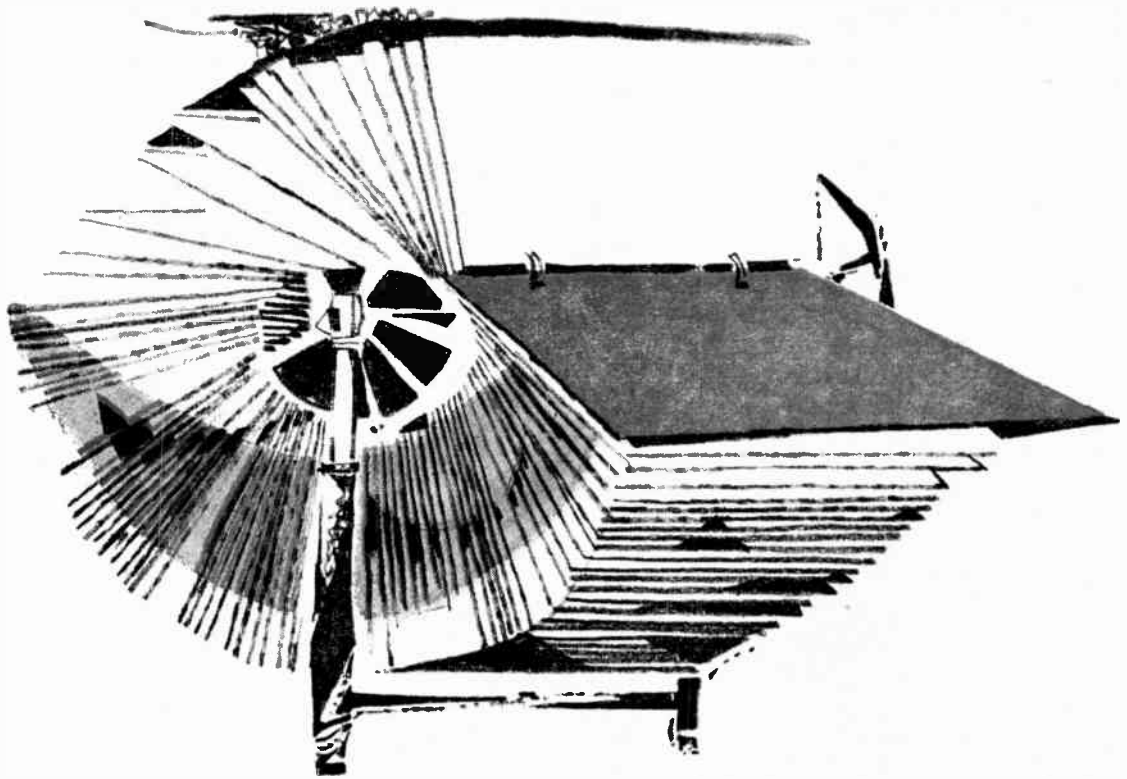

PICK A CARD AND PINPOINT STOCK

Walk into a Northern Electric warehouse and this is what you'll see... a fast index system that tells exactly "where" and "how many" for each of the more than 10,000 items stocked. And for even faster service, items are arranged according to customer demand. This studied approach to warehousing means superior sales service for our customers. For communications equipment, wires and cables, electrical supplies and apparatus, call

Northern Electric
COMPANY LIMITED



4061-4

For complete details check No. 31 on handy card, page 63

ELECTRONICS AND COMMUNICATIONS, November, 1961

**CHARACTERISTICS THAT DETERMINE
RELAY SELECTION..... NO. 12**

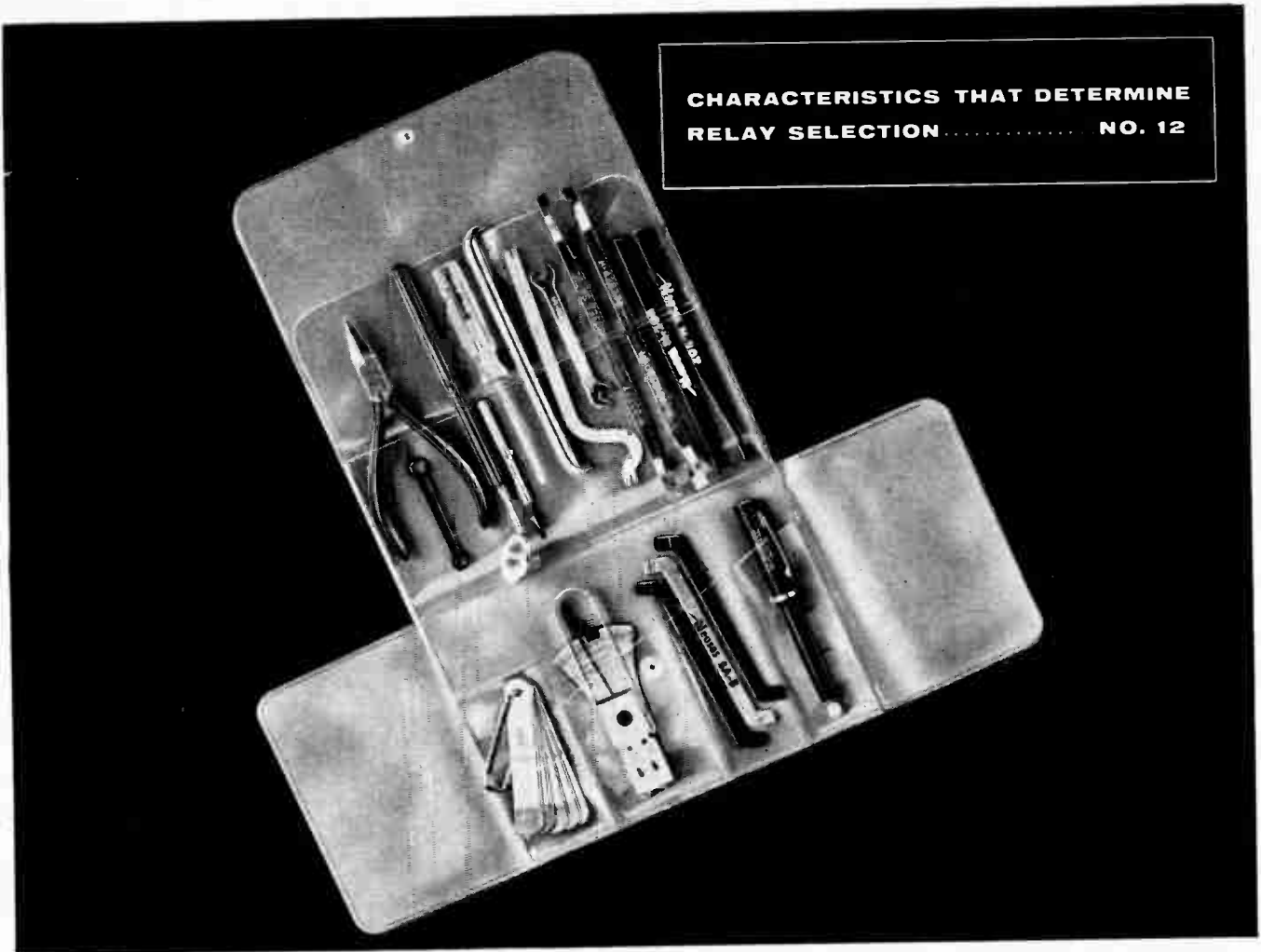

The TK-18 Tool Kit — selected tools for almost every relay requirement.

availability of related precision tools

Helpful selection data—Neuses Tools

- No. 3-316:** "Non-Residual" contact burnisher. Leaves no filings or dust.
- No. CB-5:** Pocket type burnisher with replaceable blades.
- No. SA-9:** Reverse curve type wrench. .064" slots stepped down to .032" each end.
- No. SA-18:** Spring adjuster, offset with .018" lengthwise slots.
- No. N-84:** Flat nose precision pliers 3" long.
- No. N-206:** Offset precision screwdriver.
- No. N-376A:** Magnifying inspection mirror with insulated handle.
- No. STG-2-D:** Spring tension gauge, 50-0-50 gram range in 5 gram steps.

Even relays by Automatic Electric sometimes need attention—but because they are manufactured to extreme tolerances, makeshift tools or gadgets are not the answer. In fact they can very easily cause costly damage. Where attention is necessary—as when contacts require burnishing or springs need more precise adjustment, only tools specifically made for the job should be used.

The Neuses range of small tools for communication, telephone and electronic equipment are the ideal answer. Distributed in Canada by Automatic Electric, they include every tool to meet every relay re-

quirement. The TK-18 Kit for instance—the simplest and most economical way to buy—contains wrenches, spring adjusters, an insulated contact burnisher, a set of thirteen thickness gauges, screwdrivers and many other tools—all of the finest quality on the market. And the complete Neuses range includes everything from cable strippers and sewing needles to nylon cleaning brushes.

For complete details, call or write Automatic Electric Sales (Canada) Limited, 185 Bartley Drive, Toronto 16, Ontario. Branches across Canada.

AUTOMATIC ELECTRIC

Subsidiary of

GENERAL TELEPHONE & ELECTRONICS



AN ORGANIZATION SERVING CANADIAN INDUSTRIES WITH COMMUNICATION AND CONTROL SYSTEMS

6113

For complete details check No. 6 on handy card, page 63

NEW WESTINGHOUSE IMAGE ORTHICON

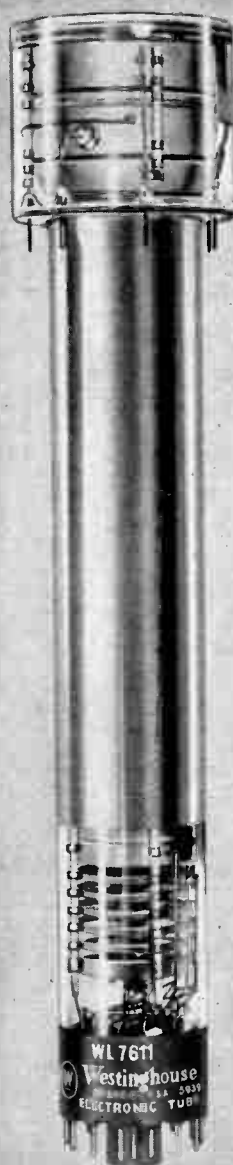

LASTS AS LONG AS ANY TWO NOW IN USE!

FREE FROM AFTER-IMAGE AND BURN . . . INTERCHANGEABLE WITH WL-5820

1000-hour warranty! That's double the life expectancy of any image orthicon now in use! And this new WL-7611, already in production, gives constant picture quality throughout the life of the tube—essentially free from after-image or picture-sticking and raster burn—without sacrificing resolution, gray-scale, noise or shading.

The WL-7611 has spectral response comparable to that of the human eye, and sensitivity equivalent to an ASA exposure index of more than 500. Outdoor or studio pictures suitable for telecasting can be obtained with as little as 10 foot-candles of illumination, and stable operation is attained over a very wide range of light levels.

The new image orthicon tube is now available from stock for immediate delivery. Call your Westinghouse distributor today, or write: Electronic Tube Division, Hamilton, Ontario. *You can be sure . . . if it's Westinghouse.*

Westinghouse

Canadian Westinghouse Company Limited

the industry's business

Defense Research Board program will speed new equipment advances

The expansion of Canada's scientific contribution to future North American and NATO defense efforts, through the mobilization of the research resources of Canadian defense industry, will become the responsibility of the Defense Research Board with the active cooperation of the Department of Defense Production.

Announced by the Hon. Douglas S. Harkness, Minister of National Defense, in the House of Commons September 12, the program will aim at speeding the introduction of new technological advances into the design of military equipment. Canadian industrial organizations should then be in a better position to participate in the Defense Development and Production Sharing Program already established between the United States and Canada.

A Directorate of Industrial Research will be established at DRB Headquarters to implement this program.

John L. Orr, MBE, will head the new Directorate of Industrial Research which has been established at Defense Research Board Headquarters. Mr. Orr will also retain his present responsibilities as director of Engineering Research.

A former officer of the Department of Defense Production, until joining the Board's staff six years ago, Mr. Orr's past training and experience equip him to direct the new program.

The objective will be to encourage industry to strengthen its research and development capabilities by sponsorship of applied research in fields of defense interest. It is expected that industry will advance new ideas leading to research projects in support of

which the Government would be prepared to make a substantial financial contribution. Thus it is hoped to



J. L. Orr

stimulate a major expansion of industrial research activity generally, as well as a significant increase in the limited number of research groups presently active in Canadian defense industry.

Emphasis will be placed on the long-term aspects of defense problems and research efforts will be concentrated in selected fields in order to achieve the required level of technological competence. The program will be closely coordinated with the research activities of Board laboratories, and fundamental research supported at Canadian universities under the DRB extramural grants system.

Willer Engineering to represent three U.S. firms

Willer Engineering & Sales Co., Toronto, were recently appointed representatives of three U.S. firms. Emerson & Cuming, Inc., Canton, Mass., who manufacture plastics and ceramics for electronics including a wide range of resin materials for casting, bonding, coating and mould-

ing, as well as a large range of microwave absorber materials; Engineered Electronics Company, Santa Ana, California, are manufacturers of packaged circuit modules; and The Sippican Corporation, Marion, Mass., who make precision welding equipment for the fabrication of electronic assemblies and for high density electronic packaging.

Canadian TV sales increase for second successive month

"For the second month in succession television sales have increased over the same period last year," said F. W. Radcliffe, general manager, Electronic Industries Association of Canada.

At August 31, the increase stood at 5.4 per cent over the first eight months of 1960 — 156,403 units versus 148,378 units.

It is evident the long-awaited TV replacement market is breaking open. Spurred by the pre-sales tax in the big Ontario market, by increased interest in and concern over international affairs, 90 per cent of Canadian homes within range of television stations are buying more and better receivers.

The industry foresees not only a continuing upswing in sales but the very real possibility of a shortage. Some manufacturers report they are already oversold on popular models.

One of the best fall selling seasons in years is expected by the industry.

IEE appoints Whittaker as Canadian representatives

Industrial Electronic Engineers, Inc., announced that Whittaker Electronics Limited, Ottawa, Ontario, electronic manufacturers representatives, have been appointed to represent the company in Central and Eastern Canada.

Whittaker Electronics will carry the complete line of IEE products, including In-line Display Readouts, Bina-View self decoding alpha-numeric readouts, "Cue" Indicator Switches, and Read-A-Call Systems.

High fidelity exhibitors optimistic about future business

Held in the Seaway Hotel, Sunnyside Beach, Toronto, the sixth Annual Canadian High Fidelity Exposition, sponsored and conducted by the Dominion High Fidelity Association, closed with a marked degree of optimism on the part of the exhibitors.

Running for four days from October 18 to 21, despite the away-from-the-downtown area of the city location, the show drew an attendance of better than 5,000 persons from the trade and general public. Exhibitors reported interest and inquiries at an all-time high for Canadian high fidelity expositions and predicted brisk business for the high fidelity dealers in the immediate wake of the exposition.

Middle East microwave network to be built in Canada

Award by the International Cooperation Administration (ICA) of a \$16,400,000 contract to the Radio Corporation of America for a 3060-mile telecommunications network linking Turkey, Iran and Pakistan was announced officially in Washington. Value of the award to RCA Victor Company, Ltd. amounts to approximately one third of the total contract.

The network will extend from Ankara, Turkey, as the western-most terminus, to Tehran and then to Karachi thus connecting the three mid-eastern countries' capitols. When completed by RCA in the next 30 months, the network will be turned over by ICA to the mid-eastern countries.

The system will be known officially as the CENTO telecommunications network taking its name from the Central Treaty Organization of which Turkey, Iran, Pakistan and the United Kingdom are members.

Initially the microwave equipment will be able to provide 600 telephone voice channels — the performance substantially exceeding any recognized standards for such communications network system facilities.

The heart of the system will be the RCA Victor MM-600 radio relay equipment similar to that developed, built and installed by RCA Victor Company, Ltd. for the Canadian National Railways along a 1300 mile system stretch-

ing from Grande Prairie, Alberta to the Alaska border.

As in the Canadian network, the CENTO project will have dual two-way radio frequency channels installed in the system (one as a stand-by) capable of carrying up to 600 telephone voice channels.

Both channels can be operated continually with the signal of each specially combined at each terminal so that the overall performance equals or betters the performance of the best channel thus providing protection against poor performance due to propagation effects or equipment failure.

Additional radio frequency channels can be added each capable of additional 600 voice channels. The network also can be readily expanded to cover additional countries.

In Canada alone RCA Victor has supplied equipment for some 321 relay stations spanning more than 8000 miles in 36 systems for various Canadian communications carrier companies as well as for the Canadian Government.

CENTO TELECOMMUNICATIONS NETWORK
PROJECTED ROUTE — 3060 MILES



Left: map showing epic communications network spanning some of the most difficult terrain in the Middle East. Below: Members of the International Cooperation Administration (ICA), U.S. State Department visit the RCA Victor Engineering Laboratories, Technical Products, in Montreal. Left to right are: R. Warren, Television Associates, Consultants to ICA; E. Hall, Television Associates; M. Whitty, RCA International Div.; J. B. Knox, Mgr., Sales and Product Admin., Communications Systems, RCA Victor Co., Ltd.; T.

Miller, Television Associates; Mr. Farkhondar of Iran, Cento Liaison Officer; Mr. Benge, of Turkey, Cento Liaison Officer; Mr. Hamid of Pakistan, Director-General Pakistan Post and Telegraph; J. McDonald, ICA; J. Arnaud, RCA International Div.; and Wm. Gage, ICA.

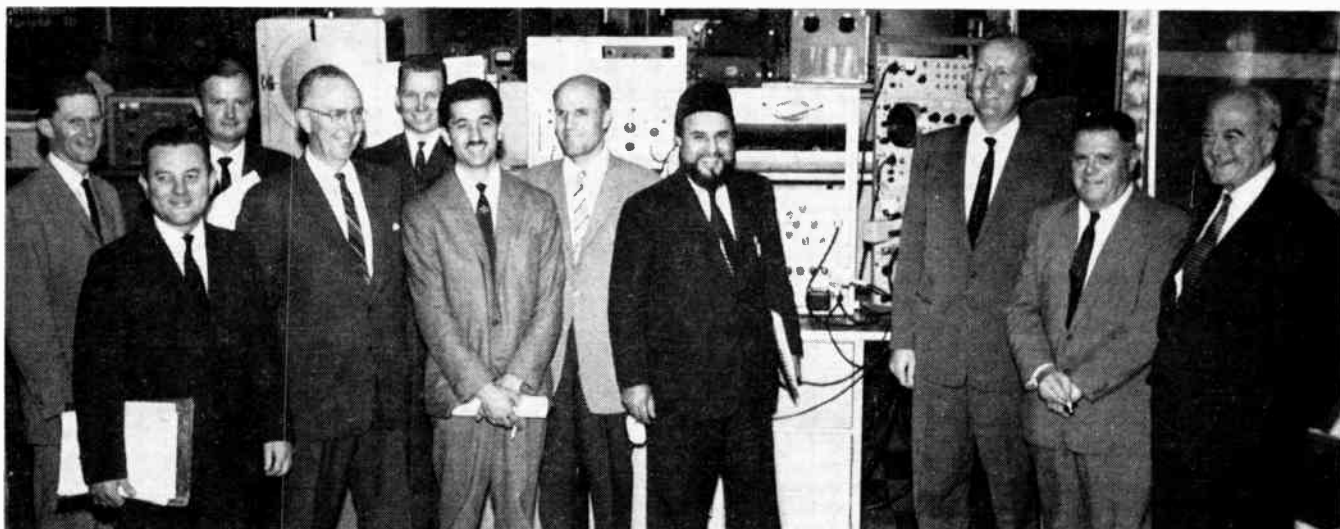

New Canadian plastics industry formed

Peter P. Paisley of Paisley Products of Canada Limited, Scarborough, Ontario, and Russell M. Houghton, president of CONAP, Inc., Allegany, New York, announced early in October, the founding of a new Canadian industry.

Named CONAP-CANADA Limited, they will produce high performance epoxy plastic compounds for the electrical, electronics, adhesive, and tooling markets.

CONAP-CANADA will be staffed entirely by Canadian personnel, and the new group forecasts improved

products and better service to their customers. No change will be made in organization or procedures of the parent companies. The CONAP-CANADA plant is located at 36 Upton Road, Scarborough, Ontario, with warehousing facilities and sales office in Montreal.

Continued on page 49

HAMMOND

SPECIALIZED TRANSFORMER DESIGN



POWER TRANSFORMERS
from 1 to 100,000 V.A. single or polyphase, military or commercial, to meet wide extremes of climatic or atmospheric conditions.

TO 100,000 V.A.
50,000 VOLTS
25,000 AMPERES

COMMERCIAL OR MILITARY SPECIFICATIONS

Hammond has produced transformers to more than 59,000 different designs. Where a complex requirement concerns transformers within the ranges listed above, the chances are Hammond has already solved the problem in a similar or related form.



AUDIO TRANSFORMERS
from microphone level to 10 KW, for broadcast or public address, computer or sonar—transistor or tube circuitry.



PULSE TRANSFORMERS
for ultra-miniature blocking oscillator and coupling transformers or high-power modulators and associated linear charging reactors.



REACTORS
for smooth and precise electronic control: filter reactors, swinging chokes, saturable reactors, charging reactors, parallel-feed chokes.



HAMMOND
ELECTRONIC TRANSFORMERS

*Standard Items Stocked
by Leading Jobbers*

H.7

HAMMOND MANUFACTURING CO. LTD. GUELPH, ONT., CANADA

For complete details check No. 20 on handy card, page 63

Canadian
Radio
Technical
Planning
Board

newsletter

by R. C. Poulter



Seventeenth Annual Meeting

The Seventeenth Annual Meeting of the Canadian Radio Technical Planning Board will be held in the Chateau Laurier Hotel, Ottawa, on Thursday, December 7, 1961. An Administrative Committee meeting will be held in conjunction with the event.

Final Recommendations on RSS-136

The Department of Transport has been advised of the results of the Official Board balloting on the General Services Band Radio Specification 136. This is the type-approval specification for equipment in the proposed so-called "citizens' radio" service in the 27 mc band. It is understood that the Department will be issuing licenses for the service starting April 1, 1962.

The final recommendations were generated in a special committee set up for the purpose. Voting members were asked to record their vote by September 22. The Official Board voted for approval of the recommendations. There were some abstentions on the ballot and some of the returns were accompanied by separate comments.

It is expected that the final issue of the specifications may be available by the end of October.

Exploratory Talks on Frequency Stability

Representatives of the Planning Board Executive Committee have held exploratory talks with Department of Transport on the whole question of frequency stability and methods of measurement.

The Technical Co-ordinator, R. A. Hackbusch, for some time has held the view that there are problems existing in the area of methods of measurement of oscillator frequency stability, and he has recommended that the Executive Committee attempt to bring some of the problems into focus to try to have them resolved to the satisfaction of the manufacturers, the licensing authorities and the users.

It is expected that, as a result of the talks held recently, that a committee of experts will soon be established to examine the question.

ITU Reprint of Essential Telecommunication Terms

The Board has recently been advised by the ITU that the list of Essential Telecommunication Terms, Part I, issued in 1957 is now out of print and the General Secretariat has received numerous orders it has been unable to fill. Hence, the Second Plenary Assembly of the CCITT decided that the initial edition should be reprinted, so that demand might be met for four or five years.

The aim of the compilers was to standardize and co-ordinate the use of telecommunication terms. The list includes all terms fairly widely used which require definition because they are not merely self-explanatory assemblies of words used in their ordinary sense.

There are no new definitions in the reprint, but the CCITT Secretariat has taken the opportunity to make some minor drafting changes, especially in English. At the same time a 50-page supplement has been issued, containing additional definitions approved by the Plenary Assembly. The supplement will automatically be supplied when meeting orders for the reprint.

The reprint runs to some 300 pages and appears in a bilingual (English-French) edition. The price per copy, including the supplement, is 16.50 Swiss Francs, and orders should be placed directly with the ITU General Secretariat in Geneva, Switzerland. Subscribers to the 1957 edition of the list can obtain the supplement separately at a cost of 2.40 Swiss Francs per copy.



**ALL
CANADA
OVERNIGHT**

**YOU CAN DEPEND ON
MILGRAY/NEW YORK
FOR OVERNIGHT
DELIVERY...
ANYWHERE
OF
SEMICONDUCTOR
PRODUCTS
FROM THESE
OUTSTANDING
MANUFACTURERS:**

**BENDIX
COLUMBUS
GENERAL ELECTRIC
GENERAL INSTRUMENT
GENERAL TRANSISTOR
HOFFMAN
MOTOROLA
NATIONAL SEMICONDUCTOR
OHMITE
PHILCO
SARKES-TARZIAN
SPRAGUE
TEXAS INSTRUMENTS
WESTINGHOUSE**

MILGRAY/NEW YORK

136 Liberty Street/New York City 6
REctor 2-4400

Zenith numbers in
leading industrial areas
TWX-NY1-4013/FAX-FQF

industry personnel



F. J. Dobson

Ontario Hydro engineer heads Ghana project

An Ontario Hydro engineer will direct Ghana's massive Volta River power project.

Frank J. Dobson, 44, construction manager of Hydro's \$250 million Lakeview thermal-electric development, on the western edge of Metropolitan Toronto, has been named chief executive of the new Volta River Power Authority by Ghana president Kwame Nkrumah. Mr. Dobson and his family leave for Accra early this month. He will be on loan from Hydro until the project is finished probably in four or five years.

Essentially the Volta River power scheme involves building a rock dam, 2,190 feet-long, 375 feet-high, a complementary saddle dam nearby, and a powerhouse with four 128,000-kilowatt generators at Akosombo, 68 miles northeast of Accra, the capital. The powerhouse will be designed for an ultimate capacity of 768,000 kilowatts. Ghana's present electrical output is about 100,000 kilowatts from diesel-electric generators.

Precision Instrument appoints Canadian engineer

Precision Instrument Company, instrumentation magnetic tape recorder manufacturer headquartered in San Carlos, California, has recently created a new Canadian engineering responsibility. To fill the assignment, the company has appointed William R. McLellan, senior systems engineer, who will be stationed in Ottawa.

Prior to assuming his new duties, McLellan was employed in the design, development, and procurement of data handling systems for the Royal Canadian Air Force Test Range in Alberta, Canada. Earlier, he served as Senior Electronics Engineer with LEO Computers Limited, London, England. McLellan has also been associated with the British Tabulating Machine Company Limited, in Northern Ireland, and with the Research and Development of Short Brothers and Harland Limited.

New company appoints personnel

Metal Industries Limited, the English electrical engineering group, has opened a new company in Canada called Dominion M.I. Limited following the dissolution of Bepeco Canada Ltd., a consortium of British electrical manufacturers.

President and general manager of the new company is E. A. Chandler, formerly chief engineer of Bepeco. General sales manager is D. J. Tamblin who was also with Bepeco as its Ontario manager.

Triangle Conduit & Cable appointments

J. W. Kerr, president, Triangle Conduit & Cable (Canada) Limited, announced the election of two new members to the board of directors, Norman L. Mathews, Q.C., and Joseph Thompson.

Mr. Mathews is senior partner of the law firm of Mathews, Dinsdale & Clark of Toronto and is closely associated with many major Canadian corporations.

Mr. Thompson is vice-president of the Travelers Insurance Company, the Travelers Indemnity Company and the Charter Oak Fire Insurance Company. He is in charge of Canadian agency operations of the Travelers Insurance Company.

CKEY appointment

William R. Onn was named chief engineer of CKEY, Toronto. Having been involved in the technical aspects of broadcasting for the past 14 years, Mr. Onn brings a wealth of experience to CKEY. He has most recently been chief engineer of CHLO, St. Thomas, a position he has held for 9 years.

An active member of the London section of the Institute of Radio Engineers, he was also the chairman of

the Engineering Section of the Central Canada Broadcasters' Association for a three year period.

Transport Department Telecommunications and Electronics Branch appointment

Appointment of James Robert MacKay to the position of chief, Design and Construction Division in the Transport Department's Telecommunications and Electronics Branch, was announced recently by Transport Minister Leon Balcer with the concurrence of the Civil Service Commission.

Joining the Radio Division in 1938, Mr. MacKay has been closely associated with the development and expansion of air navigation radio aids and has been associate chief of the Design and Construction Division for the past two years. He succeeds H. E. Walsh who recently retired on superannuation.



D. J. Tamblin



E. A. Chandler



G. G. Smith

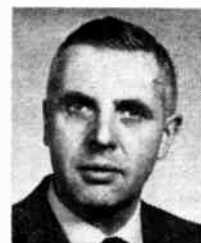

J. R. MacKay

Eldon Industries appointment

Dennis Tiberiis, vice-president and general manager of Eldon Industries of Canada, Ltd., announced the appointment recently of G. G. Smith as purchasing agent of the company's Toronto head office.

As sales representative for Eastern Canada, Mr. Smith is a former resident of Montreal where, for the past 10 years, he has served in the electronics field with leading Canadian and British industries.

Continued on page 56

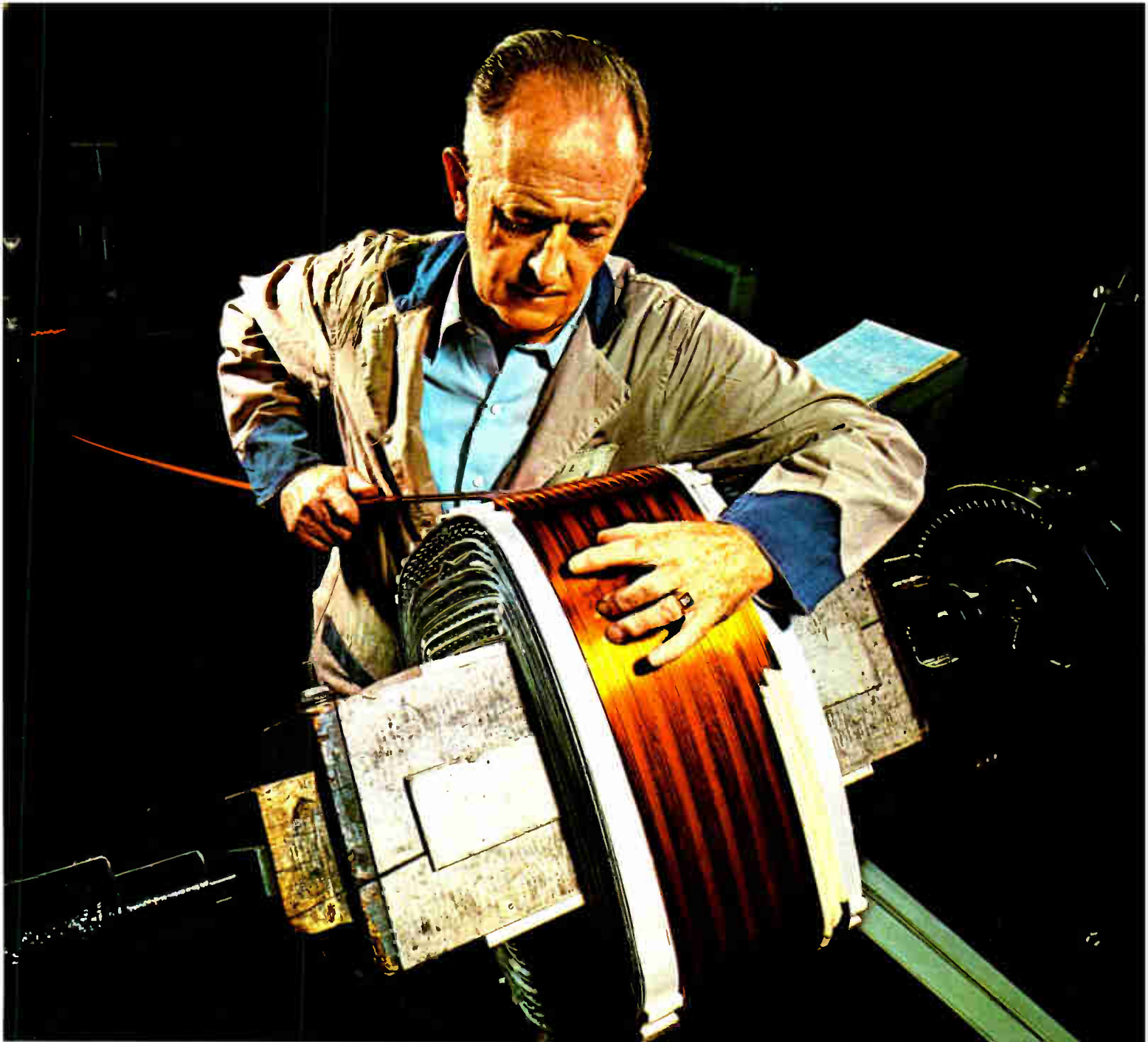

Transformer coil winding at Moloney Electric Co. of Canada Ltd.

COUNT-DOWN ON QUALITY

The skilled fingers of the technician count the turns . . . but the quality of the coil depends on the magnet wire he uses. At Phillips, the factors which determine that quality are no secret—

- **Processing which improves the electrical and physical characteristics of the copper itself**
- **Precise tolerance of wire gauge**
- **Uniformity of insulation and treatment**

From giant transformers to the smallest household appliances, the vital operating quality of your product can be improved with Phillips Magnet Wire.

Phillips Electrical Company Limited, Head Office—Brockville, Ontario. Branches—Halifax, Montreal, Ottawa, Toronto, Hamilton, Winnipeg, Edmonton, Vancouver. The Canadian affiliate of the BICC Group.



WIRES CABLES

6026

How

LORAIN

reliability is built-in

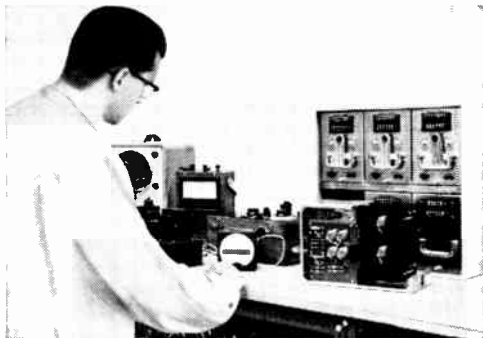

Lab testing M7.5 sub-cycle

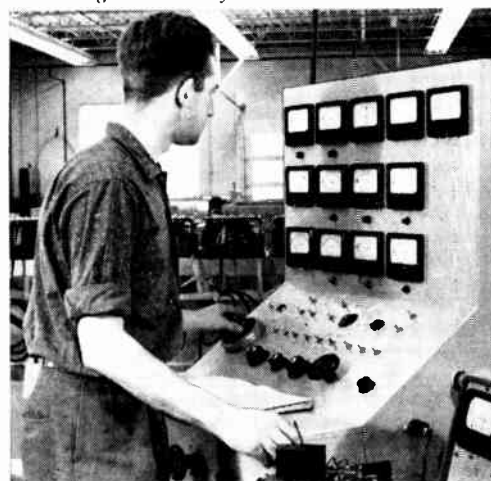

Production testing of Lorain power supply

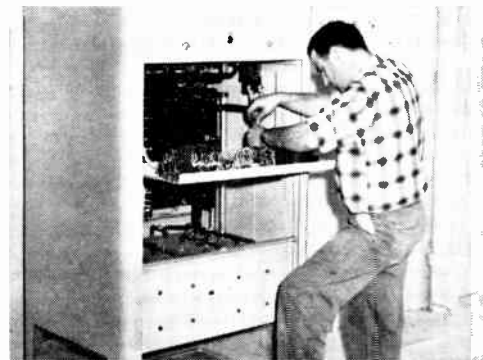

Final inspection and adjustment of large Flotrol

Nothing is left to chance at Lorain. Constant research—into basic theory, and towards new developments and applications—assures that every Lorain product is as up-to-date in design and efficiency as it possibly can be.

New ideas, tested under actual operating conditions, are incorporated into standard Lorain products the minute they have been proven. And at every stage of manufacture there are exhaustive tests every component is subjected to—and *must pass*.

By this means reliability, low operating costs, and an almost total absence of maintenance are built-in as permanent features—and recognized as hallmarks of Lorain equipment everywhere. Effective proof of this is the wide and sustained acceptance of Lorain equipment on both private and government installations.

When you need charging, ringing or power supply products, ask for expert recommendations from Lorain.

POWER EQUIPMENT FOR COMMUNICATIONS AND INDUSTRY



LORAIN *Products (Canada) Limited*

ST. THOMAS, ONTARIO

Distributed by: Automatic Electric Sales (Canada) Ltd., Toronto, Ontario



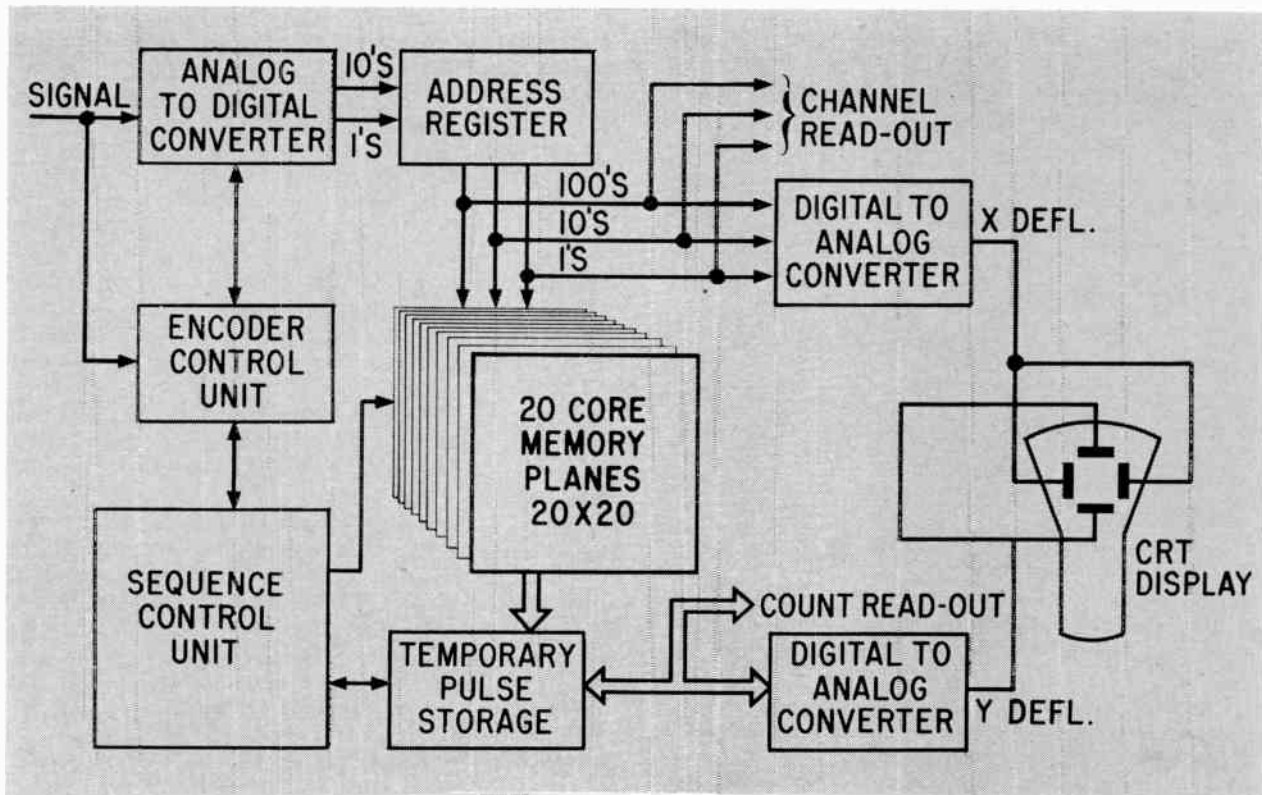

Figure 1 — Simplified block diagram of Kicksorter (Pulse Height Analyzer).

EQUIPMENT DESIGN

Kicksorter uses new high-speed analog to digital converter

A limitation of a Kicksorter with a large number of channels is the time taken to process the input. Article describes a new dual-step converter which significantly reduces dead time.

by Wladyslaw F. Korczynski, MIRE*

(first publication of a paper read at the Canadian IRE Electronics Conference, October 1961)

In recent years multichannel pulse height analyzers, or briefly, Kicksorters, have been playing an increasingly important role in nuclear energy research. Current models of these instruments are now considerably advanced over the early type Kicksorters which were limited to few channels. With the advent of semiconductor devices, improved scintillation detectors and modern computer circuit techniques, it has been possible to enormously increase the usefulness of the Kicksorter with significant reduction of size and power consumption.

A modern Kicksorter is a complicated machine into which many facilities have been built which were never

previously thought of. First, it is truly a multichannel instrument with the number of channels running as high as 1000 in some cases. However, at the same time, it becomes increasingly difficult to compromise between the number of channels required and the time which it takes to process an input pulse. By far the major portion of the total dead time, that is, the time during which the Kicksorter is shut off for the incoming signal was hitherto occupied by the analog to digital conversion process.

One of the conversion methods most widely used is to resolve the amplitude of the pulse into a series

*See page 22.

of equal steps. The other term used for these steps is channel width. If we use a 1 Mc/s clock frequency the average contribution to the dead time by the encoding process would be 50 microseconds for a 100 channel Kicksorter and correspondingly larger for higher number of channels. At the same time the computing cycle

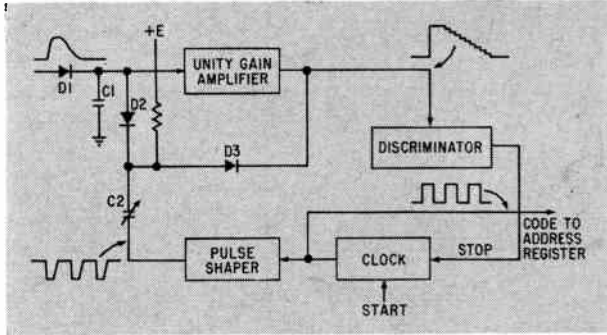

Figure 2 — Diagrammatic arrangement of single step converter.

remains independent of the number of channels and is usually of the order of 20 microsecs. In such a situation it becomes apparent that a more efficient method has to be used. The method which this article will describe employs a dual step discharge analog to digital converter which significantly reduces the conversion time, using a relatively slow clock frequency.

The essential sub-units of the Kicksorter are shown in Figure 1. From the left is shown an analog to digital converter block which converts the signal amplitude to the digital information. For the sake of clarity the amplifier and cut circuits which usually precede the encoder are omitted from the diagram.

The encoder control unit generates essential pulses necessary to control the encoding process. When the signal is accepted by the Kicksorter the control unit generates the pulses which initiate the conversion and resets the Address Register to zero. Since the Kicksorter uses a two step conversion method, the digital information consists of a series of tens and units pulses which are used to set the Address Register to the proper channel number. The Address Register contains two decade counters, one for units and one for tens, and a two stage binary counter to bring the total available number to 400. There is, of course, an intercon-

The Kicksorter is now ready to store this information in the magnetic core memory. A code completion pulse originating in the encoder control unit is fed to the sequence control unit, which in turn generates a read pulse and a resetting pulse for Temporary Pulse Storage units. Previously stored count, corresponding to the channel number stored in the Address Register, is read out to the T.P.S. unit. The count number is increased by one and the instrument is ready to display both information, i.e. channel number and the accumulated count. For digital read-out neon indicators are used and for visual observation of the spectrum accumulation a C.R.T. display is employed. X and Y deflections are generated by respective digital to analog converters.

Prior to a detailed description of the two-step conversion method, a description of the single step encoding process which forms the basis for the dual step converter is in order.

Figure 2 shows the basic building blocks of the encoder. Starting from the left, D1 is a charging diode, C₁ a storage capacitor, D2 is a discharge diode and C₂ a discharge capacitor. The unity gain amplifier accepts the signal at very high impedance and delivers the output at low impedance. The output of the unity gain amplifier is fed to the discriminator and to the D3 diode. Clock generator can be started and stopped by

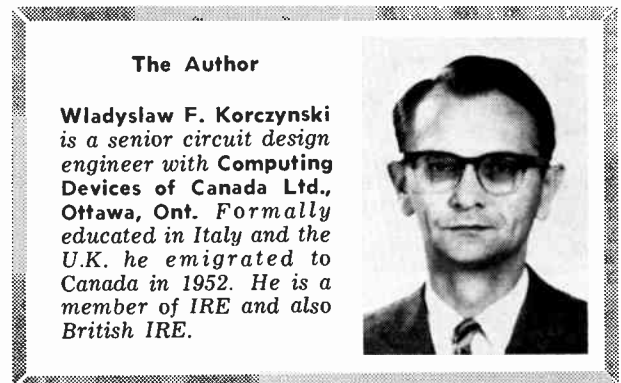

external signals. The clock is followed by pulse shaper which generates amplitude controlled pulses necessary for stable operation of the encoder.

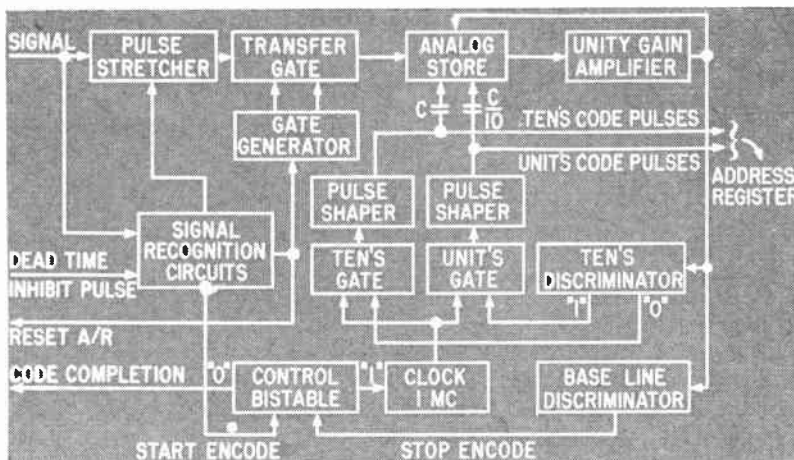

Figure 3 — Block diagram of the Encoder.

nection between the counters for carry propagation. At the end of the encoding time the count corresponding to channel number is stored in the Address Register.

The positive signal charges the storage capacitor C₁ to the peak value of the signal through D1, which subsequently is cut off. A signal recognition pulse originating in the encoder control unit starts generation of the clock pulses. The negative pulses discharge C₁ through C₂ and D₂ in equal amplitude decrements approximately equal to the ratio of C₂ to C₁. The voltage across C₁ is thus decreasing in step ladder fashion until a base line potential is reached. The base line cross over point is sensed by the discriminator which subsequently generates a stop signal. The encoding is thus completed and to each discharge step corresponds one pulse which is

sent out to the Address Register. It is important to note that the unity gain amplifier delivers an output which is almost an exact replica of the potential across C₁. Also the DC input and output levels must be sufficiently close to assure that under steady

state conditions D3 is conducting and D2 is cut off by the voltage drop across D3. Under these conditions D2 is reverse-biased by a few tenths of a volt and the leakage currents due to D2 are kept very low. D2 is conducting for a very brief period, which is actually less than the duration of the discharge pulses. Dual step discharge follows the same principles except two discharge circuits are used. The storage capacitor is first discharged in steps equal to 10 channel widths until its potential is reduced to a value corresponding to the 13th channel. Discharge then proceeds in steps equal to a single channel width until the base potential is reached.

Figure 3 shows the components of the dual step converter. To accommodate signals with various risetimes the input pulse is first stretched to approximately 3 microseconds. When the signal is accepted the signal recognition circuits trigger a gate generator which opens the transfer gate. The signal is allowed to charge the storage capacitor situated in the analog store. A delayed pulse with respect to the signal, triggers a bistable unit whose output removes the clamp on the 1 Mc/s clock generator.

Under steady state conditions both ten's and base line discriminators remain inactivated. The units gate is normally open and the ten's gate closed by com-

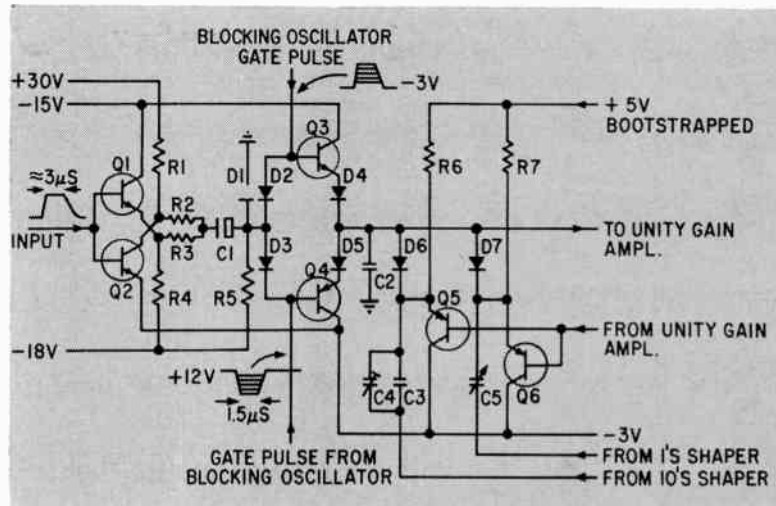

Figure 5 — Circuit diagram of transfer gate and analog store.

is an improvement by a factor of 8 compared with a single step encoder. However, such a reduction is not obtained without some penalty. For uniform channel width, especially at (13th channel) transition regions the step ratio must be maintained with extreme accuracy. This requires accurate temperature compensations of the circuits.

Pulse stretcher

Figure 4 shows the pulse stretcher circuit which precedes the encoder itself. Its function is to stretch the pulse to approximately 3 microseconds. Normally D1 is conductive and passes the relatively small current of Q₁. The signal charges C₂ to its peak value through D1. Almost simultaneously with the arrival of the signal Q₂ is cut off by a signal recognition pulse applied to the inverter stage Q₁. When the signal falls off in amplitude D1 becomes non-conductive and C₂ retains the charge for the next 3 microsecond period determined by the width of the signal recognition pulse. The decaying edge of the signal recognition pulse causes Q₂ to conduct heavily and C₂ discharges rapidly to ground via Q₂ and D3. Q₃ and Q₄ form a current amplifying stage and consist of a complementary pair of transistors slightly forward biased by the chain of resistors R₆ to R₉.

Figure 6 — Diagrammatic arrangement of unity-gain amplifier.

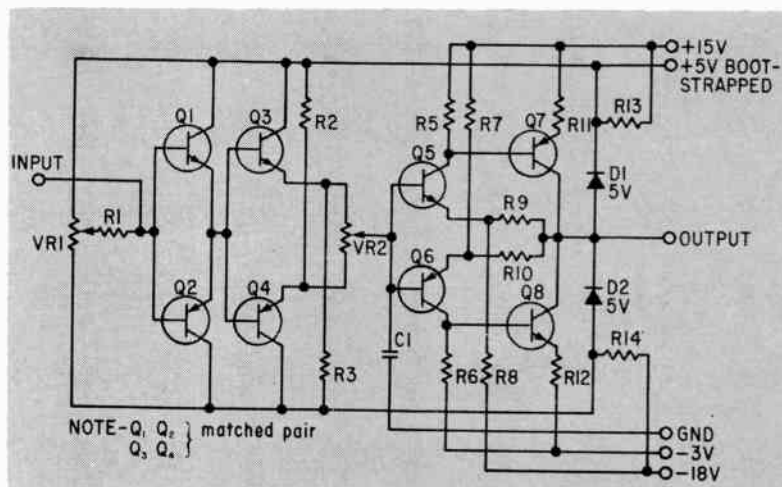

plementary outputs of the ten's discriminator. When the amplitude of the accepted signal is above the 13th channel level both discriminators are fired. This causes the opening of the ten's gate and the closing of the unit's gate. The clock pulses are directed to ten's discharge capacitor and the discharge proceeds in decrements of 10 channel widths. Simultaneously, ten's code pulses are counted in the Address Register.

The 13th channel cross over point is sensed by the ten's discriminator which immediately shuts by the ten's gate and opens the unit's gate. The discharge proceeds in units channel widths until the base line discriminator is triggered. The output of the discriminator then resets the bistable unit which stops the clock from generating further pulses and the encoding process is thereby completed. For an input signal amplitude less than the 13th channel equivalent, the encoding process is performed using only unit discharge steps.

The encoder in the Kicksorter has been designed to provide 400 channel resolution for a 10 volt pulse applied to its input. The channel width is thus 25 millivolts. For a maximum amplitude signal the conversion time is approximately 50 microseconds. This

Transfer gate and analog store

The stretched signal is passed through another current amplifying stage consisting of Q_1 and Q_2 as shown in Figure 5. The signal is DC restored by D1. The transfer gate consists of diodes D2, D3, D4, D5 and transistors Q_3 and Q_4 . Normally, all diodes and

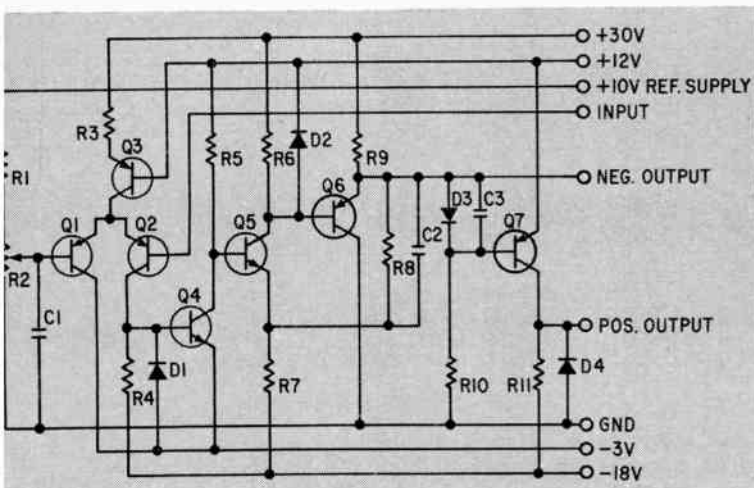

Figure 7 — Circuit diagram of the discriminator.

transistors are cut off and the gate remains closed for signals. When the signal is accepted a blocking oscillator is triggered and generates a paraphase pulse of 1.5 microseconds duration. These pulses open the gate and the storage capacitor C_2 is allowed to charge to the peak value of the signal. Upon termination of the gate pulses the diodes become again non-conductive. For proper operation of the gate it is important that positive and negative gate pulses must be time coincident to a close tolerance. D_4 , C_3 , C_1 and Q_5 form a decade discharging circuit and D_5 , C_2 and Q_6 unit discharge circuit. Note that resistors R_6 and R_7 are returned to a +5 volt boot-strapped supply to provide

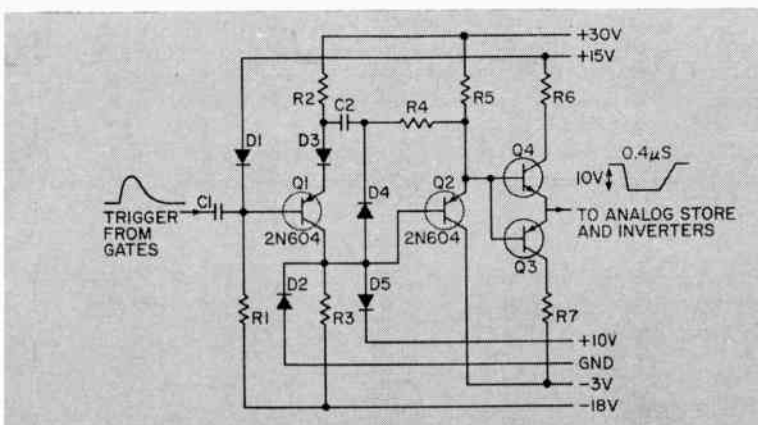

Figure 8 — Circuit diagram of the pulse shaper.

a constant current supply to Q_5 and Q_6 . This supply is obtained from a unity gain amplifier. Diodes D_6 and D_7 are fast recovery silicon diodes. Note also that the bases of Q_5 and Q_6 are driven by the output of the unity gain amplifier.

Unity gain amplifier

To achieve good linearity it is essential that the A-C impedance of the unity gain amplifier must be very high. Also, all leakage currents which tend to charge the storage capacity must be kept to a minimum.

The circuits are designed in such a fashion that the leakage currents tend to cancel out to a large degree. High A-C impedance is obtained by cascaded current amplifying stages consisting of complementary pairs of transistors.

Figure 6 shows the unity gain amplifier circuit. It consists of 4 amplifying stages. Transistors Q_1 , Q_2 , Q_3 and Q_4 are matched as closely as possible for equal I_{c0} and current gain factor β . Note that the collectors of the transistors are returned to a boot-strapped voltage supplied by a pair of zener diodes D1 and D2. This assures high collector impedance as well as preserves reasonably equal I_{c0} for all conditions.

The last two stages provide a slight voltage gain to offset voltage attenuation in the amplifier. The output of the amplifier drives a pair of 5 volt zener diodes which provide boot-strapped supplies for the first two stages. The A-C input impedance of the amplifier is of the order of 50 megohms for high beta transistors and the transient response and signal delay are satisfactory for the intended purpose.

VR_1 is used to set up the steady state DC level at the input to approximately zero potential. This, in effect, cancels to a large degree the leakage currents

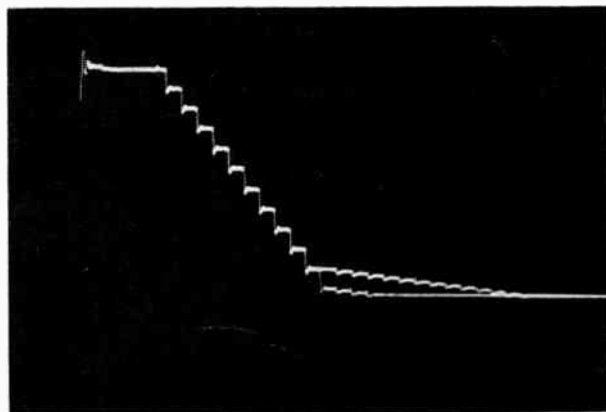

Figure 9 — Oscilloscope trace illustrating the encoded waveform and the action of the decade discriminator.

without deterioration of A-C input impedance of the amplifier. VR_2 adjustment offsets slight variations in base-emitter drops in the amplifier so that DC level at the output is almost the same as the input.

Discriminator circuit

Both ten's and base line discriminators use essentially the same circuits as shown in Figure 7. For positive triggering at cross-over points it is essential that the sensitivity of the discriminators must be high. Transistors Q_1 and Q_2 form a differential amplifier stage. The threshold potential is adjusted by R_2 and the input signal is applied to Q_2 . Transistor Q_3 supplies a constant current which is switched from Q_2 to Q_1 and vice versa, depending on the voltage level of the signal. The voltage developed across R_1 is further amplified by Q_4 . Transistors Q_5 and Q_6 form a fast Schmitt trigger circuit which provides sufficient voltage swing for gating purposes. An inverter stage Q_7 provides the complementary output required for gating. The sensitivity of the discriminator is such that a 1 millivolt swing of the input signal about the threshold triggers the discriminator fully.

Pulse shaper

As mentioned previously, the pulse shaper produces amplitude controlled discharge pulses. The circuit, as

shown in Figure 8, uses a well known emitter-coupled monostable multivibrator stage consisting of Q_1 and Q_2 and a complementary emitter follower stage Q_3 and Q_4 to provide low output impedance. Elements C_1 and R_1 differentiate the positive trigger pulses. Normally Q_1 passes full current and the trigger pulses cause the collector of Q_1 to move in negative direction. This fall in the potential is coupled to the emitter of Q_2 via Q_3 and C_2 thereby reducing further the current of Q_1 . The collector of Q_1 moves further in a negative direction and the regenerative action continues until diode D_2 clamps the collector of Q_1 to ground potential. Following this action, capacitor C_2 is charged linearly by the current in R_2 until Q_2 starts conducting again after about .4 microseconds. The reverse regenerative action of the trigger pair is continued until Q_1 is fully conducting and D_3 clamps the collector of Q_1 to +10 volt supply. The inclusion of D_4 speeds up the recovery of the circuit by rapidly recharging C_2 . The diode D_3 in the emitter of Q_1 ensures that the reverse voltage rating of the base-emitter of Q_1 is not exceeded.

Figure 9 shows the encoded waveform and the action of decade discriminator. The encoded signal consists of 9 ten's steps and 13 units steps. In each case the channel number obtained is 103. The ten's discriminator is just triggered in the transition region.

Figure 10 shows a spectrum taken using the 400 channel Kicksorter and the dual-step encoder. This is a photograph of the energy spectrum of Cesium 137 taken from the CRT display in the Kicksorter. The first broad peak is the Compton distribution and the narrow one a photon peak. Note the scale marker lines generated internally representing zero, 20,000, 40,000, 60,000, 80,000 and 100,000 counts which is the upper limit for the number that can be stored in the Kicksorter. On each scale line are visible dot markers for each channel. There are short spaces for groups of 10 channels and longer spaces for groups of 100 channels. This facilitates a reasonably close estimate to the number of counts in each channel without resorting to other more complicated means.

Linearity and stability of the encoder

Good linearity implies uniform channel widths over the full range of the encoder and also stability of the channel position. Using a precision pulse generator, no measurable departure from linearity is found between channels 10 to 350. Above 350 channels

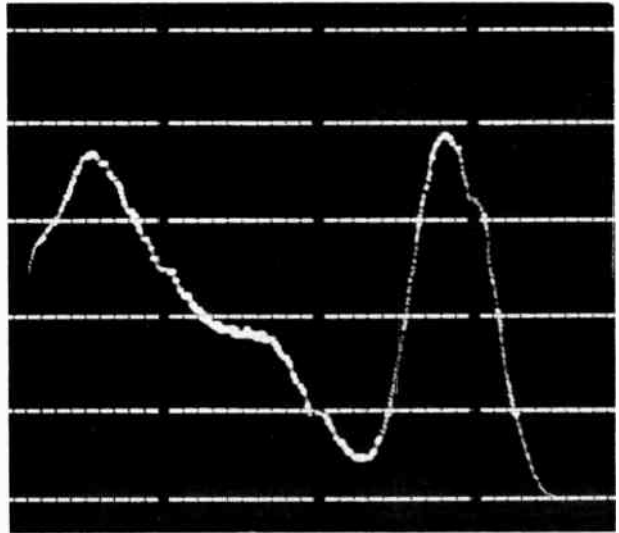

Figure 10 — The energy spectrum of Caesium 137 photographed from the CRT display of the 400-channel dual-step Kicksorter.

however, the channel width was found to increase slightly in recent tests but did not exceed 2% in the last few channels. Such behaviour cannot be immediately explained and it is suspected that over this range the pulse generator may not be functioning properly. In the bottom 10 channels the linearity is well within 2%. Separate measurements have been made on the decade and units step temperature stability. The stability measurement of ten's amplitude steps indicates an increase of 0.1% per 10°C rise in temperature. The units stability was found to be slightly worse with the same tendency towards increase in amplitude.

After an initial warm-up period the stability of the position of the channel over several hours was less than ± 1 channel.

In conclusion it should be mentioned that the performance of the encoder in recent tests was well within expectations but there is room for further refinements. There is a definite possibility of the extension of this technique to include hundred's encoding steps with further reduction of conversion time from a maximum of 50 microseconds to 25 microseconds.

Note:—Dual step conversion has been previously attempted by J. P. MacMahon at Argonne National Laboratory using vacuum tube circuits.■

The "Kicksorter" or Pulse Height Analyzer — in brief

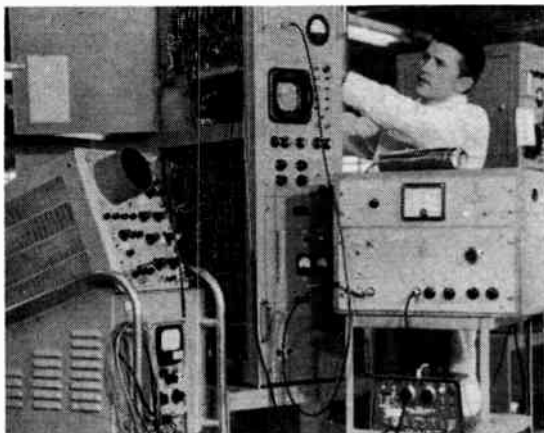

Basically, the Kicksorter consists of a means for establishing a large number of reference levels, or channels graded in unit steps from zero to some maximum value. When a series of pulses of random amplitude distribution is applied to the input, individual pulses are routed to the channel of nearest amplitude correspondence. In this way incoming pulses are effectively sorted. Provision is made for counting the number of pulses applied to each channel and a visual display of channel counts against channel number is provided on a CRT.

The I. F. Module — a new circuit component

New sealed modules contain all circuitry of complete I.F. amplifiers. Units are pre-tuned, simplify receiver design and servicing and improve reliability.

by **G. G. Armitage and B. Tennent***

(first publication of a paper read at the Canadian IRE Electronics Conference, October 1961)

SUMMARY

Through the use of coils wound on subminiature ferrite bobbins, threaded ferrite cup cores and of newly released P.A.D.T. transistors, the I.F. strips of an FM communications receiver have been packaged into two compact, hermetically sealed, pre-tuned components. This ensures built-in optimum performance, reliability, standardization, and simplified maintenance of an important section of FM receivers for all frequency ranges.

Similar developments applying to other sections of FM communications equipment and Citizen's Band Radio, are considered in this paper.

Introduction

The tremendous growth of mobile communications has recently resulted in not only the splitting in half of the adjacent channel spacings in the 50 Mc/s and 150 Mc/s bands but, also in the more extensive use of the

450 Mc/s and even the 900 Mc/s band. It has been necessary to reduce correspondingly the peak frequency deviation to the presently allowed swing of

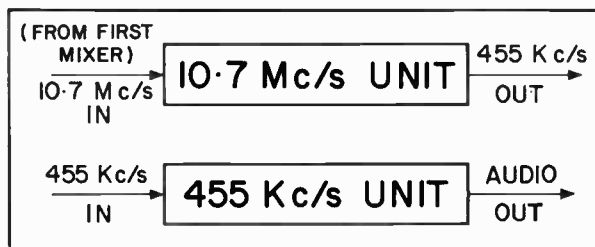
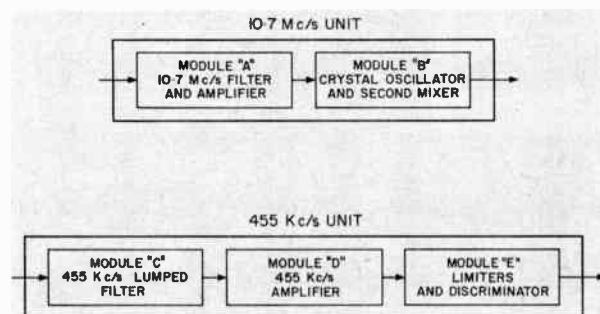

Figure 1 — (above) The basic module concept. Figure 2 — (below) Module packaging block-diagram.



*The Authors



Armitage

Tennent

The two authors are with Ferritronics Ltd., Willowdale, Ontario. George Armitage is president and B. Tennent is vice-president and chief engineer.

± 5 Kc. maximum for the 50 and 150 Mc/s bands and ± 15 Kc. for the UHF ranges. Recently the FCC has authorized the use for some purposes of so-called "split-split channel" or silver band operation with a ± 2.5 Kc. frequency deviation in the 40 Mc/s band. Channel spacings now run from 20 Kc. in the lowest frequency band up to 100 Kc. in the 900 Mc/s band.

These new regulations have increased the requirements for stability, selectivity and signal to noise ratio of the equipment which has, therefore, become more complex, diversified and critical to manufacture. Moreover with the advent of the transistor, the demand has been for equipment which is reduced in physical size and with a lower current drain, as compared to the simpler gear it has to replace.

Consequently, we not only have tube equipment but hybridized and fully transistorized sets. The hybrid equipment may use transistors only in the audio and power supply sections, or include these in all stages in the receiver except the front end.

We feel that the whole problem of designing new FM communications equipment must be re-appraised, to take into account human factors with respect to:—

- (a) standardization,
- (b) maintenance in the field.

The main purpose of this paper is to present a first approach to the solution of the above problem.

Standardization possibilities

If one examines the different present designs of FM communications equipment, particularly mobile gear, it is apparent that several sections of the transmitter and receiver used in such applications are very similar and, therefore, readily lend themselves to standardization. For example, in the receiver, the I.F. strip, the discriminator the squelch circuit, audio frequency amplifier and output stage can be made practically identical for equipment to be used at all R.F. frequency ranges with only small changes in certain elements. The same applies in the transmitter for the modulator, the oscillator, the buffer stage and the frequency multipliers. Only additional multipliers would be required for higher frequency ranges and a different output stage and power supply used in the transmitter depending on the RF power required.

However, the most striking similarity in all types of equipment for all frequency ranges, is in the I.F. strip of the receiver. Double conversion super hetero-

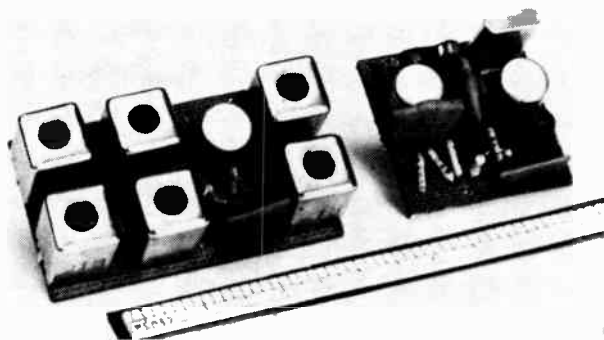

Figure 4 — Two sub-assemblies used in the 10.7 Mc/s module.

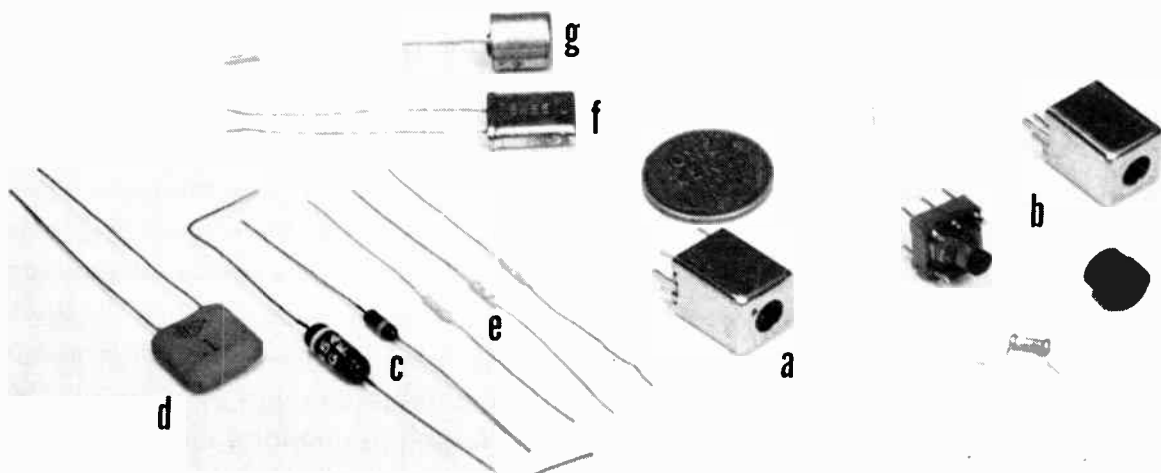

Figure 3 — Component parts of the modules.

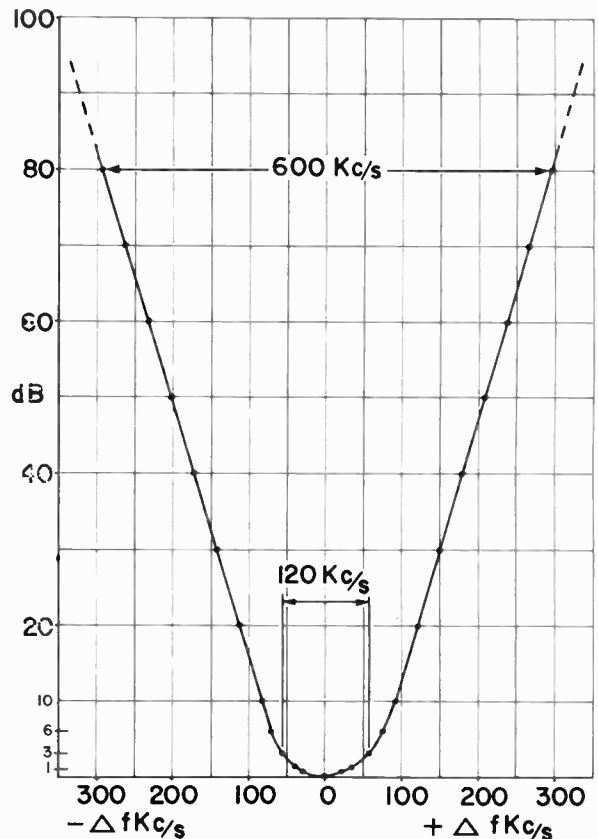

Figure 5 — Band pass curve for 10.7 Mc/s unit.

dynes are universally used and, although the first I.F. frequency may be chosen between 6 and 20 Mc/s, the second I.F. is practically always centered on 455 Kc. It is in this section of the circuitry that we have first proceeded to investigate standardization.

Basic approach

Our first step has been to break down the elements in the I.F. portion of the circuitry into functional sub-assemblies and then to package these into self-contained individually pre-tuned compact modules. These modules are then grouped into hermetically sealed packaged units which can be used as components of

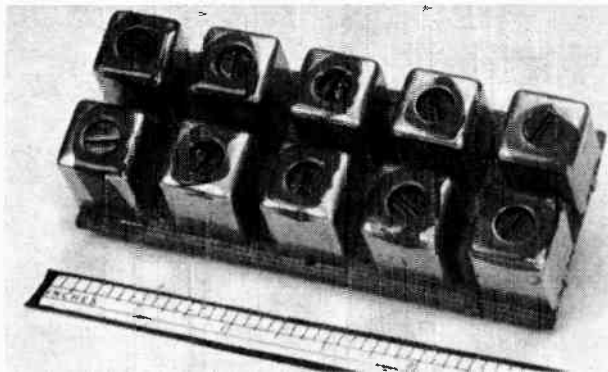

Figure 6 — 455 Kc/s filter — made up from 10 identical permeability tuned resonators.

the end equipment, without any further adjustments.

The above approach has proven to be technically possible and economically sound through the use of the following new type of components and techniques. (See Figure 3.)

- (a) In the filter section, coils are wound with Litz wire on recently released miniature threaded ferrite cup cores and ferrite bobbins. This ensures a high "Q" and small leakage factor due to the highly efficient magnetic circuit employed.
- (b) New, efficient, uniform, reliable and low priced "Post Alloy Diffused Transistors." Type 2N1515, with an average alpha cut-off of 70 Mc/s are used. (It will be seen later that by the use of these P.A.D.T. Transistors, the communications industry has a new, excellent and economical tool for simplification of FM equipment.)
- (c) Special negative temperature coefficient ceramic capacitors employed in the resonators for compensation.
- (d) Printed wiring techniques used throughout.

Figure 1 is a block diagram illustrating the overall concept of packaging the I.F. strip into two single pre-adjusted components and Figure 2 illustrates the division of the I.F. circuitry into five individually pre-tuned modules which are built into the two packages.

Components used

Figure 3 shows the basic type of component parts

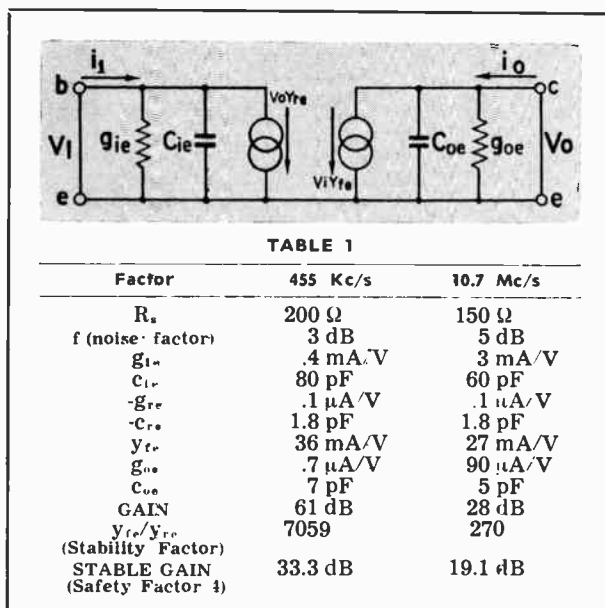

used throughout to construct the modules.

Shown are:—

- (a) An assembled subminiature resonator. Size is .4" x .4" x .6". The resonator is impregnated with a silicone compound and the terminals are laid out to fit printed wiring boards.
- (b) The component parts of the resonator consisting of the threaded ferrite cup core, the ferrite bobbin wound with Litz wire for 455 Kc., a ceramic capacitor with negative temperature coefficient which is built into the coil assembly and the mounting hardware.
The ferrite used for 455 Kc. coils is made of manganese zinc material, while for 10.7 Mc/s nickel zinc cores are used. The unloaded Q's achieved are about 150 and 100 respectively. Whenever necessary the coils are tapped for impedance matching. NPO ceramic capacitors are used for inter-coupling of the above resonators in the filters.
- (c) Germanium and subminiature silicon diodes.
- (d) Low voltage plate type 0.1 mfd. capacitors for decoupling and blocking.
- (e) Miniature Deposited Carbon Resistors.
- (f) A CR60A Sub-Miniature Quartz Crystal at 11.155 Mc/s.
- (g) And as mentioned earlier, the 2N1515 PADT transistor which is used throughout the I.F. strips.

Table 1 shows the average parameters of the 2N1515

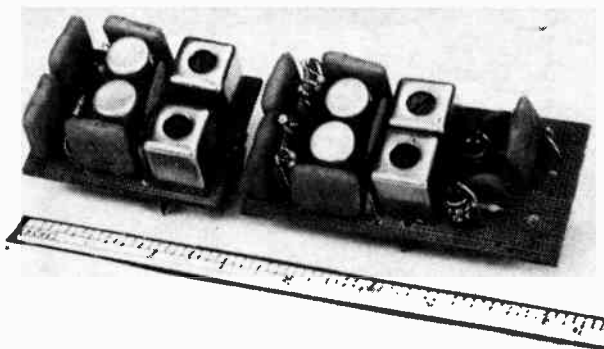

Figure 7 — Module "D" — employs two RC coupled IF amplifiers and double tuned filter.

transistor at 455 Kc. and 10.7 Mc/s for small signals. From these and from the voltage and current characteristics of the transistor, the circuit elements and the optimum matching impedances for the filters and the discriminator have been calculated.

Description of modules

The 10.7 Mc/s Unit

Figure 4 shows the two modules used in the 10.7 Mc/s package.

Module A is composed of a four resonator input filter centred on 10.7 Mc/s, the R.F. transistor amplifier and a double tuned output bandpass filter. The 10.7 Mc/s centre frequency has been chosen for the first I.F. as it is high enough to ensure sufficient image rejection at the front end for the 150 Mc/s range and still enables a single 2N1515 transistor to provide sufficient gain, to more than compensate for the filter loss.

The input impedance of the filter at 10.7 Mc/s is about 5,000 ohms which provides a suitable load for the first mixer using a tube, a transistor or a diode. The output impedance of the module is tapped down to about 300 ohms to match the base impedance of the second mixer.

The overall bandpass response of this module is steep-sided and gives a power gain of about 12db at 10.7 Mc/s.

Module B incorporates a transistorized Pierce type crystal controlled oscillator set at 11.155 Mc/s and a transistor mixer.

The voltage provided by the crystal oscillator at the base of the mixer is about .2 volts and the conversion voltage gain of the module at 455 Kc. is about 14db.

Figure 5 gives the overall bandpass response of Module A.

The curve has a bandwidth of about 120 Kc. at the 3db points which is wide enough to accommodate the full frequency swing plus the unavoidable centre frequency shifts with temperature in the transmitted frequency, the local oscillator and of the filter which varies within ± 10 Kc. over the temperature range from -20° to $+60^{\circ}$ C. It can be seen that the second image rejection at $+10$ Kc. off centre frequency is over 100db down.

The 455 Kc. Unit

Module C (Figure 6) is a lumped 455 Kc. filter which is made up of a tandem of ten identical permeability tuned resonators capacitively coupled with proper terminating taps at each end. The filter is basically of a high impedance type and the input is tapped

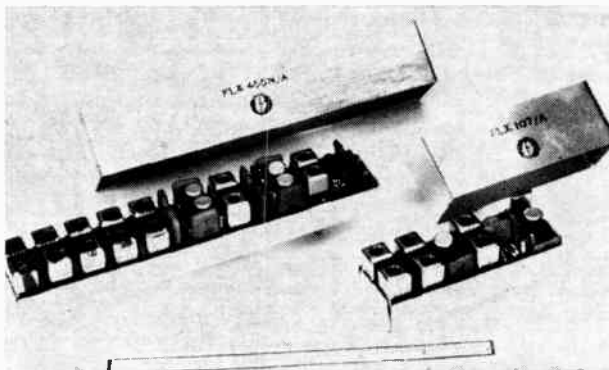

Figure 9 — Photograph of the two complete IF modules, with covers removed. Each unit has only four terminals.

down to 6.8K which provides a suitable load for the collector of the second mixer. The output impedance is tapped down to 1.5K which matches the base impedance of the following transistor stage. There are two versions of the above module: — one for narrow band; the other for wideband operation; the difference being only in the value of the coupling capacitors used and in the taps of the end coils.

In designing the I.F. amplifying and limiting stages, the choice existed between the usual way of coupling the I.F. stages by the use of separate tuned circuits for each stage, with neutralization, or the simpler way of coupling through R.C. networks. Experience proved that, in the first case, a stable voltage gain of only about 27db per stage could be obtained due to the high level of damping necessary. Even then, very careful layout was required to avoid unwanted oscillations due to the high internal feedback inherent in the transistors. Using R.C. coupled amplifiers, a stable voltage gain of 34db per stage is readily obtainable without neutralization and the units can be packaged compactly with little difficulty.

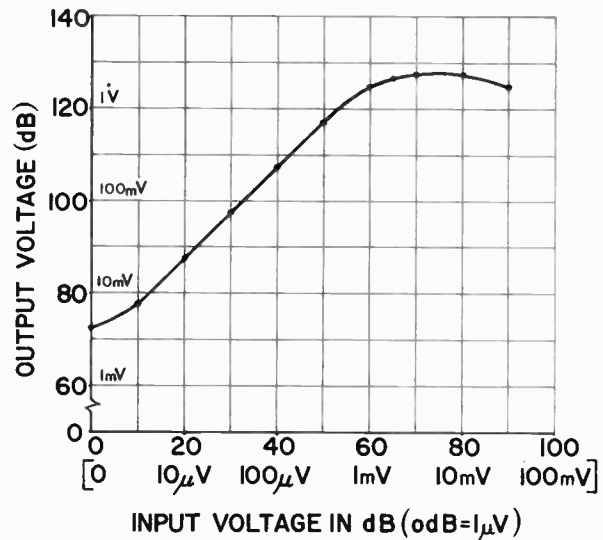

Figure 8 — Gain characteristics of sub-module "D" measured at 455 Kc/s.

However, it has been found that a second bandpass filter is required between the amplifier and limiter stages to reduce white noise. Without such a filter, the inherent noise of the 455 Kc. I.F. amplifier (with its .5 Mc. bandwidth) has a detrimental effect on the operation of the limiters and of the squelch system.

Module D (Figure 7) incorporates the two R.C. coupled I.F. amplifiers followed by the double tuned high impedance filter with proper taps at each end.

Module E includes the two R.C. coupled limiter stages which are basically identical to the above I.F. amplifiers, but have in addition two silicon diodes at each base for limiting purposes.

This module also has the built-in phase discriminator comprised of two link coupled resonators with the associated matched pair of germanium diodes.

Again, there are two versions of these two modules depending on whether they are to be used for wide or narrow band operation. The differences are confined only to the values of the coupling capacitors in the filter and discriminator, and to the location of the coil taps for suitable impedance matching. Each stage of the 455 Kc. amplifier is separately decoupled from the B+ supply by R.C. networks connected in cascade to avoid interaction through the internal resistance of the supply line.

Figure 8 shows the gain characteristic of each of the R.C. coupled I.F. amplifiers. It can be seen that a stable voltage gain of over 60db is obtained from a pair of transistors at 455 Kc.

Overall performance

Figure 9 shows the two packages supplied as components ready for incorporation in a receiver chassis.

The sizes of the units are respectively:—

- 10.7 Mc/s unit — $3\frac{1}{4}'' \times 1\frac{1}{4}'' \times 1\frac{1}{4}''$
- 455 Kc. unit — $6\frac{1}{2}'' \times 1\frac{1}{4}'' \times 1\frac{1}{4}''$

Total current drain at a battery voltage of 12.8V is below 9 mA and only four solder joints are necessary to connect each package. Also, the circuitry is off ground so that supplies with positive or negative ground may be used.

The packages are hermetically sealed with a silicone adhesive in such a way that they may be readily opened at the factory for repair, should this become

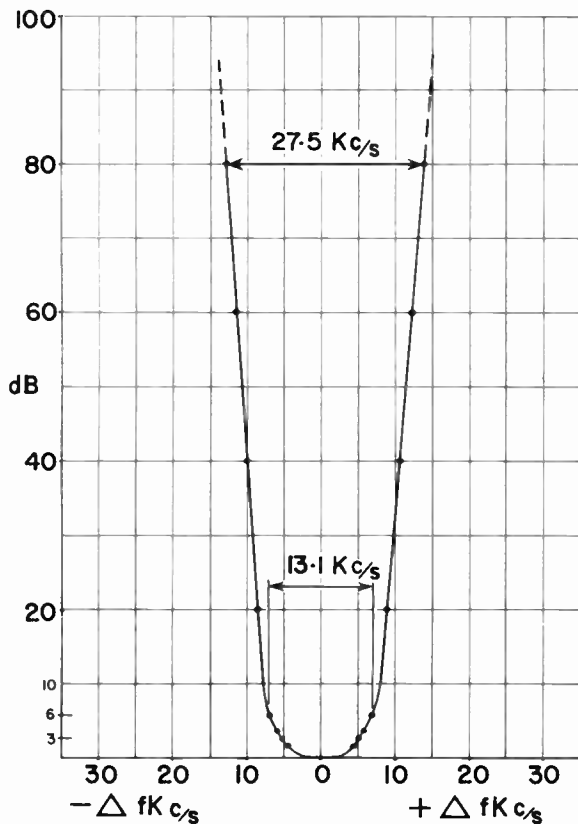
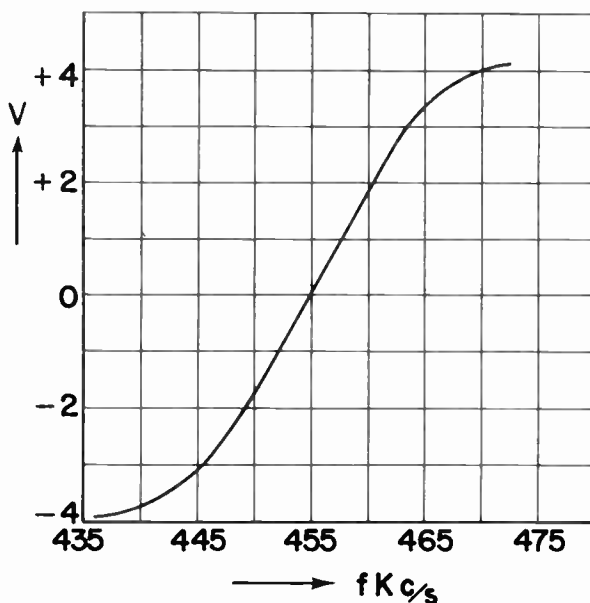

Figure 10 — (above) Overall selectivity curve for the 455 Kc/s unit. Figure 11 — (below) Characteristic curve of discriminator.



necessary, and yet are difficult to open in the field by unauthorized personnel.

Figure 10 shows an overall selectivity curve of the narrow band version. The acceptance band is about 13 Kc. at the 6db points, whilst the rejection at ± 15 Kc. is over 80db down. There is no re-entrance in the attenuation curve on either side. The centre frequency stability with temperature over the range -20° to $+60^{\circ}\text{C}$ is within ± 500 cps of the nominal, which is factory adjusted within ± 250 cps of 455.000 Kc. at room temperature.

Figure 11 shows the amplitude versus frequency response curve or the "S" curve for a narrow band

unit. It can be seen that the slope is about .4 volts per Kc. The distortion as measured by dynamic test is below 2% for a 1000 cycle tone. The voltage gain of the I.F. strip is above 100db and full limiting is achieved at an input signal of about 1 millivolt. A total of only seven transistors is used in the two units.

Further developments

As mentioned earlier, the same type of modular approach can be applied to other elements of FM communications equipment. For example, work is presently proceeding on a packaged audio unit composed of the following modules.

- (a) *Squelch Circuit* consisting of:—
 - (1) A high pass filter.
 - (2) Noise operated amplifier.
 - (3) Diode voltage doubler.
 - (4) D.C. amplifier.
- (b) *Audio Pre-amplifier* activated by the above squelch circuit and incorporating the de-emphasis network.
- (c) *Audio Output Stage* equipped with two transistors connected in a sliding-bias arrangement through a Zener diode.

Furthermore, plans are underway for a modulator unit of revised design. This will incorporate a three stage transistor audio amplifier with an automatic deviation limiter, a 2000 cps low pass filter and a pre-emphasis network.

The approach to the construction of FM communications equipment as described herein can also contribute greatly to the reliability of essential and emergency services through the redundancy conception. The various packages can easily be paralleled and switched by means of relays, while the miniature size of the units still enables the production of equipment of moderate size. In this regard, a recently developed micro-miniature mercury relay has been successfully used to switch circuit elements operating at frequencies up to 150 Mc/s.

An additional application of the two components describes is for field conversion in a matter of minutes, of existing wideband tube type mobile gear, into ready to operate, narrow band, hybrid units at an economical cost.

Conclusion

To conclude, it is felt that the modular approach to the design of FM communications equipment permits:—

- (a) The standardization of important sections of the circuitry common to practically all FM sets and independent of the frequency band used.
- (b) A smaller overall equipment size and weight with reduced current drain.
- (c) An improved stable performance in the field with closer tolerances on the assigned frequencies, and best obtainable "Sealed-In at the Factory," selectivity, phase linearity and other important parameters.
- (d) Servicing problems drastically reduced, resulting in a minimum of test equipment and skill required, and with no chance for error in readjustments.
- (e) A simple and economical way to provide "built-in" reliability, for Emergency, Public Safety and Military Services, by parallel redundant module construction with automatic relay changeover provisions.

The chargistor — a new class of semiconductor devices

The Chargistor is a new semiconductor device which employs space charge control and can operate at high voltage

by Dr. Hwa N. Yu*

(article kindly made available by IBM from an original paper in the IBM Journal of Research and Development, October 1961)

This article describes a new class of semiconductor devices called Chargistors. Each device is composed of a bar of either p-type or n-type high resistivity semiconductor material to which a number of rectifying contacts or control electrodes are attached. The conduction through the bar due to hole injection at one end and electron injection at the other is limited by space charges. The space-charge regions exist because both holes and electrons recombine in the intrinsic body. The potential and space-charge distribution in the body can be changed by the action of the control electrodes which cause the current flow to be modulated. The characteristic curves of these devices were observed

to be similar to those of vacuum tube triodes, tetrodes, and pentodes, which indicates that the control electrodes behave in a similar manner to grids.

Basic configuration

The basic working model of a triode Chargistor as shown in Fig. 1 was made of a slab high resistivity n-type, germanium bar resistivity ≈ 45 ohm-cm, lifetime ≈ 200 μ sec) with the dimensions of $0.010 \times 0.030 \times 0.200$ inch. All three electrodes, the p-type "charger",

*See page 32.

Figure 2 — Output V.-I. characteristics of the triode Chargistor.

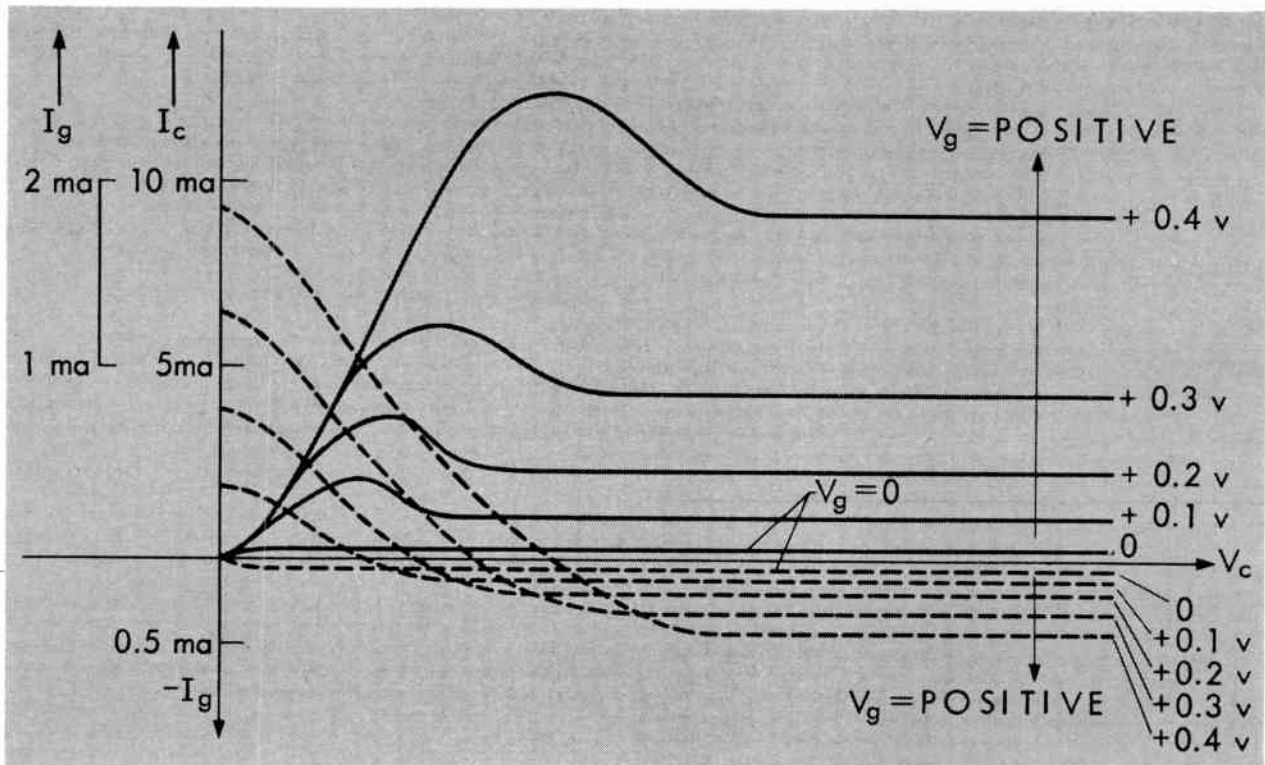

the *n*-type "feeder", and the *p*-type "gate" are alloyed on one surface of the bar. Indium was used for the *p*-type contacts and lead-tin-arsenic was used for the *n*-type contact. The *p*-type gate electrode was placed

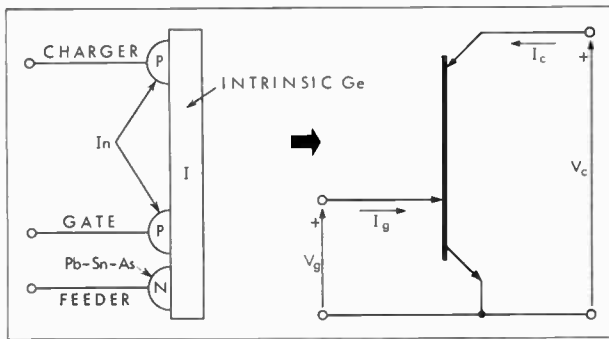

Figure 1 — The triode Chargistor showing junction arrangement and equivalent circuit.

somewhat closer to the *n*-type feeder electrode in order to obtain high transconductance. Contacts were alloyed in the form of strips having dimensions of 0.010×0.030 inch. Even though dots with the diameter of 0.010 in. have been used, it was found that when strips were used the units were more reproducible.

With positive voltage input to the *p*-type gate, the output V_c - I_c characteristics of the *p*-type charger are shown in Fig. 2. The dotted lines in the same Figure show the corresponding family of input current versus output voltage. Negative resistance as well as constant-current characteristics are obtained. These characteristics can be used for applications associated with switching, amplifying, and oscillating circuits. Figure 3 shows the output V_c - I_c characteristics when the input is open-circuited, short-circuited, and when the output conductance is saturated. The active operating range of the device lies between the short-circuited curve and the saturation curve, which are analogous to the cut-off curve and the saturation curve of a transistor or a vacuum tube.

Principle of operation

The operation of the Chargistor relies on electrostatic potential shielding as well as on the conductivity modulation effect caused by space-charge variations. The forward-conduction phenomenon of a PIN diode has been the subject of many investigations. Recent work of Lampert and Rose¹ has shown that space-charge buildup due to recombination of holes and electrons in the intrinsic body has limited the injected plasma density² even though the space-charge, due to excess charge carriers over the plasma, is a relatively small quantity as compared to the plasma density. Kleinman³ has shown

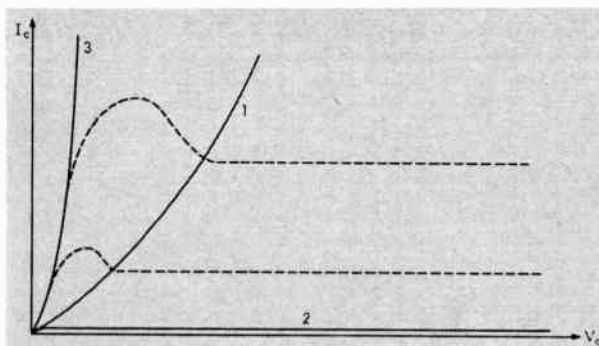

Figure 3 — Output V_c - I_c characteristics of a triode Chargistor with (1) Input open-circuited, (2) Input short-circuited, and (3) Output conductance saturated.

that, in the case of a PIN diode with a short *I*-region the V - I characteristic is expected to be similar to a *pn* junction diode since the conductivity of the short intrinsic region is fully modulated by the injected carriers. The possibility arises that if the space-charge due to excess carriers over the plasma could be compensated, the conduction through the PIN structure could be greatly increased. When a hole-injecting contact is placed in the region where excess electrons or negative space-charge exists, the injected holes tend to neutralize the excess electrons and thereby cause the conductivity to be increased. When the output voltage, V_c , is raised, the potential in the intrinsic body becomes sufficiently high to cut off the injection from the gate contact. In the transition region, negative resistance is observed.

When the gate contact is blocked from injecting carriers, the Chargistor action enters another region where the output current becomes constant regardless of the output voltage change. Since both the charge

The Author

Dr. Hwa N. Yu is staff engineer in the Applied Physics Department of the Westchester Laboratories of International Business Machines Corporation's Advanced Systems Development Division.

Previously with IBM Research, Dr. Yu joined ASDD when the division was formed in 1959. He has been with IBM since December, 1957.

Dr. Yu studied at the University of Illinois, receiving his B.S.E.E., 1953, M.S.E.E., 1954 and Ph.D.E.E., 1958.

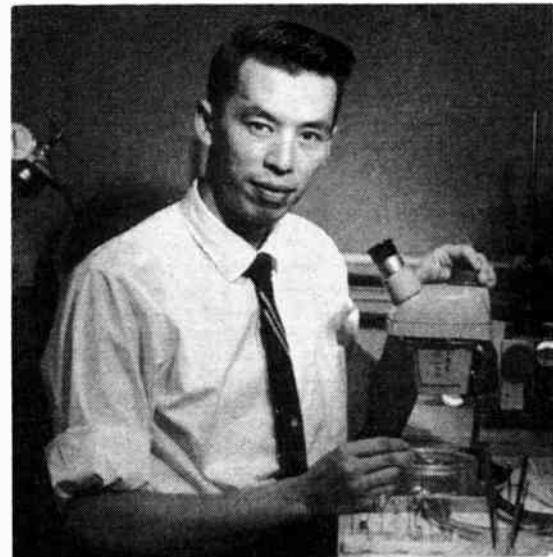

junction and the feeder junction are forward-biased at all times, the constant-output current characteristic would imply that the gate, under this condition, is acting like a grid of the vacuum tube in shielding the potential variation from one part of the body to the other. The potential distribution throughout the intrinsic body has been detected by a potential probe on a free surface of the bar for several values of the output voltage. A typical set of potential-distance curves is shown in Fig. 4. The potential of the intrinsic body in the vicinity of the gate junction assumes a value close to that applied at the gate and stays constant for different charger voltages. The electrostatic potential shielding by the gate junction is very effective. The shielding action of the gate junction is responsible for the constant-current

output characteristics. Since the potential drop in the section between the gate and the feeder ($V_{GF} = V_G$) stays constant with respect to V_C , it is obvious that the current flowing in the bar is controlled by V_{GF} . Unlike the ordinary field-effect transistor,¹ in which the transistor action depends upon the pinching effect by expanding the depletion region of the gate-channel junction, the Chargistor action depends upon the electrostatic potential shielding effect through the gate junction. In the case of the field-effect transistor, zero bias at the gate yields maximum output current, whereas in the case of the Chargistor, zero bias at the gate yields minimum output current or cut-off condition. The effect of the gate junction of the Chargistor is therefore definitely different from that of an ordinary field-effect device.

Tetrode and pentode

The idea of the electrostatic potential shielding effect has been extended further by employing a number of

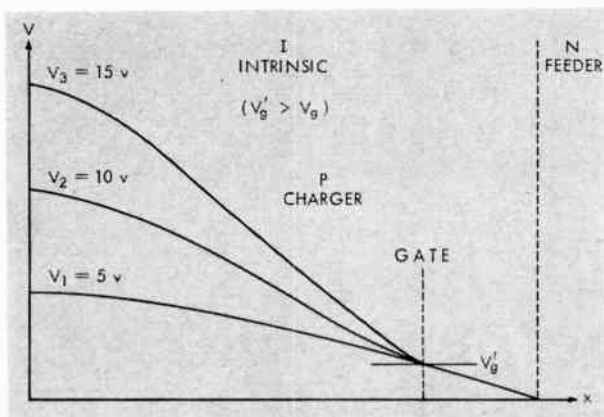

Figure 4 — The potential-distance plots in the intrinsic region of a triode Chargistor for three different charger voltages with constant gate voltage (V_G).

gates. Tetrode and pentode Chargistor devices can be constructed as shown in Figs. 5(a) and 5(b). The description of the complete behavior of such devices is beyond the scope of this article. However, the additional control by the extra gate electrode in the case of a tetrode Chargistor was found to cause the electrostatic potential shielding effect to be more effective. Also, the gain of the device can be controlled by varying the constant-voltage bias applied to Gate-2 electrode. In the case of a pentode, the various parameters can be controlled further by varying the constant voltage bias at either Gate 2 or Gate 3. Under some bias conditions, negative transconductance can be obtained in both the tetrode and the pentode Chargistors. The negative resistance region which is observed in the triode can also be controlled through biases applied to Gate 2 and Gate 3.

The number of electrodes which can be employed and the different geometries which can be used will make the Chargistor device versatile in its functional capabilities. Electrically complementary units with n -type gate electrodes closer to the p -type feeder on the same basic PIN structure have also been constructed and proved successful. A picture of an actual pentode Chargistor and its typical output V - I characteristic are shown in Figs. 6 and 7.

Terminal characteristics

Ordinarily, when intrinsic semiconductor material is used in a device, it is expected to be very sensitive to

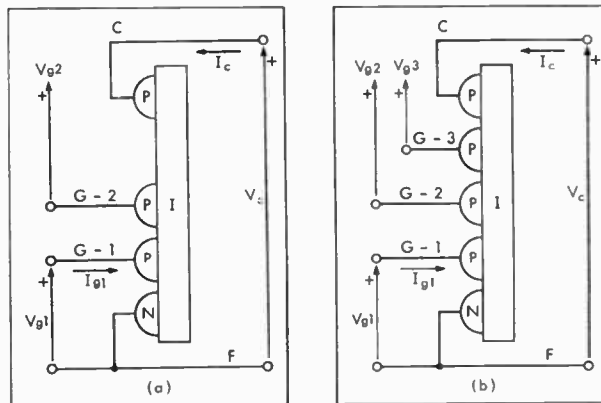

Figure 5 — (a) Tetrode Chargistor, (b) Pentode Chargistor.

temperature variations. It has been found that the power dissipation of several units under test was so high that the temperature of these units reached the melting point of indium. As a result, the germanium crystal dropped from the mounting stems with little variation in the observed output characteristics while the heating was taking place. When a heat sink was provided, a similar device was operated at two watts with a peak current of the order of 0.5 ampere for several hours without any detectable deterioration of its characteristics. When good electrostatic potential shielding is obtained, the output impedance of the device has been observed to be as high as 20 megohms and the operating voltage as high as 200 volts without any noticeable breakdown effect. The high-voltage operation capability of the Chargistor device is primarily due to the shielding effect which causes the potential drop to occur in the section of the intrinsic body between the charger and the gate. As a result, the gate junction does not sustain the entire voltage applied across the body, whereas in the case of a transistor, the collector junction sustains the entire voltage applied to the collector electrode. Chargistor operation beyond 200 volts is definitely possible. In practice, power gain of the order of 50 db has been obtained in a small-signal amplifier circuit with one Chargistor device.

With the Chargistor device described, the operation extends from DC to the submegacycle range. The frequency of oscillation with a typical device is about 200 kc/sec at room temperature. No theoretical limit on the frequency response of the Chargistor device has

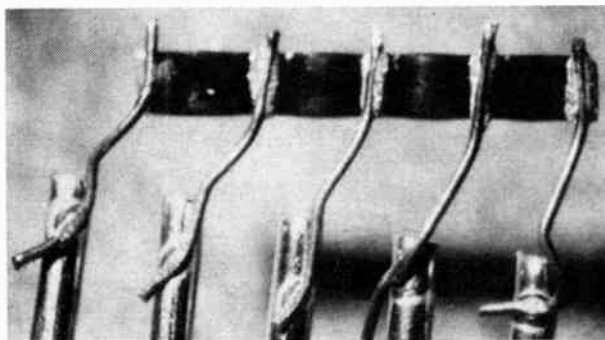

Figure 6 — Photograph of an experimental pentode Chargistor.

been established, although there are reasons to believe that the frequency response of such a device will be lower than that of a transistor. The Chargistor device

Continued on page 58

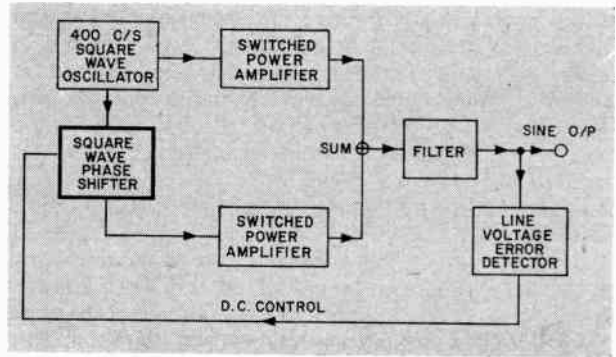
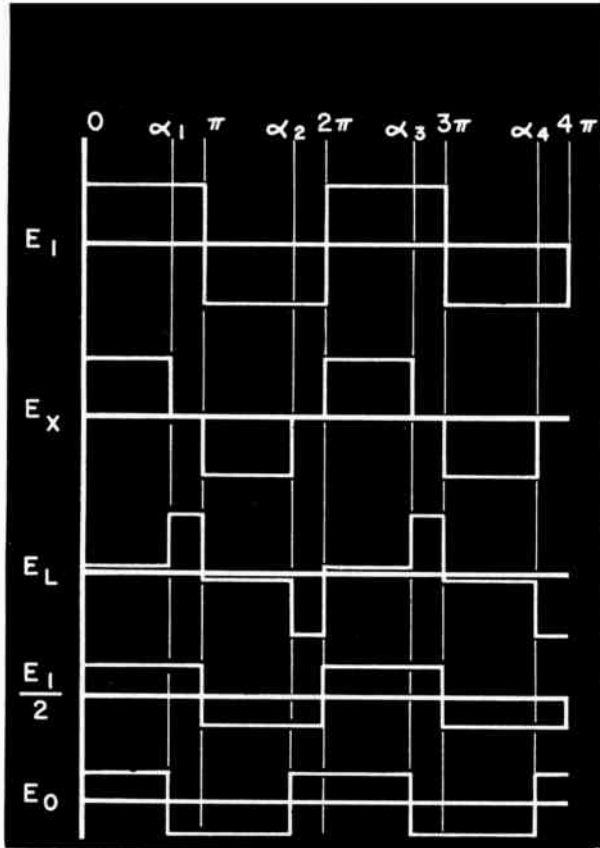

Figure 1 — (lower left) Basic Block diagram of phase-shifter.

Figure 2 — (left) theoretical wave-forms of phase-shifter.

Figure 3a — (above) Block diagram showing use of phase-shifter in voltage regulation loop.

CIRCUIT DESIGN

A novel square-wave phase-shifter

New circuit provides almost 180 degrees of phase-shift and is electronically controlled

by A. E. Maine, P.Eng.

(formerly Chief Electronics Engineer, Special Products Division, De Havilland Aircraft of Canada Ltd., Downsview, Ontario)

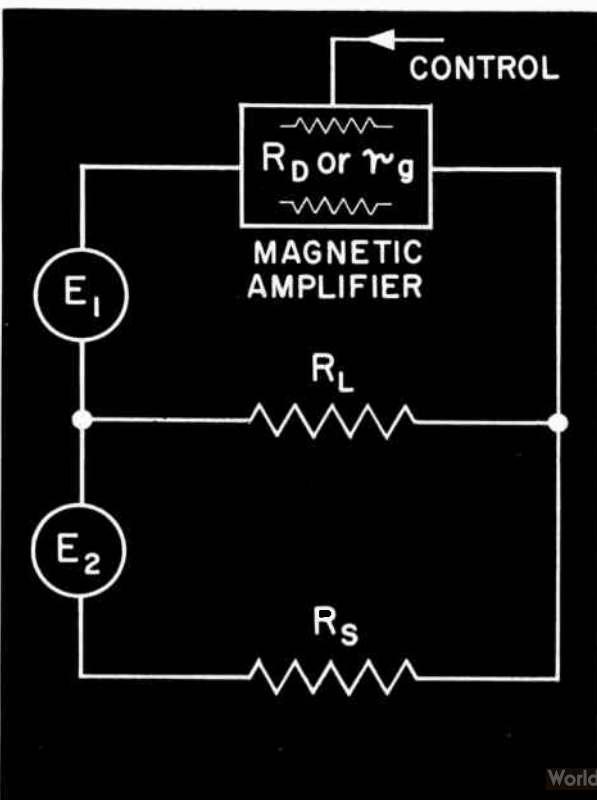

Introduction

Linear phase-shifters using passive elements and operated from sinusoidal supplies are well-known and much used devices in the electronics art. Usually such phase-shifters employ a center-tapped supply working in association with a resistance and a reactance. Adjustment of the value of either of the passive circuit elements permits the phase of the output quantity to be varied over approximately $\pm 90^\circ$ with respect to the sinusoidal input.

By means of introducing active elements into simple phase-shift circuits, for example, the substitution of a rectifier bridge and transistor for the previously used linear resistance, it is possible to provide an electronically controlled phase-shift system. In the example cited, the phase-shift produced would be some function of a control signal applied to the transistor base circuit. It will be recognized that this general kind of controlled phase-shifter constitutes an essential requirement for analog type phase-lock systems, but is only effective so long as the excitation source furnishes a reasonably sinusoidal waveform.

In many classes of equipment it is desirable to carry out all signal handling operations using active elements operated only as switches, thus involving the

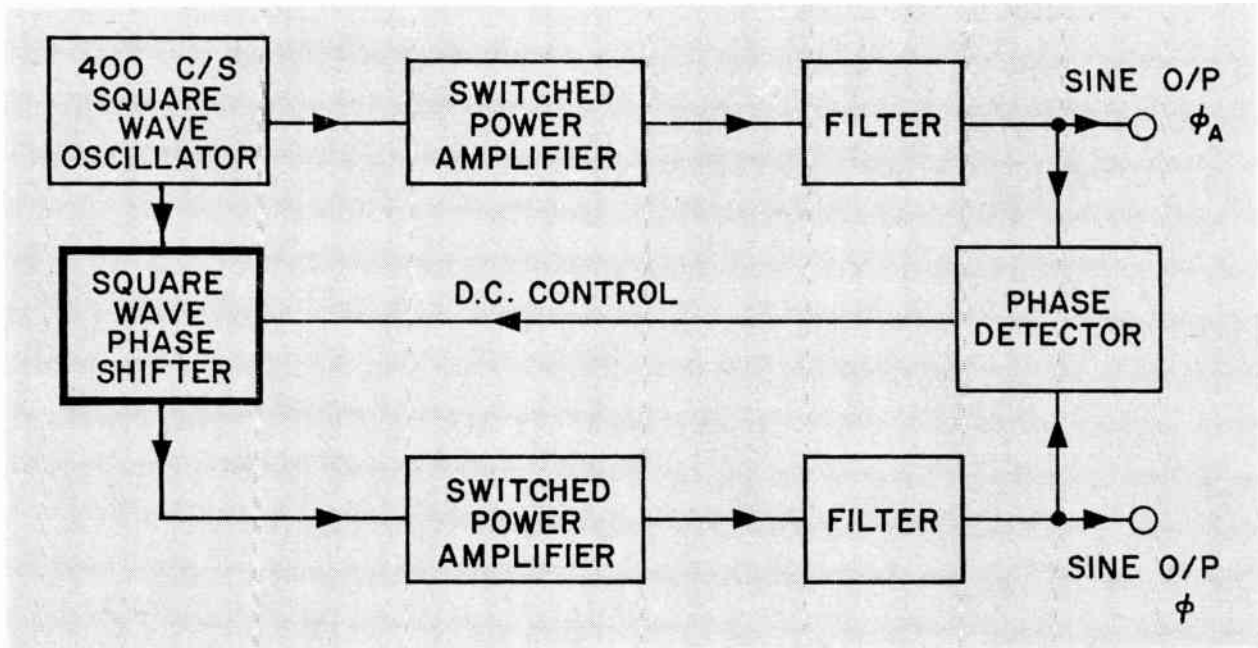

Figure 3b — Block diagram of phase control loop.

use of square-wave rather than the more customary sinusoidal supplies. A particular example here, is the high-performance static inverter. In devices of this kind, the problem arises of providing reference square-waves having precisely controllable phase-relationships. The linear methods mentioned earlier break down under conditions of square-wave excitation because the various

harmonic components are shifted by different amounts and the result becomes a grossly distorted waveform in which both peaks, and zero crossing-points, are of little value in defining the "phase" of the output quantity. Clearly, the ideal circuit arrangement required in such cases would be one, which, employing active elements only in the on/off mode was able to "phase-shift" a square-wave without introducing any significant deterioration of wave-shape.

An electronically-controlled square-wave phase-shifter meeting these general requirements has been designed (world patents pending) and has proven to be an extremely useful and versatile device.

Circuit description

The basic circuit arrangement of the system is shown in Figure 1 and consists of a tapped supply transformer, excited from a square-wave source, an elementary single ended magnetic amplifier and a series resistance. A broadly qualitative description of the mode of operation is as follows, reference being made to the waveforms of Figure 2.

The waveform E_i is that of the supply and if it is assumed that the magnetic amplifier is provided with a suitable d.c. control signal then the voltage across the magnetic amplifier is that designated E_x . The amplifier evidently supports the entire applied voltage until the angular instant α_1 , at which time the amplifier saturates and the supply voltage is then developed across the load for the remainder of the half cycle. The amplifier load voltage component consequently takes the form $E_{1..}$, illustrated in Figure 2. Suppose now, that a means is found for subtracting the full load voltage from half the original square wave (shown as $E_{1/2}$) then the result will clearly be a half amplitude square wave lagging the reference voltage E_i by the angle α_1 , as shown by the final waveform (E_o) in Figure 2. In the circuit given in Figure 1 the subtraction is simply effected by the lower branch voltage E_2 in association with the series resistance R_s . It follows that by means of varying the amplifier control signal and hence firing angle, the output square-wave can be controlled smoothly in phase over a total of 180° .

- (1) For a Pure Square Wave Output:—

$$p^2 (2 + m + q) + p [-2qmn + (m + q)(1 - n)] - 2qmn = 0$$

(NOTE: For other parameter values, output waveform will be double-stepped but this is usually not critical.)

- (2) Output Voltage

$$\frac{E_L}{E_i} = \frac{p - qn}{q(1 + p) + p}$$

- (3) Max Total Input Power

$$W_T = \frac{mn^2 + p + 1 + 2n + n^2}{m(p + 1) + p}$$

- (4) Min Circuit Power Efficiency

$$E\% = \frac{100(p - mn)^2}{[m(1 + p) + p](n^2m + p + 1 + 2n + n^2)}$$

- (5) Max Amplifier Gate Voltage

$$E_x = \frac{q(1 + p + n)}{q(1 + p) + p} \cdot E_i$$

- (6) Max Amplifier Gate Current

$$I_x = \frac{E_i}{R_L} \cdot \frac{1 + p + n}{m(1 + p) + p}$$

where:—

$$p = \frac{R_s}{R_L}, \quad q = \frac{R_D}{R_L}, \quad m = \frac{r_z}{R_L}, \quad n = \frac{E_2}{E_i}$$

and R_D = dynamic resistance of amplifier (pre-firing)

r_z = gate resistance of amplifier (post-firing)

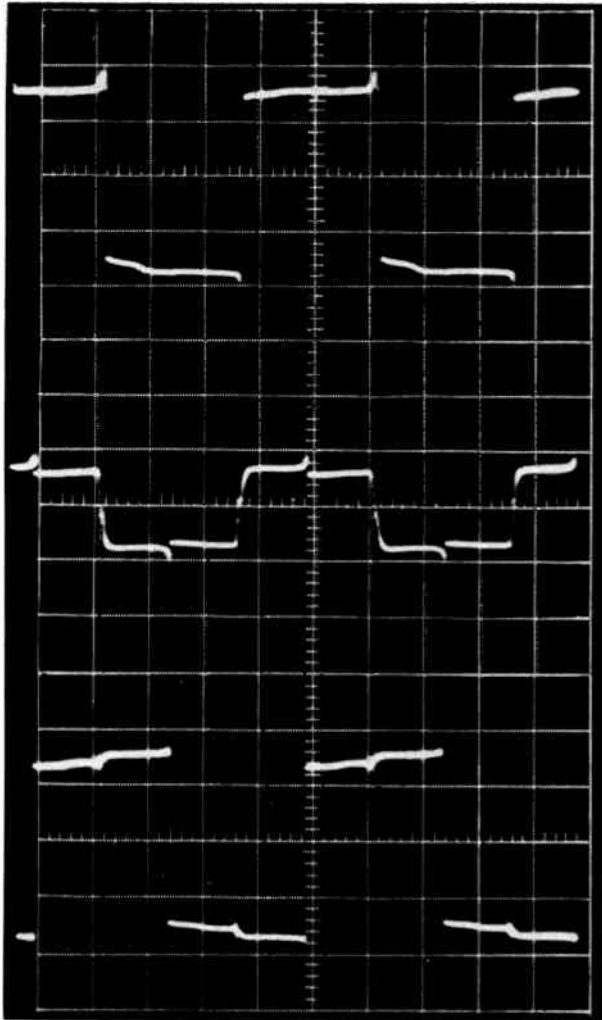
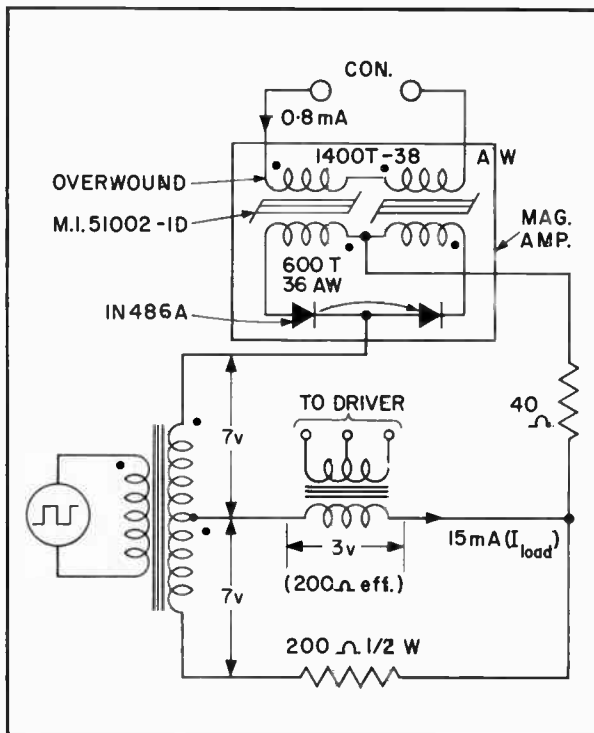

Figure 4 — (above) Bottom: input square wave, center: output from phase-shifter, top: output from following switched amplifier. Figure 5 — Typical circuit arrangement of practical phase-shifter.



Notes on application

Since the magnetic amplifier is normally designed to operate at high gain, only a relatively minute control power is needed to effect a wide change of phase angle. For this reason the magnetic amplifier used in the phase-shift bridge is usually the only amplifying device required in phase and voltage regulator loops. Conventional magnetic amplifiers have a transfer function roughly equivalent to a first order lag and in regulator application it often is desirable to make this lag as large as possible in order to overshadow other faster dynamic terms in the loop. The open-loop performance function thus becomes:—

$$PF_{OL} = \frac{M}{1 + pT}; \text{ where } M = \text{loop gain.}$$

The closed loop function is immediately obtained and is:—

$$PF_{CL} = \frac{M}{M + 1} \cdot \frac{1}{1 + p \left(\frac{T}{1 + M} \right)}$$

In the closed loop condition the amplifier time constant is divided by the loop gain thus resulting in a fast stable response. In this way the phase shifter amplifier can also effectively provide the correct system shaping network to give overall stability especially as the amplifier time constant can be easily varied by means of a shunt resistance, thus controlling overall damping.

Figures 3(a) and 3(b) show typical phase and voltage control loops used for static power inverters made possible by the new phase-shifter. Apart from the error detectors the circuits operate with only on-off active devices. In some applications, notably static inverters operating at frequencies of 1Kc/s and above, difficulty might be found in getting fast enough waveforms from the magnetic amplifier. In this case a pair of low-power SCR's connected as an a.c. switch and gated from a very small magnetic amplifier may be substituted into the basic bridge circuit. As an alternate, the output of the phase-shifter may be cleaned up using a simple transistor squaring amplifier, which in fact, may also serve as a driver in subsequent stages of the equipment. Figure 4 shows actual waveforms recorded at 400c/s indicating the performance of the combined phase-shifter and driver. Unit gave over 170° of phase-shift for 0.8mA into 100 ohms control coil.

Design notes

Analysis shows the systematic relationships existing between the various circuit parameters and the design equation given in Table 1 apply. Figure 5 shows a typical circuit together with applicable values.

Conclusions

The square-wave phase-shifter described has proved itself to be a very satisfactory circuit device in several fields of application and by no means is restricted to the example application given. However, it is generally unsuitable for use in high power circuits because it inherently operates at a rather low efficiency, usually less than 20%, and dependent upon the actual phase angle at which it is used. In cases where a fixed phase output is needed, it is possible to replace the magnetic amplifier by a single saturating choke using square-loop material.

Kind permission to published this article was given by De Havilland Aircraft of Canada. Special Products Division.

Tiny digital computer uses "solid circuits"

Recent demonstration shows fantastic reduction in equipment size through the use of micro-electronic techniques

U.S. Air Force, and Texas Instruments Incorporated, Dallas, Texas, have recently demonstrated in operation a microminiature digital computer utilizing semiconductor networks.

The advanced experimental equipment shown at the left in Figure 1, has a total volume of only 6.3 cubic inches and weighs only 10 ounces. It provides the identical electrical functions of a computer using conventional components which is 150 times its size and 48 times its weight and which is also shown in the figure, at the right for purposes of comparison. It uses 587 digital circuits (T.I. *Solid Circuit* semiconductor networks) each formed within a minute bar of silicon material. The larger computer shown uses, 8500 conventional components and has a volume of 1000 cubic inches and weight of 480 ounces.

Application of semiconductor networks will give equipments higher reliability than can be achieved presently from conventional components. The improvement will be realized because the integrated structure of the networks minimizes connections and eliminates the individual packaging required for conventional components. In addition the network is formed by relatively few process steps, allowing a high degree of

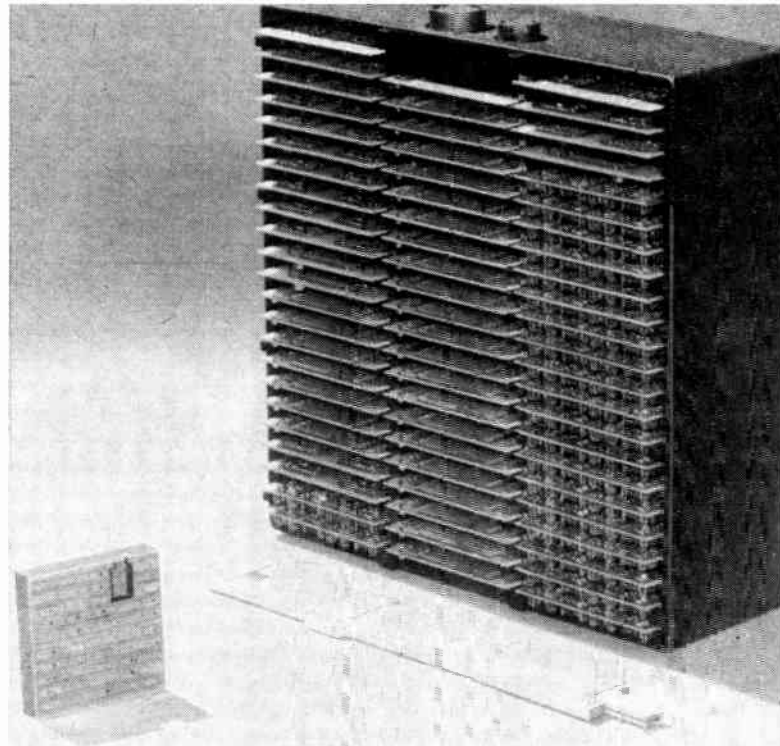

Fig. 1 — New computer (left) compared with conventional unit, right.

control, and uses only very high purity material for its fabrication.

The experimental computer shown in close-up in Figure 2a was developed as a part of the Molecular Electronic Program under the technical guidance of the Electronic Technology Laboratory, Aeronautics Systems Division, USAF. It was built by Texas Instruments as a practical application of "Solid Circuit" semiconductor networks. The successful use these networks in the computer demonstrates their capability for solving the problems of interconnections, thermal dissipation, electrical interaction, and maintenance of high density packaging in equipments of great complexity.

The general purpose computer is a serial binary fixed-point machine with an operand word length of 10 bits, plus sign. It uses synchronous logic, being timed from an internal 100-kilocycle clock. Computer memory is divided into two parts, the operand memory and instruction memory. Three types of semiconductor networks are used in the tiny computer, RS flip-flop NOR gates, and logic drivers; the total power dissipation is 16 watts.

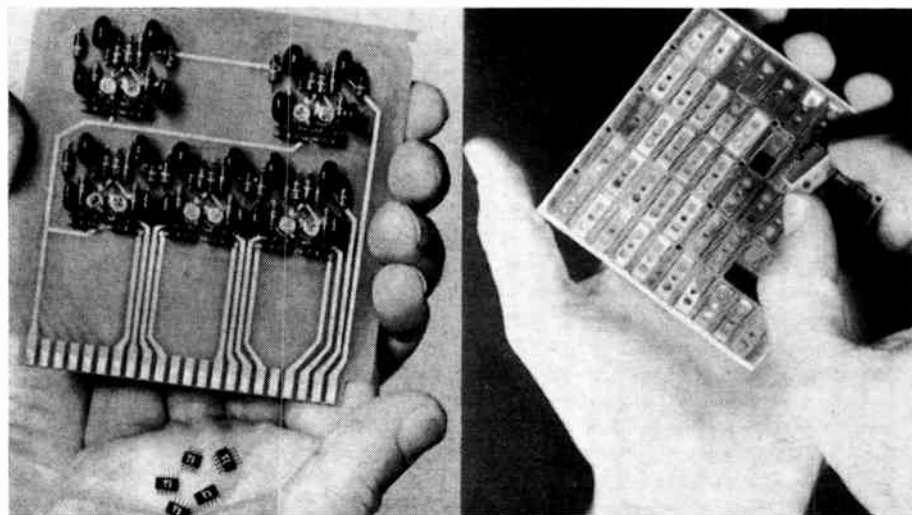

Fig. 2 — Shown at left in palm of hand is a group of tiny "solid circuits" manufactured by Texas Instruments Inc. The circuit board held above shows the size of conventional circuits that do the same job. The photograph at the right is a close-up of the new computer and shows the insertion of a sub-assembly containing many basic solid-circuits.

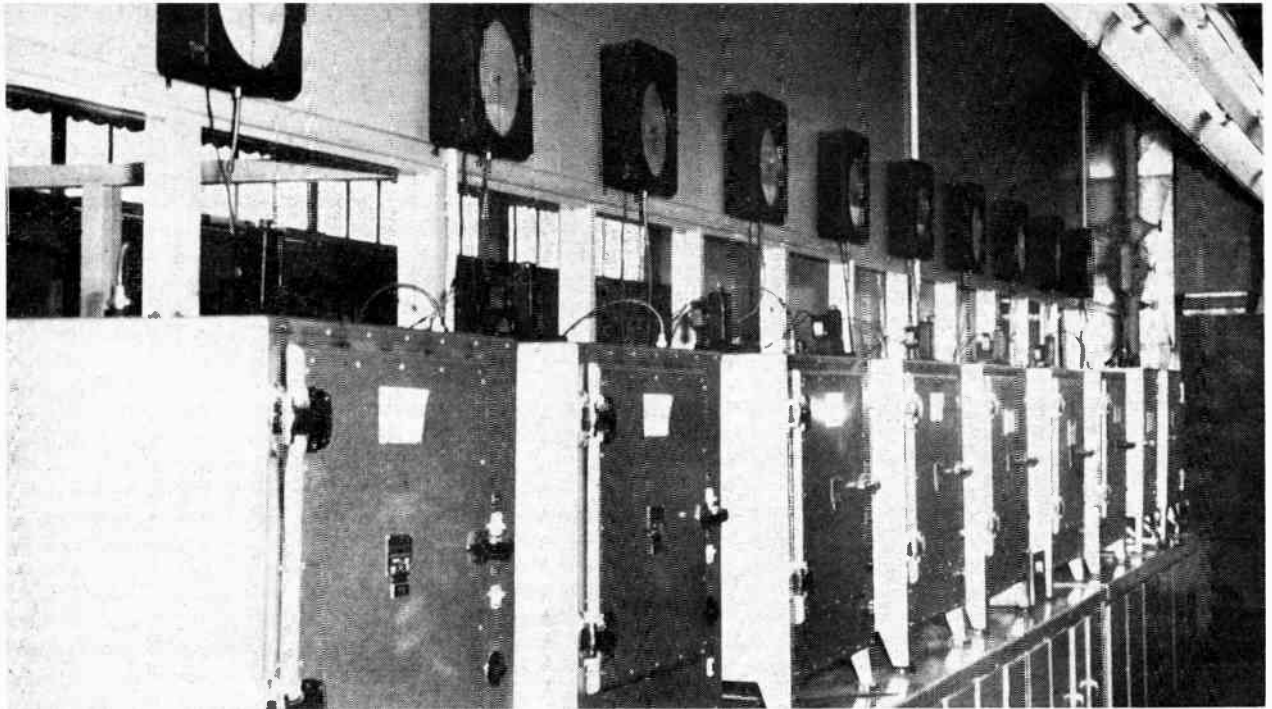

Figure 1 — A battery of ovens used for prolonged temperature testing of insulants on electrical wires.

engineering in Canada

A TOUR WITH THE EDITOR

The CSA testing laboratory

Article gives a brief look at CSA's Testing Laboratory from an electronics slant . . . in paraphrase, safety is their business

CSA's Testing Laboratories are housed in a modern 60,000 square foot building located in Rexdale, Ontario and presently employs a staff of 240 persons including 50 professional engineers. Since the testing laboratory was originally a department within the Hydro-Electric Power Commission (circa 1918), though now entirely divorced from this organization, the writer had the pre-conceived notion that CSA's testing activities would be very substantially electrical in character. A tour of the extensive laboratory area quickly dispels this idea

and it is evident that a large part of the available facilities and effort are given over to investigational work in many other areas. Notable here are the elaborate testing of gas furnaces, gas appliances, plumbing systems and components, fire-fighting apparatus and numerous other items.

In the electrical/electronic areas, the work conducted is primarily in regard to consumer type equipment, the CSA by tradition and indeed by constitution, having a particular duty to protect the public in general from hazards arising from unsafe apparatus. Technical equipment used by technically trained personnel represented a generally lesser problem it was learned from F. R. Whatmough, the laboratory's chief engineer, but CSA expect to compile requirements for scientific and technical equipment used by such personnel in the not too distant future. It was also learned that CSA has planned no regulations for battery operated equipment.

The electrical testing work conducted in the laboratories evidently falls into two informal categories. Firstly, there are routine type tests on a number of items for which specialized and generally substantial facilities have been set up. These include such items as insulated wires, switches, fuses, thermostats and so forth.



The CSA Monogram



The CSA Monogram is licensed for use as the Certification Mark on equipment, or on labels associated with equipment, which has been certified by the CSA Testing Laboratories as complying with CSA requirements.

The CSA Monogram or Label on a product certifies compliance with CSA requirements for safety of performance. It is not intended to indicate efficiency or quality.

The CSA Testing Laboratory

The Canadian Engineering Standards Association was incorporated under the Dominion Companies Act in 1919, as a non-profit, non-governmental organization to provide a national standardizing body for Canada. In 1944, Supplementary Letters Patent were granted, extending its activities to a broader field of standardization and changing its name to Canadian Standards Association.

The CSA Testing Laboratories, inaugurated in May 1940, is a division of the Canadian Standards Association, and is recognized as a testing and investigating agency by Inspection Authorities and by Fire Marshals and Fire Commissioners throughout Canada.

The chief purpose of the Laboratories is to certify by investigation and test that products comply with CSA Standards for safety.

The Testing Laboratories' Administrative Board is appointed biennially by the Board of Directors, and consists of two members from the Board of Directors, two members representing Manufacturers, one member representing the general public and the Manager of the CSA Testing Laboratories (ex-officio).

The Laboratories are located at 178 Rexdale Boulevard, Rexdale, in the Northwestern Area of Metropolitan Toronto, Canada.



F. R. Whatmough — chief engineer of the CSA Testing Laboratory.



The CSA Testing Laboratory, Rexdale, Ontario. Building occupies over 60,000 sq. ft.

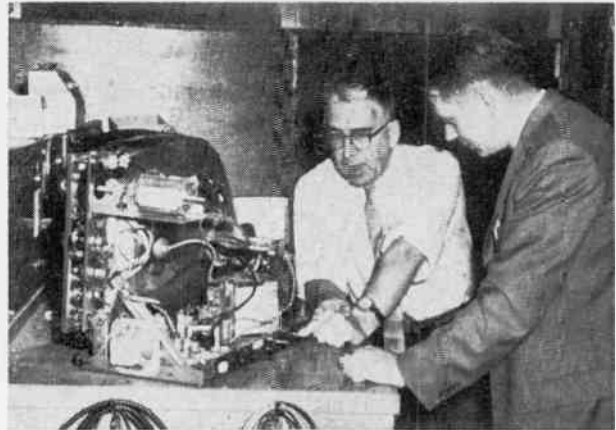

Figure 3 — G. R. Gates, electrical engineer (left) explains to the writer the test procedure employed for TV receivers which are provided with re-settable thermal cut-outs.

The second category of test work is performed in "general-purpose" electrical/electronic laboratories and concerns the very wide range of items submitted to CSA for approval. Typical here, are radio and TV receivers, picture tubes, tape-recorders, amplifiers, electronic organs, fire alarm systems and many more too numerous to mention.

Turning for a moment to the first category, Figure 1 shows a battery of ovens used for testing insulation on wires for creep and elongation and in general establishing the insulation properties of wires as a function of

Figure 2 — Technician B. E. Winger supervises moisture absorption tests on electrical wires. Tests run for 24 weeks.

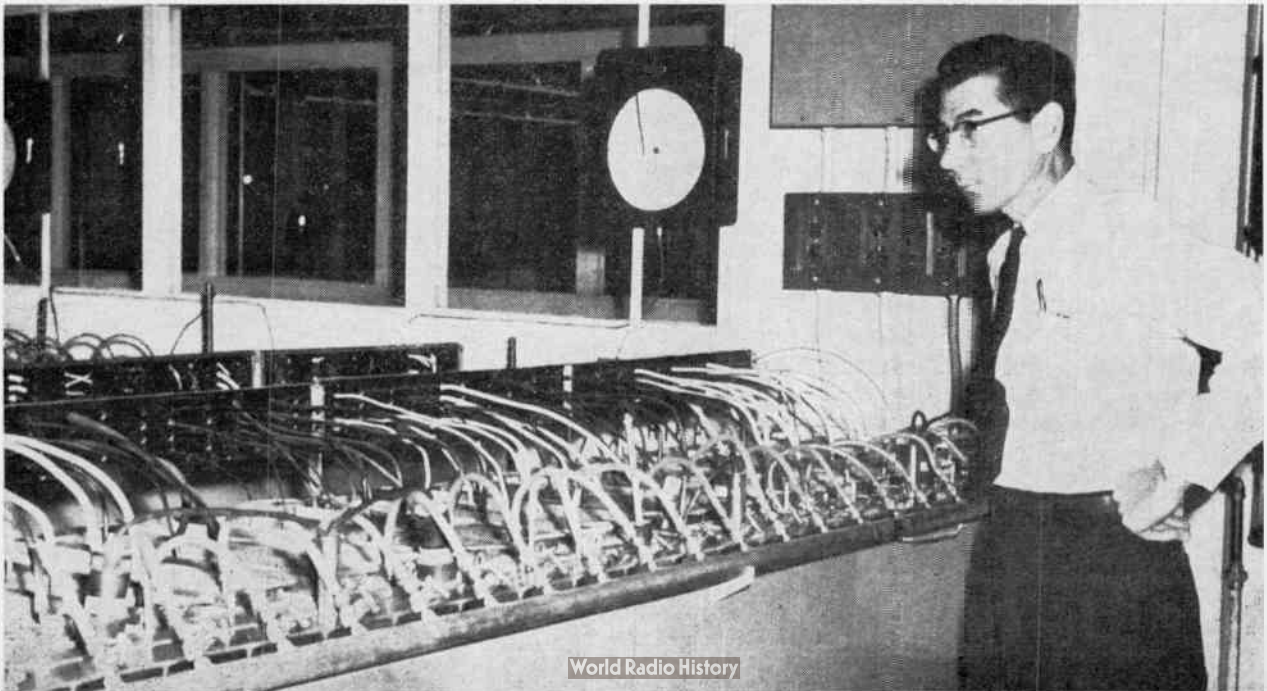



Figure 5

Tests on picture tubes and safety screens

To assess the strength of the safety glass (armour plate glass), a steel sphere weighing 1.18 pounds is swung through the arc of a circle from a point 51 inches above the center of the face of the picture tube to strike the safety screen. There shall be no openings developed in the safety screen, but it may be cracked.

Up to 21-inch picture tubes this test is standard; above 21-inches an implosion test is required. Here, a 10 lb. weight is dropped through five feet on to a point on the tube neck just behind the screen. Photograph, left, shows result of this implosion test.

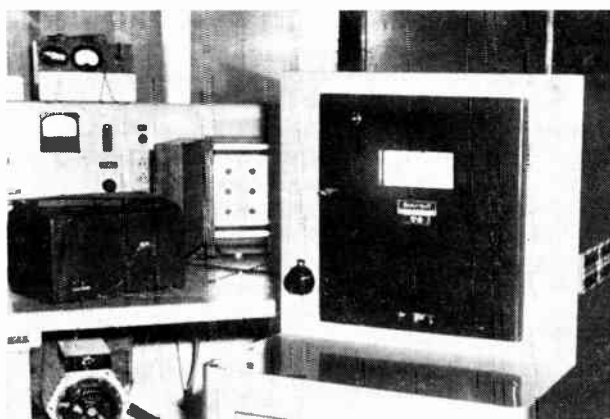

Figure 4 — Radio receiver (at left on bench) is instrumented with thermocouples to establish internal temperature rise.

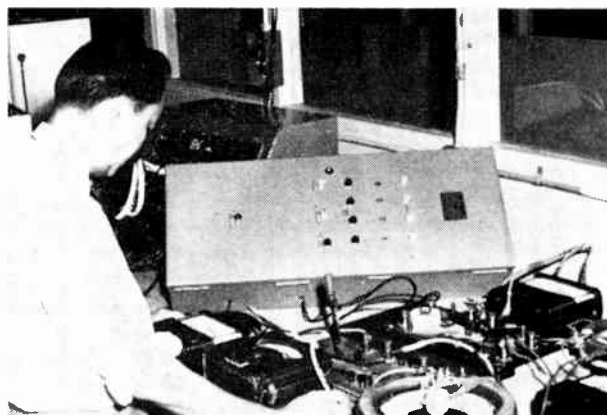

Figure 6 — Engineering Technician George Lee monitors load test on an industrial type fire alarm control box.

temperature. Figure 2 shows another extensive installation for investigating the effect of water on wire insulation. To test for moisture absorption, specimens are immersed in tanks of water at controlled temperatures for periods of up to 24 weeks. A potential of 600 volts is continuously applied . . . insulation tests are conducted each week. Other machines are used for testing the mechanical properties of wires and cables, in particular, their resistance to flexing and impact. Special rigs are provided for endurance testing of snap-action switches which typically must survive 6000 operations on full load. Fuses of all types are tested for acceptable time/current characteristics and fault clearance without producing a fire risk. Thermostats are cycled using an automatic sequence of radiant heat followed by chilled air.

Domestic radio and TV receivers are instrumented to record internal temperature rise (Figures 3 and 4) and fire and shock risks are probed. A somewhat dramatic test carried out on picture-tube assemblies is to smash them and to ascertain that no hazard exists from flying glass splinters. The writer witnessed, somewhat lugubriously, two magnificent 21" tubes "put to the hammer" in this way. Figure 5 shows an imploded tube that passed the test.

In summary, the CSA Testing Laboratory is a flexible and well equipped organization with a particularly high percentage of professional employees, and in many directions is a leader in its particular field. Other countries in the world who up to the present have taken a considerably less formal attitude to safety aspects of equipment in general, are looking upon the Canadian system of approval and test as a desirable model to study and follow.

Charges for Approval Services

Laboratory charges are for:

- (1) The testing of a prototype, invoiced as Professional Services. This charge is based on the expense incurred in investigation of a prototype and in the preparation of a report. A deposit must be remitted with an application for approval. This will be applied against the charges when the final invoice is issued.
- (2) The maintenance of Approval invoiced as an annual fee.
- (3) The purchase of labels.

A new 450 Mc/s Communications System

Article describes a new radio communications system providing up to 48 channels and operating at 450 Mc/s. The equipment is especially suitable for use in newly developing areas in Canada's northlands.

by R. B. Purser and G. H. Bennett*

A growing need for communications facilities has been building up in the new and expanding areas of Northern Canada over the past decade. As the expansion progresses, additional communications facilities are required.

The basic need is for a flexible voice communication network, and in this respect telephone circuits will undoubtedly receive the first consideration. Later, a new radio station may need a dependable link between studio and transmitter, an oil company may want equipment to control an oil pipeline or similar control equipment may be required for an electrical distribution system.

Recent studies of this situation have highlighted the need for a low cost dependable radio system suitable for telephone spur routes in sparsely populated areas.

An example of a product ready to meet these requirements in the Northern Electric type N-450 radio equipment (J-1170A). Designed to operate in the RF

range of 450 to 470 MC/s with an output of 10 watts, this equipment provides an attractive solution where requirements up to 48 message channels exist. This equipment has been designed for use with L, ON-2 and OJ multiplex carrier equipment or the equivalent.

The modulation bandwidth is 150 KC/s for 24 channel operation, and by employing reduced FM deviation, may be extended to 250 KC/s for 48 channel operation.

The advantages of radio circuits in characteristic thinly populated country are evident with line-of-sight transmission of 40-45 miles between stations. Total route lengths are restricted not by the radio equipment, which is capable of 4,000 mile toll circuit objectives, but by the type of multiplex used and the number of channels, together with the propagation losses over the individual paths. Figure 1 shows a typical first hop of an N450 radio system.

*See page 42

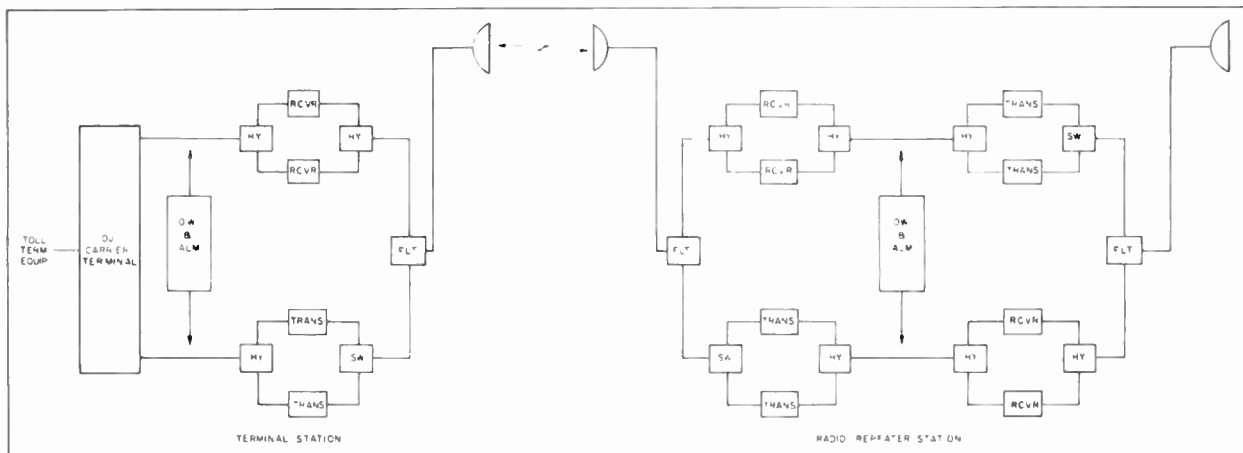

Figure 1 — Diagram showing a typical first hop of the N-450 radio system.

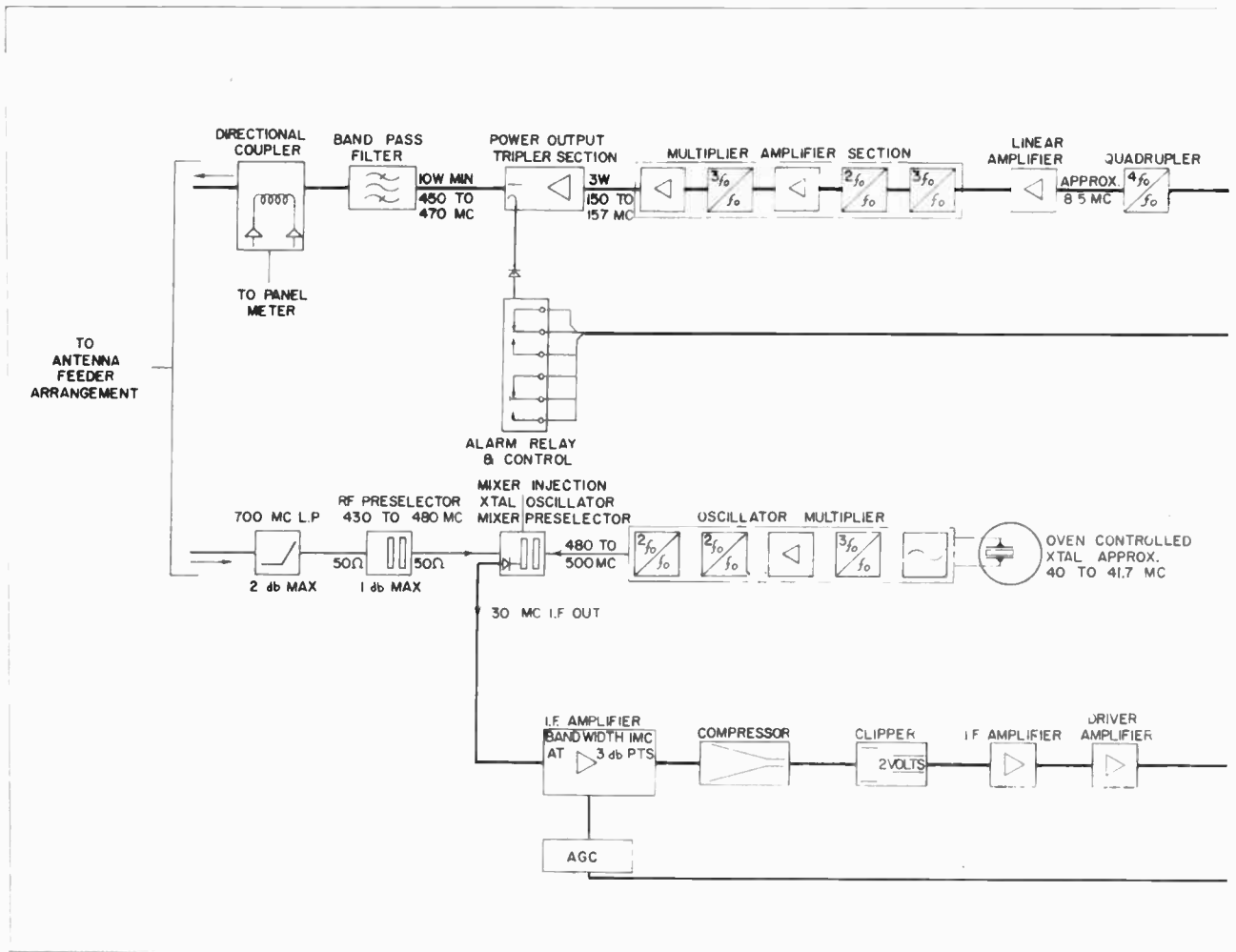

Figure 3 — Basic block-diagram of the N-450 Terminal.

The Authors



Purser

Bennett

Both authors are with the Northern Electric Company Ltd., Montreal, Quebec. R. B. Purser is a senior staff analyst in the operations research department of the company, a graduate of Queens University and a Professional Engineer. G. H. Bennett is a design control engineer at Northern Electric, was born and educated in England, and won his HNC diploma at West Ham College of Technology.

Selection of frequency band

The choice of 450 MC/s for these services is based on the following reasoning:

- (a) Higher frequencies will not permit long span operation.
- (b) Higher frequencies would require the establishment and maintenance of extra repeater stations that could be avoided at 450 MC/s.
- (c) Simple economic circuitry can be employed to obtain low-noise receivers and transmitter powers of 10 watts or higher.
- (d) Siting and path clearance requirements are less severe than at higher frequencies.

Although this radio band is designated for mobile radio service, because of the expected remote locations where this equipment will be used, interference between the two systems is not anticipated. The Department of Transport have indicated that operation will be permitted for point to point operation. Routes will be considered on a basis of location and other users in the adjacent spectrum.

Eighteen radio channels are available in the 450 to 470 MC/s band. Any frequency allocation in this range may be used, except 450 to 451 MC/s and 455 to 456 MC/s which have been previously allocated to TV sound transmission. The equipment is continuously tuneable over the whole of this range with no change in components except the crystals.

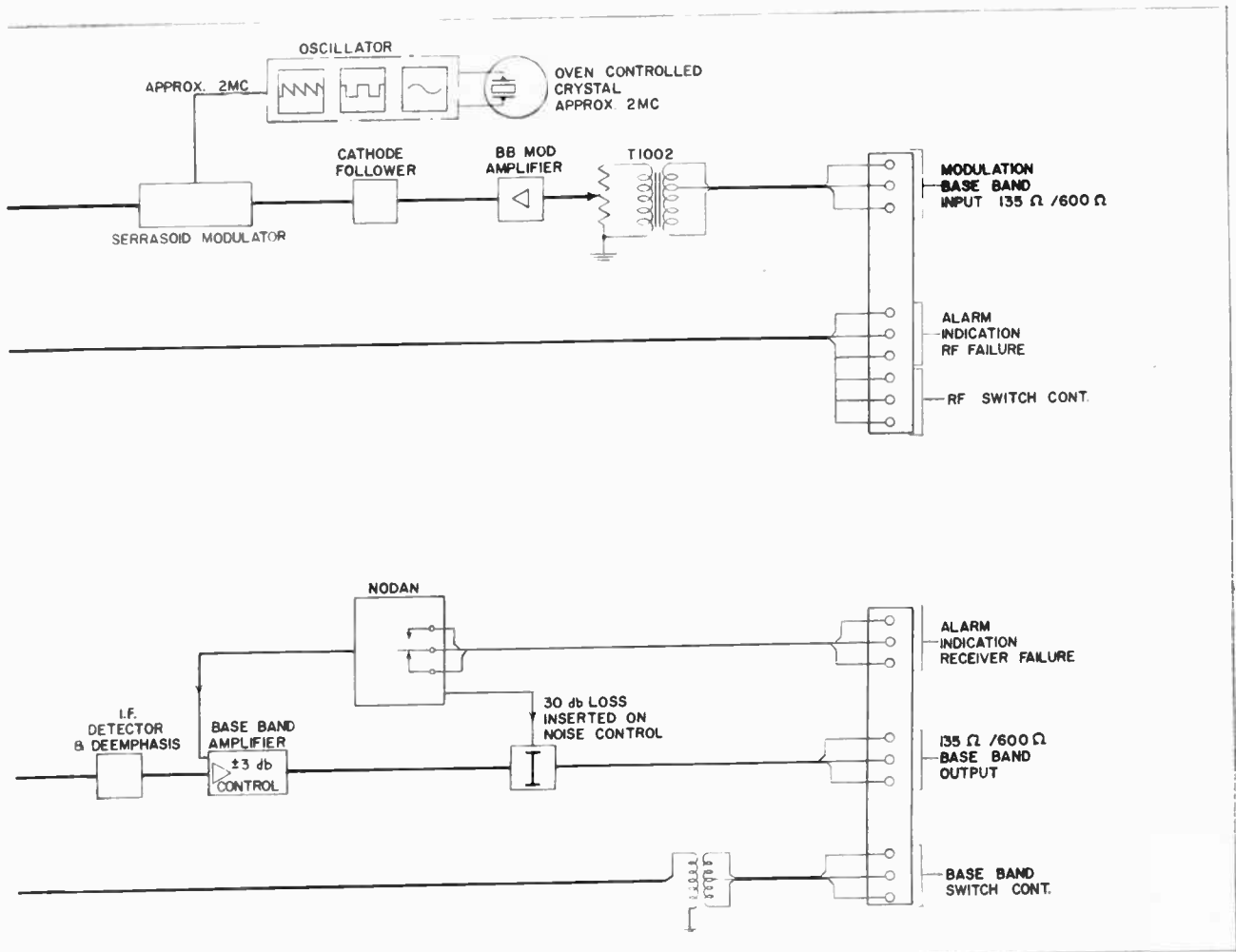

System protection

In telephone toll transmission it is normal for some form of protection to be used to reduce the incidence of equipment failure. To ensure high reliability, the N-450 system uses a twin-path parallel arrangement as illustrated in Figure 2. No appreciable advantage can be obtained by frequency diversity due to the limited range of frequencies in the 450 MC/s band.

A typical system might use a dual-channel facility for each hop with two transmitters feeding cross-polarized radiators in each direction. The receivers can be duplicated and feed an electronically switched combiner so that the receiver having the better signal-to-noise ratio is selected. In the event of a failure in one half of the system, the switching takes place in less than one milli-second.

The equipment required for this facility is provided as a separate unit and consists essentially of a combining circuit, a coaxial relay and a dummy load. Should the operative transmitter fail, the coaxial relay connects the stand-by transmitter to the antenna if that transmitter is producing output. If the failed transmitter returns to normal, the relay will automatically return it to service. A manual override switch allows maintenance to take place on either transmitter without service interruption.

Both receivers are fed into the combining circuit, and the output from the panel is at the same level and impedance as at each receiver output. Loss of the

AGC voltage in one receiver, indicating failure in the RF, IF, or local oscillator, causes the other receiver to be connected directly to the load, bypassing the combining network. In this case, no change in level occurs. Dry contact indication of equipment or circuit failures is provided for use with carrier alarm systems.

Coaxial hybrid arrangements are available to enable both receivers to operate from a single antenna. This

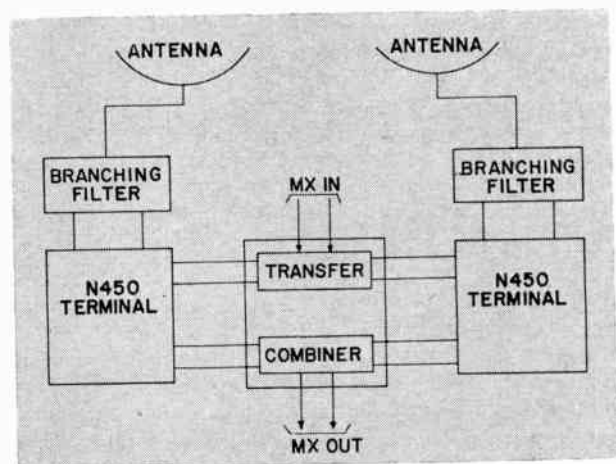
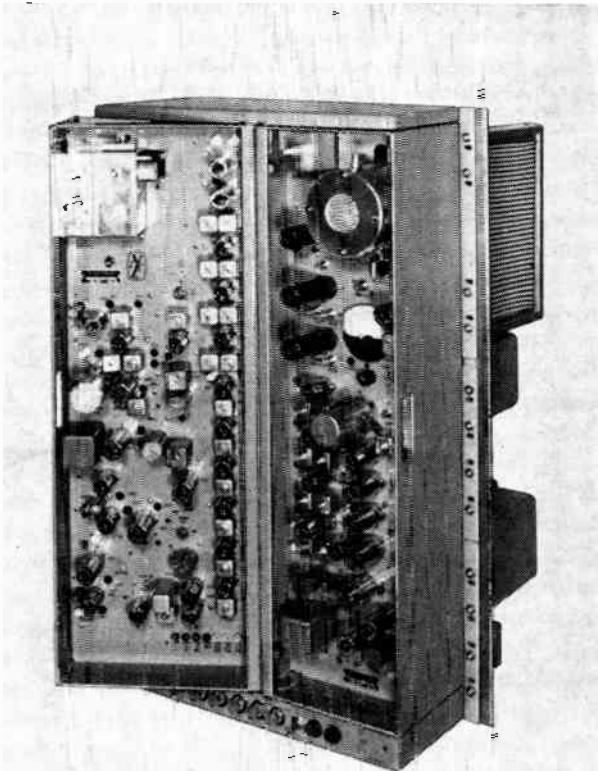

Figure 2 — Basic block-diagram of the N-450 twin-path parallel communication system.



emphasis and de-emphasis of 3.0 microseconds is employed, producing a 9.5 db boost at 150 Kc/s in the transmitter deviation, a very useful factor when conditions are marginal.

The receiver will handle any signal from below threshold up to -20 dbm without overload and the gain is sufficient to limit on noise. The intermediate frequency is 30 MC/s. The IF amplifier, with a gain of 60 db, feeds a discriminator of the balanced ratio detector type that is linear ± 2 MC/s from the centre frequency. The output of the discriminator is amplified by a negative feedback circuit giving a nominal output of -10 dbm into 135 ohms.

Figure 4 — Photograph of the terminal equipment viewed from the front with front assembly door opened.

may be a single or double yagi, a corner reflector, or parabola.

A branching filter permits the use of a common antenna for transmission and reception. It also provides increased rejection of out-of-band frequencies at the receiver and suppresses spurious transmitter outputs.

In situations where troubles may arise from overshoot on short repeater spans, the nominal output of 10 watts may be adjusted by means of a front panel control.

Order wire and alarms

A practice deemed essential by most telephone companies is the provision of a service channel for order wire and alarm connections to facilitate maintenance, and permit unattended operation of the station. The Northern Electric type NA1 order wire and alarm system has been developed specifically with the N450 radio system in mind. It requires a facility equal to one voice channel of normal bandwidth. This is capable of connecting up to 12 unattended stations on a party-line connection to the alarm centre. Both minor and major alarms are indicated and the individual trouble location identified at the alarm centre. The design of the bridging network circuits permits the use of the same frequency band for order wire purposes throughout the system.

Circuit characteristics

A basic block-diagram of the N450 terminal is given in Figure 3. As shown, indirect frequency modulation is produced from a Serrasoid phase modulator, providing very linear modulation. (The radio frequency response is within 0.5 db for ± 400 Kc/s.) At the same time, transmitter harmonics are held to better than -40 db with respect to the carrier level, while all other spurious signals are better than -60 db. A pre-

Equipment

The N450 radio terminal equipment comprises a transmitter and receiver, together with power and control units which are designed for mounting in a standard 19" telephone type bay. The receiver and transmitter are separate units that may be replaced individually for servicing. A built-in meter and multi-position switch enables the operator to monitor the supply voltages, transmitter RF output stages, forward and backward power, and potentials at pin jacks on all tubes. Circuit components are adjusted so that the meter reads approximately half scale for all pin jack tests. A photograph of the terminal equipment, showing a frontal view is given in Figure 4.

N450 radio system

The performance and major design parameters of the N450 radio-system are given below:—

Frequency Range	450-470 Mc/s
R.F. Output Power	10-15 watts
R.F. Input Impedance	50 ohms
R.F. Output Impedance	50 ohms
Input VWSR	1.25 (max)
Receiver Noise Figure	8 db (max)
Discriminator Sensitivity	2.3mV/Kc/s
Discriminator "S" curve	Linear ± 2 Mc/s
Baseband Width	300 —272,000 c/s ± 3 db
Baseband Output Impedance	135 ohms balanced
Orderwire Output Impedance	600 ohms balanced
Image rejection	55 db (min)
Spurious Signal rejection	65 db (min)
Intermediate frequency	30 Mc/s
I.F. Gain	60 db
I.F. Response:—	
± 300 Kc/s	1 db
± 500 Kc/s	3 db
± 2.5 Mc/s	60 db
R.F. Response:—	
± 250 Kc/s	1 db
± 500 Kc/s	3 db
± 2.25 Mc/s	60 db

Conclusion

The N450 radio system provides a low cost dependable communication system which will meet the most rigid transmission objectives. Careful consideration has been given to the operating companies requirements, and compatibility with existing telephone plant.

Automatic private exchange has no moving parts

Cold cathode counting tubes are used in new telephone exchange for routing and logic control.

by John Paddon*

The fact that the Pye Electronic Automatic Telephone Exchange (PEATE) has no moving parts of any kind, sweeps away the need for continuous inspection and maintenance. The operation is entirely electronic. The fault rate averages two per annum on a twenty channel exchange and accelerated life tests indicate that the equipment will have a working life of at least a quarter of a century.

Cold cathode tubes are used for ringing, speech-passing and logical control circuits of the exchange. The speech-passing tubes are arranged in the form of a crossbar switch, the twenty subscribers having access to three connecting links which are made available sequentially by an allotter. Ringing current provided by a transistor generator working at 17 cps is routed out to the called subscriber by a cold-cathode tube which is controlled by a ringing pattern generator and the calling conditions set up by the calling subscriber. Ringing tone but no dial tone is provided because the subscriber gains immediate access to the exchange except when all three connecting links are engaged. Under these circumstances, engaged tone is routed to the calling subscriber and the extension is barred. Engaged tone is also received after dialling, if the called subscriber is engaged.



The Author

John W. Paddon is general manager of Pye (Canada) Ltd. and a senior member of IRE.

The PEATE is housed in a compact cabinet 3" high, and weighs only 100 lbs. and is entirely silent in operation. Its wide environmental tolerance permits the unit to be located without regard to dust, vibration, smoke or fumes.

The sequence of operation of the cold cathode tubes can be followed visually and any fault is immediately apparent. Once a fault is spotted the defective module is snapped out and a replacement plugged in thus a fault can be cleared in a matter of seconds.

The PEATE provides for medium and small business alike an automatic rapid and extremely convenient intercommunication system. In large organizations, it can be used to provide confidential communication between executives affording complete privacy and speed of contact. Its use is economical for eight or more extensions. It is the first exchange of its kind in the world to be made available to users of private telephone systems.

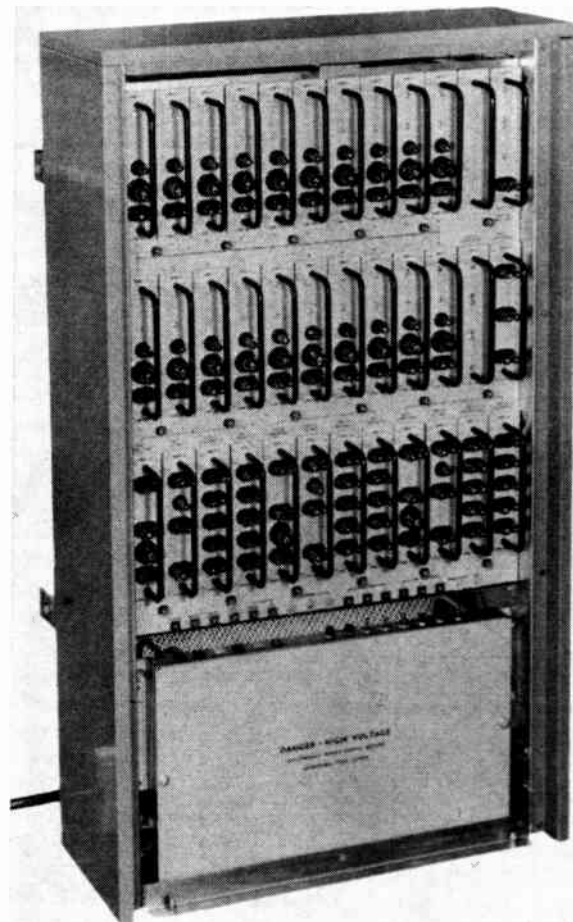

General view of exchange with covers removed. Modules are readily detachable for service when required.

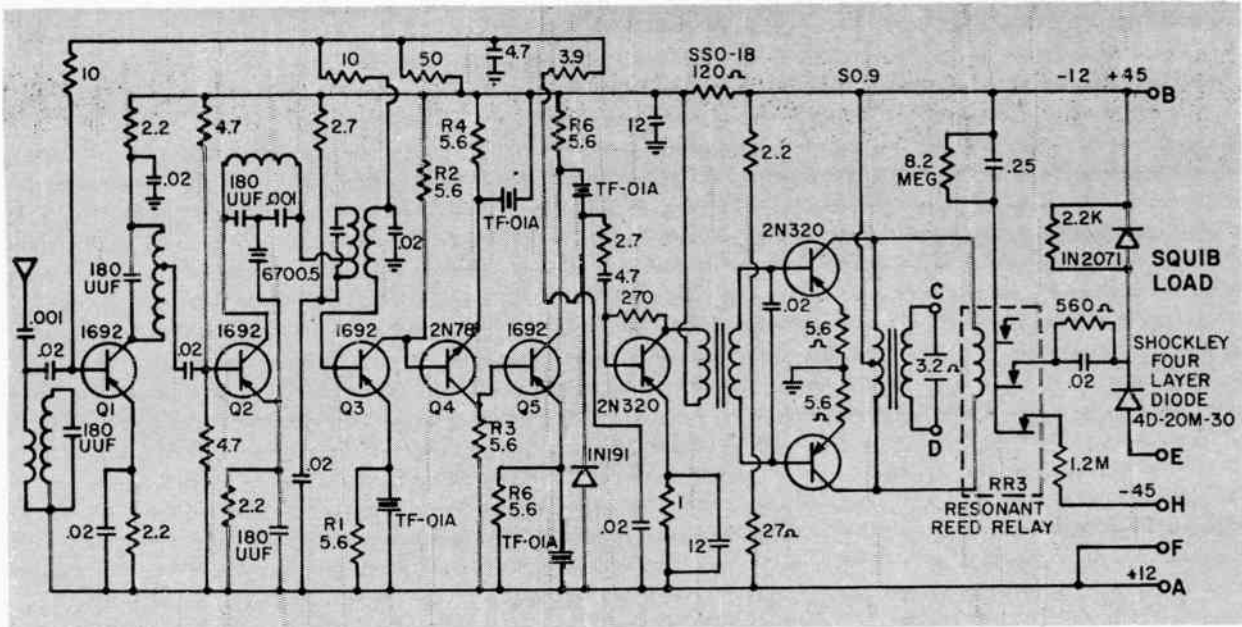

Figure 1 — Circuit diagram of balloon command receiver designed by the Schjeldahl Company of Northfield, Minn. Significant performance improvement was realized through the use of ceramic filters.

TECHNICAL DIGEST - 113 - COMPONENTS

Ceramic filters permit direct coupled I.F. amplifiers

... tiny ceramic filters replace conventional IF transformer circuitry and lead to improved performance and reduced size ...

A new design for a high-altitude balloon command receiver incorporates four fixed-tuned emitter bypass Clevite Transfilters which permit direct coupling of 455 KC IF amplifiers. The new circuit design, reduces space and weight of the previous transformer-coupled circuit, simplifies other IF circuitry, improves AGC, and maintains amplifier stability and selectivity.

Direct coupled IF amplifiers are generally more independent of variations in transistor properties or supply voltage. This type of circuit design is useful in applications where circuit simplicity, component economy, and operating stability are desired.

Figure 2 — Corner of receiver showing ceramic filters. Note size in comparison with adjacent transistors.

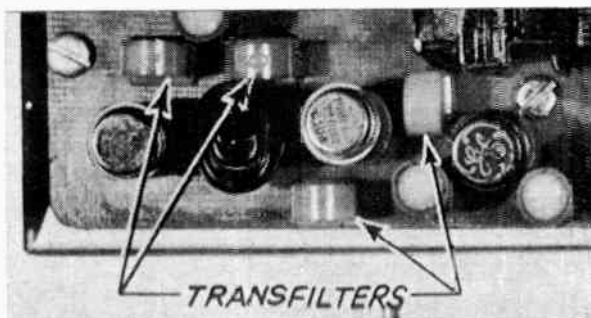

The new design, illustrated in Figure 1 eliminates transformers between the first and second IF amplifiers and between the last IF and detector stages. The change reduces space and weight considerably even after a third transistor IF amplifier — also DC coupled — is added to compensate for the loss of gain. In addition, a second detector transistor used to provide AGC feedback was replaced by a diode.

Production and field alignment is much simplified due to the fixed-tuned characteristics of the "Transfilters". Peaking the coupling transformer between the autodyne converter and the IF stage is all that is required for alignment. The AGC improvement is a result of direct coupling of IF amplifiers. Feedback voltage applied to the first IF amplifier also controls the second and third IF amplifiers.

The emitter bypass "Transfilters" (Model TF-01A) provide selectivity by creating degenerative feedback on either side of the IF frequency to attenuate undesired frequencies. Selectivity of the IF amplifier is symmetrical, 5 kc wide at 3 db and 20 kc/100 wide at 60 db. The ceramic filters (Figure 2) are produced by Clevite Electronic Components Division and have an impedance of 16Ω at the resonant frequency.

The radio command receiver works in conjunction with a ground transmitter and associated receiver decoder. The system operates in the frequency band between three and 18 megacycles.

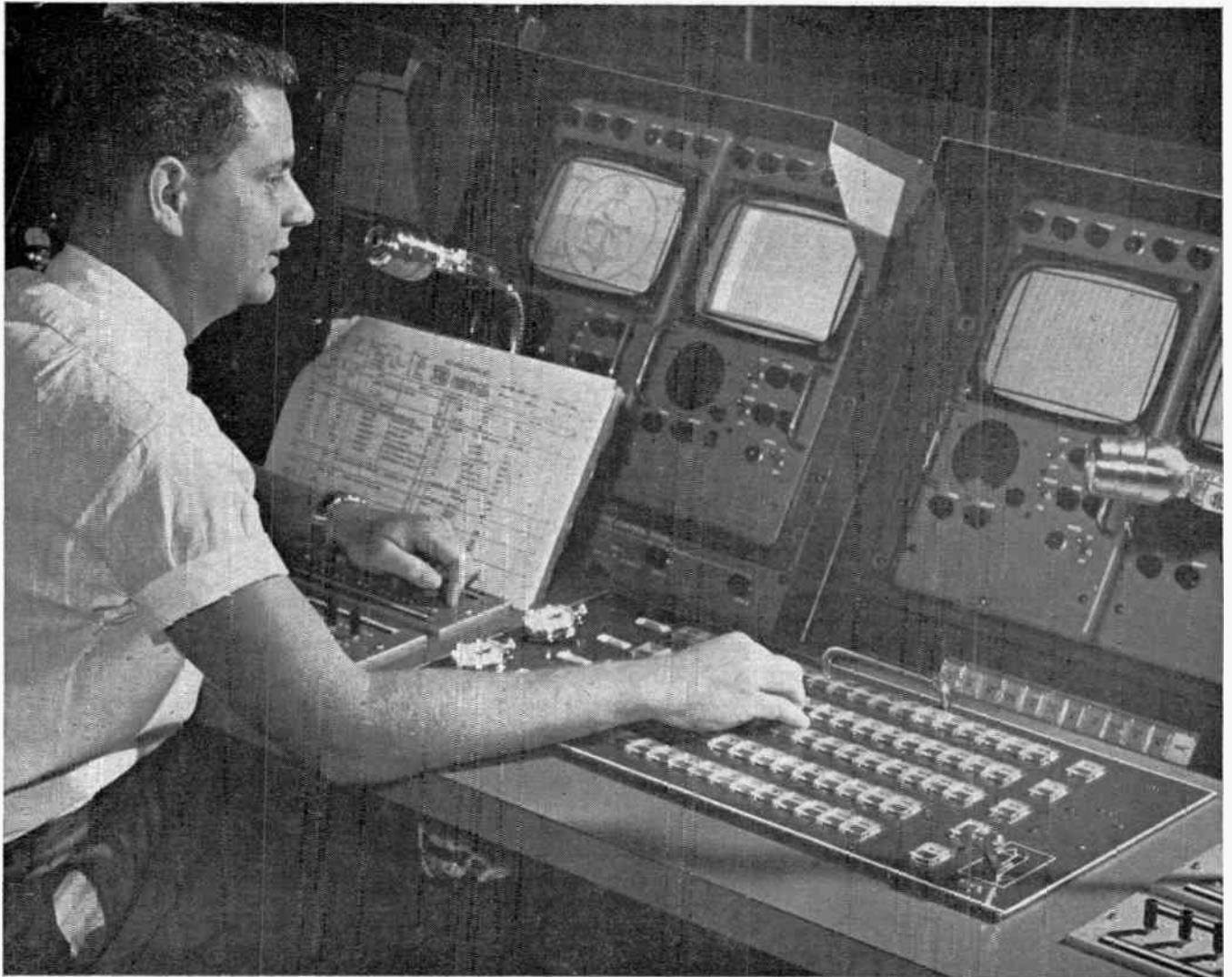

New low prices for space-saving lighted pushbutton switches

Famous MICRO SWITCH "Series 2" lighted pushbutton switches are now available at new low prices. These smartly-styled switches combine the lighted indicator and switching unit in one compact device. On some installations, this saves 50% on panel space, cuts wiring costs accordingly. Notice the TV studio control panel above: and see how impressive, how compact it is.

These MICRO SWITCH "Series 2" switches are serving on machine tools, graphic control panels

and data processing equipment. Their modular design permits complete flexibility, with any of eight different basic switches and a wide selection of colored indicator panels to fit styling requirements. The modules simply snap together without tools; then the assembly snaps into slots in the mounting panel. For further information, ask your nearest Honeywell branch for Catalog 67 or write Honeywell Controls Limited, *Precision Components Division*, Toronto 17, Ontario.

MADE IN  CANADA



Honeywell
MICRO SWITCH Precision Switches

The most complete range of electro-mechanical VIBRATION GENERATORS 21b. to 22,000lb. thrust force

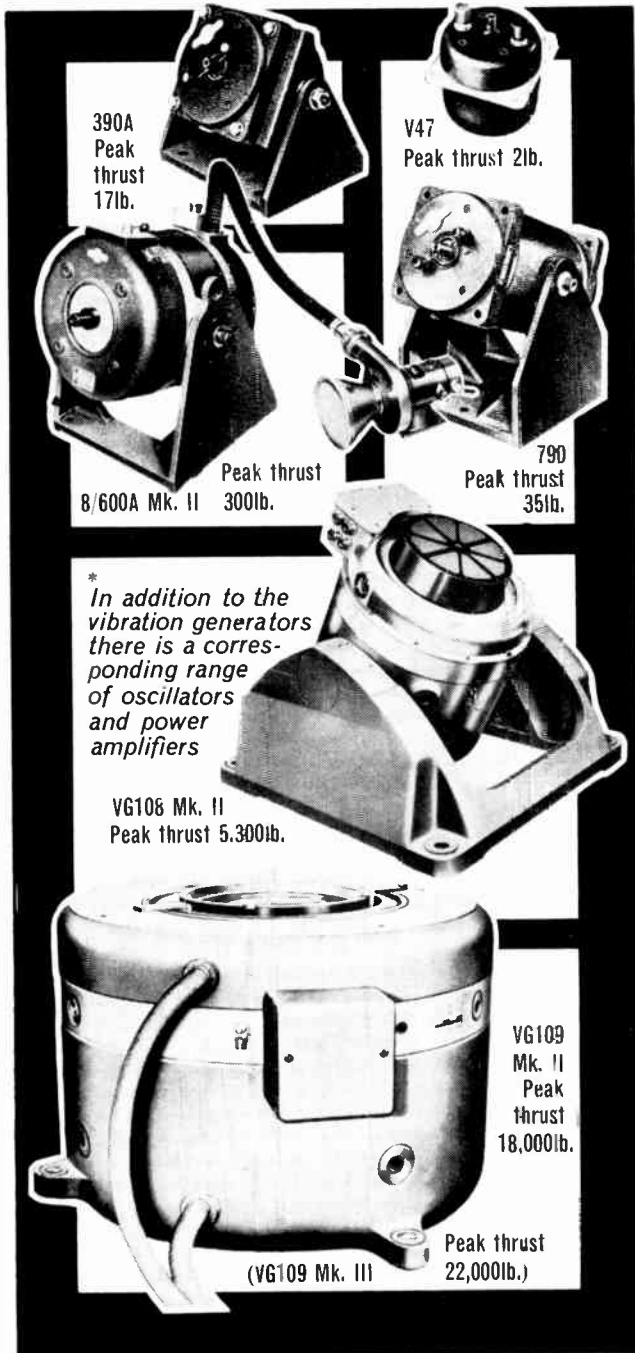

Environmental testing at each stage of development—simulating the severest field conditions of vibration—gives modern components and equipment 'built-in' mechanical and functional reliability.

Goodmans Vibration Exciters and Oscillator Power Amplifiers provide the means for this analytical approach.



GOODMANS INDUSTRIES LIMITED, AXIOM WORKS, WEMBLEY, MIDDLESEX, ENGLAND
Wembley 1200 (8 lines) Cables: Goodaxiom, Wembley, England

NICKAM INSTRUMENTS & SUPPLY LIMITED
99 Floral Parkway, Toronto 15, Ontario

For complete details check No. 29 on handy card, page 63

Defense industry barometer DDP contract awards

Given below is a list of unclassified contracts for \$10,000 or more awarded to Canadian electronics companies by the Department of Defense Production during the month of September. Figures represent total dollar value of one or more contracts in each case. Rental of communications services is not included.

Firm	Item	Dollar Value
Aircraft Appliances and Equipment Ltd., Rexdale, Ont.	test sets, electronic components, motor-generator spares	\$105,864
Ampex of Canada Ltd., Ottawa, Ont.	electronic components	\$ 17,115
A. T. R. Armstrong Ltd., Toronto, Ont.	spares for motor generator sets	\$ 12,858
Avro Aircraft Ltd. Toronto, Ont.	research contract	\$ 12,500
British Columbia Telephone Co., Vancouver, B.C.	installation of telecommunication equipment	\$343,128
CTS of Canada Ltd., Streetsville, Ont.	eddy current compensators	\$ 64,514
Canada Wire and Cable Co. Ltd., Ottawa, Ont.	power cables	\$ 10,125
Canadian Admiral Corp. Ltd., Port Credit, Ont.	radiac detector chargers	\$ 26,918
Canadian Aviation Electronics, Montreal, P.Q.	flight simulator spares	\$ 25,000
Canadian General Electric Co. Ltd., Toronto, Ont.	electronic tubes and components	\$ 27,601
Canadian Marconi Co., Montreal, P.Q.	airborne radio communications, magnetrons, doppler test equipment, h.f. radio equipment, radar test sets	\$451,265
Canadian Motorola Electronics Co., Toronto, Ont.	radio transmitter receivers	\$ 12,755
Canadian Westinghouse Co. Ltd., Ottawa, Ont.	modifications to mobile tropospheric scatter system, circuit breakers, electronic components	\$ 89,560
Collins Radio Co. of Canada Ltd., Toronto, Ont.	test sets	\$ 14,788
Computing Devices of Canada Ltd., Ottawa, Ont.	mass spectrometers, technical services, electronic components	\$116,894
DeHavilland Aircraft of Canada Ltd., Downsview, Ont.	instrumentation of aircraft tip tank	\$105,450
Electronic Marketing Co. Ltd., Montreal, P.Q.	signal generators	\$ 57,562
EMI-Cossor Electronics Ltd., Dartmouth, N.S.	telecommunication spares	\$ 12,839
Esna Canada Ltd., Toronto, Ont.	aerodrome lighting equipment spares	\$ 16,710
Anthony Foster and Sons Ltd., Toronto, Ont.	radio compass equipment	\$ 30,505
Garrett Manufacturing Ltd., Rexdale, Ont.	electronic equipment	\$347,699
Instronics Ltd., Stittsville, Ont.	electronic equipment	\$102,181
Maritime Telegraph & Telephone Co. Ltd.	installation of telecommunication equipment	\$ 90,552
Marsland Engineering Ltd., Kitchener, Ont.	modification of plotting tables	\$490,357
Micro-Towers Ltd., Scarborough, Ont.	antenna supporting structures	\$356,437
New Brunswick Telephone Co. Ltd., Saint John, N.B.	installation of telecommunication equipment and associated on-base cabling	\$ 66,032

Northern Electric Co. Ltd., Ottawa, Ont.	spares for telephone system, telephone switchboard spares, transmitting and receiving antenna kits	\$396,378
Penzer Products Ltd., St. Catharines Ont.	motor-generators	\$ 89,988
Philco Corp. of Canada Ltd., Don Mills, Ont.	telegraph and alarm control selectors	\$325,161
Phillips Electrical Co. Ltd., Ottawa, Ont.	power cable	\$ 10,955
R-O-R Associates Ltd., Don Mills, Ont.	frequency meters, electronic counters, frequency counters, and recording systems	\$156,078
Radio Engineering Products, Montreal, P.Q.	telephone terminals	\$617,213
Radionics Ltd., Montreal, P.Q.	multi-channel pulse height analyzer, frequency counters	\$ 34,560
Raytheon Canada Ltd., Waterloo, Ont.	electronic tubes	\$ 31,764
A. V. Roe Canada Ltd., Toronto, Ont.	research contract	\$ 24,774
Sperry Gyroscope Co. of Canada Ltd., Montreal, P.Q.	fixed sensing element and marine loran equipment	\$ 50,666
Stark Electronic Instruments Ltd., Ajax, P.Q.	signal generators	\$ 34,560
University of British Columbia, Vancouver, B.C.	development contract	\$ 35,000

Industry's business

Continued from page 15



Eight thousand cheques, the number of six-inch long cheques IBM's new banking equipment can process in five minutes, are balanced by Nancy Reynolds.

Electronic cheque sorter designed by IBM

The fastest machines yet offered to the banking industry for the electronic processing of cheques, deposit slips and postal money orders were introduced recently by International Business Machines Company Limited.

The equipment reads and sorts cheques encoded with magnetic ink characters at speeds up to 1,600 a minute. The new IBM 1419 magnetic character reader feeds customer chequing account information directly into the computer, while the IBM 1219 reader-sorter is used for cheque processing independent of a computer.

Continued on page 62

Even in high-frequency and rapid switching types

PHILCO offers you
the complete
— and completely
reliable — line
of transistors

Whatever the type of transistor you require — however demanding the application — you can fill your requirements from the complete, reliably-built line of Philco transistors.

This table shows a typical assortment of Philco transistors. The line also includes high-frequency and rapid-switching types, in the successful development of which Philco engineers have led the industry.

Mail the coupon below for further details

VHF-UHF Microalloy defused base (MADT) types:
2N502, 2N501, 2N499, 2N504

High-frequency Microalloy types:
2N393, 2N599, 2N600

Medium-powered alloy junction types:
2N1125

High-powered alloy junction types:
2N386, 2N387

Philco Corporation of Canada
Don Mills, Ontario.

Please send brochure describing all types of Philco transistors.

Name

Address

61-10-EC

TRANSISTOR CENTRE CANADA
PHILCO CORPORATION OF CANADA
DON MILLS, ONTARIO



PHILCO government and
industrial division

Industrial Semiconductor Distributors: **ONTARIO — ELECTRO SONIC SUPPLY CO. LTD., 543 YONGE ST., TORONTO.**
QUEBEC — CANADIAN ELECTRICAL SUPPLY CO. LTD., 275 CRAIG STREET WEST, MONTREAL.
NEW BRUNSWICK, NOVA SCOTIA, NEWFOUNDLAND —
COMMERCIAL EQUIPMENT LTD., KING STREET, SAINT JOHN, NEW BRUNSWICK.

For complete details check No. 32 on handy card, page 63

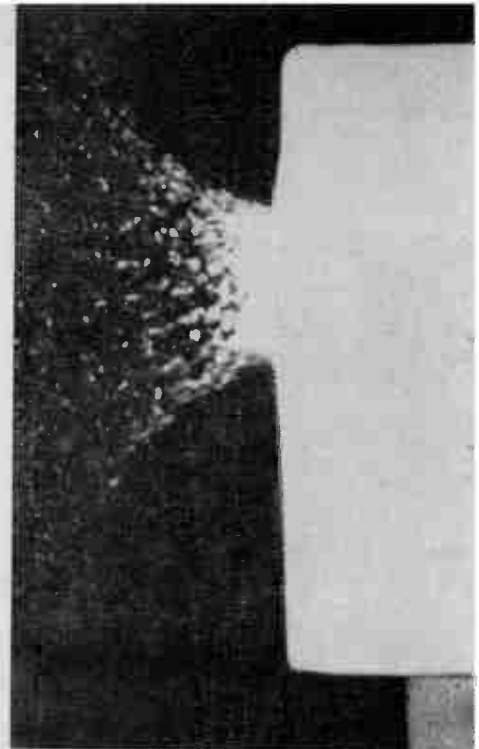
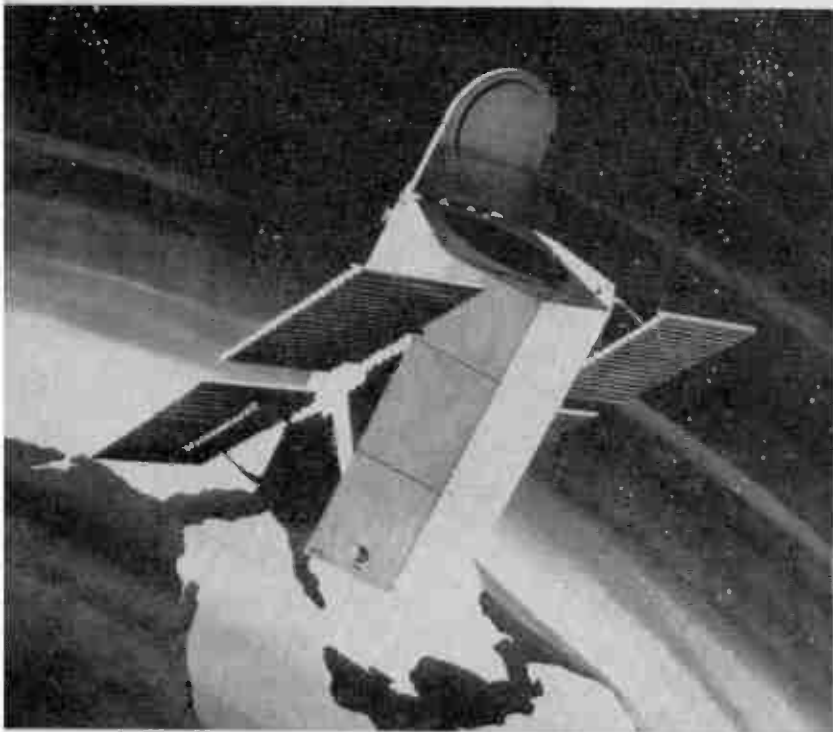

The Orbiting Astronomical Observatory satellite utilized by the National Aeronautics and Space Administration, will be a standardized shell containing stabilization, power and telemetry equipment into which one or more separate experiments can be fitted for each flight. Astronomical equipment with reflecting mirrors up to 36" in diameter will be mounted in a cylindrical chamber running through its length. Pictures will be sent back to earth by TV link.

close-up

**a pictorial comment
of the industry
in action**

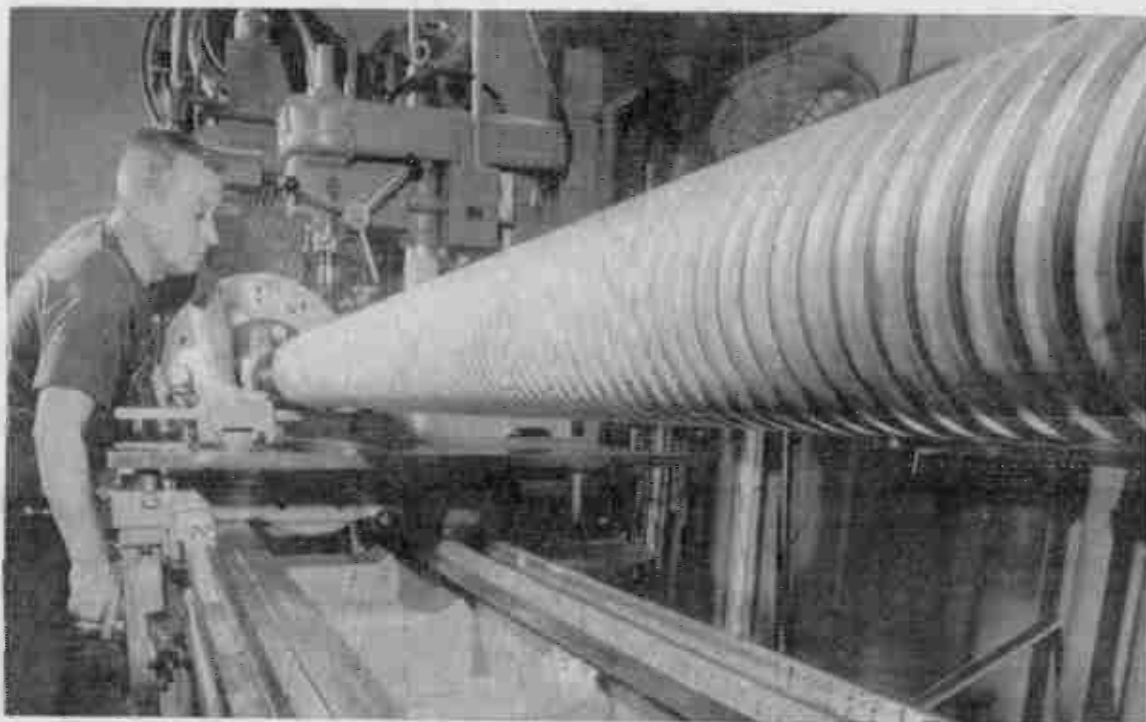

A "voice" is being manufactured for Polaris submarines. A machinist carefully winds a helical tuning coil for a WRA 2 submarine antenna, destined for service on a nuclear submarine armed with Polaris missiles. Hoffman Electronics engineers designed this antenna so it can be raised and lowered automatically, just as a submarine periscope is operated.

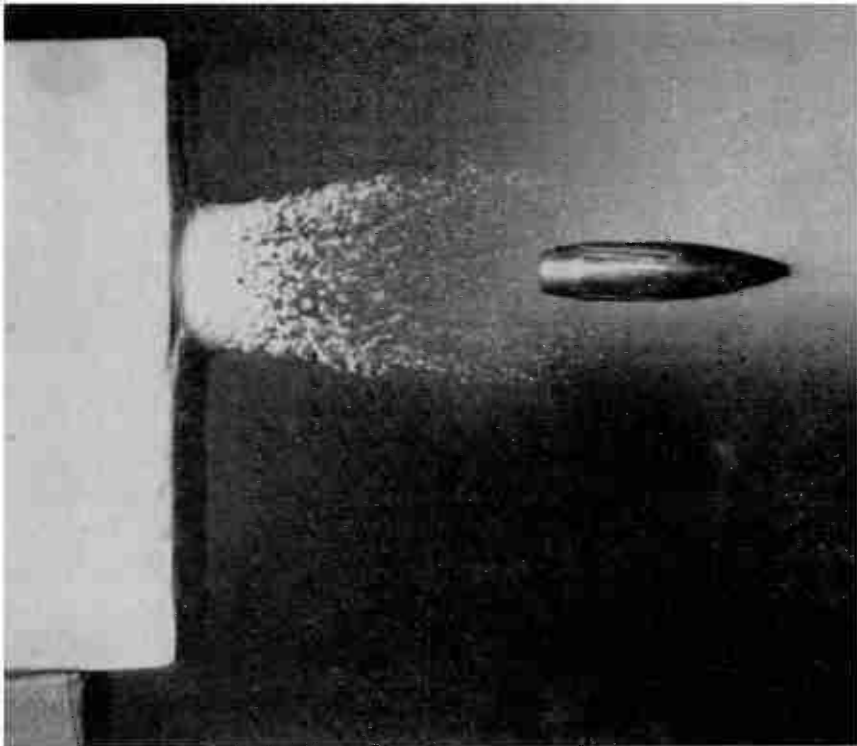

A bullet smashes into a bar of soap and flies out the opposite side. Its action has been captured on film with the use of a Microflash electronic flash unit produced by Edgerton, Germeshausen & Grier, Inc. This unit has an electronic flash lamp of ultra short duration and a high peak light output, especially suited for photographing bullets, propellor blades, and other high speed subjects.



A glass seal, 1/10,000 inch thick, protects several hundred tiny diodes on this section of a silicon wafer. A new reliability seal technique, developed by scientists in IBM's Components Division, uses a special glass powder fired at temperatures exceeding 1500°F to produce a pinhole-free, chemically resistant surface.



An engineer makes careful adjustments on gas bearing memory drum developed for space vehicles by Librascope Division of General Precision, Inc. This unit is utilized in the L-70 flight guidance computer. The memory drum spins on a thin film of helium gas replacing metal bearing suspension system of earlier computers.

The integrator shaft assembly of the LN-3 computer manufactured by Litton Systems (Canada) Ltd., Rexdale, Ontario. Unit receives signals from the east-west and north-south accelerometers in turn. After double integration the derived position outputs are transmitted to the PHI unit in form of pulses.

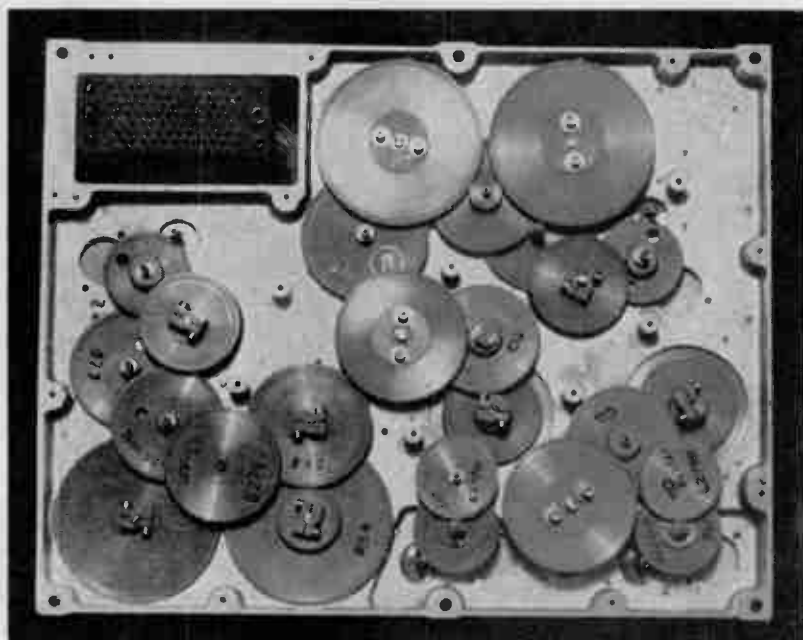

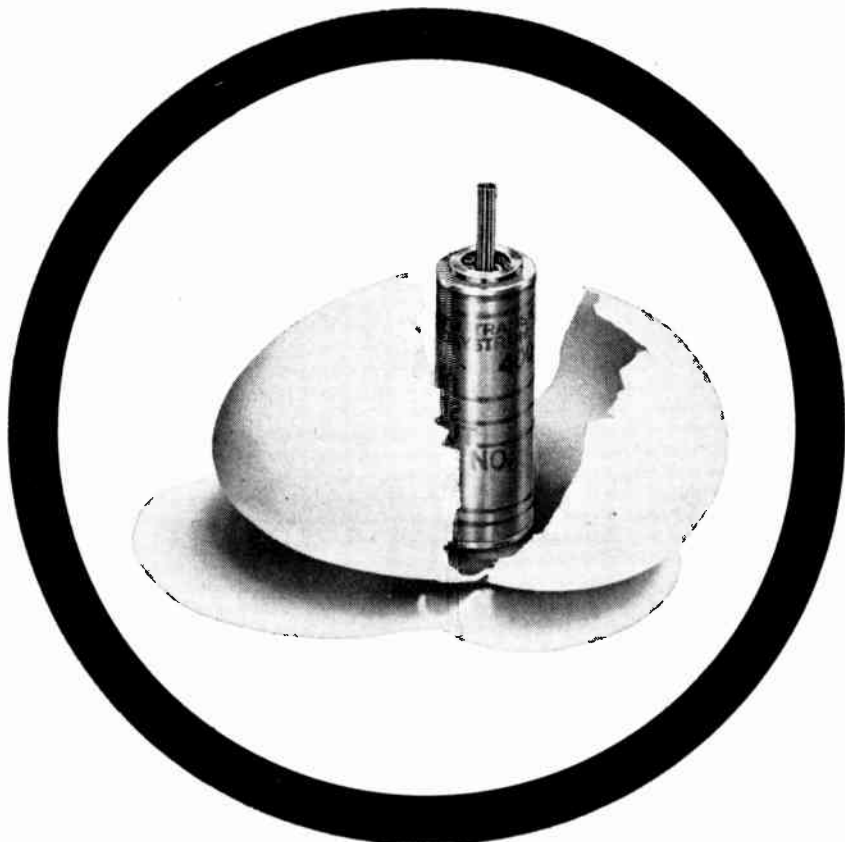

JUST HATCHED—

all-Canadian manufacturing facilities
for famous Daystrom electronic products!

Pictured above is a compact, lightweight servo motor generator. It's a *Canadian* Daystrom product—one of the growing list of high performance components now being manufactured at our Cooksville, Ontario, plant.

It took a lot of planning to equip and staff a plant capable of producing dependable electronic products. But now it's hatched—we are now offering Canadian-made Daystrom Syncros and other top-rated rotating components that are equal in quality to any on the market!

For complete technical information on these and other Canadian-made Daystrom products, write Daystrom Limited, 1480 Dundas Highway E., Cooksville, Ontario; 5430 Ferrier Street, Montreal 9, Quebec. A subsidiary of Daystrom, Incorporated.



CANADIAN PLANT—COOKSVILLE, ONT.

6137

DAYSTROM LIMITED

WORLD LEADERS IN MEASUREMENT AND CONTROL

For complete details check No. 14 on handy card, page 63

Some transistor terms defined

... many circuit designers are confused by the plethora of technical terms coming from the semiconductor device manufacturers ... this note attempts to clear the air. Designers are reminded that terminal properties, reliability and cost are the criteria of importance ... fabrication methods are merely incidental to a particular end product ...

by David H. Lewis, (Ferranti-Packard Electric Ltd., Toronto, Ontario)

JUNCTION PROCESSES

GROWN ... formed when the molten semiconductor freezes either from the doped melt, when the single crystal is formed (double doped, rate grown) or by melting and re-freezing the tip of a rod of doped material (melt-back)

ALLOYED ... produced by the freezing of an alloy which is formed by heating a semiconductor wafer in contact with the alloying material to a temperature below the melting point of the wafer material

DIFFUSED ... formed by the diffusion of impurities in a solid wafer. The impurities may be diffused from outside the wafer, or may be introduced by growing or alloying techniques. Diffusion is also used to prepare wafers with impurity density gradient (drift, micro-alloy diffused transistors)

ETCHED, PLATED ... thickness of doped base wafer is reduced by jet-etching which produces a pit on each side of the wafer. Plating suitable material onto the pit produces a metal to semiconductor junction (surface barrier transistor). If the wafer is then heated to alloying temperatures, a micro-alloy junction is formed.

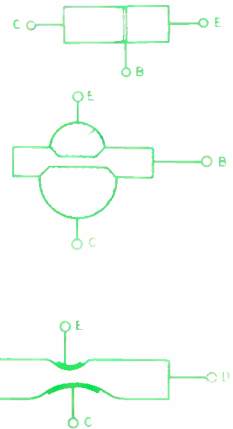

Structures

MESA — Diffused transistor structures for very high frequency applications are usually larger, for mechanical reasons, than is electrically desirable. Hence the periphery of the transistor is partially etched away leaving a small plateau or mesa-like transistor rising above the main wafer.

PLANAR — Silicon oxide provides an effective means of protecting the surface of a silicon transistor. Hence a fabrication technique for double diffused transistor has been developed which produces a structure with a plane upper surface completely protected by an oxide layer. Such a transistor exhibits very low ICBO, and unusually high gain at low emitter currents.

EPITAXIAL — The collector region of diffused base and double diffused transistors is, for mechanical reasons an epitaxial wafer which consists of a thin high resistivity layer of doped semiconductor material deposited, without interruption of the single crystal structure, onto a highly doped, low resistivity substrate of the same semiconductor material. The technique is used to produce switching transistors with lower saturation resistance and storage time. Epitaxial wafers are used to produce both planar and mesa transistors.

TRIPLE DIFFUSED — An alternative to an epitaxial wafer is a wafer into one side of which a high concentration of impurities has been diffused, producing a thin high resistivity layer on top of a thick low resistivity layer.

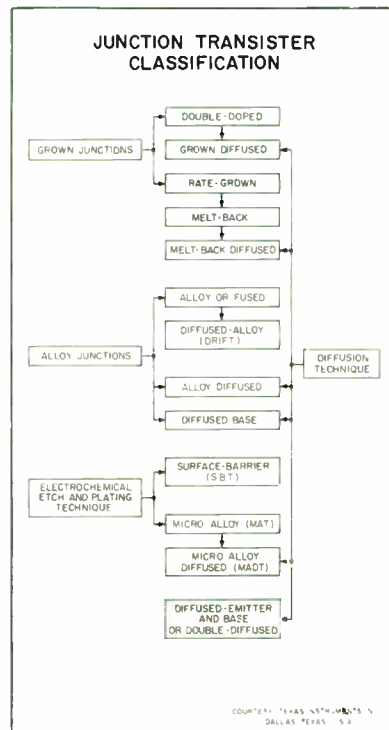

General Comments

Growing and diffusion techniques are able to produce thinner base widths than is possible with alloy techniques (except for the case where electro-chemical etching is used). Thus growing and diffusion are used to produce high frequency transistors. Diffusion has the added advantage of allowing complicated electrode geometries to be made with extreme accuracy on small structures by means of photographic masking techniques.

The nature of the diffusion process allows one junction to be made by diffusion (usually) by diffusing the base into a wafer which constitutes the collector) and the other junction by alloying. It is also possible to design a process in which diffusion proceeds after alloying so that an existing diffused region (usually the base) is "pushed" ahead of the penetration of the alloy (post alloy diffused transistor).

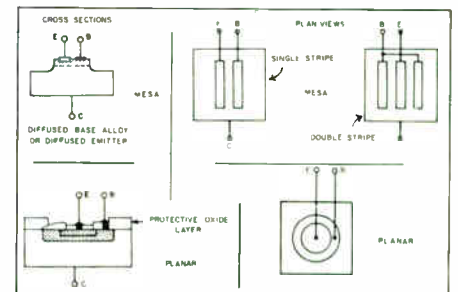

For a re-print of this page, circle 105 on the Reader Service Card or write to The Editor, Electronics & Communications 450 Alliance Ave., Toronto 9, Ontario

ALL-NEW...

TRUE RMS VOLTMETER

now . . . measure
true RMS value
of virtually all
waveforms

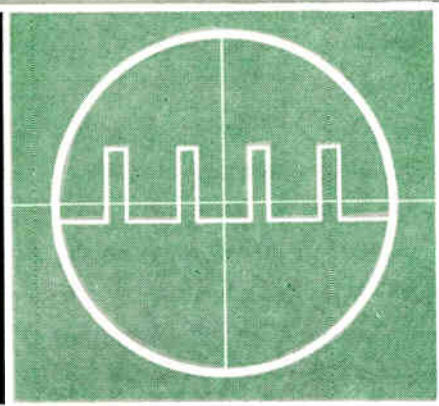

MODEL 910A

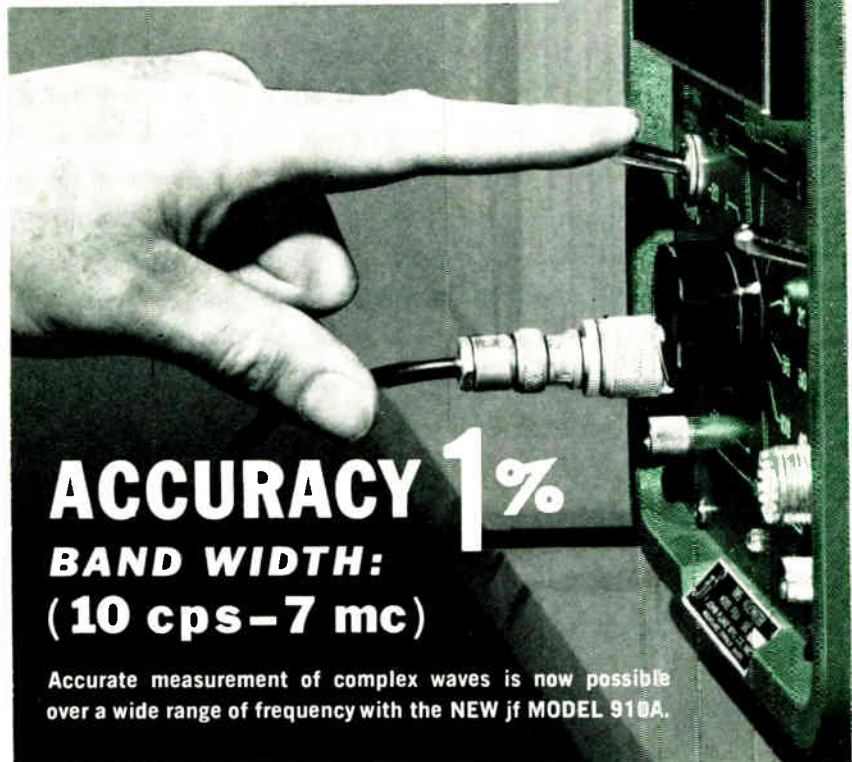

ACCURACY 1%

BAND WIDTH:
(10 cps - 7 mc)

Accurate measurement of complex waves is now possible over a wide range of frequency with the NEW jf MODEL 910A.

For the first time one instrument provides 1% midband accuracy, 10 cps to 7mc bandwidth, plus 100 u v sensitivity. For added versatility an amplifier output is provided for simultaneous oscilloscope or recorder monitoring.

Model 910A employs a thermocouple located in the feedback loop of a sensitive DC amplifier to measure the actual heating effect of the input waveform. This circuit arrangement is the key to the rapid response and high calibration accuracy of the Model 910A and also prevents any error in reading due to ambient temperature variation. Isolation of the thermocouple from the input terminals by a high gain, ultra stable AC amplifier provides high input impedance and completely protects the thermocouple from burnout under any condition of overload.

Model 910A is ideal for measuring AC currents in non linear devices, total harmonic content of distorted waveforms, noise, average power of pulse trains, and other measurements that involve waveforms which are not necessarily pure sinusoids.

Prices and data subject to change without notice.

Partial Specifications—jf MODEL 910A

Voltage Range:	1 MV to 300V (full scale readings)
Decibel Range:	-72 to +52 dbm
Frequency Response:	10 cps to 7Mc
Accuracy:	± 1% of full scale 50 cps to 800 KC ± 2% of full scale 20 cps to 2Mc ± 3% of full scale 20 cps to 3.5 Mc ± 5% of full scale 10 cps to 7 Mc
Input Impedance:	10 megohms shunted by 30 pf for 0.3 volt range and below. 10 megohms shunted by 15 pf for 1.0 volt range and above.
Crest Factor:	3 at full scale, proportionately higher for readings less than full scale.
Price:	Cabinet Model—\$545.00 Rack Model—\$565.00 U.S. Funds f.o.b. Seattle, Wash.

A more complete description will be sent to you upon request.



JOHN FLUKE MFG. CO., INC.
P. O. Box 7428 Seattle 33, Washington

Represented in Canada by: ALLAN CRAWFORD ASSOCIATES LTD., 4 Finch Ave. W., Willowdale, Ont. BA 5-7391

For complete details check No. 41 on handy card, page 63

the international scene

ITT Belgian associate produces power supplies for nuclear research

Power supplies specially designed to energize large electromagnets used for nuclear research have been produced by a Belgian associate of International Telephone and Telegraph Corporation. The power supplies replace the storage batteries usually used in such service.

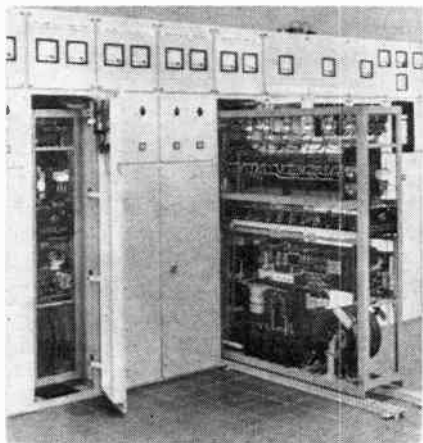

Available in a range of capacities up to 75 KW the supplies feature full-load voltage stabilities and ripple suppression of 1 part in 10,000 and output voltage adjustment means giving between 10 and 100 per cent of the rated value. Long-term stabilization is accomplished by motor-driven adjustable transformers and fast stabilization by vacuum-tube regulators. The recovery time is of the order of milliseconds and the long-term drift is not worse than 1 part in 10,000 in 48 hours while simultaneously undergoing ± 10 per cent slow and ± 3 per cent fast changes in line voltage and load current and with ± 2 per cent variations in line frequency.

British cable company wins multi-million\$ order in New Zealand

A near \$10 million contract from New Zealand's Electricity Department, to manufacture and lay 76½ miles of submarine gas filled power cables across Cook Strait, together with terminations, accessories and spares, has been given to British Insulated Callender's Cables Ltd., London W.C. 1, England (Phillips Electrical Co. Ltd., King St. W., Brockville, Ont.).

The cables will form part of a high voltage direct current interconnecting transmission system between existing power stations in the North and South

Island. The rated load capacity of the circuit will be 600 megawatts at 1200 amperes.

Papers invited for Congress of International Federation of Automatic Control

Papers are invited for presentation at the Second Congress of the International Federation of Automatic Control to be held in Basle, Switzerland, in September, 1963, under the auspices of the Swiss Association for Automatic Control. Papers should deal with theory or applications of automatic control. A few papers will be accepted on components of control systems and on general items. Further details may be obtained from the Canadian member organization of IFAC at the following address: The Secretary, Associate Committee on Automatic Control, National Research Council, Ottawa 2, Ontario.

Marconi strengthens trade ties with Ghana

Marconi's Wireless Telegraph Company Ltd., have been awarded a contract by the Ghana Posts & Telegraphs authorities for the supply and installation of a twin-path VHF multi-channel radio telephone system to link the Volta River Dam area with Accra, the capital. The carrier equipment will be provided by the Automatic Telephone & Electric Company Ltd.

Australia buys \$600,000 sonar equipment from Canadian firms

The Royal Australian Navy recently ordered two complete variable depth sonar systems and equipment from EMI-Cossor Electronics Ltd. and Canadian Vickers Ltd.

The electronic system and equipment is being manufactured by EMI-Cossor Electronics Ltd., Dartmouth, Nova Scotia, and the ship's handling equipment by Canadian Vickers Ltd., Montreal, P.Q.

Currently this Canadian-designed system is being supplied to the RCN and RN.

German technicians attend Canadian training course

Six German Air Force technicians have arrived in Montreal to attend a flight simulator maintenance training course at the headquarters of Canadian Aviation Electronics Ltd., the Canadian company which is building 25 simulators for F-104 airplanes for the RCAF and the Government of West Germany and the Netherlands.

The group will form the second class in the course which will see about 150 experts trained to maintain the simulators over the next two and half years. The first class was made up of seven Netherlands nationals employed by CAE in Europe.



Early next year Britain's Minitrack Station at Winkfield, Berkshire, will be used to track two satellites, one American and the other Canadian. At left are: the phase recorders, phase measuring gear, control console and standard frequency/timing rack. The telemetry receiving rack is on the extreme right.

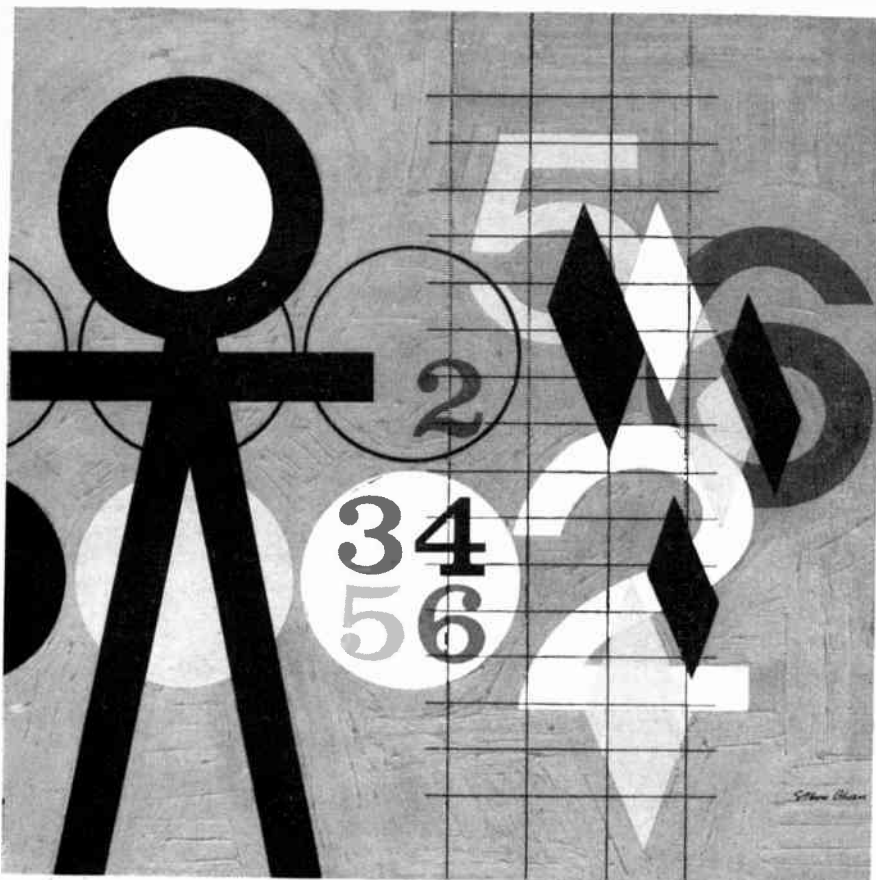

ELECTRONICS TECHNICIANS

EARN HIGH REWARD — ENJOY NEW ADVENTURE

To qualified, experienced communications and radar technicians who would like to gain priceless experience while earning high pay on a technically interesting assignment, Federal Electric Corporation offers immediate employment on the DEW Line. You will join one of Federal's highly skilled teams of technicians and engineers responsible for effective operation of this vast network of advanced electronic systems.

First, you will receive an intensive 12 to 15 week training course in the U. S. Then you will serve 15 months at a selected DEW Line site. While in training you will receive an excellent salary and expenses. On DEW Line, you will earn \$195 per week, based on a 54-hour week, plus free room and board. Upon completion of your assignment, you will receive a substantial bonus. All compensation subject to Canadian income tax.

You can qualify for employment if you have at least a Technical School diploma (military or civilian) and have two years' current maintenance experience in: COMMUNICATIONS — carrier, multiplex, scatter propagation, VHF or UHF; or RADAR — ground systems or warning systems.

Applicants are requested to send a resume of their training and experience to Mr. I. L. White.

FEDERAL ELECTRIC CORPORATION

Service Division of International Telephone and Telegraph Corporation
Winnipeg International Airport, Winnipeg, Manitoba



An equal opportunity employer.

For complete details check No. 24 on handy card, page 63

Industry personnel

Continued from page 18

Whittaker appoints head office representatives

Whittaker Electronics Limited announced the appointment of **Fred Cameron** and **Harvey Halverson** as head office representatives.

Mr. Cameron's background includes design work of mechanical and electro-mechanical devices with Canadian Signals Research and Development Establishment, Sangamo Co. Ltd. and Computing Devices of Canada Limited.

Mr. Halverson was previously associated with Measurement Engineering Limited, where he was engaged in purchasing and contract administration activities.

Sales engineer for new Montreal office named

The appointment of **Frank J. Wilkins** as field sales engineer for the new Montreal office of Transitron Electronic Corporation of Canada, Ltd. has been announced. The Montreal office is at 2774 Kent Street.

Mr. Wilkins formerly was associated with Collins Radio Company of Canada, Ltd. He is a native of Hamilton, Ontario.

Lunder elected to Onan advisory council

Jake Lunder of Simson-Maxwell, Edmonton, Alberta, was elected a member of the distributors advisory council of Onan division of Studebaker-Packard Corporation in the United States.

Lunder will take office next February, when ODAC holds its next semiannual meeting at the Minneapolis headquarters of Onan, manufacturer of industrial engines and electric generating plants.

ODAC provides Onan with year-round counsel to help improve the effectiveness of company-distributor, company-service-distributor and distributor-customer relationships.

Kennedy becomes senior liaison engineer

Litton Systems (Canada) Limited has announced the appointment of **Arthur E. "Art" Kennedy** as senior liaison engineer. Before joining Litton Systems Mr. Kennedy was associated with the Sperry Gyroscope Company of Canada Limited as a sales engineer and contracts administrator. He is a member of the Institute of Radio Engineers and the Canadian Aeronautical Institute.

the engineer's bookcase

Feature review by Ian Sharp

A Guide to FORTRAN Programming by Daniel D. McCracken
Published by John Wiley and Sons Inc., 440 Park Avenue South, New York 16, N.Y. Price: \$2.95 (U.S.)

This book achieves everything it sets out to achieve; it provides a streamlined introduction to Fortran Programming in a way that no manual ever could. It is a refreshing change from the usually impersonal and often stodgy programming manual (this is a general observation, not confined to Fortran). The examples are well chosen and relevant from an engineer's point of view although applications of the language to data-processing are hardly considered, which, in a way, is fair, since this is an algebraic compiler. There are many versions of Fortran covering a very wide range of machines and this book talks specifically about the 709-7090 (Old) version. Nonetheless prospective Fortran users on any machine would benefit from reading this short treatise, though regrettably they would be well advised to use a standard manual for confirmation of permissible statements.

It would be nice if this book were to be followed by a similar exercise on ALGOL, where the author's readable style could undoubtedly clear up many misunderstandings.

Transistor Logic Circuits by Richard B. Hurley. Published by John Wiley and Sons Inc., 440 Park Avenue South, New York 16, N.Y. Price: \$10.00 (U.S.)

Lots of people representing lots of disciplines are nowadays interested in logic, computers, numbers etc., and Richard Hurley's book has something to say to all of them. The book suffers from the disadvantage of covering an immense field in a few words and hence is more for interest than for reference. It is an excellent introduction to the principles of logical design and although the initial chapters explain binary arithmetic, Boolean Algebra, diodes and triodes in some detail it is not seriously recommended for anyone who knows nothing of these topics. Nevertheless the mathematician who wants to know something about practical circuitry, or the maintenance engineer who wants to know something of the theory, could both profit from the book; but probably it will find a home in most instances on the bookshelves of University students. It would be extremely valuable to the electronics industry if graduates in electronics engineering knew everything in this book, by the time they left University.

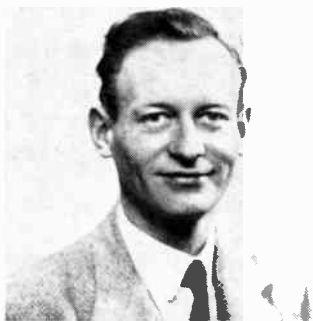

Ian Sharp, a senior engineer with Ferranti-Packard Electric Ltd., is currently working in the fields of advanced programming, computer system analysis and computer feasibility studies. Previously with the Department of Operational Research and Cybernetics of the United Steel Companies, Mr. Sharp's specialist interest in computing techniques goes back many years. He was educated in England and received his M.A. (Mechanical Science Tripos) from Cambridge University.

Understanding Microwaves by Victor J. Young, Ph.D.

This is an abridged edition of a rigorous discussion of the fundamentals of microwaves, their generation, transmission, and applications. The book opens with the explanation of electro-magnetic and electrostatic fields; then deals with radiation and reflection and Poynting's Vector and Maxwell's Equations. It then discusses

the fundamentals of wave-guides, coaxial lines and resonant cavities in connection with the magnetron, the dynatron, and the klystron. Related mathematics have been placed in the footnotes to make this book as useful as possible.

John F. Rider Publisher, Inc., 116 W. 14th Street, New York, N.Y. U.S.A.; soft cover edition; 304 pages; price \$3.50.

International Transistor Substitution Guidebook by Keats A. Pullen, Jr., Eng.D.

This book represents an effort to serve the electronic industry with accurate, reliable transistor substitution information. The selections listed are based on a critical, detailed examination of the electrical characteristics of the original transistor as well as the suggested transistor substitute.

The physical dimensions of the original, case styles and physical sizes of both the original and the substitute are indicated in the listings alongside the type numbers. A section of the guidebook pictures case styles, states the diameter, height, number of leads, and other mechanical dimensions.

John F. Rider Publisher, Inc., 116 West 14th Street, New York, N.Y.; soft cover edition, 64 pages, price \$1.50.

VHF Line Techniques by C. S. Gledhill, B.Sc. Tech., A.M.I.E.E.

Written for the undergraduate student primarily in mind, this book deals with various methods of using transmission lines as elements to perform various functions of communication circuits. Wherever applicable, the rigorous analysis of the method is given, but the aim in every section has been to show that the circle-diagram technique yields the same results as the analysis and also does it more rapidly.

The Macmillan Company of Canada Ltd., 70 Bond Street, Toronto, Ontario; hard cover edition, 60 pages, price \$2.15.

Who's Who in the Electronic Industry compiled and edited by The Scientist and Engineer Technological Institute.

This complete reference work on engineers, scientists, executives and educators engaged in all phases of the electronic industry, contains comprehensive personal, professional biographies.

The biographies are indexed alphabetically and geographically together with Greek letter and professional society information, occupational title, home address, date and place of birth, citizenship, marital status, engineering and professional licenses, honors, patents, etc.

SETI Publishers, Ltd., 176 East 75th Street, New York 21, N.Y. U.S.A.; hard cover edition; 336 pages; price: \$49.50.

LIQUIDATION SALE FINE PRECISION MACHINE SHOP

Mercer and Standard dial bore gauges; DoAll gauge block holder set; flatness checker; gauge block sets; wear gauge blocks; thread chasing heads; Gemo bevel gauge set; large supply of cutters, sharpening stones; Nobur tools, many other items. Also two heat treating furnaces; Detex watchman's clock; I. B. M. master clock set; name check cutter. All at a fraction of original cost.

HARRY H. WHITEHALL LIMITED
Galt, Ontario In Toronto call WA. 2-4968

FOR STEADY AC LINE VOLTAGE

Regulate with **STEDIVOLT**

- 0.5% accuracy
- No waveform distortion
- No relay contacts
- Single or three phase
- 2 to 350 KVA
- Custom models available

Made in Canada by
a Canadian Company

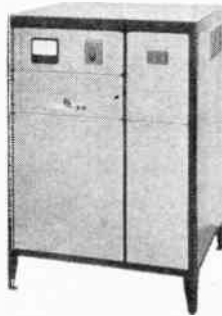

GEORGE KELK LIMITED
5 Lesmill Rd. Don Mills, Ont.

KELK

For complete details check No. 25 on handy card, page 63

THE PERMANENT TOWER THAT'S BETTER EVERY WAY

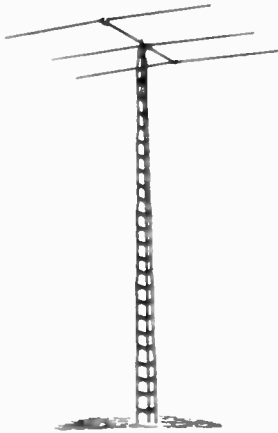

DELHI

SPAULDING STRATO-TOWER

- Completely self-supporting
- Heavily galvanized all-steel construction
- "X"-brace design for greater strength
- Smartly styled, easily erected

CHOOSE FROM 4 BASES

- | | |
|------------------------------|---|
| 1. For anchoring in concrete | 3. Cylinder base |
| 2. Screw Anchor | 4. For the side of a building, ground rods driven through holes in base |

ASK YOUR DELHI DEALER about this and other DELHI towers:
Guyed towers up to 150' and "Erect-Tower" with crank-up . . . to 100'.

DELHI METAL PRODUCTS LIMITED
DELHI, ONTARIO — PHONE: 211

Towers for all TV requirements

For complete details check No. 16 on handy card, page 63

The Chargistor

Continued from page 33

has also been found to be sensitive to light as well as to magnetic field.

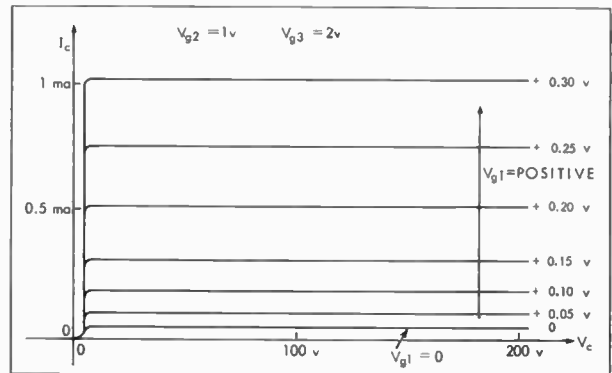

Figure 7 — Typical output V-I characteristic of a pentode Chargistor.

References

1. A. A. Lampert and A. Rose, "Volume-Controlled, Two-Carrier Currents in Solids: The Injected Plasma Case," *Phys. Rev.* 121, 26 (1961).
2. The "injected plasma density" referred to here is the condition in which the hole density is the same as the electron density. This injected plasma density is due to double injection of holes and electrons into the solid material.
3. D. A. Kleinman, "The Forward Characteristics of the P-I-N Diode," *Bell System Tech. J.* 35, 685 (1956).
4. G. C. Dacey and I. M. Ross, "The Field-Effect Transistor," *Bell System Tech. J.* 34, 1149 (1955).

SMALLER DOLLARS?



Pylons with unchanged prices* are an even better buy these days.

*Less than 4 cents of the dollar you spend at Pylon emigrates from Canada.

Pylon spends the balance in CANADA — over 96 cents — for

- Wages
- Material
- Taxes
- Profits



**"WHEN YOU BUY PYLON —
YOU BUY CANADIAN"**

PYLON ELECTRONIC DEVELOPMENT company, Ltd.

Communications Systems and Equipment

161 CLEMENT ST., VILLE LA SALLE, MONTREAL 32, QUE.

For complete details check No. 34 on handy card, page 63



PRECIOUS METAL CONTACTS FOR HIGH-RELIABILITY

Precious metal contacts in pure or alloyed forms of silver, platinum, palladium and gold provide unmatched resistance to atmospheric corrosion, deformation, arc erosion, binding and metal transfer. Baker high-reliability precious metal contacts are supplied as wire, rod, sheet and in a complete line of fabricated forms. Facilities are also available for manufacture to your specifications.



512 King Street East
Toronto, Ontario
Canada

SALES OFFICE: 660 Ste. Catherine St. W., Montreal, P.Q., Canada
For complete details check No. 18 on handy card, page 63



SOLDERING EQUIPMENT

*Illustrated
The Adcola*

Cat No. 64
(3/16 bit)

CSA APPROVED

*Designed for
bench line
production and
continual use.*

•
•
•

Canadian, British
& Foreign Pats.,
Reg. Designs.



*Adcola
Instruments*

operate at
correct soldering
temperatures
ensuring
permanent and
quality joints.

*Supplied in all
volt ranges.*

•
•
•

**ADCOLA
PRODUCTS
LTD.**
Box 103,
Weston, Ontario

For complete details check No. 1 on handy card, page 63
ELECTRONICS AND COMMUNICATIONS. November, 1961

Instantly



Model 12 - 22

**TESTS
BOTH
EUROPEAN
AND
AMERICAN
TUBES**

FIRST IN NORTH AMERICA

The first Universal Tube Tester on the American Continent embracing the performance of the patented Hickok Dynamic Mutual Conductance Circuit.

ALSO IN KIT FORM

It is the first of this type available in kit and wired form. It embraces tests for European and American tubes, a great advantage to domestic users due to growth of European tube applications. Where proper testing of tubes is required, dynamic mutual conductance readings are essential. The principle of the Starkit 12-22 is proportionally the same as that used by tube manufacturers' laboratories in designing and testing their own tubes.

TUBE OPERATING DURING TEST

Operating voltages, including DC Grid Bias, are applied to every element, and an AC signal is applied to the control grid, so that the tube is operating during the test.

The kit is supplied with step-by-step assembly instructions and a manual in French and English with complete pictorial, schematic and wiring harnesses that take the puzzle out of assembly. A unique method of calibration allows the operator to calibrate his checker with factory precision.



Model 9.66

Equipped to test all present day tubes including Octal, Loktal, Miniature, Ballast, Magic Eye, and Sub-Miniature tube types. Tests Grid Controlled Rectifier Tubes used in industrial applications . . . tests 600 mil series . . . tests Gas-filled Rectifier and Starter Tubes.

PROVISION FOR NEW TUBE DESIGNS

PROVISION FOR NEW TUBE DESIGNS
Provides Vital Lite test . . . Noise test . . . Gas test for rapid disclosure of tubes affecting AVC and IF stages. Uses rectifier current to energize both plates and grids. Will check TV picture tubes with low cost CRT adapter.

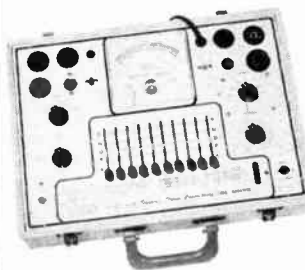

Model 9.99
LOW PRICE

Lowest priced quality tube tester. Has features only found on higher priced models.

FAST TEST

Dynamic trans conductance quality, available in both kit and factory wired units. Self cleaning switches allow you to quickly test for opens, shorts, leakage, heater continuity and quality. Includes fast acting roll chart. French and English manuals.

Write for literature on any one (or all three) of the above tube testers. If you are interested in other types of test equipment write for complete catalogue FREE.

You TEST BEST with STARKIT!



STARK ELECTRONIC INSTRUMENTS LTD.
AJAX, ONTARIO

For complete details check No. 37 on handy card, page 63

product panorama

For further information on Products use Readers' Service Cards on pages 63 and 64

Solid tantalum capacitors

Item 106

These have ratings from 6 to 75 volts, and comply to the stringent requirements of MIL-C-26655A. Kemet capacitors may be operated in the temperature range -55°C to $+125^{\circ}\text{C}$. Small in size, corrosion resistant, and with a very high reliability factor,

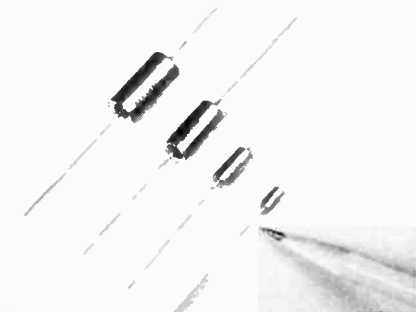

these capacitors are leak proof and have a long life span. Applications will be found in defense, industry, etc.

Union Carbide Canada Ltd., 123 Eglinton Ave. East, Toronto 12, Ont.

Millisecond-length pulse switch

Item 107

A new series (1PB3000) pushbutton switches, incorporating an electronic circuit to produce a single, millisecond-length pulse with each operation has been added to the "One-Shot" family of switches. These eliminate the need of designing special pulse input circuits for high speed electronic switching devices. They offer a longer pulse width than various switches. The square wave pulse width is factory adjustable from 30 to 500 milliseconds and the amplitude from 6 to 55 volts.

Micro-Switch, Honeywell Controls Ltd., Vanderhoof Ave., Toronto, Ontario.

Heat sink kit

Item 108

Astrokit Series A contains 17 natural convection, conduction, and forced convection (including fan) units together with

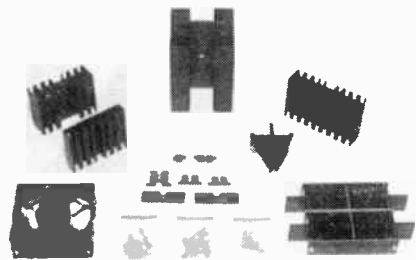

three sets of mounting kits and a supply of interface grease. These provide a range of thermal resistance to cover all possible transistor applications. A heat sink manual for aiding in proper selection is included with the kit. Data furnished also covers forced convection heat sinks.

Astro Dynamics, Inc., Northwest Industrial Park, Burlington, Mass.

Microvoltmeter

Item 109

PSC model # 1101 DC microvoltmeter is a versatile precision instrument having ± 0.1 per cent accuracy in all ranges for measuring outputs of bonded or unbonded strain gauges, thermocouples, resistance thermocouples, and low level DC voltages. Resolu-

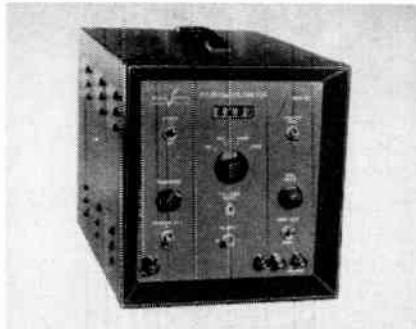

tion is one microvolt on the one millivolt full scale range. Ranges are as follows: ± 1000 microvolts; ± 10 , ± 50 , ± 100 millivolts.

Physical Sciences Corp., 389 North Fair Oaks Ave., Pasadena, Calif.

Bulk tape eraser

Item 110

Model ME-77 will erase recordings from reels of tape up to 7" in diameter and $\frac{1}{4}$ " wide in a moment. It is especially suited for the 3" and 4" reels used in office dictating. Not only is the tape free of all sound from a security standpoint; its freedom from background noise make it the equivalent of factory-fresh tape. The tape can be used and reused continuously. The security factor on confidential information recorded on tapes is assured when this simple and fast method is utilized to erase sound.

E. S. Gould Sales Co. Ltd., 19 le Royer St. West, Montreal 1, P.Q.

Military cases

Item 111

All 11 sizes of MIL-C-4150E aluminum military cases, without tooling charge, are now available. Sizes range from 18" x 21"

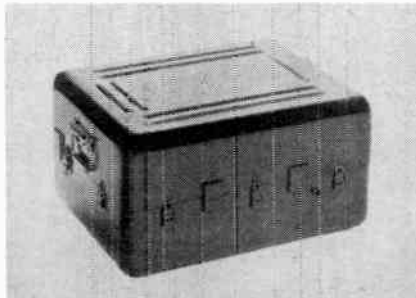

to 28 $\frac{1}{4}$ " x 28 $\frac{1}{4}$ ". The cases will meet applicable environmental protective standards such as temperature, humidity, fungus, saltspray; and pass required drop tests. Standard equipment includes handles, latches, pressure and humidity valves and shock support cushioning.

Zero Manufacturing Co., 1121 Chestnut St., Burbank, Calif.

Plastic wiring duct

Item 112

Open-slot plastic wiring duct is available in an extended range of 25 different sizes. Designated Type E Panduct, it incorporates rounded top surfaces on the duct. This protects wire insulation and prevents irritation of the installer's hands. Deep slots ex-

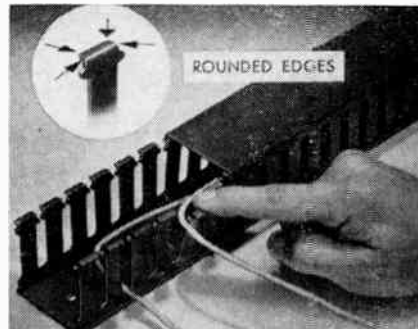

tending near the base of the duct are separated by individual plastic fingers which flex enough to allow wire to be inserted into the slots.

J. J. MacQuarrie Sales, 167 College Street, Toronto 2B, Ont.

Phase-protection relay

Item 113

This new relay adds phase protection to the present family of directional overcurrent relays (Type IR). Outstanding versatility of application is provided by the wide range of time-curve characteristics and time-dial settings available, and minimum operating current requirements. One of the features of this relay is a directional unit that torque controls both the time-overcurrent unit and the instantaneous overcurrent unit. Also included is a time-proved "E" element time-overcurrent unit.

Canadian Westinghouse Co. Limited, 286 Sanford Ave. North, Hamilton, Ont.

Power control

Item 114

An electronic power control to regulate the power flow to electric and infra-red ovens used for drying or baking, offers

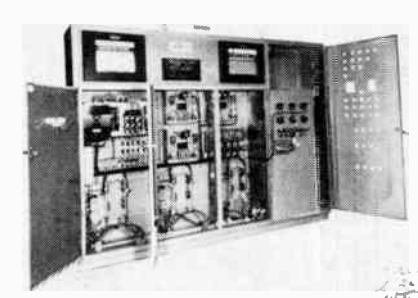

superior operating characteristics plus lower costs initially and in operation. Automatic features include switching between pre-set high heat and low-heat levels when conveyors are not constantly loaded, and automatic shutdown if oven fans fail to operate or temperature builds too high.

Weltronic Company, 3201 Marentette, Windsor, Ont.

product panorama

For further information on Products use Readers' Service Cards on pages 63 and 64

Piezoid ceramic material

Item 115

Designated as composition KE-14, this new material has electric properties which make it extremely useful for a wide range of transducer applications. It can be used in underwater sounding apparatus, ordnance systems, sensing gauges, ultrasonic

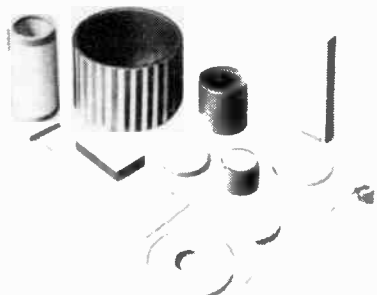

equipment, etc. The material is available in unlimited varieties of shapes and has an extremely stable dielectric constant from 55° to 300°C.

Centralab Canada Ltd., P.O. Box 400, Ajax, Ont.

Silicon controlled rectifier

Item 116

Two new series of silicon controlled rectifiers featuring micro-second switching speeds and a low firing current (5 ma at 100°C), are available. Jeedec types 2N1842 through 2N1849, rated at 10 amperes over a PRV range of 25 to 400 volts, operate over a temperature range of from -40° to +100°C. The second series, rated at 16 amperes, over a PRV range of 25 to 400 volts, are designated International Rectifier types 16RC2 through 16RC40, and operate over a range of -65°C to +125°C.

Douglas Randall (Canada) Ltd., 126 Manville Road, Scarborough, Ont.

Mobile radio unit

Item 117

The newly developed transistorized DT65 VHF FM mobile radio unit will operate in the 148-174 Mc/s range and is intended for

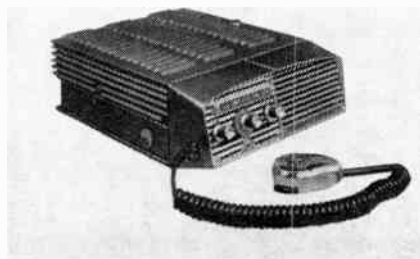

use on vehicles provided with 12 volt systems. Its features include: built-in voltage regulator; transistor "burn-out" protection; transistorized power control and audio circuits; and "long-life" professional type tubes. Full transmitter current drain is 10.5 amps at 13.6 volts for 30 watts output.

Canadian Marconi Co., 2442 Trenton Ave., Montreal 16, P.Q.

Morpho 51 plug

Item 118

A new Cannon plug designed to connect inside telephone cables is available. The new connector is similar to those of the standard Cannon Morpho series, except for the configuration and insulator material. It has a flat, elongated shape and so extends

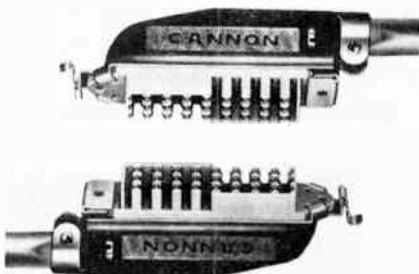

out from the surface of a wall or ceiling to a dimension equal to the thickness of the connected cable. Insulator material is Lexan, instead of cellulose acetate.

Cannon Electric Canada Ltd., 160 Bartley Drive, Toronto 16, Ont.

Power varactors

Item 119

Fifty-one silicon power varactors in hermetically sealed "computer type" packages are suitable for high efficiency RF harmonic generation and a wide variety of other applications in the 1 Mc to 3,000 Mc region. Anticipated efficiency for narrow-band multiplier (doubler) circuits in the VHF/UHF region is 70 to 80 per cent. The power dissipation rating of the new units ranges from 0.3 to 0.5 watts and shunt case capacitance is approximately 0.2 picofarads. These meet requirements of MIL-S-19500B.

E. G. Lomas, 227 Laurier Ave. West, Ottawa 4, Ont.

Scaler rate meter

Item 120

The RCR 3 incorporates all of the rigid performance specifications essential for medical, isotope applications, or radio-

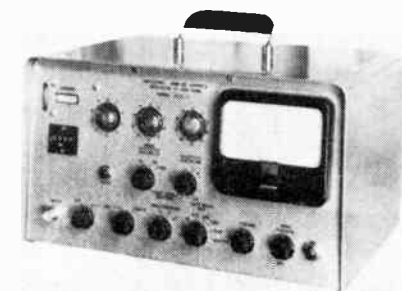

chemical and nuclear physics research. This instrument is an adjustable high voltage supply from 450 to 2500 volts, or as high as 3000 volts, a decade rate meter, with adjustable time constant and loud speaker, with volume control; scaler's capacity is up to 10 million.

Canadian Research Institute, 85 Curlew Drive, Don Mills, Ont.

Circuit board vise

Item 121

These vises conveniently hold circuit boards for soldering and similar operations. Also available are quick fastening solder masks, made of Teflon coated aluminum to prevent solder build up on the mask and solder bath contamination. Uniform clamp-

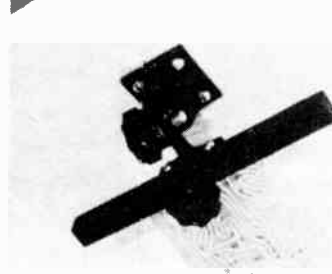

ing prevents boards from warping and will straighten warped boards upon application of heat from solder bath.

L. J. Bardwell Co., Box 142, Station D, Toronto 9, Ont.

Ultrasonic remote control

Item 122

Wireless remote control of four independent functions can be accomplished with a new ultrasonic system developed by RMS Associates, Inc. Fully transistorized, the system consists of a miniature, hand-held, battery operated 40 KC transmitter, and compact receiver. Control can be achieved with up to 30' separation when the transmitter is powered by a long-life 22v Mercury battery. The receiver uses a unique tuned relay; and does not, therefore need discriminators.

RMS Associates, Inc., 805 Mamaroneck Ave., Mamaroneck, N.Y.

Double end pliers

Item 123

This tool combines a fine cutting diagonal and a thin nose wiring plier. The plier known as the Hunter Double Ender is

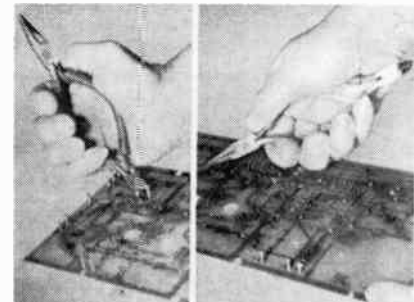

Ideally suited for electronic assembly work, as it eliminates the operator from having to lay down one plier and pick up another, everytime he switches from a cut to a bending problem. It consists of two miniature pliers joined together at the tip of the handle and covered with a soft plastic grip.

Hunter Tools, R. N. Hunter Sales Co., 9851 Albutus Ave., Sante Fe Springs, Calif.



U
N
I
M
A
X

PARDON US FOR NAME-DROPPING

But the reasons why so many major names have chosen to associate with us are likely to be the same reasons you should also. After all, we are the leading electronic supply house in Canada—we do offer in-stock, in-quantity merchandise at guaranteed factory prices—we do make quite a point of quick service. If those aren't enough reasons, we can give you more. Try us anytime.



Alpha Aracon

radio company limited

Industrial Sales Division

555 Wilson Ave., Toronto

ME 5-6181 Direct Order RU 9-4353

Telex subscribers call 02-2647

For complete details check No. 2

Industry's Business

Continued from page 49

First privately owned Canadian Aerophysics research facility established

Computing Devices of Canada Limited are currently completing the first phase of the construction of an Aerophysics Research Laboratory on a 200 acre tract of land at Stittsville, 15 miles west of the city of Ottawa.

In making the announcement, C. F. Hembury, president and general manager said, "While Canada at this time does not have any major high-speed aircraft, missile or space development programs, it is considered essential that CDC participate in and establish a reputation in the field of aerospace technology.

This will be the first such privately owned laboratory of its kind in North America engaged in the study of space technology and will provide a facility with the latest known launching equipment to conduct both company-sponsored and contract-supported basic research into the fields of impact and penetration, winged vehicle stability, plasma radiation and communications, and high g telemetry.

CDC's double chamber light gas gun.

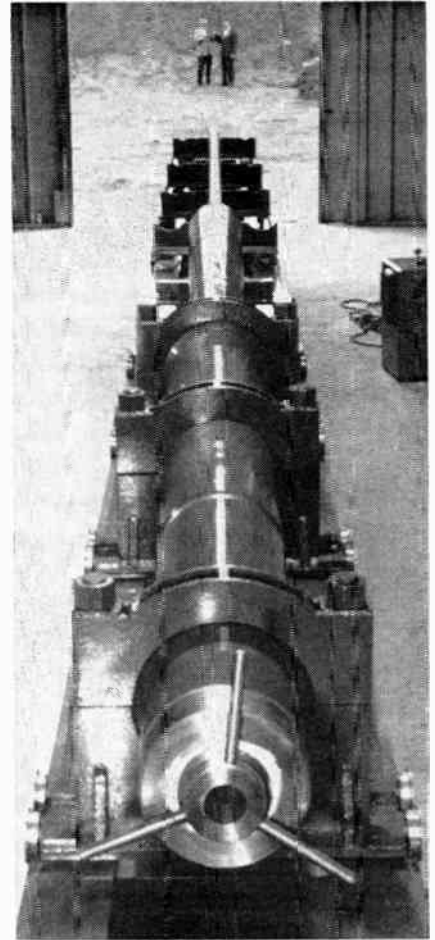

CANADA'S NUMBER ONE RESISTOR

IRC GBT 1/2



NOW JOINED BY THE GBT 1



IRC GBT 1 is now manufactured in Canada. The GBT 1 is a one watt insulated fixed carbon composition resistor, for general-purpose application. The size of the GBT 1 is .562 ± .010" — available in standard tolerances of 5%, 10% and 20%.

Performance specifications for the GBT 1 are the same as our GBT 1/2 which has gained Universal acceptance in the Canadian Electronic Industry.

Write For IRC Bulletin B 1-E



RESISTORS

a division of

RENFREW ELECTRIC CO. LTD.

TORONTO, OTTAWA, MONTREAL, CALGARY

For complete details check No. 23 on handy card, page 63

APPLICATION FOR FREE SUBSCRIPTION

TECHNICAL LITERATURE BRIEFS

Electronic parts catalog: it has 300 pages listing thousands of electronic components, public address, technical manuals, hi-fi and stereo equipment and featuring special sections on Semiconductors and Citizens Band transceivers. **Canadian Electrical Supply Co. Ltd., 275 Craig St. West, Montreal, P.Q.**

Item 136

Silastic RTV applications: 8-page brochure offers an outline of the versatility of Silastic RTV, the liquid room temperature vulcanizing rubber. Both the mechanical and electrical applications are shown. **Dow Corning Silicones Ltd., 1 Tippet Road, Downsview, Ont.**

Item 137

Composition element potentiometers: 16-page catalog provides description, complete technical specifications, dimensional drawings and photographs of eight different series of composition element potentiometers. **Tri-Tel Associates Ltd., 81 Sheppard Avenue West, Willowdale, Ont.**

Item 138

Counting units for programmed control: this 46-page booklet with a companion booklet of data and circuit diagrams, is available immediately. Both publications are fully illustrated with photos and technical drawings. **Tube, Semiconductor and Component Dept., Philips Electronics Industries Ltd., 116 Vanderhoof Ave., Toronto 17, Ont.**

Item 139

Electronic retention cooling devices: 8-page catalog 1-W describes more than 10,000 electronic cooling and/or retention devices available from the Birtcher Corporation. **Lake Engineering Co. Ltd., 123 Manville Road, Scarborough, Ont.**

Item 140

Strain recording: 20-page illustrated booklet "Strain Recording with Brush Direct Writing Recorders" describes the application of strain gauges and strain gauge based transducers for accurately recording strain, tension, thrust, load, torque, etc. **Bayly Engineering Ltd., Hunt Street, Ajax, Ontario.**

Item 141

Portable multi-range meters: bulletin No. 06-209 discusses the features and specifications of the Model 911-912 line of AC and DC voltmeters and ammeters developed by Daystrom's Weston Instrument Division. **Daystrom Ltd., Weston Instruments Division, 1480 Dundas Highway East, Cooksville, Ontario.**

Item 142

Microwave equipment: Narda catalog includes sections on waveguide and coaxial attenuators, bolometers and thermistors, directional couplers, ferrite devices, ridge waveguide test equipment, etc. **Mel Sales Ltd., 71 Crockford Blvd., Scarborough, Ontario.**

Item 143

Waveguide adapters: 2-color, 19-page catalog, JS-61A, contains mechanical data on various types of sidewall and topwall waveguide adapters covering EIA waveguide sizes from WR28 to WR187. **Tech Associates, 23 St. Thomas Street, Toronto 5, Ont.**

Item 144

Micro-miniature connectors: 6-page catalog covers expanded line of precision micro-miniature electronic connectors offering extreme miniaturization without sacrificing reliability. **Atlas Radio Corp. Ltd., 50 Wingold Ave. Toronto 19, Ont.**

Item 145

Frequency telemetering and transistorized analog system: bulletin GEA-7163, contains 8 pages and describes use and applications of General Electric telemetering systems and completely transistorized analog system. **Canadian General Electric Co. Ltd., 940 Lansdowne Ave., Toronto 4, Ontario.**

Item 146

Please **ADD** my name to receive **ELECTRONICS & COMMUNICATIONS**

Please **CHANGE** my address for mailings.

Note — Card must be completed in full to be valid.

My Name (Please Print)

Mail copies to my **home, or** **business address as noted below.**

Street
City **Zone** **Province**

If you have recently CHANGED your address please note former address here:

Company **Nature of Business**
 (State, when applicable, whether electronic equipment or components are manufactured, sold, or used in manufacturing, etc.)

ARE YOU AN ENGINEER? Yes No

Signature **Position**
 11 61

BUSINESS REPLY CARD
 No Postage Stamp Necessary if Mailed in Canada



5c POSTAGE WILL BE PAID BY

ELECTRONICS AND COMMUNICATIONS

450 Alliance Avenue

Toronto 9, Ontario



PLEASE SEND FURTHER INFORMATION ON FOLLOWING ITEMS AS NUMBERED BELOW. (All Literature & Product items Numbered)

- | | | | | | | | | | | | |
|------------------------------|------------------------------|------------------------------|------------------------------|------------------------------|------------------------------|------------------------------|------------------------------|------------------------------|------------------------------|------------------------------|------------------------------|
| <input type="checkbox"/> 105 | <input type="checkbox"/> 106 | <input type="checkbox"/> 107 | <input type="checkbox"/> 108 | <input type="checkbox"/> 109 | <input type="checkbox"/> 110 | <input type="checkbox"/> 111 | <input type="checkbox"/> 112 | <input type="checkbox"/> 113 | <input type="checkbox"/> 114 | <input type="checkbox"/> 115 | <input type="checkbox"/> 116 |
| <input type="checkbox"/> 117 | <input type="checkbox"/> 118 | <input type="checkbox"/> 119 | <input type="checkbox"/> 120 | <input type="checkbox"/> 121 | <input type="checkbox"/> 122 | <input type="checkbox"/> 123 | <input type="checkbox"/> 124 | <input type="checkbox"/> 125 | <input type="checkbox"/> 126 | <input type="checkbox"/> 127 | <input type="checkbox"/> 128 |
| <input type="checkbox"/> 129 | <input type="checkbox"/> 130 | <input type="checkbox"/> 131 | <input type="checkbox"/> 132 | <input type="checkbox"/> 133 | <input type="checkbox"/> 134 | <input type="checkbox"/> 135 | <input type="checkbox"/> 136 | <input type="checkbox"/> 137 | <input type="checkbox"/> 138 | <input type="checkbox"/> 139 | <input type="checkbox"/> 140 |
| <input type="checkbox"/> 141 | <input type="checkbox"/> 142 | <input type="checkbox"/> 143 | <input type="checkbox"/> 144 | <input type="checkbox"/> 145 | <input type="checkbox"/> 146 | | | | | | |

PLEASE SEND FURTHER INFORMATION ON THE FOLLOWING ADVERTISEMENTS AS NUMBERED BELOW. (Key numbers in column overleaf)

- | | | | | | | | | | | | |
|-----------------------------|-----------------------------|-----------------------------|-----------------------------|-----------------------------|-----------------------------|-----------------------------|-----------------------------|-----------------------------|-----------------------------|-----------------------------|-----------------------------|
| <input type="checkbox"/> 1 | <input type="checkbox"/> 2 | <input type="checkbox"/> 3 | <input type="checkbox"/> 4 | <input type="checkbox"/> 5 | <input type="checkbox"/> 6 | <input type="checkbox"/> 7 | <input type="checkbox"/> 8 | <input type="checkbox"/> 9 | <input type="checkbox"/> 10 | <input type="checkbox"/> 11 | <input type="checkbox"/> 12 |
| <input type="checkbox"/> 13 | <input type="checkbox"/> 14 | <input type="checkbox"/> 15 | <input type="checkbox"/> 16 | <input type="checkbox"/> 17 | <input type="checkbox"/> 18 | <input type="checkbox"/> 19 | <input type="checkbox"/> 20 | <input type="checkbox"/> 21 | <input type="checkbox"/> 22 | <input type="checkbox"/> 23 | <input type="checkbox"/> 24 |
| <input type="checkbox"/> 25 | <input type="checkbox"/> 26 | <input type="checkbox"/> 27 | <input type="checkbox"/> 28 | <input type="checkbox"/> 29 | <input type="checkbox"/> 30 | <input type="checkbox"/> 31 | <input type="checkbox"/> 32 | <input type="checkbox"/> 33 | <input type="checkbox"/> 34 | <input type="checkbox"/> 35 | <input type="checkbox"/> 36 |
| <input type="checkbox"/> 37 | <input type="checkbox"/> 38 | <input type="checkbox"/> 39 | <input type="checkbox"/> 40 | <input type="checkbox"/> 41 | <input type="checkbox"/> 42 | | | | | | |

Name **Position**

Company

Street **City** **Prov.**
 11 61

BUSINESS REPLY CARD
No Postage Stamp Necessary if Mailed in Canada

5c POSTAGE WILL BE PAID BY



INDEX TO ADVERTISERS

Page number is on the right. Key number for use with READER SERVICE CARD is on the left.

Key No.	Page No.
1. Adcola Products Ltd.	59
2. Alpha Aracon Radio Co. Ltd.	62
3. American Electrical Heater Co.	71
4. Amphenol Canada Ltd.	71
5. Amphenol Canada Ltd.	68
6. Automatic Electric Sales (Canada) Ltd.	12
7. Bach-Simpson Ltd.	12
8. Bendix Corp. (Scintilla Div.)	4
9. Cndn. Marconi Co. (Electronic Tubes & Components Div.)	4
10. Canadian Stackpole Ltd.	7
11. Canadian Westinghouse Co. (Electronics)	13
12. Clark Ltd., Alex L.	68
13. Collins Radio Co.	IBC
41. Allan Crawford Assocs.	54
14. Daystrom Ltd. (Weston Div.)	52
15. Delavan Electronics Corp.	9
16. Delhi Metal Products Ltd.	58
17. Electro Sonic Supply Co.	67
18. Engelhard Industries of Canada Ltd.	59
24. Federal Electric Cord	56
41. Fluke Mfg. Co. Inc., John	54
19. General Insrtument Ltd.	6
20. Hammond Mfg. Co. Ltd.	16
21. Hewlett-Packard Co.	OBC
22. I.R.C. Resistors Div., Renfrew Electric Co. Ltd.	62
25. Kelk Ltd., George	58
26. Litton Systems Canada Ltd.	IFC
27. Lorain Products (Canada) Ltd.	20
28. Milgray	17
29. Nickam Instruments & Supply Ltd.	48
30. Northern Electric Co. Ltd.	8
31. Northern Electric Co. Ltd.	11
32. Philco Corp. of Canada Ltd.	49
33. Phillips Electrical Co. Ltd.	19
34. Pylon Electronic Development Co.	58
35. R.C.A. Victor Co. Ltd.	69
36. Sprague Electric International Ltd.	71
37. Stark Electronic Industries Ltd.	59
38. Struthers-Dunn Relays Div., Renfrew Electric Co. Ltd.	67
39. Unversal Electronics	71
40. Welwyn Canada Ltd.	65

ELECTRONICS AND COMMUNICATIONS

450 Alliance Avenue

Toronto 9, Ontario

PLEASE SEND FURTHER INFORMATION ON FOLLOWING ITEMS AS NUMBERED BELOW. (All Literature & Product items Numbered)

- | | | | | | | | | | | | |
|------------------------------|------------------------------|------------------------------|------------------------------|------------------------------|------------------------------|------------------------------|------------------------------|------------------------------|------------------------------|------------------------------|------------------------------|
| <input type="checkbox"/> 105 | <input type="checkbox"/> 106 | <input type="checkbox"/> 107 | <input type="checkbox"/> 108 | <input type="checkbox"/> 109 | <input type="checkbox"/> 110 | <input type="checkbox"/> 111 | <input type="checkbox"/> 112 | <input type="checkbox"/> 113 | <input type="checkbox"/> 114 | <input type="checkbox"/> 115 | <input type="checkbox"/> 116 |
| <input type="checkbox"/> 117 | <input type="checkbox"/> 118 | <input type="checkbox"/> 119 | <input type="checkbox"/> 120 | <input type="checkbox"/> 121 | <input type="checkbox"/> 122 | <input type="checkbox"/> 123 | <input type="checkbox"/> 124 | <input type="checkbox"/> 125 | <input type="checkbox"/> 126 | <input type="checkbox"/> 127 | <input type="checkbox"/> 128 |
| <input type="checkbox"/> 129 | <input type="checkbox"/> 130 | <input type="checkbox"/> 131 | <input type="checkbox"/> 132 | <input type="checkbox"/> 133 | <input type="checkbox"/> 134 | <input type="checkbox"/> 135 | <input type="checkbox"/> 136 | <input type="checkbox"/> 137 | <input type="checkbox"/> 138 | <input type="checkbox"/> 139 | <input type="checkbox"/> 140 |
| <input type="checkbox"/> 141 | <input type="checkbox"/> 142 | <input type="checkbox"/> 143 | <input type="checkbox"/> 144 | <input type="checkbox"/> 145 | <input type="checkbox"/> 146 | | | | | | |

PLEASE SEND FURTHER INFORMATION ON THE FOLLOWING ADVERTISEMENTS AS NUMBERED BELOW.

- | | | | | | | | | | | | |
|-----------------------------|-----------------------------|-----------------------------|-----------------------------|-----------------------------|-----------------------------|-----------------------------|-----------------------------|-----------------------------|-----------------------------|-----------------------------|-----------------------------|
| <input type="checkbox"/> 1 | <input type="checkbox"/> 2 | <input type="checkbox"/> 3 | <input type="checkbox"/> 4 | <input type="checkbox"/> 5 | <input type="checkbox"/> 6 | <input type="checkbox"/> 7 | <input type="checkbox"/> 8 | <input type="checkbox"/> 9 | <input type="checkbox"/> 10 | <input type="checkbox"/> 11 | <input type="checkbox"/> 12 |
| <input type="checkbox"/> 13 | <input type="checkbox"/> 14 | <input type="checkbox"/> 15 | <input type="checkbox"/> 16 | <input type="checkbox"/> 17 | <input type="checkbox"/> 18 | <input type="checkbox"/> 19 | <input type="checkbox"/> 20 | <input type="checkbox"/> 21 | <input type="checkbox"/> 22 | <input type="checkbox"/> 23 | <input type="checkbox"/> 24 |
| <input type="checkbox"/> 25 | <input type="checkbox"/> 26 | <input type="checkbox"/> 27 | <input type="checkbox"/> 28 | <input type="checkbox"/> 29 | <input type="checkbox"/> 30 | <input type="checkbox"/> 31 | <input type="checkbox"/> 32 | <input type="checkbox"/> 33 | <input type="checkbox"/> 34 | <input type="checkbox"/> 35 | <input type="checkbox"/> 36 |
| <input type="checkbox"/> 37 | <input type="checkbox"/> 38 | <input type="checkbox"/> 39 | <input type="checkbox"/> 40 | <input type="checkbox"/> 41 | <input type="checkbox"/> 42 | | | | | | |

Name _____ Position _____

Company _____

Street _____ City _____ Prov. _____

11-61

BUSINESS REPLY CARD
No Postage Stamp Necessary if Mailed in Canada

5c POSTAGE WILL BE PAID BY



ELECTRONICS AND COMMUNICATIONS

450 Alliance Avenue

Toronto 9, Ontario

product panorama

For further information on Products use Readers' Service Cards on pages 63 and 64.

Dictating/transcribing unit

Item 124

Stenorette-Versatile is a portable unit featuring disposable penlight size mercury cells and complete compatibility with desk-top machines. Up to 45 minutes of continuous dictation can be obtained on each reel of magnetic tape. Owners can dictate on



their portable in the field, mail their tapes to the office for transcription on standard Stenorettes, or transcribe directly from the portable unit.

Business Equipment Division, DeJur of Canada Ltd., 184 Bay Street, Toronto 1, Ont.

Portable drafting kit

Item 125

A Draftette Sketch Kit, with a new type portable drafting machine mounted in a newly improved vinyl self-locking binder, is available. The portfolio fold kit includes the drafting instrument, with 3" x 5" or 4" x 6" scale and 180° protractor, pad of 50 sheets of 8½" x 11" drawing paper, and pencil. Because of its easily-handled, folding design, the portfolio can be conveniently carried or stored in desk or table. All parts of the precision-engineered Draftette instrument are machine calibrated.

Draftette Company, P.O. Box 794, Beverly Hills, Calif.

Portable photocopier

Item 126

The "Attache" photocopier (a diffusion transfer machine) was created to fulfill a need by executives on-the-go, engineers,



construction men in the field, etc., who need to copy data in the field or at reference locations. Compact and weighing a light 12½ lbs., the attractively styled case — natural luggage color with brass hardware and dual security locks — is ruggedly constructed to take the rigors of travel.

American Steel Export Co., 347 Madison Ave., New York, N.Y.

METROX

TYPE
F-20

MINIATURE MOLDED OXIDE RESISTORS

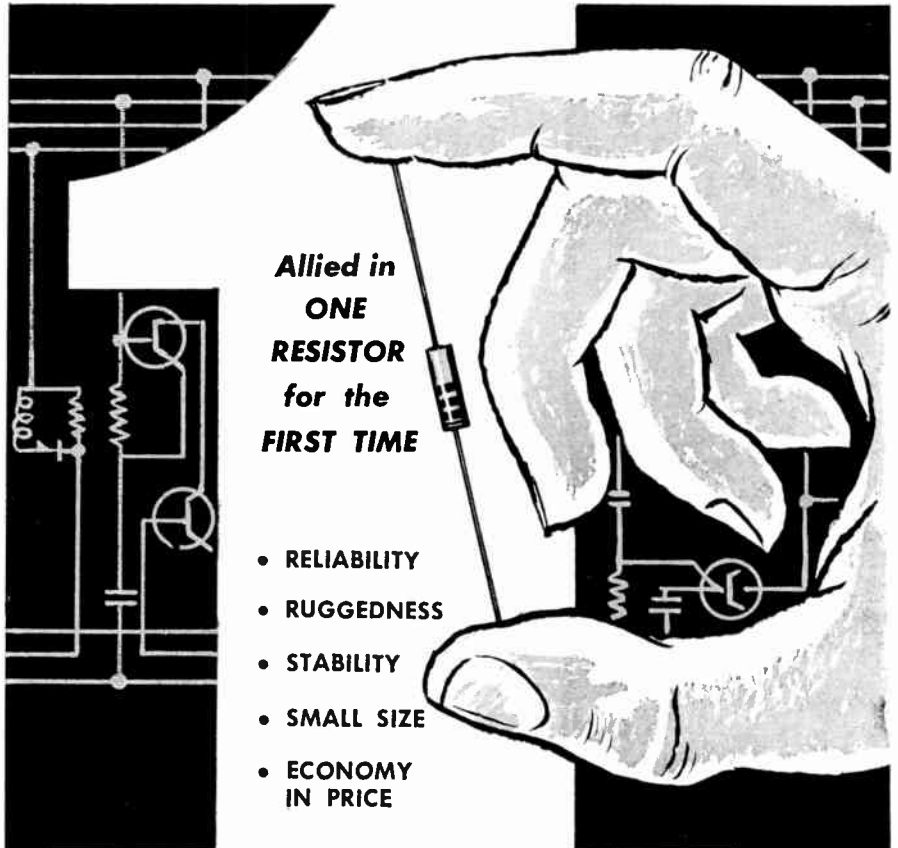

Allied in
**ONE
RESISTOR**
for the
FIRST TIME

- RELIABILITY
- RUGGEDNESS
- STABILITY
- SMALL SIZE
- ECONOMY
IN PRICE

Welwyn

RELIABILITY — Failure rate is better than one per ten million hours.

STABILITY — Under full load, the stability is better than 2% after 10,000 hours. Subsequent rate of change will not exceed 0.1% per thousand hours.

TEMP. COEF. — Will not exceed $\pm 0.05\%$ per °C.

NOISE — Less than 0.5 $\mu\text{V/V}$ applied.

TOLERANCE — All MIL - R - 11C values at $\pm 5\%$.

SIZE — Same as the Mil Type RC20.

SPECIFICATION — Exceeds materially Mil - R - 11C.

PRICE as compelling as the performance and related to 5% carbon composition resistors.

Type	Rating @ 70°C Ambient	Mil Type	Rated Voltage	Minimum Resistance	Maximum Resistance	Dielectric Strength
F20	½ Watt	RC20	350V	10 Ohms	500 K	1000 Volts



For complete data and specifications write to

Welwyn Canada Limited

1255 BRYDGES STREET, LONDON, ONTARIO

product panorama

For further information on Products use Readers' Service Cards on pages 63 and 64

Meter calibrator

Item 127

Each unit has calibration data provided to an accuracy of 0.5 per cent. Measuring only 10½" high, the 19" rack panel unit is used for instrument repair work, production floor testing, incoming receiving inspection, and by meter calibration groups and

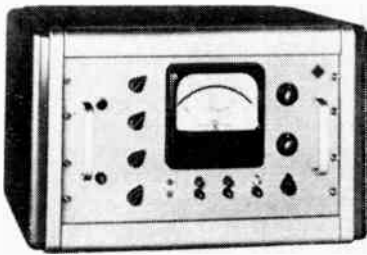

quality control departments. It's equipped with 14 AC and DC voltage ranges, and 13 DC current ranges.

Willer Engineering & Sales Co., 676 Richmond St. West, Toronto 3, Ont.

Spacecraft antennas

Item 128

STEM spacecraft antennas are designed for use in rocket, satellite and space-probe applications in which very long antenna lengths must be stowed in extremely restricted space. The unique mechanical principle employed in the STEM antennas permits the extension of up to several hundred feet of antenna from a package of minimum size, and allows for complete or partial rewind either in operation or for ground-checking purposes. Standard antenna lengths are 25 and 75 feet.

The De Havilland Aircraft of Canada Ltd., Downsview, Ont.

Epoxy module packages

Item 129

All epoxy module packages (headers and cases) which will plug into standard 8 or 10 pin crystal can relay sockets are now

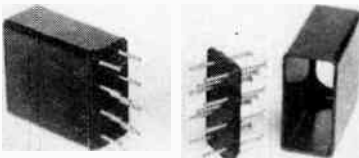

commercially available. A friction fit between the header and case prevents liquid epoxy from leaking during encapsulation. The cases are open at the top for easy filling in production line application. Header pins can be either gold plated or tinned copper.

E. S. Gould Sales Co. Ltd., 19 Le Royer St. West, Montreal, P.Q.

Trimmer resistors

Item 130

These ceramic base units are available for micro-miniature, sub-miniature and miniature applications. The available resistances range from 500 ohms to 5 megohms linear taper. Standard tolerance is ± 30 per cent although ± 20 per cent is available

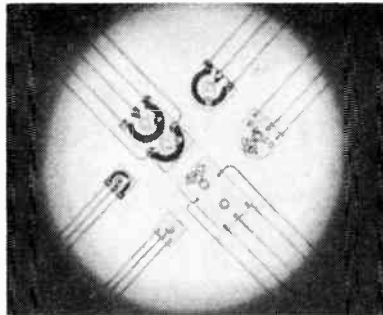

If required. Minimum end resistance is less than 5 per cent of total resistance. These are an adaptation of a packaged electronic circuit concept.

Centralab Canada Ltd., P.O. Box 400, Ajax, Ont.

Data recording system

Item 131

The 2101 consists of a precision tape transport and an electronic module assembly. Choice of 14 tracks of wideband FM recording or seven tracks of wideband FM and seven tracks of direct analog recording can be made by changing plug-in modules. This system produces accurate data during conditions of missile launch and flight for use after recovery or in-flight reproduction. Magnetic heads with gaps of 80 micro-inches help make possible high frequency response in relation to tape speed.

Litton Systems (Canada) Ltd., 165 Sparks Street, Ottawa, Ontario.

Semiconductor mount

Item 132

A molded socket, designed to allow direct chassis mounting of Jedec TO-3 outline power transistors, diodes and rectifiers for

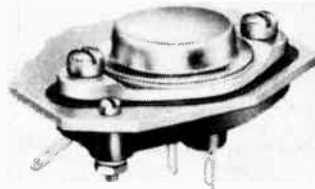

maximum heat transfer by conduction into the chassis, is available. This compact socket, complete with mica chassis insulator, weighs only .014 lb. It comes in black phenolic, melamine and diallyl phthalate. Molded-in threaded bushings are brass or nickel.

Augat, Inc., 33 Perry Ave., Attleboro, Mass.

RCR 2 counter

Item 133

A basic counting instrument for teaching elementary and advanced courses in atomic science or for use in research, medical and industrial programs, was originally designed by Nucleonics Corp. of America, for the Science Teachers Training program spon-



sored by the U.S. Atomic Energy Commission. This instrument has a high voltage supply, continuously adjustable from 450 volts, to 1500 volts.

Canadian Research Institute, 85 Curlew Drive, Don Mills, Ontario.

Solid state relay

Item 134

Model SSR-2828-3504 solid state relay is a silicon transistorized static AC switching relay with no moving parts. It was designed to overcome many of the inherent deficiencies of mechanical relays. It is an inertialess device capable of over 100 million operations. Actuation time is 2 microseconds and dropout time is 5 microseconds. Actuation or drive frequency can be as high as 5 Kc/s. This unit is especially recommended for power line switching of 60, 400, 800, 1600, 3200 and 6400 cps systems.

Radionics Limited, 8230 Mayrand Street, Montreal 9, P.Q.

Envelope Kool Klamps

Item 135

Series 7B Kool Klamps have been developed for subminiature T-3 envelopes in two types. The low cost Kool Klamps



are available with or without sockets for in-line and circular basing. The design is the open finger-type sleeve to permit easy top insertion and withdrawal. Material is beryllium copper No. 25 per QQ-C-533 in optional finishes of silver plate, cadmium, copper, gold or plain.

Lake Engineering Co. Ltd., 123 Manville Road, Scarborough, Ont.

EIA news *Continued from page 9*

New Canadian Standard Announced

CRS-20, a new Canadian EIA Standard for Installation of Sound Systems in Public, Educational, and Industrial Buildings, has been approved for distribution.

Originating in the Sound Equipment Engineering Committee of the Electronics Division, the specification establishes minimum standards covering methods of sound system distribution and the methods of maintaining standards compatible with the quality of the buildings in which such systems are installed.

Transformer Standard Proposal Revised

The Transformer Sub-committee's Proposed Standard on Power Transformers for Use in Radio, Television and Electronic Equipment up to 1 KVA is being resubmitted for approval. The proposal had been returned to the Committee for examination of possible areas of conflict with EIA Standard RS-180. The Committee said that RS-180 is too general and does not include all the requirements of the type of transformer up to 1 KVA. The proposal, in its new form, will include a guide to the manufacturer and user for all the requirements that should be specified in Canadian design.

Television — An Electrical Bargain

A recent report says that the American public is spending close to half a million dollars annually for electricity to keep TV screens lighted. If second sets were added to all homes without them TV would be pouring close to a billion into electrical company coffers. A black and white set costs the average household about 71 cents a month to operate. A color set accounts for about 92 cents a month on the electricity bill. The report is based on some 56 million TV sets and about half a million color sets in use in the nation.

There are an estimated 3,674,100 television households in Canada, or about 84 per cent of the households, not including Yukon and the Northwest Territories.

DUNCO'S 219 INDUSTRIAL CONTROL RELAY

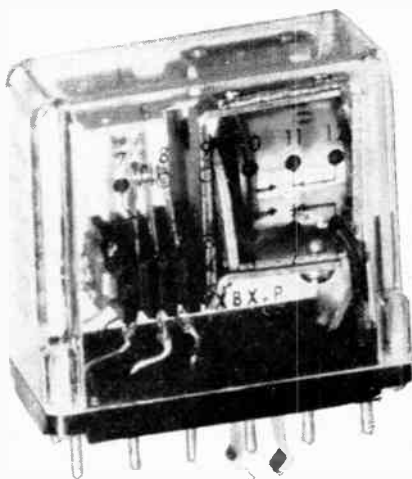

Designed for contact reliability through 20 million operations. Three standard contact arrangements meet most control needs. Contacts 10 amperes 115 Volts A.C.

Leading machine tool and industrial general purpose plug-in relay. Available in all A.C. or D.C. coil voltage.

C.S.A. approved.

A Member of the Dunco 219 Relay Family. Write for Bulletin 2219.



STRUTHERS-DUNN RELAYS

Division of RENFREW ELECTRIC CO., LIMITED

349 CARLAW AVENUE • TORONTO 8, ONTARIO

**FOR
IM-
MED-
IATE
DE-
LIVERY
OF
G-E
TRANS-
ISTORS
AND
RECTI-
FIERS
CALL**

**YOUR AUTHORIZED
GENERAL ELECTRIC
DISTRIBUTOR**

**ELECTRO
SONIC**

SUPPLY CO.

**543 YONGE ST.
TORONTO
WA. 4-9251**

HERE'S THE
**COMPLETELY
AUTOMATIC**
LONG TERM
STORAGE RECORDER

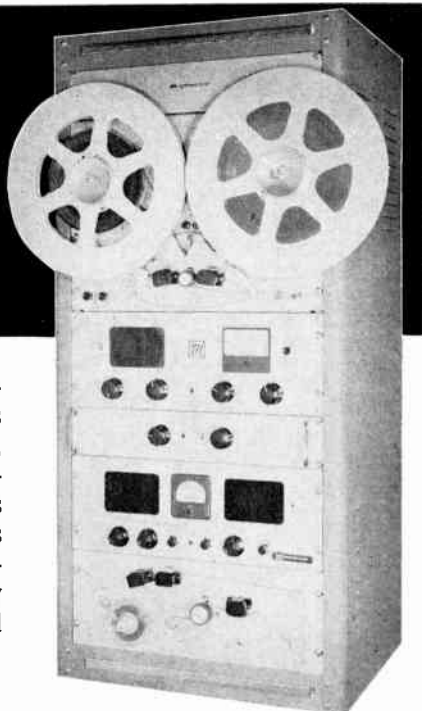

Designed to operate continuously for at least 8 hours (14 inch reels—4800-foot tape), the Magnecord 817-DL long-term storage recorder is completely automatic. Its recording time may be extended up to several weeks by the use of a voice operated relay.

Ideal for use by Police and Fire Departments, Hospitals, Business (conferences), Court Room Sessions and many others.



ASK FOR COMPLETE DETAILS

Magnecord
CANADA LTD.

3751 Bloor St. W., Toronto, Ontario

For complete details check No. 12 on handy card, page 63

MINNI-E
CONNECTORS

67 SERIES



AMPHENOL'S 67 SERIES MINNI-E CONNECTORS ARE QUICK DISCONNECT, MULTI CONTACT, MINIATURE BAYONET TYPES.

Minni-E connectors fully meet the "E" requirements of MIL-C-5015 . . . hooded contacts resist test prod damage . . . spring loaded coupling rings assure positive locking action in bayonet slot and a constant compensating force eliminates the effects of resilient face seal compression set.

MINNI-E CONNECTORS ARE PROVING THEMSELVES TO BE THE FINEST CONTACT CONNECTOR IN THE WORLD TO-DAY.

Write for Catalogue IEC-4 To-day.

AMPHENOL CANADA LIMITED

TORONTO • OTTAWA • MONTREAL • CALGARY

For complete details check No. 5 on handy card, page 63

FORTHCOMING MEETINGS

Instrument Society of America, Toronto Section, Food Industries Symposium will be held November 28 in the Westbury Hotel. Chairman will be P. Moise, editor of Food in Canada. All interested members of other technical associations are cordially invited.

1961 Eastern Joint Computer Conference opens December 12-14 at the Sheraton Park Hotel, Washington, D.C. The overall theme will be "Computers — Key to Total Systems Control". There will be both conference sessions and exhibits.

Canadian Electrical Association Eastern Zone meeting will be held in Niagara Falls on January 22-25, 1962.

Instrument Society of America, Toronto Section, Petrochemical Industry meeting on January 24, 1962, will have as its speaker Mr. Schmidt of Can. Bechtel Ltd. His topic will be "Recent Trends in Control Panels". Meeting place will be arranged.

The American Society of Mechanical Engineers Second Symposium on Thermo-physical Properties will take place January 24-26, 1962, at Princeton University, Princeton, N.J.

Instrument Society of America, Toronto Section, will meet February 28, 1962. Program and place will be arranged for their meeting concerning Atomic Energy.

Canadian Electrical Association's Western Zone members will meet at Regina, March 19-21, 1962.

Instrument Society of America, Toronto Section, will hold a technical program concerning the Pulp and Paper industry on March 22, 1962. The meeting place will be arranged later.

American Power Conference is slated for March 27-29 at the Sherman Hotel in Chicago, Ill.

ASME-SAM Management Engineering Conference has been listed as April 5-6, at the Statler Hilton Hotel, New York City.

Second International Congress of Cybernetic Medicine has been announced at Amsterdam, The Netherlands, on April 16-19, 1962. Included will be (1) Symposium on Cybernetics of the Nervous System; (2) Symposium on Cybernetics of Endocrine Glands; and (3) Free Communications. All inquiries should be sent to Dr. J. P. Schade, Secretary General, Netherlands Central Institute for Brain Research, Mauritskade 59b, Amsterdam, The Netherlands.

Instrument Society of America, Toronto Section, is having a technical program concerning Basic Steel on April 25, 1962. Program and place of meeting will be arranged.

**IRE advance
meeting notice**

Kitchener-Waterloo Section.
Time and Place: 8:15 p.m., Physics Amphitheatre, University of Waterloo.

November 20, 1961: M. A. Wilson, Westinghouse, "Ultrasonics" with a demonstration.

January 15, 1962: Barry, DRB, "Satellites".

February 19, 1962: G. A. Robitaille, CFPL, London, "Automatic Programming of a Radio Station".

March 12, 1962: Joint meeting London Section. Subject is "Stereo". Speaker to be announced.

April 16, 1962: Annual meeting. Speaker Dr. B. R. Myers. Subject to be announced. (A circuit theory topic.)

May 21, 1962: Tour through General Instrument plant in Waterloo. E. A. Thomas.

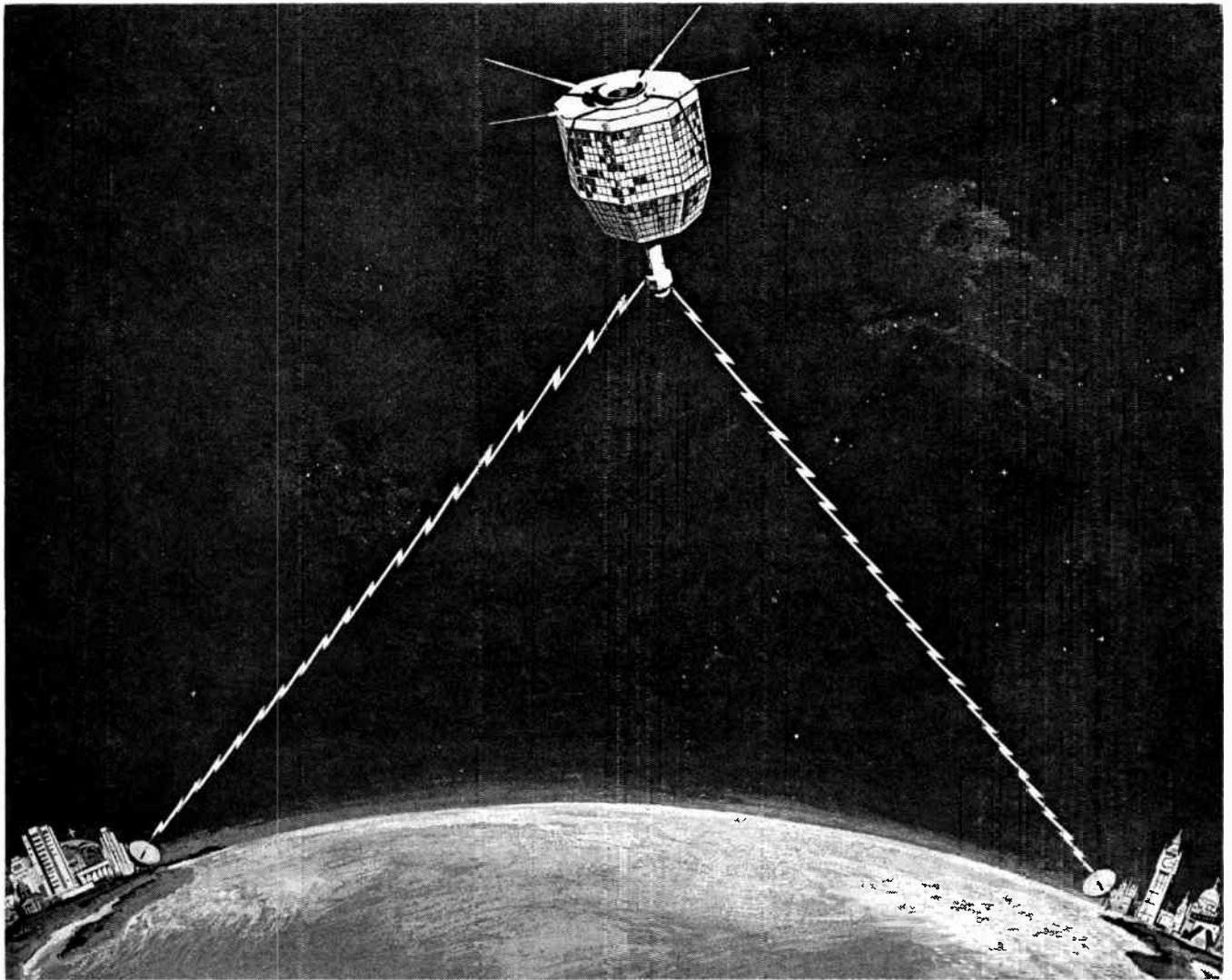

RCA TO BUILD RECEIVER/TRANSMITTER FOR EXPERIMENTAL COMMUNICATIONS SATELLITE

Scheduled to go into orbit in late summer next year, Project Relay will be the first active communications satellite. Designed to relay inter-hemisphere verbal communications, the satellite will also pioneer a new realm . . . global television.

The heart of the satellite is the Receiver-Transmitter, and RCA Victor in Canada will design and build it for the United States' National Aeronautics and Space Administration. It is a mark of recognition of Canadian skills in electronics that RCA has been awarded this vital contract. One major reason is the extensive work the company has done in microwave communications systems now in use around the world.

RCA Victor's experience in reliability engineering and environmental testing

are unique in Canada. Testing facilities in Montreal can approximate most conditions that the satellite may experience and can help to assure success of the entire project.

This new project is but one area in which RCA Victor is providing leadership in the industry. Our wide range of activity includes theoretical and practical work in:

- Microwave and Scatter Communications
- Military Systems
- Antennas
- Installation and Service
- Radar
- Systems and Reliability Studies
- TV and AM Broadcast
- Microwave Physics

- Solid State Physics
- Semi-Conductor Applications

Opportunities exist at all experience levels, for graduates in Electrical Engineering and Engineering Physics to work with distinguished technical teams on advanced engineering and research projects. To engineers and scientists RCA Victor offers excellent starting salaries . . . plus a comprehensive employee benefit programme. Applicants interested in a career with the Company should contact:



The Technical Employment Manager,
RCA Victor Company, Ltd.

1001 Lenoir Street,
Montreal 30, Quebec

PROGRESS WITH RCA VICTOR

where Important things are happening in Electronics

For complete details check No. 35 on handy card, page 63

opportunities

These classified advertisements are published to assist those in the trade who have articles for sale, positions available, positions desired, sales agency openings or business opportunities. Charges are 25c per word or figure, not including heading or box number. Minimum charge is \$5.00 payable on submission. No agency commission paid. There is absolutely NO CHARGE for "positions desired" advts.

Send all material to the attention of the Classified Editor of **ELECTRONICS AND COMMUNICATIONS**, 450 Alliance Ave., Toronto 9, Ontario.

HELP WANTED

QUALIFIED DESIGN AND SYSTEMS ENGINEER

With a good background in the telecommunications industry is required for product and systems design of VHF and UHF radio communications equipment. To locate at Calgary plant of large international company. Applications are invited for this senior engineering position from responsible and mature individuals. Excellent salary commensurate with experience and qualifications. Write giving details to:

Mr. Don A. Saunders
P.O. Box 1087, Calgary, Alberta

RESEARCH AND DEVELOPMENT LABORATORIES OTTAWA

The establishment of our new Research Center in Ottawa has created challenging opportunities for experienced Engineers and Scientists to carry out the **planning, analysis and development** of communications equipment and components connected with the following fields:

- Semi-conductor device design
- Applied research in semi-conductor materials
- Molecular electronics
- Acoustics
- Radio communications systems
- Transmission systems
- Switching systems
- Data systems
- Audio and video broadcasting

All enquiries will be treated in strict confidence. Please write:

Northern Electric Company Ltd.
Department #117
P.O. Box 6123,
Montreal 25, Quebec.

ELECTRONIC DESIGN ENGINEER

Our Company Client, a well-known manufacturer of electronic components, requires an Electronic Design Engineer, 28-33, with experience in coils, condensers, or allied products.

Applicants must be electrical graduates, and have potential to advance to management level. Starting salary is open to negotiation.

Candidates are requested to submit concise summaries in strict confidence to Executive Selection Consultants, 330 Bay Street, Toronto, Ontario, or to:

Box 5089
Electronics and Communications
450 Alliance Avenue, Toronto 9, Ontario

CONSULTING SERVICE

A senior executive with long and proven experience in the Electronics Industry will help your profits and prospects by dealing with such problem areas as: plant layout and flow of materials; day by day cost control; effective quality control for cost reduction; proper manuals for manufacturing processes and methods; product development planning and budgeting; sales and marketing.

For further introduction apply:

Box 5088
Electronics and Communications
450 Alliance Avenue, Toronto 9, Ontario

VACANCIES FOR ELECTRONIC ENGINEERS

Toronto Area:

\$5400-\$7200 annually; sales engineer for sale of instruments used for the detection and measurement of radio-activity, principally for biological and medical research; also for industrial control. Order Number 510-2-x-242A.

\$7200-\$8400 annually; data analyst to analyse data in connection with a long-term reliability test program for electronic parts; establish failure rate, drift rate or other characteristics; consultation in establishment of test programs; preparation of reports. Order Number 510-x-565.

\$6000-\$7500 annually; to be in charge of consulting engineering division, instrumentation, petro-chemical refinery construction. Order Number 510-2-x-67B.

Eastern Ontario:

\$8000-\$9000 annually; advise on design, installation and maintenance of communications equipment. Order Number 512-B1659E.

\$7000-\$12,000 annually; experienced in VHF and UHF techniques; design of installations, antennas, communication transmitters and receivers. Order Number 512-B1138.

Details and application forms may be secured from Executive and Professional sections of the
National Employment Offices.

POSITIONS REQUIRED

SALES ENGINEER

Graduate electrical engineer, 42, with 12 years experience in electronics circuitry and communications system design, plus sales background, seeks promising sales engineering position.

Box 5094
Electronics and Communications
450 Alliance Avenue, Toronto 9, Ontario

TELECOMMUNICATION TECHNICIAN

Fully experienced in supervision of installation and maintenance of teletype and facsimile and related equipment. CREI student desires position with more future.

Box 5093
Electronics and Communications
450 Alliance Avenue, Toronto 9, Ontario

JOB WANTED

Graduate engineering physicist with several years diversified experience in industry desires position as electronics engineer or computer trainee. Reply:

Box 5090
Electronics and Communications
450 Alliance Avenue, Toronto 9, Ontario

ENGINEERING ASSISTANT

An engineering assistant with an extensive background in telephone toll circuit, point-to-point and mobile radio work, is seeking a responsible position with a telephone company or industry. Send replies to:

Box 5091
Electronics and Communications
450 Alliance Avenue, Toronto 9, Ontario

ARTICLES FOR SALE

MEGGER COUNTER

This Evershed and Vignoles Megger Ohm Counter has one scale from 0 to 30 and another from 0 to 300 complete with leather case. This instrument is new and has never been put into service. The price paid for it was \$90, but any offer is welcomed. Willing to ship it on approval to any responsible party.

Box 5092
Electronics and Communications
450 Alliance Avenue, Toronto 9, Ontario

Any Change in Your Address?

If the address on the front of this magazine is in any way incorrect, please fill out and mail the card on page 63. In doing this, you will help us to keep our mailing list up-to-date and will also ensure the regular and prompt delivery of your copies of:

ELECTRONICS & COMMUNICATIONS

**+125 C DIFILM[®]
VITAMIN Q[®]
CAPACITORS**

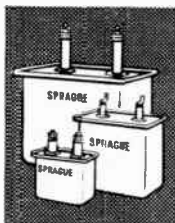

Type 272PDifilm Vitamin Q Capacitors are designed to far surpass MIL-C-25A Type CP-70 requirements for performance, reliability, size, and maximum operating temperature. These smaller, drawn-rectangular case units are leak-proof... save space and weight over 40C MIL-types which can operate safely only up to 85 C even when voltage derated.

SPRAGUE[®]

**CANADIAN
MANUFACTURING
REPRESENTATIVE**

**TELEGRAPH
CONDENSER CO.
(Canada) Ltd.**

50 Beral Road
Toronto 15, Ontario
Phone: ROger 6-6123

For complete details check No. 36

**PORTABLE
REGULATED
DC POWER SUPPLY**



Large
Capacity
Low-priced

model L3501
6" x 8" x 8"

only
\$199⁵⁰

- Constant Voltage 0-35v, 0-1A.
- Constant Current 0-30v, 0-1A.
- Fully transistorized — regulated 5 mv. N.L. to F.L. or 10% line change.
- Remote programming & Current limiting.
- Ripple 250 microvolts rms.
- Several units may be paralleled.
- Transient response 50 micro-seconds.
- 150 other models available.

Universal Electronics

Represented by Electronic Marketing Co.
Montreal, P.Q., Canada

For complete details check No. 39

ELECTRONICS AND COMMUNICATIONS, November, 1961



GLO-MELT

RESISTANCE SOLDERING



... for Perfect
lead-to-pin joints
on All sizes of A/N
and similar connections



... for Fast-Efficient
Accurate-Permanent
connections.

209-B

POWER UNITS • HANDPIECES • ACCESSORIES
for all jobs from Micro-Miniature to Heavy-Current connectors

WRITE FOR DESCRIPTIVE LITERATURE, PRICES AND NEAREST DISTRIBUTOR



For complete details check No. 3 on handy card, page 63

**NEW MINIATURE
200°C**

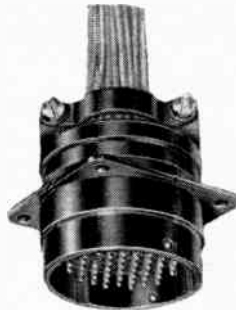

MIL-C-26500
(USAF)



AMPHENOL'S 48 series miniature circular connectors being built to MIL-C-26500 are a revolutionary step forward in the "state of the art". Performance demands of this specification have taken the connector industry boldly into the design of advanced air, missile and space systems for the next decade.

The 48 series has MIL-C-26636 (USAF) crimp type Poke-Home contacts.

Write for
Amphenol General Catalogue B-8



CANADA LIMITED

TORONTO • OTTAWA • MONTREAL • CALGARY

For complete details check No. 4 on handy card, page 63



editorial

How about a Canadian Electronics Axis?

"Large concentrations of able academic scientists and engineers placed in geographical proximity with their equally able industrial counterparts can produce very rapid economic growth in the areas concerned. One has only to look at the Boston-New York-Philadelphia electronic axis, or at its San Francisco-Los Angeles counterpart to substantiate this statement."

These words originally uttered by Dr. Ronald McFarlane, past president of the IRE, formed a dominant theme of Dr. L. V. Berkner's address at the recent Canadian Electronics Conference. We feel no shame in reiterating them again because we believe that the message has as much meaning here in Canada in the United States. In many respects these words have a greater significance to our own industries especially in view of the latter's peculiar relationship to parent organizations outside Canada's boundaries.

Unfortunately, this relationship frequently acts such that most, if not all R&D work is carried out at the parent company's main facilities leaving the Canadian organization to act in the role of manufacturers to "drawings supplied". On the surface this might not seem such a bad arrangement because, it can be argued, operations of this kind utilize the local labor force and generate Canadian business both directly and indirectly. However, many dangers are inherent, and one only has to look at the Canadian domestic TV and radio business of a few years back to see what can happen. "Just the ups and downs of general business" is a somewhat sardonic comment on these affairs and it is argued that international corporate relationships of the kind mentioned have worked tolerably well in the past. However, it is becoming increasingly evident that such relationships will be largely inadequate for the well-being of Canadian industry in the future.

By no means can all the blame for the Canadian R&D effort played in low key, be laid at the door of parent companies operating abroad. Many Canadian companies invest all too little in basic research and development, and as a consequence the national research effort per capita does not stack up too well in comparison with other technologically oriented nations.

An "electronics axis" sweeping down Canada's eastern seaboard, through Quebec and curving deep into Ontario and interwoven with a burgeoning industrial manufacturing complex should be an aim of our industry. More Canadian research and development opportunities linking with the scientists and engineers graduated by the universities in this grand arc would play a major part in promoting this realizable dream of the future. It is up to every company and organization in the Canadian electronics field to play its part in creating the required climate to trigger this growth.

A. E. Marino

Hear it right the first time...with COLLINS

If your business depends on radio communication, you need the reliability and flexibility of Collins 51S-1 Receiver. Sensitive fingertip tuning lets you set *and hold* frequency anywhere in the 2-30 megacycle range; receive upper and lower sideband, AM, or CW signals. ⚙️ Collins features advanced circuitry, produced to the Collins standard of quality. Collins mechanical filters reject interference from other channels to give you exceptional clarity. The result is a receiver of high dependability, an ideal standby unit for communications systems using several modes of transmission. ⚙️ A brochure describes the Collins 51S-1 operation and ease of maintenance in detail. Use the coupon; your request will be answered promptly. As with all Collins equipment, your 51S-1 receiver will be backed by the world-wide service facilities of 90 Collins sales representatives and dealers. ⚙️

TO COLLINS RADIO COMPANY OF CANADA, LTD. 2 CC 11
11 Bermondsey Road
Toronto, Ontario Canada
Please send me complete information about the Collins 51S-1 Receiver.

Name _____
Title _____
Company _____
Street _____
City & State _____
Country _____

COLLINS RADIO COMPANY OF CANADA, LTD. 11 BERMONDSEY ROAD, TORONTO 16, ONTARIO

OFFICES IN GENEVA, SWITZERLAND • POSTAMT FLUGHAFEN, FRANKFURT A/M, GERMANY • PARIS, FRANCE • LONDON, ENGLAND • BEIRUT, LEBANON • TOKYO, JAPAN • MELBOURNE, AUSTRALIA • RIO DE JANEIRO, BRAZIL • TORONTO, CANADA • NEW YORK, NEW YORK • WASHINGTON, D. C. • MIAMI, FLORIDA • DEALERS IN MAJOR CITIES AROUND THE WORLD.

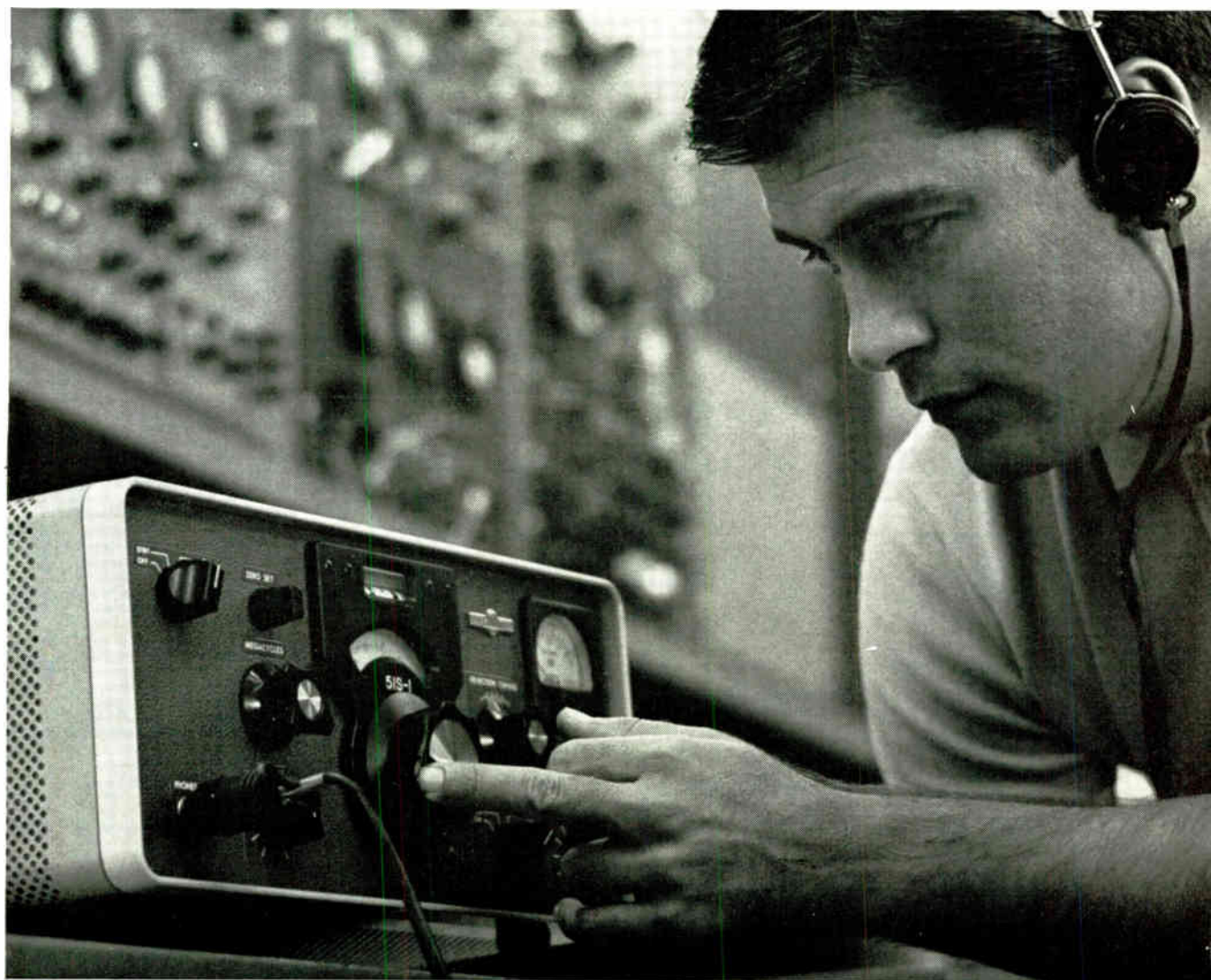

For complete details check No. 13 on handy card, page 63

Versatile programming

plug-in programming for each individual column, code options with plug-in column cards

Fast data transfer

takes just 2 msec;
prints up to 5 lines per second

Flexible BCD input

1-2-2-4 BCD input is standard; dual input available

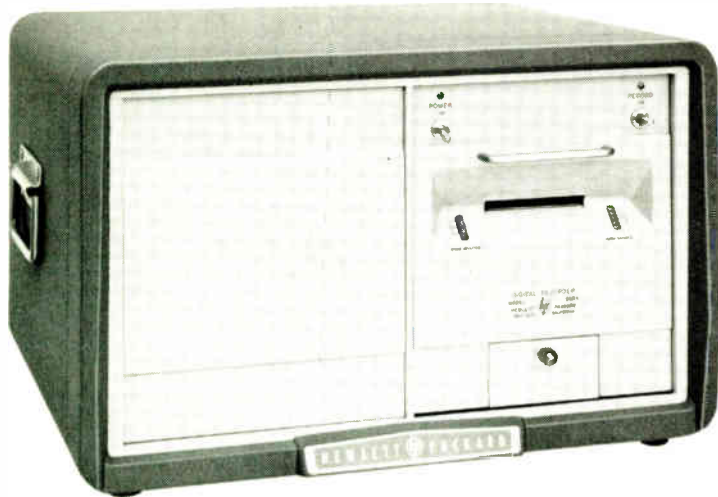

all yours with this new 562A SOLID STATE DIGITAL RECORDER

SPECIFICATIONS

Printing Rate: 5 lines/sec. maximum

Column Capacity: To 11 columns (12 available on special order)

Print Wheels: 12-position, 0 through 9, a minus and a blank (Many special character wheels available from stock)

Driving Source: Parallel-entry 4-line BCD, 1-2-2-4. Other codes available on plug-in cards. Source reference voltages establish "0" and "1" states, which may be as much as 100 v above or below ground. "1" state 4 to 75 v above "0" reference. Driving power approx. 30 μ a into 270,000 ohms.

Print Command: \pm pulse, 20 μ sec or greater in width, 6 to 20 v.

Hold Signal: (Available for each data source) -7 v to +15 v and +15 v to -7 v.

Transfer Time: 2 msec

Paper Required: Standard 3" roll or folded

Line Spacing: Single or double, adjustable

Size: Cabinet, 20 $\frac{3}{4}$ " x 12 $\frac{1}{2}$ " x 18 $\frac{1}{2}$ "; Rack, 19" x 10 $\frac{1}{2}$ " x 16 $\frac{7}{8}$ " deep behind panel.

Price: Φ 562A (cabinet) or Φ 562AR (rack mount) \$1,600.00 to \$2,200.00 depending on options. Φ 580A Digital-Analog Converter, price on request.

New, solid state Φ 562A Digital Recorder prints digital data on 3" paper as fast as 5 lines per second, each line containing up to 12 digits. The instrument incorporates a unique data storage unit for each digit column that allows the data source to transfer data to the recorder in just 2 milliseconds, after which the source is free to collect new data.

Besides the standard parallel-entry 4-line BCD code (1-2-2-4), you can easily use other 4-line codes just by substituting plug-in column cards. Ten-line code operation (without data storage feature) is also available with plug-in cards.

Further, Φ 562A accepts dual input (optional) and prints data simultaneously from two unsynchronized sources. A "patch panel" permits programming these two separate, unsynchronous inputs (even if coded differently) in any manner. Combinations of plug-in column code cards and "patch panel" column programming give complete flexibility in both dual-source data acquisition and data print positioning.

Analog output for high-resolution strip chart and X-Y recording is available as an extra-cost built-in feature of the 562A or through the new Φ 580A Digital-Analog Converter, a separate solid state, high-precision instrument.

Designed for use with solid state and vacuum tube counters, Model 562A is ideal for a wide variety of individual and system applications. Call your Φ representative today.

HEWLETT-PACKARD COMPANY

1082G Page Mill Road
Cable "HEWPACK"

Palo Alto, California, U.S.A.
DAvenport 6-7000

Sales representatives in all principal areas

HEWLETT-PACKARD S.A.

Rue du Vieux Billard No. 1
Cable "HEWPACKSA"

Geneva, Switzerland
Tel. No. (022) 26.43.36



For complete details check No. 21 on handy card, page 63

7087