

Litton (Canada) special test equipment — see cover story, page 5.

electronics and communications

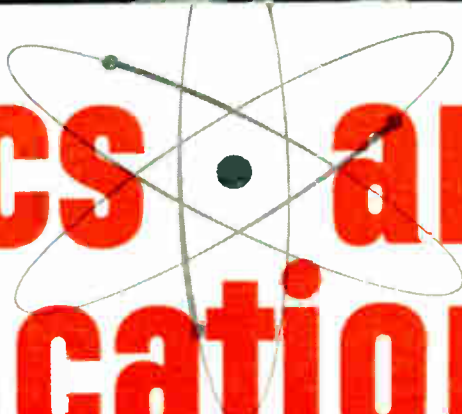

an age publication
OCTOBER 1961

1211C
QEL
CRC
EPM

MR F W PREZIOSI
8 EASTGATE CRES
SCARBOROUGH ONT

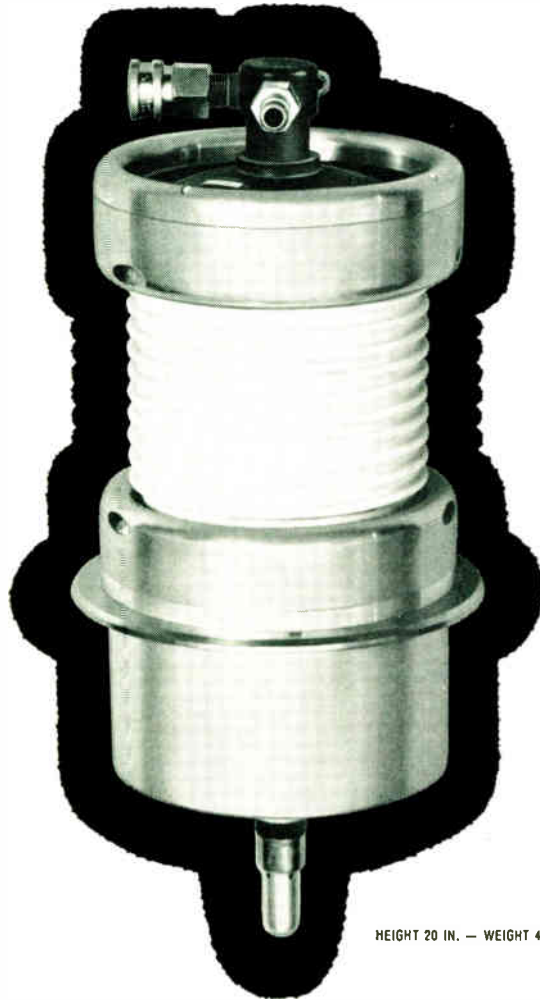

HEIGHT 20 IN. — WEIGHT 45 LBS.

NEW LITTON INJECTRON* HOLDS OFF 150 KV, SWITCHES 20 AMPS

CONSTANT CURRENT CHARACTERISTICS — L-3408

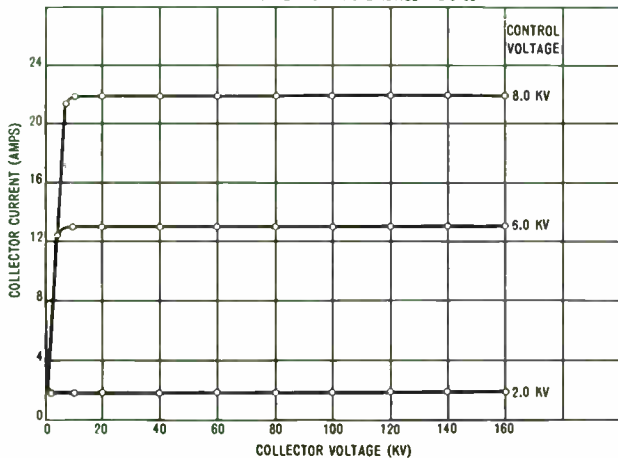

CONTROL ELECTRODE CHARACTERISTICS — L-3408

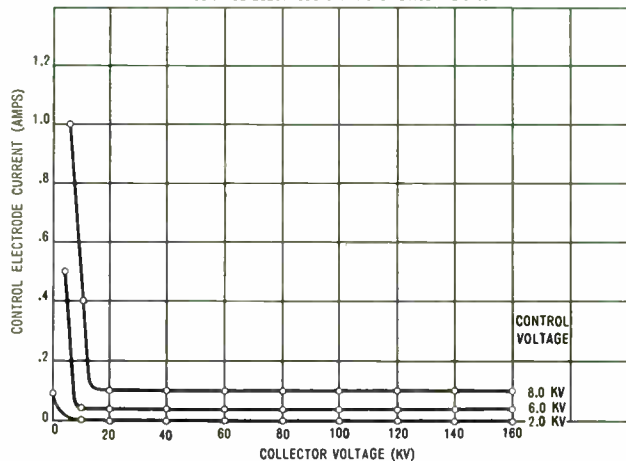

*An advanced concept by Litton for high power beam switching with high efficiency and fast rise time. Requires only low control voltages. Collector current is largely independent of collector voltage, resulting in pentode-like current characteristics. Ideal for floating deck modulators for switching modulating anode klystrons. L-3408 is in field operation now. Other models for cathode switching to 750 amps, 350 KV coming soon. Contact us at Lake Engineering Co., Ltd., 123 Manville Rd., Scarborough, Ont., for information



LITTON INDUSTRIES
Electron Tube Division

MICROWAVE TUBES AND DISPLAY DEVICES

For complete details check No. 29 on handy card, page 69

Marconi's
NEW TEST LAB
 GUARANTEES PRE-TESTING
 OF SPECIAL PURPOSE TUBES
PLUS FAST
 WARRANTY ADJUSTMENT

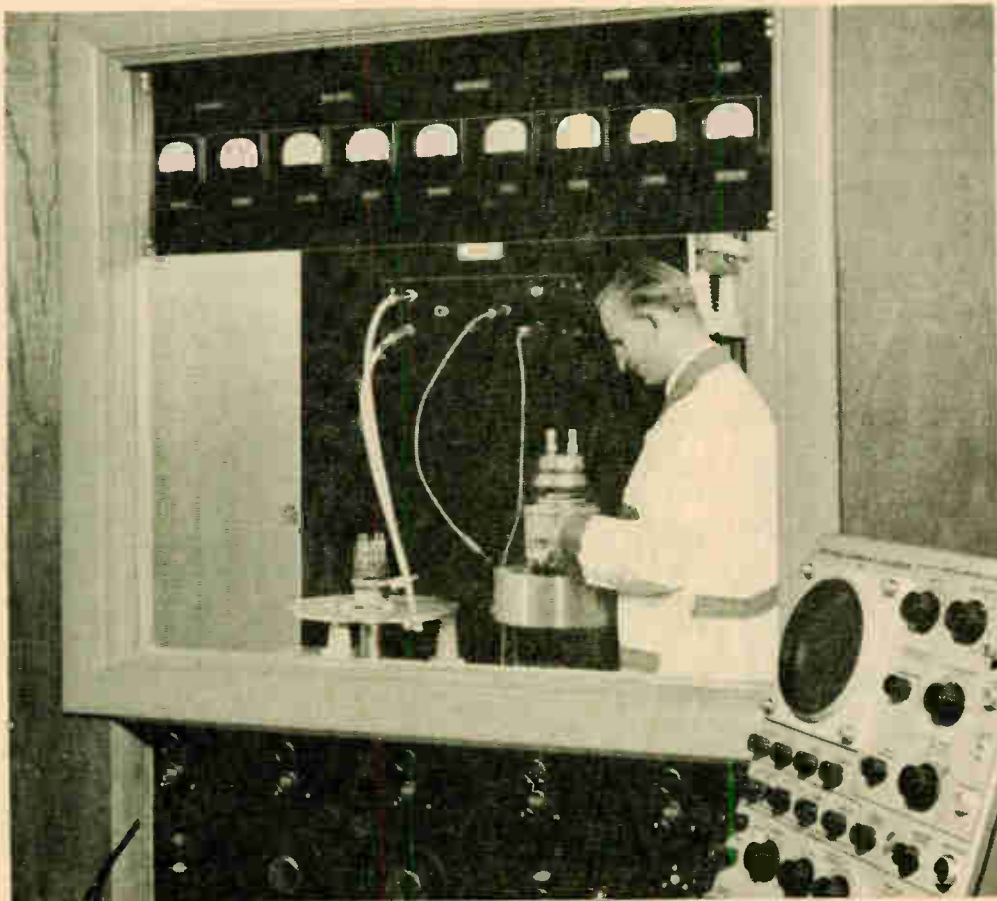

Special Purpose Tubes are tested under simulated operating conditions at the new Marconi Test Lab in Toronto—only lab of its kind in Canada. Here a technician connects a BR1102 Tube in a special pressure-controlled test room.

This means new convenience in Special Purpose Tube service for you. If you are in one of the many industries now using Special Purpose Tubes in complicated equipment you know how important this can be . . . how your whole operation can be held up while you wait for replacement or adjustment of a faulty tube. This is because these tubes are normally imported by a distributor and shipped to the customer *without* testing. *Not so* a Marconi Special Purpose Tube. Tubes are pre-tested in the new, fully-equipped Marconi Test Lab . . . sealed and protected by the Marconi warranty. If any trouble does occur, you can be sure of *immediate* warranty adjustment. Marconi electronics specialists will give you on-the-spot assistance. This service is as close as your phone.

ELECTRONIC TUBE AND COMPONENTS DIVISION
CANADIAN Marconi COMPANY
 1830 BAYVIEW AVENUE, TORONTO, ONTARIO
 Branches: Vancouver • Winnipeg • Montreal • Halifax

For complete details check No. 12 on handy card, page 69
 ELECTRONICS AND COMMUNICATIONS, October, 1961



Canadian Marconi has the widest and most complete range of Special Purpose Tubes in Canada. Marconi's extensive background of experience in electronic tubes and equipment can prove invaluable to you in the selection and use of proper tubes and components for your requirements.

10500

MORE THAN 10,000 ITEMS AVAILABLE

for immediate shipment from stock. Into our system of inventory control we have introduced methods compatible with the accuracy and efficiency found only in electronic data processing programmes. Data compilation that has heretofore taken days can now be accomplished in minutes—providing a type of sales-service that makes it easy for our customers to do business with us. For communications equipment, wires and cables, electrical supplies and apparatus, call

Northern Electric
COMPANY LIMITED

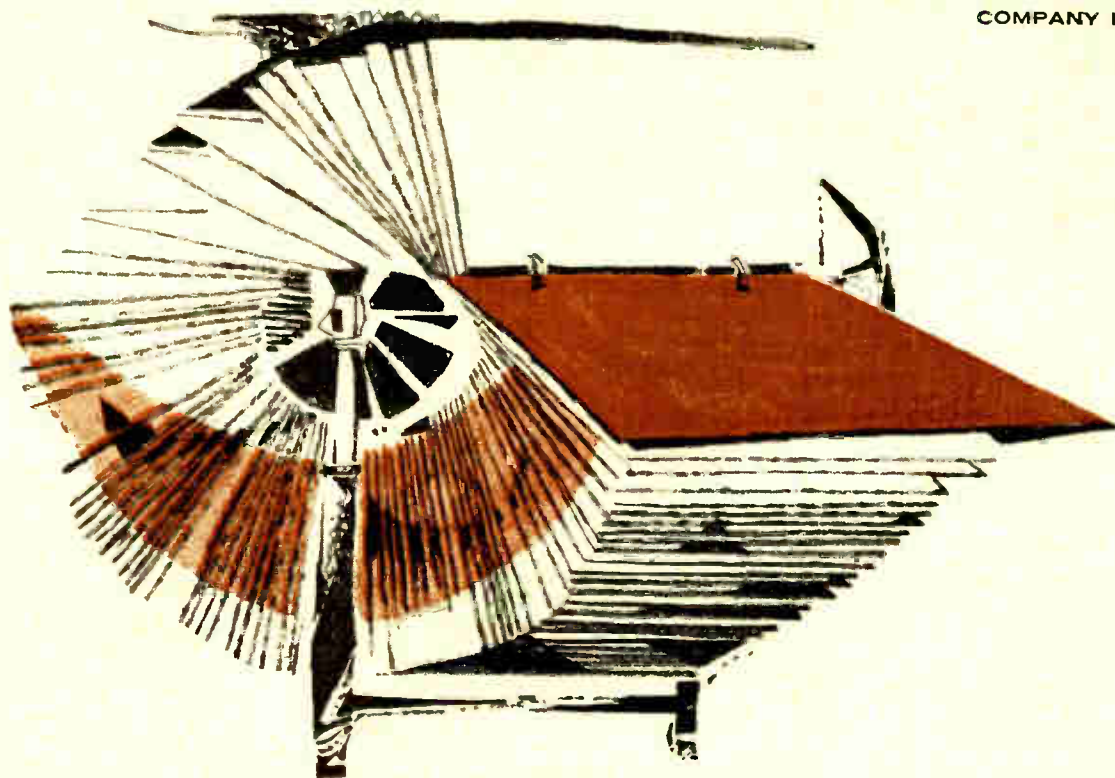

#061-3R

For complete details check No. 34 on handy card, page 69



an age publication

Arthur E. Maine, P.Eng., editor
R. C. Poulter, P.Eng., associate editor
Ron Wood, assistant editor
William Bowers, art editor
Jerry Davey, photo editor

H. E. Dallyn, manager
Derek Reynolds, advertising manager
Nevill A. Campling, production manager
Diana King, asst. production manager
Rudy Lengerer, circulation manager

L. R. Kingsland, president
K. E. Gould, executive vice-president
Paul A. Irwin, secretary-treasurer

Published by
AGE PUBLICATIONS LIMITED
450 Alliance Avenue, Toronto 9, Ontario
Telephone RO. 2-7225

Publishers of
Beverage Alcohol Reporter
Restaurants and Institutions
Automatic Heating/Plumbing/Air Conditioning
Food Service Equipment Supplier
Canadian Gas Journal

MONTREAL
J. R. "Tom" Graham
Suite 616-1
1500 Stanley St.
Montreal 25, Que.
Telephone VI 4-6782

WEST COAST
Dillenbeck-Galavan, Inc.
266 South Alexandria Avenue,
Los Angeles 4, California

U.K. and EUROPEAN REPRESENTATIVE
Norman F. Keenan
Regency House,
1 Warwick Street,
London, W.1, England

Indexed in the Canadian Business and
Technical Index of the Toronto Public Library.

Subscription Rates: Canada, British Possessions
and United States: 1 year — \$5.00; 2 years — \$9.00;
3 years — \$12.00. Foreign: 1 year — \$10.00.

Member Canadian Circulations Audit Board

Authorized as second class mail by the
Post Office Department, Ottawa, and
for payment of postage in cash.



PRINTED IN CANADA



electronics and communications

Canada's pioneer journal in the field of
electronics and communications engineering

contents **OCTOBER, 1961** Vol. 9, No. 10

- 33 The exponential failure distribution in reliability predictions
by J. T. Hanes, P.Eng.
- 36 Is the electronics industry missing out on the
Development Assistance Vote?
by W. S. Kendall
- 40 New 3-terminal PNP switch simplifies fast logic circuit design
by A. F. Cake and D. E. Richardson
- 44 New methods speed line installation and maintenance
- 46 Engineering in Canada
Silicon diodes made in Canada
- 48 A new recorder/reader system
- 51 Nuclear Radiation Detectors
by J. Sharpe, B.Sc., AMIEE
- 53 A solid-state diode parametric amplifier and mixer
*(A communication from the Marconi Research Laboratory,
Chelmsford, England.)*
- 55 1961 Canadian Electronics Conference — a review

departments

- 10 Industry's business
- 13 EIA news
- 16 Industry personnel
- 20 CRTPB newsletter
- 24 Close-up
- 59 Engineer's file page
No. 2
- 61 The international scene
- 62 Letters to the Editor
- 64 Product panorama
- 67 Defense industry barometer
- 69 Technical literature briefs
- 74 Forthcoming meetings
- 80 Opportunities
- 82 Editorial
How big is this growing child?

COVER STORY

Litton (Canada) manufacture complete inertial navigation system for F 104 fighter. Seen here is technician J. Beverly of Rexdale plant assembling a Portable Line Test Analyzer. Unit is used in field for checking-out navigation system.



The switch is on to Raytheon! More and more Canadian distributors and dealers are switching to Raytheon. Why? Because this symbol identifies tubes of the highest quality and the most advanced design. Reliability of delivery, too.

ASK YOUR DISTRIBUTOR FOR RAYTHEON RADIO AND TV RECEIVING TUBES

RAYTHEON

EXCELLENCE IN ELECTRONICS

RAYTHEON CANADA
LIMITED

WATERLOO, ONTARIO

For complete details check No. 40 on handy card, page 69

61-10

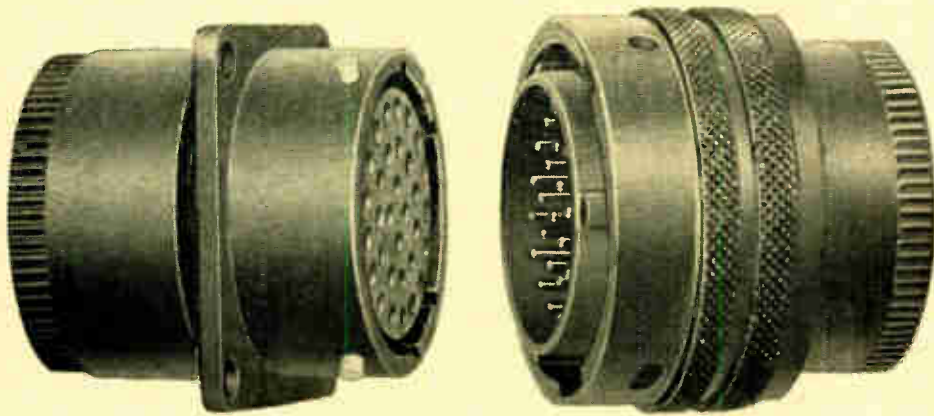

NEW

CANNON KPT/KSP MINIATURE DESIGNED TO MIL-C-26482

Quick disconnect plugs for aircraft, missiles, and all applications requiring miniature plugs. Our standard solder-pot versions, including hermetic seals, are completely interchangeable with all bayonet-lock plugs designed to MIL-C-26482!

ALSO KPT/KSP PLUGS WITH CRIMP SNAP-IN CONTACTS AND TWO SHORE INSULATOR.

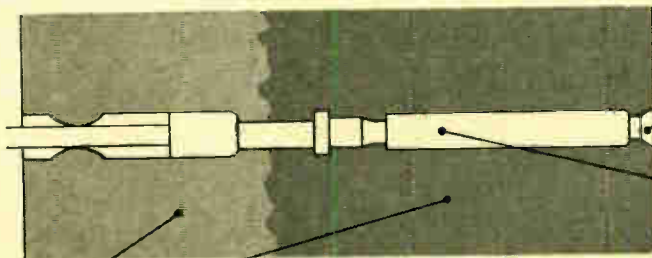

Maximum lead-in chamfer for positive alignment.

MIL-C-26636 contacts (plating gold over silver)

Two shore resilient insulators molded out of two different hardness materials (polychloroprene) into a homogenous piece. The rear portion of the insulator is the softer in order that the conductors can be sealed properly, and the front portion is the harder to retain the snap-in contacts. The two shore insulator insures a continuous moisture and pressure

seal from front to back to provide superior electrical performance at high altitudes. This method of sealing and contact retention offers the industry a most reliable crimp series meeting the requirements of MIL-C-26482. Write for catalog KPT/KSP-1 to:

Visit us at the
IRE SHOW — Booth 452

CANNON ELECTRIC CANADA LIMITED 130 Bartley Drive, Toronto 16, Ontario
MONTREAL: Montreal Airport, Dorval, Quebec • OTTAWA: 1168 Edgeland Place 6104

CANNON PLUGS



a *Genie at your command—*

the **CALL** director



The 30 button CALL director helps secretaries handle more calls, streamlines office operation.

From Northern Electric comes a new-style genie . . . the CALL director telephone. It's the versatile virtuoso of modern business communications. To reach many inter-office extensions—just press a button. To hold a telephone conference—just press a button. To connect outside calls to others—just press a button. The CALL director is available with 12, 18 or 30 buttons and many features to save precious business time.

The CALL director telephone is another step forward in the science of business communications by Northern Electric, who design and manufacture most of Canada's telephones and related equipment.



Northern's extensive experience in this field, along with their creative engineering and design personnel and modern manufacturing facilities are at your command. Branches are strategically located across Canada to serve you.

Northern Electric
COMPANY LIMITED

SERVES YOU BEST

2060-5

For complete details check No. 32 on handy card, page 69

New Bourns Precision Potentiometer Resolves the Quality-Price Dilemma!

Here is military reliability in a competitively-priced industrial potentiometer. Bourns wirewound 10-turn Model 3500 measures just $\frac{7}{16}$ " in diameter by 1" long—shorter by $\frac{1}{2}$ " than units available elsewhere—yet has a resistance element 20% longer than that of comparable potentiometers.

Fully meeting military requirements for steady-state humidity, Model 3500 can also be provided at a 10% premium to meet the cycling humidity specs of MIL-STD-202, Method 106. It's the only $\frac{7}{16}$ " 10-turn potentiometer guaranteed to meet this spec. Its published characteristics incorporate wide safety margins.

Reliability insurance is provided by the exclusive Bourns Silver-weld bond between terminal and resistance wire. Virtually indestructible under thermal or mechanical stress, this termination

eliminates a chief cause of potentiometer failure. In addition, a special close-tolerance rotor almost completely does away with backlash.

Model 3500 is also subjected to the rigorous double check of Bourns' exclusive Reliability Assurance Program. In short, every possible step is taken to ensure that the performance you specify is the performance you get. Write for complete data.

Resistances	500 Ω to 125K, \pm 3%, std. (to 250K spl.)
Linearity	\pm 0.25% std.
Power rating	2w at 70° C
Operating temp.	-65° to +125° C
Mech. life	2,000,000 shaft revolutions

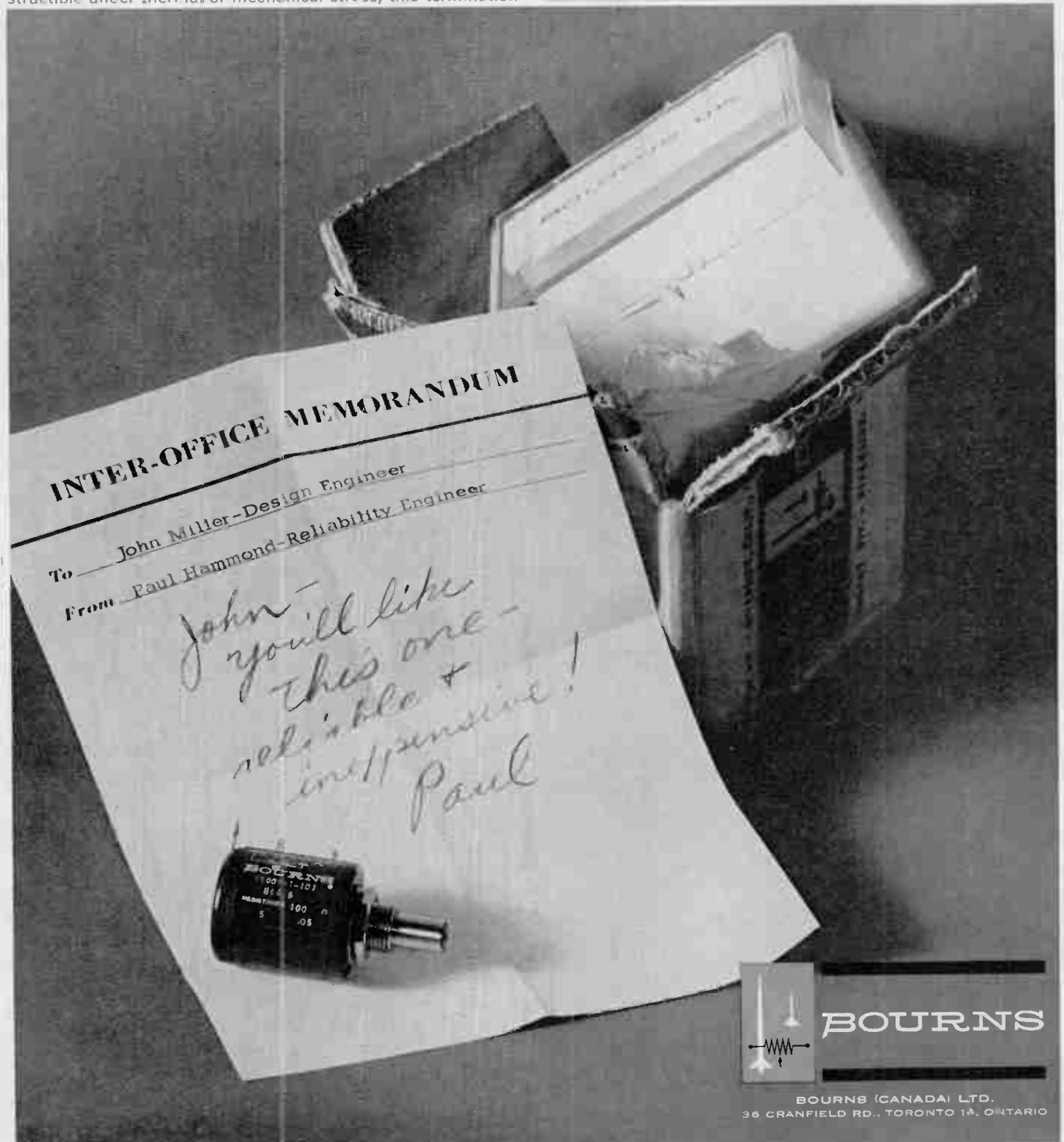

BOURNS (CANADA) LTD.
36 CRANFIELD RD., TORONTO 1A, ONTARIO

Manufacturer: Trimpot® potentiometers; transducers for position, pressure, acceleration. Plants: Riverside, California; Ames, Iowa; and Toronto, Canada

For complete details check No. 10 on handy card, page 69
ELECTRONICS AND COMMUNICATIONS, October, 1961

the industry's business

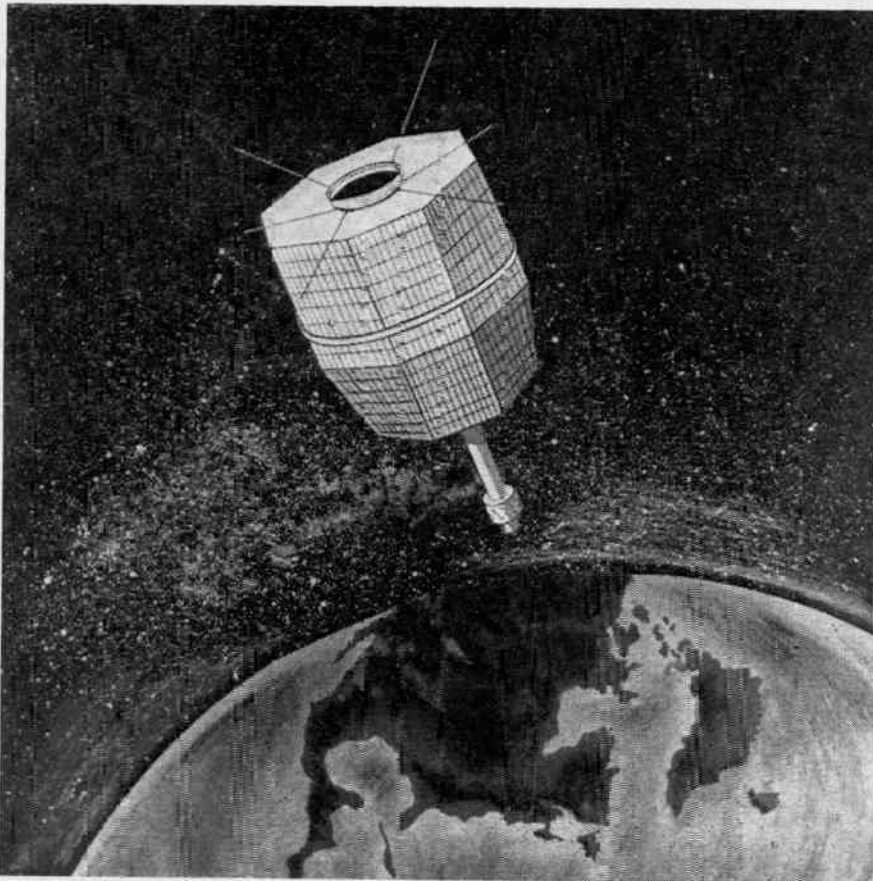

Artist's impression of the Project Relay communications satellite which will make global television possible. RCA Victor, Montreal, will build the wide-band receiver-transmitter for the National Aeronautics and Space Administration, USA.

Canadian Research Institute named exclusive Canadian reps.

Nucleonics Corporation of America are very pleased to announce the appointment of Canadian Research Institute, 85 Curlew Drive, Don Mills, Ontario, as exclusive representatives for their complete line of nuclear instrumentation for medical, industrial, educational, public health, and defense purposes.

New Canadian electronics plant opens in Toronto

Canada's growing electronics industry received another boost with the official opening of Spectrol Electronics of Canada Ltd. located in the Toronto suburb of Brampton. Occupying a 10,000 square foot building, Spectrol is now producing precision wire wound single and multi-turn linear and non-linear potentiometers. According to R. Ferrari, manager of the new facility, Spectrol is the only manufacturer of precision non-linear potentiometers in Canada.

Radionics Ltd. authorized to distribute Honeywell Visicorders

Recently New Electronics Products Ltd., London, England, became an affiliate of Honeywell Controls Ltd., and Radionics Limited, Montreal, who represent NEP in Canada, are now able to supply Canadian customers with the Honeywell Visicorders as well as the NEP line of ultra-violet, direct-writing recorders.

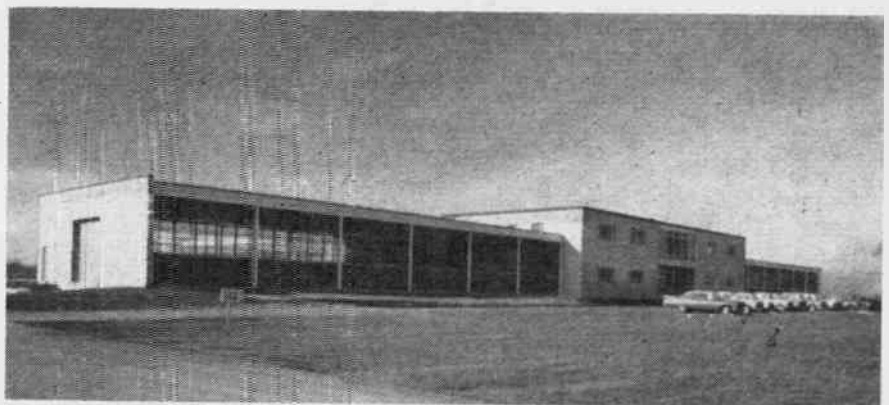

The new Spectrol Electronics plant located in Brampton occupies a 10,000 square foot building.

RCA Victor to build the wide band receiver for experimental communications satellite

RCA Victor, Montreal, will build the wide-band receiver-transmitter for the National Aeronautics and Space Administration's first experimental active communications satellite, Project Relay, which could make global television possible. The first satellite will be launched from Florida late next summer.

Project Relay is sponsored by the U.S. government and will be a practical test of methods and equipment for world-wide communications by means of an orbiting earth satellite. The system will be used to relay television, voice communications, data transmission and telegraph across the Atlantic Ocean. This experiment will include periods of two-way voice communications.

The satellite has two basic communication components—receivers to pick up messages from the earth, and transmitters to relay them to different ground stations. RCA Victor will design and build the receivers and portions of the transmitters in the company's establishment in Montreal.

Burroughs enters punched card electronic computer business

Burroughs Business Machines Ltd. has announced its entry into the punched card electronic computer business, putting the company squarely into competition for the largest single bloc of the rapidly growing market for automatic business data processing equipment.

J. L. Rapmund, president, said the company's program includes a new family of four solid-state computer systems, an expanded customer training program and a sizeable increase in the company's data processing sales and technical support force.

Canadian electronics industry optimistic about future

The Board of Directors of Electronic Industries Association of Canada at their regular meeting August 30, expressed satisfaction on the report that member manufacturers' sales of television receivers for the first six months of 1961 were 4.1 per cent ahead of same period last year. This rise in demand is expected to continue.

The early introduction of FM stereo broadcasting will bring the realism of stereo music and radio listeners in the same fullness as now enjoyed from recordings and tape.

The Board of Directors expressed further optimism as a result of members' reports of increased export business.

The recently formed Research Committee also gave Board members reason to expect increase in both domestic and foreign sales arising from recent changes in tax legislation

to encourage research within the Industry.

"The growing use of electronics in the control and operation of all major industries is an added reason why the members of EIA are facing the Fall with a buoyant confidence," said F. W. Radcliffe, general manager of the EIA.

Metron Instrument name Power Service Products as Canadian reps

Power Service Products, P.O. Box 184, Islington, Ontario, announced their appointment as Canadian representative for Metron Instrument Company of Denver, Colorado, who design and manufacture miniature variable speed and differential drive assemblies, speed changers, tachometers, speed recorders, etc.

New expansion for electronics company

Six-year-old Industrionics is becoming a public company to raise funds for extensive Canada-U.S. expansion.

A young Canadian electronics company which has already successfully entered the United States is now going



A new screen is applied to the old television picture tubes and the entire inner surface of the container is aluminized in a special process by Industrionics' technicians.

to the public for financing which will enable it to expand considerably on both sides of the border.

Formerly known as Winco Electronics Co. Ltd., the Windsor, Ontario firm recently changed its name to Industrionics (Canada) Ltd.

From a small beginning in 1955, Industrionics (Canada) has developed into a major manufacturer of replacement television picture tubes distributed under an exclusive sales arrangement with electronic parts jobbers across Canada. It has broadened with two wholly owned subsidiary corporations in neighboring Detroit, Mich.

Industrionics Inc., established in 1959, is probably the world's only successful producer of remanufactured ignitron tubes, using an internally-developed secret process. These electronic tubes control the power applied to resistance welding equipment used throughout the world by heavy steel fabricating companies.

Amphenol Canada expands production facilities

Amphenol Canada Limited is currently increasing its facilities to provide additional production area for the manufacture and sale of electronic components.

The R. F. Products license arrangement is an extension of the existing agreement with Amphenol-Borg, Chicago and will specifically cover both "IPC" and Amphenol coaxial connectors, DK coaxial switches and Amphenol coaxial cable.

Continued on page 28



Measurement Engineering Ltd. has extended its service and calibration facilities in its new and larger Industrial Sales Division in Scarborough.

Measurement Engineering expands Industrial Sales Division

D. A. Bamford, B.A.Sc., P.Eng., president of Measurement Engineering Limited, recently announced the expansion of the Industrial Sales Division and the transfer of this division into new and larger quarters at 71 Crockford Blvd., Scarborough, Ontario.

Service and calibration facilities are available at this new address under the supervision of J. Lindsay, and further expansion of sales and service facilities are planned.

Sales representative elected

George M. Fraser, Ltd., 1554 Yonge St., Toronto, Ont. was elected as sales

representative for central and western Canada by Associated Research, Inc. of Chicago, Ill. a leading supplier of instruments for testing insulation of electrical, electronic and aircraft equipment for over 25 years. The Fraser organization will supply these instruments to electric utilities, railroads and manufacturing plants.

Alex L. Clark Ltd. to represent Barker Products

Alex L. Clark Limited, 3751 Bloor Street West, Islington, Ontario, has been appointed as exclusive sales representative for Canada, except British Columbia, for Barker Products Company of West Bridgewater, Mass. Barker Products manufacture audio connecting cables, "Molded-On" plugs and connectors.

When should you use Mercury-Wetted Contact Relays?



IF YOUR RELAYS
MUST

SWITCH UP TO
100 TIMES
PER SECOND

HAVE A LIFE
IN EXCESS OF
A BILLION
CYCLES

BE COMPLETELY
RELIABLE
AND FREE FROM
CONTACT BOUNCE

THEN SPECIFY
P & B
MERCURY
WETTED
CONTACT RELAYS

An unusual combination of advantages found only in mercury-wetted relays has led many design engineers to specify them for tough switching jobs. Here are but 3 typical characteristics of our JM series:

RELIABILITY. Sealed-in-glass mercury contacts are renewed with every operation. Won't pit or weld. Make or break is positive . . . every time. No bounce, no chatter. Signals ranging from a few micro amps to 5 amps are switched with singular consistency.

LONG LIFE. Think in terms of *billions* of operations when considering JM series relays. Proper application, of course, is a requisite.

SPEED. Operate time is just less than 3 milliseconds using 2 watts of power. Release time is about 3.2 milliseconds. Thus, relays can be driven 100 times per second.

If your project calls for exceptional relay performance, perhaps the answer lies in our JM Mercury-Wetted contact relay.

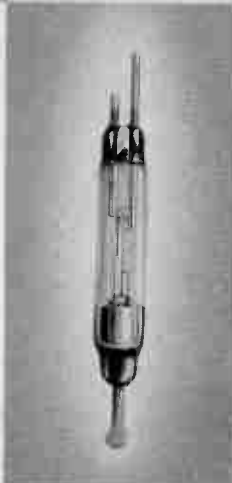

JM SERIES ENGINEERING DATA

Contact Rating:

5 amperes maximum
500 volt maximum
250 volt-amp max. with required contact protection.

Contact Configuration:

Each capsule SPDT. Combination of capsules in one enclosure can form DPDT, 3PDT, 4PDT. (All Form D.)

Terminals:

Plug-in or hook solder; 8, 11, 14, or 20-pin headers.

Coil Resistance:

2 to 58,000 ohms.

More information?

Write today for free catalogue.



P & B STANDARD RELAYS ARE AVAILABLE AT YOUR LOCAL ELECTRONIC PARTS DISTRIBUTOR



POTTER & BRUMFIELD

DIVISION OF AMF CANADA LIMITED • OXFORD STREET, GUELPH, ONTARIO

For complete details check No. 37 on handy card, page 69

WorldRadioHistory

IMMEDIATE DELIVERY

of standard P&B relays
from these leading
electronics distributors

ALBERTA

CALGARY

Canadian Electronics Ltd., 334-336 4th Ave. S.E.
Sacker Electronics Co., Ltd., 1040 8th Ave. S.W.
Smalley's Radio Ltd., 1105 7th Ave., W.

EDMONTON

Canadian Electronics Ltd., 109 St. at 107 Ave.
Sacker Electronics Co., Ltd., 10235 103rd St.
Taylor, Pearson & Carson Ltd., 1215 103rd St.

BRITISH COLUMBIA

NANAIMO

Ellison Queale Radio Supply

VANCOUVER

Robinson Electric Co. Ltd., 1179 Homer St.
Taylor, Pearson & Carson Ltd., 1006 Richards St.
L. A. Varsh Ltd., 1451 Hornby St.
Western Agencies Ltd., 951 Seymour St.

VICTORIA

Ellison Queale Radio Supply, 900 View St.

MANITOBA

WINNIPEG

Cam Gard Supply Ltd., 397 William Ave.
Del's Electric Motor Supply, 54 Princess St.
Electrical Supplies Limited, 308 Ross Ave.
United Refrigeration Parts, 223 Garry St.

NOVA SCOTIA

HALIFAX

Arvan Electronics Canada Ltd., 49 Agricola St.
Consolidated Supply Company Ltd.

ONTARIO

CHATHAM

Industrial Components (Central Ontario) Ltd.
161 Richmond Street

FORT WILLIAM

Inter-Comm Supply Company Ltd., 1315 Victoria Ave.

HAMILTON

The Crawford Radio, 119 John St. N.
Western Radio Supply Co. Ltd.
182 Rebecca St., (at Ferguson)

KITCHENER

MacDonald Electric Limited, 307 Queen Street, S.

LONDON

Industrial Components (Central Ontario) Ltd.
649 Colborne Street
C. M. Peterson Co. Ltd., 575 Dundas Street

NORTH BAY

Johnson Electric Supply Ltd., 135 McIntyre Street, E.

OSHAWA

H. W. Gourley Ltd., 311 Viola Avenue

OTTAWA

Wackid Radio Television Laboratories Ltd.
149 Gloucester St.

PORT ARTHUR

Inter-Comm Supply Company Ltd., 194 South Algoma St.

ST. CATHARINES

Niagara Vallance, Brown, 23 Permillia Street

SARNIA

Industrial Components (Central Ontario) Ltd.
267 Tecumseh Street

SAULTE STE. MARIE

Johnson Electric Supply Ltd., 419 Queen St. E.

SUDBURY

Johnson Electric Supply Ltd., 166 Elm St. E.

TIMMINS

Johnson Electric Supply Ltd., 35 Birch St. N.

TORONTO

Alpha Arcon Radio Co. Ltd., 555 Wilson Avenue
Canadian Electrical Supply Co. Ltd., 877 Yonge Street
Electro Sonic Supply Co. Ltd., 543 Yonge St.
Shipman Electronics, 1773 Avenue Road
Wholesale Radio & Electronics Ltd., 66 Orfus Road

WATERLOO

Waterloo Electronics Supply Co., 219 Hartwood Ave.

WINDSOR

Electrozad Supply Co., Ltd., 38-42 Shepherd St., E.
Industrial Components (Central Ontario) Ltd.
600 Wyandotte Street, E.

QUEBEC

MONTREAL

Atlas Wholesale Radio Inc., 4985 Buchan St.
Payette Radio Ltd., 730 St. James St. W.

QUEBEC

Crobel Ltd., 225 Rue Lee East

SASKATCHEWAN

REGINA

Radio Supply & Service Ltd., 1965 McIntyre St.

SASKATOON

Radio Supply Company Ltd., 561 2nd Ave. N.

P&B REPRESENTATIVES

Aeromotive Engineering Products Ltd.,

149 Hymus Blvd., POINTE CLAIRE, Montreal, P.Q.

A.T.R. Armstrong Ltd., 700 Weston Road,

TORONTO 9, Ontario

Chas. L. Thompson Ltd., 1440 Erin Street,

WINNIPEG, Manitoba

Chas. L. Thompson Ltd., 3115 Lonsdale Avenue

NORTH VANCOUVER, B.C.

POTTER & BRUMFIELD

Division of AMF Canada Limited

Oxford Street, Guelph, Ontario

Electronic Industries Association

of Canada

news

by R. T. O'Brien



G. L. King Appointed Chairman Land Mobile Group

W. S. Kendall, Chairman of EIA's Electronics Division, has announced the appointment of G. L. King, Canadian General Electric Company, as Chairman of the Division's Land Mobile and Marine Equipment Engineering Committee.

Mr. King replaces Maurice A. Robbins, Canadian Marconi Company, who asked for replacement due to the pressure of other work. Mr. Robbins has guided the work of the Committee through a number of difficult assignments, including the recommended standards for land mobile equipment and General Services Band equipment, since February 1960.

The Committee is currently working on the recommended EIA action on Department of Transport draft specifications RSS-104 (VHF Marine) and RSS-139 (Mobile 30-50 Mc/s), sent over by the Canadian Radio Technical Planning Board, and on Land Mobile System specifications.

Study Membership on International Committees

The Executive Committee of the Electronics Division has been asked to study, and make recommendations on, the possible membership for the Electronic Industries Association on the technical advisory groups of the International Telecommunications Union.

The technical advisory groups are the Radio Technical Consultative Commission (CCIR) in the field of basic radio communication and the International Technical Consultative Commission on Telephone and Telegraph Communication (CCITT). The work of the CCIR is handled by 15 scientific committees, each dealing with one aspect of equipment or systems and the field of telephone and telegraph is covered by 25 study groups in the CCITT.

The EIA could become a member of both the CCIR and CCITT providing the Department of Transport authorized the membership. The move to have the Executive Committee study the possibility was recommended by the Director of Engineering, Ralph A. Hackbusch, who has suggested that discussions be held with the Department of Transport before any commitments are made.

Fogarty Heads Defense Production Sharing Committee

The Board of Directors has approved the appointment of John Fogarty, Ferranti-Packard Electric Limited, as Chairman of the Defense Production Sharing Committee.

Mr. Fogarty succeeds W. S. Kendall, Computing Devices of Canada Limited, who was elected Chairman of the Electronics Division at the 32nd Annual Meeting.

R. M. Robinson, Canadian General Electric Company Limited, will continue to add his long experience to the committee as Vice-Chairman.

Survey UHF TV Band For Other Use

Following an announcement by the Board of Broadcast Governors on the undesirable non-use of UHF television band frequencies Receiver and Electronics Division members have been asked to bring forward recommendations as to whether or not any frequencies in the band (470-890 Mc/s) could be released for other communications services.

The Receiver Engineering Committee has suggested that up to 600 Mc/s would satisfy Canada's immediate and future television requirements, providing about 25 channels, with a few channels in the high end being reserved for educational television.

Continued on page 71

For recording high-speed one-shot occurrences



NOW, you can see and record non-repetitive, high-speed phenomena with a standard oscilloscope—one that does not depend upon sampling techniques. On its distributed-deflection CRT, you can observe bright displays with 100-line-per-centimeter definition. You can photograph fractional-nanosecond signals with ease on its full 2 x 6 centimeter display area.

With a Tektronix Type 519 Oscilloscope and associated C-19 Camera, you can easily photograph a single transient at 2 nanoseconds per centimeter—as illustrated in the avalanche test.

You will find the Type 519 engineered for convenience . . . *Internally*—all circuit components of the complete unit fit compactly, yet are readily accessible for easy maintenance. A fixed signal-delay line plus variable sweep-delay control maintains the wide display passband and eliminates any need for adjusting delay-cable lengths.

Externally—the Type 519 features a minimum of controls and connectors for an instrument in this range. A carefully-coordinated front-panel layout facilitates your test setups and procedures, aids greatly in saving engineering time and effort.

You need no auxiliary equipment for many high-speed applications. In fact, for normal operation, you make two connections only: (1) you plug-in the power cord, (2) you couple-in the signal source.

With such operational ease—combined with its inherent Tektronix reliability—the Type 519 is an ideal laboratory oscilloscope for your high-speed measurements up to the gigacycle region and slightly beyond—especially those applications demanding a photographic record of one-shot occurrences.*

CHARACTERISTICS **Passband**—from dc, 3db point typically above 1 gigacycle. **Instrument Risettime**—less than 0.35 nanosecond (including trigger takeoff, delay line, CRT, and termination). **Synchronization**—200 mv peak-to-peak, 1 MC to 1 gigacycle. **Accelerating Potential**—24 kilovolts. **Sensitivity**—10 volts/centimeter, maximum, into 125 ohms. **Time Base**—linear 6-centimeter sweeps from 2 nanoseconds/centimeter to 1 microsecond/centimeter in 9 steps. **Sweep Delay**—through 35 nanoseconds. **Triggering**—jitter-free: **External**—3-microwatt (20-millivolt) pulse of 1-nanosecond duration. **Internal**—2-tracewidth pulse of 1-nanosecond duration. Signal waveform undisturbed by trigger takeoff. **Power and High-Voltage Supplies**—electronically regulated. **Calibration-Step Generator. Avalanche-Transistor Rate Generator.**

TEKTRONIX TYPE 519 Oscilloscope f.o.b. factory **\$3800**

C-19 CAMERA

- Full-Intensity Mirror Viewing.
- Direct Recording.
- One-Hand Portability.
- Lift-On Mounting.
- Swing-Away Hinging.
- Comfortable Viewing—with or without glasses.

C-19 Camera **\$650**

Includes f/1.5 lens with 1:0.5 (object-to-image ratio) complete with cable release, Focusing Back, Polaroid† Back, other accessories. † by Polaroid Corporation

*1 gigacycle = 10⁹ cycles.

For a demonstration of these instruments in your own wide-band applications, please call your Tektronix Field Engineer.

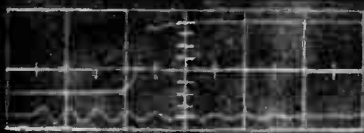

Avalanche test as illustrated may produce only one waveform of significance. The upper single-shot trace at 2 nanoseconds per centimeter displays approximately 0.4-nanosecond risetime. It is the result of the very first avalanche event.

The lower 1 gigacycle* timing trace illustrates sweep linearity.

Tektronix, Inc. P. O. BOX 500 · BEAVERTON, OREGON / Mitchell 4-0161 · TWX—BEAV 311 · Cable: TEKTRONIX

SERVING THE CANADIAN PROVINCES OF:

Quebec, New Brunswick, Nova Scotia,
Prince Edward, Newfoundland:
MONTREAL FIELD OFFICE
3285 Cavendish Blvd., Suite 160
Montreal, Quebec
Phone: HUNter 9-9707

Manitoba, Ontario:
TORONTO FIELD OFFICE
3 Finch Ave. East
Willowdale, Ontario
Phone: Toronto, BAldwin 5-1138

British Columbia, Alberta, Saskatchewan:
SEATTLE FIELD OFFICE
236 S.W. 153rd Street
Seattle 88, Washington
Phone: Seattle, CHerry 3-2494

For complete details check No. 44 on handy card, page 69



good connections right down the line

Because AUTOMATIC ELECTRIC carry a *complete line* of wiring and splicing supplies, you can order everything you need, as you need it, from an absolutely reliable source. AUTOMATIC ELECTRIC carry only top quality, name brand products—famous Scotch brand electrical tapes and connectors . . . sleeves by Slater . . . solder, cement . . . and because our stocks make full allowance for heavy or unexpected demands, you have no worries about prompt deliveries—ever. If you would like more details or illustrated literature, write: Automatic Electric Sales (Canada) Limited, 185 Bartley Drive, Toronto 16, Ont. Branches across Canada.

**Supplies for every wiring and splicing requirement.*

AUTOMATIC ELECTRIC
Subsidiary of
GENERAL TELEPHONE & ELECTRONICS



industry personnel



FRANKLIN



HURTUBISE



LUNGE



DALTON

New sales appointment at Renfrews, Montreal

D. E. Lloyd, sales manager, announced the appointment of **Florence Hurtubise** to the Montreal sales office of Renfrew Electric Co. Limited. Mrs. Hurtubise's experience began in the Electronic Industry in 1944 as a buyer for RCA Victor Co. Ltd. In 1951, she was made purchasing agent for their Home Instrument Division. In 1957 Mrs. Hurtubise joined Dominion Electrohome Industries as purchasing agent for the Electrohome Products Division. Her appointment as supervisor of Government Sales with Canadian Electrical Supply came in August of 1958 and continued until her recent appointment to the Renfrew organization in Montreal.

Franklin named CAE vice-president

Canadian Aviation Electronics Ltd. announced that **S. Edward Franklin**, MSEE, BSEE, MBA, would take a position as vice-president — Manufacturing, with headquarters at the Company's main plant in Montreal. Mr. Franklin has had experience in the Electronics industry over a period of 20 years, having been previously associated with the Link Division of General Precision Inc. in a senior manufacturing capacity.

Gordon Tebo named AIEE Fellow

The American Institute of Electrical Engineers (AIEE), one of the world's largest engineering societies, has elevated one of its Canadian members to the rank of Fellow. The announcement was made by AIEE executive secretary, Nelson S. Hibshman.

Gordon B. Tebo, manager of Testing Laboratories of the Canadian Standards Association, Toronto, Ontario was awarded this position "... for contributions to research and to developments relating to the safe use of electric power."

CRI Montreal branch manager appointed

John H. Innes, P.Eng., sales manager of Canadian Research Institute, recently announced the appointment of **Alfred (Alf) Lunge**, as Montreal branch manager. Ten years of industrial sales experience and extensive study of CRI products has given Mr. Lunge a sound background to efficiently serve his accounts. He will be responsible for all sales in the province of Quebec.



RYALL



THOMAS

Well known Canadian heads up California electronics firm

"The hard-headed, fast moving small companies will take over the exotic military business, leaving the small quantity, large dollar volume production and assembly work to the giant corporations," so said Ron Ryall, president of the booming Remanco Inc. of Santa Monica. Starting from humble beginnings a few years back, Ron Ryall guided the corporation to its present \$1 million annual business and toward the expected \$12 million volume by 1964.

Formerly an armament systems engineer with the RCAF for 11 years and later with Canadair and Bendix-Pacific, Ron is well known in Canadian military electronic engineering circles. Describing his company as a "consulting engineering firm with hardware" Ron Ryall stated that much of their success had been in the simulation field especially with regard to radar systems. Feeling that his com-

pany had developed a two year jump on the competition he said he foresaw a tremendous market ahead.

Dalton named manager at CGE

The appointment of **D. John Dalton** as manager, Marketing — Apparatus and Supplies, in the Wholesale Department of Canadian General Electric Company Limited was announced by Vice-President R. N. Fournier, general manager of the department.

In his new capacity Mr. Dalton is responsible for national marketing programs for the apparatus and supplies products distributed through the Wholesale Department.

Sales representative to serve Ottawa district

S. C. Bird, vice-president and general manager, Automatic Electric Sales (Canada) Limited, has chosen **G. W. (Gerry) Thomas** as sales representative serving the Ottawa district. Prior to his appointment, Mr. Thomas was with the Toronto Office for a period for seven years.

Huckman named sales manager

Edward R. Huckman was named general sales manager for The Foxboro Company, Ltd., according to an announcement by J. H. Bolton, managing director. He will have charge of all industrial instrument sales activities for the Montreal firm and its branch offices in St. John, Toronto, Sudbury, Port Arthur, Edmonton, Calgary and Vancouver.



SPARKS



HUCKMAN

Sparks joins RCA Victor

The RCA Victor Company, Ltd. nominated **G. W. (Ned) Sparks** as Ottawa manager of Technical Products. Mr. Sparks is responsible for negotiating the sale of specialized products and services to Government departments and agencies.

Continued on page 63

World Recognition!

The Starkit 12-22 Dynamic Mutual Conductance Tube Tester is sold all over the World because of its Low price and High quality

Types of Sockets now included . . .

The Starkit Model 12-22 has permanently wired European sockets as well as regular American sockets, and is capable of testing a wide range of tubes used in Radio, Television, Hi-Fi, Amplifiers, Transmitters, Western Electric and Industrial applications, directly from data supplied on roll chart or booklet. Types of sockets included are: Nuvistor, 9 pin (Noval), 7 pin miniature, 10 (International Octal), Loctal, UX4 (4 pin), UX5 (5 pin), UX6 (6 pin), UX7 (7 pin), 7 and 8 pin subminiature, B9G (9 pin loctal), B3G (3 pin Inline), B8A (Rimlock), B4 (4 pin), B5 (5 pin), B7 (7 pin), MO (Mazda Octal), B8G (loctal), P transcontinental, and socket G8A. Adapters available for seldom used base and socket configurations (ie) 832, 465A, 829, Compactron, other nuvistors, 10 Pin Headers, Novars, etc. This flexibility possible only with the unique versatility of the Stark Hickok patented circuit.

Tube Data Service . . .

Stark provides, for one year free of charge, data service comprising of one new chart and three supplements (published quarterly). A nominal charge for each year thereafter.

Patented Hickok Circuit . . .

The Starkit Model 12-22 is the first Universal Tube Tester produced on the American Continent embracing the highest quality circuitry performance of the patented Hickok Dynamic Mutual Conductance Circuit. In like manner it is the first Dynamic Mutual Conductance Circuit to be made available in kit form, as well as wired form. Its unique design embraces the tube tests for European as well as for American tubes. This is a great ad-



\$149.50
KIT

\$199.50
WIRED

vantage to domestic users as well, due to the constant growth of European tube applications.

Where proper testing of tubes is required, dynamic mutual conductance readings are essential. The principle of the Starkit 12-22 is proportionally the same as that used by tube manufacturers' laboratories in designing and testing their own tubes. Operating voltages, including DC Grid Bias, are applied to every element, and an AC signal is applied to the control grid, so that the tube is operating during the test.

The Starkit Model 12-22 is available in either kit or wired form. The kit is supplied with step-by-step assembly instructions and

manual in French and English with complete pictorial, schematic and wiring harnesses that take the puzzle out of assembly. A unique method of calibration allows the operator to calibrate his checker with factory precision.

Please send me further information for the Model 9-99 and other Starkit items.

Name

Business Address

Town or City Prov.



STARK ELECTRONIC INSTRUMENTS LTD.
AJAX, ONTARIO

For complete details check No. 42 on handy card, page 69



1 1/2 kw switch
capacity
in 1/10 of a
square inch!

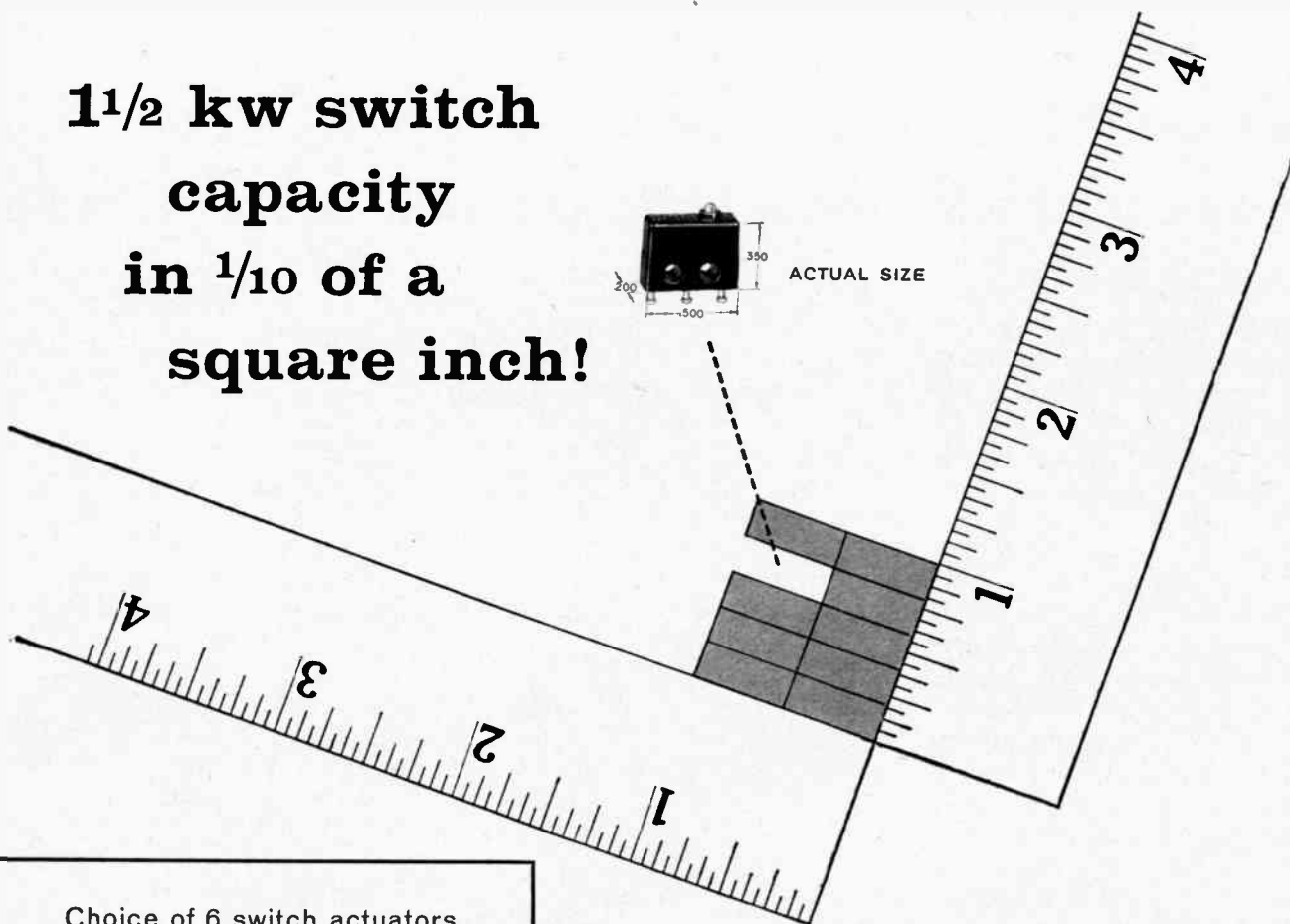
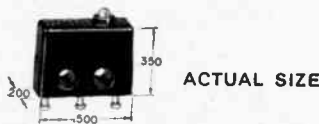

Choice of 6 switch actuators



Leaf actuator



Roller leaf actuator

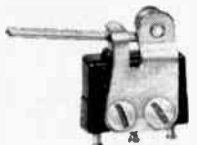

Pivoted lever actuator



Reverse leaf actuator



Reverse roller leaf actuator

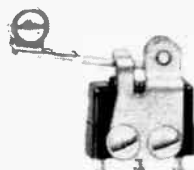

Pivoted roller lever actuator

THE MICRO SWITCH "1SX1" is the smallest single-pole double-throw snap-action switch made. It weighs only 1 gram. Yet, despite its tiny size, it performs millions of operations, in temperatures ranging from -65° F. to +250° F. And it handles precision switching jobs at capacities up to 1 1/2 kw.

The case, cover and plunger are made of high-strength plastic. Contacts are fine silver. The unique, snap-action spring is beryllium copper. The case has two mounting holes that accept No. 2 screws. One hole is slightly elongated to facilitate mounting. "1SX1" is designed to conform to MS24547-1.

For complete information, phone your nearby Honeywell office or write Honeywell Controls Limited, Precision Components Division, Toronto 17, Ontario. Ask for Catalog 63.



Honeywell
MICRO SWITCH Precision Switches

HONEYWELL INTERNATIONAL
Sales and service offices in all principal cities of the world. Manufacturing in United States, United Kingdom, Canada, Netherlands, Germany, France, Japan.

For complete details check No. 25 on handy card, page 69

HOW TO GET FLAT FREQUENCY RESPONSE FROM 37 CYCLES TO 45 KC

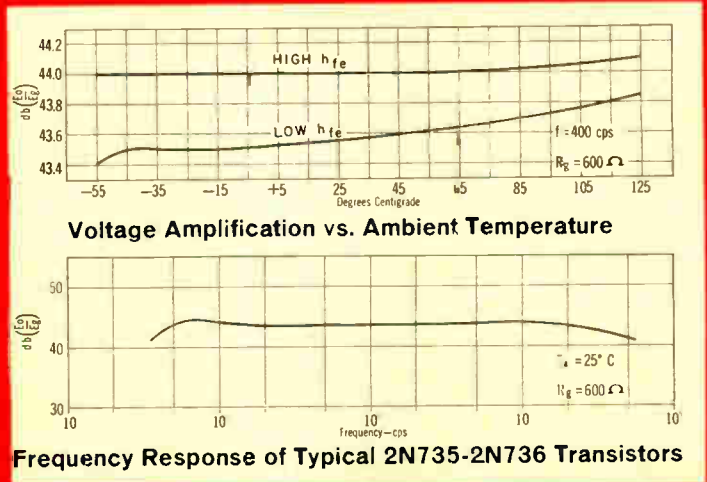
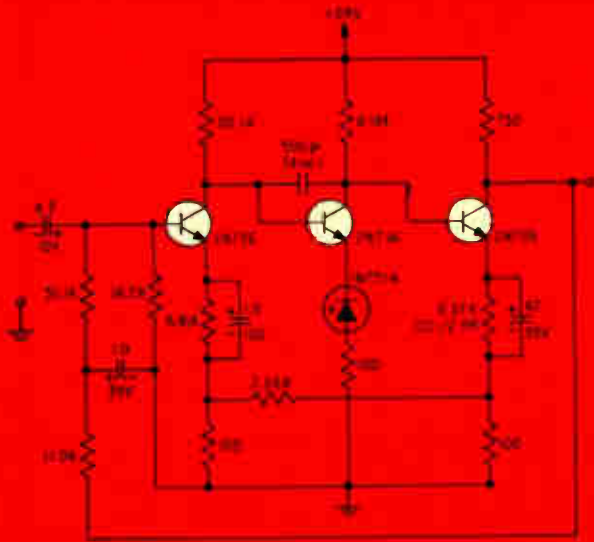

Specify TI 2N734 Series Silicon Transistors for Your Amplifiers!



For your audio/servo amplifiers, power supplies and medium-speed switches, design in TI 2N734 Series Silicon Transistors. Obtain a flat frequency response of ± 1.5 db from 37 cycles to 45 kc... guaranteed beta at 25°C (1 ma at 1 kc) (5 ma at 1 kc) (5 ma at 30 mc) and at -55°C (5 ma at 1 kc)... guaranteed 500-mw free-air dissipation... reduced equipment size and weight with TO-18 package.

For even greater power dissipation, investigate the design flexibility of the equivalent TO-5 packaged 600-mw TI 2N1564 Series Silicon Transistors.

GUARANTEED MINIMUM BETAS

Symbol	Parameter	Test Conditions	2N734	2N735	2N736
h_{fe}	A-C Common-Emitter Forward Current Transfer Ratio	$V_{CE} = 5v$ $I_E = 5ma$ $f = 1 kc$ $T_A = 25^\circ\text{C}$	20	40	80
h_{fe}	A-C Common-Emitter Forward Current Transfer Ratio	$V_{CE} = 5v$ $I_E = 1 ma$ $f = 1 kc$ $T_A = 25^\circ\text{C}$	15	30	60
h_{fe}	A-C Common-Emitter Forward Current Transfer Ratio	$V_{CE} = 5v$ $T_A = -55^\circ\text{C}$ $I_E = 5 ma$ $f = 1 kc$	12	20	40
$[h_{fe}]$	A-C Common-Emitter Forward Current Transfer Ratio	$V_{CE} = 5v$ $I_E = 5 ma$ $f = 30 mc$ $T_A = 25^\circ\text{C}$	1	2	2

Write for complete specifications on 2N734 and 2N1564 Series Today!

SPECIFY TI FOR ALL YOUR SILICON TRANSISTOR REQUIREMENTS • Small Signal • Switchers • Medium Power • Power • Order TODAY from your local TI Sales Office or TI Distributor.

Immediate Delivery Anywhere in Canada from
CANADIAN ELECTRICAL SUPPLY CO., LTD.

MONTREAL
275 Craig St., W.
UN 1-2411

QUEBEC
128 Quest, Rue St. Vallier
LA 4-3518

OTTAWA
838 Somerset St., W.
CE 2-2696

TORONTO
877 Yonge St.
WA 1-5111

TRANSISTOR
PRODUCTS
DIVISION



TEXAS INSTRUMENTS
INCORPORATED
1364 ISLINGTON AVENUE, NORTH
ELMHURST PLAZA REXDALE ONTARIO

World Radio History

Canadian Radio Technical Planning Board newsletter



by R. C. Poulter

What Is The Planning Board?

Judging from the number of enquiries received it would seem there are many readers of this column who are not aware of the functions performed by the Planning Board and how it serves the national interest. The following is a summary of the organization and its activities.

The CRTPB was formed in September 1944 at a meeting convened by the Department of Transport as a non-political, non-profit organization of users of radio communications and certain allied equipment (and thus of spectrum space), manufacturers, education and engineering societies and other interested associations and organizations.

The objectives of the Board, as stated in the constitution, are to formulate sound engineering principles and to organize technical facts which will assist in the development of the Canadian radio industry and radio services, in accordance with public interest, and to advise Government, Industry and People of its findings and recommendations.

Such activities are restricted to technical considerations except where economic factors must be considered in reaching sound engineering conclusions.

The Board co-operates closely with the Telecommunications Branch of the Department of Transport — the department of the Canadian Government responsible for the allocation of frequencies and for the preparation and enforcement of specifications for equipment using the radio spectrum or capable of creating interference with the effective use of the spectrum.

Activities of the Board include the study of spectrum use and conservation, interference problems, and equipment and systems specifications. Besides taking into account the technical aspects there are many other factors considered, such as amortization of existing apparatus. Therefore, the word of the Board affects all users of radio and allied equipment and systems of every type.

The Organization

Membership in CRTPB is entirely voluntary and consists not of individuals but of non-profit associations, societies and organizations representing users and manufacturers of telecommunications and allied equipment, and of certain engineering and educational societies and associations. These are the sponsor organizations and each sponsor appoints a main representative and an alternate to the Board. The work of the Board is financed entirely from dues received from sponsors. The general organization is as follows:

The Board

The Board consists of the accredited representatives of the sponsors, the Chairmen of the various technical and other committees and panels and the Officers.

Administrative Committee

The Administrative Committee consists of the President, Vice-President, General Technical Co-ordinator, Director of Public Relations, Secretary-Treasurer and other officers and the main representatives of the sponsors. Each sponsor's main representative has one vote.

Executive Committee

The Executive Committee consists of the President, Vice-President, General Technical Co-ordinator, Director of Public Relations, Secretary-Treasurer, Assistant Secretary-Treasurer and the immediate past President. The President and Vice-President are elected annually by the Board. Other officers are appointed annually by the President.

The present membership of the Board includes 21 organizations representing the electrical utilities, gas utilities, radio and television broadcasters, electronic and electrical manufacturers, marine interests, the trucking industry, radio amateurs, municipal and federal police, railway, telegraph and telephone companies, educational institutions, engineering societies and other interested groups.

The Committees

The Board is representative of the many branches of the radio and allied fields in Canada and is able to call upon highly competent technical experts to assist in its work. For example, there are over 100 professional engineers at present serving on technical committees.

The Board develops such studies, investigations, recommendations and standards or specifications as are required to attain its objectives, acting upon suggestions from its sponsors, the Government, or from other groups interested in the use of radio in Canada.

Here, therefore, is a large organization composed of highly competent technical specialists devoting their time and talents to the problems which are common to their respective fields. The cost of such specialized engineering services to individual users, manufacturers and other interests would be enormous but these experts all serve without remuneration of any sort other than the satisfaction of doing the job well.

The Committees deal with problems assigned to them by the Board and their reports are presented to the Board for consideration and subsequent action. The problems submitted may have to do with frequency allocations, interference, procedures, equipment specifications, amortization periods and effective dates. The problems involve all classes of electronic communications equipment and systems as well as industrial, scientific and other apparatus employing radio principles and utilizing the spectrum or capable of interfering with its effective use.

In addition to the many standing technical committees the Board may authorize the formation of special

Continued on page 65

LOOK TO **FEDERAL**



FIRST



SMALL

LARGE

MEDIUM

PAY-OFF-PAKS AND SPOOLS FOR EVERY SIZE AND TYPE OF MAGNET WIRE

Federal's 20 years of engineering know-how in the proper packaging of magnet wire can pay off for you and your company by achieving increased production and reducing excessive waste.

Federal magnet wire is practically packaged to suit your detailed and exact requirements, whether it be magnet wire from the 2" to 24" spools or in small, medium or large "Pay-off-Paks."

Whatever the size (from #6 to #40) or

type of magnet wire required, Federal can supply a complete selection of sizes, shapes and enamels. Federal's engineers can also recommend improvements in your production methods to obtain maximum benefits from Federal's highly functional spool sizes and "Pay-off-Paks."

Let Federal Magnet Wire "packaging" pay off in speed and profits for you. Please write us for further details at P.O. Box 90, Guelph, Ontario.

FEDERAL WIRE &



CABLE DIVISION

H.K. PORTER COMPANY (CANADA) LTD.

6008

PORTER SERVES INDUSTRY with steel, rubber and friction products, asbestos textiles, high voltage electrical equipment, electrical wire and cable, wiring systems, motors, fans, blowers, specialty alloys, paints, refractories, tools, forgings and pipe fittings, roll formings and stampings, wire, rope and strand.

For complete details check No. 36 on handy card, page 69

ELECTRONICS AND COMMUNICATIONS, October, 1961.

21

a pleasure
to measure
with these...



Ⓢ 5512A, 300 KC



Ⓢ 5532A, 1.2 MC

4 NEW SOLID STATE

Measure frequency, period, ratio, quickly, accurately
continuous display, no "blinking"...0.1 volt sensitivity
...Unique low frequency accuracy...Operation -20° to

All the advantages of solid-state design are now yours in these new Ⓢ solid state counters—offered at prices comparable to those of today's vacuum tube counters. And you get the *plus* advantages of greater readability, faster measurements, easier routine maintenance, rack-and-stack convenience of the new Ⓢ universal module instrument cabinets.

Offered in four models, these new counters have maximum counting rates of 300 KC or 1.2 MC, with a choice of Nixie or columnar readouts. The high-intensity neon readouts are stacked in compact columns for faster, easier reading. On the in-line readouts, Ⓢ-pioneered standard incorporation of the new long-life, wide-viewing Nixies gives you many extra hours of lamp life and heretofore unknown readability even at extreme angles. Polarized screen provides maximum readout brilliance with freedom from reflections.

A unique display storage feature of these new counters produces a continuous visual readout of the most recent measurement, even while the instrument is making a new measurement. Only if the new count differs from the previous count will the display change, in which case it will shift directly to the new reading. The fatigue and error possibility of a "blinking" display is eliminated. The storage feature may be disabled with a rear panel switch.

The counter's "inactive time" (when not making a new measurement) is independent of gate time and adjustable from 0.2 to 5.0 seconds, thus permitting a higher sampling rate.

Counter	Max. Counting Rate	Registration	Period	
			Range	Accuracy
5212A	300 KC	5 digits columnar	2 cps to 10 KC in single period; up to 300 KC in multiple period average	± 10 μs ± time base accuracy ± trigger error/ periods averaged
5512A	300 KC	5 digits Nixie		
5232A	1.2 MC	6 digits columnar	2 cps to 10 KC in single period; up to 1 MC in multiple period average	± 1 μs ± time base accuracy ± trigger error/ periods averaged
5532A	1.2 MC	6 digits Nixie		

High sensitivity permits low level measurement without accessories, and multiple period average measurement (to 100,000 periods) gives higher ac-



Note clean, compact, easy-to-service physical arrangement of new Ⓢ solid-state counters.

For complete details check No. 23 on handy card, page 69

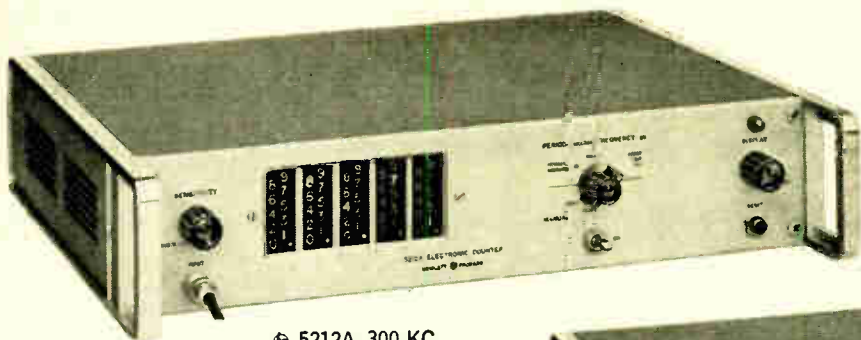

Ⓟ 5212A, 300 KC

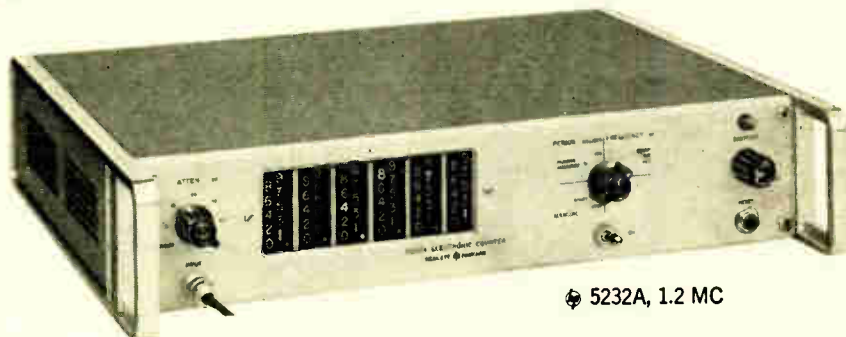

Ⓟ 5232A, 1.2 MC



COUNTERS!

...Compact, easy-to-use instruments provide
 ...Solid-state dependability...Higher sampling rate
 +65°C...Prices comparable to vacuum tube counters!

Measurement		Frequency Measurement				Ratio Measurement			Price
Reads in	Periods Averaged	Range	Accuracy	Reads In	Gate Time	Reads	Range	Accuracy	
Milli-seconds with positioned decimal	1, 10, 10 ² , 10 ³ , 10 ⁴ , 10 ⁵	2 cps to 300 KC	± 1 count ± time base accuracy	KC with positioned decimal	10, 1, 0.1, 0.01 sec.	(f ₁ /f ₂) x period multiplier	f ₁ : 100 cps to 300 KC (1 v rms into 1,000 ohms) f ₂ : same as period	± 1 count of f ₁ ± trigger error of f ₂	\$ 975.00
Milli-seconds or microseconds with positioned decimal		2 cps to 1.2 MC					f ₁ : 100 cps to 1.2 MC (1 v rms into 500 ohms) f ₂ : same as period		1,300.00
									1,550.00

accuracy in lower frequency ranges, even for noisy signals. Self-check is provided for both frequency and period measurement modes.

Only 3½" high, these counters are housed in the new modular cabinets ideal for both bench use and easy rack mounting. Routine maintenance is simple with snap-out decade/readout units and circuit cards. Readout drive directly from photoconductors eliminates a complete stage of complex circuitry, to effect genuine cost and reliability advantages. Compact design and construction and servicing ease are illustrated at the left.

Solid state design and construction gives you the advantages of low heat dissipation with minor heating effect on adjacent equipment, fast warm-up, low power consumption and new standards of reliability.

The new counters include a four-line BCD code output. This output, with assigned weights of 1-2-2-4, is available for systems use or to operate devices such as the 562A Digital Recorder. Front panel controls include Input Attenuation, Display, Reset and Function.

Call or write your representative or call us today for information and a demonstration!

Data subject to change without notice. Prices f.o.b. factory.



HEWLETT-PACKARD COMPANY

1081G Page Mill Road
 Cable "HEWPACK"

Palo Alto, California, U.S.A.
 Davenport 6-7000

Sales representatives in all principal areas

World Radio History

HEWLETT-PACKARD S. A.

Rue du Vieux Billard No. 1
 Cable "HEWPACKSA"
 Geneva, Switzerland
 Tel. No. (022) 26. 43. 36

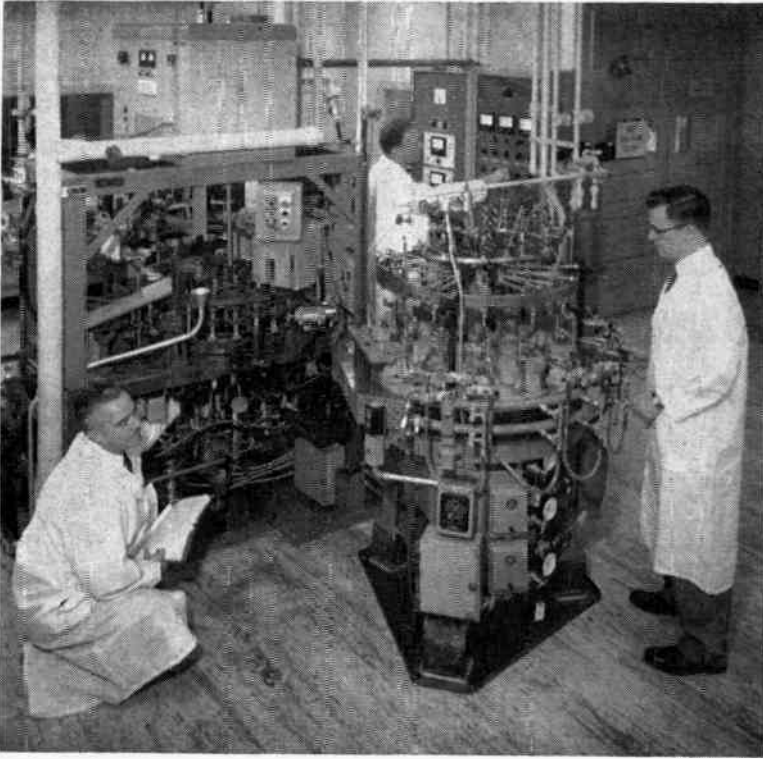

Miniature tubes for carrier equipment are sealed and the air inside removed on this complex machine at Northern Electric's plant at Shearer Street, Montreal.

close-up

a pictorial comment of the industry in action

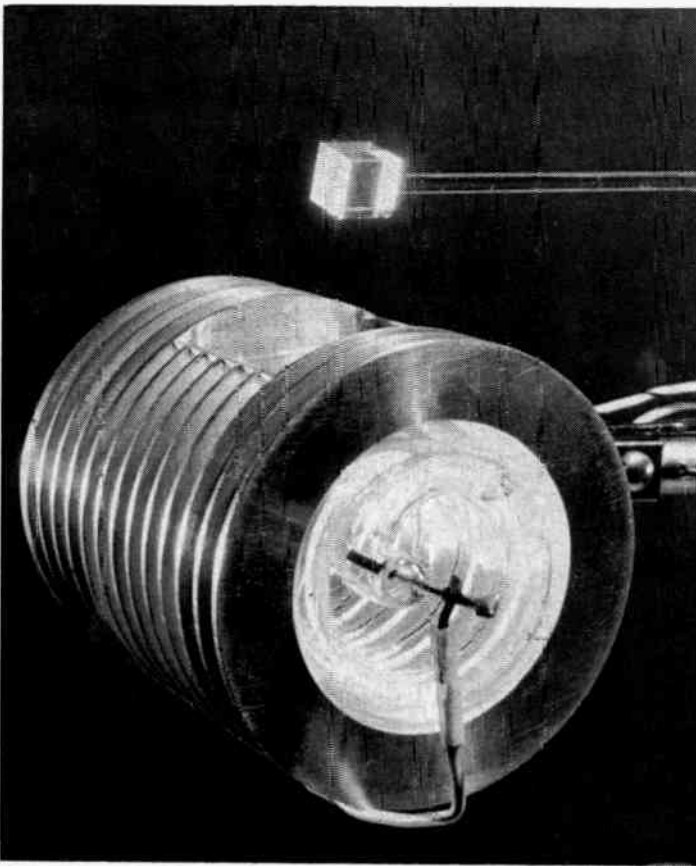

Glowing with absorbed light is a synthetic ruby crystal (top), the "heart" of the new laser (from Light Amplification by Stimulated Emission of Radiation) scientific breakthrough developed at the research laboratories of Hughes Aircraft Company. A light source (bottom) pours "random" waves of light into the ruby, exciting the gem's tightly-packed atoms. This stored energy then reradiates light in sharp beam. The laser marks man's first creation of a source of "coherent" light.

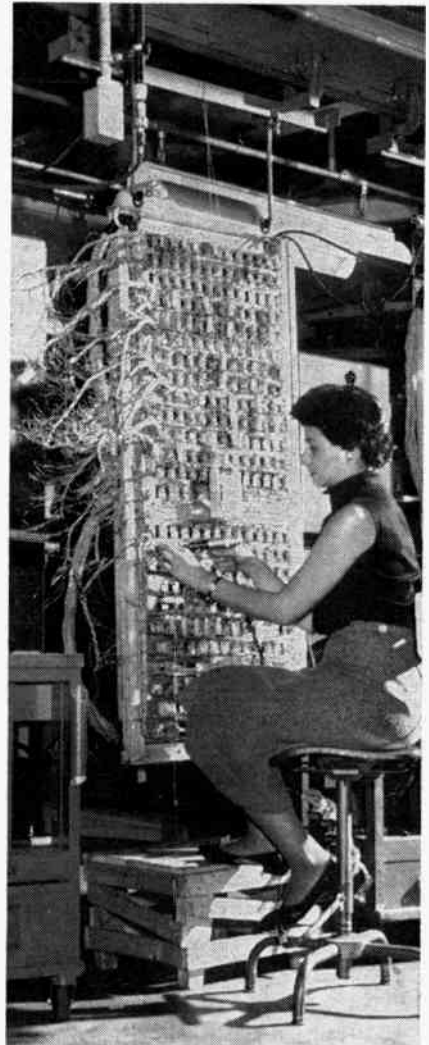

Operator Colette Blais wires slide units at Northern Electric's crossbar location in Montreal. The slides are for use in the compact 756A public branch exchange designed for customers who require 20 to 60 telephone lines with 10 or less central office trunks.

Queen Elizabeth Hospital, Birmingham, England, has been permanently equipped with a closed-circuit television assembly utilizing an EMI-Electronics' camera built into the surgical lamp over the operating table. This enables 40 students in an adjoining lecture room to watch, on large screen television receivers, operations performed by the tutorial staff of the Medical School.

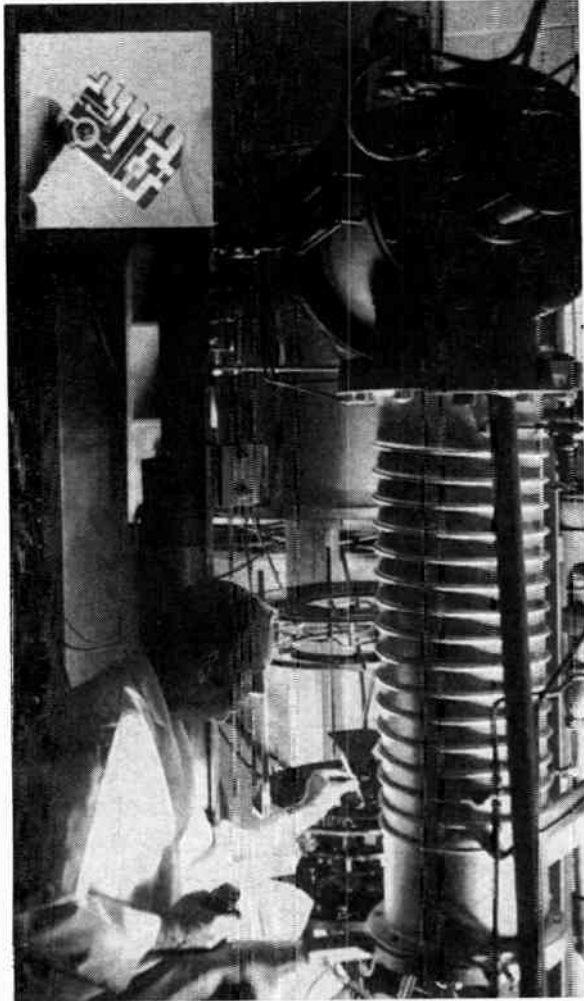

Thin-film microcircuits are manufactured by a vacuum system produced by CVC Electron Heating Corp., Medford, Mass. Model EB-101 incorporates design and production techniques developed over a two year period by CBS Electronics. The thin-film elements produced meet standard tolerances and offer high reliability.



A member of the solid state laboratory staff of Northern Electric's research and development laboratories, experiments with the growth of ultra-pure silica crystals under a variety of controlled conditions.

Complementing the line of
Canadian made Multimeters...

The
new
model

635

Featuring

PREMIUM ACCURACY
MIRROR SCALE

KNIFE-EDGE POINTER
SPRING-LOADED JEWELS
SHIELDED MOVEMENT
OVERLOAD PROTECTION

AND—the same quality and
ruggedness which have
made the Simpson Model 260
and Model 270 bywords
wherever Multimeters
are used.

Priced at \$72.50
Federal Sales Tax Included

... WITH A. C. CURRENT RANGES AND SINGLE SWITCH



WRITE FOR
SPECIFICATION
SHEETS

**Bach-Simpson**
LIMITED

1255 Brydges St., London

For complete details check No. 9 on handy card, page 69



get the shortest
etching time with

**HUNT
ETCHANTS**



Wherever Hunt Etchants are used production rates jump. **HUNT R. C. E.** (*Rapid Circuit Etch*) is a fast acting, specially balanced etchant for printed circuit board production.

HUNT S. C. E. (*Solder Circuit Etch*) is the only prepared product formulated to etch solder-plated boards at room temperature without attacking the solder.

Send for: **R. C. E. TECHNICAL BULLETIN 1 & 1A**
S. C. E. TECHNICAL BULLETIN 3

FOR SUPERIOR RESULTS AROUND THE CLOCK USE HUNT GRAPHIC ARTS CHEMICALS

PHILIP A. HUNT COMPANY (CANADA) LTD.

207 Queen's Quay West
Toronto 1, Ont.
Montreal, Quebec
Calgary, Alberta



For complete details check No. 26 on handy card, page 69
ELECTRONICS AND COMMUNICATIONS. October, 1961

**OUTSTANDINGLY
NEW**

the versatile

IMPERIAL Ungar

SOLDERING IRON

the most revolutionary
soldering iron
ever invented

Only Ungar Electric Tools could have produced this revolutionary new soldering iron! More than a decade ago, Ungar research developed the first low wattage, high temperature pencil type iron giving industry lower operating cost! This same forward thinking then pioneered interchangeability of components for maximum operational economy.

In the slim, functionally-designed PERMA COOL IMPERIAL handle, Ungar introduces a completely new heat sink principle. A double cushion of air, combined with five heat transition surfaces, evenly dissipates heat, keeping the handle cool and comfortable at body temperature all day long.

- Interchangeable Cord Sets
- Long-life Heat Cartridges
- 42 Interchangeable Tips

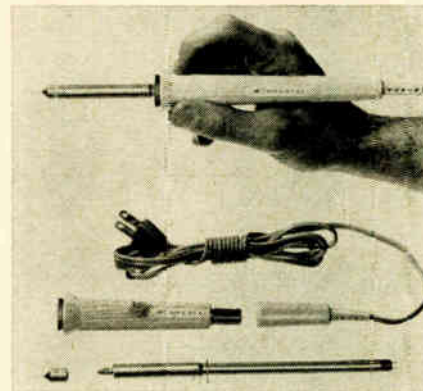

Write for details — Electronics Division

**ELDON INDUSTRIES
OF CANADA LIMITED**

44 Danforth Rd., Scarborough, Ontario, Canada

For complete details check No. 18 on handy card, page 69

We are pleased
to announce a
new addition
to our family of
fine products...

We have a new line of
HUGHES DIODES...

DETAILS ON
OPPOSITE
PAGE



Industry's business

Continued from page 11

TCA to replace vibrators with transistorised power supplies

It is reported that Trans-Canada Airlines intend to replace all the existing vibrators on their Marconi radio-compasses with transistorized power units developed recently by Marconi. One hundred and twenty units are believed to be affected.

An "AC power unit", understood to be a switching type static inverter has also been designed for the cited equipment. Manufacturer states that new units considerably increase efficiency and reliability and reduce overall weight. AC power unit sells for £65 and vibrator replacement for £55 both FOB in U.K.

U.S. power companies provide \$20 million market for remote controls

A U.S. market survey has shown that the American power industry provides a \$20 million annual market for remote control devices. Survey showed that new advances in the power industry will require several new remote control products. Some of these products include a select station, function, and command control system, an analog to digital converter for telemetering of volts, amperes, etc., and relay-type control units for simple switching techniques requiring several monitoring or control functions at one point of a direct current loop.

The Canadian power industry, though smaller than its U.S. counterpart employs similar technical methods therefore a parallel market for remote control devices must exist in this country. Companies in the instrumentation field might profitably explore this developing area.

Eldon Industries take over Astral Electric

New lines of loudspeakers, electronic office equipment and electronic toys are predicted by Eldon Industries of Canada Limited, following that Company's recent take-over of Astral Electric Co. Ltd. Pressing of more recordings in Canada is also expected.

The establishment of Eldon Industries and the completion of plans for building a new head office and plant mean that manufacturing facilities for all the divisions of Eldon, including toys, electronics and recordings will be greatly expanded.

For complete details check No. 38 on handy card, page 69

Canadian Instrumentation Exhibit at Los Angeles' ISA Show

Latest Canadian achievements in the highly specialized field of instrumentation were featured at the 16th Annual ISA Instrument-Automation Conference and Exhibit, held in Los Angeles, September 11 to 15. Eighteen Canadian firms, under the sponsorship of the Department of Trade and Commerce, exhibited a variety of precision instruments ranging from airborne navigational computers to ultrasonic geophysical survey detection units.

The broad diversity of Canadian products shown emphasizes Canada's emergence as a leading designer and manufacturer of precision instruments, in keeping with the tremendous growth of the electronic industry in this country.

A 24-page illustrated booklet, *Instrumentation And Automation Equipment From Canada*, has been published in connection with the ISA show by the Editorial and Art Services Division, Trade Publicity Branch, Department of Trade and Commerce, Ottawa, Ontario. This booklet contains detailed information on participating Canadian firms and their products, as well as informative articles on Canada's Department of Defense Production and the Industrial Development Branch of the Department of Trade and Commerce.

Electronic Measurements appoints Canadian representative

Electronic Measurements Company Inc., Eatontown, New Jersey, manufacturers of regulated DC power supplies, has appointed Electronic Controls Ltd., Belleville, Ontario, as their Canadian sales representative.

Canada Wire & Cable named exclusive Canadian sales agent

Canada Wire and Cable Company, Limited, Toronto, Ont., was elected exclusive sales agent for Copperply communications wire in Canada.

Copperply copper-covered steel wire is manufactured at National-Standard Company of Canada Ltd., Guelph, Ont. It is used for telephone conductor wire, strand, drop wire and other applications where the strength of steel plus the conductivity and corrosion protection of copper are required.

Continued on page 73

Pick 99% of your DIODE requirements from this *New* HUGHES SIMPLIFIED PRODUCT LINE



◀ GOLD BONDED GERMANIUM DIODES — 9 TYPES

These units exhibit fast recovery and low Reverse leakage. Rated inverse from 30 to 70V, all units having forward drop of 0.8 volts at 100 mA.



◀ POINT CONTACT GERMANIUM DIODES — 12 TYPES

With peak inverse of 75 or 100V, 45 mA forward current, these units have high back resistance and excellent recovery characteristics.

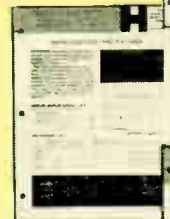

◀ ULTRA FAST SILICON COMPUTER DIODES — 5 TYPES

Maximum recovery time not exceeding 0.5 milli-microseconds and 20 volts reverse characterize these units for high speed computers and U.H.F. equipment.



◀ QUICK RECOVERY SILICON JUNCTION DIODES — 6 TYPES

Peak inverse from 50 to 150 volts, 40 to 80 mA forward current and 0.3 micro-second recovery are features of the fast diode line.

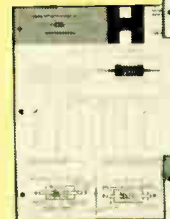

◀ STANDARD SILICON JUNCTION DIODES — 9 TYPES

The "workhorse" line with characteristics from 50 to 200 peak inverse volts, 50 to 200 mA forward and extremely high back resistance.



◀ VOLTAGE VARIABLE SILICON CAPACITORS — 7 TYPES

Capacitance control by applied voltage. Typical Q of 360 at 5 Mc. Ranges from 6 to 240 pF.

- ★ FAST DELIVERY FROM R-O-R STOCK
- ★ MADE IN THE U.K.
- ★ ATTRACTIVELY PRICED
- ★ SAMPLE DIODES SUPPLIED FREE ON REQUEST

HUGHES INTERNATIONAL
HUSINT S. A.

R-O-R ASSOCIATES LIMITED
1470 DON MILLS RD., DON MILLS, ONT.

SEND FOR
CATALOGUE SHEETS
AND PRICES

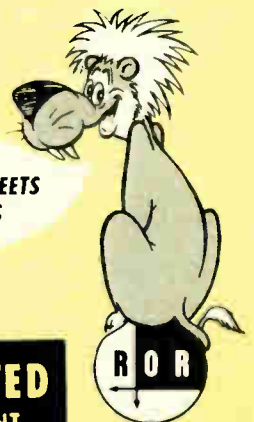

For complete details check No. 39 on handy card, page 69

Built in Canada to the most reliable standards available anywhere.

**THE GOLDEN G
PREMIUM QUALITY MICRO-MINIATURE RELAY**

This completely gold-plated, hermetically sealed micro-miniature relay will meet 50-g's vibration to 3000 cps and 250-g's shock. Tested for over 6,000 operations at 125°C, 25°C and -65°C, under dry circuit conditions prior to shipment.

RELAYS* by MARSLAND

"PILLBOX"
Microminiature Relay

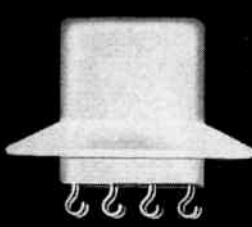

"GOLDEN G"
Microminiature Relay

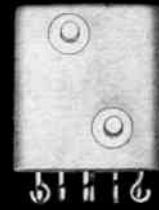
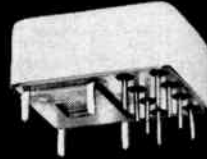

"POWRMITE"
Microminiature Relay

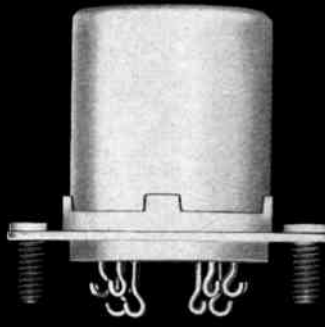

GENERAL PURPOSE
& LATCHING
Miniature Relays



Contact welding with precision tool electrodes.



High vacuum oven for degassing and backfilling with inert gas.

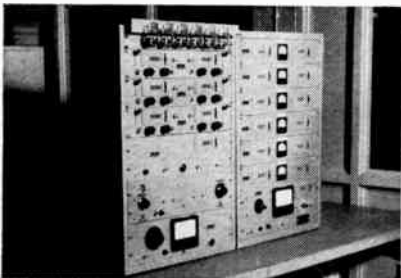

Monitoring equipment for life and low level miss testing.

MICRO-MINIATURE RELAYS

"Pillbox" relay incorporates a completely new relay configuration with terminals projecting from the side. Especially applicable for use on printed circuit boards.

The "Powrmite" package for all micro-miniature relay switching requirements. With plug in or fixed-wire mountings. In (s) or gridded header configurations.

**GENERAL PURPOSE AND LATCHING RELAYS
1 INCH AND ½ INCH**

General purpose relays in 2, 4 and 6 pole double throw contact arrangements with plug in, hooks or wire leads. For controls and circuits where high reliability, multiple switching is required.

Latching relays remain in "energized" position indefinitely without consuming power and can be electrically reset from a remote position. They have many applications in fail-safe circuits.

*Manufactured in Canada under license to Filtors Inc., Port Washington, Long Island, N.Y.

Detailed information is available on request.

MARSLAND ENGINEERING LIMITED
KITCHENER • ONTARIO

Associate Company

MARSLAND PRECISION EQUIPMENT CO. LTD. Waterloo, Ontario

For complete details check No. 30 on handy card, page 69

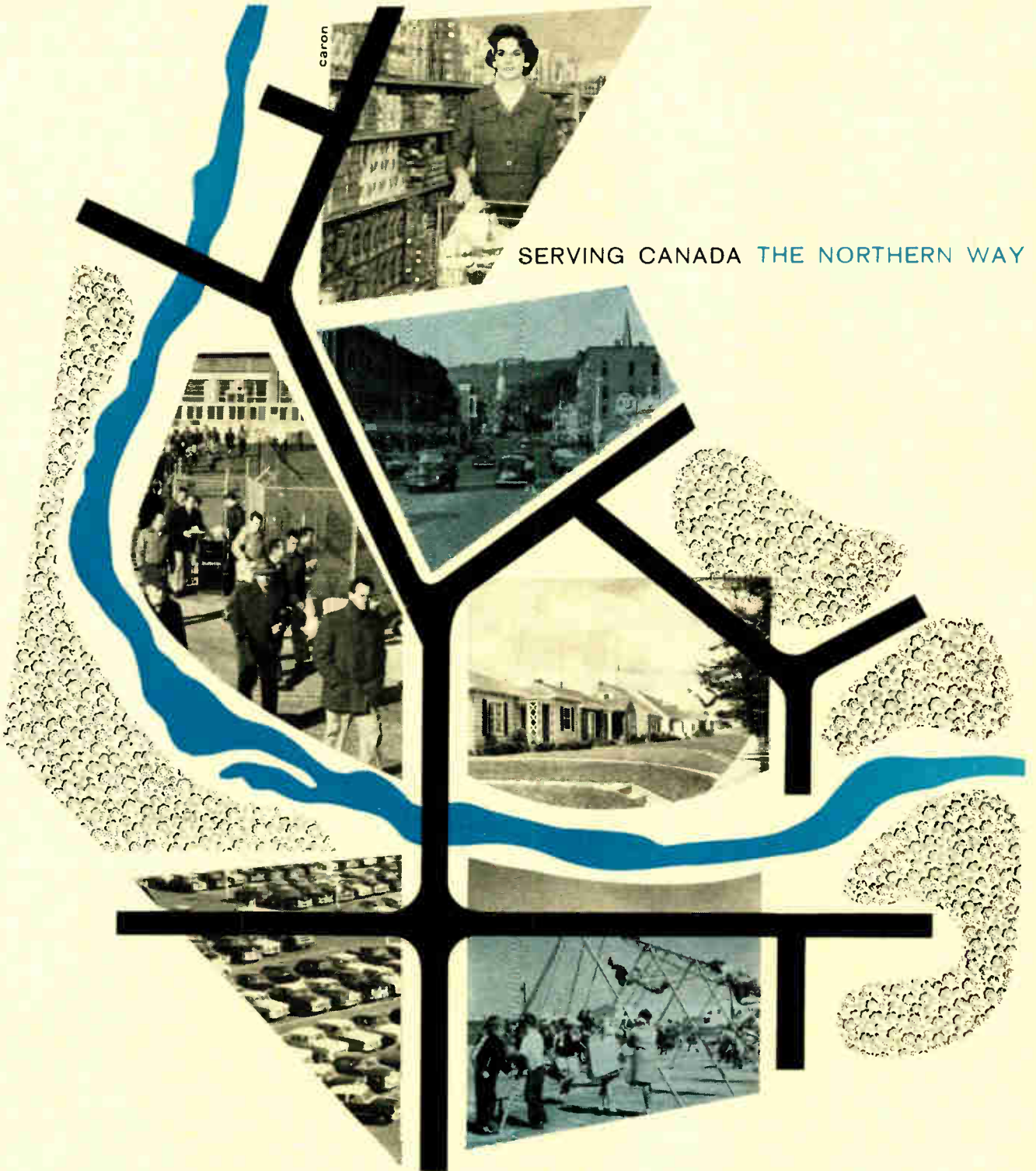

SERVING CANADA THE NORTHERN WAY

15,000 Northern People . . . individuals all with different personalities . . . different lives . . . holding various positions . . . making numerous products . . . but all linked together by a common bond as a member of the Northern Electric family, in the design, manufacture, and installation of a large proportion of Canada's telephone communication systems and equipment. ■ They produce all types of electrical wire and cable for communication and power transmission, and distribute a complete line of electrical apparatus and supplies. ■ At Northern Electric, product research and development never stops, and continuing progress is made in the communication, electrical

Northern Electric
COMPANY LIMITED

6661-4

ELECTRONICS AND COMMUNICATIONS, October, 1961 For complete details check No. 33 on handy card, page 69

for FULL
EXCURSION
TUBE
ANALYSIS:

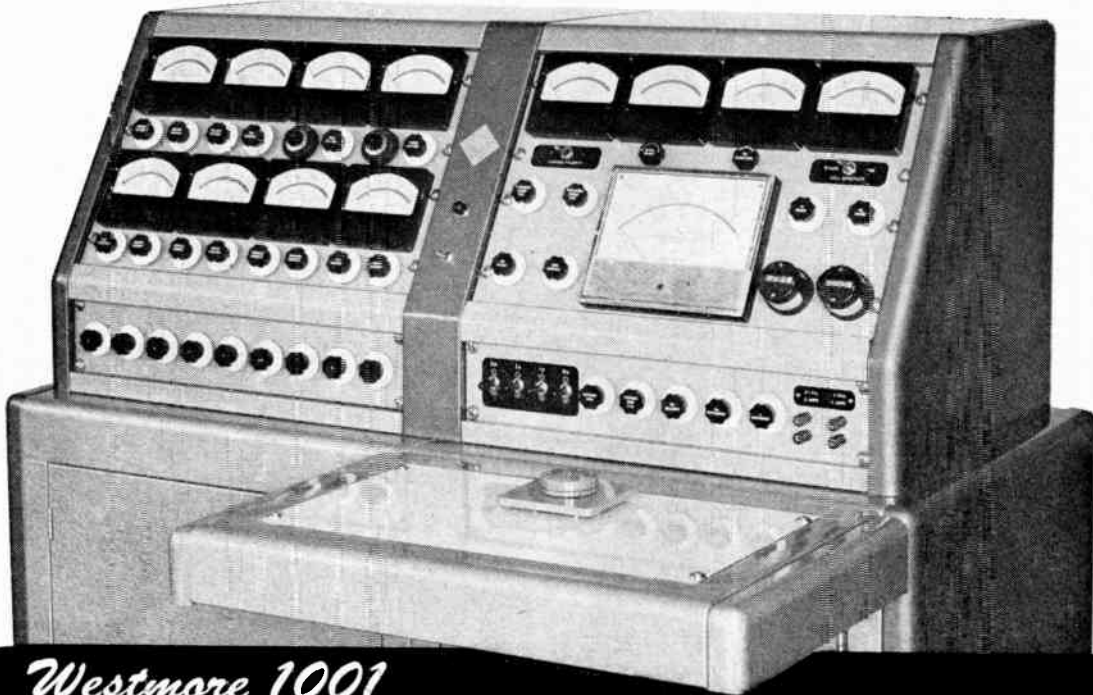
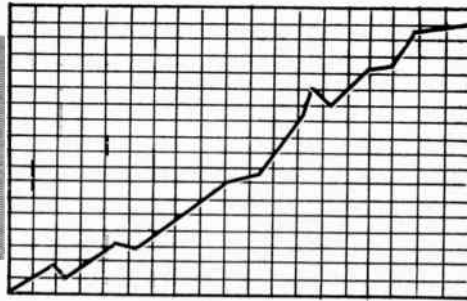

Westmore 1001
REFERENCE STANDARD TUBE TESTER

- $\pm 1\%$ Accuracy
- Direct reading Gm
- Measures Rp and Mu to MIL-E-1D

With today's emphasis on controlled instrumentation, it has become increasingly important to know the in-circuit performance of electron tubes — their characteristics at any point of excursion in the specified range as well as at performance limits • The new Westmore 1001 makes it possible to do this easily and with unprecedented accuracy, before a given tube is installed and periodically during its operational life. The 1001 measures true mutual conductance, using the proven circuitry first introduced by Westmore, as well as plate resistance and amplification factors. Bridge circuits, sensitive null detector, 1% regulated power supplies, variable voltages for tube elements and other advanced features provide the maximum in precision, accuracy, convenience and versatility • The 1001 also measures electrode insulation to 100 megohms, leakage currents to 0.1 microamps. Mobile console measures only 50" w x 60" h x 24" d. WRITE FOR TECHNICAL BULLETIN 101.

Westmore INC.

INSTRUMENTATION DIVISION

137 South Avenue, Fanwood, N. J.

Exclusive Canadian Distributor:

CONWAY ELECTRONIC ENTERPRISES LTD.

1514 EGLINTON AVENUE W., TORONTO 10, ONTARIO • TELEPHONE: RU. 3-6576; RU. 3-6626

For complete details check No. 47 on handy card, page 69

The author is with Canadian Arsenals Ltd., Toronto, Ontario.

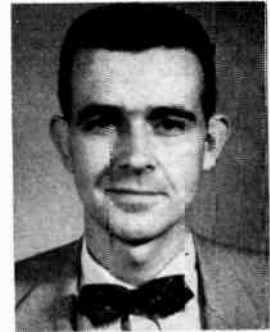

Hanes

The exponential failure distribution in reliability predictions

If random failures occur at constant average rate then failure distribution becomes exponential and leads to simplified prediction methods. (First publication of a paper read at the Canadian I.R.E. Electronics Conference, October, 1961).

by J. T. Hanes, P. Eng.

Introduction

Much of the theory of reliability is based upon the assumption that the typical electronic part fails in a random fashion at a constant average rate. If this is so, it can be shown that the distribution of failures is exponential in form.

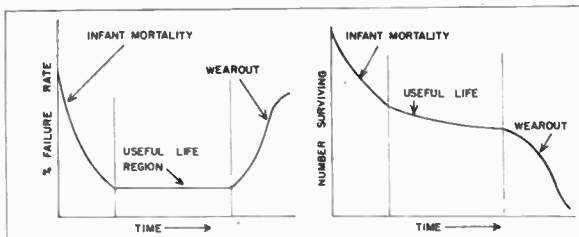

Figure 1a.

Figure 1 b.

The equipment designer, when called upon to design an equipment with a specified Mean Time Between Failures (MTBF) must know the failure rates of the constituent component parts. Furthermore, he makes the assumption that these parts fail at a constant rate; i.e. have an exponential failure distribution.

It is the purpose of this paper to study the term exponential failure distribution as it relates to component part reliability and to attempt to do so without introducing involved statistical theory.

General Theory of the Life of Electronic Parts

It is believed that many types of parts exhibit three characteristic periods of life; infant mortality, useful life, and wearout.

- (a) *Infant Mortality Region* — a short initial period of relatively high failure rate where obvious manufacturing defects cause early failures.
- (b) *Useful Life Region* — a period of low and relatively constant failure rates. It is believed that the useful life period will be one of constant failure rate when a part is produced under properly controlled conditions. This is the period we are interested in.
- (c) *Wearout* — a period of rising failure rate where the useful life of the part can be said to be over.

Fig. 1(a) shows the failure rate plotted against time giving the familiar bath-tub shaped curve.

Fig. 1(b) shows the corresponding survival curve; i.e. if N parts were put on test at time zero, the number surviving at any time is shown.

A Simple Parts Life Test

Neglecting the effects of infant mortality and wearout, it is interesting to consider what would happen if a group of similar parts having a constant failure rate characteristic is put on life test. e.g. Suppose 1000 parts are put on life test and are not replaced as they fail. If the failure rate is constant at a value of 10 per cent per 100 hours the approximate survival curve and a plot of the number of failures may be established for these conditions. (The failure rate, as quoted here, means that failures are occurring at an "instantaneous rate" expressed as a per cent of the surviving population at that time).

Using an approximate method it is seen that about 100 parts will fail in the first 100 hours leaving about 900 survivors. Of these, about 90 will fail in the next 100 hours leaving about 810 survivors and so on.

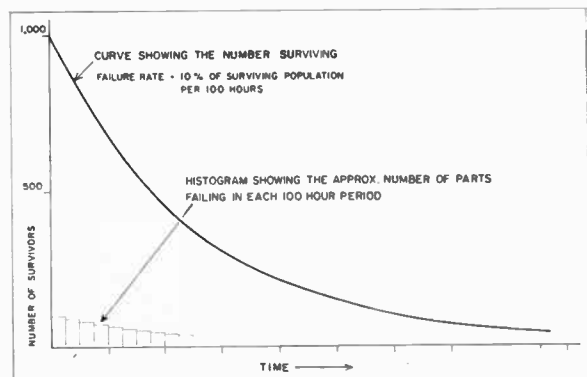

Figure 2.

Fig. 2 shows a plot of the number surviving at any time and a histogram showing the number of failures in each block of 100 hours. Each of these plots resemble exponential curves.

The histogram, in fact, represents the "exponential distribution of failures". In other words, if the individual parts in this test were to be ranked according

to length of life, it would be found that more parts belonged to the 0-100 hour block than to the next 100 hour block and so on.

The Idealized Exponential Survival Curve

It can be shown that the survival curve of a life test of parts having a constant failure rate, can be represented by the exponential formula,

$$N_s = N_0 e^{-pt}$$

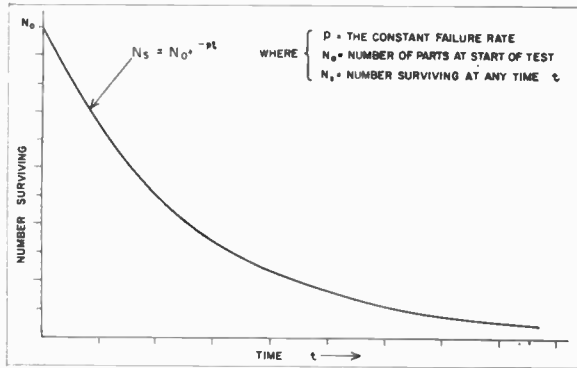

Figure 3.

The Random Occurrence of Failures

The term constant failure rate should be discussed and qualified. Actually it is assumed that failures of the type considered above occur in a random fashion. A random series of events shows no recognizable pattern or trend. Such a process will, however, exhibit a constant average rate even though the exact time of occurrence of any event cannot be predicted.

The Mean Life of Parts Which Fail Exponentially

Although the mean or average is often thought of as a centrally located value, this, of course, is not necessarily so. Mathematically, the mean is the "area under the curve" divided by the "base". Here, since the mean life $\bar{\theta}$ is required, the "base" is actually the height measured along the vertical axis.

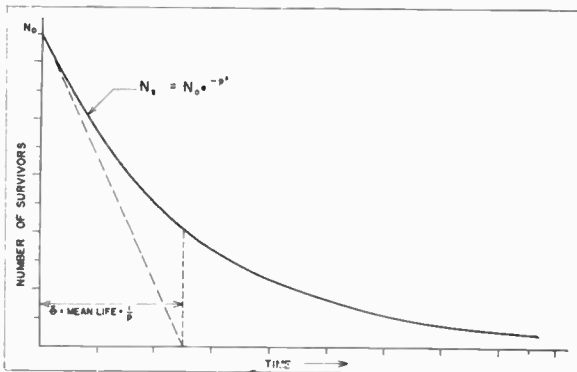

Figure 4.

$$\text{Area under the curve} = \int_0^{\infty} N_0 e^{-pt} dt = \frac{-N_0}{p} \left[e^{-pt} \right]_0^{\infty} = \frac{N_0}{p}$$

"Base" (height of curve along the vertical axis) = N_0

$$\therefore \text{Mean of average life} = \frac{\frac{N_0}{p}}{N_0} = \frac{1}{p}$$

$$\text{i.e. } \bar{\theta} = \frac{1}{p}$$

It is interesting to note that it is only in the exponential case that the mean life and failure rate are constants and thus interrelated in this fashion.

In the survival formula, $N_s = N_0 e^{-pt}$

$$\text{when } t = \bar{\theta} = \frac{1}{p}$$

$$\text{then } N_s = N_0 e^{-\frac{p}{p}} = N_0 e^{-1} \text{ or } N_s = .37 N_0$$

From this comes the important and rather surprising

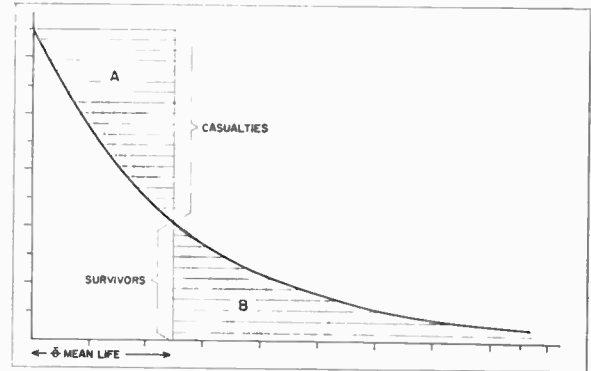

Figure 5.

fact that if a batch of parts is put on test only 37 per cent of them will survive to the mean life of their type.

It can be stated that the total number of unit hours by which the survivors exceed the mean life is equal to the total number of unit hours by which the casualties fail to reach it, or in Fig. 5, area A equals area B.

Practical Life Tests

So far, in this article, it has been implied that a life test involves putting a group of parts on test and observing the test until the entire sample has failed. In practice, of course, this rarely occurs due to the long mean life of parts with even moderate failure rate. A failure rate of 1%/1000 hours is equivalent to a mean life of 100,000 hours or over 11 years.

A practical life test, then, usually consists of placing a sample of parts on test and observing for a period much less than the mean life of the part.

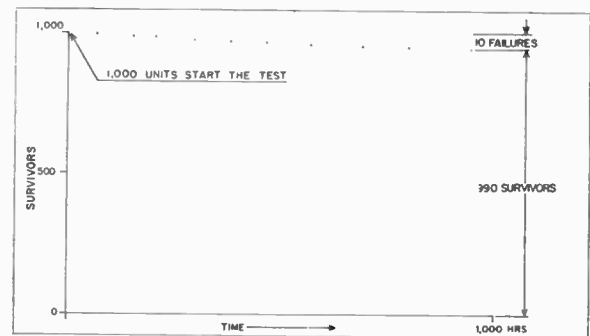

Figure 6.

If the assumption of exponential failure distribution is made, it is then possible to calculate the mean life from the results of such a truncated test.

$$\text{Best estimate of mean life, } \bar{\theta} = \frac{\text{Total No. of hrs. lived}}{\text{No. of failures observed}}$$

For example,

Suppose 1000 parts are tested for 1000 hours and during this time 10 parts fail at the following times: 67 hrs., 152 hrs., 203 hrs., 298 hrs., 384 hrs., 467 hrs., 584 hrs., 692 hrs., 805 hrs., 950 hrs.

The graph of Fig. 6 shows the survival curve of the test.

The mean life and failure rate are calculated as follows:

$$\bar{\theta} = \frac{\text{total hrs. lived}}{\text{No. of failures}} = \frac{990 \times 1000 \div \text{total hrs. lived by the failures}}{10}$$

$$\bar{\theta} = \frac{990,000 \div 4602}{10} = 99,460 \text{ hrs.}$$

or failure rate = $\frac{1}{\bar{\theta}} = \frac{1}{99,460}$

Failure rate (in %/1000 hrs.) = $\frac{100 \times 1000}{99,460} = 1.005\% / 1000 \text{ hrs.}$

The Use of Tolerance Limits in Mean Life Estimates

Because the occurrence of failures is a random process it can be seen that the exact value of the mean life estimate will depend on when the test is terminated. If the test were to be extended, there is no way of predicting when the next failure would occur. Hence, a mean life estimate made by including such an extension of the test would more than likely be somewhat different from the first estimate.

Attempting to define the range of possible true answers around the best estimate value becomes a statistical problem. It is here that use is made of confidence limits.

Confidence Limits in Mean Life Estimates

Given any set of test results (as in the previous example) it is possible to draw a probability density curve which will describe the probabilities that the true mean life has any other value than the best estimate from the test. Dr. Epstein has shown that this probability curve is related to the χ^2 (Chi-squared) distribution. (χ^2 is frequently used in statistics and tables are available).

Figure 7 shows such a probability density curve drawn for the particular test outlined above (1000 units on test for 1000 hrs. with 10 failures occurring exponentially). The χ^2 values are plotted for 20 degrees of freedom, i.e. twice the number of failures observed.

By marking off 5 per cent of each tail of the curve, 90 per cent confidence limits are thus established. That is, in this case it can be stated with 90 per cent confidence that the mean life derived from this experiment is between 63,700 hours and 184,000 hours.

Such confidence limits can be established without plotting curves by use of a formula and reference to the χ^2 tables.

It is interesting to compare the 90 per cent confidence limits for three hypothetical tests each having the same best estimate of mean life but different test dimensions.

It should be noted that the more information (number of failures) available, the closer the 90 per cent confidence limits crowd about the best estimate value. A high confidence statement, however, does not necessarily denote a very precise measurement.

TEST NO.	TEST DURATION	NO. FAILURES	BEST ESTIMATE MEAN LIFE	90% CONFIDENCE LIMITS	
				LOWER LIMIT	UPPER LIMIT
1	1,000	100 hrs.	100,000 hrs.	53,200 hrs.	184,000 hrs.
2	1,000	500 hrs.	100,000 hrs.	74,000 hrs.	256,000 hrs.
3	1,000	1,000 hrs.	100,000 hrs.	63,700 hrs.	184,000 hrs.

Practical Limitations of Life Tests

In the interests of achieving an answer without undue delay, the duration of a life test should be kept as short as possible. While some tests may continue for years, the usual practical upper limit appears to be about one year, with less than this being desirable.

With the exponential assumption, numbers on test can be traded off against test duration. However, although this article has been dealing with the exponential distribution of failures, it must be admitted that it is by no means certain that this distribution will hold for any particular class of part. Fig. 8 shows that a very short test could be very misleading should wearout or some other non exponential mode of failure be ready to occur just after the end of a test.

Parameter drift is a factor other than wearout which may interfere with the validity of an assumption of exponentiality. There are strong indications that with some components parameter drift failures may be markedly non exponential and, of course, the establishment of failure criteria of this nature is somewhat arbitrary as compared with the purely catastrophic failures.

The very low failure rates becoming current today are resulting in tests yielding very few failures. This makes it difficult to derive statistically valid results and there is pressure to increase the size of tests in order to gain more information. However, economic limitations may come into play to resist this trend.

A final comment on the exponential distribution is in order. The small number of failures experienced in a given test may make it impossible to prove or disprove the assumption of exponentiality. In the absence of such proof the assumption is frequently accepted. If this is done, suitable caution should be used particularly with regard to extrapolating beyond the test duration.

Figure 7.

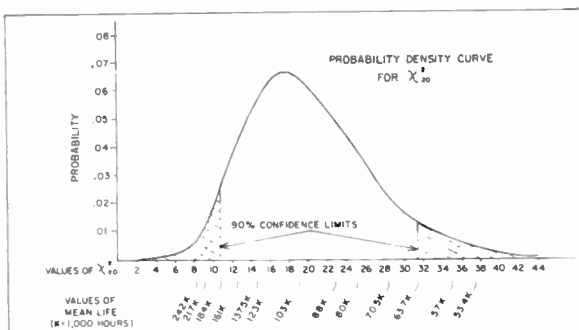
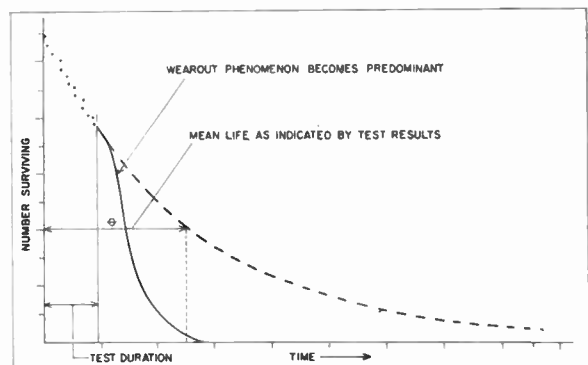

Figure 8.





MANAGEMENT

Is the industr on the Assista

by W. S. Kendall *

One of the most far reaching and important decisions to ever come out of Ottawa for the benefit of the hard-pressed Canadian electronics industry has, to a surprising extent, escaped attention. This is the Development Assistance Vote originally announced by Mr. O'Hurley, Minister of Defense Production, on July 8, 1959. This Vote has for its main purpose the maintenance of advanced technical skills so Canadian contractors can bid for business in the United States and export markets. The assistance plan requires an investment on the part of the company concerned and a carefully planned company program worked out in liaison with the Department of Defense Production. The Vote is part of a Government long-range plan to build a strong national technological base and is available to any company having technical skills and a serious determination to exploit these in world markets. Naturally there are some ground rules. The contractor has certain obligations and must be fully aware of these. In this article an attempt has been made to answer some of the commonly asked questions about the intent and scope of the Development Assistance fund.

How did the Development Assistance Vote originate?

It became apparent very early in the defense production sharing program that Canadian companies hoping for production contracts had to have either a better product or a capability in technical development which could lead to a better product. Although the production sharing concept gave Canadians free access to the United States market they found themselves

competing unsuccessfully with companies whose R & D skills had been highly developed as a result of large Government R & D expenditures.

In announcing the Development Assistance Vote in July 1959, Mr. O'Hurley asked for an initial \$5,000,000 and commitment authority for an additional \$4,000,000 in the supplementary estimates to support selective defense development programs. He pointed out that with the lessening in independent Canadian military development tasks it was no longer possible to maintain the sizeable engineering teams necessary to develop advanced technology. *The Vote was to assist those companies whose specialized technical skills could be related to the needs of the United States military market.*

What is the intent of the Development Assistance Vote?

The Government recognized that without production in Canadian plants there is no survival for the defense industry and also that most such production would be high in engineering content. Sharing in such production, according to Mr. O'Hurley, would be possible only by technical competence, advanced through the performance of suitable development tasks. The Vote will provide financial help to companies needing it to maintain this bidding capability in the Canada-United States integrated defense program.

This decision by the Canadian Government was hailed by the Electronic Industries Association as being a positive move in the right direction. At the request of the Department of Defense Production, this Associa-

**see page 38.*

electronics by missing out Development Assistance Vote?

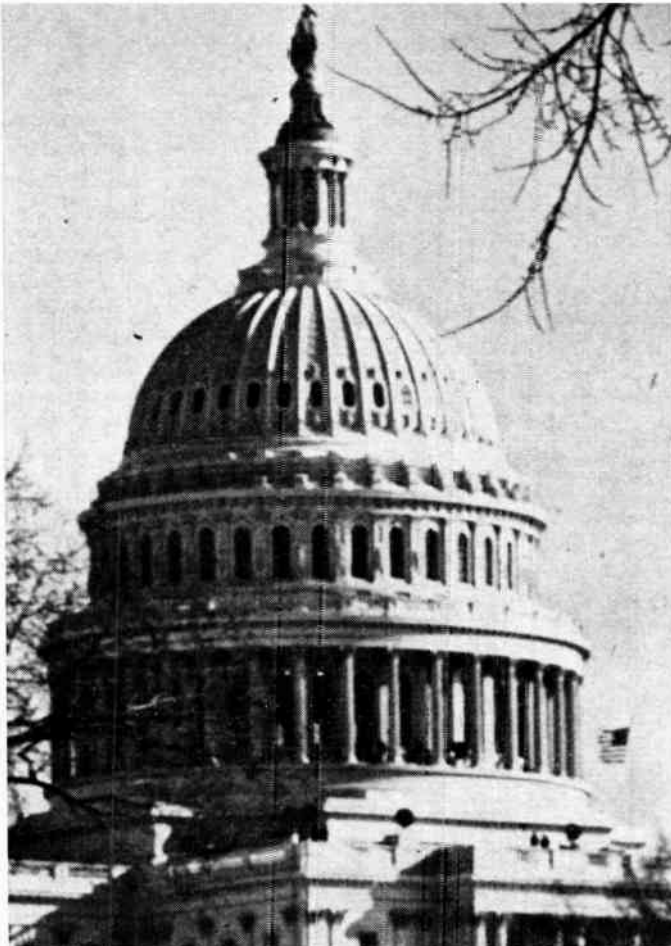

tion formed the senior level Defense Production Sharing Committee to provide the necessary liaison with the Department, and to keep its membership fully informed as the program developed.

Who can qualify for assistance?

Any Canadian company having technical capability in areas applicable to military requirements and wishing to bid for development on defense production in the United States or other world areas may apply for assistance.

What are the basic criteria in applying for assistance?

Since one of the prime objectives of the program is to obtain defense production, the project should be related to a known future requirement. The company applying should have background or experience in the particular technical field and the follow-on production should be compatible with Canadian production facilities.

The company must be prepared to match the Government contribution on a dollar for dollar basis. This is to ensure that the program forms part of the management corporate plan and the element of risk has been reduced to the greatest possible extent by such planning.

Proposals which carry possible long term economic benefits in commercial or industrial fields would be desirable.

Technical areas related to the submarine threat or the air defense of North America would be of special

interest. Typical fields might be anti-submarine warfare, defense communications, radar, high altitude research, etc.

In every case the proposal should be supported by a specific market estimate.

If the Government requires a fifty-fifty matching contribution, does this not automatically rule out the smaller company who may have excellent technical ideas but is struggling with inadequate financial resources?

The Government exercises considerable flexibility in the administration of the Vote.

Many things are taken into consideration, such as the nature of the project and the market, the size of the company, its past performance on Government contracts, its management methods, finances, its reputation, its rate of growth and many other factors. Under special circumstances the Government may waive the matching contribution requirement and negotiate some other repayment arrangement based on future profits. This is of special importance to the smaller Canadian company not having access to finances from a parent company.

Does Development Assistance have to be repaid?

Providing the company's cash contribution matches that of the Crown the Government does not ask for repayment. When the company is unable to invest the required percentage from its own resources the Government expects repayment from production profits resulting from the development. Under certain circumstances however, the Government may enter into a special

arrangement with the contractor whereby repayment is waived in consideration of the company reinvesting an agreed amount in further research and development. The Government objective is to assist Canadian Industry in establishing for itself a stable and self-sustaining research and development capability.

Are there other forms of assistance available besides direct financial help?

The urgent requirement of any business is the development of new products to meet market needs. Success in new product development can only result from accurate market knowledge. In many military



W. S. Kendall
The author is Marketing Director of Computing Devices of Canada Ltd., Ottawa, Ontario and Chairman of the Electronic Division of EIA.

fields doors to such knowledge are closed to a contractor, particularly where security is involved. Here is where the Department of Defense Production can help through its close association with the using Services in the United States, Canada and Europe.

Sometimes it is necessary to demonstrate a development to the Armed Services of a country and again the DDP can assist in arranging such evaluations.

A "Guide to Research and Development Capabilities in Canadian Defense Industry" has been published by the DDP to assist U.S. development agencies and U.S. contractors in locating potential Canadian industrial sources for R & D requirements. This guide is available to U.S. Government procurement personnel through all DDP field offices.

DDP also publish a document entitled "Canada-United States Defense Production Sharing" which contains a wealth of information on all aspects of defense production and development sharing. This document, originally published for the benefit of Canadian companies, now receives wide distribution to U.S. military and procurement agencies who regard it as the most comprehensive authority on defense production sharing available anywhere. Free copies are available in Ottawa.

PLANNING FOR DEVELOPMENT VOTE ASSISTANCE

1. Start with a technical concept.
2. Relate to company's long term corporate objectives.
3. Define the market factors: location, timing, total potential, realizeable potential, stability, competition.
4. Estimate development costs through all phases of design, prototype hardware, evaluation, to drawing release.
5. Define program authorities and responsibilities within the company.
6. Prepare and submit complete program plan to the appropriate DDP branch.

Also available on request for the guidance of Canadian companies interested in R & D are the following:

- "Notes on USAF R & D Procedures"
- "Notes on U.S. Army R & D Procedures"
- "Notes on U.S. Navy R & D Procedures"
- "Notes on NASA R & D Procedures"

These publications describe the fields of interest of U.S. R & D Agencies, how Canadian firms are listed, how bid sets are received, proposals submitted, etc.

Will Development Assistance be used to produce products for Canada's own armed forces?

The Vote is aimed primarily at export markets although it is hoped the technology acquired through its use will assist a Canadian company in bidding on domestic requirements. The Development Assistance Vote however, cannot be used to develop directly a product required by the Canadian Armed Services.

Does the United States Government accept the concept of development sharing and is this market freely open to Canadian companies?

This question can best be answered by reference to the United States Department of Defense directive, portions of which are reproduced in this article. It will be seen that senior Service and Government officials have established the policy of equal opportunity in research and development for Canadian and American companies. Those who have studied the United States market over the past few years have noted the trend away from high-volume black box production and the increasing emphasis on research and development. In fiscal 1962 the Americans will spend five billion dollars on research and development as contrasted with just over 16 billion dollars for actual hardware production. The very size of the U.S. defense market is an astonishing fact to Canadians. This year the Americans will spend almost 10 per cent of their gross national product on defense. In this complex there is room for both large and small contractors. The larger companies are needed to handle the major weapons systems and the smaller engineering companies with ideas and specialized skills are essential to the overall program.

Can Canadians compete in this market? The answer is an unqualified yes. It is true the market is an intensely competitive one but in the R & D area the competition is more technological rather than in price. Ideas are not the monopoly of any one nation, nor are they necessarily the product of an immensely large defense budget. Canadian engineers are as good as any in the world and past achievements on a very modest development budget have amply demonstrated this fact.

To whom should I apply for Development Assistance?

Applications should be made to the concerned DDP branch. In the case of an electronics project this would be the Electronics Branch.

What is the best method of ensuring success in applying for assistance?

This is an important question and the answer to it can mean the difference between success and failure in applying for Development Assistance. The first step is to determine how closely the development idea matches the general criteria laid down by Mr. O'Hurley*. It is important that the idea be related to both near term and long range market needs. It must be borne in mind that the development program is a means to an end and that end is new products, production and corporate growth.

**Extracts from
DEPARTMENT OF DEFENSE DIRECTIVE 2035.1**

Subject: Defense Economic Cooperation with Canada.

Purpose: This Directive continues the principle of economic cooperation with Canada in the interests of continental defense, and stipulates the policy of maximum production and development program integration in support of closely integrated military planning between the United States and Canada.

Policy: In view of the unsettled world situation and the mutual interest of the United States and Canada in the defense of North America, due to their close geographical proximity, United States defense economic cooperation with Canada must not only continue, but be expanded so as to achieve the following objectives:

1. Greater integration of United States and Canadian military development and production.
2. Greater standardization of military equipment.
3. Wider dispersal of production facilities.
4. Establishment of supplemental sources of supply.
5. Removal of obstacles to the implementation of the United States-Canada Production and Development Sharing Program and the flow of defense supplies and equipment between the two countries.
6. The development of channels for the exchange of information between appropriate United States and Canadian Government agencies on defense economic matters.
7. The determination of Canadian production facilities available for the supply of United States current and mobilization requirements, and the furnishing of planned mobilization follow-up schedules to Canadian contractors producing for the United States as guidance in the event of full mobilization.
8. Insure the most economical use of defense funds.
9. Accord equal consideration to the business communities of both countries.

Accordingly, it is the policy of the Department of Defense to seek the best possible coordination of the material programs of Canada and the United States, including actual integration insofar as practicable of the industrial mobilization efforts of the two countries. As a corollary, it is the policy of the Department of Defense to assure Canada a fair opportunity to share in the production of military equipment and material involving programs of mutual interest to Canada and the United States and in the research and development connected therewith.

Security: Defense economic cooperation with Canada requires the utmost in collaboration between the Governments of the United States and Canada. Accordingly there shall be comprehensive interchange of general information and access to detailed information between the two countries relating to production sharing arrangements and research and development activities associated therewith.

Effective date: This Directive is effective immediately.

SECRETARY OF DEFENSE.
July 28, 1960.

New product planning in today's technical markets is becoming so complex that more and more managements are accepting the "program" approach. In this method the development project forms part of an overall company plan which starts with corporate objectives and continues with the complete program of market analysis, market strategy, calculation of overall costs, timing, relationship to other programs, production planning, etc. The program approach reduces risk both for the company and the Government, and nothing commands more respect in the Department of Defense Production than a comprehensive and well thought out company proposal. The Canadian Government intends to make production and development sharing fully effective and will quite naturally favor those companies whose depth of planning is clearly evident in their submission.

* *Hansard July 8, 1959, Vol. 103, no. 118.*
Available from Queen's Printer, Ottawa; 5¢ per copy.

And in conclusion

The foregoing covers briefly the assistance available to industry through the Development Vote. A number of companies have already received financial help and other applications are currently under review. These companies have taken an important step and one that will help ensure their position in the forefront of technology in the years ahead.

For those seriously interested in building their defense contracting and export business, there is assistance available and waiting in Ottawa. Surprisingly, many qualified companies are not going after it. Industry must take the initiative and help itself. As D. A. Golden, Deputy Minister of Defense Production says: . . . "Industry itself is the chief architect of its own development. Governments can encourage; and they can provide goals and opportunities; and within limits, they can give financial support. But only industry can provide the drive — by its ingenuity, its energy and its willingness to take risks."

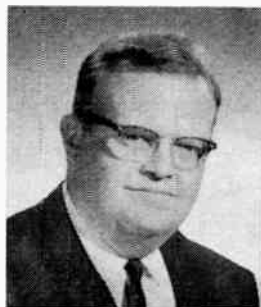

CAKE

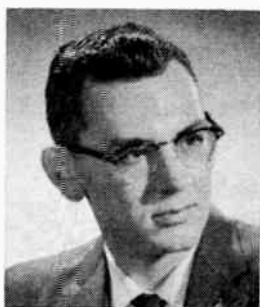

RICHARDSON

New 3-terminal PNP switch simplifies fast logic circuit design

New semiconductor switch has both turn-on and turn-off control at base, and switching time of the order 100 nanosec. Device leads to much simplified switching circuits.

by A. F. Cake and D. E. Richardson*

Introduction

The semiconductor industry's first alloyed junction, four layer device — the "Dynaquad" — has just been introduced by Tung-Sol Electric Incorporated. The device was made possible by a new manufacturing technique and has five features which make it highly practical as a component for the circuit designer.

1. It is natural switch.
2. It has both turn-on and turn-off control at the base.
3. It uses an established and reliable design.
4. It is significantly lower in cost than comparable components.
5. It leads to substantial circuit simplification and economy.

Description

The Dynaquad device, as indicated in Figure 1 is a germanium, three terminal, PNP structure packaged in a standard TO-5 case. Basically, it is a two-position

switch whose capacities and speeds are those usually associated with digital computers. It switches in the megacycle range, with rise times of the order of 0.1 μ -sec, and it is capable of providing an output voltage swing of 35 volts. Because of its bistable nature, a single Dynaquad can replace a number of transistors and associated components in many applications, and in simple on-off switching it behaves as a pulse operated latching relay with no bounce, chatter or sticking contacts.

*The Authors

The two authors of this article are with the Applications Department of Tung-Sol Electric Inc., Newark, New Jersey, and both have played major parts in the development of the Tung-Sol "DYNAQUAD" device.

Figure 1. Diagrammatic representation of "Dynaquad" semiconductor switch.

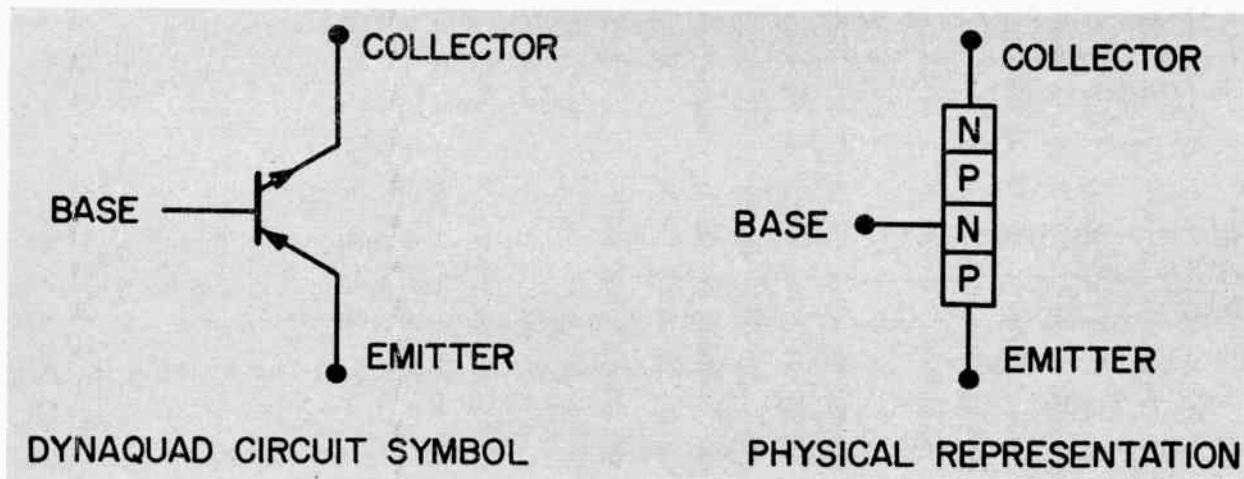

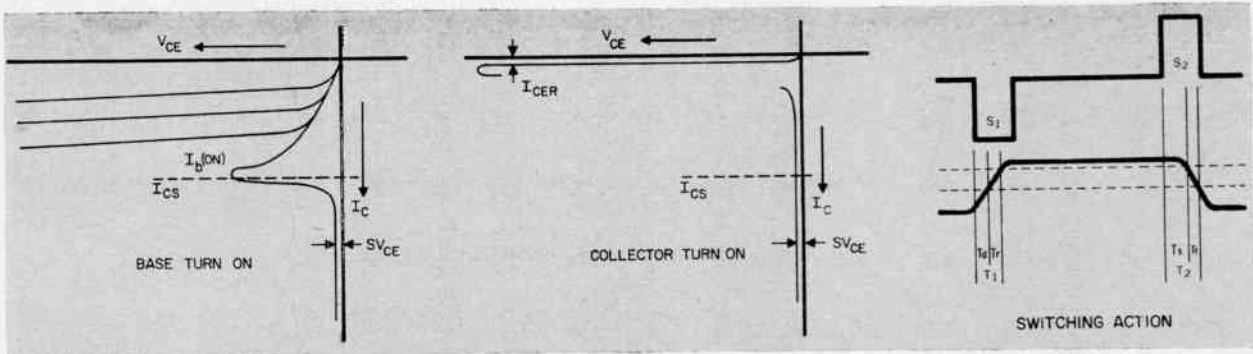
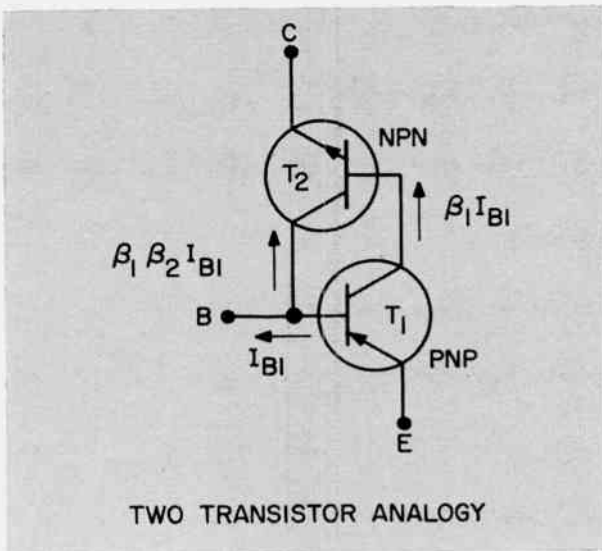

Figure 3. (left) base turn-on characteristics, (center) collector characteristics, (right) switching action.

Figure 2. 2-transistor analog of the four-layer switch.



In its normal operation, the Dynaquad is turned on by applying a small negative pulse to the base, and it will remain on after the signal is removed. Turn-off is accomplished by applying a positive pulse to the base, or by dropping the collector current below the sustaining point.

Theory and operation

The theory and operation of the Dynaquad is illustrated by the two transistor analogy in Figure 2. The first stable state of the Dynaquad is the "off" condition where the current flow is only the leakage currents. If now a small base drive current (I_{B1}) in the direction of turning on T_1 in Figure 1 is applied, then the collector of T_1 will have a current given by $\beta_1 I_{B1}$. This current $\beta_1 I_{B1}$ becomes the base drive current for transistor T_2 ; forcing the current in the collector of T_2 to a value of $\beta_1 \beta_2 I_{B1}$. This now becomes the injected current into the base of T_1 .

When the product $\beta_1 \beta_2$ becomes greater than unity, the system becomes self regenerative and the collector current increases to a value limited only by the circuit impedances. The Dynaquad has now reached its second stable state, that of being hard in saturation. In order to turn the Dynaquad off the regenerated current must be interrupted. This may be accomplished by either reducing the collector supply current below the sustaining value or by injecting a reverse current into the base sufficient to stop the regenerated current.

Manufacturing technique

The Dynaquad represents a significant departure in the design of multilayer devices. Conventionally, the four layers are formed by multiple diffusion and a critically controlled etch. There are some variations of this, but in all cases the junction formation or the final fabrication requires systems and controls that are considerably more complex than the alloyed junction transistor. The result is a more costly component that is more susceptible to defects. With the Dynaquad, a process has been developed for forming multiple junctions with the same simplicity and reproducibility as for single alloy junctions.

General applications

The binary nature of the Dynaquad makes it an efficient component in computer applications or wherever digital techniques are employed. Flip-flops, counters, shiftregisters and various forms of logic can be accomplished with a saving of one-third to one-half in components, labor and space.

The high gain and sharp rise time of the Dynaquad give the device great utility as a driver. It can accept small or smeared signals and convert them into sizeable current pulses sufficient to drive magnetic cores, relays and thyatrons. A single Dynaquad can be operated in the three basic multivibrator modes — monostable,

Figure 4. Circuit Diagram of monostable multivibrator.

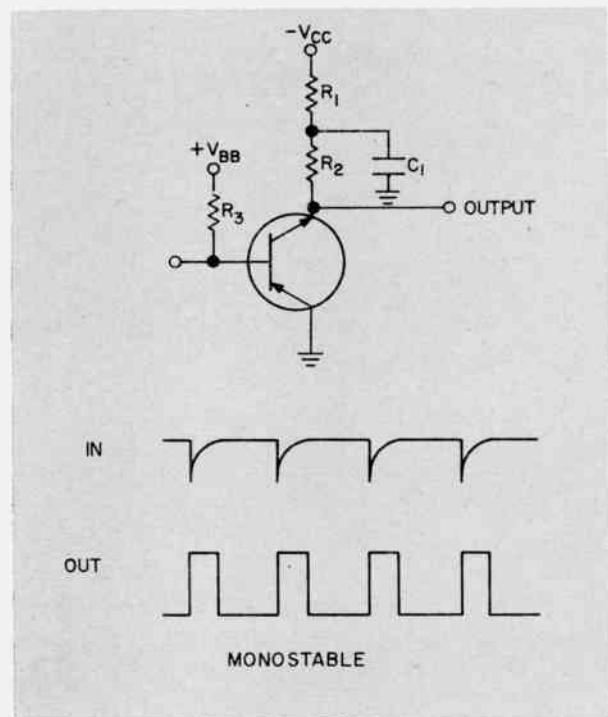

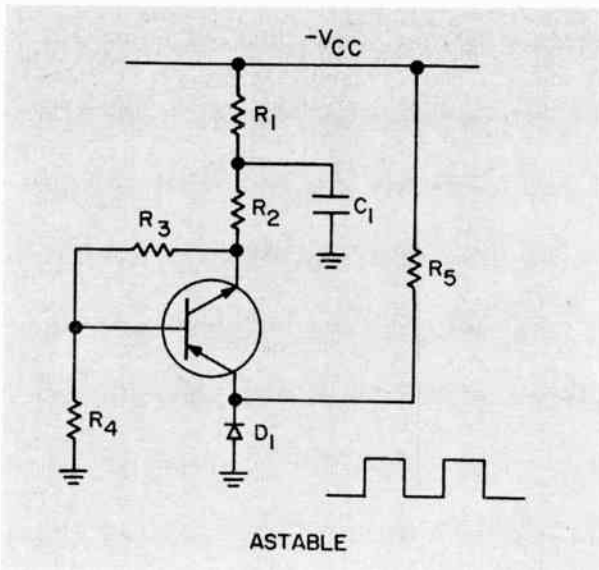

Figure 5. The "Dynaquad" in an astable multivibrator application.

bistable, astable. The circuits shown in Figures 4, 5, 6, 7 and 8 illustrate the versatility of the device.

Switching characteristics

The two curves given in Figure 3 illustrate the turn-on characteristics of the Dynaquad base and collector. The waveform given (right) in the same diagram shows the switching action of the device. The negative turn-on pulse S_1 is applied to the base. As base current increases, the collector current increases by typical transistor action until at a critical value (turn-on base current) the current system becomes regenerative. The collector current then increases to a value limited only by circuit resistance. Once regeneration has started, the external base current can be removed and the device will continue conducting. Turn-off is accomplished by S_2 which applies reverse current sufficient to start regeneration in the opposite direction.

Figure 6. A bi-stable multivibrator showing input and output waveforms.

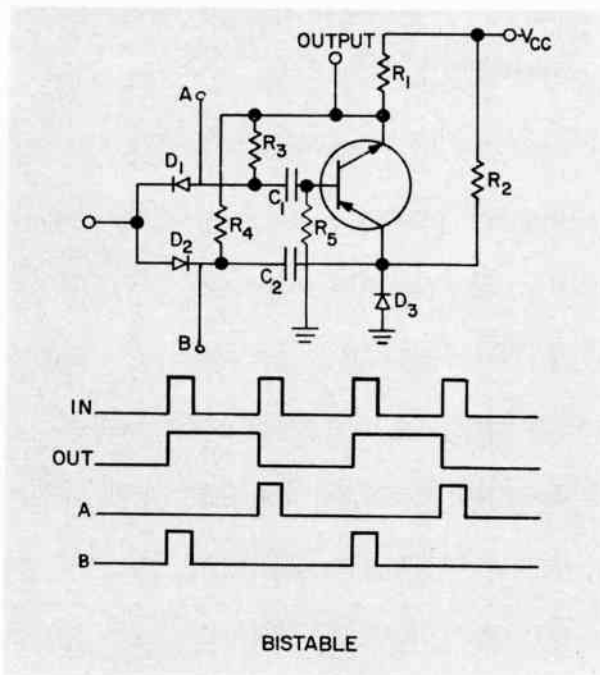

A monostable multivibrator — (Figure 4)

In this circuit R_1 is made large. When the Dynaquad is in the off state, capacitor C_1 charges up to $-V_{CC}$. A negative pulse applied to the base of the Dynaquad turns it on and C_1 discharges into the collector, thus producing an output. The width of this output is determined by the $R_2 C_1$ time constant. When the capacitor discharges the collector drops to zero thereby turning the Dynaquad off.

An astable multivibrator — (Figure 5)

When the Dynaquad is off, C_1 charges to a potential determined by R_1 , R_2 , R_3 and R_4 . At the same time, a potential is developed at the emitter due to the drop of the diode. When this potential is exceeded by that of the base (which approaches $-V_{CC}$ as C_1 charges), the base starts to draw current. When this current becomes large enough, the switch turns on. This action discharges C_1 through R_2 and produces a pulse at the collector. While C_1 discharges, the collector drops toward ground bringing the potential at the base below of the emitter. If the current through R_1 and R_2 is smaller than the I_{CS} of the Dynaquad the device turns off, and the process then repeats.

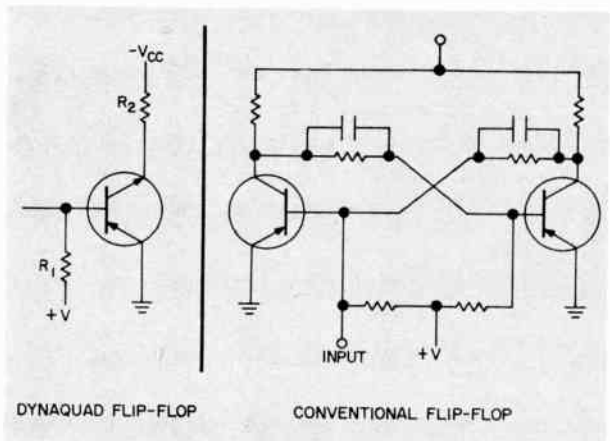

Figure 7. "Dynaquad" flip-flop at left, illustrating great circuit simplification.

A bistable multivibrator — (Figure 6)

The circuit (left) is a bistable multivibrator in which pulses of the same polarity turn the Dynaquad on and off. It can be used as a triggered pulse generator in which input pulses are converted to rectangular waves having half the frequency of the input. In addition, it provides at A and B two trains of pulses, 180° out of phase with one another and at half the input frequency. The circuit functions in the following manner: When the Dynaquad is off, the collector is at $-V_{CC}$. This biases D_2 and D_1 off. The positive input pulse is fed through D_2 to the emitter, turning the unit on. The device remains on until the next input pulse arrives. The path through D_1 is now open and the pulse is routed to the base thereby turning the unit off.

The Dynaquad as a flip-flop — (Figure 7)

Typical of the kind of circuit simplification that is possible with the Dynaquad is shown in the flip-flop circuit above. Here one Dynaquad replaces seven components in the conventional transistor flip-flop circuit. When a negative pulse is applied to the Dynaquad base the unit turns on. This raises the output from $-V_{CC}$ to zero volts. A positive pulse applied to the base turns the unit off, changing the output from zero volts to $-V_{CC}$.

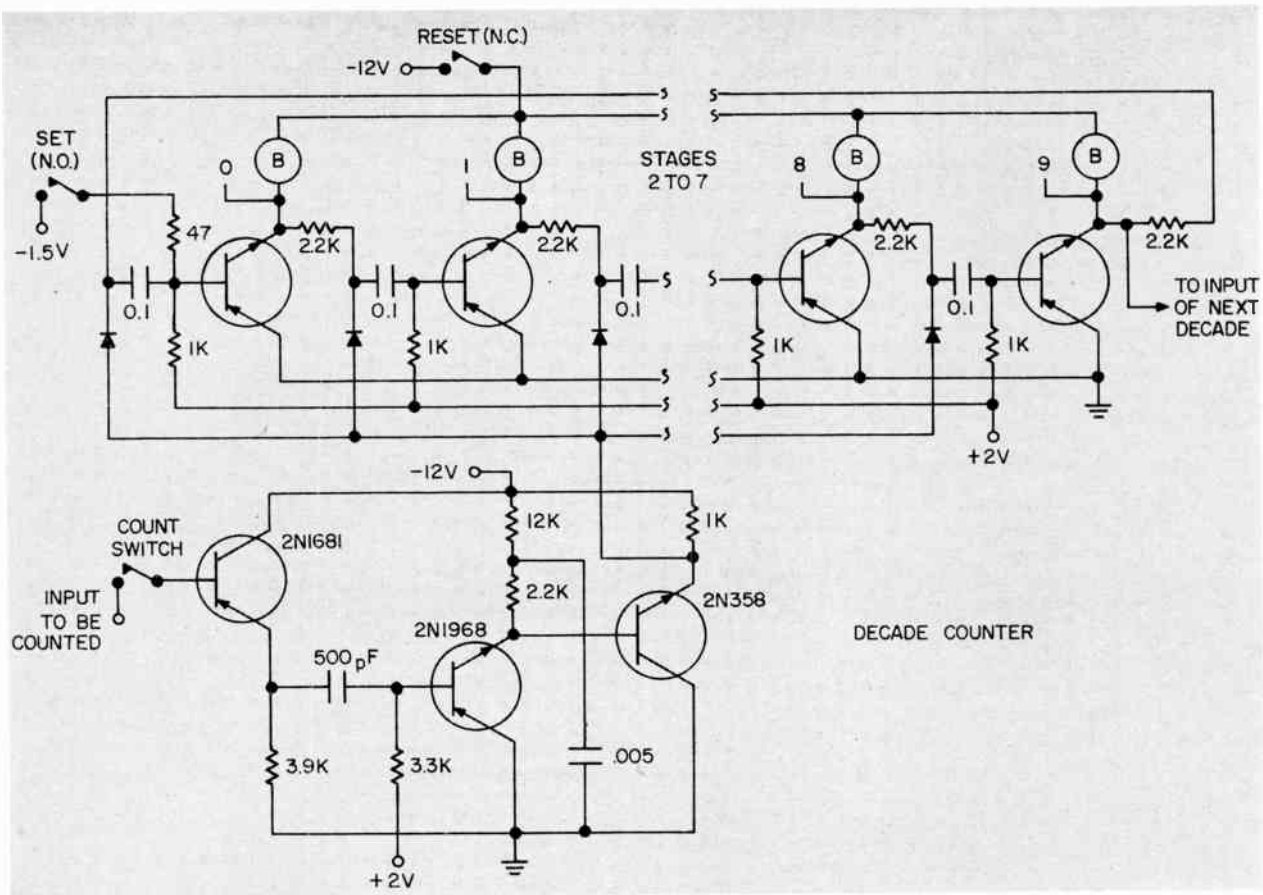

Figure 8. Circuit Diagram of a decade counter using the 4-layer switches.

A decade counter — (Figure 8)

The incoming pulses to be counted are fed into the 2N1681 transistor emitter follower circuit shown in the lower left of the schematic. The incoming signals develop low impedance negative going pulses across the emitter resistor which are capacitively coupled into the base of the 2N1968 Dynaquad. The Dynaquad circuit is operated as a monostable multivibrator which generates pulses of 8 microseconds duration. These pulses are coupled directly from the Dynaquad collector to the base of the 2N358 NPN emitter follower transistor. This circuit develops positive going pulses of 8 microseconds across the 1k resistor at the transistor output which are diode-capacitively coupled to the bases of each of the 10 Dynaquad counting stages. The positive polarity of these pulses will turn "off" an "on" Dynaquad stage. In being turned off, the Dynaquad develops a negative going pulse at its collector which is coupled to the base of the next Dynaquad, turning it "on". Each count, therefore, turns each successive Dynaquad "on" and the count progresses down the line. The tenth count is coupled back to the input, turning "on" the zero indicator; it also is coupled into identical circuitry at the input of the next decade, which counts at 1/10 the rate of its predecessor.

The RESET switch interrupts the collector voltage to all the counter Dynaquads, turning them all "off". The SET switch applied a negative voltage to the zero indicator Dynaquad only, turning it "on".

Figure 9 is a photograph showing on the left, a circuit board carrying the Dynaquad decade counter outlined in Figure 8. For comparison, the photograph shows at the right an electrically equivalent unit employ-

ing conventional transistor techniques. The substantial reduction in both the number of components and overall size, brought about through the use of the new four-layer switches is clearly shown.

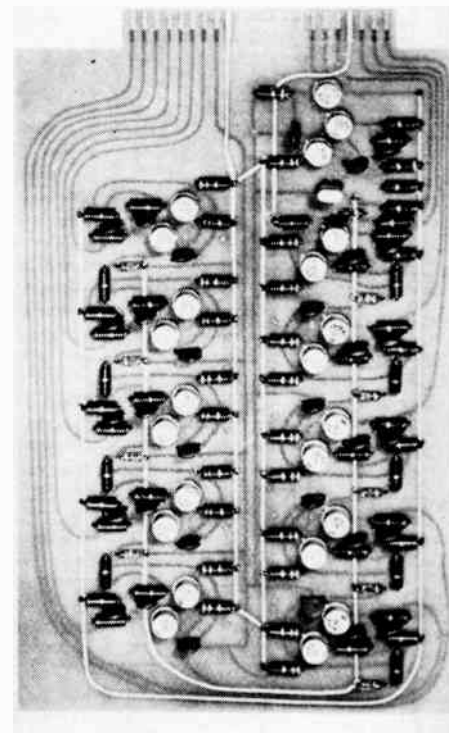
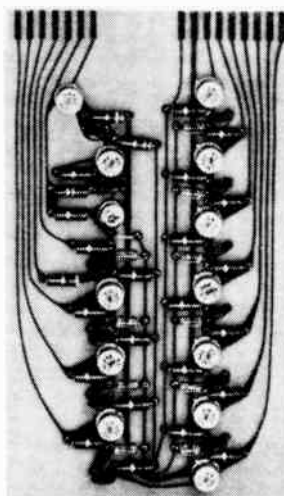

Figure 9. "Dynaquad" decade counter module (left) in comparison with conventional transistor unit (right).

New methods speed line installation and maintenance

Installing telephone lines in difficult terrain and finding leaks in pressurized cables are problems of long standing. Article describes two new approaches used by enterprising telephone companies.

The laying of telephone lines in mountainous and heavily wooded country is at the best a slow and difficult operation using conventional methods. The Pacific Telephone Company of Idaho was faced with particularly severe problems recently when a line had to be laid through the Bitterroot Mountains, east of Spokane. In this area crews had to contend with

Figure 1. Crewman braces foot on stump to maintain balance as helicopter carries in pole for planting.



densely-wooded, mile-high mountains with 40° to 50° slopes. Key to rapid solution of the problem, claimed to be 30 times faster than the old method, was use of a helicopter which flew in supplies and acted as an aerial crane.

A few days before the helicopter operation, ground crews scrambled along the right-of-way blasting holes in the rocky 45-degree slope. At the two staging areas selected for heliports, phone company crews fixed crossarms and insulators to the poles and rigged-up slings, some of which were 80-feet long.

Actual placement flights extended from a few hundred yards to a mile and one-half at speeds of 40 miles per hour. Although the Hiller 12E weighs only 1,750 pounds it lifted straight up the fully-fixture poles weighing up to 900 pounds. Because the thick forest necessitated extra long slings from the poles the helicopter was never close enough to the ground, when hovering to lift or lower the poles, to take advantage of 'ground effect'. Most powerful helicopter in its class, the Hiller was able to lift the 900-pound poles and hover motionless as it zeroed in for the planting.

Two men assisted at the heliport; two at the moment of lowering the pole in the ground; and one guided the pilot. Total flight time for all 40 poles was under four hours, with the balance of the eight-hour project consumed by preparation and standby. Once all the poles were placed, the helicopter made two runs along the line to lay two manila lead lines for stringing operations to follow. Flight time for this capping-off operation — 12 minutes.

Telephone company officials, who described the dollar savings as substantial, have already arranged for further airlift work by Evergreen's fleet of helicopters.

Location of cable leaks

Thousands of miles of multi-core cable are used in Canada for telephone communication and the Bell Telephone Company of Canada keeps this vital network pressurized to lessen the danger of water entrance which damages the insulation. Dry air is pumped into the cables at terminal points at an average pressure of 10 pounds per square inch gauge. Aerial cables, strung from pole to pole, are not subject to prolonged water exposure and are operated at somewhat lower pressures. Underground cable in conduits are often submerged in water and air pressure in excess of the water head must be maintained.



Figure 2. Hovering over staging area, Hiller 12E gets its 900 lb. cargo attached. Copter hook is released electrically by pilot.

Detecting leaks in these cables is time consuming and costly. To help reduce this expense, the Bell Telephone Company has adopted a method using "Freon-12" refrigerant manufactured by Du Pont of Canada Limited as a tracer gas which is both efficient and economical.

By flow analysis or graphing procedures, maintenance crews can narrow the area of a leak to a section of 300 feet or less. The new technique is then used to pinpoint the leak.

Basically, the method consists of injecting "Freon" gas into the cable, collecting samples of the air surrounding the cable, and testing for the presence of "Freon" in this air with a halide leak detector.

A halide leak detector consists of an open flame, fueled by acetylene gas burning through a copper ring element. A tube draws air into the system at a point below the element. The mixture of air and acetylene burns at the element with a pale yellow flame. When "Freon" gas is drawn into this tube, it breaks down on contact with the heated copper element and the resulting gases change the color of the flame from yellow to green-blue, to royal blue. Fluorine and chlorine are the halogens in "Freon" gas which are detected by the halide detector.

The technique for pinpointing leaks in aerial or block cables is fairly straight forward. A test valve is inserted in the cable downstream from the suspected leak area and left open to increase the air flow. "Freon" gas is admitted into the cable, and when it is detected at the open test valve the valve is closed.

The special gas collector consists of a hinged box which snaps shut when mounted on the aerial cable.

Figure 3. Gas collector moves along cable into which tracer gas has been injected. Operator watches flame for tell-tale indication.

The box rides on two revolving sheaves and flexible plastic foam seals the area around the cable. The collector is drawn along the cable using a handline, and manoeuvred past poles, sleeves and other obstructions by a special handling pole. The collector hose of the halide detector is attached to this box and the air around the cable is drawn down into the detector.

The collector box is drawn along the cable at a rate of about one foot per second. When "Freon" gas is indicated by the detector, the operator moves back about 25 feet, and then moves the probe back and forth until there is a steady indication of the tracer gas. The leak is thereby located and the cable sheath is repaired.

The technique for locating leaks in buried cable is the most recent development. "Freon" gas is injected into the cable at the terminal points. Holes are punched in the ground to the level of the cable, but slightly to one side, in the suspected leak area. The collector tube of the halide detector is inserted into each hole to test for the presence of "Freon" gas. In this manner, the leak can be located to within a few feet and only that section needs to be dug up in order to repair the cable sheath.

The new method of locating leaks in telephone cables was first used by some of the large telephone systems in the United States, but the Bell Telephone Company of Canada has developed it further, designing a new and more efficient gas collector for aerial cables. Also, they pioneered the technique for buried cables.



FIRST OF A SERIES



Silicon diodes made in Canada

A visit to the plant of Syntron (Canada) Ltd. reveals the methods used for the volume manufacture of double diffused etched silicon diodes. The etching process, allied to careful quality-control and "clean-room" methods leads to "strong" junctions.

All circuit designers at one time or another have found themselves using or specifying silicon diodes. Probably most of the engineers, being interested almost exclusively in the two-terminal properties of the device have, like myself, given only perfunctory thought to the question of how these circuit elements are manufactured. In this general connection a visit to the **Syntron (Canada) Ltd.** plant, where a range of rectifiers rated from 1 to 100 amps are manufactured, is certainly rewarding.

Though the 'ultimate' in white-rooms is not required for diode manufacture a high standard of cleanliness is nonetheless very important and for this reason the entire manufacturing facility is enclosed in air-conditioned, dust-filtered rooms.

Manufacture commences with the laboratory testing of incoming 1" diameter double-diffused silicon wafers. These are supplied by specialist metallurgical companies, it rarely being economic for device manufacturers to refine and process their own materials unless very large volume is involved. In order to show the main steps of fabrication, a 1-amp device is used by way of example, the various component parts being indicated in Figure 1. The discs are mounted on a wax base and then are masked with a teflon plate in which a pattern of 1/16" holes has been drilled. After spraying with an acid-resist, the discs are transferred to an etching bath. Previously masked areas are dissolved away leaving a number of 1/16" diameter pellets, or dice, which have a slightly conical form. This shape

serves the valuable purpose of enabling the operator to recognize easily, the polarity of the die during subsequent assembly work. Syntron prefer the etching method rather than sawing because it is an intrinsically clean process and leads to "strong" junction units. After etching, a microscopic examination is made as a visual check on the process (Figure 2) and micro-electrodes are available for making electrical tests if desired. The next step (Figure 3) involves assembling a mounting base, a "nail-head" lead, two solder preforms and a die in a metal "boat". Batches of boats are mounted in frames and enter the continuous-feed soldering furnace. The temperature/time histogram of the reducing-atmosphere muffle is carefully controlled to ensure a perfect joint without overheating. Figure 4 shows the boats emerging from the furnace and at this stage they are cool enough to touch. All diodes are next checked for acceptable forward and reverse characteristics using a simple jig and 'scope display as shown in Figure 5. Since only a rough indication of forward properties is sufficient at this stage, these are judged by the degree of brightness of a bulb connected in series with a voltage source and the diode under test. The succeeding step consists of injecting a quantity of special silicone compound into a "top-hat" form, mating this with the soldered assembly and then electrically welding the two parts together (Figure 6). The top-hat form is already provided with a glass-to-metal junction for the upper closed-tube connection. A simple press operation is next used to swage the top-tube and

Figure 1.

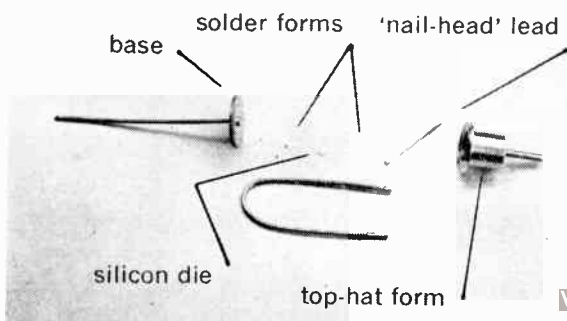
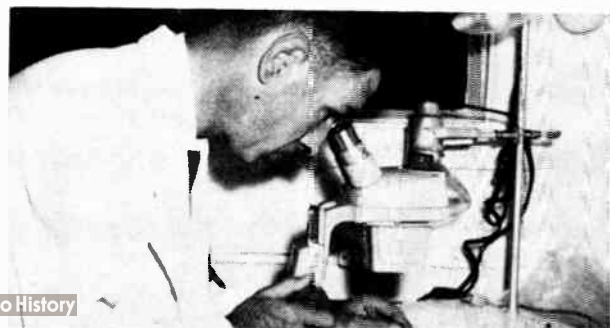

Figure 2.



internal nail-head lead together, after which a lead is spot-welded on. The device at this stage is hermetically sealed, a subsequent vacuum test being applied on a batch sampling basis as a quality control check. Each completed diode is then subjected to a detailed reverse characteristic test using a calibrated 'scope display (E_{rev} versus I_{rev}) as shown in Figure 7. The final test is of the forward characteristics where a test-set employing current and milli-voltmeters shows the forward drop at a number of test currents Figure 8 shows the general arrangement. Completed diodes are sorted and batched according to the test data obtained and then type numbers applied using an off-set printing device.

Senior engineer A. Fromanger, demonstrated the meaning of a "strong" junction. Here, a diode chosen at random was deliberately driven beyond breakdown into the avalanche region and was left in this condition for a few minutes in a simple heat sink sustaining a power dissipation of approximately 25 watts. After the diode had cooled down, subsequent to this treatment, forward and reverse checks showed the unit to be in perfectly good condition. Of interest is the act that the double-diffused diodes exhibit extremely sharp zener turn-over characteristics.

The general manufacturing process for the higher-powered units follows the same overall pattern except of course, the dice are made much larger and the manner of making off the pig-tail leads is somewhat different.

Syntron (Canada) Ltd.

Stoney Creek, Ontario

Originally formed in Pittsburg as the National Electric Manufacturing Company, the firm's name was changed to Syntron (SYNchronous elec-TRONics) in 1926 when it became active in the field of industrial vibratory devices.

The Canadian company was incorporated in 1952 initially as a marketing organization for the parent company's diverse line of materials-and-parts-handling-equipment. In 1955, the Syntron organization was purchased by the Link-Belt Company who were interested in seeing Syntron's rectifier business diversified and expanded. By 1957, Syntron (Canada) Ltd. was one of the country's largest manufacturers of selenium rectifiers. Though still active in this area, and also in the production in Canada of many types of vibratory devices, emphasis at the Stoney Creek plant is given to the manufacture of a wide range of silicon rectifiers, a complete facility for the work having been established. Syntron (Canada) Ltd. employs 50 people at its 15,000 square foot plant, operates sales offices in Montreal, Toronto and Vancouver and has acquired land in nearby Saltfleet Township for future expansion. General Manager is W. B. Armstrong.

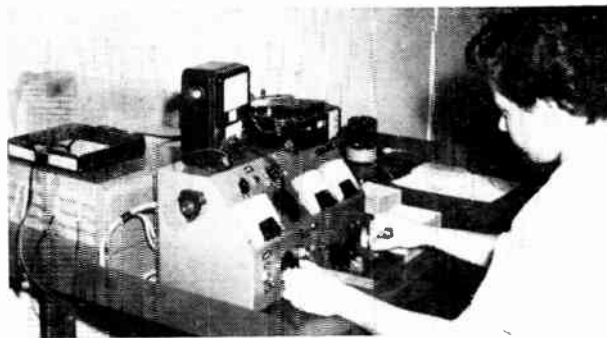

Figure 7.

Figure 8 (above).



Figure 6.



Figure 5.

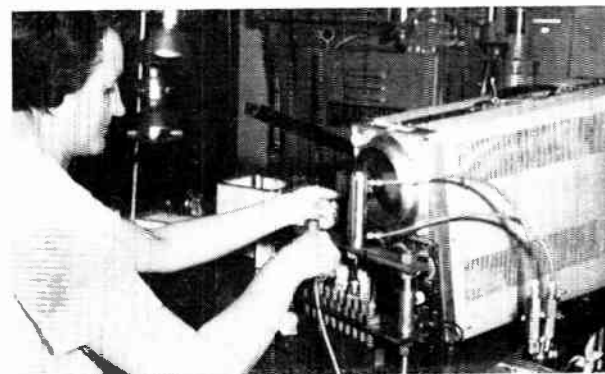

Figure 4.

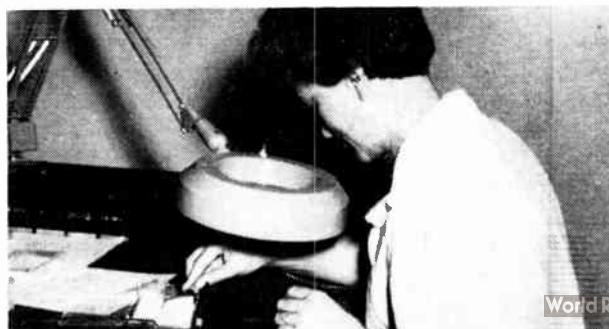

Figure 3.



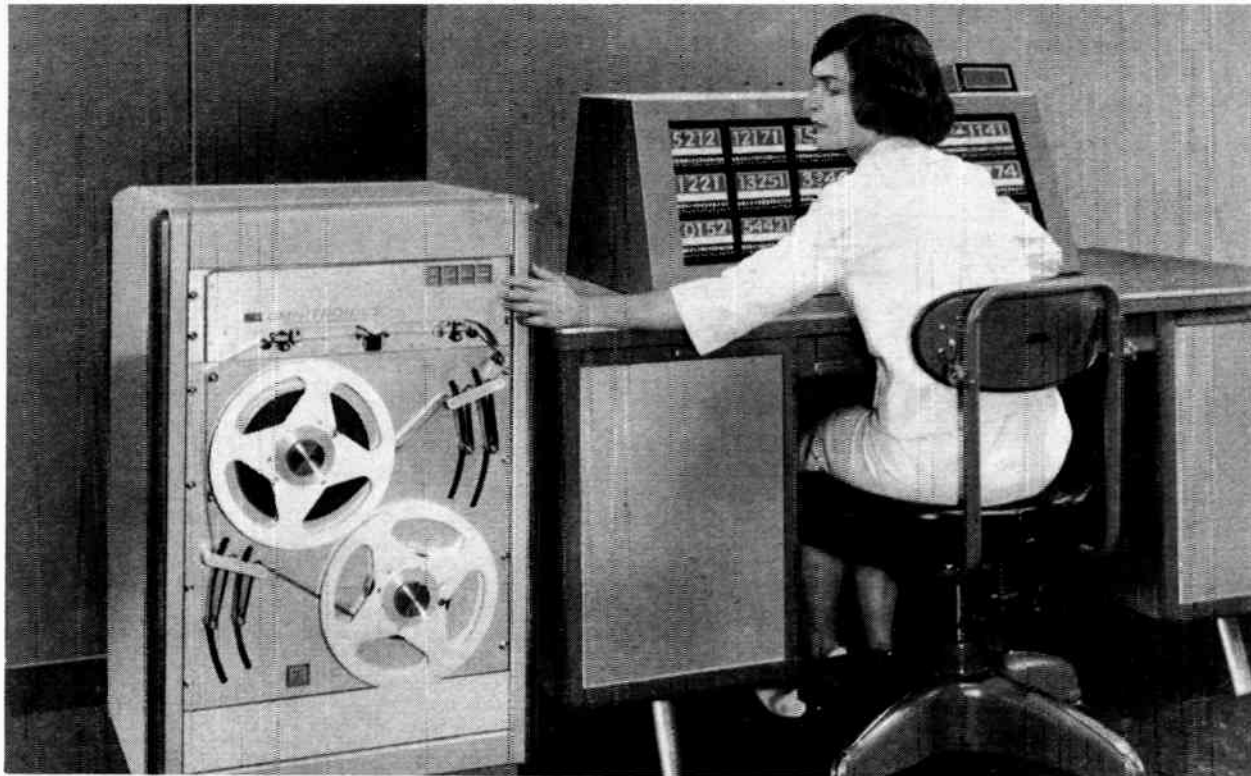

Figure 1. The Data Reader uses the chopped reflected light technique making it possible to read all standard tapes — opaque, translucent or transparent.

COMPUTERS

A new recorder/reader system

Article describes a new electrostatic recording-on-paper technique and a photoelectric reader that can be used with practically any type of paper tape.

(A special communication from the Borg-Warner Corporation, Omnitronics Division.)

Present techniques for processing paper tape have reached their limit. Mechanical punching speeds can be increased only through ultraprecise, expensive devices, which still have severe limitations and also take their toll on reliability. The uncertainty of reading tape by shining light directly through holes leads to readers requiring adjustments and expensive materials for tape.

In order to achieve an improved level of performance, conventional techniques have been discarded and a completely new approach to the problem has been employed. It is based on the recognition that most of the limitations of tape stem from the fact that all conventional techniques require going through the paper. Recording is achieved by punching holes in the tape. Reading is accomplished either by inserting pins or transmitting light through these holes. The limitations of these techniques have long been known. They involve the use of inherently slow mechanisms and in the case of photoelectric reading, reliability is dependent upon the uniform opacity of the tape.

With the "Omni-Data" technique, information is stored on the surface of the paper and at no time does the reading or recording head touch the tape. The result is a non-impact, non-contact highly flexible system which allows the full exploitation of coded paper tape as a storage medium.

To implement this approach two basic units have been developed:

- (a) The Omni-Data Recorder, which electrostatically records permanent visible spots on the tape.
- (b) The Omni-Data Reader, which uses the principle of chopped, reflected light to interpret spots or holes in the tape.

Jointly their advanced new units have the following important features:

- Speeds in excess of 1,000 characters a second.
- Higher density recording.
- The ability to read all types of tape, opaque, translucent and transparent interchangeably without modification of the equipment.
- Longer operating life of the equipment.
- Indefinitely long operating periods without adjustment.
- A new order of reliability at high speed is implicit in the technique.

The Recorder

The Recorder, illustrated in Figure 2, accepts standard data pulses (—12 volts for a mark and sprocket, 0 volts for a space) and records them as visible spots in the same code configuration as punched tape. The unit is completely self-contained with its own power supply, tape drive and controls. It handles up to eight information channels and a sprocket channel. It accepts tape widths of 11/16" to 1¼".

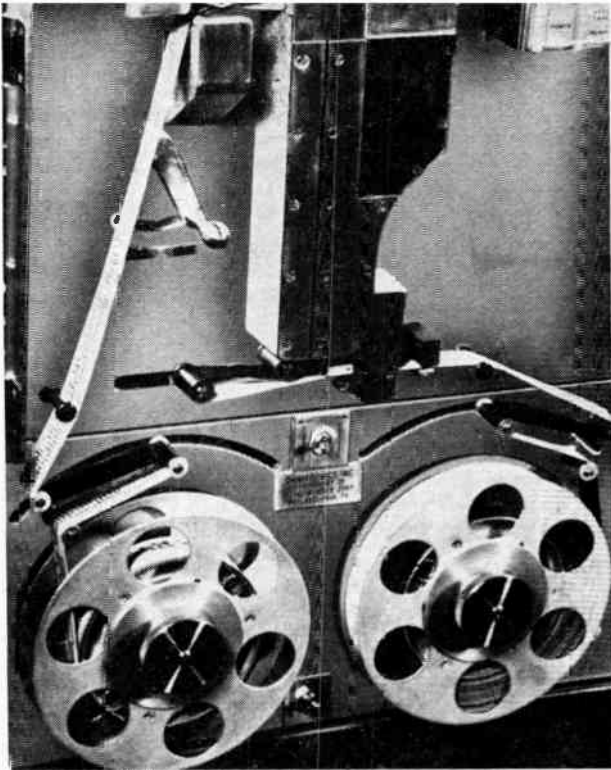

Figure 2. The Data Recorder shown here, uses electrostatic methods and permits new orders of speed and reliability.

Figure 3 illustrates the electrostatic recording technique. The tape used is a high resistivity plastic coated paper tape with a conductive backing. The "writing" head consists of two closely separated sets of electrodes. At "write" time, the electrodes are pulsed. This causes a discharge, charging the surface of the paper through ion migration from the discharge cloud to the surface of the tape with the migration confined to a precise shape and area. A latent image in the form of the electrostatic charge is transferred to the surface of the tape. The image is made visible by passing the tape through a bath of dry powdered ink which adheres to the charged area. From the ink bath the tape is passed

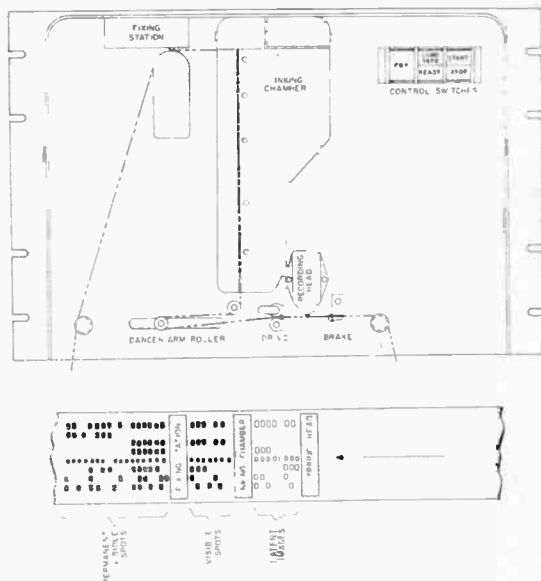

Figure 3. Diagram showing operation of the recording system.

through the fixing station and the spots are permanently fixed on the surface giving a record of the form as shown in Figure 4. This technique permits the recording of information on the tape in the order of microseconds.

The speed of processing the tape is limited only by the drive mechanism and the degree of control over tape handling. Present models of the electrostatic tape recorder have recording speeds of up to 600 characters a second. Recorders in the prototype stage have operated at speeds approaching 2,000 characters a second with increased packing.

The Reader

A significant feature of the overall design approach of the Reader shown in Figure 1 is its inherent flexibility. Because it can accommodate interchangeably all kinds of tapes — punched or printed, opaque or transparent — the equipment can be incorporated into any present tape system and extend its use by handling as direct input, tapes which were previously unacceptable. The initial group of Omi-Data Readers now available commercially is the PTR Series. These units read all standard tape widths accommodating up to eight data channels and a sprocket channel in either strip, loop or reel form at any one of nine standard speeds up to 100" per second. Bi-directional reading and start-stop on each character at speeds up to 100 characters a second are features provided in this series.

The unique aspect of the new reader is the use of chopped reflected light as the sensing means. As shown in Figure 5, light from bulb is focused by means of a double convex lens into a narrow beam at an angle to the tape. A series of light pipes, one for each channel and sprocket, is fixed in position over the tape near the concentrated line of light and at the proper angles so the light from the tape is reflected squarely on the rod ends and is directed through a rotating chopper to the sensing photodiodes. When a hole appears in the tape, light passes through and is not reflected. With the electrostatically recorded tape, the recorded spots reflect less light, this creating the same effect as a hole in punched tape.

The use of the reflected light principle permits the reading of all tapes, punched or printed, opaque, colored

Figure 4. Capsule-shaped spots instead of holes give greater packing density.

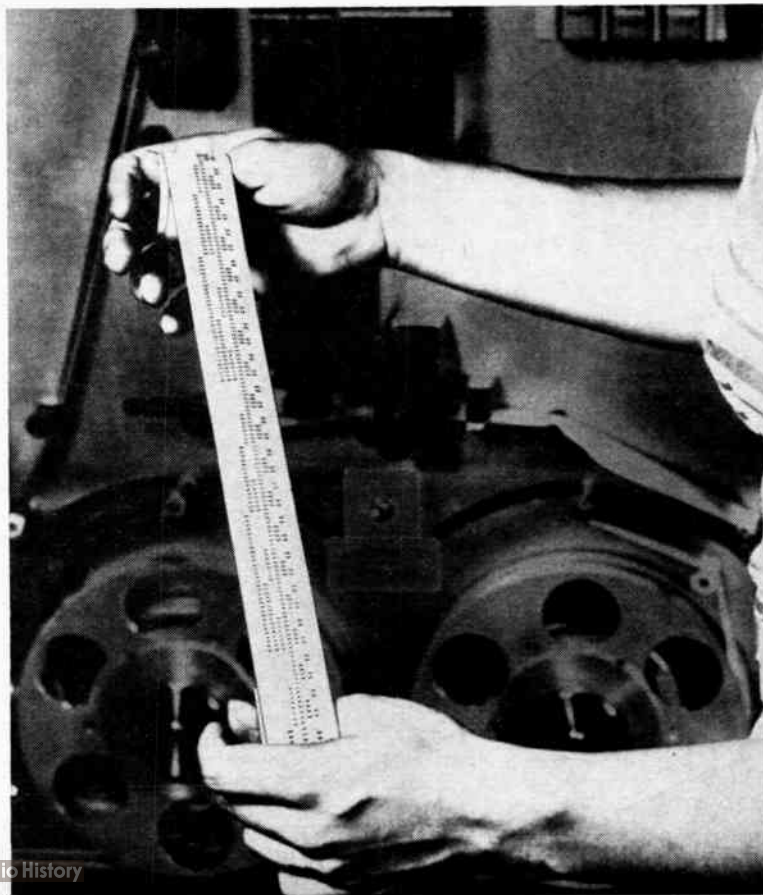

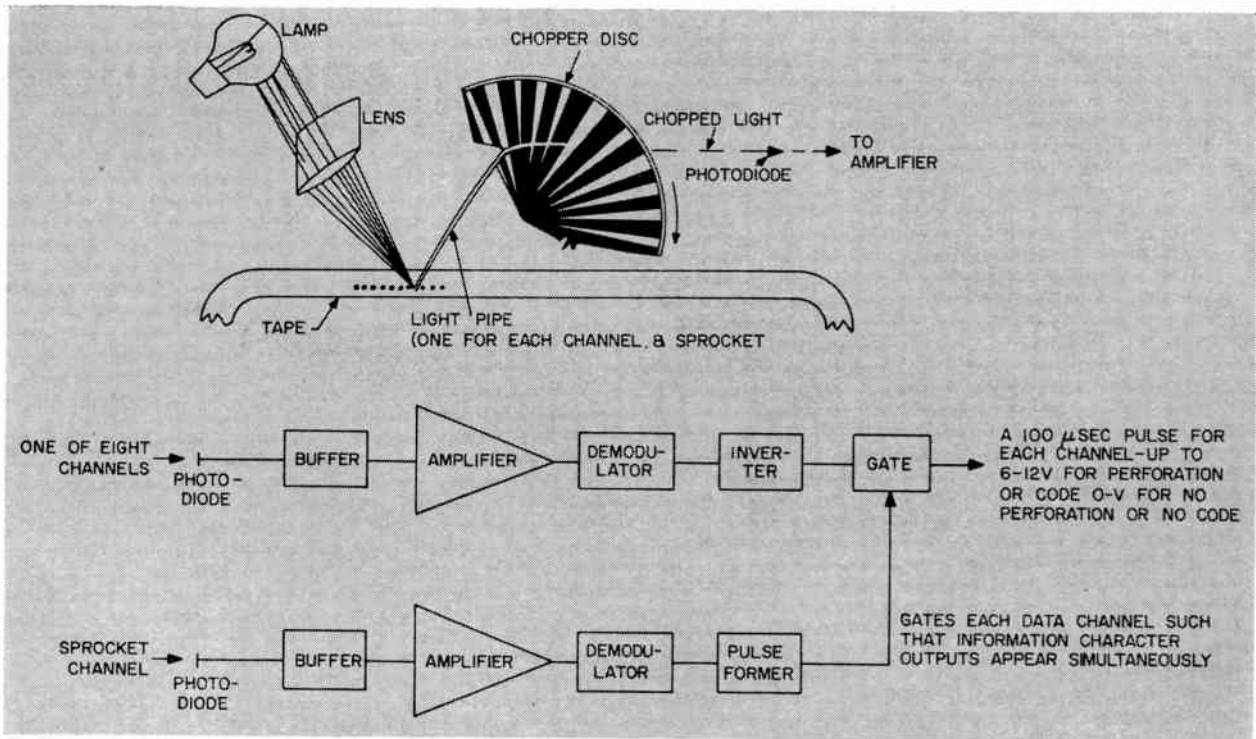

Figure 5. Diagram showing principle of photo-electric reader head using chopped light.

or transparent. The design of the reader system is such that oil spots and other changes in the opacity of the tape have no effect on the sensing. Thus greater reliability is achieved and a higher signal-to-noise ratio is attained. The chopped light allows the use of AC coupling, so eliminating the drift inherent in photo-cells and DC amplifiers. The resulting increased stability permits indefinitely long periods of operation without the need for adjustment. In fact, the design of the new reader has eliminated all variable components from the reader circuits.

Both the Reader and the Recorder are self-contained units and each have their own power supply, drive mechanisms and built-in push button controls to start,

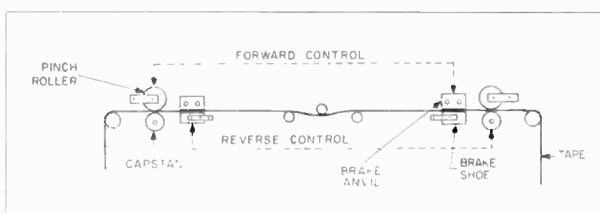

Figure 6. Arrangement of tape feed and controls.

stop, read and select speed. Figure 6 illustrates the drive mechanism used in the Reader. It is essentially the same as that used in the Recorder and provides positive stopping action before the next character following a stop signal. Starting acceleration is such that the time from zero to maximum speed is three milliseconds.

The mechanism for driving in a given direction consists of a capstan-pinch roller arrangement on one side of the head and a brake assembly mounted on the other. A solenoid pushes the pinch roller against a constantly rotating capstan to drive the tape. The same kind of action causes the brake to press against a high friction shoe to stop the tape. Both stopping and starting mechanism are synchronized so one is released before the other is engaged.

Present auxiliary equipment consists of a series of unitized servocontrolled tape handlers for use with the Omni-Data Readers and Recorders. These units are compatible with other equipment and handle all tape widths up to 1¼". A further series of auxiliaries (the RS-400 Series) operates with up to 10½" reels and is the only unitized tape reeler of this size commercially available.

Conclusion

Reviewing the features of the new system it is evident that:

- Coded paper tape has a permanent place in information handling, particularly in that area where man and machine come together.
- It is a dual language record. Both man and machine can interpret it.
- It provides an optimum means for searching and editing where more elaborate techniques are not necessary.
- It is an unalterable medium — a fact which renders it highly reliable for permanent storage or programs.
- The output signals typical of this medium are compatible with the requirements of certain industrial programming and control applications.

Present uses of the Omni-Data System are:

- Ground Support Equipment. New speeds and reliability for tape programs can be achieved.
- Large scale digital data handling equipment. High speed paper tape programming and loading can be accomplished more reliably.
- Low cost digital computers. Speeds can be increased by a factor of 10 at their most critical point — the output.
- Tape programmed industrial controls. Tapes can be processed directly from a computer — without the necessity of magnetic tape.
- Paper tape records in high speed digital communications systems can be produced directly and reliably through the use of the new method.



The author is with
E.M.I. Electronics Ltd.
Hayes, Middlesex,
England.

Sharpe

Nuclear Radiation Detectors

Article classifies detector types and indicates basic physical processes that underly their operation

by J. Sharpe B.Sc. AMIEE

Elementary particles and high energy quanta are not directly perceptible by man in sub-lethal doses and instruments of varying types have been devised to record their presence and provide quantitative information relating to their energy, number and quality.

These detecting instruments are of two general sorts, passive elements, which store up information as long as they are exposed to the radiation and which have to be inspected in order to extract the data, (a photographic emulsion) and active elements which produce an electrical signal indicative of the presence of radiation, (a geiger counter), but whatever the mode of operation of the detector itself, the first requirement is that the nuclear radiation shall dissipate some of its energy within the sensitive element.

This energy, which originally resided in the single primary particle, is then spread out over an appreci-

able volume of the detection medium and gives rise to events on a macroscopic scale which enables an observation to be made. In some cases, the useful events give rise to ionisation and the separation of the positive and negative ions by an electric field produces a signal which can be amplified and recorded. In other cases, the practice energy is used to produce many light quanta, which can be recorded by the intermediary of a photo-electric cell.

In many passive detectors, the requirement is the initiation of a permanent chemical or physical change, such as takes place in the small crystals of silver halide in a photographic emulsion, or in some chemical dosimeters. In all cases, most of the energy appears as heat and it is possible to detect a sufficiently high energy flux by some form of thermally sensitive device, such as a thermo-couple.

TABLE 1a
DETECTION OF GAMMA RAYS

PROCESS	CHARGED PARTICLE	ENERGY AVAILABLE	CROSS SECTION (1 barn = 10^{-24}cm^2 Z is atomic number)
Compton scattering	Electron	$E_{\max} = \frac{4E\gamma^2}{1+4E\gamma}$	$\sigma(c) \sim 0.2 E\gamma^{-\frac{1}{2}} Z$ barns
Photo-electric absorption	Electron	$E = E\gamma - E_K$	$\sigma(\rho) \sim 3 \times 10^{-9} E\gamma^{-\frac{3}{2}} Z^5$ barns
Pair production	Electron and positron	$E^+ + E^- = E\gamma - 1.02 \text{ MeV}$	$\sigma(\rho\tau) \sim 6.2 \times 10^{-5} (E\gamma - 1.02)^{2.1} Z^2$ barns

TABLE 1b
DETECTION OF NEUTRONS

Scatter on Hydrogen	Proton	$E_{\max} = E_n$	$\sigma(n,p) = 4.5 E_n^{-\frac{1}{2}}$ barns
$B^{10} + n \rightarrow \alpha + Li^7$	α - particle	2.8 MeV	$\sigma(th)$ (Thermal neutrons) = 3770 barns
$He^3 + n \rightarrow p + H^3$	Proton and triton	$0.78 \text{ MeV} + E_n$	$\sigma(th) = 5000 \text{ b}$ $\sigma(0.1 \text{ MeV}) = 1.5 \text{ b}$
$Li^6 + n \rightarrow \alpha + H^3$	Alpha particle and triton	4.8 MeV	$\sigma(th) = 902 \text{ b}$
$C^{12} + n \rightarrow C^{11} + 2n$	Positron from 20 min C^{11}	$E_{\max} 0.97 \text{ MeV}$	Threshold at 20 MeV.
$Cd^{113} + n \rightarrow Cd^{114} + \gamma$	None	$E_{\text{gamma}} \sim 7.8 \text{ MeV}$	$\sigma(90 \text{ MeV}) = 0.026 \text{ b}$
$In^{115} + n \rightarrow In^{116} + \gamma$	Beta particle from 54 min In^{116}	$E\gamma \sim 8.2 \text{ MeV}$	$\sigma(th) = 20,000 \text{ b}$
U^{235} fission	Heavy fragment	59 MeV	$\sigma(th) = 145 \text{ b}$
	Light fragment	93 MeV	
U^{238} fission	Light fragment	93 MeV	$\sigma(th) = 545 \text{ b}$
			Threshold = 1 MeV (Nat U) = 0.42 b at 2 MeV

Detection media

Nuclear radiation consists of three general types. Charged particles, such as electrons, alpha particles and protons; uncharged particles, such as neutrons and neutrinos and electro-magnetic radiation, such as gamma rays and X-rays. The sharing out of energy in matter is done by interaction with the electronic structure and so is only effective with charged particles so that

neutrons and gamma rays must first interact in a special way to produce a charged particle before they can be detected. Before discussing detectors themselves then, it is necessary to consider the ways by which interaction can take place and relate these to the various detection media available.

Continued on page 72

TABLE 3				
MATERIAL	Fission Fragment 70 MeV	Alpha Particle 5 MeV	Beta Particle 100 keV	
W. eV per Photoelectron (Phosphor + 60 μA/L S-11 cathode)				
NaI-Tl	5000	300	250	Decay Time 0.25 μsec
CsI-Tl			1000	1.1 μsec
ZnS-Ag		250	250	3 μsec (t ⁿ law)
Anthracene		5000	500	.032 μsec
Stilbene	150,000	15000	1200	.006 μsec
Plastic phosphor	Very large	Large	1500	.005 μsec
Liquid phosphor	"	"	1500	.002 μsec
W. eV per hole-electron pair				
CdS		14	5-10	
Ge		3.0		
Si		3.5	3.5	
W. eV per ion pair				
Air		35.6	33	
Argon	28.5	26.3	26.9	
Hydrogen		36		
CH ₄		30.3	28.5	
Secondary Emission Co-efficient. Electrons per particle				
BeCu		~5	~.05	
Ni, Al, Au, Cu.	70	2		Thin foils. Particles and secondaries emerging on same side.
Ni coated with MgO	~300			"
SbCs	~500	~5		"

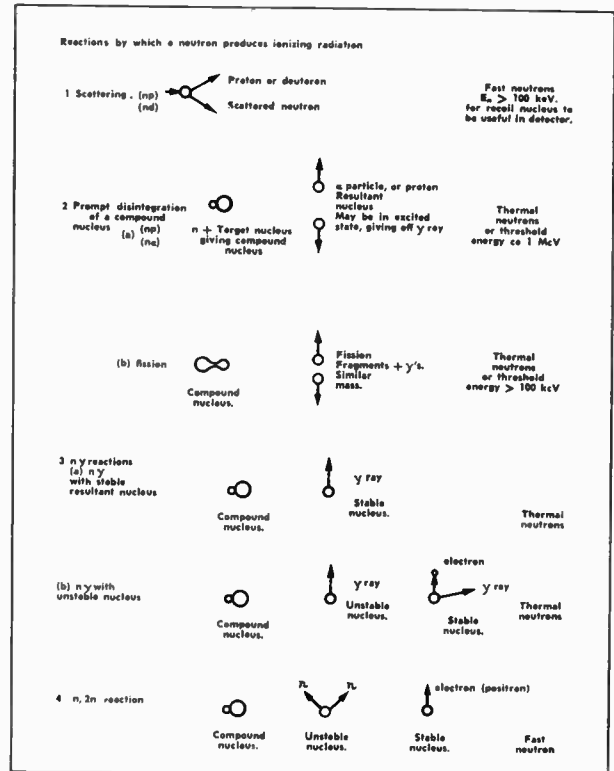
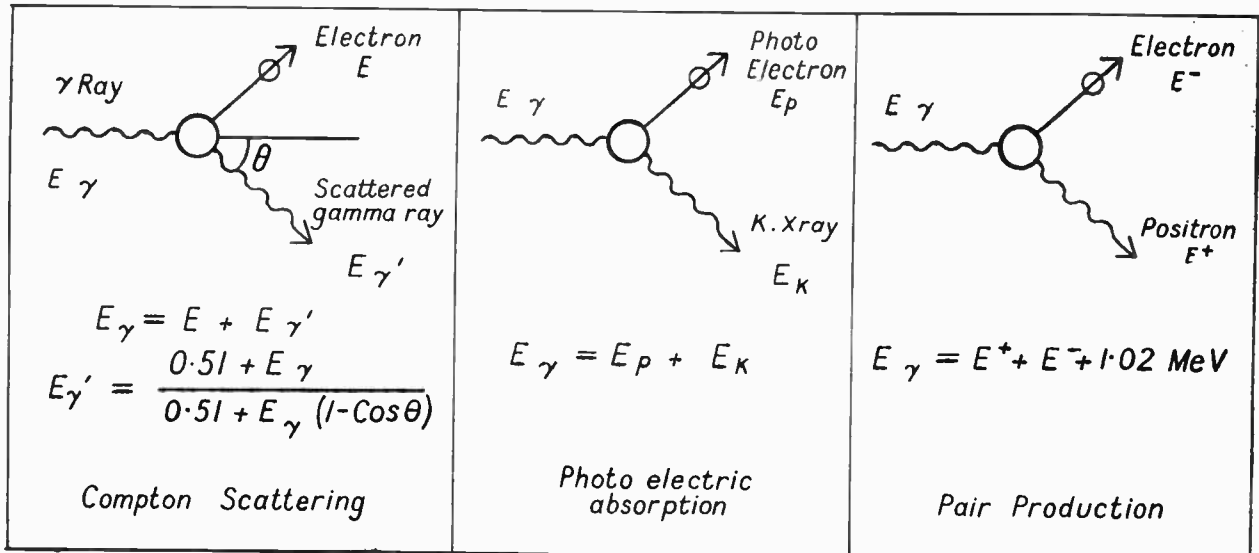

Figure 1b. Four types of reaction by which neutrons produce ionizing radiations.

Figure 1a. Three basic ways in which electro-magnetic radiation in the form of X-rays or gamma rays interacts with matter to give energetic electrons which, in turn excite the detection medium.



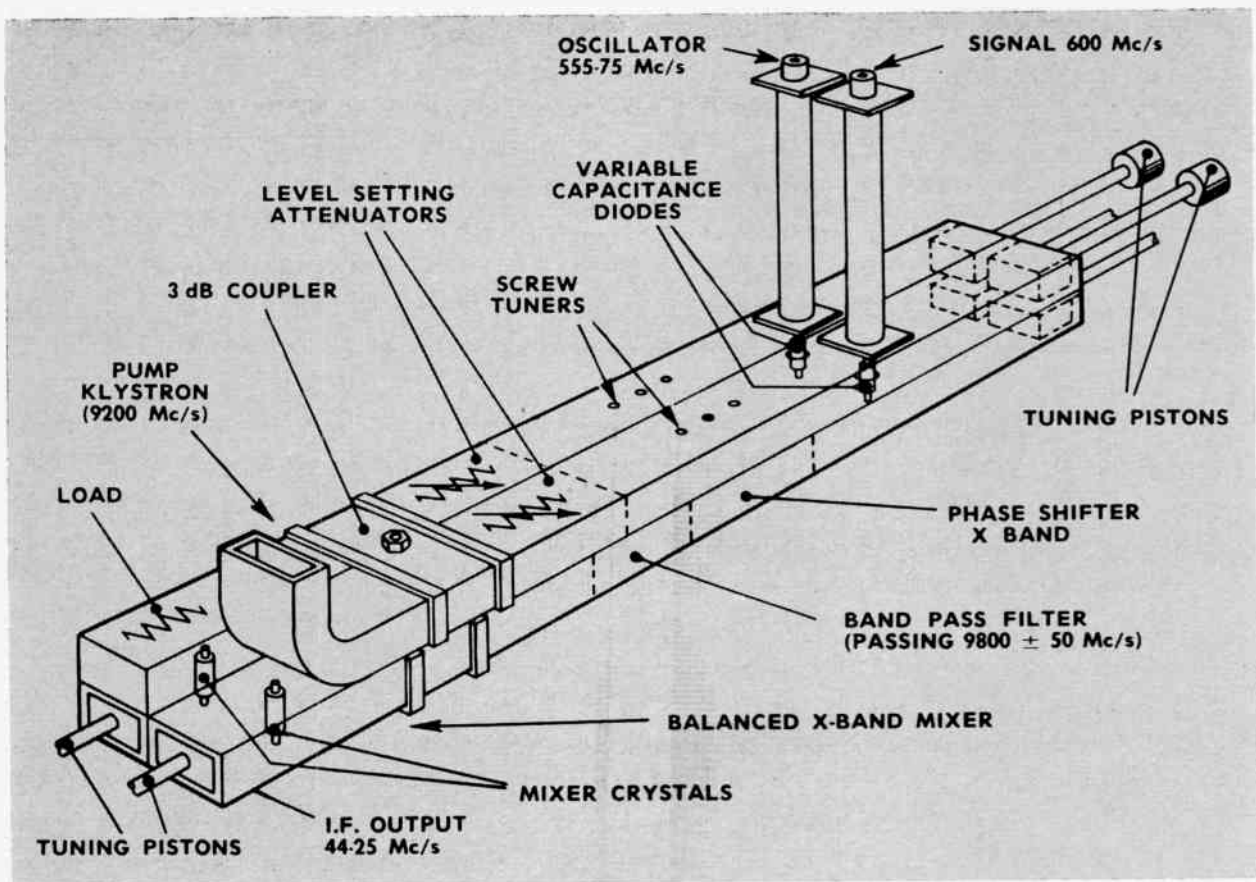

Figure 1. Diagram shows the general configuration of the Marconi experimental solid-state diode parametric amplifier and mixer.

MICROWAVES

A solid-state diode parametric amplifier and mixer

Principle of operation of the parametric amplifier is outlined and variants discussed . . . a practical 600 Mc/s amplifier pumped at 9200 Mc/s is described

(A communication from the Marconi Research Laboratory, Chelmsford, England.)

The field of research into microwave low-noise amplification is a wide one including, as it does, such devices as travelling wave tubes, tunnel diodes, masers and electron-beam or solid-state parametric amplifiers. Each of these can have many variants and this factor, together with others, such as the peculiar requirements of a specific application, overall problems of manufacture and ultimate costs, involves a systematic exploration of each which adds up to a very intensive research program.

The solid-state parametric amplifier and mixer described herein represents one of several approach aspects which are currently being investigated at the Marconi Research Laboratories. This utilizes the vari-

able-capacitance effect in semi-conductor diodes to provide low-noise amplification, but here again variants are possible, notably the negative-resistance amplifier and the "up-conversion" amplifier, each of which in turn lends itself to different approaches. The Marconi version under consideration comes into the latter category as offering certain advantages over its contemporaries.

The basic principle underlying the operation of such an amplifier can best be understood by visualizing a resonant circuit consisting of an inductance and a capacitance connected in parallel, with an appropriate signal frequency applied across it. If, in such a circuit, the capacitance is suddenly reduced whenever the signal voltage charge on the capacitor is at a maximum and

then restored whenever it is at zero, an increase in signal amplitude will result. In short, amplification is brought about by "modulating" a circuit parameter.

This additional signal energy must come from somewhere. If the process were carried out by physically increasing and decreasing the separation of the capacitor plates it would derive from a transfer from the mechanical energy involved to electrical energy in the circuit, and the mechanical work done could be regarded as a pump source. In practice, however, the pumping process is carried out electronically.

This can be brought about by employing a silicon diffused PN junction diode. In this device the depletion layer — the boundary between the P & N contact surfaces — is in effect a dielectric between the P & N layers, but it is a special form of dielectric in that it widens or narrows in proportion to the magnitude of any voltage which is applied across the diode. This variation results from a minute flow of electron and hole distributions, *but as no actual flow of charge carriers takes place in the process, shot noise is negligible.* Furthermore, as the variation in the thickness of depletion layer is almost infinitesimal, transit times, even with the highest radio frequencies in use today, do not have to be considered; neither are shunt-capacity effects serious at frequencies up to at least 60,000 Mc/s. These characteristics make the variable-capacitance diode eminently suitable for low noise amplification of microwave signals.

Considering again the simple resonant circuit; as there are two charge cycles of the capacitor per complete sine wave it would seem to follow that the pump frequency should be double that of the incoming signal. This is theoretically so for the case of maximum transfer of energy, but in practice it is difficult to maintain an exact frequency and phase relationship over long periods; under non-coherent conditions a composite output waveform is produced which, in one version of the amplifier, embodies not only the signal frequency but also a new one, namely the pump frequency minus the signal frequency. The latter is variously known as the 'lower sideband', 'the difference frequency', the 'image' or the 'idler'. By the employment of a 3-port ferrite circulator the amplified signal can be separated from the image and either or both used. In other variants both upper and lower sidebands are produced.

Another method, and the one used in the amplifier under discussion, is the "up-conversion" system. In this, the pump frequency is much higher (by about 15 times) than that of the signal. The latter, in the pumping process, is "up-converted" to a frequency which is the sum of the two; this arrangement has certain advantages over the negative-resistance type of

amplifier in that, when used in conjunction with a mixer of the type incorporated, the stability of the klystron pump is not nearly such an important issue, as any variations in pump frequency are cancelled at the mixer stage — in other words, even should the klystron frequency wander somewhat, the mixer output still remains constant at 44.25 Mc/s.

In the Marconi amplifier, the pump source is an English Electric klystron oscillating at 9200 Mc/s. The output from this is fed along two separate sections of waveguide via a 3 dB directional coupler to provide equal power in both arms; each section embodies a variable attenuator and a 3-screw tuner and, towards the far end, a variable capacitance diode.

Each diode is mounted so as to protrude through to another waveguide section, located flat-on underneath the first such that there are, in fact, in the entire assembly four waveguide sections, two lying parallel to each other at the top of the structure, and two similar ones underneath.

Into one diode is fed the 600 Mc/s signal via a low pass filter to isolate the external 600 Mc/s signal source from the pump frequency; the second diode is also connected through a low-pass filter to an external crystal controlled local oscillator operating at a frequency of 555.75 Mc/s.

Considering first the signal section: Interaction between the 9200 Mc/s pump frequency and the 600 Mc/s signal takes place as described earlier with a consequent transference of power from pump to signal. Along the lower waveguide section is now flowing a wide-band signal consisting of the pump frequency 9200 Mc/s and upper and lower sidebands extending to 9800 Mc/s (pump + signal) and 8600 Mc/s (pump — signal) respectively. After passing through a varactor the signal is fed through a band pass filter centred on the sum frequency (9800 Mc/s) and with a pass-band of ± 50 Mc/s. This accepts this band of frequencies and passes them to the mixer section; it also "traps" the lower sideband which is utilized for providing a degree of regeneration.

The local oscillator section is similar except for the different frequencies involved; in this instance the local oscillator frequency is 555.75 Mc/s and the upper and lower sideband limits 9755.75 Mc/s and 8644.25 Mc/s. In this case also a bandpass filter in the waveguide accepts the 9755.75 Mc/s signal.

Each of the 9800 Mc/s and the 9755.75 Mc/s signals passes through an arm of a 3 dB coupler to a balanced mixer stage consisting of two crystal diodes, and the resultant beat or difference signal is extracted as a 44.25 Mc/s intermediate frequency. The ends of the waveguide sections each terminate in cavity tuners.

Damped circuit boards aid reliability

A big problem in the field of electronic circuit miniaturization is vibration induced in circuit boards from external environment. High 'g' loading can result in fracture of etched wiring and resonances can shorten life of components mounted on board. Hitherto, designers often had to resort to complicated means for reducing vibration hazard. New circuit board material introduced by Lords features internal elastomer damping medium that substantially reduces

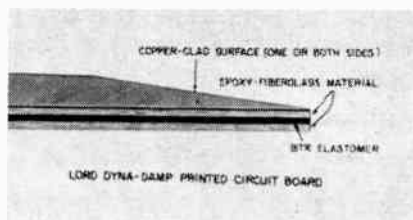

vibration amplitudes and results in significant increase in overall reliability. Photograph shows the construction of the new DYNA-DAMP

laminates. The elastomer converts vibratory energy to shear strains and it is then dissipated in the material. The elastomer has unchanging damping properties over the temperature range -65° to $+250^{\circ}$ F and is resistant to other extreme environmental factors.

For further information, write Railway and Power Engineering Corp. Ltd., 3745 St. James St. W., Montreal 3, Quebec, agents for the Lord Manufacturing Co.



Looking west from the Mezzanine over 1961 IRE exhibition hall.

1961 Canadian Electronics Conference – a review



These words were spoken enthusiastically by Fred Heath, general chairman, and endorsed by Grant Smedmor, conference manager, when both were asked for a statement after the Canadian IRE show. "Evidently, the bi-annual formula for the conference ideally suits the industry," G. Smedmor went on to say "at all events, the entire floor space was sold and from what I have heard, the exhibitors were happy with the arrangements and the results." The word "buoyancy" most aptly described the business aspects of the conference Fred Heath explained. He had learned at first-hand, and from his colleagues

The best yet

that the exhibition had been universally successful in providing a showcase for Canadian electronic products and services. "This will surely have an important and beneficial effect on the industry's business in the months ahead," he said.

The attendance estimate of 9,000 was in fact exceeded, records showing that a total of 9,637 passed through the registration desks. All of the technical sessions were particularly well attended, it was also learned.

In summary, said Mr Smedmor . . . "the best yet, and a pace-maker for the next IRE Conference in 1963."

This CARDE Cajun Payload displayed at the IRE show was designed and built by DRB scientists at CARDE to investigate the night air glow phenomenon in the Fort Churchill, Manitoba, sky. The Cajun was mounted on top of a NIKE booster rocket. Several were fired during the IGY Program.

Progress through electronics — a speech by Dr. L. V. Berkner, President, IRE



Dr. L. V. Berkner (left) and Fred Heath at the IRE exhibition.

Canadian Marconi Company, one of the 192 exhibitors at the IRE show featured a wide range of vacuum tubes at their booth.



Dr. Berkner opened his address by outlining the role of the Canadian Region and its relationship to the international IRE. He next conducted a short survey of the recent history of physics essentially taking Clerk Maxwell's work as a starting point, and showed that a new technology was clearly invading industry. In its simplest terms, the new technology was shown to be the antithesis of the empirical, rule of thumb methods that have characterized man's industrial activities for so long. Dr. Berkner went on to say:

" . . . the new technology and the industry derived from it is dependent upon men of high competence and imagination who can command the ideas from the science of our century.

The need for men of great engineering and scientific skill reflects a change of very deep social significance. As industry moves rapidly into the new technological phase, the older industries which continue to depend on the practical experience of earlier centuries, become shallow and ineffective. Those industries must gradually, and sometimes not so gradually, give way to new processes, new materials, new methods, new products.

Moreover, the new industry naturally springs up in the geographic locations where men of the most suitable intellectual backgrounds are available. As my predecessor, Dr. Ronald McFarlan, Past President, of the IRE, recently remarked:

'Large concentrations of able academic scientists and engineers placed in geographical proximity with their equally able industrial counterparts can produce very rapid economic growth in the areas concerned. One has only to look at the Boston-New York-Philadelphia electronic axis, or at its San Francisco-Los Angeles counterpart to substantiate this statement.'

Thus in the future, the extent of regional industrial growth will be inextricably tied to the graduate education opportunities of the region . . . "

Dr. Berkner closed his speech by reviewing once again the problems ahead and related these to the activities of IRE which he felt had a dominant part to play now and in the years to come. His final remarks were:

"In the last analysis, our electronic engineers in each community carry

the burden of this responsibility of our profession to our society. Through his creative contributions in industry, in education, and in government each engineer must respond in his own way to these community needs. This eighth region of IRE carries a very direct burden for the maintenance of the professional competence that can satisfy those needs in the face of rapid technological evolution. The central IRE activities in technical advancement, education and standards can give you powerful aid. And together, the local, regional and central activities of the Institute of Radio Engineers founded on the exciting ideas of our profession can, I believe, meet these challenging needs and expectations of the community . . . "

M. Feilchenfeld, circuit design engineer (left) and N. J. Grey, laboratory supervisor, both of Raytheon, took part in the design of symbol generator equipment shown here.

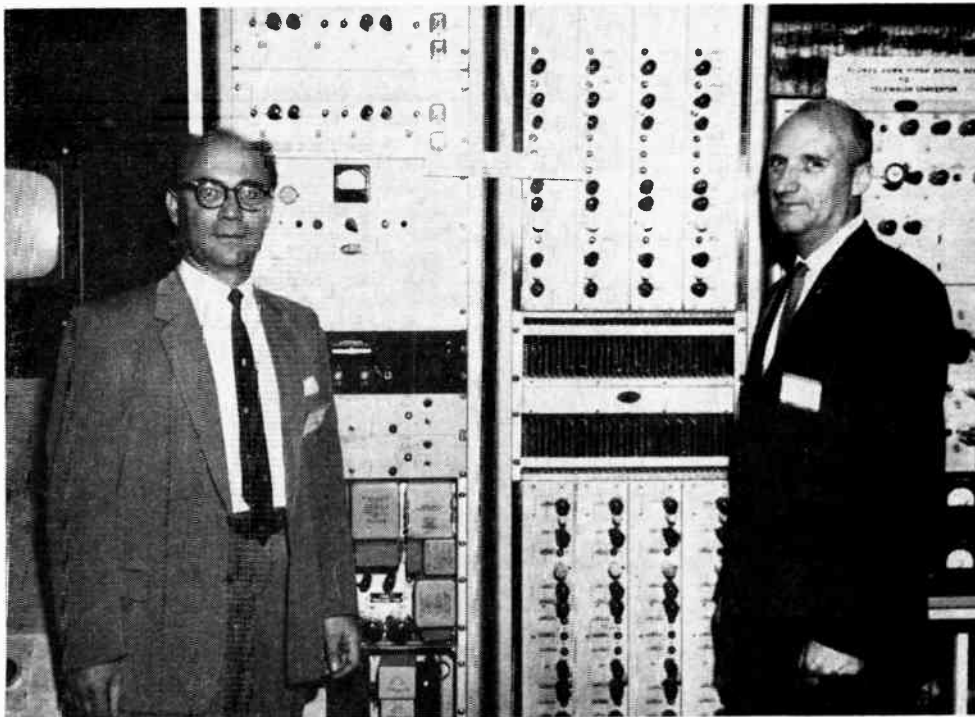

IRE honors Raytheon for new symbol generator

A new symbol generator for air traffic control equipment developed for the Department of Transport has been judged the best Canadian product exhibited at the IRE Canadian Electronics Conference in Toronto October 2-4.

The symbol generator and hand-on equipment is a product of **Raytheon Canada Ltd., of Waterloo, Ontario.**

George Armitage (left), president, Ferritronics Ltd. and Bernard Tennent, vice-president and chief engineer, stand at their booth before board carrying award-winning filter.



These electronically-generated symbols are superimposed on a TV screen to help air traffic controllers identify individual aircraft. Use of symbols simplifies control of a given flight between air traffic areas. By means of a cursor, the distance between individual aircraft and the bearing between them can be established. Designer of the equipment is R. W. Dankwardt and Dr. T. W. R. East, accepted the award on behalf of the company.

Ferritronics win Canadian IRE award

New Canadian-designed miniature communications filters which are being successfully sold in the United States received top recognition from the Canadian electronics industry. **Ferritronics Ltd., of Willowdale, Ont.,** were awarded a plaque for the best Canadian component exhibited at the IRE Canadian Electronics Conference.

The filters are of reduced size, better performance and more economical than comparable products. They have numerous applications and have already been used in two-way radios for taxicabs, police cars, military vehicles and naval craft.

So well are these filters being accepted in the U.S. market that Ferritronics are shortly opening a Buffalo plant to produce them there. Enquiries have also been received from the United Kingdom and Australia and the company believes its market for them is world-wide.

Designers of the new units are Bernard Tennent, vice-president and chief engineer of Ferritronics and George Armitage, Ferritronics president, who designed the printed circuit.

1963 Canadian Electronics Conference

Tentative plans have already been made for the next Canadian Electronics Conference to be held in Toronto September 30-October 2, 1963. The Conference Chairman will be L. C. Simmonds of **A. C. Simmonds & Sons Ltd.** of Toronto.

Compact— 50 rectifiers on a printed circuit board 2 1/4" x 2 3/4"



New Sarkes Tarzian Silicon Rectifiers

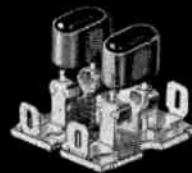

Doubler socket

Half-wave socket

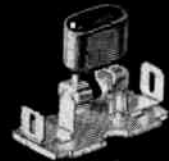

Sockets from Fastex Division, Illinois Tool Works

for plug-in sockets and printed circuits

This new series of silicon rectifiers is especially suited for use in printed circuit assemblies, or can be plugged directly into special sockets to facilitate assembly and servicing. Insulated case—11/32" x 3/16" x 1/4" high—eliminates many mounting problems. Leads are on 7/32" centers.

Reliability is excellent—in part because the construction minimizes axial strain on the junction. Special Tarzian oversize junctions increase inrush current protection, contribute to low voltage loss, and lengthen useful life in this as in other Tarzian silicon devices. Prices are realistic.

Complete line catalog available. Application engineering assistance is also available without obligation. Send for data sheet.

Tarzian Type	Amps DC (85°C)	PIV	Maximum RMS Volts	Maximum Recurrent Peak	Amps Surge (4MS)
12	.75	200	140	7.5	75
14	.75	400	280	7.5	75
16	.75	600	420	7.5	75



SARKES TARZIAN, INC.

World's Leading Manufacturers of TV and FM Tuners • Closed Circuit TV Systems • Broadcast Equipment • Air Trimmers • FM Radios • Magnetic Recording Tape • Semiconductor Devices

SEMICONDUCTOR DIVISION • BLOOMINGTON, INDIANA

In Canada: 700 Weston Rd., Toronto 9 • Export: Ad Aurjema, Inc., New York

For complete details check No. 41 on handy card, page 69

Power factor correction calculations

by A. E. Maine

It frequently becomes necessary for an inductive load to be adjusted to run at or near unity power-factor. This is normally accomplished by connecting a suitable condenser in parallel with the load.

The attached chart enables the *Leading VA per Existing VA* for a stated power factor improvement to be determined quickly with only a single movement of a straight-edge laid across the chart. The following example indicates the general design method.

Typical Problem:

A 40KVA load operating at PF 0.56 is to be improved to 0.95 PF. Find the leading KVA required and the capacitance value at 550 VRMS line. (F = 490.)

Solution

Set a rule to 0.56 PF on the central curved scale and 0.95 PF on the left-hand scale. Read 0.642 on the right-hand scale at the intersection with the rule.

Total leading VA is therefore $0.642 \times 40 \text{ KVA} = 25.7 \text{ KVA}$.

Reactance of the shunt capacitor is given by

$$X_c = E^2 / \text{KVA}_c$$

$$= 550^2 \div 2.57 \times 10^3 = 11.8 \text{ ohms.}$$

Now, $C = \frac{1}{2\pi f X_c}$, therefore,

$$C = \frac{10^6}{2 \times 3.14 \times 400 \times 11.8}$$

Hence

$$C_{\text{shunt}} = 33.6 \mu\text{F.}$$

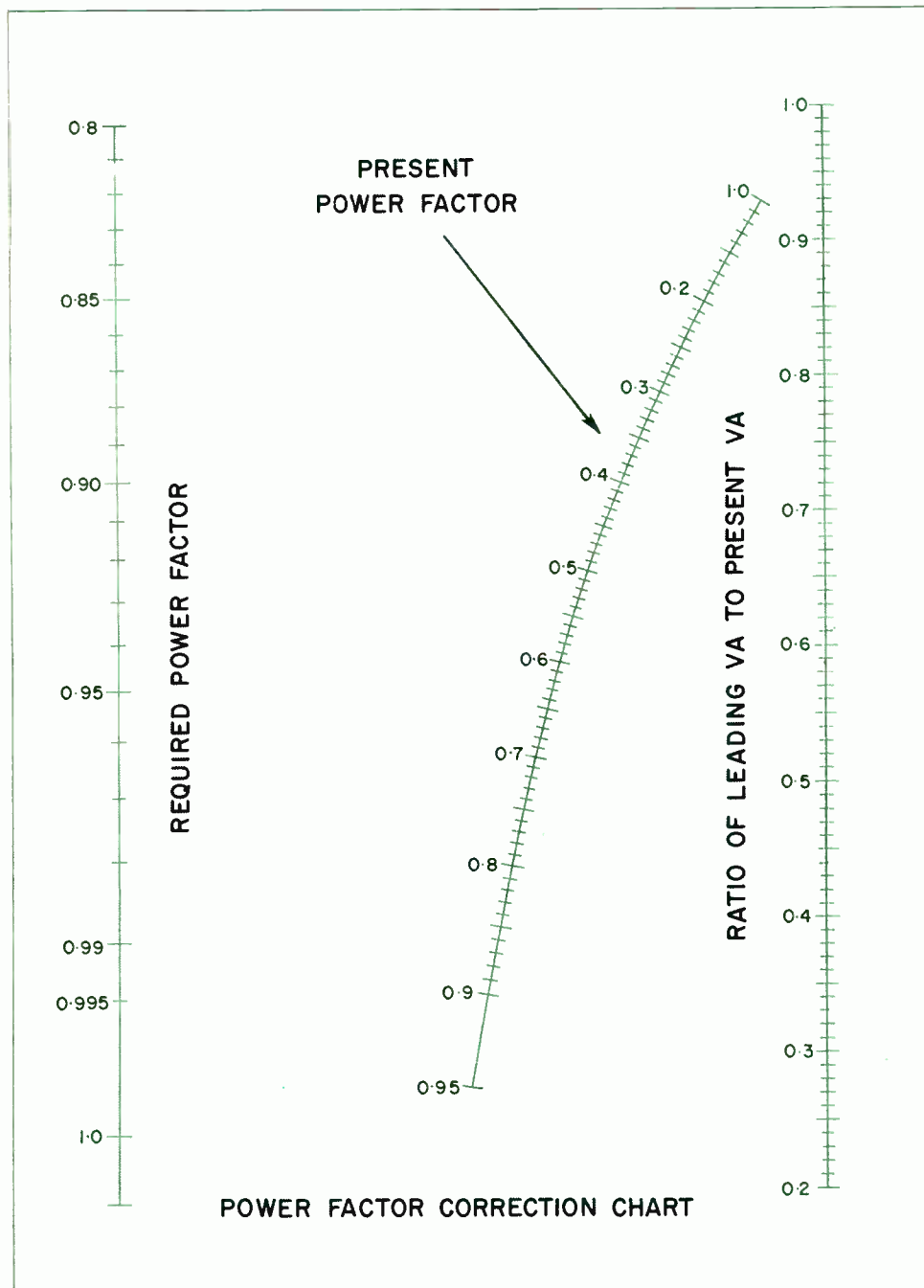

For a re-print of this page, circle 68 on the Reader Service Card or write to The Editor, Electronics & Communications, 450 Alliance Ave., Toronto 9, Ontario

E-H PRESENTS 4 PULSER THOROUGHBREDS

Which one of these advanced, quality-built instruments is right for your requirements?

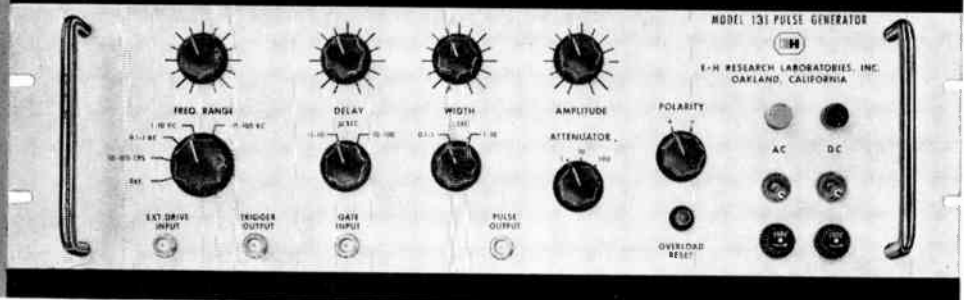

NEW! MODEL 131

Low cost pulse generator with rise time of 10 nanoseconds!

\$575 f.o.b. Oakland, California

If you've been looking for a high-quality pulser with excellent performance characteristics — but without a high price tag — the new E-H 131 was designed for you. The 131's fast rise time and high-power output pulses make it an ideal pulser for laboratory and research applications as well as production line testing of components and solid state devices. Check the 131's specifications. You'll agree it is the outstanding instrument in its price range.

SPECIFICATIONS

REPETITION RATE: 10 cps to 100 kc, internally controlled, zero to 100 kc externally driven.

RISE TIME: 10 nanoseconds.

PULSE DELAY: Zero to 100 microseconds with respect to the trigger.

TRIGGER (for sync. purposes): Positive 10 volt pulse. EXTERNAL DRIVE: 5 volts RMS or equivalent positive pulse required.

ELECTRONIC GATE: Negative 20 volts required to block the pulse train.

PULSE OUTPUT: 50 volts into a 50 ohm load.

PULSE WIDTH: 100 nanoseconds to 100 microseconds, continuously variable.

POLARITY: Positive or Negative pulses available.

DUTY FACTOR: 10 percent. An automatic limiter prevents overload.

OUTPUT ATTENUATOR: 100:1 coarse selector, 10:1 vernier control.

DIMENSIONS: Standard 19" rack panel, 5¼" high.

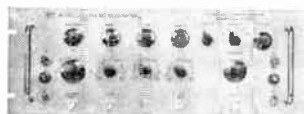

E-H MODEL 130 This double pulser has repetition rates to 4 mc, rise and fall time of 10 nanoseconds, pulse widths and delay variable from 100 nsec to 50 milliseconds, and delivers 50 volts at 500 ma at 50% duty cycle. Either pulse polarity, output attenuator, and provisions for external drive and electronic gating. Especially suited for fast circuit applications in transistor testing, computer and missile fields. \$1175 f.o.b., Factory.

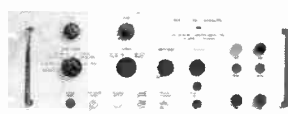

E-H MODEL 121 A high-current pulser delivering a 50 volt pulse into 50 ohms. Rise and fall times 4 nanoseconds. Width variable from 20 nsec to 1µsec. Repetition rate from 10 cps to 10 mc. Either positive or negative pulses may be selected on the front panel. Ideal for ferrite and magnetic switching studies, applications in high speed transistor and diode switching, and design of logic and memory circuits. \$1675 f.o.b., Factory.



E-H MODEL 120B Rise time — 2 nanoseconds — is ahead of the field and offers new tool for fast, high-resolution work. Two outputs independently variable in amplitude (—8 volts into 93 ohms) and widths (2.5 to 25 nsec). Inverting and impedance matching transformer available. Repetition rate 10 cps to 10 mc. Advanced trigger pulse and a fast, flexible gate for complex pulse-time and pulse-amplitude selection. \$1275 f.o.b., Factory.

Represented in Canada by: ALLAN CRAWFORD ASSOCIATES LTD., 4 Finch Ave. W., Willowdale, Ont.

BA 5-7391



E-H RESEARCH LABORATORIES, INC.
163 ADELIN STREET • TEMPLEBAR 4-3030 • OAKLAND 20, CALIFORNIA

For complete details check No. 15 on handy card, page 69

The international scene

New camera tube aids UV microscopy

The direct observation of fundamental processes in living cells has been the aim of biologists for many years. This has been brought a step nearer by the development of a new ultra-violet-sensitive vidicon television camera tube by EMI Electronics Ltd.



The new E.M.I. vidicon used in biological microscopy.

Experiments in ultra-violet microscopy have recently been carried out by Dr. R. Barer, at the Department of Human Anatomy, Oxford University, using an EMI closed-circuit TV camera fitted with this new-type EMI tube. A variety of living cell preparations were examined, including free swimming chromosomes and live sperms of mice and frogs. The above photograph indicates the general arrangement of the apparatus employed.

Tube is still in the experimental stage and is not commercially available at present.

Sales outlet in Italy offered

Sidereuropa, Corso Siccardi 9, Torino, Italy, wishes to represent Canadian manufacturers of electrical and electronic equipment or to set up a joint venture for the purpose of manufacturing such equipment in Italy. The office of the Italian Commercial Counselor in Ottawa, Ont., cannot guarantee the financial standing of the individual applicants, however, further information will be supplied on request.

Photomultiplier tube symposium held in London

The Symposium on Applications of Photomultiplier Tubes, sponsored by EMI Electronics Ltd., took place at EMI House, Manchester Square, September 13-15 and dealt with the use of photomultiplier tubes over a wide range of applications.

From the discussions on the wide diversity of these applications it is hoped that delegates arrived at a broad understanding of the advantages and limitations of photomultiplier

tubes and that tube designers derived useful information on fields in which efforts should be concentrated.

ASME has new HQ

The American Society of Mechanical Engineers has moved its headquarters' offices to the recently completed United Engineering Center. Official address of the Center, which occupies the block on United Nations Plaza between 47th and 48th Streets in Manhattan, will be 345 East 47th Street, New York 17, New York.

THE QUALITY PACKAGE IN MOBILE COMMUNICATION



NEW! No derating of performance — 40 degrees to +140 degrees F. Quiet running, dependable transistorized power supply. Compact case, easy to install. Competitive in cost, this high-power mobile unit gives base-station stability . . . provides crystal clear reception at maximum working distances . . . is fully certified for land-mobile service and complies with D.O.T. type approval requirements for split channel use. Write for literature on Du Mont mobile radio systems . . . Canada's "quality package" in mobile communication.

- HIGH POWER
- SEALED SELECTIVITY
- HIGH STABILITY
- COMPLETE, YET COMPACT

DEALER INQUIRIES INVITED

ELECTRONIC RESEARCH AND DEVELOPMENT COMPANY

Division of

MANDREL INDUSTRIES LTD.

P.O. Box 887, Calgary, Alberta

Eastern Sales Office—381 Tillbury Ave., Ottawa 3, Ontario

For complete details check No. 19 on handy card, page 69

Letters to the Editor

Bouquets

Dear Sir:

Permit me to congratulate you on your excellent pre-convention IRE issue. You have done a very fine job, both editorially and advertising wise, and I am sure this will have a very beneficial effect on the attendance at our 1961 Conference.

You will be pleased to know that I have already heard several favorable comments on this issue from members of our Executive Committee.

Yours sincerely,
Grant Smedmor, Manager,
IRE Canadian Electronics
Conference,
Toronto, Ontario.

Dear Sir:

We have quite pleased with your recent articles on New Product Planning in the defense market. Unfortunately, we did not see Part 1, but have a copy of *Electronics and Communications* for August which has Part 2 included. Is it possible that we might obtain six reprints of both these parts of this article? Please advise the writer if there are any costs involved.

Very truly yours,
H. D. Farnsworth,
Manager — Product
Planning,
Sierra Electronic
Corporation,
Division of Philco
Corporation,
Menlo Park, California.

Dear Sir:

Thank you for the copy of the September issue . . . I think it is an excellent job and I feel that the "Engineer's File Folder" feature which you have started will be a very popular one among design engineers. I read with interest your editorial. Some of the points you made regarding new approaches and improved procedures to assist Canadian companies in the United States defense market are good ones . . .

Yours very truly,
D. B. Annan, General
Manager,
Special Products Division,
The De Havilland Aircraft
of Canada Ltd.,
Downsview, Ontario.

Dear Sir:

Thank you for the September issue of *Electronics and Communications* . . .

I would certainly like to congratulate you on an excellent issue covering the IRE Show, and trust that we shall continue to see this high standard maintained . . .

Sincerely,
V. Symonds, Contracts
Manager,
Litton Systems (Canada)
Ltd.,
Ottawa, Ontario.

Dear Sir:

I would like to thank you very much for renewing my subscription to *Electronics and Communications*. I enjoy reading your industrial articles very much especially the ones on Data Processing. This seems to be the only magazine that will keep you up on the new equipment that is constantly being released.

Yours truly,
P. C. Walton,
International Business
Machines.
Ancaster, Ontario.

We receive a rocket

Dear Sir:

My attention has been drawn to an article which appeared in your magazine for September 1961, concerning among other things, the exhibit of a Black Brant II rocket at the IRE Convention in Toronto.

As I have been informed that you yourself were the author of this article, I am addressing this letter for your attention. In our opinion it would be difficult to find a piece of printing containing so many errors in so short an article as yours. To begin with, the display of the Black Brant II was arranged by CARDE at our expense following a personal approach to me on the part of Dr. Philip Lapp. *Bristol Aero Industries Limited of Winnipeg were not involved in any way.* In the second place, the Black Brant II was not designed by Bristol Aero Industries Limited, but by Canadair Limited, Montreal, in association with CARDE. The nose cone and fins of the Black Brant II were manufactured by Canadair Limited to their design and drawings. The engine cases only were manufactured by Bristol Aero

Industries Limited to Bristol Aerojet/CARDE design and drawings. Thirdly, the photograph of your article is a Black Brant I and not the Black Brant II as claimed in the caption. Finally, the Black Brant I was designed by the Bristol Aerojet Company, Banwell, England, to meet a CARDE requirement. Both the Black Brant I and II have been used by CARDE for research and development purposes.

We are surprised that a magazine of the status which *Electronics and Communications* purports to be, etc. etc. etc. . . .

Yours very truly,
J. J. Green,
Chief Superintendent,
CARDE,
Quebec, P.Q.

The Editor replies:

Only one error was actually made by us: we inadvertently used marks II and I instead of marks III and II in the caption of the picture. In regard to the picture itself, some time ago a request was made (by CAS) to DDP to supply photographs of Black Brant to illustrate an article that was being prepared on the Bristol designed research rocket. So far as I am concerned the photograph supplied was understood to be that of the Bristol bird. Certainly it would take someone very close to the project to tell the difference. At the time of going to press it was only hearsay that CARDE might supply a second rocket for the display. *The Black Brant referred to in the text was in fact supplied by Bristol Aero Industries at their own expense, negotiations having started months before.*

In summary, the error made by us is much regretted, but at the same time we wish to say that the space was made available in E&C with the best of intentions to give all concerned the maximum credit and publicity.

NOTICE

We are pleased to consider technical articles for publication. Please address material to **The Editor, Electronics and Communications, 450 Alliance Avenue, Toronto 9, Ontario.**

Industry personnel

Continued from page 16

Smith appointed to EIA Ad Hoc Committee on Research and Development

James E. Smith, vice-president of Computing Devices of Canada Limited, was appointed to the EIA Ad Hoc Committee on Research and Development. Mr. Smith joined CDC in 1953 after four years with the National Research Council and became manager of the Technical Services and New Product Branches of Engineering in 1957. From 1958 to 1960 he worked on special technical and marketing assignments with Canadian Pratt and Whitney Aircraft Company Limited before returning to occupy his present position with CDC in 1960.



GARRETSON



SMITH

Garretson appointed to board of directors

Robert H. Garretson was appointed to the board of directors of Bell & Howell Canada, Ltd. Mr. Garretson is executive vice-president of Bell & Howell Co., Chicago, and president of Consolidated Electrodynamics Corp., Pasadena, Calif., Bell & Howell subsidiary.

Connolly promoted to vice-presidency

John J. Connolly has been promoted to vice-president of Litton Systems, Inc., and general manager of the Data Systems Division, George T. Scharffenberger, executive vice-president of Litton Systems, announced recently. Mr. Connolly joined Litton in 1955 and has been associated with the company's data systems operations since their inception. During this time, he has held various management positions including that of manager of Litton's Data Processing and Process Control Department; manager of the Equipment Department, and more recently, director of the Data Systems Division.

VERY NARROW TO VERY WIDE

10 kc

400 mc

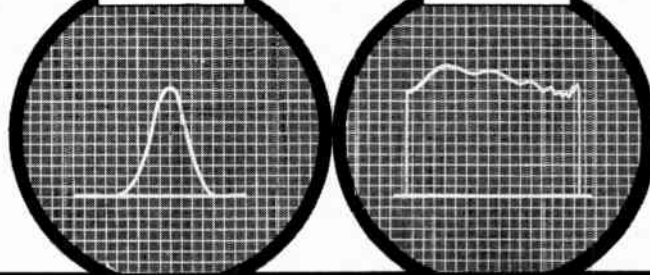

SWEEP WIDTHS *

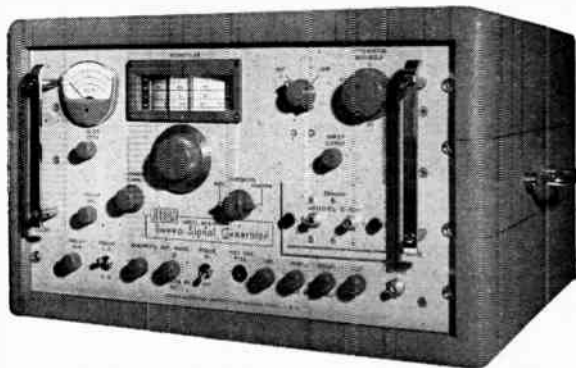

...ALL IN ONE INSTRUMENT

NEW

JERROLD® 900B

SWEEP SIGNAL GENERATOR

Here's the last word in versatility and precision, the ultimate instrument for all your IF-VHF-UHF requirements. The new Jerrold 900B offers unusual stability in sweep widths as narrow as 10 kc and as wide as 400 mc. Frequency range 500 kc to 1200 mc.

\$1980⁰⁰ f.o.b. Philadelphia**

*Illustration of scope at left shows typical communications receiver response 4 kc bandwidth at 7 mc. Illustration at right shows typical distributed amplifier response 2-220 mc.

**Prices and specifications subject to change without notice.

- Built-in crystal-controlled harmonic markers at 1, 10, and 100mc intervals.
- Each marker output individually controls from front panel.
- Built-in variable-gain dc-coupled scope preamplifier with 200X gain.
- Built-in precision attenuator from zero to 50db in 10db steps.
- Accurately calibrated frequency dial.
- High-level metered output.

Write for complete technical data.

JERROLD

ELECTRONICS (CANADA) LTD.

50 WINGOLD AVENUE, TORONTO 19

Jerrold Electronics Corporation, Industrial Products Division
Dept. ITE-120, The Jerrold Bldg., Phila. 32, Pa.

PRICES F.O.B. PHILADELPHIA — F.O.B. TORONTO PRICES ON REQUEST

*Prices and specifications subject to change without notice.

For complete details check No. 28 on handy card, page 69

product panorama

For further information on Products use Readers' Service Cards on pages 69 and 70

FM deviation monitor

Item 69

Model 400 FM deviation monitor, for both deviation and carrier shift measurements, has considerably greater accuracy, deviation

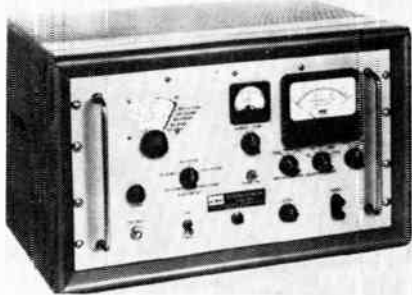

range and tuning range than previously available in one instrument. Coverage is continuous from 20 to 1000 mc, and full-scale ranges on the deviation meter are 10, 30, 100, 300 and 1000 kc (peak). Internal calibration corrects for long-term changes in meter circuitry. Accuracy is 2 per cent of FSD.

Tele-Radio Systems Ltd., 3633 Dundas St. W., Toronto 9, Ont.

Telephone click reducer

Item 70

Solitron's miniature "Varister" lasts 200,000 hours, and operates from -65° to $+175^{\circ}$ C. This is a new solid state telephone click reducer designed to replace existing copper oxide types. It contains double diffused silicon rectifications in a miniature hermetically-sealed package. The miniature Varister mounts easily by means of two eyelet leads. It's ideal for use in telephone headsets, control circuits and temperature sensing devices, the units are available for immediate delivery from 40 cents per unit.

R. D. B. Sheppard, P.Eng., 2036 Prince Charles Road, Ottawa 3, Ontario.

Dual channel plug-in

Item 71

This device provides DC to 500 KC bandwidth and 1 mv/cm maximum sensitivity on both channels. Designated type 300, the

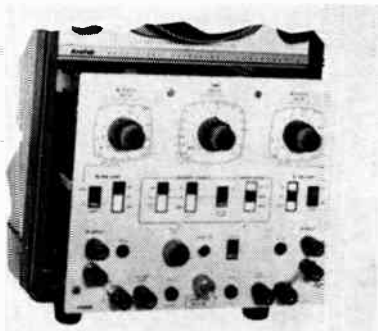

new unit is the fifth plug-in of a series designated for use with Analab's four currently available oscilloscope main frames. Selling for \$260, a trigger and sweep circuit are included, in addition to two amplifier channels. It provides single-ended or differential amplifier input, with high common mode rejection.

Radionics Ltd., 8230 Mayrand Street, Montreal 9, P.Q.

Auto radio replacement controls

Item 72

Four exact replacements for Bendix and Motorola auto radio controls have been added to the Centralab line. Model FB-59 is

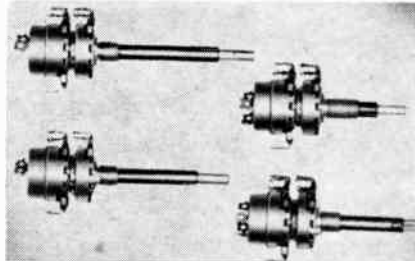

an exact replacement for Bendix controls used in 1959 Fords and Edsels. Model FM-59 is a Motorola replacement for 1959 Fords. Model RM-59-9 and RM-59 are Motorola replacements for the 1958 and 1959 Ramblers. These four units expand a line which is reportedly the most complete line of exact replacements auto radio controls.

Centralab Canada Ltd., P.O. Box 400, Ajax, Ont.

Solid state dynamotor replacement

Item 73

Designed to replace rotating equipment, this unit operates at one-third the cost per hour-of-life of a conventional dynamotor. It also has output ratings of 500 watts at 25° C ambient (5000 hours) and 500 watts at 85° C ambient (1000 hours) for any output voltage between 100 V DC to 2000 V DC, and 250 watts at 25° C ambient (5000 hours) at 85° C ambient (1000 hours) for any output voltage between 12 V DC to 100 V DC.

Radionics Ltd., 8230 Mayrand St., Montreal 9, P.Q.

Hollow-cathode discharge tubes

Item 74

Designed for atomic absorption spectroscopy these will analyze materials containing iron, copper, nickel, zinc, manganese,



magnesium, calcium, etc. The tubes feature low starting voltages, low operating voltage and stable current, the output spectral lines are narrow and steady after a short warm-up period. Five tube sizes are available as stock items, and special tubes may be had on request.

Canadian Westinghouse Company Ltd., Electronic Tube Division, Box 510, Hamilton, Ontario.

Type 567 readout oscilloscope

Item 75

Adding readout convenience to dual-trace applications the Tektronix device presents simultaneously an analog display on its 5"

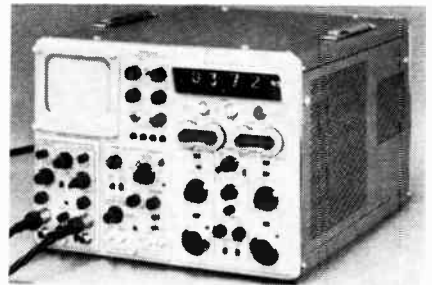

CRT with a digital presentation on the automatic computing programmer. One can select and intensify the actual points — for automatic normalization — on the CRT waveform which you wish to measure. Then you read directly the corresponding up-to-4-digit decimal units of actual measurement.

Tektronix, Inc., 3 Finch Avenue, Willowdale, Ontario.

85 watt silicon power transistors

Item 76

The 2N121 and 2N1208 are diffused junction NPN silicon transistors designed for high power switching and amplifier applications operating in the temperature range of -65° C to $+200^{\circ}$ C. Collector to emitter voltage and base voltage is 60 volts, emitter to base voltage is 10 volts, collector current is 5 amps, power dissipation at case temperature of 25° C is 85 watts, and at 100° C is 45 watts.

A.T.R. Armstrong Ltd., Box 38, Station D, Toronto 9, Ontario.

AC-DC panel meters

Item 77

Weston 1900 series of rectangular ac-dc panel meters now includes the new $3\frac{1}{2}''$ instruments, designated Model 1931. These

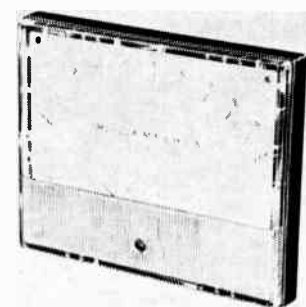

are available as ammeters, milliammeters, microammeters, and voltmeters. All are designed with optional one or two per cent accuracy, with a knife-edge pointer and mirror scale, and a lance type pointer and conventional scale, respectively. Front covers are available in either clear plastic or bakelite.

Daystrom Limited, 1480 Dundas Hwy. East, Cookeville, Ontario.

Continued on page 66

CRTB Newsletter *Continued from page 20*

or "Ad Hoc" committees to deal with special problems as was recently the case in the matter of General Services Band Radio specifications. New standing committees are organized as a need arises such as the General Utilities and Public Services Committee at present under consideration.

A heavy volume of work is handled by these committees involving many hours of careful consideration on the part of highly qualified technical personnel.

Constant Study

The work of the Board as a technical advisory body to the Telecommunications Branch of the Department of Transport is of major importance and the resulting value to the Canadian economy is of inestimable value.

The Board is constantly studying the changing state of the art and other committees will be appointed as the need arises. For example it may not be long before a committee on space electronics will be required.

The Board is constantly being asked for its suggestions and comments on Radio Standards Specifications and accordingly refers these to the appropriate committee for study and report.

Since its inception in 1944 the Board has carried out its difficult assignments in accordance with its constitution and in future years the work of the Board is bound to become increasingly important to all users and manufacturers of radio and allied equipment of all classes.

Application for membership in the Canadian Radio Technical Planning Board can be made by writing to the Secretary at 200 St. Clair Avenue West, Toronto 7, Ontario.

Join the SWITCH to GRAYHILL

— for Miniature Electrical and Electronic Components

When you switch to Grayhill you switch to the highest quality and precision standards in miniature parts . . . standards which Grayhill pioneered to meet the ever increasing demand for reduced size in electronic equipment without impairment of function or efficiency.

"N. Gineer"

A Switch to Grayhill . . . is reliability insurance.

Current Catalogue on Request

Represented in Canada by:
LAKE ENGINEERING CO. LTD.
123 Manville Rd., Scarborough, Ontario.
Phone: PLYmouth 7-3253

"PIONEERS IN MINIATURIZATION"
For complete details check No. 22 on handy card, page 69

PORTABLE REGULATED

DC POWER SUPPLY



Large Capacity
Low-priced

model L3501
6" x 8" x 8"

only
\$199⁵⁰

- Constant Voltage 0-35v, 0-1A.
- Constant Current 0-30v, 0-1A.
- Fully transistorized — regulated 5 mv. N.L. to F.L. or 10% line change.
- Remote programming & Current limiting.
- Ripple 250 microvolts rms.
- Several units may be paralleled.
- Transient response 50 microseconds.
- 150 other models available.

Universal Electronics

Represented by Electronic Marketing Co.
Montreal, P.Q., Canada

For complete details check No. 46

IRC NEW POWER METAL FILM RESISTORS

Features:

- non-inductive
- metal film stability
- solvent resistant coating

IRC, pioneer in the development of evaporated metal film resistors and the world's largest producer of these types, now makes available a new type of metal film for power resistors incorporating inherent stability and ability to withstand severe environmental conditions.

IRC "PFM" resistors are available now for the Canadian user in both three and four watt sizes. Soon to be manufactured in Canada — IRC "PFM" resistor will, because of its unique properties, prove to be the best low power resistor available.

For further detailed information and performance specifications, write for bulletin P-9.

(Actual Size)

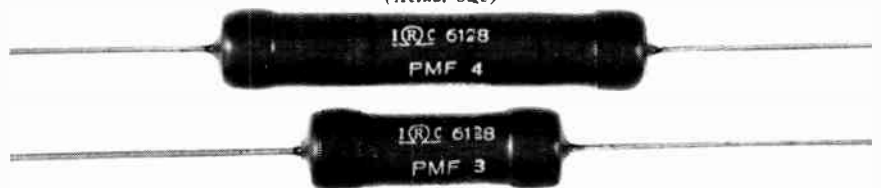

RESISTORS

Division of
RENFREW ELECTRIC CO. LTD.
349 Carlaw Ave., Toronto 6, Ontario

For complete details check No. 27 on handy card, page 69

product panorama

For further information on Products use Readers' Service Cards on pages 69 and 70

Multiple chart recorder

Item 78

Introduced into Canada recently were the range of Keinath K-Logger multiple recorder-annunciators. The K-Loggers are capable of simultaneously recording and displaying up to 400 variables on 100 separate charts, in four colors. The units produce continuous, two co-ordinate graphs indicating values of voltage, pressure, temperature,



rate of flow, Ph factor, liquid level, or any other desired variables.

Industrial Measurement Ltd., P.O. Box 115, Don Mills, Ontario.

High voltage tester

Item 79

Model E-9529 is one of the family of AC and DC dielectric strength test sets, or breakdown testers, which in addition to checking the failure of a specimen make pre-breakdown leakage tests on a microammeter incorporated in the instrument. A separate meter indicates the output voltage at all times. This permits non destructive tests as well as destructive tests. Output voltages are continuously adjustable and pilot lights and a circuit breaker assure maximum safety at all times to operator and equipment.

Canadian Research Institute, 85 Curlew Drive, Don Mills, Ontario.

Compact cooling fan

Item 80

Rotron products has a 60 cps model of the Propimax 2 fan available. It's slightly over 3" in diameter, 1½" deep and weighs 6½

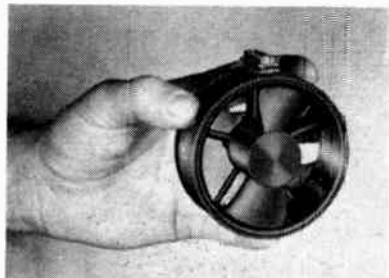

oz., yet moves 17.5 cfm under free delivery conditions. Material and finishes meet most applicable military specifications. Power required is .05 amperes at 115 volts; and the unit is physically and aerodynamically symmetrical, permitting reversing of air flow by merely turning end-for-end.

The Hoover Company Ltd., Box 128, Postal Station H, Hamilton, Ontario.

Portable Plastics Flogun®

Item 81

Injection moulding and extrusion of thermoplastic materials can be accomplished by a manually-operated machine. While it is a complete mobile system for the manipulation of thermoplastic materials, it also provides economic short-run production of thermoplastic items up to one full cubic inch capacity. The unit is designed to



operate from any 110/120 volt AC supply. A thermostatically-controlled heating element plasticizes the thermoplastic material in the barrel.

Northwest Industries Ltd., P.O. Box 517, Edmonton, Alta.

Cerafil capacitors

Item 82

Special ¼"-long cerafil capacitors are now available for potted circuits and other premium space applications such as used in sandwich-type circuit construction and other circuits where component length and/or diameter are highly critical. Units can be made as high as a 100 VDC rating. Capacity tolerance as low as +7½ per cent can also be achieved; -10 per cent to +20 per cent tolerance will cover most requirements. The unit comes either lacquer coated, durez coated or molded.

Aerovox Canada Ltd., 1551 Barton St. East, Hamilton, Ontario.

Cap-Pot potentiometer

Item 83

Priced at approximately \$2 in production quantities these Cap-Pot potentiometers feature a major breakthrough in cost for a

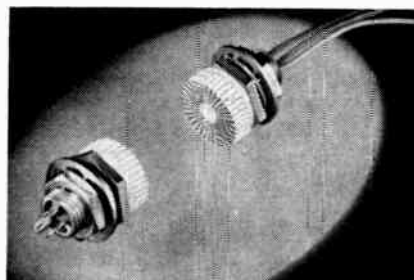

high-performance, completely sealed unit. It's ideal for trimming functions, has an unusual design with the wiper assembly mounted within the control knob, thus requiring minimum space behind panel, and permitting installation on pressurized equipment without expensive bellows bushings.

Tri-Tel Associates Ltd., 81 Sheppard Avenue West, Willowdale, Ontario.

Beryllium oxide heat sink evaluation kits

Item 84

The kits contain standard heat sinks to fit popular TO semiconductor sizes, packed in cushioning material in a convenient plastic case. Four different kits are available, each priced at \$18. The kits will allow evaluation of beryllia heat sinks in specific

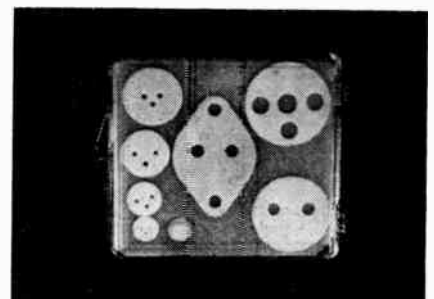

applications, comparisons with conventional dielectric materials, investigation of mounting methods, etc. Kits include technical data and samples.

Douglas Randall (Canada) Ltd., 126 Manville Road, Scarborough, Ontario.

Spring tension clips

Item 85

The 39 most-preferred National Aircraft Standards Committee type 1464 spring tension clips are now available from stock from the Birtcher Corporation/Industrial Division. The clips retain electronic components such as capacitors and resistors in diameters from 0.1" to 1.12". Materials are carbon steel or beryllium copper alloy. Tensile strength of the carbon steel clips ranges from 175,000 to 215,000 psi and beryllium copper alloy from 123,000 to 170,000 psi. Alternate finishes are cadmium plate, silver plate, nickel plate or tin plate.

Lake Engineering Co. Ltd., 123 Manville Road, Scarborough, Ontario.

Ultra-sensitive suspension type meter

Item 86

The Triplett meter is designed for high accuracy without friction error or suspension wire fatigue effect. It features good shock resistance. It is unharmed by surges many times normal full current. Special

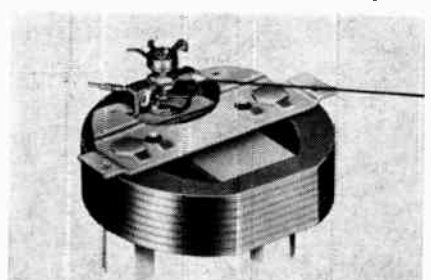

features include conical shaped spring anchors to provide maximum resilience for the taut suspension wire when the instrument is subjected to shock from any direction. Sizes range from 2½" to 8".

Len Finkler Ltd., 1794 Avenue Road, Toronto, Ont.

Continued on page 78

Defense industry barometer

DDP contract awards

Given below is a list of unclassified contracts for \$10,000 or more awarded to Canadian electronics companies by the Department of Defense Production during the month of August. Figures represent total dollar value of one or more contracts in each case. Rental of communications services is not included.

Firm	Item	Dollar Value
Alpha Aracon Radio Co. Ltd. Downsview, Ont.	capacitors, electronic components, and antenna tools	\$41,167
Ampex of Canada Ltd. Ottawa, Ont.	tape transport unit	\$10,621
Aviation Electric Ltd. Montreal, P.Q.	aircraft instruments	\$13,497
Bedard-Girard Ltd. Montreal, P.Q.	ship's service, local control and special service switchboards	\$96,653
Canadian Arsenals Ltd. Ottawa, Ont.	anti-jamming consoles	\$293,628
Canadian General Electric Co. Ltd. Toronto, Ont.	electronic components and tubes	\$122,524
Canadian Westinghouse Co. Ltd. Ottawa, Ont.	electronic tubes	\$75,337
Paul Chaput Ltee. Montreal, P.Q.	loudspeakers	\$14,549
Computing Devices of Canada Ltd. Ottawa, Ont.	electronic components and radio sets	\$366,088
Electronic Materials International Ltd. Ottawa, Ont.	electronic components	\$11,149
Field Aviation Co. Ltd. Ottawa, Ont.	harness spares and connectors	\$33,961
Anthony Foster & Sons Ltd. Toronto, Ont.	direction finder sets and equipment	\$56,415
Instronics Ltd. Stittsville, Ont.	electronic equipment	\$11,915
International Electric Co. Ltd. Montreal, P.Q.	tachometers	\$16,657
Joy Manufacturing Co. (Canada) Ltd. Galt, Ont.	cable assembly & connector plugs	\$23,547
Walter Kidde & Co. of Canada Ltd. Montreal, P.Q.	sensing elements	\$12,571
Lionel Electronic Laboratories Ajax, Ont.	maintenance spares for radiation equipment	\$13,175
Marsland Engineering Ltd. Kitchener, Ont.	mods. to range recorder	\$17,311
Northern Electric Co. Ltd. Ottawa, Ont.	communication equipment	\$25,653
Northern Radio Mfg. Co. Ltd. Ottawa, Ont.	frequency modulated voice frequency carrier telegraph terminal units	\$358,507
Patlon Aircraft of Canada Ltd. Toronto, Ont.	electronic components	\$21,822
Phillips Electrical Co. Ltd. Ottawa, Ont.	buried telephone cables and ancillaries	\$349,220
Picker X-ray Engineering Ltd. Toronto, Ont.	medical equipment	\$12,700
RCA Victor Co. Ltd. Ottawa, Ont.	unidirectional high frequency antennae	\$137,277
Railway & Power Engineering Corp. Ltd. Trenton, Ont.	aircraft instruments	\$112,977
Raytheon Canada Ltd. Waterloo, Ont.	radar sets, heat exchangers and prime power units	\$1,609,680
Renfrew Electric Co. Ltd. Renfrew, Ont.	coaxial adapter sets	\$13,927
Sperry Gyroscope Ottawa Ltd. Ottawa, Ont.	telephone sets	\$26,750
Sylvania Electronic (Canada) Ltd. Montreal, P.Q.	electronic tubes	\$81,200
TMC (Canada) Ltd. Ottawa, Ont.	electronic equipment	\$12,867
Valeriotte Electronics (Guelph) Ltd. Guelph, Ont.	antennae	\$13,209

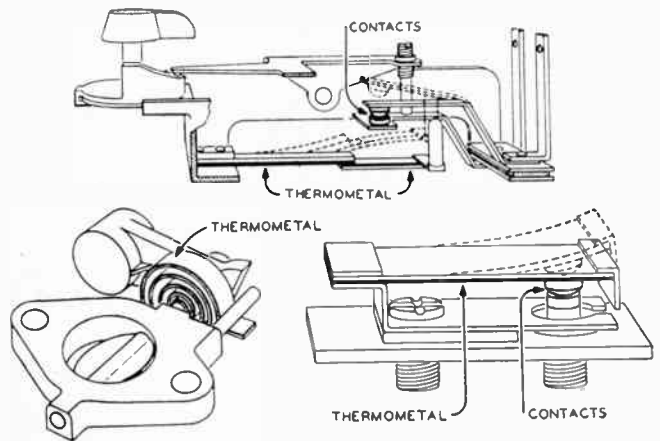

CONTROL TEMPERATURE, CURRENT AND VOLTAGE WITH THERMOMETAL®

Leading manufacturers rely on the dependable performance of Wilco Thermometal in electrical appliances, thermal cutouts, heating controls and many other applications involving the indication and accurate control of temperatures, electrical currents, voltages, etc. Thermometal is supplied in strip form, rolled and slit to close tolerances and tempered to specification. Thermometal elements and sub-assemblies are also supplied to specifications, with or without contacts attached. Send for literature.

ENGELHARD
INDUSTRIES OF CANADA, LTD.

512 King Street, East
Toronto, Ontario
Canada

SALES OFFICE: 660 St. Catherines St. West, Montreal, P.Q., Canada
For complete details check No. 20 on handy card, page 69

POLYPENCO plastic quality comes in all shapes

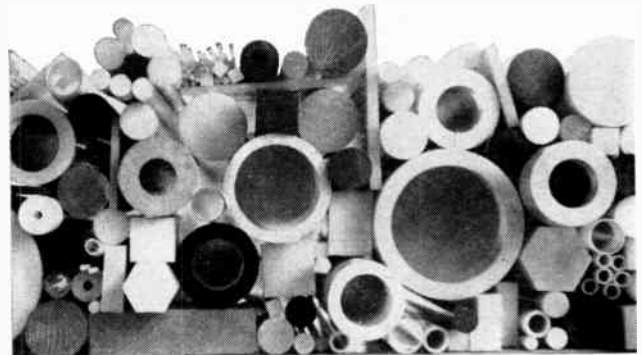

Nylon—rod, tubing, tubular bar, strip, plate, disc
NYLATRON—GS (moly sulphide filled)

MC† Nylon—economical, tough service nylon rod, tubular bar, plate in large sizes

TFE-fluorocarbon—rod, tubing, spaghetti tubing, tape, sheet, thin wall tubing

FLUOROSINT* TFE-fluorocarbon shapes and molded parts

Q-200.5 Penton*

Polycarbonate resin—mill shapes

NYLAFLOW‡ Nylon Tubing and Hose

Economical, POLYPENCO stock shapes and premium service nylons, TFE-fluorocarbons and other engineered industrial plastics are unmatched for consistent high quality... and they are available in the widest range of shapes and sizes obtainable anywhere.

POLYPENCO'S specialized engineering help offers you dependable, cost-saving production and end product economy. Local warehousing means immediate delivery. Detailed technical data and complete application information are available on all POLYPENCO materials and services

*Hercules Powder Company Trademark
†Polymer Corporation Trademark

Peckover's Limited: 115 McCormack St., Toronto

2052 St. Catherine St. W., Montreal

C. M. Lovsted & Co. (Canada) Ltd: Vancouver

POLYPENCO, INC.

2150 Fairmont Ave., Reading, Pa., U.S.A.



For complete details check No. 35 on handy card, page 69

G.E. makes semi-conductor diamonds and borazon

Methods have been discovered at the General Electric Research Laboratory which make it possible for the first time to produce semiconducting diamonds. Such diamonds are extremely rare in nature, accounting for less than one per cent of natural diamonds, but can now be grown at will using the high-temperature, ultra-high pressure process first developed at the Laboratory.



Semiconducting borazon, which is a cubic form of boron nitride and has a structure very similar to that of diamond has also been made successfully.

Diamonds are made semiconducting by adding impurities such as boron, beryllium or aluminum to the mixture of graphite and catalyst from which diamonds are made. The mixture is subjected to pressures of about 1 million pounds per square inch and temperatures above 2000°F. Under these conditions, diamonds form with concentrations of one per cent or less of the desired impurity, and have electrical conductivities in the semiconducting range.

Drs. Wentorf and Peter Common of the Research Laboratory have also prepared semiconducting diamonds by diffusing boron and aluminum into Man-Made or natural diamonds at high pressures and temperatures. All the semiconducting diamonds made so far have been p-type (positive current carriers). Both p-type and n(negative current carrier)-type crystals are necessary in transistors and other semiconducting devices, and a search for processes that will produce n-type diamonds is continuing.

In borazon, both p-type and n-type crystals can be produced, and one

type can be grown onto a "seed" of the other type to form p-n junctions. Beryllium as an impurity produces p-type borazon, and a number of substances including sulfur, silicon, many organic compounds, and potassium cyanide, when added to the synthesis mixture, result in n-type borazon.

400 management courses available in Canada

This year Canadian universities will offer businessmen a choice of over 400 part-time, non-degree courses in business subjects, according to *Management Education*, a new booklet prepared by the Small Business Branch, Domestic Commerce Services, Department of Trade and Commerce.

The booklet describes the conferences, seminars and short courses available on a part-time basis to business executives and supervisors. Included are the locations, names, dates and fees of these courses. Copies are available from the Editorial and Art Services Division, Trade Publicity Branch, Department of Trade and Commerce, Ottawa, Ont.

PYLONS SLASH POWER PLANT COSTS!



- RELIABLE STATIC DESIGN
- MINIMUM SPACE
- LARGE PRACTICAL CAPACITIES
- COMPLETE ENGINEERING DATA
- THOUSANDS NOW IN USE

PYLON MODEL	INPUT	OUTPUT
IN STOCK:		
CU-24	24V D.C.	48V D.C. @ 7.5A
CX-48P*	24/48V D.C.	{ 24V D.C. @ 10A { 130V D.C. @ 2.5A
CX-130/152A	130/152V D.C.	130/152V D.C. @ 6.0A
I-48A	{ 115V A.C. } { 24/48V D.C. }	115V A.C. @ 350VA
RG-1	24/48V D.C.	20C/S A.C. @ 20W
RTS-1	115V A.C.	20C/S A.C. @ 6W 24/48V D.C. @ 2A
IN PRODUCTION:		
CX-130/152F	130/152V D.C.	48V D.C. @ 15A
CX-130/152L	130/152V D.C.	24V D.C. @ 20A
I-48E	24/48V D.C.	115V A.C. @ 420VA

*With built-in circuitry for parallel operation. Exact replacement for former CX-48-A-1 and CX-48-B-1.

Write for further details to:



PYLON ELECTRONIC DEVELOPMENT company, Ltd.

Communications Systems and Equipment

161 CLEMENT ST., LASALLE, MONTREAL 32, QUE.

For complete details check No. 31 on handy card, page 69

APPLICATION FOR FREE SUBSCRIPTION

TECHNICAL LITERATURE BRIEFS

Comparative data on capacitors: a four-page bulletin (No. 2-61), providing a complete comparison of the Arco polystyrene dielectric capacitors with other dielectrics normally used in the same capacitance range, was issued by **Arco Electronics, Inc., Community Drive, Great Neck, N.Y.**

Item 95

Low cost, general purpose relays: an entirely new line of relays featuring simple, uncomplicated, rugged construction and offering unusual flexibility for making connections or mounting, is described in Bulletin 166 available from **Ohmite Manufacturing Company, 3653 Howard Street, Skokie, Illinois.**

Item 96

Three short form catalogs: "Semiconductor Products" (61-MS) describes microwave silicon diodes, varactors and computer diodes; "Microwave Components Division" (61-WS) lists waveguide components, test equipment, and custom engineered microwave assemblies; "Microwave Tubes and Devices" (61-TD) has information on duplexer tubes, magnetrons, ferrite devices, solid state coaxial limiters, switches, and duplexers; all available from **Department HE, Microwave Associates, Inc., South Avenue, Burlington, Mass.**

Item 97

Silicon semiconductor strain gage pressure transducer: an eight-page illustrated brochure describing the design and performance of this line is available from **Fairchild Controls Corporation, 119 Park Avenue, Hicksville, Long Island, New York.**

Item 98

Circuit blocks: 72-page brochure describes comprehensive range of circuit blocks for electronic digital systems. Profusely illustrated with photos and technical drawings. **Philips Electronics Industries Ltd., 116 Vanderhoof Avenue, Toronto 17, Ontario.**

Item 99

Silicone fluids: 30-page technical reference describes the broad range of major silicone fluids, covering hydraulic and damping fluids, dielectric and lubricants, antifoam agents, coatings for ceramics and glass, additives in urethane foams, water repellents, etc. **Canadian General Electric Co., Ltd., 214 King Street West, Toronto, Ontario.**

Item 100

Power supplies: simple and exact specification of power supplies to match required output, input, frequency range and other parameters, is included in this 16-page catalog covering hundreds of models produced by **NJE Corp., Kenilworth, N.J. Radionics Limited, 8230 Mayrand Street, Montreal 9, P.Q.**

Item 101

Development progress report: "Development in Attenuation Measurements and Standards" by Bruno O. Weinschel, a specialist in the microwave precision measurements field, is available from **Weinschel Engineering, Kensington, Maryland. Allan Crawford Associates, Ltd., 5590 Yonge St., Willowdale, Ontario.**

Item 102

Permanent heaters: catalog No. 112HH describes improved and enlarged line of permanent heaters, and heater installation. Copies available on request. **Canadian Armature Works, Inc., 6595 Urbain Street, Montreal 14, P.Q.**

Item 103

Remotely actuated display unit: described in bulletin 3.4C. Each unit has 50 2 1/2"-high numbers silk screened onto a frosted glass plate. Behind the plate are six lights, each with a different color filter for indicating the status of the car represented by the number. The lights are controlled by remote status switches. **Litton Systems (Canada) Ltd., 165 Sparks Street, Ottawa, Ontario.**

Item 104

Please **ADD** my name to receive **ELECTRONICS & COMMUNICATIONS**

Please **CHANGE** my address for mailings.

Note — Card must be completed in full to be valid.

My Name (Please Print)

Mail copies to my home, or business address as noted below.

Street
City **Zone** **Province**

If you have recently **CHANGED** your address please note former address here:

Company **Nature of Business**
 (State, when applicable, whether electronic equipment or components are manufactured, sold, or used in manufacturing, etc.)

ARE YOU AN ENGINEER? Yes No

Signature **Position**
 10-61

BUSINESS REPLY CARD
 No Postage Stamp Necessary if Mailed in Canada



5c POSTAGE WILL BE PAID BY

ELECTRONICS AND COMMUNICATIONS

450 Alliance Avenue

Toronto 9, Ontario



PLEASE SEND FURTHER INFORMATION ON FOLLOWING ITEMS AS NUMBERED BELOW. (All Literature & Product items Numbered)

- | | | | | | | | | | | | |
|------------------------------|-----------------------------|-----------------------------|-----------------------------|-----------------------------|-----------------------------|-----------------------------|-----------------------------|------------------------------|------------------------------|------------------------------|------------------------------|
| <input type="checkbox"/> 68 | <input type="checkbox"/> 69 | <input type="checkbox"/> 70 | <input type="checkbox"/> 71 | <input type="checkbox"/> 72 | <input type="checkbox"/> 73 | <input type="checkbox"/> 74 | <input type="checkbox"/> 75 | <input type="checkbox"/> 76 | <input type="checkbox"/> 77 | <input type="checkbox"/> 78 | <input type="checkbox"/> 79 |
| <input type="checkbox"/> 80 | <input type="checkbox"/> 81 | <input type="checkbox"/> 82 | <input type="checkbox"/> 83 | <input type="checkbox"/> 84 | <input type="checkbox"/> 85 | <input type="checkbox"/> 86 | <input type="checkbox"/> 87 | <input type="checkbox"/> 88 | <input type="checkbox"/> 89 | <input type="checkbox"/> 90 | <input type="checkbox"/> 91 |
| <input type="checkbox"/> 92 | <input type="checkbox"/> 93 | <input type="checkbox"/> 94 | <input type="checkbox"/> 95 | <input type="checkbox"/> 96 | <input type="checkbox"/> 97 | <input type="checkbox"/> 98 | <input type="checkbox"/> 99 | <input type="checkbox"/> 100 | <input type="checkbox"/> 101 | <input type="checkbox"/> 102 | <input type="checkbox"/> 103 |
| <input type="checkbox"/> 104 | | | | | | | | | | | |

PLEASE SEND FURTHER INFORMATION ON THE FOLLOWING ADVERTISEMENTS AS NUMBERED BELOW. (Key numbers in column overleaf)

- | | | | | | | | | | | | |
|-----------------------------|-----------------------------|-----------------------------|-----------------------------|-----------------------------|-----------------------------|-----------------------------|-----------------------------|-----------------------------|-----------------------------|-----------------------------|-----------------------------|
| <input type="checkbox"/> 1 | <input type="checkbox"/> 2 | <input type="checkbox"/> 3 | <input type="checkbox"/> 4 | <input type="checkbox"/> 5 | <input type="checkbox"/> 6 | <input type="checkbox"/> 7 | <input type="checkbox"/> 8 | <input type="checkbox"/> 9 | <input type="checkbox"/> 10 | <input type="checkbox"/> 11 | <input type="checkbox"/> 12 |
| <input type="checkbox"/> 13 | <input type="checkbox"/> 14 | <input type="checkbox"/> 15 | <input type="checkbox"/> 16 | <input type="checkbox"/> 17 | <input type="checkbox"/> 18 | <input type="checkbox"/> 19 | <input type="checkbox"/> 20 | <input type="checkbox"/> 21 | <input type="checkbox"/> 22 | <input type="checkbox"/> 23 | <input type="checkbox"/> 24 |
| <input type="checkbox"/> 25 | <input type="checkbox"/> 26 | <input type="checkbox"/> 27 | <input type="checkbox"/> 28 | <input type="checkbox"/> 29 | <input type="checkbox"/> 30 | <input type="checkbox"/> 31 | <input type="checkbox"/> 32 | <input type="checkbox"/> 33 | <input type="checkbox"/> 34 | <input type="checkbox"/> 35 | <input type="checkbox"/> 36 |
| <input type="checkbox"/> 37 | <input type="checkbox"/> 38 | <input type="checkbox"/> 39 | <input type="checkbox"/> 40 | <input type="checkbox"/> 41 | <input type="checkbox"/> 42 | <input type="checkbox"/> 43 | <input type="checkbox"/> 44 | <input type="checkbox"/> 45 | <input type="checkbox"/> 46 | <input type="checkbox"/> 47 | <input type="checkbox"/> 48 |
| <input type="checkbox"/> 49 | <input type="checkbox"/> 50 | <input type="checkbox"/> 51 | | | | | | | | | |

Name **Position**

Company

Street **City** **Prov.**

10-61

BUSINESS REPLY CARD
No Postage Stamp Necessary if Mailed in Canada

5c POSTAGE WILL BE PAID BY



INDEX TO ADVERTISERS

Page number is on the right. Key number for use with READER SERVICE CARD is on the left.

Key No.	Page No.
1.	Adcola Products Ltd. 81
2.	Airtron Canada Ltd. 71
3.	Alpha Aracon Radio Co. Ltd. 75
4.	American Electrical Heater Co. 73
5.	Amphenol Canada Ltd. 79
6.	Associated Research, Inc. 72
7.	Automatic Electric Sales (Canada) Ltd. 15
8.	Automatic Electric Sales (Canada) Ltd. IBC
9.	Bach-Simpson Ltd. 26
10.	Bourns, Inc. 9
11.	Brady of Canada Ltd., W. H. 72
49.	Canadian Electrical Supply Co. Ltd. 19
12.	Canadian Marconi Co. 3
13.	Cannon Electric Canada Ltd. 7
14.	Christie Electric Corp. 79
15.	Crawford Associates Ltd., Allan 60
16.	Daystrom Ltd. (Heath Division) 81
15.	E-H Research Laboratories Inc. 60
17.	Edo (Canada) Ltd. 76
13.	Eldon Industries of Canada 27
19.	Electronic Research & Development Co. Ltd. 61
20.	Engelhard Industries of Canada Ltd. 67
48.	Federal Electric Corp. 74
21.	Ferranti-Packard Electric Ltd. 71
22.	Grayhill, Inc. 65
23.	Hewlett-Packard Co. 22-23
24.	Hewlett-Packard Co. OBC
25.	Honeywell Controls Ltd. 18
26.	Hunt Co., Philip A. 27
27.	I.R.C. Resistors Div., Renfrew Electric Co. Ltd. 65
23.	Jerrold Electronics (Canada) Ltd. 63
29.	Litton Industries (Electron Tube) IFC
30.	Marsland Engineering Ltd. 30
32.	Northern Electric Co. Ltd. 8
33.	Northern Electric Co. Ltd. 31
34.	Northern Electric Co. Ltd. 4
51.	Payette Radio Ltd. 78
35.	Polypenco Inc. 67
36.	Porter Co. (Canada) Ltd., H. K. 21
37.	Potter & Brumfield Div. of AMF Canada Ltd. 12-13
50.	Pylon Electronic Development Co. 68
38.	R-O-R Associates Ltd. 28
39.	R-O-R Associates Ltd. 29
40.	Raytheon Canada Ltd. 6
41.	Sarkes Tarzian Inc. 58
42.	Stark Electronic Industries Ltd. 17
43.	Stark Electronic Industries Ltd. 81
44.	Tektronix, Inc. 14
45.	Universal Electronics 65
47.	Westmore, Inc. 32

ELECTRONICS AND COMMUNICATIONS

450 Alliance Avenue

Toronto 9, Ontario

PLEASE SEND FURTHER INFORMATION ON FOLLOWING ITEMS AS NUMBERED BELOW. (All Literature & Product items Numbered)

- | | | | | | | | | | | | |
|------------------------------|-----------------------------|-----------------------------|-----------------------------|-----------------------------|-----------------------------|-----------------------------|-----------------------------|------------------------------|------------------------------|------------------------------|------------------------------|
| <input type="checkbox"/> 68 | <input type="checkbox"/> 69 | <input type="checkbox"/> 70 | <input type="checkbox"/> 71 | <input type="checkbox"/> 72 | <input type="checkbox"/> 73 | <input type="checkbox"/> 74 | <input type="checkbox"/> 75 | <input type="checkbox"/> 76 | <input type="checkbox"/> 77 | <input type="checkbox"/> 78 | <input type="checkbox"/> 79 |
| <input type="checkbox"/> 80 | <input type="checkbox"/> 81 | <input type="checkbox"/> 82 | <input type="checkbox"/> 83 | <input type="checkbox"/> 84 | <input type="checkbox"/> 85 | <input type="checkbox"/> 86 | <input type="checkbox"/> 87 | <input type="checkbox"/> 88 | <input type="checkbox"/> 89 | <input type="checkbox"/> 90 | <input type="checkbox"/> 91 |
| <input type="checkbox"/> 92 | <input type="checkbox"/> 93 | <input type="checkbox"/> 94 | <input type="checkbox"/> 95 | <input type="checkbox"/> 96 | <input type="checkbox"/> 97 | <input type="checkbox"/> 98 | <input type="checkbox"/> 99 | <input type="checkbox"/> 100 | <input type="checkbox"/> 101 | <input type="checkbox"/> 102 | <input type="checkbox"/> 103 |
| <input type="checkbox"/> 104 | | | | | | | | | | | |

PLEASE SEND FURTHER INFORMATION ON THE FOLLOWING ADVERTISEMENTS AS NUMBERED BELOW.

- | | | | | | | | | | | | |
|-----------------------------|-----------------------------|-----------------------------|-----------------------------|-----------------------------|-----------------------------|-----------------------------|-----------------------------|-----------------------------|-----------------------------|-----------------------------|-----------------------------|
| <input type="checkbox"/> 1 | <input type="checkbox"/> 2 | <input type="checkbox"/> 3 | <input type="checkbox"/> 4 | <input type="checkbox"/> 5 | <input type="checkbox"/> 6 | <input type="checkbox"/> 7 | <input type="checkbox"/> 8 | <input type="checkbox"/> 9 | <input type="checkbox"/> 10 | <input type="checkbox"/> 11 | <input type="checkbox"/> 12 |
| <input type="checkbox"/> 13 | <input type="checkbox"/> 14 | <input type="checkbox"/> 15 | <input type="checkbox"/> 16 | <input type="checkbox"/> 17 | <input type="checkbox"/> 18 | <input type="checkbox"/> 19 | <input type="checkbox"/> 20 | <input type="checkbox"/> 21 | <input type="checkbox"/> 22 | <input type="checkbox"/> 23 | <input type="checkbox"/> 24 |
| <input type="checkbox"/> 25 | <input type="checkbox"/> 26 | <input type="checkbox"/> 27 | <input type="checkbox"/> 28 | <input type="checkbox"/> 29 | <input type="checkbox"/> 30 | <input type="checkbox"/> 31 | <input type="checkbox"/> 32 | <input type="checkbox"/> 33 | <input type="checkbox"/> 34 | <input type="checkbox"/> 35 | <input type="checkbox"/> 36 |
| <input type="checkbox"/> 37 | <input type="checkbox"/> 38 | <input type="checkbox"/> 39 | <input type="checkbox"/> 40 | <input type="checkbox"/> 41 | <input type="checkbox"/> 42 | <input type="checkbox"/> 43 | <input type="checkbox"/> 44 | <input type="checkbox"/> 45 | <input type="checkbox"/> 46 | <input type="checkbox"/> 47 | <input type="checkbox"/> 48 |
| <input type="checkbox"/> 49 | <input type="checkbox"/> 50 | <input type="checkbox"/> 51 | | | | | | | | | |

Name	Position	
Company		
Street	City	Prov.
10-61		

BUSINESS REPLY CARD
No Postage Stamp Necessary if Mailed in Canada

5c POSTAGE WILL BE PAID BY



ELECTRONICS AND COMMUNICATIONS

450 Alliance Avenue

Toronto 9, Ontario



electronics



PUNCHED TAPE HANDLING EQUIPMENT

This high speed paper tape reader was developed, designed and manufactured to read information into an airborne computer at 200 characters per second — one more of the many digital components and systems originating at Ferranti-Packard.

LET FERRANTI-PACKARD PUT ELECTRONICS TO WORK FOR YOUR PROFIT

- Magnetic storage drums
- High speed paper tape readers
- Remote control and telemetering systems
- Reservations systems
- Document sortation systems
- Data display systems
- Data processing systems
- Engineering computation facilities

We continually seek competent engineers and scientists for development, design and production work. Contact our Personnel Manager.

FERRANTI-PACKARD ELECTRIC LIMITED



**ELECTRONICS
DIVISION**
TORONTO 15,
ONTARIO

4107

For complete details check No. 21

ELECTRONICS AND COMMUNICATIONS, October, 1961

EIA News *Continued from page 13*

Express Satisfaction With TV Sales — Up 4.1 Per Cent

The Board of Directors has expressed satisfaction with the report that member manufacturers' sales of television receivers for the first seven months of 1961 were 4.1 per cent ahead of the same period last year.

The rise in demand is expected to continue.

Further optimism is expressed as a result of members' reports of increased export business.

General Manager Fred W. Radcliffe said that "the growing use of electronics in the control and operation of all major industries is an added reason why the members of EIA are facing the immediate future with a buoyant confidence."

A Universal Problem

Robert C. Sprague, Chairman of the Electronic Industries Association of United States Imports Committee, says that Canada is an example of what can happen when an electronics market, which lacks the cushioning effect of large-scale defense buying, is invaded by imports from low-labor-rate countries.

Mr. Sprague was speaking in Washington to a House Subcommittee studying the import impact on employment. Increasing imports of this kind in the U.S. would contract the electronics industry at a time when it should be growing to alleviate unemployment problems in other industries, he said.

New Standards Distributed

Member company engineers have received three new EIA standards: RS-243 defines the Color Coding for Stereo Pick-up Leads; RS-206A outlines the Recommended Practice for Preparation of Basing or Terminal Diagrams, and RS-241 is the EIA-NEMA Standards on Outlines for Semiconductor Devices.

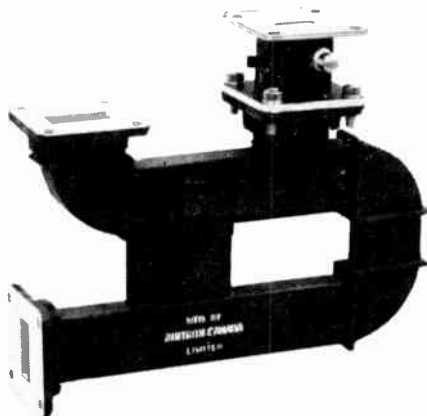

MADE IN CANADA

Specifications:

1. 5% band width C band and above.
2. Isolation between decoupled arms 20 db minimum.
3. VSWR 1.20 on all arms.
4. Insertion loss .5 db maximum.

FERRITE TEE CIRCULATOR

This economical and versatile unit can be made in various configurations and combinations to meet your microwave requirements. Used singly a very economical duplexer can be made. Used in tandem (as illustrated) a duplexer with excellent antenna to magnetron isolation can be obtained.

AIRTRON

CANADA LIMITED
Renfrew, Ontario

For complete details check No. 2 on handy card, page 69

MICRO-MINIATURE COMPONENT MARKERS

ACTUAL SIZE OF MARKERS

for resistors, diodes, capacitors, transistors. Serial numbers, color stripes, insulator wraps. Complete . . . legible . . . positive. Self-sticking. Hundreds of stock markers. Specials to order.

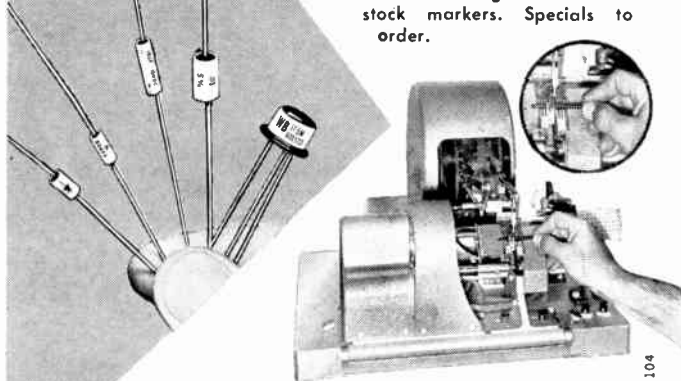

AUTOMATICALLY APPLIED

by Brady MARKERMATIC Automatic Marking Machine. Wraps or flags wires or components with Brady Markers at speeds to 1000 per hour. Accurate. Easy to operate.

Write for information and free Micro-Miniature Markers samples:

W. H. BRADY CO., of Canada Ltd., 1422 Kipling Ave. N., Rexdale, Ont. TORONTO: 249-8531 MONTREAL: RE. 9-5182

Manufacturers of Quality Pressure-Sensitive Industrial Tape Products, Self-Bonding Nameplates, Automatic Machines for Dispensing Labels, Nameplates, Masks and Tape EST. 1914

For complete details check No. 11 on handy card, page 69

.. HIGH VOLTAGE TESTING of Electronic Cables, Components, Materials and Completed Assemblies



Measures Dielectric Strength Insulation Resistance Dielectric Absorption

Mobile D-C HYPOT™

Rugged . . . Mobile . . . for Production, Installation and Maintenance Testing

Output . . . 120 kv models provide up to 5000 microamperes d-c., 75 and 45 kv models to 10 ma, 4-c.

115v A-C Line . . . Input through three-conductor power cord with two prong plug and grounding clip.

Self-Contained, Fully Portable . . . Single mobile housing with rubber tired wheels and push handle contains metering circuitry and high voltage supply.

Safe, Simple Operation . . . Direct reading of insulation leakage current. Fully interlocked, cabinet grounded, output cable shielded.

Write for Manual J-67

"Methods for Insulation Testing . . . Engineering . . . Production . . . Maintenance"

4-35.8 a

ASSOCIATED RESEARCH, Incorporated
"Electrical Testing Instruments Since 1926"

3741-C W. BELMONT AVE., CHICAGO 18, ILLINOIS
W. Hobson & Assoc., 1024 Notre Dame St., Lachine, Quebec
George M. Fraser, Ltd., 1544 Yonge St., Toronto 7, Ont.

For complete details check No. 6 on handy card, page 69

Nuclear Radiation Detectors

Continued from page 52

Figure 1a illustrates the three basic ways in which electro-magnetic radiation in the form of X-rays or gamma rays interacts with matter to give energetic electrons which in turn excite the detection medium, while figure 1b gives comparable data for neutrons. Numerical data are given in Tables 1a and 1b.

Charged particles lose energy by collision processes which result in ionisation or excitation, by radiative

TABLE 2
CHARGED PARTICLES

Particle of charge ze and velocity βc in matter of atomic number Z and atomic weight A loses energy by collision processes at rate dE/dx , given by:

$$\frac{dE}{dx} = -0.314 \frac{Zz^2}{A\beta^2} \log \frac{1.02\beta^2}{ZI(1-\beta^2)} \cdot \beta^2 \text{ MeV per gm.cm}^{-2}$$

I is average excitation energy per electron and is ca. 1105×10^{-6} MeV.

Minimum energy loss is ca. 2 MeV/gm.cm^{-2} at $\beta \sim 0.98$ for $z=1$.

Radiation energy loss (Bremsstrahlung) is approximately:

$$\frac{dE}{dx} = -\frac{0.15}{A} \frac{m}{M} \frac{Z^2}{\sqrt{1-\beta^2}} \text{ MeV/gm.cm}^{-2} \text{ for a particle of mass } M$$

(Electron mass is m)

Cerenkov radiation is emitted by a particle of velocity βc and charge ze moving through a medium of refractive index ν , in a conical wave front at an angle θ to the direction of the particle.

The intensity of light of frequency f over a bandwidth df is:

$$\frac{z^2 2\pi \sin^2 \theta}{137c} df \text{ photons per cm where } \cos^{-1} 1/\nu\beta$$

for the visible spectrum, Intensity = $450 \sin^2 \theta$ photons/cm in glass of $\nu = 1.5$

RANGES OF PARTICLES IN ALUMINIUM

Electrons	E (MeV)	0.01	0.1	1.0	10
	R g/cm ²	0.00027	0.013	0.45	5.2
Protons	E (MeV)	2	18	73	340
	R g/cm ²	0.01	0.48	5.76	79.5
Alphas	E (MeV)	5.3	7.7	73	
	R g/cm ²	0.0058	0.011	0.5	
Fission fragments	Light fragment				
	R = 4.25 mg/cm ²				
	Heavy fragment				
	R = 3.6 mg/cm ²				

processes, (Bremsstrahlung) and by the production of Cerenkov radiation, which is ultra-violet and visible light not produced by fluorescent but by a more fundamental process. These are summarized in Table 2, which also gives the ranges of charged particles in aluminium.

Useful detection media comprise gases and certain solids, in which ionisation occurs: phosphors of various kinds, in which light is produced, (and also Cerenkov radiators), this light in turn being used to produce photo-electrons from the cathode of a Photomultiplier tube, and secondary emitting surfaces, giving off a few electrons under the impact of the particle. Data on these are given in Table 3, which indicates the amount of energy abstracted from the primary energetic particle in producing one unit electron charge in the detector, for ionisation and scintillation detectors and gives the secondary emission co-efficient for the third class of detector.

Industry's business

Continued from page 29

Admiral chalks up biggest August in years

For the first time in five years, Canadian Admiral Corporation Ltd., Port Credit, Ont., is back-ordered on a variety of TV models as a result of a tremendous increase in August TV set sales.

Stuart B. Brownlee, president of the company, said last month's heavy TV sales set something of a record for this time of year, exceeding August sales predictions by well over 20 per cent. "We have not seen such an upturn in sales since the mid-fifties," Mr. Brownlee said. "It looks like our predictions at Admiral's June sales meetings are now coming true — the TV replacement and second set market is growing fast from coast-to-coast."

Brownlee said the increased sales of Admiral products are nation-wide and are not just a result of increased pre-tax (Provincial) sales in Ontario. In fact, Ontario sales in the first week of September are well above last year's figures.

Raytheon-Canada Ltd. wins \$2,286,751 contract award

The award of a \$2,286,751 contract to produce counter-mortar radars for the Canadian Army to Raytheon-Canada, Ltd., Waterloo, Ont., was released recently.

John R. Cann, president of the Canadian electronic firm stated the equipment has proven outstanding in performance during recent Canadian Army field trials.

Initial design of the AN/MPQ-501 radar was done by the National Research Council of Canada as a development for the Canadian Army. Modifications incorporating many design improvements together with product engineering will be performed by Raytheon-Canada, Ltd.

President of IHFM to address Canadian High Fidelity Exposition group

Raymond V. Pepe, president of the Institute of High Fidelity Manufacturers, Inc., of New York City, will address the 1961 Pre-Exposition opening of the Dominion High Fidelity Association show in Toronto at the Exhibitor-Dealer reception and dinner



The Foxboro Company, Ltd., Montreal, P.Q., are planning a \$600,000 addition to the existing plant.

to be held on Tuesday evening, October 17, in the Convention Banquet Room of the Seaway Hotel, Sunnyside, Toronto, which will house this year's high fidelity music and stereo exhibits.

Show Manager, John T. Rochford, reports that over 40 rooms have been sold to exhibitors who will occupy the first and second floors of the Seaway Hotel to display the latest in high fidelity and stereo complete packaged units and components.

An innovation at the Toronto Exposition is the opening of exhibit rooms from 10:00 a.m. to 2:00 p.m. daily Oct. 18-20, for the exclusive admission of dealers who will be given free badges of admission good anytime during the show.

Foxboro to expand Montreal instrument plant

Plans for a \$600,000 addition to the Montreal plant of The Foxboro Company, Ltd., were announced by J. H. Bolton, managing director. Contracts have been signed and actual construction will start soon on the firm's 12-acre site. It is expected the building will be ready for occupancy early next Spring.

The new two-story structure will give the plant a total of 110,000 square feet, permitting a substantial increase in the production of Foxboro instruments supplied to the process industries of Canada and to export markets as well.

Continued on page 74

Wassco[®] GLO-MELT RESISTANCE SOLDERING



... for Perfect
lead-to-pin joints
on All sizes of A/N
and similar connections

Wassco[®] GLO-MELT

... for Fast-Efficient
Accurate-Permanent
connections.

209-B

POWER UNITS • HANDPIECES • ACCESSORIES
for all jobs from Micro-Miniature to Heavy-Current connectors

WRITE FOR DESCRIPTIVE LITERATURE, PRICES AND NEAREST DISTRIBUTOR

Wassco[®] GLO-MELT DIVISION
AMERICAN ELECTRICAL HEATER COMPANY
DETROIT 2, MICHIGAN



For complete details check No. 4 on handy card, page 69

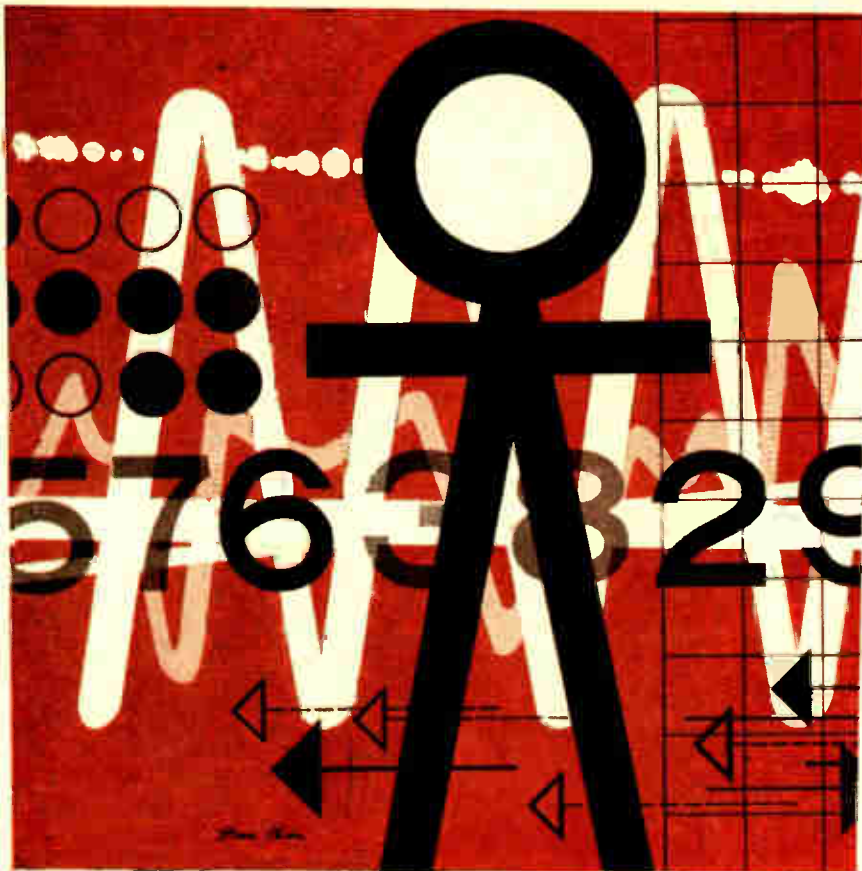

ELECTRONICS TECHNICIANS

EARN HIGH REWARD — ENJOY NEW ADVENTURES

To qualified, experienced communications and radar technicians who would like to gain priceless experience while earning high pay on a technically interesting assignment, Federal Electric Corporation offers immediate employment on the DEW Line. You will join one of Federal's highly skilled teams of technicians and engineers responsible for effective operation of this vast network of advanced electronic systems.

First, you will receive an intensive 12 to 15 week training course in the U. S. Then you will serve 15 months at a selected DEW Line site. While in training you will receive an excellent salary and expenses. On DEW Line, you will earn \$195 per week, based on a 54-hour week, plus free room and board. Upon completion of your assignment, you will receive a substantial bonus. All compensation subject to Canadian income tax.

You can qualify for employment if you have at least a Technical School diploma (military or civilian) and have two years' current maintenance experience in: COMMUNICATIONS — carrier, multiplex, scatter propagation, VHF or UHF; or RADAR — ground systems or warning systems.

Applicants are requested to send a resume of their training and experience to Mr. I. L. White.

FEDERAL ELECTRIC CORPORATION

Service Division of International Telephone and Telegraph Corporation
Winnipeg International Airport, Winnipeg, Manitoba



An equal opportunity employer.

For complete details check No. 48 on handy card, page 69

Industry's business

Continued from page 73

Chemical engineering program planned for Edmonton

Five special sessions are being planned by the Chemical Engineering Division of The Chemical Institute of Canada for the Institute's 45th Canadian Chemical Conference and Exhibition, May 27-30, 1962, at the Macdonald Hotel, Edmonton, Alberta.

These sessions will be on: natural gas and petrochemical industries; extractive mineral industries; the pipeline flow of complex systems; automation in the chemical and petroleum industry; and the role of research in Canadian industry. In addition there will be a general session on the selected aspects of heat transfer, mass transfer, chemical engineering thermodynamics and applied reaction kinetics.

In charge of the chemical engineering program is Dr. D. B. Robinson, head, department of chemical and petroleum engineering, University of Alberta, Edmonton. Prospective authors of papers should submit titles to Dr. Robinson by Oct. 31, 1961.

Dow Chemical produces chlorothene

Engineering has begun for the production of chlorothene by Dow Chemical of Canada, Limited, Sarnia, Ont.

Chlorothene is a general purpose solvent with broad industrial applications especially as a cleaner and degreaser of electrical and electronic components. Developed by Dow Chemical, the product has gained acceptance by consumers due to its unique combination of high solvency and excellent safety properties.

FORTHCOMING MEETINGS

Interplanetary Spaceflight Symposium sponsored by CAI (Astronautical Section), CAS, UTIA and the David Dunlap Observatory, University of Toronto, will be held in the Lecture Room, UTIA, Dufferin and Steeles, Toronto, on October 26-27. Sessions begin 9.30 a.m. Prominent Canadian and U.S. speakers, social events.

American Society of Tool and Manufacturing Engineers 29th Semi-Annual Meeting will be on October 26-27, 1961, in the Royal York Hotel, Toronto, Ontario; the theme of the meeting is "Economy in Manufacturing".

The American Society For Quality Control, Montreal Section, Fifth Annual All-Day Forum to be held at Ecole Polytechnique, Montreal, P.Q., October 28, 1961; four concurrent programs entitled Basic Concepts, Practical Applications, Advanced Methods and Management Problems will expand the theme of Quality Control Increases Productivity.

The Chemical Institute of Canada, Chemical Engineering Division, will meet November 6-8, at the Royal York Hotel, Toronto, Ontario.

RCA Victor engineer wins top British award

A member of the engineering staff at RCA Victor in Montreal was awarded the highest honor for a technical article by the Society of Licensed Aircraft Engineers. Meeting in London, England, on June 3rd, the Society awarded the 1960 Gold Badge to P. Hobley, AMSLAE, presently manager of the Instrument Services Department of RCA Victor.

Awarded annually for the most outstanding paper published in the Society's journal, this is the first time it has gone to a member resident outside Great Britain. Mr. Hobley's article was entitled "An introduction to the Reliability Concept". As well as describing the use of reliability concept methods in the field of electronics, the paper studied the practical application of such methods to electro-mechanical and mechanical components.

The development of the special prediction methods described in the paper was performed while Mr. Hobley was a member of the Reliability Control Section of Defense Systems Engineering at RCA Victor.

Chemical Works to build new plant

Mallinckrodt Chemical Works Limited has announced plans for the construction of new facilities on a four-acre site in Pointe Claire, Quebec. The announcement was made by Dr. D. S. Calder, vice-president and general manager of the Canadian firm. Calder indicated a capital outlay of a half-million dollars for the plant.

Designed to replace outmoded facilities in Montreal, the new plant will consolidate Mallinckrodt's manufacturing, warehousing and administrative activities in a modern work area with more than 25,000 square feet of floor space.

Mallinckrodt manufactures a complete line of Tranistar electronic chemicals for use by the electronics industry.

Pall Corp. acquires Vector Laboratories of Montreal

Dr. David B. Pall, president of Pall Corporation, Glen Cove, N.Y., recently disclosed the acquisition of Vector Laboratories, Inc., of Montreal, P.Q., for 500 shares of Pall Class A Stock.

Vector and its founder David J. Rosenberg specialize in solving problems of electro-mechanical and electronic control. Equipment developed by Vector includes "SCAD" (Servo

Calibrating Automatic Densitometer); tape controlled program timers with wide flexibility and precise repeatability; temperature scanners for monitoring large numbers of points with a single indicator-alarm, and temperature controllers for averaging temperatures over large area platens. A number of Vector's industrial products will be further developed and marketed by Pall.

While remaining president of the Canadian company, Mr. Rosenberg will make his new headquarters in Glen Cove where he will assume the position of director of research and development for special products.

Industrionics forecasts 150 per cent advance in sales in coming year

W. Wayne Shapiro, president of Industrionics (Canada) Ltd., announced the Detroit plant of the firm's new subsidiary, Winco Electronics, Inc., is now in production and has received orders which will total \$300,000 in sales during the first year's operations.

Total sales in the coming year are expected to increase by more than 150 per cent over last year, with television picture tube production in Detroit accounting for a major part of this volume gain.

"By combining this with expanding production in both our older plants, plus Canadian manufacture of a new product, we can confidently forecast total sales in excess of \$750,000 for the coming year," Mr. Shapiro said.

Industrionics (Canada) will seek Canadian public financing for its expansion plans in Canada and the U.S.

General Instrument produces silicon planar epitaxial transistors

All General Instrument silicon transistor production is now in planar epitaxial devices. The complete changeover from silicon mesa to silicon planar epitaxials is effective immediately, according to Richard E. Seifert, manager, Semiconductor Division, General Instrument-F. W. Sickles of Canada Limited.

When compared with standard silicon mesa transistors, the planar epitaxials exhibit higher gain, lower collector capacitance, minimized turn-off delay time with very low leakage current.

A complete line of silicon planar epitaxial transistors of both large and small geometry configurations in TO-18 and TO-5 packages are being offered.

Continued on page 77

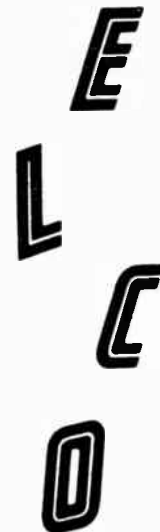
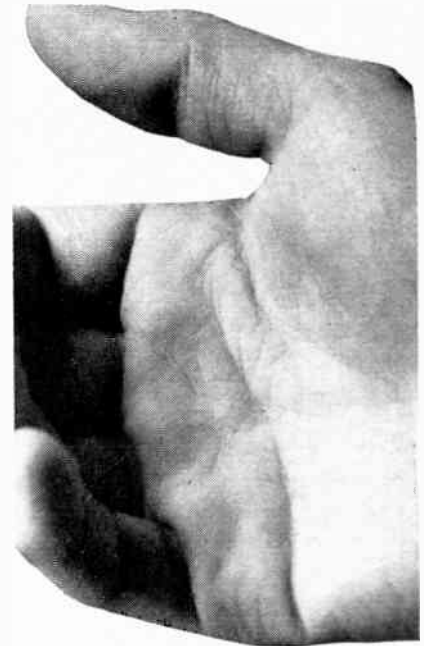

PARDON US FOR NAME-DROPPING

But the reasons why so many major names have chosen to associate with us are likely to be the same reasons you should also. After all, we are the leading electronic supply house in Canada—we do offer in-stock, in-quantity merchandise at guaranteed factory prices—we do make quite a point of quick service. If those aren't enough reasons, we can give you more. *Try us anytime.*



Alpha Aracon

radio company limited

Industrial Sales Division

555 Wilson Ave., Toronto
ME 5-6181 Direct Order RU 9-4353

Telex subscribers call 02-2647

For complete details check No. 3

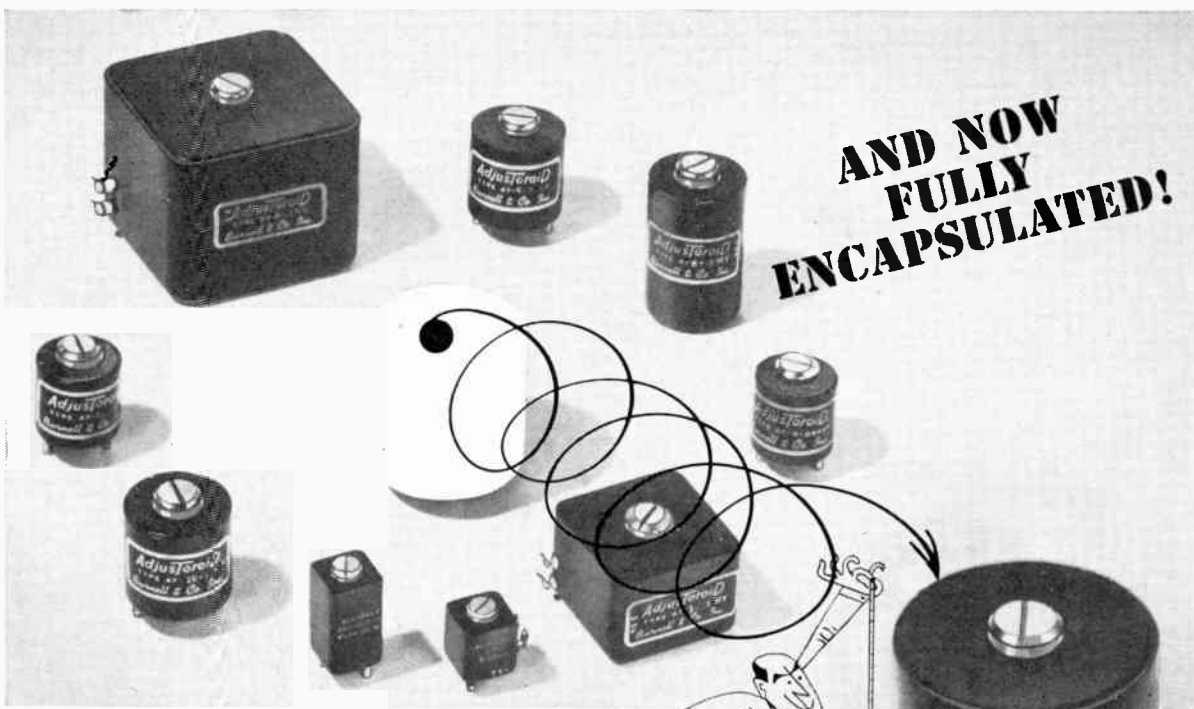

**AND NOW
FULLY
ENCAPSULATED!**

**NEW SUBMINIATURE
BURNELL ADJUSTOROIDS*
HANDLE BIG JOBS**

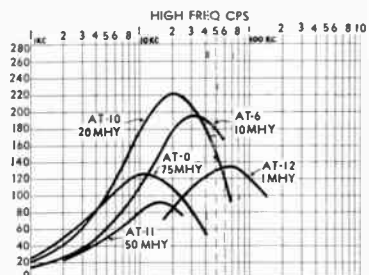

typical Q vs. frequency characteristics

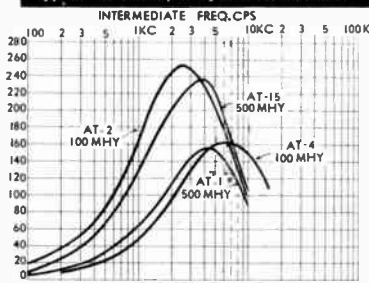

typical Q vs. frequency characteristics

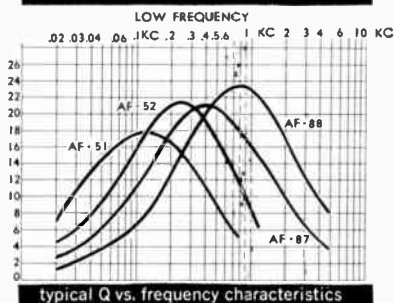

typical Q vs. frequency characteristics

The new subminiature **Burnell Adjustoroids** utilizing an ingenious patented method of magnetic biasing cover a wide range of frequencies, occupy less space and are available at low cost.

New **Burnell Adjustoroids** possess all the outstanding characteristics of non-adjustable toroids including:

Precise continuous adjustment of inductance over a 10% range.

No need for external control current.

Hermetic sealing to meet Government MIL E # 15305-A specifications.

If your adjustoroid needs can't be met from our stock catalogue, we'll be glad to manufacture to your specifications.

	Length/ Dia.	Width	Hgt.	Wt.	Useful Freq. Range	Max Q	Max L in hys
AT-0	1 1/16"		1"	2 oz	1 kc to 20 kc	10 kc	3 hys
AT-1	1 3/16"	1 3/4"	1 1/4"	7.25 oz	2 kc to 10 kc	4 kc	15 hys
AT-2	2 3/4"	2 3/4"	2 1/4"	24 oz	Below 2.5 kc	2.5 kc	125 hys
AT-4	1 1/16"		1 1/4"	4 oz	1 kc to 16 kc	6 kc	15 hys
AT-6	1 1/16"		1"	2 oz	10 kc to 100 kc	30 kc	.75 hys
AT-10	1 1/16"		1 1/4"	4 oz	3 kc to 50 kc	20 kc	.75 hys
AT-11	4 5/16"	4 5/16"	3 1/4"	.83 oz	2 kc to 25 kc	15 kc	.5 hys
AT-12	4 5/16"	4 5/16"	3 1/4"	.83 oz	15 kc to 150 kc	60 kc	.5 hys
AT-15	1 3/16"		1 7/8"	14 oz	Below 5 kc	4 kc	125 hys
AF-51	1 1/16"		2"	5 oz	30 cps to 500 cps	120 cps	1000 hys
AF-52	1 1/16"		2"	5 oz	50 cps to 1 kc	250 cps	1000 hys
AF-87	4 5/16"	4 5/16"	1 1/4"	1.7 oz	90 cps to 2 kc	400 cps	80 hys
AF-88	4 5/16"	4 5/16"	1 1/4"	1.7 oz	.16 kc to 4 kc	800 cps	42 hys



Manufactured and Sold in Canada by
Edo (Canada) Limited
P.O. Box 97
Cornwall, Ontario, Canada
Phone: Wellington 2-6774

*PAT.
2,782,020

SALES REPRESENTATIVE:

A. Deskin Sales Company, 1091 Shorecrest (14th) St., St. Martin, Montreal 40, P.Q. Phone MURray 1-0201; MURray 1-8645

For complete details check No. 17 on handy card, page 69

Longueuil, P.Q., plant for Canadian Pratt & Whitney

In one of the largest sales by Crown Assets Disposal Corporation in recent years, Canadian Pratt & Whitney Aircraft recently took over the Government-owned factory complex in Longueuil, formerly operated as the Gun Division of Canadian Arsenals Ltd., at a reputed price of \$1,400,000. Forty-five acres of land and a plant area of 404,384 square feet are involved in the transaction.

Canadian Pratt & Whitney Aircraft President Thor E. Stephenson described the purchase as part of the company's long range program. Additional space is required for all aspects of the firm's operations in manufacturing, overhaul and engineering research and development. The company has been renting space in these buildings since 1928.

The property comprises two main factory buildings and three ancillary buildings. The new addition, plus the firm's manufacturing plant in neighboring Jacques Cartier, brings company-owned factory and office space to 854,313 square feet, on an overall property of 195 acres.

To build underground air navigational aid

By next year, aircraft on the Edmonton-Vancouver airway will be guided by the world's first underground radio range, set in the top of a mountain.

The Department of Transport expects to award the contract later this year for a \$200,000 combined very high frequency omni-directional range (VOR) and tactical air navigation (TAGAN) station to be located just below the surface at the top of a 7,000-foot mountain 16 miles northwest of Enderby, B.C. The site is the highest point in the area.

Like all of Canada's 36 VOR installations (and 14 more under construction) the Enderby station will be unmanned.

The equipment to be housed in the structure calls for a round, flat, unobstructed platform 300' in diameter. Rather than extending the building's flat roof to that size, the department found it will be cheaper to shear the peak off the mountain and bury the station beneath it.

It will be Canada's first mountain-top VOR station and the world's first

to be built underground. It is expected to be operational late in 1962.

The 12-sided concrete structure itself will have a diameter of 52 feet. A tunnel will connect it with the side of the mountain. Technicians from Enderby will visit the station periodically and emergency shelter for an overnight stay will be provided in the building.

Tri-Tel Assoc. Ltd. now Canadian reps for National Radio

National Radio Co., Melrose, Mass., has announced the appointment of Tri-Tel Associates, Ltd., at 81 Sheppard Avenue W., Willowdale, Ontario, as their new Canadian representatives. Tri-Tel Assoc. is a stocking representative with warehouse facilities which assures immediate delivery of the National line of amateur, short wave and general coverage receivers throughout Canada.

Glendon Instrument made Canadian representatives

Recently the Glendon Instrument Co. Ltd., 46 Crockford Blvd., Scarborough, Ontario, were named representatives in Canada for Chrono-Log Corporation, Trygon Electronics Inc., Franklin Electronics Inc. and Somerset Radiation Laboratories Inc. All these firms are located in the U.S.

Chrono-Log Corporation, Philadelphia, Pa. manufacturers digital clocks, calendars, counters and timers; and a new sequential television equipment programmer for automation in the television broadcast field.

Trygon Electronics Inc., Roosevelt, Long Island, N.Y., are manufacturers of transistorized power supplies.

Franklin Electronics Inc., Bridgeport, Pa., produce digital voltmeters and multimeters, data gathering and reduction systems, linear pulse amplifiers and accessories, and nuclear instrument accessories.

Somerset Radiation Laboratories Inc., Stirling, N.J., make precision waveguide gauges, solid state switch modulator-attenuators and automatic frequency meters and monitors.



LET'S TALK

PRINTING VALUE!

— says printing expert Jacks Sparks *

Printing value is the combination of price, service and quality you obtain from your printer. All three factors count in the final analysis.

When you are planning your catalogues, house organs, brochures, let me give you a free estimate. Age Publications Limited is never surpassed when it comes to printing value.



* Manager, Commercial Printing Division,

age publications limited

450 Alliance Avenue
Toronto 9 - RO. 2-7275

For further information on products, use Readers Service Cards on pages 69 & 70.

Subminiature rectifiers

Item 87

Manufactured the size of a lighter flint these are capable of handling from 1000 to 2500 volts (PRV) with from 85 to 100 ma DC output on a wide range of low current, high voltage multiplier applications. The new devices exhibit maximum leakage current of 2.0 ua at PRV at 25°C, and maximum forward voltage drop of 4 volts at 150°C. Designated types Q10X through Q25X, the four units have an operating temperature range from -20 to +130°C. The unique International Rectifier "Tri-Seal" process protects each rectifier junction.

Douglas Randall (Canada) Limited, 126 Manville Road, Scarborough, Ontario.

Compactron devices

Item 88

Electrical manufacturers are using Compactron devices in lieu of conventional tubes or transistors. They have been utilized in a variety of applications including TV sets, intercom equipment, audio amplifiers, halogen leak detectors, electronic organs, auto radios and industrial measuring equipment. Features of these devices are low cost and demonstrated quality. Future applications include both home entertainment and industrial uses.

Canadian General Electric Co. Ltd., Electronic Tube Section, 189 Dufferin Street, Toronto 3, Ontario.

product panorama

Microwave phase-amplitude measuring system

Item 89

This new equipment will quickly and accurately determine the phase and amplitude of the electro-magnetic field over the aperture of an antenna. Operating frequency is 2 to 40 kmc with high sensitivity

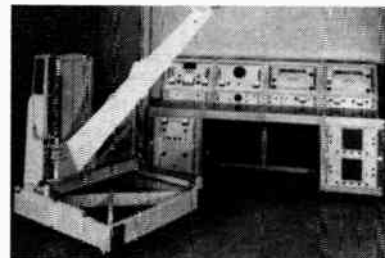

(-80 dbm at 13 kmc). Phase accuracy and stability are better than $\pm 5^\circ$ over 40 db dynamic range. Amplitude is measured to ± 0.5 db over the same range. The system can also be employed to make phase-amplitude measurements in closed waveguide systems.

Electronics Equipment Group, Philips Electronics Industries Ltd., 116 Vanderhoof Ave., Toronto, Ont.

Miniature transformers

Item 90

Weldable leads permit high reliability welded connections in high-density electronic assemblies. Special gold plated nickel iron alloy lead wire is used to provide superior weld joints. Similar electrical ratings to the Microtran catalog line are available on special order. A detailed catalog giving full specifications on the complete Microtran line is available. These units with new innovations are manufactured by the Microtran Company, Inc., located in Valley Stream, New York.

E. S. Gould Sales Co. Ltd., 19 Le Royer St. West, Montreal, P.Q.

Current or voltage indicator meter

Item 91

Available in either AC or DC type in various sizes to accommodate different panel

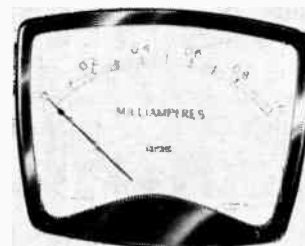

dimensions. The movements have spring loaded jewelled bearings, the zero set friction disc is by-passed by a bonding strap, and high flux cast magnets are used. All AC meters include frequency compensated rectifiers within the case. These are produced by Sifam Electrical Instruments, Torquay, England.

Roken Ltd., 822 Colson Avenue, Ottawa, Ontario.

Continued on page 79

PAYETTE
Presents...

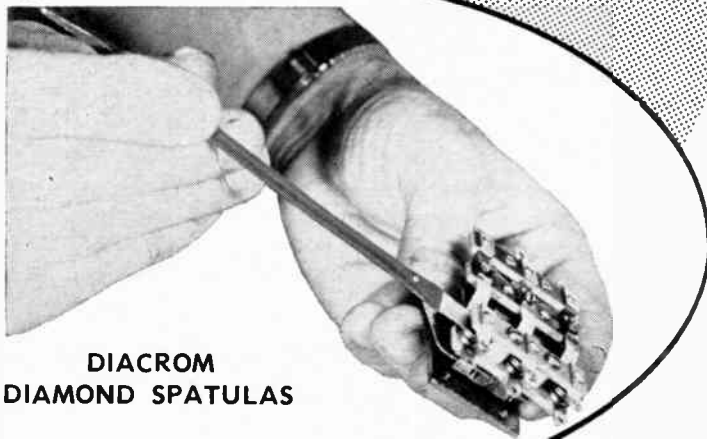

DIACROM
DIAMOND SPATULAS

FOR
CLEANING RELAYS
AND CONTACTS
OF EVERY TYPE

The Diacrom Spatula makes the cleaning of relays both practical and profitable. Because it has been specifically designed for this purpose, the Diacrom Spatula eliminates the problems usually caused by inefficient cleaning of relays, and adds a few advantages of its own. For example, one of the most important problems in cleaning any relay is to be sure that the normal gap is left unchanged. In this regard, the Diacrom Spatula, utilizing diamond particles as the abrasive element, requires so little pressure to do a thorough and effective cleaning job, that the gap is unaffected. Write for descriptive literature.

PAYETTE RADIO LTD.

730 ST. JAMES ST. W. MONTREAL 3
UN 6-6681

For complete details check No. 51 on handy card, page 69



MB CONNECTORS

NOW Amphenol offers the Canadian Electronic Industry a wider range of miniature coaxial connector designs than any other Canadian manufacture in the Industry.



The "ipc" MB Coaxial Connectors shown here, are engineered and manufactured to the most rigid and exacting specifications required.



Of particular importance to the user, is the excellent electrical and mechanical performance that is built into "ipc" MB connectors.



Frequencies up to 500 megacycles with maximum operating temperature to 400°F are just two features of "ipc" MB connectors.

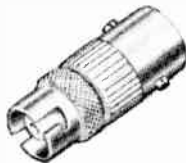

For the full story on "ipc" MB connectors plus — please write for "ipc" catalogue 11.



AMPHENOL
CANADA LIMITED
349 Carlaw Ave.
Toronto 8, Ontario

product panorama

For further information use Readers' Service Cards on pages 69 and 70.

Lineman's test set

Item 92

A universal volt-ohm-milliammeter combined with a level meter (dbm terminated and bridging) and provisions for talking and dialling over an external telephone set has been designed. Model TTS-28 also permits

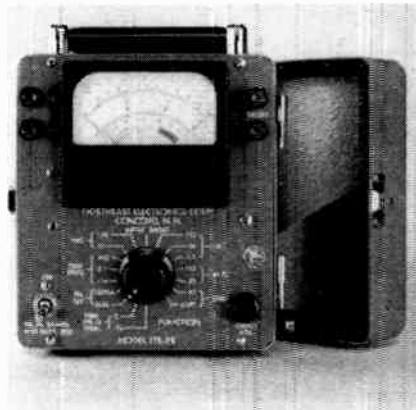

measurement of DC current and pulsing ratio in the telephone circuit. Full scale ranges are 1.5, 30 and 150 volts DC; 15 and 150 volts AC; 30 and 150 ma. DC; 500 and 500,000 ohms. Range of db measurement is -25 to +15.

Tele-Radio Systems Ltd., 3633 Dundas St. West, Toronto 9, Ontario.

DC-to-AC solid state inverters

Item 93

These will provide input current of any AC frequency from 50 to 2000 cycles, and are not normally available in mobile and airborne vehicles. They work from an input of 24 to 30 V DC. Regulation is ± 1 per cent for input variations or no-load to full-load variations. Distortion is 5 per cent maximum and ambient temperature is 50° maximum. Efficiency is rated at approximately 50 per cent, and frequency stability is ± 1 per cent. The inverters are available in 150 and 1,000 VA single phase models.

Radionics Limited, 8230 Mayrand Street, Montreal 9, P.Q.

Fast switching silicon transistors

Item 94

Designed for servo controls, DC control circuits and power switching of up to 4

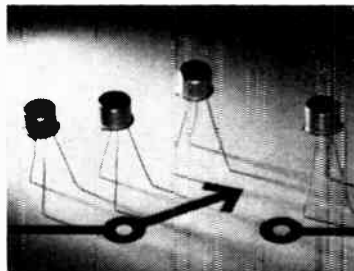

watts, have been announced. Designed to meet MIL-S-19500B requirements, the four NPN Raytheon types are packaged in an all-welded, hermetically sealed TO-5 case capable of withstanding storage temperatures as high as 200°C. The 2N497 and 2N656 are 60-volt devices and the 2N498 and 2N657 are 100-volt.

Raytheon Canada Ltd., P.O. Box 8, Waterloo, Ontario.

D-C POWER

Up to 1500 Amperes

Over 200

Rectifier Power Supplies
Automatic Battery Chargers
in these 6 Types



SILICON CONTROLLED RECTIFIER



TRANSISTOR-MAGNETIC AMPLIFIER



MAGNETIC AMPLIFIER (STAVOLT)



UNREGULATED AND SEMI-REGULATED (RECTODYNE)

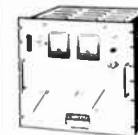

ALL TRANSISTOR



AUTOMATIC BATTERY CHARGERS FOR EVERY TYPE OF BATTERY

CHRISTIE

Write for Complete Information

CHRISTIE ELECTRIC CORP.

3412N West 67th Street
Los Angeles 43, California

opportunities

These classified advertisements are published to assist those in the trade who have articles for sale, positions available, positions desired, sales agency openings or business opportunities. Charges are 25¢ per word or figure, not including heading or box number. Minimum charge is \$5.00 payable on submission. No agency commission paid. There is absolutely NO CHARGE for "positions desired" advts.

Send all material to the attention of the Classified Editor of ELECTRONICS AND COMMUNICATIONS, 450 Alliance Ave., Toronto 9, Ontario.

HELP WANTED

QUALIFIED DESIGN AND SYSTEMS ENGINEER

With a good background in the telecommunications industry is required for product and systems design of VHF and UHF radio communications equipment. To locate at Calgary plant of large international company. Applications are invited for this senior engineering position from responsible and mature individuals. Excellent salary commensurate with experience and qualifications. Write giving details to:

Mr. Don A. Saunders
P.O. Box 1087, Calgary, Alberta

RESEARCH AND DEVELOPMENT LABORATORIES OTTAWA

The establishment of our new Research Center in Ottawa has created challenging opportunities for experienced Engineers and Scientists to carry out the planning, analysis and development of communications equipment and components connected with the following fields:

- Semi-conductor device design
- Applied research in semi-conductor materials
- Molecular electronics
- Acoustics
- Radio communications systems
- Transmission systems
- Switching systems
- Data systems
- Audio and video broadcasting

All enquiries will be treated in strict confidence. Please write:

Northern Electric Company Ltd.
Department #117
P.O. Box 6123,
Montreal 25, Quebec.

ELECTRONIC DESIGN ENGINEER

Our Company Client, a well-known manufacturer of electronic components, requires an Electronic Design Engineer, 28-33, with experience in coils, condensers, or allied products.

Applicants must be electrical graduates, and have potential to advance to management level. Starting salary is open to negotiation.

Candidates are requested to submit concise summaries in strict confidence to Executive Selection Consultants, 330 Bay Street, Toronto, Ontario, or to:

Box 5089
Electronics and Communications
450 Alliance Avenue, Toronto 9, Ontario

CONSULTING SERVICE

A senior executive with long and proven experience in the Electronics Industry will help your profits and prospects by dealing with such problem areas as: plant layout and flow of materials; day by day cost control; effective quality control for cost reduction; proper manuals for manufacturing processes and methods; product development planning and budgeting; sales and marketing.

For further introduction apply:

Box 5088
Electronics and Communications
450 Alliance Avenue, Toronto 9, Ontario

VACANCIES FOR ELECTRONIC ENGINEERS

Toronto Area:

\$5400 - \$7200 annually; sales engineer for sale of instruments used for the detection and measurement of radio-activity, principally for biological and medical research; also for industrial control. Order Number 510-2-x-242A.

\$7200 - \$8400 annually; data analyst to analyse data in connection with a long-term reliability test program for electronic parts; establish failure rate, drift rate or other characteristics; consultation in establishment of test programs; preparation of reports. Order Number 510-x-565.

\$6000 - \$7500 annually; to be in charge of consulting engineering division, instrumentation, petro-chemical refinery construction. Order Number 510-2-x-67B.

Eastern Ontario:

\$8000 - \$9000 annually; advise on design, installation and maintenance of communications equipment. Order Number 512-B1659E.

\$7000 - \$12,000 annually; experienced in VHF and UHF techniques; design of installations, antennas, communication transmitters and receivers. Order Number 512-B1138.

Details and application forms may be secured from Executive and Professional sections of the
National Employment Offices.

POSITIONS REQUIRED

JOB WANTED

Graduate engineering physicist with several years diversified experience in industry desires position as electronics engineer or computer trainee. Reply:

Box 5090
Electronics and Communications
450 Alliance Avenue, Toronto 9, Ontario

ENGINEERING ASSISTANT

An engineering assistant with an extensive background in telephone toll circuit, point-to-point and mobile radio work, is seeking a responsible position with a telephone company or industry. Send replies to:

Box 5091
Electronics and Communications
450 Alliance Avenue, Toronto 9, Ontario

Any change in your address?

If the address on the front of this magazine is in any way incorrect, please fill out and mail the card on page 69. In doing this, you will help us to keep our mailing list up-to-date and will also ensure the regular and prompt delivery of your copies of:

ELECTRONICS & COMMUNICATIONS

ADCOLA
PRODUCTS LIMITED
 (Registered Trade Mark)

MODERN SOLDERING EQUIPMENT

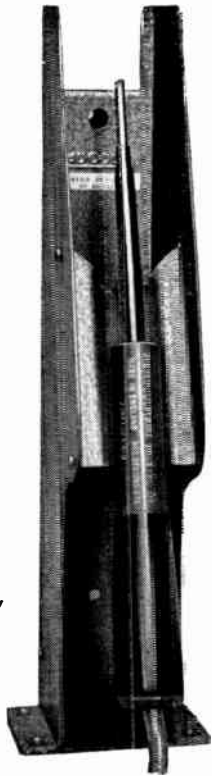

Illustrated:

Instrument
 Cat. No. 70
 and
 Protective Shield
 Cat. No. 68

**ADCOLA
 PRODUCTS LTD.**
 Box 103, Weston,
 ONT.

Used on
 the transatlantic
 submarine cable
 between
 Newfoundland
 & Nova Scotia
 for wiring
 the 2-way
 submerged
 telephone
 repeater
 amplifiers.

For complete details check No. 1 on handy card, page 69

**High Quality
 Low Low Cost**

Now everyone can afford quality meters by Stark. Never before have meters of such quality, accuracy and reliability been offered at such low prices.

Available in sizes from 1" to 6" round, square, edgewise, clear plastic and switch board. Special stylings can be designed to customer's requirements.

Write today for catalogue.
STARK ELECTRONIC SALES COMPANY
 AJAX, ONTARIO

For complete details check No. 43 on handy card, page 69
 ELECTRONICS AND COMMUNICATIONS, October, 1961

Engineered for
 accuracy and dependability...

and priced low by
HEATHKIT!

HEATHKIT AUDIO GENERATOR



Accuracy is $\pm 5\%$ and distortion is less than 0.1 of 1% between 20 and 20,000 cps. Frequencies are conveniently selected by three panel switches in steps of 1 cps from 10 cps to 100 cps and a four-position multiplier increases this range and increment in multiples of ten for an overall range of 10 to 100,000 cps. Output attenuator operates in steps of 10 db and is calibrated in 8 full scale meter ranges of 0-.003, .01, .03, .1, .3, 1, 3, and 10 volts RMS. Large 4 1/2" meter is calibrated in volts and db.

Kit Model AG-9A \$51.95

**HEATHKIT MUTUAL CONDUCTANCE
 TUBE TESTER**



Designed for professionals by professionals, the TT-1 has an impressive list of features at an outstandingly low price. It tests Gm to 24,000 micromhos, emission, leakage (direct reading ohmmeter to 10 megohms), grid current (1/4 ua sensitivity), VR firing voltages and regulation tolerances, thyatron

grid characteristics and conduction capabilities, eye tube grid characteristics, hybrid tubes, and "life." The 300, 450 and 600 ma constant current heater supplies and wide range of filament voltages protect against obsolescence. The built-in switch-operated calibration circuit and large, easy-to-read lighted meter assure accuracy.

Kit Model TT-1 \$194.95

Write for your free catalogue
 listing more than 200 easy-to-build HEATHKITS!

DAYSTROM LIMITED

1480 DUNDAS HWY. EAST, COOKSVILLE, ONT.

6127

For complete details check No. 16 on handy card, page 69

81



editorial

How big is this growing child?

Successive IRE conferences certainly tell us one thing: the Canadian Electronics Industry is growing, and growing fast. This raises an interesting and in fact a vitally important question: exactly how big are we right now? Private organizations in Canada, notably the EIA, have gone a long way in answering this question, but evidently at the present time no readily available figures exist for the *entire* industry. In a discussion with the Dominion Chief Statistician last month, it was learned that DBS had already issued questionnaires concerning the communications and consumer market aspects of the Canadian electronics scene. This magazine was most pleased to hear of this step and looks forward to seeing these important statistics at an early date. Our hopes are that at a subsequent date a questionnaire can be developed and applied which will cover the entire field.

Importance of all this has to do with the placement of foreign capital (and domestic for that matter) into Canadian operations. We hear time and time again expressions of interest from outside sources, notably in the United States, but inevitably these are coupled with a genuine lack of knowledge of the Canadian Electronics market. So long as factual information about the industry is not freely available one may expect that most of these initial probings will not develop further. We believe statistics to be very necessary at this time as an aid to the continued upswing of the industry.

An Introduction

..... "engineering in Canada" . . . is the name given to a new series of articles, the first appearing on page 48 of this issue. Each article will document an E & C staff-engineer visit to Canadian plants and laboratories across the nation. Articles are intended to give an insight into the Canadian electronic industry in action and to foster an increased awareness of its diversity and scope.

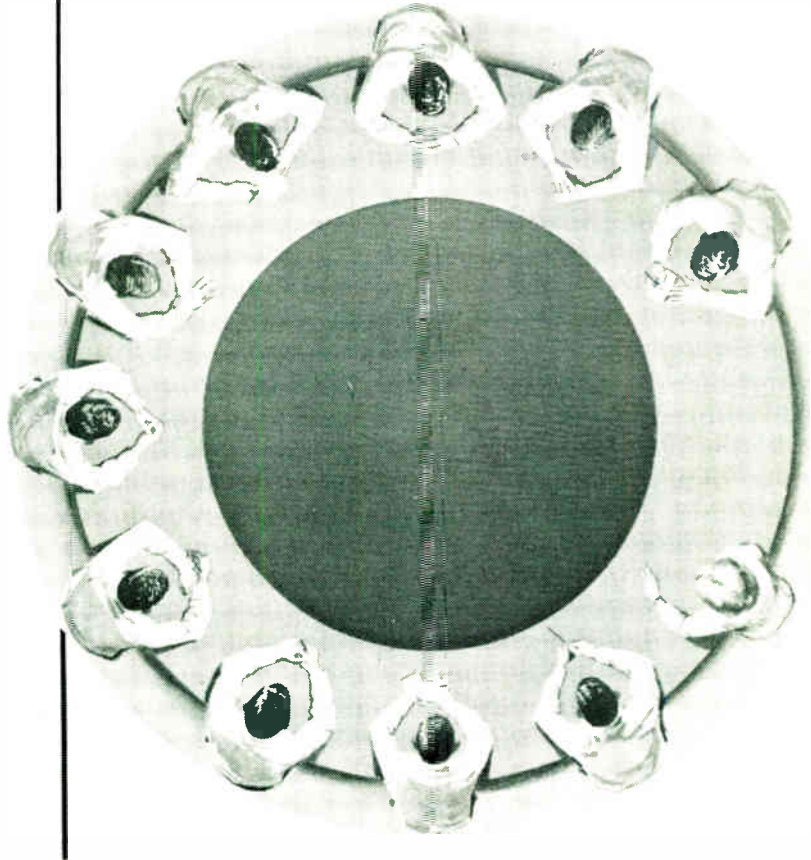

round table of modern business...PABX

Speeding internal communications for more efficient business operation . . . that's the job of PABX, the modern Private Branch telephone systems that put any required personnel right at the subscriber's fingertip. AUTOMATIC ELECTRIC PABX systems fit every budget and every need. Packaged units like the Types 95, 22 and 90-B-20, provide up to ninety inside telephones, and up to twenty Central Office trunks ● And for larger requirements there is the famous Type 75 specially engineered system, with a capacity of from 50 to 800 local lines with C.O. Trunks as required. These PABX units can be trunk connected to any type of public exchange. Special auxiliary services are also available. For full details on revenue producing PABX, write Automatic Electric Sales (Canada) Limited, 185 Bartley Drive, Toronto 16, Ontario.

** Private Automatic Branch Exchanges cut the cost of communications in business.*

AUTOMATIC ELECTRIC

Subsidiary of

GENERAL TELEPHONE & ELECTRONICS



Use it on the bench—carry it anywhere!

New High Stability Oscillator

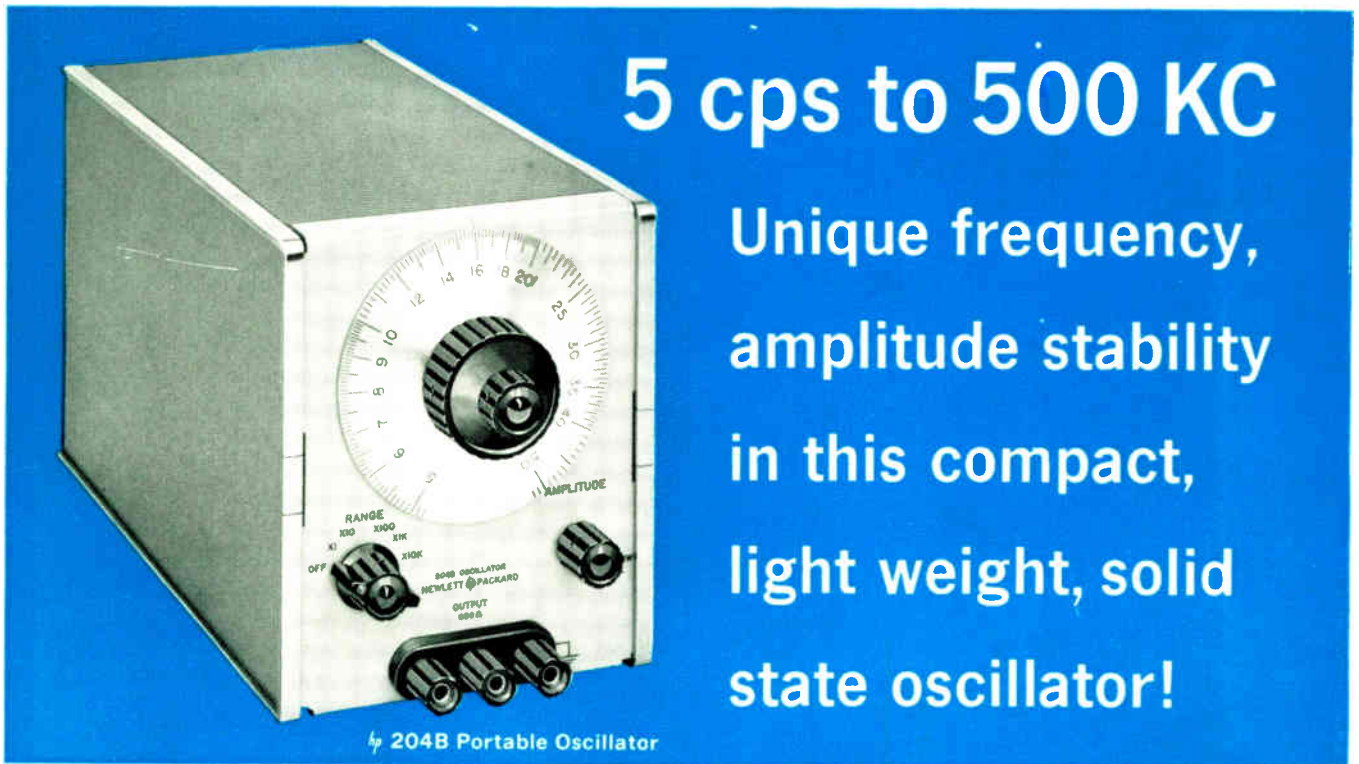

5 cps to 500 KC

Unique frequency,
amplitude stability
in this compact,
light weight, solid
state oscillator!

 204B Portable Oscillator

The unusual stability of the new  204B combines with solid state design and battery operation to give you one of the most useful, reliable, versatile oscillators available today. Because the 204B is fully transistorized, internal heat is small and warmup drift is negligible. In addition to battery operation, the 204B is operable on ac, with an ac power pack available at extra cost.



Frequency stability over the entire 5 cps to 500 KC range is better than $\pm 0.03\%/^{\circ}\text{C}$ from 0° to 55°C . Amplitude stability over rated frequency range and output levels is better than $\pm 0.1\%$ over 8 hours of operation at constant line voltage and temperature*; better than $\pm 0.2\%$ for line voltage changes of $\pm 10\%$; better than $\pm 0.1\%/^{\circ}\text{C}$, $0-55^{\circ}\text{C}$.

Output of the 204B is fully floating, isolated from both power line ground and chassis. Balanced and unbalanced loads, and loads referenced either above or below ground, can be driven by this versatile oscillator.

SPECIFICATIONS*

Frequency Range:	5 cps to 500 KC, 5 ranges, 5% overlap, vernier control
Dial Accuracy:	$\pm 3\%$
Frequency Response:	$\pm 3\%$ with rated load
Output Impedance:	600 ohms
Output:	10 mw (2.5 v rms) into 600 ohms; 5 v rms open circuit
Output Control:	Continuously variable bridged "T" attenuator with at least 40 db range
Distortion:	Less than 1%
Noise:	Less than 0.05%
Power Source:	4 battery cells at 6.75 v each, 7 ma drain, life at least 300 hours
Power Accessory Available:	AC power supply can be installed in place of batteries. Optional at extra cost.
Dimensions:	6 - 3/32" x 5 - 1/8" x 8". 6 lbs.
Price:	 204B, \$275.00

Low impedance circuits drive the 600 ohm output, effectively isolating the oscillator stage.

Designed in the new  instrument module packaging, the 204B is only 6-3/32" high, 5 1/8" wide and 8" deep; weighs just 6 pounds! A new rack mount adapter holds three 204B oscillators or other  instruments of the new modular design.

*On battery operation, stability -1% during battery depolarization, less than 30 minutes.



HEWLETT-PACKARD COMPANY

1077G Page Mill Road
Cable "HEWPACK"

Palo Alto, California, U.S.A.
DAvenport 6-7000

Sales representatives in all principal areas

HEWLETT-PACKARD S. A.

Rue du Vieux Billard No. 1
Cable "HEWPACKSA"

Geneva, Switzerland
Tel. No. (022) 26.43.36

For complete details check No. 24 on handy card, page 69