

the most powerful data processing system in its field

First fully transistorized IBM computer, the new IBM Seven-O-Seventy provides remarkable operating features for both business and science. Capable of handling complex calculations and everyday accounting problems, the IBM 7070 saves time, work and money.

Transistor design reduces space requirements, lowers initial costs and keeps your operating costs low. Also, it can give you information on your business previously imprac-

tical to obtain because of the cost. This helps you make decisions faster and helps you plan the growth of your business on a sounder, more factual basis.

And unexcelled IBM services—ranging from program planning to personnel education—work for you, helping to speed profitable operation and bring a maximum return on your data processing investment. For more complete information on the new IBM 7070 call an IBM representative today.

IBM

INTERNATIONAL BUSINESS MACHINES COMPANY LIMITED

Don Mills Road, Toronto 6, Ontario

BRANCH OFFICES IN PRINCIPAL CITIES ACROSS CANADA

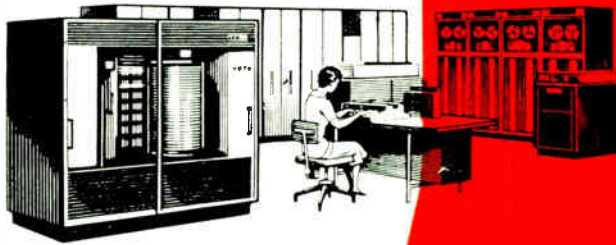

THE TRANSISTOR, BASIC ELECTRONIC COMPONENT OF THE NEW IBM 7070, PERMITS LOWER INITIAL COST, LOWER OPERATING COST

NEW IBM

7070

For complete details check No. 89 on handy card, page 95



**NEW!
IMPROVED TUBES!
FOR HIGH PRECISION
ELECTRONIC
EQUIPMENT**

MARCONI RVC INDUSTRIAL AND MILITARY TUBES

- Precision workmanship, rigid quality control and immaculate cleanliness to fulfill exacting government specifications for missiles, rockets, aircraft, satellite and radar components.
- Redesigned higher current heaters to reduce filament burn outs.
- Gold grids to reduce secondary emission.
- Structurally reinforced to withstand higher shock and vibration conditions.
- Tested to tighter controlled life-tests and conditions.

ELECTRONIC TUBE AND COMPONENTS DIVISION

CANADIAN Marconi COMPANY

830 BAYVIEW AVENUE • TORONTO, ONTARIO

BRANCHES: Vancouver • Winnipeg • Ottawa • Montreal • Halifax • St. John's, Nfld.

For complete details check No. 65 on handy card, page 95

ELECTRONICS AND COMMUNICATIONS, March, 1959



the right capacitor for the application...

your job... and **Centralab's**







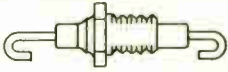
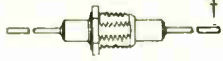

choose from

**TEN TYPES
of Centralab
FEED-THRU
CAPACITORS**

**in a wide range of values, voltage ratings,
tolerances and physical sizes**

Wherever you need a feed-thru capacitor, you can be sure that CENTRALAB can meet your needs. The table below shows the many varieties that make up the most complete line in the industry—and you get the added benefit of CENTRALAB'S unequalled experience in the design and manufacture of ceramic capacitors. Whether it's for high frequency, filtering, bypass, or coupling, you'll find the unit you need in this group.

CENTRALAB Engineering Bulletins (F'T Group) give you all the details. Write for your copies today.

TYPE	ACTUAL SIZE ILLUSTRATION †	CAP. RANGE mmf	RATING		APPLICATIONS
			VDCW	VDCT	
Bushing type DA-717		10-4000	500	1000	High frequency filtering, bypass, etc. ± 5% tolerance in lower values
Bushing type DA-720		10-5000	500-1500	1000-3000	
Step type DA-728		10-1500	500	1000	Med. freq. use, bypass, TV tuners, etc. ± 10% tolerance below 200 mmf.
Step type DA-729		10-1500	500	1000	
Ring type DA-740*		10-1000	500	900-1300	Symmetrical design. Inserts from either end... ideal for automatic insertion
Ring type DA-741*		10-1000	500	900-1300	
Eyelet type DA-784		25-1000	500	1000	For high frequency filtering and bypass, where size is important
Eyelet type DA-785		25-1000	500	1000	
Eyelet type DA-787		25-1000	500	1000	
Resistor-Capacitor type 732		470 gmv. .3 to 1.0 meg. only	1000	**	Resistor-Capacitor in parallel. ** 1500 VAC test when immersed in Silicone oil cooled with dry ice.

*patents pending

†Units marked † are 1/2 actual size

Centralab Canada Ltd.

D-5913

669 BAYVIEW AVENUE, TORONTO 17, ONTARIO
Affiliated: CENTRALAB, Milwaukee 1, Wis., U.S.A.

Variable Resistors • Electronic Switches • Packaged Electronic Circuits • Ceramic Capacitors • Engineered Ceramics

World Radio History



an age publication

Electronics and Communications

Canada's pioneer journal in the field of electronics and communications engineering

Thomas W. Lazenby, editor
R. C. Poulter, P.Eng., associate editor
D. K. Trowell, editorial assistant
William Bowers, art editor
Guido Milanesio, photo editor

H. E. Dallyn, advertising manager
Arthur Dixon, assistant advertising manager
Nevill A. Campling, production manager
Paul A. Irwin, circulation manager

Norman G. McHardy, president
L. R. Kingsland, vice-pres. and sec. treas.
Clifford A. Sparks, business manager

Published by
AGE PUBLICATIONS LIMITED
450 Alliance Avenue, Toronto 9, Ont.
Telephone ROger 2-7225

publishers of
Wine/Beer/Spirits
Restaurants and Institutions
Automatic Heating/Plumbing/Air Conditioning
Canadian Aircraft Industries

MONTREAL
Keith Edgar
116 Flandre St.
(Preville)
St. Lambert, Que.
Telephone: OR. 1-2020

WEST COAST
Dillenbeck-Galavan, Inc.
266 S. Alexandria Ave.
Los Angeles 4, Calif.

U.K. AND EUROPEAN REPRESENTATIVE
Norman F. Keenan
47 Manchester Street
London, W. 1, England

Subscription Rates:
Canada, U.S.A. and U.K. Possessions \$5.00 a year
Foreign \$10.00 a year

Member Canadian Circulations Audit Board

Authorized as second class mail
by Post Office Dept., Ottawa



PRINTED IN CANADA

60

contents

March 1959

Vol. 7, No. 3

Electronics in industry

This is the annual Industrial Issue of Electronics and Communications magazine and, as in past years, its feature columns have been devoted to a series of stories indicative of the many electronic applications which, by reason of their varied advantages, have won established places in industry and commerce. While the selection of stories contained in this issue cannot hope to portray anything but a small percentage of the almost limitless use of industrial electronics, it is hoped that they will serve to stimulate thought in many minds with respect to the inherent advantages that may be obtained from the use of this comparatively new industrial art.

departments

- 11 EIA Report
- 12 CRTPB Newsletter
- 21 Business Briefs and Trends
- 62 New Products
- 66 News Report
- 104 Editorial

AMPHENOL

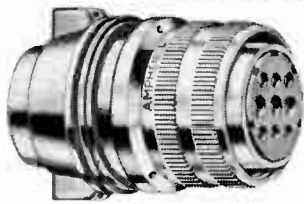

STUB *E* CONNECTORS

Environmentally resistant connectors per MIL-C-5015C with:

- Unitized grommet construction in one unit — eliminates handling of numerous components — makes assembly and disassembly easier.
- Reduced over-all length.
- Lighter weight.

Applications include:

- All electrical circuits calling for MS connectors or MS types needing environmental resistant performance.
- Aircraft and missile use with equipment requirements for sealed constructions.

4 shell types, 51 insert arrangements

Pre-filled solder pockets for easy wiring

Tamper Proof Contacts — Resist test probe damage.

WRITE FOR BULLETIN



CANADA LIMITED
300 CAMPBELL AVENUE
TORONTO 9 - ONTARIO

For complete details check No. 43 on handy card, page 95

"PLUS" VALUE NEW PRODUCTS



STEREOPHONIC DUAL Q CONTROLS

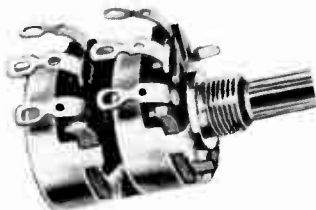

with close
tracking tolerances

SPECIFICALLY MADE FOR
STEREO APPLICATIONS

- ✓ SMALL SIZE
- ✓ RUGGED CONSTRUCTION
- ✓ SUPERIOR PERFORMANCE

- Achieves an equal balance of sound automatically
- Simplifies operation
- Available with taps and switches
- Designed to your specifications and manufactured in Canada
- Consult factory or our representative for further information

INTERNATIONAL RESISTANCE CO. LTD.
349 CARLAW AVE. TORONTO 8, ONT.

SALES OFFICES:

Radiovision Sales Ltd. 492 Somerset St. West 5890 Monkland Ave.
325 Tenth Ave. West Ottawa Montreal
Calgary, Alta. Ont. Que.

For complete details check No. 120 on handy card, page 95

TRANSFORMERS & COILS

Designed & Manufactured in Canada

Complete facilities
for . . .

ENGINEERING

RESEARCH

TESTING

PRODUCTION

SERVICE

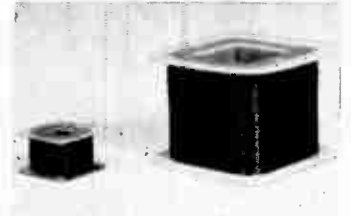
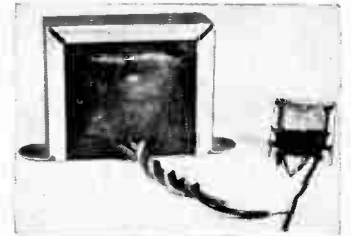

TRANSFORMERS. Power up to 500 VA for Radio, TV and Electronic Equipment, Controls and Special Application. Open Construction and Hermetically Sealed. Audio Output. Vertical Output. Chokes.

COILS. Relay. Special Purpose.

We Invite Your Inquiries

RENFREW ELECTRIC CO. LIMITED
TRANSFORMER DIVISION

300 CAMPBELL AVENUE

TORONTO, ONTARIO

For complete details check No. 112 on handy card, page 95

"PLUS" VALUE NEW PRODUCTS

STRUTHERS DUNN RELAYS

FOR INSTRUMENT CONTROL



Specifically designed for use with regulating instruments, to handle larger loads, protect instrument contacts and thereby increase instrument life.

Relay sets combine relays with other devices such as transformers, resistors, condensers to accomplish a specific purpose.

Manufactured in a variety of types, contact arrangements, contact ratings and coil voltages.

**MANUFACTURED IN
CANADA**

Write for Bulletin 6100

Our complete engineering facilities are at your service.

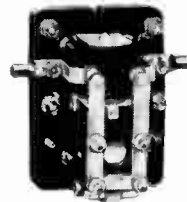

RELAY DIVISION J.R. LONGSTAFFE CO. LTD.
300 CAMPBELL AVENUE, TORONTO 9, ONTARIO

For complete details check No. 130 on handy card, page 95



15,000 WATTS P. E. P. New Ceramic Tetrode for SSB

Eimac's new, high-power 4CW10,000A is ideal for use in Class AB₁ single sideband service. This new tetrode is a water-cooled version of the widely-used Eimac 4CX5000A, with plate dissipation capability increased to 10,000 watts and a peak envelope power of 15,000 watts. Water-cooling makes the 4CW10,000A excellent for heavy duty applications where reserve plate dissipation is required.

Eimac offers the most complete line of tetrodes with the high-power gain, low distortion and excellent

stability required in Class AB₁ operation. Each has proved reserve ability to handle the high peak powers encountered in single sideband service. Efficient integral-finned anode coolers on the air-cooled types keep blower requirements to a minimum, allowing compact equipment design.

Ceramic-metal design means compactness, ruggedness, high performance, and reliability. These proved advantages of Eimac ceramic tetrodes make possible more compact, efficient single sideband equipment.



Eimac First for high power amplifier klystrons.

EITEL-McCULLOUGH, INC.
SAN CARLOS CALIFORNIA



2036 Prince Charles Road, Ottawa.

	CLASS AB ₁ SSB OPERATION				
	4CX250B	4CX300A	4CX1000A	4CX5000A	4CW10,000A
Plate Voltage	2000 v	2500 v	3000 v	7500 v	7500 v
Driving Power	0 w	0 w	0 w	0 w	0 w
Peak Envelope Power	325 w	400 w	1680 w	10,000 w	15,000 w

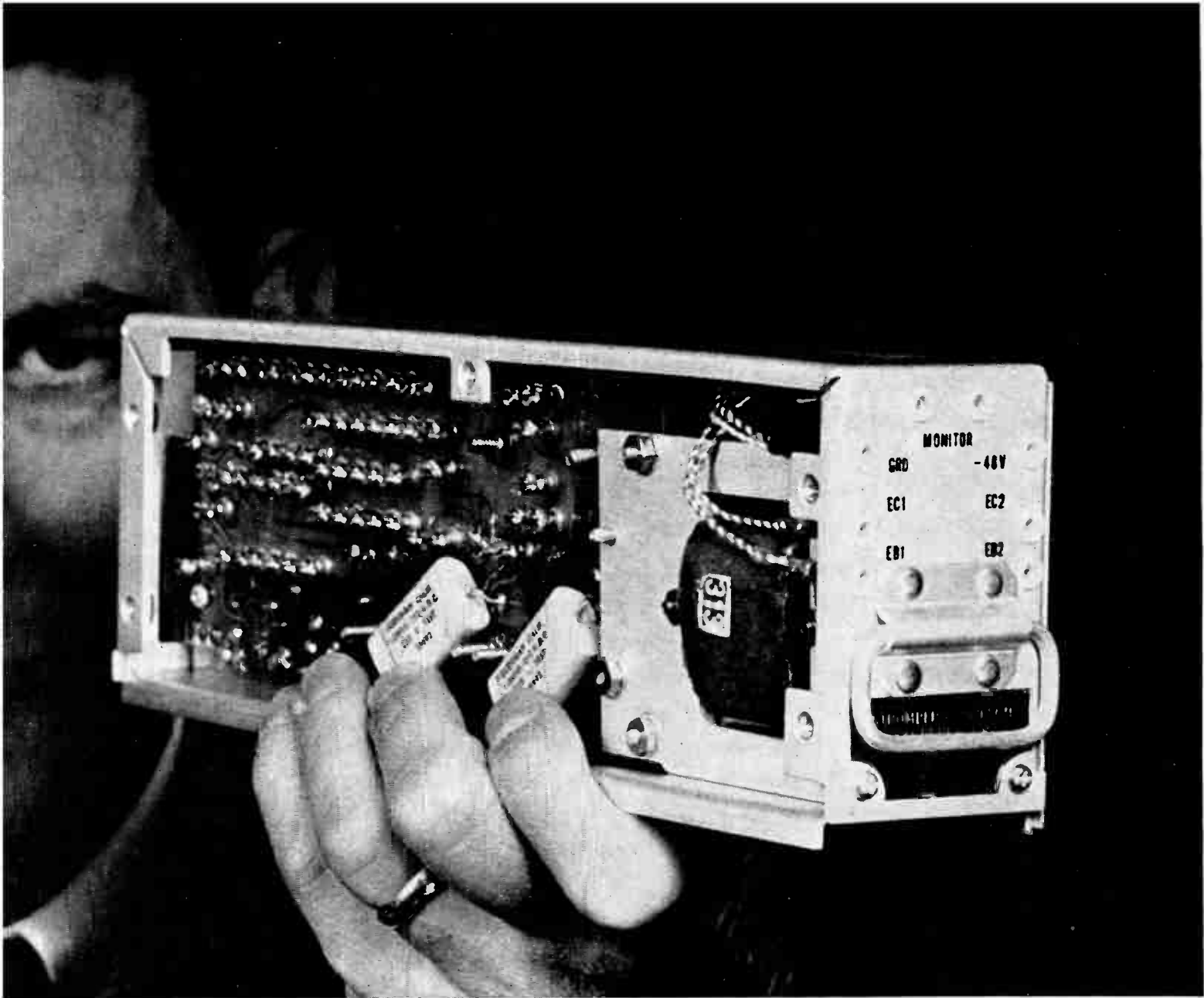

● 100% TRANSISTORIZED...You get years of service without replacement with Stromberg-Carlson's completely transistorized "541" negative impedance voice repeaters. You save space, too: a 19-inch shelf holds 8 repeaters, using only 3½ inches of vertical rack space. Power drain is the lowest - - less than 1 watt per repeater from existing 48-volt battery. Cable loading can be reduced; you use smaller gauge cable to meet today's transmission standards. "541" repeaters come in series and shunt types. Ask for full details.

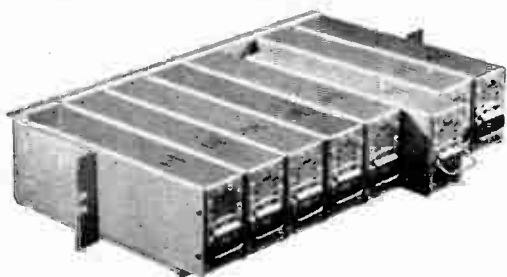

STROMBERG-CARLSON A DIVISION OF GENERAL DYNAMICS CORPORATION

Exclusive Agents HACKBUSCH ELECTRONICS LTD., 23 PRIMROSE AVENUE, TORONTO 4, ONTARIO

ELECTRONIC AND COMMUNICATION PRODUCTS FOR HOME, INDUSTRY AND DEFENSE



For complete details check No. 82 on handy card, page 95

CRIMP

at bench...or at equipment

Precision hand, pneumatic, or automatic tooling guarantees uniform and complete crimp for each connection—a measurable quality control—at a high speed production rate.

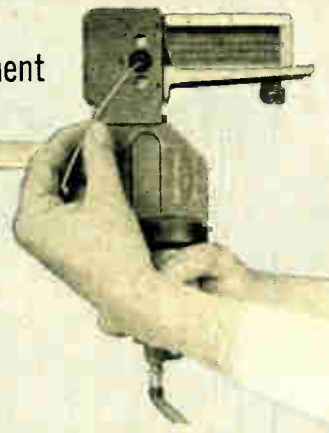

SNAP-LOCK ... in or out

Pins and sockets are easily and quickly snap-locked into plugs and receptacles. They may be removed with a simple extraction tool for circuit changes or checks.

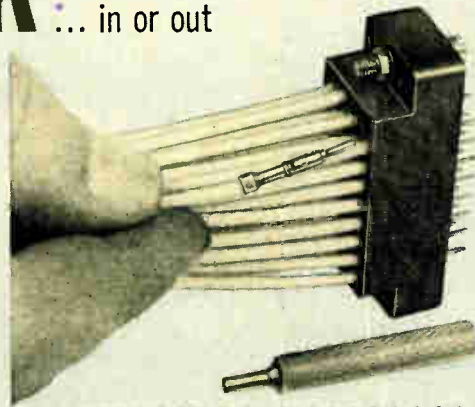

CONNECT ... only 3 points of contact

The HYFEN method provides the minimum number of contacts—3—thereby reducing reliability problems. Exceeds the requirements of MIL-C-5015C and MIL-C-8384A.

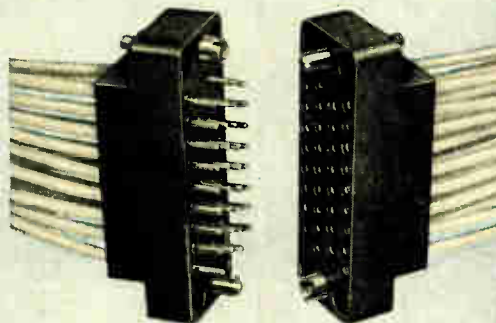
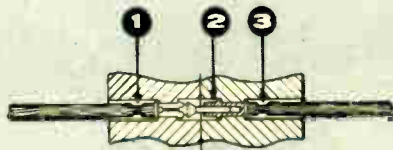

HYFEN connectors

with crimp-type snap-locked contacts

BURNDY's HYFEN method, already widely accepted in the industry, speeds the wiring of electronic harnesses and systems, and achieves greater dependability and versatility than has heretofore been possible. Crimp-type connections eliminate time-consuming solder operations and the disadvantages in the use of solder.

ACCEPTED! Hyfen Variations

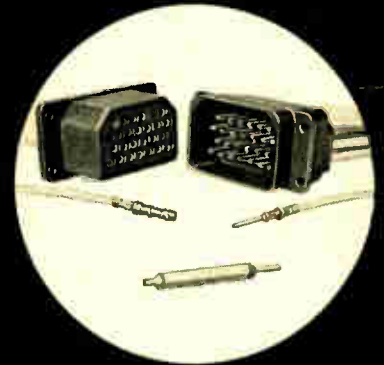

ME rack and panel HYFEN connector. 8 or 26 place configuration. One-piece shell and one-piece block. Also available for coaxial or shielded cable.

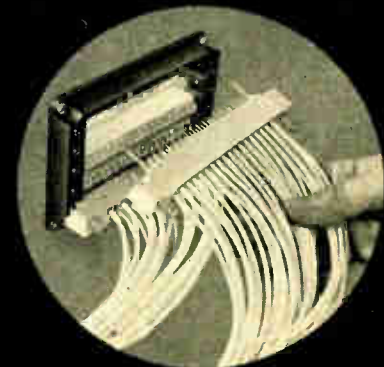

Feed-thru, modular design, multiple insert connector. 35 contact inserts can be removed from frame for easy contact insertion or removal. 5 or 8 insert frames available.



Printed circuit connector in either 31 or 45 place configuration. Accommodates single wire or combinations of wire sizes.

HYFEN types illustrated are typical of those already supplied to the industry by BURNDY. HYFEN connectors are engineered to meet specific requirements. For other types or sizes, contact BURNDY.

For complete information, write: OMATON DIVISION

BURNDY

5907

CANADA LTD.

1530 Birchmount Road, PL. 7 - 8761
Scarboro, Ontario (Metropolitan Toronto)

Offices in: Montreal Calgary
Winnipeg Vancouver

AWA

ELECTRONICS

New concepts in electronics have been developed at AWA, as a result of experience with missile systems. Now they have a wider application. Here are some of the new AWA devices now available to industry.

TRANSISTOR GALVANOMETER AMPLIFIER

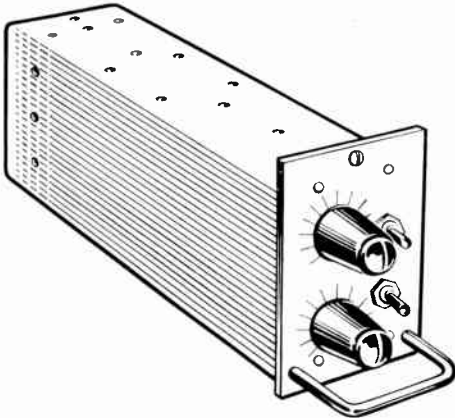

This Amplifier has been designed to drive viscous damped recording galvanometers which normally have a resistance of 50 ohms and a working range of D.C. to 2 Kc/s in frequency. The amplifier has a switched attenuator at its input and will accept single ended or push pull signals from ± 1 Millivolt to ± 500 volts and will feed a maximum of ± 50 Milliamps to the galvanometer. There is also a range of ancillary units available for use with this Amplifier as part of a comprehensive instrumentation system. *Standard specification: Dimensions: $4\frac{1}{2}$ in. x $3\frac{3}{4}$ in. x 10 in.; Frequency response: Flat from DC to 2 Kc/s, 5% down at 3 Kc/s, 3db down at 6 Kc/s; Noise level: less than 10 Microvolts; Input impedance: 40,000 ohms on range 5, 110,000 ohms all other ranges; Gain: Maximum 7.5 Milliamps/Millivolt, minimum 0.04 Milliamps/Volt; Power requirements: ± 6 Volts D.C. 220 Milliamps each line.*

COMEL 8 & 12 SWEEP OSCILLATOR AND VIBRATION CONTROLLER

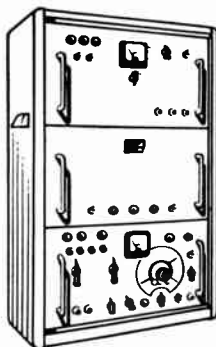

This unit is designed to drive vibrator amplifiers and has a wide frequency range. The sweep speed is variable over a range 12:1 and automatic frequency sweep facilities are provided. *Frequency Range: 10 c.p.s. to 32 Kc/s in ranges of 5 octaves each. There are 7 switch speeds ranging from 5 secs./octave-60 secs/octave. Variety of Outputs available. Vibration Controller: Input: 4V r.m.s. at appropriate frequency. Output: Up to 100 mV r.m.s. into 600 ohms. Pick Off: Sensitivity 10 mV r.m.s. per "g" peak. Overall Dimensions: 35" x 22" x 14". The Vibration Controller will control ± 40 "g" or as determined at low frequencies by the excursion of the vibrator table.*

All devices are adaptable to suit customers' own requirements. For further information consult:

COMMERCIAL ELECTRONICS DEPT.

SIR W. G. ARMSTRONG WHITWORTH AIRCRAFT LTD., Baginton, Coventry
MEMBER OF THE HAWKER SIDDELEY GROUP

For complete details check No. 45 on handy card, page 95

EIA Report

By Basil Jackson, A.R.Ac.S., Tech. M.C.A.I.

Canadian Radio Week

At a recent Receiver Division meeting a resolution was passed in which the members gave their support to Canadian Radio Week which will take place May 3-9.

Over one hundred and forty radio stations will spearhead the promotional work as arranged by the Canadian Association of Radio and Television Broadcasters. The radio manufacturers in the EIA Receiver Division will donate nearly 300 radio receivers which these stations will use as prizes for contests to be run during Canadian Radio Week. EIA Receiver Division members will also contribute to the promotional material which will be sent to the various dealers across the country.

New EIA Engineering Standard

A recent meeting of the EIA Electronics Division approved the new EIA Standard No. 513 entitled "Proposed Standard Broadcast Transmitter Specification". This specification will be submitted to the Department of Transport through the Canadian Radio Technical Planning Board. This new specification was compiled by the Radio Broadcast Committee of the Electronics Division of EIA.

Ad Hoc Committee on EIA Objectives

A meeting of the Ad Hoc Committee on EIA objectives met in Montreal recently. Progress was made on a revision of the objectives of the association and a revised edition will soon be made available for distribution to the Board of Directors for approval before the annual meeting in June.

EIA Engineers Discuss Frequency Allocations

Early in March a meeting was held of all the chairmen of the various engineering committees of the Electronics Division, and the chairman of the Receiver Division Engineering Committee, together with the Director of Engineering, to deal with the question of radio spectrum frequency allocations and the Canadian requirements over the next ten years. These discussions were made in connection with the forthcoming International Radio Consultative Committee and International Telecommunications Union conferences which are being held this year and next to deal with these important matters. At the CCIR and ITU conferences world radio frequency allocations will be discussed, a vitally important subject to Canada which has widespread radio communications networks from coast-to-coast.

National Stereophonic Radio Committee in U.S.A.

The newly-formed National Stereophonic Radio Committee in the United States held its first meeting recently and prepared to study the technical aspects of stereophonic radio broadcasting methods by AM, FM, and by TV stations. Chairman is Dr. W. R. G. Baker, Director of EIA of U.S.A. Engineering Department. The committee has panels for system specifications, interconnecting facilities, broadcast transmitters, broadcast receivers, field testing, and a "subjective aspect" panel to provide the other panels with the available scientific information on the subjective aspect of the stereophonic reproduction of sound. A co-ordination committee has also been formed.

The terms of reference of the National Stereophonic Radio Committee are given as follows:

"The function of the NSRC will be to make detailed technical studies of the several possible methods of providing compatible stereo sound for the AM, FM and TV broadcast services. The objectives of these studies will be:

- (1) To clarify the technical issues as between the several possible systems for each of these services.
- (2) To verify the technical conclusions through appropriate field tests and obtain such information as may be necessary for channel utilization purposes for the determination of the choice of standards.
- (3) To delineate appropriate signal specifications for several services based upon the best scientific information and field test data available to the committee.

The NSRC intends to obtain this information as a service to the public, the FCC and the industry. The results of its studies will be made public as soon as as the studies have been completed.

Newsletter

Canadian Radio Technical Planning Board

WHO'S WHO IN THE PLANNING BOARD

No. 12 — Association of Municipal Electrical Utilities of Ontario

The Association of Municipal Electrical Utilities (of Ontario) had its beginning as a branch of the Niagara Power Union. The Niagara Power Union was a group of public-spirited citizens from municipalities from Niagara Falls through to London who were responsible for the formation of the Hydro-Electric Power Commission of Ontario.

The membership of the AMEU is made up of senior officials of municipalities who distribute power in the Province of Ontario.

For the purpose of representation, the AMEU is divided into nine Regions corresponding with those established by the Ontario Hydro-Electric Commission. It has four spheres of operation, namely, Finance and Office Administration, General Administration, Engineering, and Internal Operations.

In 1959 this Association is observing its Fiftieth Annual Meeting. The meetings which were held prior to 1909 were not on a scheduled basis and were only for implementing directions to interested citizens.

The AMEU has 27 major committees and 35 sub-committees — one of the major committees is Communications. This Committee works very closely with the Canadian Radio Technical Planning Board and is responsible, through the authority of the Department of Transport, for assistance in allocation of channels for public utility use for mobile radio.

DOT's Area Control Center at Goose Bay

The Department of Transport's most recently established Area Control Center is located at Goose Bay, Labrador. Its purpose is to provide traffic control service to aircraft, civil and military, which operate in Canada's most north-easterly latitudes.

Goose Center works together with the RCAF, who operate approach control and tower units, to provide traffic control service. It also provides control services to aircraft which operate on a controlled airway originating at Gander, Newfoundland, and terminating at Frobisher, N.W.T. In addition, oceanic control service is provided for the area between Greenland and Labrador.

DOT Tests Marine Position-Fixing System

Evaluation tests into the value to shipping of an electronic position-fixing navigator system have been carried out for more than a year on Canada's eastern seaboard and the reports have been assembled by the Department of Transport for consideration. The results of the tests are now being studied and will determine the government's decision for the future operation of the system.

This position-fixing system has been evaluated by different types of ships including fishing boats, coastal vessels and ocean liners and freighters. Four chains of land-based stations provide continuous radio signals which, through the medium of a receiver aboard ship, give numerical readings that are plotted on a grid chart or marked on a chart by a moving pen.

U.S. to Co-ordinate Civil and Military Radar

The U.S. Civil Aeronautics Administration and the USAF Air Defense Command have agreed to amalgamate the use of their radar facilities for air traffic control. This will avoid radar interference, and will save millions of dollars in equipment, installation and maintenance than if duplicated systems were used. New microwave links and air traffic control radar displays will provide the civil air traffic control stations with data from the USAF radar facilities and reciprocal arrangements will be made.

Recent CRTPB Meetings

The Executive Committee met on March 6 in Toronto. Under discussion was the important subject of frequency allocation recommendations for the forthcoming CCIR and ITU conferences.

A meeting of the newly-formed Stereophonic Sub-Committee of the Broadcast Committee was held in Toronto on February 26.

The Microwave Task Force on Communication System Parameters met in Montreal on February 27. Work continued on the question of parameters for microwave systems.

New Transatlantic Cable to Help Air Traffic

A new transatlantic cable will be laid from Newfoundland to Scotland, running via Greenland and Iceland, the International Civil Aviation Organization announced recently. The cable is primarily designed to improve communications for air traffic control and other aviation purposes across the North Atlantic; its use is expected to solve many of the point-to-point radio communications problems that have plagued transatlantic flight and have resulted in serious delays for passengers and additional costs to airlines. The cable is necessary because the existing high-frequency radio teletype circuits in the area are subject to the frequent radio blackouts characteristic of sub-Arctic latitudes caused by the Aurora Borealis.

Canadian Radio Technical Planning Board
200 St. Clair Avenue West, Toronto 7, Ontario

F. H. R. POUNSETT, President; C. J. BRIDGLAND, Vice-President; R. A. HACKBUSCH, General Co-ordinator;
R. C. POULTER, Director of Public Relations; F. W. RADCLIFFE, Secretary-Treasurer

THE NEW QQE 04/5 TRANSMITTING DOUBLE TETRODE—Specially designed as an R.F. power amplifier or tripler in mobile high frequency ranges up to 960 Mc/s and in other R.F. applications up to 1000 Mc/s. The Rogers QQE 04/5 provides 5 Watts *into the load* with a plate voltage of only 250 volts. Designed with a modified "frame-grid" construction producing such features as high mutual conductance, short transit time, small internal capacitances, low losses and low internal impedance.

Rogers wide range of quality communications tubes are finding more and more applications in all types of professional equipment. For greater reliability and lower maintenance costs, specify Rogers.

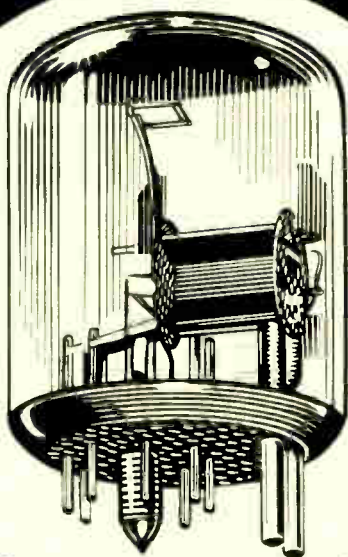

ROGERS

electronic tubes & components

A DIVISION OF PHILIPS ELECTRONICS INDUSTRIES LTD.
116 VANDERHOOF AVENUE, TORONTO, ONTARIO / BRANCHES: MONTREAL, WINNIPEG, VANCOUVER

★ Rogers Electronic Tubes are sold through Canada's Independent Electronic Parts Distributors

AMPEX

World Leader in Precision Magnetic Tape Recording Instruments

Ampex Tape Recorders are in service throughout the world in television and radio stations, and in professional sound recording studios . . . wherever finest quality is required.



VR-1000 Videotape® Recorder

First commercially available Videotape Recorder. Magnetically records what the TV camera "sees," in either black and white or color. Playbacks look "live."



MODEL 300 Magnetic Tape Recorder

Standard of the professional recording industry, it consistently delivers the finest in audio reproduction. Available in as many as 8 channels, in console and rack mounting.



MODEL 351 Magnetic Tape Recorder

First choice of the broadcasting industry. Features printed circuits and miniature tubes. Available in console, rack and portable models, with one or two channels. Sold by dealers.

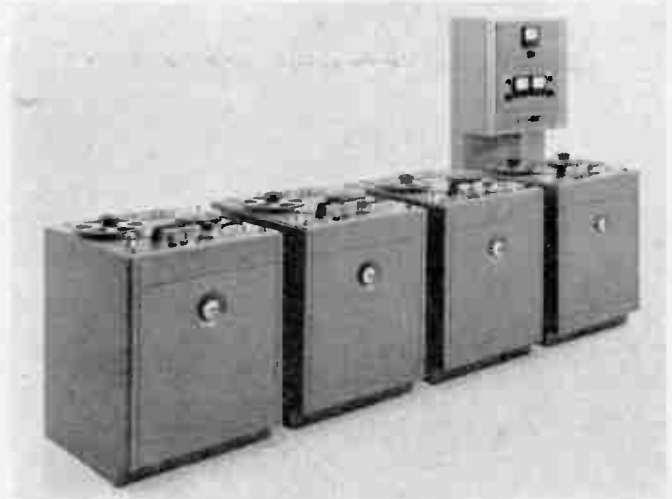

MODEL 3200 Magnetic Tape Duplicator

High speed duplication, with superb fidelity, of recorded master tapes. Makes up to 10 copies at one time. Available with one, two or four channel heads.

Fully illustrated brochures, complete with specifications, are available on each recorder and the duplicator. Technical bulletins are also available on the following subjects: VIDEOTAPE RECORDING • VIDEOTAPE SPLICING • MULTI-CHANNEL RECORDING • MULTI-CHANNEL TECHNIQUES • Write for the copies you want, today.

1537 THE QUEENSWAY, TORONTO



*TM Ampex Corporation

For complete details check No. 42 on handy card, page 95



DEPENDABLE POWER



LISTER AIR COOLED DIESEL ENGINES

In every field, Lister engines have proven themselves—setting a high standard of reliability and economy for industry and utilities. They are particularly suited to use in generating assemblies—for continuous running without attention.

Among their varied uses, Lister engines are in use for pumping and construction machinery, generating sets and marine propulsion. Parts and service are available throughout Canada.

Lister HA air cooled range. Direct injection for cold starting and greater economy. 10 BHP per cylinder continuous rating. 1800 RPM. Designed for working under the most varied conditions.

Write us for your free copy of Bulletins LD, SL and HA which describe, in detail, the Lister air-cooled range of Diesel engines 3½—30 BHP. Indicate application.

Lister-Blackstone engines 3½—1400 BHP.

CANADIAN LISTER-BLACKSTONE

LIMITED

1921 Eglinton Ave. E., Scarborough, Toronto 13, Ont.

VANCOUVER

MONTREAL

In the U.S: Lister-Blackstone, Inc., 42-32 21st Street, Long Island City 1, N.Y.

TRIPPLET

Reliability... through 15,631 accepted types

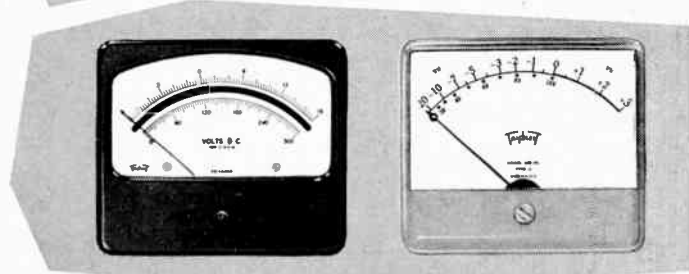
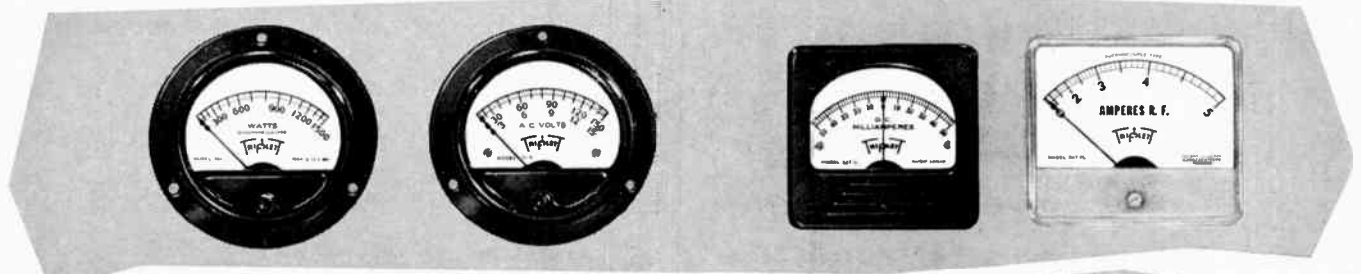
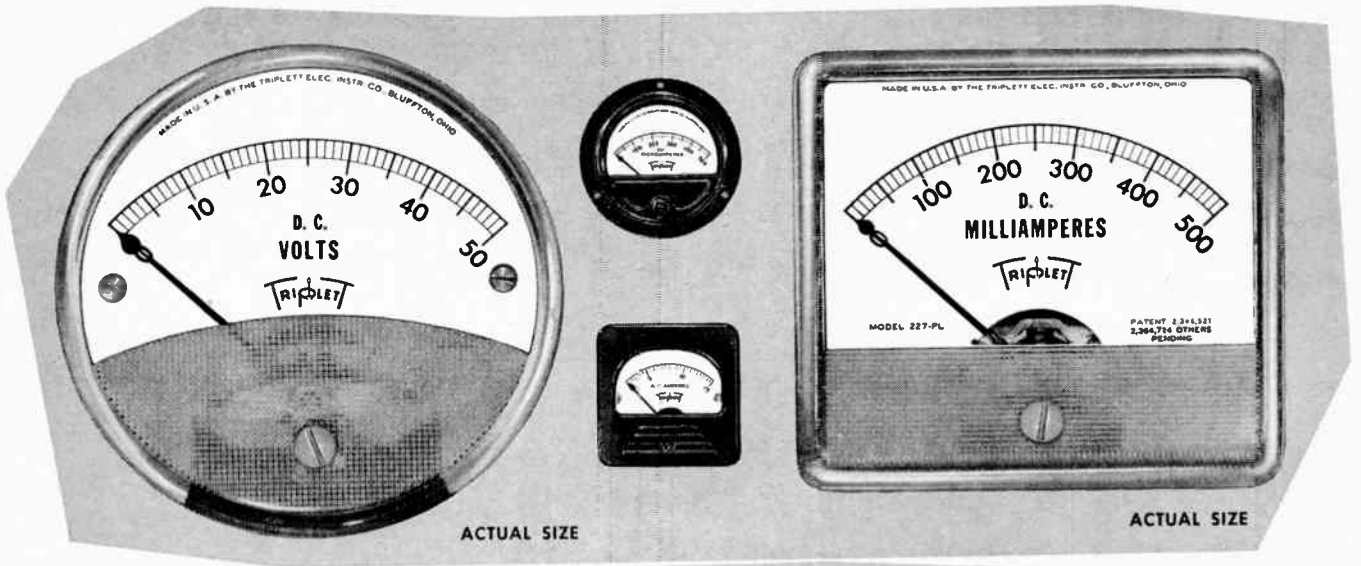

Clear plastic (PL) meters feature;

- Longer scale length
- Visibility unlimited
- Light unobstructed—no shadows
- Interchangeability—universal
- Appearance revolutionized

UNIQUE FEATURES AND CHARACTERISTICS

These guarantee superior quality in *all* TRIPPLET meters:

- High torque to weight ratio for extra rugged movement. Specially developed bearings withstand severe vibration and reduce friction to a minimum.
- Bearings are microscopically graded not only for depth and radius, but also for *polish*. Only best quality jewels are used.
- Unique hardening method assures uniformly hard pivots.
- High flux scientifically aged alnico magnets for greatest permeability. Micrometrically balanced all metal frame construction protects bearings against vibration from any direction.

- Simplicity of frame construction assures easy, accurate alignment in servicing.
- Dials are all metal—no paper dials are ever used—will not become abrasive, warp, crack or discolor under normal conditions. (Printing presses in Triplet's own plant allow fast, inexpensive service on special dial requirements.)
- Extra strong ribbed pointers precisely balanced with triple "slide and lock" adjusting weights.
- Insulations provide extra allowance for breakdown voltages.
- All metal parts processed, all molded parts pre-cured to eliminate distortions from stresses and strains.

BOSTON BROWN ADVERTISING

TRIPPLET ELECTRICAL INSTRUMENT COMPANY • 52 years of experience • BLUFFTON, OHIO
Triplet design and development facilities are available for your special requirements for meters and test equipment.

LEN FINKLER & CO.
 330 Adelaide Street West
 EMpire 8-5222

Toronto 2B, Ontario

C. M. ROBINSON COMPANY
 189 Market Street, Winnipeg
 550 Beatty Street, Vancouver
 325 10th Avenue, Calgary

For complete details check No. 125 on handy card, page 95

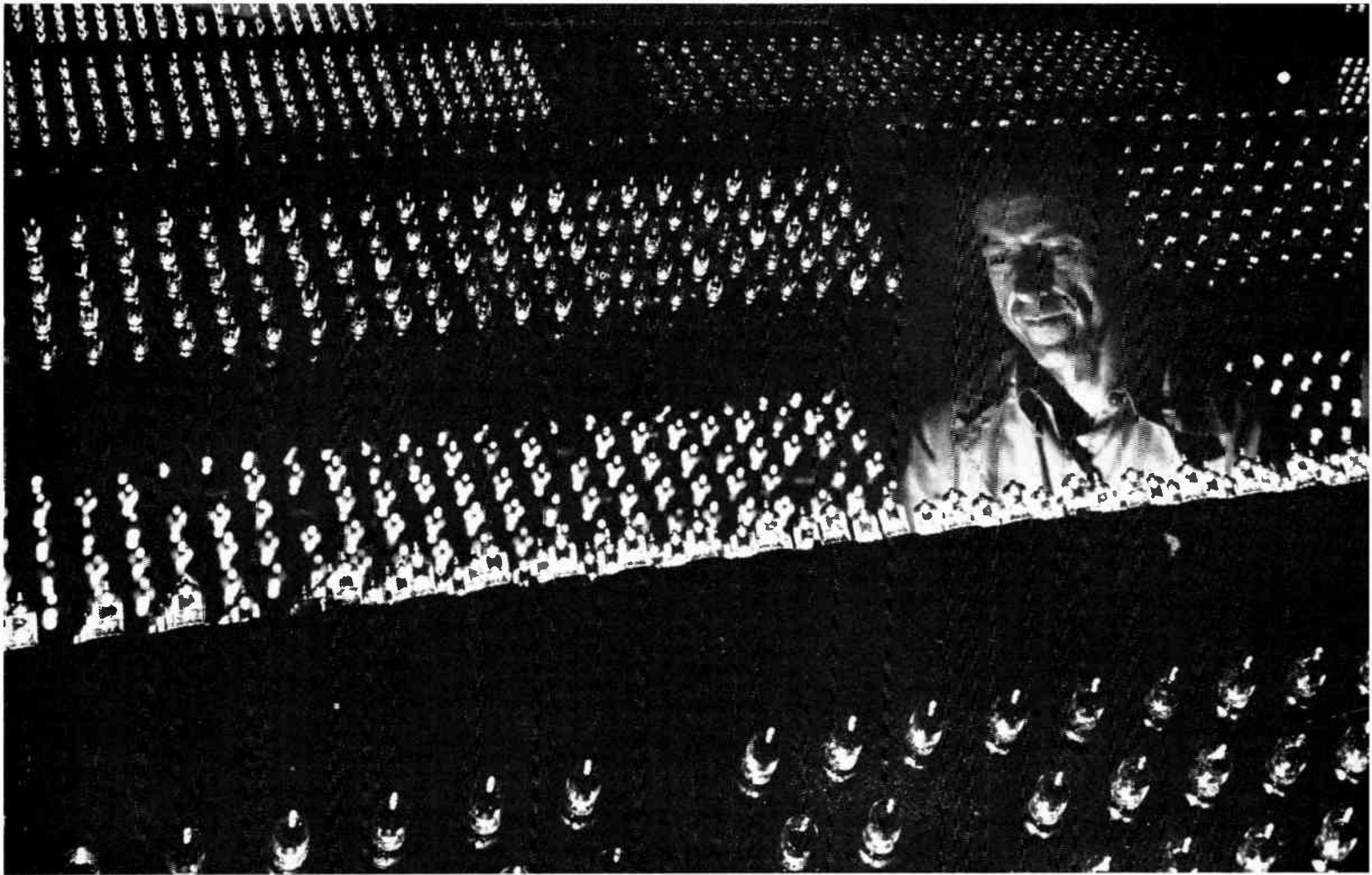

Factory Burn-in. All high-reliability G-E 5-Star tubes receive a special burn-in at C.G.E. This method weeds out possible early failures and promotes uni-

form tube performance. Every G-E 5-Star Tube has also passed rigid mechanical and electrical tests before shipment.

GET EXTRA PROTECTION FOR CRITICAL TUBE APPLICATIONS WITH G-E 5-STAR TUBES

As a manufacturer of communication, radar, computer or other industrial and military electronic equipment, your products must continue to operate dependably under abnormal and severe conditions. You can expect this service when your designs specify G-E 5-Star Tubes.

G-E 5-Star tubes are made in Canada. Their ultra-reliability and longer life is a result of these special design features, controlled manufacturing processes, and rigid tests:

- Welded heater bar and baseleads for structural rigidity
- Double mica spacers resist shock and vibration
- Critical grids are gold or silver plated to minimize grid emission
- Extra severe tests for shock, vibration, heater cycling and long life
- Burn-in process stabilizes characteristics—weeds out possible early failures.

The chart on the right shows you the prototypes which should be replaced by G-E 5-Star tubes in critical sockets. They help assure your radar, communication, computer, or other critical electronic equipment will continue to perform reliably—building a solid reputation that will lead to repeat orders for your equipment.

For further information on Canadian-made G-E 5-Star tubes contact: Electronic Tube Section, Canadian General Electric Co. Ltd., 189 Dufferin Street, Toronto, Ontario.

QUICK REFERENCE FIVE-STAR REPLACEMENT CHART

Regular Receiving Tube Type	Replace with G-E Five-Star or other Specified Types	Regular Receiving Tube Type	Replace with G-E Five-Star or other Specified Types
2CS1	5670*, 5670A, 5670WA	6AC7	6134, 6AC7WA
2D21	5727, 2D21W	6SK7	6137, 6SK7WA
5Y3GT	6087, 5Y3WGTB	6BE6	5750, 6BE6W
6AE5	5654, 5654/6AK5W, 5654/6AK5W/6096	6BM6	6265*
6AL5	5726, 6AL5W, 6097	6C4	6100, 6C4WA
6AQ5	6085, 6AQ5W, 6095	6X4	6202, 6X4WA
6AS6	5725, 6AS6W	12AT7	6201, 12AT7WA, 12AT7WB
6BA6	5749, 6BA6W	12AU7	5814A*
6AS7G	6080	12AX7	5731*, 5751WA
		12AY7	6072*

*Heater current approx. 17% higher. Check heater circuitry before substituting.



**GENERAL ELECTRIC
INDUSTRIAL AND
MILITARY TUBES**

ELECTRONIC TUBE SECTION

CANADIAN GENERAL ELECTRIC COMPANY LIMITED

World Radio History

a new

260

Series III



— with improved sensitivity and added convenience, at a new low price.

For 20 years the famous Simpson 260 has become a by-word in circuit analysis and measurement. Still maintaining its fine reputation for quality and the traditional Simpson care and attention in every detail of design and manufacture — the 260 is now available in a new series to keep up with our changing times. The Series III 260 uses printed circuits for added reliability and ease of service. Increased sensitivities are provided at no sacrifice in reliability; added ranges, and a unique scale layout to improve readability.

Best of all — a new low price making the finest in measurement available to all sizes of pocket books — all made possible only by complete Canadian manufacture.

RANGES:

D.C. Current. From 50 Microamps to 10 Amps in 6 ranges.

D.C. Volts (20000 ohms/volt). From ¼ volt to 5000 volts in 7 ranges.

A.C. Volts (5000 ohms/volt). From 2.5 volts to 5000 volts in 6 ranges.

D.C. Resistance 0-2000 ohms to 0-20 megohms in 3 ranges.

Polarity reversing switch, volume level (decibel) and DBM ranges.

Price — tax included

\$54.50

The long tradition of fine instrumentation of the Model 260 is now extended to the custom-engineered Model 270, providing increased accuracy, a mirror scale and movement overload protective service, along with full performance data. Write for further details. Priced at \$62.50.



1255 BRYDGES ST.

LONDON, ONT.

IN U.S.A.: SIMPSON ELECTRIC COMPANY, 5200 W. KINZIE STREET, CHICAGO 44, ILLINOIS

For complete details check No. 53 on handy card, page 95

4-8333

A WIRING EXPERT WITH SOME CLEAR ANSWERS

Your Phillips representative is much more than a wire and cable salesman. He is a qualified advisor. To any problem involving electrical conductors he brings his personal knowledge of the largest selection of wires and cables in Canada.

But more than this, when specialized and technical knowledge is needed, he can bring in the trained assistance and guidance of Phillips Electrical Engineers backed by years of experience, and one of the best equipped laboratories in the business.

His company has a 65-year record of service, and continuous research in the production and prac-

tical and technical application of wire and cable. Your Phillips representative brings this background along with the products he sells.

The next time you have a wire or cable problem . . . large or small . . . call on this wiring expert. Take advantage of his knowledge and service to obtain a clear, complete solution of your needs.

Phillips Electrical Company Limited. Head Office—Brockville. Sales Offices—Montreal, Ottawa, Toronto, Hamilton, Winnipeg, Regina, Edmonton, Vancouver.

5604



PHILLIPS ELECTRICAL  **COMPANY LIMITED**



By using the SHF Communications band and new, much smaller components, Westinghouse has developed a powerful yet compact MICROSCATTER system. Two MICROSCATTER components are shown above: The 2 K.W. Klystron Tube (right) and a model of the microwave block.

“Here’s how we put Microscatter on wheels!”

Now, Westinghouse has successfully reduced the size of microwave scatter—by developing an SHF system! And now, all radio equipment for a 5,000 mc. quadruple diversity *repeater* can be mounted in a 40-foot truck trailer.

For voice, teletype, television, facsimile and raw radar video . . . this advanced MICROSCATTER gives you high quality SHF transmission to points 100 to 200 miles away!

WESTINGHOUSE MICROSCATTER also gives you

HIGH QUALITY TRANSMISSION with an extremely linear, wide band Modulator, Exciter.

LOW COST PER CHANNEL MILE . . . due to minimum operating and maintenance costs . . . and low power consumption.

HIGH RELIABILITY of up to 99.99% . . . with quadruple diversity.

SMALL, NARROW-BEAM ANTENNAS, from 8 ft. to 28 ft. in diameter.



Here’s MICROSCATTER on wheels! All radio equipment for a 5,000 mc. quadruple diversity *repeater* is easily mounted in a standard 40-foot trailer.

For complete information, phone your nearest Westinghouse office. Or write to Canadian Westinghouse Company Limited, Electronics Division, Longwood Road, Hamilton, Canada.

YOU CAN BE SURE...IF IT'S

Westinghouse



WATCH "WESTINGHOUSE DESILU PLAYHOUSE" CBC TV MONDAYS

58C745

business briefs and trends

★ Attention to metal powders and powder metallurgy at a recent National Metals Exhibition in Cleveland reached record proportions, according to George Monteith, president of Metal Atomizing & Processing Corporation Limited, Toronto. "What impressed our Canadian group was the evidence that metal powders constitute one of the specialized fields in which this country can develop a new and profitable export trade," Mr. Monteith said. "This is one section of U.S. industrial demand not fully met from domestic sources."

* * *

★ A complete foundry installation is to be produced in England, delivered and erected in Canada by a British company — Foundry Equipment Ltd. This is the first time the company has tackled such a project; they displayed a full-scale working model of a foundry at a Cleveland, Ohio show last June, and this order — from Jenkins Brothers of Lachine, Montreal — is one result. Many other orders from the same show included a contract to supply a power-assisted sand rammer to a Pennsylvania foundry.

* * *

★ The Air Traffic Services, Search and Rescue Division of ICAO made recommendations recently concerning the equipment of all life saving rafts with radio survival beacons, and of all aircraft flying across areas where search and rescue would be exceptionally difficult with portable radio survival beacons. The Division also asked that states encourage the development and installation, in aircraft of their registry, of automatic crash locator beacons; in this connection it drew particular attention to the "Tumbling Aerofoil" developed by the National Research Council of Canada.

* * *

★ Canadian industry has relied too heavily on work done in the United States, C. T. Carson, P.Eng., told the annual meeting of the Association of Professional Engineers of Ontario at a recent meeting. Referring to a multitude of corporations in Canada that "are simply branches of U.S. firms and which naturally look to their parent companies for instruction and guidance", he pointed out that they should carry out more research work in Canada. He added a similar criticism could be made "quite properly" in the field of consulting practice.

* * *

★ The United States will become a second rate nation unless its technical men and industrial management raise their standards to provide almost 100 per cent reliability for parts used in today's complex tools and apparatus. This was emphasized at the seventh annual meeting of the Standards Engineers Society, held in Philadelphia recently.

* * *

★ A record net profit of \$552,000 has been reported to shareholders of Dominion Electrohome Industries Limited in a letter, signed by president Carl A. Pollock, outlining the company's 1958 activities. Net profit per share is \$5.10 compared with \$3.07 in 1957. In his letter, Mr. Pollock said, "while general business conditions in Canada were only fairly good in 1958, Electrohome experienced the best year's performance in its history".

* * *

★ The Air Traffic Services, Search and Rescue Division of ICAO has noted that, in many states, "if the density of air traffic and the speed of aircraft increase much beyond the present stage, it will no longer be possible to ensure the safety and regularity of air traffic without the aid of some form of automatic equipment". It therefore proposed a set of broad principles to ensure that the systems being developed in different states will be compatible so that full advantage of the automatic air traffic control equipment can be derived in the cooperation between area traffic control centers.

business briefs and trends

★ CJDC-TV, Canada's northernmost TV station, started telecasting here on Jan. 15, 1959. Located near the Alberta border, and north of the 55th parallel, Dawson Creek is the southern terminus of the famed Alaska Highway. With its studio and transmitter located in the center of the city and utilizing one of the lowest radiating powers in Canada, CJDC-TV represents a new type of TV station serving a local rather than a regional market. Its primary signal serves Dawson Creek and the immediate area. This is similar to the role played by local radio for many years.

* * *

★ Canadian tube manufacturers have recently adopted a new warranty date code system for carton-packed receiving tubes. In their opening announcement of December 23rd, covering this new date coding system, Canadian General Electric say: "As a result of recommendations made by the Canadian Electronic Wholesalers' Association and for our mutual protection, a new warranty date code system has been adopted for G-E Carton-Packed Receiving Tubes." We appreciate this move on the part of Canadian tube manufacturers and are looking forward to the time, not too far distant we hope, when other recommendations contained in our brief will be implemented by manufacturers and our suppliers.

* * *

★ The growth of the magnetic tape industry should continue at the healthy rate of about 35 per cent for the coming year, according to William C. Speed, president of Audio Devices. "This rate has been consistent over the past five years," said Speed, "and we see no reason to anticipate any major change for 1959."

* * *

★ Two international standards recommendations affecting electronic tubes and valves are now available from the American Standards Association. They are IEC Publication 67 (third supplement) and IEC Publication 100. The third supplement to IEC Publication 67 — Dimensions of Electronic Tubes and Valves — provides an important basis for the interchangeability of electronic equipment among the 33 nations participating in the work of the International Electrotechnical Commission.

* * *

★ Colonel T. M. Medland, executive director of the Association of Professional Engineers of Ontario, told a recent gathering of professional engineers that the average starting salary for an engineer in 1958 was \$393 per month as opposed to \$157 a month in 1945.

* * *

★ J. Herbert Smith, president of Canadian General Electric Company Limited, stated recently that a major share of electronics expenditures in the future would be for controls and the automation of factories and industrial processes. Mr. Smith said that some of the brightest prospects for the industry lie in this area, together with communications.

* * *

★ British industry is now ready to welcome enquiries for the design and construction of nuclear power stations of large and small generating capacity, research reactors, processing and handling plants, and the whole range of ancillary nucleonic and electronic equipment required for atomic energy plants, hospitals, research laboratories and industrial plants of all kinds.

* * *

★ Canadian Admiral succeeded in reversing the industry trend by increasing its television sales 45 per cent in December last. Dollar sales in 1958 were over \$1½ million higher than in 1957.

CAPACITORS

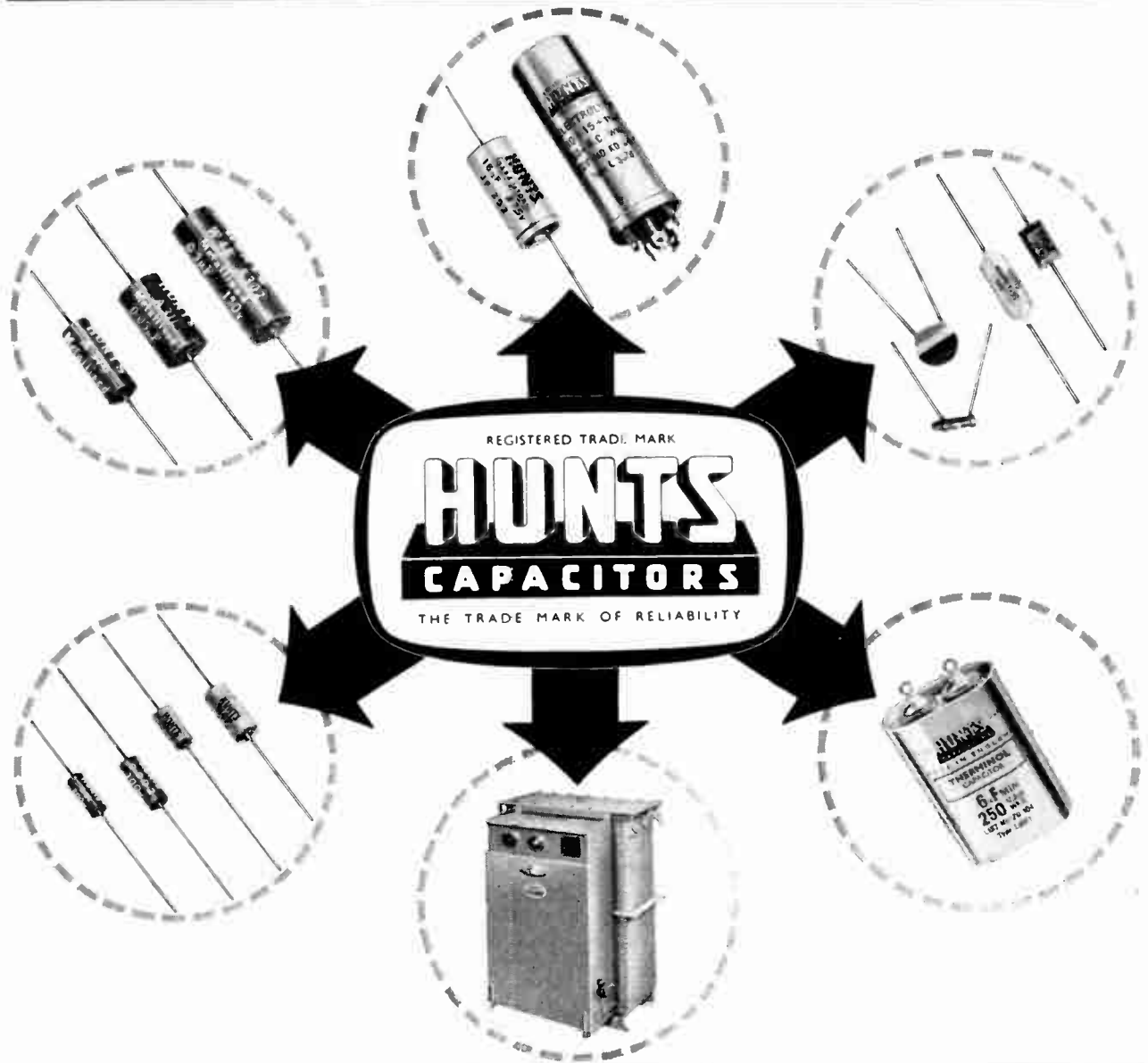

for all applications

TYPES

DRY ELECTROLYTIC · METALLISED PAPER (HUNTS PATENTS)
 METALLISED PLASTIC FILM (HUNTS PATENTS)
 PLASTIC FILM · FOIL & PAPER · SILVERED MICA
 STACKED MICA · CERAMIC · POWER CERAMIC
 TRANSMITTING AND SPECIAL R.F. TYPES

APPLICATIONS

RADIO AND TELEVISION EQUIPMENT · ELECTRONIC EQUIPMENT
 POWER FACTOR IMPROVEMENT · CAPACITOR MOTORS
 FLUORESCENT LIGHTING · PHASE SPLITTING
 H.F. AND R.F. HEATING · IGNITION AND INTERFERENCE SUPPRESSION
 TELEPHONE INSTALLATIONS

A. H. HUNT (Capacitors) LTD., WANDSWORTH, LONDON, S.W.18. Tel: VANDyke 6454

Factories also in Essex, Surrey and N. Wales.

AND IN CANADA: ADAMS ENGINEERING LTD., OTTAWA ONT., MONTREAL QUE., TORONTO ONT.

For complete details check No. 86 on handy card, page 95

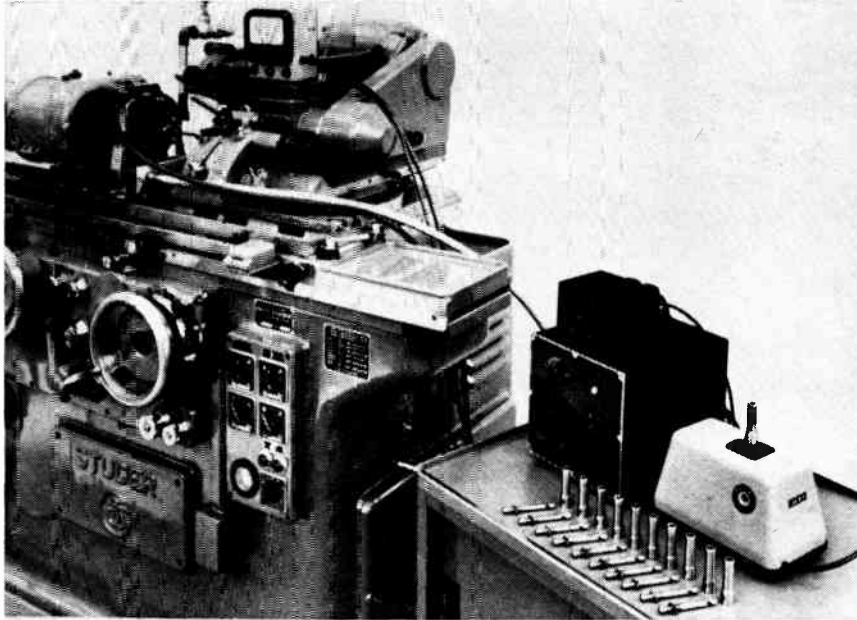

The Movolimit-Detalimit System fitted to Studer Type RHU 450 hydraulic cylindrical grinder. At extreme right is the interlimit unit. Immediately in front are a selection of standard measuring arbors.

Space age tolerance limits now being met with electronic machine tool controls

Diameter control for grinders

An automatic measuring system for cylindrical grinders is now in operation at Lucas-Rotax Limited of Toronto. It has incredible repetitious accuracy. Called the Movolimit-Detalimit System, the equipment comes from Fritz Studer Limited of Switzerland. It is the first of this make and one of only a few such units operating in Canada.

The electronically controlled system has a consistent accuracy of $\pm .00004''$ (1/25,000 or 40 millionths). It is comprised of three separate units:

1. The measuring head, which contains a precision resistor element and makes continuous two-point diameter readings directly at the point of grinding, is either mounted to the slide of the machine or suspended from the wheelhead. The reading points are carbide tipped.

2. The indicator instrument is composed of a millivoltmeter, three signal lights and control relays. It has coarse and fine scales with total scale readings of $\pm .002''$ and $\pm .0002''$ respectively. The green signal light indicates work diameter is oversize; the yellow, between roughing and finishing size; and red, that the finished size within tolerance has been reached. There are two manually adjustable fixed pointers for indicating allowable tolerance range and a moving pointer indicating simultaneously, relativity of workpiece to tolerance, concentricity, circularity and parallelity.

3. The measuring and control amplifier unit provides two decade resistor controls for independently setting the control relays; a manual change-over switch for coarse-fine selection; a remote zero adjustment for the live indicator pointer; and a power switch with signal light.

The indicator is placed at eye level on the machine while the amplifier can be placed on any convenient

table several feet from the machine.

There are two different methods of operation. If the grinder is of the mechanical type, the Movolimit may only be used as a single piece measuring system. The indicator is set according to the amount of material to be removed and the desired tolerance. As the grinding progresses, the actual decrease in diameter is shown on the instrument. By this manual method, single work-pieces are produced and the control of the machine remains the responsibility of the operator.

In the case of repetitious work on hydraulic machines the sequence of operation is as follows: The system is calibrated electrically to a master component or the first work-piece produced by the previously mentioned manual method. The Movolimit then controls the working cycle of the machine commencing simultaneously with:

1. The approach and engagement of the measuring head.
2. Rapid approach of the wheelhead.
3. Starting of the spindle and table movement.

The system then controls:

4. The roughing operation, regardless of the number of strokes.
5. Stopping of the wheel in-feed by the 'roughing control' relay.
6. Sparking out and sizing by the 'finished size' relay.

The elements of the machine and system are then returned automatically to their starting positions. Once set, the sequence of operations may be repeated as often as required and components are produced consistently within the tolerances previously mentioned.

Cosa Corporation of Canada, Toronto 14.

Ultrasonics in small parts manufacturing

**Longer life for engraving tools
and diamonds is one economy
realized from ultrasonic cleaning**

An ultrasonic cleaning plant has recently been installed by the Parker Pen Company in the press shop of their Newhaven factory, where noses and clips for pencils, and clips, clutches, caps and guards for fountain pens are produced.

The manufacturing operations for these parts are many and varied and in almost all cases involve the use of expensive press tools or diamond engraving machines. Owing to the nature of the work each part may need to be treated by several machines in succession.

The tools and diamonds used for engraving are very susceptible to damage by the presence of dirt — which may contain hard abrasives — and elaborate precautions are essential to minimize this by exhaustive cleaning of each part before it is put in a machine.

Previously, this cleaning was done by hand, a process that was not entirely satisfactory, absorbing as it did quite a proportion of the labor costs. For instance one particular component part, a "Lustraloy" cap for one of the Parker pens, undergoes 20 processes from its entry into the press shop as a blank to its exit as a fully machined cap, and no fewer than four of these operations are thorough cleansings.

To improve efficiency and to deal with the fact that component parts for pens were becoming more numerous, ultrasonic cleaning equipment was installed to increase the output of the shop and lower the costs. Besides saving in labor and space — it replaces three operators each needing a working bench and a sink — the ultrasonic equipment now enables as many parts to be cleaned in one day as was previously possible in a week.

Owing to the effectiveness and uniform nature of the ultrasonic cleaning the possibility of any tool or diamond damage due to dirt has also been greatly reduced. There is in addition a complete lack of "after-marking" which occurs with hand cleaning. The drying, which is all part of the overall ultrasonic cleaning process, also saves an operation previously effected by a centrifuge.



Caps for fountain pens being loaded into the Kerry-Mullard ultrasonic cleaning plant at the Newhaven, Sussex factory of the Parker Pen Co

The installation consists of a Kerry-Mullard ultrasonic cleaner type UHD1 driven by a Mullard ultrasonic generator type L278.

The speed of the ultrasonic cleaner can be gauged from the fact that it handles about 150 caps or 2,000 pencil noses at each filling and the whole cycle — including drying — takes about two minutes. The metals of the parts treated are rolled gold, "Lustraloy", stainless steel and nickel silver.

The actual cleaning takes place in perchlorethylene which is heat controlled and ultrasonically agitated by crystal transducers fed from electronic generators. In a separate compartment in the equipment perchlorethylene vapor at a temperature of approximately 120°C heats the components so that they flash dry as they are brought through cold coils. This section also continuously distills the solvent in the circuit to ensure it is kept clear of soluble contamination. Particle contamination in the ultrasonic tank is dealt with by a pumping and filtration system which forms part of the equipment; thus by efficient filtration and distillation the liquid is maintained at a high degree of cleanliness, which is essential if effective ultrasonic cleaning is to be achieved.

In addition to the above applications for their range of fountain pens and propelling pencils, the Parker Pen Company now have a second Kerry-Mullard ultrasonic cleaning installation undergoing initial tests in connection with the manufacture of ballpoint components.

Mullard Equipment Ltd., Torrington Place, London, England.

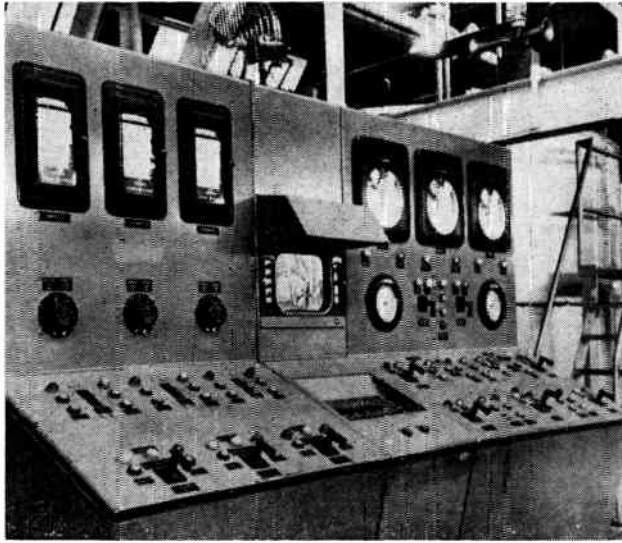

(Above) View of master control panel for hydropulping process at Western Electric Company's Kearny, New Jersey, cable plant shows centrally mounted television monitor and camera controls.

(Below) Permanent installation of camera control and switching units for television system at Western Electric Company's Kearny, New Jersey, cable plant.

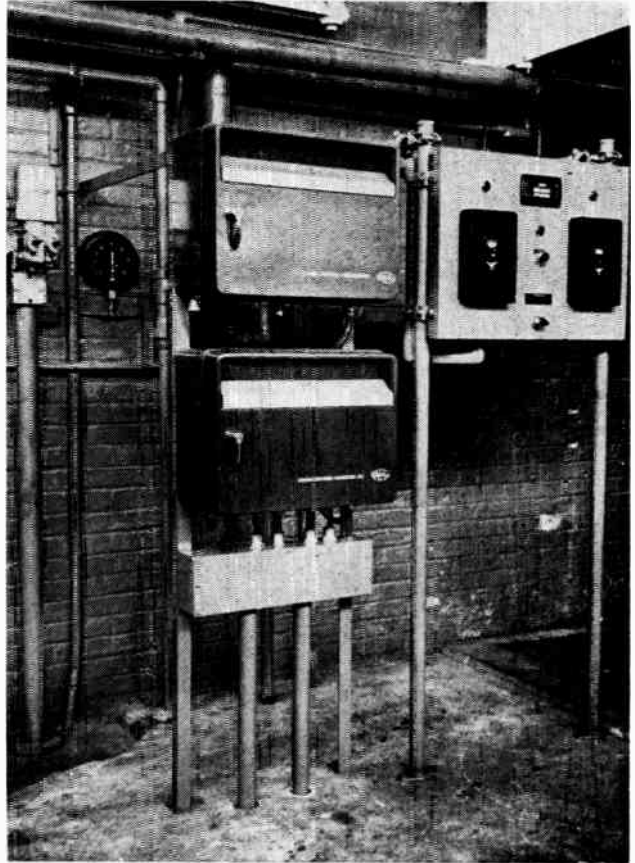

**Time and manpower savings
as well as safety benefits
are derived from the use of**

I/T/V in cable plant pulping

The continuing drive to obtain maximum production efficiency has prompted the Western Electric Company, manufacturing and supply unit of the Bell System, to enlist the aid of closed-circuit television in its Kearny, New Jersey, cable plant.

Two General Precision Laboratory television cameras — one focused on each of two 3,000 gallon hydropulper tanks — transmit a continuous picture of the hydropulping process via coaxial cable to a 14" monitor which is viewed by an operator stationed at the central control panel on a different level in an adjacent building.

The TV screen provides a full view of pulp loading conveyors and processing equipment so that the operation of automatic controls can be verified. Pictures of either tank are obtained as desired simply by pushing a button which switches the monitor's reception from one camera to another.

Since the size of Western Electric's hydropulper tanks made it necessary to place them in a location removed from the control point, the operator could not see to activate the automatic pulp conveyor for

loading the vats. The extra pair of eyes provided by the TV cameras does the job for him.

In addition to savings in time and manpower, the view on the TV screen makes it possible to verify the location of any personnel who may be nearby when the automatic cycling process is started, thus eliminating a possible safety hazard.

While watching the televised pictures, the single operator starts the hydropulper's sharp 45" diameter rotor blades to revolving at 197 revolutions per minute, turns on the water which flows from pipes circling the interior of the tank top and dumps up to 1,100 pounds of sheet pulp into the tank.

Used in conjunction with automatic controls, the system speeds production and solves space problems created by added pulp insulating machines and increased capacity pulping equipment.

This 15-minute automated pulping process is the first step in the production of paper insulated exchange area telephone cable.

General Precision Laboratories Inc., Pleasantville, New York.

Surface density and moisture gauges permit the "on-site"

Analysis of construction materials

Two new probes permit rapid determination of moisture content and density on the surface level. The surface moisture and surface density probes are the newest members of the Nuclear-Chicago "d/M-Gauge" system. These new probes provide highly accurate moisture and density measurements directly on the surface of the material eliminating the necessity of removing, weighing, or destroying a sample of the material for testing. The results obtained with the P21 and P22 probes are in many cases far more accurate and reproducible than those gained with the conventional "non-nuclear" methods, and no field laboratory, scales, or drying ovens are ever needed. One non-technical person can perform tests and successfully arrive at precise moisture and density determinations in as little as two minutes with this completely portable field system.

The surface probes are ideally suited for compaction studies, control of earth fills and embankments, tillage and cultivation studies, etc. Results with the P22 surface density probe are accurate within two lbs./ft.³ wet density. The P21 surface moisture probe provides results reproducible within ½ lb./ft.³ moisture content. The surface probes can be used on sand, clay, granular



Operator obtains final surface density (or surface moisture) reading on the construction site. The scaler has counted impulses received from the surface probe — the total count appearing on the scaler's five glow tubes. The "count" is applied to a factory supplied calibration chart for a direct density reading.



A complete d/M-gauge system for surface moisture or density determinations consists of a surface moisture probe or surface density probe (pictured above) and the portable scaler. Here the operator has placed the surface density probe on a relatively smooth part of the road surface and lowered the handle to the "use" position.

materials, asphalt and concrete. On general construction projects such as road building, air fields, the d/M-Gauge surface probes assure higher quality controls, more accurate adherence to job specifications, and greater personnel and equipment utility. They also may be used in research to assist equipment manufacturers in designing more efficient equipment to better meet the demands of the expanding building and highway construction programs.

Surface measurements are performed by placing the P21 surface moisture probe, containing a fast neutron source, or P22 surface density probe, containing a gamma-ray source, on a relatively smooth portion of the surface. The radioactivity is scattered with varying degrees when placed in contact with materials of different density or moisture content. Measurement of the "scatter" with the model 2800 portable scaler results in a number corresponding to the material's moisture content or density. A special calibration curve of the "scatter-count" vs. density or moisture content is furnished with each probe. Since both units are completely portable and measurements are performed in a minimum of time, many measurements can be made in a given area providing more dependable controls than can be gained through other slower methods.

The surface probes measure a semi-spherical volume of material whose depth varies from approximately 3" to 8" inversely with moisture content or density.

Nuclear Chicago Corporation, Chicago 10, Illinois, U.S.A.

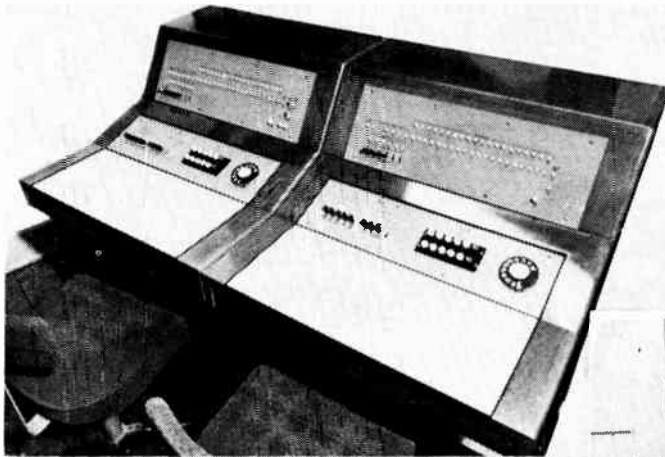

(Above) The cordless switchboard installed at Canadian Pacific Railway Company's London headquarters. The "key-sending" push-buttons can be seen next to the dial.

**Gone are the jacks,
plugs and cords of conventional
PBX telephone equipment in**

(Below) Comparison of 30 year-old equipment shown at right stands out against the clear-cut lines of modern telephone equipment shown at left.



Cordless automatic PBX switchboard

An important step in the march of progress of automation in private telephone systems was taken when the first cordless switchboard to receive Post Office sanction went into operation in Great Britain recently.

The switchboard controls a private automatic branch exchange, manufactured by Automatic Telephone & Electric Company and installed at the European headquarters of the Canadian Pacific Railway Company in Trafalgar Square, London.

Gone are the jacks, plugs and cords of the conventional switchboard. In their place are neat rows of push-buttons and keys, mounted on a small desk, smartly styled in light oak with grey panelling. Even the familiar dial is only there for stand-by use, because "dialling" has been replaced by the much faster system known as "key-sending", which the operator (not the extensions) uses for calling both internal and external numbers.

The exchange has 110 extensions, 29 lines to the public exchange and four private wires to other Canadian Pacific offices. Any extension can dial any other extension and can also dial outside numbers direct, from the same telephone. Direct access to an outside line can be barred to certain extensions if desired.

The two operators — four were needed to operate

the original equipment — are almost entirely occupied with incoming calls. A system of lamps tells the operator how many calls are waiting. To accept a call, she simply moves a key — the waiting calls are automatically brought up in rotation — and sets up the number of the required extension by pressing the appropriate push-buttons. She then presses the "send" key, the extension is rung automatically and a lamp indicates "free" or "busy". If the line is free, the outside call is put through automatically.

If busy, a "ring when free" facility can be used. This device rings the extension when it becomes free and automatically connects the outside call. Sometimes the operator will wish to advise a "busy" extension that an important outside call is waiting; she can do this by transmitting a warning tone. When the required extension hangs up he is automatically rung and, on answering, is connected to the incoming call.

An extension can "hold" an outside call while he makes an internal call; he can automatically transfer an outside call to another extension, without help from the operator; and if perhaps he is not sure to which extension the call should be transferred, he can return it to the operator for action.

Automatic Telephone and Electric Co. Ltd., London, W.C.2, Eng.

Seated in an aircraft cockpit, engineer turns a knob to "rotate the world" about the parked plane. System will save millions of dollars annually for airlines and other military and commercial users.

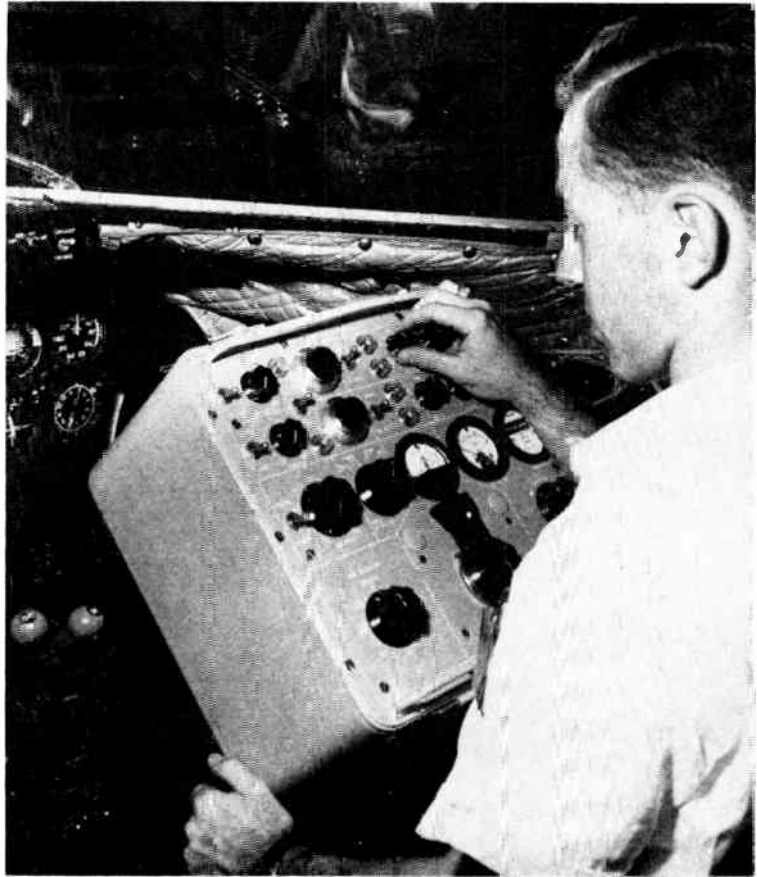

Million dollar ground and maintenance flight cost savings envisaged by the use of

System for calibrating compasses

A revolutionary method of calibrating airborne compass systems by "rotating the world" around a parked aircraft — or guided missile — was recently revealed by the U.S. Air Force and Sperry Gyroscope Company.

The new system — which Sperry developed — enables an average line maintenance man to rotate the equivalent of the earth's magnetic field about a parked aircraft for a precise check of its compass system.

This unusual development is expected to save millions of dollars in ground maintenance and flight costs and, at the same time, give these prime navigational instruments greater accuracy than ever before.

The new equipment already has been used by the Air Force and Sperry engineers to precisely calibrate the compass system for the Snark intercontinental missile, as well as those of a variety of conventional and high-performance aircraft.

Magnetic compasses must be calibrated periodically because changing metallic and electrical influences adversely affect their accuracy. Precise calibration — until now a costly, complex procedure — is of special importance with today's long-range, high-speed aircraft.

Sperry's electronic method of "swinging the earth on its axis" enables a maintenance man quickly to check the accuracy of compass indications in all directions, without moving the aircraft.

He does this simply by manipulating a switch on a small electrical console — a portable control unit plugged into the plane's compass system. With the new equipment, compasses in even the largest aircraft can be calibrated precisely in less than two hours.

In contrast to the relatively simple electronic procedure, the old manual method often requires the combined efforts of three or four men, an airplane tug and a full working day. The aircraft must be rotated painstakingly about a full 360 degree circle while crewmen check and compensate for errors on a variety of directional headings.

The circle is called a compass rose. It is a costly, precisely-surveyed compass face — 100 or more feet in diameter — painted usually on a concrete surface at an airport far from buildings, electrical equipment, and other sources of magnetic disturbance.

Because of the great expense involved in constructing compass roses — some cost as much as \$250,000 — only major airbases are so equipped, making it necessary to fly aircraft long distances to have compasses checked.

The manual method also makes it extremely difficult to reduce magnetic heading errors in compasses to less than one degree. This is increasingly disturbing because a one degree heading error can put a high-speed, long-range aircraft one mile off course for each 60 miles flown.

Sperry's electronic method, however, can reduce these errors to one-tenth degree.

The only devices needed, in addition to the electrical console, are a tripod similar to that used by a surveyor and a field monitor, a simple transit modified to include a special magnetic sensing device. Weight of the equipment is about 90 pounds.

Sperry Gyroscope Co., Great Neck, New York, U.S.A.

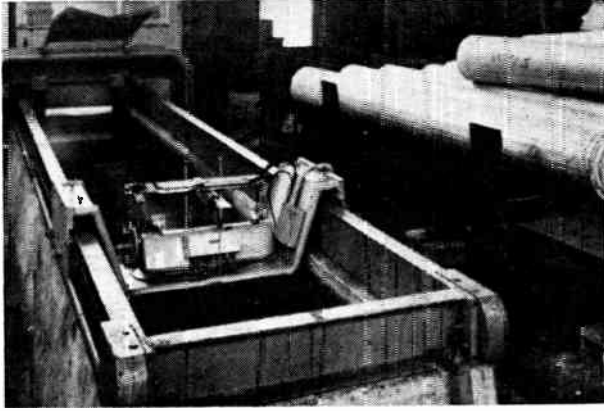

A production method of testing aluminum billets by the immersion principle, employing Autosonic Inspection Equipment.

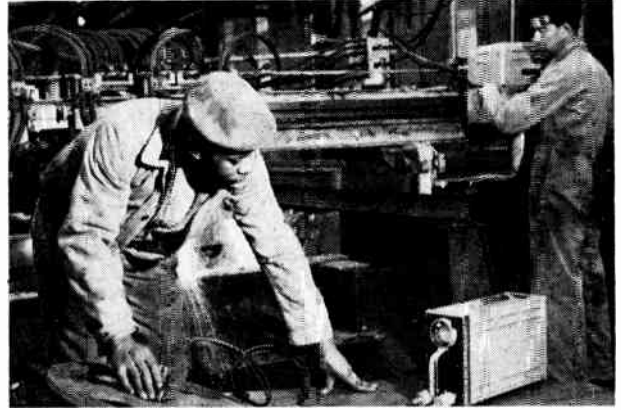

Testing a precision gear wheel cut-out for laminations using a Mark 5 ultrasonic flaw detector.

**Shipments of one hundred per cent
flawless steel shapes
assured by the use of**

Flaw detection in steel stocks

A great deal of time and effort can be wasted if steels are found to contain structural defects during final stages of machining or forming. All the preparatory handling, cleaning, cutting and, in many instances, costly transport, can be nullified at the precise moment the machining tools reveal the tell-tale streak, or the metal fails due to internal stresses at the point of weld. More dramatically, the fault may only be discovered at the latter stages of welding, of say a complex pressure vessel when scrap costs can be extremely heavy.

Alternatively a flaw can escape chance detection throughout all the preparatory stages of manufacture and may only manifest itself as the failure of a component of a complete unit — with possible drastic results.

The most commonly used methods of ensuring that metal is free from internal defects is to subject the material to x-ray, magnetic flux or ultrasonic examination. The cost involved and the topical aversions to the former method, coupled to the recommended restrictions to their use may deter the stockist from employing x-rays. Therefore ultrasonic flaw detection equipment is now becoming increasingly popular, both by the manufacturers of precision forgings and for components requiring a great deal of preparatory machining.

Portable ultrasonic equipment is now available as a compact, single case unit, weighing only 28 lbs. and operating direct from AC mains supply, so no difficulty is experienced in the employment of the equipment under normal stockyard conditions. In addition, very little training is required to operate the equipment and interpret the signals.

The applications of portable ultrasonic equipment are many and varied, but probably the most important phase of ultrasonic examination is that carried out either immediately following manufacture, or during the stock stage, before the material is used for process work.

In billet form, metals can be automatically scanned for structural defects at the foundry by the method depicted at left but the speed and/or high tempera-

ture associated with strip rolling mills precludes such testing methods, which must inevitably be carried out in the stockyard. Where these tests are not carried out, the stockists risk delay, annoyance and customer dissatisfaction if flaws are not detected until the fabrication stage. The stockist can replace the raw material, for which he is compensated by the foundry, but there is no compensation for the greater expense of time and handling costs.

Right above shows a Kelvin Hughes MK 5 flaw detector being used to detect laminations in plate in the profile cutting shop.

Conditions within the stockyard are typical of the industry, the flaw detector being used with great success on surfaces which are occasionally badly scaled or "stock rusty". No special preparation of the stock is made and the tests are always carried out in situ, using water as an acoustic coupling medium.

The types of probe employed are dependent upon the type of flaw to be detected and the material involved. The one illustrated has been selected from a very wide range of probes developed by Kelvin Hughes.

After wetting the plate to be tested, the operator "wipes" the surface with a probe, operating in a definite pattern to avoid 'blank' areas.

Development of the equipment has resulted in a fully automatic system of ultrasonic testing equipment designed for large foundries, whereby the materials are tested and faults recorded without recourse to manual handling.

A semi automatic system which is now widely used removes the onus of signal discrimination from the operator and employs audible as well as visual warning of the presence of faults.

In this system the probe is attached to a 'walking stick' arrangement through which is piped the necessary acoustic coupling fluid.

Kelvin Hughes, Knotts Green, Leyton, England and Kelvin Hughes (Canada) Ltd., Montreal, Canada.

Figure 1

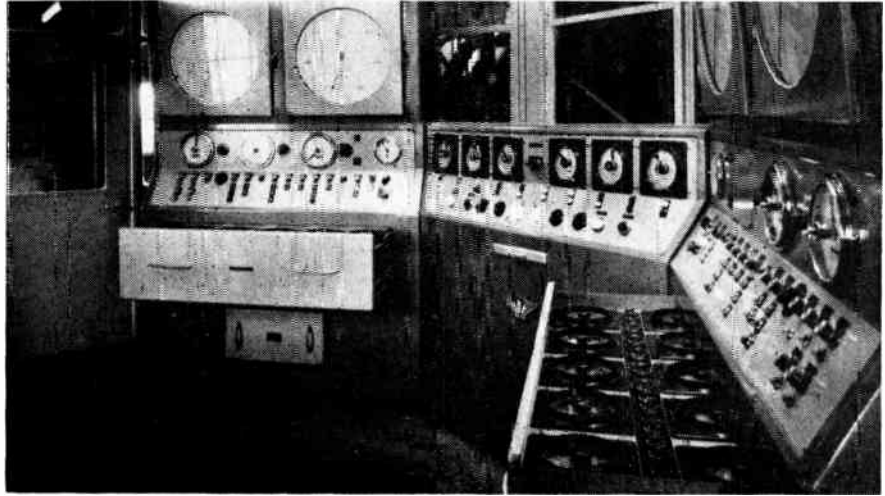

Large scale weighing operations
and proportioning control
facilitated by

Automatic bulk weighing systems

Control by weight is frequently a basic requirement necessary in many industrial processes, and only in recent years has this important application been accomplished by the use of electrical means.

The absence of moving parts reduces maintenance and as there are no knife edges to be damaged by shock loads or to deteriorate with prolonged use as with traditional mechanical scales, electrical weighing equipment maintains its original accuracy over long periods of time with the important advantages of ease of installation and site flexibility.

The basic measuring element of the electrical weighing system is the load cell. In essence the load cell is a billet of steel which, when placed on a fixed bearing surface with a load applied to its upper surface, undergoes a degree of deformation which, within the elastic limits of the material, is proportional to the weight of the applied load.

The strain set up within the billet material is measured by strain gauges bonded direct to the billet. Two pairs of strain gauges are used, an "active" pair bonded to the billet at the point of maximum stress and a "passive" pair which take no stress, or alternatively a stress of opposite sign to that measured by the active gauges. The characteristics of the four gauges are accurately matched and are connected together to form a wheatstone bridge circuit to measure the ohmic changes with load.

With no load applied to the billet and the bridge circuit energized from an AC or DC source, the measuring bridge is in electrical balance. Application of a load to the billet results in an out of balance current from the measuring bridge, this current being directly proportional to the load applied.

Use of modern servo amplifier techniques permits the use of recorders and indicators possessing high



Figure 2

orders of accuracy, together with the robustness required to meet the arduous conditions encountered in many industrial applications.

A typical example of an electronic weighing system is shown by illustration 1. The function of this equipment is to control automatically the plant shown in illustration 2. Several ingredients in a fixed proportion are required to make up a standard road surfacing mix. The automatic cycle of operation includes the mixing of 10 ingredients into a weigh hopper, the addition of flux oils and bitumastic compounds, timed heating and mixing cycles and automatic discharge to either traveling hoppers or road vehicles.

It will be seen that the control console is divided into two identical sections. These sections may be fully interlocked to perform automatic cyclic mixing and blending or alternatively two entirely different blends may be set up and used as required.

For small batch production, whilst one section is automatically producing an automatic number of batches (up to a maximum of 36 in this instance) the operator may be resetting the second section to produce a completely different blend.

One function of particular interest on this equipment is the complete interlocking with the check weighing function which ensures that should a faulty blend be made up (this may happen in the case of material shortage in the supply hopper) then on reaching the check weighing position the unit will sound a warning and discharge the faulty batch, thus ensuring consistency of the product.

Many of these plants have now been supplied to users in various parts of the world, and from the point of view of both technical and commercial usage are continuing to give every satisfaction.

Elliott Brothers (London) Ltd., London, England.

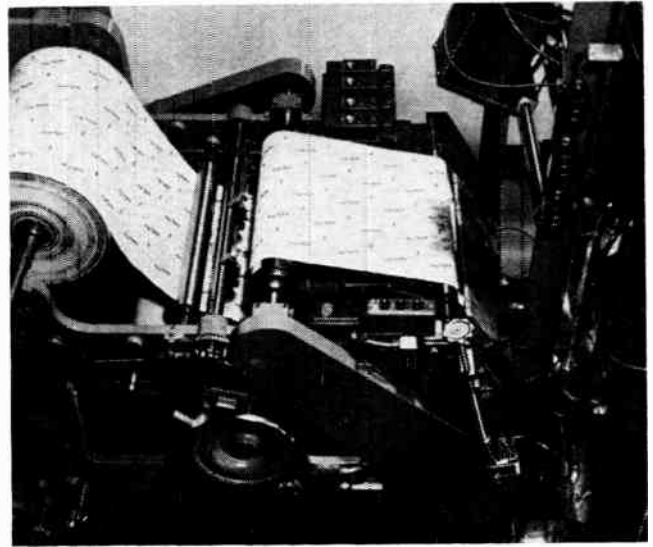
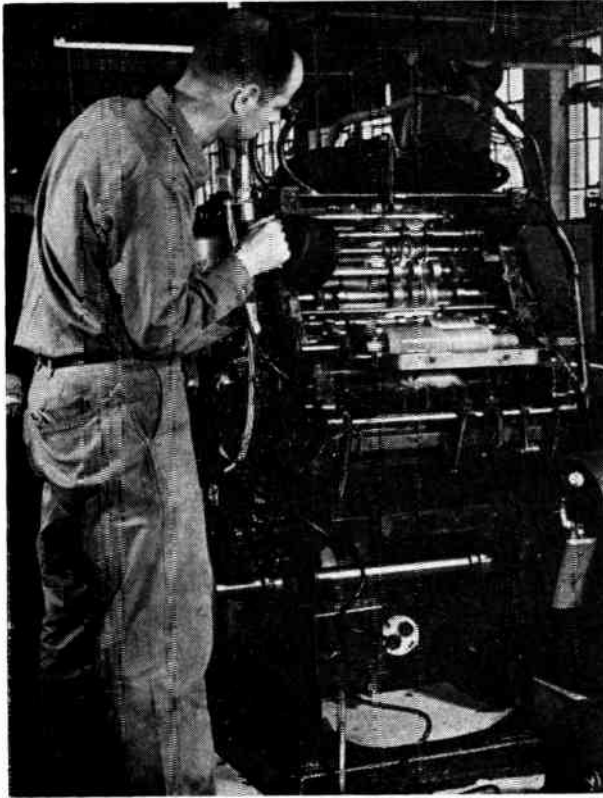

(Above) A stroboscope light is being used to examine printed matter on a moving press.

(Left) Here the stroboscope is used to examine moving mechanical parts on a printing press.

Whenever moving objects must be examined, the stroboscope is an indispensable instrument

Stroboscopes in speed measurement

The "Stroboscope" has its birthright in the earliest of recorded history. Even the Romans experienced the so called stroboscopic effect as their chariots — dashing around the arena — created apparent movement of the figures painted on the marble columns.

This persistence of vision of the human eye led several early day inventors to examine the phenomena. In this respect it is said that two men discovered the Stroboscope around the year 1832, namely Stampfer of Vienna and Plateau of Ghent. Plateau called his device a "phenakistoscope". Stampfer used the name stroboscope, composed of two Greek words, it means "whirling watcher".

Present day research by Messrs. Edgerton, Germeshausen and Grier have increased the amount of knowledge as applied to stroboscopic studies. The General Radio Company produces under license, a range of stroboscopic light sources covering a variety of industrial applications. The basic instrument — the type 631-BL Strobotac — has found its place in an ever increasing number of research laboratories, universities, and industrial undertakings.

The 631-BL Strobotac utilizes in its construction a power supply, an oscillator for controlling the rate at which the lamp is flashed, and a Strobotron or flashing lamp — all assembled in one single unit. By turning an illuminated dial, the frequency of the oscillator and hence the flashing speed of the lamp can be adjusted to any value between 60-14,400 rpm.

In using the Strobotac to measure the speed of

rotating or reciprocating mechanisms, the instrument is held so that the light from the neon lamp falls on the part to be observed after which the control knob is adjusted until the moving part appears to stand still. The scale on the Strobotac gives the speed directly in rpm.

In cases where no idea of the speed being measured is known, it is desirable to start at high speeds and work down. At twice the speed the pattern viewed is doubled and the first time a true pattern is obtained (fundamental synchronism) the dial reading then gives the correct speed.

Since the life of the Strobotron tube is much greater when flashed at low speeds than at high, the low scale on the Strobotac should be used whenever possible. When measuring speeds of objects above 5000 rpm, the Strobotac can be adjusted at higher speed, after which the switch is turned to low. The pattern seen will still be stationary because of the 4:1 relationship between high and low scale. The accuracy of the measurement is not affected. A slight twist of the knob on the Strobotac restores the high speed when desired.

The number of varied applications that call for the use of a "Strobotac" is increasing each and every day.

Based on natural fundamentals — with which it reveals hidden faults and maladjustments in manufacturing techniques, the stroboscope is becoming an increasingly valuable tool in the hands of engineers.

General Radio Company, Toronto 15, Ontario.

Corrosion-control specialist takes spot reading to determine internal corrosion in process equipment. Electronic instrument can detect a change of a millionth of an inch.



**Corrosion — the waster of millions —
can now be checked hourly to
determine its intensity with**

Electronic corrosion control

A new electronic measuring technique has been developed that promises to sharply reduce the cost of controlling internal corrosion in process equipment and pipe lines. That is the conclusion of engineers studying the results of field trials on equipment produced by the Crest Instrument Co., a division of Magna Products Co.

Internal corrosion is generally controlled by the addition of inhibitor chemicals. These serve to protect the metal surfaces against attack. The exact amount of inhibitor to do the job has been difficult to determine, however. Usual method has been to measure the weight loss of small metal coupons after they have been exposed to the corrosive atmosphere for several days, weeks, or months. The amount of inhibitor is varied to find a safe corrosion level.

The new technique provides a daily, or even an hourly record of corrosion attack. Capable of detecting as little as a millionth of an inch of corrosion, the method gives process engineers a way of judging the effect on corrosion, almost immediately, of even small changes in process conditions or inhibitor concentrations. Within days they can determine the optimum conditions that give minimum corrosion.

In one field test, for example, addition of an inhibitor reduced the corrosion rate by 75 per cent within a day

and a half. The curve then flattened out, however, and engineers suspected that the specified dosage was not actually entering the system. An inspection revealed that the pump metering the inhibitor into the system was at fault. Once this was corrected, the corrosion-rate curve resumed its downward drop, stopping at five per cent of the initial rate.

The new measuring technique also allows plant engineers to run rapid comparison tests between competitive inhibitors, permitting them to choose the compound that will provide the maximum protection at the minimum cost.

The corrosion-measuring method utilizes special "probes" consisting of two elements made from the same type of metal used on the processing equipment, one exposed to the corrosive environment, the other protected by plastic or ceramic. As the exposed element corrodes, its resistance increases. By using a special instrument which measures the resistance ratio of the exposed element to the protected element, a direct indication of corrosion is obtained. (Since both elements are at the same temperature, there is no chance that temperature variations will affect the results.)

Crest Instruments, Santa Fe Springs, California, U.S.A.

Power demand of the first all-transistorized seismic amplifier system is so low that an 8 x 15 inch silicon solar convertor supplies enough power to keep the system battery charged.

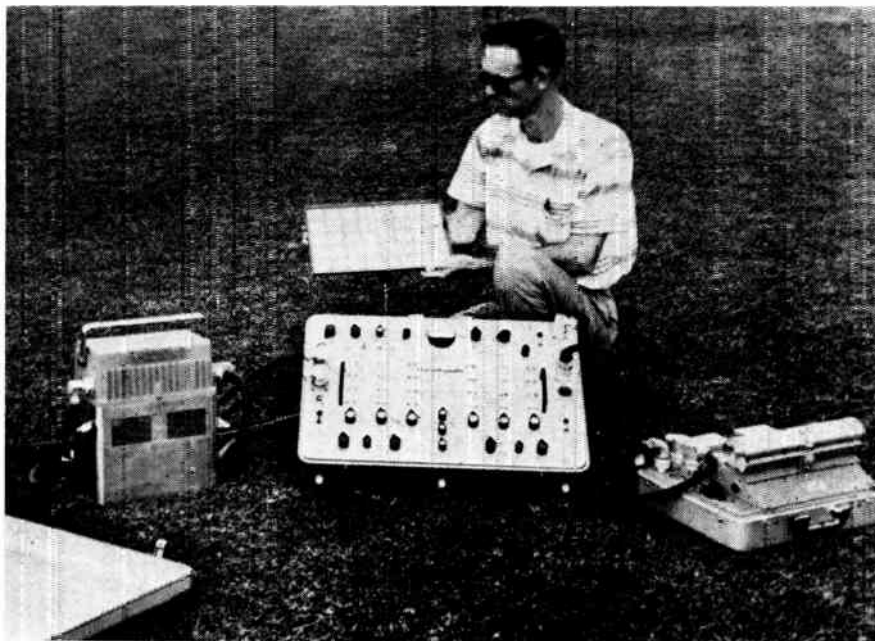

Much of the burden of transporting cumbersome equipment for exploration expeditions has been overcome by

Transistorized geophysical devices

The first all-transistorized seismic amplifier system brings transistorization's advantages of reduced equipment size and power demand and increased reliability and portability to yet another important industry.

Since seismic exploration for petroleum and other minerals continually takes geophysical crews to inaccessible locations, equipment portability and reliability are of utmost importance. Texas Instruments has naturally been concerned with this problem since geophysics was the firm's original field of activity. Its subsidiary, Geophysical Service Inc., is today the world's largest exploration contractor with crews operating in some 18 countries.

The successful application of solid state devices to this complex, ultra-sensitive electronics system yields weight, power and size savings ranging from 50 to 80 per cent over conventional vacuum tube systems! The company's Explorer, Model 8000 Seismograph, which was designed and manufactured by TI's Industrial Instrumentation division, is available to any geophysical exploration contractor or petroleum company.

Reliability and easy maintenance are assured by plug-in printed circuit construction and the exclusive use of semiconductors as circuit amplifying and control elements. Components in the system include 591 germanium transistors, 103 silicon diodes and rectifiers, and numerous tantalum capacitors and carbon deposited precision resistors.

Miniaturization achieved thereby is so great that the entire 24-channel seismograph — complete with control and test circuitry — is contained in one waterproof case weighing only 57 lb. An all-transistorized regulated power supply and lightweight 12-volt aircraft

battery both are contained in another case weighing but 45 lb.

As part of a recent demonstration of the instrument an 8 x 15 inch silicon solar convertor supplied sufficient power to keep the system's battery charged for operation. Charging at 250 milliamps at 12 volts, 10 hours' exposure to the sun would be sufficient to maintain battery charge under normal operation — representing a truly practical application for solar convertors.

The new seismograph will operate stably over a temperature range of -40° to $+140^{\circ}$ F. Twenty-two germanium transistors and four silicon diodes are employed per amplifier channel.

The equipment has a frequency response range from five to 200 cps, with a broad dynamic range of 100 db. Linear, time varied gain, or AGC amplification is selected through a control switch, with six choices of AGC speeds provided. These range from 200 db/sec to 20 db/sec with compression speed/expansion speed ratios available at 3/1 and 1/1.

A constant K high-cut filter is provided with six cut-off frequency positions ranging from 40 to 160 cps. The low-cut filters are of the single section constant K type, also with six cut-off frequencies that range from 14 to 40 cps.

Amplified and filtered output from the Explorer can be fed to any seismic oscillographic camera or magnetic recorder — disc, belt or tape. One output is at 0.5 volts for magnetic recorders and the other is capable of driving a 200 cps galvanometer one inch peak-to-peak, with increase to seven times normal level possible before signal clipping. No output transformer is used, further improving output frequency response.

Texas Instruments Incorporated, Dallas, Texas. U.S.A.



Here intermixed paper and card checks are received by operator at inscriber unit for inserting identification and amount on checks in magnetic ink.

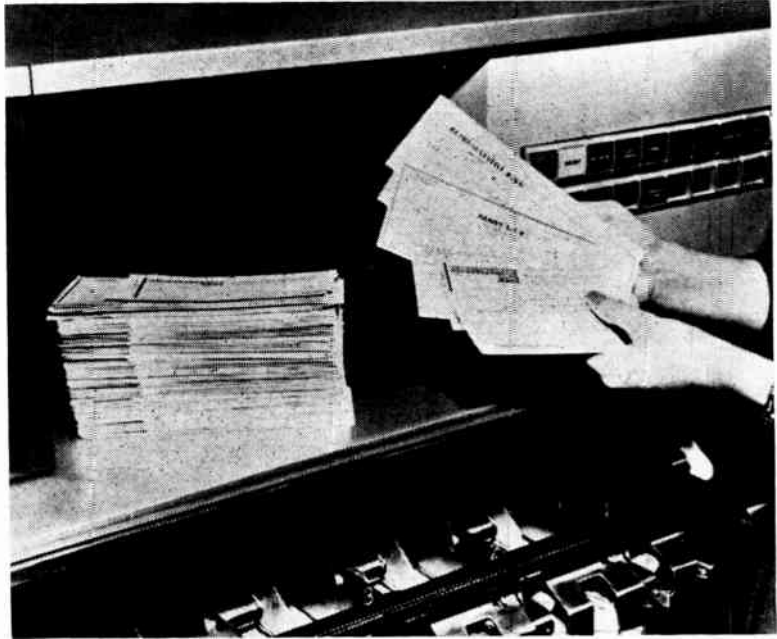

With only one recording of the check amount, complete proving, sorting, listing and totalling is performed.

Sorting and listing banking's most tedious and time-consuming job has now been speeded up by

Automated checks in world banking

The self-automated "Check of Tomorrow," bringing untold savings in time and handling costs to the world's banking industry, is just around the corner. With the development of this revolutionary new document sponsored by the American Bankers Association, banking can look forward to a new era of progress in demand deposit accounting — one of its most extensive, costly and time-consuming processes.

The chief feature of the Check of Tomorrow is that the amount, transit, account and routing numbers are imprinted just above the bottom edge of its face in magnetic ink. The check would be processed automatically by high-speed electronic equipment capable of handling both card and paper checks in random sizes. A preview of such a new electronic bank deposit system was presented recently at the International Business Machines Product Development Laboratory at Poughkeepsie, New York.

International Business Machines Corporation's answer to automatic demand deposit accounting is the experimental equipment unveiled in Poughkeepsie which, among other processes, printed check amounts in magnetic ink on intermixed checks at the maximum rate of 3,000 checks an hour.

IBM's experimental electronic bank system, which will not be marketed as yet, operates briefly as follows: a machine inscribes a magnetic bit code near the top edge of each check; other machines read the checks for sorting, post them to an electronic ledger and automatically prepare customers' statements — all with only one recording of the check amount. IBM is work-

ing on a market version of the system which will print Arabic magnetic characters near the bottom edge of each check, as recommended by the American Bankers Association committee.

With the exception of an Inscribe which places identification and amount on checks in magnetic ink and a Sorter-Reader which reads information from the checks into the data processing system, all units of the new system are general-purpose IBM electronic and electric machines. After the system is marketed it can be put to work on many other banking functions when it is not being used for demand deposit accounting.

To post personal accounts, the checks previously sorted into this group were placed in the feed of the Sorter-Reader, still in random account sequence. All information on the checks was read by the machine and transmitted to the IBM 650 computer, a medium-sized electronic data processing machine, for automatic posting to the accounts stored in a random access disk storage file. This machine works just as its name indicates; on a number of magnetic disks, each approximately the size of a long-playing record, a tremendous number of characters are stored — one RAMAC disk unit has a storage capacity of 6,000,000 characters for 40,000 accounts. Any of these 6,000,000 characters, each with its own meaning, is available in a fraction of a second. Up to three additional RAMAC units can be added to provide increased capacity.

International Business Machines, Don Mills, Ontario.

Testing of telephone equipment
to pre-set standards of
material and operational efficiency
achieved with

Automatic testing of telephone apparatus

Electrical apparatus inspection generally involves measurement of resistance, impedance and insulation, and verification of connections. With telephone equipment, timing checks must also be made of the operation of contacts or thermal devices. Telephone Manufacturing Co. Ltd., wishing to develop equipment enabling telephone apparatus testing to be performed automatically, decided to follow established practice by testing each individual component, or convenient group of components, in sequence, and to devise a system giving automatic indication of deviations from pre-set standards. Inherent simplicity and negligible maintenance requirements suggested crossbar bridges as the basis for the sequential switching circuits, while the precision relays were polarized relays, because of their high speed and sensitivity.

The crossbar bridge, a five-way switch with eight contacts per way, produces with a simple change-over relay a ten-way switch with four sets of contacts. These are used, one for test number indicator, one for

connection of the standard and two for the circuit under test. The four crossbar bridges used thus provide 40 outlet test points.

Relays are used as detectors in conventional bridge type circuits for comparing coils and capacitors with pre-set standards, and in the circuits for insulation resistance testing and contact sequence measurement.

When the telephone apparatus is inserted in the test fixture, a start pulse is automatically sent to the impulsing relays, which energize the main magnet and the first finger magnet of the first crossbar bridge, introducing test 1. Subsequently, "pass" pulses, derived from the indicators on satisfactory tests, step chains of impulsing relays to energize finger magnets and main magnets of the crossbar bridges in sequence. In the event of an unsatisfactory test, or a power or other failure, no "pass" pulse is sent, the test number lamp stays illuminated on the doubtful test, and a slow-to-release relay operates the "Fail" lamp.

The circuit of the impulsing relay chain follows conventional "counting" technique, each pulse operating a relay, releasing the previously operated one. Five finger magnets of a crossbar bridge having been operated in turn, another pulse from the impulsing relays operates a change-over relay, connecting the second set of outlets on the crossbar bridge. A pulse coming at the end of this connects to the next crossbar bridge, which is then sequentially operated twice in a similar way.

All tests, except timing or contact sequence, are carried out faster than five per second. Impedance measurement accuracy over the ranges 2-200 ohms or 200-4000 ohms is better than two per cent. Prototype equipment has performed over 100,000 test sequences without attention to the crossbar bridges or the polarized relays.

Telephone Manufacturing Co. Ltd., Toronto, Ontario.



A view of the telephone instrument assembly line at TMC's London works. The instrument under test is seen "jacked-in" to the desk front of the automatic tester in the foreground.

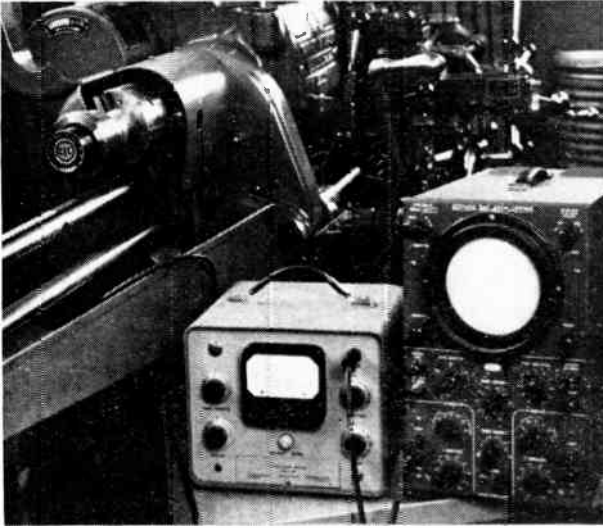

(Above) Torsiograph is mounted on spindle of turret lathe to determine why finish on aluminum drum is being marred.



(Right) Vibration meter on tool post of turret lathe shows cutting-edge life shortened by excessive vibration.

Damaging vibration undetectable to human senses yields in minutes with the use of electronic detection instruments.

Machine tool vibration analysis

Minute high-frequency vibrations in the machine shop seriously impair tool life and work quality. Finding the cause and correcting it may be an involved process that stops production.

Electronic vibration-sensing devices already used in aircraft, can monitor for excess machining vibration. Consolidated Electrodynamics Corporation engineers believe that modern machine shops, where highly paid technicians are machining high-cost metal alloys, will be turning more and more to this equipment to cut costs.

With this in mind, they installed vibration analysis instruments in their own Pasadena, California, machine shop with gratifying results. Here are some examples:

1. A defect appeared on the surface of a highly finished drum during machining. The Torsiograph and vibration meter showed that the spindle was not revolving smoothly under load. The cause was then apparent — a faulty drive belt. Less refined methods of detection, with the blemish as the only clue, would have taken much longer.

2. A linear vibration pickup and meter were mounted on a large surface grinder that was producing a poor finish. The meter indicated that chuck travel was erratic. From there it was easy to trace the cause to a chattering valve in the hydraulic system. After the valve was replaced the machine produced excellent finishes.

3. Modern electronic instrumentation can quickly determine optimum machine speed settings, as another solution showed in CEC's machine shop.

Work finish and tool life were poor for a machine finishing aluminum castings. An entire swing shift was lost while the machinist changed feeds and speeds trying to improve the work, without success. The next morning a linear vibration pickup, a vibration meter, and an oscilloscope were put to work. They indicated excessive vibration apparently at some resonant frequency. Calculations involving cutter rpm and number of teeth verified that the vibration originated with the cutter, since the frequency coincided with the frequency noted on the oscilloscope.

Cutter rpm was varied until minimum vibration output registered on the vibration meter showed that resonance had been eliminated. Then the cutter feed was varied until vibration meter readings dropped nearly to zero. With these two settings surface finish was normal, cutter life was improved and production was increased 50 per cent because one cut was required instead of two.

Vibration analysis obtained increased tool cutter life at higher speeds and feeds. Resonance at lower speeds had been a block to reaching this optimum setting. The analysis, using electronic equipment, required only about 20 minutes.

Damaging vibration may be undetectable to the touch. Electronic detection instruments can immediately confirm its presence and, if used to monitor, can warn the machinist as soon as vibration begins. In either case, many hours of faulty machining, trouble shooting and non-productive time are saved.

Consolidated Electrodynamics Corp., Pasadena, California.

Reading on cheques or
reading on trucks, it makes
no difference to this

Reading machine for industry

A reading machine intended for use in business offices and in industry should be very reliable, fast in operation, small in size and of low cost. But pattern recognition is such a complex process, with so many difficult problems, that most reading machines have till now fallen short of one or more of these objectives.

FRED (Figure Reading Electronic Device) is the result of a research program aimed at producing not a general purpose pattern recognition device but a numerical reading machine specifically for business and similar applications. During the studies it was realized that some restriction on the shape of the figures was necessary; without some restriction the figure "1" could for instance be written in the French manuscript manner and appear like a figure "7"; if a formalized type-face is to be used, there is a great advantage in designing it to be visually similar to conventional designs, while consisting of shapes which a machine can easily recognize.

One such set of numerals is shown in figure 1. The numeral can be divided into five vertical columns, each of which is mainly black or mainly white; one of the main problems has been the aesthetic one of designing a set of figures which satisfy this "five column" criterion while being visually acceptable.

From the numeral "6" shown in the illustration, the columns (reading from right to left) are:

(a) mainly black, (b) mainly white, (c) mainly white, (d) mainly black, (e) mainly black so that if "black" is represented by "1" and "white" by "0", then the numeral "6" will be coded as "10011".

Each numeral is coded in this way, and for the set shown in fig. 1 the codes (reading in all cases from right to left) are:



Figure 2. Operator shows a special typeface used by the reading device and examples of how cheques can be overprinted.

(0) . . . 10111 — (1) . . . 11000 — (2) . . . 11111 —
(3) . . . 11100 — (4) . . . 10110 — (5) . . . 11101 —
(6) . . . 10011 — (7) . . . 11110 — (8) . . . 11011 —
(9) . . . 11001 — (10) . . . 10101 — (11) . . . 10010

As the first digit in each code is always "1" (i.e. the right-hand edge of each character is always black), this form of the code gives four variable digits, with $2^4 = 16$ possible combinations. Ten of these are used for the numerals 0 to 9, or twelve to include "10" and "11" for the pence columns of sterling amounts. The remainder can be used to provide other special signs if required.

The basic principle by which the machine recognizes figures is therefore extremely simple. For example, if the amount of black in a narrow vertical slit is measured as the slit moves across the numeral, waveforms such as those of fig. 3A will be obtained; these waveforms can be squared up by limiters set to operate about the amplitude X-X to give the waveforms shown in fig. 3B. Identification of the waveforms is carried out by sampling five times, once in each column, this process being initiated by the first appearance of black in the slit (since the first column is always black) and continued at a rate controlled by the scanning mechanism of the machine. The scanning can be varied over a wide range of speed.

E.M.I. Electronics Ltd., Middlesex, England and E.M.I.-Cossor, Halifax, Canada.

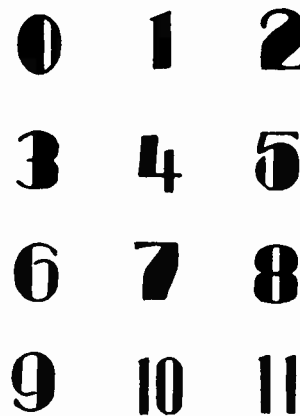

FIG.1

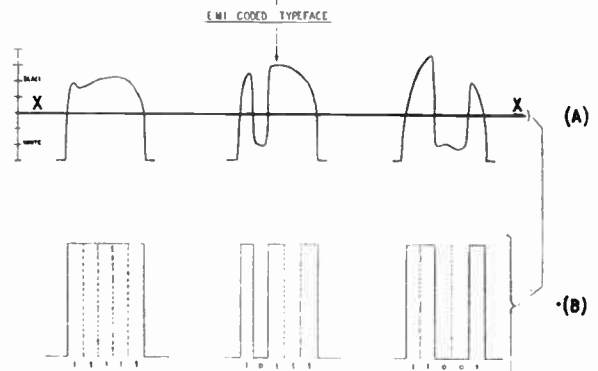

FIG.3



The "Linatrol" shown in operation automatically following the pencilled outline of a drawing while the torches to the right burn a true duplicate pattern of the master drawing.

An electronic tracing device that automatically directs a battery of gas-cutting torches through intricate cutting patterns.

Tracer control for gas cutting

An electronic tracer which can automatically direct a battery of gas cutting torches through intricate cutting patterns has been developed jointly by Canadian Westinghouse and the Westinghouse Electric Corporation. The device utilizes a vibrating photo-sensitive cell to accurately follow a pencilled drawing or pattern. Automatic tracer methods now in common use require expensive and often elaborate photographic, magnetic or machined templates. "Linatrol" is the first automatic tracer capable of accurately following a pencilled line. The unit is capable of following any patterns at speeds up to 30 inches per minute without loss of accuracy. It features a unique safety circuit which will stop the machine and turn off the gases if the tracer should leave the line pattern. Evaluation of the prototype unit indicates that pattern preparation costs are considerably reduced, cutting operation is more reliable and automatic, initial equipment costs are lower, cutting speeds are increased, and cutting accuracy is improved.

There are two principal methods of directing gas cutting torches in mass fabricating operations. One method is entirely manual with the operator guiding the tracing head along the pencil line drawing of a work piece. The torches are connected to the tracer mechanism in such a way that they will duplicate the pattern followed by the operator.

The second method, in which a pattern is followed by means of an automatic tracer, requires expensive

and often elaborate photographic, magnetic or machined templates. Linatrol, however, is the first automatic tracer capable of accurately following a pencilled drawing.

The Linatrol unit consists of a compact scanning mechanism equipped with a small, rapidly vibrating photo-conductive cell. When the line on the drawing is immediately below the center of vibration of the scanning photo-conductive cell, a zero error signal is transmitted. If the unit tends to deviate from the pencilled line, an error signal is initiated, amplified and passed on to a small steering motor which is then driven so as to return the tracer to the line.

Linatrol is capable of following any pattern at speeds up to 30 inches per minute without loss of accuracy. Power steering is employed to direct the tracing head towards the start up point on the drawing. The unit will follow a straight path until the line is intercepted, after which it will automatically trace the pattern.

Linatrol features a unique safety circuit which will stop the machine and turn the gases off if the tracer should leave the line pattern: either by accident or intent. This feature provides a means of stopping the cutting operation automatically at the end of the cut and also will prevent damage to the rest of the workplate if the tracer should inadvertently leave the line.

Canadian Westinghouse Co. Ltd., Hamilton, Ontario.

With the increasing use of radio-active materials in industry, education and medicine, a constant check against over-exposure can be assured with

Decontamination equipment for radio-active work areas

The ever increasing use of radio-active isotopes in industry has created a new requirement. This is instrumentation which ensures that close control may be exercised so that personnel are not exposed to radiation hazards. The instruments described meet this need. This group of instruments may facetiously be described as the answer to radio-active housekeeping. Seriously they provide complete assurance that no unknown radiation hazard can exist.

The equipment group includes a door-post monitor, combined power pack and ratemeter, an alpha scintillation probe, a geiger-muller beta/gamma probe, a calibrated air sampler, a geiger type lead castle, and a shielded alpha sampler.

The first item of equipment is known as a door post monitor. The geiger tubes are mounted into a door lintel and the power, control and warning equipment are located at any reasonable distance to the door. With the controls set to a pre-determined tolerance level, the passage of a source emitting beta or gamma particles will trigger the device. A red light and a warning bell will be activated. One feature of this device is that normal back ground radiation is used to continually monitor its operation. Should this self monitoring detect an equipment fault or a power failure occur, a bell will sound and a failure lamp will light. Thus at no time can the equipment develop a fault and yet be presumed to be operating. This is a fail safe device.

The interior of the laboratory may be monitored by the other equipments. The universal ratemeter serves

to provide power for the probes, and records in three ranges, integrated counts and counts per second.

The alpha scintillation probe is a small rectangular based instrument and it is capable of detecting radio-activity even into the corners of a bench, room or receptacle. The alpha probe may be used in conjunction with a drawer mount where samples may be placed, isolated from interference from other radio-active sources.

The beta/gamma probe is a conventional wand type with a sliding window to exclude beta counts.

A specially modified vacuum cleaner equipped with a recorder which indicates the volume of air sampled, draws air through the filter paper. This sample may be taken at the vacuum cleaner air intake or at the end of a hose. The hose is equipped with a clamping fixture so that if a local sample near a process operation is required, the sample can be easily obtained.

The lead castle is provided with a drawer into which filter paper may be placed in order that readings may be taken without false counts from extraneous sources.

This comprehensive group of equipments provide a complete answer to the problem of the safety of laboratory workers from radiation hazards. Despite this assurance, readings may be taken by semi-skilled personnel, thus avoiding the diversion of highly trained technicians from more productive activities. The equipment, which is made in England, has been in use at Harwell and other atomic energy laboratories.

Mechron Engineering Products Ltd., Ottawa, Canada.

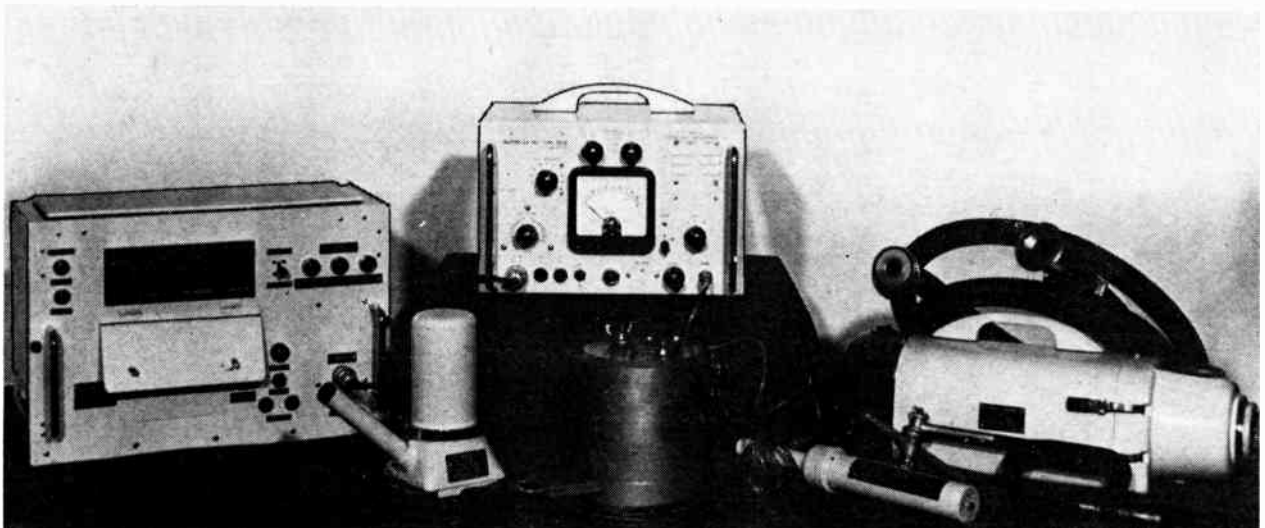

Complete equipment for the checking, control and elimination of radio-active materials is provided in the above array of instruments.

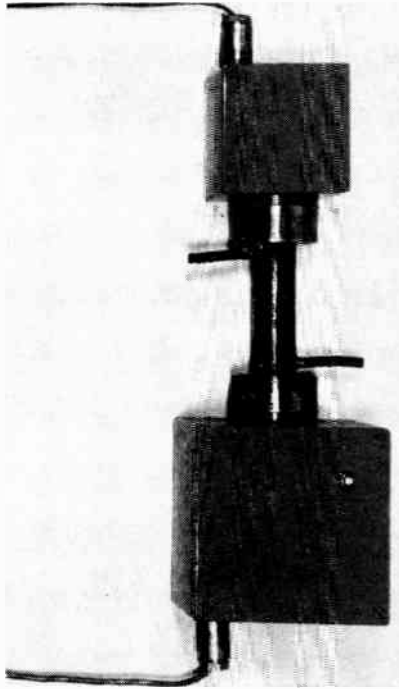

Shown above is the detecting head with fluid sample chamber and optical network enclosed.



External view of the Turbidimeter.

The change from batch to continuous process production has created the need for an instrument to assure

Better products by turbidity control

There has been an increasing trend in recent years for industries to look upon electronics as a means of solving production problems and providing new techniques for improving their products. The development of an electronic turbidity meter for continuous analysis of suspended impurities in liquid is one such example. With such instruments it is possible to monitor and continuously record and control the turbidity of process liquid and thus attain a more uniform and precise quality in the product.

Typical applications of the turbidity meter are in monitoring of filtration systems of various industries. Some of these are: breweries, pulp and paper manufacturers, food manufacturers, sugar refineries, oil companies, water supply and filtration plants. The advantages of using a continuously recording turbidity meter include the following: (1) Clarity specifications of the process stream can easily be maintained throughout the cycle by having a continuous instrument reading. (2) Insurance against serious breakdown of the filter system and subsequent loss of time for refiltering. Through the use of an alarm system the operator is alerted at the first indication of a fault. (3) Records of the efficiency of the filtration throughout the cycle. (4) Decrease in maintenance time. (5) Provides a more exact means of judging when to change filters. (6) Provides a means of evaluating various types of filter aids.

It is interesting to note that in breweries, filtration of the beer is one of the most important steps in the

production of present-day high quality beer. Beer foam, flavor and shelf life are all to some extent dependent upon the clarity of beer.

For low values of turbidity, such as are encountered in the brewing industry, a measurement is made of the intensity of a beam of light transmitted directly through the liquid containing the suspended particles. The light falling on a photocell detector decreases with increasing turbidity, and the photocell output, suitably amplified, drives a meter or recorder.

To eliminate the effect of color change on the turbidity reading a color filter suitable for each application is used.

At present there does not seem to be a widely accepted unit of measurement of turbidity. One unit commonly used is the nephelo. The meter and the recorder can also be marked off in percentage transmission, percentage obscuration or simply in 0-100 parts. The instrument can be calibrated by using a reference sample, a standard solution (distilled water for instance), or checking against a laboratory instrument such as the Coleman Nephelometer.

With the increasing change-over in industry from batch to continuous production process, the tightening of laws enforcing against water pollution by industrial waste, and the awareness of industry of the existence of a reliable instrument for continuous analysis of process stream, there will be an increasing application for the turbidity meter.

P. C. Boire, Chief Engineer, Measurement Engineering Limited, Arnprior, Ontario.

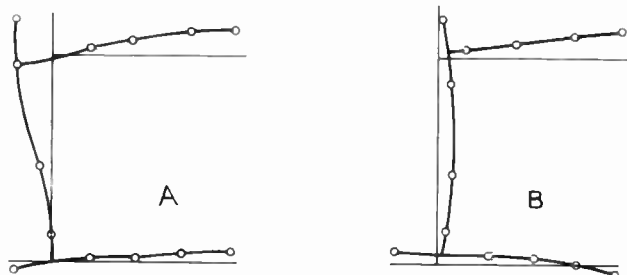

Figure 1

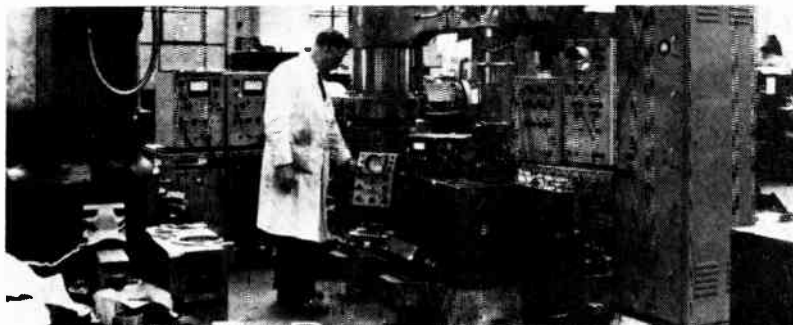

Figure 2

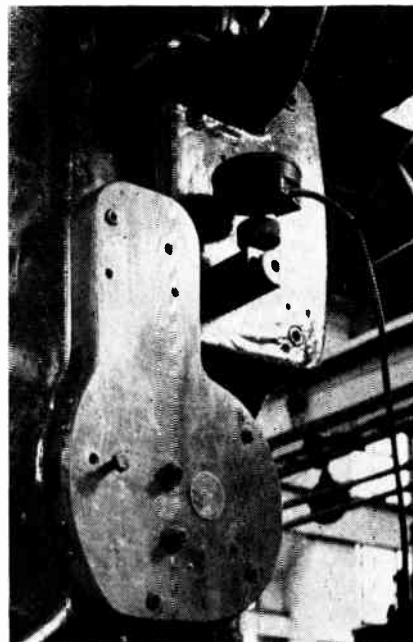

Figure 3

Irritating chatter can now be eliminated from machine tools by

Electronic pre-design analysis

The increased speeds and feeds demanded of modern machine tools have intensified the problem of chatter. This is a form of vibration arising when the impulses due to cutting generated in the tool are at a frequency which excites one or more parts of the machine tool. Such vibration is a form of resonance and can only occur if a certain relationship exists between speed and feed, the natural frequency of some part of the machine, the effective damping coefficient of the machine and workpiece, the machining characteristics of the tool, and the machinability of the workpiece. Chatter can be avoided by eliminating the undesired coincidence between these six factors. This sounds easier than it actually is; by their very nature, general-purpose machine tools are used for such a wide range of duties that any given permutation of conditions is always liable to arise. It therefore rests with the manufacturer to construct his machine so that there is no possibility of any machinist inadvertently hitting on conditions conducive to chatter.

The manufacturer's problem is made worse by the fact that chatter is not necessarily associated with the heaviest loading of the machine. Frequently chatter can be eliminated either by increasing or decreasing speed and/or feed. The frequency response of each part of a new machine tool must therefore be individually checked before the design is released for manufacture. Even on an existing machine, the effects of any major design change should be similarly checked.

A detailed vibration analysis of this kind has the advantage of indicating the positions at which additional stiffness is required to avoid chatter. There is

thus no danger of wasting money by adding extra material (and weight) at points where it is unnecessary. Figure 1, for instance, shows the two main vertical modes of vibration of a radial drill elicited by an investigation of this model and indicates, at a glance, the parts needing special attention.

Figure 2 shows the set-up for such an analysis. A vibration generator replaces the drill, to introduce the vibration under accurately controlled conditions. The resultant vibration at various points on the machine is measured by a Type 1402 Vibration Meter. To avoid the difficulties involved in holding the vibration pick-up steady by hand for long periods against the upper surfaces of such a large machine, fixed mounting points (see Figure 3) are added at all important locations. Before going to this trouble, however, the pick-up is run manually over the whole structure to determine where fixed mounting points are necessary.

The method employed is to sweep the vibration frequency applied by the vibration generator through the entire range liable to be encountered by the machine tool in service. Vibration meter readings then indicate any part liable to cause chatter at a particular working frequency. If the part cannot be redesigned to bring its natural frequency outside the working range, the speed or feed can often be modified slightly so that the resultant working frequency no longer coincides with the natural frequency. Modern machine tools are thus made chatterfree, even when operated under adverse conditions by "green" labor.

Dawe Instruments Ltd., London, England and Ottawa, Canada.

The precise checking
of control systems in metallurgical,
chemical and nuclear plants
can now be facilitated by

Servo test equipment for industry

A new Process Response Analyzer enables, for the first time, precise measurements to be made on control systems such as are required for nuclear reactor heat exchangers, metallurgical processes, chemical plant, automatic production cycles of many industrial types and numerous types of motor control when the systems are in normal operation. Accurate measurements on any slow and medium-speed dynamic system are possible even under severe non-linear and "noisy" conditions.

The Solartron Process Response Analyzer Type JY.743 is the logical development from the company's Transfer Function Analyzer (T.F.A.) which several years ago gave Solartron a well-established reputation in the field of transfer function measurement of servo testing for high-speed servo systems. This new instrument, the P.R.A., is for very much slower systems from one cycle in three hours to 100 cycles per second. This range will cover most normal industrial processes employing automatic closed-loop servo systems. So complex have many manufacturing processes now become and so interdependent the chains of servo systems and the sequences of pressures, temperatures and so forth, in industries ranging from food manufacture on the one hand to steel production on the other, that the misbehavior of one link may seriously disorganize production. Such a break in production in a plant of any size, even for a short period, is, when all the factors are considered, quite costly.

The P.R.A. provides the necessary design information for new control systems and also enables them to be proved before the production stage is reached.

It additionally enables all servo and control systems to be tested regularly without in any way halting production. The necessary adjustments may then be made before any interference is experienced.

The requisite information is given by plotting phase/amplitude response (Nyquist) diagrams with high accuracy over the entire range of frequencies to which the system will respond. Because of the instrument's very high measuring sensitivity it will operate direct from transducer signals.

This Process Analyzer is a double console instrument incorporating a very low frequency oscillator and a display unit covering a frequency range of six decades (1 cycle in 10^4 seconds to 100 cycles per second). Two wide-scale meters display the "in-phase" and "quadrature" components of the wanted signal.

The design is based on analog computer and gated integration techniques, and standard computing amplifiers and multipliers are incorporated.

Push-buttons on the oscillator provide "prime", "run" and "hold" facilities, conditions which may also be controlled externally by, for example, a computer control panel.

Solartron Inc., London, England and Burbank, California.

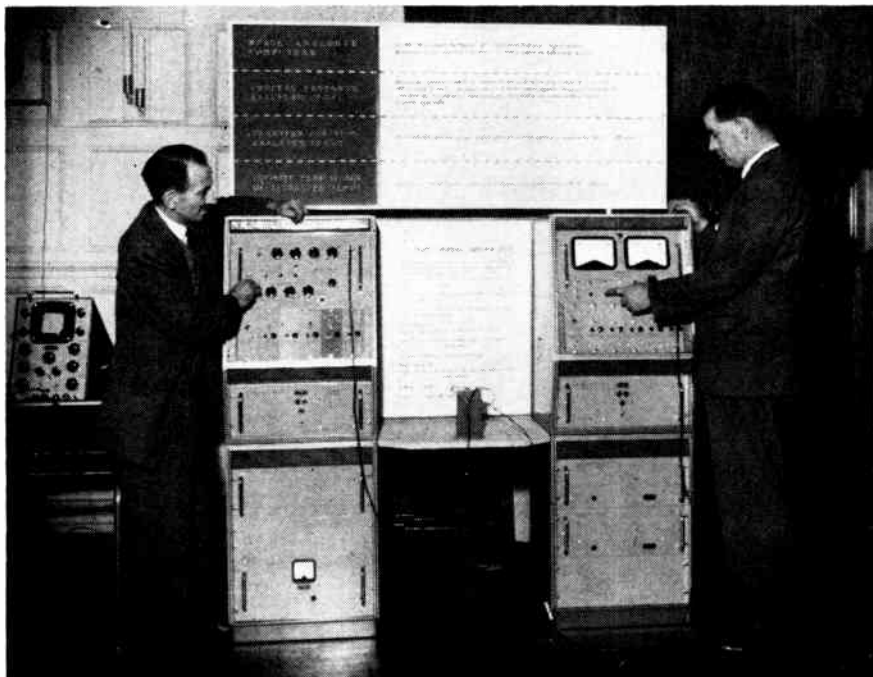

The world's most advanced industrial servo test equipment is demonstrated to a process control specialist at the recent private demonstration of Solartron instruments.

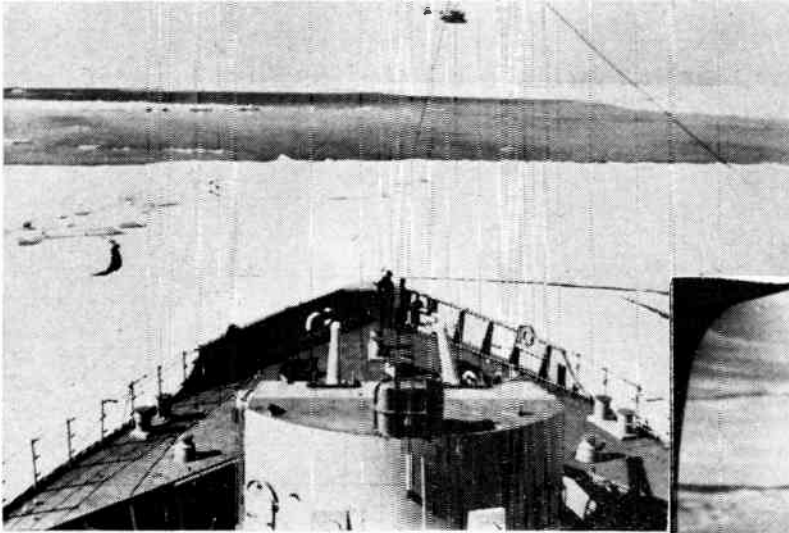

(Above) Helicopter using airborne television observes ice conditions ahead of ship and relays vital information back to the icebreaker.

(Below) Picture of the icebreaker appears on TV monitor aboard the icebreaker itself.



**It pays to know what's ahead
in the business of ice breaking
and this foresight can now be
had with the use of**

Airborne TV for ice reconnaissance

Ice reconnaissance up to a radius of 35 miles of an icebreaker is now possible through the medium of airborne television.

On a recent trip of the icebreaker U.S.S. Glacier to Thule Air Force Base, Greenland, TV pictures of surrounding ice conditions were relayed instantly from a helicopter to the television monitors aboard the Glacier.

Two TV monitors were used on the icebreaker — one on the bridge and the other in the combat information center.

Thus, the captain and his executive officer who are the only qualified ice observers aboard an icebreaker, received on-the-spot information of distant ice field conditions without leaving the ship.

Present ice reconnaissance is obtained by having a qualified ice observer scout the ice field from a helicopter and radio the information back to the icebreaker. Also, the reconnaissance area is limited to ten miles due to the ever changing weather conditions in the Arctic.

Word descriptions of ice conditions and later briefings after the copter's return depend on the observer's ability to describe what he saw. This method is also time consuming.

However, with a television monitor before him, the Glacier's observation officer was able to make a constant evaluation of ice conditions ahead as the ship continued on her course.

In the future, the Navy expects to install the airborne television equipment in a remote controlled helicopter thereby increasing the range of its ice reconnaissance and eliminating any possibility of loss of life due to the Arctic storms.

Equipment used in this Arctic experiment was developed by Philco Corporation's Government and Industrial Division and included a special airborne TV transmitter and Philco's high resolution industrial television camera.

According to Commander Huston, captain of the Glacier, the experiment was quite successful. He said the television pictures beamed from the helicopter were very sharp and clear.

Telltale signs in the ice, showing the path of least resistance through the heavily packed ice, were readily discernible on the TV monitors. Observers on the Glacier were able to distinguish between old and new ice, pack ice and pressure ridges in the ice field. Also, open patches of water and large moving ice-bergs were clearly seen on the monitors.

The Philco UHF video transmitter, which was used in the Arctic test, operates in the 780-900 megacycle frequency range up to a distance of 35 miles. A wide angle lens was used on the Philco vidicon TV camera which is small enough to fit in a briefcase.

Philco Corporation, Philadelphia, Pa., U.S.A.

A unique application of portable ultrasonic flaw detection equipment is now being used in the measurement of fat on animals.

Ultrasonics in animal husbandry

Until recently there has been no satisfactory method of accurately determining the depth of backfat in live pigs. During the last few years the only methods available have been the use of x-rays or the probing of the back with steel rules or needles, an operation not calculated to encourage the pig's co-operation in obtaining accurate measurement!

The idea of using an ultrasonic flaw detector to accurately determine the depth of backfat on live pigs has been attributed to Mr. J. Wardley-Smith, a scientific adviser to the Secretary of the Agricultural Research Council.

Results of the tests with ultrasonic equipment have been so successful that it is now possible to determine the thickness of the fat to a high degree of accuracy — without the drastic recourse to slaughter and the resultant loss of a potential breeding boar.

The equipment used by B.O.C.M. is manufactured by Kelvin & Hughes Industrial Ltd., and was designed for the non-destructive testing of metals. It operates on the principle that sound waves at frequencies well above the audible range are transmitted through materials (in which the speed of sound has been previously verified) via crystal probes, and the signals, shown on a cathode ray tube are the result of absorption and reflection from within the material.

The pig's back is moistened with liquid paraffin to ensure good acoustical coupling and a flat faced probe consisting of twin barium titanate crystals, is pressed against the pig's back at points along the loin, middle and shoulder. Ultrasonic sound waves at a pre-determined frequency of between $\frac{1}{2}$ to 5 million cycles per second (Mc/s) are transmitted through the fatty medium and are reflected vertically back to the receiver crystal at the boundary between the fat and lean tissues. See Figure 2.

The time taken for the two-way travel is dependent upon the velocity of sound in the fat and the thickness of the fat. This sequence is displayed as a trace on a cathode ray tube (Fig. 1). The vertical deflection 'A' indicates the start of the ultrasonic sound transmission, whilst the horizontal trace is proportional to the time taken for the signal to reach the lean boundary and is proportional to the depth of fat. This measurement is read directly from the graduated scale of the C.R.T.

The speed of sound through the tissues of a living animal varies with differing diets which cause variations in the chemical composition of animal fat and "lean". This variable factor is however obviated to a certain degree at the Stoke Mandeville center, by a carefully controlled diet. Statistical records of all solid and liquid intakes are maintained throughout the entire test period.

The test is absolutely painless and has no ill-effect upon the pigs. In the hands of a trained operator, the ultrasonic equipment can provide extremely accurate statistical data from live pigs which has hitherto only been available from carcass measurement.

In view of the success of the B.O.C.M. tests it seems logical to suppose that in the not-too-distant-future, ultrasonic flaw detecting equipment will be used to provide the breeder with a complete cross sectional picture of the live pig. It has already been reported from America that an impressive "photograph" of a man's back muscles and vertebra has been obtained using such equipment, designed to translate peaks on a C.R.T. into "blips" of different intensity and to scan two-dimensionally.

Kelvin & Hughes (Industrial) Ltd., greatly appreciate the co-operation of British Oil and Cake Mills Ltd., and the Agricultural Research Council for permission to publish the facts and photographs in this article.

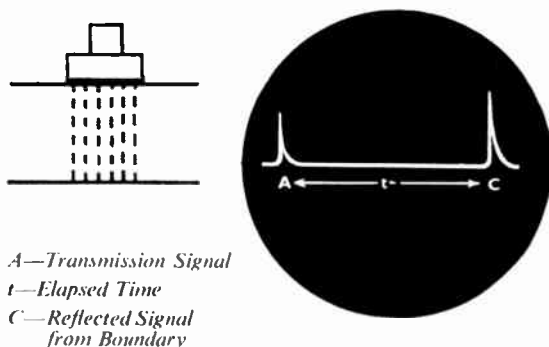

Figure 1

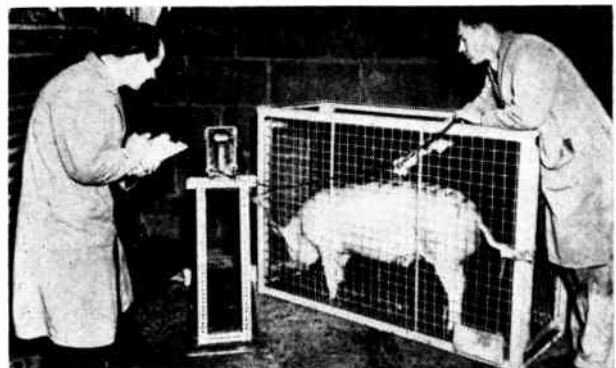

Figure 2

Hydrostatic calculations in the design of ships' hulls are now being speeded by the use of

Computers in naval architecture

Naval ship design scientists and engineers at the David Taylor Model Basin, near Washington, D.C., have solved the problem of integrating two kinds of electronic computer information with the use of a computer language translator.

The EECO computer language translator is a common language device which enables one type of computing system to supply information into a system using a "foreign" computer language.

Captain E. A. Wright, commanding officer of David Taylor Model Basin, said that a contract for lease of a computer language translator was let to the Electronic Engineering Company of California, Santa Ana, California. Negotiations for the lease of the equipment were made through navy purchasing office. The computer language translator will be employed by the Applied Mathematics Laboratory of David Taylor Model Basin.

The Applied Mathematics Laboratory is the principal computer facility for the Bureau of Ships and its field activities. The laboratory pioneered in the application of computers and auxiliary equipment to the solution of naval engineering and management problems since the date of its inception in 1952.

The computer language translator will translate UNIVAC data into data suitable for input into an IBM 704.

In addition to converting UNIVAC information into IBM 704 information, the translator, which incorporates a Packard-Bell Multiverter, enables the system to translate hydro-mechanical and structural-mechanical data; and binary coded electronic spectrum analysis data into a form acceptable to either UNIVAC or IBM 704.

The David Taylor Model Basin, the largest of its kind in the world, is the U.S. Navy ship hull design and test center. Models of all types of naval craft and merchant craft are towed through the test basin by means of a large carriage. The deep water towing basin is 3/5 mile long and is about 51 feet wide. All major U.S. fighting ships and submarines have been tested during their development stages at the center.



Data from tank tests is now processed speedily through computer language translators resulting in the saving of hundreds of man-hours of calculation.

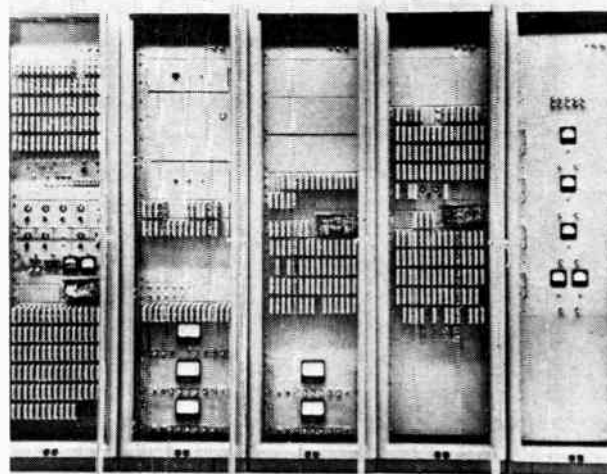

View of the computer language translator such as used by the David Taylor Model Basin in Washington, D.C.

Because of its technical facilities and size the David Taylor Model Basin is used by merchant marine ship builders to test hull designs and other maritime configurations.

The Electronic Engineering Company designed and developed the Model ZA-100 computer language translator to solve the common language problem of integrating electronic computing machinery. The computer language translator can be adapted to scientific and business data processing operations by means of varying input and output control units which match periphery data processing equipment. The computer language translator can also be used to obtain full utilization of existing data processing equipment by permitting off-line operations which would ordinarily require valuable computer time.

Electronic Engineering Company, Santa Ana, California, U.S.A.



Protection of huge shopping plaza shown at left is controlled from the electronic nerve center below.

Fire, theft and malfunctioning of services in shopping plazas detected and controlled from one center.

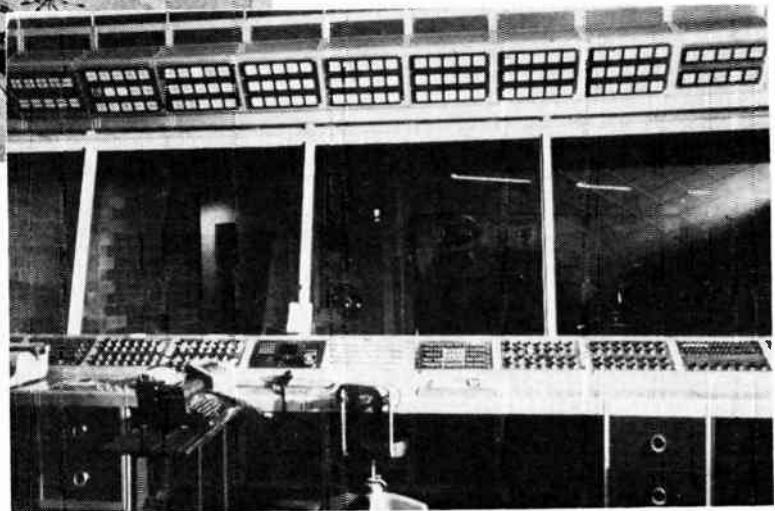

Protection for shopping plazas

The new \$20,000,000 Southdale Shopping Center just outside Minneapolis, Minnesota boasts a unique central detection center that spots fires, intrusions or machinery breakdowns instantly. The complete 75 store shopping center is monitored around the clock by a network of 165 annunciator points designed by the Scam Instrument Corporation, Chicago, Illinois. The maintenance-free annunciator network keeps watch 100 per cent of the time and even keeps watch on itself for possible malfunction.

A centralized "Protection Office" houses a system of audible and visual alarms in a modern control desk. The instant an off-normal condition develops anywhere in the 670,000 square feet of shopping space, an alarm sounds and a sign lights up telling the exact location of the disturbance. In the entire area, loud speakers broadcast coded messages to patrolling guards telling them to investigate the scene of the disturbance and report back to the "Protection Office" by telephone. This system of cross checking between the annunciator and the patrolling guard has proved so effective as to require very few personnel on the patrolling guard staff. The amount of time that will elapse between sounding of an alarm and the call back of the guard is within 60 seconds.

In measuring the efficiency of the annunciator detection system, it is estimated that since the opening of the shopping center in November of 1956, more than 22 fires have been detected, many machinery malfunctions spotted before damage could be done, and intrusion has been detected in every instance, even when shop owners have failed to inform the "Protection Office" of situations where entrance was authorized by persons doing work on off hours.

The Scam Instrument Corporation, makers of annunciator systems, developed the special detection network from systems that have been used for years in industrial manufacturing and maintenance. The characteristics of trouble-free and fool-proof detection that were needed in plant sites were designed into the shopping center system. Scam's experience in producing annunciators sensitive to various stimuli such as heat, motion, stoppage of motion, lack of heat, moisture, dryness and various others has proved valuable in designing the all-seeing detection system for the ultra modern shopping center. The air conditioning and heating systems for the vast amount of floor space are monitored for proper temperatures and the proper functioning of the blowers, generators and vast array of other machinery for the proper operation of the heating and air conditioning system.

It is estimated that the special detection system composed of annunciators has been so efficient as to have paid for itself almost immediately. The savings of thousands of dollars in machinery repairs due to instant detection of component failures has justified the cost of the system in itself. Added to this is the money saved through instant and around-the-clock fire detection and intrusion protection. This makes the annunciator system the most efficient and lowest cost unit that could be used. From a labor standpoint it is estimated that the cost of guarding the shopping center has been reduced about 50 per cent. Only ten guards are required instead of an estimated 18 needed without the aid of the electronic system.

Scam Instrument Corp., Chicago, Ill., U.S.A.

The art of crystal pulling, while sounding simple in explanation, is a difficult process, yet with the equipment shown the operator can maintain uniform chemical and physical composition with an extreme degree of control.

A basic yet flexible unit which can be modified with minimum effort to meet the individual requirements peculiar to the art of

Silicon crystal manufacturing

The art of crystal pulling for the manufacture of transistors is gradually being transformed into the technique of crystal pulling. The process consists of withdrawing a seed crystal of silicon from a crucible containing molten silicon, at a suitable rate so that a single large crystal forms and grows on the seed. As the crystal is withdrawn it is rotated and the temperature of the molten silicon, and rate of withdrawal adjusted by the operator until a crystal of the required size is obtained. This process which sounds so simple is in practice quite difficult since uniform physical and chemical composition must be maintained in the crystal being pulled, factors over which the operator can exert manipulative control.

Designed, developed and built by Edwards High Vacuum Limited, the "Speedivac" crystal puller has been arranged to be basically a flexible unit which, where necessary, can be modified by the user with the minimum of effort and expense to suit individual requirements peculiar to the art of crystal pulling.

The control systems provided are two types: electrical and mechanical. In the electrical control full compensation for supply voltage fluctuation is provided. The power to the resistance heater has both coarse and fine controls by means of variable transformers. The fine control feeds a separate, small double wound, fixed ratio transformer, whose secondary winding is in series with the 'coarse' controlled output from the larger unit, thus providing micro control of power for the system.

To ensure accurate mechanical control of the pro-

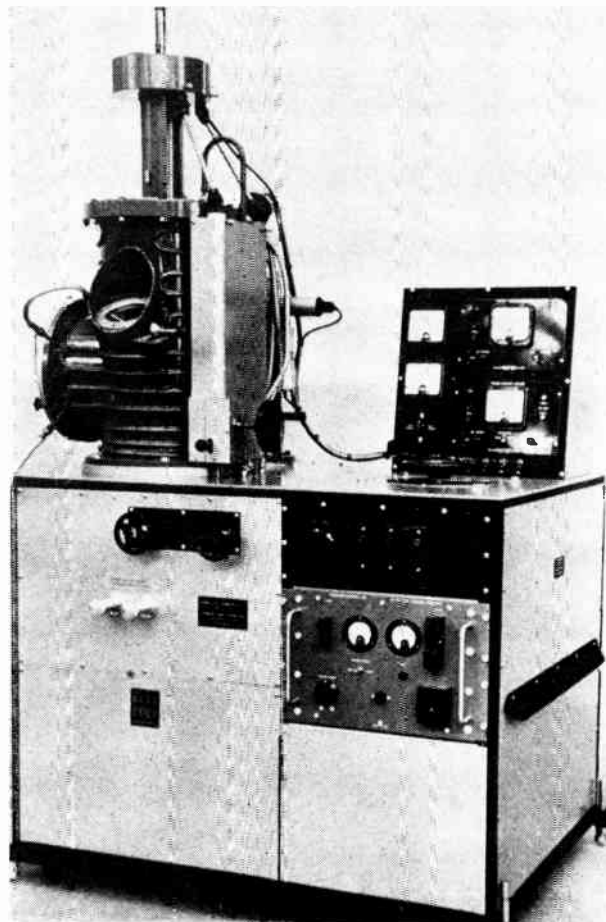

cesses involved, the prime movers for mechanical control devices on the "Speedivac" puller are electrical. To eliminate the elaborate control circuits and expensive selsyn motor drives common to home-made pullers, the "Speedivac" unit uses high speed induction type motors arranged to deliver only a fraction of their rated power, thus becoming virtually synchronized motors, whose speed, for practical purposes, becomes independent of normal supply voltage fluctuations.

The operation of "crystal pulling" necessitates simultaneous rotation and hoisting of the crystal as it is "pulled" and grown. While the rate of rotation is not critical it can be varied by means of an infinite ratio controller between the high speed driving motor and the rotation mechanism during pulling. It is thought that by controlling other variables, it may be possible, after initially varying the rate of hoist when commencing pulling, to program the rate of hoist for the rest of the operation. This variation is achieved by utilizing an identical infinite ratio gear box as that used for rotation. The rod on which the crystal is suspended is actuated by the screw and nut principle. Hoist is provided by rotating a nut, supported on suitable bearings, on the screw thread of the rod. The difference in rotation between it and the screw thread determines the rate of hoist.

The vacuum in the system is continually monitored by thermal conductivity and cold cathode gauges, and automatic protection afforded to the process chamber and pumping unit by magnetic valves.

Edwards High Vacuum (Canada) Ltd., Burlington, Ontario.

**Punched card operators can now be taught
in a fraction of the time
with the world's first**

Automatic keyboard instructor

"Saki", the Solartron Automatic Keyboard Instructor, which was shown publicly for the first time recently is the world's first thinking electronic teacher. "Saki" is one of the practical off-shoots of "Eucrates", the electronic brain employing cybernetic principles.

Designed for the training of operators of card punches, for example, for Hollerith cards, "Saki" is much more than a training device. It is a teacher in the fullest sense of the word. Step by step it takes its pupil along from the very beginning to her final, polished performance with complete, full-time personal tuition.

The rate of tuition adjusts itself to the pupil's ability to absorb and execute. The personal attention of "Saki" is far more complete than would be possible with the finest human system. The idiosyncrasies, the weaknesses, strengths and errors are carefully noted and the pupil's exercises and tests adapted accordingly. The final result is an operator with a completely balanced skill and accuracy of operation. This is extremely important, because much of the time lost through inaccurate card-punching is due to the fact that the personal operating weaknesses have not, with the human tutor, been overcome. Also, the preferential actions of certain fingers with particular keys cause a slightly uneven speed of operation. This unevenness is small enough to be unnoticed by the operator and human tutor. "Saki", however, detects it with ease and thereby corrects it by modifying exercises accordingly.

Because "Saki" plays a "game" with the pupil, the psychological reaction is extremely favorable. The pupil does not get bored or have a tendency to being bored for the attention and concentration are caught and kept. In the early stages "Saki" teaches seven times faster than the class method in the early, introductory stages.

Because "Saki" deals with the whole keyboard from the commencement of instruction and not, as by the class method, four groups of three keys, it will, on the

average, train a pupil to become a full-speed touch operator in 18 hours instead of about 50 hours. But, furthermore, when the operator has been taught by "Saki" in approximately two days, the skill is such that the later courses in reading documents and punching cards accordingly are speeded up very considerably. This is because of the interest generated in the very beginning.

The small card-punch, with electrical contacts under the keys, is connected to a box which has two sets of lights on its face. One set represents the twelve keys of the punch. The other group consists of four rows of 24 small lights each.

In the first stage a card with figures is placed over the large group of instructing lights. The pupil is then asked by lights appearing behind numbers in succession to press the requisite punch key. In the beginning, to familiarize the pupil with the punch keys, "Saki" gives the answer by lighting the correct light in the "punch" lights. But as the pupil quickly gains knowledge of the keys the lights do not appear until after a few seconds' delay or if the wrong key is pressed. This extinction occurs first with single lights, then with groups of lights. When initial proficiency is obtained they do not light at all.

The next stage is working on the figures in the first of the four lines until a certain stage of skill is obtained. The same is done with the next line and so forth. Then the lights dodge about from line to line. The speed at which the figures appear is dictated by the speed of the pupil. They appear in faster succession until the limit of the pupil's skill is reached. Then the machine slows down and helps the pupil along. Thus the machine continues to instruct and correct where the pupil finds difficulty until, finally, the pupil can operate all the keys and groups of keys with equal facility and speed and completely correctly.

The Solartron Electronic Group Ltd., Surrey, England.



"Saki" plays a game with the pupil but teaches seven times faster than the class method in the early introductory stages.

One of the most outstanding and imaginative tools of the 20th century permits speedy

Determination of LCG & VCG.

A new automatic device that tests guided missiles as fast as they leave the production line has saved the Hughes Aircraft Co., Tucson, Arizona, \$10,000 in costs alone during the first six months that it has been installed.

The device, the only one of its kind in the country, is known as the Aircraft Missile Weight and Balancing System. It was designed and built by the Electronics and Instrumentation Division of the Baldwin-Lima-Hamilton Corporation, Waltham, Massachusetts.

The equipment determines with high accuracy the center of gravity (C.G.) and thrust alignment of the Falcon missile.

The B-L-H system assesses each missile in terms of certain pre-set standards for weight, longitudinal C.G., lateral C.G. and thrust alignment. The measurements are recorded automatically on a paper called a Weight and Alignment Data Chart.

The automatic device, which has brought additional prestige to the Hughes plant and has been received with considerable enthusiasm by its personnel, consists of two major units: an instrument console and a missile platform. The equipment does these things automatically:

- Measures the weight of a missile to an accuracy of 0.1016
- Finds the longitudinal C.G. to an accuracy of .015 inches
- Determines the lateral C.G. to an accuracy of .002 inches
- Measures the thrust alignment to an accuracy of .002 inches
- Repeats measurements on the same missile to an accuracy of .0005 inches.

Prior to acquiring the new equipment, Hughes used mechanical means to determine C.G. and thrust alignment.

In contrast, the new equipment provides the first

system that can measure the C.G. and thrust alignment directly.

The quality control instrument for testing the Falcon missile was made possible through the use of two specially designed B-L-H SR-4 sensing elements and one standard SR-4 load cell. The SR-4 elements and cell, strategically located in the missile stand, enable the instrument to plot the missile's characteristics at the rate of one missile every five minutes.

Generally, the system works in this way:

The Falcon missile leaves the production line on an overhead monorail and is lowered horizontally by an air hoist onto the missile platform.

The missile is lined up on the platform by a pin which fits into a tooling hole in the missile and is then retracted. The weight and longitudinal C.G. measurements are made while the missile is in this horizontal position.

The Falcon rests on rollers while being lined up horizontally. When the missile is in this position, the operator, by pressing a button on the adjoining electronic console, lowers the missile so that it rests on a cradle mounted on a B-L-H load cell which weighs it. The cell used is a UIB SR-4 load cell. A printer stamps the weight automatically on the lower left corner of the chart provided for this purpose.

The operator turns the manual programming switch — a large wheel on the console — rotating it clockwise to the stop for longitudinal C.G. which is measured and printed on the chart in the printer. The switch has a large metal disc that permits the operating buttons to be pressed only in the correct sequence.

After the longitudinal C.G. and the weight are recorded on the data chart, the chart is taken from the printer and placed in a Moseley X-Y Plotter, also mounted on the console. The plotter records the lateral C.G. and thrust alignment.

Baldwin-Lima-Hamilton Corp., Waltham, Mass., U.S.A.

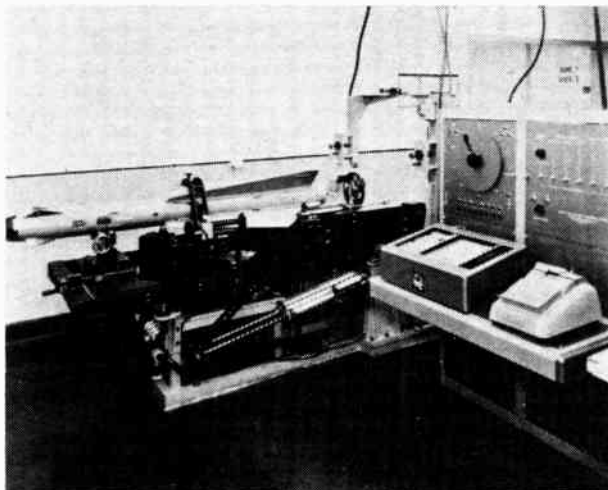

View of the test set-up shows the position of the test panel in relation to the weighing and measuring stand.

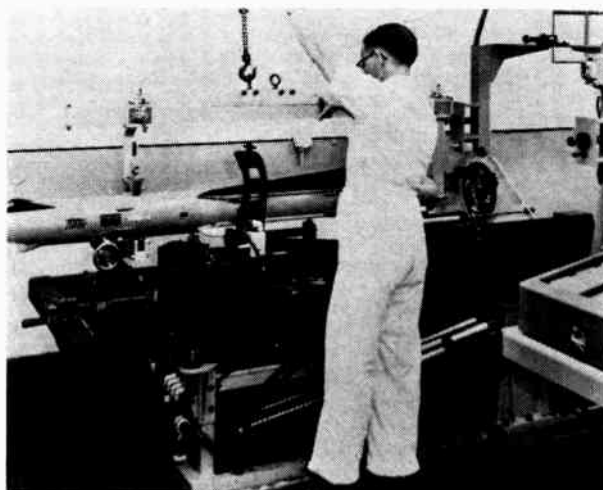

The weight and longitudinal measurements are made while the missile is in this horizontal position.

With the equipment shown scientists hope to determine how bacteria feed, when they thrive and when they degenerate.

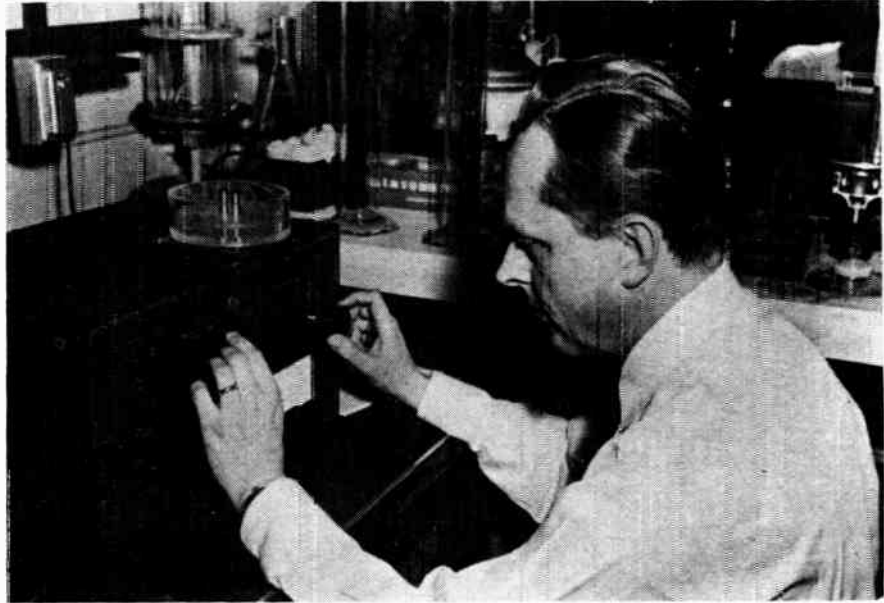

Missile and satellite guidance measuring instrumentation adapted to the study of human tissue.

From missiles to medicine with electronic instrumentation

Using some top-flight academic ingenuity, a University of Pennsylvania medical professor plunged into the world of spacemen, missiles and earth satellites and came up with medicine's latest research weapon against disease and illness.

Dr. Herman P. Schwan, associate professor at the Pennsylvania Medical Laboratories, is employing a new electronic measuring instrument, now being used on missile and earth satellite guidance systems, to determine the exact structure of human and animal tissue.

The new instrument is an RX meter. It has been in existence for four years. Designed for use by the electronics industry, its adaptation to medical research was a surprise to company officials.

With a flick of the dial, Dr. Schwan and his assistants can determine scientific data that used to take many hours of human computation. The precise structure of various tissue is determined by measuring the tissue's electrical properties.

"Our primary interest right now", said Dr. Schwan, "is in basic research. We are confident that in the future the data we are compiling today on the tissue in human beings and animals will be put to use for the improvement of health and the elimination of disease."

Dr. Schwan said the 250-A is particularly valuable in medicine because of its wide frequency range.

Specifically, Dr. Schwan said the RX Meter is used for the following purposes:

1. Measurement of the resistivity and dielectric constant of various types of tissues. The data obtained is of interest in electrophysiology (pre-dominantly at low frequencies) and electrotherapy (diathermy) in the ultra-high frequency range above 20 Mc.

2. Determination of resistivity and dielectric constant of suspensions of protein molecules.

3. Determination of dielectric constant and resistivity of suspensions of cells and subcellular units.

Dr. Schwan's experiments have been going on for many years. "We are the major center of research in this area in the world", he said. "Some work is being done at the Mayo Clinic and in foreign countries, but none as extensive as this."

He explained that every piece of tissue consists of innumerable cells, suspended in some substance.

"You may visualize a cell", he said, "as a sort of balloon. It has a thin envelope which is called a membrane. Inside the membrane, you can determine the properties of the cell."

Among other things, researchers using the equipment hope to find through the experiments how bacteria are able to pick up food, and under what conditions they thrive best, or are less energetic. They hope to do the same with virus. But at present, researchers are concerned most of all with the exact structure of normal tissue.

"There are quite a number of problems we have today in the understanding of the structure of normal tissue. Without complete understanding of normal tissue, we couldn't hope to understand abnormal or diseased tissue."

Asked if his experiments might have a bearing on the eventual discovery of a cure for cancer, which affects cells and tissues, Dr. Schwan would say only, "I hope, at a future time, people will be able to use the information obtained by this basic research for the improvement of health."

Boonton Radio Corp., Boonton, New Jersey, U.S.A.

The X-Ray installation shown enables radiologists to watch bright moving pictures of the heart, respiratory system and other internal organs without subjecting themselves or patients to excessive radiation.

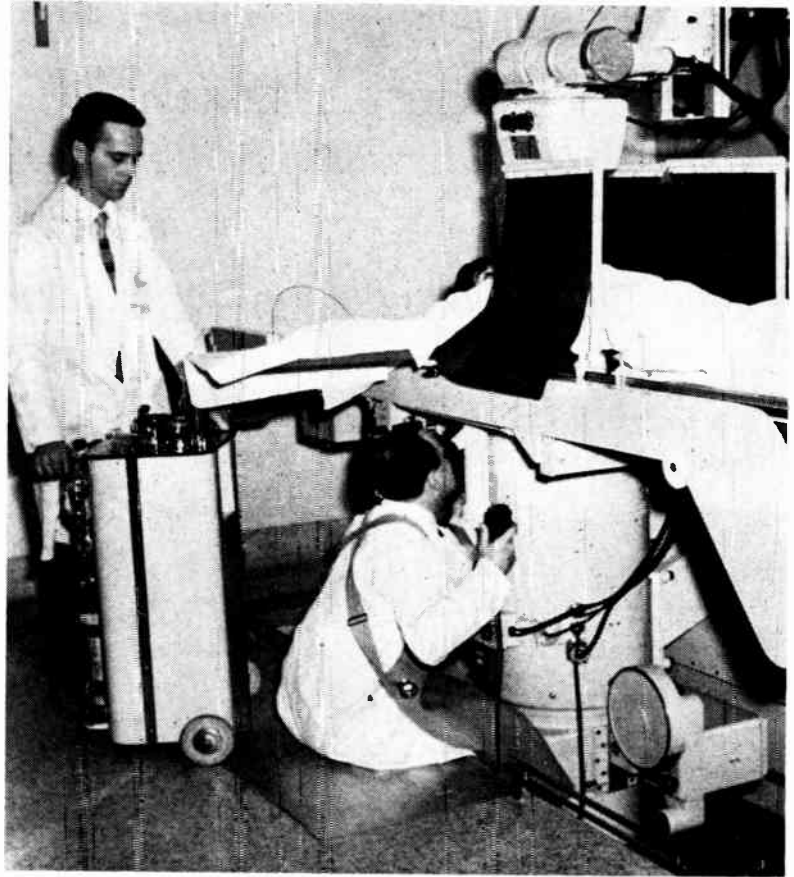

Radiological equipment provides new findings in many fields of medicine through

Advances in X-ray techniques

A safe and powerful new X-ray apparatus through which radiologists can watch bright, moving pictures of the heart, respiratory system and other internal organs has been demonstrated at Laval Hospital in Quebec City.

Developed by Philips of Eindhoven, Holland, the approximately \$100,000 installation is the first of its kind in Canada. Advances incorporated into it include two electronic units, which intensify the brightness of ordinary fluoroscopic X-ray pictures 1,000 times, and a built-in mirror cine-camera for recording the action of internal organs on 35 mm film.

The intensifying unit permits radiologists to prolong their examinations without subjecting themselves or their patients to excessive radiation. The camera, which has a variable speed control, will give them slow motion pictures of rapid and complicated actions like those of the speech organs.

At Laval, where its operation is supervised by Hospital Director, Dr. Alphonse L'Esperance, the new apparatus is invaluable for medical research, instructing students and observing the action and speed of internal organs. It was installed by technicians of Philips Electronics Industries Ltd., Toronto, who have since tested the equipment over a period of several months.

Radiologists examining patients with the new equipment can observe moving pictures as bright and large as those on an eleven inch TV screen. They are also able to make films of these pictures without darkening the room.

A unique vacuum tube whose front end is a special

fluorescent screen in close contact with a photo cathode, provides the means of intensifying the brightness of the X-ray images. When X-rays impinge on the screen the photo-cathode converts the light into an electronic beam which is amplified 1,000 times and projected on to a smaller screen. The mirror optical system provides the radiologist with a magnified view of this second screen.

Patients examined by the new apparatus are strapped to a movable tray which can be fixed in any position. The X-rays can thus be directed through the body at almost any desired angle.

A special desk is also part of the installation at Laval. An assistant seated at it is able to control the many electrical and camera adjustments while the radiologist deals with the patient.

The equipment's built-in camera allows the action of internal movements to be speeded up as well as slowed down. It is expected that the method of recording X-ray pictures, known as cineradiography, will play an important role in the study of speech defects. The screen of the 11-inch intensifier can provide films showing all the speech organs working together.

The powerful, new X-ray apparatus with its wide-screen image intensifier is regarded by doctors as a great advance in the field of medical diagnosis. Its development is assisting doctors and specialists in many fields. These include cardiology, gastroenterology, internal medicine, urology, thoracic surgery, pulmonary diseases, pediatrics, orthopedics and general practice.

Philips Electronics Industries Ltd., Toronto, Canada.

The type 23A Datatel Telegraph and Data Carrier System is fully transistorized . . . designed for universal application and may be operated from either a 48-volt or 130-volt dc supply. It offers a means of using a 4-wire channel for the simultaneous transmission of up to 18 Frequency Shift Telegraph Carrier Channels.

NEW

Type 23A

Lenkurt

datatel

TELEGRAPH and DATA CARRIER SYSTEM

SPECIAL FEATURES

- **Flexible Terminal Arrangements**—Available options include all standard loop arrangements. Where the subscriber's loop length is not excessive, the loop may be operated from the 48-volt central office battery. Optional panels simplify bridging or branching arrangements.
- **Subscriber Set**—Available as an option when a 23A Channel is to be installed at a customer's premises. Arranged to mount in the knee well of a standard teletypewriter table.
- **Compatibility**—May be operated back-to-back or end-to-end with Western Electric Type 43A telegraph system without use of auxiliary coupling units.
- **High-Speed**—Operates at 100 WPM with less than 5% distortion on average channel.
- **Frequency Shift Operation**—Affords greatest tolerance to level changes with smaller variations of bias.
- **Interchangeable Units**—One unit type is common to all channels. Frequency determining networks are plug-in, simplifying spare equipment requirements.
- **Minimum Maintenance**—Transistorized circuitry and only one polar relay keep maintenance work to an absolute minimum. A multimeter and VTVM are normally the only test instruments required.
- **Fast Delivery**—Delivery of Lenkurt Datatel is fast and delivery dates are firm.
- **First in Design**—The technical design features of Lenkurt Datatel far surpass any other equipment of this type. For full information on the finest telegraph and data carrier equipment available contact Automatic Electric.

Lenkurt



AUTOMATIC ELECTRIC
SALES (CANADA)
LIMITED, 185 Bartley
Drive, Toronto 16, Ontario.
Branches in Montreal,
Ottawa, Brockville, Hamilton,
Winnipeg, Regina,
Edmonton, Vancouver.

AUTOMATIC  **ELECTRIC**

ORIGINATORS OF THE DIAL TELEPHONE



5929

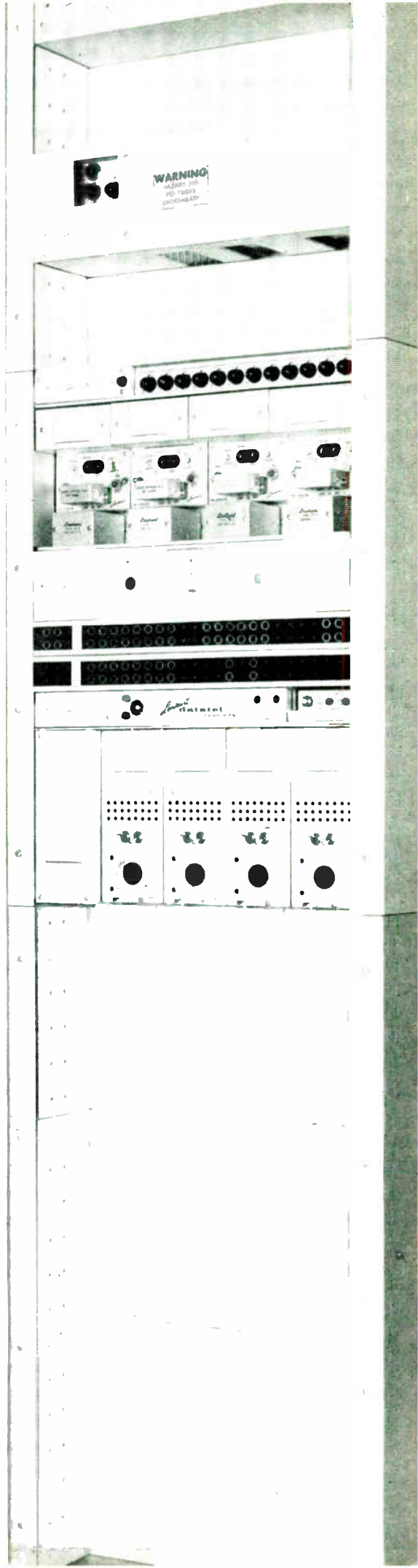

NOW FOR YOU SMALLER BUSINESSES THE TYPE



A PRIVATE AUTOMATIC TELEPHONE BRANCH SYSTEM THEY CAN AFFORD

Now available—Automatic Electric Type 85 P-A-B-X, a private automatic branch exchange with inside circuit and two public exchange trunks.

Signaling on "inside" calls is dial-controlled—producing one short ring. Ringing is thus held to a minimum making the system particularly suitable for hospitals, libraries or other applications where quiet is desirable.

This economical system is ideal for small stores, offices, factories or institutions requiring not more than three conversations at once and where secrecy of conversations is not essential.

If desired one telephone can be equipped with special wiring which permits the user to disconnect all other telephones from the trunk he is using.



AN ORGANIZATION SI

For complete details check No. 50 on handy card, page 95

OUR CUSTOMERS

85 P-A-B-X

TYPE 85 P-A-B-X IS VERSATILE

Public exchange calls may be made, answered, transferred and held at any station equipped with the Type 47 Telephone which has a number of keys for this purpose.

The two outside trunks are directly connected to each Type 47 telephone and equipped with ringers to signal incoming calls, and signal lamps at various locations to indicate when each trunk is busy.

Inside calls are dial selected. If a second signal is required, the user dials again.

Where local service only is required at certain stations, a type 80 telephone or any other automatic telephone can be installed.

ADAPTABLE

Automatic Electric Type 85 P-A-B-X is powered by a battery eliminator, comprising a conventional selenium rectifier and necessary filters, and operating on 115 volt, 60 cycle a.c. which provides noiseless 12-volt d.c. The system works equally well on magneto, common battery or automatic exchanges.

For further information contact any Automatic Electric Sales office, or write direct.

Automatic Electric Sales (Canada) Limited, 185 Bartley Drive, Toronto 16, Ontario. Branches in Montreal, Ottawa, Brockville, Hamilton, Winnipeg, Regina, Edmonton, Vancouver.

P-A-B-X

telephone communications for industry

AUTOMATIC  **ELECTRIC**

ORIGINATORS OF THE DIAL TELEPHONE



SERVING CANADIAN INDUSTRIES WITH COMMUNICATION, TIME AND CONTROL SYSTEMS

ELECTRONICS AND COMMUNICATIONS, March, 1959



Type 80 Telephone for internal calls only.



Type 47 Telephone for internal and external calls.

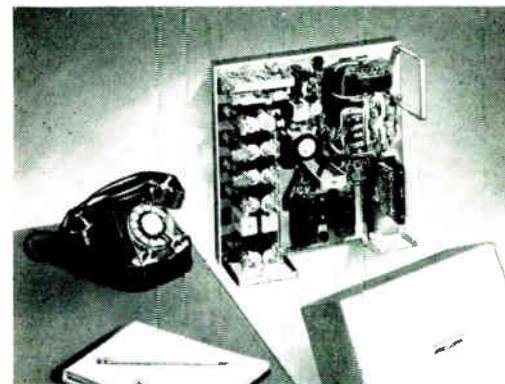

Wall-Mounting P-A-B-X Cabinet. Only 14½ inches square by 5½ inches deep.

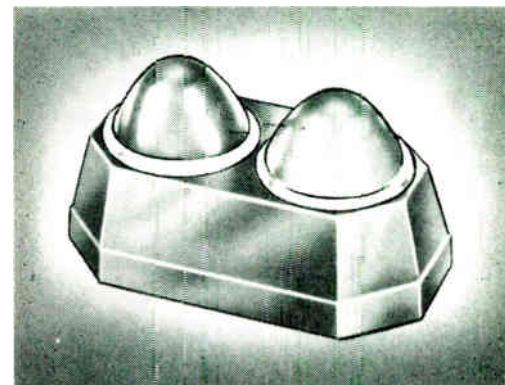

Trunk Signal Lights. Signal for each public exchange trunk when in use.

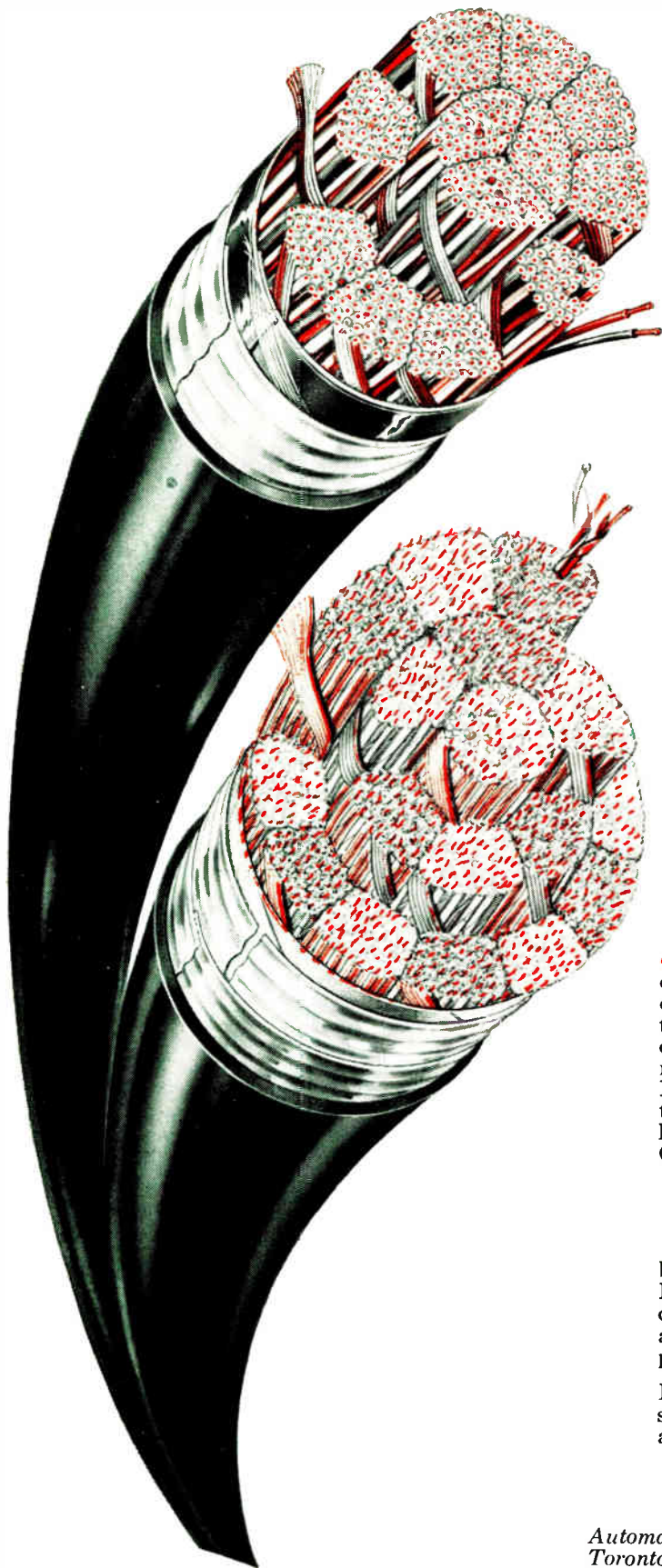

Two important new TELEPHONE CABLES by *Phillips* available from AUTOMATIC ELECTRIC

ALPETH—primarily an aerial cable, but can be constructed for direct burial. Has up to 300 pairs or more, of plastic insulated conductors in multiples of 25 pairs. Features the new simplified colour code, and corrugated aluminum shield for maximum flexibility and electrical protection. Extra light in weight, and extra easy to joint or terminate. Calls for fewer joints because longer lengths can be used. Has high dielectric strength. Cuts current loss in HF carrier circuits.

STALPETH—primarily for use in ducts, but can be used aerially or constructed for direct burial. Has up to 2727 pairs No. 26 gauge paper insulated conductors. Only half the weight of paper lead, and costs less in all sizes. Soldered steel tape provides completely moisture proof construction.

For more complete technical data ask for cable specifications — ALPETH FP-28, STALPETH FP-38, available from any Automatic Electric office.

Automatic Electric Sales (Canada) Limited, 185 Bartley Drive, Toronto 16, Ontario. Branches in Montreal, Ottawa, Brockville, Hamilton, Winnipeg, Regina, Edmonton, Vancouver.

AUTOMATIC ELECTRIC

SALES (CANADA) LIMITED



5928

For complete details check No. 51 on handy card, page 95

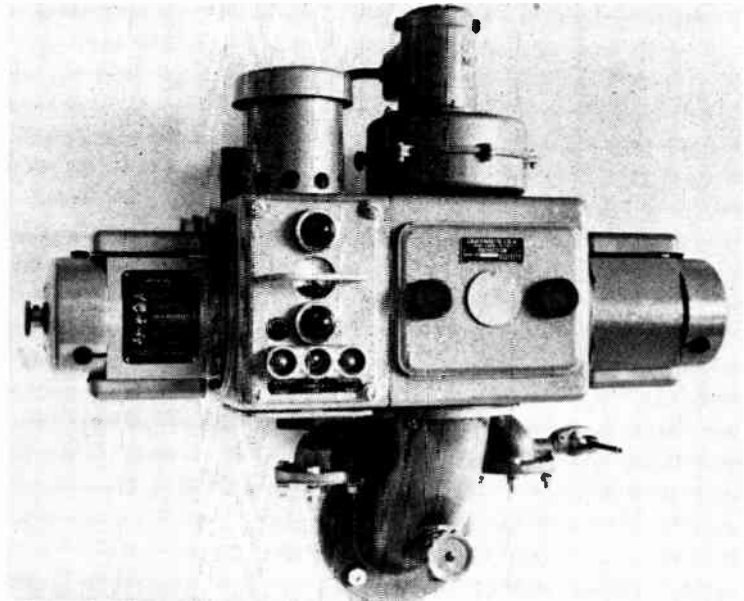
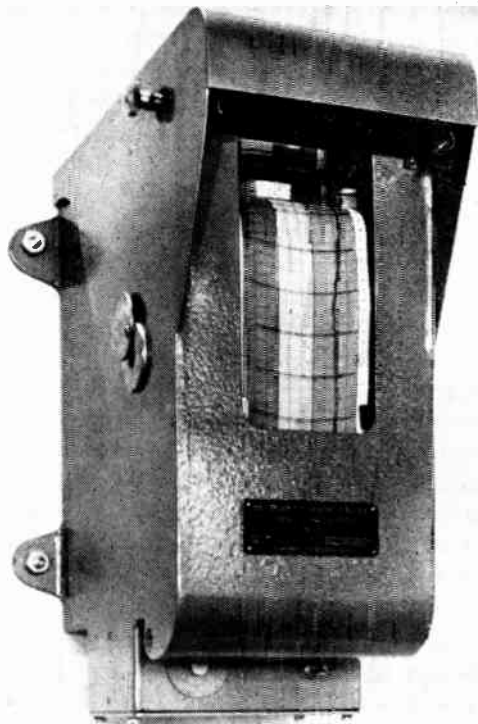

(Above) General view of the detector.

(Left) The chart recorder.

Crankcase explosion hazards have been virtually eliminated by the development of a

Warning device for diesel engines

An oil mist detector has now been formally approved by U.K. authorities for use in British passenger ships. It is an automatic photo-electric device to give early warning when dangerous conditions arise in diesel engine crankcases.

The detector has undergone extensive test-bed and sea-going trials and will perform its function under service conditions over long periods, without the need for anything other than occasional routine servicing.

A degree of mist generation of low concentration is associated with the normal running conditions of a diesel engine and is due to vaporization of lubricating oil at normal running temperatures. This produces a small deflection on a chart recorder of the detector and should remain substantially constant after the engine has settled down to steady running conditions. If overheating takes place with subsequent generation of more oil mist the chart recorder reading will rise above the normal. At a concentration depending on the sensitivity setting of the instrument an alarm will be sounded and visual warning will be given.

The detector is said to have a fast response to small increases in mist density above the normal level associated with the particular engine. In the case of a large diesel engine therefore, explosive or dangerous conditions cannot be reached until long after the detector has given warning. This time lag will depend on the free volume of the crankcase, but will be long enough to allow the engine to be slowed down or stopped so that the defect may be remedied or the crankcase

atmosphere inerted with a medium such as carbon dioxide.

The detector unit is designed to bolt directly to the engine crankcase through a short 4-inch (10.1 cm.) diameter suction duct. This feature avoids use of long intake connecting pipes and dispels the possibility of high rate condensation of oil mist before the samples reach the detector. It also ensures that the sample coincides with the mist conditions within the crankcase, thus eliminating lag in response time.

The equipment is so installed that the detector unit can take samples from the most advantageous position, as near central as possible in the case of a single unit installation, or the middle chamber of each successive group in a twin unit installation. In either case the suction port is located immediately below the lower end of the cylinder liner or diaphragm. The return pipes must lead away to the remote ends of the crankcase on a continual fall line to avoid oil pockets and to ensure continuous circulation and consequent agitation of the crankcase atmosphere.

Each individual engine installation must be treated on its merits and engineered to suit. Tests now show that on open crankcase types one unit will adequately cover up to at least six cylinders.

Apart from the short 4-inch pipe between crankcase and detector unit only two other pipes are necessary, the two 2-inch return pipes, although a branch pipe to the camshaft drive casing may be necessary in certain types of engines.

Graviner Mfg. Co. Ltd., England.

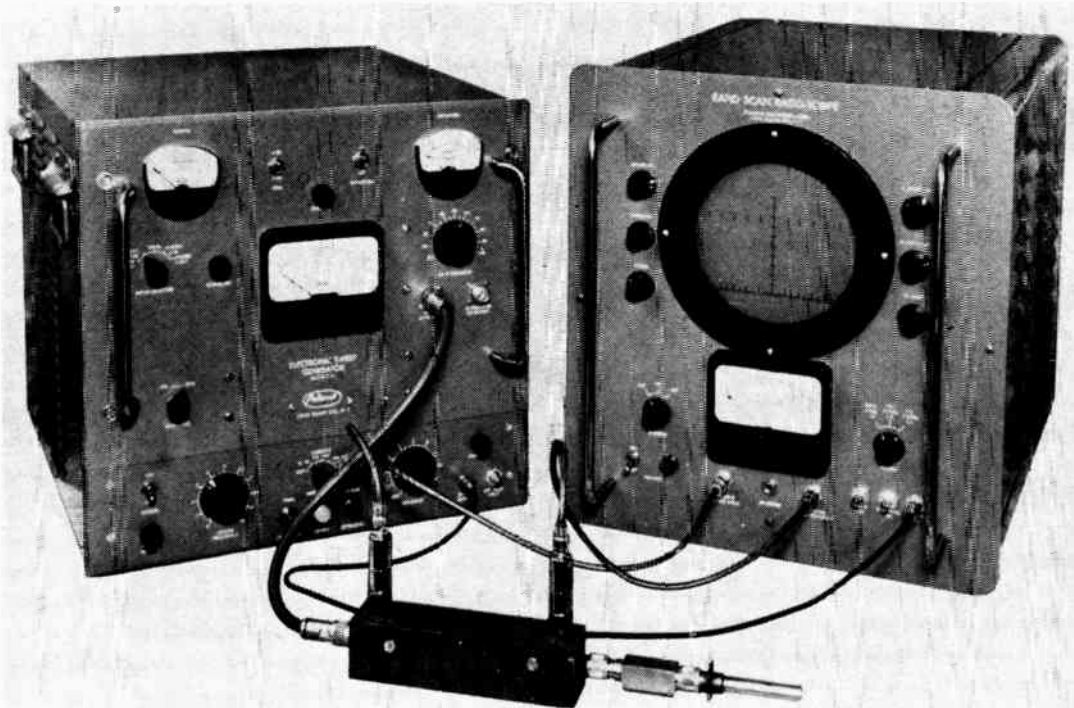

From left to right above are shown the sweep generator, directional couplers and rapid scan ratio-scope, a combination of equipment for simplifying the reading of microwave measurements.

**With the use of the rapid scan ratio-scope
hitherto tedious computations are
eliminated in**

Reading microwave measurements

A simple method of making microwave measurements employs a system of equipments consisting of a sweep generator, directional couplers, and a Rapid Scan Ratio-Scope. (See picture.) This system enables simple, fast, and accurate measurements of such parameters as reflection coefficient, attenuation, amplifier gain, and circuit responses. These measurements can be made over broad frequency ranges and displayed on the Rapid Scan Ratio-Scope, as a function of frequency. Measurements may also be taken at single frequencies; indications are then read directly on the Ratio-Scope panel-mounted meter. Multi-measurement techniques and tedious computations are eliminated by the use of this system.

In order to perform at the full capabilities of the system, the components employed in the test set-up require certain basic considerations. These are as follows:

(a) A means must be provided to eliminate ambiguities caused by amplitude variations from the signal source.

(b) Fast sweep rates must be available, to avoid the usual difficulty encountered in aligning complex microwave components, when using a CRT display.

(c) A modulated signal source is one of the basic components of the system. The signal source must be capable of meeting the following requirements:

(1) Operation at a fixed frequency, or at continuously adjustable sweep widths up to at least an octave.

(2) A 60 cps sweep rate, which will produce a continuous CRT display, free of flicker.

(3) Output power sufficient for measurements of high attenuation, with provision for adjusting the output power level.

(4) A sweep output, which is adjustable in phase.

The solution to the measurement problem is obtained with the use of the Rapid Scan Ratio-Scope, shown in picture. This instrument analyzes the input signals and displays them directly, independent of common amplitude variation. The Ratio-Scope incorporates within its design two narrow-band amplifiers operating at 456 kc, a seven-inch cathode-ray tube, a meter indicator and provision for connection to an external recorder.

The Electronic Sweep Generator now meets the requirements for the modulated signal source described immediately above. This instrument covers the tuning range from 1000 mc to 15,000 mc, through the use of plug-in tuning heads. It develops sweep output and includes a power-monitoring meter. A 1000 cps square-wave modulated output is also available. In addition, provision has been made for pulse-modulation from an external source. Each tuning head employs a backward-wave oscillator, eliminating the need for moving mechanical parts and assuring noise-free, dependable operation.

Polarad Electronics Corp., Long Island City, N.Y., U.S.A.

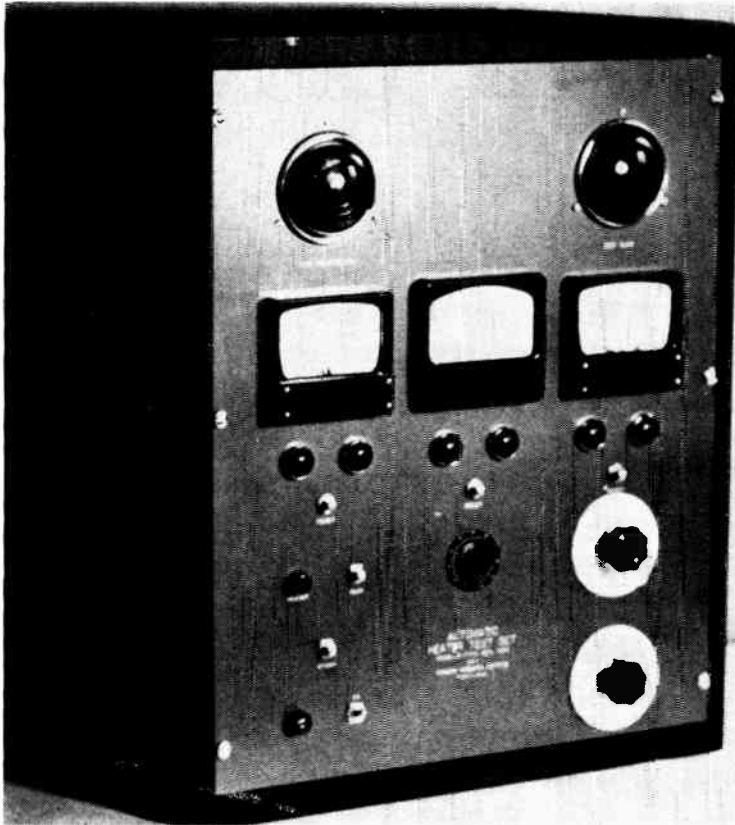

The automatic appliance tester has built-in characteristics that make it especially useful to Canadian manufacturers required by law to meet Canadian Standards Association specifications.

Be it stove elements, toasters, irons, waffle cookers, vacuum cleaners or electric shavers, they can be tested to meet required specifications faster with

Test set for automatic appliances

Ever since the day when the first prehistoric man burned a hole in the center of a slab of tree trunk and road-tested his finest invention, inspection has been an indispensable even though often thorny part of production. In modern manufacturing, while a few firms still staunchly turn their backs on testing and try to avoid it altogether, most progressive companies recognize the necessity for production control, and a few even appreciate its good points, while lamenting its expense!

To put production testing into its proper perspective, we must acknowledge that the control and inspection of our output product is both compulsory and desirable. Compulsory to keep the goodwill of our customers, desirable to keep our self-respect — to say nothing of checking up on our own abilities as an efficient manufacturer. Nevertheless, the cost of such tests must be scrutinized carefully in order to keep production costs within reason. Believe it or not, the most frequently overlooked item in cost accounting is the direct labor and the overhead involved in inspectors plying their task.

To keep the direct labor charges of inspection at a minimum, there are available many automatic and semi-automatic testing devices. The latest of such testers is a Model E-7740 Automatic Appliance Test Set, designed by the Canadian Research Institute of Toronto for high speed testing of electric stove elements,

toasters, irons and other similar devices which must be tested singly to meet CSA requirements.

The Automatic Appliance Test Set comprises a CSA breakdown tester, a limit bridge, and an insulation leakage tester all in one enclosure, along with automatic sequencing equipment and GO-NO GO indicator lamps. In operation, a jig makes all necessary connections simultaneously, with the appliance under test. This starts the test cycle, which consists of, first, application of the CSA dielectric strength proof voltage for one second. If the specimen fails to withstand this potential, it is immediately rejected without further testing. If it passes this test, the tester immediately and simultaneously checks circuit resistance, and insulation leakage at 500 volts. These tests require about five milliseconds, when the inspector is advised that the test is over and a series of indicator lamps tell a non-technical operator of the nature of the fault in the event of a failure.

Meters are provided on the panel with adjustable limit stops under a panel cover removable only with tools so that the engineer or foreman may, without any external standards, set the test set up at the beginning of a run, in approximately 50 seconds! Thenceforth, no reading of meters is required on the part of the inspector, nor is he able to change the test limits.

Canadian Research Institute, Toronto, Canada.

Self-controlled feeding and counting process detects objects at clearances of six inches and parts as small as 0.1 inches in diameter.

A packaging count control system

In a newly developed automation application, proximity transducer systems are being used to control the movement of nuts from a vibratory parts feeder and also to count the nuts coming from the feeder.

Proximity transducer systems are electronic devices that sense the proximity of metal parts, whether moving or stationary, without physical contact. Each system consists of a small proximity pickup, which is mounted close to or surrounding the parts to be sensed; a proximity control unit, which provides an electrical impulse to control associated equipment, and a cable that connects the pickup to the control unit.

Two proximity transducer systems, used with a vibratory parts feeder, provide a self-controlled feeding and counting process. Nuts fed out of the parts feeder by vibration pass through a feed tube. One proximity pickup consists of a coil surrounding the upper portion

of the tube. This coil senses each part as it falls through the tube. Each time a falling part is sensed by the proximity pickup, the associated proximity control unit operates an electric counter. As a result, an accurate rapid count of parts being fed out is maintained.

A second proximity pickup surrounds the tube at a lower point to control the flow of nuts. Unlike the pickup used for counting, the flow-control pickup does not respond to nuts falling through. Instead, it responds only to stationary nuts.

Thus, when nuts in the feed tube pile up to a point where there are nuts present in the proximity pickup, the pickup senses their presence. This causes the associated proximity control unit to switch off the vibratory parts feeder, halting the flow of nuts into the feed tube.

As soon as the level of the nuts in the feed tube falls below the level of the proximity pickup, the proximity control unit switches on the parts feeder again.

Nuts are fed from the tube into containers. Since the proximity control system controls the rate at which nuts come from the vibratory parts feeder, there is no possibility that nuts will be fed out too rapidly for the packaging operation. Also, the life of the vibrating part feeder is increased, since it operates only when parts are required.

Proximity transducer systems detect both ferrous and non-ferrous metals. They are sensitive to very thin metal pieces, and do not attract or hold ferrous chips. Only the small proximity pickup need be located in the work area. Pickups are available for detecting metal objects at clearances of over six inches, and for detecting parts as small as 0.1 inch in diameter.

Electro Products Laboratories, Chicago, Illinois. U.S.A.

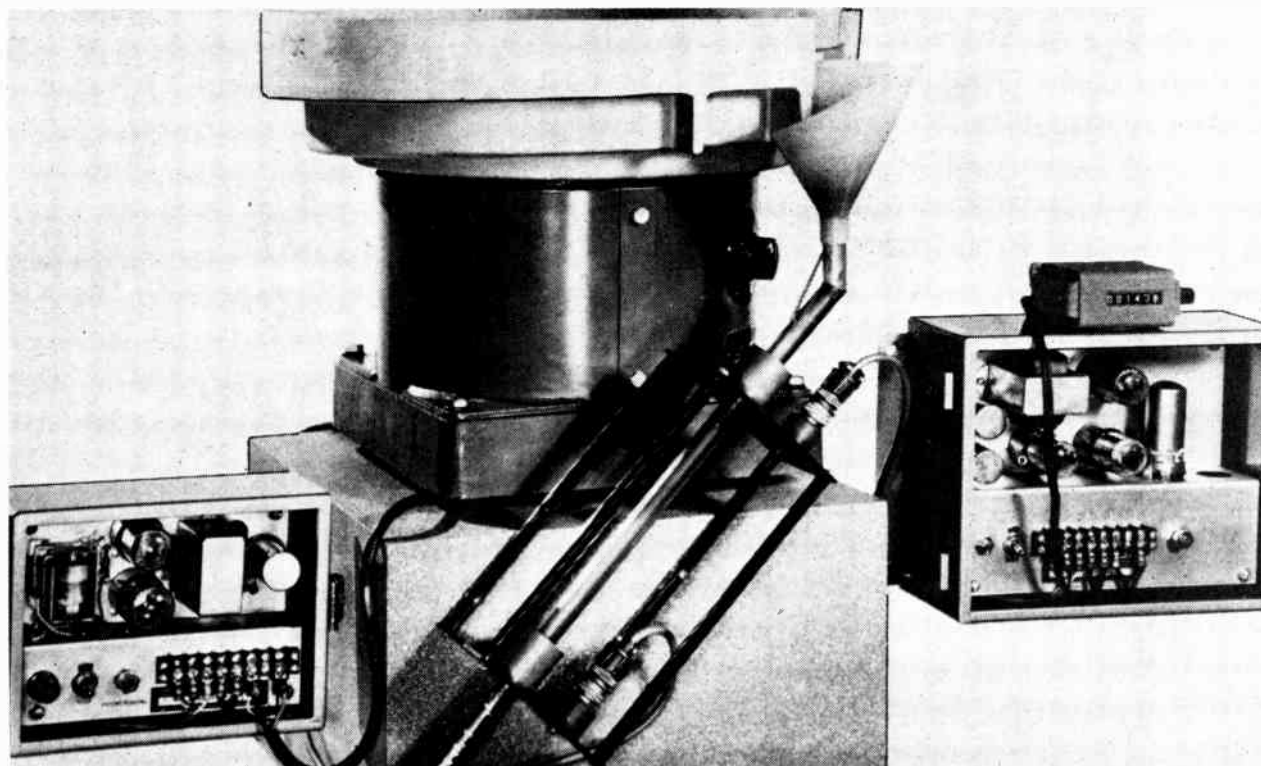

General view of the equipment is: proximity pickup at right, proximity control unit, lower center, and associated proximity control unit at left which shuts off feeder when too many nuts enter the tube.

**WHEN
MEN'S LIVES
ARE AT STAKE . . .**

CANNON ELECTRIC CANADA LIMITED

Specifies

SEL-REX

**"KARATCLAD" HARD GOLD
AND BRIGHT SILVER
PLATING PROCESSES**

Subminiature D-Series Connectors Combine the use of SEL-REX "Karatclad" Hard Gold and Bright Silver Plating — These subminiature connectors supplied courtesy Cannon Electric Canada Limited, are SEL-REX "Karatclad" Hard Gold and Bright Silver plated to the following extents— "Karatclad" Gold—.000025. Bright Silver—.0002 to .0003. At the right are shown finished connectors. The entire SEL-REX plating operation is carried out by The Electric Chain Company of Canada Limited.

CANNON ELECTRIC CANADA LIMITED

100 Bartley Drive, Toronto 16, Ontario / PLYMOUTH 7-2845

March 4th, 1959.

The Electric Chain Company of Canada, Limited,
86 Bathurst Street,
TORONTO, Ontario.

Attention: Mr. E. B. R. Ekblad.

Dear Mr. Ekblad:

You may be interested to know that our high-reliability subminiature D-series connectors, which are widely used in critical military electronic assemblies, have achieved quite an enviable record in service. They are subjected to extraordinarily stringent inspection procedures by our customers, and continue to meet with their wholehearted approval. In circuits where the presence of one poor contact can cause the entire equipment to become unserviceable, and possibly thereby endanger the lives of aircrew, these connectors have shown themselves to be uniformly dependable.

We feel that the reliability of these units is due in no small measure to the "Karatclad" Hard Gold Plate over Sel-Rex Bright Silver Plate which we have specified as a finish for the contacts. Your Company's careful and high-quality workmanship and inspection in applying this finish, have been of tremendous help to us in maintaining our standard of "Quality First".

I have, therefore, approved your Company as our sole source for this type of plating.

Yours truly,

CANNON ELECTRIC CANADA LIMITED,

Thomas D. Hayes

Thomas D. Hayes
Chief Engineer

TDH/ba

**HERE'S PRAISE INDEED . . . and from
the World's Largest Manufacturer
of Electrical Connectors**

In the electronics and electrical fields, it is constantly being proved that the qualities of SEL-REX "Karatclad" Hard Gold and Bright Silver plating processes cannot be duplicated.

The experience of Cannon Electric Canada Limited provides another striking example.

In cases where there can be no compromise with uniform reliability, leading manufacturers invariably specify either SEL-REX "Karatclad" Hard Gold Plating or Bright Silver Plating.

As has been shown, Cannon Electric Canada Limited is advantageously employing a combination of the two to produce a "Quality First" Product.

SEL-REX "Karatclad" Hard Gold and Bright Silver Plating Processes are available in Canada through The Electric Chain Company of Canada Limited. We invite your enquiries. Let us tell you more about these remarkable processes . . . how net costs are lower . . . how they have been proved by comparative tests to give unbelievably greater protection than that afforded by any type of conventional plating. SEE OUR EXHIBIT AT THE NATIONAL INDUSTRIAL PRODUCTION SHOW, TORONTO, MAY 4 TO 8 — BOOTH NO. E-1.

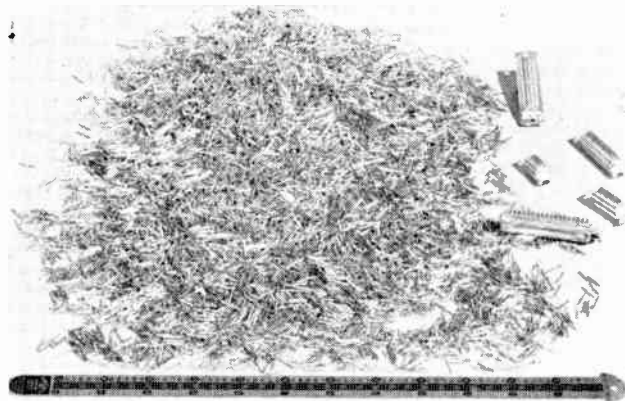

THE ELECTRIC CHAIN COMPANY OF CANADA LIMITED

86 BATHURST STREET

EM. 3-8881

TORONTO 2B, ONTARIO

For complete details check No. 75 on handy card, page 95

ELECTRONICS AND COMMUNICATIONS. March, 1959

61

New Products

New Product specifications published in Electronics and Communications have been briefed for your convenience. If you require further information on any of the items published you may readily obtain such by using our Readers' Service, Page 95. Just mark the products you are interested in on the coupon on Page 95 and the information will be in your hands within a few days.

Ruggedized silicon solar cells

Item 2279

A significant advancement in the manufacture of silicon solar cells has been announced by International Rectifier Corporation, El Segundo, California, with the development and production of ruggedized cells capable of converting 10 per cent and higher of the radiant energy falling on their surface. Conversion efficiencies of this caliber make these the most efficient solar converters currently available.

Designed and manufactured to extremely rigorous military specifications, these rectangular cells are now available for both commercial and military applications, and are capable of providing an output of approximately 9 watts per sq. ft. of active cell area in bright sunlight. The high efficiency and rugged construction of these units is due in part to new alloying techniques which permanently bond the contact to the silicon wafer, making the contact an integral part of the cell itself, while still allowing soldering of individual cells. This intimate bond between contact and cell results in substantial gains in operating efficiency . . . minimizes series resistance.

Individual cells are obtainable, with or without color-coded pigtail leads, in sizes $\frac{1}{2} \times 1$ cm., $\frac{1}{2} \times 2$ cm., and 1×2 cm.

For additional information write for Bulletin SR 275 to the Canadian factory representatives: Atlas Radio Corporation Ltd., 50 Wingold Avenue, Toronto 19, Ontario.

Telmag grain-oriented silicon iron transformer cores

Item 2280

Grain oriented silicon iron cores have been available for some time in the following shapes: toroids, "C" core loops, "E" cores and cruciform. The cruciform is a toroid or "C" core of cruciform cross section. To this range, the "Y" core configuration has been added.

Cold rolled grain oriented silicon-iron core material is manufactured in varying widths and in three thicknesses. The frequency response improves as the thickness decreases.

The advantages of grain oriented cores over conventional hot rolled iron laminated cores are listed below.

- (1) Total iron losses reduced up to 40%.
- (2) Maximum allowable flux density increased up to 30%.
- (3) Magnetizing current reduced up to 75%.
- (4) Weight and volume reduced up to 30%.
- (5) Stacking factors improved.

The various shapes have differences in their performance. For example a toroid and a "C" core loop are basically similar.

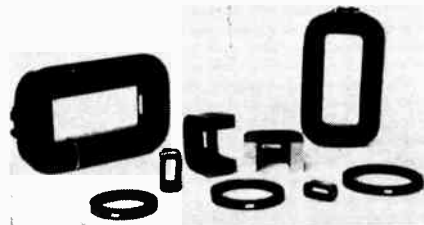

The "C" core being a toroid that has been cut into two half loops and with an accurately matched interface. The cutting into two sections of a "C" core results in a slightly inferior performance when compared to a toroid, but the separation

results in a more simple winding operation with attendant manufacturing economy. Hence for many applications the "C" core is ideal.

The cruciform core is available as an uncut toroid or when cut as a "C" core loop. Cruciform cores are constructed by winding various widths of steel ribbon which increase and decrease in width by increments of $\frac{1}{4}$ ". The end view of a sectioned core is roughly cruciform in shape.

Cruciform shaped cores are used for core-type construction whereas for shell-type construction a half cruciform section is available.

Three phase cores are available in the "E" and "Y" core shape. The "E" type core suffers from a higher core loss and although used for transformers up to 25 KVA, it is most useful where small size and light weight are major design criteria, e.g., 400 c/s aircraft equipment.

The "Y" core which is a major advance in core design enables a three phase transformer to be manufactured with all the advantages that the "C" core provides for a single phase transformer. "Y" cores are available in a range of eight sizes suitable for transformers of 25 to 500 KVA.

Mechron Engineering Products Ltd., 2437 Kaladar St., Ottawa, Ont.

Multi-purpose counters

Item 2281

IVO mechanical and electrical counters are newly available in Canada.

The model illustrated is the F106 Electro Magnetic counter giving speeds up to 20 imp. per sec. for DC and 15 imp. per sec. for AC. The manufacturers claim a life of 60 to 70 million operations. The F106 is available with solder or screw terminals and can be supplied with Zero reset or non reset as required.

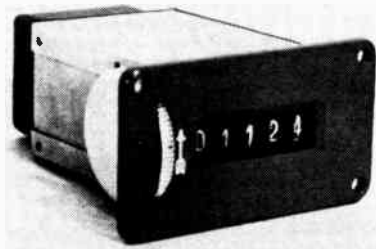

These counters are used in a wide variety of industries for such applications as piece counting on machines, assembly line and conveyor belt counting and control, man hour records and measuring control in flat goods industries. For permanent records, IVO printing counters are available in various models.

Full information and literature is available from Aeromotive Engineering Products Ltd., 147 Hymus Blvd., Pointe Claire, Quebec.

Combination plug and jack

Item 2282

Cambridge Thermionic Corporation has added a new combination plug and jack to its line of Cambion® guaranteed electronic components.

The new plug and jack, #2317, has been designed to allow piggy-backing of patch work panels and additional plugs; that is, it can be plugged into a jack on a board and another plug can be plugged into it. The jack is equipped with a captive key

permanently held in place by a beryllium copper spring. Insertion of the plug forces expansion of the spring giving positive trouble-free contact. Because of the unique construction, lateral pressure on the plug cannot damage the unit. The jack mates with Cambion's 2201-2 plug. It is available in four shank lengths to accommodate terminal boards with thicknesses ranging from .087 to .214. Processed from quality brass, the #2317 is finished in .0002" bright alloy plate.

For further information write to Cambridge Thermionic Corporation, 445 Concord Avenue, Cambridge 38, Massachusetts, U.S.A.

Weather-proof plugs

Item 2283

New, weather-proof connectors, designated Series LR and MR, have been developed by Cannon Electric (Canada) Limited. These all-weather connectors are capable of withstanding extreme conditions of mud, ice and water.

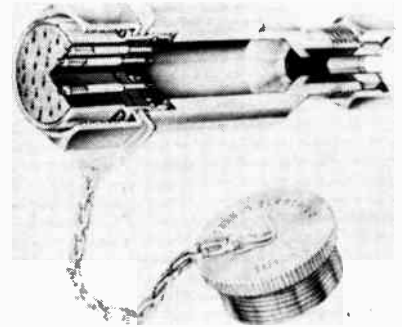

Used on arctic radar warning systems, such as the "DEW Line", the LR and MR Cannon plugs feature clear and black anodic coating for maximum corrosion resistance; built-in rubber gland and gland nut for moisture sealing around the cable; and chain-attached caps for sealing off the connector faces when plugs and receptacles are unmated. All-weather maintenance is facilitated by the use of coupling nuts which may be removed with open-end wrenches.

Machined from premium quality bar-stock, the new LR and MR connectors are heavier and stronger in construction than comparable die-cast types. Standard MS insert arrangements are available. Coupling threads and sizes are also standard to Military Specification MIL-C-5015.

For technical information, write to Cannon Electric (Canada) Limited, 160 Bartley Drive, Toronto 16, Ontario.

Quick disconnect connectors

Item 2284

The new Amphenol 31 Series Quick Disconnect Connectors are designed for use with the RG-108A U Cable & include the contact polarizing feature.

For use in computer circuits where low signal levels — high sensitivity circuits or where the conventional co-axial cable is inadequate.

The new 31 Series with twin conductor balanced configuration reducing noise pick-up features: rating 100 volts peak; weather-proof; coupling-bayonet lock; captivated contacts in both plug & receptacle; polarized contacts to prevent mismatching; small size.

For further information write to Amphenol Canada Limited, 300 Campbell Avenue, Toronto 9, Ontario.

New Products

Audio frequency spectrometer

Item 2285

Audio Frequency Spectrometer Type 2110 has been developed basically to facilitate rapid and accurate frequency analysis of complex signals such as the ones encountered in noise and vibration measurements. It may also be used as a true R.M.S. reading vacuum tube voltmeter and for harmonic analysis of electrical signals.

It is basically a frequency analyzer which divides the frequency band 35 to 35000 c/s into $\frac{1}{3}$ octave ranges by means of 30 bandpass-filters with very high selectivity (40 db rejection at 2 times passband center frequency) and zero passband attenuation.



The input to all filters are paralleled and frequency band selection is carried out by means of a switch in the filter output circuit. The switch can be operated manually or be driven automatically with the aid of an external motor drive.

A very important feature of the spectrometer is its ability to measure not only the arithmetic average value of the input signal, but also the true R.M.S. value (for signals with crest factors up to 5) as well as the peak value. The desired type of indication is selected by means of a switch.

The instrument can also be switched to operate as a linear amplifier and VTVM in the frequency range 2 to 35000 c/s. Two different meter damping characteristics are provided so that accurate measurements and easy meter reading are obtained also at the lower frequencies.

For further information write either to A/S Brüel & Kjaer, Naerum, Denmark, or the Canadian representative: R-O-R Associates Limited, 1470 Don Mills Road, Don Mills, Ontario.

Marine radar equipment

Item 2286

Decca Radar (Canada) Limited announce the introduction of a completely new range of marine radar equipment, the D7 Series.

The Decca D7 Series consists of seven new radar sets, each one planned and designed to fulfil a precise need according to the requirements of any given ship. The shipowner is now able to select from the planned range of a single manufacturer a radar set at a price he can afford and offering the performance standards of his choice.

These seven new sets include two new True Motion Radars which embody many improvements based on the unique and highly successful Decca TM. 46. system. The standards of performance and reliability of the new series are claimed to be higher than at present available in any comparable equipment.

Each radar is of the most advanced design employing modern techniques including

printed circuits and great care has been taken in planning the most logical arrangement of controls to ensure maximum simplicity of operation.

The new D7 Radar Series has been developed in the Decca Radar Laboratories utilizing to the full the accumulated experience gained from the previous types of Decca Radar of which over 7,700 sets have been ordered for every maritime country in the world and for the Royal Navy and the navies of thirty foreign countries. This has resulted in greatly improved design features based on the known requirements of present day radar from searching practical examination in the use of radar at sea.

The D7 Series consists of:

	Display	Mile Range	
The Decca 303	9"	36	10 k.w.
The Decca 404	9"	48	20 k.w.
The Decca 505	9"	48	75 k.w.
The Decca 606	12"	48	20 k.w.
The Decca TM.707	12"	48	20 k.w.
			(True Motion)
The Decca 808	12"	48	75 k.w.
The Decca TM.909	12"	48	75 k.w.
			(True Motion)

Further details and information available from Decca Radar (Canada) Limited, Marine Division, 23 Six Points Road, Toronto, Ont.

Portable weighting network

Item 2287

The Lenkurt FIA Weighting Network provides a convenient means of adapting any good quality, high impedance, vacuum tube voltmeter to read FIA noise measurements.

FIA noise measurements are accepted as the standard in the communications industry in evaluating the noise performance in dba of voice frequency circuits derived from physicals, carrier channels and radio equipments. The addition of the Lenkurt FIA Weighting Network makes the purchase of separate noise measuring equipment unnecessary.

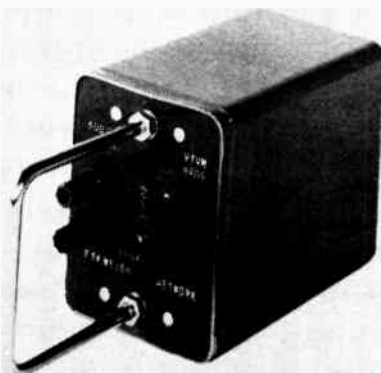

The Lenkurt FIA features light, compact design and measures only 8" x 3 1/4" x 4 1/2". It is encased in rugged aluminum, suitable for portable use or panel mounting. A chrome carrying handle also serves to protect the banana-type terminals.

This precision instrument is priced at a fraction of the cost of conventional noise measuring equipment. For more information on the Lenkurt FIA, write Automatic Electric Sales (Canada) Limited, 185 Bartley Drive, Toronto 16, Canada.

Portable fixture holds all standard chassis

Item 2288

A fully adjustable, portable universal fixture designed to hold all EIA standard chassis is now being distributed in Canada by W. R. Watkins Company Ltd., 41 Kipling Ave. South, Toronto, Ont.

Designated Tronic-Hold T-300, this unit can accommodate any chassis up to 30 inches square, and covers 90 per cent of all possible shapes. It can fit almost any

type of chassis with or without gusset, making it suitable for a variety of uses, including electromechanical assemblies, laboratory testing, inspection and servicing of electronic chassis or similar devices.

Tronic-Hold is fully adjustable, enabling the chassis to be held in any position desired by the operator, who can work on either side. Maximum distance to reach any part of the chassis is only 10 inches.

There is no added weight for the operator to lift or transport as the fixture fully supports chassis up to 200 lbs., with complete safety from bumping or dropping. Casters allow high mobility, so that the unit can be inserted or removed from an assembly line at any time. Bench and sub-assembly models are also available.

Users of Tronic-Hold report savings of up to 50 per cent in direct chassis assembly time.

Further details upon request to W. R. Watkins Company, Ltd., 41 Kipling Avenue South, Toronto, Ontario.

Ultrasonic impact grinder

Item 2289

A major cost breakthrough in an ultrasonic impact grinder using a magnetostrictive transducer to permit a 100 per cent duty cycle is announced by the Industrial Equipment Department of Raytheon Manufacturing Company. Simple, rugged and versatile, the unit known as Model 2-335 is used for cutting, slicing, drilling, grinding and trepanning regular or irregular shapes quickly, accurately and economically. Among the substances that can be worked are semiconductors, ceramics, ferrites, carbides, metals, jewels and other hard or brittle materials.

The cutting head is mounted on a rugged base, has a foolproof cutting force adjustment and has a built-in force dial. The slurry tray is readily removed for cleaning and tool cones can be interchanged easily. The ultrasonic driver produces 100 watts and is based on design thoroughly proved in numerous field applications.

A unique feature offered by Raytheon, on its line of ultrasonic impact grinders, is a full year guarantee on the transducer, with an additional 18 months warranted on a pro-rated time basis. The unit is available for immediate delivery.

Further details upon request to Raytheon Manufacturing Company, Industrial Equipment Dept., Waltham 54, Massachusetts, U.S.A.

Zero backlash universal joints

Item 2290

Mini-Joints provide greater freedom in instrument design at low mechanical power levels. Sealed-in lubrication, maximum operating angle of 30°, zero backlash are important design features.

The double Mini-Joint is a zero backlash, constant velocity joint when connecting parallel shafts or when connecting intersecting shafts such that the angles between the intersection and the two other shafts are equal. Typical applications include synchros, resolvers, mechanical indicators, repeaters, potentiometers, sub-fractional

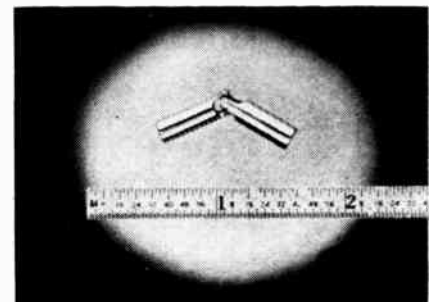

H.P. Motors. Torque ratings available up to 64 in. oz.

Distributed in Canada by Canavia Engineering & Sales Co., Malton Airport, Malton, Ontario.

New Products

Sensitive hi-pot tester model H 5, AC/DC

Item 2291

An improved line that automatically deenergize high voltage when leakage current reaches 5 micro-amps. Models



available from 2 kv to 120 kv. Will show leakage that less sensitive instruments cannot detect.

Peschel Electronics, Inc., R.F.D. #1, Towners, Patterson, N.Y. Canadian Representative: Stark Electronic Sales Co. of Ajax, Ontario.

Transistorized headset amplifier

Item 2292

The Daven Company announces a new transistorized interphone amplifier, Type 90, designed specifically to aid in meeting the stringent requirements of modern television studio communications systems. This unit is designed to mechanically and electrically replace the Western Electric Type 101 induction coils previously employed in studio interphone systems.

Used in conjunction with a Western Electric Type 52 headset, or equivalent, this new unit provides the following important advantages over the traditional coils with no significant increase in power consumption:

1. A gain of up to 20 db in received sound level!
2. Up to 32 stations may be used on the same bus instead of the 6 normally considered a limit with induction coils.
3. Received signal level may be fixed at any desired setting independently at each station in a system. Alternately, manually adjustable gain may be provided at stations where changing ambient acoustic noise calls for this feature.
4. Side-tone (level of the speaker's voice in his own earphone) is held at a fixed ratio below received signal level regardless of the number of stations connected to the interphone bus — and is independent of received signal gain setting.
5. Operation is independent of 24 volt "talk" bus polarity and the amplifier is thereby protected against burnout.

This easily installed device once and for all solves the problem of cameramen, boom operators, floor managers or other studio personnel not being able to hear vital control room instructions.

For further information, contact The Daven Company, Livingston, New Jersey, U.S.A.

1,000-line storage tube

Item 2293

Improved background uniformity, finer spot size, and more linear gun transfer characteristics are some of the features of a new single-gun, recording storage tube, the QK-685, now available from Raytheon Manufacturing Company.

Resolution of 1,000 lines at 50 per cent modulation, and shading-to-signal ratios of less than 10 per cent result from use of a double collimating lens with wider deflection angle and smaller collimation error than previous designs.

A specially developed tetrode electron gun gives better maintenance of spot size with beam current, and better control over beam cut-off than conventional triode guns. The gun is designed for magnetic deflection and focusing, with provisions also made for dynamic electrostatic focusing. Elements of the tube's output structure are separately mounted on a ceramic insulating plate to assure low output capacitance of less than 10 micro micro farads.

Additional information and specifications can be obtained by addressing inquiry to Raytheon Manufacturing Company, Microwave & Power Tube Division, Waltham 54, Massachusetts, U.S.A.

20-ampere autotransformer

Item 2294

A more rugged, more adaptable, and more durable autotransformer than its predecessors, the General Radio Type W20 Variac® Autotransformer is the latest model to be announced in the new re-designed W series. These designs are the result of long-term careful planning aimed at supplying the best possible continuously adjustable autotransformers for today's dollar.

Wrought metallic parts have been substituted for castings in the interest of improved mechanical properties. Heat transfer between coil and base, brush and radiator has been improved. Ball-bearing models for motor-drive and other demanding applications are stock items. All W20 models have Duratrak contact surface, developed by General Radio, which minimizes brush-track deterioration under adverse environmental or load conditions and assures long and trouble-free life.

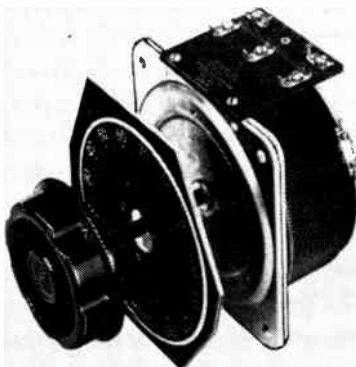

Basic uncased models are available for 115-volt and 230-volt service and are rated at a maximum of 3.0 and 2.4 KVA, respectively. Cased models have knockouts for conduit or armored cables. The case front is easily removed for access to terminals, mounting holes, and brush. Ample space is available inside the case for wiring. Two portable models include a 3-wire attached cord and plug, output receptacle, switch, and overload circuit breaker.

All W20 models can be connected to provide 17% over-voltage output if desired. Two- and three-gang assemblies are available cased and uncased, and motor drives can be supplied for all models.

General Radio Company, 275 Massachusetts Ave., Cambridge, Massachusetts, U.S.A.

Microwave analyzer

Item 2295

A new microwave analyzer featuring very wide dispersion has been developed by Polarad Electronics Corporation, 43-20 34th Street, Long Island City 1, New York. This unit, Model TSA-W, permits complete visual analysis of extremely narrow to extremely wide microwave pulsed signals in the frequency range 10 to 44,000 mc. For analysis of pulses as short as 0.1 microsecond, the analyzer provides frequency dispersion up to 70 mc. For wide pulse analysis, the instrument provides a narrower display bandwidth with extremely high resolution (7 kc).

Among the unique features of this

sensitive analyzer are a logarithmic amplitude display to accommodate signals within a wide dynamic range; a wide-range marker oscillator calibrated in frequency difference and pulse width; a vernier marker oscillator dial, with stable local oscillators, and non-contacting short-type tuning cavity chokes for long equipment life. The spectrum is displayed on a cathode ray tube which has special provision for high intensification for viewing in a brightly-lit room. The frequency range is covered by five highly sensitive interchangeable plug-in tuning units.

Model TSA-W may be used for all microwave spectrum analysis work requiring wide dispersion range, high sensitivity and resolution, such as observing several signals simultaneously, comparing two signals having relatively small or wide frequency separation, measuring and displaying pulse modulation components, attenuation and band width characteristics, r-f leakage and interference, VSWR, and modulator and transmitter malfunctionings.

Polarad Electronics Corporation, 43-20 34th Street, Long Island City 1, N.Y., U.S.A.

Wide range DC/AC power supplies

Item 2296

Sorensen & Company, South Norwalk, Connecticut, announces a new line of variable-output unregulated power supplies providing both DC and AC outputs for general purpose laboratory or production-line test-bench applications.

The new supplies, styled the "RC-Nobatron Rangers", consist essentially of a compact, conveniently packaged variable autotransformer, rectifier and filter circuit. Although unregulated, the new supplies have exceptionally low internal impedance as a result of their conservatively rated components.

Models are available to supply DC voltages ranging from zero to 36 and zero to 150 volts, each having available zero to 130 volts AC. Either 36- or 150-volt models available in maximum DC power ratings of approximately 500 or 1000 watts.

Complete specification data is contained in Product Data Sheet DC270 which will be supplied upon request to Sorensen & Company, Inc., Richards Avenue, South Norwalk, Conn., U.S.A.

Linear variometer

Item 2297

Size 11 Linvar (linear variometer) is a small size, low weight instrument, housed in a standard Bu-Ord Size 11 synchro frame, and has a voltage output proportional to rotor angle rising to 42.5 volts.

The linear relationship of $\pm 1/4$ per cent extends over the range ± 85 degrees from the zero output position, and is achieved by a special patented design of the rotor and stator laminations which gives a smooth variation of output voltage devoid of any fluctuations due to tooth ripple.

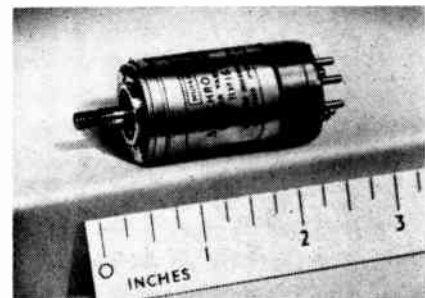

The linvar can be applied to satisfy the requirements of analog computation, remote control or indication, and may be operated by mechanical measuring devices, e.g., strain and deflection gauges, weighing machines, etc., where an AC output voltage varying linearly with deflection is required.

Data sheets are available giving full technical information upon request to Muirhead Instruments Limited, Stratford, Ontario.

New Products

Voltage regulated power supply

Item 2298

Kepeco announces the release of a new tubeless transistorized small package voltage regulated power supply featuring excellent regulation, low ripple content, fast recovery time, good stability, low output impedance, low temperature coefficient, short circuit protection, over-current control, remote programming, and remote error signal sensing.

The Model SC-32-2.5 delivers 0 to 32 volts, 0 to 2.5 amperes. Regulation for line or load is less than 0.01% or 0.002 volt, whichever is greater. Ripple is less than 1 millivolt RMS. Recovery time is less than 50 microseconds. Stability for 8 hours is less than 0.01% or 0.002 volt, whichever is greater. Operating ambient temperature is 50°C maximum. Temperature coefficient is less than 0.01% per °C. Output impedance is less than 0.01 ohm.

Additional features include the following: overtemperature protection; continuously variable output voltage without switching; a design to operate continuously into a short circuit; either positive or negative can be grounded; units can be series connected; suitable for square wave pulse loading; terminations on front and rear of unit; power requirements 105 to 125 volts, 50 to 65 cycles. 400 cycle units are available.

This compact unit is 19" wide, 3½" high and 13" deep.

Kepeco Laboratories, Inc., 131-38 Sanford Ave., Flushing 55, N.Y., U.S.A.

Transistorized inverters

Item 2299

Four types of new transistorized printed circuit converter-inverters are now available from Spectrol Electronics Corporation, San Gabriel, California, manufacturer of precision electronic components.

Spectrol converter-inverters are static type power sources designed to replace motor generator and vibrator type devices for the conversion of AC or DC input voltages to AC and DC outputs of different voltage levels or frequencies. The new units have wide application as aircraft radio, radar and utility power supplies; missile instrumentation, power supplies; mobile and marine radio power supplies; remote radiotelephone and telegraph; portable powerpacks; and other devices calling for sturdy, reliable power supplies.

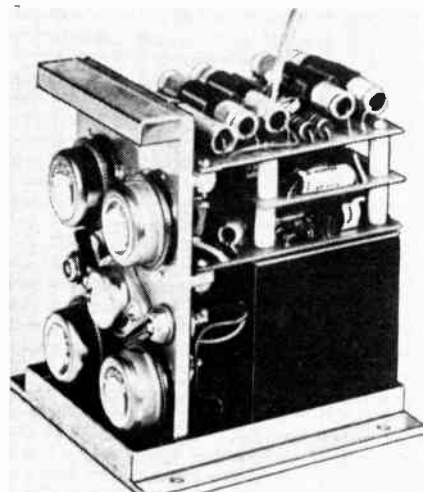

Characterized by high output per unit volume, the new devices offer up to 5 watts cubic inch output. Efficiency of the new units is 80 per cent for input voltages greater than 23 volts DC.

Other key specifications for the various

types are for series 760, DC in to DC out: input voltage of 6.3 to 32 v DC; output voltage, 1.0 to 10 kv DC; output power, up to 1 kw at 0.01 per cent regulation. For series 770, AC in to DC out: input voltage of 6.3 to 440 v AC (60-2000 cps); output voltage 1.0 v to 10 kv DC; output power up to 1 kw at 0.01 per cent regulation. For series 780, DC in AC out: input voltage of 6.3 to 32 v DC; output voltage 0 to 440 v AC (60-400 cps); output power, up to 200 watts at 0.5 per cent regulation. For series 790, AC in to AC out: input voltage 6.3 to 440 v AC (60-2000 cps); output voltage, 1.0 to 10 kv AC (60-2000 cps); output power, up to 1 kw at 0.5 per cent regulation.

For complete technical information, please address Spectrol Electronics Corporation, 1704 South Del Mar Avenue, San Gabriel, California, U.S.A. or the Canadian rep.: E. E. Whittaker, Box 3255, Arnprior, Ont.

20 million operations with low cost relay

Item 2300

Known as the #219 Frame this new Struthers-Dunn Relay aids in economizing complex industrial panels that are "over relayed" with larger, more costly contactor type units. These small — low power — low cost units feature: physical size — 1½" wide x 2¾" deep x 2½" high exclusive of octal plugs; plastic enclosed for mechanical protection.

Stock types: DPDT plus 1 normally open and 1 normally closed contact on a 12-pin plug; DPDT on octal plugs; DPDT plus 2 normally open contacts on 12-pin plugs; AC or DC operating coils; 10-ampere contacts;

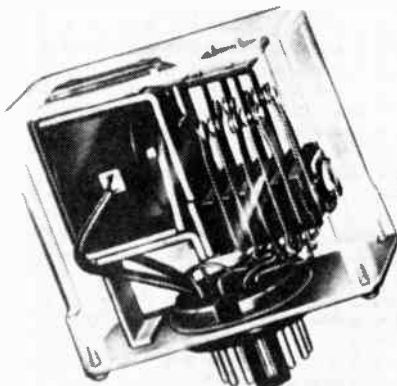

minimum of 1,500 volts AC dielectric test; 20 million operations mechanical life.

For further information write to: J. R. Longstaffe Co. Ltd., 300 Campbell Avenue, Toronto, Ontario.

Meter for automatic noise figure measurements

Item 2301

A new noise figure meter, which automatically measures the noise figure of amplifier and microwave receiver systems, is now available from the Hewlett-Packard Company.

The instrument, Model 340A Noise Figure Meter, enables semi-skilled personnel to make quick and accurate noise measurements and to adjust receivers and components for optimum performance. Receiver performance can be improved with the 340A over the best adjustment previously possible.

Model 340A provides direct noise figure readings in db, needs no periodic calibration and operates over any frequency range for which there are noise sources. Receiver ranges from 2.6 to 18.0 KMC are covered with Hewlett-Packard's Model 347A Waveguide Noise Source. For IF amplifier measurement, the company provides Model 345A IF Noise Source operating at either 30 or 60 MC.

With the IF noise source, the instrument reads noise figure from 0 to 15 db with an accuracy of ± ½ db. With the waveguide noise source, it reads from 10 to 25 db

with an accuracy of ± ½ db, and from 3 to 30 db with an accuracy of ± 1 db.

In addition to its usefulness in optimizing receiver performance, Model 340A is particularly helpful in designing circuit components such as IF amplifiers, crystal mixing circuits and traveling-wave tubes.

Additional information available from the exclusive Canadian Representative, Atlas Instrument Corporation Ltd., 50 Wingold Ave., Toronto 19, Ontario.

Delayed pulse and sweep generator

Item 2302

This new versatile pulse generator, designed to meet the need for a comprehensive instrument covering a wide range of pulse work, provides four main

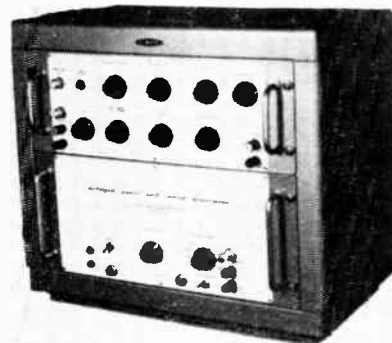

facilities: 1. A pre-pulse of fixed width and amplitude; 2. The main pulse of variable width, amplitude and polarity delayed on the pre-pulse by a variable time; 3. A negative — going sawtooth (sweep) coinciding with the main pulse; 4. A cable formed pulse derived from the main pulse.

The instrument is eminently suited to research measurement and testing in such fields as radio navigation, radar, television, electronics, nucleonics, computers, telemetering, physiological research and many others.

Manufactured by Dawe Instruments Ltd., London, England and available from Cossor (Canada) Ltd., 72 Grenville St., Toronto 5, Ontario.

Inertia-damped servomotor

Item 2303

Helipoint Division of Beckman Instruments, Inc., represented by R-O-R Associates Ltd., 1470 Don Mills Road, Don Mills, Ontario, has come up with a sure cure for the servo designer's headache . . . the Beckman Size 8 Inertia-Damped Servomotor. It is a pill-size unit (2 ounces, 1.355 inches long) specifically designed for acceleration and deceleration damping in subminiature systems without loss in steady state velocity.

Damping in Model 8 IM 420 is provided by the viscous friction induced by the magnetic coupling of a low inertia drag cup to a freely rotating magnet flywheel. The result: the same upper corner frequency improvement offered by AC notching filters or DC lead-lag networks.

Design of this inertia-damped servomotor permits use of a rotor which has an inertia of only 0.24 gm.cm.². Combined with the comparatively high stall torque of 0.25 oz. in. this produces acceleration at stall of 73,500 rad/sec.². As a result of this swift, sure response to input signal, upper corner frequencies approaching 45 cycles per second are attained.

No-load speed is 6,000 rpm; flywheel inertia is 2 gm.cm.², and the flywheel damping factor is 40 dyne-cm-sec/rad. Power input is 2.6 watts per phase.

Model 8 IM 420 has a stainless steel case, shaft and bearings, and all windings are completely encapsulated for positive protection against temperature extremes, humidity and vibration. Units are available within 30 days of order.

Write R-O-R Associates, Ltd., 1470 Don Mills Road, Don Mills, Ontario.

News Report

A monthly roundup of news and personnel changes in the Canadian electronics industry

Northern Electric plant for London, Ontario

The Northern Electric Company Ltd. of Montreal announced recently that a contract in excess of \$3 million had been placed for the construction of a manufacturing plant and office some five miles south of the business district of London, Ont. Construction will commence immediately with completion scheduled for early 1960.

In this plant the company plans to manufacture telephone sets of all types, including the various new colored sets, as well as other lines of associated products. The plant is being established to provide for the expanded manufacturing operations of the company and, when operating at capacity level, will provide employment for approximately 1,000 people.



J. R. Houghton

J. R. Houghton, assistant works manager of the communications equipment division of Northern Electric Company, Limited, has been given the additional appointment of manager of the company's plant at London, Ontario.

Born in London, Ont., Mr. Houghton was educated in Montreal and graduated from McGill University with the degree of B.Eng. mechanical engineering. He joined the company in 1935 as an engineer in the telephone division at Shearer Street.

Mr. Houghton, who has held various supervisory positions with Northern Electric since 1943, was appointed assistant works manager in 1958.

New Calgary office for Dominion Sound Equipments

The Calgary district sales office of Dominion Sound Equipments Ltd. is now located in its new premises (office and warehouse) at 731-10th Ave. S.W.

According to W. F. Graham, district manager, the larger premises were urgently needed to keep pace with the rapid growth of their business in the Calgary area.

Capacitor and resistor manufacturer appoints sales reps

The Arrow Radio Company of Toronto, through W. Clelland, has recently announced the appointment of Douglas Randall (Canada) Limited of 126 Manville Road, Scarborough, Ontario, as its exclusive Canadian sales representatives.

LENKURT ELECTRIC COMPANY APPOINTMENTS



H. R. HERRON

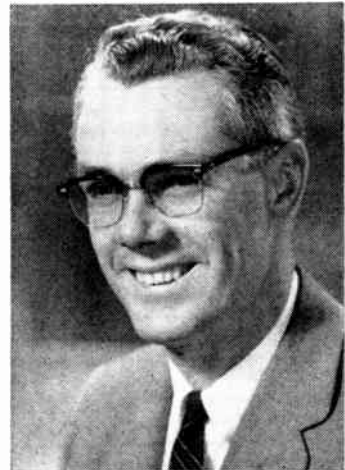

T. D. CUSHING

C. W. Hunter, vice-president and general manager of Lenkurt Electric Co. of Canada, Ltd., Burnaby, B.C., announces the appointment of H. R. Herron as Marketing Manager, and T. D. Cushing as Engineering Manager.

Mr. Herron, a U.B.C. graduate, and member of the AIEE, served in the R.C.A.F. during World War Two, and was formerly employed in the engineering department of C.N. Telegraphs. At Lenkurt, he assisted with formation of the Test and Quality Control Departments. He was appointed Manager of Quality Control and Instrumentation early in 1956, and served as Manager, Sales Engineering, from June, 1957, until his present appointment.

Mr. Cushing, whose new position was recently created at Lenkurt, studied at U.B.C., and is a member of the Institute of Radio Engineers. His experience includes eight years with Northwest Telephone Co., Vancouver, where he was responsible for major radio engineering projects, including the B.C. portion of the Trans-Canada TD-2 System. He was formerly with Electronic Laboratories of Canada and National Research Council. He joined Lenkurt in 1957, and prior to coming to Vancouver, was Applications Engineering Manager at the plant of the parent company in San Carlos, California. He will direct engineering of multi-channel carrier and microwave systems and related equipment manufactured and marketed by the firm throughout Canada.

Temperature Testing | MADE EASY



The cabinet is constructed to Canadian Military Electronics Standards Agency testing requirements for constant temperature operation over the range of minus 50°C to plus 100°C and will maintain its temperature within plus or minus 1°C once equilibrium is reached. The unit is simple to use and easy to maintain. It can be mounted in a fixed location or on a mobile base.

SPECIFICATION SUMMARY

Temperature range of operation: —50°C to +100°C.
Temperature regulation: ±1°C.
Overall dimensions: 38" x 22" x 30" (excluding base).
Specimen chamber: 14" x 19" x 13".
Heat-cool chamber: 14" x 8 1/2" x 13".

Thermal regulator: DeKhotinsky, manual adjust type.
Control relays: two Cansfield, type J11.
Thermal protection: fusible link for 150°C.
Power supply: 110V, 60 cycle, maximum demand 1200 watts.
Net weight: 255 lbs.

McPHAR MANUFACTURING LIMITED
139 BOND AVENUE DON MILLS, ONTARIO

For complete details check No. 101 on handy card, page 95

ULTRASONICS

CLEANERS
WELDERS
EMULSIFIERS
DELAY LINES
FILTERS
BRAZERS
TRANSDUCERS
SOLDERING
NON-DESTRUCTIVE TESTING

TranSonic Limited

McMaster Avenue
Ajax, Ontario
Ajax 1510

For complete details check No. 124 on handy card, page 95

FIRST PERIODICAL IN THE ELECTRONICS INDUSTRY

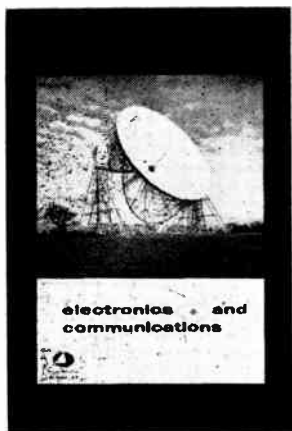

**MORE IMPACT
FOR YOUR
ADVERTISING**

*more of everything
in 1958 than the
second periodical
in the field*

- OVER 100% more advertising —
- OVER 100% more advertisers —
- OVER 18% more circulation —
- OVER 3 times more publishing experience
in the field —
- OVER 31% more technical articles —
- OVER 70% more New Product Reports —



Electronics and Communications
450 Alliance Ave., Toronto 9, RO. 2-7225

an age publication

BREAKTHROUGH!

VECTOR announces a new low-cost PROCESS TIMER

- Uses Dupont Mylar punched tape with indefinite life
- Continuous recycling — exact repetition
- Up to 24 hour cycle — 12 to 144 operations
- Unlimited variation of Process Timing
- Directly controls 1 kw loads
- Prototype now in successful operation in Dupont's Kingston plant
- Available in quantity within 5 weeks

For more information write or phone —

vector labs inc.

736 NOTRE DAME W., MONTREAL PHONE UN. 1-6552

DESIGN & MANUFACTURE OF INSTRUMENTS AND CONTROLS

For complete details check No. 127 on handy card, page 95

..... EMPLOYERS! FREE EMPLOYMENT SERVICE



THE HELP YOU NEED MAY BE AVAILABLE FROM RCC'S EXPANDED FACILITIES
AM-FM COMMUNICATIONS • RADIO OPERATING
TELEVISION • ELECTRONICS • RADAR • MICROWAVE
PLEASE CALL, WRITE OR PHONE MR. HOBBS (COLLECT) ABOUT YOUR REQUIREMENTS

Radio College of Canada



86 BATHURST ST., TORONTO
TELEPHONE EM. 4-5176

SERVICE
ACROSS CANADA

3454 ST. DENIS ST., MONTREAL
TELEPHONE VI. 2-9458

For complete details check No. 111 on handy card, page 95

Telmag Grain - oriented strip wound cores for transformers and chokes



Available in frequency ranges from —
25 to 200,000 cycles per second.

Standard sizes up to 500 KVA.

Special sizes or requirements quoted on
application.

MECHRON ENGINEERING PRODUCTS LTD.

2437 KALADAR AVENUE

OTTAWA, ONTARIO

RE. 3-3855

For complete details check No. 99 on handy card, page 95

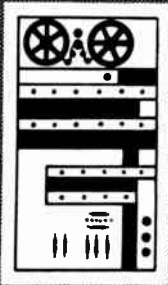

waste

Eight hours to set up an electronic computer. Three seconds for it to solve the problem. One computer component failure and you start all over. Sprague high reliability components are used in computers because they're least likely to fail.

SPRAGUE

**CANADIAN
MANUFACTURING
REPRESENTATIVE**

Micarta Fabricators
Limited
18 Toronto Street
Toronto, Ontario
Phone EMpire 8-4251

For complete details check No. 68

**PRECISION FREQUENCY
MEASUREMENTS...**
0.1 to 175 mc. At low cost!



**LAMPKIN 105-B
MICROMETER FREQUENCY METER**

- Heterodyne type, A.C. operated.
- Measures nearby transmitters, 100 KC to 175 MC (to 3000 MC by measuring multiplier stages of crystal-controlled transmitters).
- Accuracy better than 0.0025%. Reset-fability 0.0005%.
- Automatic correction for temperature of crystal calibrator.
- Pinpoint CW signal generator 20 MC to 200 MC.
- Size only 13" x 8 1/2" x 5". Weight 9 1/2 lbs.
- Price \$220.00 net (does not include duty).

Satisfaction guaranteed or money refunded.
For indication of FM deviation, up to 25 KC swing, at carrier frequencies from 25 to 500 MC, use the companion unit: the LAMPKIN 205-A FM MODULATION METER.

Write today for technical data on both instruments.

LAMPKIN LABORATORIES, INC.
Dept. 707, Bradenton, Florida, U.S.A.

For complete details check No. 94

**Automatic Electric Co.'s
technical training program**

Available to the technical personnel of every Canadian telephone company, a training course is offered free of charge by the Automatic Electric Company of Northlake, Illinois, U.S.A.

The 11-week course of training in "Maintenance and Operation of Strowger Automatic Telephone Equipment" is twofold in purpose — maintenance of apparatus in central office equipment and electrical circuitry of central office equipment. The train-



ing includes actual work on the latest types of linefinders, selectors and connectors used in the automatic switching of dial telephone calls, as well as classroom and laboratory instruction in the trunking and circuitry by which calls are routed between offices and exchanges, electrical power sources for operating various automatic mechanisms and other subjects related to automatic telephone exchanges.

Signalman Kenneth J. Stamp, Alberta Signal Squadron, Royal Canadian Corp of Signals, shown in the picture, makes an operation test of a step-by-step connector switch in Automatic Electric Company's training school central office at Northlake, Illinois. Stamp recently completed an 11-week course of training on "Maintenance and Operation of Strowger Automatic Telephone Equipment" at the Northlake plant and technical center.

**Vancouver manager of
CNT appointed**

Harry Mills, for many years a well-known figure in the communications field in Western Canada, has been appointed Vancouver manager of Canadian National Telegraphs, succeeding Robert I. Bradley, retired on pension.

Mr. Mills joined the railway in 1923 as a clerk in the freight depart-

Hartford **THE STATES COMPANY** Conn., U.S.A.

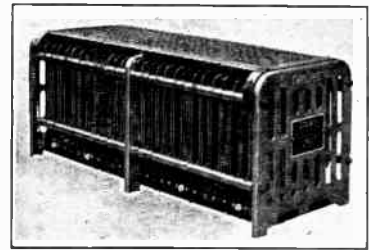

OHM-SPUN RESISTOR
Dummy Antenna—Heater Units
Wide Variety of Ohmic and
Wattage Ratings

PHASE SHIFTERS

Phase Displacement continuously from 0° to 36°.

Made in
50 — 200 —
300 — 500 —
1000 VA.

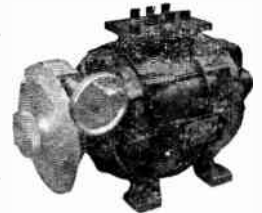

Canadian Representatives:
FILER SMITH CO. LTD.
503 Confederation Life Bldg.
WINNIPEG

IRVING SMITH LTD.
2095 Madison Avenue
MONTREAL

For complete details check No. 119

**AVOID TOWER LIGHTING
ISOLATION
TRANSFORMER TROUBLES**

INSTALL MODERN DESIGN

- ... by HUGHEY & PHILLIPS, Inc
- ... your most dependable source of Obstruction Lighting Equipment
- ... the widest selection of Control and Alarm Apparatus in the Industry.

FEATURING:

- HIGHER EFFICIENCY
- IMPROVED REGULATION
- ADDITIONAL TAPS
- FIBER GLASS INSULATION
- EPOXY ENCASED
- VERSATILE MOUNTING

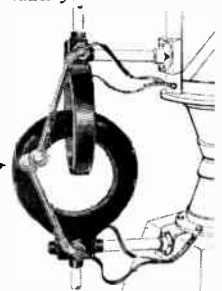

THREE SIZES . . . 750, 1750, 3500 WATTS

Essential wherever 60 cycle power must be transferred efficiently across two points with very low capacitance or at very high voltages.

In CANADA: **BEECHY ENTERPRISES**
1162 Main St. North — Toronto 15, Ontario
Request Descriptive Bulletin HPS-152

HUGHEY & PHILLIPS, INC.

MANUFACTURERS OF
300MM Beacons, Obstruction Lights, Photo-Electric Controls, Beacon Flashers, Special Junction Boxes, Microwave Tower Light Control and Alarm Systems, Tower Isolation Transformers, and Complete Kits for: Tower Lighting, Sleetmelter Power and Control.

3200 N. San Fernando Blvd. Burbank, Calif.

For complete details check No. 85

**750 MILS TO 55°C
100 TO 600 PIV**

Tarzian F SERIES SILICON RECTIFIERS

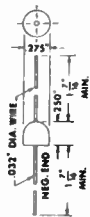

- Positive Environmental Seal
- Extra Heavy Duty Junction
- Low Cost
- Axial Leads (No Heat Sink)
- Low Forward Drop
- Low Reverse Current

AMPERES D.C. (100°C)	PEAK INVERSE VOLTAGE	TARZIAN TYPE	MAX. RMS VOLTS	MAX. RECURRENT PEAK AMPERES (100°C)	MAX. SURGE AMPERES 4MS
0.75*	200	F-2	140	7.5	7.5
	400	F-4	280	7.5	7.5
	600	F-6	420	7.5	7.5

*.75A to 55°C, .5A @ 100°C.

Tarzian H SERIES SILICON RECTIFIERS

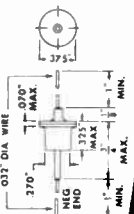

- Hermetically Sealed (Double Seal)
- Heavy Duty Junction
- Low Cost
- High Efficiency
- Axial Leads
- Low Forward Drop
- Low Reverse Current

AMPERES D.C. (100°C)	PEAK INVERSE VOLTAGE	TARZIAN TYPE	MAX. RMS VOLTS	MAX. RECURRENT PEAK AMPERES (100°C)	MAX. SURGE AMPERES 4MS
0.75*	100	10H	70	7.5	7.5
	200	20H	140	7.5	7.5
	300	30H	210	7.5	7.5
	400	40H	280	7.5	7.5
	500	50H	350	7.5	7.5
	600	60H	420	7.5	7.5

*.75A to 55°C, .5A @ 100°C.

Write for design notes No. 30 and 31

SARKES TARZIAN, INC.
RECTIFIER DIVISION
Dept. EC-2, 415 North College Ave.
Bloomington, Indiana

In Conada: 700 Weston Rd., Toronto 9, Tel. Roger 2-7535
Export: Ad Auriemo, Inc., New York City

For complete details check No. 115
ELECTRONICS AND COMMUNICATIONS. March, 1959

ment at Regina, transferring to the communications department the following year. After a brief break in service, he returned to the company in 1927 and served at various other points in Saskatchewan.

Mr. Mills was appointed manager at Fort William, Ontario, in 1932 and subsequently held similar posts at Regina and Calgary before moving to Vancouver in 1952 as assistant manager.

Amphenol Canada appoints general manager

J. E. Partridge has been appointed general manager of Amphenol Canada Limited, as announced recently by



J. E. Partridge

J. R. Longstaffe, president of the company.

Mr. Partridge, who is in charge of sales, joined the company in 1954 when Amphenol Canada Limited was first formed. At that time he was in charge of setting up all Canadian manufacturing facilities of this company. Prior to 1954, Mr. Partridge had spent several years with the Ontario Hydro as a supervisor in the 60 cycle conversion program.

ARNOLD

MAGNETIC MATERIALS

*The most complete line
in the industry*



TAPE WOUND CORES
of high-permeability materials

SILECTRON C, E & O CORES

MO-PERMALLOY POWDER
CORES

IRON POWDER CORES

BOBBIN CORES

SENDUST CORES

ALNICO MAGNETS,
CAST or SINTERED

SPECIAL MAGNETIC
MATERIALS

**THE ARNOLD ENGINEERING
COMPANY, MARENGO, ILLINOIS**

SPECIALISTS IN MAGNETIC MATERIALS

★ ★ ★

Canadian Representative:

BAYLY ENGINEERING LIMITED

Hunt Street, Ajax, Ontario
Phone: Empire 2-3741 (Toronto Exchange)

For complete details check No. 46

TELEVISION TUNERS

Switch Type
Licencee of Sarkes-Tarzian Inc.

HERMETICALLY SEALED RELAYS

Licencee of Filtrors, Inc.

WIRE WOUND RESISTORS
Cement and Vitreous Enamelled
Coatings - MIL Approved

TUNING CAPACITORS AND TRIMMERS

Radio Tuning Types - Special
Units For Military Application

LOUDSPEAKERS
Domestic and Military Types
**LEDEX ROTARY
SOLENOIDS AND
SELECTOR SWITCHES**

**PERMEABILITY TUNERS
PRECISION GEARS AND
GEAR TRAIN ASSEMBLIES
SERVO MECHANISMS
MICROWAVE
COMPONENTS**

ALL SYSTEMS
AND
COMPONENTS
ENGINEERED

TOOLED AND
MANUFACTURED IN
OUR KITCHENER
PLANT



**marsland
ENGINEERING
LIMITED**
KITCHENER, ONT., CANADA

For complete details check No. 97

Prizewinning students announced at IRE — AIEE meeting

The Institute of Radio Engineers and American Institute of Electrical Engineers held a student papers competition at their annual joint meeting on February 12.

First cash prize was awarded to P. V. Ozawa, a graduating student at the University of Toronto, who gave an excellent paper on "Multi-Channel Communication by Pulse Code Modulation".

Other prizewinners were: 2nd — A.

J. Alcock — Hall Effect Applications of Semi-Conductors; 3rd — B. C. LeBer — Racetrack Odds Computer; 4th — J. H. Gibson — Protective Relaying of Transmission Lines.

Judges of the students' papers were: George Floyd, Ken MacKenzie, Clive Oakes and Bruce Ross.

Assembly Products, Inc. appoints Canadian rep

Aeromotive Engineering Products, Ltd., Pointe Claire, Montreal, Quebec, has been appointed exclusive sales representative in Canada for Assembly Products, Inc., manufacturer of sensi-

tive instruments and controls, Chesterland, Ohio.

Aeromotive will stock the most popular models of API meter-relays and panel meters, and will also handle repairs for Canadian customers. Besides its main office and factory at 147 Hymus Blvd., Pointe Claire, Montreal 33, Aeromotive has a sales office at 1912A Avenue Road, Toronto.

Arden C. Boland is president of Aeromotive Engineering Products.

Northern Electric Co. makes sales appointment

D. K. Atkinson has recently been appointed sales manager of the eastern zone of Northern Electric Company, Limited.

Joining the company in 1930, Mr. Atkinson had experience in commercial engineering and in telephone



D. K. Atkinson

sales before becoming illumination manager in the sales department in Montreal. Later he served as business manager and supervisor of naval electrical equipment in Toronto. Returning to Montreal in 1942, Mr. Atkinson was successively appointed government sales service manager in the special products division, assistant to the sales manager and sales manager of the electronics division, and market research and export manager of the sales division.

In 1951 Mr. Atkinson went to Winnipeg as district sales manager in the mid-western district, becoming assistant district manager in 1955, district manager in 1957, and assistant zone manager later in the same year.

Former Canadian appointed by Robertshaw-Fulton Controls

W. J. (Jim) Chadburn, has recently been named manager of field operations, electronics, at the Aeronautical and Instrument Division, Robertshaw-Fulton Controls Co., according to an announcement by R. H. Heller, general sales manager of the Anaheim, California, firm.

Prior to becoming a United States citizen, Mr. Chadburn was with the Department of Transport, Dominion Government of Canada, as a technical assistant.

For approximately ten years before joining Robertshaw-Fulton Controls Co., Mr. Chadburn was engaged in industrial engineering representation and consumer sales with General Electric Co.

YOUR PROBLEM

*may already have been
solved by*

MEASUREMENT ENGINEERING LIMITED

Measurement Engineering Limited is a highly integrated organization specializing in the design, development, and production of any equipment in any division of Communications, Nucleonics, and Industrial Measurement and control.

The accent throughout our entire operation is placed on quality. For this reason we do not manufacture anything on a mass-production basis. Every piece of M.E.L. equipment — whether we build one or up to 1000 units — can be counted on to give many years of dependable, trouble-free service!

The same adaptable facilities and highly skilled staff that are frequently selected for contract work by the Armed Services, various Government agencies, Atomic Energy research establishments, and numerous industrial firms, are placed entirely at your disposal.

Whether your problem is just an idea (no matter how impracticable it looks), a piece of prototype equipment, or in a complete specification, M.E.L. engineers are ready now to discuss, develop, and completely engineer it into an efficient functional unit. Whatever your problem, we would like to talk it over with you.

Measurement and Control Equipment for Industrial Automation

**MEASUREMENT
Engineering Limited**



HEAD OFFICE AND PLANT, ARNPRIOR, ONTARIO

MONTREAL: Phone GR. 3-9198, P.O. Box 1352, Postal Station "O"
TORONTO: Phone HU. 1-0231, 1969 Avenue Road, Toronto, Ontario

5909

For complete details check No. 98 on handy card, page 95

specializing in custom built RELAYS

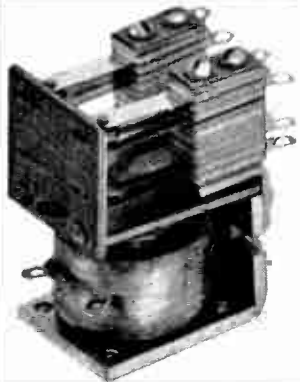

"Made in Canada"

"OSBORNE'S new general purpose relay, Type F, features multiple contacts, rugged dependability, low cost, and made to C.S.A. specifications. Available in all standard coil voltages, either a.c. or d.c. and with standard contact arrangements from SPST to 4PDT rated eight amperes.

A truly Canadian operation to design, develop, manufacture entirely within our own plant, multiple pole leaf or keying relays, telephone type, R.F. switching, dynamotor starting, time delay, power, hermetically sealed and co-axial relays. All custom built from standardized component parts to suit your specific needs."

Manufactured by

OSBORNE ELECTRIC COMPANY LTD.

95 WESLEY STREET TORONTO 18, ONT.

SPECIALIZING IN CUSTOM BUILT RELAYS

For complete details check No. 105 on handy card, page 95

FREE! 350 page catalogue

Canada's most complete Buying Guide to electronic equipment for Industry, Communications and Research. Thousands of items listed, illustrated and indexed in this complete reference catalogue. Our experienced staff is always ready to serve and assist you in the selection of the right equipment for your special needs at either of our locations.

Ample free parking.

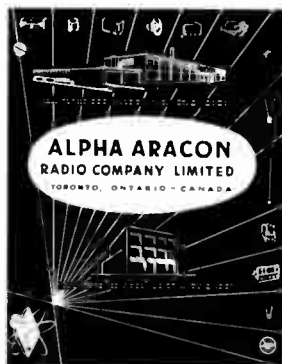

Name

Company

Address

City Prov.

ALPHA ARACON RADIO COMPANY LIMITED

555 Wilson Avenue, Downsview, Ontario.

Branch Office: 29 Adelaide St. W., Toronto

For complete details check No. 39 on handy card, page 95
ELECTRONICS AND COMMUNICATIONS. March, 1959

0.25% Linearity now standard in Model A Helipots

0.25% linearity and 3% resistance tolerances now standard in values between 100 ohms and 100K. Other resistances are 0.5% linearity and 5% tolerance.

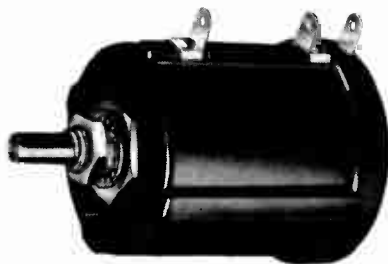

STANDARD VALUES	
25 ohms	5K ohms
50 "	10K "
100 "	20K "
200 "	30K "
500 "	50K "
1000 "	100K "
2000 "	200K "
	300K "

Prices FOB Toronto or Montreal

Model A Helipot \$12.50

RB Duodial 7.20

sales tax extra

Substantial quantity discounts

Model A pots can be supplied with linearity to .05% and in any value between 10 ohms and 450K. Taps and ganged sections also available.



Phone or Write For
Complete Catalogue.

R-O-R ASSOCIATES LIMITED

1470 DON MILLS RD., DON MILLS, ONT.

TORONTO
HICKORY 4-4429

TELEPHONE

MONTREAL
HUNTER 1-0700

For complete details check No. 114 on handy card, page 95

Canadian broadcast consultants form group

At an Ottawa meeting held during the first public hearings of the new Board of Broadcast Governors, an association of broadcast consultants was formed, consisting of those engineers accredited by the Department of Transport. To be known as the Canadian Association of Broadcast Consultants, the group will have, for the first time, a single voice in Canadian radio and television affairs. W. B. Smith of the Department of Transport was present at the inaugural meeting.

The prime reason for the formation of the new group is that, up to the present, the consultants, while bound to proceed under the rules and regulations of DOT specifications, were powerless to request modernization of the regulations. Only through recommendations of the Canadian Radio Technical Planning Board can DOT change its specifications, and by formation of the association the consultants now can serve on and advise the CRTPB. Some of the arbitrary limits set on the broadcaster's operation have proved to be stumbling blocks in the design of new stations, or in changes of facilities.

Westinghouse announces rebuilt picture tube line

Canadian Westinghouse has announced it will offer a restricted line of factory-rebuilt and tested television picture tubes, in addition to the existing premium "Luma-Ray" line. The rebuilt tubes will be made from reclaimed glass envelopes and subject to the same manufacturing processes and rigid quality control tests as the company's premium picture tubes. They will also carry the same one year warranty, as new tubes.

In making the announcement, which will reach consumers through the company's nationally televised TV show, A. A. Peters, marketing manager, Electronic Tube Division, said: "The public will now have an opportunity to purchase Westinghouse factory-rebuilt tubes at much lower prices than a brand new picture tube. A careful analysis of the replacement tube market has revealed a demand for less costly rebuilt tubes. We will now make available to our jobbers, dealers and the public a factory-rebuilt tube that carries the Westinghouse name and warranty. The rebuilt line, designated the 'Budget Line', is limited to 27 tube types in the 14, 17, 20, 21 and 24-inch sizes".

The "Budget" tube will be clearly marked and the warranty card which accompanies every Westinghouse picture tube will indicate to the customer that the tube is factory-rebuilt.

Appointments by Canadian National Telegraphs

Two appointments in Canadian National Telegraphs' personnel and accounting departments have been announced recently by John R. White, general manager.

K. B. Cockhill, former personnel assistant, Toronto, has been named general personnel assistant. W. H. Barton, former schedule analyst, Toronto, has been appointed wages supervisor.

Mr. Cockhill joined CNT in the personnel department at Montreal in 1947. He came to Toronto in 1957 as personnel assistant, a position he has held until his present appointment.

Mr. Barton joined the company at Moncton and held various positions in the superintendent's office there before transferring to Toronto in 1946 as statistician, later as schedule analyst.



BOHNE SPRINGS IN QUANTITY

CAPACITY 660,000 PIECES PER SINGLE SHIFT

PRECISION MECHANICAL SPRINGS

WIRE SPRINGS

CLIPS

FLAT SPRINGS

FORMINGS

MULTI-SLIDE FORMING MACHINE PRODUCTS

LIGHT PRESS WORK

*Prompt quotations given from blueprints,
specifications or samples*

BOHNE SPRINGS

INDUSTRIES LIMITED

1153 QUEEN STREET WEST, TORONTO 3

WANTED

Electrical Engineer, for design of electronic supervisory control systems. Must have experience in or with Canadian power utilities. For new company.

Box 5010

Electronics and Communications
450 Alliance Avenue, Toronto 9, Ont.

For complete details check No. 56 on handy card, page 95

Complete Range of **VARIABLE COMPOSITION RESISTORS**

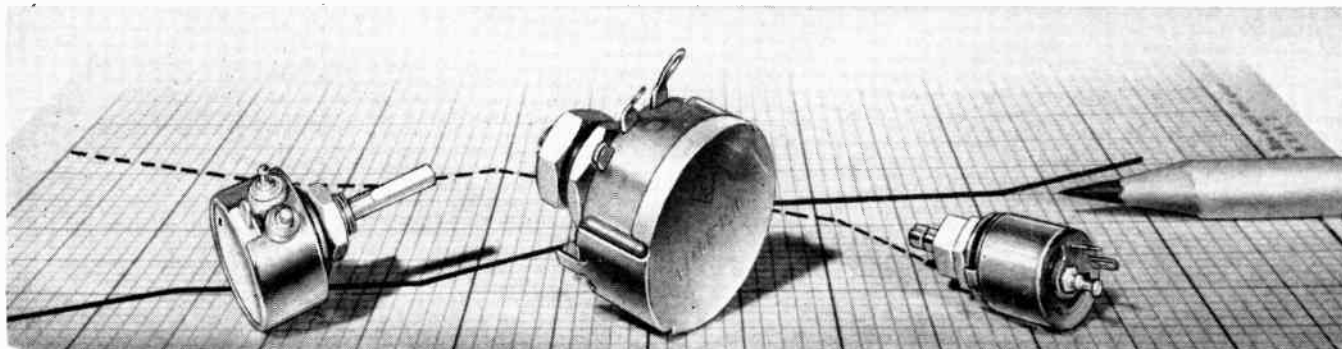

2 Watt
(Type R.A.)

3 Watt
(Type V.G.)

1/3 Watt
(Type S)



Type: T & U
3/8" Dia.

Types "L" and "RA" are available at:

Alpha Aracon Radio Co. Ltd., Toronto.
Payette Radio Ltd., Montreal.
Wackid Radio TV Lab. Ltd., Ottawa.

MANUFACTURED ENTIRELY IN CANADA BY:

COMPLETE ENVIRONMENTAL TEST LABORATORY



PRECISION ELECTRONIC COMPONENTS (1959) LTD.

50 WINGOLD AVE., TORONTO, ONTARIO. RU. 1-6174

For complete details check No. 108 on handy card, page 95

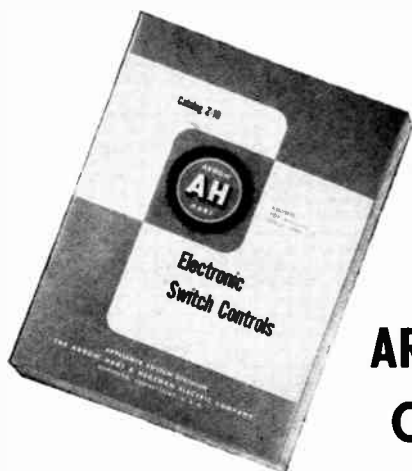

NEW ARROW-HART CATALOGUE

of Electronic Switch Controls (No. Z-10)

for electronic, radio, appliance,
motor and military applications.

SEND FOR YOUR FREE COPY NOW!



ARROW-HART & HEGEMAN (CANADA) LIMITED
Industry Street, Toronto 15, Ontario. Phone RO. 2-1101
7365 Mountain Sights, Montreal, Quebec.

Representatives: Cochrane Stephenson (Western) Ltd., Winnipeg, Calgary,
Edmonton, Vancouver • George C. Robinson, Saint John, N.B.

QUALITY MOTOR CONTROLS • WIRING DEVICES • APPLIANCE SWITCHES
5905

For complete details check No. 47 on handy card, page 95
ELECTRONICS AND COMMUNICATIONS. March, 1959

OUR SPECIALTY . . . Industrial Electronic Parts

- SIGMA RELAYS • GRAYHILL SWITCHES
- SOLA TRANSFORMERS • GUARDIAN RELAYS
- CANNON PLUGS • OHMITE RESISTORS
- SUPERIOR POWERSTATS
- LICON SWITCHES • GENERAL TRANSISTOR
- HAMMOND TRANSFORMERS

LARGEST INDUSTRIAL TUBE STOCKS

CESCO carries one of the largest assortment of Industrial Tubes in Canada. A complete and varied range of type numbers is available at all times from our stocks. Special LOW PRICES available on many items. Send in your tenders so that we may quote on quantity prices. Full information and prices on request.

FREE! Write in for your FREE copy of
"Industrial Tube Replacement and
Cross Reference Guide."

WHOLESALE DISTRIBUTORS

Canadian Electrical Supply CO. LTD.

MONTREAL: 275 Craig St. West Tel. UN. 1-2411
MONTREAL: 1534 Jarry St. East Tel. RA. 9-5251
QUEBEC: 128 Rue St. Vallier Ouest Tel. LA. 4-3518
OTTAWA: 838 Somerset St. West Tel. CE. 2-2696
TORONTO: 877 Yonge St. Tel. WA. 1-5111

For complete details check No. 62 on handy card, page 95

Soldering is **EASIER FASTER BETTER** with American Beauty Soldering Tools

American Beauty electric soldering irons are the highest quality made. The finest engineering, best materials and on-the-job experience since 1894 is yours with every American Beauty. There is a right model, correct tip size and proper watt input to do any soldering job easier, faster and better.

TEMPERATURE REGULATING STANDS

Automatic devices for controlling tip temperatures while iron is at rest—prevents overheating of iron, eliminates frequent retinning of tip, while maintaining any desired temperature. Available with perforated steel guard to protect user's hand.



201-B

NO. 3125
¼" TIP
60 WATTS



NO. 3138
¾" TIP
100 WATTS



NO. 3158
¾" TIP
200 WATTS



NO. 3178
¾" TIP
300 WATTS



NO. 3198
1¼" TIP
550 WATTS

WRITE FOR 20-PAGE ILLUSTRATED CATALOG CONTAINING FULL INFORMATION ON OUR COMPLETE LINE OF ELECTRIC SOLDERING IRONS—INCLUDING THEIR USE AND CARE.

AMERICAN ELECTRICAL HEATER COMPANY

DETROIT 2, MICHIGAN



For complete details check No. 40 on handy card, page 95

4th annual IRE Canadian Convention and Exposition

The fourth annual IRE Canadian Convention and Exposition will be held in the Automotive Building, Exhibition Park, October 7, 8 and 9, Eric L. Palin, general chairman of the executive committee has announced.

The three previous IRE Canadian Conventions have been Canada's largest annual scientific events. Last year's event attracted over 10,000 scientists, engineers, technicians and business men and during its three-day Technical Program, 117 scientific papers were presented by Canadian, U.S. and overseas authors.

On the first day of the 1959 Convention a fall executive meeting of the IRE International will be held in Toronto. It will be followed on the second and third days by a board meeting of the organization. Twenty directors and officers, including the eight Regional Directors, are expected to participate in these executive sessions. A. P. H. Barclay, IRE Region 8 Director is making arrangements for the Toronto meetings which will result from the IRE International's acceptance of a long standing invitation from the Canadian Convention Committees.

Don K. Ritchie, chairman, Technical Program, is now inviting IRE members and other scientists to submit papers for possible use during the 1959 Convention. These may be on any subject in the fields of nucleonics and electronics. Interested authors should first submit in duplicate 500 word summaries of their papers to Mr. Ritchie at the IRE Canadian Convention Offices, 1819 Yonge Street, Toronto. One hundred word abstracts of papers are also required for use in printed booklets covering the Technical Program. At the 1958 Convention the scientific papers presented were in 23 categories ranging from medical and industrial electronics to cosmic rays and communications.

R. C. Mullaley promoted by Collins Radio Co.

Robert C. Mullaley, who joined Collins Radio in 1951 as a staff counsel, and became secretary of Collins Radio Company of Canada, Ltd. in 1955, has recently been elected assistant secretary of the Collins Radio Company of Cedar Rapids, Iowa, by the directors of that company. Subsequent to his Canadian appointment, Mr. Mullaley became director of sales administration of the International Division of Collins in 1956, and since early in 1958 has been assistant director of Collins' Texas Division in Dallas.

MICRO-MINIATURE precision wire-wound RESISTORS

fixed, noninductive

newly developed Kelvin "RELAXED WINDING" techniques practically eliminate resistance drift with age and "shorts" or "opens" due to thermal shock.



PLASTIC ENCAPSULATED SERIES "EP"

The 0.05W micro-miniature type EP-00 is .080" dia. x .325 long, 50K ohms max. resistance. Available with radial and axial lead wires. ALL CONNECTIONS ARE WELDED. High temperature epoxy plastic is used in an exclusive vacuum encapsulation process. Standard resistance tolerances to 0.1% (specials to 0.01%). Environmental temperature range: -65°C to +125°C.

CERAMIC SERIES "CB"

The 0.15W miniature type CB-05 is ¼" dia. x ¼" long, 500 K ohms max. resistance. Available with radial and axial lead wires, or lug terminals. Standard resistance tolerances to 0.1% (specials to 0.01%). Environmental temperature range: -55°C to +85°C.



Send for literature



Kelvin Electric Company
Van Nuys, California

Exclusive Canadian Distributor:
**CONWAY
ELECTRONIC ENTERPRISES**
1514 Eglinton Avenue West
Toronto 10, Ontario; RU. 3-6576

For complete details check No. 92 on handy card, page 95

CALVERT ELECTRONICS INC.

TUBES

Over One Million
TUBES
Always In Stock

RCA • KEN-RAD • SYLVANIA • CBS
WESTINGHOUSE • WESTERN ELECTRIC

RECEIVING TUBES IN LOTS OF 100

1A3	.19	6AF6G	.45	6SK7GT	.32	12SR7	.42
1L4	.19	6AG5	.35	6SJ7	.45	12X4	.32
1LD5	.30	6AJ6	.45	6SL7GT	.65	14A4	.35
1LH4	.40	6AM6	1.00	6SQ7	.48	14A5	.35
1LN5	.40	6BK7A	.67	6SS7	.45	14A7	.45
1R4	.50	6BQ7A	.79	6U7G	.25	14B8	.40
1T5	.50	6C4	.20	6ZY5G	.45	14J7	.35
1U4	.10	6C6	.24	7A4	.40	14N7	.35
1V2	.55	6C8G	.22	7A6	.25	14W7	.40
2A3	.59	6D6	.29	7A8	.35	24A	.35
2X2	.10	6F8G	.25	7AG7	.50	25Z5	.50
3A4	.45	6G6	.55	7F7	.55	30	.30
3Q4	.45	6H6GT	.15	7H7	.20	36	.25
354	.45	6J6	.35	7Q7	.50	38	.25
5U4G	.45	6J7G	.39	7W7	.39	41	.25
5V4	.77	6K7G	.15	7Y4	.35	46	.25
5Z3	.55	6K8G	.50	12C8	.29	76	.25
5Z4	.85	6SC7GT	.55	12L8GT	.29	77	.10
6AB7	.29	6SD7GT	.16	12BY7A	.60	78	.10
6AC7	.39	6SG7M	.55	12SF7	.15	84	.45
6AH6	.85	6SG7GT	.16	12SJ7	.45	89Y	.10
6AF4A	.79	6SH7GT	.15	12SK7	.44	91	.35

This is Only a Partial List of the Many Great Values Available.

CALVERT ELECTRONICS INC.
536 BROADWAY, NEW YORK 12, N.Y., U.S.A.

Write For Catalog
Cable Address: Calverton, N.Y. • Telephone: CAnal 6-7400

For complete details check No. 60 on handy card, page 95

To solder or weld any aluminum or zinc

CHEMALLOY

Improved Fluxless Aluminum Solder
and Welding Rod

Requires no flux, metal cleansing or physical shaping.

Solders foils, very thin gauge aluminum, potmetals and zinc.

Utilizes any heat source including torch, hot plates, stove burners, or soldering guns sufficient to melt 500, 600 or 800 deg. F. rod.

Personnel require no special skill or training to perform first class soldering or welding. It will not splatter or explode.

Machines - Polishes - plates. Lathe cuttings come off as fine powder which will not irritate or cut skin.

Antifriction properties permit it to withstand chafing or friction without appreciable heat rise. Can be used as a dry bearing metal without lubrication.

Withstands immersion and contact with liquids excepting the most violent chemicals.

Soft solder adheres to Chemalloy tinned surfaces to facilitate copper attachment to aluminum.

For more information write or phone —

PAYETTE RADIO LIMITED

730 St. James W. • UN. 6-6681 • Montreal

For complete details check No. 106 on handy card, page 95

USECO

Cut production costs, reduce inventory, lower terminal costs

with new **LOC-FIT** insulated & feed-thru **TERMINALS**

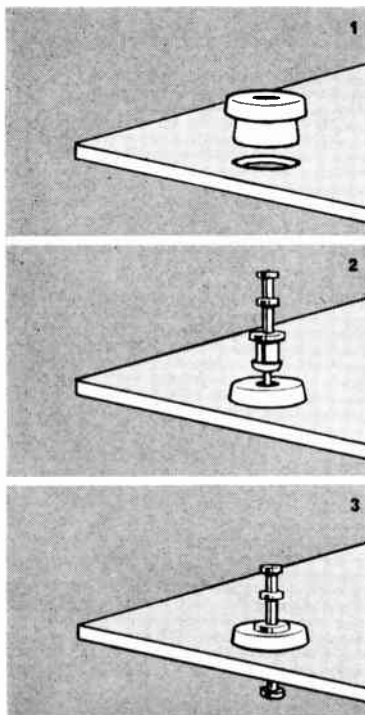

1. **PUSH TEFLON GROMMET INTO HOLE**—by hand or with available tooling. No precision tolerances, no counter-boring or de-burring operation needed with Loc-Fit terminals. **SAVE 40% ON CHASSIS PREPARATION!**

2. **INSERT LOC-FIT TERMINAL**—Any standard configuration of insulated or feed-thru terminal readily fits one of only two grommets. **DOWN GOES YOUR INVENTORY.**

3. **SNAP LOC-FIT INTO PLACE!** Positive lock is effected immediately. Teflon deformation around terminal base and chassis assures 18 to 20 pounds in-line pull strength. **GET HARD USAGE APPLICATIONS AT LOWER COST!**

TEST LOC-FIT YOURSELF! Request engineering Data Sheet and representative samples of Loc-Fit insulated and feed-thru terminals.



LITTON INDUSTRIES
U.S. ENGINEERING CO. DIVISION

5873 Rodeo Road, Los Angeles 16, California

In Canada — Lake Engineering Co. Ltd., 123 Manville Road, Scarborough, Ontario.

For complete details check No. 96 on handy card, page 95

**ADAPTABLE
FOR ALL
APPLICATIONS**

Hoyt Panel Meters



Model No. 661

New series for limited space installations. Front opening — 1½" class — 2% accuracy — standard mounting dimensions — front zero adjustment. In DC ranges from 100 microamps; and self-contained rectifier types, VU, and voltmeters up to 300 v.

Be sure of the highest accuracy, dependability, and readability — *plus economy* — with HOYT precision electrical instruments. Moving coil, rectifier, and repulsion types available in a wide variety of sizes, ranges, cases, and colors — many with parallax-free, mirror scales . . . the *complete* Line of matched AC and DC Panel Meters for original equipment or replacement use. Also, custom-designed (including 50-2000+ cycle applications) to meet your most rigid specifications.

Prompt Delivery — M/A Forms mailed on day of shipment.

Service Facilities — strategically located in Canada.



Write Export Manager — new illustrated literature contains descriptions, engineering data, and prices.



ELECTRICAL INSTRUMENTS

Sales Div.: BURTON-ROGERS COMPANY
42 Corleton Street, Combridge 42, Moss., U.S.A.

For complete details check No. 59 on handy card, page 95

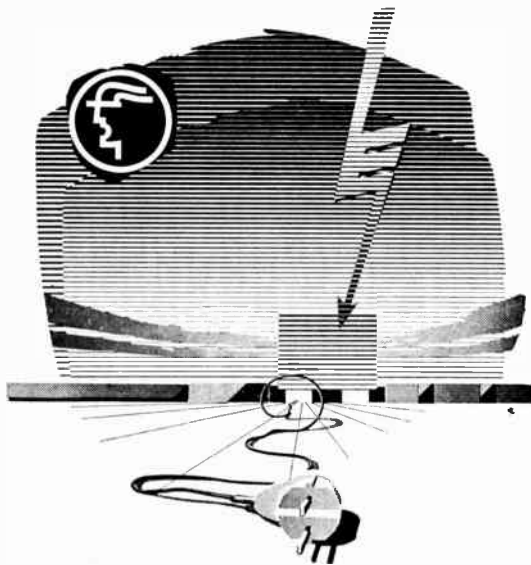

HANNOVER
the most important Market of the
ELECTRICAL INDUSTRY

for heavy equipment and consumer goods

GERMAN INDUSTRIES FAIR

APRIL 26 - MAY 5, 1959

Information and catalogues from:
The Trimont Corp. Ltd.,
1170 Drummond Street, Montreal, P.Q.
Encom Agencies (Dipl. Ing. George J. Bezdán)
Ste. 209, 1485 Davie St., Vancouver
Wilson Equipment Supply Co., Winnipeg
MacNutt Associate Industries Ltd.,
809 8th Avenue, Calgary

For complete details check No. 123 on handy card, page 95

for an entirely new
range of time delays

delay intervals:
 $\frac{1}{10}$ to 5 seconds

recovery rate:
extremely rapid



specify sturdy, thoroughly
field-tested

**G-V HOT WIRE
TIME DELAY RELAYS**

Series H

Over two years of successful field service in electronic, aeronautical and industrial equipment prove these new G-V relays to be dependable, efficient and accurate.

- Adjustable Delay even though hermetically sealed
- DC or AC of any frequency for energization
- Small and Light. ¾" diameter, 2¾" length. Weight: 1 oz.
- Wide Ambient Range compensated from -70°C to 100°C or higher
- Continuous Energization without damage
- Available in 7-pin Plug-in and Flanged designs



Write for Pub. No. 35 — engineering data and drawings

G-V CONTROLS INC.

LIVINGSTON, NEW JERSEY

Represented in Canada by:

LEONARD ELECTRIC, LTD., 346 Bering Ave., Toronto 18

For complete details check No. 80 on handy card, page 95

SCIENTIFIC STAFF

required for

**COMMUNICATIONS SYSTEMS
LABORATORY**

Research and Development Division

NETWORK DESIGN ENGINEER

to carry out the design of networks using modern synthesis techniques.

ELECTRONIC CIRCUIT DESIGN ENGINEER

to carry out the design of active networks using both electronic and semi-conductor devices.

Candidates should be professionally qualified with at least three years specialized design experience.

COLLEGE RELATIONS DEPARTMENT

Northern Electric

COMPANY LIMITED

P.O. Box 6123

MONTREAL

For complete details check No. 103 on handy card, page 95

Douglas Randall rep for Electronic Controls

Electronic Controls Limited of Belleville, Ontario, has recently announced the appointment of Douglas Randall (Canada) Limited, 126 Manville Road, Scarborough, Ontario, as its sales agents for Ontario and Western Canada.

Electronic Controls Limited manufacture industrial rectifiers, DC power supplies, DC braking equipment, magnetic amplifiers and specialized industrial electronic equipment.

Moldings Div. announced by H. K. Porter Company

A twelfth manufacturing division for expanding H. K. Porter Company, Inc., diversified industrial concern based at Pittsburgh, Penna., was announced recently by C. L. Holbert, president.

The new division, known as the Moldings Division, will manufacture and market the complete line of automotive and other metal moldings formerly produced by Herron-Zimmers Molding Company, whose plants at Detroit, Michigan, and Frankfort, Kentucky, were a recent acquisition of the Porter Company.

The 12 divisions of H. K. Porter Company, Inc. now operate 49 plants in the United States, Canada and Mexico.

Industrial Production Show Scheduled For May

The Canadian Industrial Management Association has joined three other technical societies in sponsoring the National Industrial Production Show of Canada, to be held in Exhibition Park, May 4th to 8th, next. They will hold a seminar in the building during the show with an address, among others, by a prominent speaker on the subject of "Principles Relating to the Replacement of Machine Tools and Industrial Equipment."

The Committee of the American Society of Mechanical Engineers headed by J. W. Miller have appointed a program committee, and will have a series of addresses with the general theme of "Productivity as Affected By Engineering." This will apply to various branches of industrial production.

In addition to Canadian and U.S. exhibits, different European governments and individual firms have booked space, so that interested buyers will be able to see in one place the latest improvements in machine tools and industrial equipment from different parts of the world.

MORE ACTIVE! EFFECTIVE!



THE BEST FOR TV-RADIO WORK . . . EVERYTHING ELECTRICAL—Kester "Resin-Five" Core Solder is better and faster than any solder ever developed. It has an activated flux-core that does a perfect job on all metals including zinc and nickel-plate. The flux residue is absolutely non-corrosive and non-conductive.

Available in all practical Tin-Lead Alloys; 40/60, 50/50 and 60/40 in diameters of $\frac{3}{32}$ ", $\frac{1}{16}$ ", $\frac{3}{64}$ ", $\frac{1}{32}$ " and others.

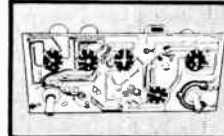

Printed Circuit Soldering
On Copper-etched boards use 60% Tin - 40% Lead Alloy . . . for those that are Silver-surfaced use 3% Silver-61½% Tin-35½% Lead

KESTER SOLDER COMPANY

OF CANADA, LTD., Dept. U

Brantford, Canada

For complete details check No. 93 on handy card, page 95

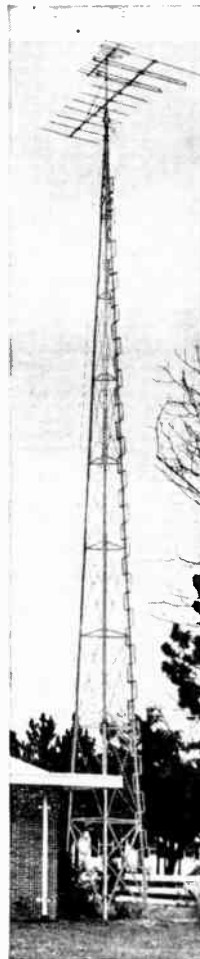

ANTENNA TOWERS

for TV—AMATEURS—COMMUNICATIONS

Check these features — they're found in all Aermotor Steel Antenna Towers.

SELF-SUPPORTING — no cumbersome guy wires needed.

HEAVILY GALVANIZED AFTER FABRICATION — completely protected against rust.

EASILY ASSEMBLED

STRONG — towers safely sustain loads of 1500 lbs. — safe in winds to 85 MPH.

← **TYPE MI-98**

For TV Antenna up to 6 square feet of projected area. Heights to 100'.

TYPE MP-5 →

For Amateur Beams up to 20 square feet of projected area. Heights to 97'3".

TYPE MP-9 (Not illustrated)
Meets "RETMA" Standard TR-116 Specifications. Heights to 123'5".

TYPE MP-15 (Not illustrated)
In heights up to 149' for heavy duty radio and TV applications.

TYPE MP-29 (Not illustrated)
In heights of 40 - 80 and 100' for heavy duty Microwave Antenna applications.

Write today for complete information on Aermotor Steel Antenna Towers and an Aermotor Franchise in your territory.

AVIATION ELECTRIC LIMITED

200 Laurentien Blvd., Montreal, P.Q.
Branch Plant: Aviation Electric Pacific Limited,
Vancouver Airport, Vancouver, B.C.

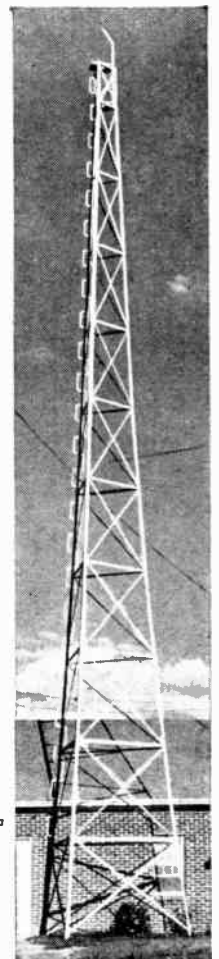

For complete details check No. 52 on handy card, page 95

ADCOLA
REGISTERED TRADE MARK
 (Regd. Trade Mark)

SOLDERING EQUIPMENT

*Illustrated
 The Adcola*

Cat No. 64
 (3/16 bit)

CSA APPROVED

*Designed for
 bench line
 production and
 continual use.*

•
 •
 •

Canadian, British
 & Foreign Pats.,
 Reg. Designs.



*Adcola
 Instruments
 operate at
 correct soldering
 temperatures
 ensuring
 permanent and
 quality joints.*

*Supplied in all
 volt ranges.*

•
 •
 •

*Canadian Sales
 and Service
 L. J. LAMB
 Box 103,
 Weston, Ontario*

For complete details check No. 38 on handy card, page 95

**Wound to
 Meet Your
 Prototype
 and
 Production
 Needs**

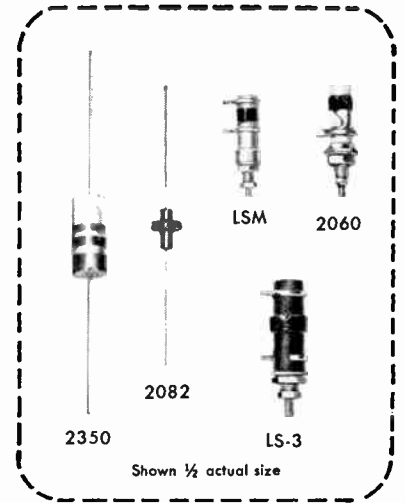

CAMBION® standard wound coils are available in types and sizes covering requirements in the broadest range of frequencies. Wound on ceramic or phenolic forms — vertical for conventional circuits and vertical and horizontal for printed circuits — many feature the Perma-Torq® tensioning device, which allows locking of tuning cores while still tunable. Special windings on shielded forms available to meet your needs.

Most prototype specifications can be filled from the broad CAMBION coil line. Unusual requirements can be handled by the widely-known CAMBION 0-8 Laboratory Coil-Development Department. And for your regular production, count on the same quality in any quantity. Another excellent aid for prototypes or lab experimenting is the CAMBION Coil Kit, containing 10 coil forms wound in overlapping inductance ranges from 2 μh to 80 μh. For complete details, write to Cambridge Thermionic of Canada, Ltd., 2425 Grand Boulevard, Montreal 28, P. Q.

For complete details check No. 61 on handy card, page 95

WRIGHT ELECTRONICS OF CANADA LIMITED ARE PLEASED TO ANNOUNCE THAT WE HAVE CHANGED OUR NAME AND TRADEMARK AND HENCEFORTH WE WILL MANUFACTURE THE SAME HIGH QUALITY ELECTRONIC COMPONENTS UNDER THE NAME OF

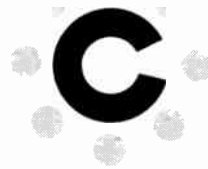

croven LIMITED
 628 KENT STREET • P.O. BOX 1420
 WHITBY • ONTARIO • CANADA

precision made quartz crystals and crystal ovens

ALWAYS SURE, DEPENDABLE TOP QUALITY AND PERFORMANCE ● EMERGENCY 24-HR. DELIVERY SERVICE
 SERVING THE MOBILE AND AIRCRAFT INDUSTRIES WORLD-WIDE ● MADE IN CANADA . . . BY CANADIANS

for complete satisfaction specify **croven LIMITED**

For complete details check No. 71 on handy card, page 95

Dietzgen of Canada opens coating plant

Eugene Dietzgen Co. of Chicago, manufacturers of drafting, surveying and print making supplies, has announced the formation of Dietzgen of Canada and the opening of a new coating plant and warehouse at 5304 Fifth Street, S.E., Calgary, Alberta.

Dietzgen of Canada will operate with H. S. Sandler, vice-president in charge of sales and marketing, directing all sales and marketing matters. W. C. Dietzgen is in charge of all plant operations.

The complete line of Dietzgen engineering and drafting instruments and supplies will be distributed throughout Canada through exclusive arrangements made with Riley Reproductions, Ltd. in the Western Provinces; Instruments (1951) Ltd. in the Eastern Provinces, and the W. J. Dick Company in Manitoba.

"Rapid technical and industrial developments in Canada are compelling factors in our decision to form Dietzgen of Canada", Mr. Sandler comments. "We have sold Dietzgen products in volume to Canadian customers for some time. Our Calgary coating plant and warehouse will significantly improve our customer service by insuring fresh stocks of sensitized materials coated in Canada as well as Dietzgen's extensive line of other products."

Eugene Dietzgen Co. has been a leading manufacturer of drafting, surveying and print making supplies for more than 75 years.

Ground approach control system for Gander airport

A Ground Control Approach system, installed as an additional safety factor for air operations, has been commissioned at Gander, Newfoundland, according to a recent announcement by the Department of Transport, Ottawa. The system will augment the already extensive establishment of radio aids to air navigation serving traffic at that airport.

The new system is operated by nine specially trained men of the Department's Air Traffic Control Division, certified in the use of "GCA". Maintenance is undertaken by five technicians of the Telecommunications Branch who have also undergone special training.

The new system was put to the test shortly after installation and it operated with complete success when a Trans-Canada Air Lines aircraft was forced to make a landing in blizzard conditions.



ALUMINUM COAXIAL TRANSMISSION LINES and COMPONENTS

Available now . . . rigid aluminum transmission line and components that comply fully with EIA and Military Specifications TR-134 and MIL-L-3890. The copper inner conductor is supported by Prodelin's patented reactance compensated teflon pin insulators; compensated anchor insulators are also used throughout.

The aluminum outer conductor provides strength and corrosion resistance together with lightness of weight and handling ease.

Available in sizes 1 1/2", 3 1/2", and 6 1/2" — 50 ohm impedance.

FOR MILITARY AND COMMERCIAL SERVICES

FEATURES

- Highest Power Handling
- Low VSWR
- Performs up to 250°C
- Corrosion Resistant
- Constant 50ohm Impedance
- High Tensile Strength
- Lightweight, Easy to Handle
- Minimum Maintenance Required

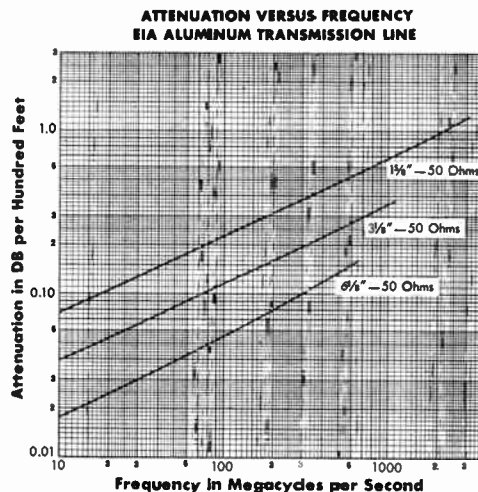

WRITE TODAY
FOR TECHNICAL BULLETIN 589



Dept. EC
307 Bergen Ave., Kearny, N. J.

Manufacturer of the World's Finest Air Dielectric Transmission Lines, Connectors, and Associated Components

See us at the IRE Show,
Booth 4534 — Coliseum, N.Y.C.

For complete details check No. 109 on handy card, page 95



Fast service is our business!

No, we can't get your orders out the day before yesterday.

Not that we don't try. We come very close to it sometimes.

But we *are* geared to fill all your requirements for Industrial Electronic and Electrical control components . . . fast!

If it is a stock item (and it usually is), we ship the same day. And if it is a special item, we take direct action to get it for you in a hurry.

Call WA. 4-9251 (if in Toronto) right now. It's the new direct line to our order desk.

It's your first step to fast service.

And fast service is our business.

ELECTRO SONIC
SUPPLY CO. LTD.
543 YONGE ST., TORONTO 5
WA. 4-9301



For complete details check No. 76 on handy card, page 95

80

SMOOTH AND PRECISE ELECTRONIC CONTROL



LIGHTING



MECHANICAL POWER

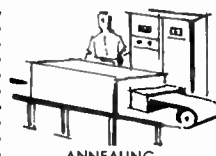

ANNEALING

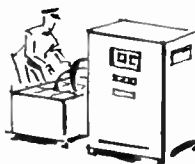

BATTERY CHARGING



CHEMICAL
PROCESSING



ELECTRO PLATING

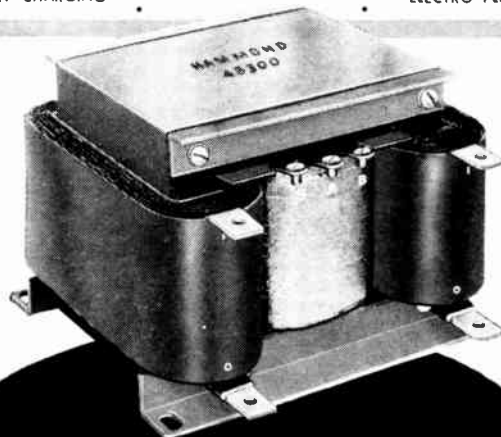

HAMMOND SATURABLE REACTORS

Hammond Saturable Core Reactors will control large A.C. powers with small amounts of D.C. Current. They are highly efficient, completely reliable and require no maintenance.

Available in all sizes, from milliwatt level to 50 kilowatts, and for all commercial power frequencies including 400 cycle. A typical Hammond Saturable Reactor, when connected in series with a load, will vary the load voltage from 10% to 95% of line voltage. The D.C. power requirements are generally 2% of the controlled power. The Reactor may be remotely controlled by a small potentiometer.

Saturable reactors are not expensive and have numerous varied applications throughout industry.

Write for Bulletin 5057.

INDUSTRIAL and SPECIAL TRANSFORMERS

HAMMOND MANUFACTURING CO. LTD.

H/13

GUELPH • ONTARIO • CANADA

For complete details check No. 83 on handy card, page 95

Lake Engineering adds to represented lines

Lake Engineering Co. Limited of 123 Manville Road, Scarborough, Ont., has announced its appointment by ITT Components Division of International Telephone and Telegraph Corporation, Clifton, New Jersey, as their Canadian sales representative for silicon and selenium rectifiers, tantalum capacitors, and hermetic seals as well as Federal transmitting, traveling wave and image storage tubes and Kuthe hydrogen thyratrons.

Lake Engineering has also been appointed as the Canadian sales representative for Microdot Inc. of South Pasadena, California, for their micro-miniature coaxial cables, connectors and assemblies.

Institution of Electrical Engineers changes name

By a decision of the Council on February 5, 1959, the name of the Radio and Telecommunication Section of The Institution of Electrical Engineers was changed to "Electronics and Communications Section".

The incorporation of the word "Electronics" into the name of the Section is intended to emphasize to the profession that The Institution of Electrical Engineers is obviously the appropriate society for those properly qualified electrical engineers who regard themselves as "electronic" engineers.

The word "Radio" no longer appears in the title of the Section, because it is felt that this word, with its modern connotation of certain limited applications, is now insufficiently comprehensive. The continued inclusion within the sphere of the Section of such interests as navigational aid systems and radar is, it is felt, implied in the new title.

So far as the omission of the word "Telecommunication" is concerned, it is considered that the word "Communications" will be interpreted broadly within the context of electrical engineering, and the change makes for a shorter and at the same time a more comprehensive title.

Milan International Trade Fair

F. Slataper, Italian Trade Commissioner in Canada, announces that the Milan International Trade Fair will be held from April 12 to April 27, 1959.

The Milan Fair is claimed to be the largest and most varied of its kind in Europe, covering an area of over four million sq. feet with a display frontage of 42 miles.

NEMS · CLARKE RECEIVERS



As part of an over-all program to provide the ultimate in telemetry receivers commensurate with the state of the art, Nems-Clarke now offers the 1400 Series Receivers employing phase-lock detection.

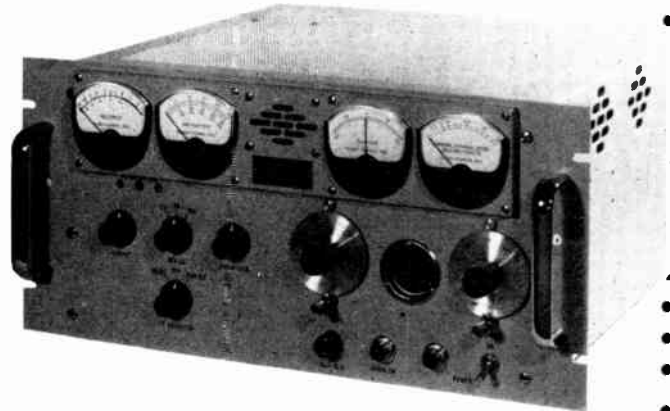

TYPE 1432 SPECIFICATIONS

Frequency range (determined by plug-in crystals)	215 to 260 mc
Noise figure	less than 8 db
Video output	Sensitivity: 0.16v peak-to-peak per kc of deviation. Frequency response within 3db. AC coupled, 10 cps to 100 kc per second. Adjustable output control on front panel.
VU Meter in Video Output Circuit	Frequency response: flat over frequency range of 400 cycles to 80,000 cycles. Provided with front panel adjustable reference level control.
Frequency Monitor Output	30 mc
Signal Strength Recorder Output	High impedance, 0-15v
Spectrum Display Output	30 mc
Input Impedance	50 ohms nominal
IF Rejection	Greater than 60 db
Image Rejection	Greater than 48 db
IF Bandwidths	500 kc and 100 kc
Power Input 117v AC, 60 cycles, approximately 150 watts	
Size	8¼" x 19" x 16½"
Weight	Approximately 40 pounds
Finish	Gray enamel



We reserve the right to make changes in specifications.

NEMS · CLARKE COMPANY

A DIVISION OF VITRO CORPORATION OF AMERICA

919 JESUP-BLAIR DRIVE • SILVER SPRING, MARYLAND • JUNIPER 5-1000

REPRESENTED IN CANADA BY —

ELECTRO-MECHANICAL PRODUCTS
Markham Road, Agincourt, Ontario

For complete details check No. 102 on handy card, page 95

SYNTRON

SELENIUM RECTIFIERS

designed for your application

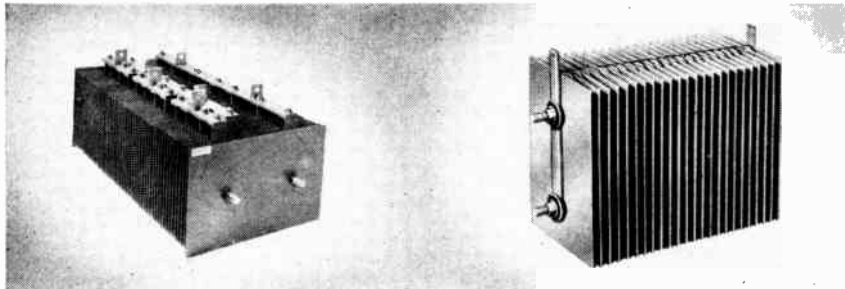

Industrial Power Rectifier Stacks — high efficiency, low maintenance. Designed for arc welders, heavy d-c power supplies, etc.

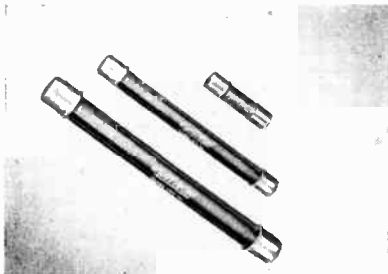

Cartridge Rectifier Stacks — low current, high voltage. Maximum 25 milliamperes, maximum input 15,000 R.M.S. volts.

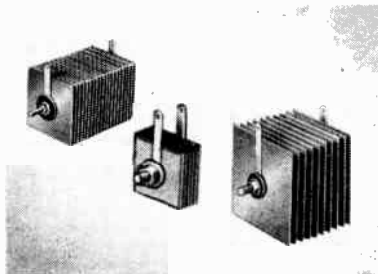

Commercial Rectifier Stacks — Designed for business machines, elevator controls, magnetic chucks, brakes, clutches, vibratory equipment,

provide higher d-c output for given a-c input because of lower forward drop.

SYNTRON Selenium Rectifier cells are manufactured by a unique vapor deposit vacuum process and quality control method to provide rectifiers of extreme uniformity, long life and stability.

Years of successful industrial and commercial application have proven their dependability and quality.

SYNTRON Selenium Rectifiers are noted for these outstanding characteristics — low voltage drop, low leakage current, low temperature rise and cell uniformity for long stack life.

SYNTRON builds rectifier stacks for every application — from industrial Power Stacks with 12" x 16" cells, down to low current, high voltage cartridge type stacks.

SYNTRON Selenium Rectifiers provide high efficiency, low maintenance and longer life to every application.

SYNTRON Selenium Rectifiers are made in Canada

Write for free informative literature

SYNTRON (CANADA) LIMITED

12 MAIN STREET EAST • Dept. K • STONEY CREEK, ONTARIO

For complete details check No. 121 on handy card, page 95

Canada linked to Chicago by Telex service

Messages of greeting passed back and forth in rapid exchange between Chicago and Canadian cities on February 10 during inauguration ceremonies of a new Telex service.

Chicago is the first United States midwestern city to be linked with Canada by the new service.

Participating in the exchange from the Canadian side were executives of Simpson-Sears Limited, the Canadian Chamber of Commerce, Canadian National Telegraphs and Canadian Pacific Communications. They exchanged greetings with officials of Sears-Roebuck and Company, Illinois state representatives, Western Union and Canadian Consul-General Gerald A. Newman, Chicago.

Telex, a new and revolutionary service for business communications, provides instant printed conversations with other subscribing firms throughout Canada as well as to New York and Europe.

The recent inauguration established Chicago as a Telex exchange point, and officially started service between that city and 23 Canadian cities already in the Telex network.

APPOINTMENT



M. T. Douglas

The appointment of Murray T. Douglas as manager, engineering department, at the Canadian Westinghouse Company's Electronics Division, Hamilton, has been announced. Formerly manager of manufacturing, he succeeds G. P. Adamson who was recently named Electronics Division manager. Succeeding Mr. Douglas is Ewart O. Bridges, who moves up from the post of superintendent of industrial engineering.

We ended
chemical
dangers
and
increased
production
**WHEN
WE...**



STOPPED
making our own etchant
and **STARTED** using
HUNT S.C.E.

"We made our own etchant for plated circuit boards until we heard about HUNT S.C.E. Solution.

"It took time to mix up large quantities of chromic and sulphuric acid into an etching solution which gave off noxious fumes and was dangerous to handle. It varied from batch to batch and had to be heated to 140° F. to etch properly.

"So we did the wise thing... stopped mixing our own solutions and switched to Hunt S.C.E. . . . No more chemical dangers and we're saving money too . . . we etch at a uniform rate around the clock. HUNT S.C.E. (Solder Circuit Etch) is best for your plant too because it:

1. Etches rapidly at room temperature.
2. Has high capacity for copper.
3. Never attacks the solder-plated circuit.
4. Gives fast, odorless etching of copper.
5. Produces boards that pass all corrosion and stability tests.
6. Is a prepared solution with guaranteed uniformity and rigid laboratory control.



For detailed information about HUNT S.C.E. and valuable production handling information, write for Technical Bulletin No. 3 — "The Etching of Solder Plated Circuit Boards by Hunt S.C.E. Solution."

PHILIP A. HUNT COMPANY (CANADA) LTD.
77 LESLIE STREET • TORONTO 8, ONTARIO • TELEPHONE HO 5-1145

For complete details check No. 87 on handy card, page 95
ELECTRONICS AND COMMUNICATIONS, March, 1959

FIRST
in the industrial field

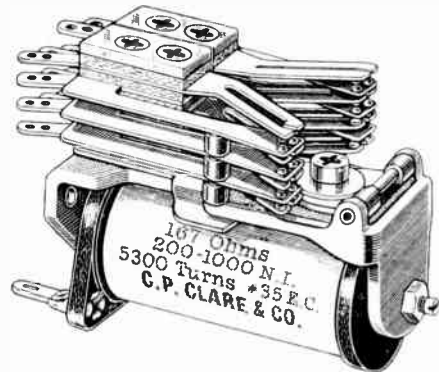

The "ideal" relay to
meet the exacting
requirements of

your industrial designs

MADE IN CANADA

Possessed of the most positive of all twin-contact designs, the CLARE Type J Relay has all the desirable features of a telephone type relay — yet greatly reduced in bulk.

Many basic design ideas have been improved by this relay — a CLARE original — whose wide acclaim has provoked a lot of imitators but never an equal — whose many distinctive features have provided an eminently satisfactory solution to many perplexing problems involving efficient, long-life relay operation.

Let us work with you to pick the best relay for your important relay requirement. Address:

C. P. CLARE CANADA LTD.

2700 Jane Street

Toronto 15, Ontario

MEIrose 3-6793

TYPE J DESIGNS TO MEET WIDE DESIGN REQUIREMENTS
Standard Type J Relays. Twin contacts (Palladium standard). Rated current-carrying capacity: 4 amperes, 150 watts.

Power Type J Relays. Heavy-duty contacts riveted to springs. Code 18 (Silver). Rated current-carrying capacity: 10 amperes, 27½ volts d-c.

Type J Video Relays. For switching video and other high-frequency currents.

Write for Engineering Data Book
and Bulletin 119

CLARE RELAYS
FIRST in the industrial field

For complete details check No. 70 on handy card, page 95

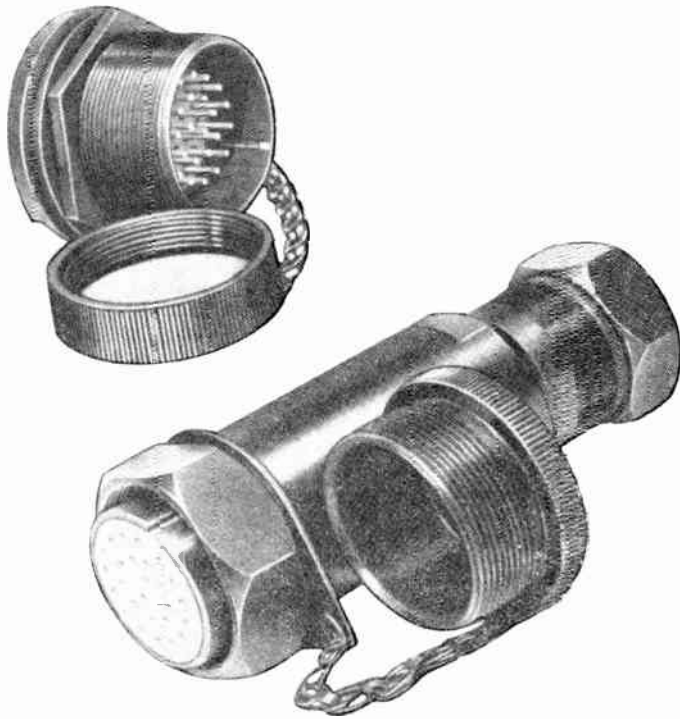

LR and MR Series RUGGED, WATERPROOF CONNECTORS by CANNON

- Sealed for protection against severest weather. Impervious to water, ice and mud.
- Standard MS insert arrangements available in both series.
- Anodized finishes provide extra protection. Other finishes available.
- Machined from top quality bar stock for much greater strength.
- Simple maintenance under all conditions.

Write for Bulletin LRMR-1.

CANNON (CANADA)  **ELECTRIC** LIMITED

160 Bartley Drive, Toronto 16, Ontario

Branch Offices in MONTREAL and OTTAWA

Factories also in LOS ANGELES, SALEM, LONDON, MELBOURNE

Licencees in PARIS, TOKYO

5901

For complete details check No. 68 on handy card, page 95

New Brunswick Telephone Co. adds to line mileage

Transport Minister George Hees recently announced that some 75 miles of telephone line which had been operated by the Government since 1884 in the Chatham-Escuminac district of New Brunswick would be acquired by the New Brunswick Telephone Company on or about April 1. This includes a section of the line between Point Sapin and Kouchibouguac.

In making the announcement, Mr. Hees said that arrangements were being made with the New Brunswick Telephone Company to rehabilitate and expand this system, provide modern dial equipment in place of the present magneto type telephone and increase the hours of service to a 24-hour basis. The whole system would eventually be connected with the Company's new Cross Bar exchange to be located in the Newcastle area, thus providing communication comparable to the standard throughout the province.

The stretch of telephone line which the Department is relinquishing to the New Brunswick Telephone Company is one of the oldest in Canada.

Sales agent for "Bakelite" products

Bakelite Company, Division of Union Carbide Canada Limited, has appointed National Fibre Company of Canada Limited as exclusive sales agent for "Bakelite" brand laminated plastic products, according to a recent announcement by W. S. Berry, sales manager.

This arrangement provides for the manufacture of the primary products by Bakelite Company. The sale of sheets, rods and tubes and the production of fabricated parts will be exclusive functions of National Fibre Company of Canada Limited.

Marr Electric reps for International Register

International Register Company Limited of Chicago, Illinois, have appointed Marr Electric Limited, Toronto, as their exclusive sales representatives for range timers, interval timers, dryer timers, radio clocks, clock movements and motors.

Marr Electric Limited, who are located at 160 Perth Avenue, Toronto 9, have been representing International Register Company, on intermatic time switches, for many years.

In addition to sales, Marr Electric Limited will continue to operate a service station for all International Register Company products.

Dialco Pilot Light Assemblies

Dialight Corp., 60 Stewart Ave.,
Brooklyn 37, N.Y.

NEON INDICATOR LIGHTS

Now also available with new High Brightness NE-51H Neon Glow Lamp. Have Patented Built-in Resistor.



Two Types Available: Series 95408 enclosed neon indicator light has 56,000-ohm, 1/2-watt resistor built in for use with the regular NE-51 neon lamp on 105-125 volt circuit. Series 95408H has built-in resistor of 18,000 ohms for use with new NE-51H high brightness neon lamp on 105-125 v. AC circuits or DC circuits of 160 volts. Rugged design; resistor fully insulated in molded bakelite. Plastic head gives 180° light spread. Lens holder and mounting bushing are white nickel plated. Comes with steel hex nut; and internal tooth lockwasher with iridite protective coating over cadmium plate. Solder terminals. Size, 2 1/4" long, 1 1/8" O.D.; mounts in 1 1/2" hole in panels up to 3/8" thick. U/L and CSA listed. Shpg. Wt., 3 oz. Less lamp. For High Brightness version, add suffix H to stock number (Example, 95408H-931).

DIALCO NEON SERIES 31914

Enclosed assemblies for use with NE-45 neon glow lamps with candelabra screw base for 105-125 volt circuits. Replaceable from front of panel. Convex lens in choice of colors has friction-fit lens holder of polished chrome finish. Nickel plated mounting bushing. Iridite coated, cadmium plated steel hex mounting nut and split lockwasher. Binding screw terminals. Size, 2 1/2" long, 1 3/8" O.D.; mounts in 1" hole. U/L and CSA listed.



DIALCO HALF-INCH SERIES 81410

For use with T-3/4 bulb, miniature bayonet base incandescent, for 2-55 volt circuits. Replaceable from front of panel. Aviation type assembly with socket shell encased in molded bakelite. Smooth face jewels in 1/2" brass lens holder. Holder and mounting bushing are white nickel plated. Iridite coated, cadmium plated steel hex nut and internal-tooth lockwasher supplied. Solder terminals. Size, 2 1/4" long, 1 1/8" O.D.; mounts in 1/2" hole in panels up to 3/8" thick. U/L and CSA listed. Shpg. Wt., 3 oz. Less lamp.



ENCLOSED ASSEMBLIES DIALCO ONE-INCH SERIES 314001

Series for use with S-6 incandescent bulbs with candelabra screw base for 6-125 volt circuits. Lamp replaceable from front of panel. Faceted lens in choice of colors with friction-fit lens holder of polished chrome; white nickel plated mounting bushing. Iridite coated, cadmium plated steel hex nut and split lockwasher. Solder terminals. Size, 2 3/4" long, 1 3/8" O.D.; mounts in 1" hole. U/L and CSA listed.



NEW SUBMINIATURE SERIES

Extra compact assemblies for use with T-1 3/4 bulbs for 1.3-28 volts. Caps unscrew for bulb replacement from front of panel. Military grade phenolic assures permanent isolation from ground; all connections, lamp and socket fully insulated from bushing and panel. Rugged brass structure finished in black nickel. Lockwasher and nut supplied. Size, 1 3/8" long, 3/4" O.D.



Series 101-5030
Front Mounting



Series 101-3830
Back Mounting

TWO-TERMINAL PLASTIC DOME TYPES Series 101-5030 Front Mount and Series 101-3830 Back Mount; Front mounting units mount in 1 1/2" hole; back mounting units, in 1 3/2" hole. Solder terminals.

Front Mfg. No.	Color	Back Mfg. No.
101-5030-951	Red	101-3830-951
101-5030-952	Green	101-3830-952
101-5030-973	Amber	101-3930-973
101-5030-975	White	101-3830-975

DIALCO TWO-TERMINAL NON-DIMMING SERIES 111-3830



Rugged, general purpose with glass lens in metal holders; unscrew for easy lamp replacement. Frosted lens except as otherwise noted. Internal tooth lockwasher and nut; solder terminals. Size, 1 1/2" long, 3/8" O.D.; mounts in 1 3/2" hole. Shpg. Wt. 1 1/2 oz. Less lamp.

Dialco No.	Lens Color
111-3830-111	Red
111-3830-112	Green
111-3830-113	Amber
111-3830-135	White*
111-3830-117	Clear

*Translucent unfrosted lens.



DIALCO 1-TERMINAL NON-DIMMING TYPES With Binding Screw or Solder Terminal

For grounded circuits; meet applicable MIL specs. Frosted lens unless otherwise noted. Size, 1 1/2" long, 3/8" O.D.; mounts in 1 3/2" hole.

Binding Screw No.	Color	Solder Term. No.
8-1830-111	Red	8-1930-111
8-1830-112	Green	8-1930-112
8-1830-113	Amber	8-1930-113
8-1830-135	White*	8-1930-135
8-1830-117	Clear	8-1930-117

*Translucent unfrosted lens.



TT-61 AND TT-62 FOR PLASTIC PLATE EDGE-LIGHTING

Subminiature units for MIL-P-7788 plastic plate panels on qualified products list QPL-7806 per mil. drawing MS25010-1A to 8A. Size, 1 1/8" long, 1 1/2" O.D.; mounts in 1 3/2" hole. Shpg. Wt., 2 oz. Less lamp.

Solder Terminal No.	Filter	Screw Terminal No.
TT-61	Red	TT-62
TT-61-B7	Clear	TT-62-B7
TT-61-R1	Red*	TT-62-R1
TT-61-C7	Clear*	TT-62-C7

*With light-emitting top.

OIL-TIGHT ASSEMBLIES

For Heavy Duty Industrial Applications
1" SERIES



Enclosed rugged design gasketed with oilproof gaskets impervious to oil, water and dust. Rugged binding screw terminals. Caps unscrew from face of panel. One-piece, solid brass mounting bushing; solid brass knurled lens holder; chrome finish. Glass lens gives omnidirectional (180°) light spread. High impact phenolic insulation. Size, 1 7/8" long, 1 3/8" O.D. Mounts in 1" clearance hole.

FOR 656 INCANDESCENT LAMPS Torpedo Faceted Lens

For Screw Base	Lens	For Bayonet Base
103-3101-1331	Red	103-3502-1331
103-3101-1332	Green	103-3502-1332
103-3101-1333	Amber	103-3502-1333
103-3101-1334	Blue	103-3502-1334
103-3101-1335	White*	103-3502-1335
103-3101-1336	Yellow	103-3502-1336
103-3101-1337	Clear	103-3502-1337

DOME TYPE LENS (FROSTED BACK)

103-3101-1211	Red	103-3502-1211
103-3101-1212	Green	103-3502-1212
103-3101-1213	Amber	103-2502-1213
103-3101-1214	Blue	103-2502-1214
103-3101-1235	White*	103-2502-1235
103-3101-1216	Yellow	103-2502-1216
103-3101-1217	Clear	103-2502-1217

*Translucent unfrosted.

FOR NEON GLOW LAMPS

For use with NE-45 candelabra screw base lamps. Resistor built into lamp base. Size, 2 3/4" long, 1 3/8" O.D. Fits 1" clearance hole. Shpg. Wt., 3 oz. Less lamp.

Lens Color	Dialco Number
Red	103-3114-1231
Amber	103-3114-1233
Yellow	103-3114-1236
Clear	103-3114-1237
Clear*	103-3114-1217

*Frosted back.

MODEL 1316-L ADAPTER SET

Gasketed reducer for adapting any 1" Dialco pilot light assembly to 1 1/8" hole. Impervious to oil, water and dust.

1 1/16 SERIES

Stovepipe Lenses
Fluted or Plain
With built-in resistor.
Size, 2 3/8" long, 1 1/8" O.D.
Mounts in 1 1/2" hole.



FOR NE-51 NEON GLOW LAMP

Fluted Lens	Color	Plain Lens
125-408-1191	Red	125-408-1131
125-408-1193	Amber	125-408-1133
125-408-1196	Yellow	125-408-1136
125-408-1197	Clear	125-408-1137
.....	Clear*	125-408-1117

*Frosted back.

FOR LOW-VOLTAGE T-3/4-MINIATURE BAYONET BASE LAMP

Fluted Lens	Color	Frosted Back
125-410-1191	Red	125-410-1111
125-410-1192	Green	125-410-1112
125-410-1193	Amber	125-410-1113
125-410-1194	Blue	125-410-1114
125-410-1195	White	125-410-1135*
125-410-1196	Yellow	125-410-1116
125-410-1197	Clear	125-410-1117

*Translucent unfrosted.

DIALCO ONE-INCH SERIES 75 DETACHABLE LAMP SOCKET



Candelabra base, 115 volt pilot light assembly with faceted jewel in highly polished chrome plated brass holder. For standard bulbs. Requires hole of 1-inch diameter for mounting. Easily adjusted to panel thickness.

DIALCO SERIES 31-18-16 ONE-INCH REMOVABLE JEWEL

Candelabra base, 115 volt pilot light assembly with faceted jewel in highly polished chrome plated brass holder. For standard bulbs. Requires 1" mounting hole. Solder terminals. Easily adjusted to panel. Secured to panel by separate bushings into which the lens holders are a friction fit, permitting removal for lamp replacement.



The assemblies listed are only a few of the more popular types. Dialco manufactures every type of assembly for any purpose and we can supply the complete line. Write for information on any types not listed.

IN CANADA:

Lake Engineering Co. Ltd.
123 Manville Road
Scarborough, Ont.

Proven Performance!



View of mountain top microwave installation

... proven performance, where rough conditions are normal all year. Here is a high mountain-top tower where ANDREW equipment was installed to perform, exposed to 100 mph winds, driving sleet, ice and snow.

Selection of the best antenna systems for such problem installations is made easy through a choice of 30 ANDREW stack parabolic reflectors, which utilize the three standard microwave feeds. And tower work has been simplified too, with the new mount, which has separate elevation and azimuth adjustments for precise alignment.

All standard ANDREW antennas meet or surpass EIA recommendations and DOT specifications, governing radiation patterns and side lobes.

Uniform all weather performance is assured by the use of radomes and built-in automatic de-icing equipment.

Why not check today on how you can get the maximum performance in your installation—just call the ANDREW Engineer in your area or write

Andrew
ANTENNA
CORPORATION LTD.
606 BEECH ST., WHITBY, ONTARIO

ANTENNAS, ANTENNA SYSTEMS, TRANSMISSION LINES

For complete details check No. 44 on handy card, page 95

DIPOLE FEED



for 400-960 mc

COAXIAL HORN FEED



for 1700-2700 mc

WAVEGUIDE HORN FEED



for 3700-13,200 mc



Request Catalog 22
for complete
description of
500 Antenna
System Products



Convention record committee for IRE Toronto section

The IRE Canadian Convention Record was discussed at the supper meeting of the Toronto Section of the Institute of Radio Engineers held on January 12, 1959. Because of the experience gained through handling the recent Record, E. L. (Eric) Palin, 1959 convention general chairman, has set up a committee to investigate the pros and cons of future Convention Records. They will make their recommendations at a later date.

C. A. (Clare) Norris was named chairman and A. P. H. (Alec) Barclay and R. J. A. (Ray) Turner as committee members. Additions to the committee may be made by its chairman.

Closed circuit TV seen by Canadian executives

During February some forty executives and business press representatives were invited to witness a closed circuit television presentation of the Eagle Pencil Company, in the King Edward Hotel ballroom, by the S. W. Caldwell Company Limited of Toronto.

Caldwell's provided the technical facilities for bringing the show into Canada and received permission to invite a chosen audience to view the telecast in an adjacent room, and also in the auditorium, where they could observe the impact on the audience, of the "live" nine by twelve foot picture.

The Eagle Pencil show, devoted to "Value Analysis", originated in their new plant in Danbury, Connecticut, and by means of five thousand miles of television cable and microwave links, was witnessed by about thirty thousand people from coast to coast in ten U.S. cities and two Canadian cities, Montreal and Toronto.

Prior to the show Bob Wilson, sales manager of Caldwell's Closed Circuit Television Division, had an opportunity to address the select group of Canadian executives and referred to closed circuit television as the "Third Medium" in the communications field, the first two being the printed word and radio-television. Mr. Wilson gave examples of the many and varied applications to which closed circuit television commends itself.

C.E.W.A. ANNUAL MEETING

Fort Garry Hotel
Winnipeg

APRIL 13-15, 1959

He's getting results...

WITH THE NEW BRUSH RECORDER MARK II

So can you. The versatile Mark II is an integrated oscillograph package—a readout tool for engineers and technicians everywhere . . . in the shop . . . in the lab . . . in the field.

Just plug it in . . . put it to writing . . . anywhere.

PERFORMANCE SPECIFICATIONS

Recordings—Uniform, crisp, easily reproduced. Trouble-free ink writing on precision chart paper.

Channels—Two analog, plus two event markers.

Sensitivity—Maximum of 10 mv/chart line (mm); range, 10 mv to 400 v.

Input—Differential; impedance 5 megs each side to ground.

Frequency Response—D.C. to 100 cps.

Write for free booklet 2521A for complete specifications. Immediately available from stock. Price \$1350, f.o.b. Cleveland, Ohio



In Canada:
Bayly Engineering Ltd.
Ajax, Ontario

brush INSTRUMENTS

DIVISION OF

37TH AND PERKINS

CLEVITE
CORPORATION

CLEVELAND 14, OHIO

For complete details check No. 57 on handy card, page 95





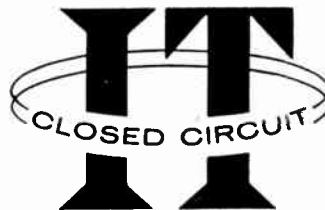



you
designed



Your needs are top consideration in the design of Du Mont Industrial Television. Du Mont IT offers you exactly what you need to fully realize the amazing potentials of television in your business or profession . . .

Two great systems

 <p>Series 100 Camera is complete in itself. May be used directly with ordinary TV receivers if desired.</p>	 <p>Remote control available for focus, lens change, pan and tilt. Also wide choice of camera housings, etc.</p>	 <p>Your choice of 17" or 8" monitors that provide bright, sharp pictures even under high ambient light conditions.</p>
 <p>Series 200 Camera for super-detailed transmission. Sharpest pictures available, yet extremely compact.</p>	 <p>Remote control of camera and mount. Du Mont systems may be expanded at any time with no obsolescence.</p>	 <p>Both systems are Du Mont all the way from camera to picture, assuring matched components for top performance.</p>

Your inquiries invited.
Write for Catalogues.
Canadian Distributor

DU MONT®

ELECTRONIC SERVICE SUPPLY COMPANY

Head Office: 210 - 9th Avenue E.

Calgary, Alberta

Branches & Representatives:

9828 Jasper Ave., Edmonton, Alta.
2810 Dewdney Ave., Regina, Sask.
Eyers Electronics Ltd.,
752 Hastings St. E., Vancouver, B.C.

Western Sound Services Ltd.,
613 Portage Ave., Winnipeg, Man.
Tele-Radio Systems Ltd.,
3534 Dundas St. W., Toronto, Ont.

For complete details check No. 77 on handy card, page 95

Pixberg & Co. appoints Canadian Research Institute

The West German firm of Pixberg & Company, manufacturers of all types of resistance wire, has announced the appointment of Canadian Research Institute as sales representatives in Canada.

Available are all the well known alloys, including nickel-chrome, manganin, constantan, and compositions to give special characteristics. Wires are available from heavy gauges down to as fine as No. 50 B & S, in bare, oxidized, enamelled and with natural synthetic fiber covering.

The Canadian Research Institute is located at 46 St. George St., Toronto 5, Ontario.

Controls Co. of America (Canada) Ltd. elects president

Announcement was made recently by Louis Putze, president of the parent Controls Company of America that Dan O'Leary had been elected president of Controls Company of America (Canada) Ltd., located at Cooksville, Ontario. Mr. Putze said that this action had been taken to form a more direct tie between the Canadian plant at Cooksville and domestic operations in the United States as well as to allow Remy Ludwig, vice president in charge of the International Division of Controls Company to give more attention to the company's growing operations in Europe and South America.

Mr. O'Leary joined Controls Company in 1954 as sales manager in charge of the Canadian operations. In February 1957 he became vice president and general manager, which post he held at the time of his election as president.

CEWA annual convention

Leo Rosenberg, president of the Canadian Electronic Wholesalers' Association, has announced that the fourth annual national meeting and convention of CEWA will be held in Salon "C" of the Fort Garry Hotel, Winnipeg, Manitoba, on Monday, Tuesday and Wednesday, April 13, 14 and 15, 1959.

Arrangements are being made to hold an industry dinner, with an outstanding speaker, in Salon "B" of the Fort Garry Hotel on the evening of Tuesday, April 14.

Ample opportunity will be provided for suppliers to meet the electronic wholesalers attending the convention and it is planned to invite all segments of the electronics industry, whether members of CEWA or not, to attend the convention dinner.

BEHLMAN

INVERTRON[®]

*At work for Sperry**

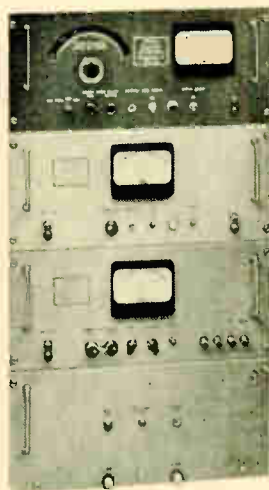
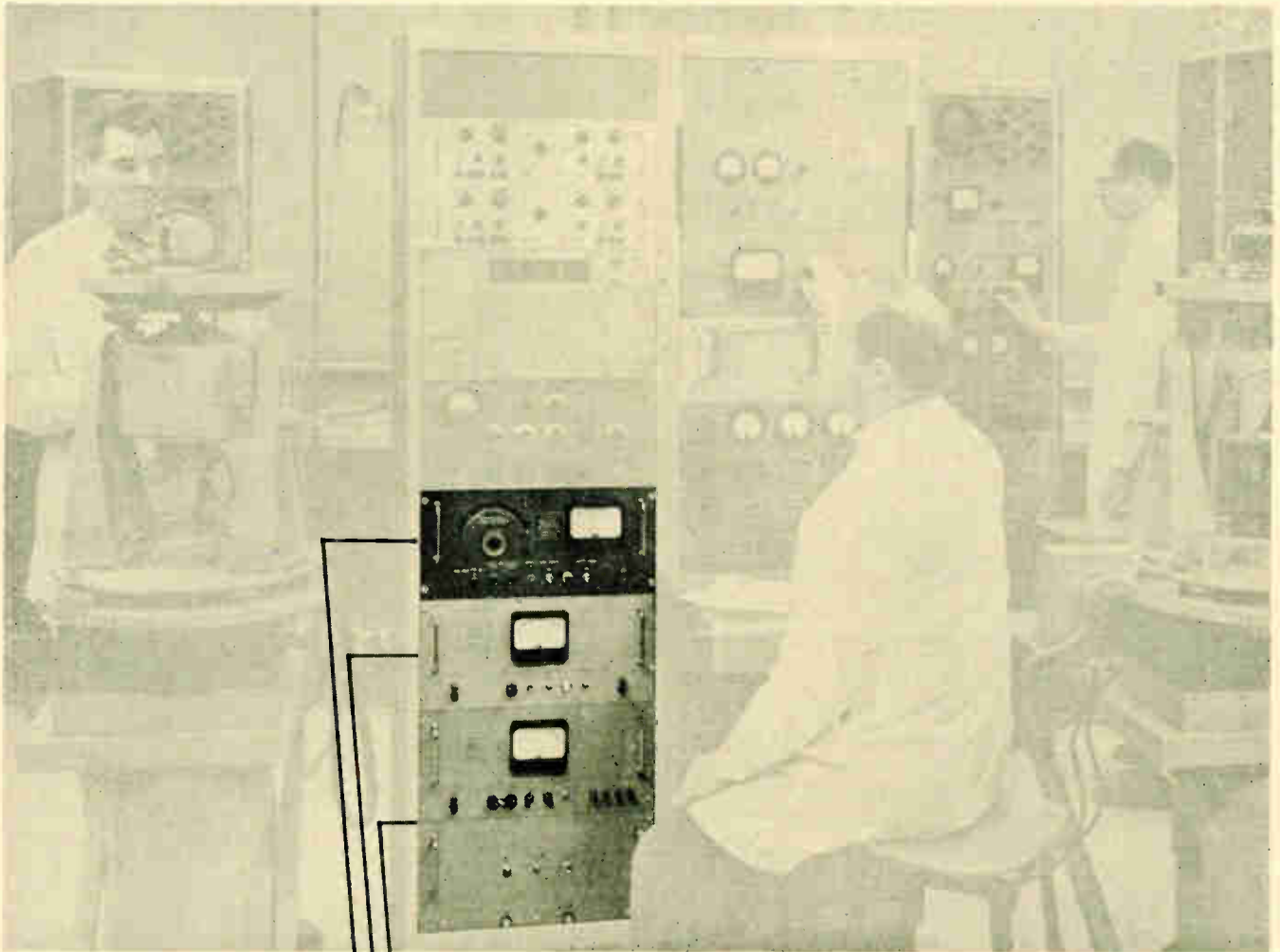

160VA Single
Phase Unit
Variable
Frequency

160VA Single
Phase Unit
Fixed Frequency

500VA Three
Phase Unit
Fixed Frequency

*... and wherever an accurate
AC Power Source is needed.*

Shown above are three Behlman INVERTRON units being used by Sperry Gyroscope Company for the development of an inertial guidance system.

Sperry depends on the accuracy of INVERTRON . . . 0.001% (one part in 100,000) frequency accuracy!

If guidance or instrumentation is your concern — investigate the Behlman INVERTRON.

For further information write or call



ELECTRONICS • MECHANICS • OPTICS
DESIGN • DEVELOPMENT • PROTOTYPE

BURBANK, CALIFORNIA

Sperry Gyroscope Company
Great Neck, New York

REPRESENTED IN CANADA BY

ELECTROMECHANICAL PRODUCTS
MARKHAM ROAD AGINCOURT, ONTARIO



The LARGEST and the smallest

Sizes 08—23 Made in Canada

MUIRHEAD

SYNCHROS

There's a Muirhead Synchro for every Synchro Function.

Backed by more than 20 years' synchro manufacturing experience, MUIRHEAD synchros and servomotors are built to the highest standards of quality. The types of synchros in production are extensive and new elements are being added continuously—made to CAMESA, U.S. Military and N.A.T.O. specifications where applicable.

MUIRHEAD synchro sizes include 08, 10, 11, 15, 18 and 23; Types: Control Transmitters, Control Transformers, Control Differential Transmitters, Resolvers, Torque Differential Transmitters and Receivers, Linear Variometers, Servomotors and Tachometer Generators.

The Muirhead technical service will gladly advise on any servo or synchro problem—do not hesitate to call, write or 'phone.

MUIRHEAD TECHNIQUE

Readers of *Technique* have a unique opportunity of learning how Muirhead instruments are actually being applied to the problems of research and industry. You would be wise to join our readership and acquire this valuable information for yourself. After all, the other fellows' problem might also be yours.

Muirhead Technique is sent free on request; write to the address below to have your name placed on the mailing list.

373/3ca

MUIRHEAD INSTRUMENTS LTD • STRATFORD • ONTARIO • Tel: 3717

For complete details check No. 100 on handy card, page 95

J. J. Kingan heads International Systcoms

International Systcoms Limited is a new Canadian electronic engineering company. The organization is headed

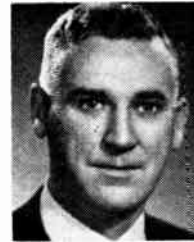

J. J. Kingan

by J. J. Kingan, a well known figure in Canadian electronics, who is an ex vice-president of Electronic Industries Association of Canada (until recently known as RETMA).

The new company will be active in the planning of communication systems and in the design and manufacture of communications equipment. Initial product releases have been made in the field of VHF mobile equipment. W. Ornstein is manager of commercial products and is responsible for new product development. F. J. Looker is the company's production manager.

In announcing the formation of the new company, Mr. Kingan has stated that the basis of the company's operation is its confidence in the continuing rapid growth of radio communications in Canada. It is believed that an important role can be played by Canadian companies in planning Canada's future communications systems and in the design and manufacture of the equipment to be used in these systems.

International Systcoms Limited is located at 8235 Mountain Sights Ave., Montreal 29, Que.

Symposium on electro-magnetic theory

An International Symposium on Electromagnetic Theory will be held at the University of Toronto during the period June 15-20, 1959. The Symposium is sponsored by Commission VI of U.R.S.I. (Union Radio Scientifique Internationale) and the University of Toronto, with support from the U.S. National Science Foundation and the National Research Council of Canada.

The Symposium will be the third in a series of international symposia on electromagnetic theory, the previous ones being the Symposium on Microwave Optics at McGill University in 1953 and the Symposium on Electromagnetic Wave Theory at the University of Michigan in 1955.

The technical program will consist of a number of invited papers on topics of current interest, designed to stimulate discussions. It is hoped that much of the time devoted to technical sessions will be used for discussion.

VARIAN STRIP CHART RECORDERS

(POTENTIOMETER TYPE)

Compact, moderate cost recorders using the time-proven potentiometer principle — the same as is used in expensive chart recorders to achieve superior stability, sensitivity, ruggedness and

high input impedance. Chart is rectilinear. Pen driving power is ample, even for inkless recording, since it is independent of the source being measured.

VARIAN G-10

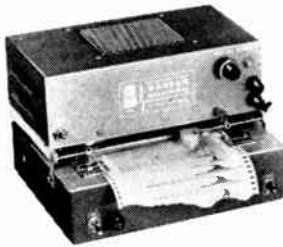

Portable for laboratory or bench use where chart's horizontal position and accessibility are of prime importance.

SPECIFICATIONS

MODEL	FIXED-SPAN G-10 (span permanently set)	ADJUSTABLE-SPAN G-10 (continuous adjustment with inside controls)
Base Price (not including options or accessories)	\$360.00	\$420.00
Span (millivolts across chart)	100 mv., d.c., fixed	As specified within 10-100 mv. d.c. range
Full Scale Standard Balancing Time <i>Optional</i>	2½ seconds 1 second	2½ seconds 1 second
Limit of Error	1% of span	1% of span
Sensitivity (½ deadband)	¼% of span	¼% of span
Reference System	Mercury cell	Mercury cell
Input & source resistance	See explanation*	See explanation*
Input Circuit	Ungrounded. Signals floating above ground by as much as 200 volts d.c. are permissible with proper considerations.	
Input Polarity—Standard <i>Optional</i>	Positive-going signals cause left-to-right pen travel. Reversed polarity. Positive-going signals cause right-to-left pen travel.	
Chart Dimensions	Calibrated width nominally 5"; Overall 6¾"; Length 85'.	
Chart Speeds Single speed is standard <i>Dual speed is optional</i>	1, 2, 4, 8, 12, 16"/min, 1, 2, 4, 6, 15, 16, 24, 30, 40, 48"/hr. Any combination available on dual speed.	
Power Requirements	110-120 volts, 1 ph, 58-62 cps, 55 volt-amp max, power factor approx 0.7. Also 50-cycle version, 115/230 volts	
Overall Dimensions	7" high x 10¾" wide x 10" deep.	
Weight	Basic recorder 15 lbs. net. Maximum shipping weight 25 lbs.	
Accessories Available	Inkless charts, stylii, card-type charts, chart take-up unit, carrying case, replaceable chart drive motor assemblies.	

MADE IN CANADA *INPUT & SOURCE RESISTANCE (Both G-10 & G-11A)

With null balance operation, the separately-powered servo system adjusts the measuring voltage until it "bucks out" the measured voltage. Thus the input resistance approaches infinity at balance, is several hundred thousand ohms off balance. The result is that source resistances as high as 50K ohms are permissible with spans in the range of 10-20 mv. Permissible values increase to 75K ohms for 20-50 mv spans and to 100K ohms with spans of 50-100 mv.

VARIAN G-11A



For portable, panel or rack use (two fit side by side in a 19-inch rack mounting); designed for OEM, lab or field for long-term monitoring; interchangeable input chassis as shown in specification chart.

SPECIFICATIONS

MODEL	G-11A with A1 or A2 input chassis	G-11A with B1 input chassis	G-11A with F1 input chassis	G-11A with T2 input chassis
Base Price (not including options or accessories)	A-1 \$515.00 A-2 \$555.00	\$555.00	\$515.00	\$605.00
Type	Gen. purpose null-balance potentiometer	Gen. purpose potentiometer with input attenuator	Current-type for use as general purpose recording milliammeter	Thermocouple potentiometer with reference junction compensation
Span	9-100 mv. d.c. as specified	Nine-step adjustable 10 mv. to 100 volts d.c.	1 milliampere, d.c.	0°F to 400, 600, 750, 1100, 1800 or 2200°F. Also -150°F to +250°F
Field Span-Adjust	Continuous, with inside controls	Knob on front panel	Fixed No adjustment	Front-panel plug-in range elements
Full-scale Balancing Time	1 second	1 second	1 second	1 second
Limit of Error	1% of span	1% of span on 10 mv. 2% on all others	1% of span	1% of span
Reference System	A1—Mercury cell A2—Cont. electronic	Mercury cell	Mercury cell	Continuous electronic
Sensitivity (½ deadband)	¼% of span	¼% of span	¼% of span	¼% of span
Input Resistance	See notes above*	100K ohms minimum	1350 ohms	---
Maximum Source Resistance	See notes above*	---	---	---
Input Circuit	Ungrounded. Signals floating above ground by as much as 200 volts d.c. are permissible with proper considerations.			
Chart Dimensions	Calibrated width nominally 5"; Overall width 6¾"; Length 85'			
Chart Speeds—Standard <i>Optional</i> <i>Optional</i> <i>Optional</i>	Single speed 1, 2, 4, 6, and 8"/minute; ½, 1, 2, 3, 8, 12, 15, 20, 24 and 30"/hour. Dual chart motors. Dual Motors provide most combinations of two speeds. 1:4 chart speed shifter. Chart speed shifter divides any basic speed by four. Quadruple speeds achieved by two motors plus shifter.			
Case dimensions	Portable—10½" high x 8¼" wide x 7¾" deep. Panel mounting—10¾" high x 8¾" wide x 7¾" deep with 5¼" behind front panel			
Power Requirement	110-120 volts, 1 phase, 58-62 cps, 55 volt amperes max., power factor approximately 0.7. 50-cycle version available, 110-120 volts only.			
Weight	Basic recorder 15 lbs. net. Maximum shipping weight 25 lbs.			
Accessories Available	Inkless charts, stylii, solenoid-operated event marker pen, extra input chassis, replaceable chart drive motor assemblies.			

SPECIFICATIONS AND PRICES SUBJECT TO CHANGE WITHOUT NOTICE.

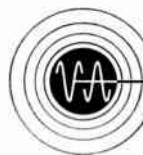

VARIAN associates
OF CANADA LTD.
GEORGETOWN, ONTARIO

For complete details check No. 126 on handy card, page 95

SELF-CONTAINED
COMPANDOR

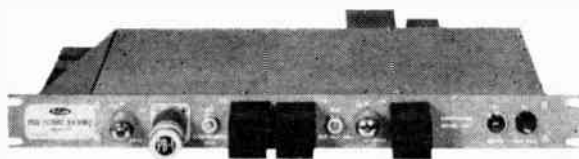

MODEL CP-1

For use with physical, carrier-derived, or radiotelephone voice circuits. Fully self-contained and A.C.-powered, no ancillary equipment is necessary.

The CP-1 offers an economical and reliable means of improving the quality of noisy circuits through compandor action.



PYLON ELECTRONIC DEVELOPMENT company, Ltd.

Communications Systems and Equipment

161 CLEMENT ST., VILLE LA SALLE, MONTREAL 32, QUE.

For complete details check No. 110 on handy card, page 95

Meters ??
Test Equipment ?

Call



for

- the Unusual
- the Difficult

For over 25 years Canada's largest manufacturer of Electronic Test Equipment.

FIRST in Canada to produce...
Tube Testers . Volt-Ohm Milliameters . Oscilloscopes
Signal Generators . Vacuum Tube Voltmeters . Kits
Panel Meters . Portable Meters . Ruggedized Meters
Hermetically Sealed Meters . 250 Degree Meters . and
soon - Taut Band Suspension Meters.

STARK STARK ELECTRONIC INSTRUMENTS LTD.
Ajax, Ontario

For complete details check No. 118 on handy card, page 95

In Canada: ACTIVE RADIO & TV LTD., TORONTO.



why two phones cost less than one!

You can get more hours of work done per day by separating "outside" and "inside" calls with two phones! Your private second phone lets you step up daily output . . . and saves money to boot! Automatic Fanon Fones need no operator; equipment is not rented thus no monthly bill! Minimizes rented equipment needed for external calls and discourages "personal calls", where necessary, by confining other than management staff to communication within the office or plant.

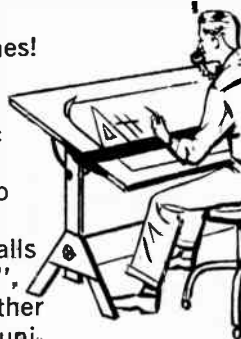

OUTSIDE PHONE means business for you . . .
Regular "outside" phone (rented from telephone company) communication with customers, etc

FANON FONE means getting it through . . .
"Inside" FANON FONES (owned by your company) for rapid communication within the plant, expediting orders, production, etc.

FANON FONE Private Automatic Telephone Systems

- Accelerates inside calls split-second connections.
- Relieves switchboard congestion, allows better service on outside calls.
- Fully automatic service 24 hours per day.
- No more "have to call you back". Hold outside call while you check information on your private automatic phone.
- Paging facilities . . . automatic busy signals available.
- Executive priority to cut into busy line if emergency prevails.



GET THE FACTS! WRITE TODAY!

Complete specifications are now available on the new Fanon PAX systems. Fanon communication engineers can serve your every need.

OTHER FANON SYSTEMS:

Ask about the complete line of Fanon Fones from two phones and up. Loud speaker intercom systems also available.

Desk by Strelmaster

FANON ELECTRIC CO., INC.

98 Berriman Street, Brooklyn 8, N. Y. Dept. P-1
In Canada: Active Radio-TV Dists. 58 Spadina, Toronto

For complete details check No. 79 on handy card, page 95

NEW and UNUSUAL PRODUCTS from Columbia

"AMERICA'S MOST COMPLETE WIRE SOURCE"

Columbia's PERMALINE

The ONE twin lead with proven quality with a guarantee up to 25 years. Give your customer the best... distinctive appearance, high molecular weight, polyethylene, weather-proof.

PERMAFOAM COAXIAL CABLES

For community television systems and many other coaxial cable applications. Foamed polyethylene insulation over the conductor replaces conventional solid polyethylene dielectric. Non-contamination Permaline jacket resists sunlight, salt air, chemical fumes, etc.

FLEXFOAM MICROPHONE CABLE

The best microphone cable you will obtain. Has foam polyethylene dielectric which lowers the capacity more than one third. Super flexible comparable to rubber, this is the first microphone cable with such a low capacity.

PROTECTO-CORD

Safety first with Columbia's new quality "Safety" PROTECTO-CORD. Available in any size, length, or type. Can be used in any application. Can be easily cut to any length desired.

COLUMBIA... wire, cord sets, cable, assemblies...

Columbia products are sold only through recognized jobbers

Columbia WIRE & SUPPLY CO.

2850 Irving Park Road Chicago 18, Illinois

For complete details check No. 78 on handy card, page 95

ILLINOIS CAPACITORS KNOWN THE WORLD OVER for their TIME TESTED QUALITY!

there is an Illinois Electrolytic Capacitor for every Electronic Requirement!

Single Anode SMT

Dual Anode or Cathode SMT

ILLINOIS 350 MFD 3 WV SMT-3503 PAT PENDING

Tubular SMT

PE Octal Plug-in

UMP Twist Prong

UMS Molded Terminal

UMC Energy Storage and Photo Flash

LN Flexible Lead Types, Screw Neck Mounting

IHC Replacement Types

UMT Clamp Mount

MS Motor Starting

IHT Tubular Pigtaills

Illini "300" Bantam and "300"

ITC Ceramic Caseo Paper

BT Electrolytic and Paper

More than a quarter century of research and development is backed by the production facilities of four factories to produce electrolytic capacitors at any and every type to meet your requirements. Whether you need a small quantity of highly specialized types... or, large production quantities, you will find that we can offer you better service, PLUS many other advantages worthy of your consideration.

Catalog Literature Upon Request

ILLINOIS CONDENSER CO.
1616 N. Throop Street
Chicago 22, Illinois
phone: EVERglade 4-1300

Sales offices in principal cities
EXPORT DEPT., 15 MOORE ST., NEW YORK 4, N. Y. CABLE "MINTHORNE" TWX: CG3149

For complete details check No. 88 on handy card, page 95

Buy WALDOM

SOLDERLESS TERMINALS



All types and sizes. Insulated and Non-Insulated.

PANEL METERS

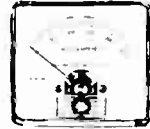

All-purpose types in Clear Plastic and Black Bakelite.

PRINTED CIRCUIT SOCKETS



8 types in various sizes from 7 to 9 pins with center shields.

PLANETARY DRIVES



Single Speed and Two Speed Models.



DIAL PLATES & KNOBS

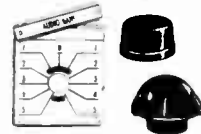

Many sizes and types to meet most applications.

Waldom Quality Line for Industry includes: Anode Connectors, Azimuth Dials, Crimping Tools, Instrument Cases, Jack or Trimmer Covers, Terminals and many others.

For complete details check No. 128 on handy card, page 95

Adjust-A-Volt

VARIABLE TRANSFORMERS

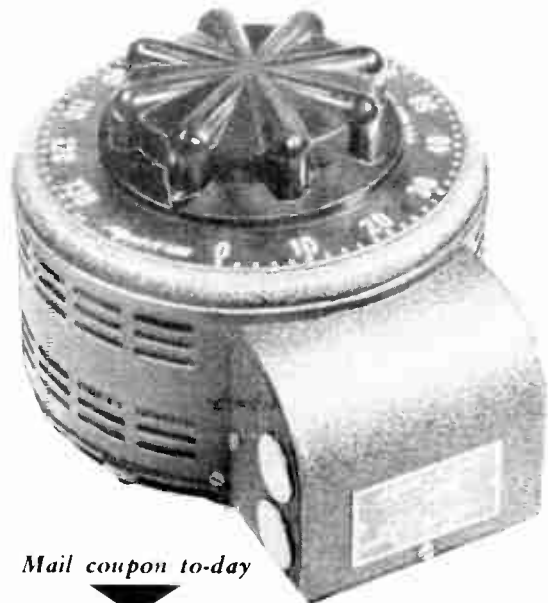

Mail coupon to-day

FOR ALL APPLICATIONS

ACTIVE RADIO & TV LIMITED
58 Spadina Avenue, Toronto 2B
Please send me your catalog.

Name

Address

For complete details check No. 117 on handy card, page 95

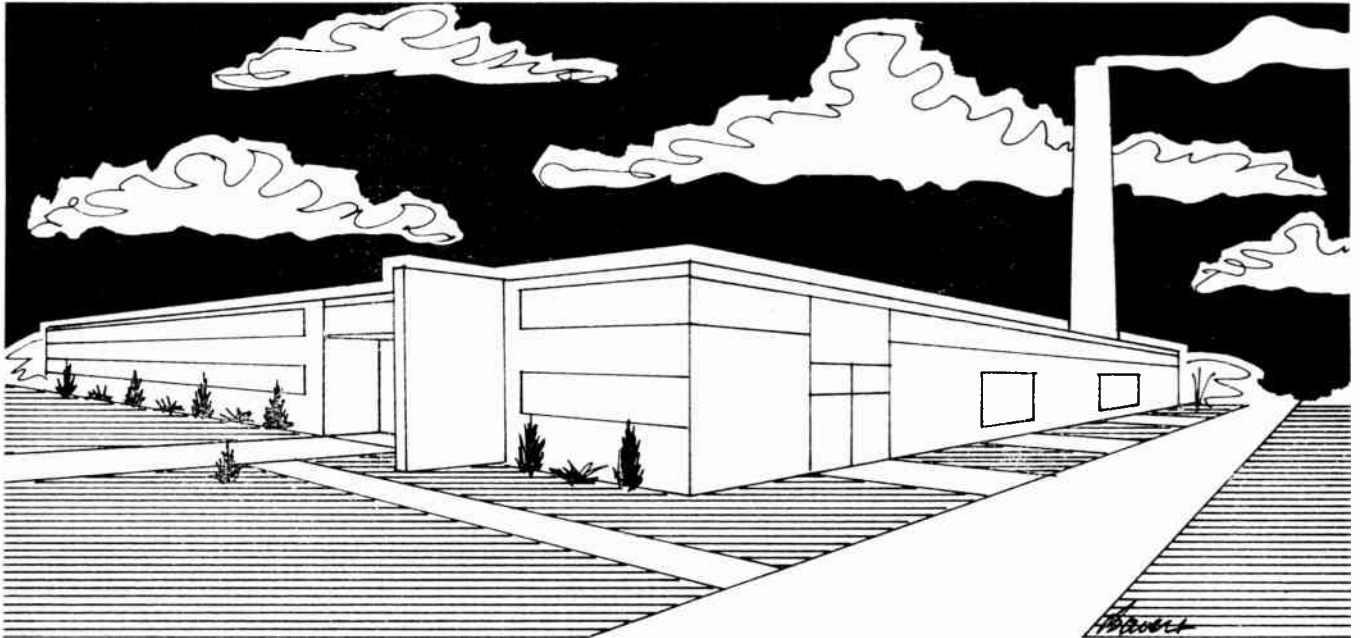

Is there a place in your industrial plant for modern electronic instrumentation?

Let us show you how electronics can help you increase production, cut costs and control product performance.

Modern electronic instruments can help you **MEASURE, COUNT, DETECT** and **CONTROL** with reliability and accuracy.

We Sell, Stock, and Service a comprehensive line of modern electronic test equipment covering the complete range from DC through microwave, as well as complete instrumentation systems and closed circuit television.

Representing:

Hewlett-Packard Company
Gertsch Products, Inc.
Kintel (Kay Lab)
Sierra Electronic Corporation,
Tel-Instrument Electronics Corp.
Erik A. Lindgren & Associates

Dymec, Inc.
Skydyne, Inc.
Weinschel Engineering and Mfg. Corp.
Taller & Cooper, Inc.
Electro Products Laboratories, Inc.

Our engineers would be pleased to assist you.



ATLAS INSTRUMENT CORPORATION LTD.

50 Wingold Avenue, Toronto 19, Canada

BRANCHES IN: MONTREAL • WINNIPEG • VANCOUVER

For complete details check No. 48 on handy card, page 95

APPLICATION FOR FREE SUBSCRIPTION

INDEX TO ADVERTISERS

Page number is on the right.
Key number for use with
READER SERVICE CARDS is
on the left.

Key No.		Page No.
38.	Adcola Products Ltd.	78
39.	Alpha Aracon Radio Co. Ltd.	71
40.	American Electrical Heater Co.	74
41.	Amperite Co.	102
42.	Ampex Corporation	14
43.	Amphenol Canada Ltd.	6
44.	Andrew Antenna Corporation Ltd.	86
45.	Armstrong Whitworth Aircraft Ltd.	10
46.	Arnold Engineering	69
47.	Arrow-Hart & Hegeman (Canada) Ltd.	73
48.	Atlas Instrument Corp. Ltd.	94
49.	Automatic Electric Sales (Canada) Ltd.	53
50.	Automatic Electric Sales (Canada) Ltd.	54-55
51.	Automatic Electric Sales (Canada) Ltd.	56
52.	Aviation Electric Ltd.	77
53.	Bach-Simpson Ltd.	18
54.	Behlman Engineering Co.	89
55.	Bendix Aviation Corp.	100
56.	Bohne Industries Ltd.	72
57.	Brush Instruments	87
58.	Burndy Canada Ltd.	9
59.	Burton-Rogers Co.	76
60.	Calvert Electronics Inc.	75
61.	Cambridge Thermionic Corp.	78
62.	Canadian Electrical Supply Co. Ltd.	73
63.	Canadian General Electric Co. Ltd.	17
64.	Canadian Lister-Blackstone Ltd.	15
65.	Canadian Marconi Co.	3
66.	Canadian Stackpole Ltd.	105
67.	Canadian Westinghouse Co. Ltd.	20
68.	Cannon Electric (Canada) Ltd.	84
69.	Centralab Canada Ltd.	4
70.	Clare Canada Ltd., C. P.	83
78.	Columbia Wire & Supply Co.	93
71.	Croven Ltd.	78
72.	Daystrom Ltd., (Weston Div.)	101
73.	Dialight Corp.	85
74.	Eitel-McCullough Inc.	7
75.	Electric Chain Co. of Canada Ltd., The	61
76.	Electro Sonic Supply Co. Ltd.	80
77.	Electronic Service Supply Co.	88
79.	Fanon Electric Co. Inc.	92
80.	G-V Controls, Inc.	76
81.	General Radio Co.	106
82.	Hackbusch Electronics Ltd.	8
83.	Hammond Manufacturing Co. Ltd.	80
84.	Helipot Division of Beckman Instruments	99
85.	Hughey & Phillips Inc.	68

(Continued overleaf)

Please ADD my name to receive ELECTRONICS & COMMUNICATIONS.

Please CHANGE my address for mailings.

NOTE — Card must be completed in full to be valid.

My Name (Please Print)

Mail copies to my home, or business address as noted below.

Street

City Zone Prov.

If you have recently CHANGED your address for receiving copies of ELECTRONICS & COMMUNICATIONS please note former address here:

Company Nature of Business
(State, when applicable, whether electronic equipment or components are manufactured, sold, or used in manufacturing, etc.)

Signature Position
3-59

PLEASE SEND FURTHER INFORMATION ON THE FOLLOWING NEW PRODUCT ITEMS AS NUMBERED BELOW — USE PRODUCT ITEM NUMBERS

- | | | | | | | | | | |
|-------------------------------|-------------------------------|-------------------------------|-------------------------------|-------------------------------|-------------------------------|-------------------------------|-------------------------------|-------------------------------|-------------------------------|
| <input type="checkbox"/> 2279 | <input type="checkbox"/> 2280 | <input type="checkbox"/> 2281 | <input type="checkbox"/> 2282 | <input type="checkbox"/> 2283 | <input type="checkbox"/> 2284 | <input type="checkbox"/> 2285 | <input type="checkbox"/> 2286 | <input type="checkbox"/> 2287 | <input type="checkbox"/> 2288 |
| <input type="checkbox"/> 2289 | <input type="checkbox"/> 2290 | <input type="checkbox"/> 2291 | <input type="checkbox"/> 2292 | <input type="checkbox"/> 2293 | <input type="checkbox"/> 2294 | <input type="checkbox"/> 2295 | <input type="checkbox"/> 2296 | <input type="checkbox"/> 2297 | <input type="checkbox"/> 2298 |
| <input type="checkbox"/> 2299 | <input type="checkbox"/> 2300 | <input type="checkbox"/> 2301 | <input type="checkbox"/> 2302 | <input type="checkbox"/> 2303 | | | | | |

PLEASE SEND FURTHER INFORMATION ON THE FOLLOWING ADVERTISEMENTS AS NUMBERED BELOW — USE KEY NUMBERS

- | | | | | | | | | | | | |
|------------------------------|------------------------------|------------------------------|------------------------------|------------------------------|------------------------------|------------------------------|------------------------------|------------------------------|------------------------------|------------------------------|------------------------------|
| <input type="checkbox"/> 38 | <input type="checkbox"/> 39 | <input type="checkbox"/> 40 | <input type="checkbox"/> 41 | <input type="checkbox"/> 42 | <input type="checkbox"/> 43 | <input type="checkbox"/> 44 | <input type="checkbox"/> 45 | <input type="checkbox"/> 46 | <input type="checkbox"/> 47 | <input type="checkbox"/> 48 | <input type="checkbox"/> 49 |
| <input type="checkbox"/> 50 | <input type="checkbox"/> 51 | <input type="checkbox"/> 52 | <input type="checkbox"/> 53 | <input type="checkbox"/> 54 | <input type="checkbox"/> 55 | <input type="checkbox"/> 56 | <input type="checkbox"/> 57 | <input type="checkbox"/> 58 | <input type="checkbox"/> 59 | <input type="checkbox"/> 60 | <input type="checkbox"/> 61 |
| <input type="checkbox"/> 62 | <input type="checkbox"/> 63 | <input type="checkbox"/> 64 | <input type="checkbox"/> 65 | <input type="checkbox"/> 66 | <input type="checkbox"/> 67 | <input type="checkbox"/> 68 | <input type="checkbox"/> 69 | <input type="checkbox"/> 70 | <input type="checkbox"/> 71 | <input type="checkbox"/> 72 | <input type="checkbox"/> 73 |
| <input type="checkbox"/> 74 | <input type="checkbox"/> 75 | <input type="checkbox"/> 76 | <input type="checkbox"/> 77 | <input type="checkbox"/> 78 | <input type="checkbox"/> 79 | <input type="checkbox"/> 80 | <input type="checkbox"/> 81 | <input type="checkbox"/> 82 | <input type="checkbox"/> 83 | <input type="checkbox"/> 84 | <input type="checkbox"/> 85 |
| <input type="checkbox"/> 86 | <input type="checkbox"/> 87 | <input type="checkbox"/> 88 | <input type="checkbox"/> 89 | <input type="checkbox"/> 90 | <input type="checkbox"/> 91 | <input type="checkbox"/> 92 | <input type="checkbox"/> 93 | <input type="checkbox"/> 94 | <input type="checkbox"/> 95 | <input type="checkbox"/> 96 | <input type="checkbox"/> 97 |
| <input type="checkbox"/> 98 | <input type="checkbox"/> 99 | <input type="checkbox"/> 100 | <input type="checkbox"/> 101 | <input type="checkbox"/> 102 | <input type="checkbox"/> 103 | <input type="checkbox"/> 104 | <input type="checkbox"/> 105 | <input type="checkbox"/> 106 | <input type="checkbox"/> 107 | <input type="checkbox"/> 108 | <input type="checkbox"/> 109 |
| <input type="checkbox"/> 110 | <input type="checkbox"/> 111 | <input type="checkbox"/> 112 | <input type="checkbox"/> 113 | <input type="checkbox"/> 114 | <input type="checkbox"/> 115 | <input type="checkbox"/> 116 | <input type="checkbox"/> 117 | <input type="checkbox"/> 118 | <input type="checkbox"/> 119 | <input type="checkbox"/> 120 | <input type="checkbox"/> 121 |
| <input type="checkbox"/> 122 | <input type="checkbox"/> 123 | <input type="checkbox"/> 124 | <input type="checkbox"/> 125 | <input type="checkbox"/> 126 | <input type="checkbox"/> 127 | <input type="checkbox"/> 128 | <input type="checkbox"/> 129 | | | | |

Name Position

Company Nature of Business

Street City Prov.
3-59

PLEASE SEND FURTHER INFORMATION ON THE FOLLOWING NEW PRODUCT ITEMS AS NUMBERED BELOW — USE PRODUCT ITEM NUMBERS

- | | | | | | | | | | |
|-------------------------------|-------------------------------|-------------------------------|-------------------------------|-------------------------------|-------------------------------|-------------------------------|-------------------------------|-------------------------------|-------------------------------|
| <input type="checkbox"/> 2279 | <input type="checkbox"/> 2280 | <input type="checkbox"/> 2281 | <input type="checkbox"/> 2282 | <input type="checkbox"/> 2283 | <input type="checkbox"/> 2284 | <input type="checkbox"/> 2285 | <input type="checkbox"/> 2286 | <input type="checkbox"/> 2287 | <input type="checkbox"/> 2288 |
| <input type="checkbox"/> 2289 | <input type="checkbox"/> 2290 | <input type="checkbox"/> 2291 | <input type="checkbox"/> 2292 | <input type="checkbox"/> 2293 | <input type="checkbox"/> 2294 | <input type="checkbox"/> 2295 | <input type="checkbox"/> 2296 | <input type="checkbox"/> 2297 | <input type="checkbox"/> 2298 |
| <input type="checkbox"/> 2299 | <input type="checkbox"/> 2300 | <input type="checkbox"/> 2301 | <input type="checkbox"/> 2302 | <input type="checkbox"/> 2303 | | | | | |

PLEASE SEND FURTHER INFORMATION ON THE FOLLOWING ADVERTISEMENTS AS NUMBERED BELOW — USE KEY NUMBERS

- | | | | | | | | | | | | |
|------------------------------|------------------------------|------------------------------|------------------------------|------------------------------|------------------------------|------------------------------|------------------------------|------------------------------|------------------------------|------------------------------|------------------------------|
| <input type="checkbox"/> 38 | <input type="checkbox"/> 39 | <input type="checkbox"/> 40 | <input type="checkbox"/> 41 | <input type="checkbox"/> 42 | <input type="checkbox"/> 43 | <input type="checkbox"/> 44 | <input type="checkbox"/> 45 | <input type="checkbox"/> 46 | <input type="checkbox"/> 47 | <input type="checkbox"/> 48 | <input type="checkbox"/> 49 |
| <input type="checkbox"/> 50 | <input type="checkbox"/> 51 | <input type="checkbox"/> 52 | <input type="checkbox"/> 53 | <input type="checkbox"/> 54 | <input type="checkbox"/> 55 | <input type="checkbox"/> 56 | <input type="checkbox"/> 57 | <input type="checkbox"/> 58 | <input type="checkbox"/> 59 | <input type="checkbox"/> 60 | <input type="checkbox"/> 61 |
| <input type="checkbox"/> 62 | <input type="checkbox"/> 63 | <input type="checkbox"/> 64 | <input type="checkbox"/> 65 | <input type="checkbox"/> 66 | <input type="checkbox"/> 67 | <input type="checkbox"/> 68 | <input type="checkbox"/> 69 | <input type="checkbox"/> 70 | <input type="checkbox"/> 71 | <input type="checkbox"/> 72 | <input type="checkbox"/> 73 |
| <input type="checkbox"/> 74 | <input type="checkbox"/> 75 | <input type="checkbox"/> 76 | <input type="checkbox"/> 77 | <input type="checkbox"/> 78 | <input type="checkbox"/> 79 | <input type="checkbox"/> 80 | <input type="checkbox"/> 81 | <input type="checkbox"/> 82 | <input type="checkbox"/> 83 | <input type="checkbox"/> 84 | <input type="checkbox"/> 85 |
| <input type="checkbox"/> 86 | <input type="checkbox"/> 87 | <input type="checkbox"/> 88 | <input type="checkbox"/> 89 | <input type="checkbox"/> 90 | <input type="checkbox"/> 91 | <input type="checkbox"/> 92 | <input type="checkbox"/> 93 | <input type="checkbox"/> 94 | <input type="checkbox"/> 95 | <input type="checkbox"/> 96 | <input type="checkbox"/> 97 |
| <input type="checkbox"/> 98 | <input type="checkbox"/> 99 | <input type="checkbox"/> 100 | <input type="checkbox"/> 101 | <input type="checkbox"/> 102 | <input type="checkbox"/> 103 | <input type="checkbox"/> 104 | <input type="checkbox"/> 105 | <input type="checkbox"/> 106 | <input type="checkbox"/> 107 | <input type="checkbox"/> 108 | <input type="checkbox"/> 109 |
| <input type="checkbox"/> 110 | <input type="checkbox"/> 111 | <input type="checkbox"/> 112 | <input type="checkbox"/> 113 | <input type="checkbox"/> 114 | <input type="checkbox"/> 115 | <input type="checkbox"/> 116 | <input type="checkbox"/> 117 | <input type="checkbox"/> 118 | <input type="checkbox"/> 119 | <input type="checkbox"/> 120 | <input type="checkbox"/> 121 |
| <input type="checkbox"/> 122 | <input type="checkbox"/> 123 | <input type="checkbox"/> 124 | <input type="checkbox"/> 125 | <input type="checkbox"/> 126 | <input type="checkbox"/> 127 | <input type="checkbox"/> 128 | <input type="checkbox"/> 129 | | | | |

Name Position

Company Nature of Business

Street City Prov.
3-59

BUSINESS REPLY CARD
No Postage Stamp Necessary if Mailed in Canada

5c POSTAGE WILL BE PAID BY

ELECTRONICS AND COMMUNICATIONS

450 Alliance Avenue

Toronto 9, Ontario



BUSINESS REPLY CARD
No Postage Stamp Necessary if Mailed in Canada

5c POSTAGE WILL BE PAID BY

ELECTRONICS AND COMMUNICATIONS

450 Alliance Avenue

Toronto 9, Ontario



BUSINESS REPLY CARD
No Postage Stamp Necessary if Mailed in Canada

5c POSTAGE WILL BE PAID BY

ELECTRONICS AND COMMUNICATIONS

450 Alliance Avenue

Toronto 9, Ontario



INDEX TO ADVERTISERS

(Continued)

Key No.		Page No.
86.	Hunt Capacitors Ltd., A. H.	23
87.	Hunt, Philip A.	83
88.	Illinois Condenser Co.	93
89.	International Business Machines Co. Ltd.	2
90.	International Resistance Co. Ltd.	6
91.	International Systcoms Ltd.	97
92.	Kelvin Electric Co.	74
93.	Kester Solder Co. of Canada Ltd.	77
94.	Lampkin Laboratories Inc.	68
95.	Lenkurt Electric	66
96.	Litton Industries	75
97.	Marsland Engineering Ltd.	69
98.	Measurement Engineering Ltd.	70
99.	Mechron Engineering Products Ltd.	67
100.	Muirhead & Co. Ltd.	90
101.	McPhar Mfg. Co. Ltd.	66
102.	Nems-Clarke Co.	81
103.	Northern Electric Co. Ltd.	76
104.	Northern Electric Co. Ltd.	103
105.	Osborne Electric Co. Ltd.	71
106.	Payette Radio Ltd.	75
107.	Phillips Electrical Co. Ltd.	19
108.	Precision Electronic Components Ltd.	73
109.	Prodelin Inc.	79
110.	Pylon Electronics Development Co. Ltd.	92
111.	Radio College of Canada	67
112.	Renfrew Electric Co. Ltd.	6
113.	Rogers Electronic Tubes & Components (A Division of Philips Electronics Industries Ltd.)	13
114.	R.O.R. Associates Ltd.	71
115.	Sarkes Tarzian Inc.	69
116.	Sprague Electric International Ltd.	68
117.	Standard Electrical Co.	93
118.	Stark Electronic Instruments Ltd.	92
119.	States Co., The	68
120.	Struthers Dunn Relays	6
121.	Syntron (Canada) Ltd.	82
122.	Tektronix Inc.	98
123.	Tishbein, O. F.	76
124.	TranSonic Ltd.	66
125.	Triplett Electrical Instruments Co., The	16
126.	Varian Associates of Canada Ltd.	91
127.	Vector Labs Inc.	80
128.	Waldom Electronics	93
129.	Ward Leonard of Canada Ltd.	100

**ELECTRONICS and
COMMUNICATIONS**

is a



audited publication



Complete SY-30 illustrated

Industrial design by Dresdner

There IS something **NEW** in Mobile Radio!

The SYSTCOMS SY-30 150Mc/s Mobile Radiotelephone — the smallest, lightest 30-watt unit available **anywhere**

Features:

- Transistorized power supply and heater voltage regulator.
- Available wide band or split channel (simple field conversion).
- Single, dual or triple channel.
- Meets or exceeds all DOT or EIA specification requirements.
- Underdash mounting practical for all vehicles.
- Transmitter-receiver unit only 4" high by 11" wide by 12" deep. Weight 15 lbs.
- All tubes operated CCS ratings. Fixed bias protection for transmitter power amplifier.

CANADIAN DESIGNED AND MANUFACTURED
Now in production. See your local SYSTCOMS dealer or write:

Distributorships
open in some
areas



International **SYSTCOMS** Limited

8235 MOUNTAIN SIGHTS AVENUE, MONTREAL • RE. 3-1814 • RE. 1-2515

NEW DC-to-30 MC DUAL-BEAM Oscilloscope

with Calibrated Sweep Delay

TYPE 555



SWEEP DELAY

Simultaneous display of pulse chain (upper beam) and third pulse on expanded delayed sweep (lower beam). Portion of original display that appears on faster delayed sweep is identified by trace brightening.

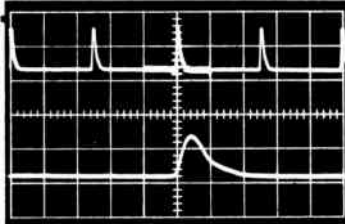

Two electron beams, each with its own X and Y deflection plates, help make possible a highly versatile dual-beam oscilloscope.

Either of the two time-base generators in the Type 555 can deflect either beam for dual and single displays, and either can deflect both beams for a dual display on the same time base.

With one time-base generator functioning as a delay generator, the start of any sweep generated by the other can be held off for a selected time interval with a high degree of accuracy. Both the original display and the delayed display can be observed at the same time. The "triggered" feature can be used to obtain a jitter-free display of signals with inherent jitter.

Signal-handling versatility is provided by nine available types of plug-in preamplifiers, any combination of which can be used in the two fast-rise vertical channels. In addition to the many application areas opened with Tektronix plug-in preamplifiers, a three-channel or four-channel display is available through use of the time-sharing characteristics of Type C-A Dual-Trace Units in one or both channels.

Please call your Tektronix Field Engineer or Representative for complete specifications.

Characteristics

INDEPENDENT ELECTRON BEAMS

Separate vertical and horizontal deflection of both beams.

FAST-RISE MAIN VERTICAL AMPLIFIERS

Passbands—dc-to-30 mc with Type K Units.
Risetimes—12 μ sec with Type K Units.

All Tektronix Plug-In Preamplifiers can be used in both vertical channels for signal-handling versatility.

WIDE-RANGE TIME-BASE GENERATORS

Either time-base generator can be used to deflect either or both beams.
Sweep ranges—0.1 μ sec/cm to 12 sec/cm. 5 x magnifiers increase calibrated sweep rates to 0.02 μ sec/cm.

SWEEP DELAY—Two modes of operation.

Triggered—Delayed sweep started by signal under observation.
Conventional—Delayed sweep started by delayed trigger.

Delay range—0.5 μ sec to 50 sec in 24 calibrated steps, with continuous calibrated adjustment between steps.

HIGH WRITING RATE

10-KV Accelerating potential provides bright traces at low repetition rates and in one-shot application.

REGULATED POWER SUPPLY

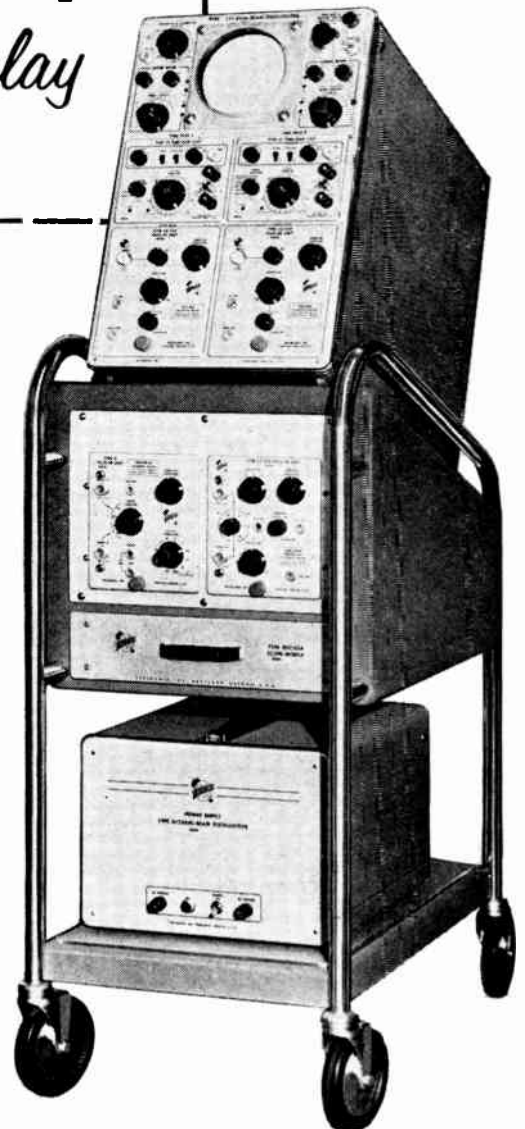

PRICE, Type 555 without plug-in preamplifiers . . . \$2700

Includes Indicator Unit, Power Supply Unit, Scope-Mobile, 4-10 x atten. probes.

Price f.a.b. factory

Tektronix, Inc.

P. O. Box 831 • Portland 7, Oregon

Phone CYpress 2-2611 • TWX-PD 311 • Cable: TEKTRONIX

TEKTRONIX FIELD OFFICES: Albertson, L.I., N.Y. • Albuquerque • Atlanta, Ga. • Bronzville, N.Y. • Buffalo • Cleveland • Dallas • Dayton • Elmwood Park, Ill. • Endwell, N.Y. • Hanston Lathrup Village, Mich. • East Los Angeles • West Los Angeles • Minneapolis • Mission, Kansas • Newtonville, Mass. • Orlando, Fla. • Palo Alto, Calif. • Philadelphia • Phoenix • San Diego • St. Petersburg, Fla. • Syracuse • Towson, Md. • Union, N.J. • Washington, D.C. • Willowdale, Ont.

TEKTRONIX ENGINEERING REPRESENTATIVES: Hawthorne Electronics, Portland, Oregon., Seattle, Wash.; Hytronic Measurements, Denver, Colo., Salt Lake City, Utah.

Tektronix is represented in 20 overseas countries by qualified engineering organizations.

CANADIAN FIELD OFFICE:

3 Finch Avenue East, Willowdale, Ontario

Phone: Toronto, Baldwin 5-1138

For complete details check No. 122 on handy card, page 95

New address for

A. Deskin Sales Co.

In order to cope with an expanding stock policy, A. Deskin Sales Co., formerly located at 6875 Fielding Ave., Montreal, Que., have found it necessary to move to larger quarters.

As of April 16, 1959, the company will be situated at 1091-14th Street, St. Martin, Que. The telephone number will be: MURRAY 1-0201.

Electronic Parts Distributors Show

The continuing interest of Canadians in the Electronic Parts Distributors Show to be held in the Conrad Hilton Hotel, Chicago, from May 18 to 20 inclusive, will be evidenced by the larger number from the Canadian electronics industry who are expected to attend the show this year.

Canadian interest will center around the Canadian headquarters in Room 419 of the Conrad-Hilton. The headquarters will be under the direction of Chas. G. (Jerry) Pointon, chairman of the Canadian Electronic Sales Representatives, assisted by Canadian HQ Manager John T. Rochford and a capable receptionist to receive and register Canadian delegates. Headquarters will be open day and evening, commencing at 9:00 a.m. on Monday, May 18, and continuing through to the close of the show on Wednesday, May 20.

On the calendar of events will be the 16th annual Canadian luncheon, which will take place on Tuesday, May 19, with an informal reception in the Bel Air Room at 12 noon, followed by luncheon in the Beverly Room of the Conrad Hilton at one o'clock. An outstanding speaker will be guest of honor and C. G. Pointon will chair the luncheon.

On Wednesday morning, at 8:30 o'clock, the annual breakfast meeting of the Canadian Electronic Sales Representatives, will be held in Private Dining Room No. 8 in the Palmer House. This is a closed meeting for members only.

Electrolabs appointed exclusive Canadian representatives

Ultrasonic Engineering Company, Maywood, Illinois, announce the appointment of Electrolabs, 7385 St. Lawrence Blvd., Montreal, as their exclusive Canadian representative.

'Ultrasonic Engineering' make a line of sonic and ultrasonic equipment for industrial, medical and scientific use. Their products comprise a wide range of types in terms of frequency range, output power and vessel sizes. Distributor and user inquiries are invited.

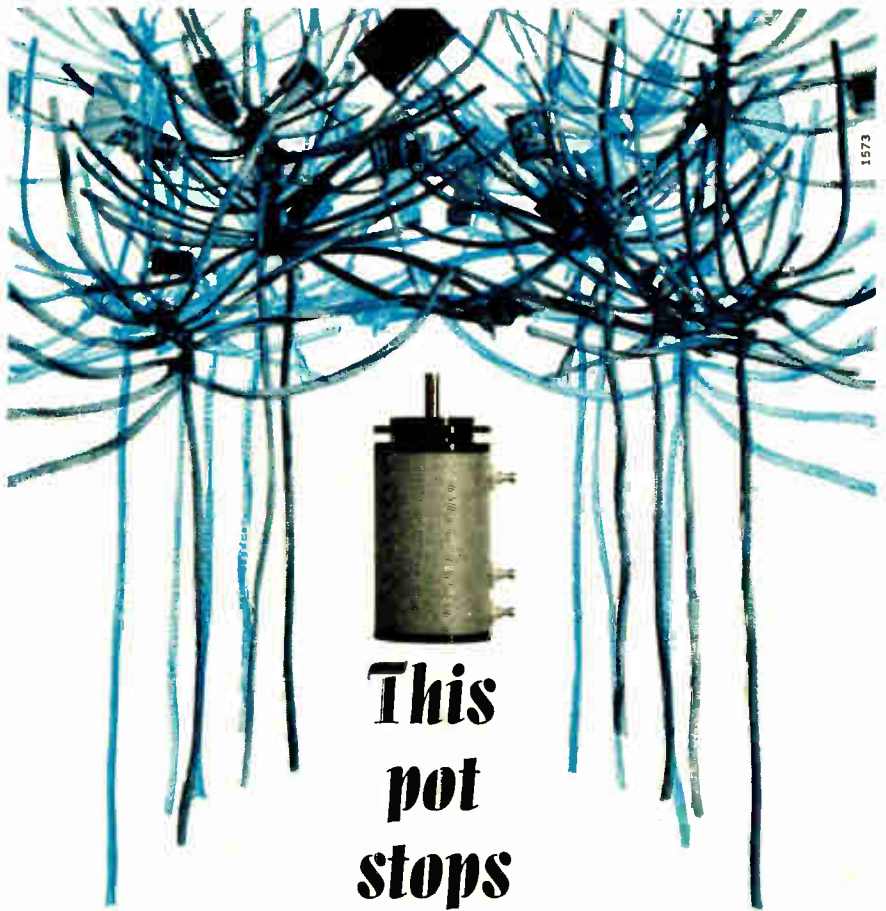

This pot stops hunting

There are no magic components. The familiar type of servo-hunting can be avoided only by overall system design.

But, by specifying the HELIPOT® 7/8" Series 7200, you can stop another, equally serious kind of hunting...for the buried ten-turn pot whose sheared stop or seized shaft has caused a system failure.

The all-new Series 7200 blocks servomotor overshoot with 128 oz. in. of stop strength. Shaft bearings, front and back, resist radial loading.

Priced for the parsimonious, this instrument-quality potentiometer has 18" of high resolution coil neatly helixed in its 1-1/2" long case. Your accuracy requirements are answered by linearities to $\pm 0.05\%$.

Interested?... You should be! This volume-produced pot is long on everything but price and delivery!

For your further enlightenment...

resistance range 25 to 125,000 ohms

power rating 1.5 watts at 40°C

noise 100 mv maximum

starting torque 0.6 oz. in. maximum

moment of inertia 0.2 gm. cm².

Applicable sections of NAS 710, MIL-R-19, JAN-R-19 and MIL-R-19518 are met or exceeded... and we have certified test data to prove our every claim. To enrich your leisure hours, write for Data File E32.

Beckman® Helipot®

Helipot Division of Beckman Instruments, Inc.
Toronto, Ontario
Sales Representative: R-O-R Associates, Ltd.
Don Mills, Ontario

potentiometers : dials : delay lines : expanded scale meters : rotating components : breadboard parts

For complete details check No. 84 on handy card, page 95

COMPACT, LOW COST POWER for hundreds of uses



"VOLTABLOC" BUTTON CELLS

NICKEL-CADMIUM • SINTERED • Hermetically Sealed • RECHARGEABLE

6 TYPES

Available:

- VO — .100
- VO — .180
- VO — .250
- VO — .500
- VO — 1
- VO — 2

Write for literature.

Button cells are the latest addition to Saft's extensive line of "Voltabloc" hermetically sealed, nickel cadmium sintered-plate batteries. Smaller than a silver dollar, these miniature batteries offer unlimited possibilities in electronic and electrical applications.

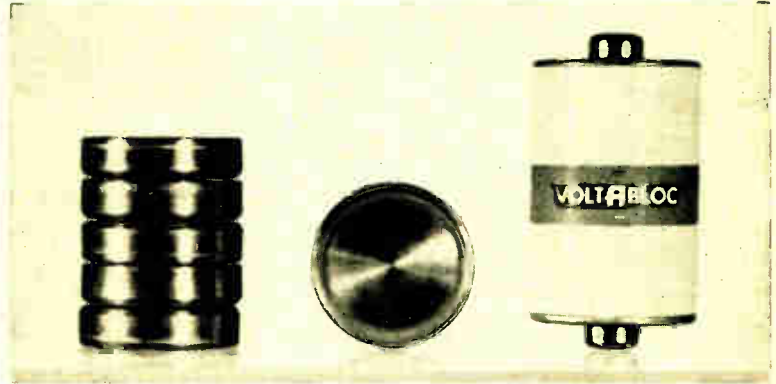

**WARD LEONARD
OF CANADA LIMITED**

1070 BIRCHMOUNT ROAD TORONTO 16

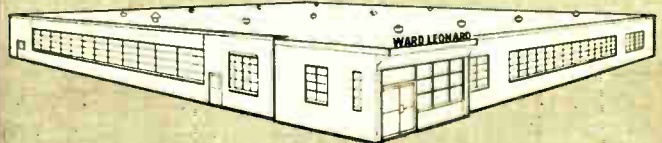

CANADIAN FACTORY AND HEAD OFFICE

Resistors • Rheostats • Relays • Motor Controls • Dimmers • SAFT Batteries • Barkelew Switches • Kenco Pumps 5806-R
For complete details check No. 129 on handy card, page 95

BENDIX SR RACK AND PANEL CONNECTOR

*with outstanding resistance
to vibration*

The Bendix type SR rack and panel electrical connector provides exceptional resistance to vibration. The low engagement force gives it a decided advantage over existing connectors of this type.

Adding to the efficiency of this rack and panel connector is the performance-proven Bendix "clip-type" closed entry socket. Insert patterns are available to mate with existing equipment in the field.

Available in general duty, pressurized or potted types, each with temperature range of -67°F to $+257^{\circ}\text{F}$.

Here, indeed, is another outstanding Bendix product that should be your first choice in rack and panel connectors.

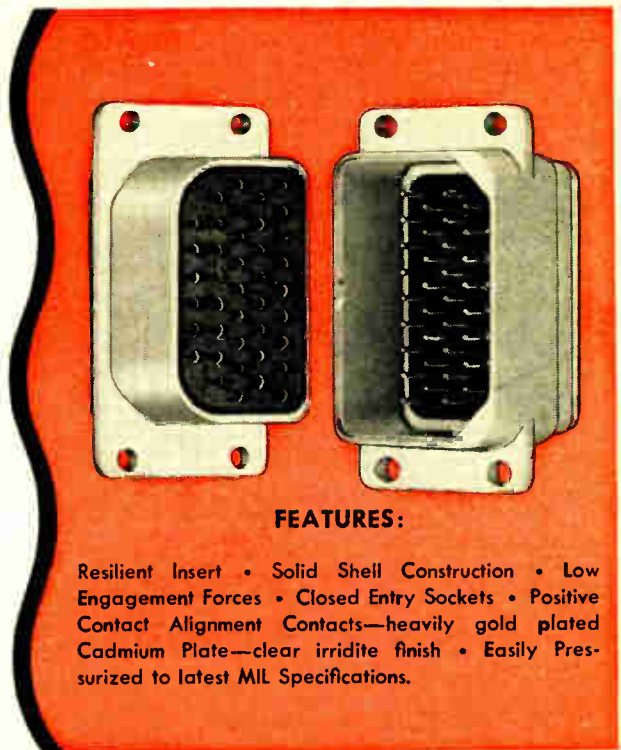

FEATURES:

Resilient Insert • Solid Shell Construction • Low Engagement Forces • Closed Entry Sockets • Positive Contact Alignment Contacts—heavily gold plated Cadmium Plate—clear irridite finish • Easily Pressurized to latest MIL Specifications.

SCINTILLA DIVISION
SIDNEY, NEW YORK



Export Sales and Service: Bendix International Div., 205 E. 42nd St., New York 17, N. Y.
Canadian Affiliates: Aviation Electric Ltd., 200 Laurentien Blvd., Montreal 9, Quebec.

For complete details check No. 55 on handy card, page 95

Centralab appoints distributor sales rep

Peter J. Heenan Ltd. of Toronto, Ontario, has been appointed distributor sales representative in Eastern Canada for Centralab electronic components. This is in addition to Heenan's previous responsibility of industrial sales in the territory.

The announcement of Heenan's expanded responsibilities was made in Milwaukee by James A. Hannan, sales manager, International Division of Centralab, a Division of Globe-Union Inc., of which Centralab Canada, Ltd. is an affiliate.

Mr. Hannan stated that this appointment is another step in integrating the Centralab Canada organization as a self-sufficient member of the parent company. This step has been taken because of the rapid growth of the Canadian electronics market and the anticipated further expansion of the industry in this dynamic region.

Peter J. Heenan Ltd.'s headquarters are at 804 Mount Pleasant Road, Toronto 12, Ontario.

U.K. exhibits at National Industrial Production Show

The National Industrial Production Show, to be held May 4 to 8 inclusive, in the Industry Building, C.N.E. Park, Toronto, will be augmented by the addition of a group display by British manufacturers being organized by the British Board of Trade and the Birmingham Exchange and Engineering Center.

This action is partly in response to the policy of the British and Canadian Governments to favor imports from Great Britain of which the visit to Britain of the Canadian Trade Commission in 1958 was striking evidence.

Impressed by the importance and success of the National Industrial Production Show of Canada, held for the first time in May 1957 on a two-yearly basis, the British Trade Commission of Toronto on behalf of the British Board of Trade approached the Show management to reserve a block of space for British exhibits under their direction. Arrangements were finally completed after a visit to England of E. M. Wilcox, manager of the Show, where he attended a meeting of some fifty British manufacturers in Birmingham.

The object of the National Industrial Production Show of Canada is to present in one place a collection of engineering equipment that will provide the latest ideas for production improvement to plant executives and engineers.

CUT LAB EQUIPMENT COSTS IN HALF



ELECTRONIC KITS

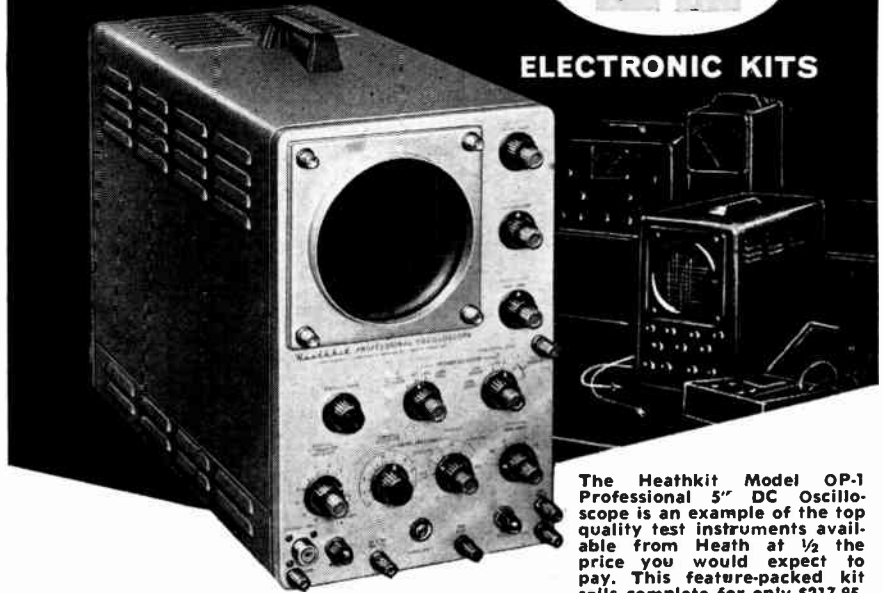

The Heathkit Model OP-1 Professional 5" DC Oscilloscope is an example of the top quality test instruments available from Heath at 1/2 the price you would expect to pay. This feature-packed kit sells complete for only \$217.95.

Heathkits give you twice as much equipment for every dollar invested.



The Heathkit Model V-7A is the world's largest selling VTVM. Precision 1% resistors are used in the voltage divider circuit for high accuracy and an etched circuit board simplifies assembly and cuts construction time in half. Price of this outstanding kit is only \$35.95.



The Heathkit Model PS-4 Variable Voltage Regulated Power Supply Kit is another outstanding example of Heath Company engineering ingenuity. Truly professional in performance as well as appearance yet it costs only \$74.95.

FREE CATALOGUE



Write today for the latest catalogue describing over 100 easy-to-build, high quality electronic kits.

A DAYSTROM UNIT **DAYSTROM LIMITED**

Distributors of Heathkits in Canada

**2 RATHERM ROAD
TORONTO 19, ONTARIO**

5907

For complete details check No. 72 on handy card, page 95

AMPERITE PREFERRED

by design engineers—because they're
MOST COMPACT • SIMPLEST • MOST ECONOMICAL
HERMETICALLY SEALED



Thermostatic DELAY RELAYS

2 to 180 Seconds

Actuated by a heater, they operate on A.C., D.C., or Pulsating Current.

Hermetically sealed. Not affected by altitude, moisture, or climate changes.

SPST only—normally open or closed.

Compensated for ambient temperature changes from -55° to $+70^{\circ}$ C. Heaters consume approximately 2 W. and may be operated continuously. The units are rugged, explosion-proof, long-lived, and—inexpensive!

TYPES: Standard Radio Octal, and 9-Pin Miniature . . . List Price, \$4.00.
 Standard Delays

Also — Amperite Differential Relays: Used for automatic overload, under-voltage or under-current protection.

PROBLEM? Send for Bulletin No. TR-81

BALLAST REGULATORS

Amperite Regulators are designed to keep the current in a circuit automatically regulated at a definite value (for example, 0.5 amp.) . . . For currents of 60 ma. to 5 amps. Operate on A.C., D.C., or Pulsating Current.

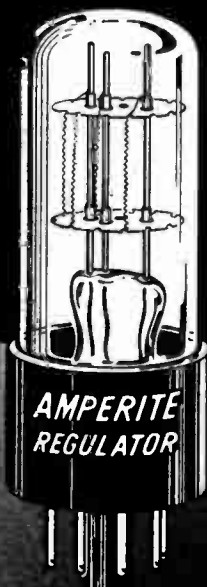
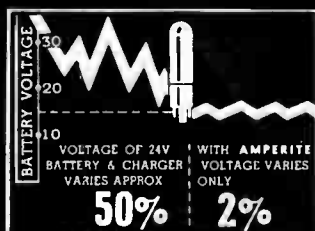

Hermetically sealed, they are not affected by changes in altitude, ambient temperature (-55° to $+90^{\circ}$ C.), or humidity . . . Rugged, light, compact, most inexpensive List Price, \$3.00.

Write for 4-page Technical Bulletin No. AB-51



AMPERITE CO. Inc., 561 Broadway, New York 12, N. Y.

Telephone: CANal 6-1446

In Canada: Atlas Radio Corp., Ltd., 50 Wingold Ave., Toronto 10

For complete details check No. 41 on handy card, page 95

E & C editor visits U.K.

It is with considerable pleasure, not unmixed with pride, that the management of Age Publications Limited has learned of the signal honor conferred upon the editor of one of its publications.

Tom Lazenby, who has so ably edited *Electronics & Communications* since its inception six years ago, has been invited by the British Government to be one of a party of four journalists from the Canadian technical press to visit



T. W. Lazenby

the United Kingdom for a month-long stay during April. This will be a rewarding experience for Mr. Lazenby to see, firsthand, evidences of the progress which is being made in trade and commerce in Great Britain. It is also very gratifying to the publishers of *Electronics & Communications* to feel that their publication, which was the pioneer paper in the Canadian electronics field, is being recognized as a representative of the Canadian technical and trade press worthy to qualify for the unique tribute which is being bestowed upon it and its editor by the British Government.

CLASSIFIED

SALES ENGINEER

With communications experience for component and apparatus sales to Electronic and Electro-Mechanical accounts in Ontario and Quebec. Applicants to be between 25 and 35 years of age with good electronics engineering experience and liking for sales work. Bilingual. asset but not essential. Position is salaried with prospects for advancement. Application should be made in writing to the Sales Manager giving full details, age, qualifications, experience and salary bracket. All applications held in strict confidence.

Box 5009
 Electronics and Communications
 450 Alliance Avenue, Toronto 9, Ont.

WANTED

Electronics Engineer. Toronto specialists, component manufacturer requires Design and Production Engineer. No age barrier. Replies held in strictest confidence.

Box 5008
 Electronics and Communications
 450 Alliance Avenue, Toronto 9, Ont.

PARTNERSHIP AVAILABLE

Small expanding business in the communications and signalling field. Some commercial experience desirable but not essential. Write for appointment to:

Box 5007
 Electronics and Communications
 450 Alliance Avenue, Toronto 9, Ont.

SERVING **YOU** BEST...

in communications

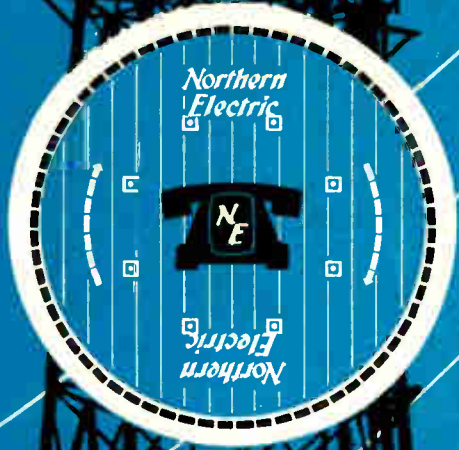
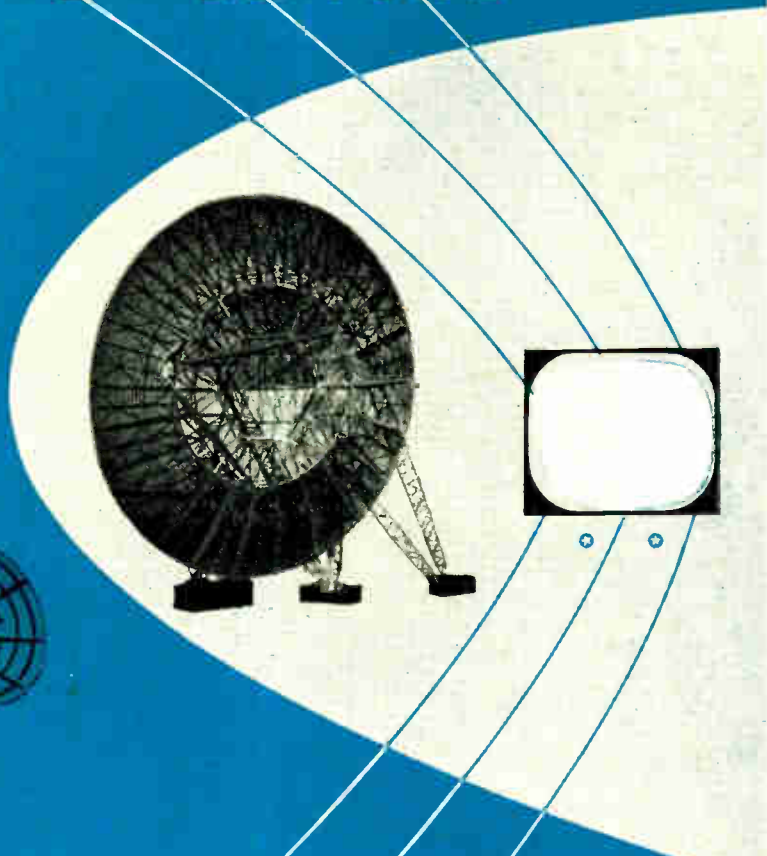

In the North a line of steel guardsmen stand on sentry duty with eyes sweeping the horizon, ears listening to the silence of the snows... by his television set a farmer is studying the weather report... at your office the switchboard is receiving the first calls of the day. This is **communications**, where Northern Electric's research and development are pioneering new techniques and improving established ones.

The equipment for Canada's Trans-Continental Microwave system was manufactured and installed by the Northern Electric Company Limited, for the Trans-Canada Telephone System.

Northern Electric
SERVES YOU BEST

For complete details check No. 104 on handy card, page 95

editorial

Industrial electronics—forefront of historic change

Within the next few years hundreds of business owners will have to make the decision of whether to automate their operations or run the risk of increased business competition from opposition concerns that have installed modern processing and testing equipment with which they are able to operate more efficiently, economically — and without doubt in the majority of cases, produce better end products.

The trend to automation in practically every type of business, both in the spheres of manufacturing and office administration, has increased a thousandfold in the past ten years. This, of course, has been due largely to the rapid development of electronics and the seemingly endless variety of functional uses to which the art of electronics can be applied.

There is little doubt that business management will of necessity have to turn to automated procedures — or if you will, the use of industrial electronic applications — in order to survive in the business world of the future. It is understandable, therefore, that the first to take advantage of the varied processes in this new technology will derive the greatest benefits and many of those who procrastinate will unfortunately fall by the wayside.

The significance which business management must of necessity attach to the use of automation is comprehensively summed up in the words of Leon Bagrit, Deputy Chairman and Managing Director of Elliott-Automation, Ltd., who, writing on the subject of “The New Technology” in a recent *Financial Times* survey of electronics and automation, said: “One interesting and possible decisive trend in the electronics and automation fields which must be remembered is that most new developments tend to make automation and electronic devices smaller and cheaper, and frequently suitable for use by small-scale producers. The impression, therefore, that electronics and automation are only for the very largest companies must be dispelled.

“There still remains, however, some confusion between ‘mechanisation’ and ‘automation’. Mechanisation is concerned with predetermined ‘automatic’ movements, and lacks the self-correcting character of automation. Automation’s ‘brain system’ implies a robot-like plant which not only carries out its operations automatically, but which will adapt the instructions given to it in accordance with the conditions it finds in its operation. It will observe, sense, and decide what action is the best under existing circumstances, and then signal the ‘muscles’ of the system to ‘self-correct’ in minute fractions of a second — far faster than any human intelligence. The speed and volume of these computations are possible only with electronics.

“Unfortunately, many industrialists are reluctant to face up to the technological future and its problems. Sometimes an attitude is adopted of playing down the meaning and consequences of automation — that there is nothing ‘really new’ in automation except, perhaps, a few gimmicks. This reflects a failure to understand the significance of a trend which is destined to change the whole of our society.

“The same type of ‘systems engineering’ is used in producing atomic energy, controlling flight, and operating a chemical plant. In each case one can expect to reach great heights of productivity with all the consequent effect upon the standards of living and upon the creation of real wealth.

“When the history of our time comes to be written, the second half of the twentieth century may well be described as the age of ‘automation and nucleonics’, characterized by the almost limitless supply of electrical energy driving machines and operating plants controlled by automation. Those who use the new techniques to the full will find themselves in the forefront of historic change; those who are indifferent to the new techniques may find themselves very much in the same position as those who delayed using steam power and machines in the first industrial revolution.”

In cognizance of the importance of industrial electronics to Canadian industry, *Electronics and Communications* magazine is presenting this Industrial Issue which, it is hoped, will assist in some degree those who seek further information on the varied capabilities of this new technology. While it has only been possible to deal with but a few applications, they have been chosen with the view to stimulating extended thought on the application of electronics to whatever business the reader may be engaged in.



how many Resistors have you soldered recently?

It's no trick today to obtain resistors that give everything you need in the way of conventional characteristics such as load life, resistance-temperature, temperature cycling, and so on.

But what a whale of a difference when it comes to "solderability"! Try the different makes for yourself and see. Whether you solder by hand or by automatic dipping, you'll find that Stackpole Coldite 70+ resistors solder lots better, lots faster and lots more surely.

Just hit 'em with solder and they stay soldered—because they're the only resistors whose leads get an extra final solder dip *in addition* to the usual tin-lead coating. You get faster production, fewer rejected assemblies. And there's less chance of trouble developing after your products reach the field.

COMPARE THESE "SPECS"! — Write for Stackpole Resistor Bulletin giving complete scorecard for Coldite 70+ (cold-molded) resistors in relation to MIL as well as commercial specifications. And remember that they give you unmatched solderability in the bargain—at no extra cost!

CANADIAN STACKPOLE LTD., 550 Evans Ave., Toronto 14, Ont.



Ceramag® ferromagnetic cores • Slide and Snap switches • Variable composition resistors
Ceramagnet® ceramic magnets • Fixed composition capacitors • Electrical contacts
Brushes for all rotating electrical equipment
Hundred of related carbon, graphite, and metal powder products.

STACKPOLE
Coldite 70+
fixed composition resistors

For complete details check No. 66 on handy card, page 95

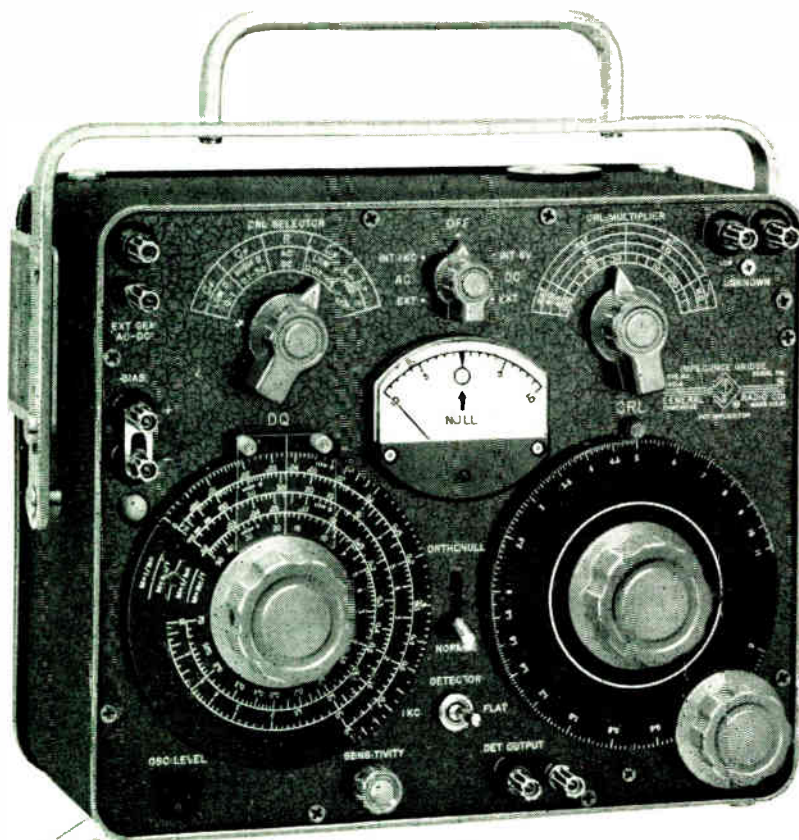

**RUGGED
PORTABLE PACKAGE**



... provides protection in transit and convenience in use



... panel tilts to any convenient angle



Announcing... A NEW IMPEDANCE BRIDGE

A Completely New Design to Replace A Famous G-R "Workhorse"

- ★ Bridge is battery operated and completely self contained — has built-in transistorized 1-kc oscillator and selective detector; meter null indication for both ac and dc. Total battery drain is less than 10 ma, providing 1-yr. life for typical laboratory use.
- ★ Orthonull* — a new, unique mechanical ganging of bridge's variable elements permits measurements to be made *without annoying sliding balances*.
- ★ Wide range — to 1000 μf , 1000 h, and 10 M Ω .
- ★ Accuracy holds over all ranges — not reduced at range extremes.
- ★ Provision for applying up to 600v dc to capacitors and small currents to inductors for polarization purposes and measurements at various d-c levels.

PARAMETER	RANGE	ACCURACY
Resistance, AC and DC (External DC required above 100 k Ω)	0.001 Ω to 10 M Ω 8 ranges	$\pm 1\%$ $\pm 0.001 \Omega$ (residual R $\approx 1 \text{ m}\Omega$)
Capacitance, series or parallel	1 μf to 1000 μf 7 ranges	$\pm 1\%$ $\pm 1 \mu\text{f}$ (residual C $\approx 0.5 \mu\text{f}$)
Inductance, series or parallel	1 μh to 1000 h 7 ranges	$\pm 1\%$ $\pm 1 \mu\text{h}$ (residual L $\approx 0.2 \mu\text{h}$)
D (for series capacitance case)	0.001 to 1 at 1 kc	$\pm 5\%$ ± 0.001 at 1 kc
D (for parallel capacitance case)	0.1 to 50 at 1 kc	$\pm 5\%$
Q (for series inductance case)	0.02 to 10 at 1 kc	$\pm 5\%$
Q (for parallel inductance case)	1 to 1000 at 1 kc	For 1/Q $\pm 5\%$ ± 0.001 at 1 kc

FREQUENCY RANGE: (1-kc supplied internally)
 1% accuracy for L and C from 20c to 20 kc
 1% accuracy for R from 20c to 5 kc
 D and Q ranges are direct reading at 1kc

Type 1650-A Impedance Bridge . . . \$440.

Type 1650-PI Test Jig, for convenient production testing . . . \$19.00.



SEE IT AT THE IRE SHOW

along with 15 other important new instruments

Booth Numbers 3302-3312

*U.S. Patent 2,872,639

GENERAL RADIO COMPANY

The Best Instruments In Electronics

99 FLORAL PARKWAY, TORONTO 15, ONTARIO

Arthur Kingsnorth

Richard J. Provan

Telephone: CHerry 6-2171

Repair Service:
Bayly Engineering, Ltd.,
Ajax, Ontario