

General View Of Jodrell Bank Telescope (see story on page 16)

electronics and communications

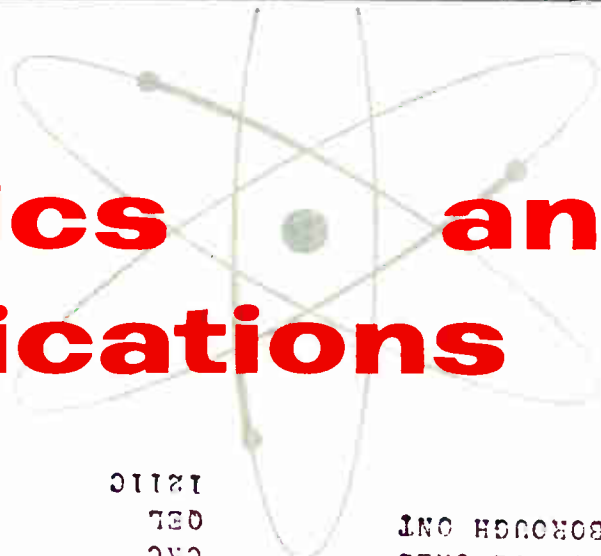

an age publication

OCTOBER 1958

1211C
DEL
CRC
EPM

MR F W PREZIOSI
8 EASTGATE CRES
SCARBOROUGH ONT

OHMITE[®] industry's most complete line of

WIRE-WOUND RESISTORS

WRITE ON COMPANY LETTERHEAD FOR CATALOG 58

Ohmite has exactly the resistor you need

Ohmite offers the most complete line of high quality resistors on the market... fixed, adjustable, tapped, noninductive, and precision resistors in many sizes and types of terminals... in a wide range of wattages and resistances. All-welded construction. Ohmite application engineers will be pleased to help you in selecting the resistors for your job.



FIXED

Resistance wire is wound on a ceramic tube and protected by a vitreous-enamel coating. Many kinds of terminals available. May be single winding, tapped, or multisection. Watts, 3 to 1000; ohms, 0.1 to 1,700,000.

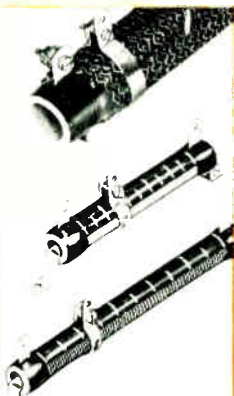

DIVIDOHM ADJUSTABLE

Vitreous-enamelled resistors with the wire exposed in a strip along one side for contact with adjustable lugs. Most Ohmite resistors can be ordered adjustable. Watts, 10 to 1000; ohms, 1 to 100K.

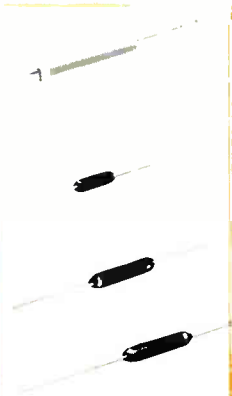

AXIAL LEAD

Small vitreous-enamelled resistors with wire leads axially welded to caps on ends of the units. Also TUBE OHM ceramic jacketed style. Watts, vitreous 3 to 10; Tubeohm, 5 to 25; ohms, vitreous 1 to 50K; Tubeohm 1 to 25K.

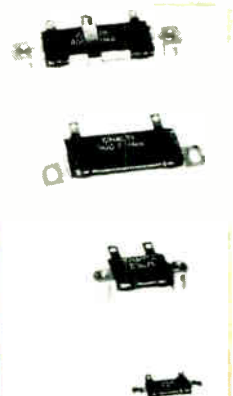

THIN

Resistance wire is wound on a core of flattened oval cross section and protected by vitreous enamel. Several sizes. Fixed, adjustable or tapped. Watts, 10 to 75; ohms, 0.1 to 100K.

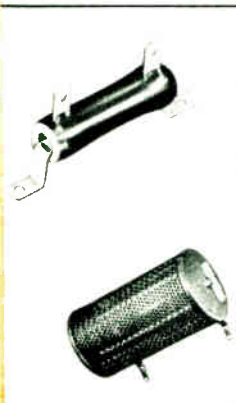

NONINDUCTIVE

Tubular vitreous-enamelled resistors with special winding. Dummy antennas consist of assemblies of several resistors. Watts, 5 to 1000; ohms, 1 to 5000.

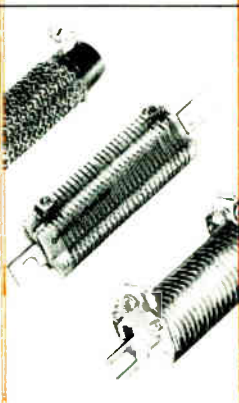

HIGH CURRENT

CORRIBS have exposed corrugated ribbon wound and enamelled on a tubular core. POWR-RIBS have bare coil of edgewise wound ribbon or round wire.



PRECISION WIRE-WOUND

Pie-wound resistors, encapsulated, impregnated, or hermetically sealed in glass. Also standard resistors wound to close tolerance. Watts, 1/8 to 2; ohms, 0.1 to 5 megohms.

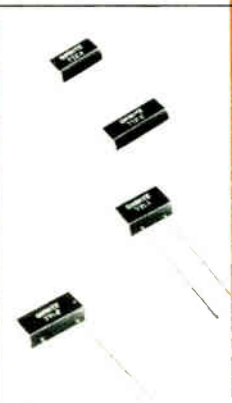

PRECISION METAL FILM

Consists of a unique metal film permanently bonded to a glass plate. The assembly is sealed in a high-temperature resistant plastic case. Watts, 1/4 at 150°C to 1/2 at 105°C; ohms, 25 to 350K.



SPECIAL VARIETIES

Ohmite can provide toroids, flat strips, plaques, special-sized tubes, or tubes with mixed terminals, etc. Watt ratings and resistances are available as required.

RHEOSTATS RESISTORS RELAYS
TAP SWITCHES TANTALUM CAPACITORS
R. F. CHOKES VARIABLE TRANSFORMERS

OHMITE MANUFACTURING COMPANY
3689 Howard Street, Skokie, Illinois



The Latest Improvement in Image Orthicons
THE ALL-NEW MARCONI TYPE 7293*!

for sharp

BLACK
to **WHITE**

transition

*without spurious
effects*

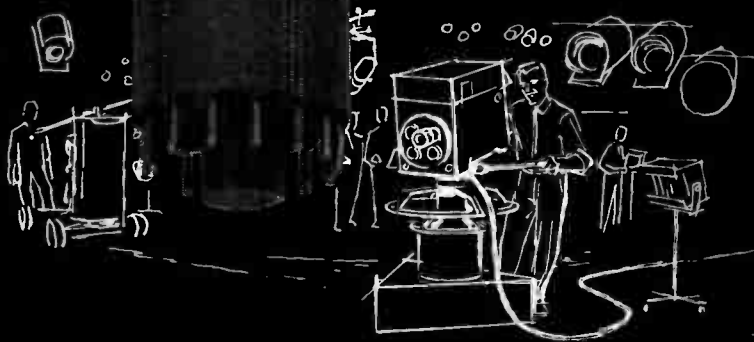

*JEDEC registration

From Marconi come new techniques of design . . . improved corner resolution, geometry and picture shading. These three important points are produced by an improved field mesh and give a critically sharp black to white transition. Send for full technical data.

ELECTRONIC TUBE AND COMPONENTS DIVISION

CANADIAN Marconi COMPANY

830 BAYVIEW AVENUE • TORONTO, ONTARIO

BRANCHES

Vancouver • Winnipeg • Montreal • Ottawa • Halifax • St. John's, Nfld.

NOW...the **accepted standard** of the **Relay Industry!**



Varian's high performance relay klystron

It's the VA-220, another outstanding example of Varian design leadership... research and product engineering that brings you optimum reliability plus performance characteristics unsurpassed by any other relay klystron.

**UNDEPASSED
FOR EVERY
RELAY APPLICATION**

Microwave relay system designers and equipment buyers have long known that Varian relay klystrons are unmatched for frequency stability, power to override noise, reliability and long life. The VA-220 gives you performance that even exceeds the high standards set by Varian X-26 klystrons... at half the cost.

In the 6000 - 8000 megacycle band, VA-220 klystrons will consistently outperform all others. Here are six reasons why this sensational new klystron is your best buy for all relay applications:

**THESE ADVANTAGES
MEAN TOP PERFORMANCE**

- **Greater Power**—VA-220 high power klystrons are conservatively rated. They will deliver more than rated power without failure.
- **Greater Frequency Stability**—VA-220 klystrons have negligible frequency drift.
- **Greater Uniformity**—Varian mass production techniques assure uniformity—every klystron is as reliable as a nut and bolt.
- **Longer Life**—VA-220 klystrons can be operated at full power for thousands of hours.
- **Less Distortion, Less Noise**—FM distortion and inherent noise are negligible—60 db below a 1-megacycle deviation.
- **Lower Cost**—VA-220 klystrons cost far less than any other relay klystron with comparable performance characteristics.

TYPE	FREQUENCY RANGE	RESONATOR VOLTAGE	POWER OUTPUT	BANDWIDTH	MODULATION SENSITIVITY
VA-220*	5925 - 7425 mc	750 v	1.2 watts	35 mc	375 kc/v
*VA-220 B, C, D, E and F each cover a frequency range of approximately 300 mc					

FOR COMPLETE SPECIFICATIONS

... and technical data on the VA-220 and other Varian klystrons, write to the Varian Application Engineering Department today.

THE
MARK OF
LEADERSHIP

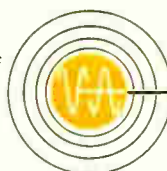

VARIAN associates
OF CANADA, LTD. • GEORGETOWN, ONTARIO

KLYSTRONS, TRAVELING WAVE TUBES, BACKWARD WAVE OSCILLATORS, LINEAR ACCELERATORS, MICROWAVE SYSTEM COMPONENTS, R. F. SPECTROMETERS, MAGNETS, MAGNETOMETERS, STALOS, POWER AMPLIFIERS, GRAPHIC RECORDERS, RESEARCH AND DEVELOPMENT SERVICES

Electronics and Communications



an age publication

Canada's pioneer journal in the field of electronics and communications engineering

Thomas W. Lazenby, editor
D. K. Trowell, editorial assistant
Leslie Hill, Ph.D.Eng., consulting editor
William Bowers, art editor
Guido Milanesio, photo editor

H. E. Dallyn, advertising manager
Arthur Dixon, assistant advertising manager
Nevill A. Campling, production manager
Paul A. Irwin, circulation manager

Norman G. McHardy, president
L. R. Kingsland, vice-pres. & sec. treas.
Clifford A. Sparks, business manager

Published by
AGE PUBLICATIONS LIMITED
450 Alliance Avenue, Toronto 9, Ont.
Telephone ROger 2-7225

publishers of
Wine, Beer and Spirits
Restaurants and Institutions
Automatic Heating
Heating, Plumbing and Air Conditioning AGE
Canadian Aircraft Industries

MONTREAL
Keith Edgar
116 Rue de Flandre
Montreal 23 (Preville), Que.
Telephone: OR. 1-2020.

WEST COAST
Dillenbeck-Galavan, Inc.
226 South Alexandria Ave.
Los Angeles 4, Calif.

U.K. AND EUROPEAN REPRESENTATIVE
Norman F. Keenan
47 Manchester Street
London, W. 1, England

Subscription Rates:
Canada, U.S.A. and U.K. Possessions \$5.00 a year
foreign: \$10.00 a year

Member Canadian Circulations Audit Board

Authorized as second class mail
by Post Office Dept., Ottawa



Printed in Canada



contents

October 1958

Vol. 6, No. 10

- 16 The Jodrell Bank Telescope Computer and Control
 - 22 Developments In Reverse Breakdown Of Silicone Diodes
By Morton B. Prince
 - 26 Quartz Crystal Measures Its Own Cleanliness
By Ernest B. Lewis
 - 30 Artificial Auditory Recognition In Telephony
By Edward E. David Jr.
 - 32 Transistor Power Units Of Giant Capacity
By Stanley E. A. Pinnell, M. Sc.
 - 33 We Were There: Pictorial Review Of The IRE Canadian Exhibition
-
- ## departments
- 11 EIA Report
 - 14 Business Briefs And Trends
 - 58 New Products
 - 65 CRTPB Newsletter
 - 66 News Report
 - 95 Book Review
 - 100 Editorial



Leadership for
22 Years...

ANTENNAS

ANTENNA SYSTEMS

TRANSMISSION LINES

The ANDREW product line covers the related fields of antennas for communication and broadcasting, and transmission lines to connect these antennas to transmitters, receivers or other electronic equipment.

PARABOLIC ANTENNAS

A wide selection of standard models in a complete range of sizes and frequencies is stocked for immediate delivery. Special antennas are designed and manufactured to meet individual requirements. Here is a representative selection of stock antennas.



Type P4-59 4-foot antenna with waveguide horn for 5925-6425 mc.

TYPE NUMBERS OF STOCK PARABOLIC ANTENNAS

Frequency Range (MC)	ANDREW Type Number			
	4 ft. dia.	6 ft. dia.	8 ft. dia.	10 ft. dia.
890-960	P4-8	P6-8		P10-8
1700-1850	P4-17	P6-17		P10-17
1850-1990	P4-18	P6-18		P10-18
1990-2110	P4-18	P6-18		P10-18
2450-2700	P4-24	P6-24		P10-24
3700-4200			P8-37	
5925-6425	P4-59	P6-59	P8-59	P10-59
6575-7125	P4-65	P6-65	P8-65	P10-65
7125-7425	P4-71	P6-71	P8-71	P10-71

Tower or roof mounts are available for all sizes of ANDREW parabolic antennas. They must be ordered separately. T4 is a tower mount for four or six-foot antennas. For roof mounting, order Type M4. Mounts for eight and ten-foot antennas are designed for either tower or roof mounting. Order Type T8 for either of these antennas. Most standard ANDREW mounts include elevation and azimuth adjustments of at least $\pm 5^\circ$.

Dish and feed heaters are available as standard items and are recommended for antennas above 5000 mc in ice areas.

COMMUNICATIONS ANTENNAS

FOLDED UNIPOLES—(25 mc to 174 mc), omnidirectional. The ideal fixed station transmitting and receiving antenna. Inexpensive, lightweight and easy to install. Some lower frequency models incorporate new design changes which increase wind load ratings and eliminate field cutting of vertical elements to frequency.

HIGH GAIN—for 148-174 mc, 400-470 mc. ANDREW High Gain omnidirectional antennas will increase your coverage and multiply benefits by the number of mobile units in the system. Type numbers, frequency and gain are shown below.

Omnidirectional Pattern		
Type 3000	148-174 mc	6.3 db
Type 3006	148-174 mc	9.0 db
Type 212	450-470 mc	10.0 db
Type 4000	450-470 mc	7.6 db
Type 4002	450-470 mc	5.0 db
Type 4010	400-420 mc	7.5 db

Offset Omnidirectional Pattern		
Type 201	450-470 mc	10.8 db in max. dir.
Type 3004	148-174 mc	8.1 db in max. dir.

CORNER REFLECTORS. Unidirectional antennas for 25-174 mc, 400-470 mc, and 890-960 mc. Preferred for their high gain and stable operation under severe weather conditions. Also may be utilized for low power TV transmitting in directional and omnidirectional arrays.

ANTENNA SYSTEMS AND PLANNING

ANDREW offers engineering assistance in the planning of your antenna-

transmission line system at no cost to you.

Be sure to visit ANDREW Booth No. 253 at the IRE Show and register for your copy of the new 1959 ANDREW Catalog No. 22.

TRANSMISSION LINES

HELIAX, flexible air dielectric cable combines the efficiency of the finest copper cables with handling ease of solid dielectric types. Available in two sizes, $\frac{7}{8}$ " Type HO and $1\frac{1}{8}$ " Type H1, with complete series of pressurized end fittings. Type HO may now be used up to 5000 mc.

RIGID AND SEMI-FLEXIBLE. Complete range of sizes for UHF and VHF systems. Semi-flexible soft copper cable in $\frac{3}{8}$ " and $\frac{7}{8}$ " sizes, rigid copper line $\frac{7}{8}$ " to 9" sizes. Adaptors and fittings available from stock. New 50 ohm, $6\frac{1}{8}$ " line now available for high power applications.

WAVEGUIDE. High efficiency aluminum or copper clad steel waveguide in sizes ranging from $9\frac{3}{4}$ " to 21" for UHF systems. Includes accessories for complete line installation.

COAXIAL SWITCH. Automatic, 50 ohm, $3\frac{1}{8}$ ", UHF and VHF. This new, automatic switch now allows high power communication systems, as well as VHF and UHF television stations, the convenience of four-second switching of $3\frac{1}{8}$ " coaxial transmission line at powers up to 10 kw at 1000 mc. Both automatic and manual models include automatic high voltage disabling switch and remote position indicating lights.

ASSOCIATED ANDREW PRODUCTS

Antenna Reflectors, Parabolic Antennas, Tropospheric Antennas, Yagi Antennas, Mobile Antennas, UHF and VHF Cable, Transmission Line (all types) Connectors, Coaxial Cable

Controls, Photoelectric Dehydrators, Automatic Filters, Microwave Filters, UHF and VHF Lighting Equipment, Tower Lines, Slotted Masts, Telescoping Phasing and Tuning Equipment

Andrew
ANTENNA
CORPORATION LTD.
WHITBY, ONTARIO

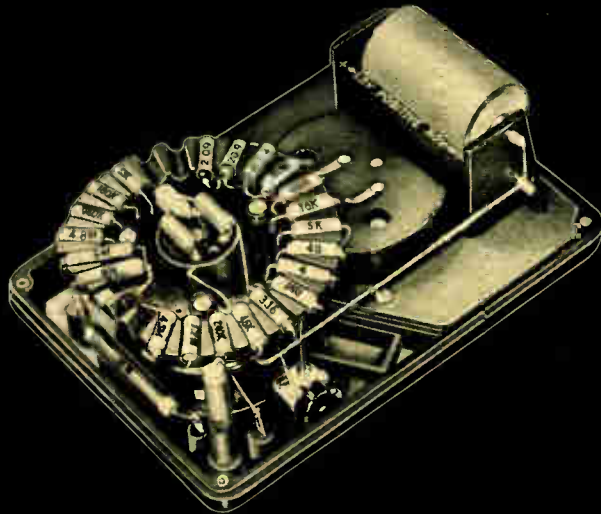

new... most easy to read

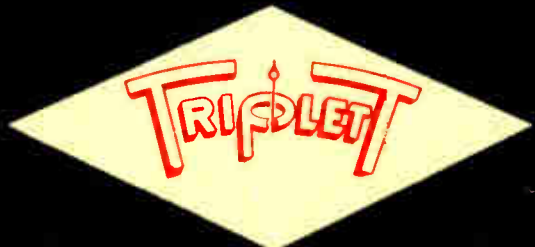

- Clear, unbreakable, shadowless front for instant wide vision.
- 5 to 500,000 cps on A.C.
- Continuous resistance reading from 0.1 ohms to 100 megohms.
- Polarity reversing switch.
- *Only one* (king-sized) switch selects both circuit and range—minimizes wrong settings, burnouts.

Only Triplet affords you such a wide choice of VOMs. Whatever your application—broad or limited—there is a Triplet VOM particularly suited for it.

the mighty nine + two

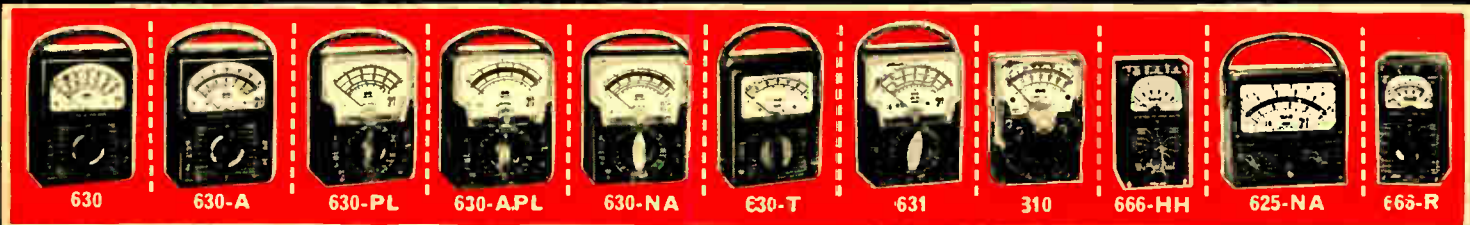

TRIPLETT ELECTRICAL INSTRUMENT COMPANY • BLUFFTON, OHIO

**JUST
ANNOUNCED!**



-hp- voltmeters for every need



-hp- 410B — 20 cps to 700 MC, ac or dc coverage, also dc VTVM with over 100 megohms input impedance, or ohmmeter 0.2 ohms to 500 megohms. Ac measurement input capacity 1.5 μ f, input impedance 10 megohms. Standard voltmeter of electronics industry. \$245.00.



-hp- 400H — 1% accuracy to 500 KC, $\pm 2\%$ to 1 MC, $\pm 5\%$ full range. 10 cps to 4 MC; 5" mirror scale meter, range 0.1 mv to 300 v. 10 megohm input impedance minimizes loading. 56 db amplifier feedback insures highest stability. \$325.00.



-hp- 400AB—high value multi-purpose VTVM. 10 cps to 600 KC, range 0.3 mv to 300 v, 11 ranges. High stability, sensitive, accuracy $\pm 2\%$ to 100 KC. 10 megohm input impedance. Reads direct in volts, dbm. \$200.00.



-hp- 400D, best VTVM value built. 10 cps to 4 MC, accurate within $\pm 2\%$ to 1 MC, range 0.1 mv to 300 v. Reads direct in v, dbm. High 10 megohm input impedance prevents circuit loading. New 56 db feedback amplifier circuit insures highest stability. \$225.00.

Data subject to change without notice. Prices f.o.b. factory.

-hp- 400L LOGARITHMIC VOLTMETER

**High accuracy
5" true log voltage scale
10 cps to 4 MC
12 db linear scale
10 db range steps
Generous scale overlap**

New Model 400L's logarithmic voltage scale plus long scale length provides an instrument of maximum readability and an accuracy which is a *constant percentage of the reading*. Voltage scales are more than 5" long, with a 12 db scale spread across the full scale length. The meter is mirror backed for maximum accuracy. A range switch changes voltage sensitivity in 10 db intervals. This feature, together with the 12 db scale, provides generous overlap and is of particular convenience in work involving decibel levels. Accuracy is $\pm 2\%$ of reading or $\pm 1\%$ of full scale, whichever is more accurate, to 500 KC.

Features of the new 400L include 0.3 mv to 300 v range (12 steps, 1-3-10-30 sequence), high stability, 10 megohm input impedance, large overload capacity, compact size. The instrument is also a stable amplifier. Model 400L (cabinet) \$325.00; (rack mount) \$330.00.

HEWLETT-PACKARD COMPANY

Represented in Canada by: ATLAS INSTRUMENT CORPORATION, LTD., 50 Wingold Avenue, Toronto 10, Ontario; 106-525 Seymour Street, Vancouver 2, B.C.; 72 Princess Street, Winnipeg, Manitoba.

4816



value standard of the industry

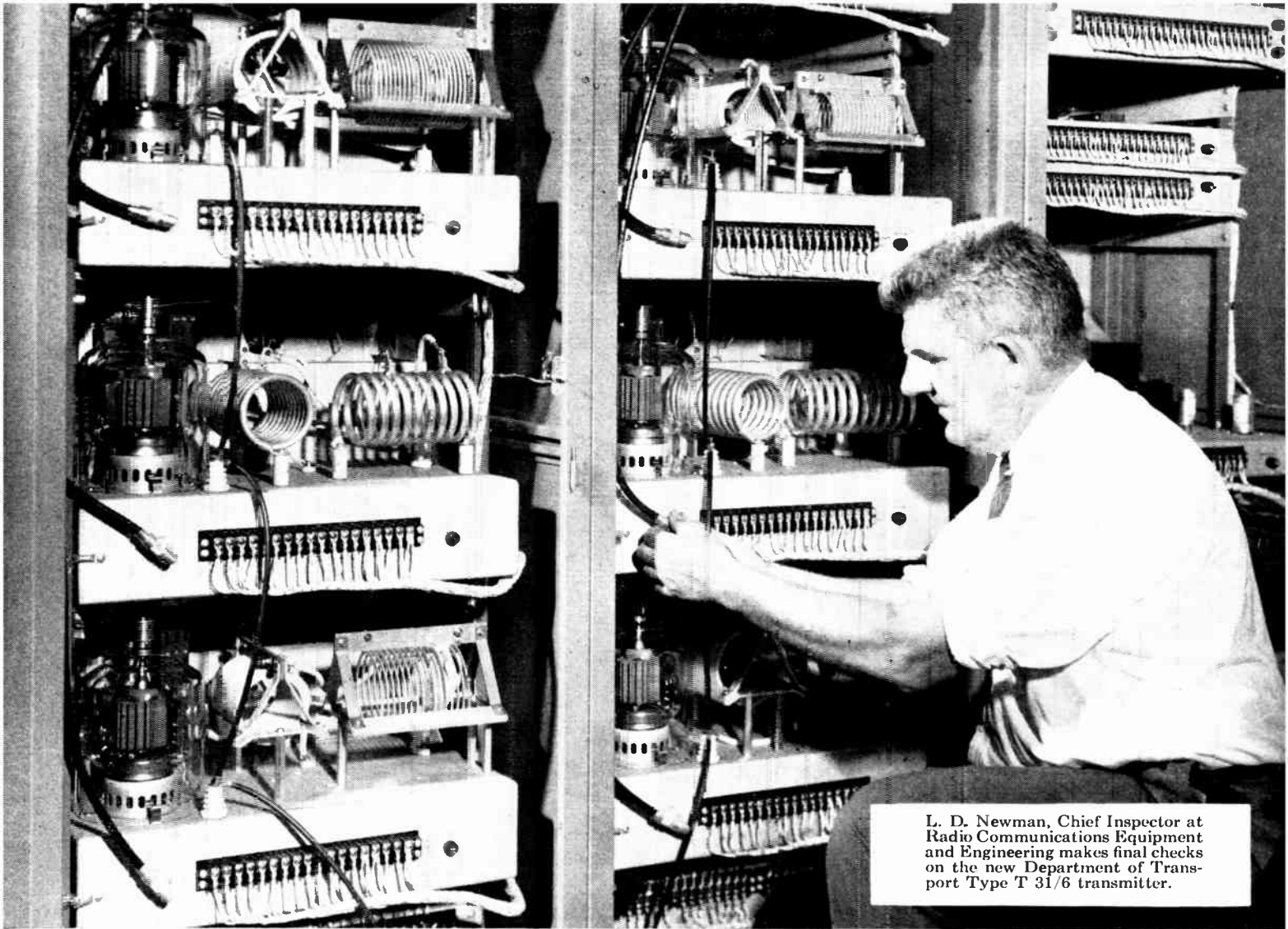

L. D. Newman, Chief Inspector at Radio Communications Equipment and Engineering makes final checks on the new Department of Transport Type T 31/6 transmitter.

NEW DEPARTMENT OF TRANSPORT RADIO TRANSMITTER EQUIPPED WITH EIMAC TETRODES

The type T 31 6 radio transmitter, shown above, has just been designed and built for the Department of Transport by Radio Communications Equipment and Engineering, Montreal. It is equipped with six 4-1000A tetrodes, manufactured by Eitel-McCullough.

Designed for CW or radio-telephone operation, the transmitter has output of 1 kilowatt carrier, and a frequency coverage of from 2 to 30 megacycles. It consists of 6 radio frequency units complete with a common modulator and power supply. A separate radio frequency unit is used for each channel so as to provide instantaneous channel switching. Complete operational control, including channel selection, may be accomplished remotely up to a distance of 20 miles over a standard telephone pair.

The Eimac 4-1000A tetrodes in the final amplifiers (the large glass tubes at the left of each unit in the photograph) operate Class C, each giving one kilowatt output when keyed, and one kilowatt carrier when amplitude modulated.

The design, quality and performance of Eimac tubes have made them first choice by manufacturers in many different fields, and for a variety of different applications. Tetrodes, pentodes, triodes, klystrons—it pays to investigate Eimac, whatever your requirements.

For further information, or for specific recommendations, write our Canadian representative: R. D. B. Sheppard, 2036 Prince Charles Road, Ottawa 3.

Eimac first FOR DEPENDABILITY AND PERFORMANCE

EITEL-McCULLOUGH, INC.

SAN CARLOS

CALIFORNIA

The World's Largest Manufacturer of Transmitting Tubes

Canadian Representative:

R. D. B. SHEPPARD

2036 Prince Charles Road, Ottawa 3, Canada



Negative Grid Tubes
Reflex and Amplifier Klystrons

EIMAC DESIGNED AND MANUFACTURED PRODUCTS
Ceramic Receiving Tubes
Vacuum Tube Accessories

Vacuum Switches
Vacuum Pumps

Includes the most extensive line of ceramic electron tubes

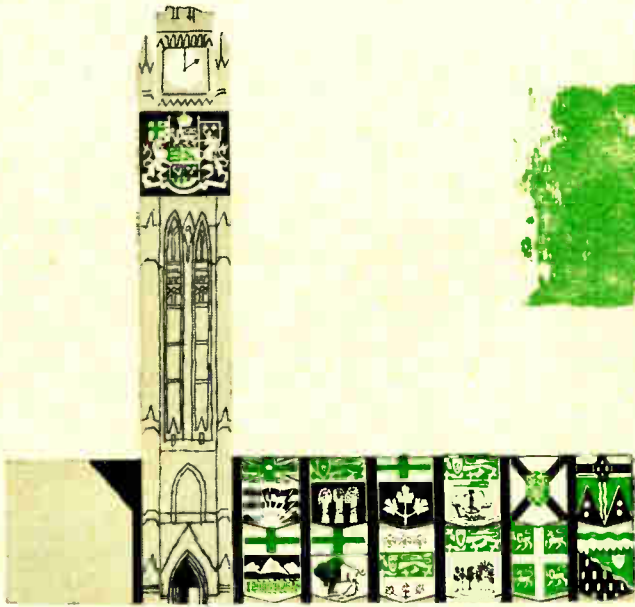

Blueprinting The Future...

"You'll find them at the intersection of 'Eleventh and Elm' in any of a thousand little towns . . . or strung across the concrete canyons of a hundred hustling cities.

You'll find them sharing the sedate seclusion of a small suburban sidestreet . . . or standing, shadowed by a towering tenement, a movie theatre, a school, a hardware store . . .

You'll stop—or go—or wait, as they direct; their red and green and amber eyes gentling you through a moiling maze of taxis, trucks, and public transport; of pedestrians and private cars.

Their shapes may vary, too—these automated sentries which secure our daily safety.

You'll see them as a street lamp . . . familiar, friendly, comforting . . . guiding your way through winter gloom and fragrant summer night . . . or as a fire alarm box, ruddy hued and cheerful . . . a patch of precious colour to add playful contrast to the graying, wistful haze of early Autumn dusk."

In keeping with their belief that Canada's future is being shaped today, the Northern Electric Company Limited is continuously searching for new and better ways to bring you more efficient traffic signals, street lighting equipment, and fire alarm systems.

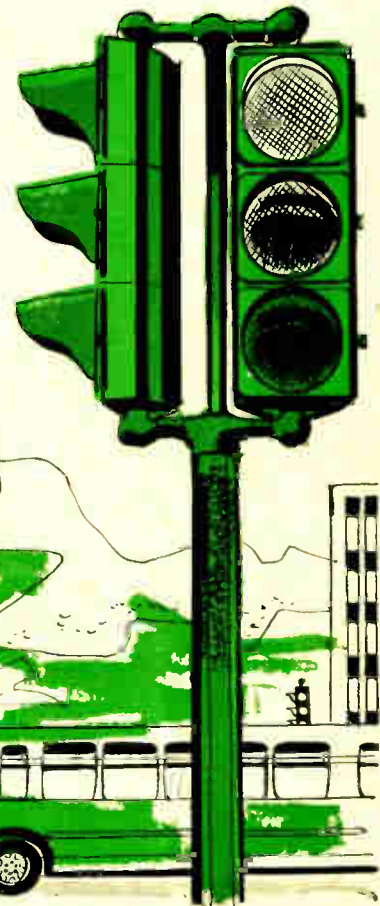

Northern Electric
SERVES YOU BEST

EIA Report

By Basil Jackson, A.R.Ae.S., Tech. M.C.A.I.

Questions and answers on electronic components

A press conference was held after the Components Division meeting at the Cedar Brae Golf and Country Club in Scarborough, Ontario, recently. The conference was organized to underline the vitally important contribution the components segment of the electronics industry makes to the advancement of the industry as a whole, and to emphasize the fact that components are essential for the construction and successful operation of all end products, including home entertainment products, military, commercial and industrial electronic equipment.

Eight very enlightening questions about Canadian electronics components were asked by members of the trade press and were answered by authoritative speakers from the Components Division of the Electronic Industries Association of Canada.

The questions, with their answers, were as follows:

What electronic components are now being made in Canada which were not manufactured here five years ago?

During the past five years over fifty additional different types of electronic components have gone into production in Canada. This is shown by comparing the 1952 edition of the EIA Trade Directory with the 1957 edition (the latest). Some of these additional components now manufactured in Canada include television distributing amplifiers, antennae couplers, picture tube bases, certain types of capacitors, connectors, crystal bases, semi-conductor diodes, ceramics, focus devices, glass-to-metal headers, hydrophones, klystrons, magnetrons, microphone and pickup cartridges, printed circuit sheet material and printed wiring boards, certain types of relays and resistors, kinescope sockets, transformer laminations, television horizontal output transformers, transistors, transistor headers and bases, television traps, automatic tuning units, television tuning units, and television deflection yokes.

There are many others which are not mentioned in this list. However, the components listed give a good idea of the ability of the components segment of the industry to advance with the development of the art and science of electronics.

Approximately how many new electronic component manufacturers have started manufacturing operations in Canada during the past five years?

It is estimated that there are about 40 per cent more electronic component manufacturers in Canada today than there were five years ago.

In general are there any types of electronic components, not now made in Canada, which it would be desirable to have manufactured here?

Yes, there are, but the great majority of electronic components are now made in Canada. However, within the types of components made in Canada there are special types that are not manufactured here. While it would be desirable to make these in Canada, the volume so far does not make this possible. However, to the degree that the EIA adoption of the "Made In Canada" campaign and the tariff policy are followed, this should eventually be achieved.

What is the approximate percentage of components, used by the Canadian electronics industry, imported from other countries?

Of the electronic equipment manufactured in Canada, the "Canadian-content" is about 80 per cent, but it is estimated that, of the overall use of electronic components in Canada, about 50 per cent is imported.

What is the annual dollar sales value of the Canadian electronic components manufacturing industry?

We believe the annual sales volume of the Canadian electronics components manufacturing industry to be in excess of \$50 million.

Some television service technicians complain about the inaccessibility of some components in the narrower television sets. Has there been any attempt to separate the various circuits so that they may be removed as separate units or sub-assemblies of components, as may be done with a tuner?

A television receiver is designed for ease of servicing. Items which are not soldered are usually located for accessibility and ease of replacement. The idea of modular construction is being given consideration continuously.

Will the EIA Office compile sales statistics on transistor radio receivers to be listed separately from portable tube-equipped radios?

The EIA Office issued forms for members to report transistor radio sales beginning with the July statistics.

EIA Report

Has any progress been made in the development of a flat television picture tube — one that can be hung on a wall — as forecast a few years ago?

Yes. During the past three years the back-to-front dimensions of television picture tubes have been shortened considerably and progress is still being made.

EIA sponsors TV servicing course

The first industry-sponsored television servicing night-school course in Canada for technical and vocational schools started at the Ryerson Institute of Technology in Toronto on October 15. Sponsored by the Electronic Industries Association of Canada, the course takes sixteen weeks, at two nights a week, to complete, and is an upgrading course for practicing service technicians. Some of the workbench equipment has been supplied by EIA member companies.

The EIA Service Committee organized the course, and it is intended to extend it, ultimately, right across Canada. This will be done by forming local industry advisory groups which will work in co-operation with the boards of education in the various cities and towns.

Over the years the EIA has assisted television service technicians to upgrade their technical knowledge to keep abreast of the rapid technological developments of the electronics industry. For many years EIA, in co-operation with the Ryerson and other educational institutes, organized the Town Meetings of Service Technicians, each a three-day concentrated course of instruction on television servicing. These meetings were very successful, and they were held in many cities and towns right across Canada, from Halifax to Vancouver.

The current course is an extension of this upgrading educational program, and an industry-recognized certificate of proficiency will be awarded to technicians who pass the final examinations. It is intended to issue progress reports on the course on a monthly basis.

EIA film well shown

The EIA film entitled "Electronics In Canada", which received its premiere on February 15, 1956 in Montreal before the Board of Directors and Receiver Division, has since been shown to over 5,000 people at various meetings. The audiences have included cabinet ministers, schoolchildren, electronic technicians, and audiences made up of EIA member companies personnel, members of religious organizations, a science film club, Canadian Army, Royal Canadian Air Force, Atomic Energy of Canada Limited, technical institutes, Gordon Royal Commission on Canada's Economic Prospects, Department of Defense Production, Canadian Arsenals, Canadian National Telegraphs, Canadian IRE Show, Department of Citizenship and Immigration and others.

This 16 mm. sound-color film gives a narrative account of the achievements of the Canadian electronics industry, its production capacity and potential, and gives some glimpses behind the scenes of Canadian research activity.

The film may be borrowed, free of charge, by service clubs, schools and other educational groups, film clubs, or any other interested groups. Just drop a line to the EIA Office, 200 St. Clair Avenue West, Toronto 7, Ontario, mentioning the date most desired for showing the film.

New members of EIA

Two new members were recently admitted into the Electronics Division as follows:

Aviation Electric Limited, 200 Laurentian Blvd., Montreal 28, Que., manufacturers of servo amplifiers, compass coupler amplifiers, VHF ground antennae, aircraft and missile gyros, accelerometers, radar scanners, and specialized test equipment.

F. V. Topping Electronics Limited, 94 Laird Drive, Toronto, Ontario, manufacturers of communications transmitter exciters, communications control equipment, transistorized radio telephone equipment, point-to-point communications equipment, transistorized audio amplifiers and power supplies, geophysical apparatus and airborne electronic devices.

THINK OF MAGNET WIRE ... THINK OF PHILLIPS

Significant changes are taking place in the Magnet wire field. Changes that may mark the beginning of a new era for magnet wire users. The successful development of Formel provided a reliable satisfactory wire for general winding purposes. Now, to meet the needs of industrial applications, the increase in Home Appliances, and the expansion in Electronics, a number of new and promising wires are being actively developed. These new types employ recently produced synthetics for their insulation, and are the result of months, even years, of painstaking research, selection, and testing.

Tests in which some of you may have participated. As a result, Daglas, Philsol, and Fuzel are now on the market, and others are coming.

You may be assured, that when new and improved magnet wires are needed—Phillips will have them.

Phillips Electrical Company Limited. Head Office—Brockville. Sales Offices—Montreal, Ottawa, Toronto, Hamilton, Winnipeg, Regina, Edmonton, Vancouver. The Canadian affiliate of the British Insulated Callender's Cables Group.

5718

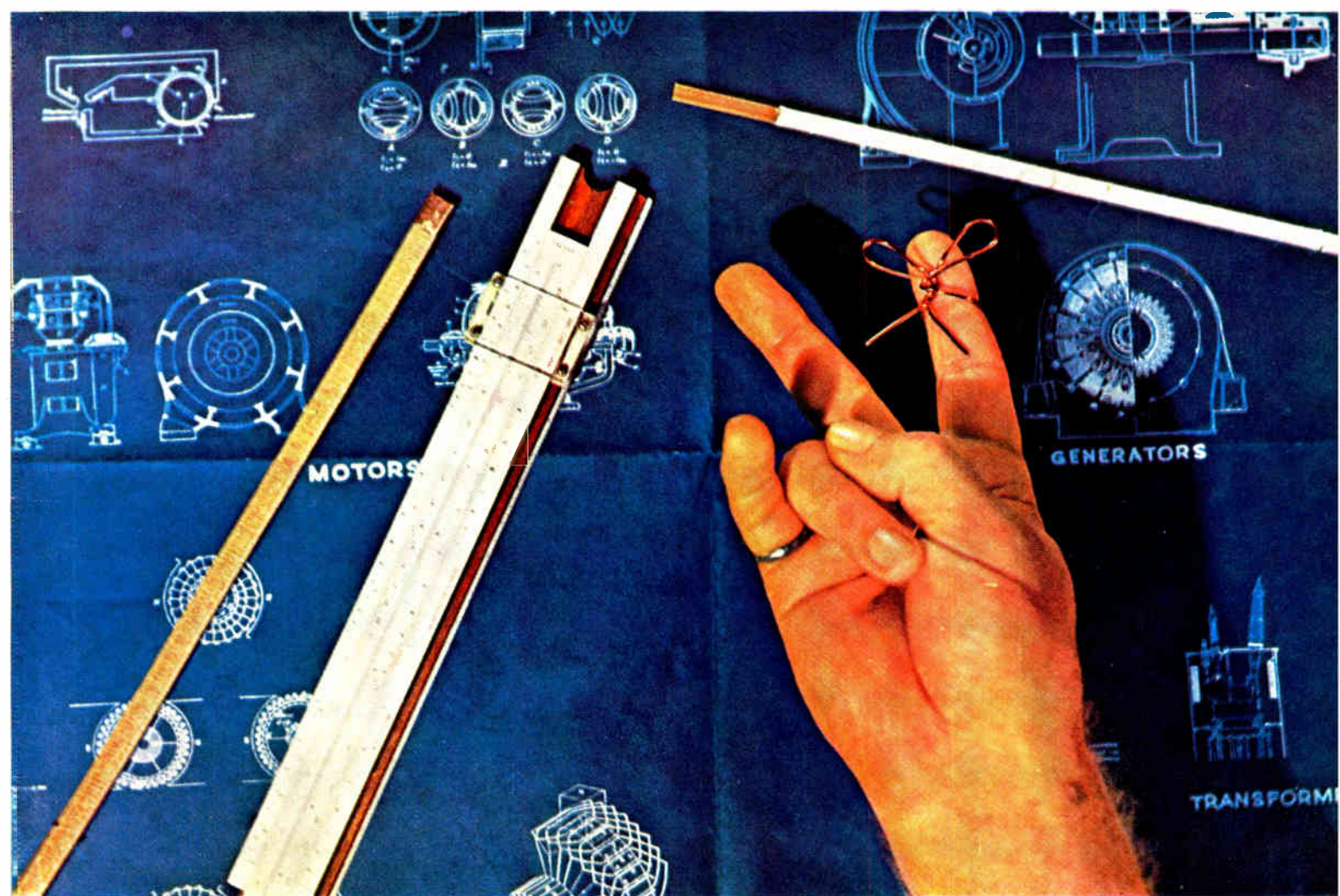

PHILLIPS ELECTRICAL  COMPANY LIMITED

business briefs and trends

★ Two Canadian scientists, Leonard Kelly, B.Sc. and James Hutter, B.Sc., department heads at the surface milling plant of Bicroft Uranium Mines, near Bancroft, Ontario, have devised an apparatus for the sorting of ores that will reduce the amount of waste rock being treated with the ore. The inventors claim that any type of ore having physical properties distinguishable by means of electronics can be treated with the K and H electronic sorter and thus reduce labor costs very materially. The electric eye mechanism and radiatron counter in the equipment were designed and developed by Electronic Associates of Toronto.

* * *

★ At a total cost of \$1¾ million, the Remington Rand Company has begun the installation of an electronic "brain" in the head office premises of the London Life Insurance Company in London, Ontario. Univac II will occupy 4,000 sq. ft. of floor space and is expected to require some 20 to 30 highly trained personnel to operate it.

* * *

★ In the opinion of R. M. Robinson, president of the Electronic Industries Association of Canada, swift action should be taken by the Canadian Government to standardize radio frequency use and thus counteract the possible overcrowding of the radio spectrum. When the full operation of the St. Lawrence Seaway takes effect next year, permitting ocean-going vessels, using many different types of radio communication, to penetrate into Canadian waters, this condition could seriously interfere with Canadian frequencies already being used; furthermore, the whole electronics industry in Canada would be seriously threatened by such interference.

* * *

★ In an address on "Manufacturing Perspective: 1958" before the Manufacturers' and Service Clubs' Day Luncheon at the Canadian National Exhibition, J. Herbert Smith, president of Canadian General Electric Company Ltd., said: "A strong Canadian defense establishment is an absolute necessity, yet it is one toward which — for a variety of reasons — Canadian manufacturers have not yet been able to contribute their full potential. There has been recent evidence of movement in the right direction in this vital area. The Estimates Committee of the House of Commons has recommended that the Defense Production Department: (1) encourage, assist and co-ordinate the growth of technical skills and knowledge in Canadian industry as a program of industrial preparedness; (2) distribute purchases as broadly as possible in Canada; (3) use the maximum of Canadian equipment and parts possible; (4) make available the technical assistance offered to larger corporations to smaller Canadian companies; (5) provide Canadian companies with every opportunity to tender on defense contracts."

* * *

★ Canada's highest power television satellite (booster station), located at Elk Lake, Ontario, which began commercial operations in mid-August, is powered by a General Electric 1500 watt modular transmitter. The Elk Lake satellite receives its signal from its parent station, CFCL-TV, in Timmins and rebroadcasts it to homes in the area, extending approximately 30 miles in all directions.

* * *

★ The Royal Canadian Naval Establishment at Halifax, N.S., is to have an ingenious training device which can simulate under-sea, surface and air actions. Named the Action Speed Teacher, it has been ordered from the United Kingdom company of Redifon Ltd. at a cost of \$900,000, and will be supplied by Redifon (Canada) Ltd. of Montreal. It is expected to take a year to build and a further six months to complete the installation in a specially constructed Establishment building.

* * *

Turn to page 24

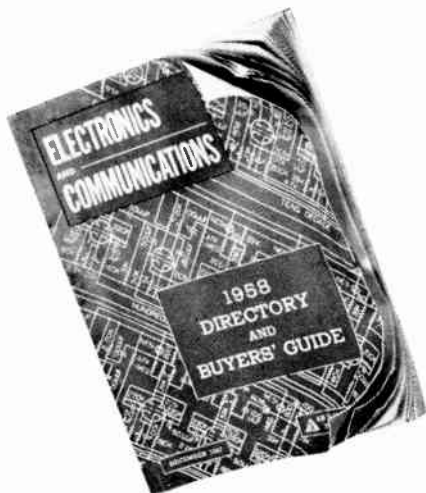

**the 1958 DIRECTORY
and Buyer's Guide
of ELECTRONICS AND COMMUNICATIONS
is still working hard
for both readers and advertisers.**

10,000 copies were mailed and three weeks after this mailing, 1,023 requests for further information were received and relayed on to interested suppliers. Many thousands have since been processed. On our last week's count, over 40 enquiries with regard to products advertised in it were received by us from Engineers and Administrative personnel and relayed on to interested suppliers—among those to whom these enquiries were addressed:

Electrovert Limited
Acme Electric Corp.
Canadian Stackpole Ltd.
Hackbusch Electronics
Ltd.
Aircraft-Marine Products
of Canada
Pye Canada Limited
Canadian Westinghouse
Co. Ltd.
RCA Victor Co. Ltd.
Canadian Marconi Co.

Alliance Motors
Radio Communications
Equipment &
Engineering
Centralab Canada Ltd.
Sperry Gyroscope Co.
of Canada
Sigma Instruments, Inc.
Electro Sonic Supply
Co. Ltd.
Erie Resistor of
Canada Ltd.

Narda Microwave Corp.
Honeywell Controls Ltd.
Northern Radio Mfg. Co.
Precision Electronic
Components
Northern Electric Co.
Conrad, Inc.
Mel Sales Limited
Sensitive Research
Instrument Corp.
International Rectifier
Corp.

Daystrom Limited
Cannon Electric
(Canada) Ltd.
Associated Electronic
Components
Barry Electronics Corp.
General Radio Company
Amphenol Canada Ltd.
Atlas Instrument
Corp. Ltd.
R. H. Nichols Co. Ltd.

J. F. D. Electronics Inc.
Burton-Rodgers Co.
Computing Devices of
Canada Ltd.
Canada Wire & Cable Co.
Rogers Majestic
Electronics Ltd.
Measurement
Engineering Ltd.
Stark Electronic
Instruments
Sola Electric Company

The 1959 Annual Directory and Buyer's Guide of ELECTRONICS AND COMMUNICATIONS will be bigger, more comprehensive than any of the previous Four Annual Directories. It goes to press December 12th. Do not fail to take advantage of the opportunity its advertising columns provides you to keep your company and its products before the entire market during all of 1959. Write for details to-day. Regular rates prevail.

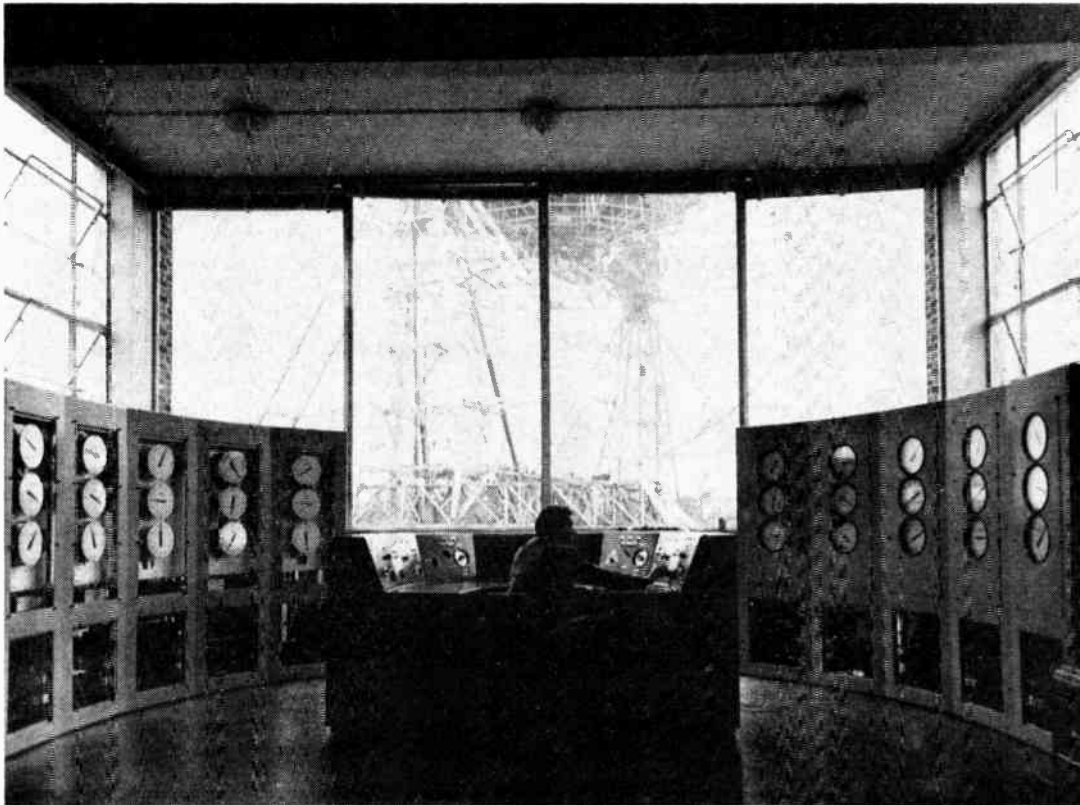

General view of the Jodrell Bank telescope and close-up of the control desk.

The Jodrell Bank telescope computer and control

In use the radio telescope is required to carry out relatively complex motions. In this article the method of computing and controlling these movements is described.

The 250 ft. diameter radio telescope built for the University of Manchester at Jodrell Bank, Cheshire, weighs approximately 2,000 tons of which some 700 tons comprise the bowl and bowl structure.

The bowl or mirror is parabolical in shape and its aperture is 250 ft. in diameter; the focus lies in the aperture plane. The bowl surface is constructed of sheet steel welded plates and the aerial is carried on a tower 60 ft. high. The bowl is pivoted on bearings at the top of two towers some 180 ft. high and is rotated by four 50 h.p. motors (2 to each pivot) through circular racks which were taken from gun mountings on the battleship 'Royal Sovereign.'

The two towers are each mounted on 4 bogies running on double tracks laid on concrete, the bogies being driven by four 50 h.p. motors.

A central pivot is provided about which the structure

revolves in azimuth and all power and signal cables are taken up through the pivot. Immediately above the pivot is the motor room housing the Ward-Leonard sets and motor control gear.

Suspended immediately below the centre of the bowl is a swinging laboratory housing pre-amplifying equipment, etc.

The basic movements are in azimuth—about a vertical axis—and, elevation—about a horizontal axis, the movements being independent; the azimuth movement is restricted to a total of 420° from $Az-90^\circ$ to $Az+330^\circ$, and the elevation to 400° , 20° either side of vertically downwards.

Acknowledgment is made to Electronic Engineering magazine, London, England, in which this article was first published, and to the United Kingdom Information Office for their co-operation in making available to Electronics and Communications magazine the first North American publishing rights for this article.

During operation of the telescope the aerial is, of course, always above the horizon, provision for tilting downwards being made for maintenance purposes and for the changing of aerials and aerial tubes.

Automatic stops are provided to prevent the telescope from moving beyond the pre-set limits on either co-ordinate.

The automatic control equipment is housed in a control room in the main building some 100 yds. from the telescope.

The telescope is remotely controlled and has the following basic facilities:—

(a) It is capable of being locked in any given azimuth and elevation.

(b) It is capable of continuous motion in azimuth with fixed elevation and vice versa and at different rates of azimuth and elevation.

(c) It is capable of continuous sidereal motion for following a particular star.

(d) It may be driven to follow several scanning motions (described below).

The control equipment comprises a central console at which the 'controller' sits and two groups of panels with indicator dials visible from the desk.

While the telescope is capable of movement in only two basic co-ordinates, azimuth and elevation, in following a star it is necessary to set up the control in its fixed co-ordinates—right ascension and declination—and a complex computer is required to convert these into the motions of which the telescope is capable; similarly, it is required to be able to scan across or along the Milky Way employing another set of co-ordinates—Galactic latitude and longitude. Again, it will sometimes be necessary to scan in azimuth and elevation and to be able to read off the positions in the other two pairs of co-ordinates—right ascension/declination and Galactic latitude/longitude. The computer must, therefore, be capable of solving instantaneously and continuously, the fundamental equations of spherical trigonometry and to be capable of control in any one of the three pairs of co-ordinates RA/Dec—Az/EI—Long/Lat.

The computer takes the form of an electrical ana-

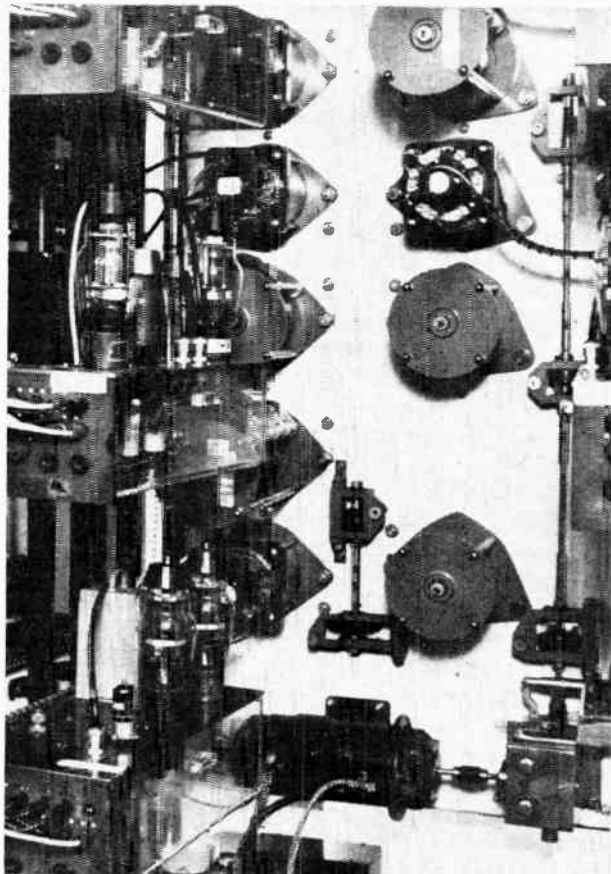

Rear view of the Azimuth co ordinate panel showing four resolver amplifiers, servo amplifier and servo motor.

logue in which Magslip resolvers (giving output signals proportional to the sine and cosine of the angle through which their rotors are turned) are employed to solve the trigonometrical equations. The resolvers employed are Muirhead type 2, in which excitation is applied to the stator windings through feedback amplifiers, the feed-

Rear view of control desk showing galactic computer, reference phase selector and servo motor controls.

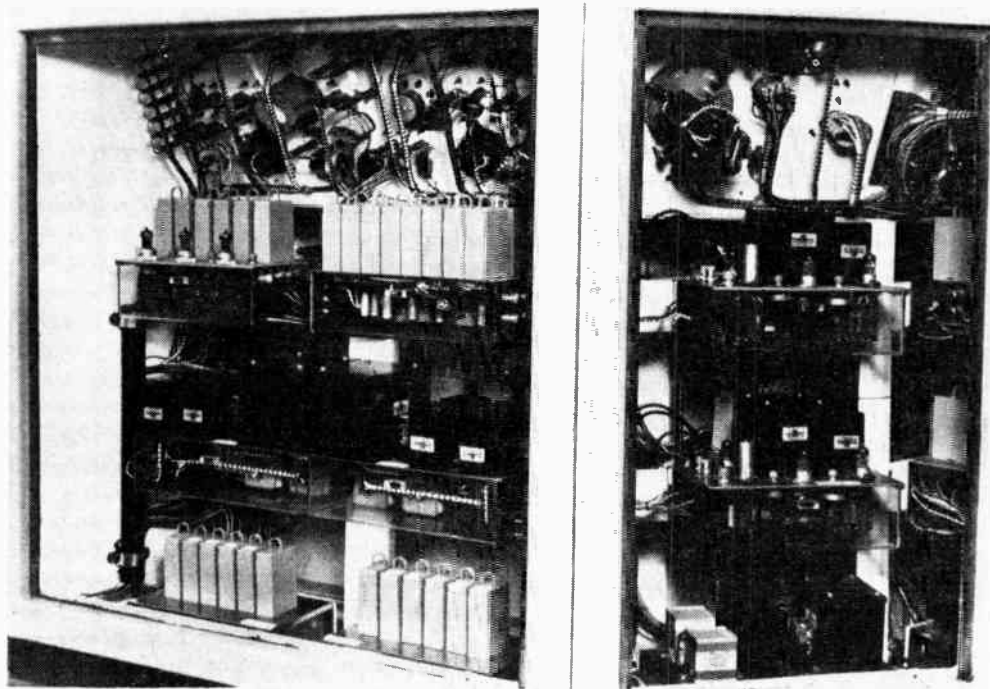

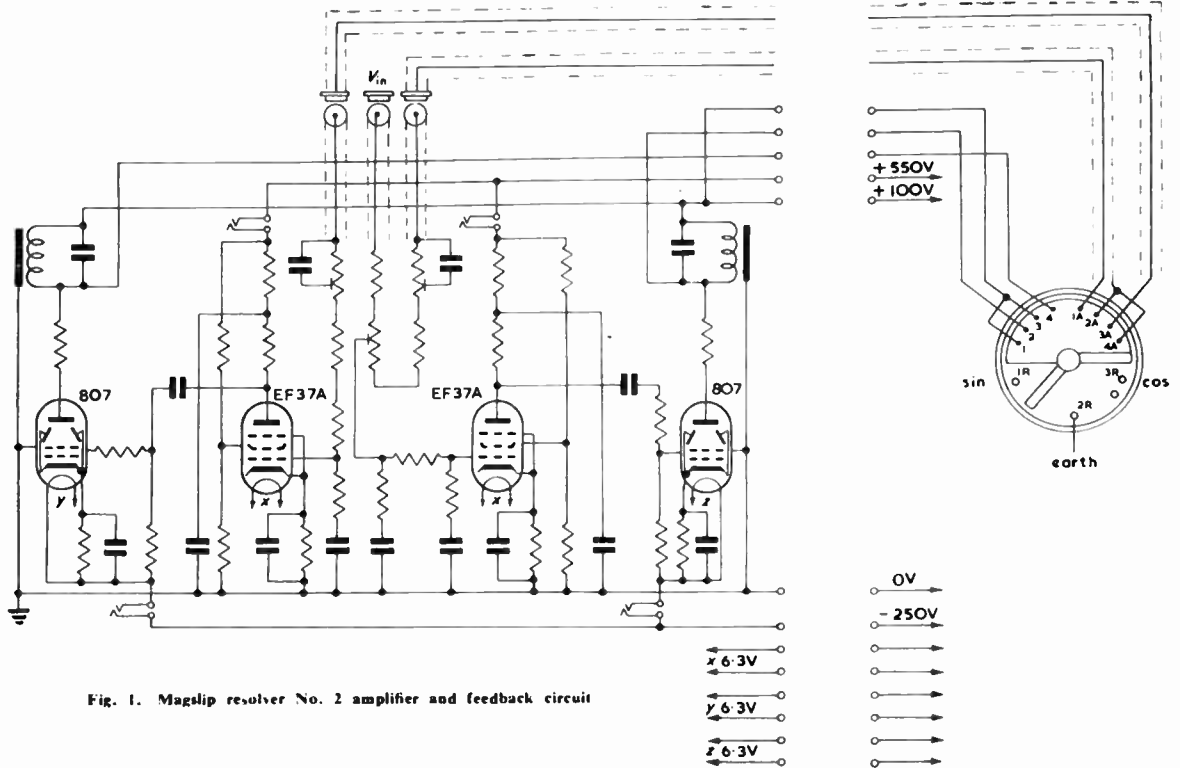

Fig. 1. Mag slip resolver No. 2 amplifier and feedback circuit

Fig. 2. Computer amplifier phase sensitive rectifier circuits (a) AZ—(Long) (b) EL—(Lat)

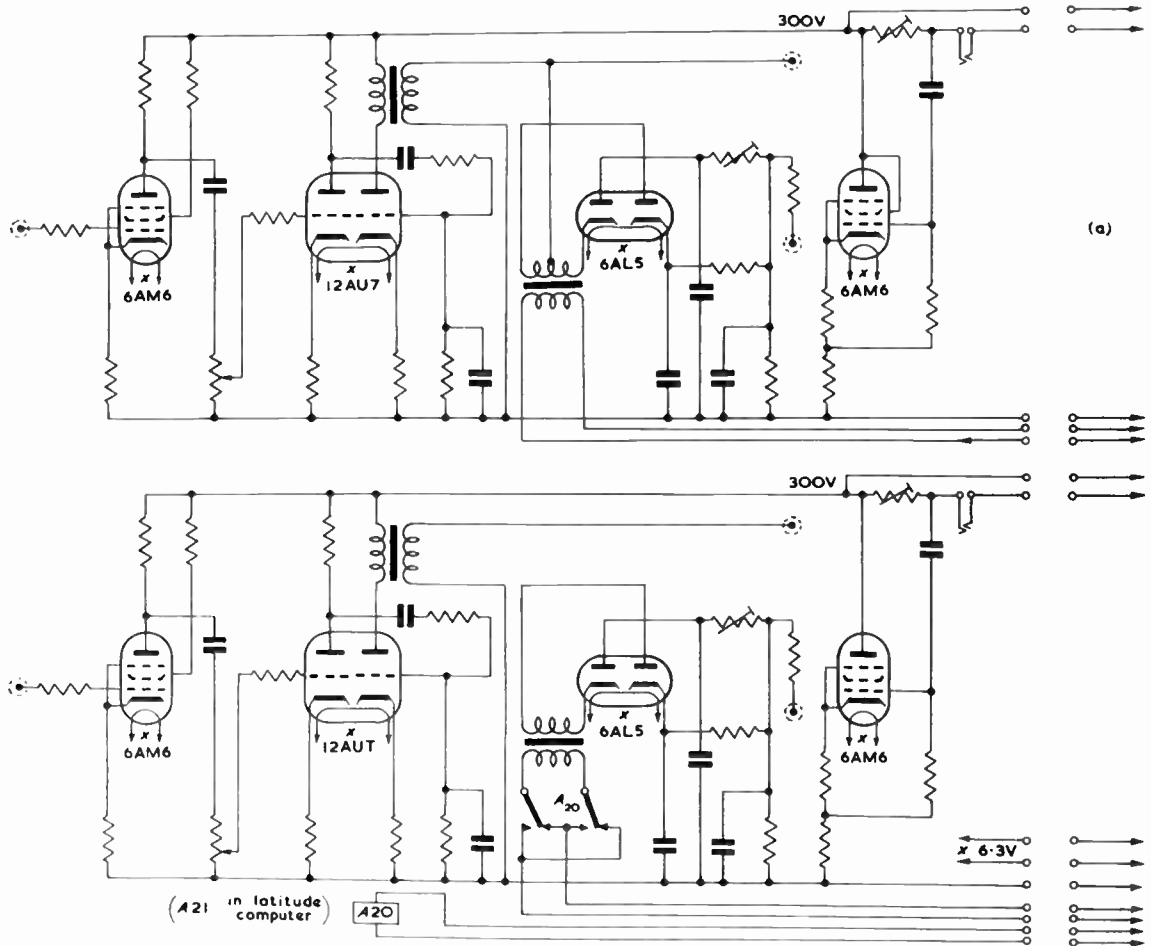
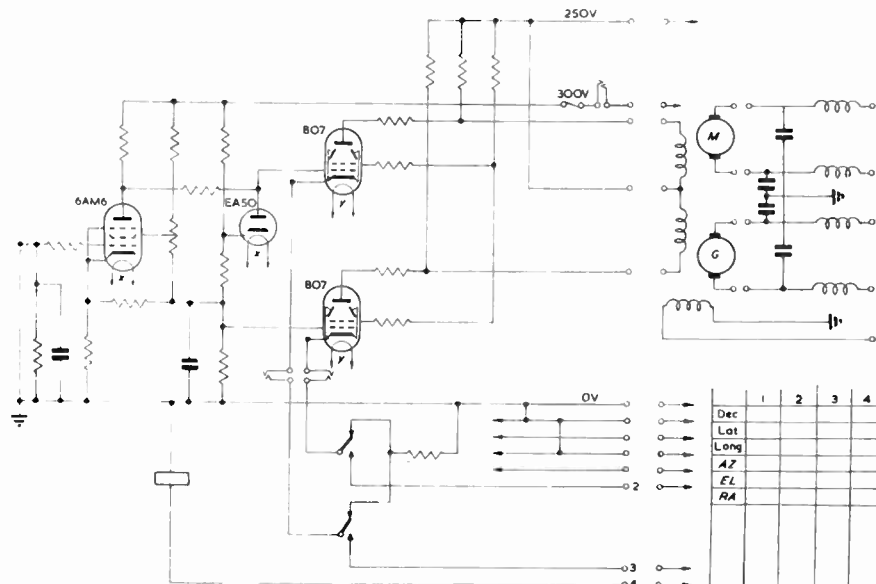

Figure 3. Velodyne amplifier and Velodyne circuit.



back voltage being derived from auxiliary stator windings. The function of the electronic amplifier is to obviate the non-linearity in output due to electrical losses and unwanted flux. Fig. 1 shows the type of twin high gain two-stage RC coupled amplifier employed in the computer.

A typical example of the computation required may be seen from that employed to compute E (elevation) from the known quantities L (latitude of station), D (declination) and H (hour angle, which is the difference between the right ascension of a given star and sidereal (star) time). The equation may be written:—

$$\sin E = \sin L, \sin D + \cos L, \cos D, \cos H.$$

The three known terms are derived from resolvers and combined to provide an 'error' signal given by—

$F = \sin E - \sin L, \sin D + \cos L, \cos D, \cos H$, the error signal being fed to an RC coupled amplifier with phase sensitive rectification (Fig. 2) whose output drives a d.c. motor generator (via a d.c. amplifier, incorporating feedback control (Fig. 3)) to which is coupled the E Magslip, in such a sense that a positive value of F drives E towards zero. The basic circuit is shown in diagrammatic form in Fig. 4.

Unfortunately, since no single equation gives sufficient accuracy of control over all parts of the sky, it has been necessary to provide a number of equations which are brought into operation according to the position in the sky of the target. For this purpose cams are provided on the RA, Dec. Az. El. Lat. and Long. shafts which automatically switch in the appropriate equations.

In all, 14 different equations are employed in the computer:—seven being for calculating azimuth and elevation from hour angle and declination and vice versa, and seven for calculating longitude and latitude from right ascension and declination and vice versa. A block diagram showing the former is shown in Fig. 5, that for solving Long./Lat. from RA/Dec. being very similar.

When a body near the earth is to be observed such as the moon, since the equations are computed on the assumption that the viewer is at the center of the earth while the telescope is mounted at its periphery, a correction for parallax must be made to the elevation. For

this purpose an additional elevation resolver (Elp on Fig. 5) is employed, the amount of parallax correction required, which may be taken from the Nautical Almanac, being set upon a calibrated potentiometer on the control desk.

While the position of the stars in right ascension and declination, remain, for all practical purposes constant, those of the sun, moon and planets are continually moving across the sky. It is, therefore, necessary to apply corrections in right ascension and declination when observing these bodies. The amount of correction—per

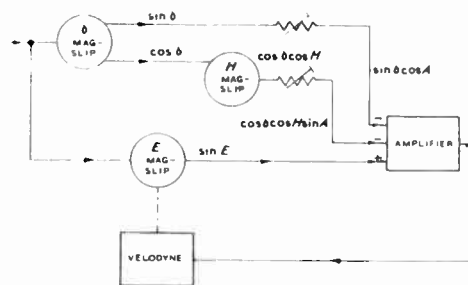

Figure 4. Schematic layout of co-ordinate control.

hour or per day—is shown in the Nautical Almanac in sec/arc for declination and sec/time for right ascension. The required quantities are set up on the control desk which cause motors coupled through differential gears to the right ascension and declination computing mechanisms to revolve the required number of seconds of time per hour or per day for right ascension and seconds of arc for declination respectively. The impulses for driving the correction motors are selected by switches from impulses generated by commutators on the sidereal time shaft.

The motors driving the resolvers for the three pairs of co-ordinates are coupled also to indicator dials which indicate in degrees and minutes of arc, and hours, minutes and seconds of time. In addition, sets of dials are provided to indicate sidereal time, universal time and the repeated back position of the telescope itself in azimuth and elevation.

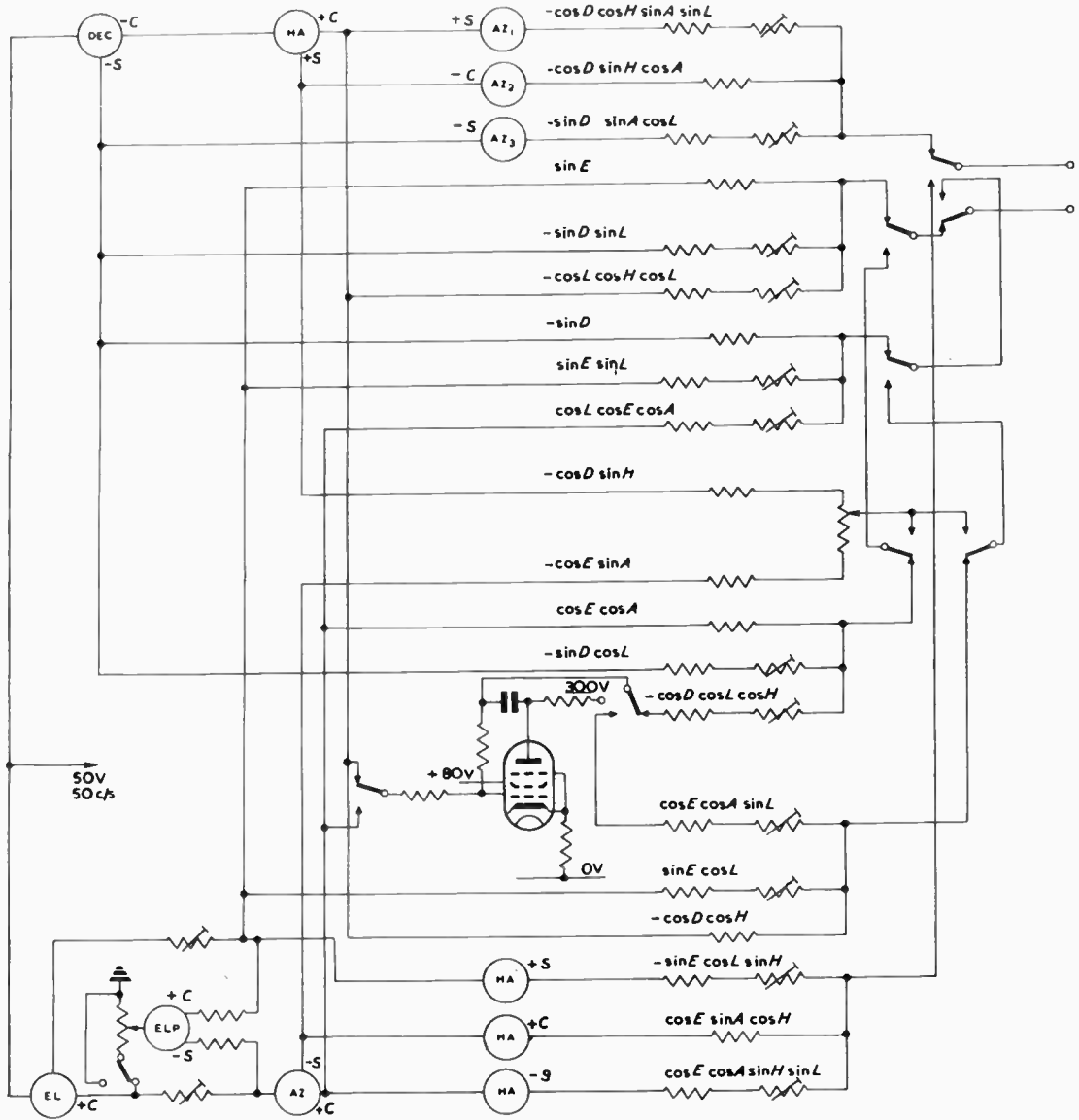
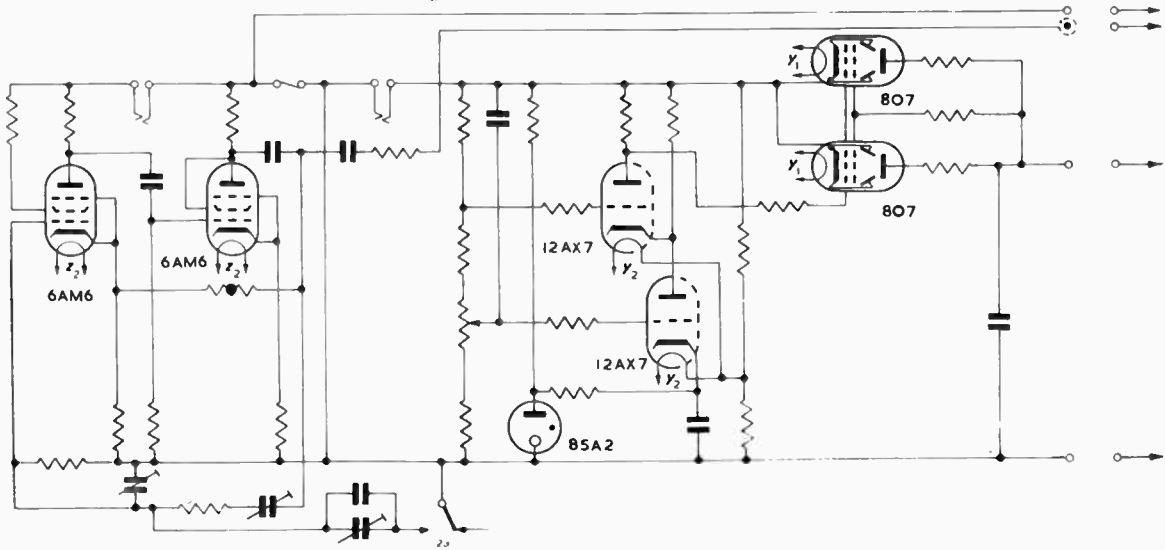

Fig. 5. Azimuth and elevation equation unit

Fig. 6. Clock oscillator, cascode stabilizer



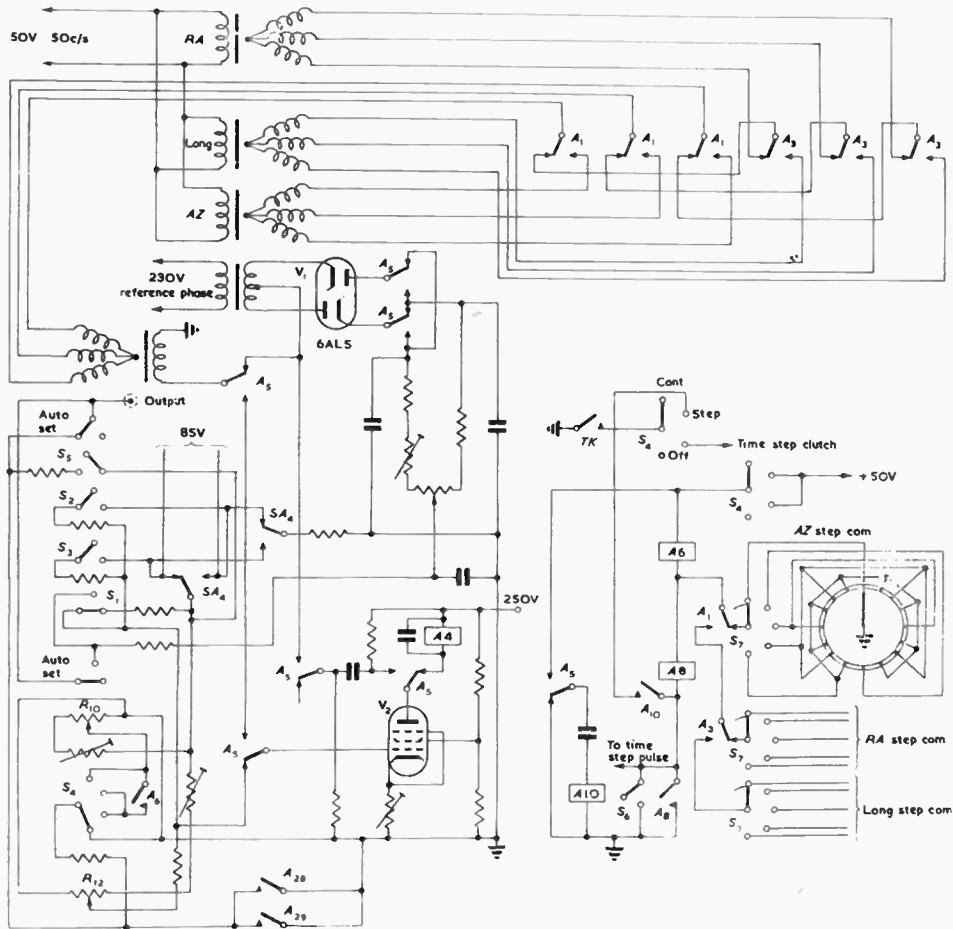

Figure 7. Step unit, scanning and auto set (AZ, RA Long)

Also coupled to and driven by the motors on the azimuth and elevation shafts are coarse and fine Magslip transmitters (geared 90:1 to each other) which are electrically connected to coincidence transmitters driven by the telescope itself. The output of the coincidence transmitters, which is proportional to the error between the required position given by the control transmitters and the actual position by the coincidence transmitters is fed to servo amplifiers controlling the Ward-Leonard sets and telescope driving motors in such a sense as to cause the telescope to be driven so as to reduce the error signal to zero. Similarly, transmitters driven by the telescope are coupled to coincidence transmitters on the repeater shafts in the control room to control the repeater drive motors. The fine Magslips, which make one revolution per 10° of the telescope, are provided so that during normal operations where a high degree of accuracy is required, the signal from the fine Magslips gives a tight and accurate control. On the other hand, should the telescope be moved while the control is switched off, as must happen on occasions, the coarse Magslips are required to ensure that control is never lost. Valve operated relays are provided to switch automatically from fine to coarse control according to the displacement between the required and actual positions.

The hour angle Magslips are driven by the right ascension motor on the one hand and a synchronous motor running at sidereal time on the other. The synchronous motor is controlled by an RC coupled regenerative oscillator through a power amplifier (Fig. 6). The speed of the motor is compared every 30 sec. with

a pendulum driven master clock and is arranged to drive very slightly faster than the required sidereal time. If, at the time of checking, the motor-driven clock is in advance of the master clock, a check capacitor is closed across the input to V; (see Fig. 6) thereby reducing the frequency of oscillation and the speed of the motor, bringing it back into coincidence with the master.

At any given time, one of the three pairs of co-ordinates (Az/El, RA/Dec, Galactic Long/Lat) is the controlling set, the other two sets being obtained from these by means of the computer. In following a star or planet the controlling pair is RA/Dec, and they may be required to remain constant as in following a star, or, to vary very slowly as in the case of following a planet, the sun or the moon as described above.

On the other hand, it may be required to scan a given area of the sky in a regular pattern in any of the three sets of co-ordinates. Means are provided for scanning in a number of different ways and for setting up the required positions of the driving co-ordinates.

In Fig. 7 with switch S_1 in the normal position, a continuous drive, whose speed is controlled by the potentiometer R_{10} , is applied to the motor generator of the controlling co-ordinate, the sense, positive or negative, of the drive being controlled by operation of S_2 or S_3 .

By operation of the "auto set" switch S_6 , the position of the co-ordinate may be set up automatically. Upon operation of this switch valve V_2 becomes a single stage amplifier which drives, via the phase sensitive rectifier V_1 , the selected co-ordinate motor until coincidence be-

Please turn to page 57

Developments in reverse breakdown of silicone diodes

An analysis of recent studies in the breakdown phenomenon of silicon diodes

by Morton B. Prince *

This article will consider new developments in the reverse breakdown voltage characteristics of silicon p-n junction diodes. The two phenomena that are currently accepted for causing the breakdown will be reviewed briefly; the control of the breakdown voltage will be described; the impedance in the breakdown region will be considered; and the switching speed from the high impedance condition before breakdown to the low impedance condition after breakdown will be discussed.

Current voltage characteristic

Figure 1 shows a typical current voltage characteristic of a silicon p-n junction diode. In the forward direction, the diode will start to pass considerable current after the voltage reaches 0.6 volt. In the reverse direction, the diode will conduct only a very small current until the voltage reaches a value near V_B , the breakdown voltage. At V_B the current increases extremely rapidly and the device is said to go into the breakdown region. This breakdown is not destructive and one can cycle the diode into and out of this breakdown condition indefinitely as long as the unit is kept within the thermal limitations.

Breakdown mechanisms

The earliest explanation of the breakdown phenomenon is due to Shockley; he explained the phenomenon by the zener mechanism of breakdown in insulators. This phenomenon is due to the internal field emission of electrons from the valance band to the conduction band in the presence of strong electric fields. A necessary condi-

tion for this phenomenon is a narrow space charge region. Recently it has been shown by several workers that the zener mechanism is responsible for the breakdown phenomenon at voltages less than 6 volts. A second explanation has been forwarded by McKay and his co-workers based on an avalanche mechanism. This is the same phenomenon that takes place in a gaseous discharge. During a mean free path a charge carrier in the high field space charge region will pick up enough energy to cause ionization on collision leading to mobile charge multiplication. This mechanism requires moderate space charge widths. The avalanche phenomenon accounts for breakdowns at voltages greater than 6 volts. In the region of 6 volts both phenomena are taking place simultaneously. The temperature variation of the breakdown voltage for

Please turn to page 25

* Hoffman Electronics Corporation, Semiconductor Division, Evanston, Illinois.

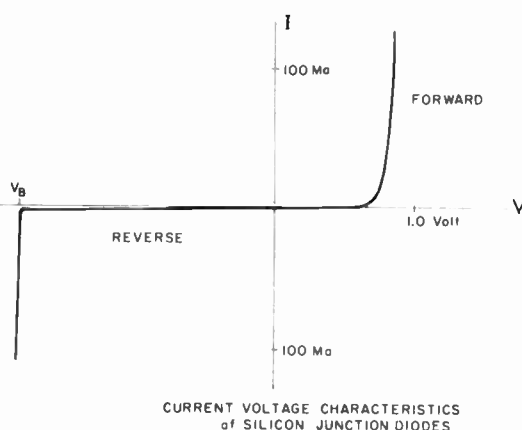

Figure 1.

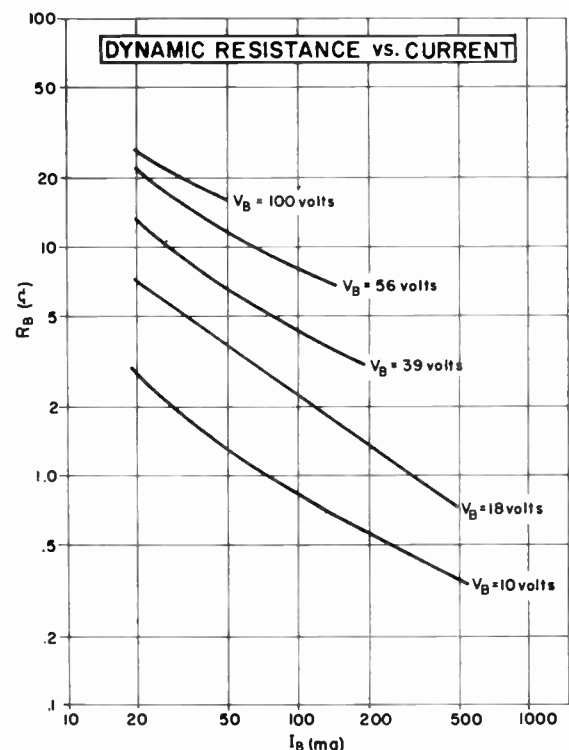
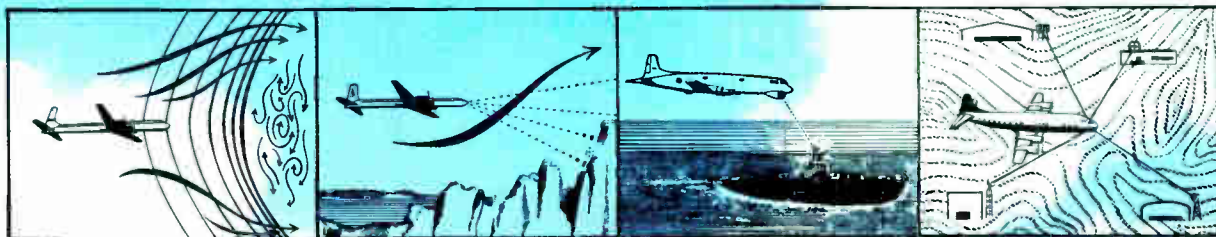

Figure 2.



Electronic vision is needed . . .

SPERRY supplies it!

Multi-purpose airborne radar is just one of the many developments demanded by modern flying conditions. Sperry APN-59 fills four important military needs — storm warning, navigation, search and coded beacon identification. In extensive military service on this Continent, the APN-59 weighing only 175 pounds, is being manufactured at Sperry's Montreal plant for the Royal Canadian Navy.

This is one more example of the versatility of Sperry engineers in the field of electronics.



SPERRY

SPERRY GYROSCOPE COMPANY OF CANADA, LTD.

P. O. Box 710 • Montreal, Que.

business briefs and trends

★ The Belgian Atomic Energy Authority, it is reported, has ordered a Mercury electronic digital computer made by Ferranti Limited, whose Canadian representatives are Ferranti-Packard Electric Ltd. of Mount Dennis, Toronto 15, Ontario. This is the seventh European atomic center to be equipped with the computer which will undertake most of their atomic energy and nuclear engineering calculations in the next few years . . . the calculations involved, for instance, in the design of the nuclear power reactors on which many of the centers are working.

* * *

★ A Short General Purpose Analog Computer is to be installed in the Department of Electrical Engineering at McGill University, Montreal. It will be used there for research on electrical circuit design and control system analysis. It may also be available for use by outside organizations and for demonstrations to come of the smaller industrial groups in the provinces of Ontario and Quebec. The instrument is being supplied by Short Brothers and Harland Ltd. of Belfast, Northern Ireland, and the Bristol Aeroplane Company of Canada Ltd., Montreal.

* * *

★ One of the latest developments in the field of mobile radio-telephone service in British Columbia is the establishment of terminals at Dawson Creek and Fort St. John, providing coverage along the Alaska Highway between these two centers and within a 30-mile radius of them.

* * *

★ By means of teletype equipment provided by the British Columbia Telephone Company in a six-station network, the Powell River Company Ltd. now has communication between its B.C. and U.S. offices. Five to six hundred messages a month are passing back and forth, and the company says the network is bringing it into closer contact with customers and opening the way to more efficient service.

* * *

★ A question posed at a recent press conference with the Electronic Industries Association of Canada elicited the opinion that of the electronic equipment manufactured in Canada, the "Canadian-content" is about 80 per cent, but it is estimated that, of the overall use of electronic components in Canada, about 50 per cent is imported.

* * *

★ An electronic device, intended for industrial or military use where heat control is a factor, was recently exhibited by I.T. & T. Corporation, an associate company of Standard Telephones & Cables Mfg. Co. (Canada) Ltd. It is claimed that the value of this device, a "magic eye" using advanced infrared techniques, lies in its ability to measure heat accurately and to "inspect" large numbers of items passing in front of it, such as occurs on industrial conveyor lines. The device has proved effective in detecting overheated railroad car journals as the cars move rapidly before it, enabling immediate journal replacement. I.T. & T. engineers envision applications of this technique in paper manufacturing, glass molding, electric motor operations, furnace control, and even for fire alarm systems.

* * *

★ Within 50 to 75 years, more than 200 million Americans may conduct all their financial affairs without the use of cash, coins or cheques, according to industrial design and electronic systems specialists employed by Designers for Industry of Cleveland, Ohio, one of the foremost independent creative research firms in the United States, specializing in the development of data processing equipment and electronic systems. Under the new monetary system, all bank deposits and withdrawals, all "charge" payments and all so-called "cash" purchases will be made with the use of individual "electronic pocketbooks", and auxiliary data processing equipment used by employers, businesses and banks.

Silicone diodes

voltages greater than 6 volts shows that the breakdown voltage increases with increasing temperature. At voltages less than 6 volts the breakdown voltage decreases with increasing temperature. This can be explained on the basis of the two phenomena that have just been described. For higher temperatures the forbidden energy band is reduced in energy and thus a lower electric field is needed to cause the zener breakdown. At higher temperatures the mobility of charge carriers is reduced and thus higher electric fields are necessary to cause charge carriers in a mean free path to pick up enough energy to cause the multiplication or avalanche phenomenon. This is one of the observations that have enabled workers to distinguish between the internal field emission effect and the avalanche effect.

Control of breakdown voltage

The breakdown voltage is controlled by two parameters, (1) the resistivity in the more lightly doped region of the p-n junction and (2) the gradient in the impurity concentrations in the vicinity of the junction. For diffused junctions made with p-type silicon into which phosphorus is diffused at 1250°C for 16 hours, Table 1 gives the relationship between the resistivity and the breakdown voltage. It is possible to get much lower breakdown voltages for the listed resistivities by diffusing the impurities for an extremely short time.

Table 1

ρ ohm - cm	V_b Volts	V minimum Volts
.01	10	5
.1	28	10
1	75	25
10	210	60

These voltages are given in the third column of

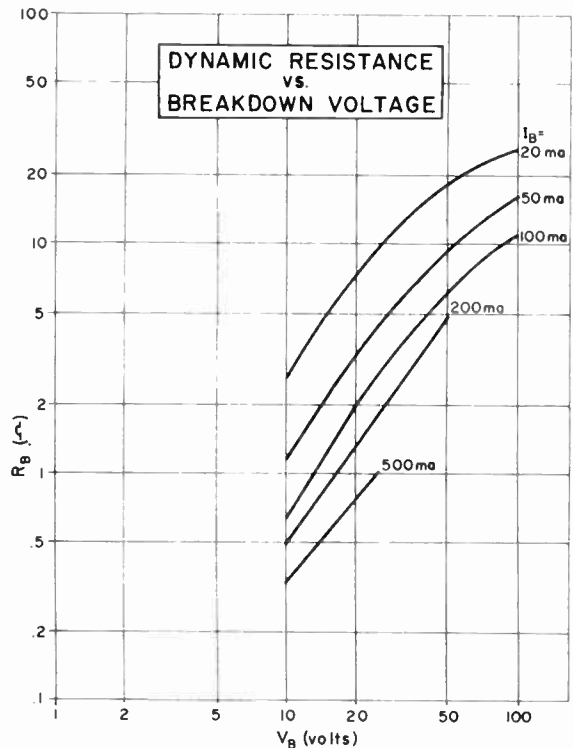

Figure 3.

the table. It is seen that the breakdown voltage can be controlled from 5 to 210 volts by variation of two parameters; resistivity of starting material and diffusion time. Thus it is possible by the diffusion technique to control quite accurately the voltage at which breakdown will occur.

Impedance in the breakdown region

For the diodes under consideration to be used for regulation purposes the impedance in the breakdown

Please turn to page 64

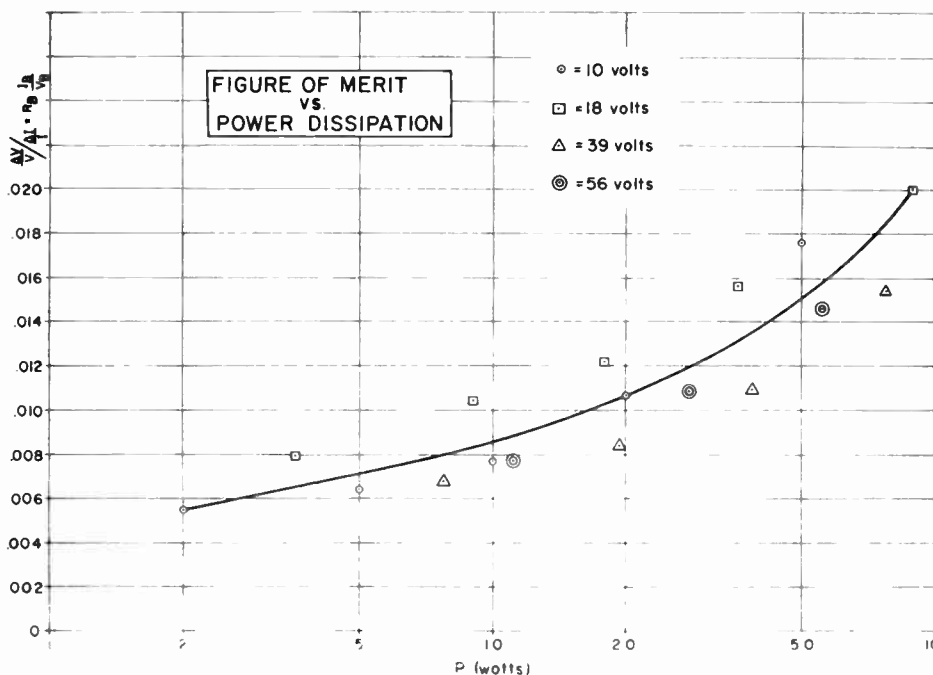

Figure 4.



Figure 1. Ultrasonic generator (left in photograph) produces high frequency (38 kc) vibrations which are sent to transducer in bottom of stainless steel cleaning tank. Cavitation produced in liquid removes all vestiges of oil, dirt, dust, contaminant which would interfere with operation of crystal.

Quartz crystal measures its own cleanliness

The quartz crystal is its own best detector of cleanliness, being capable of measuring a trace of soil half a billionth of an inch thick.

by Ernest B. Lewis*

Cleanliness is a matter of degree, but no one is more concerned with achieving the ultimate in decontamination than the designer of electronic parts. You can't see the soil, smell it, or weigh it, but a way has been found to measure it: quartz crystals.

A simple formula relates the thickness of the crystal to its resonant frequency: $F \times T = k$, where F is the frequency in kilocycles, T the thickness in millimeters, and k a constant, equal to 1670 for A. T. cut quartz. The shape of the curve for this relationship is

a hyperbola.

If we make appropriate substitutions, we find that for a 25-mc quartz crystal, the thickness must be 0.0668 mm, or 0.00253 in. Now, if we reverse this process, and increase the thickness of the crystal by 0.1 per cent, the corresponding frequency will be 24,975,025 cps. In other words, if there is soil or contaminant on each side of the crystal, only $1\frac{1}{4}$ millionths of an inch thick, the

* President E. B. Lewis Company, Inc., East Hartford, Conn.

resonant frequency will change by 24,975 cycles. (We are assuming that the constant for soil is the same as for the crystal, which is of course a rough approximation, though the magnitude of the change is likely to be correct.)

These calculations show that in the quartz crystal we have a fabulous tool for measuring cleanliness, particularly because there are instruments which permit us to measure its resonant frequency to within a single cycle. Theoretically, therefore, it should be possible to detect a layer of dirt 0.000000001 in. thick.

Ultrasonic equipment for high-speed cleaning

John Rameika, chief engineer of the E. B. Lewis Company, first developed this method of testing for contaminants when it was required to check the efficiency of Branson Ultrasonic Corporation's cleaning equipment installed by the E. B. Lewis Company. To find just how fast the Sonogen ultrasonic generator, transducer, and tank will work, the frequency of crystals which had been cleaned of lapping compound and cleaned in chromic acid was first checked.

The same crystals were then immersed in the ultrasonic bath for 5, 10, 15, 20 seconds, and so on, and after each exposure the resonant frequency was again measured. The results of one such test are shown in the graph, Fig. 1. Note, particularly, that the frequency increases very rapidly at first, and begins to stabilize at its final value after only one minute.

These findings have led to a change in the entire cleaning procedure at the E. B. Lewis Company with several important benefits. First, the new method takes less time. Second, it is easier to handle. Third, less toxic fumes are generated because there is no longer any need to let the chromic acid boil for ten minutes. Fourth, few crystals are broken again because of the elimination of the violent agitation in a boiling solution. Fifth, the new method is perfectly reproducible, with always identical results.

These are certainly worthwhile reasons for cleaning with ultrasonics. But the single most important advantage is the fact that high-speed agitation by the Sonogen equipment forces acid or detergent between the perfectly flat crystals, even though hundreds of them are heaped on top of another. Formerly, it was necessary to boil the solution to get some penetration, or else to rack crystals individually. Now, large batches of quartz



Figure 2. Lapping brings quartz crystals down to final thickness, sometimes no more than 0.002 in. All traces of oil and compound must be removed if crystal is to function dependably.

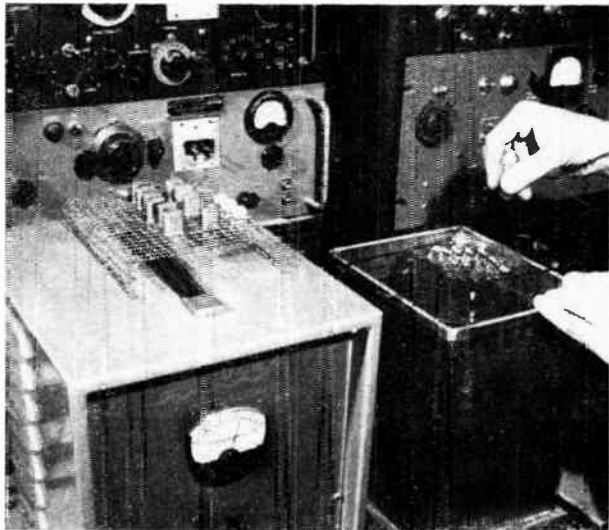

Figure 3. When only a few custom-built crystals are cleaned, they are racked before being immersed in ultrasonic bath, as shown here. In mass production, batches of several hundred crystals are processed at once without racking, yet all come out uniformly clean.



Figure 4. Some crystals are so delicate that they are best picked up with a moist finger. Yet, despite their thinness (as little as 0.001 in.) ultrasonic cleaning does not crack or shatter them.

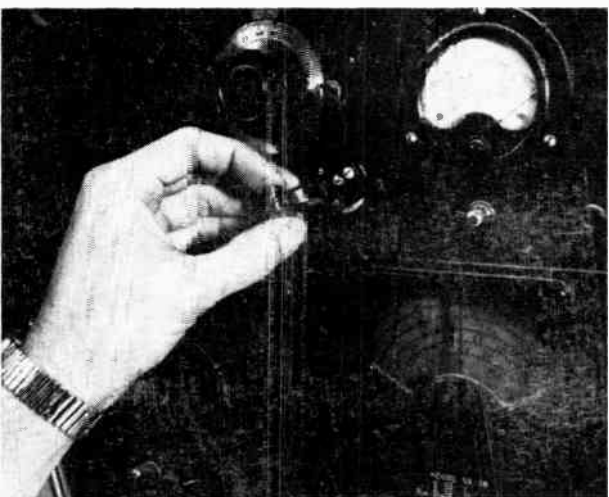
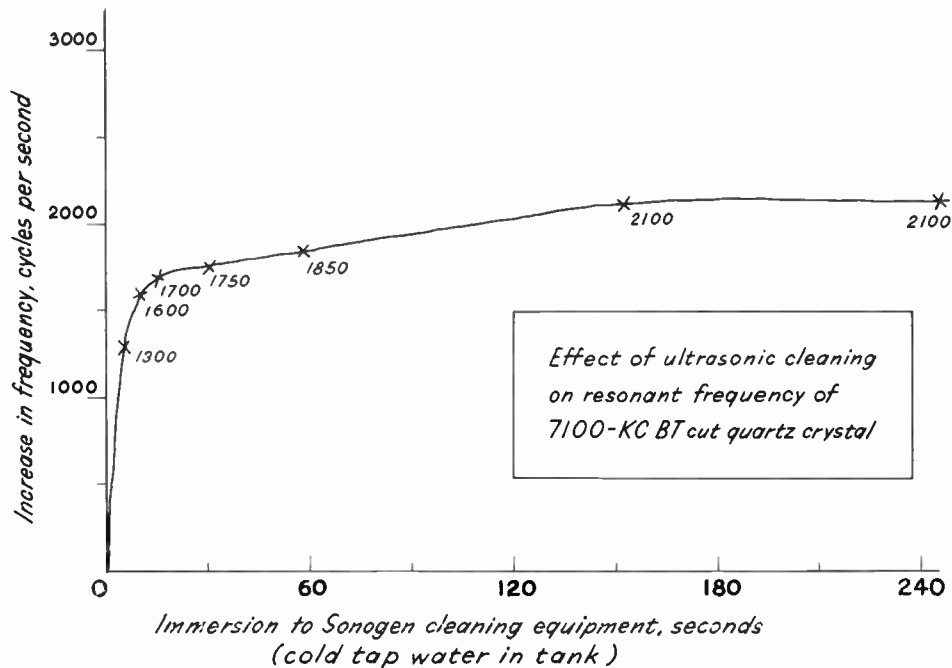

Figure 5. Crystal is its own best detector of cleanliness. For a 25-mc crystal, for example, a minute trace of contaminant (1¼ millionths of an inch thick) will change frequency by 24,975 cycles.



crystals are deposited in the ultrasonic tank; they all come out consistently clean, resulting in a minimum of rejects due to pull-away of the silver coating later applied. For the sake of comparison, both methods are outlined below.

Former method of cleaning quartz crystals

- 1—Remove lapping compound with hot water rinse.
- 2—Boil in chromic acid for ten minutes, to cut grease, organic matter, lint.
- 3—Boil in detergent solution, up to one hour.
- 4—Rinse in tap water, five or six times.
- 5—Rinse in distilled water.
- 6—Dry in oven at 400 F.
- 7—Inspect carefully. If any spot is visible on any one crystal, reclean entire batch. (This used to be necessary in about one out of 20 batches.)

Present method

- 1—Remove lapping compound.
- 2—Immerse in hot (not boiling) chromic acid for ten minutes. Up to 300 crystals at a time may be processed. Drain acid, for later re-use.

3—Rinse in really hot tap water.

4—Immerse in ultrasonic cleaning bath—hot tap water — two to three minutes. Watch spread of yellow color, indicating removal of chromic acid traces.

5—Drain, repeat with fresh hot tap water several times, until no yellow stain is obtained.

6—Rinse in 140 F detergent solution for 10 minutes.

7—Three fast rinses in hot tap water, followed by an ultrasonic rinse.

8—Three 5-minute rinses in distilled water.

9—Dry crystals in oven at 400 F.

Actually, though the newest method seems to have a greater number of steps, the total time taken is less and, more important, there are almost no do-overs necessary. The crystals come out of the oven looking like so many soap flakes, snowy white, and absolutely clean. See Fig. 6.

Although breakage of quartz crystals during cleaning has been reduced, the high-speed ultrasonic vibration detects crystals having an incipient crack. These will break, thus automatically eliminating crystals which might later fail in service.

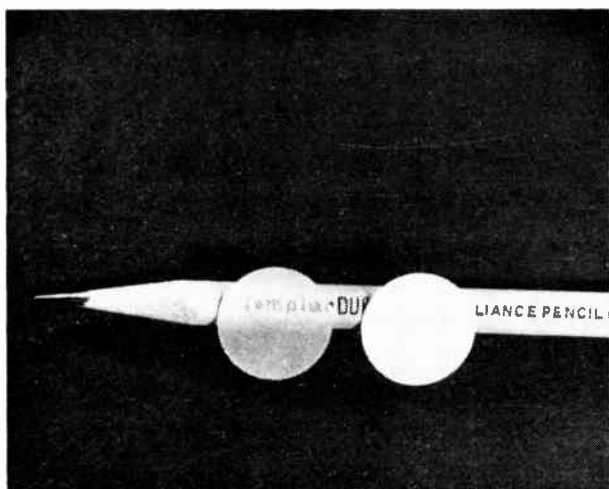

Figure 6. For comparison, two circular quartz crystals before cleaning (left) and after. The snow-white crystal (right) looking much like a soap flake, has gone through complete cleaning procedure.



Figure 7. After cleaning, silver contacts are vacuum-plated onto crystals. Holder can handle four at one time.

The graph on page 28 illustrates the increase in frequency of a crystal, as it is cleaned ultrasonically. There is, however, another measurement, which again allows the checking of soil removal, i.e., "activity", as measured by a standard government oscillator and in accordance with specification MIL-C-3098B.

The following values are typical of results that have been obtained. The sample in this particular test was a 9-mc over-tone quartz crystal.

TABLE I

	Frequency, kc	Activity, microamp
1) After boiling in chromic acid	29,926	42
2) Scrubbed with tooth brush, and detergent solution	29,928	44
3) Ultrasonically cleaned in clear water for 5 minutes	29,936	90

Table I brings up two interesting points. First, hand-scrubbing with a toothbrush, often resorted to in the past, is no longer necessary. Second, the frequency and activity achieved after 5 minutes in the Sonogen equipment remained essentially the same after further immersion, indicating that almost all the soil is removed in the first few minutes.

The silver plate demonstrates the power of ultrasonic agitation in another way. When plated crystals are subjected to an ultrasonic bath, the silver itself can be removed by the high-speed, high-energy implosions within the liquid. If left in the bath for only a moment, perhaps up to five seconds, no change is visible. Should the crystal be immersed for fifteen seconds, however, erosion of the silver will begin, as shown by the two test samples in Figure 9. The same power of ultrasonic energy can be similarly demonstrated by immersing the foil from a cigarette package in the liquid; holes will shortly appear in the foil. Therefore if plated samples are to be ultrasonically cleaned, precautions must be taken not to expose them too long.

Principles of ultrasonic cleaning

Ultrasonic cleaning, itself, is a development of the electronics engineer. To produce a very intense scrubbing action in the cleaning medium, high-frequency energy is needed. A Sonogen model of AP-25-B generator transforms 110-v a-c into 38-kc power by means of one vacuum tube, a heavy-duty transformer, and an oscillator coil. An 11-position rotary switch is also incorporated which, together with a variable inductor, permits fine selection of frequency for highest cleaning efficiency.

A number of piezoelectric transducers, bottom-mounted in the type T-52 stainless steel tank, receive the electrical impulses and convert them into mechanical vibrations of the same frequency. Although completely inaudible, these sound waves are transmitted into the solvent, detergent or other liquid, where they produce cavitation.—Cavitation is a phenomenon resulting from repeated build-up and sudden collapse of localized pressure cells.—Because of the myriads of implosions within the liquid, even insoluble soils are quickly removed from any surface in contact with the cleaning agent.

The quartz crystal is its own best detector of cleanliness, a trace of soil half a billionth of an inch thick being measurable. Although we cannot guarantee that ultrasonic cleaning will remove the very last vestige of contaminant, we do know that it gets our crystals cleaner, in less time, and with less operator attention than any other method we have ever tried.

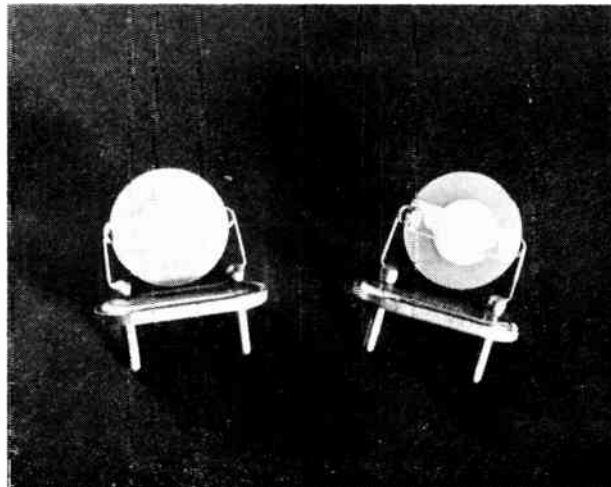

Figure 8. Ultrasonic cleaning is very powerful, as evidenced by these test samples. If a quartz crystal with its flash plate of silver is kept in the ultrasonic bath for more than a minute, the silver will begin to wear off, as in the sample at the right. Left, a plated crystal which was ultrasonically cleaned for about 15 seconds. Silver has not been affected.

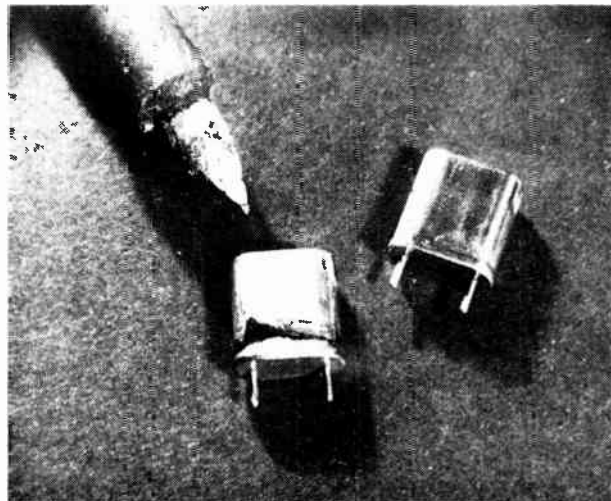

Figure 9. Another application for ultrasonic cleaning: the finished crystal. Water soluble soldering flux is quickly removed ultrasonically to achieve a bright, shiny product.

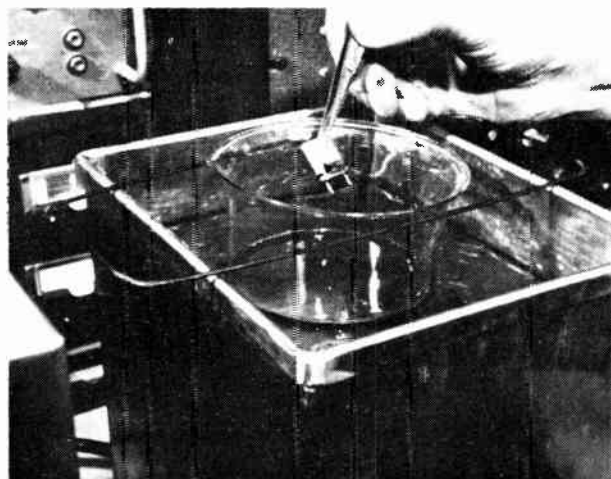
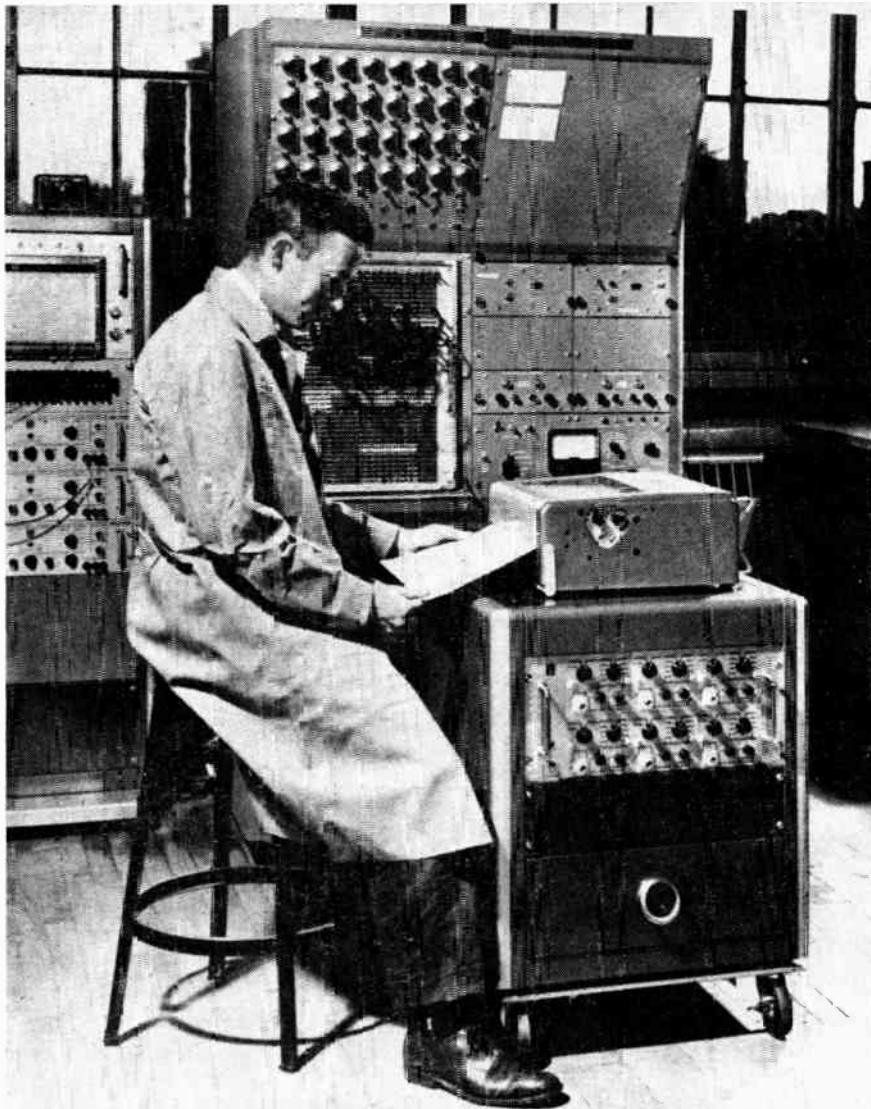

Figure 10. Crystals, after soldering, are ultrasonically cleaned to achieve a bright, shiny end product.



A continuing search is being conducted in laboratories to bridge the auditory recognition gap between man and machine.

Artificial auditory recognition in telephony

While giant strides have been made in the art of telephony in recent years, researchers look forward to the day when machines may not only record and repeat the human voice but interpret it too.

by Edward E. David, Jr.*

The difficulty of achieving efficient communication between man and machine has become almost legendary among communication scientists. Men are adept at reading handwriting, understanding speech, associating two-dimensional pictures with their three-dimensional counterparts—abilities at which machines are notoriously inept. Such abilities are commonly described as pattern recognition or sensory Gestalt. If machines could perform like functions, man-machine communication would be considerably aided.

It is appropriate that telephone research has long

been concerned with recognition since problems of auditory recognition crop up often in telephony. The telephone system is a complicated machine which must be precisely controlled. A person controls the machine by communicating through a dial or perhaps by voice to an operator. In addition, during conversation, the voice signals themselves may control parts of the telephone apparatus. For instance, devices called speech detectors which recognize when speech, as contrasted to noise, is present on transmitting lines are used to remove dis-

* Bell Telephone Laboratories, Incorporated, Murray Hill, N.J.

turbing echoes which sometimes occur on long circuits. Speech detectors are actuated by the human voice and so in this sense perform a human-like function, namely discriminating between speech and the variety of other sounds they might encounter. Even though speech detectors are relatively simple devices in both their decision criteria and in their instrumentation, they can lead to great advantages in communication systems.

For instance, the traffic capacity of multiple-channel communication systems can be increased by taking advantage of the one-way characteristics of conversations. Usually in a conversation only one person talks at a time, and therefore a connection need be provided only in that direction. Commonly, circuits in both directions are simultaneously available for a conversation. Thus, one circuit is often idle. In addition, there are usually many circuits or channels in each direction between two cities, for example, so that many conversations can be handled simultaneously. If in each conversation one party is silent, there will always be, on the average, idle circuits in both directions. Thus a sufficiently intelligent switch at each terminal can make use of the idle circuits to the other terminal for further conversations. In addition to this "conversational" factor, the natural pauses in a person's speech permit a further gain. In fact studies have shown that about 90 conversations can be handled simultaneously over a 36-channel system without objectionable interference. This method for utilizing the natural characteristics of conversations is known as TASI*. Speech detectors provide the sensory input to TASI. They sense who, among the potential talkers at each terminal, is speaking at a particular instant so that the programmed switch can provide a suitable connection for each active talker to the correct listener. Such man-machine coupling yields rather substantial dividends in communication efficiency.

Thus, the utility of machines to emulate human sensory functions seems firmly established. In fact, many researchers think that an essential link in the ultimate human-communication channel is such a recognizer. For instance, coupling between people at a distance might ideally be performed by a man-recognizer link at the transmitter followed by a functionally inverse link at the receiver or destination. The voice-coding philosophy originated by H. W. Dudley incorporates just such features.

Dudley proposed several devices known as vocoders whose recognizer-analyzers might be likened crudely to the ear and brain of a listener, and whose receiver-synthesizers might be thought of as analog vocal tracts. Ideally such a system hears and analyzes the talker's voice, selecting from it certain perceptually important features, transmitting a description of these features to the receiver which then reproduces the talker's utterances. In an elementary vocoder, the features to be described by the transmitted signals might be perceptually important components of the speech frequency spectrum. In a more ambitious vocoder, the signals might denote the sounds of speech, or words from a specified vocabulary, these having been recognized at the analyzer. In this case, of course, the signals could actuate a "voice typewriter" or some other voice-operated device.

A number of working vocoders have been built and demonstrated. Typically they reduce the channel capacity necessary to transmit articulate speech by a factor between 10 and 30. In one of the most recent applications of the vocoder principle, high-quality speech of 10 kilocycle/second bandwidth was transmitted over a

* Time Assignment Speech Interpolation

3 kilocycle/second channel. However, vocoder analyzers still cannot perform recognition functions sophisticated enough to carry the principle very far. Indeed, yet unsolved is one of the most elementary, and yet fundamental, recognition problems, that of sensing a talker's voice pitch and inflections under the variety of conditions often found in communication situations.

Features which might be utilized to describe the voice, could we recognize them automatically, are displayed visually on so-called sound spectrograms, or visible speech displays. Just how each of the features, which are often visually conspicuous, contributes to the perceptual value of an utterance is not well understood, although for vowel sounds particularly the frequency location of prominent energy concentrations, known as formants, are the determiners of phonetic value.

After long training, people can learn to associate these visual patterns with the corresponding utterances. A rather complex set of rules has been drawn up to aid the learning process. These concern the individual sounds of speech, the phonemes. However, it has been shown that if the spoken vocabulary is suitably restricted, much simpler rules for identifying spectrograms can be formulated. These rules address longer segments of speech than the phonemes. Such a process is probably more nearly akin to human speech perception under ordinary conditions. A set of rules for ten spoken numbers are presented. They were tested by naive subjects who applied them without practice to 330 utterances taken from 13 men, 7 women, and 10 children, achieving over 90% success in identifying the utterances.

These rules concern rather gross properties of the spectrograms and require no very precise measurements. Rather it is the relation between spectral features as well as between successive intervals of the same features that is important. Further, the identity of each word does not depend exclusively on any one of its properties. To confuse one word with another requires the simultaneous confusion of several features. These characteristics of the rules are essential to their success, and probably have a correspondence in human auditory perception.

However, the rules are couched in terms of spectrographic features, which themselves must be recognized. As in the case of pitch, no method rivaling human ability to recognize these features has been demonstrated. Yet with a limited vocabulary very elementary methods have achieved some success. For instance, highly simplified versions of spectrograms, displaying spoken numbers, were achieved by representing all areas of the picture as being entirely black or entirely white. Relatively light grey areas were converted to white, while darker grey areas were assumed to be black. An ensemble of 140 utterances of ten individual digits by 9 men and 5 women was considered. Two master patterns for each digit, one black and one white, were compiled from the ensemble of samples. When the simplified patterns were matched against the masters it was found that the utterances could be successfully identified in over 99% of the cases. This result again shows the utility of the "many gross feature" or diversity approach, and is indicative of present capabilities with a limited vocabulary and a small population.

Whether the spectrographic features are to be recognized for word identification or for transmission, the spectral analysis should not introduce artifacts which might confuse the recognizer. It can be shown that current methods for spectral analysis tend to introduce

Please turn to page 57

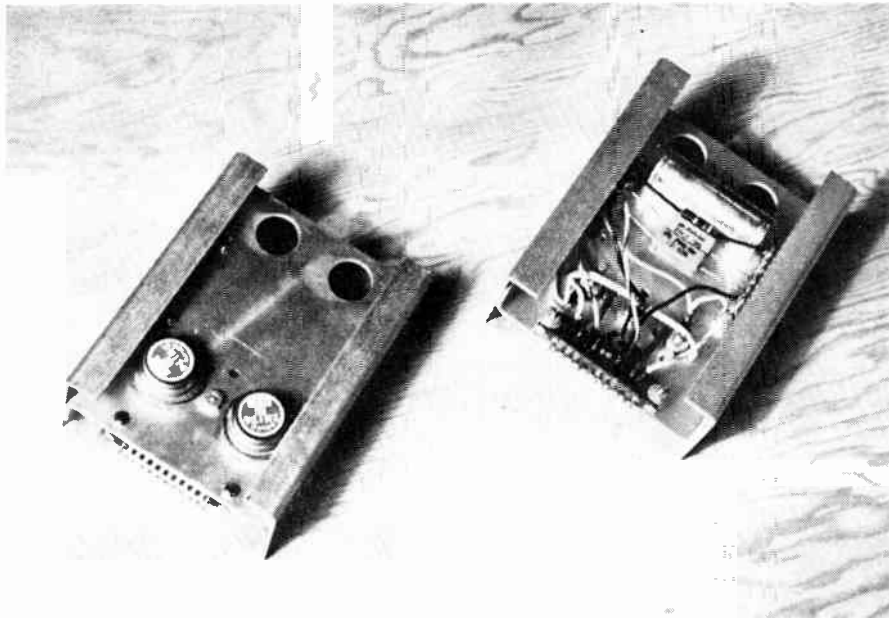

Figure 1. Basic transistor power module: this new Pylon design concept eliminates former difficulties in locating and replacing defective transistors and makes possible for the first time the construction of practical power equipments embodying large numbers of transistors.

A two year research and development program by a Canadian electronic engineering firm has resulted in the production of . . .

Transistor power units of giant capacity

by Stanley E. A. Pinnell, M.Sc.*

In recent years transistor power units have come into widespread use, particularly in aircraft, as D.C. powered converters or inverters. The transistor units offer important advantages in efficiency, reliability, and the elimination of maintenance. These units are available as compact packages with a peak capacity of about 500 watts. The objective of increasing this capacity to adapt the transistor units for service as prime power sources is one which is being actively pursued by a number of laboratories in North America.

The possibilities are intriguing. The efficiency and reliability are so high and the idle drain so low that converters may be considered as effective for general reserve supply purposes as a prime battery supply. A communications station employing this type of supply may be visualized as having one single reserve battery supply, probably 130 volts if the power requirements are large. This battery is floated continuously from the A.C. mains, and its entire output is fed to a single giant transistor inverter which provides 60 cycle 115 volt A.C. output. This output may then be suitably regulated or stabilized if required. Heavy duty converters consisting of transformer rectifiers with brute force filtering pro-

vide other standard D.C. voltages at heavy current, for example, 24 volts, 48 volts, 60 volts or 180 volts. Ordinary transformers provide proper heater voltages for various vacuum tubes and pilot lights. During a power failure the only change that occurs is that the battery is not floated, but transfers its reserve power through the power unit to the load.

Unfortunately, serious difficulties have been encountered in the past in extending the power capacity of these transistor units to a range which would permit this type of power plant layout. These may be briefly summarized as follows:

- (1) The maximum allowable collector to emitter voltage limits the D.C. input which may be applied to a transistor power switch. For a collector to emitter rating of 80 volts the maximum allowable D.C. input voltage may be taken as 32 volts. This is not adequate for service in conjunction with battery potentials of 48 volts or 130 volts which are standard in higher capacity supplies.
- (2) Recurrent waveform spikes, of however short duration have a serious effect on transistor life. Recurrent pulse peaks result in 'slow death' of transistors.

* Pylon Electronic Development Co., Ltd., Montreal.

Please turn to page 63

*We
Were
There...*

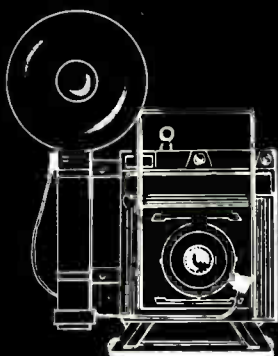

The Third Canadian

IRE

**Engineering Symposium
and Exposition**

OCTOBER 8-9-10, 1958

AUTOMOTIVE BUILDING, C.N.E.

Toronto - Ontario - Canada

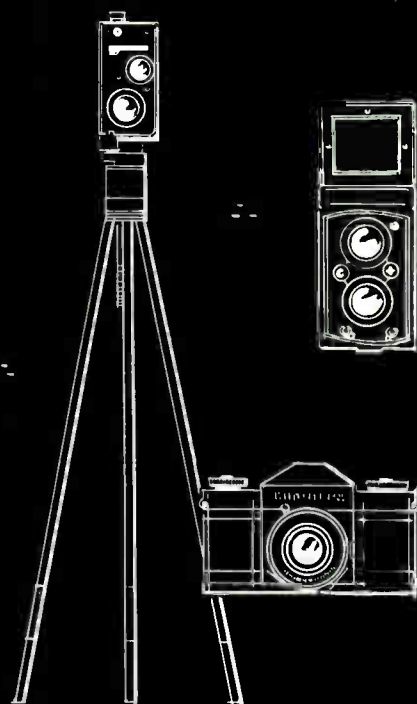

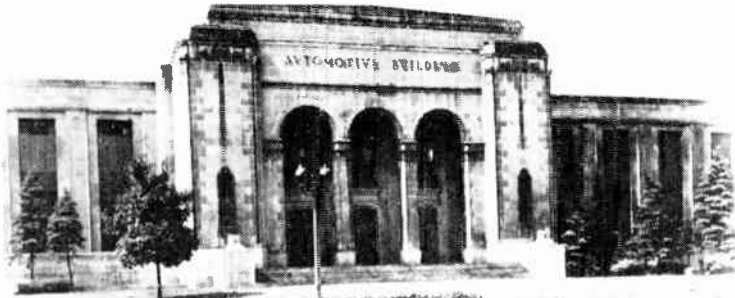

“The Best Yet”

This is the third occasion on which Electronics and Communications has had the privilege of presenting a photographic review of those companies who have participated as exhibitors in the Canadian IRE Exposition.

The outstanding success of the recent IRE Exposition and Convention is a tribute to the growth and development of the Canadian electronics industry and its confidence in the future. It is especially a tribute to those companies who, by actual participation in the Exposition, made evident their pride in being members of Canada's fastest growing industrial complex — the electronics industry.

We are pleased to present in the following pages a pictorial presentation of many of those companies who helped to make the third annual Canadian IRE Exposition and Convention “the best yet”.



World Radio History

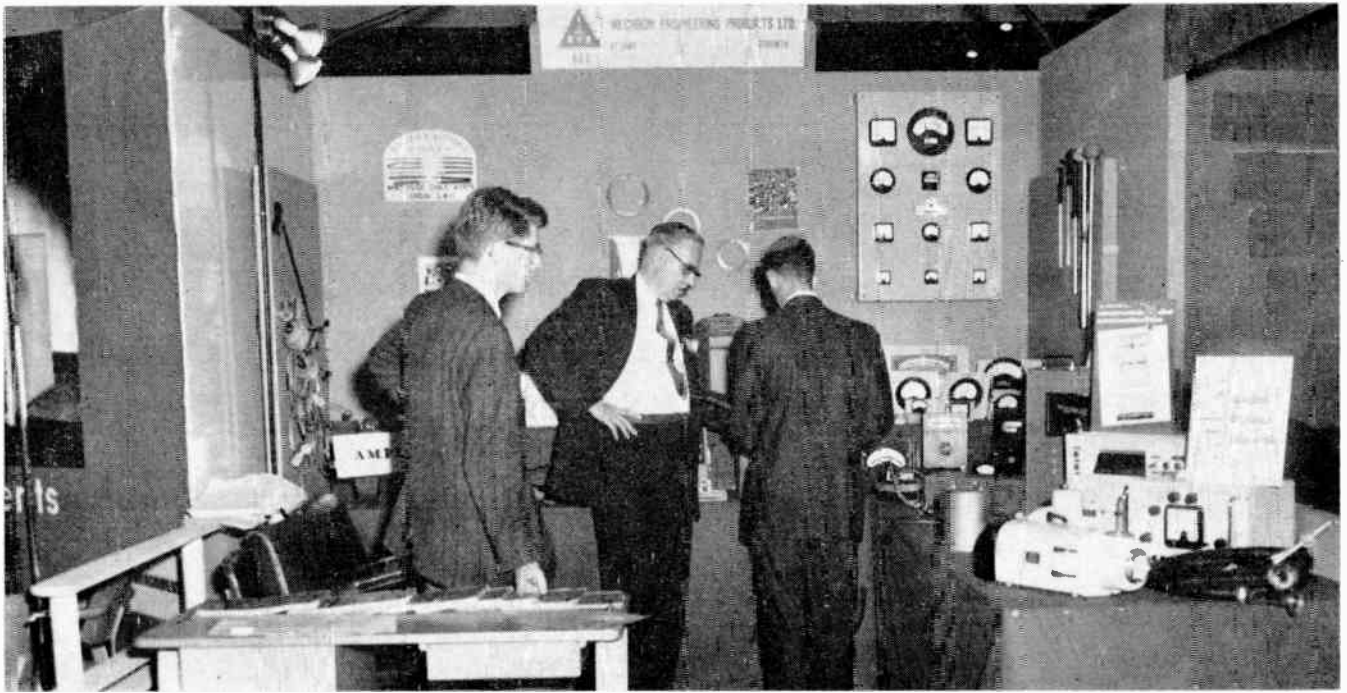

A Canadian Company supplying a wide variety of electronic and nucleonic equipment throughout North America. Developmental effort available. Also suppliers of no-break and automatically controlled diesel generating plants.

Mechtron Engineering Products Ltd.

Ottawa, Canada



Active in the field of laboratory, military and industrial instrumentation and control. Analog and digital computing devices and quality radio communications equipment.

Instronics Limited

P.O. Box 51, Stittsville, Ontario



With emphasis on complete range and coverage, an extensive selection of Marconi standard and specialized tubes were shown, along with Clarostat and National industrial components

Canadian Marconi Company

Electronic Tube and Component Division

830 Bayview Avenue, Toronto, Ontario

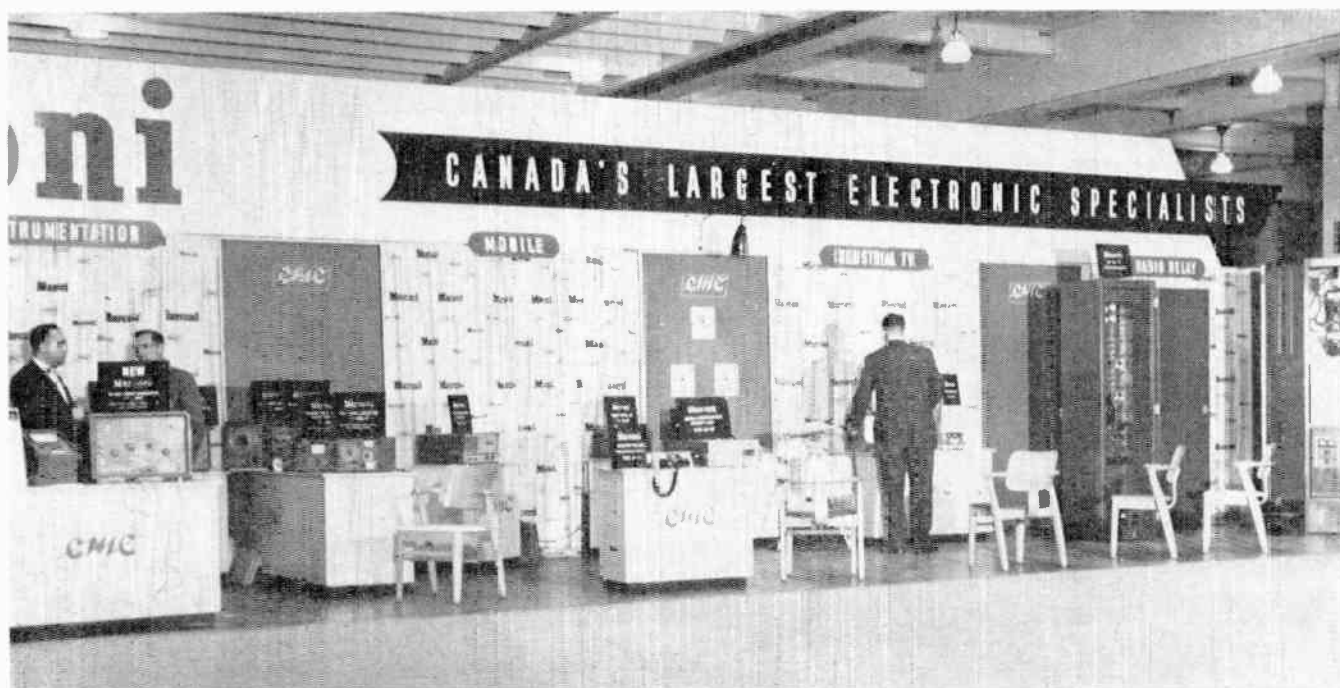

A full range of Radio Relay systems and of land, sea and air communications and navigational equipment designed and manufactured in Canada is featured by this major Electronics Company, which is noted also for its extensive lines of instruments and its special installation and maintenance services.

Canadian Marconi Company

2442 Trenton Avenue, Montreal 16, Quebec



Lindsay Antenna & Specialty Products Limited — an all Canadian Company specializing in communications antennas. Standard designs in yagis, corner reflectors, ground plane, unipole with ground plane, cardioids, etc., are available. Antennas also manufactured to customer specifications.

Lindsay Antenna & Specialty Products Ltd.

11 Wellington Street, Lindsay, Ontario



A Company recognized for quality in the Electronics Field.

Philco Corporation of Canada Ltd.

Don Mills, Ontario



TI is the largest commercial manufacturer of transistors. The TI-line displayed at the show included silicon and germanium transistors, silicon diodes and rectifiers, precision film resistors, the new SENSISTOR silicon resistors, and tan-TI-CAP solid tantalum capacitors.

Texas Instruments Incorporated

Earl Johnson, Sales Engineer

53 Queen Street, Ottawa, Ontario



Manufacturers of turntables, audio and video amplifiers, power supplies, portable and studio equipment, racks and accessories.

McCurdy Radio Industries Ltd.

22 Front Street West, Toronto, Ontario - EMpire 6-6531



The Canadian Astronautical Society, founded in Toronto in 1957, is a new organization in Canada, aimed at promoting and advancing in this country all arts and sciences related to the field of astronautics. Though essentially a professional body, all interested persons across Canada are encouraged to join. Regular meetings, publications and theoretical and experimental projects comprise the main activities.

Canadian Astronautical Society

c/o de Havilland Aircraft of Canada, Guided Missile Division - Downsview, Ontario



A complete display of instruments and panel meters by HICKOK ELECTRICAL INSTRUMENT CO. — High voltage power supplies by PESCHEL ELECTRONICS — Erec-tronic experimental circuitry systems by SCIENCE ELECTRONICS — Shielded rooms by SHIELDING INCORPORATED — test instruments and panel meters and kits by STARK ELECTRONIC INSTRUMENTS LTD. — All represented by

Stark Electronic Sales Co.

Stark Building, Ajax, Ont.



Our modern Canadian facilities at Whitby, Ontario can provide Canadian made products to meet all your antenna and transmission line requirements. Consult us on your Systems Engineering problems without obligation.

Andrew Antenna Corporation Ltd.

606 Beech Street, Whitby, Ontario



Eimac exhibited the latest developments in ceramic tubes, including a new line of Reflex Klystrons for C, X and K Band applications. Ceramic Negative-Grid tubes and high power amplifier Klystrons extensively used in Canadian applications were displayed.

Eitel-McCullough, Inc.

798 San Mateo Avenue, San Bruno, California

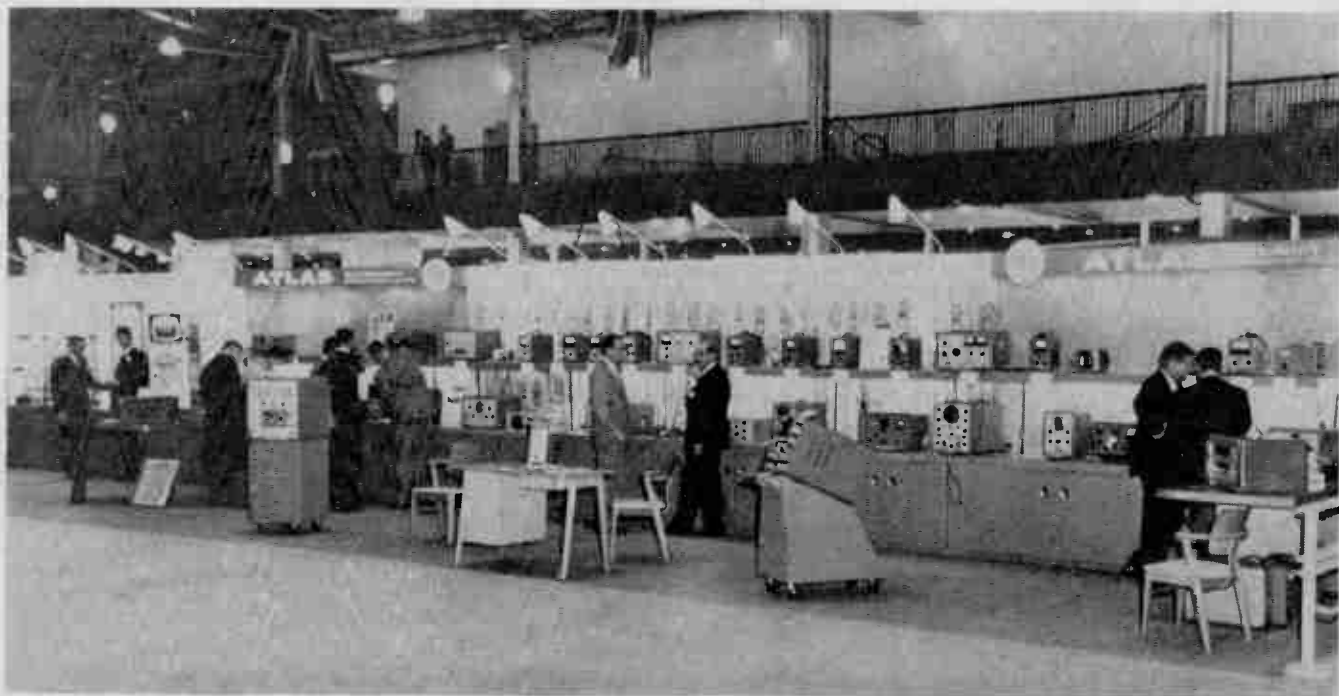

The large display of Atlas Instrument Corporation Limited, exclusive Canadian representative for leading U.S. manufacturers in the electronic instrumentation field. Prominently displayed are instruments manufactured by Dymec, Inc.; Electro Products Laboratories Inc.; Gertsch Products Inc.; Hewlett-Packard Company; Kintel; Tel Instrument Electronic Corp.

Atlas Instrument Corporation Limited

50 Wingold Avenue, Toronto 19, Ontario



A wide range of Transistorized Power Supplies for both Military and Commercial application and a unique Transistorized Mount-to-Mount Dynamotor replacement was shown by this Concern, together with a fine range of instrumentation manufactured by Advance Components Limited of England, this including A.F. and R.F. Attenuators.

Conway Electronic Enterprises

REG'D

1514 Eglinton Ave. West, Toronto 10, Ont., Canada - RU. 3-6576, RU.3-6676



We specialize in a complete line of relays covering; high speed resonant, transistorized DC polarized, latching, hermetically sealed, sub miniature, high shock (1,000 G's) high temperature. Miniature versions of standard electronic components our specialty. Miniature bearings, transformers, capacitors, relays, tubing and resistors. Motors; shaded pole, unidirectional, reversible, synchronous, geared head, geared head multiple output, permanent magnet DC, 400 cycle AC, split series DC and rectangular shape permanent magnet.

John Herring and Company Limited

3468 Dundas St. W., Toronto, Ont.



Microwave Instrumentation & Test Equipment

Polarad offers a complete line of microwave signal generators covering the frequency range of 400 mc to 50,000 mc, a complete line of various Spectrum Analyzers covering the spectrum of 10 mc to 100,000 mc, and features the only Field Intensity Meter approved for use in the 1000 mc to 10,000 mc region in MIL E 26600, the new Air Force specification on Interference Control Requirements which supersedes MIL-I-006181C.

Polarad Electronics Corporation

43-20 34th Street, Long Island City, New York, U.S.A.



Canada's leading distributor of electronic components for every industrial requirement. Prompt processing of orders and vast stock assure immediate delivery of your orders. Write for FREE Industrial Components Catalogue.

Electro Sonic Supply Co. Ltd.

Industrial Sales Division

543 Yonge St., Toronto 5, Ont. - WAlnut 4-9301



An associate of the International Telephone & Telegraph system of companies engaged in the engineering and manufacture of electronic and communication equipment. Items of special interest exhibited were a Single Side Band Receiver, Small Core Coaxial Repeater, Transistorized Rural Telephone Carrier, and components.

Standard Telephones & Cables Mfg. Co. (Canada) Ltd.

9600 St. Lawrence Blvd., Montreal



Component parts for ground, airborne and missile platforms with max. sensitivity/temp./life.

- Components 0.5 — 90 Kmc — absorbers: flex guide: diodes (parametric, mixer, video): magnetrons: tr's: w.g instruments: rf connectors.
- IF, RF and TWT low noise amplifiers ● Semi-conductor — power supplies; diodes.
- Printed circuit — connectors, precision resistors, boards, hardware, lights.

E. G. Lomas

227 Laurier Avenue W., Ottawa 4, Canada

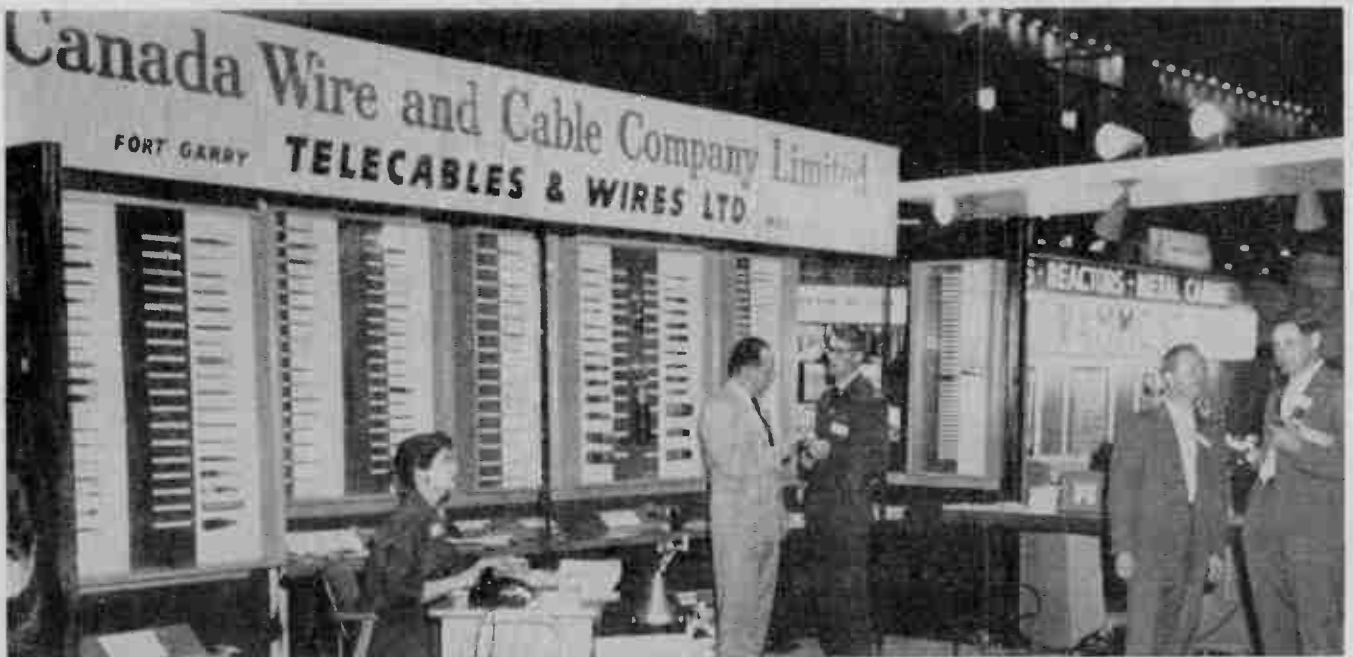

IRE CONVENTION DISPLAY: Canada Wire and Cable Company Limited display at the Institute of Radio Engineers' Convention and Exposition at Exhibition Park, Toronto, featured a complete range of radio frequency and specialty magnet wire for radio, television and electronic industries. The display also included the full range of telephone cables being manufactured by its subsidiary company, Telecables & Wires Ltd.

Canada Wire & Cable Co. Ltd.

147 Laird Drive, Postal Station 'R', Toronto 17

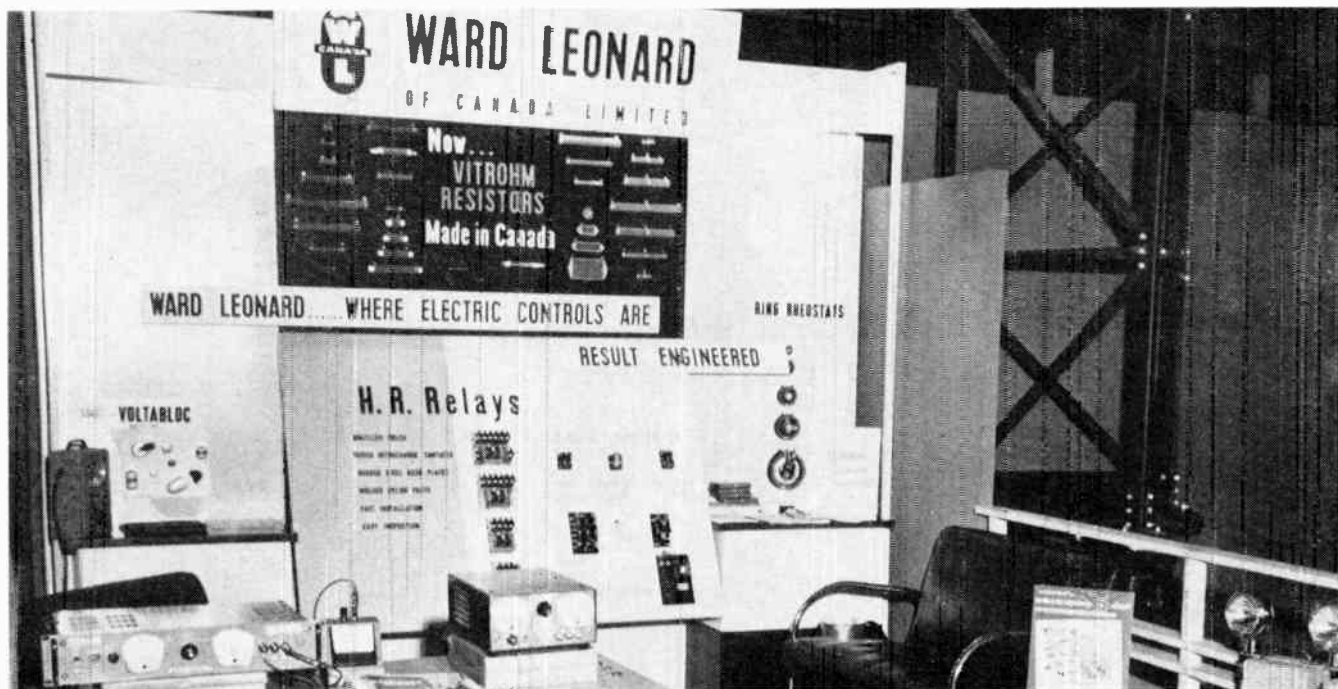

The Ward Leonard booth featured made-in-Canada Vitreous enamel resistors, various types of relays and rheostats, the SAFT line of hermetically sealed nickel cadmium batteries, and the Saftlite emergency lighting unit. It also introduced to Canada Kepeco transistorized packaged DC power supplies.

Ward Leonard of Canada Limited

1070 Birchmount Road, Toronto 16, Ontario



Established for over 35 years as a sales organization operating throughout Canada, representing leading Manufacturers of Quality Electronic Components and Equipment.

A. C. Simmonds & Sons Limited

100 Merton Street, Toronto 7, Canada



Out of RCA Victor electronic research come advances in defense electronic systems . . . broadcast audio and video equipment . . . microwave, mobile, industrial, aviation and marine electronic equipment . . . and tubes and components. You can count on RCA Victor electronic equipment for the most up-to-date features . . . the greatest satisfaction . . . and the lowest possible maintenance costs.



RCA VICTOR COMPANY, LTD.

HALIFAX • MONTREAL • TORONTO • WINNIPEG • CALGARY • VANCOUVER



Cosson (Canada) Limited, designers, manufacturers and distributors of precision electronic apparatus for laboratory, industrial and medical application. Distributors of audio equipment, stentorian speakers, microphones and projectors. Representing A. C. Cosson Limited, Cosson Instruments Limited, Cosson Radar Limited, Dawe Instruments Limited, Rank-Cintel Limited, Evans Electro Silenium Limited, Spencer Kennedy, Inc., Magnetic Amplifiers Inc., Whitley Brothers Limited, B. T. H. Limited (sound projectors).

Cosson (Canada) Limited

Head office: 301 Windsor Street, Halifax, Nova Scotia

Branch offices: Toronto, Ottawa, Montreal



Automatic Electric, manufacturers of telephone-type relays and stepping switches and pioneers of their use in industrial applications, offers the electronic field 60 years of design and manufacturing experience. A comprehensive display of electrical control apparatus was on show.

Automatic Electric Sales (Canada) Limited

Branches across Canada

185 Bartley Drive, Toronto 16, Ontario



Automatic Electric and Lenkurt, leaders in Carrier Communications, "teamed-up" to provide the finest in microwave equipment. The display featured Lenkurt MICROTREL — Type 74A radio equipment, designed for operation in the 6000 mc band.

Automatic Electric Sales (Canada) Limited

185 Bartley Drive, Toronto 16, Ontario



The products displayed included panel instruments, permanent magnets, specialty resistors, thyrite varistors, thermistors, and inductrol voltage regulators.

INDUSTRIAL PRODUCTS DEPARTMENT

Canadian General Electric Company Ltd.

940 Lansdowne Avenue, Toronto, Ontario



Posing for the "We Were There" cameraman are members of Electronics and Communications magazine with guest Al Goldberg of Polarad Electronics Corporation of Long Island City. From left to right are: T. W. Lazenby, editor, Electronics and Communications; Al Goldberg, Polarad Electronics Corporation; Norman McHardy, president, Age Publications Limited; and Bud Dallyn, Advertising Manager, Electronics and Communications.

Electronics and Communications

450 Alliance Avenue

Toronto 9, Ont.



Manufacturers and Distributors of Radio Communication Equipment, Wires and Cables, Telephone, Telegraph Equipment, Power Apparatus, Wiring Materials, Illumination, Lamps, Overhead and Underground Equipment.

Northern Electric Company Limited

General Offices: 1600 Dorchester Street West, Montreal, Canada



Canada's leading Manufacturers of Electronic Equipment for industry and defense. The product lines represented in the exhibit were: Microwave Scatter Systems, power line carrier, line-of-sight microwave equipment, environmental laboratories, analog computing facilities, machine tool control, airborne electronics, homing torpedoes.

Canadian Westinghouse Company Limited

Electronics Division,

Hamilton, Ontario

IRE Convention Committees

EXECUTIVE COMMITTEE

Dr. George Sinclair, General Chairman
A. P. H. Barclay, Technical Program
E. D. Etches, Social Activities
F. J. Heath, Exhibits
H. W. Jackson, Toronto Section IRE
A. Jones, Advertising and Publicity
S. F. Love, Recording Secretary

T. M. Lynd, Finance
C. A. Norris, Past Chairman
E. L. Palin, Registration and Reception
J. M. Toye, IRE Region 8 Liaison and Corresponding Secretary
R. J. A. Turner, Convention Record

ADVISORY COMMITTEE

Dr. B. G. Ballard, Vice-President, Scientific, National Research Council
T. J. Bell, President, Canadian Electrical Manufacturers Association
C. T. Carson, President, Association of Professional Engineers of Ontario
Dr. George S. Field, Chief Scientist, Defense Research Board
Dr. Gordon Patterson, President, Canadian Aeronautical Institute
General Charles Foulkes, C.B., C.B.E., D.S.O., C.D., Chairman, Canadian Chiefs of Staff, Department of National Defense.
W. H. Jeffery, President, Electronic Industries Association of Canada

Dr. W. B. Lewis, Vice-President, Research and Development, Atomic Energy of Canada Limited
J. G. Morrow, President, Canadian Industrial Preparedness Association
A. B. Oxley, Regional Director, Institute of Radio Engineers
F. H. R. Pounsett, President, Canadian Council of Professional Engineers
Prof. W. O. Richmond, Canadian Council of Professional Engineers
R. W. Ryan, President, Air Industries and Transport Association
Prof. G. F. Tracy, Vice-President, District 10, American Institute of Electrical Engineers — also representing The American Society of Engineering Education
K. F. Tupper, President, Engineering Institute of Canada

CONVENTION MANAGER

Grant Smedmor

IRE CANADIAN CONVENTION

Convention Office: 1819 Yonge Street

GRANT SMEDMOR, Canadian IRE Convention,
745 Mount Pleasant Road, Toronto 12, Ontario.

TECHNICAL PROGRAM COMMITTEE

A. P. H. Barclay, Chairman
W. E. Hodges

D. K. Ritchie
J. R. Bain

E. L. Kerridge
Dr. G. Sinclair

F. A. Ford
W. Ornstein

SOCIAL ACTIVITIES COMMITTEE

E. Etches, Chairman

W. F. Choat

R. G. Bullock

F. W. Deacon

REGISTRATION AND RECEPTION COMMITTEE

E. L. Palin, Chairman

G. L. Stewart

L. Price

Geo. Armitage

Reserve Space In The

**PRODUCT
INFORMATION SECTION**

OF

**ELECTRONICS and COMMUNICATIONS
1959 ANNUAL DIRECTORY
and BUYERS GUIDE**

**TAKE ADVANTAGE *of this* RARE OPPORTUNITY to
INTRODUCE YOUR PRODUCT to CANADIAN BUYERS**

HERE IS THE PLAN The December issue of ELECTRONICS AND COMMUNICATIONS, Canada's Pioneer Publication in this Canadian Market will be the fifth Annual Directory and Buyers' Guide issue. In addition to the regular Directory listings, the issue will carry a PRODUCT INFORMATION SECTION, as has been carried in the last four issues of this Directory. There, in reader form, with illustrations if required, will appear catalog-like descriptions of interesting components, materials, equipment or literature, prepared by the suppliers themselves.

THIS IS NO EXPERIMENT This section is a real enquiry-producer — proven by several

years' experience — Buyers and Engineers like it. Inside of two weeks, from date of mailing last year, the section produced over 1,000 postcard enquiries for users of space in it.

HOW TO USE IT Send along write-ups of your products, or have your agency do so, to reach us not later than December 1st. We will set it up and bill you or the agency at the very reasonable rate of \$10.00 per column inch for space used, plus a very nominal charge for any engravings needful. Regular agency discounts are of course payable.

ELECTRONICS and COMMUNICATIONS

450 ALLIANCE AVENUE



TORONTO 9, ONTARIO

Electronics and Communications is published by AGE PUBLICATIONS LIMITED, publishers of Restaurants and Institutions; Automatic Heating; Canadian Aircraft Industries; Heating, Plumbing and Air Conditioning Age; Wine, Beer and Spirits.

NEW ACCESSORIES

FOR AN OLD FAVOURITE

THE *Electronic Secretary*

During the past year the Electronic Secretary has become one of the most popular items of telephone equipment for both telephone companies and subscribers.

Subscribers are delighted by the convenience. The Electronic Secretary answers telephone calls when the office is empty, with a pre-recorded message. It also records the message the caller wishes to leave. Subscribers save time and increase business efficiency.

Telephone companies are delighted by the extra revenue and goodwill the Electronic Secretary brings.

Here are the new accessories to increase the versatility and popularity of the Electronic Secretary.



TAPE ADAPTER ATTACHMENT:

Instead of using a pre-cut record of his opening message, the subscriber may change this message whenever he chooses, merely by dictating the new message on to the tape.

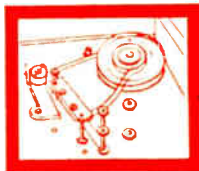

REMOTE CONTROL CALL BACK SET:

Now, the subscriber need not return to his office to play back his messages. By dialing his number and using the remote call back set, an activating signal trips a switch, and plays back all his calls — *on the telephone!*



VOICE CONTROL ADAPTER:

Normally the caller has a minute or so to record his message. Some offices require longer periods for in-coming calls. The Voice Control Adapter records as long as the caller is speaking. A 20 second break would cut him off.

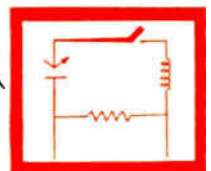

ALSO AVAILABLE:

TR Answering Unit — answers the phone with a (pre-recorded) message but does not record incoming messages.

TT Answering Unit — same as the TR model, except that the outgoing message may be changed as frequently as desired.

Both the TR and TT Answering Unit are available at approximately $\frac{1}{2}$ price of the standard Electronic Secretary.

The ELECTRONIC SECRETARY in no way interferes with normal telephone use. It is distributed to telephone companies in Canada by

AUTOMATIC SALES AND SERVICE (CANADA) LIMITED

185 Bartley Drive, Toronto 16, Ontario

Branches in: Montreal
Ottawa
Brackville
Hamilton
Winnipeg
Regina
Edmonton
Vancouver

AUTOMATIC ELECTRIC

SALES (CANADA) LIMITED

LOCATE TROUBLES BEFORE T

...with
AUTOMATIC ELECTRIC
testing equipment

HERE...

are just a few of the many special items of testing equipment developed by AUTOMATIC ELECTRIC for telephone, communication and electrical control equipment. Call or write us for complete information.



CURRENT FLOW TEST SET

For use in making mechanical adjustments of switches and relays. Compensates for test current voltage variations and directs measured amount of current to coil of switch or relay under test. Circular 1831.

THEY AFFECT YOUR SERVICE—



PORTABLE DIAL SPEED TESTER—Tests telephone type dials, impulse repeaters, key senders and automatic switching equipment quickly and easily at any location where a 48 volt battery is available. Ask for Circular 1707.

LINEFINDER TEST SET

Provides complete operational checks of two-motion linefinder switches on the test bench. Passes them ready for service. Circular 1826.

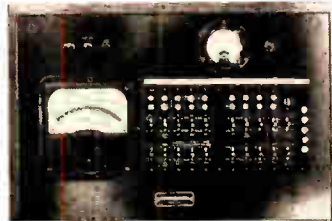
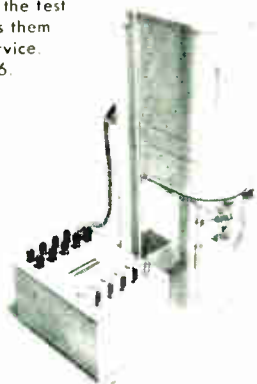

TYPE 21 TEST TURRET

Tests subscribers' lines and trunks in small automatic telephone exchanges (of not more than 1000 lines capacity) and in private automatic branch exchanges (P-A-B-X's) of any size. Full details in Circular 1830.

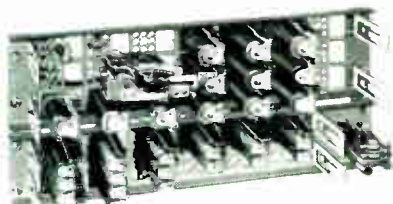

REMOTE-CONTROLLED DIAL SPEED TESTER Enables service men to test telephone dials at subscribers' stations by merely dialing a test number to exchange. Operates automatically without help from exchange personnel. Circular 1707.



LINE INSULATION ROUTINER with new PRINTROLLER

Automatically routines exchange lines for insulation faults at the rate of 30 lines per minute. Locates and records shorts, crosses and grounds even checks itself automatically. See Circular 1811 A.

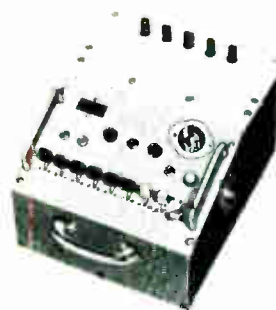

VARYING MACHINE—PULSING TEST SET

Tests Strowger Automatic, step-by-step switches, and interoffice pulse repeaters duplicating actual operating conditions. Can also be used to generate pulses for other Automatic Electric test equipment. Ask for Circular 1898.

Automatic Electric Sales

(Canada) Limited, 185 Bartley Drive,

Toronto 16, Ontario

Branches in

Montreal, Ottawa,

Brockville, Hamilton, Winnipeg,

Regina, Edmonton, Vancouver.

AUTOMATIC ELECTRIC

ORIGINATORS OF THE DIAL TELEPHONE



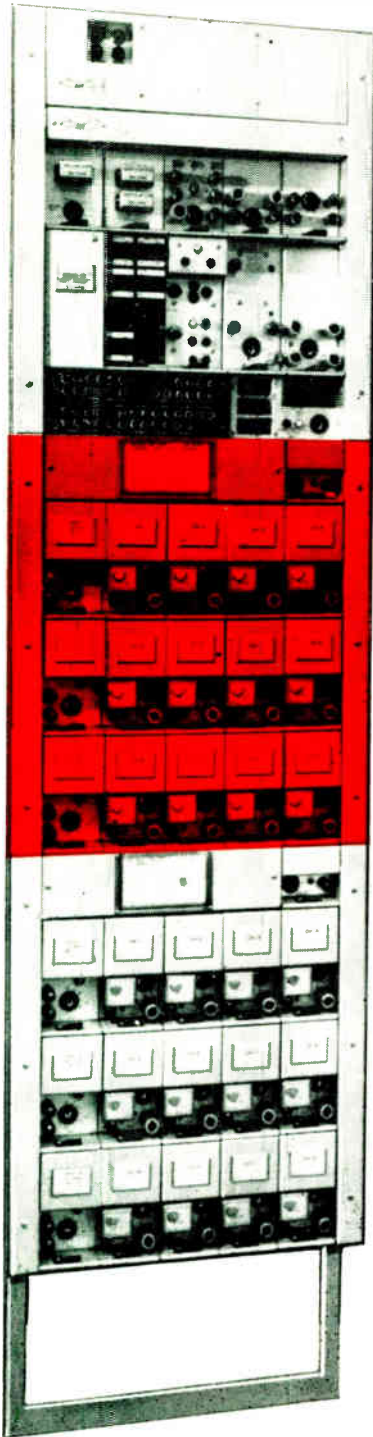

WITH

Lenkurt

STACKABLE

CARRIER EQUIPMENT

**you can add
one channel at a time**

- Lenkurt stackable carrier equipment provides an orderly, economical, "building-block" method of expanding telephone services on a channel-at-a-time basis.
- You buy—and pay for—only the equipment you need, add additional equipment step-by-step, as your company grows.
- Practical and economical—designed to meet the needs of large *and* small communities.
- Economical on long *and* short toll circuits—the entire range of telephone networks.
- Already tested and proven—on thousands of telephone lines—in almost every part of the world.

Lenkurt

For further details call any Automatic Electric office or write direct to: AUTOMATIC ELECTRIC SALES (CANADA) LIMITED, 185 Bartley Drive, Toronto 16, Ontario. Branches in Montreal, Ottawa, Brockville, Hamilton, Winnipeg, Regina, Edmonton, Vancouver.

AUTOMATIC  **ELECTRIC**

ORIGINATORS OF THE DIAL TELEPHONE



The Jodrell Bank Telescope *Continued from page 21*

tween the position setting Magslip and a coincidence Magslip on the co-ordinate shaft is reached.

Again, the controlling co-ordinate may be arranged to scan across a given arc about a pre-determined center, the center being established by the position setting Magslip which is again coupled to the coincidence Magslip on the controlling co-ordinate. The output of the coincidence Magslip is coupled to and compared with the pre-set amplitude bias on the relay valve, the amplitude of the bias being set by R_{12} . The bias determines the limit of the scan by operating or releasing relay A_4 when the Magslip error signal exceeds that of the bias. Operation and release of A_4 changes the sense of the driving voltage, the speed being governed by the setting of the scan speed control R_{10} .

While one of the co-ordinates is scanning about a given center, in order to provide a second dimension to the scanning raster, the other controlling co-ordinate can be varied by a finite amount. The variation may be initiated each time the first co-ordinate reverses direction or by time impulses which are set upon the control desk. The source of initiation is selected by operation of S_1 . If the stepping motion is to be initiated by reversal of direction of scan of the first co-ordinate, operation and release of A_6 (equivalent to A_4 in duplicate unit controlling the first co-ordinate) causes a relay A_{10} to pulse. Pulsing of A_{10} operates A_9 and A_8 which connect the driving voltage to the motor generator. The step commutator on the co-ordinate shaft is driven round until an earthed segment is reached which causes A_8 to release which in turn releases A_9 which breaks the driving signal to the motor generator, A_6 will remain released until a further pulse of A_{10} . The size of the step is decided by the commutator segment which is selected by S_2 . When it is desired to step on a time-base, relay A_6 is operated by impulses received from the timer instead of by pulsing

of A_{10} .

Duplicate scanning units are provided so that each of the co-ordinates in the driving pair may be controlled independently.

During scanning, the telescope and the other sets of co-ordinates follow via the computer.

Means are provided so that if, while following a star, the telescope reaches its limit of rotation in azimuth, a contact on the co-ordinate shaft causes the normal signal to the azimuth motor generator to be disconnected and a fixed input is fed in causing the motor to drive in the reverse direction for 360° when a further contact restores the normal signal and the drive is resumed and the star is again picked up. During the auto-reversing of azimuth, the input to the elevation is disconnected so that the elevation position is locked.

Circuits are provided so that in the event of component breakdown or other fault causing errors either in computation or following, normal tracking of the telescope will cease and alarms will be raised. Interlock facilities are provided to prevent entry into the bowl or to the swinging laboratory while the telescope is in motion and to prevent the telescope from being moved while personnel are in the bowl.

A feature of the control gear is the easy accessibility of all chassis and components for maintenance and servicing. All chassis connections are made by plug and sockets for easy and quick replacement.

Ratios of 21 600:1 exist between the Magslip resolvers and the motor generators which they control and which in turn drive them, a small amount of backlash in the drive could therefore introduce large errors and ambiguities in the computations and control system. Great care has, therefore, had to be taken in the mechanical design and construction to avoid backlash in gearing and to keep friction to a minimum.

Auditory Recognition In Telephony *Continued from page 31*

such artifacts when these methods are applied to a broad population of talkers. A scheme for overcoming this defect is presented. It requires that analysis be carried out synchronously with the voice pitch. From this standpoint, pitch recognition is fundamental to the whole problem of speech analysis, and very likely to speech recognition for a wide population of talkers and a large vocabulary.

While some progress has been made in various areas of speech recognition for communication, many basic problems remain. Solutions are probably not to be found in juggling and refining presently available speech-processing devices. Rather we must study the anatomy and physiological processes of human beings and animals. Physiological research must be supple-

mented by measurements of human ability and behavior in the process of recognition. And finally, the problems of recognition must be attacked by considering logically and mathematically how a human being or a machine could recognize speech patterns, and by testing the validity of proposed schemes. Here the use of digital computers to simulate the necessary experimental equipment will yield very considerable economies of time and effort, while retaining the necessary flexibility. As this work proceeds, the use of artificial human recognizers in communication, computation, and control will come to depend upon how much human time, effort, and money people are willing to expend in simulating human functions.

COVER STORY

The largest fully steerable radio telescope in the world is built in Cheshire, England, at the Jodrell Bank Experimental Station of the University of Manchester. It is powered by electric motors and the control system is designed so that the telescope can be driven to counteract the motion of the earth in order to follow a star automatically.

It is believed that many of the radio sources which this telescope will study lie far out in space at distances of, perhaps, 1000 million light years. The telescope can also be used as a transmitting aerial in which form it will be used to study the radio echoes from shooting stars, the moon and possibly the planets and artificial earth satellites.

New Products

New Product specifications published in Electronics and Communications have been briefed for your convenience. If you require further information on any of the items published you may readily obtain such by using our Readers' Service, Page 91. Just mark the products you are interested in on the coupon on Page 91 and the information will be in your hands within a few days.

Quick-acting electronic recorder

Item 2101

This Cambridge recorder has been re-designed to meet the increasing demand for a very high speed, high performance recorder, capable of operating continuously at peak performance under the most exacting conditions. The leading characteristics are briefly summed up: response better than 0.4 seconds full scale; rated for continuous operation; ranges down to 1 mv. full scale; accuracy better than 0.5% full scale; sensitivity better than 0.1% full scale; chart speeds up to 2"/second; powerful, reliable 2 phase servo-motor re-balance system of entirely new design.

The measuring circuits are: a self-balancing DC potentiometer, with ranges from 0-1 mv, single or multi-range. Calibration may be in electrical units, temperature, light intensity, radiation intensity, etc. The slidewire is fed by current from a dry cell, or rectified AC supply unit. Standardization is achieved against a miniature standard cell with a built-in centre-zero galvanometer as a null indicator. The maximum external circuit impedance is 500 ohms for 1 mv. full scale.

A self-balancing DC bridge, with temperature ranges down to spans of 10°C in conjunction with resistance thermometers, single or multi-range. A self-balancing DC ratiometer, which measures the ratio of two variables that can be applied in the form of two voltages or currents. The amplifiers are powerful, multi-stage with a push-pull output, capable of operating continuously under peak loading. They are completely self-contained with their own power unit, and are easily accessible.

R. H. Nichols Limited, P.O. Box 500, Downsview, Ontario, Canada.

Unit for producing pure echo effects

Item 2102

A new, compact reverberation unit capable of producing exceptionally pure echo effects for radio, TV and recording studios, is now available from Ahearn and Soper Company Limited, of Ottawa.

The unit, made by Viditon Corporation Limited, and known as the EMT 140, is approximately 8' x 2' x 4'. It is adaptable to either special effects, symphonic music or jazz, and where studio space is limited, can be stored in cellars or hallways and operated by remote control.

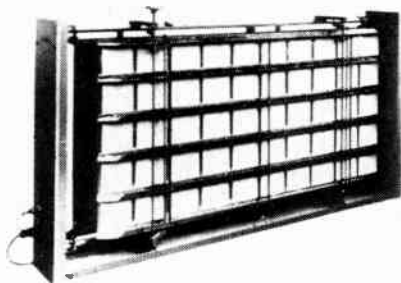

The new unit is said to completely eliminate the problem of mixed echo and original sound, and to provide true and acceptable echo characteristics with a very rich reverberation spectrum. Distortion-free output is between 30 and 12,000 cycles. Reverberation time ranges from 0.8 to 6 seconds.

For complete information write to Ahearn and Soper Company Limited, 384 Bank St., Ottawa, Ontario.

Sub-miniature multiturn limit stop

Item 2103

The LS 104 is a new sub-miniature, multi-turn, infinitely adjustable limit stop for use in miniature servo and instrument mechanisms.

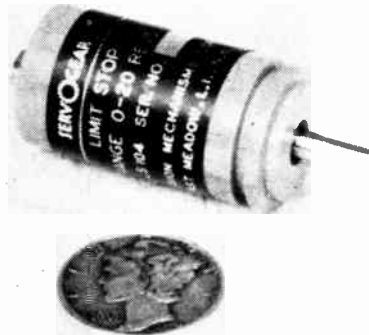

The new unit is the smallest of a standard line of mechanical limit stops. It is .625 inches in diameter, 1 1/2 inches long, synchro mounted, and has a torque rating of 18 ounce inches. It can be set to limit rotation to any angle from 0 to 20 revolutions by means of an external screw at the end of the unit. Precision ball bearings provide low starting torque.

Of anodized aluminum alloy and corrosion resistant steel construction, it meets the requirements of MIL-E-5400.

The new stop is a pre-designed component for the miniature mechanisms field. It provides a combination of extremely small size, large turns capacity, and simplicity in range setting. Its use eliminates the time, cost, and engineering effort required to develop limit stops for each new application.

Precision Mechanisms Corporation, 577 Newbridge Ave., East Meadow, N.Y., U.S.A.

Mini-E connectors pass resistance tests

Item 2104

New Amphenol 67 Series Mini-E Connectors have been engineered specifically for the aircraft and missile industry.

This series of connectors are manufactured to pass tough altitude, moisture resistance tests and feature:

- Environmentally sealed with the utilized back and grommet which meets altitude moisture resistant requirements of MIL-C-5015C. Paragraph 4521.
- Spring loaded coupling providing a positive locking action in the bayonet slot.
- Stainless steel bayonet slots and pins to reduce wear.
- Flattened inclined angle bayonet slots reducing mating force requirements.
- Face seal gasket with individual barriers to isolate each contact.
- Hard insert dielectric to positively retain contacts.
- Test voltage 1500 volts RMS 70,000 feet on sealed connectors.
- Vibration per method 204 of MIL-STD-202A 10-20,000 CPS at 20 g's.
- Temperature cycling range per MIL-C-5015C paragraph 453 increased to 257°F maximum and minus 67°F minimum.

For further information write to Amphenol Canada Limited, 300 Campbell Ave., Toronto 9, Ontario.

Transistor test set

Item 2105

The Transistor Tester Type 236 is a general purpose instrument designed to measure the small signal, low frequency parameters of P-N-P transistors of either junction or point type over a wide range of operating conditions. The instrument is entirely mains operated and enables static tests to be made up to a current of 40 mA with a maximum collector voltage of 80 volts. In addition, certain small signal parameters are measured directly by a bridge system at 420 cps.

Resistance measurements are extended by a multiplier switch to give a complete range of measurement from 0.1 ohm to 10 meg-ohms. The same dial and ratio switch is used to extend the range of ratio measurements to give an overall range of ratio from 0.1 to 1,000.

A bridge oscillator and detector is incorporated in the instrument and facilities are provided for an external oscilloscope to be connected to detect distortion and check the linearity of the small signal measurements, or telephones may be used for aural null detection of bridge balance.

Airmec Limited, High Wycombe, Buckinghamshire, England.

Quick reset counter

Item 2106

The Trumeter Predetermined Counter can be used on looms, spinning machines, knitting machines, presses, coil winding machines, etc.; in fact, for any counting operation. It controls overruns and under-runs, thus preventing waste.

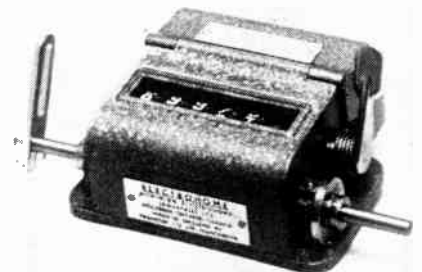

The control is provided by a non-inductive micro-switch operated by the counter mechanism. The switch contacts have a maximum rating of 600V 2 amps, and can be operated on 110 volt supply with a maximum current of 10 amps. Other values of supply voltage may be used with a proportionate reduction of the current rating. The counter operates at 5000 R.P.M. or 1000 Strokes/minute. Other features include oil impregnated sintered iron bearings—the finest available, die cast base and cover, and Quick and Positive Reset Lever.

Quick Reset is not a new feature of Trumeter counters: however, improvements are constantly being made. By depressing the lever 45°, the counter is immediately reset. Of interest is the fact that the resetting can take place while the machine is in operation. It should also be noted that once the control impulse is given it is sustained until reset.

Since the shaft runs in covered bearings the Predetermined Counter is virtually maintenance-free.

Further details may be obtained from the Technical Products Division of Dominion Electrohome Industries Ltd., of Kitchener, Ontario. Electrohome is the Canadian representative for Trumeter.

New Products

Servo components

Item 2107

Two new ranges of servo motors have been developed by Evershed and Vignoles Limited, of London, England, and sample motors are available at short notice. The first range conforms to International and NATO standards in both dimension and performance. At present it comprises:

Size 15 Mark VII Mod. 1.—	} 400 c/s
E. & V. reference FAP3—	
Size 18 Mark VIII Mod. 1.—	} 115V motors
E. & V. reference FABI—	

The second range consists of units based on long established E. & V. designs, but adapted to provide fixing and mounting facilities, shaft details, etc. in compliance with International Standards. These comprise:

Size 15 A.C. motors—E. & V. FAM. FT, FV and FAH range.

Size 18 D.C. motors—E. & V. FAR.

Size 23 A.C. and D.C. motors—E. & V. FC, FZ, FD, FAF A.C. motors, and FP, FQ, FAD and FAG D.C. motors.

Size 31 A.C. and D.C. motors are under development. These will have performance similar to those shown on sheets 3 and 5 of the existing Publication No. 301.1.

The exact International type of mounting is retained for units up to and including size 18 only. An integral square flange is provided for larger motors.



D.C. servo motors can now be supplied with field windings requiring from 50-1,500 mA for full torque. The preferred values are 50, 80, 200, 500, 800 and 1,500 mA. Armatures can be wound for 220, 110, 50 and in some cases 28 or 24V supplies. Armature supply units Evershed PA11 series for connection to 230V 50/60 c/s supplies are now available for most D.C. motors.

A.C. motors and motor generators are now available with windings for 50V 50 c/s or 115V 50 60 c/s supplies. Control windings for direct coupling to the output stages of valve or transistor amplifiers have been developed. For the transistor windings the preferred collector to collector voltages are 15V 50 c/s and 24V 400 c/s, but alternative voltages could easily be accommodated if required. Most motors can also be wound for three phase supplies.

The range of amplifiers to control servo motors has also been extended and type PA25C D.C. amplifier is suitable for all Evershed split field motors. This amplifier produces full torque with an input of 250 mV D.C., and has an initial gain of 600 mA per volt. For 50 c/s A.C. systems amplifiers 6, 12 and 28 watts output are available.

Evershed and Vignoles Limited, Acton Lane Works, Chiswick, London, W. 4, England.

Universal breakdown tester

Item 2108

A new model of breakdown tester which can truly be termed "Universal" is now available from the manufacturers, Canadian Research Institute, Toronto, Canada.

This compact portable tester covers all of the requirements for testing dielectric strength to the specifications of the Canadian Standards Association, the Hydro Electric Power Commission or Underwriters' Laboratories, for the maker of all types of electrical and electronic equipment, household appliances, industrial motors, etc.

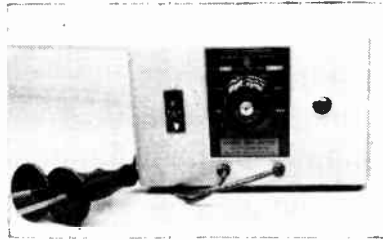

The unit, designed for simplified speedy productions testing, is housed in an attractive sturdy steel cabinet with rounded corners, only 17" x 9" x 8". Test voltages continuously adjustable from 0 to 5000, indicated directly on a large 3" meter, are available at 500 volt-ampere rating, permitting testing to CSA requirements. A fuseless circuit breaker and large indicator lamp are provided.

Easy operation with a high measure of safety is provided by long flexible high tension test leads and oversize prods, fitted with plastic guards so that the operator's hands are kept away from the high tension, which, as a further safeguard, is completely isolated from the power line and from the cabinet.

The universal breakdown tester is designated the Model RM-7 and is made in Canada for 115 volt operation, either on 60 or 25 60 cycle, the latter requiring no conversion.

For further details write to Canadian Research Institute, 46 St. George St., Toronto 5, Ontario.

Higher rotational-life potentiometer

Item 2109

A new improved design giving higher rotational life, plus the ability to take tough environmental specifications, has resulted in the new H-751 potentiometer.

Features:

1. Improved quality at no extra cost.
2. 50 to 25,000 ohm resistance range with tolerance as low as 1%.
3. Rotation 350° minus 0 plus 4°.
4. Linearity to $\pm 5\%$ for most resistance values.
5. Temperature co-efficient -20×10^{-6} per degree centigrade for all standard resistance values.
6. Power rating 1 watt.
7. Net weight 1 ounce.

For further information write to International Resistance Co. Ltd., 349 Carlaw Ave., Toronto 8, Ontario.

Epoxy-bonded fibre glass antennas

Item 2110

New omnidirectional high gain fixed station antennas for use in the 150 and 450 megacycle bands have been announced by Dielectric Products Engineering Co. Inc., of Raymond, Maine. Named the "Heliphase" Line, these epoxy-bonded fibre glass antennas feature a new type of feed system which reduces internal loss and greatly improves electrical performance.

VSWR is less than 1.5 to 1 for all models, which are available with a gain of 5.5 db at 150 mc, and 5.5, 7.5 and 10 db in the 450 mc band.

For further information contact Canadian representative: Dayrand Limited, Room 301, 901 Victoria Square, Montreal 1, Quebec.

AM transmitter

Item 2111

The RCA type BTA-500R IR is a truly new transmitter both electrically and physically. Color doors and modern functional styling will blend the BTA-500R IR with the radio station's decor. New electrical developments make it more efficient and economical to operate.

Only 11 tubes including rectifiers are used in the BTA-500R IR. A common exciter chassis employed in both the 500 and 1000 watt transmitter simplifies power change. Tetrodes are used throughout to eliminate neutralization and to simplify tuning. The low voltage and bias power supplies use selenium rectifiers, while the high voltage supply employs two type 8008 rectifiers.

Modern vertical chassis construction permits ease of maintenance. All operating controls are on the front of the transmitters. By connecting the RCA type BTR-11A/20A remote control system to the BTA-500R IR remote terminal bus, the transmitter can be operated completely by remote control.

The BTA-500R and the BTA-IR Transmitters are available for delivery in thirty days.

Further particulars available from Broadcast Equipment Marketing Department, Engineering Products Division, RCA Victor Company Ltd., Montreal 30, Que.

Variable reluctant diaphragm type transducer

Item 2112

A miniature, single coil, variable reluctance, diaphragm type transducer can be used as the variable inductor in commercially available inductance and reactance controlled FM/FM sub-carrier oscillator systems has been announced by Ultradyne, Inc., P.O. Box 3308, Albuquerque, New Mexico. Differential, gage and absolute models are offered with a wide selection of pressure ranges between 0-10 psi and 0-5000 psi.

Called the S-60, the unit combines very low sensitivity to shock, vibration and acceleration (.001% g to .01% g, or less, depending on pressure range) with a rise time of 75 to 150 microseconds. The basic size is $\frac{7}{8}$ " diameter x $\frac{7}{8}$ " long. This model can be supplied with a wide variety of fittings and cable adaptors. It is also available as a water cooled unit. High overload rating and high diaphragm burst pressure protect the gage where transient overpressures exist.

Standard deviation is $\pm 7\frac{1}{2}\%$ ($\pm 5\%$) for all RDB bands unless otherwise specified by the customer. Operating temperature range is from -85°F through $+240^\circ\text{F}$.

These units are suited for a wide variety of telemetering applications. Their high reliability under extreme acceleration, vibration and shock conditions qualifies them for missile and nuclear applications.

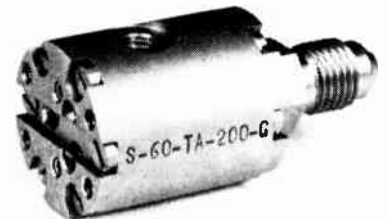

Since the coil and pole pieces are isolated from the main pressure port by the diaphragm, conductive and corrosive fluids, sand, dirt and other foreign matter may be applied to the main pressure port without effect on transducer operation.

S-60's are mechanically adjusted at the factory for $\pm 1\%$ linearity and the correct deviation for the sub-carrier oscillator type specified by the customer.

Ultradyne, Inc., P.O. Box 3308, Albuquerque, New Mexico, U.S.A.

New Products

Transistorized DC to AC inverter

Item 2113

The "Transverter" series of DC to AC inverters announced by Vibration Research Laboratories Inc. of Tuckahoe, N.Y., employs a radically new transistor circuit which makes the output frequency independent of input voltage or load. Nominally rated at 115 volts 60 cycles output, the frequency is adjustable by means of a calibrated dial to any figure between 55 and 65 cycles.

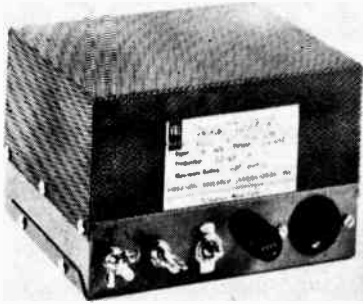

Transverter models are available for 6 volts input, output capacities 30 to 150 watts; for 12 volts input, capacities from 40 to 250 watts; for 24-28 volts input, capacities from 120 to 500 watts; and for 32 volts input, capacities from 130 to 500 watts. Weights vary from 3 lbs. for the 30/40 watt models, to 28 lbs. for the 500 watt models. Efficiency of over 90% is claimed, as well as complete freedom from RF noise and transient spikes.

Represented in Canada by Tele-Radio Systems Ltd., 3534 Dundas St. W., Toronto 9, Ontario.

Electrolyte tantalum capacitors

Item 2114

The development of a broad new range of solid electrolyte tantalum capacitors has been announced by the Swiss electronic firm Chimel, S. A. of Geneva, one of the pioneers in the development of sintered tantalum capacitors. A product of long laboratory research, the new Chimel products have capacitance values of several times those known previously any place in the world. The new series includes capacitors of up to 400 microfarads at 6 volts; 220 microfarads at 10 volts; 150 microfarads at 15 volts; 100 MF at 20 volts; and 22 MF at 35 volts.

These units supplement the wide range of existing Chimel solid electrolyte tantalum capacitors.

For further information write Chimel S.A., 5 Quai de l'Île, Geneva, Switzerland.

"Sensistor" silicon resistor

Item 2115

An entirely new dimension was recently added to the field of electrical components by Texas Instruments Incorporated with the announcement of a completely new solid state device—the "Sensistor" silicon resistor.

The most significant characteristic of the new "Sensistor" silicon resistor is that it has a 0.7%/°C positive temperature coefficient of resistance. Now, for the first time, a device is commercially available which responds to an increase in temperature with an increase in resistance that rises rapidly along a stable, retraceable characteristic curve.

Because of this large positive temperature coefficient, the "Sensistor" silicon resistor is expected to have wide application as a temperature compensating device in miniaturized amplifiers, servos, computer switching circuits, magnetic amplifiers and power supplies. The new "Sensistor" silicon resistor is also ideal for use as a temperature sensing element for automatic controls and other precise temperature indicating appli-

cations. Previous temperature sensing devices, such as thermistors, have been characterized by a decrease in resistance with a rising temperature.

There are two configurations of the new "Sensistor" silicon resistor. The TM 1/4 is an axial lead molded device which is linearly derated at full load from 100°C to 150°C. The TC 1/8 is encased in a TO-5 round-welded package and is derated linearly at full load from 125°C to 200°C. Both units are immediately available in commercial quantities in standard resistance ratings ranging from 100 to 1,000 ohms at 25°C.

Texas Instruments Incorporated, Semiconductor-Components Division, P.O. Box 312, Dallas, Texas, U.S.A.

Radiation - shielded temperature sensor

Item 2116

Designed to permit air-temperature measurements substantially independent of solar and other radiation, this new Beckman & Whitley Temperature Sensor includes a triple-shielded enclosure integrated into a support arm together with an aspirating blower.

Located within a vertical cylindrical enclosure (at left, as illustrated), a thermal sensitive element is surrounded by an inner shield with a high surface-to-mass ratio and fabricated from 0.003-in. stainless steel. Surrounding this combination is a second cylinder of 0.062-in. thick aluminum.

This outer shield is of different material to reduce the effect of secondary radiation and also serves to provide mechanical protection for the assembly. A third shielding element, hat-shaped, is included for the further reduction of maximum solar radiation error. The blower and motor are located at the remote end of the mounting arm.

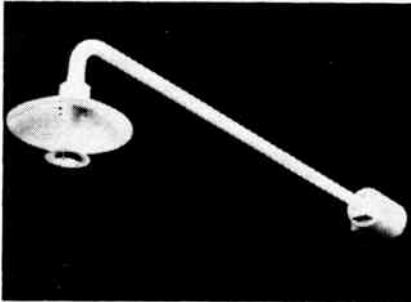

In laboratory testing as well as in service, this combination shield (which is based on a design of Pacific Division of Bendix Aviation Corp.) provides radiation shielding effective to a maximum temperature deviation of 0.2 deg F.

Beckman & Whitley, Inc., San Carlos, California, U.S.A.

Multiple preset counters

Item 2117

Development of the new 2020 Multiple Preset Counters for counting and control applications has been announced by Freed Transformer Company, Inc., Brooklyn, New York. These Freed Preset Counters can be supplied with multiple groups of presetting controls for use in all vital industrial operations for accurate, high speed sequential predetermining counting and control.

With the new 2020 Preset Counters a complete program can be preset for winding multiple tapped coils or for any event which requires a machine controlled at different predetermined counts.

Freed 2020 Multiple Preset Counters can be supplied with various inputs, including photocell, mechanical contacts or pulses and operated at counting speeds up to 30,000 per minute. Dimensions for Type 2020-4-6 Preset Counters, illustrated, are: 13" high, 11" wide by 8½" deep. Complete unit weighs 9 lbs.

For further information about the new 2020 Multiple Preset Counters and Freed's new Catalog No. 581 write directly to manufacturer, Freed Transformer Company, Inc., 1716 Weirfield Street, Brooklyn 27, New York, U.S.A.

Saucer fan

Item 2118

Engineering catalog sheet illustrates and describes unique "saucer" shaped fan developed by Rotron Manufacturing Company of Woodstock, N.Y., expressly for cooling electronic console equipment.

The unit features an electrical driving motor built into the propeller hub reducing the axial length of the fan to more than the thickness of the propeller.

Air delivery for the fan is 260 CFM against 0 static pressure. Airflow in either direction can be obtained by reversing the fan end-to-end.

Write for catalog sheet No. 50109-1 to the Canadian Representative—The Hoover Company Ltd., Gage and Barton Streets, Hamilton, Ontario.

Capacitors break heat barrier

Item 2119

Development of a new electronic component that breaks the heat barrier by exceeding the highest temperature limitations for all existing capacitors, is announced by Dr. Leslie K. Gulton, president, Gulton Industries, Inc., Metuchen, N.J.

Called Glennite Hi-T units, the new ultra-thermic, glass-coated, ceramic capacitors are designed for continuous operation at temperatures ranging from -60°C (-76°F) to +225°C (+437°F). With the development of these units, the maximum operating temperature for capacitors has been increased from a previous high of +150°C. The units for +150°C operation were also a Gulton Industries' development.

According to Dr. Gulton, "present day electronic equipment cannot operate accurately at elevated temperatures because of the limitations of many of their basic components. Research, as it progresses, is demonstrating the continuing extension of the operating temperature range of our capacitors, is supplying the answers to many of these problems".

The new Glennite Hi-T units have successfully passed 1000 hour life tests at +225°C at twice their rated voltage. Subminiature in design, they have leads of pure silver to provide ease of soldering, greater flexibility and corrosion resistance. The capacitors have an insulation resistance of 10,000 Megohms at +25°C and 100 VDC.

For further information contact the Gulton Canadian Representative: Lake Engineering Co. Ltd., 767 Warden Ave., Scarborough, Ontario.

Arc-angle meters

Item 2120

The Stark 250° Arc-Angle Meters, with accuracy up to 1% and scale 2½ times longer than conventional meters, are specifically designed to save up to 60% in panel space.

A 3½" 250° meter has the scale length and readability of a conventional 6" meter. Can be supplied in all DC ranges and AC rectifier types. They are manufactured in conventional panel, aircraft, sealed or ruggedized from 2½" to 5½" case size. Presently being employed by Avro in flight testing the Arrow.

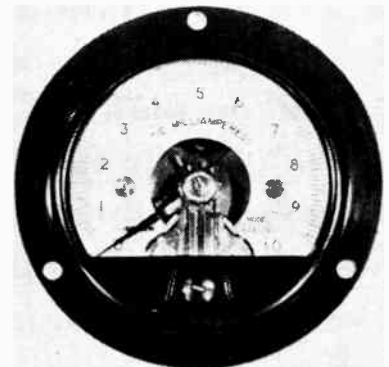

For further particulars contact Stark Electronic Instruments Ltd., Ajax, Ontario, Canada.

New Products

Patch-cord programming system Item 2121

Virginia Electronics Company Incorporated of Washington, D.C., manufacture the Velco Patch-Cord Programming System.

This is an uncomplicated method of rapidly changing from one pre-determined circuit arrangement to another and features: flexibility, compactness and simplicity of design.

The system is adaptable for use with: Analog and digital computers; telemetering systems; automatic test equipment; communication systems; automotive machine tools.

For further information write to J. R. Longstaffe Company Limited, 300 Campbell Ave., Toronto 9, Ont., who now represent Virginia Electronics Company in Canada.

Magnetic "hold-in" switch Item 2122

A completely sealed, momentary-action toggle switch that can be converted to a maintained-contact switch by means of a built-in solenoid has been developed by Micro Switch, a division of Honeywell Controls Limited.

The precision single-pole double-throw switching unit and a 28 vdc solenoid are contained in an environment-proof unit measuring slightly over three inches from the top of the toggle lever to the bottom of the case. Diameter of the case is one inch. This small switch (designated 5ETI-6) is designed for aircraft and electronic uses. No auxiliary relay is required, making it ideally suited for application where space is a critical factor.

When the toggle lever is operated, and the solenoid is energized, the solenoid holds the lever in the operated position. This magnetic "hold-in" feature permits remote electrical release of the lever, returning it to the unopened position. Immediate release is possible by manually over-riding the toggle lever.

To insure constant operating characteristics, regardless of changes in atmospheric conditions, the solenoid and switching unit are sealed within a cylindrical shaped enclosure that has been evacuated and filled with an inert gas. An elastomer seal at the base of the toggle lever keeps out dust and moisture.



The switch may be wired either normally-open, normally-closed or double-throw. Environment-proof magnetic hold-in switches are rated at 4 amperes, 28 vdc, resistive load. They are available with either wire leads or side-facing screw terminals.

Enquiries should be directed to: B. Colwell, Merchandising Department, Honeywell Controls Limited, Toronto 17, Ontario. Ask for Data Sheet No. 121.

Sub-miniature switches Item 2123

Engineering data sheets on various types of sub-miniature switches are announced by International Instruments Incorporated of New Haven, Connecticut.

These data sheets provide full description of the following: Sub-miniature double deck rotary switches and spring return (Series 5000 and Series SR 5000); Sub-miniature switches, rotary and spring return (Series 7000 and Series SR-7000); Sub-miniature lever and spring return lever switch (Series L-7000, L-5000 and Series SRL-7000, SRL-5000).

These switches are designed for use in transistorized or miniaturized equipments, where space saving is a prime consideration, at no sacrifice to versatility or reliability.

Double-wiping silver alloy contacts assure low resistance and guarantee long life. Large number of distributing contacts provides unusual switching flexibility. All materials have been selected for their inherent corrosion resistance or are treated for protection.

For additional particulars apply to the Canadian representative: E. E. Whittaker, Box 3255, Arnprior, Ontario.

Hematocrit centrifuge Item 2124

Chicago Surgical & Electrical Co., Division of Labline, Inc., Chicago, Illinois, is now in production on its new model 31 Hematocrit Centrifuge. This unit incorporates ball-bearing motor lubricated for life; automatic electric brake stopping the centrifuge smoothly in 1½ minutes; and an ultrasoundproofed cast aluminum housing giving practically noiseless operation.

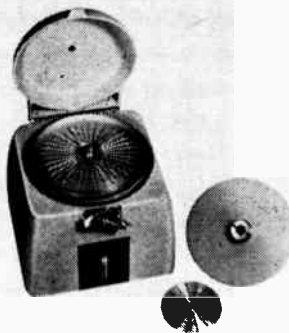

Two heads are available, one head holding 36 standard Hematocrit tubes, and a combination head holding 8 Hematocrit tubes and 8 75 mm x 1.75 mm tubes. Speeds up to 12,000 RPM are obtainable. Cover also has double safety latch with built-in switch preventing operation of centrifuge unless cover is in closed operating position.

A new type Hematocrit reader, developed by Dr. Samuel Natelson, is made of plastic with special slide to provide easy reading of Hematocrit tubes. Reader is 7½" x 12", and because of size eliminates the necessity of magnifying glasses and other devices.

Write for Bulletin 326 to Chicago Surgical & Electrical Co., Division of Labline, Inc., 3070-82 W. Grand Ave., Chicago 22, Illinois, U.S.A.

Spectra-striper Item 2125

The Spectra-Strip Wire & Cable Corporation (formerly Organic Development Corporation Spectra-Strip Division) announces a new version of its Spectra-Stripper. This is practically a pocket sized machine; the chassis only measures 4½ inches x 8 inches.

This apparatus is entirely hand operated and will put a color stripe on vinyl covered wire as fast as the wire can be drawn through the guides. It uses the same inks as the larger machine so that no drying tower or heat of any kind is required.

The unit was developed to meet the needs of many users who only require one stripe in their coding operation. The list price has been brought down pretty close to the cost of production and distribution, in order to promote the wider use of Spectra-Ink. Details and prices can be had by writing Spectra-Strip Wire & Cable Corporation, P.O. Box 415, Garden Grove, Calif., U.S.A.

Modular connectors Item 2126

Methode Manufacturing Corp. of Chicago, Ill. has introduced a novel line of Uno-Link modular connectors, variations of which are available for (1) standard wire harness arrangements; (2) the firm's Plyo-Duct film insulated multiconductor cable; and (3) printed circuit card receptacles.

Multiple unit construction permits the designer to specify the exact number of connecting links desired with resultant economies in space and cost. The mating in-line arrangement of plug pins and socket contacts utilize nesting insulator segments which are combined in any numbers from two to thirty modules. The long creepage distances embodied in the modular construction permit maximum power applications in high density packaging requirements.

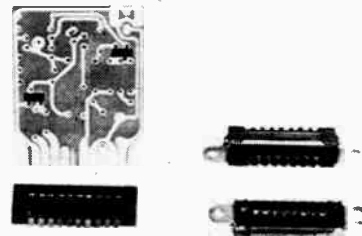

Ribbon type plug blades are engaged in wiping socket contacts and the spring characteristics of both members provide easy insertion and withdrawal with low contact resistance ratings. End segments provide positive polarization.

Printed circuit card receptacle types (as well as rack and panel variations) available with right angle and in-line terminals. Terminal types for card plug-in, standard solder lead attachment, and taper pin connection.

Uno-Link connectors are available with melamine-phenolic and diallyl phthalate insulation, brass, phosphor bronze and beryllium copper terminals, and cadmium, silver and gold finishes.

Represented in Canada by P. J. Heenan Limited, 804 Mount Pleasant Rd., Toronto 12, Ontario.

Adapter takes phono plug at each end Item 2127

Demand by sound technicians and Hi-Fi enthusiasts for an adapter that will accept a phono plug at each end has prompted the addition of this Part No. 349A to their large line of adapters by Switchcraft, Inc. of Chicago, Ill.

Deliveries are now being made to distributors.

Full details may be obtained by writing the Canadian Factory Representatives — Atlas Radio Corporation Ltd., 50 Wingold Avenue, Toronto 19, Ontario.

High-impact phenolic laminate Item 2128

A new high-impact phenolic laminate for rocket and missile applications has been announced by Spaulding Fibre of Canada Ltd., Toronto, Ontario.

The new modified XXXP has been designated XXXP-793. It has an Izod impact strength more than four times that of NEMA grade XXXP. The high impact strength makes this material particularly suited to printed circuit applications and minimizes cracking and breaking under shock or impact loading.

XXXP-793 values are 1.5 ft. lbs./in. of notch with the grain and 1.2 ft. lbs./in. of notch against the grain. This compares favorably with typical XXXP values of .35 with the grain and .30 against the grain.

Spaulding XXXP-793 is available in fabricated parts, sheets or copper-clad. Its cost is slightly higher than standard XXXP.

Further enquiries to: Spaulding Fibre of Canada Ltd., 70 Coronet Road, Toronto 18, Ontario.

New Products

"Surface shield" panels

Item 2129

Bud Radio Corp. announces a new line of blemish-free aluminum rack panels for the electrical and electronic industry.

Each panel is covered on both sides with sturdy self-stick white paper to protect against surface damage. The paper provides an excellent surface for indicating size of drilling, punching or milling. These operations may then be done while the paper is still in place, thus minimizing the possibility of surface damage and elimination of surface soil. The paper, which in no way affects the surface, is not removed until the panel is ready for installation.

For complete information write for Bulletin 3458, Bud Radio Corp., 2118 East 55th Street, Cleveland 13, Ohio, U.S.A.

Rectilinear recorder

Item 2130

Readily installed in any standard (19" wide) rack-panel cabinet, this 12¼" high Rectilinear Recorder writes on true rectangular coordinates for ease of examination. Write-out is by the heated stylus method with an individual stylus heat control for each channel. Available with from 2 to 6 recording channels, the instrument features flat frequency response to 70 cps. It will faithfully record almost any known phenomena. A pop-out, sliding chart-drive unit slashes paper-loading time and minimizes interference with the recorder components. A second set of rugged drawer slides facilitates recorder and galvanometer maintenance.

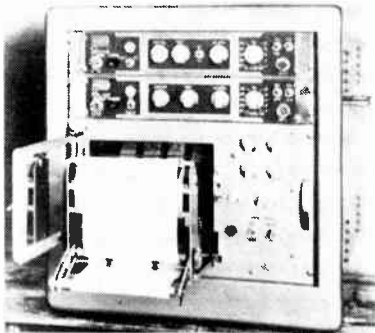

An easy-to-use electric Speed Changer provides instantaneous selection of eight chart-drive speeds ranging from 250 mm/sec down to 1 mm/sec. Optional accessories include Time and Event Markers, a 10:1 speed reduction device and a special unit for total remote controlled operation.

Weighing only 60 lbs., the instrument is constructed of aircraft-grade aluminum. All parts subject to exposure or heavy wear are of stainless steel.

Edin Company, 207 Main Street, Worcester 8, Massachusetts, A Division of Epsco Incorporated. Represented in Canada by A. C. Wickman Limited, P.O. Box 9, Station "N", Toronto, Ontario.

L-band isolators

Item 2131

Airtron Canada Limited announce the manufacture of a new series of L-band, WR-650 resonant absorption Ferrite Isolator which provides constant uni-directional transmitter to load isolation for low, medium and high power microwave applications in lower microwave frequency ranges.

The WR-650 Ferrite Isolator furnishes sufficient isolation between the transmitter and the RF energy reflected from line mismatches to ensure optimum frequency stability and power output, thus affording protection to transmitter tubes and eliminating the necessity for mechanical adjust-

ments of phase shifters to correct "Long Line" effects.

All units are WR-650 waveguide size and operate over a frequency range from 1250 to 1350 mc/s with a high degree of performance.

While the low and medium power versions do not require cooling, the high power unit requires either forced air or a liquid cooling agent. Recommended liquid flow is one gallon per minute with the cooling liquid at a maximum temperature of 65°C.

For further information please write to Airtron Canada Limited, 300 Campbell Ave., Toronto 9, Ontario. Request catalog sheet No. 3550.

Mobile radio power supply

Item 2132

A fully transistorized high-voltage power supply specifically designed to replace the dynamotor in mobile FM transmitters is announced by Vibration Research Laboratories, Inc., Tuckahoe, N.Y.

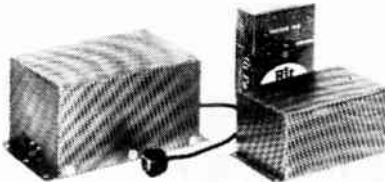

Delivering 500 volts DC at 200 ma. continuous, the model 12TP1 comes in a package only 3" x 4½" x 2½" and weighing 2¼ lbs. Mounting centers coincide with those of most dynamotors.

The 12TP1 also provides an output tap delivering 250 volts at 100 ma. for the mobile receiver; a built-in relay changes the output from receive to transmit. Model 12TP2 is available less this relay if preferred. An unusual feature is the protection circuit which removes the B+ voltage in case of a short and restores it instantly when the short is removed, without the need to replace fuses.

Available for 12 volts only, the 12TP1/2 has a maximum battery drain of under 13 amperes at full output. Model 12TP3 is also available for receivers or low-power transmitters; its output rating is 250 volts at 100 ma.

Enquiries for further particulars should be addressed to the Canadian representative: Tele-Radio Systems Ltd., 3534 Dundas St. West, Toronto 9, Ontario.

Sub-miniature amplifier

Item 2133

Endevco Corporation offers a new sub-miniature AC instrument amplifier, Model 2618, to satisfy latest requirements of missile telemetry and general airborne use. Designed for application with Endevco piezoelectric accelerometers, the new Endevco amplifier provides variable gain, 6 to 20. It is completely sealed and will operate continuously in ambients of 250°F under normal flight vibration and shock.

Fully compensating feedback reduces harmonic distortion and non-linearity to less than 1% with a gain stability of ±1%. This amplifier withstands vibration and shock to 100 g's without shockmount.

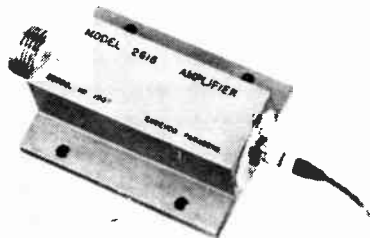

For additional technical information write the Endevco Corporation, 161 East California Street, Pasadena, California, U.S.A.

New low noise mixer diode

Item 2134

Improves receiver noise figure in the 300 mc to 4000 mc frequency range. The

manufacturer, Microwave Associates, Inc. of Burlington, Massachusetts claims typical noise figures of 5 to 5.5 db are now being achieved by the electronics industry with their new MA-421B crystal when used in conjunction with a 30 mc IF of 1 db noise contribution.

Some applications for this diode are in UHF scatter communications, low noise UHF TV, telemetering, microwave link, radio navigation, amateur radio receivers, long range radars, and radio astronomy. A cost reduction in the manufacture of UHF receiver RF front ends can be achieved with this diode by eliminating RF vacuum tube pre-amplifiers and their associated power supplies previously needed to achieve low noise figure performance.

Life of the MA-421B is indefinite in applications where incident RF signal levels are limited to 150 milliwatts or less. The crystal requires no dc bias.

Receiver noise figure improvements obtainable in low noise receivers equipped with the MA-421B when compared to the best valuable low noise RF preamplifier vacuum tube are as follows: at 300 mc, 0 db; 500 mc, 1 db; 700 mc, 2.5 db; 1000 mc, 3 db; 2000 mc, 6.5 db. These figures include .5 db preselector losses and assume an IF noise figure of 1.0 db.

Typical conversion loss and noise temperature values for this crystal are 4.0 db and 1.05 times. The MA-421B maximum receiver noise figure is specified to be 1 db less than the 1N21E. In receivers designed for the 1N21C or 1N21E types maximum noise figure improvement can be obtained by retuning the RF match, adjusting local oscillator injection for lowest noise figure and adjusting the IF matching transformer for the lower IF impedance characteristics of the MA-421B. For minimum receiver noise figure the MA-421B should be matched into a cascode IF strip using tubes similar to the 417A, etc.

Tight VSWR and IF impedance specification limits insure crystal-to-crystal uniformity thus allowing holder and IF matching circuits to be more closely controlled for improved and uniform receiver noise figure performance.

This new diode is available in production quantities. For further detailed information contact E. G. Lomas, 227 Laurier Avenue West, Ottawa 4, Ontario, Canada.

Canadian relay service

Item 2135

Stegg Electric Limited of Belleville, Ontario, now offers a complete Relay Service, starting with the design of a relay for any particular application and following through to ultimate delivery in line with a customer's requirement.

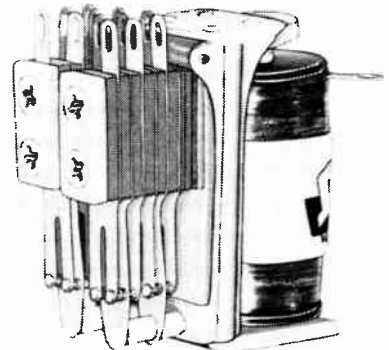

Stegg is a 100 per cent Canadian owned and operated company. In the past two years the company has designed and supplied relays for special applications which even the American relay manufacturers could not furnish economically. Many relay users are still going to the large American relay manufacturers with their problems because, up to recently, this was the only recourse, as there was not an adequate Relay Service available in Canada.

The sales representatives of Stegg Electric Limited—Lake Engineering Co. Limited, of 767 Warden Avenue, Scarborough, Ontario—are equipped to discuss the subject further with those seeking advice.

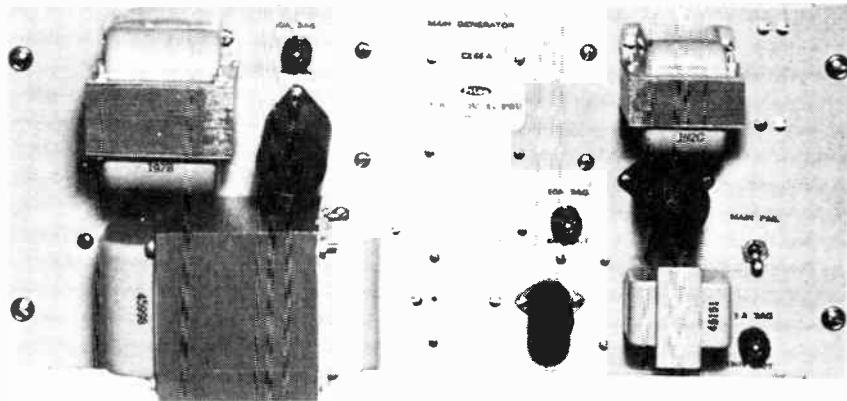

Figure 2. 300 watt transistor converter model CX48A; this unit accepts 48 volt battery input and provides outputs replacing 130 volt plate battery, 24 volt signalling battery and 24 volt talking battery. An automatic transfer facility is included.

Higher energy pulses quickly break the transistors down. This latter effect may be easily demonstrated by keying the input of available transistor power units. Unless special precautions are taken this action will cause a complete breakdown in a few seconds.

- (3) Transient overloads cause transistor breakdown. Transistors have maximum current ratings which cannot be exceeded, even momentarily, without risking destruction of the junction.
- (4) High power capacity means operation of large numbers of present day transistors in parallel. The current gain of production transistors varies from unit to unit over a considerable range and is in addition markedly dependent on temperature. When a number of transistors are placed in parallel, particularly in switching service, it is found that some units draw excessive current and others are not pulling their share. Unfortunately, this effect is amplified by the fact that the units which draw excessive current tend to become heated and draw even more current until they are overloaded. The effect is similar to that of "thermal runaway" in single transistor circuits, but is greatly increased in the parallel type of operation.
- (5) A second danger in parallel operation is that of catastrophic or chain reaction failure of an entire complement of transistors. If one transistor becomes overloaded and breaks down due to continuous high load or a transient effect, the load must be shared amongst the remaining units. The possibility exists and has been a source of difficulty in the past, of a chain of failures wiping out the entire transistor complement. Some manufacturers of transistor power units advise their customers that there is no means available of guarding against transient overload or chain reaction failure.

As a result of these difficulties, high power units have not been available to the communication industry.

Recently, however, following almost two years of research and development by Pylon Electronic Development Company Limited of Montreal such equipment is now available on a custom engineered basis. These power units completely overcome or circumvent the

basic limitations outlined above, and there is no technical upper limit to the power capacity for which they can be engineered. These units are distinguished by the following exclusive features:

- (1) Standard design input voltages are 24, 48, and 130 volts, D.C.

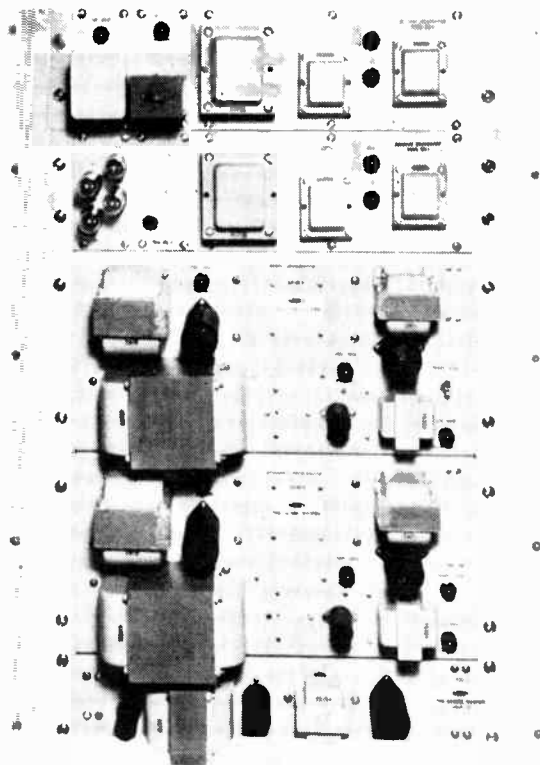

Figure 3. Power assembly model 206; this assembly accepts 48 volt battery input and provides outputs replacing 130 volt plate battery, 24 volt signalling battery and 24 volt talking battery. A.C. outputs provide 20 c/s ringing current (automatically timed 2 seconds "ON" 4 seconds "OFF") and 1000 c/s signalling tone. Full standby is incorporated on all outputs with automatic transfer.

- (2) The units have a maximum capacity of 190% of rated capacity.
- (3) The transistors cannot be damaged by accidental or deliberate overload, including short circuits.
- (4) Chain reaction failures are eliminated, failure of any transistor, either open or short, cannot in any way affect the life of the remaining transistors.
- (5) Transistors are fully guarded against transient voltage peaks by a method which is not subject to conceivable failure. Under these conditions, bearing in mind that modern power transistors never die but are murdered through misuse, it can be anticipated that transistor replacement problems should be vir-

- tually eliminated during the service life of the equipment.
- (6) Transistor operation may be checked in service and units may be replaced without shutting the equipment down.
- (7) The cost of equipment in higher capacities is approximately 80 cents per watt of rated capacity, and for certain types of D.C. to D.C. converters may be as low as 50 cents per watt of rated capacity.

These units are a result of an entirely Canadian development which represents an outstanding achievement in electronics and users who install this equipment are pioneering a new type of power operation.

Silicone diodes — Continued from page 25

region should be as small as possible. Figure 2 shows the relation between the resistance in the breakdown region as a function of the current in the breakdown region for several devices with different breakdown voltages. The figure shows that the impedance varies anywhere from .3 ohms to about 30 ohms depending upon the current and voltage levels. In the case of a reverse biased diode it is the majority carriers that cause the current flow; thus it is not possible to conductivity modulate the resistivity in the vicinity of the junction. One would expect to be able to obtain resistances of the order of the bulk resistance of the device. The equation for the bulk resistance is given as

$$R = \frac{\rho l}{A} \text{ where } \rho \text{ is the resistivity of the more lightly}$$

doped region, l is the thickness of the diode and A is the cross sectional area of the device. For the devices under consideration $l = .02$ cm and $A = .01$ cm², thus $R = 2\rho$. However, such low resistances are not seen in the experimental diode. The reason for this is based on the fact that the avalanche breakdown takes place through pulses of current of the order of 100 microamperes in regions having diameters of the order of 1 micron. These observations have been made by McKay and his colleagues. Thus the resistance in the breakdown region is due to the spreading resistances of these avalanche regions in parallel. The spreading resistance is approximately the resistivity divided by the diameter of an avalanche spot. The number of spots is approximately the current divided by 100 microamperes. Thus the resistance in the breakdown region, R_b , is given approximately by the resistivity expressed in ohm-cm divided by the current, I_b , expressed in amperes. Typical examples are given as follows:

I_b	V_b	R_b
100 ma	10 volts	0.1 ohm
100	56	5
20	56	25

From the above numbers and Figure 2 it is seen that most of the observed breakdown resistance is accounted for. Figure 3 gives another plot of the same

data in a different form; the breakdown impedance versus the breakdown voltage for different current levels. A figure of merit for the regulation ability of these devices can be expressed as the fractional change in voltage divided by the fractional change in current. Figure 4 is a plot of the figure of merit for four different voltage diodes as a function of the power dissipation in the diode. It is observed that the figure of merit is approximately 0.01 for these devices. For gaseous regulator tubes the figure of merit is approximately 0.1 and thus the semiconductor devices can give much better regulation than the gas tubes.

Switching times

Another application of these breakdown diodes is their use in switching circuits. Instead of switching a diode from a forward conduction state to a high impedance reverse conduction state where one is troubled with hole storage transient one can switch from a high conductance breakdown condition to low conductance condition below the breakdown voltage. There is no hole storage phenomenon associated with this switching mechanism and the time associated with this mode of switching is limited only by the dielectric relaxation time of the semiconductor. This time is of the order of 10^{-10} seconds. Another way of calculating the switching time is to consider the drift time necessary to sweep out the carriers from the space charge region. The limiting velocity of carriers in the space charge region is approximately 10^7 cm per second and the width of the space charge region is of the order of 10^{-3} cm. Thus the drift time is of the order of 10^{-10} seconds. Reports on the use of such diodes have been given by Salzberg and his colleagues.

Conclusion

A review of the breakdown phenomenon has been given and the effect of the avalanche mechanism on the dynamic impedance in the breakdown region has been discussed. It is believed that diodes are now being made that approach the ultimate in low impedance in the breakdown region and high speed for switching in the breakdown region.

Electronics and Communications 5th Annual Directory and Buyers' Guide

Canada's established Buying Guide for the electronic and communications market.
This Directory will be published in December 1958 to serve our readers and advertisers during the following twelve months.

Newsletter

Canadian Radio Technical Planning Board

Who's Who In The Planning Board No. 7 — Hydro-Electric Power Commission of Ontario

The Hydro-Electric Power Commission of Ontario was founded in 1906 and endowed by the Power Commission Act of 1907 with authority to administer a co-operative enterprise, which includes the municipalities, to supply electric power throughout the province. It does this by generating and purchasing electricity and transmitting it over a province-wide network for re-sale by the associated municipal utilities. A second aspect of its function is direct service to some two hundred industrial customers, to rural areas and to a large part of northern Ontario.

Ontario Hydro supplies electricity at the lowest possible cost consistent with sound economic administration. It is also responsible for preserving the water powers of the province in the public interest.

The retail distribution systems are owned and operated by the municipal utilities which are administered by local hydro-electric commissions. They exist in most cities and towns, many villages and certain township areas. Ontario Hydro is empowered to approve and control certain features of their operations, including their rate structures, accounting practices, financial actions, and capital construction. Each cost contract utility has an equity in the assets of Ontario Hydro to the extent of its contribution to the sinking fund, a levy which is included in Ontario Hydro's wholesale cost of power to them. For administrative purposes Ontario Hydro has subdivided the province into nine regions, each with a regional office.

Recent CRTPB Meetings

The Microwave Task Force on Communication System Parameters met in Toronto on August 27. Under discussion was the future area of work of the task force. It was decided first to investigate the overall system requirements for various services such as telephony, telegraphy, and television and then proceed to equipment requirements and measurements. A further meeting of this task force on October 7 dealt with radio spectrum use, performance of specific channels, and proposed methods of measurement.

The Executive Committee met in Toronto on October 6. A budget comparison for the nine months ended August 31 showed operating costs to be within \$38.00 of the budget for the period, which was considered to be very satisfactory. The cost of the monthly Newsletter was reflected in the printing and stationery account; actual expenses for the nine month period amounted to \$516.90 compared to the \$350.00 budget for twelve months. This situation was due to increased distribution of the Newsletter as requested by contributing sponsors.

President Pounsett reported on the meeting he and the General Co-ordinator, Ralph A. Hackbusch, had had

with DOT officials in Ottawa on October 1 to discuss possible CRTPB participation in the forthcoming CCIR-ITU conferences. It was pointed out to DOT that CRTPB was not in a position to render financial assistance in connection with Canadian representation at the conferences while DOT said that it would be unable to give financial assistance toward CRTPB representation. At the October 6 meeting the Executive Committee recommended that the General Co-ordinator set up a special committee to consider CCIR-ITU activities.

The status of a number of DOT specifications was discussed in detail.

It was reported that G. A. Muir, Chief Engineer, Manitoba Telephone System, had accepted the chairmanship of the newly formed Amortization Committee. Mr. Muir will, in effect, be chairman of all ad hoc committees which will be formed periodically to deal with amortization problems in connection with various specifications.

On October 22 the Executive Committee again met, this time to complete the draft revisions of the constitution which will be presented to the annual meeting in December for approval.

14th annual meeting

The 14th Annual Meeting of the CRTPB will be held at the Chateau Laurier Hotel, Salon "D", on Thursday, December 11, 1958 commencing at 9:30 a.m. Contributing sponsor representatives are urged to plan now to attend this important meeting. Hotel reservations should be made direct with the Chateau Laurier.

FCC permits private microwave links

The FCC in the United States recently ruled that station licensees may install their own private microwave links or use common carrier facilities. Previously, it was mandatory that common carrier facilities be used when available. Also, broadcasters who installed their own microwave links had to cease using them when common carrier facilities became available.

It is expected that this FCC ruling will benefit state educational television networks and commercial broadcasters who will now be able to join with other stations to produce programs of a type which they could not produce alone.

Frequency allocation chart available

Copies of the Canadian Radio Frequency Allocations Chart are available from the CRTPB Office at 50 cents each. Measuring 34 in. by 30 in., the chart is in full color, has a color key, table of frequency nomenclature, a colored band showing microwave absorption characteristics, and general explanatory notes on the frequency allocations.

This is the only chart available in Canada which shows the radio spectrum allocations, and is the best fifty cents' worth of data anybody connected with electronics can obtain.

Canadian Radio Technical Planning Board
200 St. Clair Avenue West, Toronto 7, Ontario

F. H. R. POUNSETT, President; C. J. BRIDGLAND, Vice-President; R. A. HACKBUSCH, General Co-ordinator;
R. C. POULTER, Director of Public Relations; F. W. RADCLIFFE, Secretary-Treasurer

IRE Toronto Convention declared "best yet"

Despite the setback caused by defense contract cancellations, Canada's \$500,000,000 electronics industry can look forward to renewed growth and expansion in the opinion of exhibitors and technical personnel who participated in the Institute of Radio Engineers 1958 Canadian Convention and Exposition.

New government radio links in Canada's northland, defense radar installations, and new applications of electronics to business and industry were among the reasons for confidence advanced by exhibitors and delegates. IRE officials, however, warned that commercial industry could not absorb all the electronics experts displaced by cancellation of the Sparrow contract.

Hundreds of thousands of dollars worth of new electronic equipment, products and components was displayed in the IRE Exposition covering the spacious floor of the CNE's Automotive Building. With registration of technical personnel at the Convention up several hundred over last year, commercial exhibitors expressed satisfaction with the results of their participation. General opinion among exhibitors was summed up by D. Provan, Canadian representative of General Radio Co., Cambridge, Mass. He reported that "this year has brought more serious queries from people approaching our booth and many appear to have a definite program in mind. We are quite happy with the results of the show."

The effects of the build-up of two previous Conventions were also noted by exhibitors. G. E. McCurdy, president of McCurdy Radio Industries Ltd., Toronto, suggested that it had made an important contribution to the success of this year's Exposition, which he described as "the best yet".

The IRE award for the outstanding Canadian electronic product developed during 1958 was presented during the Convention Banquet to R. Wilton of Bach-Simpson Limited. The prize-winning product was a new oscilloscope which the London company put on the market in February.

At the close of the Convention it was announced that Eric L. Palin will succeed Dr. George Sinclair as Chairman of the IRE's Executive Committee responsible for Convention planning. Mr. Palin is Administra-

Slaves - robots or engineers Swinton asks IRE members

tive Assistant to the Principal, Ryerson Institute of Technology, Toronto.

Too much emphasis on guided missiles and not enough on guided thinking was the main thought behind Kurt R. Swinton's talk at the Institute of Radio Engineers' 1958 Convention banquet recently in the Royal York hotel, Toronto.

Speaking as an engineer, Mr. Swinton, who is vice-president of Encyclopaedia Britannica of Canada, suggested that almost everything is possible through electronics, including chaos. The key to the control of nature is now via electronics — a woman married to a radio engineer could in all seriousness claim that she had married a superman, he pointed out.

Tracing the world's scientific progress through the "childish optimism of the 19th century" and its appreciation of a mechanical model of the universe — as opposed to a spiritual one — the speaker said the main event of this century was the Henry Ford principle of mass production. Because scientific progress had not philosophically integrated with social changes, we now find ourselves working with 18th and 19th century ideas in the middle of the 20th century.

"If the 19th century saw the death of God, the 20th century may well see the death of man as an individual," he warned.

"Man is puzzled nowadays", said Mr. Swinton, "when he seeks for the symbol of authority. When even the authority of the Church is questioned,

man finds himself led by an amorphous anonymous authority, largely represented by the term 'conformity'. Radio engineers greatly helped to bring about this situation by making mass media available — seventy million people saw Eisenhower explain the latest trip to the brink."

Referring to the further danger of brainwashing, Mr. Swinton quoted Norbert Wiener's sensational 'feedback' principle by which behavior



KURT R. SWINTON

of the public can be modified by surveys scientifically analyzed.

All the great threats to our world civilization are recognized by society, but society itself cannot avert the dangers if the individual is overlooked, concluded Mr. Swinton. To admire the institutions of government, education and science instead of recognizing the individuals who compose them, tends to produce a routine world instead of a creative core of people. Society by its attitude toward the creative person can actively insure its own constant invigoration and regeneration.



Canadian university engineering students who this year won the all-expense trips to the Canadian IRE Exposition and Convention sponsored by the IRE are shown above. They are: Fred Schrack, UBC; Gary Jopling, Institute of Technology and Art, Calgary; Peter Kupin, University of Alberta; Norman Reid, University of Saskatchewan; Robert Long, Ryerson Institute of Technology; Blake Cherrington, University of Toronto; Robert Gelineau, University of Ottawa; and Jules Delisle, Laval University.

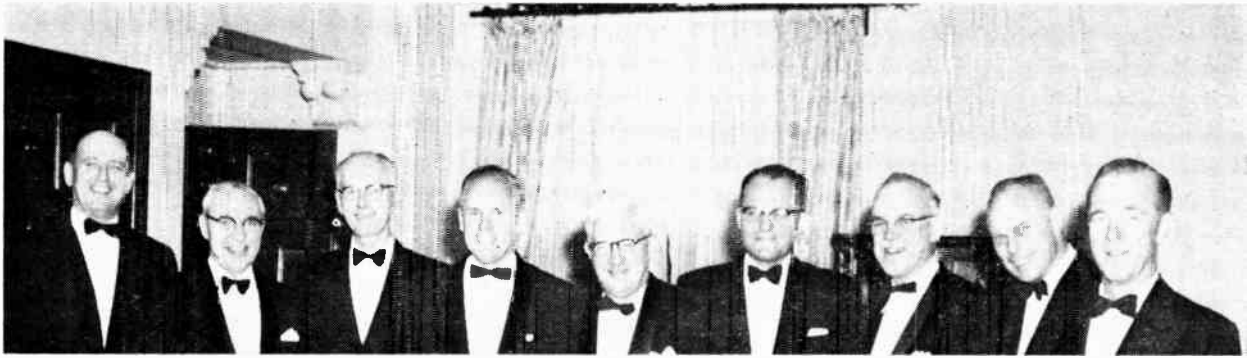

Head table guests at the 1958 IRE Convention banquet are shown above. From left to right they are: Donald G. Fink, president of the IRE; A. B. Oxley, Director Region 8, IRE; F. H. R. Pounset, president, Canadian Radio Technical Planning Board; Dr. George Sinclair, general chairman, IRE Convention executive committee; His Worship the Mayor of Toronto, Nathan Phillips; Lt. Col. Kurt R. Swinton, banquet speaker; Professor G. F. Tracy, Dr. B. G. Ballard vice-president scientific, National Research Council; and W. H. Jeffrey, president Electronic Industries Association of Canada.

Donald Fink Re-affirms Remarks

Mr. Donald G. Fink, IRE President, met with the IRE Toronto Section Executive for luncheon and a round-table discussion following the recent IRE Convention.

One of Mr. Fink's stated policies during his term of office is to visit as many of the IRE Sections as possible.



DONALD G. FINK

This meeting with the Toronto Section now completes over 50 per cent of his visits to Canadian Sections.

Mr. Fink amplified some of the points he made in his official opening address for the IRE Canadian Convention. He stressed that we must not bring pressure to move towards cheapening the technical quality of the

IRE Proceedings. The addition of one or two review or tutorial papers for each issue is a move which is presently being studied. In radio and electronics where a stable technology has not been achieved it is essential that the Proceedings provide current working tools for specialists and as such it is not unreasonable that many members would find "a large number of unreadable papers". Mr. Fink pointed out that one of the ways in which he tries to put this across at mixed gatherings is to speak specifically to engineers' wives, pointing out that they must not encourage the destruction of Proceedings but rather champion their retention by telling the engineer of the house that five years later he may be able to understand them.

A specific example was pointed out in relation to Armstrong's Wideband FM System which was published in 1935 and which was taken by many at that time to be a "crackpot" approach.

Mr. Fink also pointed out the urgent requirement for advancement of engineering curricula in the basic areas of mathematics, physics and information theory. For too long now, "the electronics engineering curricula has been dominated by the existing style of planning in the conservative, stable technologies of Civil and Mechanical Engineering."

The Lighter Side

On the last day of the IRE Show in Toronto recently, when the public was admitted, a small boy was seen at the U.S. exhibit listening to the recording of the countdown of the U.S. Explorer satellite when it was fired from Cape Canaveral. He was overheard to synchronise his treble voice with the solemn voice of the announcer— " . . . five, four, three, two, one—BLAST OFF — and there goes Mighty Mouse!"

* * *

There was also the beautiful young thing who, on passing the lecture hall labelled "Pulse Room," in which papers on medical electronics were being presented, said to her escort, "John, let's go in and get our pulses taken—maybe we can give a pint of blood."

* * *

A man looking at the radar screen of the weather, transmitted by relay from the radar scanner at Malton Airport to the roof of the IRE Show building, was heard to say, "Look Joan, those dark shadows are rain clouds around the building. We'd better stay indoors until it stops."

It was a beautiful autumn afternoon outside, blue sky and an horizon studded with white cumulus.

* * *

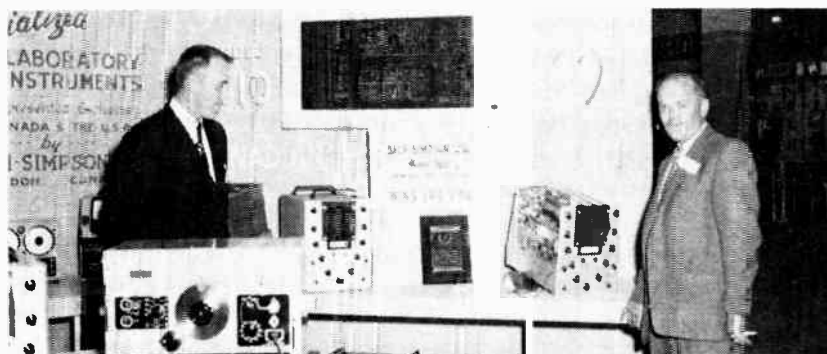

The IRE award for the outstanding Canadian electronic product developed during 1958 was won by Bach-Simpson Limited of London, Ontario. The prize-winning product was a new oscilloscope developed by the company. Shown at left is a portion of the Bach-Simpson booth and the prize-winning oscilloscope. (See story on page 82.)

Milton J. Stark visits Orient electronics industry

With the object of seeing first hand some of the startling product developments of the Orient's electronics industry, Milton J. Stark of Stark Electronics Instruments Limited, Ajax, Ontario, recently completed a tour of the Japanese and Indian industries as part of an itinerary which took him from Vancouver to Tokyo, Bombay, Israel, France, England and back to Canada.

In an interview with *Electronics and Communications* Mr. Stark pointed out some statistics and characteristics of the electronics industry in the far east where in Tokyo, for instance, no less than 500 businesses crammed into a two city block area comprise Tokyo's famed Radio Row known as Akihabara and where any desired radio part may be purchased from the out door street stalls in true "Orient bazaar" fashion. In contrast to this mode of business however one wholesaler operating from modern premises employs no less than 80 salesmen who ring up an annual sales volume in excess of \$12,000,000.

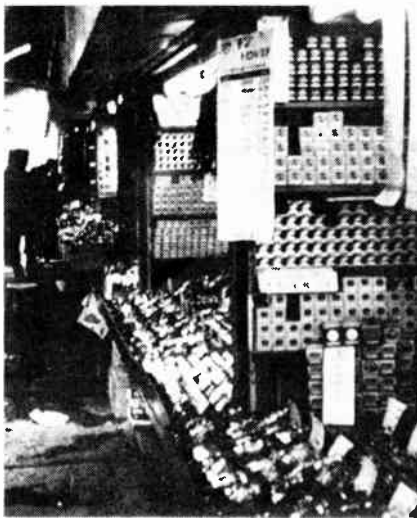

Typical of the outdoor radio stores in Tokyo's "Akihabara" is the above stall specializing in the sale of radio tubes.

In contrast to the concentration of the Japanese industry the Indian electronics business is more widespread among the larger cities. In Delhi, for instance, in the Bhagirath Palace area there is estimated to be in the neighborhood of 50 to 60 electronic shops where the turnover of a dealer may be from 20,000 dollars annually to 400,000 dollars annually.

Unlike the Japanese industry which manufactures many components the Indian industry imports from England, Germany, Italy, Japan and recently has imported some equipment from China and Hungary.

Toronto Section, IRE announces 1958-1959 officers

The Toronto Section of the Institute of Radio Engineers has recently completed its organization for the coming season's technical and social meetings. As heretofore, Monday night will be IRE night in Toronto.

Elected officers for the 1958/59 season are: Chairman — H. F. Shoemaker, Radio College of Canada; Vice-chairman — R. J. A. Turner, Philips Electronics Industries Ltd.; Secretary-treasurer — K. MacKenzie, McCurdy Radio Industries Ltd.

Recently appointed standing committee chairmen are: Meetings and Papers — G. T. Quigley, Philips Electronics Industries Ltd.; Membership — W. H. Anderson, P.Eng., Ryerson Institute of Technology; F. A. Ford, P.Eng., Canadian General Electric Co., Ltd.; Entertainment — A. H. Secord, P.Eng., Sinclair Radio Labs. Ltd.; Education — C. R. Oakes, University of Toronto; University of Toronto Student Branch Representative — Dr. J. L. Yen, University of Toronto; Ryerson Institute Student Associate Branch Representative — E. L. Kerridge, Ryerson Institute of Technology; Section Editor, Region 8 Publication — G. G. Armitage, Rogers Electronics Tubes.

Complete supper meeting and technical program details will be announced when available.

E. E. Whittaker opens Central Ontario branch

Announcement is made by E. E. Whittaker, electronic manufacturers' representative, of P.O. Box 3255, Arnprior, Ontario, of the opening of a Central Ontario branch office at Dundas, Ontario. This branch office is intended to serve the industry in the general area of Toronto, Hamilton and Kitchener for the purpose of furnishing information regarding technical details and price and delivery data on quotations or orders.

The new branch office will be under the management of J. (Jim) F. Scammell, who is a graduate of Ryerson Institute of Technology. Mr. Scammell has had several years of experience with Canadian General Electric Co. Ltd. on the Pinetree project. Immediately prior to joining Mr. Whittaker's organization, he was with the Canadian Westinghouse Co. Limited, Electronics Division, Air Armament Department.

Correspondence and telephone calls for the Dundas Branch office should be routed to: E. E. Whittaker, 12 Glenmorris Drive, Dundas, Ontario.

L. B. Kiely vice-president of Zenith of Canada

Lloyd B. Kiely has been elected vice-president by the board of directors of Zenith Radio Corporation of Canada, Ltd., as announced by Hugh Robertson, president.

Mr. Kiely joined Zenith of Canada early in 1958 as general manager of



L. B. Kiely

the radio-TV-electronics division. From headquarters now set up in Toronto, the organization handles sales of Zenith radios, television receivers, stereophonic high-fidelity instruments and phonographs to independent Canadian distributors in the provinces of Nova Scotia, Newfoundland, Prince Edward Island, New Brunswick, Manitoba, Saskatchewan, Alberta and British Columbia and to dealers in the provinces of Ontario and Quebec.

Previously, Zenith hearing aids were the only product distributed in the Dominion by the Canadian corporation, Mr. Robertson said.

New head office location for Northern Electric Co.

The Northern Electric Company Limited have announced that the head office of the company is now located in The Northern Building, 1600 Dorchester Street West, Montreal.

TV manufacturers sponsor service course

The first industry-sponsored television servicing night-school course in Canada for technical and vocational schools started at the Ryerson Institute of Technology in Toronto on October 15. It is sponsored by the television manufacturers through the Electronic Industries Association of Canada.

For practicing television service technicians, this advanced upgrading course will enable technicians to learn the latest servicing theories and techniques. Some of the workbench test equipment has been supplied by members of the Electronic Industries Association of Canada. Technicians who pass the final examinations will be awarded an industry-recognized certificate of proficiency.

The course, of sixteen weeks' duration — two nights a week — will be extended to cities and towns across Canada next year through the formation of local industry advisory groups working in co-operation with local boards of education.

Union Carbide Canada changes Polyethylene marketing

Effective immediately, marketing responsibilities for Thermoplastic products, including Polyethylene and Polystyrene, formerly sold by Bakelite Company, Division of Union Carbide Canada Limited, are being transferred to the Carbide Chemicals Company Division, according to an announcement by F. Perry Wilson, Vice-President of Union Carbide Canada Ltd.

Bakelite Company will continue to market Thermosetting products including phenolics, silicones and epoxy resins.

"Designed to improve customer service, the move integrates sales with the Division responsible for the manufacture of the product, thus permitting greater efficiency in the developing and marketing of new applications and materials", Mr. Wilson stated.

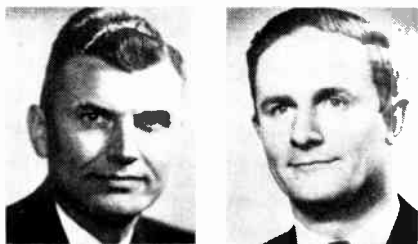

W. S. Berry

A. A. Allan, Jr.

Personnel formerly concerned with the marketing of Thermoplastic products in Bakelite Company are continuing in the same capacity with Carbide Chemicals Company. A. A. Allan, Jr., has been appointed Sales Manager — Plastics for the latter firm, a position he previously held in the Bakelite group. W. S. Berry assumes the position of Sales Manager for Bakelite Company, with responsibility for the marketing of Thermosetting plastics. Both will continue to make their headquarters at 40 St. Clair Avenue East in Toronto.

Also contained in Mr. Wilson's announcement is a statement to the effect that "Bakelite" Polyethylene will in future be marketed under the trade name "Union Carbide" Polyethylene.

Change of address for J. W. Ellis Industries

Effective September 25, 1958, The J. W. Ellis Industries, formerly at 42 Lombard St., Toronto, Ontario, moved to new, larger and more convenient premises occupying the whole main floor of 80 Richmond Street East, Toronto 1. The new location is half a block east and one block north of the previous address.

The telephone number remains unchanged — EMpire 6-1434.

US. firm seeks Canadian representation

General Devices, Inc. of Princeton, N.J., who design, develop and produce multichannel, electronic and mechanical switches, data handling and telemetering systems, and other equipment suited for multichannel instrumentation, is in the process of securing additional representation, particularly in the United States and Canada, and welcomes inquiries from interested manufacturer's agents.

Upgradings in membership announced by Toronto IRE

H. F. Shoemaker, chairman of the Toronto Section of the Institute of Radio Engineers announces recent upgradings in Section Membership. Upgradings through Student, Associate, Full Member to Senior Member result from demonstrated experience in radio engineering or allied fields.

G. T. Quigley, Philips Electronics Industries Ltd., now qualifies as a Senior Member, while the following have been promoted to Members: A. G. Breckenridge, Philips Electronics Industries Ltd.; C. J. Brown, Canadian General Electric Company Ltd.; J. H. N. Denyer, Canadian Aviation Electronics Ltd.; A. G. Dodge, Canadian Arsenals Limited; H. B. Dulmage, Collins Radio of Canada Ltd.; T. G. Gracey, The Bell Telephone Co. of Canada; H. E. Graham, Ted Graham Appliances; J. L. Jordan, North York

Hydro; R. D. Leask, International Nickel Co. of Canada Ltd.; and W. B. Pugh, Cannon Electric Canada Ltd.

Fellow grade is awarded as an honor of recognition to those who have made outstanding contributions to the science of technology of radio or allied fields. At present the Toronto Section has six Fellows on its roll.

The grade of Senior Member, open to Professional Engineers and Scientists of considerable achievement in radio or allied fields, is the highest grade for which application may be made.

The grade of Member is provided for the Professional Engineer and others who do not fully meet all the requirements of the Senior Member grade.

Required by Cossor (Canada) Limited, for their Service & Installations Division

A MANAGER

The Service & Installations Division is primarily concerned with the repair, overhaul, evaluation, modification and installation of electronic and electro-mechanical equipment for the Armed Forces.

Candidates must possess the following qualifications:

- (1) An understanding and appreciation of electronics as applied to seaborne, airborne and ground defensive and offensive weapons.
- (2) Previous managerial or executive experience.
- (3) The ability to establish and maintain close liaison with relevant Government engineering and procurement departments and design authorities in the Armed Forces.
- (4) Possess an Engineering Degree or its equivalent.
- (5) The ability to lead an engineering staff, maintain top quality engineering standards, discuss and provide answers relating to engineering problems raised by first class engineers both within the framework of the Company and in the Armed Services.

The position is one in which there is scope for expansion and development. Remuneration in accordance with demonstrated suitability.

Replies will be treated in strict confidence and should be addressed to:

The General Manager,
Cossor (Canada) Limited,
301 Windsor Street,
Halifax, N.S.

..... EMPLOYERS! FREE EMPLOYMENT SERVICE

THE HELP YOU NEED MAY BE AVAILABLE FROM RCC'S EXPANDED FACILITIES
AM-FM COMMUNICATIONS • RADIO OPERATING
TELEVISION • ELECTRONICS • RADAR • MICROWAVE
PLEASE CALL, WRITE OR PHONE MR. HOBBS (COLLECT) ABOUT YOUR REQUIREMENTS



86 BATHURST ST., TORONTO
TELEPHONE EM. 4-5176

SERVICE
ACROSS CANADA

3454 ST. DENIS ST., MONTREAL
TELEPHONE VI. 2-9458

Radio College of Canada



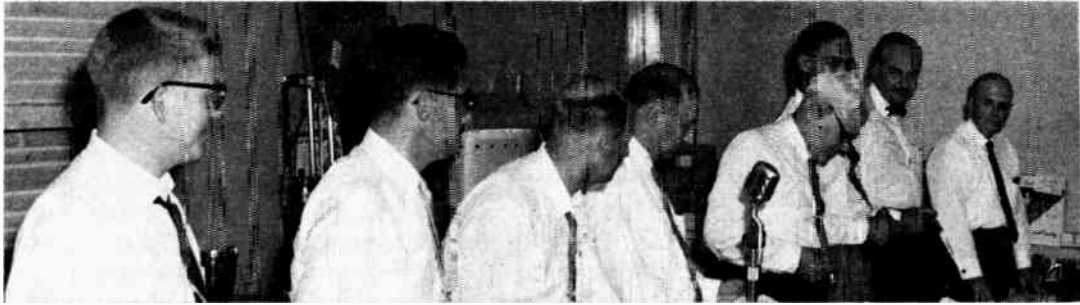

Head table guests at the recent annual golf tournament of the Electronic Industries Association of Canada are shown above being introduced. They are, from left to right: E. W. Leaver, EIA Vice-President and Chairman of the Electronics Division; J. Key, EIA Vice-President and Chairman of the Components Division; R. M. Robinson, EIA President; C. D. Murdock, Chairman, 1958 EIA-IRE Golf Tournament Committee; H. Shoemaker, Chairman, Toronto Section, Institute of Radio Engineers; E. A. Thomas, Chairman, Hamilton Section, Institute of Radio Engineers; S. D. Brownlee, EIA Vice-President and Chairman of the Receiver Division; and F. W. Radcliffe, EIA General Manager.

EIA-IRE golf tournament well attended

The fairways of the Cedar Brae Golf and Country Club again survived the joint attack of EIA and Institute of Radio Engineers' members on September 25. Over a hundred golfers took part in this annual event and nearly two hundred people sat down to the dinner in the evening. After dinner, the presentation of the trophies took place together with the award of many lucky draw prizes which had been generously donated by member-companies of EIA.

Photographic Survey Corp. adds to directorate

Announcement was recently made by Douglas N. Kendall, vice-president of Hunting Associates Limited, of the appointment to the board of directors of The Photographic Survey Corporation Limited of E. W. I. Keenleyside.

Mr. Keenleyside has been with The Photographic Survey Corporation since 1948, and for the past eight years has been the Ottawa representative of Hunting Associates Limited of which The Photographic Survey Corp. is a member.

Philips Electronics represent Julie Research Labs

Julie Research Laboratories, Inc., New York, N.Y., recently announced that their products are now being marketed exclusively in Canada by Philips Electronics Industries Ltd., 116 Vanderhoof Ave., Toronto 17, Ontario.

Julie Research Laboratories are manufacturers of precision laboratory equipment of very high accuracies, and precision encapsulated resistors to .01 per cent over military temperature ranges.

AMPHENOL

The SMALLEST LIGHTEST "E" CONNECTOR!

Surpasses MIL-C-5015C

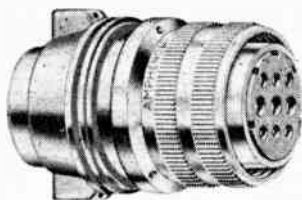

STUBE

**Environmental
Resistant
Connectors**
4 Shell Types and Sizes
51 Insert Arrangements

Fully Unitized Rear Sealing Grommet
for Fast Assembly

Silver Plated Contacts Pre-filled for
Instant - Low Cost Soldering

Shorter Length - Tamper Proof Contacts
Lighter Weight

SPECIFY — INSIST on Amphenol Quality

For further information write to Department 31

CANADA LIMITED
300 CAMPBELL AVENUE
TORONTO 9 - ONTARIO

MICROWAVE ENGINEER

Excellent opportunity for a graduate engineer, or applicant with equivalent training, between 25 and 35 years of age, who is seeking promotion and greater responsibility in the communications field. Experience in the application of microwave systems in telephone plants is essential.

Employment would be in Toronto with a well established and expanding firm. Employee benefits, pension plan, etc.

Apply in writing, stating education, experience and age, to:

**General Manager,
Automatic Electric Sales
(Canada) Limited,
185 Bartley Drive,
Toronto 16, Ontario.**

REMEMBER —

The postcard we send you periodically is a sincere request for your help in keeping our mailing list up-to-date.

— Please complete and return it promptly.

ELECTRONICS AND COMMUNICATIONS

12 minutes from downtown **DETROIT**
FUN days & nights

Resort accommodations—air conditioned rooms, suites, kitchenettes with TV, radio & phones—with heated pool. Delightful dining and entertainment nightly by top stars in the Casino. Ideal for the family—baby sitter service.

AL SIEGEL PRESENTS
TOP STAR
 NIGHTLY REVUES
 8:30 & 11 pm
 ORCHESTRA
 DANCING
 DINING

ELMWOOD
 CASINO
 DETROIT PHONE WO 5-6877

DETROIT PHONE
 WO 5-3320

ELMWOOD
 MOTOR HOTEL
 and CASINO
 WINDSOR, CANADA

**Things out of control?
 switch to SCAICO...**

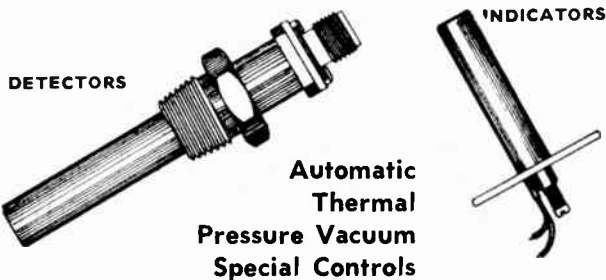

**Automatic
 Thermal
 Pressure Vacuum
 Special Controls**

*A Complete Assortment of Temperature Controls
 Designed for Quality Performance*

- Stainless Steel Shells • Accurate Repeatability • Range up to 2200°F • Hermetically Sealed Types • Close Operating Differential • Wide Variety of Mountings • Complete Engineering Facilities to Solve Your Requirements

*For Further Information, Write to Department 34
 for Data Bulletin No. 48*

J.R. LONGSTAFFE CO. LTD.
 300 CAMPBELL AVE. • TORONTO 9, ONTARIO



DYNAMIC MUTUAL CONDUCTANCE



**TUBE
 TESTER**

(VALVE CHARACTERISTIC METER)

Completely analyzes practically all receiving tubes and many small transmitting types.

Will provide you with: complete tube characteristic measurements... plate, screen and grid currents... amplification factor, plate resistance... mutual conductance... interelectrode insulation measurement in megohms... breakdown of cathode or heater to other electrodes in megohms... cathode-heater insulation in megohms... heater continuity... quick "Good/Bad" reading... overload cut-out.

Designed to meet progressive trends in tube development.



4544 DUFFERIN STREET, TORONTO
 TORONTO MAIL: OTTAWA VANCOUVER
 P.O. Box 500 P.O. Box 113 624 Vancouver Block
 Downsview, Ontario 736 Granville St.



Pocket size



MULTIMINOR

- Pocket size, pocket wise... a great little instrument; at a low, low price.
- Made by the makers of the famous Avo Meters
- 10,000 ohms/volt on DC.
- 19 Ranges: To 1000 volt AC and DC (first indication 2mV on DC) To 1 amp DC (first indication 2 microamps) Resistance to 2 megohms
- Single rotary range selector switch
- Accuracy: 3% DC, 4% AC, of full scale.
- Servicing facilities available in Canada.



4544 DUFFERIN STREET, TORONTO
 Mailing address Box 500, Downsview, Ont.

Quality Products

FROM

GENERAL TRANSISTOR

JETEC 30 TRANSISTOR



Transistors PNP and NPN

Write For Descriptive Literature

AUDIO	BROCHURE G-110
RF, IF & RADIO	BROCHURE G-120
COMPUTER	BROCHURE G-140
HIGH FREQUENCY	BROCHURE G-150
GENERAL PURPOSE	BROCHURE G-160
BILATERAL	BROCHURE G-170
DRIFT	BROCHURE G-180
PHOTO TRANSISTOR	BULLETIN 2N469
COMPLEMENTARY	
SYMMETRY	BULLETIN 2N529

GERMANIUM GOLD BONDED DIODES

Write For Brochure GD-10



BOBBINLESS PRECISION WIRE WOUND RESISTORS

Write For Brochure GR-20



For Immediate Delivery From Canadian Stock At Factory Prices Contact Your Nearest Authorized G. T. Distributor:

Canadian Electrical Supply Co. 275 Craig St. West Montreal, Quebec, Canada	Electro Sonic Supply Co., Ltd. 543 Yonge Street Toronto, Ontario, Canada
Payette Radio Limited 730 St. James St. West Montreal, Quebec, Canada	Western Agencies, Ltd. 951 Seymour St. Vancouver, B. C., Canada
Lee Bern Radio Supply Co. 341 William Ave. Winnipeg, Manitoba, Canada	Alpha Aracon Radio Co. 29 Adelaide St., W. Toronto, Ontario Canada

For Additional Information
On Any GT Products, Contact:

DESSER E-E LTD.
441 ST. FRANCOIS XAVIER
MONTREAL 1, QUEBEC, CANADA
TELEPHONE VICTOR 5-6570



New Division For Automatic Electric



Automatic Electric (Canada) Limited recently announced the establishment of an Industrial Products Division to manufacture relays, stepping switches and other devices for electrical control applications. A large area of the company's modern plant at Brockville, Ont., has been assigned for the purpose.

Automatic Electric, who originated the dial telephone, have been making relays and other components for automatic telephone exchanges since their inception 65 years ago. They also pioneered the use of these compo-

nents for electrical control purposes.

Now, instead of taking the components off the telephone equipment production line, products for industrial use will be engineered, manufactured and assembled in the Industrial Products Division. The company expect their new, self-contained facilities will greatly increase the supply of the entire range of these devices for industrial applications.

The products will be distributed in Canada by Automatic Electric Sales (Canada) Limited, Toronto, through their sales offices in principal cities.

Automatic Electric appointment

Automatic Electric Sales (Canada) Limited, Toronto, announces the appointment of Mr. A. C. Stewart as Manager, Industrial Sales. In this capacity, he will be responsible for directing the sales of Automatic Electric relays and switches, Stromberg time equipment, Paragon time controls and TelAutograph telescribing service to commercial and industrial accounts.



A. C. Stewart

Mr. Stewart is a graduate of the School of Electronics, Ryerson Institute of Technology and, after sales and technical experience with other firms, headed up the Radio Section of Head Office Carrier and Radio Sales for Automatic Electric.

Defense contracts awarded to Canadian firms

A list of unclassified defense contracts for \$10,000 or more awarded to Canadian firms by the Department of Defense Production, Ottawa, during the first half of September included 68 contracts with a total value of \$4,872,477. The contracts covered such items as fuel oil, clothing, ammunition, aircraft navigation equipment, coal, and medical supplies.

During the same period six contracts for \$10,000 or more amounting in total to \$763,144, were placed by Defense Construction (1951) Limited.

The combined value of contracts for \$10,000 or more placed by both the Department of Defense Production and Defense Construction (1951) Limited, totals \$5,635,621.

EIA and IRE hold radio fall meeting

The Thirtieth Radio Fall Meeting, sponsored by the EIA (Electronic Industries Association) Engineering Department with participation by IRE professional groups, convened in the Sheraton Hotel, Rochester, N.Y., from October 27 to 29 inclusive.

The program included sessions on such subjects as engineering management, component parts panel reorganization, "Let's Speak English—Standards or Specifications," quality improvement and reliability, radio and television (broadcast receivers and TV receivers), and electron devices (tubes and transistors).

Social events were arranged by courtesy of the Sprague Electric Company and the Stackpole Carbon Company.

The Radio Fall Meeting Dinner, held on Tuesday, October 28, had as its guest speaker, D. R. Hull, president of the Electronic Industries Association, whose subject was "Engineering Maturity."

you can't buy better precision than **IRC** PERFORMANCE — RELIABILITY QUALITY



← Type WWJ
Precision Wire Wound

Encapsulated
Precision Wire Wound →



- Widest Range and Tolerance Values Available
- Over 25 Years' Winding Experience
- Continuous Inspection Assure Quality

Meets MIL-R-93A Specifications
Standard Tolerances $\pm 1/20\%$ to $\pm 1\%$
Closer Tolerances Available
Terminations Available — Lug, Radial Lead and Axial Lead

Complete Engineering Facilities For
YOUR Special Requirements

OVER 140 DIFFERENT TYPES

For Further Information write to Department 31
For Data Bulletin D-1b and PH

INTERNATIONAL RESISTANCE CO. LTD.

349 CARLAW AVE.

TORONTO 8, ONT.

Radiovision Sales Ltd.
325 Tenth Ave. West
Calgary, Alta.

SALES OFFICES:
492 Somerset St. West
Ottawa
Ont.

1500 St. Catherine St. West
Montreal
Que.

TRIL Export Sales Agents



FOR

KURMAN RELAYS



Kurman Relays are engineered to the highest standards of quality. Performance proved since 1928 in industry and Government agencies for ruggedness, dependability and long life.

SUB-MINIATURE
SENSITIVE
RELAY
SERIES T



Medium
Power
Series 26

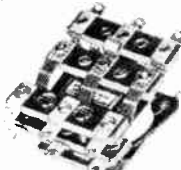

Ultra-
Sensitive
Polar
Series P



QUALITY DESIGNED RELAYS
FOR EVERY REQUIREMENT:

- Sensitive
- Polar
- Telephone
- Power
- Time Delay
- General Purpose

TRIL is the trademark of Terminal Radio International, Ltd., exclusive in-stock suppliers of America's greatest names in Radio, TV, Audio, Electronic and Nucleonic instruments and components. Fast, dependable delivery anywhere in the world.

Your request for literature, technical bulletins and price quotations will receive our prompt attention. Write us your requirements.

TERMINAL RADIO INTERNATIONAL, LTD.

135 Liberty St., New York 6, N. Y., U.S.A. • Cable: TERMRADIO

World's First Battery Operated Pocket Tape Recorder

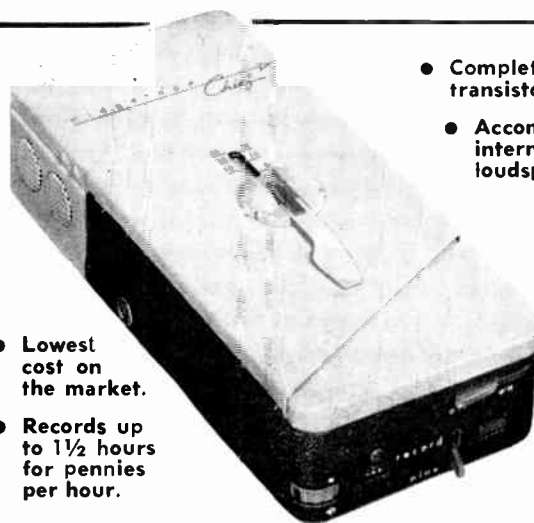

- Completely transistorized.
- Accommodates internal loudspeaker.

- Lowest cost on the market.
- Records up to 1½ hours for pennies per hour.

Midgetape is pocket size. It has a variety of devices for confidential recordings. Power converters for non-battery use in car, office or home. One battery with visual life indicator. Ideal for engineers, lawyers, insurance investigators, doctors, public relations and salesmen, as well as for inventory taking.

INSTANTANEOUS RECORDING SERVICE

40-42 LOMBARD STREET - TORONTO 1, ONTARIO
TELEPHONE EMPIRE 3-5767

POLYPENCO® TEFLON® SHAPES

An unusual plastic completely resistant to industrial chemicals

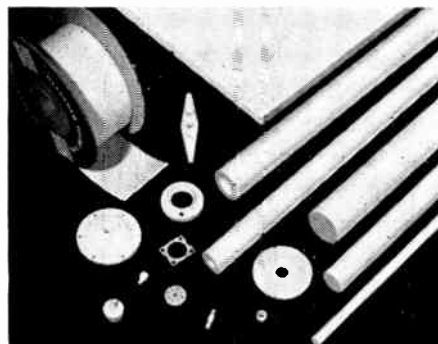

Small components machined from illustrated standard shapes for chemical processing and electronic equipment. Parts are easily fabricated on lathes and punch presses.

POLYPENCO TEFLON

properties— inert to chemicals • service temp. range: -110°F. to $+500^{\circ}\text{F.}$ • water absorption—nil • power factor—0.0005 • dielectric constant—2.0 • dissipation factor—0.0002 • surface resistivity (100% R.H.)— 10^{13} ohm

applications—insulators and bushings • terminal connectors • stand-off insulators • valve-seats • gaskets and packings

available in—rod • tubular bar • tape • sheet • spaghetti tubing
POLYPENCO Teflon shapes are stocked in wide range of sizes for immediate shipment. For more information write to:

Distributors and Sales Engineers

Peckover's Limited: 115 McCormack St., Toronto
2052 St. Catherine St. W., Montreal

C. M. Lovsted & Co. (Canada) Ltd.: Vancouver • Edmonton • Calgary
POLYPENCO, INC., 2150 Fairmont Ave., Reading, Pa., U.S.A.

POLYPENCO®

Toronto section, IRE plan busy agenda for November meeting

A meeting of the Institute of Radio Engineers will be held on Monday evening, November 3, at 8 p.m. in the Bell Telephone Equipment building at 15 Asquith Avenue, Toronto (Bloor-Yonge).

Representatives of the Bell Telephone Company of Canada will provide an individually guided tour of facilities in the recent addition to their Asquith building. New equipment was recently cut into service

there as a direct result of the increased space demands for Toronto's direct distance dialling equipment.

Technical Personnel will be on hand to answer specialized questions.

Robert C. Poulter, P.Eng. will address the supper meeting of the Institute of Radio Engineers, Toronto Section, at 6 p.m. on Monday, November 3, at Hart House. He will give an illustrated talk on "Mexico, the Land of Contrast". He will show colored slides taken during his visit to Mexico in the spring of 1958 and will make some remarks about the history of Mexico and its early Aztec culture.

Montreal hi-fi exposition

The annual hi-fi exposition sponsored by the Dominion High Fidelity Association will take place in the Windsor Hotel, Montreal, from October 29 to November 1, inclusive. Last year's show was held in Toronto.

R. C. Kahnert, association president, says that plans for this year's exhibition have been most extensive and that a number of new and interesting developments in the high fidelity music field will be on view at the show.

Forty-three exhibitors have booked 57 salons and rooms to demonstrate their wares and answer questions on high fidelity music. The exhibition will be officially opened at 6 p.m. on October 29 and will remain open from 1 to 10 p.m. on the subsequent three days.

Two prominent British hi-fi specialists will be among the many experts on hand at the exposition. R. Merrick, managing director of the British Ferrograph Recorder Company will visit the show prior to undertaking a series of TV broadcasts with the CBC. The second visitor, Harold Leak, also from England, managing director and design engineer of the audio amplifier which bears his name, will present a series of lectures in Canada and will be on hand at the show for informal chats in connection with the exhibit of his amplifiers.

APPOINTMENT



E. H. HAYES

E. H. Hayes, who has been appointed director of planning, reporting to A. B. Hunt, general manager of the research and development laboratories of Northern Electric Company Limited. A graduate of the University of New Brunswick, where he took the degree of B.Sc. Electrical Engineering in 1928, Mr. Hayes joined Northern Electric upon graduation.

NEW DEPARTURE

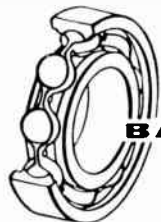

BALL BEARINGS

for

High capacity high speed applications

or miniature instrumentation

From high capacity, ultra precision N. D. bearings of special steels, finish and tolerances, to tiny instrument bearings of exquisite accuracy, your Canadian source of supply is R&M Bearings Canada Ltd. Experienced salesmen and engineers are available to discuss standard or specialized applications. Call your nearest R&M office for prompt service.

R&M BEARINGS CANADA LTD.

VANCOUVER WINNIPEG LONDON HAMILTON
TORONTO MONTREAL THREE RIVERS QUEBEC CITY



For catalogues write **R&M** at
1006 Mountain Street, Montreal, P.Q.
Catalogue ABC for high capacity bearings.
Catalogue PIB for miniature bearings.



R&M 6-

1/8" Bit L. No. 70
Shield L. No. 68

ADCOLA
(Regd. Trade Mark)

3/16" Bit
L. No. 64

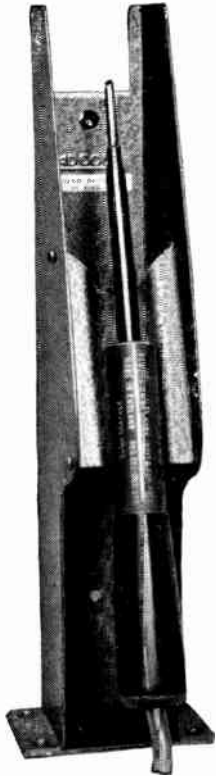

C.S.A. APPROVED

SOLDERING INSTRUMENTS

Designed in Three Sizes
1/8" 3/16" & 1/4" Bits.

Manufactured for
All Supply Voltages
6/7 to 230/50 v.

Instruments maintain
soldering temperatures
and through jointing is
achieved in all the
fields of soldering, from
pin point to general
work in all sound equip-
ment.

Insulation standards are
approved in all leading
countries.

All Designs Cover the
Demands for Continual
Bench Production
Assembly.

Canadian, British and
Foreign Pats.
Reg. designs, etc.



Canadian
Representative:

L. J. LAMB
Box 103 - Weston, Ont.

Airtron

FOR INCREASED PERFORMANCE

Where Size And Weight Are Critical

Miniature X Band

Ferrite Phase

Differential
Duplexers

Single Unit
Construction

Smaller Size — Lighter and More Rugged Assembly



Frequency Range	8500 - 9600 mc s	Received Insertion Loss	.5 db
Transmitted Insertion Loss	.5 db	Magnetron Input VSWR	1.20
Load To Magnetron Isolation	20 db	Antenna Input VSWR	1.20
Magnetron To Receiver Isolation	25 db		
Power Handling Capabilities To	600 kw Peak		

A PRODUCT OF CANADA

For Further Information
Write to Department 33 For Data Bulletin 3744

Airtron CANADA LIMITED
300 CAMPBELL AVE. TORONTO 9, ONTARIO



**THE SMALLEST ROTARY SWITCH
EVER MADE!**

Daven's New Series G Sub-Miniature Switch, 1/2" Diameter!

A new sub-miniature rotary selector switch, developed by DAVEN, is specifically suited for application in missiles, aircraft, handy talkies, field pack sets, frog-man communication equipment, and all types of mobile apparatus. This explosion-proof, waterproof switch has the same reliability as its bigger brothers... but in a fraction of the space. It meets applicable military specifications on temperature, humidity, corrosion, vibration, acceleration, shock and immersion.

This unit is available as a single pole, 10 position switch and can be obtained with up to four poles on a single deck.

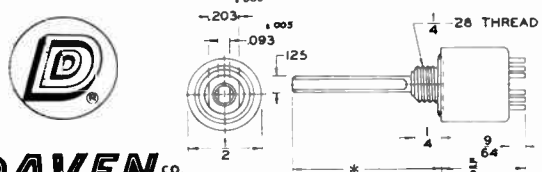

THE **DAVEN** CO.
LIVINGSTON, NEW JERSEY

Write today for comprehensive technical report on the new Series G Sub-Miniature Rotary Switch.

IN CANADA: Adams Engineering Ltd., Montreal & Toronto

SPECIFY Hoyt METERS

FOR
EVERY
APPLICATION

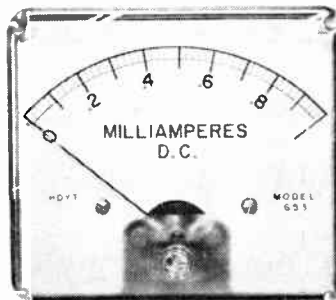

No. 653 illustrated

NOW! 2 1/2, 3 1/2, 4, 4 1/2 inch, anti-static treated, AC or DC meters with clear polystyrene cases for modern installations. Feature standard or matched colors on lower frosted panel for appearance and functional identification.

Be sure of the highest accuracy, dependability, and readability PLUS economy with HOYT precision AC and DC instruments — the complete line of Panel Meters. Moving coil, rectifier, and repulsion types available in a wide variety of sizes, ranges, cases, and colors. Also, custom-designed (including 400-800+ cycle applications) to meet your most rigid specifications for a quality instrument.

Write Export Manager — new illustrated literature contains descriptions, engineering data, and prices.



Prompt Delivery — M/A Forms mailed on day of shipment.

Service Facilities — strategically located in Canada.



ELECTRICAL INSTRUMENTS

Sales Div.: BURTON-ROGERS COMPANY
42 Carleton Street, Cambridge 42, Mass., U.S.A.

MEASUREMENTS'



MODEL 162

NEW

VACUUM TUBE VOLTMETER

Provides RANDOM ACCESS to all functions and ranges through the use of push-button switches.

- For voltage and current measurements in laboratories, service shops and on production lines.
- For accurate rf and ac voltage measurements from 0.1 to 300 volts on electronic equipment from the low audio range through the VHF range.
- For dc voltage measurements from 0.01 to 1000 volts without disturbing circuit performance.
- For direct current measurements as low as 0.001 microampere.

WRITE FOR BULLETIN

Laboratory Standards  **MEASUREMENTS**
A McGraw-Edison Division
BOONTON, NEW JERSEY

Sales Representative: H. Roy Gray Ltd., 46 Danforth Rd., Toronto 13, Ont., OX. 1-1131

for counting and control...

TYPE 8A low cost, miniature CAM SWITCH

- A decimal-to-binary converter switch
- A control switch
- A decade switch

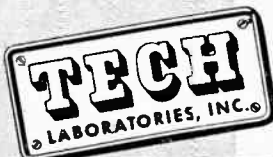

This versatile, miniature Cam Switch by Tech Laboratories is made in six- and ten-position models for a variety of computer and control applications. It is the least expensive and smallest switch of its kind, yet life tests in excess of 40,000,000 breaks have been performed with no evidence of failure! Type 8A is rated at one-amp., 110 volts, a-c and has a breakdown rating of 1500 volts. Available in single and double-ended designs for clockwise and counter-clockwise operation. Variations in design on application.

Send for complete technical data

Manufacturers of
Precision Electrical Resistance Instruments
PALISADES PARK, NEW JERSEY

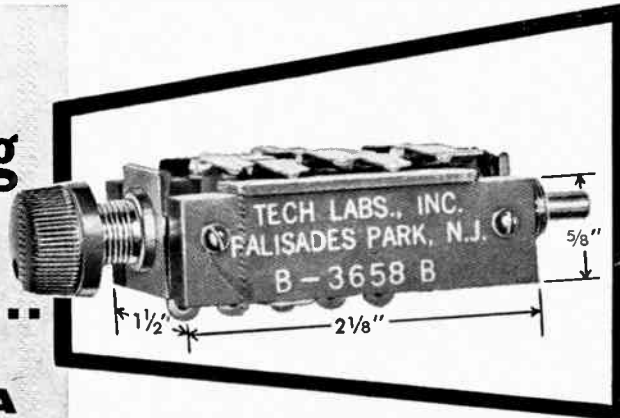

CDC supply data processing system for RCAF Station

A contract for design and construction of a multi-location weapons system range data processing system for the Cold Lake RCAF Station, Grand Centre, Alberta, has been awarded to Computing Devices of Canada Limited, and Epsco Incorporated. CDC is the Canadian representative of the U.S. electronics firm.

The system is initially intended for use in forthcoming trials of the Sparrow II air-to-air missile and the CF-105 Arrow.

Some of the equipment is to be installed at Cold Lake, the rest at adjacent Primrose Lake. Test flight data is to be gathered at the Primrose Lake Primary Data Collection facility and relayed via a radio pulse code modulation link to the data processing installation at Cold Lake.

Housed in 18 racks, the equipment includes two Epsco high speed reversible analog-to-digital converters, ten of Epsco's Model FM-102 dual channel discriminators and a DR-704 digital computer format tape recording system.

Other equipment includes over 120 precision bandpass and lowpass filter units, several PDM-to-voltage converters, electronic multiplexers and a Time Code Translator Unit. Self-correction for errors in the analog tape mechanism is provided by Epsco velocity deviation detectors.

Total value of the equipment to be installed is understood to be in excess of \$600,000.

Lake Engineering represents Transistor Electronics

Lake Engineering Co. Ltd., has been named the Canadian manufacturer's representative for Transistor Electronics Corporation.



A. Ainlay

Lake Engineering has its headquarters at 767 Warden Avenue, Scarborough, Ontario. General manager A. Ainlay and his associates Frank P. Taylor and Ted Thompson will market Transistor Electronics' line of panel indicator lights, coils and test equipment for computers.

Transistor Electronics Corporation is a designer and manufacturer of transistorized electronic components located at 3357 Republic Ave., Minneapolis 26, Minn.

TRANSISTOR POWER EQUIPMENT

CANADIAN "KNOW-HOW" MARKS UP
ANOTHER FIRST IN APPLIED ELECTRONICS*

Transistor power equipment offers a great step forward to the communications power field, with advantages in reduced maintenance, increased reliability, improved flexibility, and higher efficiency. Shown below is the PYLON Power Assembly Model 206, now in service with a number of major Canadian telephone companies.

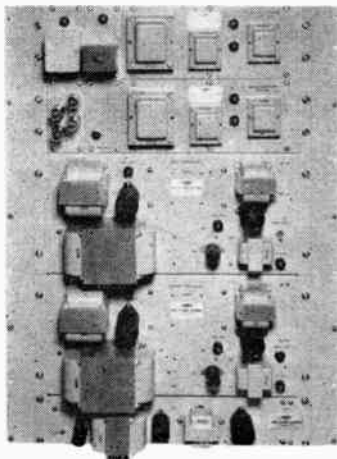

PYLON Power Assembly Model 206

SPECIFICATIONS

INPUT: 48V D.C.

- OUTPUTS:
1. 130V D.C. plate battery supply at 1 amp, ripple less than 50 mV.
 2. 24V D.C. signalling battery supply at 5 amps, ripple less than 100 mV.
 3. 24V D.C. talking battery supply at 1 amp, ripple less than 12 mV.
 4. 75-105V A.C. ringing current supply, 20 c/s at 20 watts keyed 2 seconds "ON", 4 seconds "OFF".
 5. 1000 c/s A.C. signalling tone, adjustable to 0 dbm.

Full standby is included on outputs 1-4 with built-in transfer facilities.

This equipment incorporates the PYLON Power Module and the sensational new PYLON "Auto-verter", the high efficiency D.C. to D.C. converter without rectifying elements.

* Other PYLON firsts in transistor power equipment:

1. First transistor ringing current generator.
2. First transistor equipment for 48V D.C. input.
3. First transistor equipment for 130V D.C. input.
4. First successful circuitry for load sharing amongst parallel transistors.
5. First (and still sole) supplier of high-capacity transistor power equipment.
6. First (and still sole) successful circuitry for fusing power transistors.
7. First (and still sole) user of the "TRANSISTOR POWER MODULE" concept.
8. First practical circuitry for D.C. to D.C. conversion without rectifying elements, the new exclusive high-efficiency PYLON "AUTOVERTER".

ALL PYLON TRANSISTOR EQUIPMENT CARRIES
A FULL ONE-YEAR WARRANTY



PYLON ELECTRONIC DEVELOPMENT company, Ltd.

Communications Systems and Equipment

161 CLEMENT ST., VILLE LASALLE, MONTREAL 32, QUE.

400 CYCLES - 200 WATTS

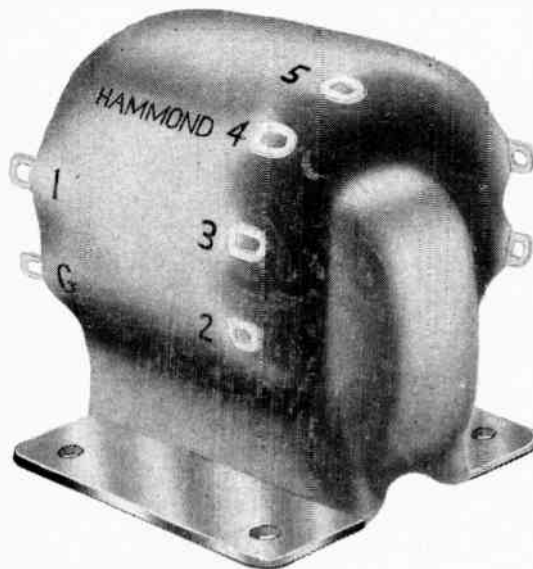

15 CUBIC INCHES

- ★ GRAIN-ORIENTED "C" CORES
- ★ "DUREN" ENCAPSULATION
- ★ HIGH TEMPERATURE INSULATION



This Hammond 400 cycle transformer measures only 2 7/16" x 2 1/2" x 2 1/2". High temperature wire and insulation plus Hammond's exclusive "Duren" encapsulation enable it to operate at high as well as low temperatures. As much as 200 watts power handling ability can be built into a space of 15 cubic inches without the use of heat sinks or fan cooling.

Hammond has been manufacturing a broad range of 400 cycle transformers for *single phase* and *three phase* applications for over fifteen years. Special transformers to your specification supplied for development or production work on short notice.

ASK FOR ENGINEERING DESIGN BULLETIN 5090
Standard items stocked by jobbers coast to coast

HAMMOND

INDUSTRIAL AND SPECIAL TRANSFORMERS

HAMMOND MANUFACTURING COMPANY LIMITED

GUELPH, ONTARIO, CANADA

H14.

EDUCATIONAL TV

ON A
Modest Municipal Budget

WITH
Prodelin
PACKAGED
ETV ANTENNA SYSTEMS
LOW POWER - LOW COST
for High Band VHF Service

FEATURING **Spir-O-line**® THROUGHOUT

Prodelin's ETV Tri-Loop Antenna System is an economy package all the way — initial cost, installation, and maintenance — brings educational TV within the means of the most modest municipal budget.

Already an outstanding field-proved performer in military "morale" stations, educational TV, commercial TV, and satellite services, the Prodelin ETV Tri-Loop Antenna System is now improved with the use of *Spir-O-line* and *Spir-O-lok*, the high performance coaxial cable and connectors that reduce installation and maintenance.

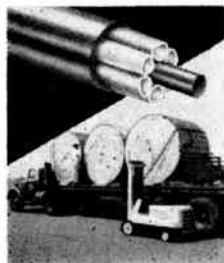

Spir-O-line

1000' reels of Prodelin's *Spir-O-line*, the revolutionary semi-flexible aluminum coaxial cable, are going everywhere to users who want *Spir-O-line*'s unusual combination of very low attenuation, high power rating, broadband characteristics, and substantial reductions in installation and maintenance costs.

ELECTRICAL & MECHANICAL SPECIFICATIONS

Type	Power Gain	No. Loops	Height	Radiation Center	Moment Ft. Lbs.	Shear Lbs.	Weight Lbs.
ETV-2	2.0	2	10'	5'	1797	298	280
ETV-4	3.98	4	20'	10'	6471	600	560

for prices and further specifications, write

Prodelin Inc
307 Bergen Avenue • Kearny, N. J.
Dept. EC-10

Represented in Canada by Adams Engineering Co.
Toronto • Ottawa • Montreal

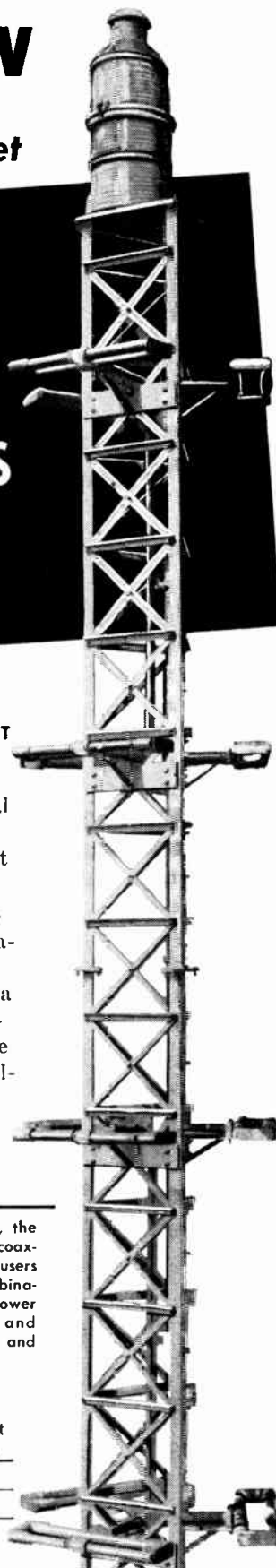

P. J. Casella promoted to top U.S. post

The appointment of P. J. Casella, president, RCA Victor Company, Ltd. as executive vice-president of the Radio Corporation of America was recently announced by the Radio Corporation of America.

Mr. Casella will be responsible for the activities of the RCA Victor TV



P. J. Casella

Division, the RCA Victor Radio and "Victrola" Division and the RCA Victor Record Division. In addition to his new duties Mr. Casella will continue as president of RCA Victor Company, Limited in Canada.

Mr. Casella has been president of RCA Victor Company, Ltd. since 1956 and prior to that was vice-president of the company's distribution operations. Later he was vice-president of consumer products which entailed development, production and sales of consumer products. Mr. Casella also served as managing director of the RCA Italian subsidiary.

RCA of Canada handles Keleket X-ray services

Malvern Gross, vice-president of Keleket X-Ray Corp. announced recently that as of October 3, RCA Victor Company, Ltd. of Montreal, Canada, would be the firm's exclusive sales and service agent throughout Canada.

RCA operates one of the largest electrical and electronic organizations in the western hemisphere and is active in installation and service of such complex equipment as radio and TV stations, radar stations, etc., and such fine medical equipment as electron microscopes.

Keleket is the pioneer firm in the X-ray industry in the western hemisphere having engaged in design and manufacture of X-ray equipment for radiologists and hospitals since 1900.

Key members of the RCA organization have just completed an intensive training course in the use and service of X-ray apparatus at the ultra modern Keleket plant in Waltham, Massachusetts, and are the nucleus of a staff which will operate through RCA's offices across Canada in Halifax, Quebec, Montreal, Ottawa, Toronto, London, Sudbury, Winnipeg, Calgary, Edmonton, Vancouver and Victoria.

SYNTRON

SELENIUM RECTIFIERS

designed for your application

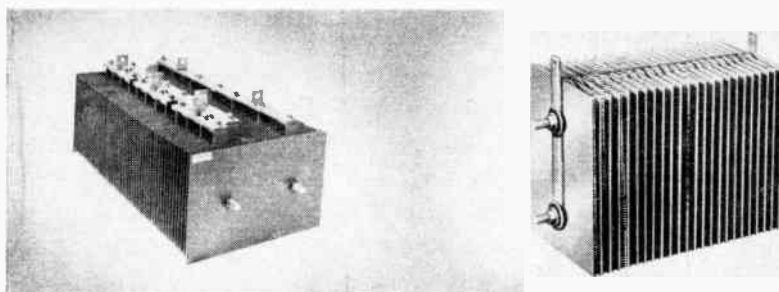

Industrial Power Rectifier Stacks — high efficiency, low maintenance. Designed for arc welders, heavy d-c power supplies, etc.

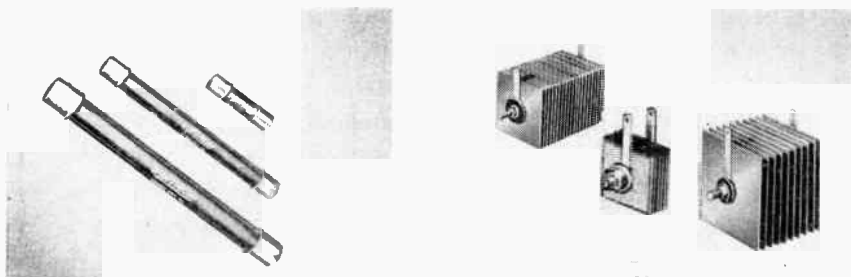

Cartridge Rectifier Stacks — low current, high voltage. Maximum 25 milliamperes, maximum input 15,000 R.M.S. volts.

Commercial Rectifier Stacks — Designed for business machines, elevator controls, magnetic chucks, brakes, clutches, vibratory equipment,

—The widest range of cell sizes in the industry

SYNTRON Selenium Rectifiers are manufactured under laboratory controlled conditions, assuring product uniformity.

SYNTRON Selenium Rectifiers are noted for these exceptional characteristics — low voltage drop, low leakage current, low temperature rise and cell uniformity for long stack life.

Let our applications engineers make recommendations for all your rectifier needs.

Other SYNTRON Equipment
*designed to increase production,
 cut production costs, improve products*

- | | |
|--------------------------------------|--------------------------------------|
| Vibrators
(bins, hoppers, chutes) | Rectifiers
(Silicon and Selenium) |
| Vibratory Feeders | a-c to d-c Selenium Rectifier Units |
| Vibratory Screens | Electric Heating Panels |
| Shaker Conveyors | Electric Heating Elements |
| Vibratory Elevator Feeders | Sinuated Wires |
| Weigh Feeders | Shaft Seals |
| Packers and Jolters | Electric Hammers |
| Hopper Feeders | Concrete Vibrators |
| Lapping Machines | Paper Joggers |

Our representatives will be glad to work with you in selecting the proper equipment for your operation.

Call your nearest Syntron representative.

For more information write for complete catalog . . . *Free*

E 358

SYNTRON (CANADA) LIMITED
 12 MAIN STREET EAST • Dept. K • STONEY CREEK, ONTARIO

R. P. Matthews manager of Andrew Antenna Corp., Ltd.

Richard P. Matthews was recently appointed to the position of manager of Andrew Antenna Corporation Ltd.,



R. P. Matthews

Whitby, Ontario, Canada, manufacturer of antenna systems. Mr. Matthews was formerly director of sales and engineering. He will replace John McLeod, who is being assigned to the company's new operation in Europe.

Richard Matthews, a native of Canada, received his B.A. and B.S. degrees from Regina College and the University of Saskatchewan. He has had extensive experience in the field of communication and electronics, and is a registered professional engineer in the Province of Ontario. He also is a senior member of the IRE and a member of AIEE.

December meeting of Toronto Section, IRE

The next meeting of the Institute of Radio Engineers will be held on Monday evening December 8, at 8:30 p.m. in Room 252 of the Mechanical Building, University of Toronto. Dr. T. R. Hartz, Defence Research Board, will present "Measurements on Solar Corpuscles and their Relation to Ionospheric Storms".

Dr. Donald A. MacRae, Professor of Astronomy at the David-Dunlap Observatory, University of Toronto, will speak at the 6:00 p.m. Supper Meeting at Hart House. He will give an illustrated talk on his impressions of Russia received while attending the International Astronomical Union Assembly in Moscow during August 1958.

Toronto engineering student wins APEO scholarship

An 18-year-old graduate of Vaughan Road Collegiate, Toronto, Norman Marvin Kerbel, has been awarded the \$500 scholarship presented by the Association of Professional Engineers of Ontario.

The scholarship, awarded alternately to students entering the University of Toronto or Queen's University, Kingston, is presented to the student entering university to take a course in engineering with the highest academic standing in Grade XIII.

Norman Kerbel graduated with eight firsts and one third. He has enrolled in engineering physics at the U of T.

It looks good in **THEORY...**

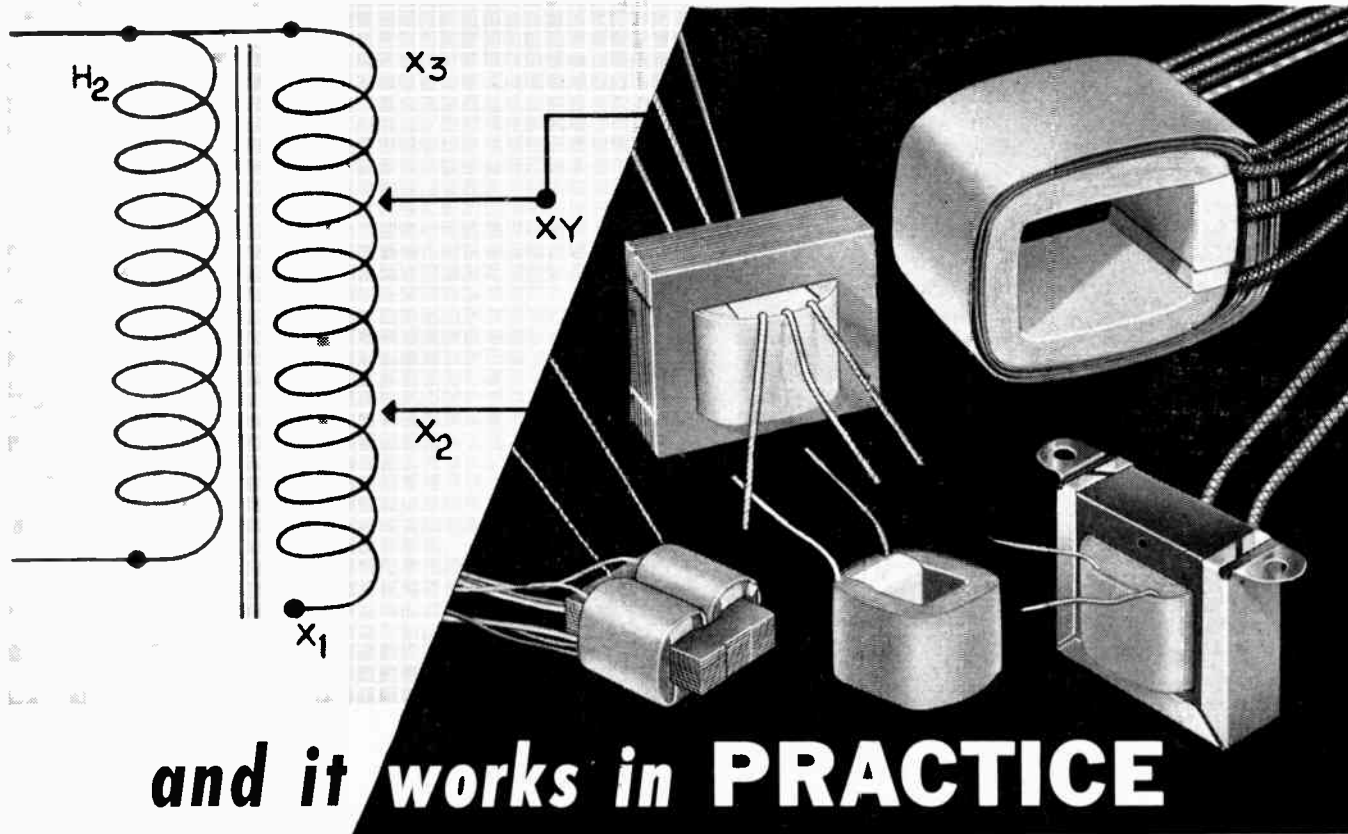

and it **works in PRACTICE**

Whatever your application—if it calls for magnet wire you can depend on Federal's "quality control" to ensure top performance. From copper rod to finished reel the uniformity of materials and processes are checked continually, safeguarding quality right to the finished product.

Avoid costly inspection procedures and rejects—provide additional assurance of long lasting dependability—put Federal's "quality control" to work for you.

"It looks good in THEORY", and it's been proven. "it works in PRACTICE".

To get the best in Magnet Wire Service call FEDERAL

5301-R

GUELPH, ONTARIO • St. John's Nfld. • Truro • Montreal • Toronto • Winnipeg • Regina • Saskatoon • Calgary • Edmonton • Vancouver

H. K. PORTER COMPANY (CANADA) LTD.
FEDERAL WIRE AND CABLE DIVISION

Divisions of H. K. Porter Company, Inc.: Connors Steel, Delta-Star Electric, Disston, Forge and Fittings, Leschen Wire Rope, Quaker Rubber, Refractories, Riverside-Alloy Metal, Vulcan-Kidd Steel. In Canada: H. K. Porter Company (Canada) Ltd., Disston, Federal Wire and Cable.



**From
EVERY
angle...**

MUIRHEAD Synchros are best!

Backed by more than twenty years' synchro manufacturing experience, MUIRHEAD synchros and servomotors are built to the highest standards of quality.

The constantly expanding range of types is made to U.S. Military, N.A.T.O., R.A.E., and Admiralty specifications in sizes from 08 to 23. Stocks of most types are held in readiness for immediate delivery.

*Ask for the comprehensive broadsheet.
Data sheets and prices are also
available on request.*

MUIRHEAD

PRECISION ELECTRICAL INSTRUMENTS

Do you receive copies of Muirhead TECHNIQUE? It's a quarterly journal you will find of interest.

MUIRHEAD INSTRUMENTS LIMITED, STRATFORD, ONTARIO

Tel: 3717 & 3718

343/3ca

IRE Exhibition Award won by Bach Simpson Limited

The Canadian IRE Convention exhibit award for the best product or exhibit at the 1958 Convention and Exhibition was won by Bach-Simpson Limited of London, Ontario. Presentation of a plaque signifying the award was made at the Convention banquet held in Toronto during the course of the recent IRE Convention. Purpose of the award is to stimulate research and development in Canada and thereby encourage Canadian companies to develop their own products. The award was won by Bach-Simpson for the design and development of an oscilloscope which the company recently placed on the market.

The special committee that had been set up to select the award winner was comprised of the following: H. Ross Smyth of the National Research Council; Eric Robinson of the National Research Council; George Glinski, Professor of Electrical Engineering at the University of Ottawa; Ross Freeman of Computing Devices of Canada Ltd. and Jim MacKay of the Department of Transport. This is the first occasion on which this award has been presented.

DIRECTOR



F. PERRY WILSON

The election of F. Perry Wilson to the Board of Directors of Union Carbide Canada Limited is announced by A. A. Cumming, President. A chemical engineering graduate, Mr. Wilson joined the Bakelite organization in 1941. He assumed the position of Vice-President in charge of Sales of Bakelite Company, Division of Union Carbide Canada Limited in 1953, becoming President the following year. In 1956, he was appointed a Vice President of Union Carbide Canada Limited, the position he holds today.

SERVO COMPONENTS TO COMPLETE ASSEMBLIES

DAYSTROM TRANSICOIL designs and manufactures a wide variety of precision servo components and complete assemblies for both industry and the military. The precision that goes into these products is the result of many years of specialized experience in the servo field. You're getting a head-start on quality when you specify Daystrom Transicoil . . .

SERVO MOTORS & MOTOR GENERATORS

Frame Size: 6, 8, 9, 11, 15, and 18 for 60 and 400* cycle operation
Standard Operation: -55 C to +120 C
*400 cycle units may be wound for operation with transistor drive

GEAR TRAINS

Mounted on the motor or generator
Maximum backlash will not exceed 30 minutes as measured with a 1 in. oz load on the output shaft.
Ratios from 7:1 to 2187:1. Other ratios available to suit customer specifications

SYNCHROS—Transmitters, Control Transformers, Differentials

Frame Sizes: 8 and 11 for 400 cycle operation
Also Inductive Potentiometer, Frame Size 11, 400 cycle, infinite resolution
Output: linear

AMPLIFIERS—Tube or Transistor Types

Miniaturized amplifiers to drive a combination of Daystrom Transicoil rotating components and assemblies
Designed to meet industrial and military requirements

COMPLETE ASSEMBLIES

Design and manufacture of complete servo assemblies to customer specifications



CATALOGUE — for complete specifications, mechanical data, dimensions, and characteristics, write for the Daystrom Transicoil Catalogue.



840 Caledonia Road, Toronto 19, Ontario;
5430 Ferrier Street, Montreal 9, Quebec.
A subsidiary of Daystrom Incorporated.

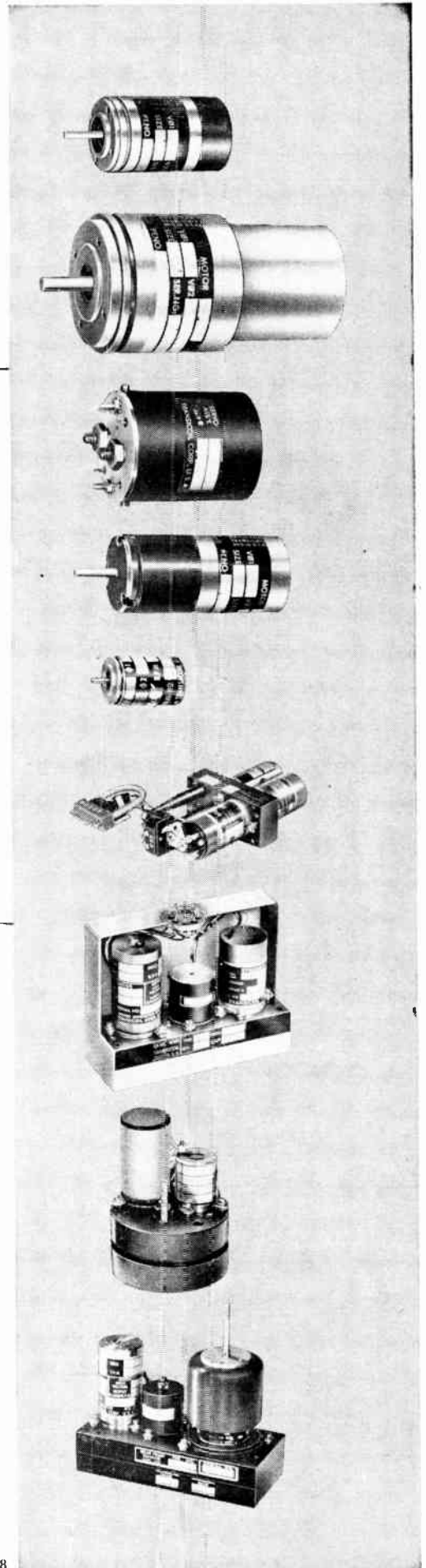

5828

The Complete Industrial Television System...



Completely matched from camera to monitor

The only Industrial Television system designed as a complete package... every piece of equipment designed to work perfectly with associated equipment... complete for either local or remote pickup. Designed and manufactured by Du Mont... from camera to monitor.

Complete planning, installation and servicing

The only Industrial Television system offering complete, local planning, installation and servicing by competent local contractors... your assurance that the system will be right... right from the start.

DU MONT®

Canadian Distributor

ELECTRONIC SERVICE SUPPLY COMPANY

210 - 9th Avenue East
Calgary, Alberta

Branches or Representatives in most
Canadian Cities

**INDUSTRIAL
TELEVISION DEPARTMENT
ELECTRONIC SERVICE SUPPLY
COMPANY**

210 - 9th Ave. East Calgary, Alberta

I'm interested in a demonstration.
Please tell me more.

Send me Industrial Television Handbook.

NAME _____

COMPANY _____

ADDRESS _____

Canadian Westinghouse designs defense operations equipment

A Canadian-developed system for long-range communications will provide a vital link in U.S. continental defense operations. The system — super-high frequency “scatter” communications equipment that sends signals far beyond the horizon — has been developed and perfected by Canadian Westinghouse electronics engineers.

Initial use of the system will be in the establishment and testing of ground control to guide the advanced U.S. Bomarc “B” ground-to-air supersonic missile, according to W. J. Cheesman, manager of the Canadian Westinghouse electronics division at Hamilton.

Mr. Cheesman said the company has received an order for multi-channel voice and radar equipment to be installed as part of the ground control system. The order is part of a \$10 million contract awarded the Westinghouse Electric Corporation in the U.S. by Boeing Airplane Company, prime contractor for the U.S. Air Force on the Bomarc project.

Essence of the new “scatter” technique it employs is that when a very powerful signal is beamed toward the horizon, some of its power is scattered to earth hundreds of miles distant. Signals reach around the curvature of the earth in much the same manner that the glow of oncoming headlights is seen over a hill.

Canadian Westinghouse has also received a second U.S. order for its scatter communications equipment, it was disclosed. Slated for the U.S. Air Force, it will go into service in a tactical system capable of transmitting and receiving 48 voice conversations simultaneously.

Canadian technical services for powder metallurgy

For the first time, industry in this country has available from a Canadian source, technical and research services specifically organized to deal with powder metallurgy. These are being provided through the research division of Metal Atomizing & Processing Corporation Limited, whose executive offices are at 25 Adelaide Street West, Toronto.

The services cover powders and their properties, commercial applications, design and processing techniques, new product development.

The company has under construction a plant for the production of powders which will be in operation early this fall.

THE MULLARD 6146 R.F. TETRODE is one of a line of Rogers quality tubes which has proven its reliability in two-way radio amplifiers. Having exceptional tube to tube consistency, the 6146 is also recommended for use as a modulator, oscillator or audio amplifier. The tube may be used at reduced ratings up to 175 Mc/s and, as an R.F. class "C" amplifier, will provide up to 25 watts at this frequency. At 60 Mc/s the tube output is 52 watts.

Rogers wide range of quality communications tubes are finding more and more applications in all types of professional equipment. For greater reliability and lower maintenance costs, specify Rogers tubes.

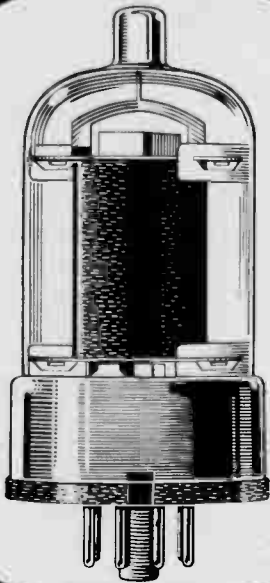

ROGERS

electronic tubes & components

A DIVISION OF PHILIPS ELECTRONICS INDUSTRIES LTD.

116 VANDERHOOF AVENUE, TORONTO, ONTARIO / BRANCHES: MONTREAL, WINNIPEG, VANCOUVER

★ Rogers Electronic Tubes are sold through Canada's Independent Electronic Parts Distributors

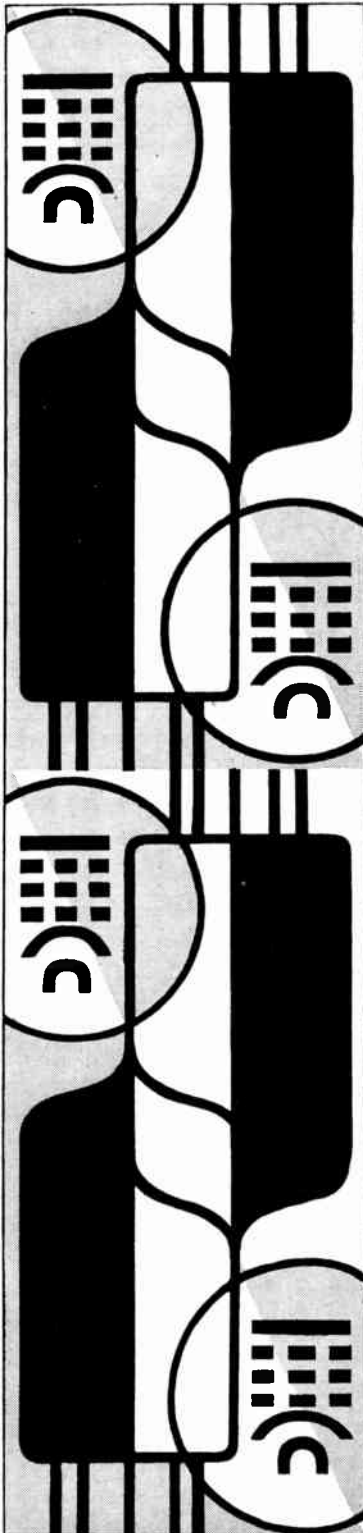

ERICSSON

TELEPHONE SALES
OF
CANADA LIMITED

AVAILABLE FROM STOCK!

L M ERICSSON

**MINIATURE, LONG-LIFE
ELECTRONIC TUBES**

- 10,000 hours warranty with much higher life expectancy for most types.
- Mechanical properties far superior to international standards.
- Ruggedized and specially tested for stability, vibration output, glass strain, etc.

some of the Ericsson tubes now available:

TWIN TRIODES

2C51/396A, 407A, 5842/417A

H.F. PENTODES

5590/401A, 5591/403B,
5847/404A, 6028/408A

POWER AMPLIFIER PENTODES

6760, 6761, 6AQ5L, etc.

- For complete Electronic Tube Data Sheets, sign and mail this coupon with your letterhead today!

ERICSSON TELEPHONE SALES OF CANADA LIMITED

MONTREAL: 130 Bates Road — REgent 1-6428

Please send data sheets on your long-life electronic tubes to:

Name: _____

Fire officers learn use of mobile radio

Speed in communication may mean the difference between life and death, success or disaster, especially in the instance of fire in neighboring communities. That is why the newly-opened Ontario Fire College at Gravenhurst, Ontario, is teaching mobile radio procedure to fire chiefs and fire officers as part of their courses.

The Ontario Fire College radio station is the control unit for the Muskoka district mutual fire aid program. This program, established by Ontario Fire Marshal W. J. Scott, consists of a radio hook-up among neighboring fire departments so that when one department needs assistance, or advice, they have immediate contact with other departments in the district.

The Ontario Fire College erected a 200-foot steel tower atop a high hill overlooking the 92 acres of land occupied by the College. At the base is located the 250 watt G-E transmitter. Mounted on the top of the tower is a high-gain antenna which boosts the effective radiated power to 1,000 watts. A remote control unit is located 1,300 feet away in the main administration building, where D. E. Barrett, B.A., director of the college, sends and receives messages from his staff as they operate various apparatus.

Mr. Barrett makes the following comment on the purpose of the college: "Mobile radio forms a link between headquarters and the fire trucks operating at a fire. In turn, they provide a means of communication between the chief fire officer at the scene and the various pieces of apparatus under his command."

CNT purchases Yukon Telephone Co.

Acquisition of the Yukon Telephone Company by Canadian National Telegraphs was announced recently by John R. White, general manager, Canadian National Communications. The price was not disclosed.

Canadian National Telegraphs will now take over operation of the Yukon Telephone Company's exchanges at Whitehorse, Keno and Mayo.

Telegraph and telephone services in these communities will be integrated with the Northwest Communications System, of C.N.T., a vital link in defense and commerce between Edmonton and the Alaska border.

Employees of Yukon Telephone will be offered employment with Canadian National Telegraphs.

Racal announce the first in the 'field' low priced Single Sideband 60W Radio Telephone

TRA.55

Transportable



- ★ Equivalent to Radio Link 600W on DSB
- ★ 4 pre-set crystal controlled channels
- ★ Frequency range: 3-12 Mc/s in 2 bands
- ★ 60W P.E.P. continuous rating
- ★ Extreme simplicity of operation
- ★ Transportable
- ★ May be used for CW operation

The enormous effective gain in power obtained by SSB transmission is now available in compact and economical form, especially suited to the needs of colonial communications authorities, geological survey teams, meteorological services, mining companies, oilfields, civil aviation and overseas armed forces.

The TRA.55 is tropicalised and designed for use by unskilled personnel, the transmitter and receiver being tuned simultaneously to 4 pre-set channels, selected by a single switch. The R/T transmit switch is incorporated in the handset handle. International-type valves and connectors are used throughout.

ABRIDGED SPECIFICATION

Frequency range:	3-12 Mc/s
Channels:	4 crystal controlled (2 in band 3-6 Mc/s) (2 in band 6-12 Mc/s)
Output power:	60 watts P.E.P. continuous rating
Aerial:	2 outputs: (a) 75 ohm for tuned aerials (b) single-ended output for long wire untuned aerials
Finish:	High grade tropical standard for ambient temperatures of 40°C.
Power supply:	100-125 and 200-250V 40/60 c/s AC supply
Consumption:	36vA standby 95vA receiver only 180vA receiver with transmitter available 300vA full power transmission
Dimensions:	Width 20½ inches (52 cms) Height 24½ inches (62½ cms) Depth 20½ inches (52 cms)
Weight:	Approx. 160 lbs. (72.5 Kg)



BRACKNELL, BERKSHIRE

Telephone Bracknell 941
Cables/Grams. Racal Bracknell Berks

Agents in Canada:

INSTRONICS LTD.
P.O. Box 51
Stittsville, Ontario

Long Kiln - Short Delivery

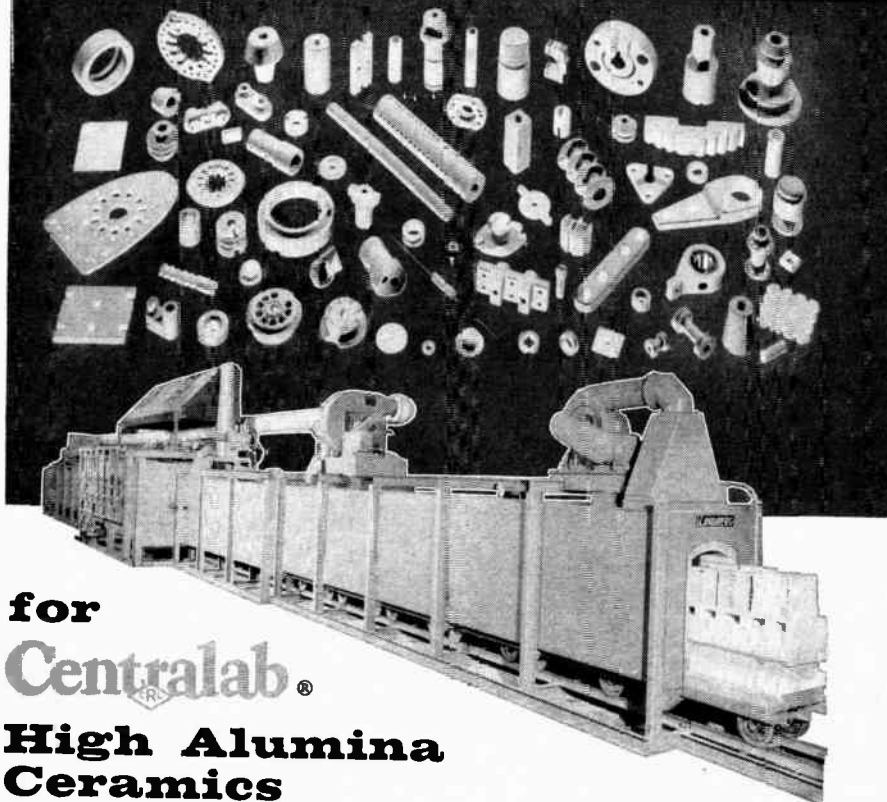

for Centralab® High Alumina Ceramics

Fast delivery of 95% and 85% High Alumina, to your most critical specifications, is assured by Centralab's new 80 foot continuous kiln. First of its design in the United States, this new kiln is capable of producing 21 tons of exceptional quality High Alumina every month. Consistent reproduction of electrical and physical properties from batch to batch is guaranteed.

Superior Electrical Properties at High Frequencies

Extremely stable dielectric constant and a power factor of .00045 at 9000 megacycles (see graphs of Bureau of Standards tests below) make Centralab Body 206 (95% alumina) your logical choice for all types of high reliability electrical and electronic applications.

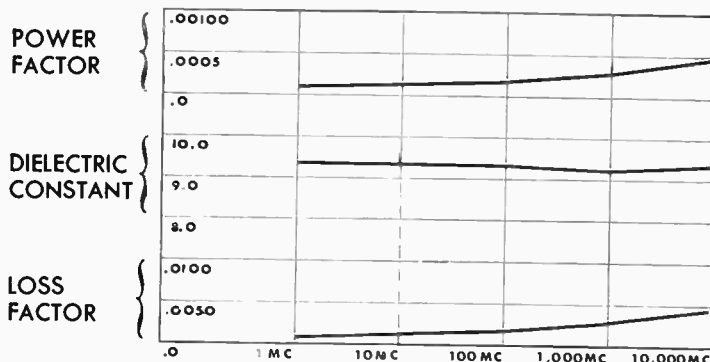

For complete specifications and design data write Centralab or consult Sweet's Product Design File (folio 4 a/cw).

X-5830

Centralab Canada Ltd. 804 MT. PLEASANT ROAD
TORONTO 12, ONTARIO
Affiliated: CENTRALAB • MILWAUKEE 1, WISCONSIN
VARIABLE RESISTORS • SWITCHES • PACKAGED ELECTRONIC CIRCUITS
CERAMIC CAPACITORS • ENGINEERED CERAMICS • SEMI-CONDUCTOR PRODUCTS

Western Electric engineers meet in conference

The third annual Western Electric Company Test Set Engineering Conference was held on October 8, 9 and 10 at the Sheraton Mount Royal Hotel, Montreal, Que.

Organized in 1956 by Western Electric engineers and department chiefs concerned with test set design, the purpose of the conference was to exchange ideas and information on design, maintenance and testing in general among the various plants of the company through the presentation of papers. Members of Bell Telephone Laboratories and Sandia Corporation were also represented.

The conference was held in Montreal at the invitation of Northern Electric Company Limited and a number of plant tours were organized for the delegates.

Syndicated Films appointment

Graham R. Hampson, has been appointed operations manager at Syndicated Film Services Ltd., 103 Church Street.

In addition to his technical and production duties Mr. Hampson takes over as executive assistant to Mr. Pat Clever, Syndicated president.

Mr. Hampson, who has had several years' experience in film editing, lab operations and TV production, was formerly with S. W. Caldwell and Sponsor Film Services, in Toronto.

His appointment marks one of the first steps in Syndicated's plans for consolidation of their operations and departments.

Heath Company official wins award

During September an award was made by the Direct Mail Advertising Association, Inc. to C. M. Edwards, director of advertising and sales promotion of the Heath Company, Benton Harbor, Michigan.

Regarded as one of advertising's top honors, the Direct Mail Award was presented to Mr. Edwards for his company's outstanding mail advertising campaign during the year ending August 1, 1958.

Colin Campbell, executive vice-president of Campbell-Ewald Company, who served as chairman of the jury of awards committee and who made the presentations to Mr. Edwards and other successful contestants, named many Canadian and U.S. firms for their outstanding direct mail campaigns.

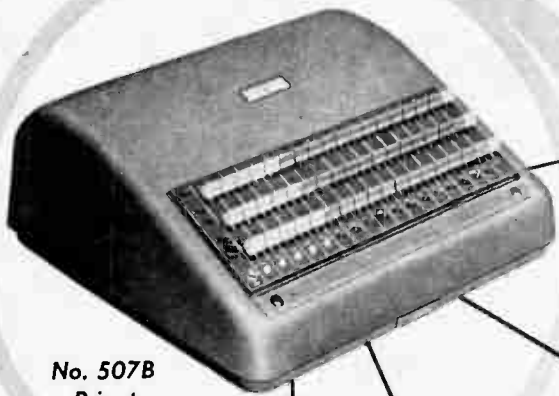

No. 507B
Private
Branch Exchange

**modern
compact
efficient**



Photo—courtesy of
The T. Eaton Co.



Photo—courtesy of
National Life Assurance Co. Ltd.



Photo—courtesy of
Joeger Co. Ltd.



Photo—courtesy of
Hyde & Ahearn.

finished in neutral beige-gray colour with a fine wrinkle texture, the No. 507B P.B.X. will blend with the most modern office equipment. It is particularly adapted to operation by those who have other duties to perform in addition to switchboard attendance. The specially contoured keyhandles and smoothly working keys make this board a pleasure to operate. Provides terminating equipment for 12 Station Lines and 5 Central Office Trunks and permits 5 Simultaneous Conversations. Operation is from 24 or 48 volt battery with manual or dial telephone.

Northern **E**lectric

COMPANY LIMITED

44 BRANCHES THROUGHOUT CANADA

2054-2

NEW DAYLIGHT PORTABLE OSCILLOSCOPE



Bright Trace

High Performance

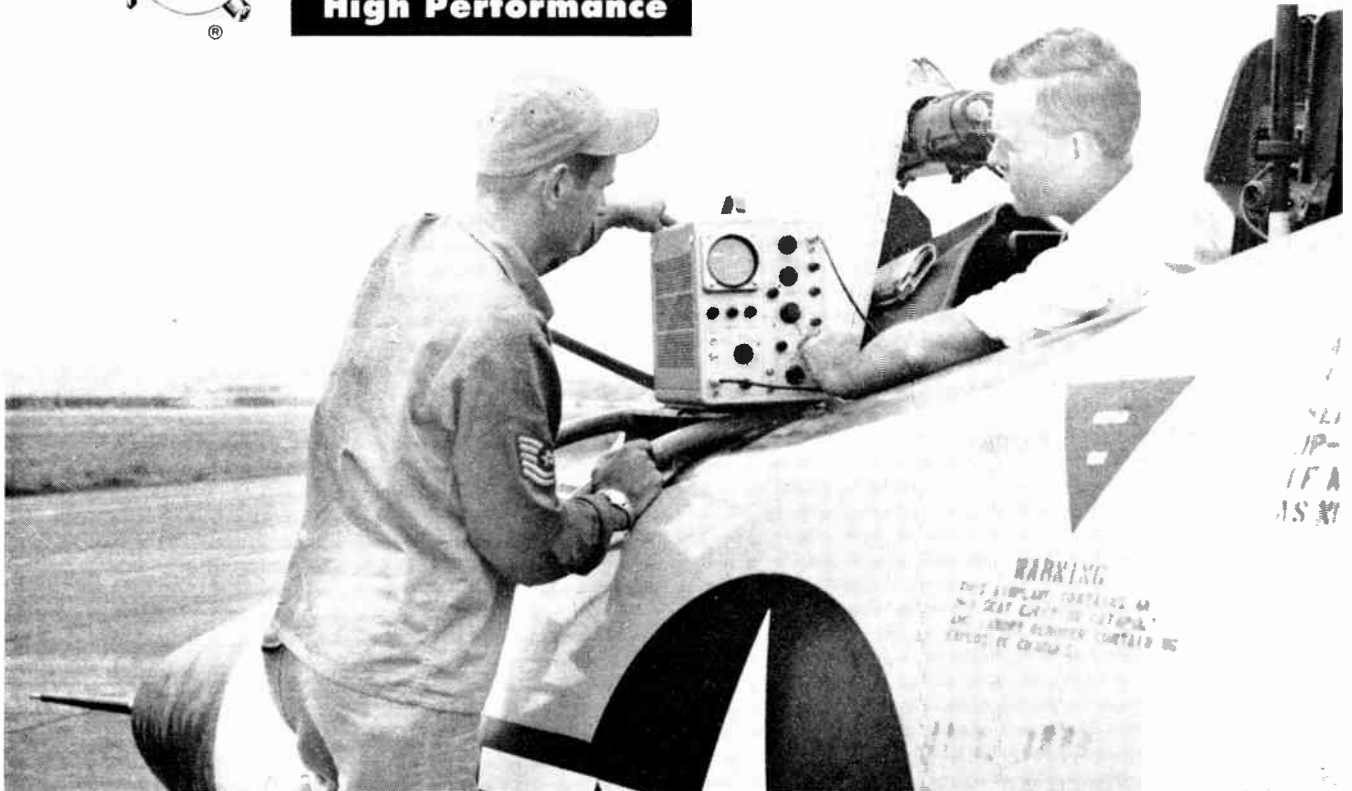

Courtesy Commander 337th Fighter Group, U S A F

TYPE 317

It's excellent for the daylight conditions often encountered in the field and at production test stations. The brilliant trace, provided by 10-KV accelerating potential on a new Tektronix 3-inch cathode-ray tube, is easily readable in bright areas, even at low sweep-repetition rates. And its DC-to-10 MC vertical response easily takes care of most of today's complex field applications.

The Type 317 is an excellent laboratory oscilloscope, too. Ask your Tektronix Field Engineer or Representative to arrange a demonstration in your most demanding applications.

TYPE 317 CHARACTERISTICS

VERTICAL RESPONSE

Passband—dc to 10 mc.
Risetime—0.035 μ sec.
Sensitivity—0.1 v div to 125 v div, dc-coupled and ac-coupled—
0.01 v div to 0.1 v div, ac-coupled only. Twelve calibrated sensitivity steps.

SWEEP RANGE

0.2 μ sec div to 6 sec div. 22 calibrated steps from 0.2 μ sec div to 2 sec div.
5-x magnifier increases calibrated sweep rate to 0.04 μ sec div.

TRIGGERING

Preset or manual stability control with amplitude-level selection, and fully-automatic triggering.

ACCELERATING POTENTIAL

10-KV on new Tektronix high-voltage 3-inch cathode-ray tube.

CALIBRATOR

Amplitude calibrator, 0.05 to 100 v in 11 steps, square-wave frequency about 1 kc.

OTHER FEATURES

Electronic power-supply regulation.
External input to horizontal amplifier.
Warning lights for uncalibrated sweep-rate and sensitivity settings.
Magnifier indicator light.
Size—8½" wide, 12" high, 19½" deep.
Weight—35 lbs.

Type 317 . . . \$800 (50 to 60 cycle supply).
Type 317 MOD101 . . . \$835 (50 to 800 cycle supply).
f.o.b. factory

Canadian Field Office

3 Finch Avenue, East
WILLOWDALE, ONTARIO
Phone: Toronto, BALDWIN 5-1138

Tektronix, Inc.

P. O. Box 831 • Portland 7, Oregon
Phone CYPRESS 2-2611 • TWX-PD 311 • Cable: TEKTRONIX

INDEX TO ADVERTISERS

Page number is on the right. Key number for use with READER SERVICE CARDS is on the left.

Key No.	Page No.
1. Adcola Products	75
2. Airtron Canada Ltd.	75
3. Amperite Co.	96
4. Amphenol Canada Ltd.	70
5. Andrew Antenna Corp. Ltd.	6
6. Automatic Electric Sales (Canada) Ltd.	53
7. Automatic Electric Sales (Canada) Ltd.	54-55
8. Automatic Electric Sales (Canada) Ltd.	56
9. Bach-Simpson Ltd.	79
10. Bell Telephone Co. of Canada, The	98
11. Bendix Aviation Corp.	97
12. Burton-Rogers Co.	75
13. Canadian Marconi Co.	3
14. Centralab Canada Ltd.	88
15. Daven Co., The	75
16. Daystrom Ltd. (Heath Division)	83
17. Daystrom Ltd. (Weston Instrument Div.)	99
18. Eitel-McCullough Inc.	9
19. Electronic Service Supply Co.	84
20. Elmwood Casino & Motor Hotel	71
21. Engelhard Industries of Canada Ltd.	94
22. Ericsson Telephone Sales of Canada Ltd.	86
23. General Radio Co.	102
24. General Transistor Corp.	72
25. Hackbusch Electronics Ltd.	93
26. Hammond Mfg. Co. Ltd.	77
27. Helipot Division of Beckman Instruments	95
28. HELLERMAN Canada Ltd.	97
29. Hewlett-Packard Co.	8
30. Instantaneous Recording Service	73
31. International Resistance Co. Ltd.	73
32. Longstaffe Co. Ltd., J. R.	71
33. Measurements Corp.	76
34. Muirhead & Co. Ltd.	82
35. Nichols Ltd., R. H.	71
36. Northern Electric Co. Ltd.	10
37. Northern Electric Co. Ltd.	89
38. Ohmite Mfg. Co.	2

(Continued overleaf)

APPLICATION FOR FREE SUBSCRIPTION

Please ADD my name to receive ELECTRONICS & COMMUNICATIONS.

Please CHANGE my address for mailings.

NOTE — Card must be completed in full to be valid.

My Name (Please Print)

Mail copies to my home, or business address as noted below.

Street

City Zone Prov.

If you have recently CHANGED your address for receiving copies of ELECTRONICS & COMMUNICATIONS please note former address here:

Company Nature of Business
(State, when applicable, whether electronic equipment or components are manufactured, sold, or used in manufacturing, etc.)

Signature Position
 10-58

PLEASE SEND FURTHER INFORMATION ON THE FOLLOWING NEW PRODUCT ITEMS AS NUMBERED BELOW — USE PRODUCT ITEM NUMBERS

- | | | | | | | | | | |
|-------------------------------|-------------------------------|-------------------------------|-------------------------------|-------------------------------|-------------------------------|-------------------------------|-------------------------------|-------------------------------|-------------------------------|
| <input type="checkbox"/> 2101 | <input type="checkbox"/> 2102 | <input type="checkbox"/> 2103 | <input type="checkbox"/> 2104 | <input type="checkbox"/> 2105 | <input type="checkbox"/> 2106 | <input type="checkbox"/> 2107 | <input type="checkbox"/> 2108 | <input type="checkbox"/> 2109 | <input type="checkbox"/> 2110 |
| <input type="checkbox"/> 2111 | <input type="checkbox"/> 2112 | <input type="checkbox"/> 2113 | <input type="checkbox"/> 2114 | <input type="checkbox"/> 2115 | <input type="checkbox"/> 2116 | <input type="checkbox"/> 2117 | <input type="checkbox"/> 2118 | <input type="checkbox"/> 2119 | <input type="checkbox"/> 2120 |
| <input type="checkbox"/> 2121 | <input type="checkbox"/> 2122 | <input type="checkbox"/> 2123 | <input type="checkbox"/> 2124 | <input type="checkbox"/> 2125 | <input type="checkbox"/> 2126 | <input type="checkbox"/> 2127 | <input type="checkbox"/> 2128 | <input type="checkbox"/> 2129 | <input type="checkbox"/> 2130 |
| <input type="checkbox"/> 2131 | <input type="checkbox"/> 2132 | <input type="checkbox"/> 2133 | <input type="checkbox"/> 2134 | <input type="checkbox"/> 2135 | | | | | |

PLEASE SEND FURTHER INFORMATION ON THE FOLLOWING ADVERTISEMENTS AS NUMBERED BELOW — USE KEY NUMBERS

- | | | | | | | | | | | | |
|-----------------------------|-----------------------------|-----------------------------|-----------------------------|-----------------------------|-----------------------------|-----------------------------|-----------------------------|-----------------------------|-----------------------------|-----------------------------|-----------------------------|
| <input type="checkbox"/> 1 | <input type="checkbox"/> 2 | <input type="checkbox"/> 3 | <input type="checkbox"/> 4 | <input type="checkbox"/> 5 | <input type="checkbox"/> 6 | <input type="checkbox"/> 7 | <input type="checkbox"/> 8 | <input type="checkbox"/> 9 | <input type="checkbox"/> 10 | <input type="checkbox"/> 11 | <input type="checkbox"/> 12 |
| <input type="checkbox"/> 13 | <input type="checkbox"/> 14 | <input type="checkbox"/> 15 | <input type="checkbox"/> 16 | <input type="checkbox"/> 17 | <input type="checkbox"/> 18 | <input type="checkbox"/> 19 | <input type="checkbox"/> 20 | <input type="checkbox"/> 21 | <input type="checkbox"/> 22 | <input type="checkbox"/> 23 | <input type="checkbox"/> 24 |
| <input type="checkbox"/> 25 | <input type="checkbox"/> 26 | <input type="checkbox"/> 27 | <input type="checkbox"/> 28 | <input type="checkbox"/> 29 | <input type="checkbox"/> 30 | <input type="checkbox"/> 31 | <input type="checkbox"/> 32 | <input type="checkbox"/> 33 | <input type="checkbox"/> 34 | <input type="checkbox"/> 35 | <input type="checkbox"/> 36 |
| <input type="checkbox"/> 37 | <input type="checkbox"/> 38 | <input type="checkbox"/> 39 | <input type="checkbox"/> 40 | <input type="checkbox"/> 41 | <input type="checkbox"/> 42 | <input type="checkbox"/> 43 | <input type="checkbox"/> 44 | <input type="checkbox"/> 45 | <input type="checkbox"/> 46 | <input type="checkbox"/> 47 | <input type="checkbox"/> 48 |
| <input type="checkbox"/> 49 | <input type="checkbox"/> 50 | <input type="checkbox"/> 51 | <input type="checkbox"/> 52 | <input type="checkbox"/> 53 | <input type="checkbox"/> 54 | <input type="checkbox"/> 55 | | | | | |

Name Position

Company Nature of Business

Street City Prov.
 10-58

PLEASE SEND FURTHER INFORMATION ON THE FOLLOWING NEW PRODUCT ITEMS AS NUMBERED BELOW — USE PRODUCT ITEM NUMBERS

- | | | | | | | | | | |
|-------------------------------|-------------------------------|-------------------------------|-------------------------------|-------------------------------|-------------------------------|-------------------------------|-------------------------------|-------------------------------|-------------------------------|
| <input type="checkbox"/> 2101 | <input type="checkbox"/> 2102 | <input type="checkbox"/> 2103 | <input type="checkbox"/> 2104 | <input type="checkbox"/> 2105 | <input type="checkbox"/> 2106 | <input type="checkbox"/> 2107 | <input type="checkbox"/> 2108 | <input type="checkbox"/> 2109 | <input type="checkbox"/> 2110 |
| <input type="checkbox"/> 2111 | <input type="checkbox"/> 2112 | <input type="checkbox"/> 2113 | <input type="checkbox"/> 2114 | <input type="checkbox"/> 2115 | <input type="checkbox"/> 2116 | <input type="checkbox"/> 2117 | <input type="checkbox"/> 2118 | <input type="checkbox"/> 2119 | <input type="checkbox"/> 2120 |
| <input type="checkbox"/> 2121 | <input type="checkbox"/> 2122 | <input type="checkbox"/> 2123 | <input type="checkbox"/> 2124 | <input type="checkbox"/> 2125 | <input type="checkbox"/> 2126 | <input type="checkbox"/> 2127 | <input type="checkbox"/> 2128 | <input type="checkbox"/> 2129 | <input type="checkbox"/> 2130 |
| <input type="checkbox"/> 2131 | <input type="checkbox"/> 2132 | <input type="checkbox"/> 2133 | <input type="checkbox"/> 2134 | <input type="checkbox"/> 2135 | | | | | |

PLEASE SEND FURTHER INFORMATION ON THE FOLLOWING ADVERTISEMENTS AS NUMBERED BELOW — USE KEY NUMBERS

- | | | | | | | | | | | | |
|-----------------------------|-----------------------------|-----------------------------|-----------------------------|-----------------------------|-----------------------------|-----------------------------|-----------------------------|-----------------------------|-----------------------------|-----------------------------|-----------------------------|
| <input type="checkbox"/> 1 | <input type="checkbox"/> 2 | <input type="checkbox"/> 3 | <input type="checkbox"/> 4 | <input type="checkbox"/> 5 | <input type="checkbox"/> 6 | <input type="checkbox"/> 7 | <input type="checkbox"/> 8 | <input type="checkbox"/> 9 | <input type="checkbox"/> 10 | <input type="checkbox"/> 11 | <input type="checkbox"/> 12 |
| <input type="checkbox"/> 13 | <input type="checkbox"/> 14 | <input type="checkbox"/> 15 | <input type="checkbox"/> 16 | <input type="checkbox"/> 17 | <input type="checkbox"/> 18 | <input type="checkbox"/> 19 | <input type="checkbox"/> 20 | <input type="checkbox"/> 21 | <input type="checkbox"/> 22 | <input type="checkbox"/> 23 | <input type="checkbox"/> 24 |
| <input type="checkbox"/> 25 | <input type="checkbox"/> 26 | <input type="checkbox"/> 27 | <input type="checkbox"/> 28 | <input type="checkbox"/> 29 | <input type="checkbox"/> 30 | <input type="checkbox"/> 31 | <input type="checkbox"/> 32 | <input type="checkbox"/> 33 | <input type="checkbox"/> 34 | <input type="checkbox"/> 35 | <input type="checkbox"/> 36 |
| <input type="checkbox"/> 37 | <input type="checkbox"/> 38 | <input type="checkbox"/> 39 | <input type="checkbox"/> 40 | <input type="checkbox"/> 41 | <input type="checkbox"/> 42 | <input type="checkbox"/> 43 | <input type="checkbox"/> 44 | <input type="checkbox"/> 45 | <input type="checkbox"/> 46 | <input type="checkbox"/> 47 | <input type="checkbox"/> 48 |
| <input type="checkbox"/> 49 | <input type="checkbox"/> 50 | <input type="checkbox"/> 51 | <input type="checkbox"/> 52 | <input type="checkbox"/> 53 | <input type="checkbox"/> 54 | <input type="checkbox"/> 55 | | | | | |

Name Position

Company Nature of Business

Street City Prov.
 10-58

BUSINESS REPLY CARD
No Postage Stamp Necessary if Mailed in Canada

5c POSTAGE WILL BE PAID BY

ELECTRONICS AND COMMUNICATIONS

450 Alliance Avenue

Toronto 9, Ontario



BUSINESS REPLY CARD
No Postage Stamp Necessary if Mailed in Canada

5c POSTAGE WILL BE PAID BY

ELECTRONICS AND COMMUNICATIONS

450 Alliance Avenue

Toronto 9, Ontario



BUSINESS REPLY CARD
No Postage Stamp Necessary if Mailed in Canada

5c POSTAGE WILL BE PAID BY

ELECTRONICS AND COMMUNICATIONS

450 Alliance Avenue

Toronto 9, Ontario



INDEX TO ADVERTISERS
(Continued)

Key No.	Page No.
39. Phillips Electrical Co. Ltd.	13
40. Polypenco Inc.	73
41. Porter Co. (Canada) Ltd., H. K.	81
42. Prodelin Inc.	78
43. Pylon Electronic Development Ltd.	77
44. R. & M. Bearings Canada Ltd.	74
45. Racal Engineering Ltd.	87
46. Radio College of Canada	69
47. Rogers Electronic Tubes & Components (A Division of Philips Electronics Industries Ltd.)	85
48. Sperry Gyroscope Co. of Canada Ltd.	23
49. Syntron (Canada) Ltd.	80
50. Tech Laboratories Inc.	76
51. Tektronix Inc.	90
52. Terminal Radio International Ltd.	73
53. Triplett Electrical Instrument Co.	7
54. Varian Associates of Canada Ltd.	4
55. Ward Leonard of Canada Ltd.	101

ACTIVE CIRCULATION

It costs us a lot of active dollars annually to keep our circulation lists up-to-date and it's important enough to us that we have them audited every year by CCAB (Canadian Circulations Audit Board Inc.)

Advertisers trust CCAB audited figures so we get more advertisers and YOU get the high standard of editorial you have always wanted to read.

ELECTRONICS and COMMUNICATIONS

is a



audited publication

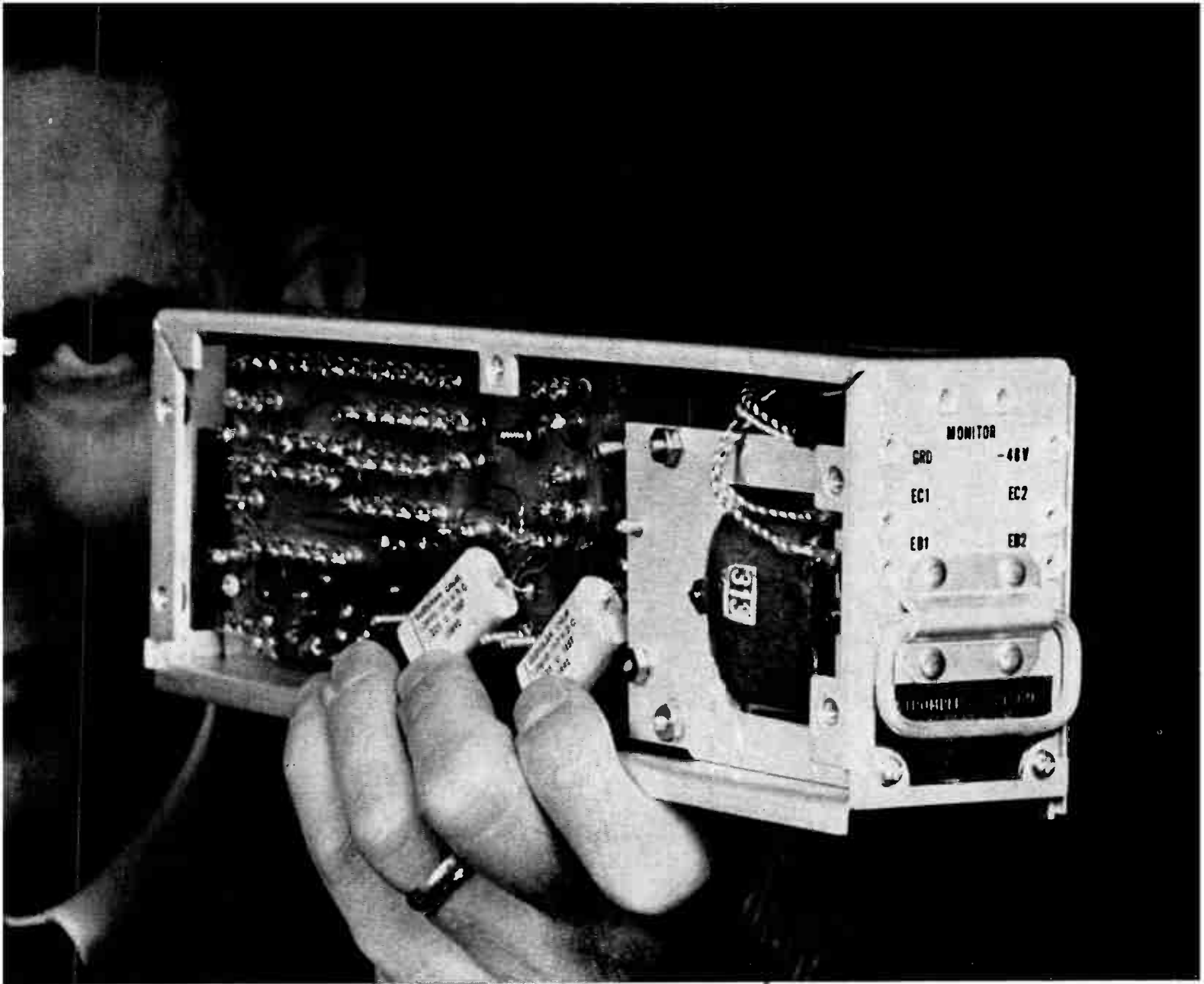

● 100% TRANSISTORIZED...You get years of service without replacement with Stromberg-Carlson's completely transistorized "541" negative impedance voice repeaters. You save space, too: a 19-inch shelf holds 8 repeaters, using only 3½ inches of vertical rack space. Power drain is the lowest - - less than 1 watt per repeater from existing 48-volt battery. Cable loading can be reduced; you use smaller gauge cable to meet today's transmission standards. "541" repeaters come in series and shunt types. Ask for full details.

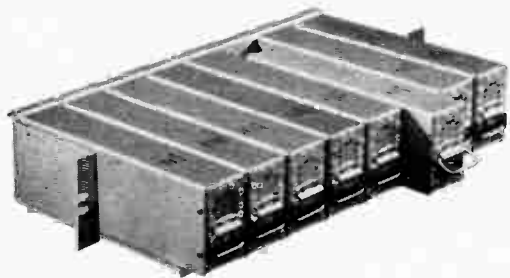

STROMBERG-CARLSON A DIVISION OF GENERAL DYNAMICS CORPORATION

Exclusive Agents HACKBUSCH ELECTRONICS LTD., 23 PRIMROSE AVENUE, TORONTO 4, ONTARIO

ELECTRONIC AND COMMUNICATION PRODUCTS FOR HOME, INDUSTRY AND DEFENSE



THERMOMETAL®
 for use in electrical appliances, thermal cutouts, heating controls... in any application involving the indication and accurate control of temperatures, electrical currents, voltages, etc. Supplied in strip form, rolled and slit to close tolerances and tempered to meet specifications. Also supplied as elements and sub-assemblies, with or without contacts attached, fabricated in accordance with specifications.

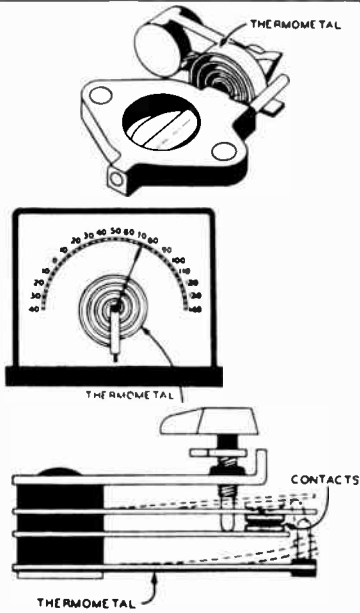

FINE WIRE . . .
 of ductile and non-ductile materials for every application requirement. BAKER research has developed processes for bare drawing wire as fine as .0004". Where smaller fine wire is required, the Wollaston process, for ductile metals, and the Taylor and Extrusion methods, for non-ductile materials, are employed.

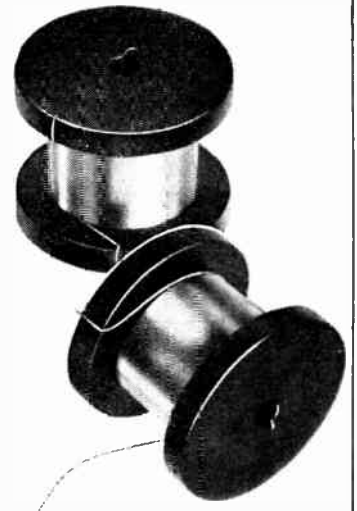

- ▶ for controlling temperature...
- ▶ for fine wire...
- ▶ for precious metal contacts...
- ▶ for corrosion-resistant surfaces...

PRECIOUS METAL CONTACTS
 for long operating life and unvarying performance. Available in pure or alloyed forms of Silver, Platinum, Palladium, and Gold. These contacts provide extremely high resistance to atmospheric corrosion, deformation, arc erosion, sticking and metal transfer. They are supplied as wire, rod, sheet, and as fabricated forms.



RHODIUM PLATING . . .
 an economical, hard, white, corrosion-resistant surface. Extremely well-suited for many electrical and electronic applications. Resistant to corrosive atmospheres, oxidation, arc erosion. Reduces wear on moving surfaces, assures low noise level for moving contacts, no oxide rectification, low and stable contact resistance. Ideal when a low-resistance, long wearing, oxide-free contact is required.

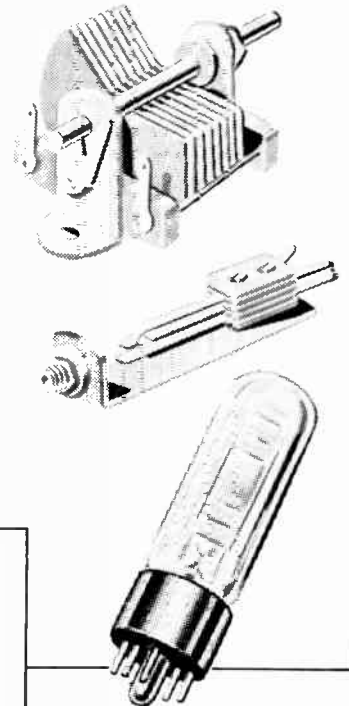

ENGELHARD INDUSTRIES
 OF CANADA, LTD.

512 KING STREET, EAST • TORONTO, ONTARIO, CANADA



SALES OFFICE: ENGELHARD INDUSTRIES (QUEBEC), LIMITED

1255 UNIVERSITY STREET, MONTREAL, P.Q., CANADA

Book Review

Theory of Electrical Machines by W. S. Wood, B.Sc., A.M.I.E.E., Lecturer in Electrical Machinery, Royal College of Science and Technology, Glasgow, Scotland.

This book provides a complete text in electrical machines suitable for final-year electrical engineering students. It treats the subject in a general fashion without departing from the conventional methods of analysis employing equivalent circuits and vector diagrams. Though little attention has been paid to constructional detail and to pure design problems, an appendix on the fundamentals of design has been included, as such fundamentals have a contribution to make towards the understanding of electrical machines. M.K.S. units have been used.

Theory Of Electrical Machines is published by Butterworth & Co. (Canada) Ltd., 1367 Danforth Avenue, Toronto 6, Ontario, contains 317 pages, hard cover bound, price \$10.00.

An Introduction To Automatic Computers by Ned Chapin, Systems Analyst, Stanford Research Institute.

For the business man, accountant, or systems engineer who wants a quick, sure understanding of the profitable use of an automatic computer, this clearly written guide by a noted authority will give the reader all the basic facts he needs.

It answers such perplexing questions as: What is an automatic computer? What can it do? How does it function? How is it programmed and operated? How are computer applications prepared? How are they evaluated? How can the need for a computer be pinpointed? How can its use be justified?

To know whether an automatic computer can be profitably used in one's business, the computer's functions, uses and limitations must be thoroughly understood. This book is intended to convey just such knowledge and to point out how to obtain profitable use of an automatic computer in business situations. Included are comparative data on available models, including costs, definitions of special terms as they are introduced, discussion of major analysis techniques, examples, and many helpful illustrations.

An Introduction To Automatic Computers is published by D. Van Nostrand Company (Canada) Limited, 25 Hollinger Road, Toronto 16, Ontario, contains 525 pages, hard cover bound, price \$7.50.

Electric Machinery—A Coordinated Presentation of A-C and D-C Machines by Clifford C. Carr, E.E., Chairman of Curriculum and Head of Department of Electrical Engineering, Pratt Institute, Brooklyn, N.Y.

Written by an author who has been teaching electric machines as an integrated subject for many years, this book provides a coordinated one-volume presentation of electric machinery. It includes transformers as well as both direct—and alternating—current machines.

The approach employed is, first, to establish clearly in the reader's mind the purpose of the machine which is the conversion of energy. This is followed by an analysis of the feasible application of basic electric phenomena to fulfill the desired energy conversion. From this is developed the types of machine construction most commonly employed.

The book then covers the topics common to all electric machines, such as types of windings, voltage relations, magnetic-field relations, energy losses, energy flow, efficiency, ratings, and basic torque relations. The remainder of the book deals with the application of these basic principles and relations to the detailed analysis of the performance of the different types of machines.

Electric Machinery is published by John Wiley & Sons, Inc., 440 Fourth Avenue, New York 16, N.Y., contains 537 pages, hard cover bound, price \$9.25.

These seven dwarfs do the work of 10's



Are you grumpy trying to design subminiature systems with oversize components? Here's what the doc ordered—a full line of BECKMAN size 8 servomotors. Look at this storybook performance:

... torque and acceleration measure up to or surpass the best size 10's!

... seven models, three for operation at 115 volts, four at 26 volts!

... continuous operation at stall, both windings fully excited, to ambients of 130°C; total unit temperature to 200°C!

... stainless steel case, shaft and bearings; windings encapsulated for environmental protection—shock to 100G's, 30G's vibration to 2,000 cycles, exceeding MIL-E-5272A specs!

The secret? A new design, new laminations—and craftsmanship, certainly nothing to sneeze at, these days. Delivery? Thirty days or less.

Don't be bashful. We'll be happy to send you all the dope in Data File E 103.

BECKMAN SIZE 8
2-PHASE AC SERVO MOTORS
(no-load speed 6,000 rpm)

	Weight oz.	Length in.	Rotor Inertia gm. cm. ²	Acceleration at Stall rad./sec ²
26-volt models (torque at stall .25 oz. in., power input 2.3 watts)				
8 SM 420 servomotor	1.1	.840	.1	170,000
8 MG 420/410 servomotor-rate generator	1.9	1.350	.16	110,000
8 VM 420 velocity-damped servomotor	1.9	1.395	.24	73,000
8 IM 420 inertia-damped servomotor	2.0	1.355	.24	73,500
115-volt models (torque at stall .33 oz. in., power input 2.9 watts)				
8 SM 460 servomotor	1.6	1.165	.2	115,000
8 VM 460 velocity-damped servomotor	2.4	1.720	.34	68,000
8 IM 460 inertia-damped servomotor	2.5	1.680	.34	68,500

Helipot Division of
Beckman Instruments, Inc.
No. 3 Six Points Road
Toronto 18, Ontario
Sales Representative:
R-O-R Associates, Ltd.
1470 Don Mills Road
Don Mills, Ontario

Beckman® Helipot®

potentiometers . . . dials . . . delay lines . . . expanded scale
meters . . . rotating components . . . breadboard parts

AMPERITE PREFERRED

by design engineers—because they're
MOST COMPACT • SIMPLEST • MOST ECONOMICAL
HERMETICALLY SEALED



Thermostatic DELAY RELAYS

2 to 180 Seconds

Activated by a heater, they operate on A.C., D.C., or Pulsating Current.

Hermetically sealed. Not affected by altitude, moisture, or climate changes.

SPST only—normally open or closed.

Compensated for ambient temperature changes from -55° to $+70^{\circ}$ C. Heaters consume approximately 2 W. and may be operated continuously. The units are rugged, explosion-proof, long-lived, and—inexpensive!

TYPES: Standard Radio Octal, and 9-Pin Miniature . . . List Price, \$4.00.
 Standard Delays

Also—Amperite Differential Relays: Used for automatic overload, under-voltage or under-current protection.

PROBLEM? Send for Bulletin No. TR-81

BALLAST REGULATORS

Amperite Regulators are designed to keep the current in a circuit automatically regulated at a definite value (for example, 0.5 amp.) . . . For currents of 60 ma. to 5 amps. Operate on A.C., D.C., or Pulsating Current.

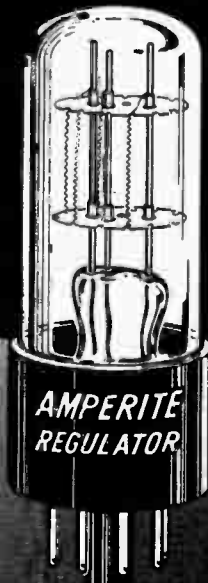
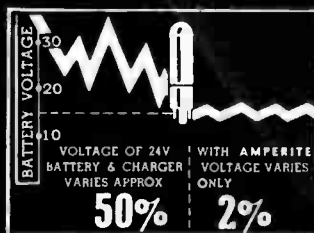

Hermetically sealed, they are not affected by changes in altitude, ambient temperature (-55° to $+90^{\circ}$ C.), or humidity. . . Rugged, light, compact, most inexpensive . . . List Price, \$3 00.

Write for 4-page Technical Bulletin No. AB-51



AMPERITE CO. Inc., 561 Broadway, New York 12, N. Y.

Telephone: CAnal 6-1446

In Canada: Atlas Radio Corp., Ltd., 50 Wingoind Ave., Toronto 10

Book Review

Elementary Statistical Physics by C. Kittel, Professor of Physics, University of California, Berkeley, California.

This book is a fundamental and modern treatment of statistical mechanics, including stochastic processes and transport theory. Throughout the presentation, the Gibbs method of ensembles is used, with detailed discussions of its applications.

In its coverage of a wide range of important applications of statistical physics, the work considers kinetic methods, the principles of detailed balance, the Boltzmann transport equation, thermal noise, and the thermodynamics of irreversible processes and fluctuations. Mention is also made of negative temperature, magnetic energy, density matrix methods, and the Kramers-Kronig causality relations.

Problems and examples are given which are applicable to many scientific fields—nuclear physics, electrical engineering, solid state physics, metallurgy, and chemistry—and are presented in a simple, clear, and understandable manner.

Elementary Statistical Physics is published by John Wiley & Sons, Inc., 440 Fourth Avenue, New York 16, N.Y., contains 228 pages, hard cover bound, price \$8.00.

Magnetic Recording Techniques by W. Earl Stewart, Chief Product Engineer, The Standard Register Company.

Here is a practical guide to the technology of magnetic recording methods and devices, for engineers and technicians concerned with their use in audio, video, communications, automation, computer, and other fields. Principles of the recording and reproducing processes; recording materials, including the theory of ferromagnetism; recording mechanisms; and established standards are all discussed at a realistic engineering level. The reader will find an orderly, easy-to-understand development of design techniques for the various elements of magnetic recording systems. Included are definitions, tables, derivations of important formulas, and practical test circuits.

This treatment emphasizes the fundamentals needed to attain good performance in many new and opening fields of application. The author discusses the recording and reproducing functions separately to simplify the reader's understanding of the effect each has on the recording media and on the overall performance. Many recent developments are covered, including new formulas for magnetic oxide coatings. There are also sections on some of the lesser-known types of recording, such as boundary recording (computer memory work), the Factrol system (automation), flux-sensitive heads (special applications), transistor circuits, and TV recording.

Magnetic Recording Techniques is published by McGraw-Hill Company of Canada Limited, 253 Spadina Road, Toronto 4, Ontario, contains 272 pages, hard cover bound, price \$9.80.

Principles And Applications Of Random Noise Theory by Julius S. Bendat, Ph.D., Member of the Senior Staff, The Ramo-Wooldridge Corporation, Los Angeles, California, and Lecturer in Mathematics, University of Southern California.

The presentation includes discussions on probability theory, random noise analysis, random processes, engineering systems, correlation functions, power spectral density functions, and optimum filters. A great deal of the material relative to power spectra, optimum prediction and filter theory, analog computer techniques, detailed statistical error analysis for correlation measurements, advanced optimum time-variable designs, and the zero-crossing problem appears for the first time in book form.

Principles And Applications Of Random Noise Theory is published by John Wiley & Sons, Inc., 440 Fourth Avenue, New York 16, New York., contains 431 pages, hard cover bound, price \$11.00.

Now! FAST, ACCURATE

CABLE STRAPPING

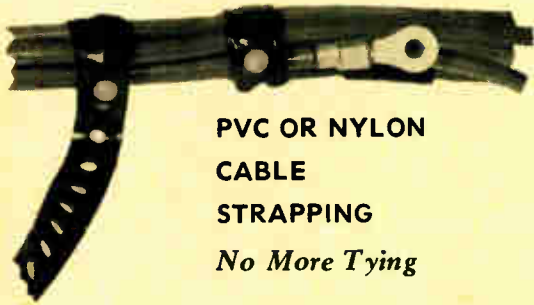

PVC OR NYLON
CABLE
STRAPPING
No More Tying

CABLE MARKING

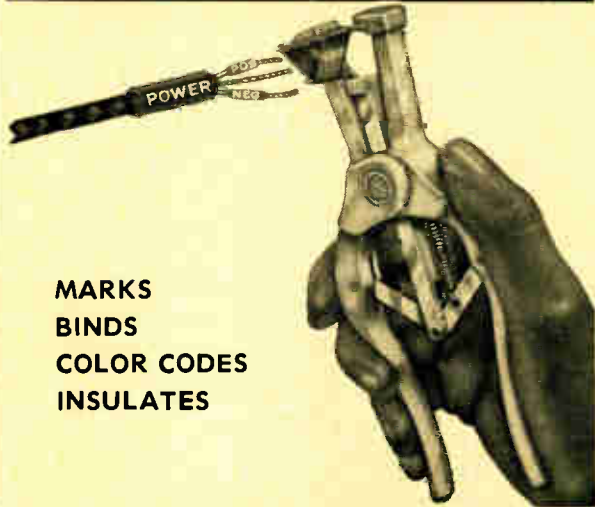

MARKS
BINDS
COLOR CODES
INSULATES

SEND FOR
FREE SAMPLE AND CATALOGUES

Name Position

Company

Address

City Prov.

HELLERMANN CANADA LTD.
44 DANFORTH RD. TORONTO OX. 1-1131

PYGMY

**MINIATURE
ELECTRICAL CONNECTORS**

Accommodate 3 times as many circuits
as comparable AN arrangements

- 5-Key Polarization on PT Series
- AN Mounting Dimensions
- Lightweight, Compact
- Forged or Bar Stock Shells
- Resilient Inserts
- Closed Entry Sockets
- Moisture resistant
- Vibration resistant
- Heavily Gold-plated Contacts
- Quick Disconnect, Either Series

*TRADEMARK

Bendix SCINTILLA DIVISION of **Bendix**
SIDNEY, N. Y. AVIATION CORPORATION

Export Sales and Service: Bendix International Division, 205 East 42nd St., New York 17, N. Y.
Canadian Affiliate: Aviation Electric, Ltd., 200 Laurentien Blvd., Montreal 9, Quebec

PC SERIES Double Stub Thread



PT SERIES 3-Point Cam Lock



FOUR WIRE TERMINATIONS

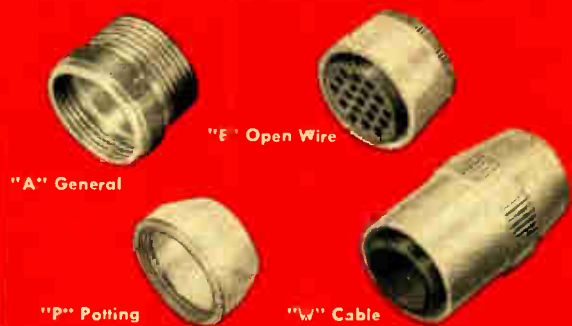



*"This message from my boss
will be at our branch office
in a matter of seconds...with
BELL TELETYPE"*

Reproduces, even at distant points,
carbon copies of orders, reports, etc.

Doubly Useful

Does your business require written communication between two points on your own premises—or to many points in distant cities? In either case, BELL TELETYPE can be tailored to meet your needs... save you money.

An "Automation" Service

In distributing data by BELL TELETYPE, the whole operation is 90% automatic. You can carry on two-way communication between factories, branches, warehouses. All orders, reports, etc. go down in writing... in

single or multi-copy... at both sending and receiving ends; they can be quickly checked, filed for future reference.

No Upkeep Cost

With BELL TELETYPE you have no equipment to buy, thereby conserving capital. You also gain the extra dependability of Bell operation and maintenance.

Enquire NOW

With more and more automation in business record keeping and integrated data processing, BELL TELETYPE is worthy of your immediate interest.

Call collect: Toronto-EM 8-3911 Ext. 2151, Montreal-UN 6-3911 Ext. 2981

THE BELL TELEPHONE COMPANY OF CANADA



TECHNICAL PERSONNEL AVAILABLE

Technical Personnel Available classified ads are offered as a service by Electronics and Communications to those seeking employment in the electronics and communications or allied industries. You are invited to send particulars of your qualifications to the editor.

MANAGEMENT - SALES ENGINEER, 30-50 years. Preferably university graduate in electrical engineering, with broad background and experience in sales engineering and management in the Canadian electrical industry. Starting salary \$7,000 and up, leading to eventual company shares. Box 5001, Electronics and Communications.

SALES MANAGER WANTED, age 30 and up. Salary and commission. Well established component manufacturers of electrical and electronic equipment requires manager with sales ability. A self-starter needed to further develop sales in Ontario and Quebec. Must be capable of promoting general enquiries into sales. Box 5002, Electronics and Communications.

ELECTRONIC TECHNICIAN: 30 years old, 13 years in electronics, experience in communications and radar, service and commercial. Presently and past five years in mobile communications with some audio and broadcast work. Experienced in installation and maintenance of large systems. Desire technical position with responsibility and opportunity of advancement on merit. Complete resume on request. Box 5003, Electronics and Communications.

WANTED: Sales Engineer with Communications Systems Engineering background for position in antenna and transmission line field. Salary open.

Andrew Antenna Corporation Limited
606 Beech Street,
Whitby, Ontario.

LOOK FOR
ELECTRONICS AND
COMMUNICATIONS
1959 ANNUAL
DIRECTORY AND
BUYERS' GUIDE
PUBLISHED
DECEMBER 1958



**TV ALIGNMENT
GENERATOR KIT
HEATHKIT TS-4A**
for fast, reliable TV alignment

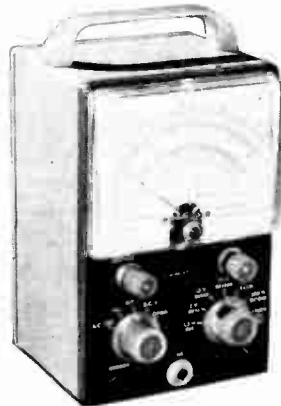

**ETCHED CIRCUIT VTVM KIT
HEATHKIT V-7A**
world's largest selling VTVM kit



**RF SIGNAL GENERATOR KIT
HEATHKIT SG-8**
a basic service instrument



**CONDENSER CHECKER KIT
HEATHKIT C-3**
complete condenser
testing facilities

*Choose
from more
than 100
HEATHKIT
models
— write
for your
free
catalogue!*

A COMPLETE ELECTRONIC LABORATORY

**...at less cost than
you'd think possible!**

Now you can equip your experimental laboratory or service shop with up-to-date, accurate test instruments — at a fraction of the cost you'd expect to pay!

Famous HEATHKIT test equipment meets the highest standards of quality and reliability. And HEATHKITS are low-priced — you save by assembling and wiring yourself.

Get ready to handle bigger jobs — with HEATHKIT test instruments!

**5" OSCILLOSCOPE KIT
HEATHKIT O-12**

laboratory
quality at
utility scope
price



Distributors of
Heathkits in Canada

**DAYSTROM
LIMITED**

2 Raitherm Road

— Toronto 19, Ont.

Costly but not obsolescent

The cancellation of the Arrow Weapon System is now 'old hat' but its impact on the Canadian electronics industry will be sorely felt for some time to come. To be philosophical in a business sense about this matter, one may rationalize and claim with a reasonable degree of soundness that the Arrow Weapon System was not the 'be all and end all' of the Canadian electronics industry, but there is a deeper significance to the cancellation of this contract than can be measured with dollars and cents. More significant than the dollars and cents that are involved in the cancellation of this project is the disruption that will take place in the engineering and scientific complex that has been built up or that was in progress of being built up to handle this project but which now stands in jeopardy of being scattered to the four winds. This is not the first time this tragedy has befallen the Canadian electronics industry in the past few years and one wonders, with justification, how many more flops of a similar nature the industry can afford to absorb on behalf of the government.

This aspect of the situation is aptly treated in a letter to the Prime Minister which was made public on the occasion of the annual golf tournament and dinner of the Electronic Industries Association of Canada held recently in Toronto. The letter signed by R. M. Robinson, president of the Association, reads as follows:

Rt. Hon. J. G. Diefenbaker,
Prime Minister of Canada.
Ottawa

Sir:

In view of the pending Government decision regarding the future of the Arrow Weapon System, we urgently request your consideration of the following significant implications which this important program has for the Canadian Electronics Industry.

Our industry, which consists of over 100 manufacturers of electronic equipment and components, employs 25,000 Canadians in engineering and production and supports an additional 25,000 in distribution, maintenance and service. Employment in this industry is down approximately 20 per cent over 1957 and indications are for continued reduction in this area.

The Electronics Industry, while attempting to reverse this trend through the normal growth of consumer and industrial markets requires in addition continued participation in major defense programs. These enable us to keep abreast of rapidly advancing technological progress and to retain the scientific and engineering personnel and facilities on which the industry depends for development of new products for domestic and foreign markets.

Military systems for ground, sea, or air defense, are becoming predominantly electronic and increasingly complex in nature. To meet this challenge and to fulfill these future defense system requirements, Canada's electronics industry must be strong, competent and self-sufficient. Scientific and engineering capabilities necessary to plan, develop and produce or even to operate and maintain these

complex equipments, must be supported and continually utilized if this industry is to be prepared to play its vital role in any national emergency.

The Arrow Weapon System Program can provide in the immediate future the necessary Canadian defense electronic capability and continued employment of essential Canadian scientific and engineering personnel.

This program has been planned by the Government to retain a major share of the dollar expenditures in Canada, and to spread widely within Canadian industry the knowledge and experience not previously available in this country. Highly skilled teams of engineers and management personnel have already been assembled in many Canadian companies and the planned transition from a predominantly United States Program to a comprehensive Canadian Program is well under way.

It is our considered opinion therefore that the Arrow Weapon System Program is vital to the future of the whole Electronics Industry and in particular to its ability to satisfy future defense needs. It will provide increasing employment, a new competence and self-sufficiency in the handling of major Defense Electronic Systems, and provides the challenge and opportunity for large numbers of Canadian engineers and scientists who might otherwise be irretrievably lost to the Industry and to the Country. Our industry is prepared to demonstrate its growing capability and to provide equipment and services of the required quality and performance, and at a cost which will result in a minimum of net public expenditure.

Our Government Liaison Committee will welcome any opportunity for more detailed discussion of this important subject.

Respectfully,
(Signed) R. M. Robinson
President

It will be observed from the tense of the foregoing communication that it was written prior to what we now look upon as the final government decision regarding the Avro Arrow and its weapon system.

Although the government has promised to review the carrying through of the Avro Arrow program as of next March, it is pretty well taken for granted that this promise is but part of the well known government routine of administering slow death rather than killing outright. In other words, it is a six or seven month reprieve granted by the government on behalf of its own defense just in case someone should turn up with the ability to prove to our defense authorities that the day of the manned interceptor is not now and will not be for many years to come obsolescent. Costly, yes, but not obsolescent. Until such times as we are able to construct a guided missile with the inherent ability and intelligence to discriminate between friend and foe and return itself to its launching pad without the necessity of having to blow its costly "inards" to bits then so long will it be necessary for us to have manned interceptors both from a strategic and an economic point of view.

NEW

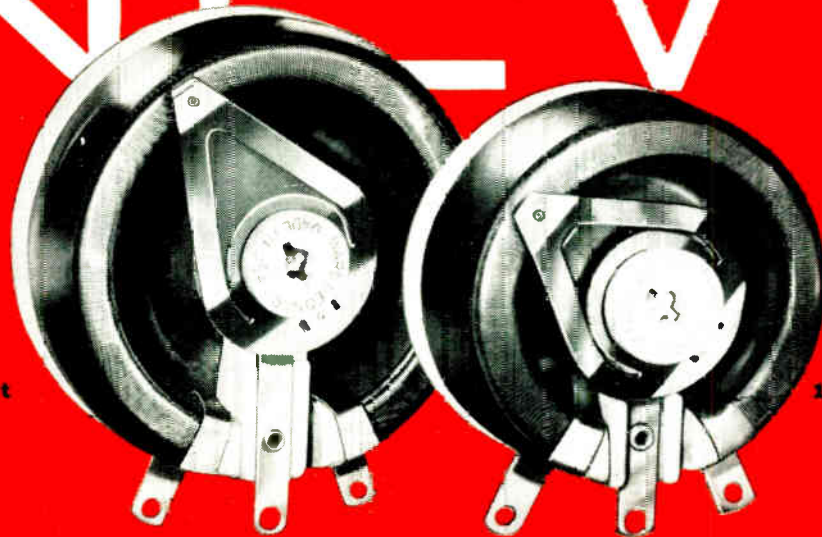

SMOOTH-PERFORMING RING RHEOSTATS

New 100- and 150-watt sizes incorporate latest design improvements

ENGINEERING DATA

Type	Rating*	Ring Diameter	Max. Depth behind panel	Resistance Range (Stock Values)	Rotational Travel
100R	100 Watts	3 5/32"	1 1/2"	1 to 10,000 ohms	300°
150R	150 Watts	4"	1 3/4"	1 to 10,000 ohms	314°

*—Ratings based on a 300°C rise in a 40°C ambient.

Contact Shoe: "Twin" metal graphite, equipped with integral copper leaf conductor ribbon riveted to the control arm.

Contact Arm: Balanced beryllium copper, locked directly to insulating hub.

Base and Core: High-grade ceramic of high dielectric strength with toroidally wound resistance wire or ribbon of highest stability.

Max. Voltage Spacings: 300 volts in accordance with Underwriters' Laboratories requirements.

Naturally, these new 100- and 150-watt ring rheostats give you the same outstanding, proved design features you get in 25-, 50-, and 300-watt sizes. Exclusive "twin-contact" shoes insure uniform contact resistance, extra-smooth resistance change. Two sintered, self-lubricating contacts—one on the collector ring and one on the resistance winding—can't gall or seize like metal-to-metal contacts. They insure long, stable operating life under rated loads.

Ward Leonard Vitrohm vitreous enamel permanently bonds base and core, firmly secures the high-stability resistance wire. Base and core are of high-density, low-porosity molded ceramic of high dielectric strength.

A new ceramic hub design substantially eliminates backlash. It also makes for fast delivery on special shaft requirements.

Write for Ward Leonard Bulletin 60RR. It gives complete specifications on 25-, 50-, 100-, 150-, and 300-watt ring rheostats. Ward Leonard of Canada Limited, 1070 Birchmount Road, Toronto 16.

5823

LIVE BETTER...Electrically



**WARD LEONARD
OF CANADA LIMITED**

1070 BIRCHMOUNT ROAD TORONTO 16



CANADIAN FACTORY AND HEAD OFFICE

Resistors • Rheostats • Relays • Motor Controls • Dimmers • Switchboards • SAFT Batteries • Bo-kelew Switches • Kenco Pumps

THIS REGULATOR HUNTS OUT LINE-VOLTAGE PROBLEMS



The HUNTER...

... a General Radio Type 1570-A Automatic Line-Voltage Regulator ... consists of a ball-bearing Variac, "buck-or-boost" step-down transformer to multiply Variac power rating, and a proportional-control servomechanism to automatically position the Variac.

The application of proportional control servomechanisms to voltage-regulator design offers many operating advantages. These include full accuracy of $\pm 0.25\%$ at any load power factor and considerably less weight and cost per KVA than other types. Overall system efficiency is 98%.

G-R TYPE 1570-A AUTOMATIC LINE-VOLTAGE REGULATOR

- 115v, 60-cycle models for bench, rack, or wall mounting ... \$490; 230v models ... \$510
- 3 units may be used to regulate legs of a 3-phase circuit
- 50-cycle models also available

Militarized Model, 50 and 60 cycles Type 1570-AS15, \$670

... meets MIL-E-4158A requirements. Control circuit is on one panel; Variac, buck-boost transformer and servo-motor are on another.

Write for Specifications.

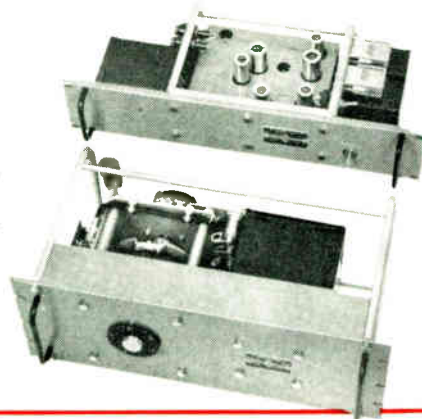

Write for the G-R Automatic Regulator Bulletin
For Further Information

GENERAL RADIO Company

Cambridge, Massachusetts, U.S.A.

Canadian Office: 99 Floral Parkway, Toronto 15, Ontario

Arthur Kingsnorth

Richard J. Provan

Repair Service:
Bayly Engineering, Ltd.,
Ajax, Ontario

Telephone: CHerry 4-6221



WE SELL DIRECT. Our District Sales Offices are staffed by engineers especially trained to help you in the selection of instruments and measuring systems best suited to your needs. We welcome your inquiries — will help solve your problems.

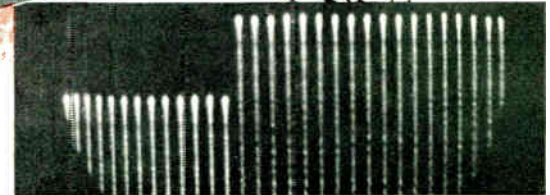

The HUNTED ... any change from constant output voltage, such as the 2% change in 60-cycle voltage shown above. The Automatic Voltage Regulator will maintain output constant within $\pm 0.25\%$ for input variations up to $\pm 10\%$, with 6 KVA power capacity. The same model can also be easily connected to handle $\pm 20\%$ input variations at loads to 3 KVA (accuracy $\pm 0.5\%$). Short period overload rating is up to ten times steady-state rating.

A special model, the Type 1570-ALS10, is available to correct $\pm 5\%$ voltage variations and is capable of handling loads to 12 KVA.

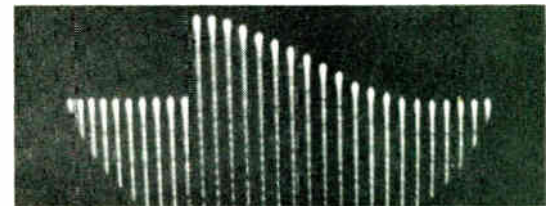

The CHASE ... begins immediately with a sensing of the line-voltage variation. An error voltage, proportional to the variation, is fed to the Regulator's two-stage balanced amplifier, then applied in push-pull to a thyatron circuit controlling a two-phase motor that drives the Variac. Correction takes place at the rate of 10 volts/second (in oscillogram above, 2% change is corrected in 12c or 0.2 sec).

This instrument is a true proportional control system, rather than an off-on device. Hence, correction is smooth — "dead zones" are absent. Overshoot is negligible.



and the KILL ... is accomplished quickly and neatly. No waveform distortion is introduced by the regulator, nor are there any power-factor restrictions. There are no relays to cause transient pulses or chattering.