

MR F W PREZIOSI  
8 EASTGATE CRESCENT  
TORONTO 16 ONT

EPM  
QEL  
FEM  
7220

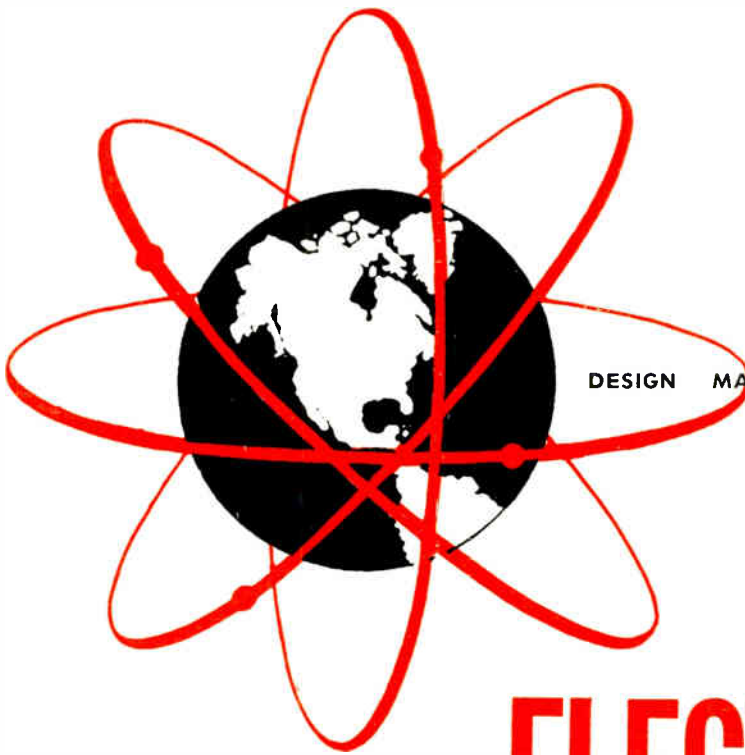

DESIGN MANUFACTURE ENGINEERING APPLICATION

# ELECTRONICS AND COMMUNICATIONS

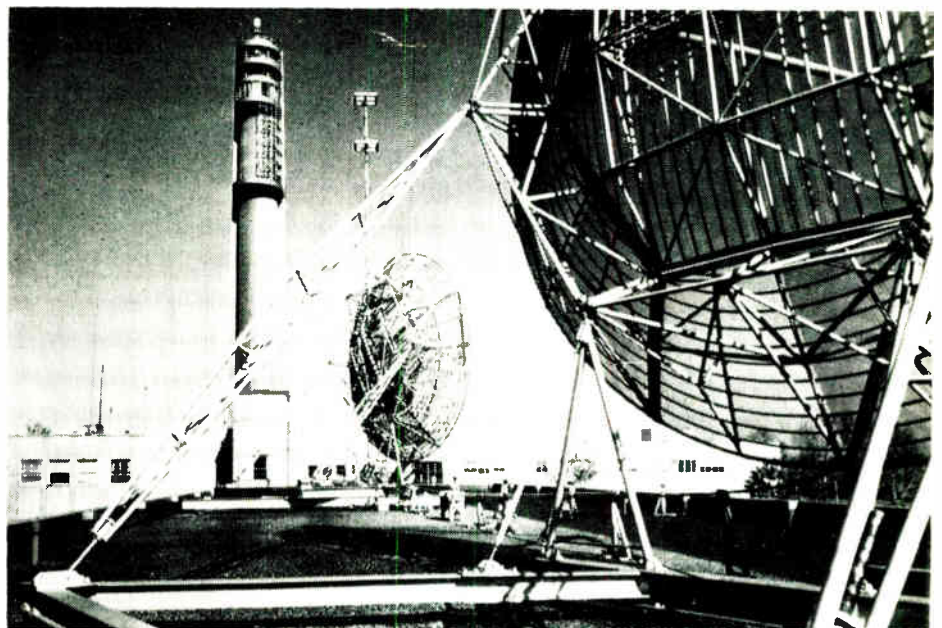

MARCH, 1957



An AGE Publication

Toronto, Canada

Experiments by IT & T scientists are yielding important new findings in the application of over-the-horizon techniques to multi-channel radio communication. Shown here atop building of Federal Telecommunication Laboratories, IT & T research center in Nutley, New Jersey, are parabolic antennas used for communication with Southampton, L.I., 91 miles distant.

Distribution Of This Issue Over 10,000 Copies

another . . .

*Airtron*

. . . first

# FERRITES\*

**compounded and fired specifically  
for microwave applications**

- ✓ Isolating
- ✓ Duplexing
- ✓ Circulating
- ✓ Rapid Scanning
- ✓ Rapid Switching
- ✓ Beam Switching
- ✓ Remote Attenuation
- ✓ Polarization Diversity
- ✓ Improved Recovery Time
- ✓ Single Side Band Generation

Complete research and production facilities enable Airtron to manufacture your ferrite devices fully tested, both electrically and mechanically, to meet your most rigid specifications. Write for special informative and illustrated brochure.

Recognizing the advantage of Ferrite components, Airtron has been engaged in a rigorous development program to bring these better devices to a practical stage of application.

Specifically produced to your requirements, new ferrite components by Airtron, make possible far better operation on both new and old radar systems. You are assured of optimum performance on all microwave bands. Because Airtron develops and produces its own ferrites you are certain of compactness, efficiency and reliability.

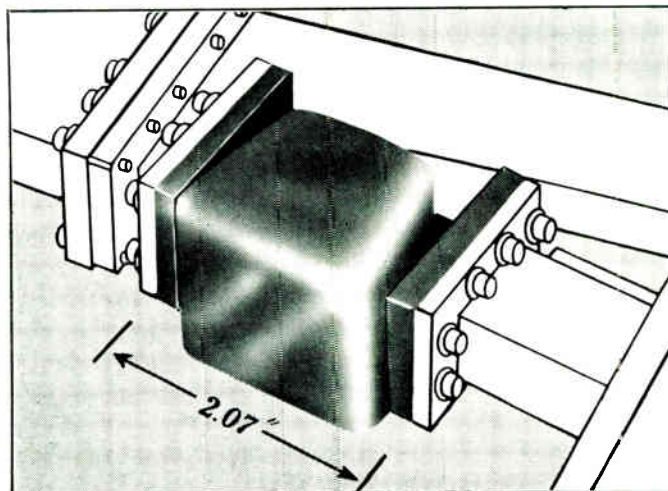

\*Ferrite components are waveguide assemblies incorporating Ferrite materials which have a non-reciprocal effect on microwaves.

MANUFACTURED IN  
CANADA BY

*Airtron*

**CANADA • LIMITED**

BRANCH  
OFFICES:

5890 Monkland Ave.,  
Montreal

492 Somerset St. W.,  
Ottawa

300 CAMPBELL AVE., TORONTO  
PLANT: RENFREW, ONT.

Radiovision Sales Ltd.,  
325 10th Ave., West, Calgary, Alta.

For further data on advertised products use page 73.

# DO YOU USE OR MANUFACTURE TV CAMERAS?



## TAKE A LOOK AT THESE PICK-UP TUBES

The most complete range of TV Pick-up tubes in the world are manufactured in Britain for Marconi by the English Electric Valve Company. The 4½" Image Orthicon has no equivalent. It stands unsurpassed for performance, the only tube of its kind in use. We would like to tell you more about its specific advantages. If you use or manufacture TV cameras, why not write for technical data on the complete line.

TYPE NO.	DESCRIPTION
P807	3" Image Orthicon
5820	3" Image Orthicon
P811	4½" Image Orthicon
6198	Vidicon for Industrial use
6326	Vidicon for film pick-up

ELECTRONIC TUBE AND COMPONENTS DIVISION

CANADIAN **Marconi** COMPANY

830 BAYVIEW AVENUE, TORONTO, ONTARIO

BRANCHES: Vancouver • Winnipeg • Montreal • Halifax • St. John's, Nfld.

Direct reading, wide range, outstanding value

# SIGNAL GENERATORS

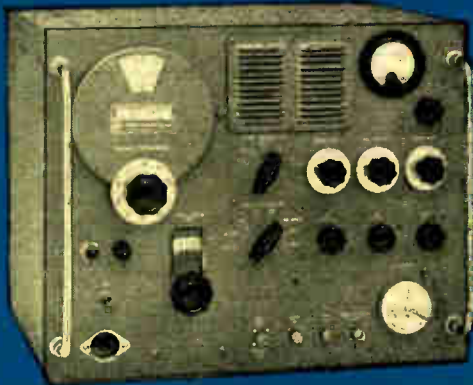

## NEW! -hp- 626A/628A shf Signal Generators

10 to 21 KMC, 10 mw output

SWR 1.2, high accuracy

No calibration charts

Pulse, FM, square wave modulation

### Typical -hp- signal generators



-hp- 608D vhf Signal Generator



-hp- 612A uhf Signal Generator



-hp- 624C X Bond Test Set

New -hp- 626A/628A are the first commercial signal generators to bring the wide range, high power, convenience and accuracy of lower-frequency signal generators to the 10 to 21 KMC range. -hp- 626A covers frequencies 10 to 15.5 KMC; -hp- 628A, 15 to 21 KMC.

Operation of the instruments is typical of -hp- generators. Frequencies are directly set and read on one dial. No calibration charts are required. Output voltage is directly set and read. Output is 10 to 20 db better than previous spot-frequency generators. SWR is better than 1.2 at 0 dbm and lower. Internal pulse, FM or square wave modulation is provided, together with facilities for external pulsing or FM'ing. -hp- 626A, \$3,250.00. -hp- 628A, \$3,000.00.

### OTHER -hp- SIGNAL GENERATORS

Instrument	Frequency Range	Characteristics	Price
-hp- 608C	10 to 480 MC	Output 0.1 $\mu$ v to 1 v into 50 ohm load. Pulse or CW modulation. Direct calib.	\$ 950.00
-hp- 608D	10 to 420 MC	Output 0.1 $\mu$ v to 0.5 v. Incidental FM less than 0.001% entire range.	1,050.00
-hp- 612A	450 to 1,200 MC	Output 0.1 $\mu$ v to 0.5 v into 50 ohm load. Pulse, CW or square wave modulation. Direct calibration.	1,200.00
-hp- 614A	800 to 2,100 MC	Output 0.1 $\mu$ v to 0.223 v into 50 ohm load. Pulse, CW or FM modulation. Direct calib.	1,950.00
-hp- 616A	1,800 to 4,000 MC	Output 0.1 $\mu$ v to 0.223 v into 50 ohm load. Pulse, CW or FM modulation. Direct calib.	1,950.00
-hp- 618B	3,800 to 7,600 MC	Output 0.1 $\mu$ v to 0.223 v into 50 ohm load. Pulse, CW, FM or square wave modulation. Direct calibration.	2,250.00
-hp- 620A	7,000 to 11,000 MC	Output 0.1 $\mu$ v to 0.223 v into 50 ohm load. Pulse, FM or square wave modulation.	2,250.00
-hp- 623B	5,925 to 7,725 MC	Output 70 $\mu$ v to 0.223 v into 50 ohm load. FM or square wave modulation. Separate power meter and wave meter section.	1,750.00
-hp- 624C	8,500 to 10,000 MC	Output 3.0 $\mu$ v to 0.223 v into 50 ohm load. Pulse, FM or square wave modulation. Separate power meter and wave meter section.	2,265.00 $\Delta$

Data Subject to change without notice. Prices f.o.b. factory.

### HEWLETT PACKARD COMPANY

3340G Page Mill Rd., Palo Alto, California, U.S.A.

Represented in Canada by:

ATLAS RADIO CORPORATION, LTD.

50 Wingold Ave.,  
Toronto 10, Ontario

505 McIntyre Bldg.,  
Winnipeg, Manitoba

$\Delta$ Rack mounted instrument available for \$15.00 less.



## COMPLETE COVERAGE, HIGHEST QUALITY

For further data on advertised products use page 73.

# COSSOR-SANDERS

## PRECISION MICROWAVE TEST EQUIPMENT

Designed expressly for precision measurements to the most exacting specifications. All 3-centimeter parts in stock and all standard couplings, bends and twists available.

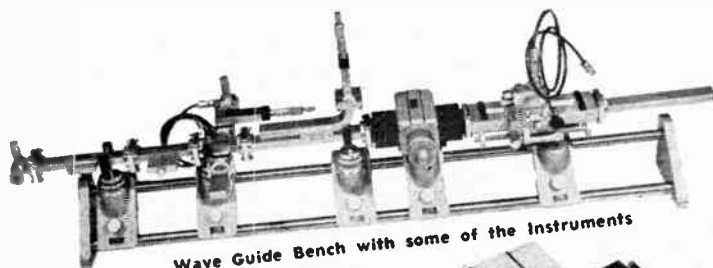

Wave Guide Bench with some of the Instruments

### 3-Centimeter Stock List

Directional Couplings 10 to 40 dB  
 Crystal Mixer Mount  
 Crystal Detector Mount  
 Coaxial Crystal Detector Mount  
 Wavemeter  
 Calibrated Attenuator  
 Matched Termination  
 Matched Load  
 Preset Attenuator  
 Variable Attenuator  
 High Sensitivity Coaxial Detector  
 Crystals  
 Wave Guide Support Bench and  
 Carriages  
 Adjustable Short Circuit  
 Standing Wave Meter  
 Klystron Mount Assemblies  
 Matched Terminations  
 Centimetric Noise Source Unit  
 Klystron Power Unit  
 Waveguide Adaptors



Wide Band Coaxial  
 Crystal Detector  
 (200 to 15000 Mc/s)

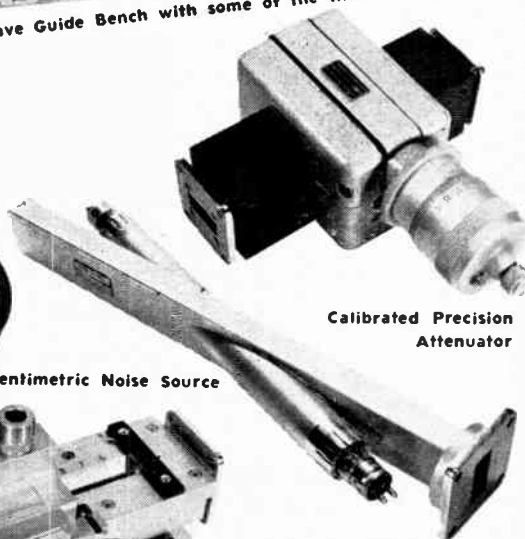

Calibrated Precision  
 Attenuator

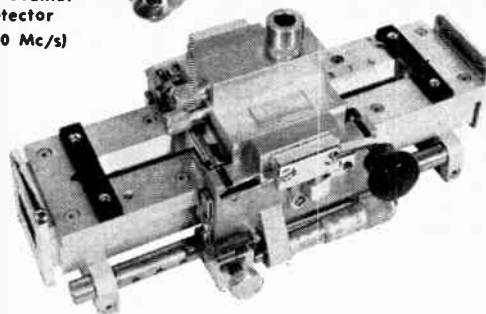

Precision Standing Wave Meter

Centimetric Noise Source



Illustrating method of packing

Multi - Purpose  
 Klystron  
 Power Supply

Equipment for other wave bands available at short notice.

Complete information and specifications from



## COSSOR (CANADA) LIMITED

301 Windsor St.

HALIFAX

Phone 4-6487

OTTAWA

MONTREAL

TORONTO

160 Laurier W.

8230 Mayrand St., Decarie Boulevard

648A Yonge St.

5-4306

RE 3-6502

WA. 4-1226

# ACTUAL SIZE

complete with selector switch...

## TRIPLET

ELECTRICAL INSTRUMENT CO.  
Bluffton, Ohio



• 5,000 ohms per volt. A.C.

• 20,000 ohms per volt. D.C.

• BANANA-TYPE JACKS—positive connection and long life.

• EXCLUSIVE SELECTOR SWITCH speeds circuit and range settings. The first and only miniature VOM with this exclusive feature for quick, fool-proof selection of all ranges.



### CARRYING CASE

Handsome leather carrying case with adequate space for Model 310 tester and accessories. Trousers belt slips through loop on back of the case for out-of-the-way carrying. MODEL 369 CASE — Suggested Canadian Dealer Net **\$4.50**

## Model 310 MIGHTY MITE

# the only complete miniature V-O-M (AC-DC)

### LOOK AT ALL THESE RANGES

DC VOLTS: 0-3-12-60-300-1200 at 20,000 Ohms/Volt.  
AC VOLTS: 0-3-12-60-300-1200 at 5,000 Ohms/Volt.  
DC MICROAMPERES: 0-600 at 250 Millivolts.  
DC MILLIAMPERES: 0-6-60-600 at 250 Millivolts.  
OHMS: 0-20,000-200,000 (200-2000 at center scale).  
MEG OHMS: 0-2-20 (20,000-200,000 Ohms at center scale).  
OUTPUT: Convenient chart in instruction book.

SEE IT AT YOUR JOBBER  
AND IT'S ONLY ONE OF TRIPLET'S MIGHTY NINE VOM LINE!

ONLY **\$48.30** Suggested Canadian Dealer Net



**631**  
Combination V-O-M—VTVM

**630-NA**  
For Best Testing Around The Lab, Production Line or Bench

**630**  
The Popular All-Purpose V-C-M

**630-A**  
A Good Job and Production Line V-O-M

**630-T**  
For Telephone Service

**666-HH**  
Medium Size For Field Testing

**625-NA**  
The First V-O-M With 10,000 Ohms/Volt AC

**666-R**  
Medium Size With 630 Features

**LEN FINKLER**  
330 Adelaide St. W., Toronto, Ont.

**C. M. ROBINSON COMPANY**  
189 Market Street, Winnipeg 325 10th Avenue, Calgary  
530 Beatty Street, Vancouver

**Announcing the second annual:**  
**IRE CANADIAN CONVENTION**  
**AND EXPOSITION** *Automotive Building, Exhibition*  
*Park, Toronto, Canada, October 16, 17, 18, 1957*

**ELECTRONICS & NUCLEONICS**

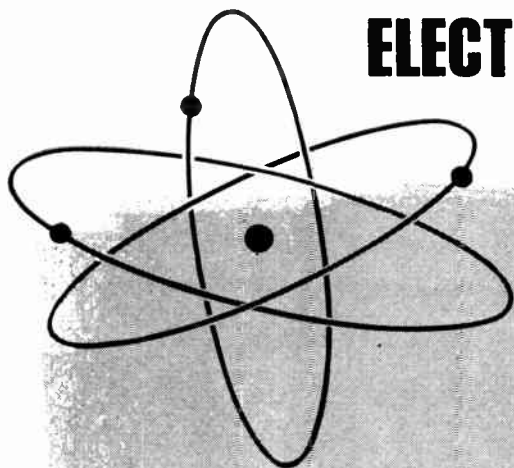

**RESERVE YOUR EXHIBIT SPACE NOW!**

Enlarged by 25 per cent to meet the demand for more exhibit space! The 1957 IRE Canadian Convention promises to draw an even larger attendance than last year's 10,038 engineers, technicians and buyers.

Now is the time to plan your company's exhibit participation in this great event. Write today for your copy of the brochure.

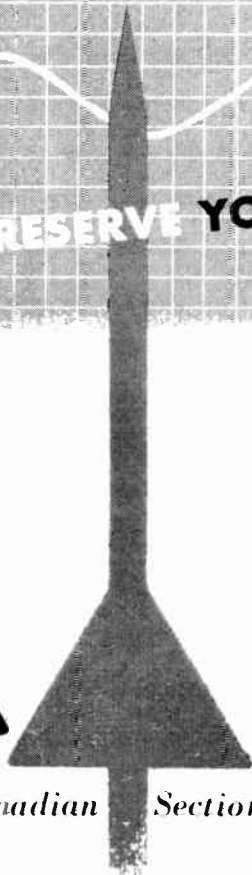

**IRE CANADIAN CONVENTION**

*Sponsored by the Canadian Sections of the Institute of Radio Engineers*

Office: 745 Mount Pleasant Road, Toronto 7, Canada  
 Telephone: HUdson 8-7768

**CANADA'S LARGEST SCIENTIFIC CONVENTION AND EXPOSITION**

THE NEW  
**Westinghouse**  
 HA SERIES  
**TRANSMITTERS**  
 FOR CONTINUOUS, 24-HOURS-A-DAY  
 COMMERCIAL COMMUNICATIONS

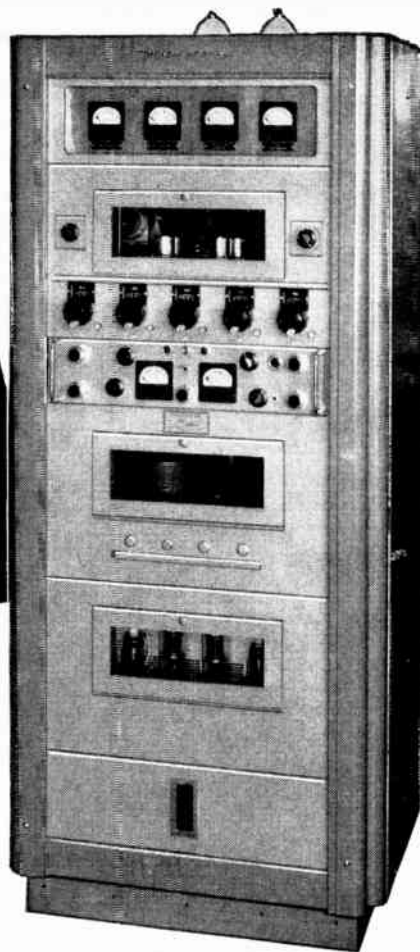

Here is a completely new series of 1 KW and 500 Watt High Frequency Transmitters Canadian designed and manufactured to meet modern operating conditions. The HA series incorporates many desirable features such as continuous frequency coverage and suppressed TV frequency harmonics.

These new transmitters are available on a "building block" basis for a wide variety of applications.

- HA-1 CW and Frequency Shift Keying — single 1000 watt channel
- HA-2 CW and Frequency Shift Keying — 2 simultaneous 500 watt channels
- HA-3 CW and Frequency Shift Keying — 2 simultaneous 1000 watt channels
- HA-4 Radiotelephony — 1000 watts carrier 100% modulated (illustrated)

#### DESIGN FEATURES

1. Continuous frequency coverage 2.0 – 27.5 Mc/s without band switching.
2. Switch selection of ten crystal frequencies.
3. Output impedance 600 or 300 ohms balanced over 2 to 27.5 Mc/s with continuously tunable balun circuit.
4. Keying speeds A1 — 600 words/min.  
F1 — 150 dot cycles/sec.  
Complete suppression of carrier radiation during "space" up to keying speed of 60 w.p.m.
5. Frequency response (HA4)  $\pm 2$  db from 350 – 3000 c/s.
6. Distortion (HA4) less than 7.5%, 350–3000 c/s, at 95% modulation.
7. Noise Level (HA4) more than 45 db below 100% modulation.
8. Rapid convenient tuning from five front mounted controls.
9. Highest quality components and conservative tube operating conditions ensure reliability under all extremes of temperature and humidity.
10. All components and tubes readily accessible.

COMMUNICATE WITH **Westinghouse**  
 ELECTRONICS DIVISION

CANADIAN WESTINGHOUSE COMPANY LIMITED • HAMILTON, CANADA

Halifax • Moncton • Quebec • Montreal • Ottawa • Toronto • Hamilton • London • Windsor • North Bay • Fort William • Winnipeg  
 Regina • Calgary • Edmonton • Lethbridge • Trail • Vancouver

56D745

See Television's Finest Hour "STUDIO ONE" Monday Nights 10:00 p.m.

For further data on advertised products use page 73.



# PUBLISHER'S VIEWPOINT

## Our New Cover

For nearly a year and a half now our editors have been pressing for a new cover design for *Electronics and Communications*, but editors in some respects are like high-strung race horses and if given full rein will sometimes bolt the gate and run wild on a merry editorial race of grandiose ideas only to have their noses broken and their dreams dashed on the first hurdle.

Actually I've held silent agreement with the idea for a new cover design for some time but despite the failings of the old cover which have been known to all of us, it has, over the course of four years, become identified as the messenger of the Canadian electronics and communications industries. For this reason alone there has been a reluctance to alter it and we have continued using it on the assumption that what it lacked in artistic perfection was made up for by the editorial and advertising content of *Electronics and Communications*.

Editors, however—or at least our editors—are a persistent and scheming lot, for which I have learned to be thankful, for while they sit and brood in their back rooms they are bound, now and again, to produce a case sufficiently strong to overcome old prejudices. Such was the case recently when supported by one of Canada's up and coming illustrators they presented a new cover design for *Electronics and Communications* so appealing that it was decided to scrap our old cover by which *Electronics and Communications* magazine has been identified since its inception four years ago.

The new cover design has been used for the first time on this issue. It is, without doubt, a radical departure from our old cover but we think you will agree with us that it is a positive improvement. Like the old cover it will continue to mark *Electronics and Communications* magazine as the messenger of the Canadian electronics and communications industries which will, of course, continue to keep both engineers and management fully informed on significant technical and business developments in the field.

\* \* \*

## Engineers Want Copies

A couple of months back, when we planned the little 24-page booklet entitled "What Are Engineers Really Like?" it was our intention to distribute it among advertisers and suppliers to the Canadian electronics and communications industries only.

(Continued on page 52)

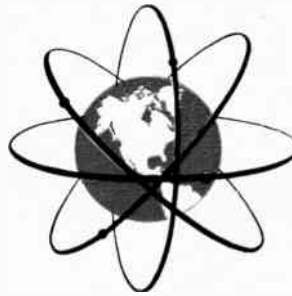

# ELECTRONICS AND COMMUNICATIONS

March, 1957

Vol. 5, No. 3

## EDITORIAL CONTENTS

### FEATURES

	PAGE
Pressure Resin Splice Meets Universal Needs . . . . .	24
<i>Minnesota Mining &amp; Manufacturing Co.</i>	
Electronic Analog Computers . . . . .	26
<i>by Farrell Chown, M.A.Sc., P. Eng.</i>	
Modern Coil Winding Methods . . . . .	28
<i>Lenkurt Electric Co.</i>	
Automatic Machining Of Germanium . . . . .	30
Radome Testing System . . . . .	30
Fire Protection For Remote Radio Relay Stations . . . . .	31
Wire Cutter Meets Specific Needs Of Electronics Industry	31
Closed Circuit Television Furthers Study of Proton Beam	34
Point Probe Microanalysis . . . . .	34
Expansion Of Britain's Electronics Industry . . . . .	35

### DEPARTMENTS

RETMA Report . . . . .	11
Editor's Page . . . . .	17
Editorial . . . . .	19
Business Briefs And Trends . . . . .	21
News . . . . .	36
New Products . . . . .	53
Electronics In Business And Industry . . . . .	63

President, NORMAN G. McHARDY; Editor, THOMAS W. LAZENBY; Editorial Assistant, D. K. TROWELL; Advertising Manager, H. E. DALLYN; Production and Marketing Consultant, W. EVAN-JONES; Production Manager, NEVILL A. CAMPLING; Business Manager, CLIFFORD A. SPARKS; Circulation Manager, PAUL A. IRWIN; Art Editor, WM. McREYNOLDS; Photo Editor, GUIDO MILANESIO.

### PUBLISHED BY AGE PUBLICATIONS LIMITED

Founded by Norton W. Kingsland

Also Publishers of Restaurants and Institutions, Hotel and Tavern, Heating, Plumbing & Air Conditioning AGE, Oil & Gas Heat.

MONTREAL, QUE., CANADA  
Room 504, Dominion Square Building  
1010 St. Catherine Street West  
Tel. UNIVERSITY 6-7897

TORONTO, ONT., CANADA  
31 Willcocks Street  
Tel. WALNUT 2-3115

Subscription Rates: Canada, U.S.A. and British Possessions . . . \$ 5.00 per year  
Foreign . . . \$10.00 per year

Authorized as second class mail. Post Office Department, Ottawa.

Member Canadian Circulation Audit Board, Inc.



PRINTED IN CANADA



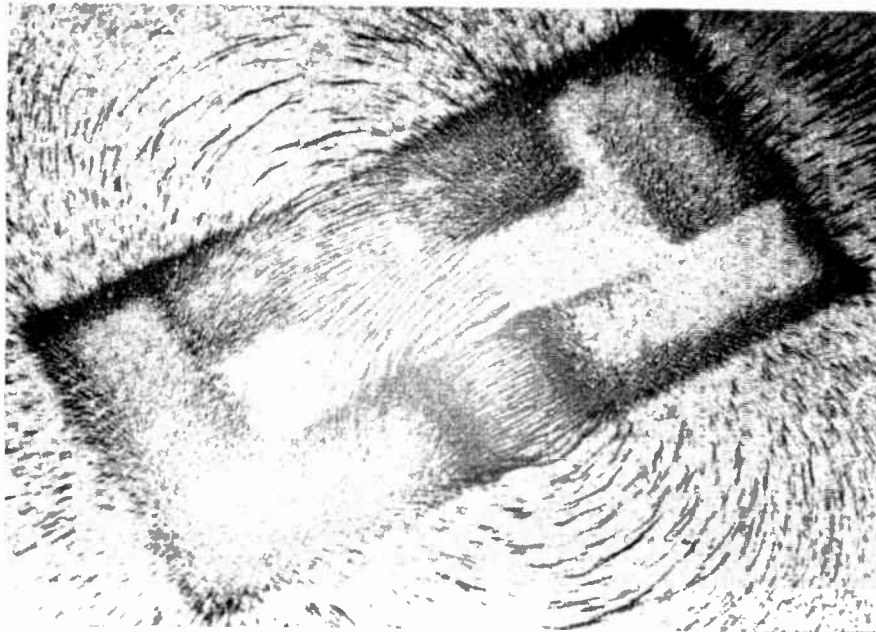

Flux pattern of experimental magnetic circuits

## How location of magnets affects magnetic circuits

Adapted from an article by Charles A. Maynard, vice president, Research and Engineering, The Indiana Steel Products Company

The LOCATION of permanent magnets in a magnetic circuit is a definite factor in design. To determine the extent to which this is true, involved calculations are necessary.

A comparatively simple experiment, however, which shows the nature of the changes that take place when permanent magnets are placed in different positions in a magnetic circuit, was devised by Mr. Maynard. The material on which the following questions and answers are based was taken from a report, "An Experiment in Magnet Location," published in Vol. 3, No. 5, of Applied Magnetics. A copy of this issue is available on request to The Indiana Steel Products Company of Canada Limited, Kitchener, Ontario.

**Question:** What effect does the location of permanent magnets have on a magnetic circuit?

**Answer:** It has a marked influence on the flux density in the various portions of the magnetic circuit.

**Question:** Is there a preferred location for magnets?

**Answer:** Yes, it is important to place the magnets as close to the air gap as possible.

**Question:** What is the benefit of their location?

**Answer:** The leakage flux is reduced, and the useful flux in the air gap is increased.

**Question:** How is this an important factor in design?

**Answer:** It minimizes the amount of magnet material required to produce a given flux in the air gap.

**Question:** Does this mean lower magnet costs?

**Answer:** Generally, this is true. However, structural considerations may prevent the placement of permanent magnets at preferred positions.

**Question:** Are there available quantitative data which indicate the degree to which magnet position influences the efficiency of a circuit?

**Answer:** A brief experiment was conducted on the nature and magnitude of the changes that occur when magnets are placed in various positions in a simple magnetic circuit. The results are discussed in *Applied Magnetics*, Vol. 3, No. 5.

### World's largest permanent magnet separates electron particles

The largest and most powerful permanent magnet ever designed is an important part of a new Mass Spectrometer to be used for high molecular weight hydrocarbon



Indiana's C. A. Maynard inspects air gap of giant Alnico V magnet assembly

analysis at the Whiting, Indiana, research and development laboratories of a large Midwestern oil company. Function of the spectrometer is to establish a strong magnetic field that separates electron particles.

The Alnico V permanent magnet used in the assembly has a maximum field strength of 6,000 gauss . . . equal to 10 tons of magnetic holding force . . . and weighs 1,300 pounds. The complete assembly, which weighs approximately 4,700 pounds, was designed and fabricated by The Indiana Steel Products Company, Valparaiso, Indiana.

THE INDIANA STEEL PRODUCTS COMPANY  
OF CANADA LIMITED  
KITCHENER, ONTARIO

THE WORLD'S LARGEST MANUFACTURER  
OF PERMANENT MAGNETS

INDIANA  
PERMANENT  
MAGNETS

For further data on advertised products use page 73.

# RETMA Report



By Basil Jackson, A.R.Ae.S., Tech. M.C.A.I.

## Engineering Activities of RETMA

Since the beginning of the year there have been added engineering activities within the Radio-Electronics-Television Manufacturers Association of Canada. During February a technical panel discussion took place in Toronto on dip soldering techniques and procedures used by end-product manufacturers. RETMA engineers and quality control managers were in attendance. The discussion on technical information dealt with such items as the optimum soldering pot temperature, composition of solder, time of dip, fluxing, and the chemical cleaning of printed wiring boards. A discussion of the merits of Standard Proposal 503 entitled "Solderability Test Standard", took place.

The open panel discussion on dip soldering technique and procedures was sponsored by the RETMA Sub-Committee on Solderability of Components, under the chairmanship of Mr. Tom Fleming. This sub-committee is one of the twenty-four which comprise the RETMA Components Engineering Committee, each of which deals with an electronic component or generic sub-assembly.

## RETMA Chief Engineers Meet

Also during February, the first meeting of the chief engineers of RETMA member-companies was held. The meeting was held in Toronto and was under the chairmanship of the RETMA Director of Engineering, Mr. Ralph A. Hackbusch. The meeting was called to clarify the work of the various engineering committees of the three RETMA divisions and to invite suggestions for the best way to allocate engineering man-hours for the great amount of engineering work now being undertaken by RETMA. The new standardized procedures for the compilation, approval, and final promulgation of RETMA of Canada engineering standards were explained.

The vital importance of the engineering work of RETMA, both in the fields of domestic products such as radio and television receivers and in the wider fields of industrial and military electronic equipment was strongly emphasized by the engineers present. The feeling was that top management, and the lower management echelons, should appreciate that without such engineering work, there would be no end products to sell. It was essential for engineers to participate unhindered in this work for the good of the individual companies and for the advancement of the electronics industry as a whole.

## Components Engineering Committee Meets

The RETMA Components Engineering Committee recently met in Toronto. The various sub-committee chairmen, who make up this committee, made their reports dealing with the particular electronic components or processes dealt with by their sub-committees. Various important topics were discussed and decisions made.

(Continued over page)

# RETMA Report

---

## **New RETMA Members**

Recently-admitted new members of RETMA are as follows:

### **TMC Canada Limited, Ottawa, Ont.**

Manufacturers of antenna multi-couplers, antenna transformers and accessories, wide band HF transformers, communications receivers, communications transmitters, tone systems, communication measuring devices and associated electronic devices.

Accepted into membership by Electronics Division.

### **Record Player Corporation, Montreal, Que.**

Manufacturers of record players with and without amplifiers, wooden cabinets, metal parts, speaker baffles and tube caddies.

Accepted into membership by Components Division.

### **Quality Hermetics Limited, Toronto, Ont.**

Manufacturers of hermetic sealed headers, bases, feed thru's, stand-offs, glass to metal seals.

Accepted into membership by Components Division.

## **RETMA Appeals 15% Excise Tax**

On February 22nd the RETMA General Manager, Fred W. Radcliffe, presented a brief to the Minister of Finance, the Honourable Walter E. Harris, appealing the 15 per cent excise tax levied against radio and television receivers. A summary of the main points of the brief is as follows:

- RETMA urged that the 15 per cent Excise Tax be removed from radio and television receivers, electronic phonographs and record players and associated products, because,
- (1) The tax is no longer providing the objective for which it was set up in 1953 - CBC requires a stable, not a constantly varying, source of revenue.
  - (2) The industry felt very strongly that taxwise it should be treated fairly in comparison with the other consumer goods industries with whose products it competes.
  - (3) The removal of the Excise Tax would permit several hundred thousand Canadian homes who have not yet been able to afford a TV set to acquire such and share in the benefits of this great Canadian service.
  - (4) The increase in production and sales resulting would relieve the unemployment situation in the industry and help Government revenues from the other established forms of taxation.
  - (5) Removal of the Excise Tax on our products for the support of a specific service would eliminate this doubtful principle of taxation.

## **Industrial Relations Committee**

At a recent meeting of the Industrial Relations Committee, it was noted that a successful panel had been organized in conjunction with the last meeting of the Components Division in Montreal. It dealt with "Communications with Employees" with Mr. Dick Scott acting as moderator and two speakers, Dr. W. A. Westley, chairman of the Department of Sociology and Anthropology of McGill University, who spoke on the "Fundamentals and Barriers in Person-to-Person Communication", and Mr. C. H. Cheasley, manager of the Employee Relations Section of the Montreal Board of Trade, who spoke on the subject of "Effective Communication on the Job".

## KEEP UP-TO-DATE ON MAGNETICS

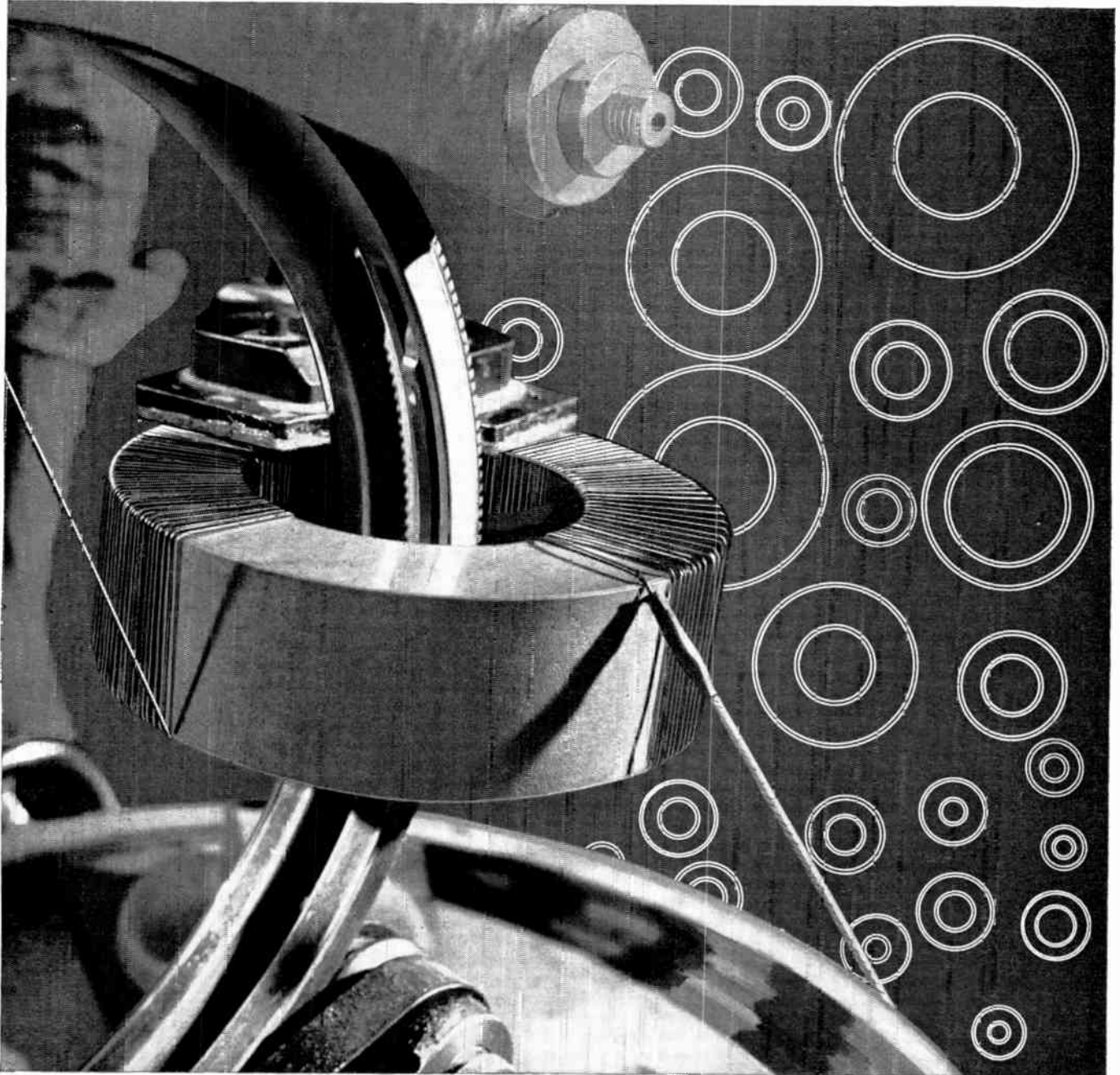

## **How will tape wound core users be affected by new size standards?**

If toroidal core winding is a familiar sight in your plant, you'll welcome news that standard sizes for tape wound cores have been proposed by the A.I.E.E.\* You are going to benefit from a high in consistency of core performance, brought about by our being able to concentrate on your most important sizes.

Magnetics, Inc. is now stocking all of the proposed standard core sizes in both aluminum and phenolic core boxes for immediate delivery. Consistency of core performance is increased because each size is made in large lots taken from the same alloy batch and dry hydrogen anneal. They all bear our exclusive Performance-Guarantee.

You can find all specifications for these AIEE-standardized tape wound cores in Catalog TWC-102, a new publication

which, incidentally, is the most comprehensive tape wound core text published anywhere by anybody. Your copy of this Catalog-Design Manual may be obtained by writing on your letterhead to *Magnetics, Inc., Dept. EC-34, Butler, Pa.*

**MAGNETICS inc.**

*\*Paper 57-206. Proposed Size Standards for Toroidal Magnetic Tape Wound Cores. Report of the Magnetic Amplifiers Material Sub-Committee, at the 1957 Winter General Meeting, A.I.E.E.*

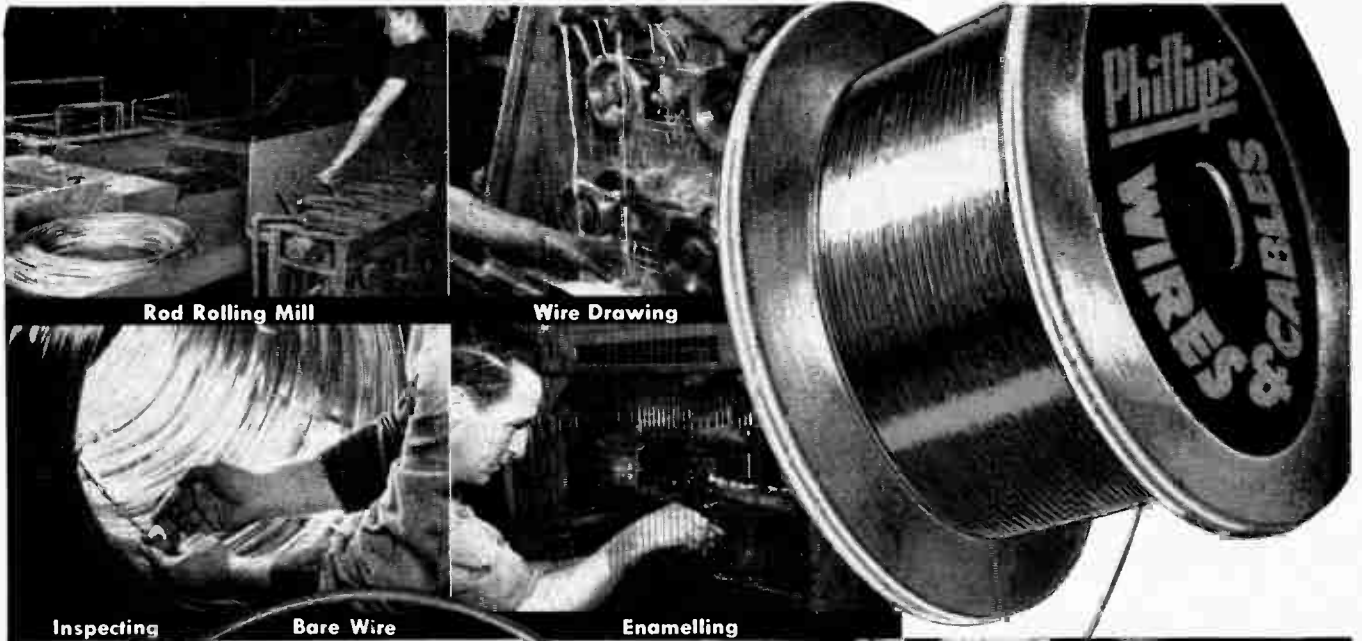

*your apparatus  
is only as good as  
the quality of its  
magnet wire*

Some of the finest Magnet Wire obtainable comes from the 99.9% pure copper rolled in Phillips rod mill. Throughout the rolling and drawing operation a high surface finish is imparted to the wire that is invaluable in bare wire, and essential for all insulated types. The annealing process used renders a unique softness to the copper that is ideal for easy winding. When insulated, the dielectric is applied in a smooth impervious layer that is Phillips guarantee of complete reliability.

Whether you need bare, shaped or insulated Magnet Wire, your best bet is Phillips.

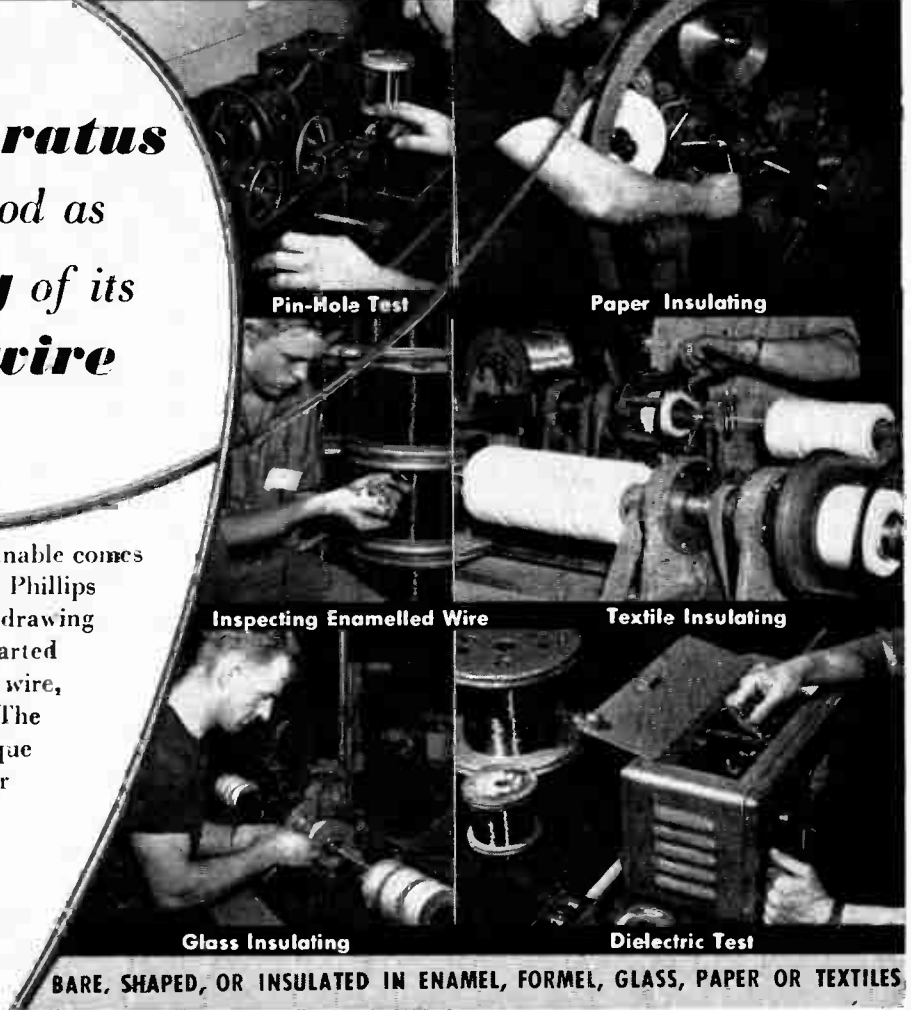

**BARE, SHAPED, OR INSULATED IN ENAMEL, FORMEL, GLASS, PAPER OR TEXTILES**

Phillips Electrical Company Limited. The Canadian Affiliate of the British Insulated Callender's Cables Group. Head Office—Brockville, Ontario. Sales Offices—Montreal, Ottawa, Toronto, Hamilton, Winnipeg, Regina, Edmonton, Vancouver.

*Phillips*  
**Electrical**  
*Company* LIMITED  
**WIRES AND CABLES**

**NOW—**  
**PORTABLE**  
**ELECTRICITY**  
 for Work or Play

**Bendix**  
 Portable Electric Generator



RADIO COMMUNICATIONS



FOR TRAILERS



ON BOATS



HUNTING AND FISHING TRIPS

**PROVIDES**  
**ELECTRICITY**  
**FOR MANY PURPOSES**

Weighing only 55 lbs., this small (19" x 11½" x 13") unit can provide you with modern living wherever you go!

Powered by a two cycle, 2 h.p. air-cooled engine, this 110V, 60 cycle A.C. portable generator will produce a power of over 800 watts —enabling you to take your power supply with you.

In emergencies, on trips into the bush, aboard boats or as a convenient power source at remote sites the BENDIX PORTABLE POWER GENERATOR is a MUST!

Write for details and descriptive literature today.

**Dealer Inquiries Invited**



CIVIL DEFENSE



HOME EMERGENCIES



DURING CONSTRUCTION



FOR POWER TOOLS



ON THE FARM

**AVIATION  ELECTRIC**  
 LIMITED

200 LAURENTIEN BLVD., MONTREAL, P.Q.  
 World Radio History  
 HALIFAX • TORONTO • CALGARY • VANCOUVER



# AVOID A COSTLY MISTAKE!

*with crystals*

When Human Lives depend on accurate frequency control of Aircraft Radio for navigation and communications. "Avoid a costly mistake".

Specify Snelgrove Precision engineered low drift quartz crystals.

You cannot afford to take chances with life and property. Insist on getting Snelgrove crystals because they are tested and quality controlled for maximum stability and rugged proven performance, under the most severe operating conditions.

Yes — Snelgrove can supply crystals for Aircraft-Ship To Shore radio communications, — Defense installations, and any other specified crystal controlled equipment applications, wherever highest standards of efficiency and reliability are demanded.

"You will avoid a costly mistake" when you specify your crystal requirements by Snelgrove.

## QUARTZ CRYSTALS

C. R. **SNELGROVE** CO. LIMITED

141 Bond Avenue, Don Mills (Toronto), Ontario — Phone HI. 4-1107-8.

Canada's Foremost Frequency Control Specialist — Licensed Under Bell System Patents

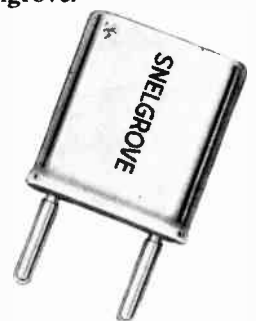



# the editor's page

*A commentary on affairs  
pertinent to the electronics  
and communications industries.*

## A Commendable Move

The recently announced plans of the Association of Professional Engineers of Ontario to establish a system whereby engineering technicians may — according to their qualifications — become registered as technicians with the A.P.E.O. is, in our opinion, one of the most valuable actions that has been taken in order to bolster our technical ranks.

There is little doubt that recognition fires enthusiasm for one's vocation or profession and the decision of the A.P.E.O. to register engineering technicians and thereby afford them some degree of semi-professional status will do much, we believe, to hold their ranks intact and attract more men to this field of endeavor.

According to the announcement of the Association of Professional Engineers of Ontario, engineering technicians would be examined by the Association and classified in four grades which would be determined by their educational qualifications and technical experience.

The Association points out that at present there is no registering body for engineering technicians in the province, and that such a system would be of great value both to industry and to the technician.

The A.P.E.O. have emphasized that this move does not mean that engineering technicians would become members of the Association, but pointed out that such technicians by self-improvement, further education and experience, could advance through various stages and finally secure registration as members of the Association.

At a recent meeting of the Executive Council of the A.P.E.O. a report was tabled by a special committee which has been studying the engineering technician problem.

The committee, headed by Dr. George B. Langford, P. Eng., of the University of Toronto, noted in its report that: (a) engineering technicians were invaluable assistants to professional engineers in that they are able to take over some of the non-professional duties of an engineer and thus allow the latter to carry out full-time professional work; (b) there was a rapid increase in the number of such technicians to keep pace with the demand for their services, and many industries now are employing four or more technicians for every professional engineer; (c) there was evidence within the engineering technician body of a desire for recognition and the establishment of accepted standards of technical qualifications.

The fact that there is an important relationship between the professional engineer and the technician in their day-to-day activities is the underlying reason for the interest of the Association in the technicians, the report states.

Dr. Langford said there was an urgent need for such a system of registration for technicians. It would, he added, encourage them to progress, and would also serve industry as a method of defining the upgrading of their technical employees, employment requirements and salary structure.

## Cabot Tower

We understand that a move is afoot to have federal government authorities maintain Cabot Tower on Signal Hill in St. John's, Newfoundland as a national memorial. This, of course, would be in recognition of the fact that Marconi transmitted the first trans-Atlantic wireless signal

from this site. We are of the opinion that this suggestion merits favorable consideration and we're willing to take a small wager that had Marconi chosen some site within the boundaries of the United States from which to send his historic signal that the site would have been established as a national memorial by the American government many years ago. Canadians, unfortunately, would appear to be somewhat lethargic in the matter of national monuments, apart from those commemorating the war-dead, and it is considered that some revitalized thinking on the significance that commemorative shrines can have in the minds of New Canadians may be in order at this time. It would be nice to think that the proposed suggestion concerning Cabot Tower may be the starting point for such a trend of thought on the part of the appropriate government department in Ottawa.

## On Modernizing Sport

There is no doubt that technology is invading the field of sport and turning it into a dial-twisting, wind-testing, sample-taking, weather-analysing hum-drum round of scientific excursions as far removed from the original purpose of sport as Presley is from Puccini. The latest gimmick that has been contributed to turn sport into science is an electronic fish finder. According to reports this angler's companion is designed to ferret out everything from whales to sardines in water up to 500 feet deep. The instrument identifies the fish by size and type and indicates the best place to dangle the bait. It works in fresh and salt water and can be fitted on pleasure craft or small fishing vessels. This "supped up" angler's asdic uses a portable indicator scope and a hull-mounted transmitter-receiver to give the fisherman a continuous picture of fish activity under the keel. It does it with sound — short, focussed, ultra-sound impulses transmitted downward through the water. Fish which interrupt the sound waves are projected as distinctive "blips" on the indicator scope. The fish's exact location and depth are recorded on the indicator after lightning-fast electronic computation of the time it takes the transmitted ultrasound wave to strike the fish and bounce back to the transceiver unit. This sportsman's must measure less than a foot square, weighs about 26 pounds and is equipped with a handle to allow the angler to wander the length of the boat and still know the best fishing spots. Well the whole thing sounds pretty fine but we doubt if fishermen will rush out to the first sale to pick one up because there seem to be a few refinements necessary before it will attract the attention of the true follower of Isaac Walton. For instance, couldn't this device be incorporated with a small type depth charge thrower armed with the necessary projectiles? It would, we believe, be an easy matter to improve the fish finder by the use of photo-electric circuits and the use of silhouette patterns by which the detector could be fed information on the type and size of fish required. When located the depth charge thrower could be automatically triggered to slay the under-water quarry which would dispense with the messy and archaic business of fishing rods, bait and the questionable thrill of reeling in a big one.

Yes, there's no doubt that technology is invading the realm of sport. Already there's talk of modernizing the fine old game of golf. Clubs and balls? I should say not! Miniature satellites, atomic projectors and remote control from the club house cocktail lounge.

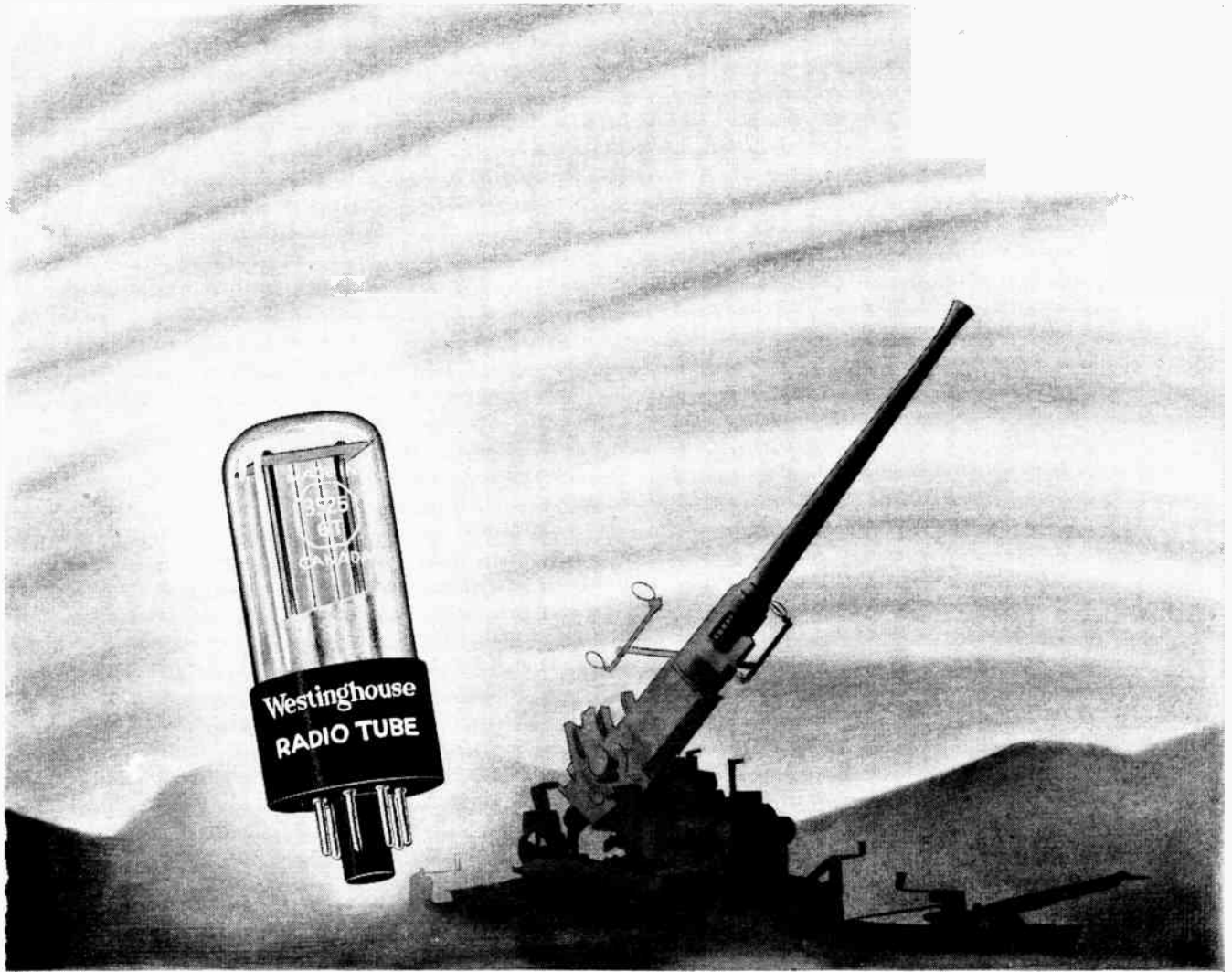

# Invisible Man behind the gun

Only man behind this gun is a Westinghouse tube. Electronics engineers at Westinghouse are working day and night developing and producing superior devices for Canada's modern defence needs.

*One such project is the development of automatic firing controls for anti-aircraft guns.*

The same engineering skill and modern, up-to-the minute machines that produce the tubes for Canada's top secret defence projects also turn out the tubes you receive for home radio and T.V.

What better testimonial could there be for the reliability of Westinghouse Tubes!

**YOU CAN BE SURE...IF IT'S** **Westinghouse**

**CANADIAN WESTINGHOUSE SUPPLY CO. LTD.**

Halifax • Quebec City • Montreal • Ottawa • Toronto • Hamilton • North Bay  
Fort William • Winnipeg • Regina • Saskatoon • Edmonton • Calgary • Vancouver

For further data on advertised products use page 73.



# IRE Convention Assured Careful Planning

*The recent announcement by Clare Norris executive committee chairman of the IRE Canadian convention, that a second IRE Canadian Convention and Exposition will be held in Toronto in October will be welcomed by the Canadian electronics and communications industries.*

*According to the announcement the decision to hold a second annual convention resulted from the outstanding success of last year's convention and the demands of exhibitors for larger space. It is understood that one exhibitor who last year represented a number of manufacturers has applied for individual booths for each of the firms at this year's show.*

*While plans for this year's convention and show call for a twenty per cent increase in floor space, a jump from 120,000 square feet in 1956 to 145,000 square feet in 1957, it has been pointed out by convention officials that there is no intention or wish to produce a "super" show space-wise. The actual increase in the number of booths, we understand, is 57.*

*The expressed intention of show officials to keep the size of the convention within manageable limits is, we believe, well taken, because there is little doubt that one of the most outstanding characteristics of the 1956 show was the air of spaciousness, cleanliness and organization all of which played a significant part in complementing the excellence of the exhibits.*

*There is, in our opinion, little doubt that the available exhibit space for the 1957 show will be at a premium and for this reason there is every likelihood that show officials will be pressed to accept reservations for exhibits in excess of the number planned for.*

*While it may be somewhat embarrassing for show authorities to refuse booth space to overflow exhibitors as well as somewhat discouraging to turn down the additional revenue that could be realized from such exhibitors, show officials, we believe, will hold fast to their plans for a twenty per cent increase in space and will not exceed this figure.*

*Based on the quality of last year's show-management we believe that every possible contingency has been planned for in allowing for the increase of 57 booths for the forthcoming show. This means that show-management have taken into consideration the possible increase in the number of visitors who are likely to attend the 1957 show. Last year more than 10,000 persons attended and although it means suspending ourselves on a limb of prediction we believe it reasonable to assume that the 1957 show will attract in the neighborhood of 15,000 to 20,000 visitors.*

*This prediction is based on the assumption that additional thousands of visitors will be attracted to the convention through the widespread and favorable publicity gained by the 1956 convention and by the public interest in electronics that will be aroused during the months ahead by the influence of publicity concerning the International Geophysical Year.*

*With the increase of 57 booth spaces and a sizeable increase in the number of daily visitors it has been suggested that the 1957 show may just possibly be a bit crowded.*

*In this respect we find little to worry about. According to show officials the increase of 57 booth spaces is only a modest increase and in our opinion there is little possibility that show authorities would sacrifice the cleanliness, spaciousness and orderliness which characterised the 1956 show for the sake of accommodating 57 additional booths.*



**TINY  
TOUGH  
TERRIFIC**

**INEXPENSIVE  
VERSATILE  
EASY TO INSTALL**

# HASLER PAX-12

## Completely Automatic Telephone System

- No operator required
- Line length up to 3 miles
- Self contained power supply
- Operates from any standard 110-250 Volt AC supply
- Up to 12 independent lines
- Cut-in facility
- Easily installed — no special skill required

Simplicity of operation  
Complete reliability in service  
Small space requirements

**RADIO COMMUNICATIONS EQUIPMENT &  
ENGINEERING LTD.**

475 Metropolitan Blvd., Lachine, Montreal 32, P.Q.  
For More Phones: PAX-27 (27 lines); PAX-45 (45 lines)



For further data on advertised products use page 73.

## business briefs & trends

★ Britain's electronics industry is reported to be making plans for a large scale change-over in its production plans. Reason for the change is recently announced plans for a new defense set-up which sees the role of the bomber plane taking precedence over the fighter. According to Duncan Sandys, Minister of Defense, the power of defense is at a low ebb compared to that of offense and Britain's only chance of staving off nuclear attack would be the ability to retaliate in kind, hence the need for bomber type aircraft, and the gearing of the electronic industry to meet its specialized needs.

★ The Jones and Laughlin Steel Corporation have purchased \$1.5 million dollars' worth of automatic controls for its Aliquippa, Pa. plant from the Westinghouse Electric Corporation. The equipment will be used to control the 6,000 horsepower universal reverse roughing mill which will feed a six stand continuous hot strip mill which in turn will be controlled by a card programmed system governing all stages of the roughing mill functions.

★ A new device developed by MIT and A.D. Little Inc., may hold promise of reducing the present size of data processing machines to the size of a shoe box. Key to the development is a component known as a cryotron which in appearance looks like a bent pin. It functions as an on-off switch through its superconductivity. Engineers of the A.D. Little company propose to hook 200,000 cryotrons together to form a logic circuit which they claim will allow them to pack a complete computer into a case the size of a shoe box.

★ According to an American report Canadian electronic equipment manufacturers are hopeful that the expanding Canadian industry will form a foundation on which to develop an export market. The report states that this hope is based on past success in exporting instruments to 40 countries. The report goes on to say that Canada's greatest opportunity for improving her economy in the future is apparently in the export of skills.

★ Henry E. Prew of the Sperry Gyroscope Company told a recent gathering of the American Astronautical Society that the electronics industry will soon be called upon to design and build electronic equipment for space exploration. Mr. Prew said that the great challenge in this respect was the development of adequate instrumentation and earth based control facilities for unmanned space research rockets.

★ The Canadian Marconi Company's new magnetron plant in the Town of Mount Royal which was completed last year at a cost of \$1.5 million dollars is now reported to be reaching full production. First types of magnetrons to be produced by the company will operate in the microwave frequency range of approximately 1,000, 3,000, and 10,000 megacycles, and will go to fill Canada's defense and civilian radar requirements.

★ A report on the state of the American electronics industry says that 1957 will be a banner year with the television-phone and the pocket TV set becoming realities in the not-too-distant future. A further advanced contribution which is expected from the electronics industry before too long is three dimensional

television on which several basic patents have been granted in recent months.

★ In order to gain publicity for its technical discoveries General Dynamics Convair division is encouraging its scientists to write articles on their findings for publication in scholarly journals — the majority of which do not pay for contributions. In lieu of this the company is paying \$150 for each article that is written and published by a company engineer or scientist. So far 41 articles have been published.

★ Telephone subscribers in Paris have recently had a new service made available to them. It is known as Telechanson and from Monday to Friday Paris subscribers may call SUF 84-20, lean back in their chairs and listen to songsters such as Charles Trenet, Edith Piaf, Gilbert Becaud and others. If this fare does not suit their mood they may dial for stock market quotations, or a recorded news program as well as a wake up service. All this is part of the efforts of the government owned postal telegraph and telephone service to give its subscribers everything they need by phone.

★ Electronic Associates of Long Branch, N.J. have contracted to set up an analog computer center in Brussels next summer. The center will be available on a rental basis and will also act as a sales base for computer equipment for the European market.

★ CBS-HYTRON, Danvers, Mass., demonstrated a new machine for the automatic production of germanium diodes. Through the elimination of hand assembly, the company says the machine will cut manufacturing costs in half.

★ RETMA of the United States reported production of 6,760,045 TV sets and 12,266,597 radios from January to November 1956. This compares with 7,151,895 TV receivers and 12,834,102 radios in the 1955 period. Retail sale of TV receivers for the first 11 months of 1956 totaled 5,847,590 as against 6,487,616 in the corresponding 1955 period. Radio set sales for the 1956 period totaled 6,680,127 (exclusive of automobile sets) as against 5,332,583 for January-November 1955.

★ A major step forward in the field of postgraduate education for practicing physicians throughout the United States was signified by the recent announcement of the acquisition of 33 newly developed large-screen projection television systems by the Upjohn Company, pharmaceutical manufacturers of Kalamazoo, Michigan, from General Precision Laboratory of Pleasantville, New York. The new systems will be used in conjunction with similar equipment to enable physicians in more than 50 cities across the nation to simultaneously observe clinical staff meetings, diagnostic procedures, surgery and to participate with distinguished clinicians in the evaluation of difficult and unusual case problems.

★ From a modest beginning eight years ago, with six carefully selected associates, \$22,000 dollars capital and no orders on the books, Varian Associates have achieved the spectacular growth record today of \$11 million dollars in sales in 1956.

(Continued over page)

## business briefs & trends

★ A \$2,500 fellowship for graduate study in electronics has been established by the National Electronics Conference. The fellowship provides for one year's work at the master of science or doctor of philosophy level at any of eight colleges and universities participating in the conference. These include Illinois Institute of Technology, Northwestern University, and University of Illinois as sponsors, and Michigan State, Purdue, Michigan, Notre Dame, and Wisconsin as co-operating institutions. The sponsoring group also includes the American Institute of Electrical Engineers and Institute of Radio Engineers, with the Radio-Electronics-Television Manufacturers Association and Society of Motion Picture and Television Engineers as participating members.

★ The trans-Canada teletype service stretching from Halifax to Kitimat has recently been completed for the Aluminum Company of Canada and constitutes one of the longest private teletype services in the world. Construction of the service was achieved through the co-operation of the member companies of the trans-Canada Telephone System.

★ The first commercial order for Videotape was recently awarded to ORRadio Industries Incorporated by the Columbia Broadcasting System's Television Division. Videotape, the new magnetic tape which will record both pictures and sound simultaneously has been afforded considerable research and development time by ORRadio Industries Incorporated working in conjunction with the Ampex Corporation of Redwood City, California, a leading manufacturer of recording equipment.

★ A pocket transistor radio weighing less than one pound was introduced recently by Canadian Admiral Corporation. According to Ed. Whittaker, vice-president and general sales manager, the new pocket radio is unique because it is the only one of its size designed to utilize seven transistors on a printed circuit board. The automatic gain control system in the set is augmented by a special transistor and circuitry which allows the receiver to handle a wider range of signal strength.

★ During the first International Congress of Automatism (Automation) which grouped 1,000 representatives from 25 countries in Paris, it was learned that the first almost entirely automatic factories were already in operation in France. For reasons of industrial secrecy, the construction of these plants was not publicized. Automatism ranging from 60 to 80 per cent now exists in a large radio tube plant, a film plant, chemical product factories, plants for treating agricultural products and electronic and mechanical production centers.

★ An international financing program is presently being worked out to pay for the cost of a new and better air warning and communications system to encompass the member of the North Atlantic Treaty Organization according to General Lauris Norstad, NATO Supreme Allied Commander. General Norstad hopes that the new system will be effective by the end of 1958. As envisioned the new system would include communications nets using tropospheric and ionospheric forward scatter. The present system has been referred to as being antiquated and inadequate resulting in intermittent communications between NATO countries.

★ Faced with a profit drop of \$4.5 million dollars to \$1.2 million dollars the Raytheon Manufacturing Company are reported to be turning their attention to the possibilities of their commercial products division. Like some of the other large companies in the industry they have dropped their unprofitable television department and are looking to the wider and more promising field of industrial electronics, a field that has been neglected in the past for the more immediate dollar returns which have been gleaned from the television market.

★ Television is growing rapidly in France. In 1954 factories turned out 11,500 television sets. In 1955 185,000 television sets and 850,000 radios were produced. Estimates for 1956 are about 1 million radios and over 300,000 television sets. These figures, augmented by similar increases for automobile radios and phonographs make this sector one of the most active in France.

★ Several hundred thousand dollars' worth of electrical and electronic equipment built by Canadian Westinghouse, Hamilton, went into service aboard Canada's new aircraft carrier "Bonaventure" when the fighting ship was commissioned in January at Belfast, Northern Ireland. The company supplied diesel-driven generators, steering gear controls, motors and electrical apparatus for use with radar and radio equipment. The firm's Electronics Division also produced considerable communications equipment for the new carrier. Fighting strength of the ship will come from Westinghouse-powered "Banshee" jet aircraft and CS2F1 sub-hunter planes. Radar and airborne electrical equipment for both types of aircraft was also supplied by the company.

★ A series of evening courses designed to help engineers qualify for the professional engineering license in New York or New Jersey will be offered under the auspices of The American Society of Mechanical Engineers and the American Institute of Electrical Engineers, beginning in February. Courses, held weekly for a period of about twenty weeks, will cover structural planning and design, basic engineering sciences, mechanical engineering, electrical engineering and engineering economics and practice.

★ RCA Institutes' home study courses in radio-TV electronics, television servicing and color television are to be made available in Canada on a "Pay As You Learn" plan, according to R. H. Newton, general manager, service division, RCA Victor Company, Ltd. The Radio-TV Electronics course is planned for both the student who knows nothing of electronics and the technician interested in refreshing his knowledge. The course in Television Servicing is a practical one, covering television theory, servicing and trouble shooting. The Color Television course is intended for the TV technician interested in advancing himself.

★ West Germany's new Air Force has placed a \$75 million order with Canadair, Ltd., of Montreal, for 225 Sabre Jets. This order also entails the spending of a further \$30 million with Orenda Engines, Ltd., sole Canadian manufacturer of jet engines for military aircraft. Lucax-Rotax, Ltd., of Toronto and Montreal, will also enter the transaction in supplying jet fuel injection systems.

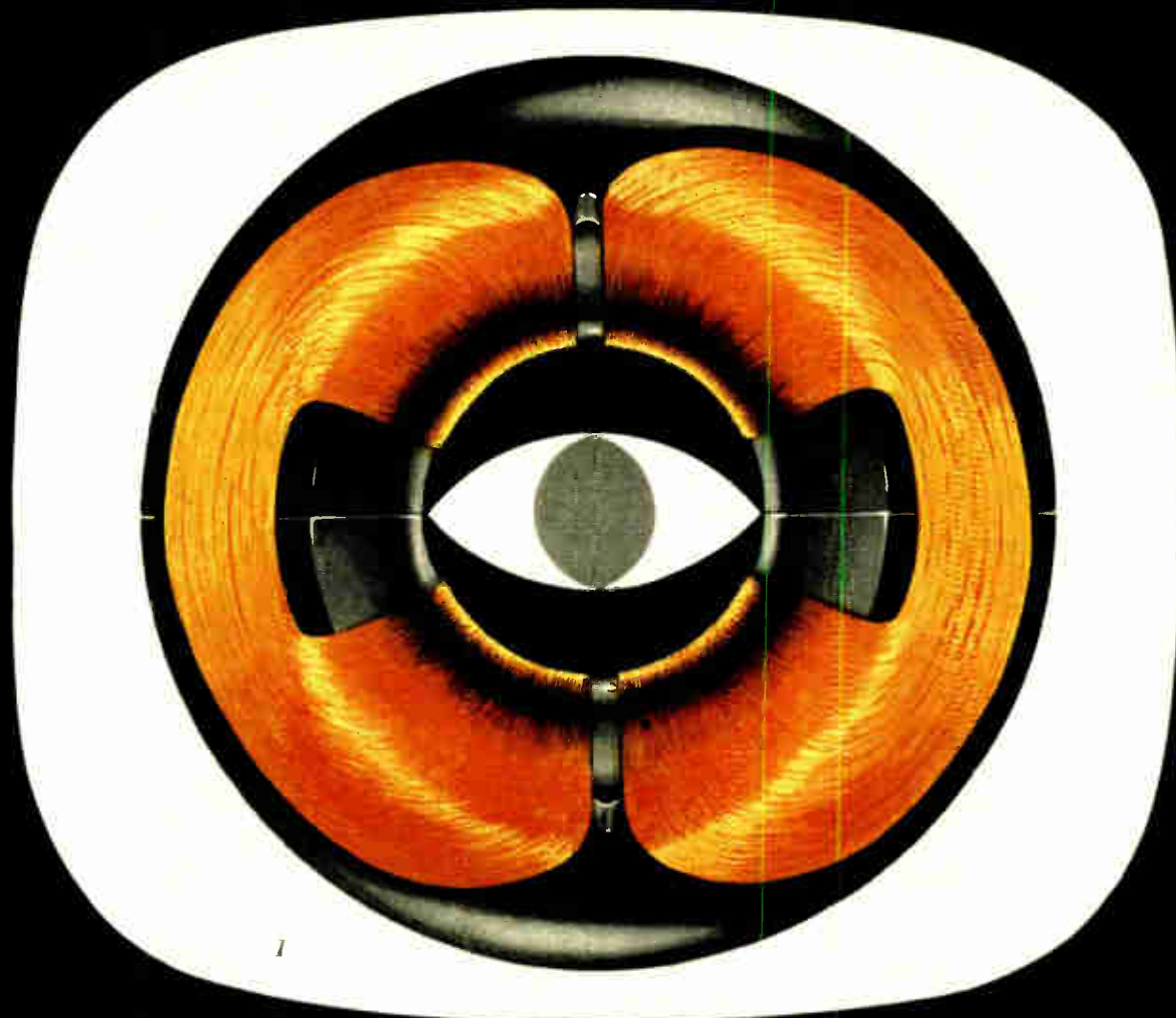

1

*Magnet Wire at its finest comes from* **FEDERAL**

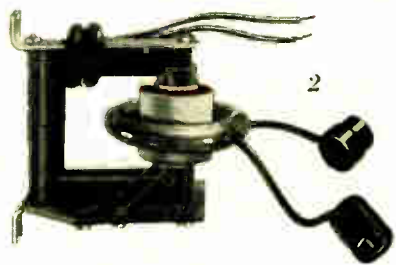

2



3



4



5

1 Deflection Yoke  
—Federal Bondel

2 Horizontal Transformer  
—Federal Formel

3 Width Control  
—Federal Formel

4 Blocking Oscillator  
—Federal Formel

5 Horizontal Stabilizer  
Coil—Federal Formel

6 i. f. coils with traps  
—Federal Formel



6



**FEDERAL** Wire and Cable Company Limited

Head Office and Factory: GUELPH, ONTARIO

Sales Offices and Warehouse Stocks: St. John's, Nfld., Toronto, Montreal, Winnipeg,  
Regina, Saskatoon, Calgary, Edmonton, Vancouver.

World Radio History

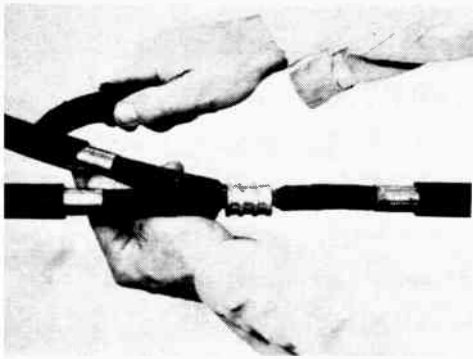

● Fig. 1

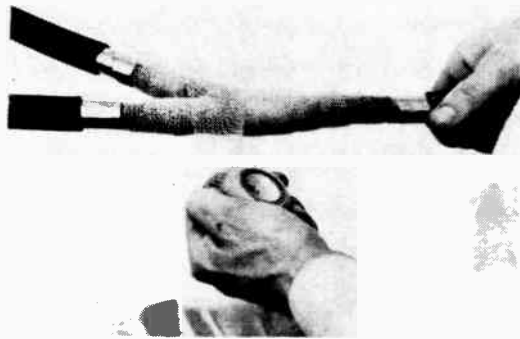

● Fig. 2

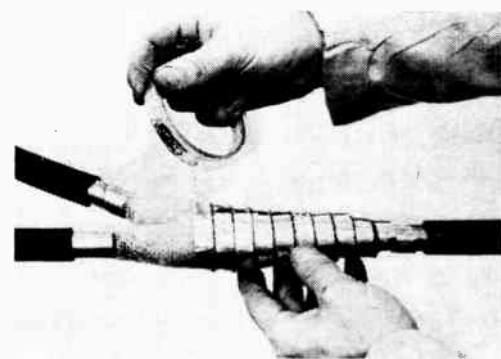

● Fig. 3

**Fig. 1:** Cable to be spliced is prepared in the usual manner using the desired connector. The cable insulation is thoroughly scraped to provide a good adhering surface for the epoxy resin. **Fig. 2:** The prepared cable is then wrapped with successive servings of a grid-like spacer tape which provides a mechanical build-up yet allows spaces for the resin to penetrate to all points in the splice. **Fig. 3:** Shielded cable can be continuously spliced by using an aluminum foil tape to carry the shielding over the splice area. The tape is wrapped around the first layer of spacer tape as shown to allow for a layer of resin on both sides of the shielding.

# Pressure Resin Splice

Minnesota Mining & Manufacturing Co.

**S**PLICES shot from a gun — a new and versatile method of protecting and insulating electrical splices with epoxy resin injected into a mold that is tailor made in the field constitutes an efficient technique that will do much to assist line construction in the communication industry.

Called the "Scotchcast" resin pressure splice, the new method is expected to find wide usage among utilities and power companies, electrical contractors and communications concerns for both buried and aerial cable. Due to the versatility of the method, lead, rubber and plastic sheathed cable or even combinations of these as well as shielded cable can be spliced. The method has worked satisfactorily on oil-saturated cable.

The pressure splice method uses an open mesh screen-like tape as a spacer material, wrapped around the splice. This build-up of open screening is covered with a liquid-impervious plastic tape holding an injection fitting to allow entry of the resin into the splice. The plastic tape in turn, is covered with a low stretch tape to restrict the expansion of the plastic envelope when resin is forced into the splice.

The adaptability of the new method allows the mold for the splice to be tailor made for each splice, providing moisture proof, void free, high dielectric strength insulation around nearly any size or shape of splice. Also it makes possible uniform quality splices in less time than previous methods

and removes much of the factor of human error. The splices can be made by electricians without extensive special training or experience.

Resin for impregnating the splice is supplied in a plastic envelope — the "Unipak" container — which holds resin on one side of a dividing membrane and a hardener, or activator, on the other. When the divider is broken, the resin and activator are mixed by squeezing the ends of the container forming a resin which sets up or cures through internal heat.

## Preparation of Splice

In preparing the splice, the insulation is first scraped to remove all wax, oil and dirt. The conductors are then fastened together with a suit-

**Fig. 7:** With the vinyl tape in place, a supporting wrap of fabric tape is applied over the plastic to provide mechanical support for the stretchy vinyl. This arrangement is similar to an automobile tire and inner tube with the vinyl tape acting as the inner tube and the fabric tape as the tire. **Fig. 8:** After the splice is wrapped, the resin and resin gun are prepared to "shoot" the splice. First the nozzle fitting with the pressure-sensitive back is positioned on the side of the "Unipak" container which holds the epoxy resin and catalyst in divided compartments. **Fig. 9:** With the nozzle fitting in place the separating membrane between the resin and activator is ruptured and the container contents mixed by squeezing alternate ends of the envelope 30 to 40 times. Then the envelope of mixed resin is inserted into the special pressure gun with the nozzle down so that it can be inserted into the metal gun nozzle. With the gun nozzle in place the trigger is squeezed two or three times and the envelope is punctured by reaching in through the metal and plastic nozzle with a sharp tool. The plastic nozzle in this case acts as a disposable liner for the gun nozzle and the "Unipak" container as a disposable liner for the gun barrel to minimize clean-up.

● Fig. 7

● Fig. 8

● Fig. 9

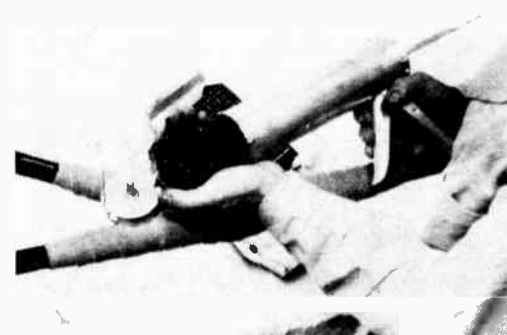
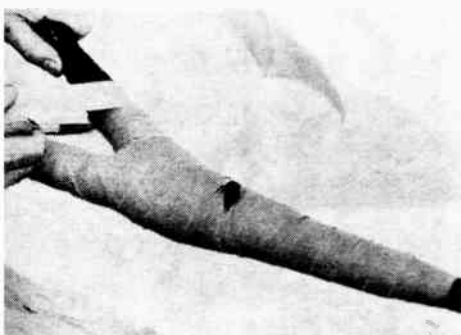



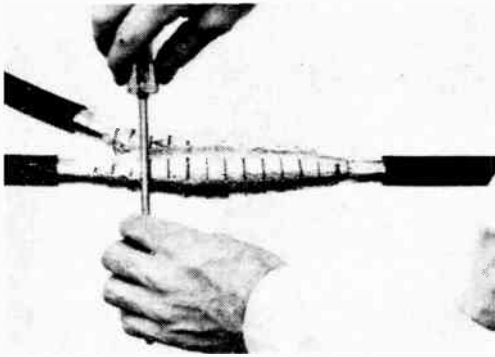

● Fig. 4

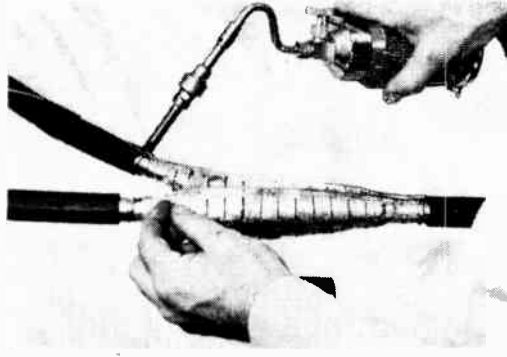

● Fig. 5



● Fig. 6

Fig. 4: Strips of foil tape are then run from shield to shield on both the main cable and the branch to insure a continuous shielding. Then the foil tape is "ironed" down with a round object such as a screw driver shank. Fig. 5: The shielding is completed by soldering jumper wires across the splice from the original cable shielding. Fig. 6: With the shielding completed, a new layer of spacer tape is applied until the desired thickness for the splice requirements is reached. Then a wrap of vinyl tape is begun and the injection fitting is positioned under the vinyl tape wrap. The pressure-sensitive vinyl forms a liquid impervious seal to contain the resin.

## Meets Universal Needs

able connector and the splice is wrapped with the spacer tape to the proper splice diameter.

The plastic injection fitting with its one-way, non-return valve is positioned at the proper point on the splice.

The plastic tape envelope is wrapped over the apron of the injection fitting to secure it firmly in place, wrapping away from the fitting to the ends of the splice forming a liquid-tight container for the resin.

Over the plastic tape is wrapped a layer of fabric tape to give the stretchy plastic added mechanical support against the pressure of the resin. The last layer of fabric tape can be compared to an automobile tire while the plastic tape is comparable to the inner tube.

With the fabric tape secured, the pressure gun is prepared. Similar to a caulking gun, it holds the "Unipak" container which acts as a disposable liner to eliminate clean-up.

First a plastic nozzle spout is pressed to the side of the "Unipak" by its adhesive back. Then the contents of the "Unipak" are mixed by squeezing. After it is thoroughly mixed, the "Unipak" is inserted in the gun with the plastic nozzle spout protruding from the gun spout. A puncturing tool (included with the gun) is pushed through the nozzle puncturing the container wall and the gun is ready to operate.

The nozzle is inserted in the injection fitting on the splice and the trigger worked to force resin into the built-up mold. Small air holes are

punched in the splice casing at the ends farthest from the injection fitting. When resin begins to drip from these pin-holes, the splice is fully impregnated.

According to the manufacturer, the new method is adaptable to almost any kind of splice and the required insulating values may be regulated by increasing or decreasing the thickness of the spacing buildup.

Because of the custom-made nature of each splice, shielding for shielded cable can be made continuous through the splice by running it through the spacer tape buildup. External grounds may be attached before applying the spacer tape and parallel exit of cables from the splice can be arranged by padding cables into place with insulating putty before beginning the splice.

Fig. 10: With the gun completely assembled and the envelope punctured, the nozzle is inserted into the injection fitting and the trigger squeezed forcing resin into the splice under considerable pressure until drops of the liquid resin appear through tiny holes punched at the extreme ends of the splice. After the splice is full the resin sets up into a hard solid mass throughout the splice through internal heat created by chemical action within the ingredients of the resin. Once the resin has set, usually after from 5 to 10 minutes, the outside fabric tape can be removed if desired. Fig. 11: A cut-away of the completed splice shows the complete saturation of the resin to all points in the splice — due to the extremely low viscosity of the resin before it sets. In this cut-away the shielding tape, jumper wires, connector and conductor strands are shown as they appear imbedded in resin. Note that the resin has penetrated even into the spaces between the conductor strands.

● Fig. 10

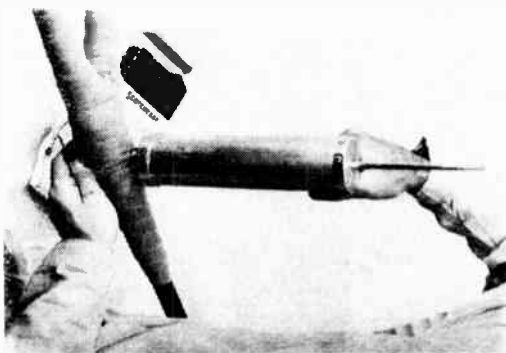

● Fig. 11

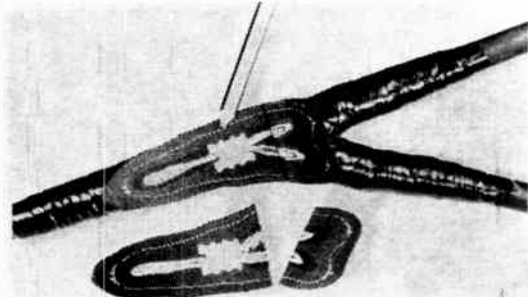

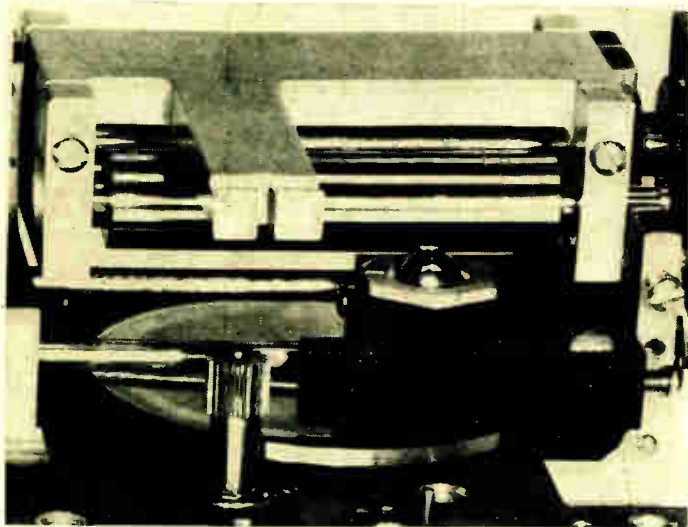

● Fig. 1: Ball and disc indicator

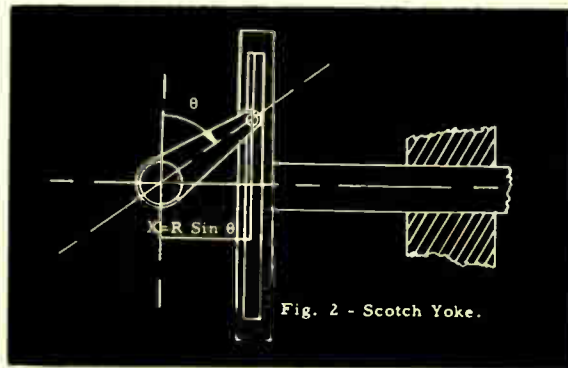

Fig. 2 - Scotch Yoke.

● Fig. 2: Scotch Yoke Mechanism

# Electronic Analog Computers

by B. FARRELL CHOWN, M.A.Sc. P.Eng.

*Head, Analog Analysis Department,  
Computing Devices of Canada Limited*

ONE of the more difficult things about analog computers is deciding on an acceptable definition. Many hours have been spent with learned people discussing how an analog computer differs from a simulator, and how it differs from a model.

One way of defining an analog computer is to say that it is a machine which can be adjusted so that certain physical quantities in the machine behave in the same way as other physical quantities in some other system. By this definition, the speedometer in a

car is an analog computer. It determines the speed of a car and drives the pointer to vary in the same way as the car's speed varies.

There are two features about a speedometer which are common to all analog computing elements:

First its accuracy is limited. One may, with great pains, construct a very precise speedometer but the basic principle of operation is bound to limit the accuracy at a value of perhaps one tenth of one per cent, which by digital computer standards is really quite crude.

Second, it makes its calculation continuously. There is no need for any storage of intermediate results as occurs with digital machines. Also, since it does not carry out its calculation step by step there is no need to set up a sequence of operations. This is generally true of analog computation so that in this field the term "programming" which is used in digital work has no place.

If one accepts the foregoing broad definition of analog computer then it is found that the art of analog computing goes back for thousands of years, for in very early days men undertook to build devices which

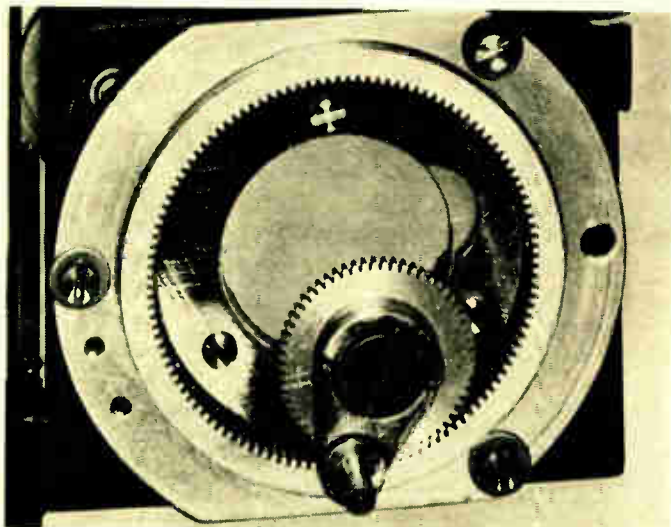

● Fig. 3: Geared Sine Crank.

would behave in a way analogous to the sun's apparent motion around the earth.

The hour glass is an example of another feature of analog computing.

The ancients did not find it necessary to reduce the motion of the sun to mathematics to construct an analog. They simply sought a device which would behave in about the same way. This practice continues today in analog computing when one is faced with problems for which no good mathematical description exists, for instance in computing the effect of a human pilot on the flight of an aeroplane.

In spite of this ancient past, the history of analog computing did not become really active until the time of Lord Kelvin. Both he and Clerk Maxwell, (the author of Maxwell's Equations) became interested in a device known today as a ball and disc integrator. This gadget consists of a disc which can be rotated. A ball which is held in a cage can be positioned anywhere along a diameter of the disc. The third element (See Fig. 1) is a cylinder on the side of the ball opposite to the disc. As the disc is rotated the ball rolls on the disc and its rotation is transmitted to the cylinder on the opposite side. The rate of rotation of the cylinder is proportional to the product of the distance of the ball from the center of the disc. That is:

$$\frac{d\theta_{cyl}}{dt} = K D_{ball} \frac{d\theta_{disc}}{dt}$$

Integrating one obtains

$$\theta_{cyl} = \int (K D_{ball}) d\theta_{disc}$$

Thus the device is capable of integration. If the disc is rotated at constant speed, for instance, and if the ball is positioned so that its distance from the center of the disc is proportional to speed, then the number of turns of the cylinder will be a measure of distance traveled.

The ball and disc integrator is a purely mechanical device. There are many other mechanical elements which can duplicate useful mathematical operations. The differential is probably best known of these, since it appears in every car. This mechanism, as used in a car, operates so that the number of rotations of the left rear wheel plus the number of rotations of the right rear wheel is equal to a constant times the number of rotations of the drive shaft. The constant depends on the number of teeth in the gears giving the right angle drive. If this constant is made equal to unity it is seen that the differential is capable of addition. Very precise miniaturized mechanical differentials are used in mechanical analog computers.

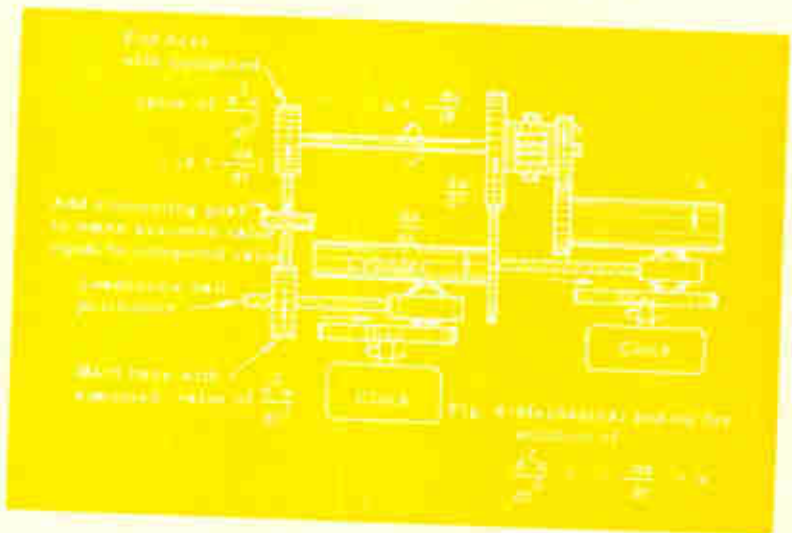

Fig. 4

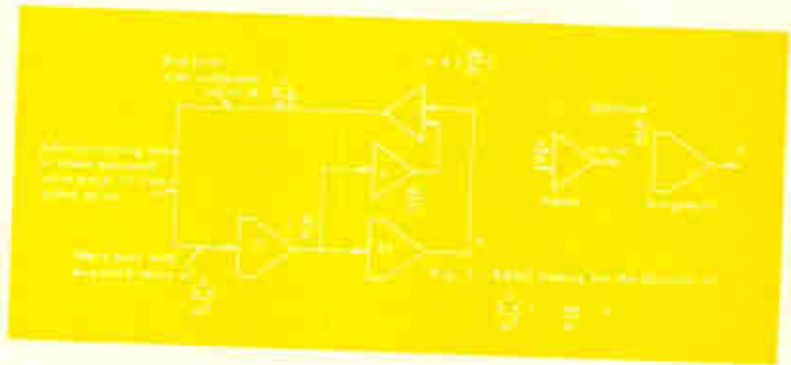

Fig. 5

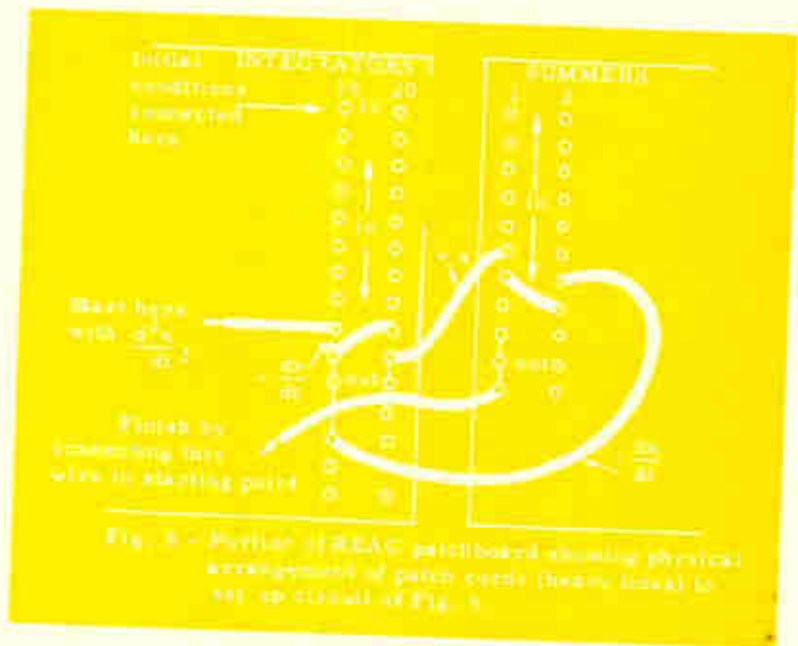

Fig. 6

### Mechanical Generation Of Sine and Cosine

A third mechanical device is the mechanical generation of sine and cosine. The classical example of a mechanism which moves sinusoidally is the Scotch Yoke (Fig. 2). In this

device a stud on a crank engages in a slot in the head of a "T" shaper bar. If the leg of the T is located over the crank axle, then the leg will move back and forth a distance proportional to the sine of the crank angle as the crank

(Continued on page 67)

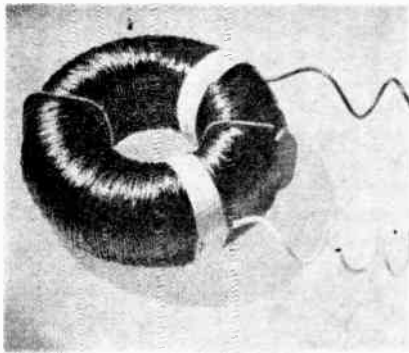

● Fig. 1: Typical Toroidal Coil

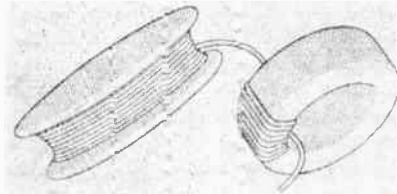

● Fig. 2: Hand winding of toroidal coils can be accomplished by the use of a long, narrow shuttle. The shuttle is passed through the center of coil for each turn.

**P**HYSICALLY, the toroidal inductor is a length of insulated copper wire wound on a doughnut-shaped core. In use, it is usually inter-connected with capacitors to form a resonant or antiresonant circuit in an electric wave filter which selects or rejects specific bands of frequencies. The toroidal shape is not selected because of physical convenience. It is more an electrical necessity. Coils can be wound on any number of different shape cores, but few shapes are as electrically suitable as the toroid. A typical coil is shown in Fig. 1.

The core material, wire size and type, and winding pattern are determined largely by the electrical characteristics desired. For use in carrier circuits, cores are pressure molded

of powered metal mixed with plastic as a binder. Carbonyl iron or Molybdenum-Permalloy iron powders are the most frequently used core metals. Either stranded or solid wire is used, depending upon electrical requirements.

Once the core has been molded, the manufacture of a coil entails two main operations:

# Modern Coil Winding Methods

*Lenkurt Electric Co. - San Carlos, Calif. & Vancouver, B. C.*

1. Winding the wire on the core.
2. Determining the exact amount of wire needed for the inductance desired.

The first of these operations is purely mechanical. The second can be achieved roughly by calculation or accurately by measurement. For some applications of toroidal coils, the required amount of wire can be determined by calculating the number of turns to wind. However, an accuracy of only about  $\pm 5\%$  can be achieved because of the difference in permeability of individual cores.

For filter applications, this is not normally accurate enough. The amount of wire must be determined by measuring the inductance of the completed coil and making adjustments in the number of turns.

The Lenkurt technique combines the operations of winding and inductance measurement and performs them simultaneously. In this way, unit of manufacturing time and the possibility of error are reduced.

## The Winding Technique

The toroidal coil winding machine winds a coil in much the same manner as if it were wound by hand. In hand winding (Fig. 2) a length of wire is first wound onto a long narrow shuttle that will pass through the hole in the core. The shuttle is then passed repeatedly through the center and around the core until the desired number of turns is reached. As the winding progresses, wire is unwound from the shuttle.



● Fig. 3: A complete toroidal winding installation. The principal components of the equipment are: (a) turn counter and loading pulleys; (b) inductance measuring panel; (c) standard coil; (d) tension arm; (e) shuttle; (f) oscilloscope; (g) winding machine; (h) core holder; (i) tension pin; and (j) core.

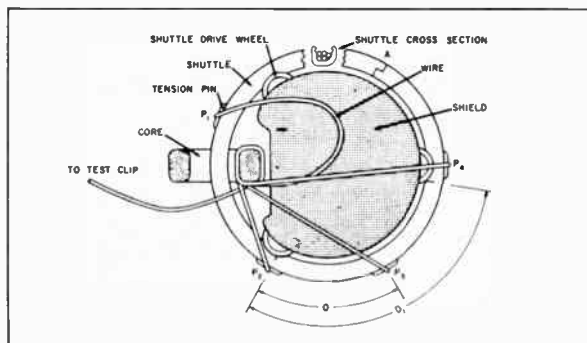

● Fig. 4: The shuttle, tension pin, and wire at various stages of the winding cycle. While the shuttle moves through the arc  $d_1$ , the tension pin moves through the arc  $d$ . The difference between arcs  $d_1$  and  $d$  is the length of wire removed from the shuttle and wrapped on the core in one turn.

When used in winding machines, the shuttle assumes a different form—that of a thin, ring-shaped sheave. Various views of the shuttle are shown in Figs. 3, 4, and 5. The inside surface of the shuttle is shaped in such a manner as to allow it to rotate on the machine's three drive wheels. To hold the wire that is to be wound on the core, a groove is machined in the shuttle's outer surface. A cross-sectional view of the shuttle is shown in Fig. 4.

Since the shuttle must rotate through the center of the core, a break in the shuttle (Fig. 4, point A) permits it to be spread apart for insertion in the core. The shuttle and the core are then placed in their respective positions on the winding machine and a supply of wire is wound onto the shuttle.

A tension pin (Fig. 3, 4, and 5) slides in small grooves machined on the inside surface of the wire-holding cavity of the shuttle. This pin controls the unwinding of wire from the shuttle. It helps keep the wire uniformly taut during the winding operation. As each turn is placed on a core, a length of wire equal to one wrap around the core is pulled through the tension pin.

The process is illustrated by the drawing in Fig. 4 which shows four positions of the wire during the cycle  $P_1$ ,  $P_2$ ,  $P_3$ , and  $P_4$ . The photos in Fig. 5 show these same four positions on an actual winding machine.

The winding cycle begins at point  $P_1$ , where a turn of wire is about to be placed on the core. From this point, the tension pin rotates to position  $P_2$  where the wire draws taut. As the shuttle continues to rotate past  $P_3$ , the tension pin slides in its grooves until a length of wire is unwound from the shuttle. At point  $P_4$ , the wire ceases to unwind from the shuttle and the tension pin advances again to point  $P_1$ , where another turn loop begins for repetition of the cycle.

The tension arm (a) shown folded back away from the wire in Fig. 5 normally rides against the loose wire loop and keeps it taut while the shuttle progresses from  $P_1$  to position  $P_2$ . Under operating conditions, the arm is locked firmly into place.

During the winding process, the core holder (b) is moved back and forth about a pivot so that layers of wire can be evenly distributed on the core.

#### Inductance Measurement of Coils

Before the development of present measurement techniques, coils were wound with more turns than calculated to be necessary for an average core. The inductance was then measured and a number of turns were removed to obtain the desired value. Often as many as 100 turns would have to be removed from a core with high permeability to meet requirements.

With use of the measuring tech-

nique developed at Lenkurt, the time required to wind and test a coil was cut in half. With this technique, the coil inductance is measured while the coil is being wound. When the desired inductance value is reached, the operator stops the machine and the coil is completed—to a tolerance of 1 per cent or better.

The inductance of the coil being wound is measured by comparing its inductive reactance to that of a known "standard" which is being duplicated. This is accomplished by substituting it during winding for the standard coil in a measuring circuit. To make the comparison, a signal is transmitted through the standard coil and compared to a reference signal by using an oscilloscope. Figure 6 shows a block diagram of the measuring equipment and photographs of typical oscilloscope patterns. A decade capacitor is adjusted so the phase of the signal from the standard coil is identical to that of the reference signal. Under this condition, the oscilloscope screen presents a straight line inclined  $45^\circ$  from the horizontal.

At the beginning of the winding process, the measuring circuit is switched from the standard coil to the unit being wound. The winding is complete when the oscilloscope presentation matches that for the standard. A test clip and a brush which rides on the shuttle during winding constitute the two input leads to the measuring panel.

At the start of winding, the reference and measured signal are out of phase and an elliptical oscilloscope pattern is present. As the coil is wound, the phase difference decreases and the pattern changes into a straight line. At this point, the inductance of the coil being wound equals the inductance of the standard. Once the measuring equipment has been adjusted for a particular coil, additional identical coils can be wound rapidly and measured accurately by observing the oscilloscope pattern.

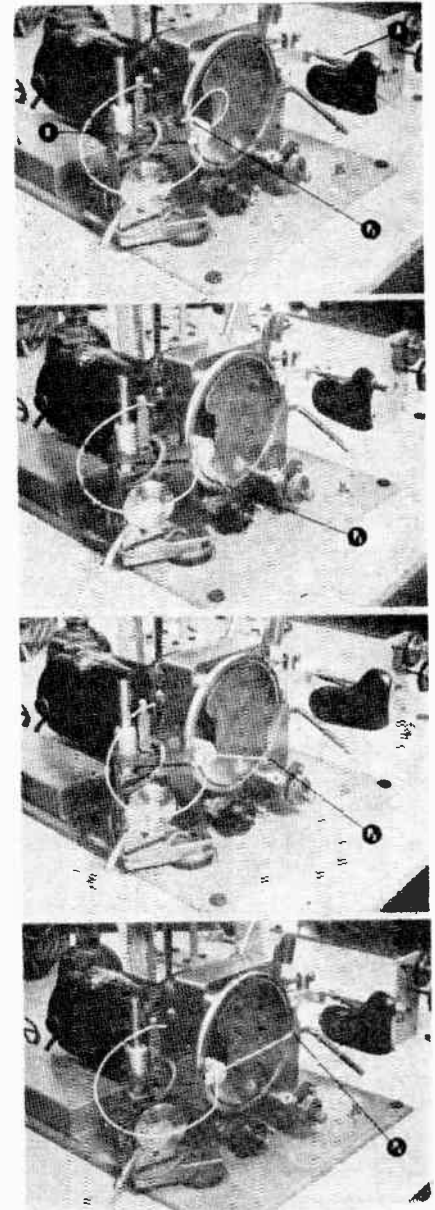

● Fig. 5: Four positions of the shuttle during the winding cycle — points  $P_1$  to  $P_4$  in Fig. 4. Ordinarily, fine copper wire is used in the machine; white wire was used in these photos for clarity.

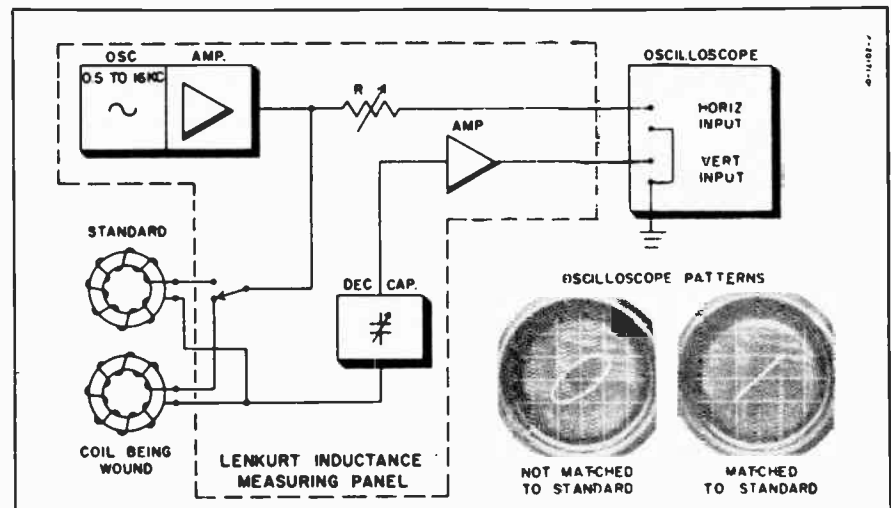

● Fig. 6: A block diagram of the inductance measuring equipment. Typical output oscilloscope patterns are shown in the inset.

# Automatic Machining Of Germanium

**Milling Machine Equipment Designed Specifically For  
The Automatic Machining Of Germanium, Silicon And  
Quartz Meets Approval of Transistor Manufacturers.**

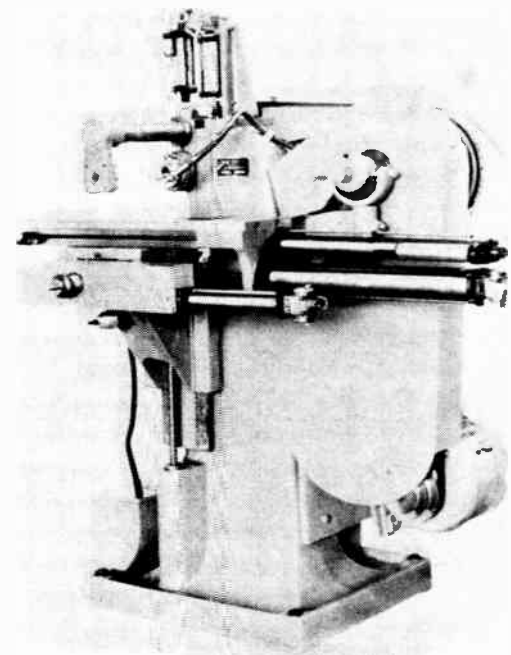

● Completely automatic the new milling machine has won favor with manufacturers in the electronic industry.

**M**ILLING of germanium, silicon and quartz for manufacturing transistors, oscillators and related electronic products is now being accomplished with special milling machines. These completely automatic units are being used to "cut off" material to proper size by using a diamond impregnated rotating disk, supported on a revolving arbor.

There is no arbitrarily accepted best method for machining this type of material, since it is a relatively new field. Table feed rates and other variables are determined only after extensive experimentation. However, the unusual flexibility of the new type mill allows complete freedom during such experiments. The table feed speed and cycle may be adjusted to requirements. Special spindle speeds, arbor sizes, table cycles, etc., may also be readily added.

The material is brought to the mill in the shape of a cylinder, generally not more than five inches long and one inch in diameter. This boule, as it is called, is first sliced into strips from .010 to .125 inches thick. Then these wafers are lapped and/or etched to their proper size and finish. This operation, termed "dicing," is usually done with a "gang" of blades on a single arbor.

After the first cut is made, the work-holding fixture is indexed 90°, and the milling operation repeated. This produces a number of square pieces from each wafer.

Completely automatic operation of the mill makes possible the most complicated table feed cycles specified by users. Here is a typical sequence of operations: head descends, table feeds longitudinally, head retracts, table retracts, saddle feeds in, head descends, etc. Cycle is automatically repeated until entire boule is milled.

Infeed of the saddle is accurately controlled from .001 inch to .150 inch per cut. Amount of feed can be adjusted to fit needs.

Unusual feature of the special mill is that the infeed indexing clutch is mounted inside the pinion gear, which in turn meshes with the rack attached to the air cylinder. An additional rack attached to the positive stop meshes with the same pinion gear and contacts a positive stop. This latter action keeps the air cylinder's thrust controlled to the amount of infeed needed.

During the retraction stroke, the one-way indexing clutch permits returning the cylinder rod to its starting position without feeding. Table and head feed are the same as those on the standard unit.

The new type mills used for machining germanium must be more carefully built than is common in standard commercial practice. V belts are carefully selected, pulleys balanced, run-outs minimized, vibration and over-all performance scrutinized. Self-aligning ball bearing arbor support brackets and pilot type arbors must be

used. Dynamically balanced drive motors are recommended.

Clear water is used as a coolant to prevent contamination and to assist in reclaiming the valuable chips. All efficient slicing operations require the use of copious quantities of coolant. Double coolant tanks can be furnished to permit filtering the returning liquid, and to assist in reclaiming the chips.

The new type equipment offers a number of important basic advantages over other methods of machining germanium and similar materials. First of all, the arbor on which the diamond blade is secured may be supported on its outer end by a conventional milling machine outboard support and as mentioned earlier, table feed speed and cycle may be "tailored" to requirements, and special spindle speeds, arbor sizes, table cycles, etc. may be readily added.

## Radome Testing System

**A** SERIOUS problem in the proper performance of modern radar tracking systems is presented by beam deflection caused by the non-uniformity of the plastic radome wall. Of importance to the manufacturer of plastic radomes as well as the aircraft and engineering firms installing and testing radar equipment is the CTI Radome Boresight-Error Measuring System which automatically records beam deflection as a continuous function of radome position, and requires far less time and does not miss discontinuities often overlooked by manual, point-by-point measurements.

In operation, a transmitting parabola on the end of a null-seeking boom directs a pencil beam at the radome and receiving antenna located at the other end of a 1500-inch range. The received signal, by means of a servo system, positions the null-seeking boom to the apparent axis of the receiving antenna as seen through the deflecting radome. While the motor-driven Radome Holding Fixture rotates, three recorders, synchronized with the position of the radome, plot the magnitude and the horizontal and vertical components of the beam deflection angle as re-

presented by the position of the null-seeking boom.

Although usually supplied as a complete system, for transmission efficiency measurements, antenna pattern plotting, or to augment existing antenna ranges, combinations and modifications of the following basic components are in use by industry engineers: Null-Seeking Boom and associated error and servo amplifiers, Radome Holding Fixture and Control Panel, R-F Transmitter, Log-Linear Amplifier, and Recording System.

# Fire Protection for Remote Radio Relay Stations

**Rate-of-temperature-rise carbon dioxide fire extinguishing systems protect remotely located radio relay stations in the Bell Telephone network.**

**R**ADIO transmission carries telephone communication in certain remote areas. This is the Bell System's answer to handling traffic in areas not considered feasible to transmit by line or cable.

For example, in two remote areas of Canada — between Bala and Bracebridge and between Little Current and Killarney — trailer housed radio relay stations provide six circuits over a distance of thirty to forty miles. Signaling may be arranged for either dial or manual operation and calls are then fed into standard lines for connection to over 95,000,000 phones throughout the world.

For both the Bala-Bracebridge and the Little Current-Killarney systems, two trailer set-ups are required —

one at each end. The four trailers were manufactured by Gardner Trailers Ltd., and outfitted by Bell engineers.

The equipment in each trailer has been arranged as two independent systems so trouble in one would not mean a discontinuance of service. The trouble-free system would continue to function.

The trailers normally will be powered by Hydro. An emergency gasoline power unit is mounted in the rear of the trailer to maintain service in case of main power loss. This may be used for the sole power source if the system is needed for only a short time. If Hydro is not available and power is required for a long period, an auxiliary diesel can be used.

The need to protect these unattended and valuable electrical relay stations against loss or damage by fire was paramount in the minds of Bell engineers. As a result Walter Kidde & Company of Canada Ltd. provided automatic rate-of-temperature-rise carbon dioxide fire extinguishing systems for each trailer. Should fire flash, rate-of-temperature-rise fire detectors actuate a 50-lb. cylinder of the fire smothering gas.

The pressurized gas floods from its cylinder, passes through piping to the power generating compartment, and discharges from Multijet nozzles in sufficient volume to smother the blaze immediately. The carbon dioxide piping in each trailer has built into it a two-pole, hi-shock pressure-operated switch which is tripped by the passage of the gas. When thrown it de-energizes power generating equipment ignition switches.

Bell finds carbon dioxide ideal for fire safety applications of this kind. Besides being self-powered and automatic, carbon dioxide is a non-conductor of electricity and being an inert gas cannot damage electrical equipment or motors. Finally, as it eventually dissipates into the atmosphere following discharge it leaves no mess to be cleaned up.

# Wire Cutter Meets Specific Needs Of Electronics Industry

**A** NEW automatic wire cutting and stripping machine, with features designed to meet specific needs of the electronics industry, has been produced by the Eubanks Engineering Co.

The machine is designed to cut single conductor, solid or stranded wire of from 32 ga. to 12 ga. in

• This new automatic wire cutting and stripping machine was designed for high speed operation (for example, 6,000 6-inch pieces an hour) and fast set-up changes. The machine cuts 32 ga. to 12 ga. wire automatically to lengths of from 1" to 300" and strips 1/8" to 1" of insulation from one or both ends.

lengths of from 1 inch to 300 inches and to remove the insulation from one or both ends without scraping or cutting strands. The strip lengths may be varied from 1/8 inch to 1 inch.

The equipment has been field-tested in several aviation and electronics plants and, according to the manufacturers, has proven to be economical for short-run as well as long-run production.

Wire travels through the machine at speeds up to 150 feet per minute, with split-second stops for cutting and stripping. Production rates at top speed range from approximately 350 300-inch pieces per hour to more than 8,000 1-inch pieces per hour.

In setting out to develop a machine for the electronics industry, F. G. Eubanks, the designer, had several objectives. He wanted a machine capable of producing accurate lengths and clean strips at a high rate of speed and of standing up under high-volume operation with a minimum of maintenance.

At the same time, he saw a need for a machine that could be used economically for short runs of from four or five to 100 wires. The machine that has been developed meets both of these objectives. Test models have been operated daily over periods of

several months under actual production conditions without need for repair. On the other hand, because of the speed with which set-up changes can be made, the machine can be used economically in prototype work to cut and strip wires of varying lengths for a single harness.

Changes in wire length can be made in less than one minute by means of a micrometer adjustment, and wire sizes and strip lengths can be changed in less than five minutes.

Because of its simplicity, the machine can be set up and operated by an unskilled operator.

The machine, controlled from a central panel, uses both electric and pneumatic power. The feed rolls are motor driven and pneumatically controlled. Pneumatic power is also used to operate the cutting and stripping mechanism and to eject the finished wires.

Among other features, the makers point out that the machine is semi-portable, that it can cut and strip tough insulation, such as Teflon and Fiberglass, and that it can be synchronized with accessory equipment, such as a marking device or an induction heating unit for reflowing the tin on stranded wires before cutting and stripping.

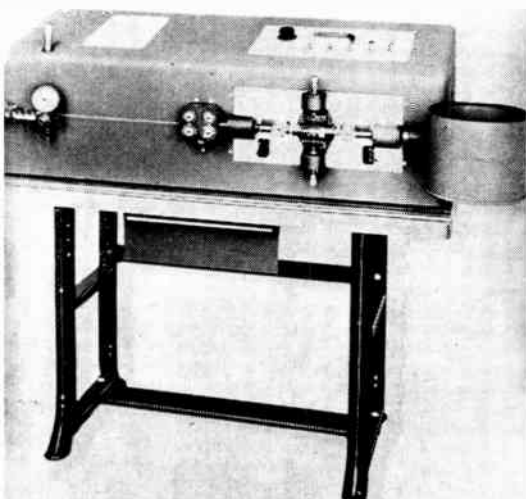

and now

# Kineplex<sup>®</sup>

a high-speed digital transmission system

## to double communication capacity

### DATA

3,000 bits per second  
or 40 teletypewriter channels  
of 100 words per minute in  
a 3 kc bandwidth, or a  
combination of the two.

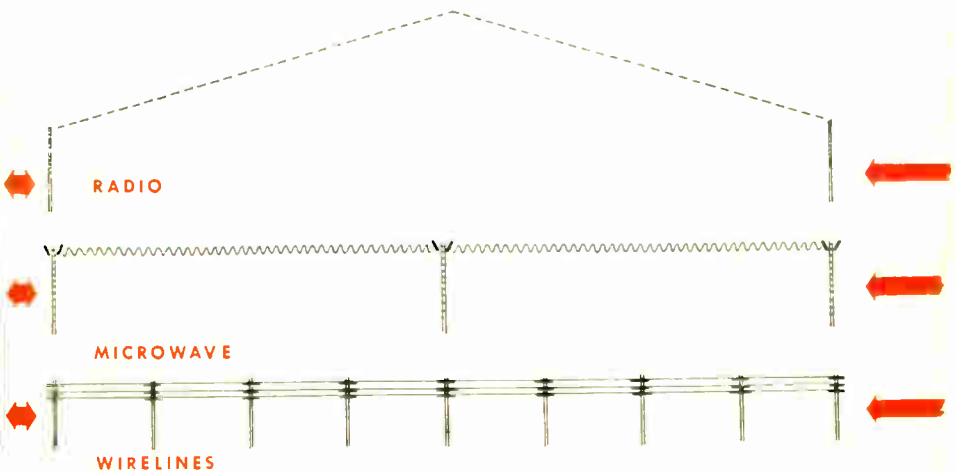
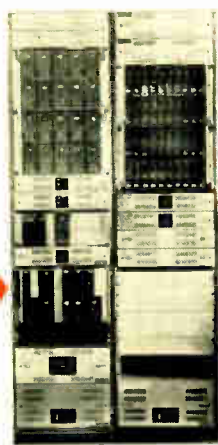

*Collins*

**CREATIVE LEADER IN COMMUNICATION**

**COLLINS RADIO COMPANY OF CANADA, LTD.**

11 Bermondsey Road, Toronto 16, Ontario, Phone PLYmouth 7-1101



# Collins also leads development in the fields of

Another major stride forward in communication. From the research and development laboratories of Collins Radio Company comes KINEPLEX — a spectrum conserving, high-capacity, synchronous data system which transmits and receives 3,000 bits of information per second on a 3 kc band, with superior signal-to-noise performance.

Adaptable to wireline, cable, radio, or microwave facilities, KINEPLEX provides twice as many channels on a 3 kc band as present day carrier teletypewriter systems. In teletypewriter applications this means 40 channels on a 3 kc band at 60, 75, or 100 words a minute operation.

KINEPLEX will take stored business machine data in serial or parallel form and transmit it at the same 3,000 bit per second rate. Material can be fed from magnetic tape, paper tape, punched cards, or other storage media.

KINEPLEX can also be used for telemetering, supervisory control, and facsimile. The total data transmission capacity of the system can be divided between various services to fit specific applications. Write today for literature on Collins new TE-202 KINEPLEX Data System.

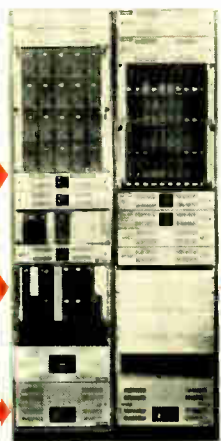

## DATA

3,000 bits per second  
or 40 teletypewriter channels  
of 100 words per minute in  
a 3 kc bandwidth, or a  
combination of the two.



For additional information: call your Collins sales office or write for technical brochure.

## AVIATION

Collins completely outfits airline, military and business aircraft with the most advanced communication, navigation, flight control and instrumentation systems in aviation. Many new lightweight, reduced-size versions are now being delivered. Collins designed the original Integrated Flight System, leads in combining comm/nav/ident units into a single compact "CNI" package for new military aircraft, and continues to pace the industry in developments in airborne radar, ADF, ILS, VOR, HF and VHF communication.

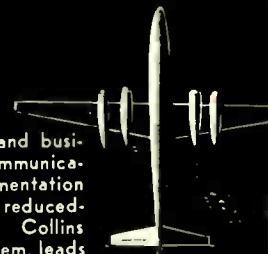

## GROUND COMMUNICATION

Collins engineers, designs and supplies the equipment, installs, and puts into operation integrated point-to-point communication systems of any scope. The Collins system engineering staff is backed by the finest equipment in the world, whether standard MF, HF or VHF, Transhorizon "scatter," microwave relay and multiplex or single sideband HF. Typical of Collins communication progress is "Kineplex" — a high speed data transmission system doubling communication capacity.

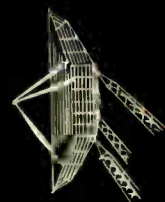

## AMATEUR RADIO

In the early 1930's Collins set the standard in Amateur radio and, through continuous design and development, has raised this standard to its present single sideband station — the most honored and prized in the Amateur fraternity. This station is the top performing rig on the air with its kilowatt KWS-1 transmitter and highly selective 75A-4 receiver. Many of the leaders in the electronics industry became acquainted with Collins through the Company's superior Amateur equipment.

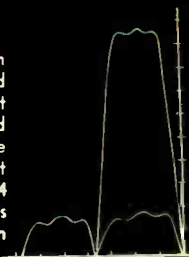

## BROADCAST

Collins supplies a complete new AM station from mike to antenna or modernizes existing facilities. Besides the superior line of transmitters, Collins supplies the broadcaster's needs with such advanced additions as TV-STL microwave relay system, the lightest 4-channel remote amplifier on the market, phasing equipment and audio consoles. Collins field service organization has built an enviable reputation in assisting the broadcaster in installation or in times of emergency.

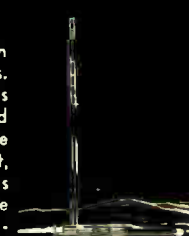

## COMPONENTS AND TEST EQUIPMENT

The degree of precision and reliability of Collins products requires development by Collins engineering of components such as Autotunes and Autopositioners, Mechanical Filters, oscillators, heat reducing tube shields and ferrites. These developments and other high quality components are sold by a Collins subsidiary, Communication Accessories Company of Hickman Mills, Missouri. The same principles of accuracy and reliability apply to Collins test equipment, built especially for Collins but adaptable to testing other equipment types.



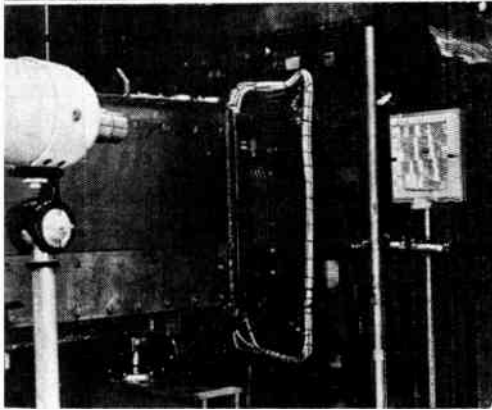
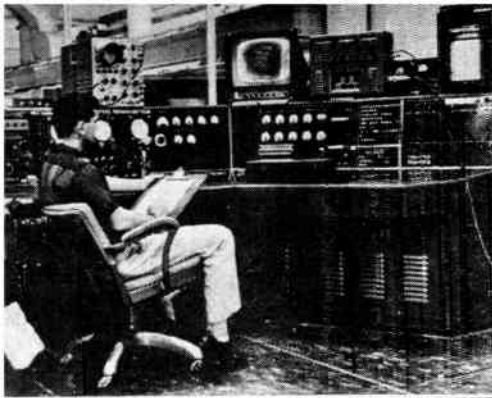

● *Top:* Picture of sodium iodide mosaic used to view 3 Bev external proton beam from Cosmotron appears on TV screen at remote monitoring station. *Bottom:* Closed-circuit television is shown set up to transmit picture of sodium iodide mosaic.

# Closed Circuit Television Furthers Study of Proton Beam

**I**N what is believed to be the first application of its kind in the field of nucleonics, the versatile closed-circuit television camera is now being put to work observing a high-energy proton beam.

At Brookhaven National Laboratory, the problem of safely studying the shape of this beam has been solved by the installation of a small five-pound television camera.

Through pictures transmitted by the TV camera to a remote monitor, physicists can now watch the pattern made by the 3 Bev external proton beam on a sodium iodide mosaic with greater clarity and without exposure to radiation. From observation of the

illuminated area of the mosaic, accurate adjustment of the focusing magnets can be made. This orientation is required for the effective bombardment of the nuclei of the matter being studied. The placement of the matter at the proper location for the probing of its composition by the proton beam is greatly aided by the new system.

The ability to remotely control the direction and lens iris and focus of the camera makes possible a clear, bright picture of the beam's patterns despite the low light level of the mosaic. Picture detail is unaffected by the high magnetic pulses created in operating the Cosmotron.

# Point Probe Microanalysis

**"P**oint probe microanalysis," a new metallurgical research technique, permits analysis of steel-specimen areas 10,000 times smaller than is possible by any other method. The new technique was conceived in France about six years ago and is now being developed and refined by scientists at U.S. Steel's Research Center in Monroeville, Pennsylvania.

The point probe method of analysis involves the use of an electron microscope containing a focused electron beam to excite X-ray emission from a region as small as a few microns in diameter. The characteristic X-rays emitted are then analyzed by a crystal spectrometer.

This method has wide application in metallurgy for study of intergranular corrosion, analysis of segregation of alloying elements among the metallic phases and along metallic grain boundaries, measurement of inter-diffusion during welding and plating, and for determining the composition of fine precipitate particles.

The basic instrument being studied and modified at U.S. Steel's Fundamental Research Laboratory is a vertical, 7½-foot electron microscope with a 4-foot electron column.

The steel samples to be studied are placed in a specimen chamber through a door in the base of the column. A vacuum is then created by a standard

oil-diffusion pump. An optical binocular microscope and mechanical stage motion permits the operator to make a visual adjustment of the specimen under the beam.

The beam is generated by an electron gun which accelerates electrons through approximately 30,000 volts. The beam is focused by three electrical lenses. The electron-beam crossover point formed by the objective lens is focused by the repeater lens on the surface of the steel sample.

The focused beam strikes a selected area of the specimen's surface, causing X-ray emission. The X-ray beam is then analyzed to determine its component wave lengths by reflection from a lithium-fluoride crystal. Each chemical element in the sample emits an X-ray of characteristic wave length. The concentration of the element determines the intensity of that wave-length component. At present the instrument is able to detect all elements with atomic number equal to 22 (titanium) or higher.

The X-ray intensity at each wave length is measured by a geiger or proportional counter. The signal is

amplified through a vacuum-tube arrangement to activate a pen on a graph. The X-axis of the graph indicates the wave length and the Y-axis charts intensity. The technician can analyze these data into a quantitative analysis.



● An electron microscope, modified for analysis by X-ray emission spectroscopy of areas a few microns in diameter in steel specimens, is shown being focused by a scientist.

## Special Report

Of interest to Canadian industry are the outstanding developments in military and commercial electronics which have led to the - - -

# Expansion of Britain's Electronics Industry

In every branch of the United Kingdom's electronics industry there has been considerable activity. Extension of television at home and abroad, the lack of communications in fast-developing countries, the widening demand for electronic navigational aids at sea, the increased speeds and height of aircraft, civil and military, "automation" in the factory and the office and the development of atomic plants are all helping to keep the industry "on its toes".

It has already been announced that the provisional value of exports of British radio equipment of all kinds in 1956 was £40.3 million (20 per cent above the record figure for 1955) and of this the direct exports of capital goods accounted for a value of £16.6 million (or about 41 per cent of the total), a new high record and £3.6 million above the 1955 figure. To this must be added the value of equipment installed in aircraft, ships etc., sold to countries abroad — probably bringing the figure to about £20 million.

Activity during the year included the following:

### Communications

\* Tests over 200 miles of a tropospheric "scatter" system for multi-channel communication. Complete links for carrying television signals or up to 60 telephone or teleprinter circuits to be available in 1957.

Contract for complete UHF/FM wide-band radio telephone link in Portugal.

Installation of VHF multi-channel radio telephone system along the National Iranian Oil Company's 600-mile pipe-line between Abadan and Teheran, the contract valued at £326,000.

Radio communication network completed for Shell Petroleum in Western Venezuela providing sole means of communication between headquarters at Maracaibo and the main oilfields at La Concepcion and La Gunillas.

Production of the first transistorized personnel location system in place of bells, lights, and internal telephone systems, messages being received by factory executives, etc.,

by means of vest-pocket receivers. Also on trial with Royal Navy for flight-deck personnel.

### Marine Communications And Navigational Aids

Radio telephone equipment for the Pacific liner *Reina del Mar*, making possible two-way talks throughout the world.

Orders for ship radar received by one firm alone now exceed 6,000 and this firm's equipment is used by over 1,000 ship owners in 45 countries.

Orders received from nine countries for installations in more than 150 ships of the new type radar which shows directly on the cathode-ray tube the "true-movement" of objects instead of relative movement.

Wind-measurement radar introduced and installed in the Antarctic ship *Magga Dan*.

Britain's fastest and largest trawler, *Portia*, equipped with new radar and fish-indicating echo sounder which distinguishes between fish packed on the sea bed and the sea bed itself. The echo sounder has showed indications of marine life at 1,000 fathoms.

### Air Communications And Navigational Aids

Now in production and being supplied to Commonwealth countries and the R.A.F. — a Doppler navigator which is self-contained and is independent of any ground-based station. Immense possibilities for civil aviation are foreseen.

Bristol Britannia now going into service on world flights, carries a mass of British electronic equipment including cloud-collision warning radar.

Latest HF radio telephone equipment provides 200 channels with fully-automatic tuning and enables pilots to speak over distances of more than 3,000 miles.

On B.O.A.C. aircraft on a scheduled flight from London to New York, first use by aircraft of airborne teleprinter automatically recording meteorological navigational reports transmitted from stations in Britain and Newfoundland, special radio receivers being used.

Development of multi-channel recording system for air traffic control for quantity delivery to the R.A.F., up to 20 communication channels being simultaneously recorded on a single magnetic tape.

VHF airborne navigational equipments standard in 24 air forces, including R.A.F., and used by numerous airline and charter companies can now be modified by a kit providing 44 channels and increased automatic tuning.

### Industrial Electronics

Electronic control of machine tools was extended during 1956. Automatic co-ordinate setting through punch cards was applied to jig borers giving automatic dimension settings to an accuracy of 0.0001 inches.

A new 5-stand strip-mill was commissioned at the Velindre works of the Steel Company of Wales with magnetic amplifier control of the generators supplying the 1,800 h.p. motors to maintain appropriate speed of the stands and tension of the strip. A similar equipment has been ordered by the same company for a 4-stand tandem coal mill for the Abbey Works.

Order worth 200,000 dollars from Canadian Department of Defense, production including more than 100 of a new type of signal generator and wide variety of telecommunication measurement equipment.

Signal generators to the value of £23,000 delivered by one company to the Royal Swedish Air Board in face of severe, including U.S., competition.

A new aid to medical research and industry, the "Flying Spot Particle Resolver". A particle down to one micron in weight "examined" on the slide by the TV-microscope has its analysis automatically registered on a dial, within eight seconds, to two per cent accuracy. Application foreseen for cancer research, industrial silicosis, blood content surveys, the eight seconds comparing with half-an-hour by human and possibly not so accurate means.

### Nuclear Research And Control

It has been estimated that the value of electronic equipment in use in U.K. atomic plants is £10 million and possibly more. Here are a few examples:

Very small industrial television cameras, including 3-dimensional for observation with reactors.

Detection gear installed at Calder Hall for warning excessive radio activity caused by faulty fuel containers within the atomic pile.

Equipment being supplied for nuclear power station at Berkeley, Gloucestershire, will be 330 control rod actuators with their respective control panels on sub-station plant.

Numerous monitors for checking contamination of personnel, meters for monitoring gamma activity, instrument for counting out pulses at rates of up to two million per second etc.

(Continued on page 32)

# NEWS



## Color TV Technicians Being Trained by RETS

A first step in the training of technicians for the servicing and maintenance of color television sets was undertaken recently with the opening of a color television course by Radio Electronic Television Schools of Canada Limited. The course under the directorship of Dr. Leslie Hill is being held in anticipation of the future introduction into Canada of color telecasting and is being conducted at the Toronto school of RETS.

Duration of the course is twenty-two weeks and the class of 30 who have enrolled and been accepted for the course are accredited technicians in the servicing of black and white television receiver equipment.

The course which has been prepared exclusively for the Radio Electronic Television Schools of Canada Limited was developed by Dr. Hill, a member of the engineering faculty of the school.



● Modern color television equipment and facilities shown in the above photograph are used by Radio Electronic Television Schools of Canada Limited in their color television course which recently got under way at the school's Toronto headquarters. Shown in the photograph are some of the thirty students who have enrolled for the course.

## DDP Places Large Contract With Collins Radio

Collins Radio Company of Canada Ltd. have received a 2.8 million dollar contract from the Department of Defense Production for an advanced design of Airborne HF Equipment. The AN/ARC-38 has been ordered for new and existing long and medium range aircraft. It is the military equivalent of the Collins 618S HF Transceiver which has been in world wide airline use for several years. The AN/ARC-38, by use of a stabilized master oscillator, has a channel capacity of 35,000 channels as compared to the crystal controlled 618S which has 144 channels.

The equipment provides A.M. or CW. communication in the range of 2 to 25 mc at a power level of 100 watts. Frequency control is obtained by means of a crystal stabilized master oscillator, and twenty frequencies may be preset. Frequencies as close as 500 c.p.s. may be selected in the range of 2 to 14 mc, or as close as 1000 c.p.s. in 14 to 25 mc. When used in conjunction with an automatic antenna tuning unit, such as the Collins 180L-3, tuning and loading is completely automatic after a channel has been selected. The channel change time is less than five seconds.

The equipment is of a unique modular construction which is conducive to ready maintenance and an economy of spare parts. All modules except those for the stabilized master oscillator are

interchangeable with the modules of the Collins 618S. Mechanically, the AN/ARC-38 can be fitted in the space normally utilized by the Collins 618S.

The power requirements are extremely modest for equipment of 100 watt rating. Both DC and DC 400 c.p.s. power supplies are available.

## Canadian Electronic Wholesalers Plan Year's Meetings

The annual meeting of the Eastern Division of Canadian Electronic Wholesalers' Association will be held in the Mount Royal Hotel, Montreal, Que., on Monday, March 18th, 1957, commencing at 10:00 a.m. I. Morris, chairman of the Eastern Division, will preside.

The annual meeting of the Western Division of Canadian Electronic Wholesalers' Association will be held in the Empress Hotel, Victoria, B.C., on Wednesday, April 24th, 1957, commencing at 9:00 a.m. John Dunn, chairman of the Western Division, will preside.

The annual meeting and convention of Canadian Electronic Wholesalers' Association will this year be held in the Empress Hotel, Victoria, B.C., on Thursday and Friday, April 25th and 26th, commencing at 9:00 a.m. John Dunn, president of the association, will preside. A feature of this year's national convention will be the display of new electronic products in the convention hall. Information may be secured by writing the Secretary, John T. Rochford, 25 Taylor Drive, Toronto, Ontario.

## Eitel-McCullough Name Marketing Executives

O. H. Brown has been named director of marketing for Eitel-McCullough, Inc., San Bruno, California, manufacturer of Eimac electron power tubes. Mr. Brown, who joined Eimac in 1941, is widely known in the electronics industry through contacts made as the firm's manager of commercial marketing. He is a senior member of the Institute of Radio Engineers and a veteran amateur radio operator with the call letters W6HB. He succeeds Frank Mansur, who recently resigned as director of marketing.



O. H. BROWN



W. H. McAULAY

William H. McAulay, previously manager of application engineering at Eimac, has been appointed assistant to the director of marketing. Mr. McAulay served as an instructor of radar for the Navy at Massachusetts Institute of Technology during World War II. Prior to joining Eitel-McCullough, Inc., in 1954 he was station engineer and transmitting engineer with the National Broadcasting Company.



A. C. STEWART

S. T. LUCK

J. S. FULTON

● To systematically handle rapidly increasing sales of carrier and radio communication equipment, Mr. C. R. Hughes, president, has increased the head office sales staff of Automatic Electric Sales (Canada) Limited. The following appointments are now in effect. J. S. Fulton is responsible for carrier sales to telephone systems. S. T. Luck handles carrier sales to railways and rural telephone companies. A. C. Stewart specializes in radio systems for all applications. These men are responsible to R. C. Fawcett, manager, Carrier and Radio Sales.

### Engineering Alumni "Award Of Merit"

At each Triennial Reunion, the Engineering Alumni Association of the University of Toronto presents two medals to two outstanding graduates in engineering. The next Triennial Reunion will be held November 1 and 2, 1957.

The purpose of the "Award" is to recognize the achievements of engineers, graduates in Applied Science of the University of Toronto, who have contributed greatly to engineering knowledge, or who through the skilful application of their engineering training have been successful in developing methods or machinery for the advancement of Canadian industry, or whose accomplishments have contributed to the comfort, convenience or welfare of humanity.

The Engineering Alumni Medal Committee is ready to receive nominations of engineers whose qualifications, as outlined above, commend them as being eligible to receive the "Award of Merit" Medal.

Nominations, which must be filed before July 1, 1957, and which must be accompanied by full details of the achievements and merits of the nominee, should be sent to J. Dudley Barnes, Secretary, Engineering Alumni Medal Committee, c/o Canadian Standards Association, Box 506, Weston, Toronto 15, Ontario.

### R. E. T. S. Conducts Industrial Electronics Course

The Radio Electronic Television Schools of Canada Ltd., with head office in Toronto and branches from coast to coast, are including in their available tuition courses one on Industrial Electronics.

Dr. Leslie L. Hill, Ph.D. (Eng.), chief engineering consultant for R.E.T.S., is the author of the course.

Entrance requirements are that the student should have a basic knowledge of mathematics and physics and should have passed his Junior Matriculation. The syllabus covers twenty lessons.

(Turn to page 38)

## ECLIPSE-PIONEER SYNCHROS



### FOR SERVO MECHANISMS AND COMPUTING DEVICES

A complete line of high accuracy transmitters, receivers, resolvers, differential and linear synchros is available in sizes 10, 11, 15 and 22 — standard or corrosion resistant models.

Fast delivery on small quantities for your engineering prototypes.

**AVIATION ELECTRIC**  
LIMITED

CANADIAN AFFILIATE OF BENDIX AVIATION CORPORATION



## Beatty Telemasts

**FOR COMMERCIAL COMMUNICATIONS**

Masts to 200 ft.—single, twin-H, and quadruple — designed to CSA specifications. Hot galvanized steel, resistance welded to Canadian Welding Bureau standards, in accurate jigs that insure easy and perfect erection. 10-foot sections completely hot galvanized after all fabrication. Galvanized hinged steel base and complete line of attachment fittings.



**BEATTY BROS. LIMITED**  
Fergus, Ont. Est. 1874

## LEADERS IN QUALITY, AVAILABILITY

For a complete line of  
RECEIVING AND PICTURE TUBES

POWER AND TRANSMITTING TUBES

TRANSISTOR, DIODES AND RECTIFIERS



# Electronic TUBES

CANADIAN GENERAL ELECTRIC COMPANY LIMITED

# ElectroData Appointments



Top row, left to right: George Glinski, D. H. Peacock, W. J. McDowell, W. R. Wade.  
Bottom row, left to right: R. Mason, C. J. Williams, W. H. Jenkins, G. V. Scully.

## ElectroData Expands In Canada

In keeping with the general expansion of ElectroData Division of Burroughs Corporation in the United States, the Canadian services and activities of ElectroData have recently undergone an extensive expansion and re-organization program.

ElectroData Division of Burroughs Adding Machine of Canada Limited with Canadian regional offices in Ottawa provides sales, technical and field engineering service to all of Eastern Canada—Ontario, Quebec and the Maritime provinces.

Mr. George Glinski, P. Eng., Dipl. Eng., regional manager for ElectroData, heads up the Canadian ElectroData organization. Mr. Glinski is a pioneer in the field of electronic data processing and computation. Sales and technical application services for the Eastern Canadian area come under Mr. D. H. Peacock, as district manager. Mr. Peacock was formerly sales manager for Computing Devices

of Canada Limited and more recently vice-president and managing director of Data Processing Associates Limited. Mr. W. J. McDowell has been appointed district supervisor of field engineering. Mr. McDowell will supervise the field engineering and maintenance services for ElectroData in Eastern Canada.

ElectroData Division of Burroughs Adding Machine of Canada Limited also announce the opening of two new sales offices — one in Toronto, Ontario and one in Montreal, Quebec, with the following new appointments.

Mr. William Ross Wade, formerly assistant to the vice-president of General Steel Wares Limited, Toronto. Mr. Wade will be located in Toronto and will fill the position of technical sales representative.

Mr. Colin J. Williams will fill the position of technical sales representative in the ElectroData Ottawa Office.

Mr. George V. Scully is appointed sales representative for the ElectroData Montreal sales office.

Mr. Reginald Mason has been appointed ElectroData sales representative for the Toronto area, and Mr. William H. Jenkins will fill the position of technical sales representative for Montreal and area.

The ElectroData Division of Burroughs Adding Machine of Canada Limited is responsible for the sales, rental and servicing of the DATA-TRON electronic data processing systems, the Burroughs E101 desk-size digital computer and the G101 high-speed printer. To date two DATA-TRON computer systems have been installed in customers' plants in Canada and one Burroughs E101 is available for demonstration purposes.

**Bendix**  
**SCINTILLA**  
**CONNECTORS**



- ▶ DELIVERY IS RIGHT
- ▶ PRICE IS COMPETITIVE
- ▶ QUALITY IS TOPS

BENDIX-SCINTILLA connectors are now available in Canada. Profit from the dependable performance of these famous connectors.

Fast delivery of AN Types A, C and E from Montreal stock.

**AVIATION ELECTRIC**  
LIMITED

CANADIAN AFFILIATE OF BENDIX AVIATION CORPORATION

Plan Now To Attend

The IRE  
Canadian Convention  
in Toronto

October 16 - 17 - 18

## ELECTROLYTIC CAPACITORS



### Twist Prong Mounting

Type RTP. Any capacity-voltage combination up to 4 sections supplied to order with standard or printed circuit mounting dimensions. Hermetically sealed aluminum can: 1" or 1 3/8" diam.

Hermetically sealed ALUMINUM TUBULARS and Wax filled CARDBOARD TUBULARS extensively manufactured.

Write for Illustrated Brochure on Complete Range Electrolytic Condensers — Motor Starting Capacitors

**DALY-ARROW LIMITED**

Manufacturers of Electrolytic Capacitors  
140 KENDAL AVE. TORONTO 4, ONT.

For further data on advertised products use page 73.

Why is

**ELECTRONICS & COMMUNICATIONS**

a member of CCAB?

To have a circulation statement that is believed by Advertisers and their Advertising Agencies.

Advertisers, by nature, are doubting Thomases, and may not believe that you have received this copy of E&C. We know you have, of course, but that is not good enough.

Therefore, along with 214 other Canadian publications, we have joined CCAB. Advertisers, and Advertising Agencies, have also joined, and we give to them a majority position on the Board of Directors.

Once every year, the CCAB auditor visits our Circulation Department. He checks our records thoroughly, demanding proof that you are in the electronics, communications or allied industry, that you are where we say you are, and that you are being sent E&C regularly.

It is this auditor's report that is believed. We are proud of it, and shall be glad to send you a copy if you wish.

**ELECTRONICS & COMMUNICATIONS**

a member of Canadian Circulations Audit Board Inc.

**VERSALITE**

The NEW, tough thermoplastic of 1,001 APPLICATIONS

Uses: INDUSTRIAL PRODUCTS:

Electric Panels, Instrument Boards, Name Plates, Chemical-resistant Pipe, Tote Boxes, Textile Bobbins, Cathode Edge Strips, Electrolytic Tanks.

CONSUMER GOODS:

Radio Cases, Luggage, Typewriter Cases, Golf Bag Bottoms.

Characteristics:

• Flexible • Chip-proof • weather resistance • Fungus resistance • Light weight • electrically non-conductive

**VERSALITE**

Can be sawed, sheared, drilled, punched, sanded, cemented and polished. Can be worked with ordinary tools and machinery. Can be vacuum formed, screwed, rivetted and bonded.

Available from stock in standard sizes at an attractively low price

For full information, contact **EMPIRE ENGINEERING CO.**



Specialists in Specials  
SALES • SUPPLIES • SERVICE

Flexible Shaft and Portable Equipment, 2 & 3 Dimensional Pantographs, Routers, Hand Engravers Supplies

**EMPIRE ENGINEERING CO.**

738 Dundas St. E., Toronto • EM. 4-2928

**CLM  
DARCY  
RELAYS**

Now you can get fast delivery with Canadian made relays. All standard types are available and all are electrically and mechanically interchangeable with other makes.

Illustrated are only a few telephone type relays. Other spring and coil combinations are available.

For full information call or write Jack West, Sales Manager, Rectronic Division, Canadian Line Materials Limited, Toronto 13, Canada.

SALES OFFICES AND WAREHOUSES  
ST. JOHN'S Nfld. • HALIFAX • SAINT JOHN • MONTREAL • OTTAWA  
FORT WILLIAM • WINNIPEG • REGINA • CALGARY • VANCOUVER

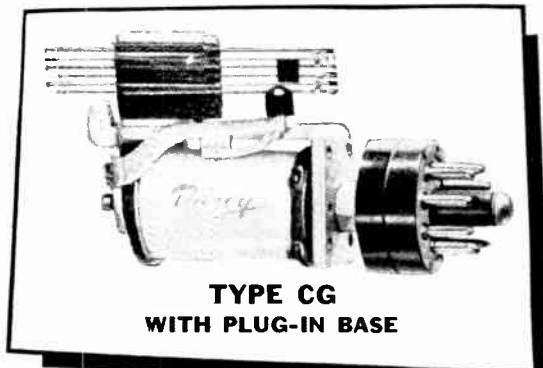

**TYPE CG  
WITH PLUG-IN BASE**

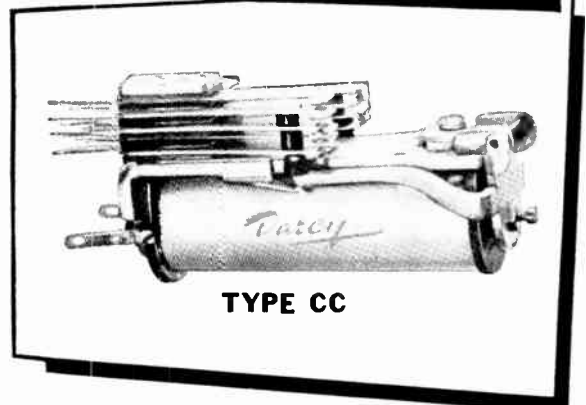

**TYPE CC**



**CLM-DARCY  
RELAYS**

## NEWS

(Continued from page 38)

## Town Meetings Of Radio And Television Technicians

An outstanding program of technical papers, discussions, and demonstrations is scheduled for the Town Meetings of the Radio and Television service technicians due to take place in various centers across Canada in May, June and July. These Town Meetings, each an industry school at which lectures are given on the theory and practice of television services, will be held in Toronto, Winnipeg, Regina, Calgary and Vancouver.

The Town Meetings are organized jointly by the Radio-Electronics-Television Manufacturers Association of Canada (RETMA of Canada) and the National Advisory Council of Town Meetings. Since these Town Meetings were started in 1949 over 3500 service technicians have attended and have gained valuable experience in servicing and maintaining the products of the Canadian electronics industry. For the first time in the history of the Town Meetings, some of the lecture programs will deal with color television and transistor and printed circuits, depending on the location of the

## Sol Budd And D. F. Eakin Join A. T. R. Armstrong

Al Armstrong, general manager, takes pleasure in announcing that Sol Budd and D. Frank Eakin are now associated with him as active principals in the operation of A. T. R. Armstrong Limited, well known electronic sales representatives located at 700 Weston Rd., Ontario, Canada.



SOL BUDD



D. F. EAKIN

Mr. Budd, formerly of Sol Budd Associates, and Mr. Eakin, for several years with Motorola Canada Limited, are both very well known to the electronic industry.

Mr. Sol Budd will be in charge of all phases of distributor merchandising, and Mr. Frank Eakin will concentrate on OEM and industrial sales.

Keeping pace with the expanding electronic industry in Canada, A. T. R. Armstrong Limited has completed extensive additions to its warehouse and office facilities.

## Proposed Radio Tower On Mount Royal For Various Radiotelephone Systems

In response to many requests for permission to install radiotelephone transmitter-receivers and antennae on Mt. Royal, the City Administration has decided to investigate the feasibility of constructing one antenna tower and equipment vault at a choice location on the mountain for use by any interested parties. Space would be rented to manufacturers of D.O.T. approved equipment for a nominal fee, who might in turn sublet same to users of such equipment, the City retaining the right to remove any apparatus causing interference or being misused.

Interested manufacturers are invited to write Mr. J. M. Rousseau, Engineer-Superintendent, Electrical Division, City of Montreal, 4050 Park Ave., Montreal, stating their views of this project and estimated requirements (if any).

meeting. Some of the subjects to be covered are the Operation of Three-Gun Shadow-Mask Kinescope, Basic Colorimetry, How Transistors Work, Color Purity and Conversion Adjustments, Color Receiver Trouble Shooting, The N.T.S.C. Color Television Signal, Black and White Receiver Trouble Shooting, Transistor Faults

and Testing-Printed Wirings, Recent Horizontal Deflection Circuitry, Controlled Warm-Up Tubes, Selenium Diodes and TV Sound and Horizontal Detectors.

The three instructors will be B. J. Byers, G. L. Stewart, and H. W. Jackson, all of the Ryerson Institute of Technology in Toronto.

## Quinte Section, IRE Holds February Meeting

Fifty engineers and physicists of the Quinte district were given an excellent description of the latest technique in radio communication at the regular monthly meeting of The Institute of Radio Engineers on February 12 in Belleville, Ontario.

The speaker was Dr. Hans J. VonBaeyer, Chief Engineer, Systems Engineering Group, R.C.A.F. Headquarters, Ottawa.

Dr. VonBaeyer's address, "U.H.F. Long Range Point to Point Communications", dealt with "Scatter" type communication systems, and the merits of Frequency Modulation and Single Side Band Modulation in these systems.

## Edo Corporation Forms Canadian Subsidiary

Recent announcement was made by Noel B. McLean, president of the Edo Corporation of College Point, L.I., N.Y., of the formation of Edo (Canada) Ltd., a wholly owned subsidiary.

The company, which manufactures electronic equipment and aircraft components, has purchased property two miles east of Cornwall, Ontario, and plans to erect immediately a medium-size production facility, capable of eventual expansion to 400,000

square feet. Plans call for the completion of the new plant by approximately September, 1957.

For 32 years Edo has been the world's principal builder of seaplane floats and in the past ten years the company has become increasingly engaged in the development of all forms of sonar and related equipment, including radar and loran. In the past, Edo floats, widely used by freight planes and bush pilots in Canada, have been built by Canadian licensee.

## Leland Electric Move General Sales Offices

The move of their general sales offices from the main plant on Crimea Street, Guelph, to the recently purchased No. 3 Plant on Oxford Street, Guelph, is announced by G. Ernest Robertson, president of Leland Electric Canada Limited.

Although a substantial addition was made at their Crimea Street Plant just over three years ago, at the same time as their Plant 2 was acquired, Leland Electric's rapid expansion since then has necessitated much larger accommodation for the increased staff.

In addition to housing the sales offices, the new building will give approximately 30,000 square feet of manufacturing area.

(Turn to page 42)



# STEDIVOLT Output Remains Constant

Regardless of • • • Changes of Load • Line Voltage Changes  
• Power Factor • Waveform • Frequency Changes

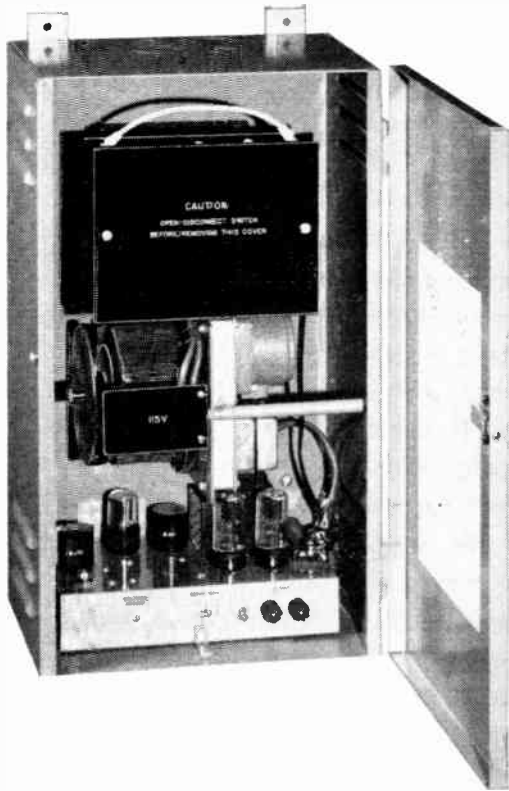

While many stabilizers compensate for line voltage variations they do not compensate for the effects of changing load. Stedivolt regulators maintain *constant voltage independent of load* from zero to full rated output. Waveform distortion is often important . . . Stedivolts introduce *zero* distortion.

**NO RE-SET**—Should power supply drop or rise beyond the wide Stedivolt control range, the unit will still supply maximum correction. Even after a power shutdown the unit will still continue to operate at the selected output voltage without resetting.

**EASY TO MAINTAIN**—Separate control circuit fusing permits unregulated power to be fed to load without interruption should faults develop. All parts accessible from front. No relays . . . no thyratrons . . . only 3 tubes.

#### Specifications Model P17 Stedivolt

	For 115V Supply		For 230V Supply	
	Series	Parallel	Series	Parallel
Jumper Connections . . . . .				
Input voltage range for 115 (or 230) V regulated output.	95-136	105-126	210-251	220-241
Output voltage adjustment range for nominal 115 or 230V input . . . . .	98-141	107-128	213-256	221-243
Load Rating . . . . .	30 amp	60 amp	30 amp	60 amp
KVA . . . . .	3.5	7	7	14
Regulated output accuracy . . . . .	0.5%	0.5%	0.5%	0.5%

Other Stedivolt regulators now in production include units from 1 KVA up, rack mount styles, 3 phase models and 400 cycle units. Ask for details.



Manufactured in Canada by George Kelk Limited

**R-O-R ASSOCIATES LIMITED**

290 Lawrence Avenue W., Toronto 12

ANOTHER  ACHIEVEMENT

## A resilient insert rack and panel connector

Here is the new and improved Bendix Type SR rack and panel electrical connector with outstanding resistance to vibration. The low engagement force of this connector gives it a decided advantage over existing connectors of this type.

Pressurization is easily accomplished. The resilient inserts press firmly against the shell wall holding the contacts in exact position. Insert patterns are available to mate with existing equipment in the field.

Adding to the efficiency of this rack and panel connector is the performance-proven Bendix "clip-type" closed entry socket.

Here, indeed, is another outstanding Bendix product that should be your first choice in rack and panel connectors.

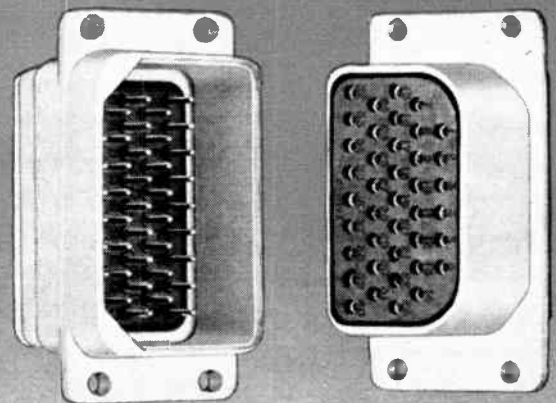

#### OUTSTANDING FEATURES

Resilient Insert • Solid Shell Construction • Low Engagement Forces • Closed Entry Sockets • Positive Contact Alignment Contacts—heavily gold plated • Cadmium Plate—clear irridite finish • Temperature range  $-67^{\circ}$  to  $+250^{\circ}$ F. • Easily Pressurized to Latest MIL Specifications.



SCINTILLA DIVISION of  
SIDNEY, NEW YORK



Export Sales and Service: Bendix International Division, 205 East 42nd St., New York 17, N.Y.

FACTORY BRANCH OFFICES:

117 E. Providencia Ave., Burbank, Calif. • Paterson Building, 18038 Mack Ave., Detroit 24, Mich. • 545 Cedar Lane, Teaneck, N. J. • 5906 North Port Washington Rd., Milwaukee 17, Wisc. Hulman Building, 120 W. Second St., Dayton 2, Ohio • 2608 Inwood Road, Dallas 19, Texas • Boeing Field, Seattle 8, Washington • 1701 "K" Street, N.W., Washington 6, D. C.

## NEWS

(Continued from page 40)

### CDC To Sell And Service Decca Navigator In Canada

Arrangements whereby Computing Devices of Canada Limited assumes responsibility for installation and maintenance of Decca Navigator equipment in Canada were announced recently in Ottawa jointly by H. F. Schwarz, managing director of Decca Navigator Company Limited; R. C. Fuller, general manager, Pacific Division, Bendix Aviation Corporation; and C. F. Hembury, president, Computing Devices of Canada Limited.

The Pacific Division of Bendix Aviation Corporation holds North American sales and manufacturing rights from the Decca Navigator Company Limited. These rights in Canada have been acquired by CDC, actively supported by the activities of Bendix Pacific and Decca's Canadian subsidiary, Decca Navigator of Canada Limited.

### Electronic Components Symposium, May 1-3

The latest developments in electronic components will be reported in 43 technical papers and three luncheon addresses at the 1957 Electronic Components Symposium in Chicago on May 1-3.

More than 1,000 persons are expected to attend the three-day meeting at the Morrison Hotel, according to Dr. R. M. Soria, general chairman.

Technical papers will be given at seven sessions—introductory, components I, nuclear and environmental studies, components II, high temperature investigations and development, instrumentation and measurements, and materials.

Advance registration for all sessions and luncheons can be made by sending a check or money order for \$15 to J. S. Powers, Arrangements Chairman, Electronic Components Symposium, 84 E. Randolph St., Chicago 1, Ill.

### 1957 IRE National Convention Record

All available technical papers presented at the 1957 IRE National Convention in New York City in March will be published in July 1957 in the IRE National Convention Record. This 1700-page volume, issued in ten Parts, will provide an invaluable record of the latest important developments in practically every branch of the radio engineering field.

Individual Parts or the complete volume may be ordered from The Institute of Radio Engineers, Inc., 1 East 79th St., New York 21, N.Y. To ensure delivery of orders, these must be received, with remittance, prior to April 30, 1957. Prices vary for individual Parts, and according to whether the order comes from a member, a non-member or a college or library. The Institute of Radio Engineers will be glad to supply an order form upon request.

### Panellit, Inc., Opens New West Coast Plant

As part of a program to increase customer service and reduce costs in engineering and manufacture of instrument control centers, Panellit, Inc., Skokie, Illinois, announces the opening of new West Coast manufacturing facilities. Panellit, Inc., is a fabricator of instrument control centers, and designer and fabricator of control systems, data reduction systems and annunciators.

Begun as a Panellit engineering office over a year ago, the addition of manufacturing facilities makes Alhambra the third "complete service" outlet established since the firm's inception 10 years ago. Complete sales, engineering and manufacturing facilities are also offered at the main Skokie plant, opened in 1946, and at the Toronto, Ontario, outlet opened two years ago. In addition to these three "complete service" outlets, application engineering service is available at Wilmington, Delaware. Also, agents are maintained in principal cities.

### H. McGuire Appointed Personnel Manager For RETS

Mr. David Fingard, president of Radio Electronic Television Schools of Canada Limited, has announced the appointment of Professor Hermann McGuire, M.A., B.Paed., as executive assistant to the president and acting personnel manager.

Professor McGuire has been with Radio Electronic Television Schools almost since its inception prior to which he had held the position of Dean of Men at the University of Toronto for a period of eighteen years.

From 1941 to 1942 Professor McGuire served in the Wartime Bureau of Technical Personnel as executive assistant to Mr. Elliott Little and from 1942 to 1946 served both in Canada and overseas with the rank of lieutenant colonel in the Directorate of Personnel Selection (District Army Examiner).



H. MCGUIRE

## Canada Wire Sales Appointments

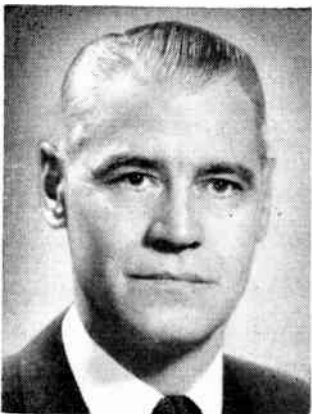

J. H. PRYCE



O. W. FRANCOEUR



W. N. HEROD

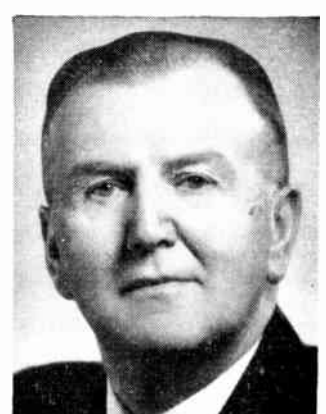

E. W. JOHNSON

● The following appointments have been announced by L. G. Lumbers, vice-president, Canada Wire and Cable Company Limited, Toronto (Leaside). J. H. Pryce, general sales manager; O. W. Francoeur, sales manager, Eastern Region covering the territory Ottawa east to Newfoundland; W. N. Herod, sales manager, Central Region consisting of the provinces of Manitoba and Ontario east to Ottawa; E. W. Johnson, sales manager, Western Region comprising the provinces of Saskatchewan, Alberta and British Columbia. District sales managers within these sales regions will be responsible to the regional sales manager.

The facts  
 about Lenkurt's new  
 4 channel  
open-wire carrier\*  
 in a nut shell...

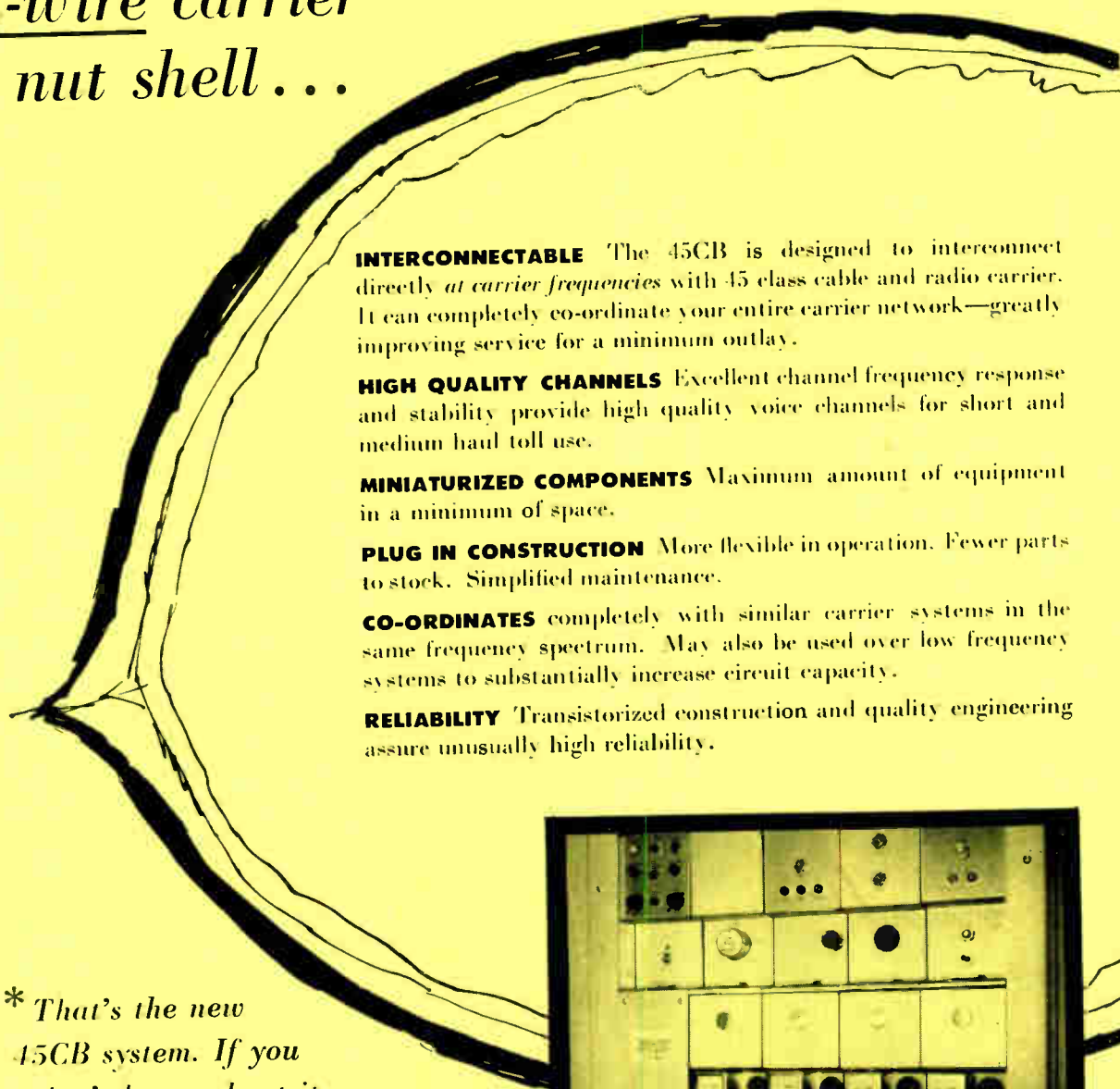

**INTERCONNECTABLE** The 45CB is designed to interconnect directly *at carrier frequencies* with 45 class cable and radio carrier. It can completely co-ordinate your entire carrier network—greatly improving service for a minimum outlay.

**HIGH QUALITY CHANNELS** Excellent channel frequency response and stability provide high quality voice channels for short and medium haul toll use.

**MINIATURIZED COMPONENTS** Maximum amount of equipment in a minimum of space.

**PLUG IN CONSTRUCTION** More flexible in operation. Fewer parts to stock. Simplified maintenance.

**CO-ORDINATES** completely with similar carrier systems in the same frequency spectrum. May also be used over low frequency systems to substantially increase circuit capacity.

**RELIABILITY** Transistorized construction and quality engineering assure unusually high reliability.

\* That's the new  
 45CB system. If you  
 don't know about it  
 already, we'll be delighted  
 to tell you the whole story.

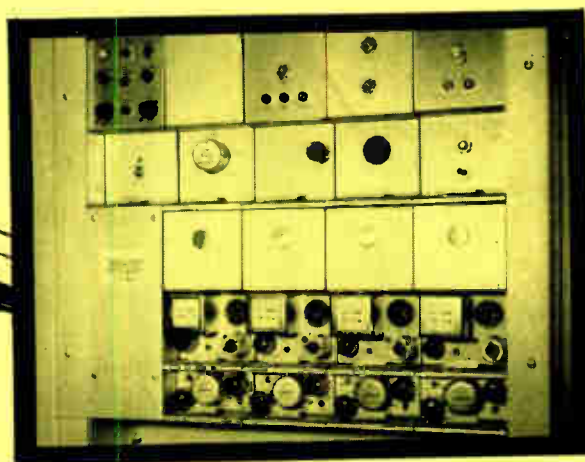

Write or call Automatic Electric Sales (Canada) Limited, 185 Bartley Drive, Toronto 16, Ontario. Branches in Montreal, Ottawa, Brockville, Hamilton, Winnipeg, Regina, Edmonton, Vancouver.

**AUTOMATIC  ELECTRIC**

PIONEERS IN AUTOMATIC CONTROL





# CONSIDER

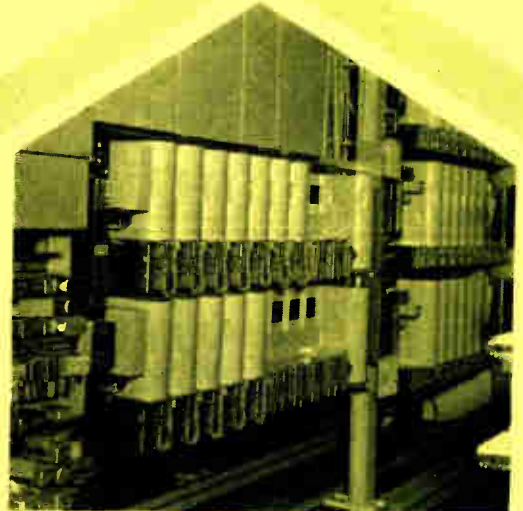
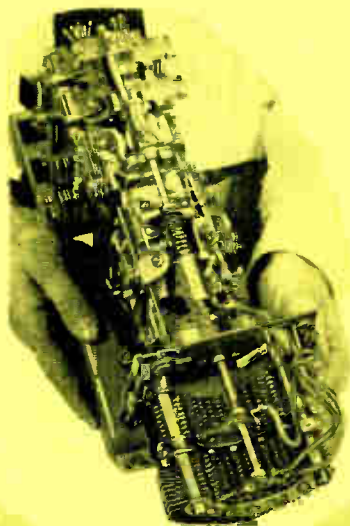
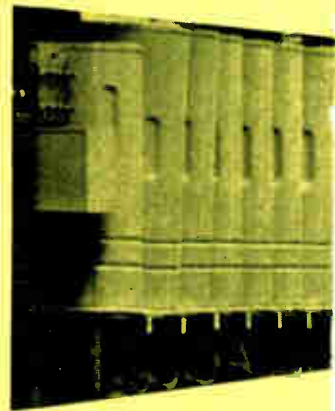

# DERING DIAL?

*every thought suggests*

## STROWGER

Consider your problem from every angle . . . cost . . . maintenance . . . dependability . . . economy . . . adaptability . . . on every count your best investment is Strowger.



### TO-DAY'S NEEDS

Strowger brings high-grade local service in the most economical manner. Operation is simple, direct and easily adaptable to Nationwide Toll Dialing, Automatic Toll Ticketing, etc.

### EASY EXPANSION

Expansion is easy with Strowger. For moderate growth, just jack in an extra switch or two on the extra banks provided with your equipment. For larger growth, add a shelf, complete with pre-wired banks. And for heavy growth, add a frame with as many shelves of switches as you need. There's no capacity limit to Strowger expansion.

### FUTURE DEVELOPMENTS

Telephone requirements in the coming years may differ considerably from to-days. If your telephone equipment can't adapt it must be replaced. Strowger equipment *will* adapt easily and economically, as it has with rotary trunk selection, intertoll dialing, "2-5" numbering, automatic toll ticketing, expansion to director operation and many other developments.

Strowger equipment is built by the company with the longest experience in manufacturing dial switching equipment. Contact an Automatic Electric Engineer soon and discover what Strowger can mean if you're considering Dial.

**AUTOMATIC  ELECTRIC**

ORIGINATORS OF THE DIAL TELEPHONE





## **HARDWARE WITHOUT HARDSHIP FROM AUTOMATIC ELECTRIC**

When you want telephone hardware fast—whether it's made by Slater, C.L.M., or any other manufacturer—just call us. We offer quick delivery on *all* items.

Avoid hardware hardship, order all your needs from one complete source of supply—Automatic Electric. Automatic Electric Sales (Canada) Limited, 185 Bartley Drive, Toronto 16, Ontario. Branches in Montreal, Ottawa, Brockville, Hamilton, Winnipeg, Regina, Edmonton and Vancouver.

**AUTOMATIC ELECTRIC**  
**SALES (CANADA) LIMITED**

For further data on advertised products use page 73.

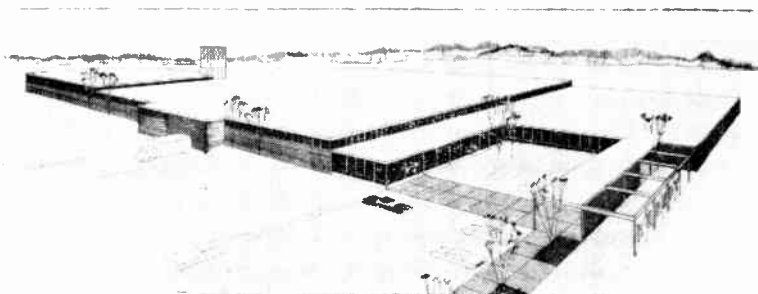

## Burndy Canada Ltd. Announces Expansion Program

An extensive plant expansion program for Burndy Canada Ltd. has been announced by F. H. McLena-

ghan, general manager of Burndy operations in Canada. Already under construction and scheduled to be completed this summer is a 75,000 square foot plant on Birchmount Road in Scarborough, a municipality of

Metropolitan Toronto.

This modern plant, to employ 200 people, will consolidate office, manufacturing and warehouse facilities and will increase by 2½ times the floor space of present locations. A mechanized non-ferrous foundry, a modern press shop and the latest in office techniques will increase Burndy's ability to provide a vastly improved service on the production and supply of electrical connectors for power companies, original equipment manufacturers, electrical distributors, contractors, and industrials across Canada. The 10 acre site provides room for future expansion as required.

## Top Level Appointments Made By RCA Victor

P. J. Casella, president of RCA Victor Company, Ltd., Montreal, has announced the appointment of Harry G. Marpole, F.C.I.S., as vice-president and secretary and F. T. Myles as treasurer.



H. G. MARPOLE



F. T. MYLES

Secretary of the company since 1950, Mr. Marpole joined RCA Victor in 1919 as assistant secretary. Prior to that he was associated with a number of important building developments in Montreal.

Mr. Myles has been associated with RCA Victor since 1926. His first assignment was in the accounting department. Subsequent positions included those of credit manager, district office manager of the Calgary and Vancouver sales offices and just prior to his present appointment, Mr. Myles was operations manager of the distributing organization of RCA Victor.

## Avro Companies Aid Aerophysics Institute

A joint grant of \$50,000 was recently made to the Institute of Aerophysics of the University of Toronto by Avro Aircraft Ltd. and Orenda Engines Ltd., members of the A. V. Roe Canada Group. This was given to assist in the expansion program designed to meet the need for more aeronautical engineers for the aviation industry in Canada.

A new location has been set aside by the University for the Institute of Aerophysics, but construction has to await additional financial aid from other sources.



**CLM**  
**RECTIFIERS**  
**nurse**  
**your**  
**batteries**

You'll protect your investment in station-type batteries when you install CLM Electronic Regulated Selenium Rectifiers.

**CONSTANT OUTPUT VOLTAGE.** In a CLM rectifier the output voltage is kept constant from no load to full load which increases battery life.

**SELF-PROTECTING.** CLM rectifiers are self-protecting on overload as the voltage curve drops off rapidly after 115 percent load is reached. CLM electronic regulated rectifiers are convection cooled, noiseless and require a minimum of maintenance.

**FREE BULLETIN.** For your *free* copy of Bulletin SR-14 which describes in detail, the performance characteristics of CLM rectifiers for station-type batteries write: Jack West, Sales Manager, Rectronic Division, Canadian Line Materials Limited, Toronto 13, Canada.



**SELENIUM RECTIFIERS**

## NEWS

(Continued from page 47)

### Dow-Key Company Appoints E. S. Gould Sales Company

The Dow-Key Company Inc. of Warren, Minnesota, has appointed E. S. Gould Sales Company, 3500 Atwater Ave., Suite 108, Montreal 25, P.Q., as its factory representative for the entire Eastern Canadian area from the Ottawa Valley to the Atlantic Coast. They will call on jobbers and industrial accounts.

### New Appointments For T. M. C. (Canada) Ltd.

D. V. Carroll, MBE, president and managing director, has announced three new appointments to the staff of T.M.C. (Canada) Ltd., namely, A. G. Sheffield, C.D., as executive assistant to the managing director, Shelley M. Presentey, P.Eng., as assistant chief engineer, and Dieter Lohr, P.Eng.

Mr. Sheffield joins the company on his retirement from the Royal Air Force after serving 16 years in the Telecommunications Branch. In the rank of Squadron Leader he filled various Branch Head positions at R.C.A.F. and Air Materiel Command Headquarters. In the Telecommunications Branch he was responsible for the engineering and installation of the R.C.A.F. Radio-Teletype and Tape Relay System and similar facilities. Prior to the war Mr. Sheffield served as a member of the CBC engineering staff.

Mr. Presentey has had wide electronics experience in communications and navigational aids in his capacities as engineering advisor to Duffour & Igon, S.A., head of the electronics division of the LeHavre Port Authority, both of France, and consultant and senior project engineer with Canadian Marconi Company, Montreal.

Mr. Lohr has been design engineer with the Canadian Radio Manufacturing Corporation, Toronto; telephone engineer with Alberta Government Telephones, and more recently, research engineer for Canadian Marconi Company.

### Amalgamated Electric Appoints R. H. Meadows

The Amalgamated Electric Corporation Limited, in conjunction with the Heavy Engineering Division, The General Electric Co. Ltd. of England, announce the appointment of Ronald H. Meadows as resident turbine engineer in Canada.

Before coming to Canada Mr. Meadows was the senior turbine sales and contracts engineer for Heavy Engineering Division of The General Electric Co. Ltd. of England.

(Turn to page 50)



## The Curtiss-Wright "SNAPPER"

### NEW CONCEPT... ADVANCED DESIGN IN THERMAL TIME DELAY RELAYS

- Eliminates chatter with snap action
- Single-pole, double throw contacts
- Wide ambient range ( $-65^{\circ}\text{C} + 100^{\circ}\text{C}$ )
- For military, commercial and industrial applications
- Metal envelope (7 or 9 pin) miniature or (8 pin) octal
- Glass envelope in 9 pin miniature
- Preset time delays in metal from 3 to 90 seconds, glass from 5 to 60 seconds

Write to Thermal Devices Department  
for latest data sheets



Canadian Representative:  
Consolidated Electronics Equipment Co. Ltd.,  
1156 Yonge St., Toronto, Ontario.

### FREED VARIABLE TEST VOLTAGE MEGOHMMETER NO. 1620



The Freed Type 1620 Megohmmeter is a versatile insulation resistance measurement instrument with a continuously variable DC test potential from 50 to 1000 volts.

Components such as transformers, motors, printed circuits, cables and insulation material can be tested at their rated voltage and above, for safety factor.

- Resistance — 0.1 megohms to 4,000,000 megohms.
- Voltage — variable, 50 - 1000 volts.
- Accurate — plus or minus 5% on all ranges.
- Simple — for use by unskilled operators.
- Safe — high voltage relay controlled.
- Self-contained — AC operated.

**TYPE 1620C MEGOHMMETER** — a type 1620 with additional circuitry for testing capacitors.  
**TYPE 3020B MEGOHMMETER** — a 500 volt fixed test potential. Range 1 megohm to 2 million megohms.

**TYPE 2030 PORTABLE MEGOHMMETER** — battery operated, 500 volt test potential. Range 1 megohm to 10 million megohms.

Send for NEW 48 page transformer catalog.  
Also ask for complete laboratory test instrument catalog.

**FREED TRANSFORMER CO., INC.**  
1716 Weirfield St., Brooklyn (Ridgewood) 27, N.Y.



Eight hours to set up an electronic computer. Three seconds for it to solve the problem. One computer component failure and you start all over. Sprague high reliability components are used in computers because they're least likely to fail.

## SPRAGUE

CANADIAN  
MANUFACTURING  
REPRESENTATIVE

Micarta Fabricators  
Limited

18 Toronto Street  
Toronto, Ontario  
Phone EMpire 8-4251



# MINIATURES

**ENGINEERING DEPARTMENTS —  
PLEASE NOTE !**

In the illustrated square inch  
you can place a total of:

**1 SQ. INCH**

- 444 Ball Bearings with races
- or
- 41 Capacitors
- or
- 16 Transformers
- or
- 3 Relays
- or
- 1 Blower Impeller

**Sales and Technical Assistance on all miniatures and sub-miniatures as follows:**

**TRANSFORMERS:** Sub-miniature — various types in sizes  $\frac{1}{4}$ " square to 1" sq. Primary .45 H at 0.4 ma: 900 ohms DC to 30H at 0.3 ma: 1500 ohms DC.

**BLOWERS:** Sub-miniature — 1" Impellers — will move 8 CFM at 1" static pressure. LR Type. 115 volt, 400 cycle AC motor.

**BALL & ROLLER BEARINGS:** Sub-miniature — from .043" OD Ball Bearings to 1.0236" Roller Bearings.

**RESISTORS:** Miniature type ceramic power resistors —

**INSTRUMENT SWITCHES and ATTENUATORS:** Miniature type —

**CAPACITORS:** Sub-miniature — VSR Voltage sensitive ceramic capacitors  
UHF Ultra High frequency ceramic capacitors

**MOTORS:** Miniature types — from .0012 HP to .05 HP in unidirectional, synchronous, reversible, geared head and shaded pole types.

**RELAYS:** Sub-miniature — Any combination of SPST to DPDT.  
Capacity — Low RF 2.5 uuf or less — 1 amp at 28 VDC non-inductive AMECO types R95-2029 and R95-2267.

The above are just the Miniaturized specials of the complete line of electronic supplies and components which we carry.

**JOHN HERRING & COMPANY LIMITED**

3468 DUNDAS ST. W. TORONTO 9, ONT.

ROger 2-9824

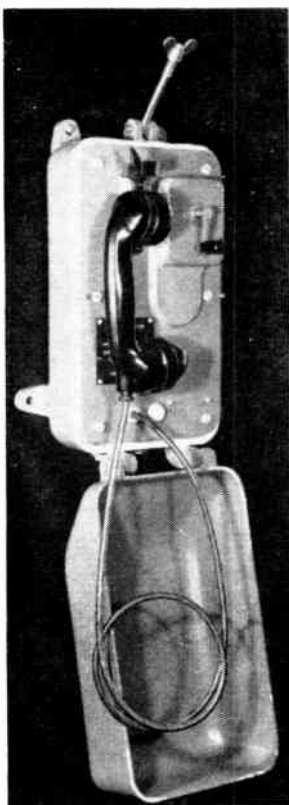

Weatherproof Hood Telephone (wall fixing) Dial, C.B., Magneto or Sound Power models available.

## MAGNETO TELEPHONE EQUIPMENT FOR *RURAL* AREAS

For almost a DECADE Canadians from every Province have been using T.M.C. Magneto Telephone Equipment in rural areas. Each year demand increases.

Forty years' experience is embodied in the equipment you buy which is designed and manufactured to operate under all climatic conditions for long periods, without attention. Highly competitive initial cost, simple maintenance — all parts are easily accessible — T.M.C. Magneto telephone equipment is the best value at time of purchase and continues to prove it during long years of service. Our engineers are ready to assist you in any problem.

Telephone EM. 6-5314 or write for descriptive brochure to Dept. EC.

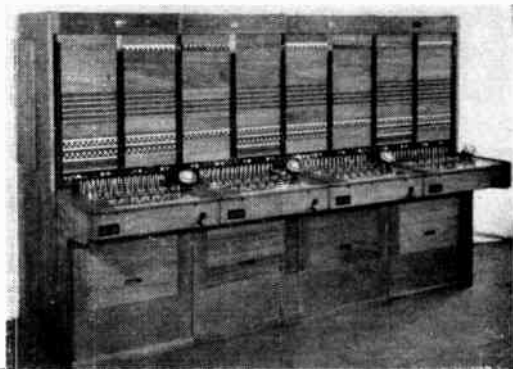

Four Position C.B. Switchboard.

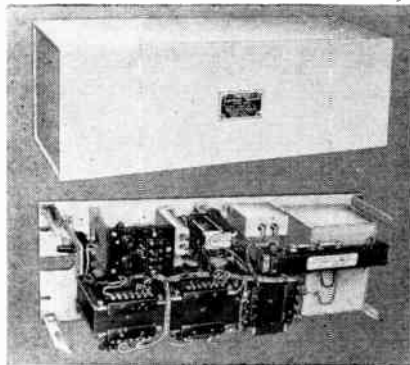

Syncycle — Synchronous Converter.





● *Left to Right:* Will James, general manager, Canadian Operation; J. R. Johnson, vice-president, Standard Coil Products Co. Inc.; C. W. (Chuck) Peterson, sales manager, Canadian Operation; Frank Hedemark, sales engineer; Jim Leakey, production manager; Bill Doenges, chief engineer, Canadian Operation.

# Marconi

offers a **NEW**  
**SIGNAL GENERATOR**



**Advanced features provide:**

- **greatly increased oscillator tube life**
- **freedom from variable r.f. contact resistance.**

The Marconi TF-801B Signal Generator covers the frequency range 10 to 500 Mc/s with a source impedance of 50 ohms and output continuously variable from 0.1  $\mu$ V to 2V.

The hand calibrated main tuning dial and auxiliary vernier dial allow fast and accurate reading, precise and easy interpolation for bandwidth measurements.

To give freedom from the variable properties of r.f. contact resistance *contactless* wave band selection is employed.

A NORMAL/HIGH output switch on the front panel enables oscillator tube life to be considerably prolonged since the tube is under-run in the NORMAL position and the HIGH position is used only when maximum or near-maximum output is needed.

Also available is the TF801B/1 Signal Generator, similar to the above, covering the frequency range 12 to 470 Mc/s with extremely low incidental FM.

# Marconi

CANADIAN MARCONI  
MONTREAL 16



COMPANY

Canada's  
Largest  
Electronic  
Specialists

## Standard Coil Toronto Symposium

On March 7th Standard Coil Products (Canada) Limited conducted a symposium at the Seaway Hotel, at which time Mr. J. R. Johnson, vice-president of Standard Coil Products Co. Inc., outlined their past, present and future TV tuner program to the principals of the Canadian TV set manufacturers.

The keynote of this conference was the versatility of Standard's tuner line and its adaptability to all TV set manufacturers' applications; highlighting the main different adaptabilities of the Standard tuner to UHF.

## S. W. Caldwell Ltd. Forms Subsidiary Company

Spence Caldwell, president of S. W. Caldwell Ltd., announces the formation of a new subsidiary—the Caldwell A-V Equipment Co. Limited.



M. M. ELLIOTT

The firm's president is M. M. "Pete" Elliott, it has been announced. Mr. Elliott has been associated closely with radio and television broadcasting industries for many years. He was formerly general sales

manager of Marconi in Montreal, and more recently general manager of Motorola Canada Limited.

A-V will handle the latest audio-visual equipment for radio and TV stations, film labs and studios. The firm is at 400 Jarvis Street in Toronto.

## Appointment



● Announcement has been made by Mr. J. S. Dewar, president, National Carbon Company, Division of Union Carbide Canada Limited, of the appointment of Mr. G. B. Lawrance as advertising and sales promotion manager.



**NOW...with JIC Enclosure**

Seals tight against...moisture, oil, metal chips, paint. Discourages tampering.

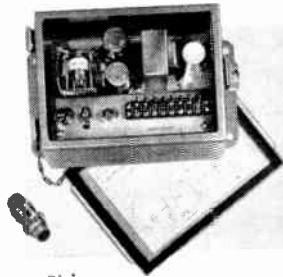

4905-RAC Control Unit & 4910-AN Pickup

**Control operations...count parts with new Metal\* Proximity Detector**

Standard and hollow coil pickups. Hollow coil models pass metal objects through the sensing coil without con-

tact. Pilot relay in control unit operates electric counters...motor controls...solenoids.

**Typical Applications**

- Controls parts feeders
- Limit switches
- Counts screw machine parts, cans, etc.

Eng. Bulletin #1001 describes a variety of sensing pickups and control units available. Write today for free copy.

System shown above

\$111.00 List

Prices start at \$86.00 List

Quantity prices available for O.E.M.

\*Steel, aluminum, brass or copper



**ATLAS RADIO CORP., LTD.**  
50 Wingold Avenue  
Toronto 10, Ont.



**SOLDERING EQUIPMENT**

Soldering instrument detachable bit model 3/16"  
List No. 64

Protective Shield  
List No. 68

All voltages supplied

CSA Approvals No. 11910

Canadian, British and Foreign Pats., Registered Designs, etc.

Canadian Rep:

**L. J. LAMB**  
BOX 103  
WESTON, ONT.

U.S. AGENTS  
**Stratford Electronics Inc.**  
P.O. Box 1114, New York 1, N.Y.

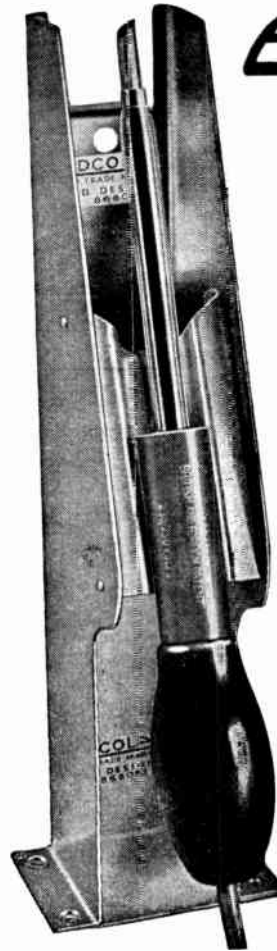

**G-V quality at half the cost!**

Where hermetic sealing is not necessary, the G-V Red Dot Thermal Relay is unexcelled for long life at low cost.

**RED DOT THERMAL TIMING RELAYS**



• Rugged, welded stainless steel operating mechanism for reliable operation.

• Stainless steel encased heater for long life.

• Dust-tight metal shell protects against damage or tampering.

• Available from stock for delays of 2 seconds to 3 minutes with heater voltages from 6.3 to 230 volts, AC or DC.

Request publication 130 for complete data and prices.

**G-V G-V CONTROLS INC.**  
54 Hollywood Plaza • East Orange, N.J.

Represented in Canada by:  
**LEONARD ELECTRIC, LTD.,** 346 Bering Ave., Toronto 18

**HERE'S HELP** in applying these advantages of **POLYPENCO® TEFLON**

- ✓ Excellent Heat Stability!
- ✓ Water Repellent!
- ✓ Chemically Inert!
- ✓ Good Electrical Insulation!
- ✓ Low Dielectric Loss!
- ✓ Low Temperature Impact Strength!

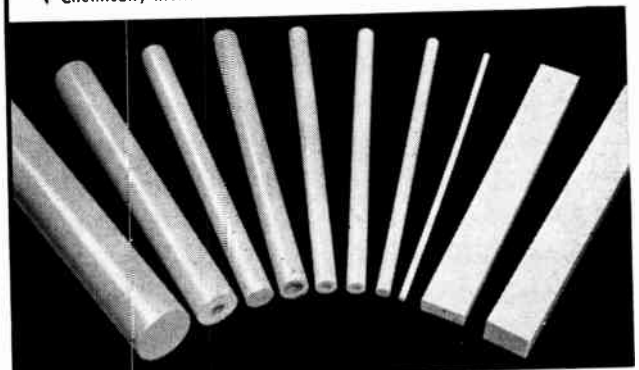

If you want to apply Teflon for best results at lower cost Polypenco offers this complete service . . .

1. Full technical assistance on applications.
2. Quick delivery of rod, tape, tubing and slabs, as well as parts fabricated to your specifications.

Send for the new 8-page bulletin.

DISTRIBUTORS AND SALES ENGINEERS:  
Peckover's Limited, 115 McCormack St., Toronto, Ontario  
2052 St. Catherine St. W., Montreal, Quebec  
C. M. Lovsted & Co. (Canada) Ltd., Vancouver, Edmonton, Calgary  
POLYPENCO, INC. • 2150 Fairmont Ave., Reading, Pa., U. S. A.

**POLYPENCO** Nylon, Teflon\*, Q-200.5 and K-51

\*DU PONT TRADEMARK

# MARK 7 & MARK 8 SERVO MOTORS

MADE EXACTLY TO  
BuOrd Specification

**DELIVERY FROM STOCK**

**MUIRHEAD**

#### PERFORMANCE

##### STALLED TORQUE

1.45 oz in 104 gm cm

##### TORQUE AT 2500 REV/MIN

(Max. Power output)

1.0 oz in 72 gm cm

##### MINIMUM SPEED

(No Load)

4800 rev/min

##### WEIGHT

7.32 oz 258 gm

Supply to Phase 1 115V 400c/s

Supply to Phase 2 115V 400c/s  
or 58V 400c/s



**MARK 7 MOD 1 (Size 15)**

#### PERFORMANCE

##### STALLED TORQUE

2.35 oz in 170 gm cm

##### TORQUE AT 2500 REV/MIN

(Max. Power output)

1.5 oz in 110 gm cm

##### MINIMUM SPEED

(No Load)

4800 rev/min

##### WEIGHT

13 oz 370 gm

Supply to Phase 1 115V 400c/s

Supply to Phase 2 115V 400c/s  
or 58V 400c/s



**MARK 8 MOD 1 (Size 18)**

**DATA SHEETS AND PRICES ON REQUEST**

**MUIRHEAD**

PRECISION ELECTRICAL INSTRUMENTS

**MUIRHEAD INSTRUMENTS LIMITED**  
STRATFORD · ONTARIO · CANADA

## Publisher's Viewpoint

(Continued from page 9)

However, it was not long before engineers about whom the booklet was written began sending in requests for copies. To us this meant one thing more than anything else and that was that the booklet was evoking interest among engineers who comprise the largest segment of our readership.

In view of this interest we publicized the booklet in our January issue, offering copies of the booklet on request, with the result that we have been deluged with a veritable flood of requests which has necessitated an additional press run.

Needless to say it has been something of a task taking care of these thousands of requests and something of an expense as well, but it has confirmed one thing in our minds—if confirmation were ever needed—and that is that *Electronics and Communications* is certainly being read by engineers in Canada.

## British Electronics

(Continued from page 35)

### Television And Microwave Links

Transmitting and studio equipment supplied for four of the six Australian television stations now in service, the contracts being valued at approximately £1 million.

Permanent SHF links are now an important part of the television network in the United Kingdom and in the Eurovision system. Portable links are also used by the B.B.C. Export contracts for SHF links include Austria, Brazil, Canada, Japan, Sweden and Switzerland.

Complete equipment for 120-mile microwave television link between London and Windsor, Canada.

In preparation for the development of Color TV — sales to many radio manufacturers of recently developed color caption scanner supplying red, green and blue signals from color transparencies.

Installation of nine 20 kw broadcasting transmitters at Paradays, South Africa, total radio equipment exported to the station being valued at about £240,000.

Installation of two 100 kw Marconi broadcasting transmitters at Baghdad. Two more going shortly.

**IRE Canadian  
Convention**  
October 16 - 17 - 18

# new products

New Product specifications published in *Electronics and Communications* have been briefed for your convenience. If you require further information on any of the items published you may readily obtain such by using our Readers' Service, Page 73. Just mark the products you are interested in on the coupon on Page 73 and the information will be in your hands within a few days.

## ● Noise And Field Intensity Meter

Item 1474

Empire Devices Products Corp. has developed two new accessories — a coaxial switching unit and a dipole antenna — for use with the company's Noise and Field Intensity Meter, Model NF-105. The new switching unit simplifies calibration procedures, permitting more rapid and convenient measurement of radio-frequency interference and field strengths. The new antenna incorporates a balun, consisting of a unity-coupled broad band transformer which requires no adjustments over its entire frequency range.

In operation, the switching unit is connected between the pickup device and the NF-105 meter input. A built-in coaxial switch effects a rapid changeover from antenna signal to calibrating signal. The switching unit is designed to function efficiently over the entire frequency range of the instrument (150 kc to 1000 mc). Low VSWR and high crosstalk ratio are maintained over this range.

The new antenna consists of three separate assemblies, whose ranges correspond to three tuning ranges of the NF-105. One unit is provided for 20 — 200 mc, one for 200 — 400 mc, and one for 400-1000 mc. In each case the broad band balun matches, without power loss, the balanced voltage of the dipole to the unbalanced input of the noise and field intensity meter. A clamping block mounting affords simple and rapid orientation of the antenna.

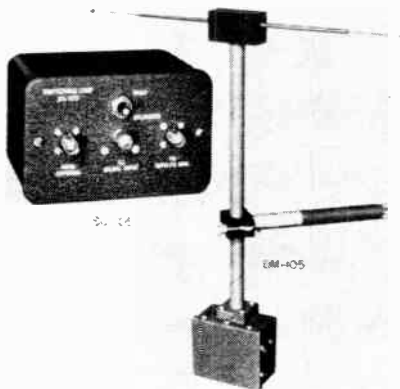

The Noise and Field Intensity Meter NF-105 remains unchanged. Consisting basically of a receiver, calibrating circuits, indicators and pickup devices, it is constructed for field use under stringent military requirements. It is recommended for measurements to military and commercial specifications of field intensity, RF interference, local oscillator radiation of receivers, antenna pattern analysis, determination of shielding effectiveness and of harmonic or spurious frequency output of transmitters. The unit may also be used as a sensitive rf VTVM or as a tunable high-sensitivity null detector.

Both accessories are available for immediate delivery. For further information, contact Empire Devices Products Corp., 38-15 Bell Blvd., Bayside, N.Y. Canadian representative Cossor Canada Ltd., 758 Victoria Square, Montreal, P.Q.

## ● Sub-Miniature Potentiometer

Item 1475

Model C-050, a precision  $\frac{1}{2}$  inch diameter potentiometer offering extreme miniaturization without sacrificing design features found in larger types, has been developed by the DeJUR-Amsco Corporation.

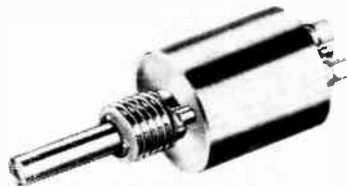

Features include a one piece nickel plated bronze case and bearing, sealed silicone fiberglass cover with end mounted terminals, and "O" ring sealed shaft if required. Despite sub-miniature size, the voltage breakdown between shaft and terminals is a full 1000 volts A.C.

Standard electrical rotation is 320 degrees, mechanical rotation is 325 degrees with stop or continuous 360 degrees. Threaded bushing mounting designs are standard, servo or other mounting arrangements on order. Standard shafts are .125 diameter ground and passivated stainless steel.

Technical literature is available on request. Write to the Electronic Sales Division, DeJUR-Amsco Corporation, 45-01 Northern Blvd., Long Island City 1, New York.

## ● Capacity Telemeter

Item 1476

Manufacturing plants and refineries now can be equipped with remote control devices that measure the level in storage tanks and bins located more than three quarters of a mile away.

The Fielden Instrument Division of Robertshaw-Fulton Controls Company announced recently it is supplying a variety of these electronic instruments to several leading industrial concerns.

The instrument, called a capacity telemeter, can be connected by coaxial cable to a control position as far as 4,000 feet away. Its accuracy in gaging the contents of a tank, the company said, is unaffected by changes in weather conditions or electrical properties of the cable.

The instrument currently is being used mainly by chemical and manufacturing plants, refineries and other industries with materials stored in tanks and bins scattered over a sizeable area. However, its use is also economically feasible for some single tank installations, particularly in hard-to-measure situations.

The complete capacity telemeter system consists of a measuring unit, a remote probe unit for each tank, and an indicator which can be a meter, recorder or precision indicator.

The size and shape of tanks using the remote system can be varied with no effect on its accuracy, the company said.

Additional information on the multi-tank level capacity telemeter is available without obligation from either Keith Mercer Company, Ltd., Suite 101, 5165 Sherbrooke Street West, Montreal 28, Quebec; Keith Mercer Co., Ltd., P.O. Box 11, Station K, Toronto, Ontario; or Chemical and Industrial Sales Ltd., 8411 103 Street, Edmonton, Alberta.

## ● Data On Constant Voltage DC Power Supplies

Item 1477

A new booklet on fixed-output constant voltage dc power supplies is available on request from Sola Electric Co., Chicago, manufacturer of constant voltage transformers and lighting ballasts.

The booklet gives technical data for six, standard-design, regulated dc power supplies for intermittent, variable, and pulse loads, or high-amperage loads. The text is amply illustrated with photographs, schematic drawings, and tables showing mechanical and electrical specifications and performance data. These dc power supplies combine a constant voltage transformer, a germanium power rectifier and high-capacitance filter without choke.

Information on Sola's special design and assembly service for custom made units is included in the booklet, together with specific instructions on how to get additional data or estimates on special design problems.

The theory of operation of these unique dc power supplies is covered in detail in the booklet, with oscillograms, schematic diagrams and charts showing output voltage curves for a typical power supply assembly at various loads and supply line voltages. Ratings for the six stock dc power supplies are shown on specification charts. More than 30 other ratings are offered on special order.

The booklet has 8 pages, measures  $8\frac{1}{2}$ " x 11" and is pre-punched to fit a standard 3-ring binder. Write to Sola Electric Co., 4633 West 16th Street, Chicago 50, Illinois, for bulletin DC-235.

## ● TV. Transmitter Monitor

Item 1478

A major advance in station instrumentation is represented by the new General Radio Type 1184-A TV Transmitter Monitor. This instrument is more than a monitor, because it provides many operational tests that will speed and improve adjustment and maintenance in both aural and visual transmitter circuits.

TV visual transmitter and intercarrier frequencies can be monitored with the Type 1184-A Monitor. In addition, a complete intercarrier sound-detection system has been included within the monitor. In addition to provisions for the measurement of residual a-m noise on the aural transmitter, circuits for the direct measurement of the residual f-m noise on the visual transmitter carrier are also provided.

Every operation in the installation, use, and maintenance of this new monitor can be handled from the front. All major circuits in the monitor can be checked for proper operation by means of a panel selector switch. The entire monitor, while operating, can be slid forward on slides out of the relay rack. All tubes, internal circuit adjustments, cables, and plugs are within easy reach. All adjustments and test points are color coded, and signal paths are indicated by flow lines also marked on the chassis.

Further information and literature on the Type 1184-A Monitor can be obtained from Commercial Products Division, Canadian Marconi Company, 2442 Trenton Avenue, Montreal, P.Q. Canadian distributors for General Radio products.

(Turn to page 54)

## NEW PRODUCTS

(Continued from page 53)

### ● Pulsing And Modulation Apparatus

Item 1479

Light pulses in the microsecond range and modulated light beams at variable frequencies from D.C. through the video region are easily obtained with the new model high speed light pulsing and modulation apparatus announced by Baird Associates-Atomic Instrument Company of Cambridge, Mass. Canadian distributor for Baird Associates-Atomic Instrument equipment is Canadian Marconi Company, Montreal, Que. Applications for this equipment to date include use in such areas as sound-on-film, video-on-film, polarimetry, densitometry, photography, photometry, interferometry, measurement of semiconductor parameters, psychological experiments and biological studies.

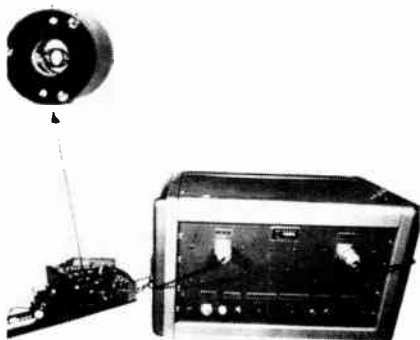

The light modulator, a crystalline analogue of a Kerr cell, is made up of a Z cut (001) plate of ammonium (ADP) or potassium (KDP) di-hydrogen phosphate. The crystal plate is placed between electrodes which will allow light to pass in the same direction as the applied electric field. For normally incident collimated light, the unit has the properties of a polarization retardation plate, with magnitude of retardation directly proportional to the applied voltage. When the crystal device is placed between polarizers, a light beam can be intensely modulated in accordance with the voltage applied for frequencies well beyond the video region.

Five models of the light modulator are available to meet a wide range of operating requirements. Baird-Atomic says one of its models — JV-2 — provides the highest degree of versatility since it features a moderately large angular field, has low voltage requirements and is designed for use at frequencies from D.C. to 10 megacycles per second. Modulators of special crystal or case dimensions can be supplied on order.

For further information write: Canadian Marconi Company, 2442 Trenton Avenue, Montreal, P.Q.

### ● Annunciators

Item 1480

Just as Supervisory Control acts as an extended arm for the modern utility, the annunciator acts as its memory. In size, they vary from the three point device to the 400 point system, occupying two large cubicles. Where a small unit is not associated with a remote control system, it can be mounted as a self-contained device in a switch-gear panel, with a finish to match the panel.

As with Supervisory Control, different customers have different requirements for operation. Mounting, lamps and circuit may all be specially designed to give a required appearance or method of operation. Circuitry depends upon the type of initiating contact and the form which the display should take. If the alarm condition is "sustained," or exists for some time, what

should the annunciator display? A steady light, a flashing light, or a colored light? When the condition clears, should there be a different audible alarm, and what visual indication should be displayed? These same questions must be answered when considering the instantaneous, or "trip" alarm condition. Here, of course, the first requirement of the annunciator is that it must respond to very short alarm impulses, and must store the indication until the operator cancels it. The same variety of indications may be provided, but acknowledgment usually returns all trip alarms to their normal appearance.

While the "sustained" and the "trip" alarm are most common, we have occasionally run into specifications which require special circuitry. For example, there was the annunciator which we produced recently that could "think". Under normal circumstance, it would display alarms as they occurred. If, however, a predetermined sequence of alarms should ring in, the annunciator would automatically take steps to shut down the central equipment quickly, without waiting for the operator, thus saving valuable seconds.

Have you an annunciator problem? A short description will place our design department at your service. For further information write: R. H. Nichols, Limited, 2781 Dufferin Street, Toronto, Ontario.

### ● 10 db. Coaxial Directional Couplers

Item 1481

Four new models of 10 db. coaxial directional couplers, covering a range of 225 to 4000 megacycles, have been announced by the Narda Corporation, Mineola, L. I., New York. The new 10 db. models supplement the existing line of Narda 20 db. and 30 db. coaxial directional couplers which operate over the same frequency ranges.

Machined to exacting standards from solid blocks of aluminum, the Narda 10 db. coupler provides flat coupling over a full octave frequency range with low VSWR. Included with the unit is a built-in secondary arm termination. All four models, 3000-10, 3001-10 and 3002-10 and 3003-10, take Series N female connectors and are of the same width and length, 7/8 inch by 2 1/8 inches, respectively. The height of each model, however, varies as follows: 3000-10, 10 3/4 inches; 3001-10, 6 1/4 inches; 3002-10, 4 inches; and 3003-10, 5 inches.

The coupling values of the new 10 db. unit, which may be used at lower frequencies than the specified range, are within 1 db. of nominal value over the specified range. Calibration charts are provided to  $\pm 0.2$  db. accuracy. Coupling increases below the specified range at approximately 6 per octave. Directivity exceeds and remains above 20 db. for all models except 3003-10 for which the directivity decreases below 2000 mc.

All models have a maximum primary line VSWR of 1.15 and a power rating peak of 10 KW. Models 3000-10, 3001-10 and 3002-10 have a forward power rating of 200 watts average and a reverse of 2 watts average. Model 3003-10 has a forward power rating of 2000 watts average and a reverse of 20 watts average.

For further information contact Measurement Engineering Limited, Arnprior, Ont.

### ● Radiation Monitoring System

Item 1482

A new remote area radiation monitoring system designed to meet the requirements of the AEC for monitoring radiation from a single control center is announced by The Victoreen Instrument Co.

In reactor installations, hospitals and laboratories where radiation work is performed simultaneously at many locations, the new system offers the most reliable and convenient method of continuously monitoring radiation levels, according to the manufacturer.

Victoreen also states that the system is based on a modular unit concept so the "customized" installations can be made up from standard units. The system is comprised of five elements and necessary connecting cables. These elements are: basic control unit, plug-in stations mounted singly or in groups of five in the control unit, remote sensing units with sealed ionization chamber containing the electrometer tube, calibration check source with strontium 90 beta emitter sealed in detector unit, and beta window with discriminator.

The control units operates on 115-volt, 60-cycle ac and has sufficient power to operate up to 20 remote stations. Sensing elements can be located up to 5000 feet from the control point. Output of the sensing element is logarithmic with respect to radiation, thus enabling one channel to monitor three decades of radiation intensity on a single scale without switching ranges. Ion chamber and circuitry are insulated from the case to minimize effects of non-radiation sources.

Ranges are any three adjacent decades from .01 to 1,000,000 mr/hr as standard; six decades are available on special order. High sensitivity enables the system to detect changes as small as .002 mr/hr when used with the proper chamber. Gamma energy response is independent within  $\pm 10$  per cent from 80 Kev to 1.3 Mev.

For further information write: Victoreen Instrument Company, 5806 Hough Ave., Cleveland, Ohio.

### ● Electronic Hardness Tester

Item 1483

A new instrument manufactured by Gardner Laboratory, Inc., Bethesda, Md., for measuring hardness of painted surfaces, provides greater accuracy by eliminating "human errors" and other variables that distort test results. Operation of the "ICI Automatic Sward Hardness Rocker" depends on the number of times in a given interval a pendulum-like rocker oscillates over the surface being tested; the harder it is, the more oscillations. Automatic counting takes place as a shutter on the rocker interrupts a light beam, focused on a phototube in the counting circuit. Total interruptions or oscillations are presented digitally on a four digit register.

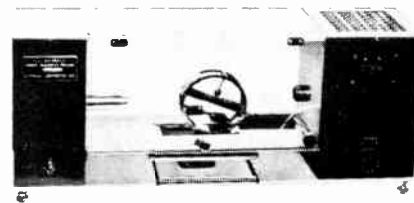

The basis of the counter circuit in the new Gardner instrument is a Sigma Model 1 CdS Photorelay. Developed for "light, no-light" applications such as this, the Photorelay consists simply of a cadmium sulfide cell and Sigma Series 41 relay housed in a dust-proof can 1 1/2" square x 1 7/8" high, mounted on a 5-pin base. As a plug-in unit, the Photorelay can be put in or removed from the circuit quickly and conveniently. Since no vacuum tubes or transistors are used, trouble-free operation can be expected. The Photorelay operates directly on 115 VAC. Guaranteed minimum speed is two operations per second.

Hardness tests of 100 readings on the new instrument were found to have a mean square deviation better than 1.0 per cent of the average, compared to 5 per cent when counting was done visually. Further information and specifications are contained in Bulletin No. 149, available on request from Gardner Laboratory, Inc., Bethesda 14, Md.

## ● "Microtel" The Lenkurt 74A Microwave System

### Item 1484

Microtel is the name of the latest addition to the Lenkurt radio line . . . a new microwave system for use in the 6000 mc common carrier band of frequencies. Microtel has been designed for large channel capacity, low cost, ease of installation and maintenance in a short to medium haul communications facility for toll quality telephone operations.

#### Features:

- Operates from standard telephone office battery or from a-c mains.
- Space saving construction . . . general mechanics similar to Lenkurt 45-class equipment.
- Front access for all panels . . . rear access unnecessary.
- Frequency allocation plans co-ordinate with those of proposed W.E. TH equipment.
- Frequency allocation plans presently being formulated will include standby channel protection.
- Bandwidth — 3 to 1200 kc.
- 32 uni-directional or 16 two-way radio channels available in the 5925-6425 mc common carrier band.
- 120 message channel capacity on each radio channel using Lenkurt 45BX or equivalent carrier equipment.
- Multiple hop operation to approximately 300 miles.
- Fully expanded, each radio channel can handle up to 240 toll standard message channels over shorter distances.
- Transmitter power output — 0.7 watt, minimum.
- AFC . . . ovens and blowers not required . . . transmitter frequency stability better than 0.05 per cent.
- 30 db baseband gain at repeater points facilitates channel branching, dropping and reinserting.
- Alarms for section pilot, transmitting baseband amplifier, RF power output and receiver noise.

For further information write: Carrier and Radio Sales, Automatic Electric Sales (Canada) Limited, 185 Bartley Dr., Toronto.

## ● Molded Plug-In Miniature Transformers

### Item 1485

Microtran Company, Inc., 145 E. Mineola Ave., Valley Stream, N.Y., now have available, from stock, a new line of epoxy molded plug-in, printed circuit, miniature



transformers. These units, which are available in a wide range of electrical ratings, have been designed to meet the requirements of MIL-T-27A, Grades 2 and 5. Further information available by writing for latest 1957 Transformer Catalog.

For further information write: Microtran Company, Inc., Mineola Ave., Valley Stream, New York.

(Turn to page 56)

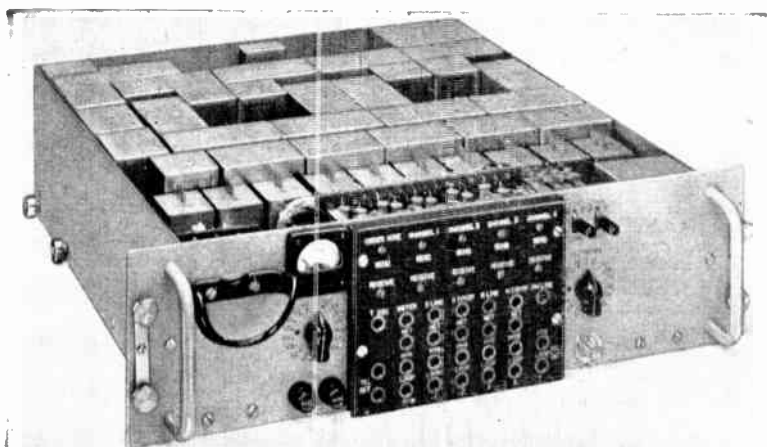

## FOUR-CHANNEL CARRIER-TELEPHONE TERMINAL FOR RADIO LINKS

This is a miniaturized unit of advanced design which provides four voice channels on a frequency-division basis above a voice-frequency order-wire channel. Each of these five channels is provided with a 4-wire 2-wire termination and a voice-frequency ringing circuit for d-c or 20-cycle signals. Adjustable attenuators are provided in the 4-wire side of all channels, and a built-in test oscillator and meter permit complete line-up, maintenance and trouble-shooting checks to be made. Channel levels are from -9 to 0 dbm and line levels from -30 to 0 dbm. Channel width is 300 to 3500 cycles within 1 db.

This unit is only 5¼" high by 19" wide by 14" deep. It mounts on a standard rack and operates from 115 volts 50-60 cycles a.c.

**RADIO ENGINEERING PRODUCTS**  
1080 UNIVERSITY ST., MONTREAL 3, CANADA  
TELEPHONE  
UNiversity 6-6887  
CABLES  
RADENPRO, MONTREAL

# KESTER



EASIER  
TO USE



Absolutely non-corrosive and non-conductive, KESTER "RESIN-FIVE" CORE SOLDER contains an activated type of resin that gives you that fast, positive action on all your jobs . . . including the most difficult.



LONGER  
LASTING

KESTER SOLDER COMPANY  
OF CANADA, LTD.  
Dept. U - Brantford, Canada

# SOLDER



Plugs into octal socket  
(Also available with solder lugs  
for printed circuit connections)

## Frequency Detectors for Transistor Circuits

For telemetering, tachometers, generator test sets -  
wherever frequency changes are converted to amplitude  
changes, these compact Magmeter frequency detectors  
can simplify your instruments and control equipments.

- Operates from push-pull transistor amplifier
- Output current is linear with input frequency
- Frequency ranges from 0-50 CPS to 0-5 KC

**AIRPAX**  
PRODUCTS  
COMPANY

DESIGNERS ENGINEERS  
ENGINEERING DIVISION  
MIDDLE RIVER  
BALTIMORE 20  
MARYLAND

## NEW PRODUCTS

(Continued from page 55)

### ● Printed Circuit Coil Forms

Item 1486

A new line of Resinite printed circuit coil forms and collars with Berg lugs attached is now available. Lugs are firmly and permanently staked to provide a mechanically strong and electrically efficient connection.

Berg lugs are used to provide a completely reliable soldered joint; also because they can be staked to thin or heavy wall coil forms of varying diameter. Three different types of lugs are available. One type is dimpled to hold the coil form upward before soldering. The other two can be bent over before soldering. All lugs are available in standard hot tin finish.

Two to six lugs per coil form can be located at any desired angular configuration. However, not less than 60° is recommended between adjacent lugs. It is common practice to polarize the coil form to guarantee correct insertion in the printed circuit board.

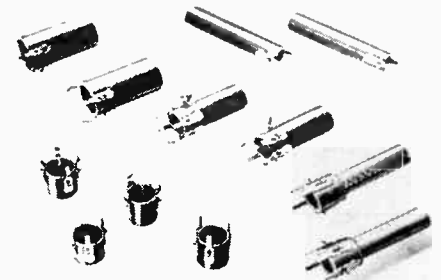

A special Berg developed multiple-strip coil form lugging machine is used to insure uniform and efficient staking of lugs. The machine not only assures product uniformity, but also contributes to the low unit cost at which the coil forms and collars are available.

Resinite Printed Circuit Coil Forms and Lug Collars are available in a full range of I.D.'s, O.D.'s and lengths to meet every requirement.

For further information contact Resinite Corp., Division of Precision Paper Tube Co., Dept. EST, 6980 N. Central Park Ave., Chicago 45, Lincolnwood, Ill.

### ● "Tape It Easy"

Item 1487

Techniques for protecting underground pipe from corrosion with "Scotchrap" Brand Pipe Insulation Tape is the subject of a new "How To Do It Booklet" announced by Minnesota Mining and Manufacturing of Canada Limited, P.O. Box 757, London, Ontario.

Called "Tape It Easy", the new 24-page booklet provides step by step photographs and instructions for wrapping bends, elbows and short sections, packing pipe with tape, preparing joints for wrapping, wrapping welded joints and taping straight pipe sections as well as straight "T" fixtures and other typical fittings.

An additional section contains a "Summary of Helpful Suggestions" for making pipe protection with tape easy.

A coverage table on the book's back cover lists recommended tape width for various pipe sizes, outlining the minimum recommended tape overlap and the number of squares of tape needed per one-hundred feet of pipe using various overlaps.

Procedures outlined in the "Tape It Easy" booklet are summaries of experiences of contractors using "Scotchrap" Vinyl Pipe Insulation Tape.

This booklet may be obtained by writing Minnesota Mining and Manufacturing of Canada Limited, P.O. Box 757, London, Ontario.

## EXTENDED FREQUENCY RANGE

with these STANDARD SIGNAL GENERATORS



**MODEL 80**  
2 Mc to 400 Mc

**MODEL 80-R**  
5 Mc to 475 Mc

#### SPECIFICATIONS

**FREQUENCY RANGE:** (Model 80) 2 to 400 Mc in 6 bands.  
(Model 80-R) 5 to 475 Mc in 6 bands.

**FREQUENCY ACCURACY:**  $\pm 0.5\%$

**FREQUENCY DRIFT:** Less than .1% after warm-up.

**OUTPUT VOLTAGE:** Continuously variable from 0.1 to 100,000 microvolts (-7 to -127 DBM).

**OUTPUT ACCURACY:**  $\pm 10\%$  at 0.1 volt from 5 to 200 Mc.  
 $\pm 15\%$  at 0.1 volt from 200 to 475 Mc.

**MODULATION:** AM is continuously variable from 0 to 30%.  
Internal modulation, 400 and 1000 cycles.  
External modulation, 50 to 10,000 cycles.

**RESIDUAL FM:** Less than 500 cps at 450 Mc for Model 80-R,  
and correspondingly lower for both models at lower frequencies.

**POWER SUPPLY:** 117v, 50-60 cycles, 70 watts.

#### FEATURES

- Direct-Reading scales and dials; individually calibrated.
- Convenient microvolt and DBM output scales.
- Accurate indication of output voltages at all levels.
- Low residual FM due to hum and noise.
- Provision for external pulse modulation.

Laboratory Standards



**MEASUREMENTS  
CORPORATION**  
BOONTON · NEW JERSEY

For further data on advertised products use page 73.



## ● High Fidelity Equipment

Item 1488

Canadian General Electric Company's Tube Marketing Section has announced that its high-fidelity equipment will soon include a new high-frequency speaker and a transistorized pre-amplifier, model number UPX-003B.

The speaker, 2 $\frac{3}{4}$  inches in diameter and rated at 8 watts, is designed to operate as a "tweeter" with any 8-ohm single-cone speaker regardless of size. To adapt this "tweeter" to existing speakers, a new two-way crossover network is also being put on the market. Having a frequency response of 1500 to 15,000 cycles, the new speaker will greatly improve high-frequency reproduction in the harmonic ranges of music.

The transistorized pre-amplifier is the first in the industry to combine the economies of tube-designed circuitry with the low-hum performance of transistors. It can be used in conjunction with all types of popular magnetic pickups. Its response ranges from 30 to 20,000 cycles, with as little as six per cent distortion.

For further information on this equipment write to: Canadian General Electric Company Limited, 214 King Street West, Toronto, Ontario.

## ● Unipoise Arm And Fluxvalve Pickup Assembly Item 1489

A new lightweight, integrated arm and pickup assembly which features low arm mass and low friction for precision, non-wearing reproduction of current and future microgroove recordings, has been introduced by Pickering and Company, under the designation Fluxvalve-Unipoise Pickup Arm, Model 194-D. The assembly consists of a molded pickup and arm with a single needle-point bearing to allow both vertical and horizontal motion. The integral cartridge is designed to use the high-compliance, low-dynamic-mass stylus inserts developed by Pickering for the Fluxvalve pickup.

The assembly consists of a molded head and lightweight arm riding on an upright needle pivot, which provides free, frictionless motion in both horizontal and vertical planes. The pickup cartridge is an integral part of the assembly, and is permanently sealed into the housing for life.



The upright bearing member passes through a slot in the arm, at which point a radically new damping method is employed to completely control arm resonance.

The arm mounts with a single hole in the mounting board, and is easily adjusted to match the height of the turntable surface above the board. A directly calibrated sliding weight allows for adjustment of the stylus force between one and six grams. The cartridge will accept any of the Fluxvalve stylus inserts including the new half-mil stylus pioneered by Pickering.

Other features of the Fluxvalve-Unipoise assembly are: Output at 1000 c.p.s. with 10 cm sec stylus velocity — 15 millivolts; Frequency response, flat — 20 to 30,000 c.p.s., plus or minus 2 db; Overall length, 11 $\frac{3}{4}$  inches; Distance of mounting hole from turntable center, 8 inches; Maximum height above motor board, 3 inches.

For further particulars, contact Pickering's Canadian representatives, Charles W. Pointon Ltd., 6 Alcina Avenue, Toronto 10, Ontario.

(Turn to page 58)

**SYNTRON** Vacuum Process

# SELENIUM RECTIFIERS

**NOW made in Canada**

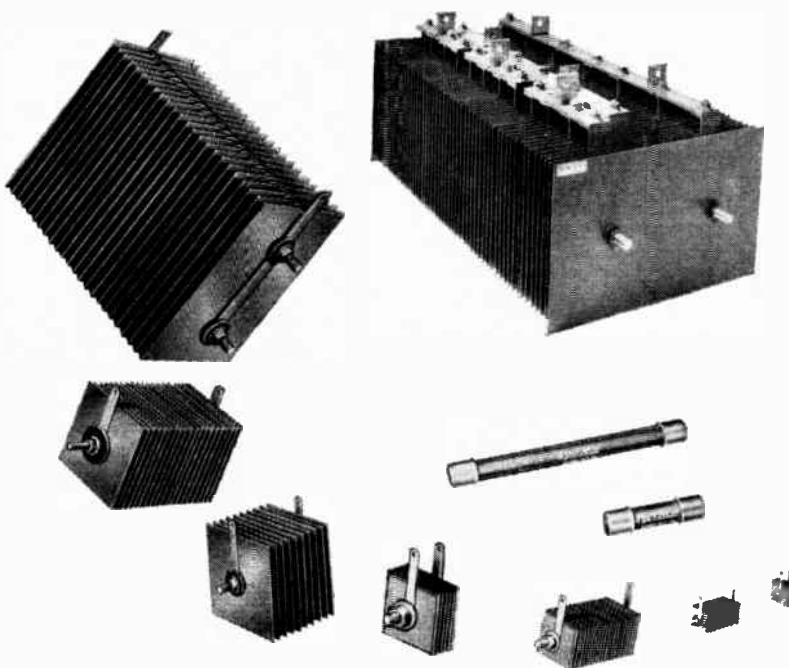

**Designers and Engineers appreciate their performance proven dependability**

- Syntron's unique vapor deposit process and quality control methods provide rectifiers of extreme uniformity.
- Low forward voltage drop means longer life and lower operating temperature.
- High short circuit surge current ability to 300 times normal rating.
- Withstand high transient conditions without damage.
- Largest range of cell sizes in the world. This permits Syntron to build rectifier stacks to any specifications or size.
- Syntron high quality Selenium Rectifiers are now made in Canada.

Our applications engineers will gladly submit recommendations on request.

**SYNTRON (CANADA) LIMITED**  
12 MAIN STREET EAST • Dept. K • STONEY CREEK, ONTARIO

*experience means reliability*



# CANNON PLUGS

300 Million Electric Connectors Made Since 1915

CANNON ELECTRIC CANADA LIMITED, 160 Bartley Drive, Toronto 16, Ontario,  
Montreal Office: Montreal Airport, Dorval, P.Q.



EAST HAVEN • TORONTO • WAKEFIELD • LONDON • PARIS • MELBOURNE • TOKYO

## NEW PRODUCTS

(Continued from page 57)

### ● Insulating Connectors With Teflon Bodies

Item 1490

The Joelin Manufacturing Company, North Haven, Connecticut, has announced the development of an important new idea in insulating connectors for high frequency coaxial service in radio, radar, and other electronic equipment. For the first time, connectors are now available with an insulation material, hermetically sealed, that is non-flammable, that will not carbonize under arcing, and that is indestructible in the face of the roughest handling on assembly lines. This news will be of special

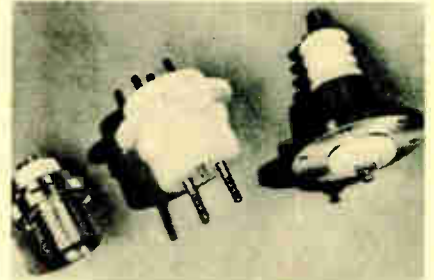

interest to the makers of electrical transformers, capacitors, motors, relays, requiring a wide range of temperature service and a low power loss insulation at high voltages. These advantages are gained because the insulating body is molded of DuPont Teflon, a chemically inert compound with high dielectric strength that is serviceable at temperatures from -100 to +500F. In addition, the connectors withstand high internal pressure, humidity, mechanical shock and vibration. The socket pin assemblies shown above are fabricated by the new molding process which effects the required seal without the use of adhesives. The simplicity of design and manufacturing is ideal for miniaturization work.

For further information write: Joelin Manufacturing Company, North Haven, Connecticut.

### ● New RF Probe Tuneable Over Range of 900 to 18,000 Megacycles

Item 1491

A new precision, tuneable RF Probe, Narda Model 229, which includes an optional detector for use with all waveguide and coaxial slotted lines provided with a standard 3/4-inch diameter mounting hole, has been announced. Insertion loss is 25 db, or less in most slotted lines.

The Narda Model 229 has a fine wire probe adjustable in depth over a wide range by a fine-pitch threaded knob. This fine wire probe is an extension of the center conductor of a coaxial line which is provided with shunt and series tuning elements for tuning the probe pick-up over the range of 900 to 18,000 megacycles. There are two probe outputs. A detector output, which takes a BNC series connector has provision for a standard microwave crystal, Series IN21 or IN23, or a Narda N-610B Bolometer. Because of its r-f output, the Model 229 RF Probe can be used with microwave receivers or other internal detectors.

The Narda Model 229 RF Probe is mechanically and electrically equivalent to and interchangeable with the military probe MX-1019 U. Improved contact design in the Narda model permits its use over a wider frequency range than the standard military model.

The Model 229 is recommended for use with Narda Models 219, 220, 221, 222, 223, 224, 231 and 232 waveguide and coaxial impedance meters.

For further information write to: Measurement Engineering Ltd., Arnprior, Ontario.

(Turn to page 60)

For further data on advertised products use page 73.

# Tap and Fasten

**in one operation**

**Immediate savings in  
time and money assured!**



**SHAKEPROOF®**  
Thread-Cutting Screws



Special points, special heads, and special-purpose screws incorporating the Shakeproof Thread-Cutting slot provide added cost-cutting advantages.

- End separate tapping costs
- Shakeproof Thread-Cutting Screws cut perfectly mated threads
- Available in three styles for metals, die-castings and plastics
- Can be removed and re-used
- Extra strength due to heat treating
- Available in all standard head styles, pre-assembled as Sems, and in many special application designs as shown above.

*Write for sample kit containing Shakeproof Thread-Cutting Screw assortment*

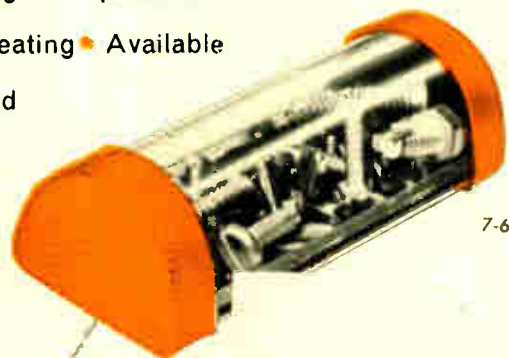

7-6L

**SHAKEPROOF FASTEX**  
"FASTENING HEADQUARTERS"

**DIVISION OF CANADA ILLINOIS TOOLS LTD.**

67 SCARSDALE ROAD • DON MILLS, ONTARIO

# SCIENTIFIC INSTRUMENTS

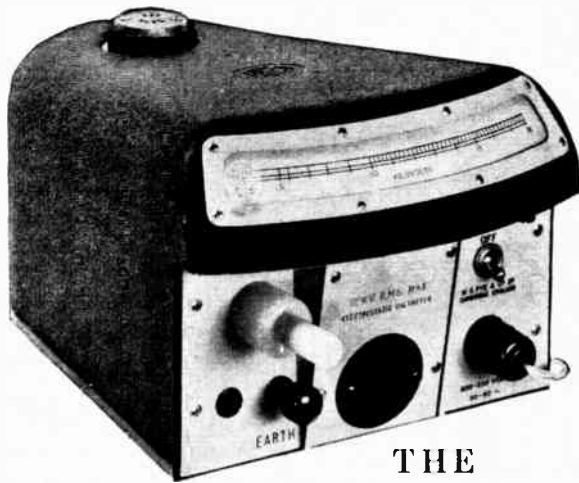

## THE SCALAMP RANGE OF VOLTMETERS

For high voltage measurement at zero current drain the "Scalamp" Electrostatic Voltmeter is the ideal instrument. With a three-second period and hairline-spot indicator on a clear open scale, measurements can be taken with great rapidity and ease. The instrument is completely self-contained with lamp illumination effected from mains-supply through a built-in transformer or from an external 4V battery. For complete details write for catalogue number 11310.



## GALVANOMETERS

The "Scalamp" Galvanometer is available in a range of sensitivities and is one of the most versatile instruments of its kind. Either mains or battery operated it features slow-motion drive to the zero-control, and an automatic self-shorting foot. For complete details write for brochure number 7900/s.



## FLUXMETERS

The "Scalamp" Fluxmeter features a two-speed "return-to-zero" for rapid and easy measurement. Either battery or mains operated this instrument will give a truly outstanding performance. For complete details write for catalogue number 8834.



78 BANK ST., OTTAWA

193 E. Hastings St., VANCOUVER  
1191 University St., MONTREAL

82 Northline Rd., TORONTO 16  
3 Duke St., HALIFAX

5615

## NEW PRODUCTS

(Continued from page 58)

### ● Plug-In Connectors Prove Advantages Of SEL-REX Bright Gold Precision Plating

Item 1492

SEL-REX Bright Gold Precision Plating is making remarkable advancements in the field of electronics. More and more parts testify to its excellence for this type of operation. The plug-in connector, illustrated, provides an excellent example of the versatility of the SEL-REX process. Its unusually beneficial characteristics are demonstrated by the fact that was possible to plate this part internally and externally after moulding in the bakelite.



SEL-REX Bright Gold Precision Plating, continues to replace silver plating in the electronics field for two important reasons. Firstly, because of its undoubted resistance to tarnish. Secondly, SEL-REX Bright Gold plated parts never develop "whiskers" under operating conditions.

SEL-REX Bright Gold Process is specified by leading manufacturers in the electronics field, both in Canada and the United States. For further information, write or phone:

The Electric Chain Company of Canada Limited, 86 Bathurst Street, Toronto 2B, Ontario. EM. 3-8881. Photograph courtesy: Amphenol Canada Limited.

### ● Multiple Channel Strain Gage Power Supplies

Item 1493

Western Gear Corporation, Electro Products Division, announces the availability of Model 7P01 single or multiple channel strain gage power supplies.

Specifications are 115 V., 60 cycle input; 10 V.D.C. output, adjustable from 9-11 V.D.C. with a 10-turn potentiometer; output voltage changes less than plus or minus .05 per cent due to temperature change from 0 to 45°C.; output voltage changes less than 0.1 per cent due to 2 per cent change in load current; output ripple is less than 300 microvolts RMS, isolated from ground as follows: insulation resistance to ground — 10,000 Megohms, AC pickup voltage to ground — 5 Microvolts Peak.

For further details address Western Gear Corporation, Electro Products Division, 132 West Colorado St., Pasadena 1, California.

(Turn to page 66)

For Further  
Information On  
New Products And  
Advertising In This Issue  
Use Handy Coupon  
On Page 73

**get greater efficiency on small jobs...use**

**the Ungar electric soldering pencil**

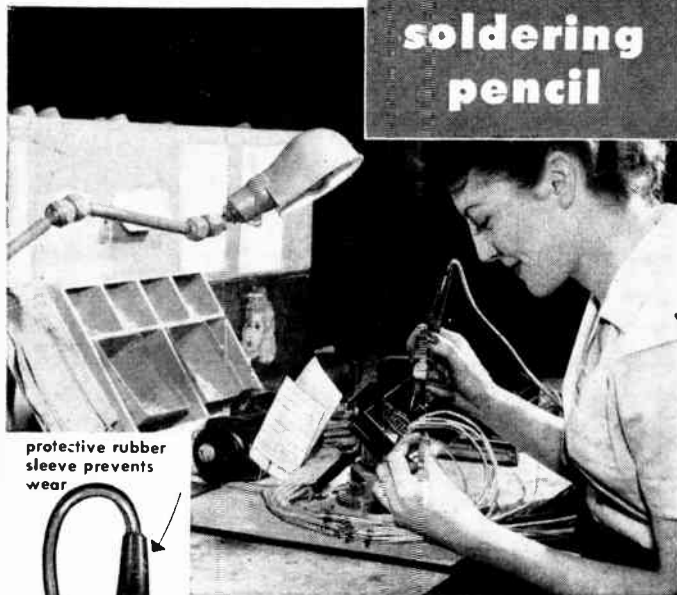

protective rubber sleeve prevents wear



costs 1/3 less to operate!

Mrs. Joan Simpson of A. V. Roe Canada Limited using an Ungar-Electric Soldering Pencil to solder electrical connector assemblies for the CF-100.

Feather-light, but really rugged, the Ungar Electric Soldering Pencil can be used for all standard soldering. It is especially suitable for the aircraft industry . . . because it gets into hard-to-reach places easily — and does the job quickly! You can count on it to last longer, too . . . for the Ungar heating units are built to give you hundreds of hours of extra life. Add to this the inexpensive, easily changed Elkaloy Tiplets and you'll save time and money all round!

**CHECK THESE BIG FEATURES:**

- Full length tinsel cord.
- New, cooler handle of durable molded plastic (patent applied for).
- Seven interchangeable tips. Ample copper heats to 600° in 90 seconds.
- Ceramic separators for double safety.
- Spring action rivet assures positive contact at all times.
- Extra length brass shell firmly engages all threads. Keeps heating unit tight.
- Fully CSA approved Seal on complete pencil set.
- 20 watt element, 1000 hours operation 21c. 110-120 volt. A.C.-D.C.

SEE YOUR JOBBER

5303

**Ungar**

**ELECTRIC TOOL CO. OF CANADA**  
44 DANFORTH ROAD  
TORONTO 13, CANADA

ELECTRONICS & COMMUNICATIONS, MARCH, 1957

**Wide Range, Accurate Measurement**

- RESISTANCE from 100 K to 10 million megohms
- D. C. VOLTAGE from 0.01 to 2000 volts
- CURRENT from 10 micro-microamps upward

**With One Compact Instrument**



only \$163.00

F.O.B. TORONTO

**Size:**  
Only 10" x 7" x 6"  
**Weight:**  
9 lbs.

This Bruel & Kjoer Megohmmeter, Model 2423 will increase efficiency of production, inspection and research and greatly assist service engineers in measurements of high resistances, and D. C. voltages and currents.

**UNIQUE FEATURES INCLUDE:**

- Constant zero adjustment on all ranges
- Stabilized for wide variation of line voltage
- Low (10V) test potential for transistor circuits
- Illuminated scale for quick, accurate readings

**Used as a Megohmmeter,** accuracy is 3%. Test potentials of 10 or 100 volts are stabilized to 0.03%. Semi-logarithmic scale spreads values for easy reading. A "Key" position is provided permitting instantaneous charging of capacitors.

**Used as a D. C. Voltmeter,** accuracy is 2%—input impedance is 1000 megohms on 1 volt range and 100 megohms on other ranges.

**Used as a Microohmmeter,** entire range is covered with only 1 volt drop for full scale deflection.

High voltage accessory Model 3423 extends range to 100 million megohms with 1000 V potential. Any test voltage from 10 to 1000 volts can be selected.



**R-O-R ASSOCIATES LIMITED**  
290 LAWRENCE AVE. W. TORONTO 12

For further data on advertised products use page 73.

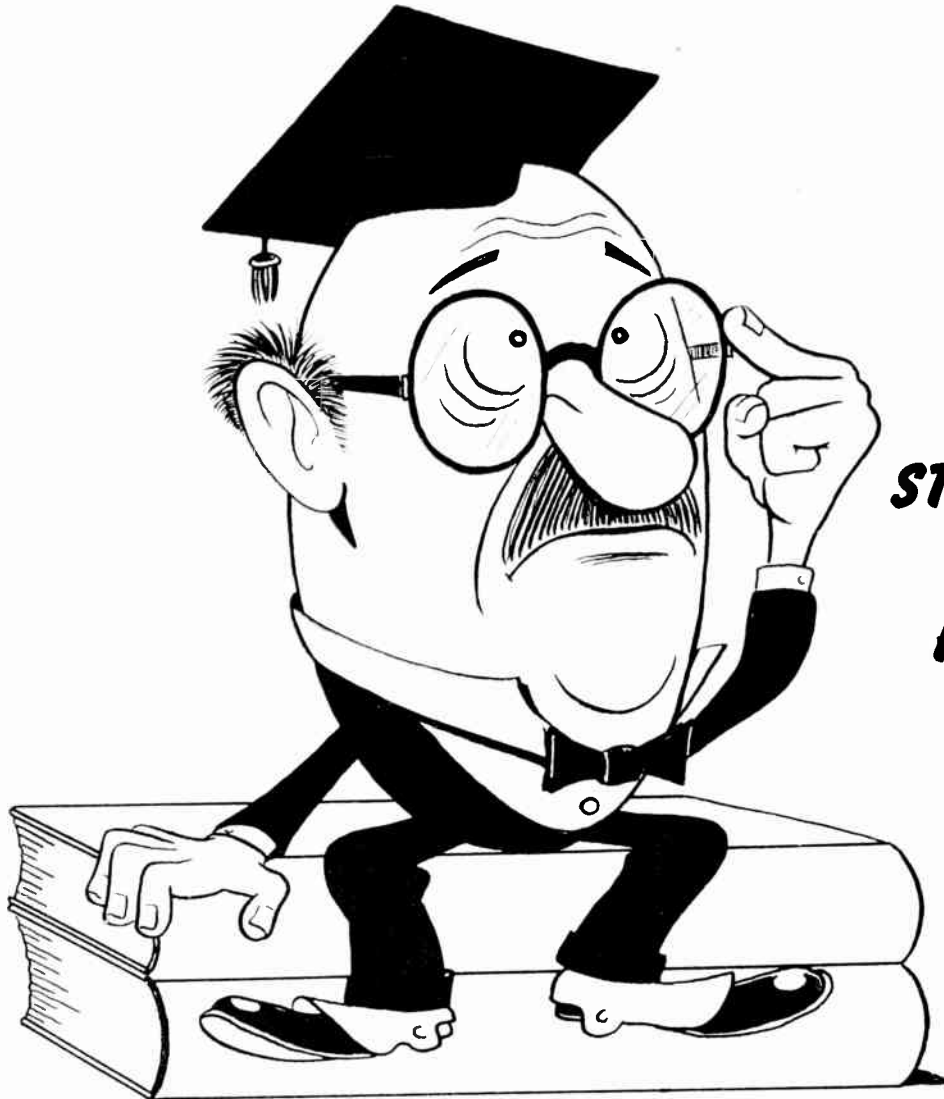

*Are*  
**ENGINEERS**  
**EGG-HEADS?**  
*are they*  
**STUFFED SHIRTS?**  
*are they*  
**HIGH-BROWS?**

Do they feed on Figures?  
 Dine on differential calculus?  
 Is their interest confined to  
 Diagrams? Equations? Graphs?  
 Text Books? Technical Reading?

Here is a sample of the thousands of requests being received from Engineers for "What Are Engineers Really Like".

"We have just received your interesting and humorous Booklet 'What Are Engineers Really Like' and enjoyed it immensely. We would like to share copies of this Booklet with our Engineer friends and would appreciate six extra copies. We would also like to mention our appreciation for such a fine magazine as Electronics and Communications."

Quinton W. James.  
 H. K. Walter & Associates Ltd.,  
 Consulting Engineers,  
 Kitchener & Hamilton, Ont.

Send us your name, address etc. and we will gladly mail you a copy — as long as the supply lasts.

The Advertising Department of ELECTRONICS AND COMMUNICATIONS recently prepared a little Booklet, titled "What Are Engineers Really Like". It provides an emphatic "NO" as the answer to the above questions.

Reference to the Booklet appeared in the January issue of ELECTRONICS AND COMMUNICATIONS.

As a result of this publicity in ELECTRONICS AND COMMUNICATIONS, requests have come in for thousands of copies from Engineers all over Canada and each day's mail continues to bring scores more of similar requests. An additional press run of the Booklet has been needful to take care of them.

But whether Engineers be Egg-heads, Stuffed Shirts, High-brows — or just regular guys, there can be no disputing the above evidence, that they read closely ELECTRONICS AND COMMUNICATIONS.

That we suggest is the important thing to advertisers whose messages in it are directed their way.

## **ELECTRONICS & COMMUNICATIONS**

Pioneer publication in the Canadian Field.

For further data on advertised products use page 73.

# electronics

## in business & industry

### water filtration . . .

A pneumatic-electronic control system for increasing the efficiency of filtration plants is a robot monitoring system which automatically adjusts the amount of water being filtered or purified to meet a city's normal fluctuating demands. The system, designed by Honeywell engineers, in collaboration with a Pittsburgh engineering firm, will automatically increase the amount of water being treated as the demand rises. It will reduce the filtering rate as the demand drops.

\* \* \*

### audience coverage . . .

Dealers attending a sales convention which required two halls in a hotel to seat them all were enabled to watch the proceedings simultaneously by means of closed-circuit television, in conjunction with large screen projection equipment. TelePromPter of Canada Ltd., who supplied the equipment, points out that the advantage of rear-projection plus plastic screen, is that ordinary room lighting need not be altered to get a top-quality image.

\* \* \*

### bottle inspection . . .

The monotony of watching for flaws in an endless row of soft drink bottles or scanning their contents for "foreign" particles has been eliminated by the introduction of beverage inspection machines, such as those produced by the Radio Corporation of America. Detection of trouble is made by six sets of electronic "eyes" which scan separate areas of each filled bottle.

\* \* \*

### portable P.A.S. . . .

A public address system, consisting of an 8 inch loudspeaker, transistorized 10 watt amplifier, batteries and "press-to-talk" microphones, has been introduced to the market by John Ould, USA Ltd., of Mount Vernon, N.Y. The equipment, which is contained in one portable case, is suitable for use in sightseeing buses, railway stations and social or athletic gatherings, which do not require the services of a regular P.A. system.

\* \* \*

### negative inspection . . .

The Houston-Fearless Division of the Color Corporation of America and the Eastman Kodak Co. have combined to develop a photographic processing machine which examines negatives electronically. The process is used to get the best results from aerial reconnaissance films. The entire length of aerial film is partially developed, then the machine scans each single negative and decides upon the additional chemical development time required for each negative. The developing process is then completed by the machine to yield uniform results.

\* \* \*

### blood analysis . . .

An instrument has been devised in Great Britain for the purpose of measuring the oxygen content of human blood. Comparison is made of two separate wavelengths of light which are transmitted through the patient's ear lobe to approximately filtered photocells. The degree of light absorption determines the percentage of oxygen in the blood.

\* \* \*

### electronic cat . . .

The introduction of "The Electronic Cat" has revolutionized the process of catching mice. The device consists of a plastic dome-shaped cage with a floor, both being coated with a thin, electrically conductive metal film. When the cord is plugged into a circuit, the interior of the cage is connected to one current pole, the floor surface to another. The mouse enters by a hole at the top of the cage, seeking the bait placed inside. Standing on the floor, his nose or tail soon touches the interior of the cage, thus completing the circuit. The animal electrocutes itself instantaneously and bloodlessly, and can be easily disposed of by releasing the floor of the cage when the cage is lifted.

\* \* \*

# electronics

## in business & industry

### railway safety . . .

Automatic train control will be put into operation on British railways following government permission to install an electromagnetic system which can be used on either steam or electric locomotives. If an engineer does not take the necessary action upon approaching a warning signal, the brakes are partially applied by the device and will halt the train before it arrives at the danger signal.

\* \* \*

### machine control . . .

Automatic stepless speed control through electronic regulation of spindle revolutions has been achieved through the introduction of the "Eltromatic" constant cutting speed lathe. This machine has been developed by Max Mueller Brinker Maschinenfabrik of Hannover, Germany, and is being marketed in Great Britain by K. S. Paul Ltd. It is claimed that, compared with the customary methods of regulating spindle revolutions of a lathe by steps, this equipment will save machining time, meet higher output requirements, and improve quality of surface finish.

\* \* \*

### bank protection . . .

Electronics research and development have resulted in the production by Hughes Products, A Division of Hughes Aircraft Company, of the Tonotron direct-display storage tube for use in closed-circuit television systems. This tube is used in connection with regular telephone lines, so that installation cost does not have to cover intricate circuits and cables. It is conceived that such a system might be used in banks and large establishments where those handling money need every possible protection that science can provide.

\* \* \*

### rolling mill . . .

The Stanat Manufacturing Company of Long Island City, N.Y., has produced a semi-automatic rolling mill, which has been designed to process radioactive materials for nuclear reactors. It operates in a clear, airtight, plastic cocoon and is capable of turning out 3/1000ths of an inch sheet, or bars, rods, or ovals, out of 4-inch square ingots.

\* \* \*

### storm warning . . .

A special purpose radar known as the AVQ-50 manufactured by the RCA Victor Company Limited has been made available for the first time in Canada to pilots of small aircraft. The radar, a storm detection equipment, can detect approaching storms at a distance of 75 miles.

\* \* \*

### reactor inspection . . .

A special television camera has been designed and manufactured to enable engineers at Calder Hall atomic plant to carry out complicated inspection inside the pressure vessel of the reactor. The new Pye camera has been reduced to under 3" in diameter and 24" in length, so that it can form part of a mechanical grab to be lowered into the fuel channels of the graphite core to remove possible obstructions. The focus for this camera, which carries its own source of illumination, is pre-set to the fingers of the mechanical grab before it is inserted in the reactor.

\* \* \*

### food grading . . .

In the bean district of Southwestern Ontario electric-eye sorting machines are selecting and separating good and off-grade beans at the white bean elevator of W. G. Thompson Ltd., Blenheim. The electric eye sorters not only check the beans for size and quality but also detect and reject stones or other foreign matter. The machines, which could also be used for other types of beans and even for rice, will operate 24 hours a day, seven days a week, with one attendant.

\* \* \*



# NEW NORTHERN RADIO REGENERATIVE REPEATER

**Type 207 Model 1**  
**the most advanced**  
**in the industry!**

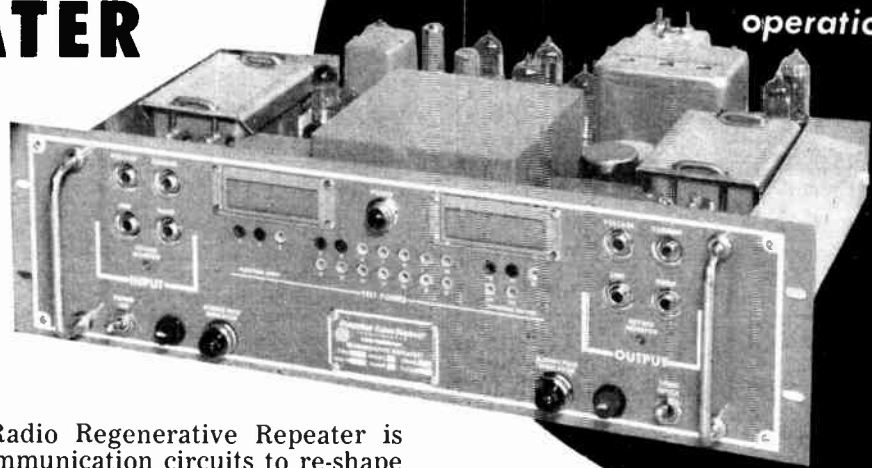

The new Northern Radio Regenerative Repeater is designed for use in telecommunication circuits to re-shape and re-time distorted signals for local use or retransmission. Special provision has also been made for use of this unit on half duplex circuits — where it will not only regenerate the ordinary teleprinter signals but also faithfully reproduce such special signals as “break” signals and “mark restoration” information.

Further provision has been made for use of this Regenerator with synchronous binary signals on either single channel circuits or multi-channel time division multiplex systems. Provision is made to synchronize this unit from an external source.

## OUTSTANDING FEATURES:

- **Maximum Acceptable Signal Distortion:** new circuitry accepts up to 47% mark or space distortion.
- **“Floating” Input & Output Circuits:** completely electronic output, no relays.
- **Greater Timing Circuit Stability:** time base derived from highly stabilized L-C oscillator.
- **Switch Selection of Speeds:** 60, 75, 100 words per minute.
- **Adaptable to Any Speed:** low-pass filter and frequency-determining elements are plug-in units.
- **Faithfully** reproduces “break” signals
- **Transmits** “break” signal in case of line failure
- **Protected** against “space lock-out”
- **Output Can Be Open-Circuited** with no excessive rise in line voltage and no harm to the Repeater
- **22 Front Panel Test Points** for checking equipment function, current and voltage measurements.
- **8 Jacks** for input and output line monitoring
- **Completely Self-contained:** internal power supply and line battery.

### Input Keying Signal Requirements:

- (1) Neutral keying, positive or negative sense
  - (a) on off 60 ma pulses (40 ma min)
  - (b) on-off voltage pulses 10-100V into 100K ohms
- (2) Polar keying  $\pm 30$  ma
- (3) Dry contact keying

### Frequency Stability of Time Base Generator:

Less than 1 point range loss for  $\pm 10\%$  line voltage variation or  $\pm 20^\circ\text{C}$  ambient change from  $25^\circ\text{C}$

### Sampling Time:

Approximately 50 microseconds

### Output:

Electronic tube outputs:  
(a) neutral 65 ma max. into 2K ohms.  
(b) polar 33 ma (max.) into 2K ohms

### Output Distortion:

- (a) Signal bias distortion less than 0.5%
- (b) Signal element random jitter less than 1%
- (c) Signal history (duty cycle) distortion less than 0.5%
- (d) Total distortion less than 2%

### Power Requirement:

125 watts approx. 110-220V, 50-60 cps.

### Mounting:

Standard 19" rack mounting, 5 1/4" panel



PACE SETTERS IN QUALITY COMMUNICATION EQUIPMENT

## NORTHERN RADIO

MANUFACTURING COMPANY LIMITED  
1950 BANK STREET, OTTAWA, ONT.

In U.S.A. Northern Radio Company Inc. 147 West 22nd St. New York 11, N.Y.

# AT LAST a completely new kind of regulator!

**ACTUALLY THREE REGULATORS IN  
ONE—PLUS MULTIPLE SENSING!**

The APR 1010 combines many new regulation and sensing systems in one versatile package. Here's flexibility of operation never before possible... saves space, eliminates instrument duplication, means greater economy in engineering operations.



- RMS VOLTAGE REGULATION
- AVERAGE REGULATION
- PEAK REGULATION
- FIVE PRINCIPAL SENSING ARRANGEMENTS
  1. Internal
  2. External
  3. Remote
  4. Constant Current
  5. DC

**ELECTRICAL CHARACTERISTICS:**

Input	95-130 VAC, 1 $\phi$ (50 or 60 cps $\pm$ 10%)
Output	115 VAC, adj. 110-120V
Regulation accuracy (RMS, average, or peak, switch selected)	$\pm$ 0.1% against line $\pm$ 0.1% against load
Distortion	3% max.
Load	0-1000VA
P.F. range	Unity to 0.7 lagging
Recovery time	0.1 sec.

**WRITE FOR COMPLETE TECHNICAL DATA.**

See the new  
APR 1010  
at Booths 2627-9  
I.R.E. Show!

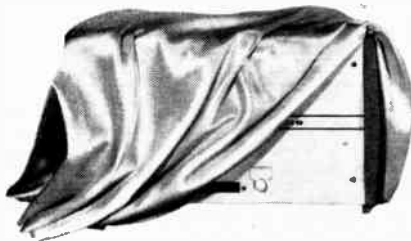

**Sorensen**<sup>®</sup>

**SORENSEN & COMPANY, INC. • STAMFORD, CONN.**

*In Canada, Bayly Engineering Limited, Ajax, Ontario*

## NEW PRODUCTS

(Continued from page 60)

### ● Subminiature Hermetically Sealed Relays

*Item 1494*

Ace Relay Associates, Inc., a subsidiary of Ace Electronics Associates, Inc., announces a new series of sub-miniature, hermetically sealed relays featuring outstanding reliability. The 201 Series Ace-relays are for radar systems, missiles and rockets, computers, ground and airborne equipment, and wherever ultra-compact size, together with positive reliability are demanded.

Weighing less than  $\frac{3}{4}$  of an ounce and no larger than a 3c stamp, the Acerelay (patent applied for) is designed so it functions perfectly under the most severe conditions of shock, vibration, and acceleration. The coil assembly is hermetically sealed independent of contact assembly, thus eliminating all possibility of contact contamination. Bifurcated contact design, with generous overtravel and wipe, insure positive reliability both in power and dry circuit work.

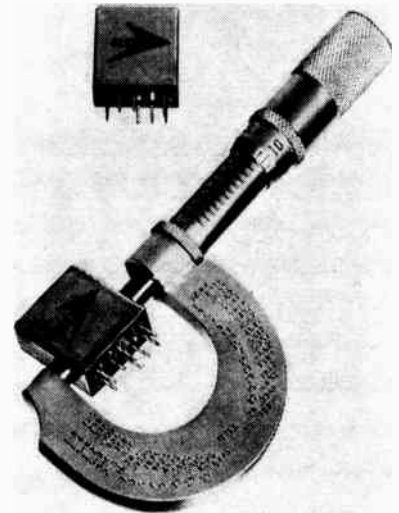

Standard specifications include: Contacts — double pole double throw bifurcated break before make or make before break contacts; Contact Rating — 3 amp resistance @ 115V AC or 28V DC; Coil Resistance — to 10,000 ohms; Vibration 20G at 5-2000 CPS; Shock — 50G; Life — minimum of 500,000 operations; Entire relay hermetically sealed; Meets MIL-R-5757C; Temperature — standard units to 125°C. — higher temperature units available.

Modifications of the above to meet special applications are available. Prototypes are handled in a special order department and delivery can be made in 2 weeks. Production units are also given expedited service.

For complete details contact, **Ace Relay Associates, Inc., 103 Dover St., Somerville, Massachusetts.**

### ● Power Klystron Bulletins

*Item 1495*

Eitel-McCullough Incorporated have announced the publication of two new brochures on Eimac power amplifier klystrons. They are: Application bulletin Number Ten, "The Care and Feeding of Eimac Power Klystrons," which includes general information on klystron tubes plus specific remarks on the operation and maintenance of Eimac klystrons, and "Power Amplifier Klystrons for UHF and Microwave Transmission" which describes the development of klystrons at Eimac for UHF and microwave work. Copies of the brochures may be obtained from Eitel-McCullough, Inc., San Bruno, California or Ahearn and Soper Limited, Sparks St., Ottawa.

(Turn to page 68)

For further data on advertised products use page 73.

# Analog Computers (Continued from page 27)

is rotated. Like all other mechanical devices the Scotch Yoke suffers in practice from difficulties due to wear, friction, backlash and the like. Various ingenious ideas have been tried to overcome these difficulties, the most successful being the geared sine crank and the ball resolver which are in current use in mechanical computers. The geared sine crank (Fig. 3) works on the principle that the end of a crank mounted on a gear will move sinusoidally as the gear rolls around an internal gear having twice as many teeth. The ball resolver works on the principle of constraining a ball to rotate about a definite axis. Rollers are placed at right angles to each other and in the plane of the ball's axis of rotation. These pick-up rotations are proportional to the sine and cosine of the angle between one of the rollers and the axis of rotation.

Now it occurred to Lord Kelvin that if one were to hook up a variety of these mechanical computing elements one could make them behave according to predetermined mathematical equations. One of the first equations he tried was this: (Fig. 4)

$$\frac{d^2X}{dt^2} = \frac{-dX}{dt} - X$$

This method of attack was as follows:

First he took a shaft whose angular position he assumed was proportional to  $\frac{d^2X}{dt^2}$ . He connected this shaft to a

ball and disc integrator driven by a clock motor. The output of this mechanism is then the integral of  $\frac{d^2X}{dt^2}$  or  $\frac{dX}{dt}$ .

Using a second integrator he obtained X from  $\frac{dX}{dt}$ . Next he fed the output

of the first integrator  $\frac{(dX)}{(dt)}$  and the

output of the second integrator (X) into a differential. The output shaft of the differential rotated an amount

just equal to  $\frac{dX}{dt} + X$ . The final step

was to reverse the direction of rotation by passing the drive through a single pair of gears, giving  $\frac{-dX}{dt} - X$ .

According to the equation

$$\frac{d^2X}{dt^2} = \frac{-dX}{dt} - X$$

this shaft should rotate an amount just equal to that needed on the input shaft to the first integrator, so he coupled the two together. The result was the world's first differential analyser — a mechanical analog computer which would operate according to a differential equation.

All this took place about one hundred years ago. Lord Kelvin's achievement was greeted by the scientific world by deafening silence. Why? Because mechanisms of the time were simply not accurate enough for the task. The errors in the computation were just too great to be tolerated. Another defect arose because the integrators tended to slip if called upon to supply very much torque. As a result the machine ground to a halt if very many integrators were involved.

With the improvement of mechanical designs and the arrival of electric servos to take the load of the integrators, the mechanical differential analyser again became practical and in 1928 Dr. Vannevar Bush at M.I.T. built the first computer to become a useful research tool. This machine has its shortcomings however, the chief ones being the difficulty involved in setting up a problem since this involved installing special gear trains and complicated shaft arrangements. Equally serious was the problem of keeping the computer operating since it was necessary to maintain a very precise instrument which was physically as large as an average two storey house.

## Mechanical Computers More Flexible

While it cannot be said that mechanical analog computing is a thing of the past, it is safe to say that today these methods find their main application in special purpose devices which do not require alteration once built and which can be made of manageable size to keep maintenance problems down. In place of the general purpose mechanical differential analyser, the electronic analog computer has entered the field. The similarity between the two is striking, but it must be said in all fairness that the mechanical computer can still deal with a wider variety of problems than is the case with its electronic cousin.

A REAC computer cabinet contains three main elements — a control panel which is used to start and stop the calculation, a patchboard which is used to interconnect the various computing elements (and which serves the same function as the shafting did on the mechanical machine) and the computing elements themselves. The computing elements can be thought of as boxes which perform electrically the same functions as Lord Kelvin's mechanisms did. That is to say, the cabinet contains electric or electro-mechanical devices which can add, integrate, multiply, generate sines and cosines and read graphs.

The only difference between this computer and a mechanical differential analyser is that, whereas the

earlier machine used shaft positions to represent physical quantities, voltage is used in the REAC. For instance on the differential analyser if it were required to add two and two, two shafts would be connected to a differential, each shaft turned two degrees which then would measure the output rotation as four degrees. On the REAC two wires would be connected to an adder and each wire fed with two volts which would read four volts on the output.

The operational amplifier is the most important part of the computer. This is a very high gain chopper stabilizer dc amplifier which can be used to add or to integrate. When a condenser is used in the feedback circuit, we have an integrator. Substitution of a resistor for the condenser makes it an adder. It should be noted that the precision of the computation depends entirely on the accuracy of these elements and very special polystyrene condensers are used.

Multiplier units used in the REAC are electro-mechanical devices. They perform the operations of multiplication, sine and cosine generation and graph reading. The graphs are given to the machine in the form of a network of resistors which can be mounted on plug-in cards on the sides of the unit.

Potentiometers serve the same function as gear ratios on a mechanical machine and are used to set in the constants of the problem.

Electrical connections to these computing elements are brought out to terminals on the patch bay. Actual setting up of a problem is done on a patch board which can be plugged into the patch bay; on this board are placed the interconnections between elements to make the computer follow the proper equations.

## Patchboard Equations

Consider how the equation

$$\frac{d^2X}{dt^2} = \frac{-dX}{dt} - X$$

would be connected upon the patchboard (Fig. 5). As with the mechanical differential analyser one starts by taking a wire, assuming it carries a volt-

age proportional to  $\frac{d^2X}{dt^2}$ . This wire is

plugged into the input of an integrator. Now electronic computers differ from their mechanical counterparts in that the output of the amplifiers must, for negative feedback purposes, be opposite in sign to the input. Thus the integrator delivers the negative integral of its input. Here the input is  $\frac{+d^2X}{dt^2}$ , so that the output is  $\frac{-dX}{dt}$ .

The signal is fed to a second

(Continued on page 69)

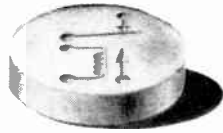

*panacea*

for **ENGINEERS, INVENTORS,**  
**RADIO AMATEURS, MODEL BUILDERS**

for controlling toys, model boats, planes, cars,  
garage doors, electric fences,  
robot lawn mowers, iron-core politicians

In addition to a variety of rather specialized sensitive relays developed for particular applications, Sigma also makes several "basic" types, among them the five DC sensitive SPDT types shown here. The unenclosed styles (illustrated) allow contact observation, and readjustment or cleaning in case of accident. They are

also available in a variety of sensitivities, coil resistances, mounting styles and enclosures (open frame, dust cover or hermetically sealed; permanent or plug-in connections). One-at-a-time purchases can best be made from Sigma jobbers.

\* \* \*

Complete catalog is available on request.

**4F-8,000 S.**  
8,000 ohms, wt. — 2 1/4 oz. Price for one \$6.00. Operates on 1.6 ma., releases on 0.75 ma., withstands 11 ma. continuously without overheating. Silver contacts rated at 2.0 amp. Withstands 10 g vibration while operating. Radio Central Modelers' long-time choice because it is fairly sensitive, highly reliable, easy to mount and adjust. Lately overshadowed by the "26".

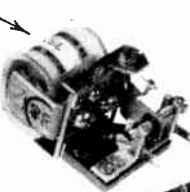

**5F-8,000 SS.**  
8,000 ohms, wt. — 4 1/4 oz. Price for one \$9.75. Operates on 0.35 ma., releases on 0.15 ma., withstands 15 ma. continuously without overheating. Palladium contacts rated at 0.25 amp. Too sensitive for applications where vibration will be encountered while operating. Other adjustments give secure contacts under 5, 10 or 15 g vibration.



Good for condenser time delay circuits and for holding during pulse trains.

**41F-2,000 SK.**  
2,000 ohms, wt. — 2 1/2 oz. Price for one \$4.50. Operates on 4.0 ma., no specified release, withstands 22 ma. continuously without overheating. Tungsten contacts rated at 1.0 amp.



Keying relay giving clean, bounce-free pulses on a normally open contact circuit at speeds up to 100 pulses per second. Coil should get at least 6 ma. signals from at least 150 volt supply. (Plate circuit, not cathode follower.)

**11F-6,000 G.**  
6,000 ohms, wt. — 1 oz. Price for one \$1.70. Operates on 2.9 ma., no specified release, withstands 13 ma. continuously without overheating. Silver contacts rated at 1.0 amp. Withstands 10 g vibration while operating.



Within its ratings, a good combination of high quality and low cost.

**26F-8,000 CD5.**  
8,000 ohms, wt. — 2 oz. Price for one \$8.50. Operates on 0.7 ma., releases on 0.4 ma., withstands 11 ma. continuously without overheating. Drop-out is held within 0.1 to 0.2 ma. of pull-on and within above limits. Palladium contacts rated at 0.5 amp. Withstands 5 g vibration while operating.

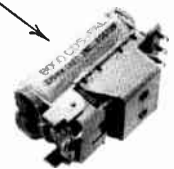

Designed especially for use in low power radio control circuits.

**SIGMA**

SIGMA INSTRUMENTS, INC.,

85 Pearl Street, So. Braintree, Boston 85, Massachusetts

Canadian Representatives:

SAMUEL C. HOOKER (CAN.) LTD., Montreal and Toronto • RON MERRITT, Vancouver, B.C.

## NEW PRODUCTS

(Continued from page 66)

### ● Teflon Tubing

Item 1496

Teflon tubing is now available in American Wire Gage sizes of 0 (.336" ID), 1, 2, 3, 4, 5, 6, 7 and 28 and 30 (.013" ID) from Polypenco, Incorporated, Reading, Pennsylvania, U.S.A. Known commercially as Polypenco Teflon spaghetti tubing, it has been currently available in American Wire Gage sizes 8 through 26.

The high temperature spaghetti tubing is used as a low and high frequency insulation sleeving for electronic component development. The thin wall tubing has a minimum dielectric strength of 750 volts-mil, a low dielectric constant of 2.0 and a high surface resistivity above  $10^{12}$  ohms per  $cm^2$ .

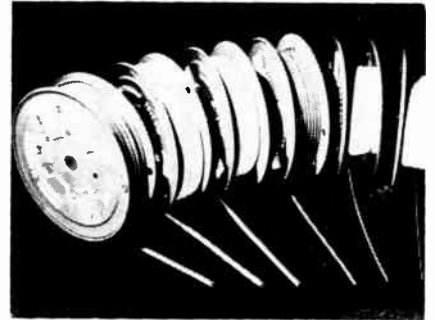

The material permits assembly miniaturization because it combines outstanding electrical properties with a wide temperature service range of  $-320^{\circ}F.$  to  $+550^{\circ}F.$ , zero water absorption, and resistance to flex and vibration. It completely resists soldering heats and is unaffected by bending and flexing during assembly.

The new sizes are designed to meet the requirements of a broadening range of applications. All sizes are available in ten coded colors for circuit identification. For further information write: Polypenco Inc., Reading, Penn., U.S.A.

### ● Digital Timing Generator And Tape Search Unit

Item 1497

A Digital Timing Generator, Model 201 and a Magnetic Tape Search Unit, Model 202 have just been introduced by Hycon Eastern, Inc., Cambridge, Mass. to provide automatic high-speed access to selected data in Ampex Recorders and similar multi-channel magnetic tape instrumentation systems.

The Digital Timing Generator, Model 201, generates numerically coded timing signals which are recorded on the magnetic tape throughout the data recording periods, providing a precise digital index in terms of elapsed time. The Generator also visually displays exact time in hours, minutes and seconds as illuminated digits.

The Magnetic Tape Search Unit, Model 202 operates during data reduction periods. On the basis of time indices recorded on the tape by the Digital Timing Generator, this instrument automatically locates and selects for controlled playback the tape data included between a "sequence start time" and a "sequence end time" specified by panel dial settings. The time index is visually displayed as illuminated digits on a small separate panel which may be remotely located for convenience.

Design features include tape speeds of 60, 30, 15, 7 1/2, 3 3/4 or 1 3/4 inches per second for recording; these same 6 tape speeds plus high-speed search rate for playback; and forward or reverse directions. Both Models mount in RETMA standard 19" relay racks.

For information, write for Bulletin TSG to Dept. DR, Hycon Eastern, Inc., 75 Cambridge Parkway, Cambridge 42, Mass.

(Turn to page 70)

For further data on advertised products use page 73.

# Analog Computers (Continued from page 67)

grator whose output will be plus  $X$ . Our next task is to obtain the sum  $\frac{-dX}{dt} - X$ . One way to achieve this is

to pass  $\frac{-dX}{dt}$  through an adder to get  $\frac{+dX}{dt}$ , connect  $\frac{+dX}{dt}$  and  $+X$  to an adder and obtain  $\frac{-dX}{dt} - X$ . The output

could then be connected to the first integrator since it was assumed that the input to the first integrator was  $d^2X$

which, by our equation is equal  $\frac{-dX}{dt} - X$ . (In practice, a more economical interconnection is used.)

Let us return now to the patchboard to see just how this equation is connected up (Fig. 6). The patchboard is divided off into colored panels, and each panel carries terminals which are the inputs and outputs of a particular group of computing elements. To set up our example equation we take a wire and plug it into the input of an integrator. The other end we let hang. Then a wire is plugged into the output of the integrator. This lead will carry a voltage proportional to

$\frac{-dX}{dt}$ . This lead is plugged into the input of a second integrator. The output of this integrator ( $X$ ) is connected to the input of an adder. We

also wish to add  $\frac{+dX}{dt}$  to  $X$ , so we take

$\frac{-dX}{dt}$  from the first integrator, pass it through second adder to get  $\frac{+dX}{dt}$

and connect this output to the first adder so that  $\frac{+dX}{dt}$  and  $+X$  will be

added to give  $\frac{-dX}{dt} - X$ . This quantity is equal to  $\frac{d^2X}{dt^2}$  so we take the loose

end of the wire which is the input to the first integrator and plug it into the output of the adder. The problem is now set up. It is necessary of course to introduce initial conditions in the problem and appropriate holes on the patchboard are provided.

On a typical control panel for a computer, various controls tell the machine whether it is to compute, stop calculating and wait, or wipe out the present calculation and prepare for

the next. Push buttons are provided for testing that the machine is running properly and that the problem has been properly set up on the patchboard. Other push buttons permit one to watch the calculation as it proceeds at any of the integrators or adders. Using certain switches one may watch the calculation using a recording voltmeter or an X-Y plotter.

As an example of the type of problem where an X-Y plot is useful we may take the computation of the path of a ball thrown into the air. In this case the machine will compute the vertical and horizontal speed and position as a function of time, but the engineer is accustomed to thinking of this problem in terms of the trajectory of the ball and a plot of horizontal distance traveled against vertical distance traveled is desirable since it gives a pictorial result which can be easily checked for reasonableness.

This concept of "reasonableness" is what makes the analog computer an invaluable tool for the engineer. Since the machine produces a pictorial display of the performance of the system under study and produces it at the same rate as actually occurs in the field, the engineer is able to bring to bear all his experience to help him bring the study to a successful conclusion.

## ELECTRONICS AND COMMUNICATIONS ENTERS FIFTH YEAR OF PUBLICATION—

*Four years ago the first copy of Electronics and Communications magazine came off the press. A lot can happen during even so short a period. For one thing, the market has consolidated itself and expanded at a terrific pace. Some say that Electronics and Communications has been a most important contributing factor in this regard.*

*Certainly through its lively pages those in it and those to whom it sells its products have learned much about it that they did not know before 1953. That includes Electronics and Communications itself — which enters its fifth year profiting by its past four years' experience and fully resolved to maintain and increase the esteem it enjoys among its wide readership of engineers and management and the confidence it has earned among its growing list of advertisers.*

## ELECTRONICS AND COMMUNICATIONS

The Pioneer Publication In The Field

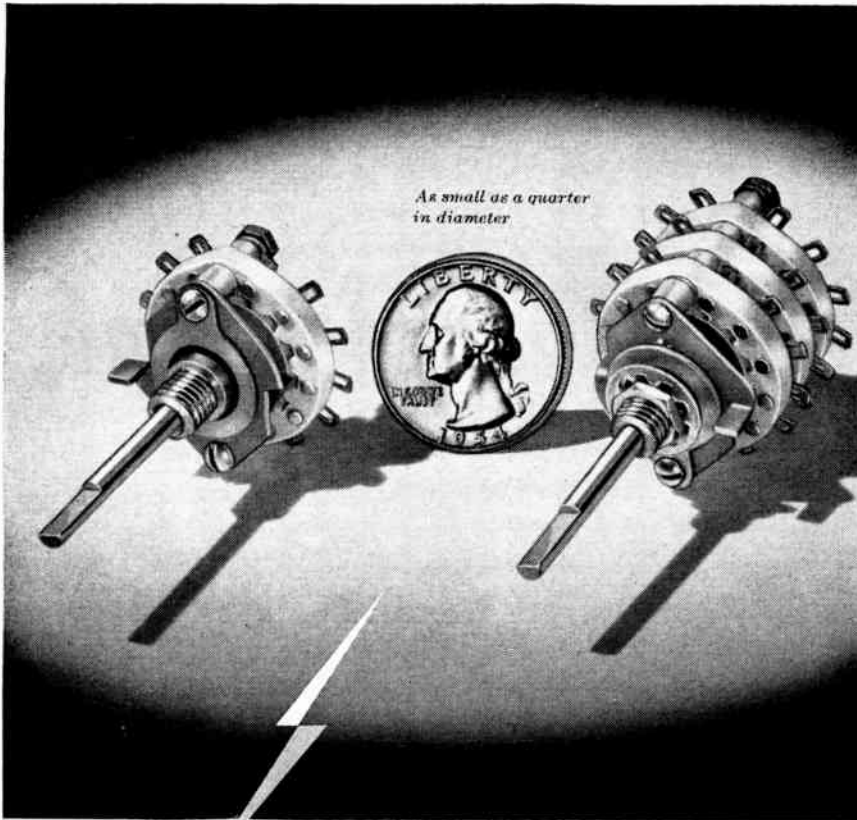

## Multiple switching sequences

*in a switch only 15/16" in diameter*

*For military and commercial applications...*





*Guided missiles*

*Band-switching in extra-small electronic equipment*

*Transistor circuits*

*Aircraft instruments*

### Centralab Series 100 Sub-Miniature Rotary Switch

-  A lightweight, ultra-small switch with the electrical rating of larger switches.
-  Available up to 12 positions. Make and break, resistance load, 1 ampere at 6 volts d.c.; 150 milliamperes at 110 volts a.c.; current-carrying capacity, 5 amperes.
-  Sections are ceramic — Centralab Grade L-5 Steatite. Wafers can be stacked up three sections per shaft.
-  Meets the corrosion-resistance requirements — and exceeds the insulation resistance — specified by MIL-S-3786.

Write for Technical Bulletin EP-73 for complete engineering data.

P-2756

**Centralab Canada Ltd.**

804 Mt. Pleasant Rd, Toronto 12, Ontario

**A DIVISION OF GLOBE-UNION INC.**

964C East Keefe Avenue • Milwaukee 1, Wisconsin  
In Canada: 804 Mt. Pleasant Road, Toronto, Ontario

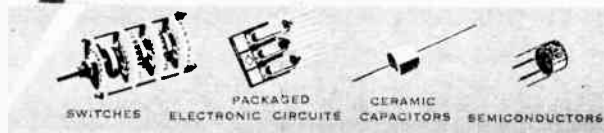

## NEW PRODUCTS

(Continued from page 68)

### ● High Vacuum Rectifier

Item 1498

Eitel-McCullough, Inc., San Bruno, California, manufacturer of Eimac power vacuum tubes has announced a new high vacuum rectifier. Designated the 2-450A, the new rectifier is intended for use in rectifier units or special applications whenever conditions of extreme ambient temperatures, high operating frequency, or high peak inverse voltages prevent the use of gas-filled tubes.

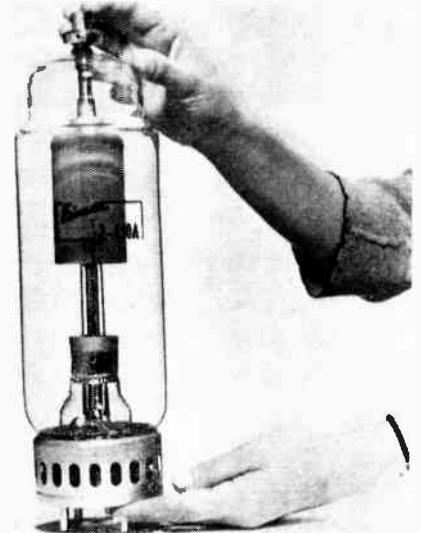

The 2-450A has a maximum d.c. current rating of 1 ampere and a maximum peak inverse rating of 25,000 volts. Maximum peak plate current rating is 8 amperes.

Overall height of the 2-450A is 14 3/4" and the diameter is 4 1/2". Maximum plate dissipation is 450 watts.

For further information write Ahearn and Soper, Sparks Street, Ottawa.

### ● Input Transformers

Item 1499

These Input Transformers are the same dependable components developed and proved through years of service in Brown Electronik recorders, controllers and indicators. Three models, having different primary impedances, are available for use with thermocouples, transducers and other signal generators. They faithfully handle low-level signals of 0.5 microvolts to 200 millivolts; steady dc, pulsing dc or low-frequency ac.

Because Brown Input Transformers were designed for use in chopper-modulated input circuits, they have center-tapped primaries.

Here the transformer, together with the converter, serves as the coupling device between the d-c voltage source and the a-c amplifier. The low-level d-c signal is fed across the center-tap and one side of the primary.

The converter blade switches the input from side to side. Thus, the stepped-up input voltage developed across C is a modified square wave of line frequency. This signal is fed to the grid of amplifier tube.

The capacitor C is generally selected to tune the secondary to line (converter) frequency, for maximum input impedance.

Selection of a transformer from among the three models would be dictated primarily by the impedance of the source.

Brown Input Transformers can, of course, be used as coupling devices in low-frequency a-c circuits. If maximum gain is desired, half the primary winding should be used. If maximum impedance is desired, the full primary winding should be used.

For further information write to: Minneapolis-Honeywell Regulator Company, Toronto 17, Ontario.

(Turn to page 80)

For further data on advertised products use page 73.



*a comprehensive*  
**Telecommunication  
 Engineering Enterprise**

The largest telecommunication manufacturing organisation in the British Commonwealth **Standard Telephones and Cables Limited** covers the whole waterfront of telecommunication engineering and is engaged in the research, development, manufacture and installa-

tion of all types of communication and control systems.

The Company is in an unrivalled position to undertake, within its own organisation, the co-ordinated systems-planning of complete communication projects involving inter-dependent systems of various types.

**'Standard' productions include:—**

**Telecommunication Line Transmission  
 Equipment**  
**Radio Broadcasting Equipment**  
**Radio Communication Equipment**  
**Air Radio Navigational Aids**  
**Supervisory and Remote Control Systems**  
**Railway Communication Apparatus**  
**Railway Control Equipments**  
**Telephone Cable**  
**Sound-Reinforcement Systems**  
**Public and Private Telephone Systems**  
 (Automatic and Manual)

**See exhibits—Booths Nos. 4249-53 and 4350-54.**

**Canadian International Trade Fair—Toronto May 31-June 11.**



**Standard Telephones & Cables  
 Mfg. Co. (Canada) Ltd.**

9600 ST. LAWRENCE BLVD., MONTREAL 12. P. Q.

# *from virgin forest . . .* to a **COMPLETE INSTALLATION**

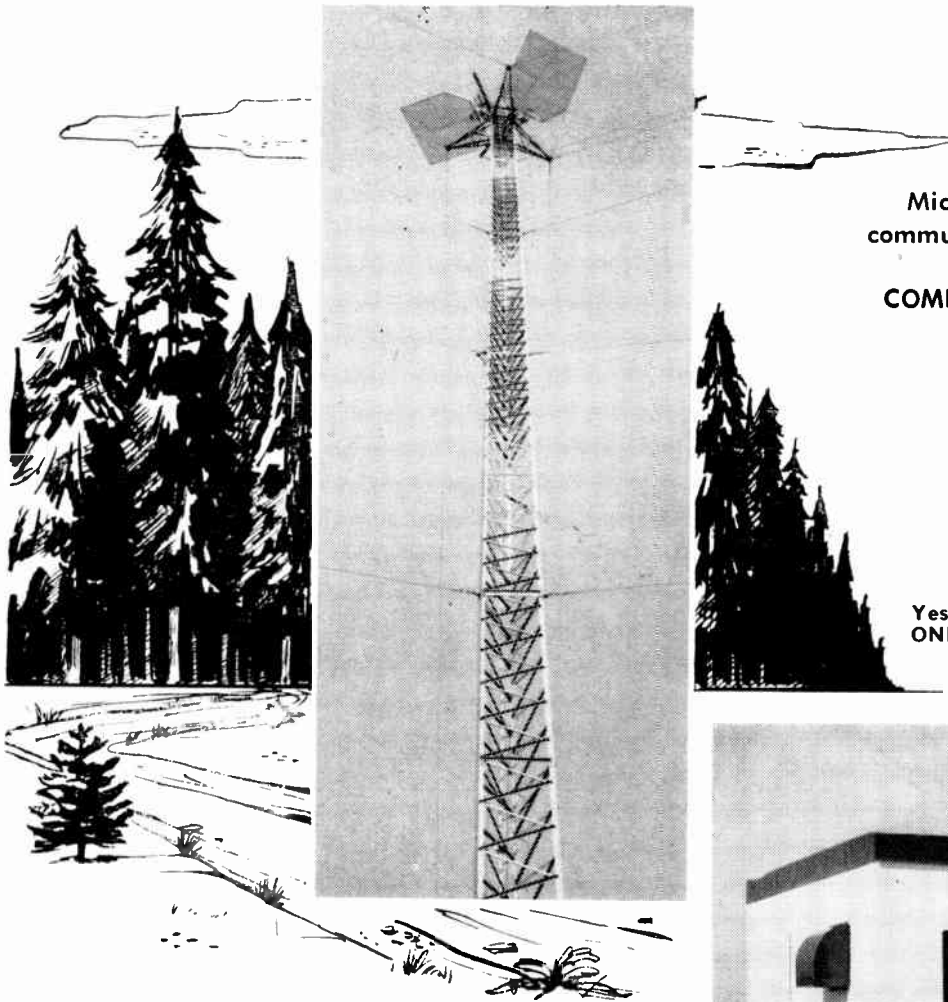

Micro-Tower Limited converts your communications requirements into an operating system by a **COMPLETE SERVICE** that includes:

- Preparation of the site;
- Construction of roads and buildings; erection of towers and antennas;
- Installation of power services, including engine generator sets;
- Installation of communications electronic equipment.

Yes, from concept to construction, **ONE** order and **ONE** responsibility.

## **FROM COAST TO COAST**

Illustrative of the variety and scope of work undertaken by Micro-Tower Limited; some recent projects include:

- Rhombic transmitting arrays and multiple dipole receiving arrays, for communications with Australia and New Zealand, for Canadian Overseas Telecommunication Corporation near Vancouver.
- Providing microwave towers for the Canadian National Telegraphs between St. John's and Clarendville, Newfoundland. This microwave system will connect with the New Trans-Atlantic telephone cable.
- Supply and erection of VHF towers and antennas and microwave TV links, for the Bell Telephone Company of Canada, and for the Manitoba Telephone System.



Above, left: 300 ft. guyed microwave tower with two 10' x 15' reflectors, supplied and erected at Moorefield, Ontario, to relay television network programs from Kitchener to CKNX-TV, Wingham, Ontario.

This microwave system is owned and operated by the Canadian National Telegraphs and the Canadian Pacific Telegraphs.

▲ Repeater building for the Kitchener-Moorefield-Wingham system. Micro-Tower constructed road and building, supplied and installed standby diesel generator set; and installed microwave equipment, ready for final adjustment by equipment manufacturer's engineers.

# **MICRO-TOWER LIMITED**

891 O'CONNOR DRIVE  
TORONTO • CANADA

For further data on advertised products use page 73.



# INDEX TO ADVERTISERS

Page number is on the right.  
Key number for use with  
READER SERVICE CARDS is  
on the left.

Key No.	Name	Page No.
1.	Adcola Products Ltd.	51
2.	Ahearn & Soper Co. Ltd., The	81
3.	Airtron Canada Ltd.	2
4.	Airpax Products Co.	56
5.	Automatic Electric Sales (Canada) Ltd.	43-46
6.	Aviation Electric Ltd.	15
7.	Aviation Electric Ltd.	37
8.	Aviation Electric Ltd.	38
9.	Beatty Bros. Ltd.	37
10.	Bell Telephone Co. of Canada, The	80
11.	Bendix Aviation Corp.	41
12.	Canada Illinois Tools Ltd.	59
13.	Canadian General Electric Co. Ltd.	37
14.	Canadian I.R.E. Convention	7
15.	Canadian Line Materials Ltd.	39
16.	Canadian Line Materials Ltd.	47
17.	Canadian Marconi Co.	3
18.	Canadian Marconi Co.	50
19.	Canadian Westinghouse Co. Ltd.	8
20.	Canadian Westinghouse Co. Ltd.	18
21.	Cannon Electric (Canada) Ltd.	58
22.	Centralab (Div. Globe Union Inc.)	70
23.	Collins Radio Co.	32-33
24.	Cossor (Canada) Ltd.	5
25.	Curtiss-Wright Corp.	48
26.	Daly-Arrow Ltd.	38
27.	Eitel-McCullough Inc.	81
28.	Electro Products Laboratories	51
30.	Empire Engineering Co.	39
31.	Federal Wire & Cable Co. Ltd.	23
32.	Freed Transformer Co.	48
33.	G-V Controls Inc.	51

Mr. Circulation Manager:

My proper address is shown below.  
Check

(My old address is ..... City .....)

Please add my name to your Electronics & Communications' mailing list.  
Check (No obligation)

Name ..... Position .....

Company ..... Nature of Business .....

Company Address ..... City ..... Prov. ....

Signature .....  
3-57 (Not valid without signature)

PLEASE SEND FURTHER INFORMATION ON THE FOLLOWING NEW  
PRODUCT ITEMS AS NUMBERED BELOW — USE PRODUCT ITEM NUMBERS

PLEASE SEND FURTHER INFORMATION ON THE FOLLOWING  
ADVERTISEMENTS AS NUMBERED BELOW — USE KEY NUMBER

Company ..... Nature of Business .....

Name ..... Position .....

Street ..... City ..... Prov. ....  
3-57

PLEASE SEND FURTHER INFORMATION ON THE FOLLOWING NEW  
PRODUCT ITEMS AS NUMBERED BELOW — USE PRODUCT ITEM NUMBERS

PLEASE SEND FURTHER INFORMATION ON THE FOLLOWING  
ADVERTISEMENTS AS NUMBERED BELOW — USE KEY NUMBER

Name ..... Position .....

Company .....

Street ..... City ..... Prov. ....  
3-57

**BUSINESS REPLY CARD**  
No Postage Stamp Necessary if Mailed in Canada

5c POSTAGE WILL BE PAID BY

**ELECTRONICS AND COMMUNICATIONS**

31 - 35 Willcocks Street

Toronto 5, Ontario



**BUSINESS REPLY CARD**  
No Postage Stamp Necessary if Mailed in Canada

5c POSTAGE WILL BE PAID BY

**ELECTRONICS AND COMMUNICATIONS**

31 - 35 Willcocks Street

Toronto 5, Ontario



**BUSINESS REPLY CARD**  
No Postage Stamp Necessary if Mailed in Canada

5c POSTAGE WILL BE PAID BY

**ELECTRONICS AND COMMUNICATIONS**

31 - 35 Willcocks Street

Toronto 5, Ontario



**INDEX — Continued**

Key No.	Name	Page No.
34.	Heath Co.	75 - 79
35.	Helipot Corp.	82
36.	Helipot Corp.	83
37.	Herring & Co., John	49
38.	Hewlett-Packard Co.	4
39.	Indiana Steel Products Co. of Canada Ltd., The	10
40.	Kester Solder Co.	55
41.	Magnetics Inc.	13
42.	Measurements Corp.	56
43.	Micro Tower Ltd.	72
44.	Muirhead & Co. Ltd.	52
45.	Northern Radio Mfg. Co. Ltd.	65
46.	Phillips Electrical Co. Ltd.	14
47.	Polypenco Inc.	51
48.	Pye Canada Ltd.	60
49.	R.C.A. Victor Co. Ltd.	84
50.	R.O.R. Associates Ltd.	41
51.	R.O.R. Associates Ltd.	61
52.	Radio Communications Engineering	20
53.	Radio Engineering Products Ltd.	55
54.	Sigma Instruments Inc.	68
55.	Snelgrove & Co. Ltd., C. R.	16
56.	Sorenson & Co. Inc.	66
57.	Sprague International Ltd.	48
58.	Standard Telephone & Cables Mfg. Co. (Canada) Ltd.	71
59.	Syntron (Canada) Ltd.	57
60.	Telephone Mfg. Co. Ltd.	49
61.	Triplett Electrical Instrument Co.	6
62.	Ungar Electric Tool Co. of Canada	61

Your request for further information on New Product items or additional information concerning advertisements in Electronics and Communications will be promptly acknowledged.

*world's finest  
electronic equipment  
in kit form...*

# HEATHKIT®

*High Quality  
Advanced Design  
Reliable Performance  
Real Economy*

## Heathkit AMATEUR CW TRANSMITTER KIT

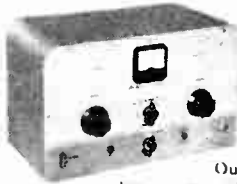

MODEL AT-1  
**\$29.50**  
Shpg. Wt. 15 lbs.

Outstanding dollar per-watt value! 30-35 watts plate power input, bandswitching for 80, 40, 20, 15, 11, and 10 meters. Crystal or external VFO excitation. 52 ohm output—key click filter—copper-plated chassis—pre-wound coils. Uses 6AG7 oscillator, 6L6 final.

## Heathkit PHONE & CW TRANSMITTER KITS

Both the DX-100 and the DX-35 are designed especially for you—with the features most important to efficient and practical amateur operation!



MODEL DX-100

**\$189.50**

Shpg. Wt. 120 lbs.  
Shipped major freight unless otherwise specified.  
\$50.00 deposit required on c.o.d. orders.

This transmitter is rapidly becoming the accepted standard in its price class. An outstanding dollar value!

100 watts RF output—built in power supplies—built in VFO and modulator—bandswitching on 160, 80, 40, 20, 15, 11, and 10 meters—phone or CW operation. 100 watts output on phone, and 120 watts on CW. TVI suppressed—pi network output coupling—extensive shielding—matches 50 to 600 ohms—VFO dial and meter face illuminated—high quality components used throughout. Uses 1625 tubes in push-pull to modulate 6146 tubes in parallel. Complete schematic diagram and technical specifications available on request.



MODEL DX-35

**\$56.95**

Shpg. Wt. 24 lbs.

This exciting new kit features phone and CW operation on 80, 40, 20, 15, 11, and 10 meters. Completely bandswitching. Plate power input up to 65 watts on CW, with controlled carrier modulation built-in to 50 watts on phone. Features built-in modulator, power supplies, pi network output circuit. Separate 12BY7 buffer stage assures plenty of drive to the 6146 final. Switch selection of three crystals, or may be excited from external VFO. Panel meter reads final grid or plate current. Complete schematic and specifications on request.

## Heathkit VFO KIT

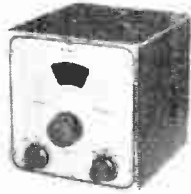

MODEL VF-1  
**\$19.50**

Shpg. Wt. 7 lbs.

Go VFO for added convenience and flexibility. Functions with Heathkit AT-1 or DX-35, or with most modern transmitters. Covers 160-80-40-20-15-11 and 10 meters. Three basic oscillator frequencies provide better than 10 volt average RF output. Plug provided for crystal socket of transmitter. VR tube for stability. Requires only 250 VDC at 15 to 20 ma and 6.3 VAC at 0.45A.

## Heathkit ALL BAND COMMUNICATIONS TYPE RECEIVER KIT

Unusual sensitivity and selectivity for price. Covers 550 kc to 30 mc in 4 bands. AC power supply—electrical bandspread—antenna trimmer—separate RF and AF gain controls—noise limiter—headphone jacks—AGC—BFO. Cabinet available separately as shown.



MODEL AR-3  
**\$27.95**

(less cabinet)  
Shpg. Wt. 12 lbs.

## Heathkit "Q" MULTIPLIER KIT



MODEL QF-1  
**\$9.95** Shpg. Wt. 3 lbs.

Adds selectivity and flexibility to your receiver, and rejects undesired signal or heterodyne. Tunes any signal within 1F of receiver with effective Q of approximately 4,000. Provides sharp "Peak" or "null." Surpasses crystal filter in flexibility of operation. Use with receiver having 450-460 kc IF. Will not function with AC-DC receivers. Requires 6.3 VAC at 300 ma, and 150-250 VDC at 2 ma. Cable and plugs supplied for connection.

## Heathkit GRID DIP METER KIT



MODEL GD-1B  
**\$19.50**

Shpg. Wt. 4 lbs.

Use as a signal source for determining unknown frequency, for checking resonance of tuned circuits, or for adjusting wave traps. Equally valuable in ham shack, service shop, or laboratory. Features 500 ma meter with sensitivity control, for indication. Covers 2 mc to 250 mc with five coils, supplied with kit. Coils pre-wound, dial scale pre-calibrated. Easy to build, and extremely valuable for literally hundreds of jobs.

## Heathkit ANTENNA COUPLER KIT



MODEL AC-1  
**\$14.50**  
Shpg. Wt. 4 lbs.

This coupler matches between the transmitter, and a long-wire end-fed antenna, and incorporates an L-type filter to attenuate signals above 96 mc and reduce TVI. 52 ohm coaxial input. Tapped inductor and variable capacitor for matching antenna. Neon RF indicator—copper-plated chassis—simple to build. Handles power up to 75 watts, 10 through 80 meters. Use with Heathkit AT-1 or DX-35.

## Heathkit ANTENNA IMPEDANCE METER KIT

Use this instrument, with a source of RF signal, to determine antenna impedance, line impedance, and to solve impedance matching problems with fixed or mobile antennas or transmission lines. Also, will double as field strength indicator, or phone monitor. Uses 100 ua meter and features calibrated impedance scale on control knob. Covers 0 to 600 ohms. A valuable device in any ham shack.



**\$14.50** MODEL AM-1  
Shpg. Wt. 2 lbs.

**HEATH COMPANY** A Subsidiary of Daystrom, Inc. **BENTON HARBOR 3, MICH.**

**Heathkit HARMONIC DISTORTION METER KIT**



MODEL HD-1  
**\$49<sup>50</sup>**

Shpg. Wt. 13 Lbs.

Use with low-distortion audio generator to measure harmonic distortion of audio amplifiers. Reads distortion on meter as percentage of input signal. Operates between 20 and 20,000 cps. High impedance VTVM built in for initial reference settings and final distortion readings. VTVM ranges are 0-1, 3, 10, and 30 volts full scale. 1% precision resistors employed. Distortion scales are 0-1, 3, 10, 30, and 100% full scale.

**Heathkit 6-12 VOLT BATTERY ELIMINATOR KIT**

MODEL BE-4  
**\$31<sup>50</sup>**

Shpg. Wt. 17 Lbs.



Will supply either 6 or 12 volt output to take care of auto radios on even the most modern cars. Output voltage is variable from zero to 8 volts DC or 0 to 16 volts DC. Will deliver up to 15 amperes at 6 volts or up to 7 amperes at 12 volts. Two 10,000 microfarad output filter capacitors insure smooth DC output. Panel meters monitor output current and voltage. Will double as a battery charger.

**HEATHKIT AUDIO TEST EQUIPMENT**

You can equip your shop for complete analysis and test of high fidelity audio equipment by employing Heathkit instruments. Professional equipment you can afford!

**AUDIO OSCILLATOR KIT (SINE-WAVE - SQUARE WAVE)**



MODEL AO-1  
**\$24<sup>50</sup>**

Shpg. Wt. 10 Lbs.

Produces sine wave or square wave signals from 20 to 20,000 cps in three ranges. Designed for use in service shop, or home workshop. Employs thermister for output regulation. Features high level output, low distortion, and low impedance output. Produces sine waves for audio testing, or will produce good, clean square waves with a rise time of only 2 microseconds. Very simple to build from complete instructions supplied.

**AUDIO GENERATOR**

MODEL AG-9  
**\$34<sup>50</sup>**

Shpg. Wt. 8 Lbs.



This generator features low distortion (less than .1%). Ideal for use with Model HD-1, or in other applications requiring low signal distortion. Frequency accuracy within  $\pm 5\%$ . Features step-type tuning from 10 cps to 100 kc, with three rotary switches to provide two significant figures and a multiplier. Output monitored on a large  $4\frac{1}{2}$ " meter. Meter calibrated for output voltage or db. Output ranges are—.003, .01, .03, .1, .3, 1, 3, and 10 volts.

**AUDIO ANALYZER KIT**



MODEL AA-1  
**\$59<sup>50</sup>**

Shpg. Wt. 13 Lbs.

This combination instrument provides the functions of an AC VTVM, audio wattmeter, and intermodulation analyzer. Includes built-in high and low frequency oscillators for intermodulation distortion tests. VTVM ranges are .01, .03, .1, .3, 1, 3, 10, 30, 100, and 300 volts rms. Wattmeter ranges are .15 mw, 1.5 mw, 15 mw, 150 mw, 1.5 w, 15 w, and 150 w. 1M scales are 1%, 3%, 10%, 30%, and 100%. Provides internal loads of 4, 8, 16, or 600 ohms. An extremely valuable instrument for the audio engineer, or serious audiophile.

**Heathkit HANDITESTER KIT**

This compact model easily slips into tool box, glove compartment, or coat pocket. Valuable as "extra" instrument in service shop, and ideal for the home experimenter. Very popular with appliance repairmen and electricians. Measures AC or DC voltage at 0-10, 30, 300, 1000, 5000 volts full scale. Direct current ranges are 0-10 ma and 0-100 ma. Attractive black bakelite case. Ohmmeter ranges are 0-3000 and 0-300,000 ohms.



MODEL M-1  
**\$14<sup>50</sup>**

Shpg. Wt. 3 Lbs.

**Heathkit VARIABLE VOLTAGE REGULATED POWER SUPPLY KIT**

MODEL PS-3  
**\$35<sup>50</sup>**

Shpg. Wt. 17 Lbs.



Supplies regulated DC output that can be manually controlled from 0 to 500 volts. It will supply up to 130 ma at 200 VDC, and up to 10 ma at 450 VDC. Large panel meter monitors output voltage or current. Also provides filament voltage at 6.3 volts AC, up to 4 amperes. Filament and B+ circuits are isolated from ground. Idea: lab power supply.

**Heathkit "Q" METER KIT**

The Model QM-1 measures the Q of inductances and RE resistance and distributed capacity of coils. Employs a  $4\frac{1}{2}$ " 50 microampere meter for direct indication. Features built-in signal source for tests at frequencies of 150 kc to 18 mc in 4 ranges. Measures capacity from 40 mmf to 450 mmf within  $\pm 3$  mmf. Indispensable for coil winding, and for determining unknown capacitor values.

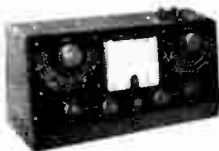

MODEL QM-1  
**\$44<sup>50</sup>**

Shpg. Wt. 14 Lbs.

**Heathkit IMPEDANCE BRIDGE KIT**

MODEL IB-2  
**\$59<sup>50</sup>**

Shpg. Wt. 12 Lbs.

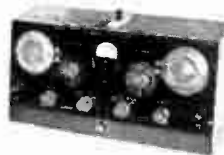

Features a built-in oscillator and amplifier. Measures resistance, capacitance, inductance, dissipation factors of condensers, and storage factor of inductance. D, Q, and DQ functions combined in one control. Employs  $\frac{1}{2}\%$  resistors and  $\frac{1}{2}\%$  silvermica capacitors. 100-0-100 ua. meter indicates null. Two section CRL dial provides ten separate units with accuracy of .5%. Fractions of units read on variable control.

**Heathkit CRYSTAL RECEIVER KIT**



MODEL CR-1  
**\$79<sup>5</sup>**

Shpg. Wt. 3 Lbs.

This crystal radio covers the standard broadcast band from 540 to 1600 kc. It employs two high Q tank circuits that are tuned separately for the desired station. A sealed germanium diode is featured for detection. No critical "cat's whisker" to adjust. Kit includes a pair of high impedance head sets, and is easy to build, even for a beginner. Construction manual takes "educational" approach and explains theory of signal reception. Requires no external power for operation. Ideal standby unit for emergency reception of civil defense signals in case of power failure.

**Heathkit BROADCAST BAND RECEIVER KIT**

You can build your own radio receiver with confidence, even if you are a beginner. Complete step-by-step instructions insure success. Features transformer-type power supply, high gain miniature tubes, built-in antenna,  $\frac{1}{2}$ " speaker, and planetary tuning from 550 kc to 1600 kc.

CABINET: Fabric covered plywood cabinet with aluminum panel as shown. Part #91-9A, shipping weight 5 lbs. \$4.50.

MODEL BR-2  
**\$17<sup>50</sup>**

(less cabinet)

Shpg. Wt. 10 Lbs.

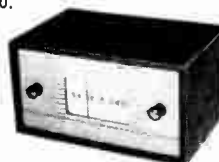

# HEATHKIT HIGH FIDELITY AMPLIFIER KITS

Proven circuit designs and step-by-step instructions insure successful construction, even if you have never built a kit before.



### KIT COMBINATIONS:

**W-5M Amplifier Kit:** Consists of main amplifier and power supply, all on one chassis. Complete with all necessary parts, tubes, and comprehensive manual. Shpg. Wt. 31 lbs. **\$59<sup>75</sup>** Express only.

**W-5 Combination Amplifier Kit:** Consists of W-5M amplifier kit listed above plus Heathkit Model WA-P2 Preamplifier kit. Complete with all necessary parts, tubes, and construction manuals. Shpg. Wt. **\$79<sup>50</sup>** 38 lbs. Express only.

## Heathkit 25-WATT ADVANCED-DESIGN

This 25 watt amplifier incorporates the "extra" features required for really outstanding performance. Employs KT66 output tubes in push-pull, and features a Peerless output transformer. Response is within  $\pm 1$  db from 5 cps to 160 kc at 1 watt. Harmonic distortion only 1% at 25 watts, 20 to 20,000 cps. IM distortion only 1% at 20 watts. Output impedance is 4, 8, or 16 ohms. Hum and noise are 99 db below rated output.



**\$16<sup>95</sup>** MODEL A-7D  
Shpg. Wt. 10 lbs.

## Heathkit 7-WATT

Using a tapped-screen output transformer of new design, frequency response of this unit is  $\pm 1\frac{1}{2}$  db from 20 to 20,000 cps. It provides good sensitivity, with surprisingly low distortion. Transformer tapped at 4, 8, and 16 ohms. Push-pull output. Separate bass and treble tone controls.

**MODEL A-7E:** Same as Model A-7D, but with stage of preamplification. Extra gain for low-level cartridges. RIAA compensation. Shipping weight 10 lbs. **\$18<sup>50</sup>**

## Heathkit 20-WATT DUAL-CHASSIS WILLIAMSON TYPE

Features the famous Acrosound TO-300 "ultra linear" output transformer. Uses 5881 tubes and has a frequency response within  $\pm 1$  db from 6 cps to 150 kc at 1 watt. Harmonic distortion only 1% at 21 watts. IM distortion at 20 watts only 1.3%. Output impedance is 4, 8, or 16 ohms. Hum and noise is 88 db below 20 watts.

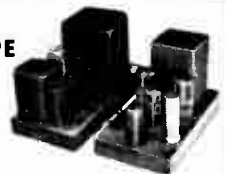

### KIT COMBINATIONS

**W-3M:** Consists of main amplifier and power supply for separate chassis construction. Includes all tubes and components necessary for assembly. Shpg. Wt. 29 lbs. **\$49<sup>75</sup>** Express only.

**W-3:** Consists of W-3M kit listed above plus Heathkit Model WA-P2 Preamplifier described on this page. Shpg. Wt. 37 lbs. **\$69<sup>50</sup>** Express only.

## Heathkit 20-WATT SINGLE-CHASSIS WILLIAMSON TYPE



The original low-priced Williamson Amplifier kit. A Chicago output transformer and 5881 output tubes are featured. Frequency response is  $\pm 1$  db from 10 cps to 100 kc at 1 watt. Harmonic distortion only 1.5% at 20 watts. IM distortion only 2.7%. Output at 4, 8, or 16 ohms. Hum and noise 95 db below 20 watts.

### KIT COMBINATIONS

**W-4AM:** Consists of main amplifier and power supply for single chassis construction. Includes all tubes and components necessary for assembly. Shpg. Wt. 28 lbs. **\$39<sup>75</sup>** Express only.

**W-4A:** Consists of W-4AM Kit listed above plus Heathkit Model WA-P2 Preamplifier described on this page. Shpg. Wt. 35 lbs. **\$59<sup>50</sup>** Express only.

## Heathkit 20-WATT

This amplifier can provide you with high fidelity at a surprisingly low price. Preamplifier built into same chassis as main amplifier. Four switch selected, compensated inputs are available, as are bass and treble controls. Features full 20-watt output using push-pull 6L6 tubes. Frequency response is  $\pm 1$  db from 20 to 20,000 cps. Harmonic distortion only 1% at full output.



**MODEL A-9B** **\$35<sup>50</sup>**  
Shpg. Wt. 23 lbs.

## Heathkit HIGH FIDELITY PREAMPLIFIER KIT

MODEL WA-P2

**\$19<sup>75</sup>**

(with cabinet)  
Shpg. Wt. 7 lbs.



Designed for use with Heathkit main amplifiers. Features five separate switch-selected input channels, each with its own input level control. Four-position turnover and roll-off controls for record equalization. Separate bass and treble tone controls. Special hum control to insure minimum hum level. Will do justice to finest program sources. Beautiful satin-gold finish.

## Heathkit TUNER KITS

These tuners measure only 12 9/16" long x 3 5/8" high x 5 7/8" deep, and are finished in beautiful satin-gold enamel. Easily stack one over another to form compact control unit.

### FM HIGH FIDELITY

MODEL FM-3

**\$24<sup>50</sup>**

(With cabinet)  
Shpg. Wt. 7 lbs.



This FM tuner offers sensitivity, selectivity, and stability, not expected at this price level. Efficient 7-tube circuit is entirely new, and incorporates AGC, cascade front end, temperature-compensated oscillator, built-in power supply, and other outstanding design features. Pre-aligned IF and ratio transformers. Sensitivity is better than 10 microvolts for 20 db of quieting. Covers 88 to 108 mc.

### AM BROAD BANDWIDTH

MODEL BC-1

**\$24<sup>50</sup>**

(With cabinet)  
Shpg. Wt. 8 lbs.



Designed for use with high fidelity systems. Low distortion voltage-doubler detector. Covers 550 to 1600 kc. 20 kc IF bandwidth. Audio response  $\pm 1$  db from 20 cps to 2 kc. 6 db signal-to-noise ratio at 2.5 microvolts. RF and IF coils pre-aligned. Power supply built-in. Efficient, modern circuit. Matches WA-P2 and FM-3 in color and style.

## Heathkit SPEAKER SYSTEM KITS

The models SS-1 and SS-1B are matched so that when the smaller unit is placed on top of the larger unit, the appearance of a single piece of furniture is achieved.

### SS-1 HIGH FIDELITY

MODEL SS-1 **\$39<sup>95</sup>**

Shpg. Wt. 30 lbs.



Employs two Jensen speakers to cover from 50 to 12,000 cps. Response is within  $\pm 5$  db. Built-in crossover functions at 1600 cps. System rated at 25 watts, with nominal impedance of 16 ohms. Enclosure is ducted-port bass reflex type. Merely assemble the cabinet, wire the speakers and crossover network, and finish to your taste.

### SS-1B HIGH FIDELITY RANGE EXTENDING

Employs woofer and super tweeter to cover 35 to 600 cps, and 4000 to 16,000 cps. Extends frequency range of SS-1 at both ends of the spectrum, for total of  $\pm 5$  db from 35 to 16,000 cps. The kit includes necessary crossover circuits and balance control. Power rating is 35 watts for speech and music. Impedance is 16 ohms.



**MODEL SS-1B** **\$99<sup>95</sup>**  
Shpg. Wt. 80 lbs.

## Heathkit ELECTRONIC CROSS-OVER KIT

The XO-1 separates high and low frequencies at selectable crossover points, to feed two separate power amplifiers, one for high frequencies and one for low frequencies. Speakers are then connected to the amplifiers directly, without the usual LC crossover. Separate level controls provided for both outputs. The XO-1 consumes no audio power. Crossover frequencies are 100, 200, 400, 700, 1200, 2000, and 3500 cps. Attenuation is 12 db per octave.



**MODEL XO-1** **\$18<sup>95</sup>**  
Shpg. Wt. 6 lbs.

**HEATH COMPANY** A Subsidiary of Daystrom, Inc. **BENTON HARBOR 3, MICH.**

## NEW Heathkit PROFESSIONAL RADIATION COUNTER KIT



MODEL RC-1

**\$79<sup>95</sup>**

Shpg. Wt.  
8 Lbs.

- ▶ Completely modern design for maximum sensitivity and reliability.
- ▶ Both visual (4½" meter) and aural (panel-mounted speaker) indicators for radiation level.
- ▶ Meter calibrated in CPM and mR/hr. Four measuring ranges.
- ▶ Employs 900-volt Bismuth tube in beta/gamma sensitive probe.

This radiation counter provides design advantages found only in units costing several times its low kit price. It incorporates features essential to the serious prospector. High sensitivity is provided, with ranges of 0-100, 600, 6,000, and 60,000 counts per minute, and 0.02, .1, 1, and 10 milliroentgens per hour. A type 6306 Bismuth tube is employed in the probe, and the probe and a radiation sample are included in the kit price. The circuit employs 5 tubes (plus a transistor) to assure stable and reliable operation. High quality, 4½" 200 micro-ampere meter eliminates "guess work" and indicates radiation level directly in cpm, or mR/hr. In addition, transistor oscillator provides aural signal from panel-mounted speaker. High voltage power supply is "packaged" pre-built unit with reserve capacity above 900 volt level at which it is regulated. Merely changing regulator tube would allow use of scintillation probe if desired.

Fulfills requirements of those who want a prospecting instrument that can be relied upon. Has selectable time constant, to allow for different rates of travel over the area being investigated. Measures only 9½" high x 6½" wide x 5¼" deep, and weighs only 6½ lbs. Not to be confused with novelty radiation detection devices on the market. A top-quality instrument, yet simple to build.

## Heathkit TUBE CHECKER KIT

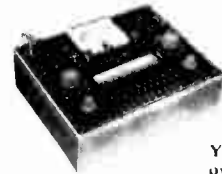

MODEL TC-2

**\$29<sup>50</sup>**

Shpg. Wt.  
12 Lbs.

You can afford your own tube tester, even if you only do part-time service work. Uses a 4½" meter with 3-color meter face for simple "good-bad" indications of tube quality, on the basis of emission. Tests all tubes commonly encountered in radio and TV service work. 14 different filament voltages—built-in roll chart—ten 3-position lever switches for open or short tests on each tube element.

## Heathkit CATHODE RAY TUBE CHECKER KIT



MODEL CC-1

**\$22<sup>50</sup>**

Shpg. Wt. 10 Lbs.

Indicates condition of CRT on large "good-bad" scale. Spring-loaded switches protect operator. Checks all electromagnetic deflection picture tubes normally encountered in TV servicing. Supplies all operating potentials and tests for shorts, leakage, and emission on the work bench, in the carton, or in the set. Features shadowgraph test to indicate tube condition.

## Heathkit VISUAL-AURAL SIGNAL TRACER KIT



MODEL T-3

**\$23<sup>50</sup>**

Shpg. Wt. 9 Lbs.

Features a high-gain RF input channel for signal tracing and troubleshooting from the receiver antenna input clear through all RF and IF stages. Separate low-gain channel for audio circuit exploration. Built-in loudspeaker provides audio response, while electron beam "eye" tube gives visual indication. Ideal for signal tracing in AM, FM, and TV receivers.

## Heathkit TV ALIGNMENT SWEEP GENERATOR KIT

All-electronic sweep eliminates mechanical hum or vibration. Features improved linearity—effective AGC—flat output—0 to 40 mc sweep. Covers all frequencies in FM, monochrome TV and color TV. Plenty of RF output for alignment of tuners, IF strips, boosters, etc. Fundamental output from 4 to 220 mc in four bands. Incorporates crystal oscillator (4.5 mc and multiples thereof), and variable marker covering 19 to 60 mc on fundamentals—up to 180 mc on harmonics. Effective two-way blanking.

MODEL TS-4

**\$49<sup>50</sup>**

Shpg. Wt. 16 Lbs.



## Heathkit SIGNAL GENERATOR KIT



MODEL SG-8

**\$19<sup>50</sup>**

Shpg. Wt. 8 Lbs.

This tried and proven generator covers 160 kc to 110 mc on fundamentals in five bands, and calibrated harmonics extend to 220 mc. Very popular in service shops, laboratories, and home workshops. RF output is in excess of 100,000 microvolts, controlled by a variable and a fixed-step attenuator. Output is pure RF, RF modulated at 400 cps, or 400 cps audio for amplifier testing.

## Heathkit CONDENSER CHECKER KIT

Measures paper, mica, ceramic, and electrolytic capacitors in 4 ranges from .00001 to 1,000 microfarads. It indicates condenser value and quality. Also measures resistance from 100 ohms to 5 megohms. All values indicated directly on panel scale, after adjusting for null on electron beam "eye" tube. No calculations necessary. A valuable instrument in service or laboratory applications.



MODEL C-3

**\$19<sup>50</sup>**

Shpg. Wt. 7 Lbs.

## Heathkit LINEARITY PATTERN GENERATOR KIT



MODEL LP-2

**\$22<sup>50</sup>**

Shpg. Wt.  
7 L

Supplies information for white dots, cross-hatch pattern, horizontal bar pattern, or vertical bar pattern. Use for adjustment of vertical and horizontal linearity, picture size, aspect ratio and focus. Dot pattern is a must for color convergence adjustments. Clip merely connects to antenna terminals of TV set. Panel provision for external sync if desired. Covers channels 2 to 13, 5 to 6 vert. bars and 4 to 5 hor. bars.

## Heathkit LABORATORY GENERATOR KIT

MODEL LG-1

**\$39<sup>50</sup>**

Shpg. Wt. 16 Lbs.



This signal generator covers from 100 kc to 30 mc on fundamentals in 5 bands, 400 cycle modulation variable from 0 to 50% RF output up to 100,000 microvolts. Meter reads RF output or percentage of modulation. Fixed step and variable output attenuation. Voltage regulation, double copper-plated shielding for stability, and other "extras." Provision for external modulation. Output impedance 50 ohms.

**HEATH COMPANY** A Subsidiary of Daystrom, Inc. **BENTON HARBOR 3, MICH.**

## HEATHKIT ETCHED CIRCUIT OSCILLOSCOPE KITS

You may choose from three different oscilloscope models when you purchase a Heathkit scope. All three units employ printed circuit boards for increased circuit efficiency and simplified assembly. Construction time cut almost in half. Outstanding dollar values for you!

### 5" COLOR TV

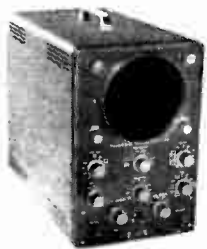

MODEL O-1  
**\$69.50**

Shpg. Wt. 21 Lbs.

Amplifier response essentially flat from plus 2 db -5 db from 5 mc down to 2 cps without extra switching. Extended sweep oscillator range allows single-cycle observation of signals up to 500,000 cps, and will sync signals even higher. Uses etched metal circuit boards. Push-pull vertical and horizontal amplifiers—built in peak-to-peak calibrating source—step attenuated input—preformed and cabled wiring harness. A professional oscilloscope, ideal for color TV work in the lab or service shop. The 11-tube circuit features SUP1 CRT.

### FULL SIZE 5"

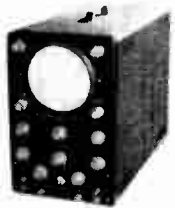

MODEL OM-1  
**\$49.50**

Shpg. Wt. 21 Lbs.

The Model OM-1 with a 5", 5BP1 cathode ray tube has many big scope features—yet it is priced reasonably. Features etched-metal circuit boards. Incorporates 3-step input attenuator—phasing control—built-in peak-to-peak voltage calibrator—and push-pull vertical and horizontal amplifiers. Vertical amplifier flat within  $\pm 3$  db from 2 cps to 200 kc. Sweep circuit functions from 20 cps to 100,000 cps.

### 3" PORTABLE



MODEL OL-1  
**\$29.50**

Shpg. Wt. 14 Lbs.

Has many of the features of the Model OM-1, yet is smaller in physical size. Employs etched-metal circuit boards. Features vertical frequency response within  $\pm 3$  db from 2 cps to 200 kc. Sweep generator operates from 20 to 100,000 cps. The 8-tube circuit features a type 3GPI CRT.

## Heathkit AC VACUUM TUBE VOLTMETER KIT



MODEL AV-2  
**\$29.50**

Shpg. Wt. 5 Lbs.

This VTVM combines high impedance, wide frequency range, and high sensitivity. It is designed especially for audio work. Frequency response is substantially flat from 10 cps to 50 kc. Sensitivity allows measurements as low as 1 mv at high impedance. Ranges are .01, .03, .1, .3, 1, 3, 10, 30, 100, and 300 volts rms. Total db range is -52 to +52 db. 1 megohm input impedance at 1 kc. An outstanding instrument for your laboratory, service shop, or home workshop.

## Heathkit ETCHED CIRCUIT VACUUM TUBE VOLTMETER KIT



MODEL V-7A  
**\$24.50**

Shpg. Wt. 7 Lbs.

The Heathkit Model V-7A features a 200 ua meter, 1% precision resistors, and an etched metal circuit board. Very simple to build. Measures DC voltage, ACV (rms) ACV (peak-to-peak), and resistance. AC (rms) and DC voltage ranges are 0-1.5, 5, 15, 50, 150, 500, and 1500 volts. Peak-to-peak ranges are 4, 14, 40, 140, 400, 1400, 4000 volts. Ohmmeter ranges provide multipliers of X1, X10, X100, X1000, X10K, X100K, and X1 megohm. DB scale also provided. 11-megohm input impedance.

## Heathkit 20,000 OHMS/VOLT VOM KIT



MODEL MM-1  
**\$29.50**

Shpg. Wt. 6 Lbs.

This instrument is especially valuable for portable applications where AC power is not available. Sensitivity is 20,000 ohms-per-volt DC and 5,000 ohms-per-volt AC. Black bakelite case -4 1/2" 50 ua. meter-1% precision resistors. AC and DC ranges are 0-1.5, 5, 50, 150, 500, 1500, and 5000 volts. Direct current ranges are 0-150 ua., 15 ma., 150 ma., 500 ma. and 15 a. Resistance multipliers are X1, X100, and X10,000. DB range from -10 db to +65 db.

## Heathkit DIRECT-READING CAPACITY METER KIT



MODEL CM-1  
**\$29.50**

Shpg. Wt. 7 Lbs.

This unique measuring instrument indicates capacitor values in mmf, or mfd, directly on a large 4 1/2" 50 ua meter. It provides ranges of 0-100 mmf, 0-1,000 mmf, 0-0.1 mfd, and 0-1 mfd. Residual capacity less than 1 mmf. Scales are linear. Merely connect the capacitor to the instrument and read its value directly on the scale. Instrument not susceptible to hand capacity effects. Will measure even small value trimmers or variable air capacitors.

## Heathkit ELECTRONIC SWITCH KIT



MODEL S-3  
**\$21.95**

Shpg. Wt. 8 Lbs.

This new instrument design allows simultaneous oscilloscope observation of two input signals by producing both signals, alternately, at its output. The all-electronic circuit provides 4 switching rates, selected by a panel switch. Provides actual gain for input signals, and features frequency response of  $\pm 1$  db from 0 to 100 kc. Employs 7 miniature tubes. Sync output provided to control scope sweep. Functions at signal levels as low as 0.1 volt. Ideal for observing amplifier input and output simultaneously for comparison purposes.

# ORDER BLANK

NOTE: All prices subject to change without notice.

Enclosed find ( ) check ( ) money order for \_\_\_\_\_ Please ship C.O.D. ( ) postage enclosed for \_\_\_\_\_ pounds.

On Express orders do not include transportation charges — they will be collected by the express agency at time of delivery.

ON PARCEL POST ORDERS include postage for weight shown. ORDERS FROM CANADA and APO's must include full remittance.

Name \_\_\_\_\_  
Address \_\_\_\_\_  
City & Zone \_\_\_\_\_ State \_\_\_\_\_  
(PLEASE PRINT)

- SHIP VIA
- Parcel Post
  - Express
  - Freight
  - Best Way

QUANTITY	ITEM	MODEL NO.	PRICE

**HEATH COMPANY** A Subsidiary of Daystrom, Inc. **BENTON HARBOR 3, MICH.**

**BELL TELEPHONE'S SPECIALIZED COMMUNICATIONS SERVICES**



**Mobile Telephone** — Service speeds work, keeps costly equipment busy.

**Push Button Telephones**—incoming calls—outgoing calls—inter office calls *all* on one telephone.

Take the  
**HIDDEN COSTS**  
out of your  
**BUSINESS COMMUNICATIONS**

Your first cost isn't your last cost when you provide your own communications system. Many of the continuing costs are buried deep in idle equipment, taxes, depreciation and loss of interest on capital.

With BELL Communications, you pay only for service—service tailored to your specific operations TODAY but flexible to changes needed TOMORROW. With new techniques and new equipment constantly being developed by BELL to improve your service—*obsolescence becomes our problem not yours.*

Why not let us analyse your problem? Just telephone us and we'll be glad to call on you. There's no charge!

**THE BELL TELEPHONE COMPANY OF CANADA**



**PBX (Private Branch Exchange)**—a dial switchboard system which is faster and more efficient.

**Bell Teletype**—flexibility makes it readily and economically adaptable to any business—large or small.



**Microwave Radio Relay System** for Long Distance and TV programs.

**Channels for Telemetry and Supervisory Control**—as used by the Oil, Gas and Power Industries.



Whatever your communication needs be sure to consult the BELL

**NEW PRODUCTS**

(Continued from page 70)

● **Miniature Aluminum-Can Electrolytic Capacitor**

Item 1500

A miniaturized version of the hermetically-sealed aluminum-can electrolytic is announced by Aerovox Canada Limited, Hamilton, Ont.

Designated as Aerovox type XPP, the tiny electrolytic is ideal for applications where size and weight must be kept at a minimum without undue sacrifice of operating characteristics and service life. Such tiny electrolytics are particularly suited for transistorized radios, hearing aids and other miniaturized assemblies. They incorporate the latest technical advances in electrolytics with regard to extended service life, along with relatively high capacitance values at low voltages.



Type XPP units range in size from  $\frac{7}{8}$ " to  $\frac{3}{4}$ " dia., and from  $\frac{1}{2}$ " to  $\frac{3}{4}$ " long. Copper-weld leads serve as terminals. Plastic outer insulating sleeves are available. Working voltages of from 3 to 25 D.C., and capacitance values of from 1 to 50 mfd. Standard operating temperature range of  $-20^{\circ}\text{C}$  to  $+65^{\circ}\text{C}$ , with desirable electrical characteristics.

The foregoing covers the standard listings. Special capacitors can be made to order. Engineering data sent on request. Aerovox Canada Limited, Hamilton, Ontario.

● **Ultrasonic Transducer**

Item 1501

The General Ultrasonic Company of Hartford, Connecticut announces a new fully protected ultrasonic transducer for cleaning, degreasing, pickling, plating and other physical and chemical processes. The type T-1 Sonicell is completely sealed, metal jacketed, stainless steel lined and thermostatically protected.

Its stainless steel treatment chamber permits use of a wide variety of process liquids. Provision is made for draining and recirculating process liquids during operation.

The type T-1 Sonicell treatment chamber is 14" long, 8" wide and 6" deep with a liquid capacity of 5 quarts.

Its resonant frequency of 20 kilocycles per second provides maximum cavitation energy above the range of human audible perception. It is powered by the company's Model 400 Ultrasonic Generator which is continually variable in frequency from 10 kc. to 1200 kc. and which has an output of 400 watts.

Further information from the company's Ontario and Quebec representatives, Elder Electronics, 2 Robert Street, Burlington, Ontario.

● **Sorteberg Force Bridge**

Item 1502

Catalog C80-1 describes the Sorteberg Force Bridge, a computing device which can be used in pneumatic measurement or control circuits for square root extraction, ratio setting, division, multiplication, squaring, pressure or temperature compensation.

For further information or the brochure describing this instrument write: Honeywell Controls Limited, Toronto 17, Ont.

(Turn to page 82)

For further data on advertised products use page 73.





## EIMAC KLYSTRONS are used in DEW Line forward-scatter network

Collins Radio Company's pioneering of circuits and equipment has contributed greatly to the success of the revolutionary new art of forward-scatter communications. From the beginning of this program, Eimac tubes have provided the high power necessary to make scatter propagation practical. In Collins newest high power microwave transmitters for beyond-the-horizon communications in the Distant Early Warning network, only Eimac klystrons are used as final amplifier tubes.

*Third in a series of advertisements emphasizing the extensive application of Eimac amplifier klystrons and circuit components, negative grid tubes and rectifiers by leading manufacturers of forward-scatter UHF/microwave transmitters.*



Collins two and ten kilowatt forward-scatter transmitters utilize Eimac amplifier klystrons, negative grid tubes and rectifiers.



**EITEL-McCULLOUGH, INC.** SAN BRUNO CALIFORNIA

The World's Largest Manufacturer of Transmitting Tubes

Represented in Canada by



**THE AHEARN AND SOPER**

**COMPANY LIMITED** P.O. Box 715, Ottawa, Ontario

## TECHNICAL PERSONNEL AVAILABLE

**TELEVISION TECHNICIAN** with three years experience on bench work and repair to all makes of television sets desires employment with company engaged in industrial or medical electronics. Prepared to accept company training in either of the above branches of electronic maintenance. Reply to Box 501, Electronics and Communications.

**PROFESSIONAL ENGINEER**, experienced in setting up merchandising operations and sales of new engineering products in Canada, is shortly available for new project. Reply to Box 502, Electronics and Communications.

**15 YEARS** in electronics, P. Eng., presently employed at leading manufacturing company for 3½ years, design and manufacturing of TV sets, immigrant. Reply to Box 503, Electronics and Communications.

**ELECTRONIC ENGINEER**; 25 years experience on design, test, installation and specification of all types of communication equipment is open for offers as head of Quality Control or Reliability section. Specialist in Reliability and statistical quality control. Reply to Box 504, Electronics and Communications.

**ENGINEER** — Secondary education in London, England, followed by professional education with degree from London Electrical Training College, Manor Gardens, London N7. Also certificate proficiency wireless telegraph and telephony as signed by Postmaster General, London, England. Reply to Box 505, Electronics and Communications.

**ENGINEER** — Manager - Consultant: broad experience in technical personnel development; management assignments at top decision level; electrical and electronic engineering (holds several patents); economic analyses and engineering studies. Interest lies in management work requiring technical background. Sen. Mem. I.R.E., Mem. A.I.E.E., Assoc. Mem. O.R.S.A. and P.Eng. Reply to Box 506 Electronics and Communications.

**ELECTRONIC & COMMUNICATION ENGINEER** Member IRE with more than 15 years' experience in electronics, acoustics, ultrasound and telephone equipment, Excellent fundamental background in electrical and electronic engineering, able to do responsible design and development work. Speaking and writing fluently French, German and Italian. Expected to be Canadian citizen 1958. Good organizer, able to undertake new methods, is looking for a situation where his qualities may be utilized full. Reply to Box 507, Electronics and Communications.

## NEW PRODUCTS

(Continued from page 80)

### ● Public Address Amplifiers Item 1503

A completely new line of Bogen public address amplifiers, comprising 12 models, is currently being introduced by David Bogen Co., Inc., of Paramus, N.J., an affiliate of Unitronics Corporation. This new Bogen Flex-Pak line combines finest performance specifications, outstanding operating control and true portability.

This P. A. line offers a new concept in styling, with its light weight and slim, modern look. In addition, it provides increased efficiency, lower distortion and better low frequency response than previous lines, plus the added features of easy installation and easy service.

Features of the "L" series in the improved line include: constant voltage output taps which eliminate difficult calculation to determine speaker matching transformers; special filters to improve speech clarity; equalized phono input for all cartridges; separate bass and treble controls, plug-in sockets for low impedance transformers; pencil-in, erase-out identification strips for all channels, and sturdy leather carrying handles.

The "LX" series has all the features of the "L" series, plus exclusive antifeedback control which minimizes acoustical feedback without compromising tone quality or volume and built-in remote gain-control circuit which allows changes in gain from distances up to 2,000 feet.

Both the "LX" and the "L" series amplifiers have a three-position switch which converts one of the microphone channels for microphone, tuner or phonograph cartridge. This switch can be used as a selector switch, thus adding to its flexibility.

The new "LOM" preamplifier has higher power output and gain than previous models, plus a greatly improved circuit.

The new Bogen Flex-Pak line also offers separate accessory phonograph tops, tamper-proof locking plates, remote controls, wall and rack mounts and complete indoor, outdoor and portable systems providing unusual versatility at every popular wattage.

Each of these amplifiers is available in a wide variety of packaged P.A. systems for the most common applications.

The new Bogen Flex-Pak catalog, complete with engineering specifications, is available upon request from: David Bogen Co., Inc., Paramus, N.J.

### ● Subminiature Relay For High Precision Work

Item 1504

A new high precision subminiature relay, in the popular crystal can size, is announced by the Electronics division of Elgin National Watch Company.

Designed to meet the most severe military specifications, the new relay will be marketed under the code name MV and will be available with both solder-lug and plug-in terminals.

It is a rotary action DPDT relay designed to operate in a temperature range of up to +125°C. with a contact rating at 2 amps resistive at 28 VDC or 115 VAC.

For further information write to: Elgin National Watch Company, Elgin, Illinois.

**ELECTRICAL ENGINEER, B.S.M.S.E.E.**

41 years old, bilingual, married, holds pilot license, familiar with all types of industrial electrical problems, good knowledge of electronics, presently employed with large Canadian company, seeks responsible position as assistant plant manager or similar. Would consider assignment abroad. Reply to Box 508, Electronics and Communications.



## Beckman Servomotor- Rate Generator

Snug as two bugs in their unitized stainless steel housing, motor and generator work hand-in-hand on the same shaft . . . to improve response characteristics of suffering servo systems.

Where the trouble is in the dynamics of your system components, watch this purposeful pair roll up their sleeves and go to work. The high torque-to-inertia motor, for instance, responds quickly and accurately to error signals . . . with acceleration at stall up to 100,000 radians/sec.<sup>2</sup>. Signal-to-noise ratio of the linear generator is 25:1 or better. Aiding and abetting each other in their dedicated mission, they'll operate continuously at stall and at total unit temperature from -55°C to 200°C.

Right now, our corrosion-resistant, completely encapsulated Servomotor-Rate Generators are available in sizes 11, 15 and 18. (We'll soon add size 8; eventually, other sizes.) We've got descriptive literature available too. It's data file 337.

**Beckman® Helipot**  
Corporation  
a division of Beckman Instruments, Inc.

Canadian Factory:

No. 3 Six Points Rd., Toronto 18, Ont.

Sales Representative: R-O-R Associates, Ltd.,  
290 Lawrence Ave. West, Toronto 12, Ont.

956

Another  
product  
surprise  
from  
Helipot!

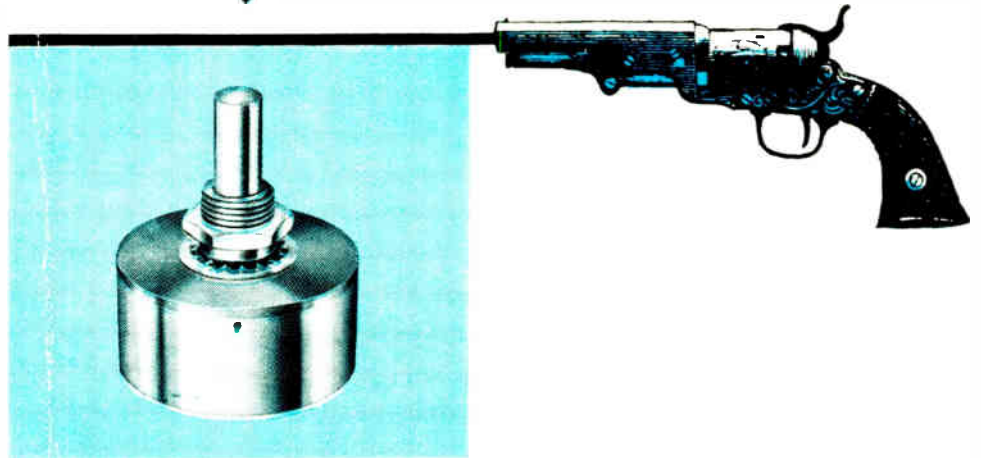

## Fanfare & Cigars



Tooting a symbolic clarion and passing out imaginary cigars, Helipot introduces one of its new-born offspring . . . the series 5300 precision potentiometer.

A single-turn unit, it's 1-1/4 inches in diameter . . . designed for bushing mounting. With its innards comfortably ensconced in an accurately drawn one-piece aluminum cup, the 5300 gives you ruggedness, compactness and long life. We proud papas direct your attention to such salient features as the range of total resistance . . . from 25 to 49,000 ohms . . . linearity as close as  $\pm 0.25\%$  . . . and considerable improvement in torque, noise and mechanical runout.

For vital statistics on this prodigy of a progeny, write for data file 327.

Helipot makes precision potentiometers . . . linear and non-linear . . . in the widest choice of sizes, mounting styles and resistances. Many models are stocked for immediate shipment. Our engineers will gladly adapt standard models to your requirements or design entirely new HELIPOT\* precision potentiometers for you.

®

**Helipot** Corporation: a division of Beckman Instruments, Inc.

Canadian Factory: No. 3 Six Points Rd., Toronto 18, Ont.

Sales Representative: R-O-R Associates, Ltd., 290 Lawrence Ave. West, Toronto 12, Ont.

955\* REG. U. S. PAT. OFF.

For further data on advertised products use page 73.

VALUES TO LOOK FOR IN TWO-WAY RADIO

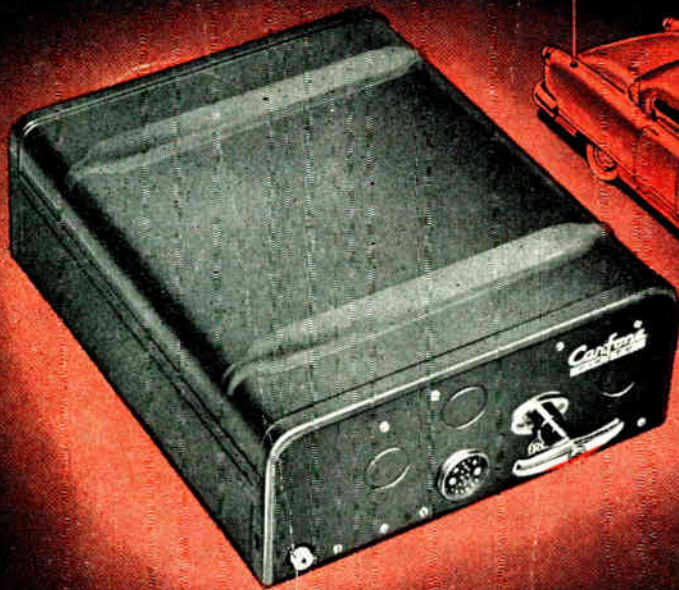

Type CMF  
100A Series  
25-54 mc

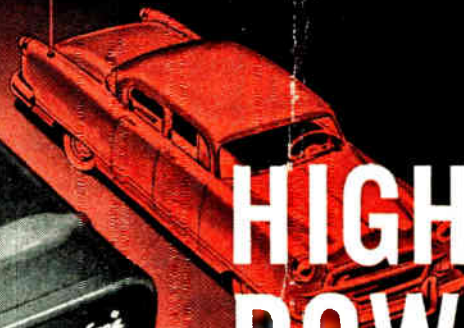

# HIGH POWER

for greater  
2-way radio  
coverage

...in the new RCA *Carfone* for low band!  
FIFTY

### 100 WATTS OF POWER

in the new CMF 100A Series for 25-54 mc plus other quality features make it the finest equipment RCA has ever offered for low band coverage! Designed to provide greater range and a better signal at any distance, this sharp increase in power means improved performance, mobile to mobile, and throughout the system.

### HERE'S YOUR ANSWER

to increased reliability, lower maintenance, built-in reserve power, much greater adaptability—the new RCA Carfone Fifty!

### PLUS THESE QUALITY FEATURES

- Built-in 6/12 volt convertibility.
- Best frequency stability.
- Elliptical loud speaker providing 3 times more acoustical power than the ordinary type.
- Color directed "rainbow" tuning.
- Sturdy drawer-type modern design case.
- Functionally perfected, hand fitting "Red Head" Microphone. (Transistorized or carbon type.)

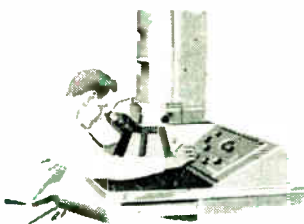

**RCA Electron Microscopes** are vital research tools of science and industry. They permit clear observation and photography of particles less than 1/5,000,000th of an inch.

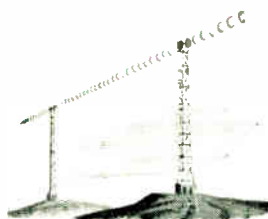

**RCA Microwave** provides point-to-point communication by radio signals. For pipelines, railroads, utilities, government agencies and other qualified users.

**RCA VICTOR COMPANY, LTD.,  
TECHNICAL PRODUCTS DIVISION,  
1001 LENOIR ST., MONTREAL.**

Please send me complete information on the new RCA Victor Carfone equipment for:

- 25-54 mc.       148-174 mc.       450-470 mc.  
 Have an RCA Victor Communications Specialist call on me.

NAME \_\_\_\_\_ TITLE \_\_\_\_\_  
COMPANY \_\_\_\_\_  
ADDRESS \_\_\_\_\_  
CITY \_\_\_\_\_ ZONE \_\_\_\_\_ PROV \_\_\_\_\_



TECHNICAL PRODUCTS DIVISION

**RCA VICTOR COMPANY LTD.**

MONTREAL

• HALIFAX

• TORONTO

• CALGARY

• VANCOUVER

For further data on advertised products use page 73.