

F. W. PERIOTTI  
2336 HINGSTON AVE  
MONTREAL 28 P. Q.

EPM  
QDL  
SEM

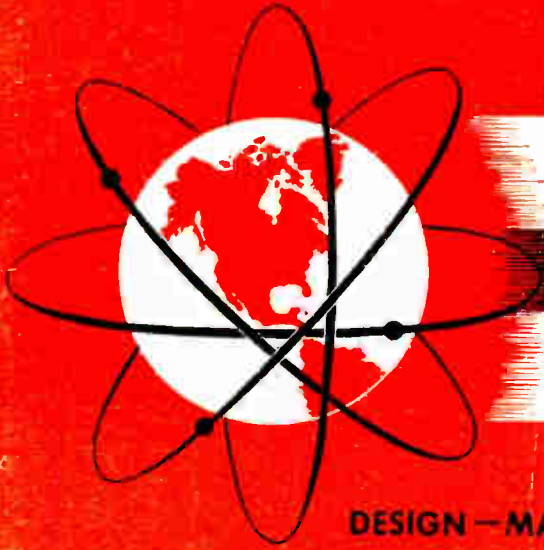

# ELECTRONICS *and* COMMUNICATIONS

DESIGN — MANUFACTURE — ENGINEERING — DISTRIBUTION — APPLICATION

Time Consumed in  
Producing Printed  
Circuit Prototypes  
Reduced By Weeks . . . 28

Tape Recorders  
Permit Acquisition Of  
Accurate Flight Test  
Data . . . . . 30

Split Second Data  
Recording With  
Slave Typewriters . . . 31

Booster Pump Speeds  
Capacitor Drying  
Time By Seventy  
Percent . . . . . 58

New Equipment  
Revolutionizes  
Inter-Com  
Conversation . . . . . 82



The mass production of miniature vacuum tubes used in television and radio receivers is now in full swing in Canadian plants. The above photo shows a characteristic testing unit where the tiny tubes receive a thorough inspection before being given their final check out.

Jan.-Feb. 1956 ★ \$5.00 a year  
An AGE Publication, Toronto, Canada

Circulation Of This Issue  
Over 10,200 Copies

# Look mom...no hands!



Mom died a thousand deaths when Junior free-wheeled his two-wheeler down Deadman's Hill... no hands, yet!

Despite dire predictions, Junior grew up... but he didn't change a bit.

True, he's outgrown his bike... more complex machines are his meat today. He's designing industrial indicators, recorders and computers... automatic machine tools... six-figure process controllers. Tomorrow, his dream of automation will come true in the completely automatic factory.

Yes, Junior's grown up, but his war-cry is the same... "look mom, no hands!"

*Junior outgrew his bike when he discovered HELIPOT\* precision potentiometers. If you're still riding in circles, join Junior! You'll find that Helipot makes the most complete line...linear and non-linear...in the widest choice of sizes, mounting styles and resistances...that our engineers will gladly adapt standard models to your requirements... even design entirely new ones for you. For information and specifications... write for data file 207.*



*first in precision potentiometers  
Canadian Factory: No. 3 Six Points Rd., Toronto 18, Ont.  
Sales Representative: R-O-R Associates, Ltd.  
290 Lawrence Ave. West, Toronto 12, Ont.  
a division of Beckman Instruments, Inc.*



For further data on advertised products use page 83.



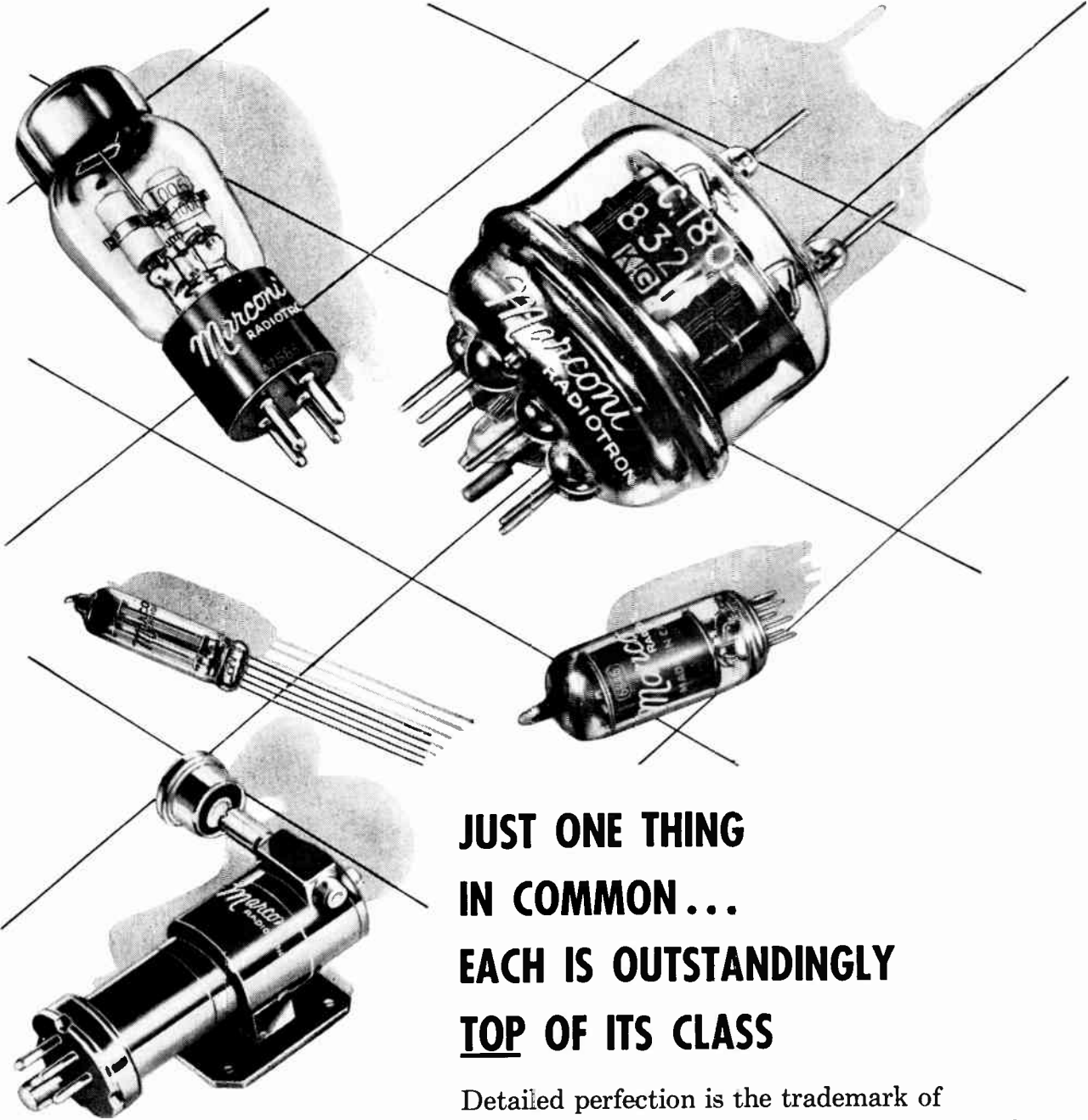

**JUST ONE THING  
IN COMMON...  
EACH IS OUTSTANDINGLY  
TOP OF ITS CLASS**

Detailed perfection is the trademark of every unit . . . the evidence of critical inspection at every stage of production . . . the proof that maximum standards of every specification are observed.

Marconi quality and volume combined with customer-conscious service offers the most for complete satisfaction.



**MARCONI**  **RADIOTRONS**

ELECTRONIC TUBE AND COMPONENTS DIVISION

CANADIAN **Marconi** COMPANY

830 BAYVIEW AVENUE • TORONTO, ONTARIO

BRANCHES: Vancouver • Winnipeg • Montreal • Halifax • St. John's, Nfld.

new  
digital  
magnetic  
tape  
transport

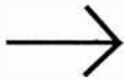

the **AMPEX FR200** for digital handling provides new performance standards, new convenience features and an unmatched excellence of design

**NEW EASE OF TAPE CHANGE...**

The time saving feature of single loop threading is provided by a lever which moves the idlers into a straight line. This arrangement eliminates chance of faulty threading by unskilled personnel.

**NEW MACHINE-TO-MACHINE TAPE COMPATIBILITY...**

All Ampex FR200 Tape Transports are manufactured to exact standards that permit tapes recorded on one to be reproduced on any other. Ampex-to-Ampex compatibility is guaranteed — and at no extra cost.

**NEW PLUG-IN HEADS TO MATCH OTHER TAPE TRANSPORTS...**

The Ampex FR200 uses self aligning plug-in head assemblies. These can be furnished to match other digital or analog tape recorders to permit tape interchange. A second head stack for monitoring or "off-tape" parity checking can also be added if desired.

**HIGH-SPEED START AND STOP...**

On the Ampex FR200 the tape attains full speed or full stop within less than 5 milliseconds to provide high information storage density. A remote control provision is provided, as well as pushbuttons on the topplate.

**NEW STANDARD OF EXCELLENCE...**

The FR200 brings to digital applications the reliability, durability and adherence to specification that have made Ampex Tape Recorders the most widely used in instrumentation.

**NEW LOW PRICES BEGINNING AT \$2675**

The base price of \$2675 is for a complete FR207-TB tape transport, with 7-track head, for 1/2-inch tape operating at 30 ips tape speed. Prices will be quoted on machines with other tape speeds, multiple speeds, other tape widths and other heads.

**FULL SPECIFICATIONS ON THE FR200** and description of its features and accessories are given in descriptive literature. For your copy, write Dept. SS-2539.

**AMPEX**  
CORPORATION

934 CHARTER STREET  
REDWOOD CITY,  
CALIFORNIA

Canadian Distribution by Ampex American, 70 Grenville Street, Toronto, Ontario

For further data on advertised products use page 83.

# NEW OSCILLOSCOPES

By

# EMI

**COSSOR CANADA LIMITED**  
are exclusive Canadian distributors

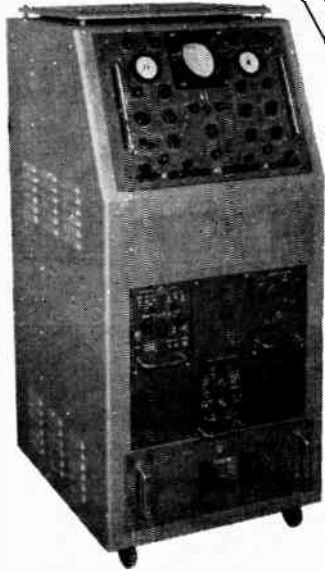

## OSCILLOSCOPE Type WM.5

A new multi-purpose precision measuring oscilloscope  
**NEW FEATURES:** (a) The console model accommodates up to 6 plug-in sub units. This allows the basic oscilloscope to be adapted for a wide range of requirements: i.e. additional gain at high and low bandwidth, signal delay, comparison of signals, T.V. picture and line selection, high voltage inputs, monitoring high impedance sources, etc.

- (b) Continuously variable EHT—10KV.
- (c) 25 Mc/s bandwidth 'Y' Amplifiers.
- (d) D.C. or A.C. coupled 'X' and 'Y' Amplifiers.
- (e) Linear pre-sweep. A visual delaying sweep.

Time Range—10 milli-micro-seconds to 0.1 sec.

Measurements by instantaneous metering system. No calibration markers required.

Voltage Range—10 mV to 500 V AC/DC

Photo Sweep—Single sweep for photo recording of transients, subsequent few sweeps before blackout of the tube give reference trace which can be pre-set to any D.C. voltage between 0 &  $\pm$  500V.



## DISTRIBUTED AMPLIFIER Type 2B

A high level wide band amplifier for use with high speed oscilloscopes, signal generators, etc.

Voltage Output—150 Vpp.      Bandwidth—100 Mc/s.      Gain—x12.  
Input Impedance—75 ohms.      Output Impedance—200 ohms.

## OSCILLOSCOPE Type WM.3B

A compact general purpose portable oscilloscope with facilities for making rapid precision measurements of time and voltage.

EHT—0.8—1.2KV      Bandwidth—D.C.—4.5 Mc/s.

Volts Range—10mV—500V.AC/DC

Time Range—0.5 micro-seconds  
—40 milli-seconds

Measurements by instantaneous metering system. No calibration markers required

Max. writing speed — 0.5 micro-second/cm

## OSCILLOSCOPE Type WM.1

An inexpensive general purpose miniature measuring oscilloscope.

EHT—800 V      Bandwidth—1 Mc/s—3 Mc/s.

Volts Range  $\pm$  0.5—500 volts. AC/DC

Measurements by instantaneous metering system. No calibration markers required.

Sweep Range—200 milli-seconds—10 micro-seconds (uncalibrated).

Sensitivity—1 cm/Volt.

Max sweep speed—2 micro-seconds/cm.

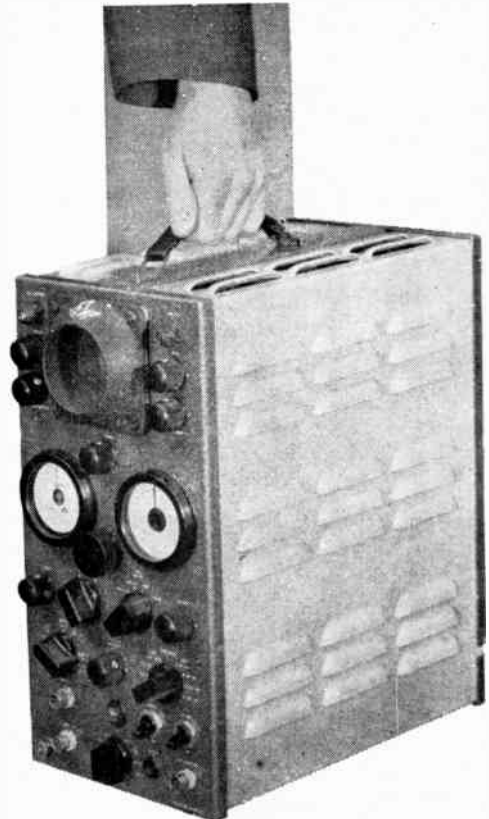

**OSCILLOSCOPES For All Applications**

# COSSOR

8230 Mayrand Street  
Decarie Blvd.  
MONTREAL, QUE.

648A Yonge Street  
TORONTO, ONTARIO



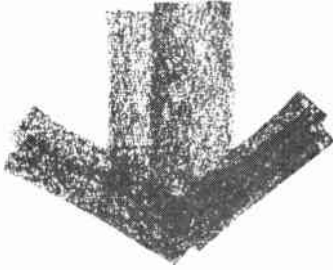

# LET "THE DEMODULATOR"

the monthly magazine which has received such enthusiastic support since its introduction by Lenkurt Electric in 1952

# KEEP YOU UP TO DATE

as it has thousands of others in both Canada and the U.S.A. with timely and important articles



# ON CARRIER COMMUNICATIONS

and developments connected with this field. For example, articles have appeared on: Factors affecting the propagation of Micro-waves; Transmission of Dial and Teletypewriter signals; Cable Transmission characteristics; Amplitude modulation, etc., etc. It is circulated

# FREE OF CHARGE

to everyone on the mailing list. A limited supply of back copies are also available. Handsome binders to hold 12 copies are available at 25¢ each. Check your requirements on the coupon and mail it today.

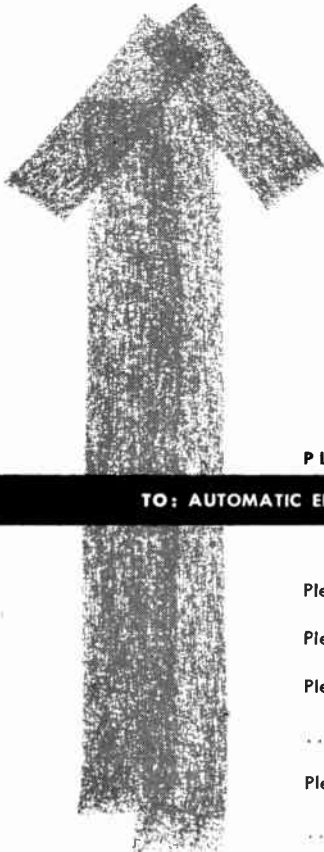

(CANADA) LIMITED

*Distributor in Canada*

**AUTOMATIC ELECTRIC SALES (CANADA) LIMITED**

Head Office: 185 Bartley Drive, Toronto 16

MONTREAL • OTTAWA • BROCKVILLE • HAMILTON • WINNIPEG • REGINA • EDMONTON • VANCOUVER

PLEASE PRINT CLEARLY

TO: AUTOMATIC ELECTRIC SALES (CANADA) LIMITED • 185 BARTLEY DRIVE, TORONTO 16, ONTARIO

✓

Please put my name, without charge or obligation, on your mailing list

Please note my change of address

Please send me the following back copies, if available

Please send me ..... binders at 25¢ each for which I enclose .....

NAME ..... POSITION .....

COMPANY .....

ADDRESS .....

5604

For further data on advertised products use page 83.

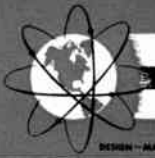

**ELECTRONICS**  
*and*  
**COMMUNICATIONS**

DESIGN - MANUFACTURE - ENGINEERING - DISTRIBUTION - APPLICATION

THE ONLY CANADIAN JOURNAL DEVOTED SPECIFICALLY TO  
THE APPLICATIONS OF COMMUNICATIONS AND ELECTRONICS

JAN. - FEB. • 1956  
Vol. 4 No. 1

## EDITORIAL CONTENTS

President and Publisher  
NORTON W. KINGSLAND  
Vice-President and  
Director of Advertising  
NORMAN MCHARDY  
Editor  
THOMAS W. LAZENBY  
Consulting Editor  
LESLIE L. HILL, Ph.D.  
Advertising Manager  
H. E. DALLYN  
Production Manager  
NEVILL A. CAMPLING  
Business Manager  
CLIFFORD A. SPARKS  
Circulation Manager  
PAUL A. IRWIN  
West Coast Representative  
DUNCAN A. SCOTT & Co.,  
Mills Building  
San Francisco

### FEATURES

	Page
Navigation Utilizing The Doppler Effect . . . . . <i>By Leslie L. Hill, Ph.D.</i>	24
New Directional Moving-Coil Microphones . . . . . <i>By Dr. R. Gorike.</i>	26
Prototypes in Forty Minutes . . . . . <i>Manufacturing Time Of Printed Circuit Originals Reduced By Weeks.</i>	28
Airborne Magnetic Tape Recorders . . . . . <i>Modern Equipment Proves Boon To Flight Research Engineers.</i>	30
Slave Typewriter . . . . . <i>Provides Instantaneous Data Recording For Varied Industries.</i>	31
Canada's Largest Private Wire System . . . . . <i>Latest Communications Technique Achieves Faster Service, Greater Economy.</i>	47
Ring-Jet Booster Pump . . . . . <i>Speeds Capacitor Drying Time By Seventy Per Cent.</i>	58
Loud-Speaking Telephone . . . . . <i>New Equipment Revolutionizes Inter-Com Conversation.</i>	82

### DEPARTMENTS

Editorial . . . . .	9
RETMA Report . . . . .	11
Business Briefs And Trends . . . . .	16
Editor's Page . . . . .	23
News . . . . .	34
New Products . . . . .	36
Book Review . . . . .	42

### PUBLISHED BY AGE PUBLICATIONS LIMITED

Also Publishers of Restaurants and Institutions, Hotel and Tavern, Heating,  
Plumbing & Air Conditioning AGE, Oil & Gas Heat, Industrial Digest.

MONTREAL, QUE., CANADA  
Room 504, Dominion Square Building  
1010 St. Catherine Street West  
Tel. UNiversity 6-7897

TORONTO, ONT., CANADA  
31 Willcocks Street  
Tel. WALnut 2-3115

Member Canadian Circulation  
Audit Board, Inc.



PRINTED IN CANADA



Subscription Rates: Canada and British Possessions . . . . . \$5.00 per year  
United States of America . . . . . \$7.50 per year • Foreign . . . . . \$10.00 per year

Authorized as second class mail. Post Office Department, Ottawa.



# LOOK AGAIN!



You will see a small precision part .090 in diameter. We make others — some even smaller and threaded and others up to 2". We guarantee satisfaction — quick service — competitive prices.

\* MACHINED PART ACTUAL SIZE

## AMONG THOSE WE HAVE SERVED . . . .

C.G.E.	●	Amphenol	●	Collins Radio
De Havilland Aircraft	●	I.B.M.	●	Canadian Arsenals

*Send for Brochure and samples of our work.*



# SMALL PARTS LIMITED

234 DAVENPORT ROAD

TORONTO 5, ONT.

WA. 3-5691

For further data on advertised products use page 83.



# Pipeline To Pool Of Know-How ---

*It would be difficult to estimate the exact amount of pure research being conducted by industry in Canada, but it may be said with reasonable assurance that this type of scientific activity is not extensive. Fundamental research is a costly business, requiring large expenditures of money, and it is not always certain that the end result of such activity will pay dividends to those engaged in its pursuit. If, however, Canada's phenomenal industrial growth is to be provided with the means of continued support, then it will be necessary to stimulate and nurture our productive capacity and ability with the results of fundamental research and the "Know-How Techniques" and new products which emanate from it.*

*Up to the present time Canadian industry, for the most part, has had to rely on the possibility of being granted licensing privileges from alien companies, the granting of which, in the past, has been based solely on the desire and will of the licensing company to establish business operations in this country. At the best, this situation has been far from satisfactory and certainly not adequate to satisfy the growing demand for new ideas and technologies to keep Canada in the forefront as an industrial nation, a position which has been attained in the past two decades. Now, however, as the result of the establishment of Philips Canadian Industrial Development Company Limited, Canadian industrial management need no longer look upon the lack of fundamental research as a road-block to the continued prosperity and growth of Canadian industrial enterprise.*

*Philips Canadian Industrial Development Company Limited has been formed by the N. V. Philips concern of Eindhoven, Holland, and will make available to Canadian industry a vast pool of knowledge gained from years of research by nearly one thousand scientists employed in the vast research laboratories of the parent firm in Eindhoven. The new company will function as a service organization concerned with encouraging the adoption by Canadian organizations of many industrial processes and techniques which are not yet in use here. The company will provide Canadian concerns with a direct pipeline to a pool of "Know-How" developed by a world leader in research. It will make these processes and the manufacturing techniques available to any Canadian company which has the necessary capital, organization and talent to make a success of any chosen project.*

*The activities of this new company will, without doubt, benefit Canada's expanding industrial economy and will provide the opportunity for Canadian business management, who, in recent times have been lamenting the lack of scientific "Know-How" and technical personnel as an obstacle to their business development, to avail themselves of the required information for the production of articles hitherto not made in Canada by reason of patent restrictions and lack of "Know-How". The next move is up to Canadian industrial management. We suggest they lose no time in investigating this opportunity.*

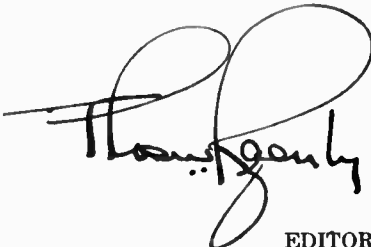
**EDITOR**

# cae

THE LARGEST CANADIAN-OWNED ELECTRONICS COMPANY

Bringing Canada's future  
a little closer  
a little faster

...through electronic research

Vision first lights the way. Then progress follows. Today intricate electronic devices like the new OSCILLOSCOPE, recently developed by CAE research experts, are "blazing the trail" into tomorrow's "push-button" world.

Basic to all electronics, the CAE Oscilloscope shines deeper into the secrets of the natural world than man has ever seen before. It "sees" into the structure and action of the heart, permitting accurate diagnosis. It "sees" into the heart of aeroplane engines, actually picturing the efficiency of metals and parts. It "sees" into fog and darkness in the form of radar.

Into business, industry, home and national defense shines this new light, seeing and reporting data with such fantastic speed and accuracy that revolutionary methods become possible.

With these new electronic tools and many more which will be discovered in CAE'S research laboratories... Canada will develop a new and powerful economy... with greater productivity, higher quality, less waste, greater national security... bringing a higher standard of living for all.

Through research, design, development and engineering, the skilled personnel of CAE are proud of their electronic contributions that are destined to play a major role in our country's most ambitious projects.

*At CAE there are unlimited opportunities for those who plan their future in the exciting world of electronics. CAE is an ultra-modern and progressive company that offers unexcelled working conditions and unparalleled benefits.*

CAE Research Technician Sid Lashley observes the behavior of a CAE Du Mont television picture tube with the aid of a CAE Oscilloscope.

A LEADER IN ELECTRONICS  
FOR GOVERNMENT,  
HOME AND INDUSTRY

# cae

CANADIAN AVIATION ELECTRONICS LTD.

Montreal • Ottawa • Toronto • Winnipeg • Vancouver



For further data on advertised products use page 83.

# RETMA REPORT

*A Monthly Bulletin Of Association Activities  
Prepared For Electronics And Communications*

By  
**BASIL JACKSON**



## **A New Department**

With this issue of Electronics and Communications a new regular department has been inaugurated — RETMA REPORT. This will give up-to-date news about the electronics industry from the trade association that officially represents the Canadian manufacturers active in electronics. The Radio-Electronics-Television Manufacturers Association of Canada now has 116 member-companies engaged in the manufacture of communication equipment, broadcast equipment, radio and television receivers, tubes, electronic components of all kinds, electronic requirements for the Defense program, and many other types of electronic equipment. The Association has three main Divisions, a Receiver Division comprising twenty-two member-companies who design and manufacture radio and television receivers, a Parts and Accessory Division consisting of seventy-two member-companies engaged in the design and production of electronic components and accessories, and an Electronics Division, comprising twenty member-companies who design, develop and manufacture electronic equipment for industrial and military use. Membership also includes two Associate Members in the paper and carton packaging industry.

## **Electronics Division Widens Scope**

Indicative of the widening scope of the Canadian Electronics Industry is the fact that the Electronics Division of RETMA of Canada recently created a new Section, bringing the total number of Sections in this Division to five. The new Section will deal with computing and data processing devices and industrial, scientific and medical applications of electronics. A sub-committee has been set up under the chairmanship of W. Jones, Vice-Chairman of the Electronics Division, to define the scope and field of the new Section and to establish its name. The existing four Sections of the Electronics Division comprise the General Communications Section, Broadcast Equipment Section, Sound Equipment Section, and the Government Relations Section.

## **New Members of RETMA**

Recently-admitted new members of the RETMA of Canada Parts and Accessory Division are as follows:  
Canadian Videocraft Limited, 42 Gladstone Avenue, Toronto, Ont., manufacturers of focus devices, deflection yokes and coils.  
Oki and Willadsen Limited, 43 Crockford Blvd., Toronto 16, Ont., manufacturers of laminated phenolics, glass melamines, glass bonded micas, acrylics, nylon, teflon, acetates, and vinyls.  
Varian Associates of Canada Limited, 45 River Drive, Georgetown, Ont., manufacturers of klystron tubes.  
Computing Devices of Canada Limited, Ottawa, Ont., manufacturers of miniature servo amplifiers.  
Standard Coil Products Limited, Mimico, Ont., manufacturers of television receiver tuners.

A new member for the Electronics Division is:

Northern Radio Manufacturing Company Limited, P.O. Box 389, Billings Bridge, Ottawa, Ont., manufacturers of radio and electronic equipment.

An application for membership in the Electronics Division has been received from Spilbury and Tindall Limited, 44 Water Street, Vancouver 4, B.C., manufacturers of radio communication equipment.

(Continued Overpage)



# RETMA REPORT

## Royal Commission Studying Electronics Industry

The Royal Commission on Canada's Economic Prospects, under the chairmanship of Walter Gordon, has chosen the Canadian Electronics Industry as one of the principal secondary industries that will have such an effect on Canada's future that it requires a separate study. George Armstrong, of Canadian Business Service Limited, has been retained by the Royal Commission to prepare this report. RETMA of Canada has been requested to assist in the compilation of the report and has formed a Special Policy Committee, under the chairmanship of R. M. Brophy, Past President of RETMA of Canada and a past Deputy Minister of Defense Production, to direct a Task Group of market research and other specialists to procure and correlate the necessary data.

The various regular committees of RETMA, the Tariff Committee, Industrial Relations Committee, Broadcast Relations Committee and others, are providing information peculiar to their fields. The RETMA Office is providing historical data on the Electronics Industry for inclusion in the Report.

In addition to George Armstrong's report, RETMA of Canada will present its own Brief to the Royal Commission. Due to the tremendous impact that the art and science of electronics has had on the Canadian economy during the last decade, and the industrial revolution which is beginning to take place in Canada due to the material manifestations of this art and science, the RETMA of Canada Brief will give an overall picture of the great effect on the national economy that the development and expansion of the electronics industry will produce.

These effects are phenomenal. Today the industry is making products that did not exist ten years ago - television receivers, for example, of which 2,000,000 have been manufactured and sold in Canada, were non-existent as home-produced products seven years ago.

## Television Antenna Production

That portion of the industry devoted to the production of television antennas, excluding the supporting mast, is estimated to have a volume of over \$20,000,000 annually. In 1952, when production began in Canada, most antennas were of relatively simple design for single channel reception. With the opening of more telecasting stations, the demand for the so-called "all-channel" antenna has grown.

## RETMA Engineering Standards

Engineering Standards currently being developed by the Electronics Division of RETMA of Canada, or under review at Divisional or committee level, are RETMA Standard No. 10 - Microwave Towers and Accessories, RETMA Standard No. 11 - Multiplexing and Terminating Equipment, RETMA Standard No. 12 - Microwave Transmission Systems RETMA, Standard No. 13 - Microwave Housing Facilities, and RETMA Standard No. 14 - Microwave Emergency Stand-By Power Generators and Accessories.

These Canadian standards are the result of work undertaken by the Microwave Radio Relay and Multiplexing Engineering Committee which reports to the General Communications Section of the RETMA Electronics Division. Also reporting to the same section is the Mobile Equipment Engineering Committee. This committee has recently sent to the Division, for approval, four specifications dealing with Minimum Standards for Land-Mobile AM Communication Transmitters and Receivers, and for FM or PM Communication Transmitters and Receivers, all in the 450 - 470 mc/s band.

These RETMA Engineering Committees work in close co-operation with corresponding Task Groups of the Canadian Radio Technical Planning Board which serves as the official link between industry and the Telecommunications Division of the Department of Transport. A typical example of this type of work is provided by the RETMA Engineering Standards for land-mobile communication transmitters and receivers operating in the 25 - 174 mc/s band. These were prepared by the RETMA Land-Mobile Engineering Committee (Electronics Division) and then passed to the Canadian Radio Technical Planning Board who submitted them to the Department of Transport. The requirement specifications issued by the Department of Transport for land-mobile equipment licensed in this field are based on the original RETMA of Canada Standards.

# THERMALLY BALANCED...

## to Prevent Crazing



## OHMITE

### "Brown Devil" RESISTORS

Ohmite "Brown Devil" Resistors have been carefully designed to provide *balanced thermal expansion*. All parts—core, resistance wire, vitreous enamel coating, and terminal band—have a thermal expansion that has been carefully matched. Consequently, Ohmite "Brown Devil" Resistors expand and contract as a unit. This eliminates cracking of the enamel, keeps terminals firmly anchored, and prevents the entrance of moisture.

**THE RESULT:** You are assured high-quality resistors that provide the utmost in dependability under the toughest service. Specify Ohmite "Brown Devils" on your next job.

## They Last Longer!

#### 1 PATENTED WELDED TERMINALS

Ohmite welded terminals provide a perfect and permanently stable electrical connection that is unaffected by vibration or high temperature.

#### 2 HIGH TEMPERATURE STEATITE CORE

This strong, rugged, steatite core has excellent electrical characteristics, and a coefficient of thermal expansion that matches the other resistor materials.

#### 3 EXCLUSIVE HIGH TEMPERATURE VITREOUS ENAMEL

This special-formula enamel was developed by Ohmite after extensive research. Its thermal expansion is properly related to that of the steatite core, terminal, and resistance wire.

Be Right with

## OHMITE

OHMITE MANUFACTURING COMPANY, 3689 Howard Street, Skokie, Illinois (Suburb of Chicago)

RHEOSTATS • RESISTORS • RELAYS • TAP SWITCHES

A. C. SIMMONDS & SONS  
100 Merton St., Toronto 12



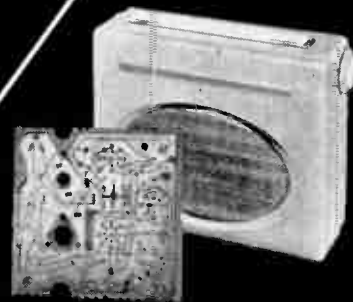
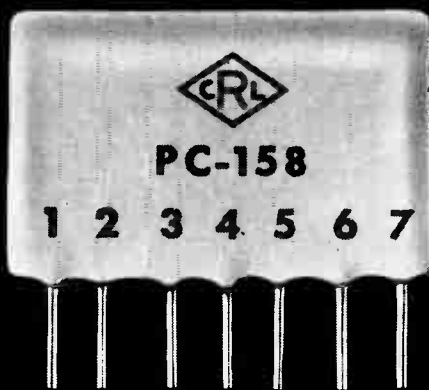

C. M. ROBINSON CO.  
207 Scott Block, Winnipeg.

This  
is  
now  
a Packaged  
Electronic  
Circuit



Don't confuse  
with this...called a  
printed circuit

## It pays to know the difference!

-  A Centralab Packaged Electronic Circuit (P.E.C.\*) is a *complete circuit*, which can include capacitance, resistance, and inductance... in addition to wiring.
-  *Circuit performance* can be guaranteed with Centralab P.E.C.'s, because they are manufactured and tested on a performance basis.
-  A Centralab Packaged Electronic Circuit offers (a) Operating life many times that of conventional components; (b) Reduction in size, weight, and assembly cost; (c) Saving in soldering time; (d) Elimination of wiring errors.
-  Over 160 standard P.E.C. designs are available for your immediate use. For your special requirements, ask for custom design.
-  60 million Centralab P.E.C.'s are in use in the electronics industry.

For complete basic data, write for Technical Bulletin 42-227.

\*Trademark

Centralab Canada Ltd.

804 Mt. Pleasant Rd, Toronto 12, Ontario

A DIVISION OF GLOBE UNION INC.

964A E. Keefe Avenue, Milwaukee 1, Wisconsin In Canada: 804 Mt. Pleasant Road, Toronto, Ontario

VARIABLE  
RESISTORS



SWITCHES



CERAMIC CAPACITORS



ENGINEERED  
CERAMICS



PACKAGED  
ELECTRONIC  
CIRCUITS



SINCE 1922, INDUSTRY'S NO. 1 SOURCE OF STANDARD AND SPECIAL COMPONENTS

For further data on advertised products use page 83.



# How to end LOW LEVEL RECEPTION PROBLEMS

Weak incoming signals, noisy locations and low hearing ability all result in poor telephone reception. Research at AUTOMATIC ELECTRIC has developed special-purpose equipment to overcome reception difficulties.

These developments include a *transistorized* telephone that "speaks up" for the hard of hearing, a *transistorized* operator's headset that compensates for weak signals, and many others listed below.



### Transistorized Type 80 Monophone

Provides "normal" reception for people who are hard of hearing—even if they are unable to use a standard telephone! Compact, single transistor amplifier about the size of a pencil eraser is installed in telephone housing. It boosts incoming speech up to 16 times. Volume is controlled by a small knob that is out of sight behind the telephone cradle.



### Transistorized Operator's Headset

Amplifies up to 16 times. Enables operator to hear very weak signals. Transistor amplifier is only 2 1/2" x 1 3/8". It is housed in the plug to keep the headset light in weight. Draws all the current it needs to operate from the circuit. Connects through the plug. Volume control enables operator to adjust gain to comfortable hearing level.

### OTHER AUTOMATIC ELECTRIC SPECIAL PURPOSE EQUIPMENT

- ROANWELL 'CONFIDENCER' for noisy locations
- TYPE 25 HANDSET for moderately noisy locations
- TYPE 27A HANDSET for the hard of hearing
- TYPE 27B HANDSET for extremely noisy locations
- TYPE 38 ANTI-NOISE HANDSET with special noise-excluding mouthpiece and earpiece

For complete information  
write today for Circular 1823



**AUTOMATIC ELECTRIC**  
(CANADA) LIMITED

Distributor in Canada

**AUTOMATIC ELECTRIC SALES (CANADA) LIMITED**

Head Office: 185 Bartley Drive, Toronto 16

MONTREAL • OTTAWA • BROCKVILLE • HAMILTON • WINNIPEG • REGINA • EDMONTON • VANCOUVER

## business briefs & trends



★ A full-fledged boom for closed-circuit television in industry and education is predicted for 1956 by James L. Lahey, General Manager of Dage Television Division of Michigan City. According to Mr. Lahey, present market conditions indicate that at least 5,000 closed-circuit TV installations will be made by the end of 1956. The Dage company plan to install about 1,700 cameras next year.

★ A Canadian-developed and produced magnetometer has discovered more than one hundred million tons of ilmenite in South West Norway. The magnetometer, which has been developed and produced by PSC Applied Research Limited, of Toronto, has been instrumental in locating valuable mineral discoveries around the world.

★ James H. Goss, President, Canadian General Electric Company Limited, in summarizing the developments of the Canadian electrical manufacturing industry in 1955, said that "in the field of television the market for monochrome receivers appears to have reached its peak in 1955 with an estimated total of 850,000 sets having been produced". Mr. Goss also stated that the TV market appears favorable for the next eight to ten years. He anticipated that industry production in 1956 will total 700,000 sets with a market value of \$210,000,000. With regard to color television, Mr. Goss claimed that the industry has good color broadcast equipment, but it still does not have a color picture tube for receivers that, together with the necessary associated circuitry, can be produced in volume at a price to reach the mass market.

★ In dedicating the new plant of the Bogue Electric Company of Canada, Ltd., The Rt. Hon. C. D. Howe said that "more and more industries in Canada, as in the United States, are turning to electronic equipment for good economic reasons. These new tools help to ensure higher quality of products, to reduce waste, to improve service and to cut costs. No wonder, then, that we are seeing increasing use being made of electronic equipment in the pump and water industries, in the oil and natural gas industries, by the railways and in air and water navigation, in hydro development, and by the motor car industry and a number of other manufacturing industries . . . . ."

★ The near future will see Vancouver as the focal point in the new Canadian Overseas Telecommunications Corporation's \$2,000,000 program that will provide a direct telephone and telegraph link between Canada, Australia and New Zealand. Completion of the link will provide a new United Kingdom to Australia communications system of which the new trans-Atlantic cable and the Trans-Canada Telephone System will be vital parts.

One of the most recently completed telephone systems on Canada's west coast is that which serves the Kitimat Townsite of the Aluminum Company of Canada. The system is a modern common battery system, capable of serving well over 1,500 telephones.

★ Officials of the United States Radio-Electronics-Television Manufacturers Association believe that color television is a supplementary entertainment medium and will make its own place in the pattern of our lives, but will not replace or obsolete black-and-white television.

★ Dr. Donald G. Fink, director of research for the Philco Corporation, indicated in a recent statement that transistors are now being developed with a life span of more than one hundred years. The high quality vacuum tubes presently used in the trans-Atlantic telephone cables have a life span of only about forty years.

★ A new twist on the business scene is indicated by the recent announcement that a Canadian electronic equipment company is planning the construction of manufacturing facilities in the United Kingdom. The company is Nuclear Enterprises Ltd., of Winnipeg, who have announced the acquisition of a manufacturing site in the Sighthill industrial estate of Edinburgh, Scotland.

★ Contracts for electronic equipment awarded by the Department of Defense Production from October 1st to October 31st, 1955, amounted to a total of \$889,231. This total includes only those contracts in excess of \$10,000 and does not include contracts awarded for classified equipment. Firms to whom contracts have been awarded include: Measurement Engineering Ltd., United Industrial Services, Valeriot Electronics Ltd., Canadian General Electric Co. Ltd., RCA Victor Co. Ltd. and Standard Telephone & Cables Mfg.

★ The United States Department of Commerce has recently appealed to American television and radio service technicians in an effort to help relieve a critical shortage of selenium caused by production losses during recent work stoppages in the industry. The United States radio-television industry consumes roughly one million pounds of selenium in a year. Technicians are being asked to salvage parts and components containing this element.

★ Some indication of the size and growth of the American electronics industry can be realized from the recent announcement by H. Leslie Hoffman, National President, Radio-Electronics-Television Manufacturers Association, in which he stated that the industry provides employment for more than one and three-quarter million people. This means that one out of every forty persons employed in the United States today, or 2.7 per cent of the working American population, is engaged in the electronics industry. Of even greater significance is the fact that 75 per cent of the jobs filled by these people did not even exist a scant ten years ago.

★ The American Federal Communications Commission have recently certified three Canadian companies to operate mobile radiotelephone equipment installed in vehicles in the United States. The companies, which receive their service from the Bell Telephone Co. of Canada, are Algoma Adjustors and Lyons Fuel Hardware & Supplies Ltd. of Sault Ste. Marie, and the Woolatt Construction Ltd. of Windsor. The recent certifications make a total of 80 FCC approvals who operate such equipment in the United States.

★ Pye Limited, of Cambridge, England, have announced plans for the formation of a French subsidiary company to be known as Pye (France) S.A. The French company will be primarily engaged in the introduction to the French market of Pye Telecommunications products.



**for**

**service**

**satisfaction**

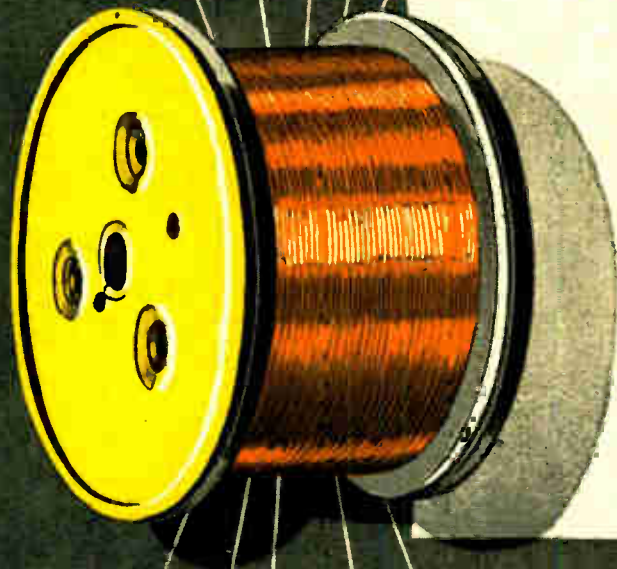

**FEDERAL**

**Magnet**

**Wire**



THE FEDERAL WIRE AND CABLE COMPANY LIMITED  
GUELPH ONTARIO



# EIMAC klystrons bring high power to another frequency range...

## 225-400mc

### 20kw CW Power Output

#### TYPICAL CW OPERATION

Eimac X590D Amplifier Klystron  
225-400mc

D-C Beam Voltage . . . . .	20kv
D-C Beam Current . . . . .	2.32 amps
Power Input . . . . .	46.4kw
Power Output . . . . .	20kw
Driving Power . . . . .	11w
Efficiency . . . . .	43%
Power Gain . . . . .	32.6db

Another frequency range, 225-400mc, has been spanned with a commercially available Eimac high power amplifier klystron. The Eimac X590D, the first klystron developed for operation at the VHF-UHF junction, delivers 20kw/CW power output with only 11 watts drive. Its high power gain of 1800 times and efficiency of 43% typifies the incomparable performance of Eimac klystrons.

Incorporation of Eimac's unique modulating anode gives X590D outstanding versatility. It can be 100% modulated to peaks of 40kv in AM operation or easily pulse modulated with low pulsing power.

A new, indirectly heated oxide cathode greatly simplifies cathode power and cooling requirements.

With the X590D, Eimac now covers the 225-1000mc range at high power with only four klystron types. Wide range tuning and an easy, economical approach to high power UHF transmitters is made possible by the Eimac feature of completing RF circuitry outside the vacuum system with permanent circuit components.

Microwave high power is easily obtained by driving an Eimac klystron amplifier with existing low power equipment.

Transmitters employing Eimac klystrons give incomparable performance and reliability plus unmatched economy, since costly RF circuitry is not repurchased with each tube replacement.



Eimac X590D amplifier klystron with circuit components permit ease of transmitter design by equipment manufacturers

- Eimac offers the most extensive selection of high power amplifier klystrons for pulse, CW and AM applications. For information contact our Technical Services Dept.



**EITEL-McCULLOUGH, INC.**  
SAN BRUNO, CALIFORNIA  
The World's Largest Manufacturer of Transmitting Tubes

Take the trouble out of winter

with **Jeep** **4Wheel-drive** **VEHICLES**

solve your toughest transportation problems too!



CJ-5 'JEEP'

You're always sure and safe with 4 wheel-drive

'Jeep' vehicles are internationally recognized as the most dependable means of transportation today! The ability of these modern workhorses to go through snow, sand, mud, over icy roads, up and down steep grades, across open country, make 'Jeep' 4 wheel-drive vehicles Canada's first choice for the really tough jobs!



'JEEP' SEDAN DELIVERY



**TRACTION.** Four wheel-drive gets you through snow, ice, mud.

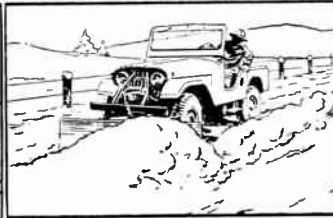

**SNOW PLOWS.** Angle, V or Blower types.



**TRUCK WRECKER.** Gives sure service in any weather.



**CAB.** Ideal for winter working comfort. **WINCH** increases uses of vehicle.

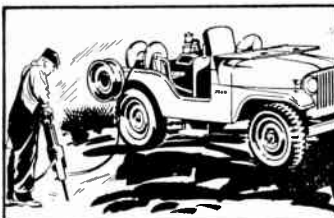

**COMPRESSOR.** Power take-off driven. One-man operation.



**WELDER.** Service on the spot in any weather.



**DUMP-O-MATIC.** Saves time, cuts costs.

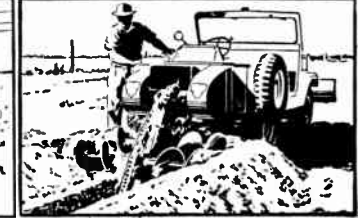

**JEEP-A-TRENCH.** Even trenches in frozen ground.

For the toughest "impossible" jobs the world automatically thinks of 'Jeep'

**KAISER-WILLYS OF CANADA LTD.**

WINDSOR • ONTARIO

Canada's most useful vehicles

KW-582





S (CP) — In the average greater Eastern umbia. Department report for Commons 158 speon farms r a five-

that the return for nagement firm, com-B.C. and al invest- from \$45 19 in the

PUT P.C. OTAL

BUP) — roduction 1955 to against year be-tics said. ever, do-jumped 1,852,000 0 pounds roduction ces and re out- the rest

fter Jan. 100,030,- with 91,-

James week he what he plus" of ed it at ty." r's of

decline as anticipated. Non-ferrous metals showed the sharpest price advance in 1955 — 17 per cent. at the wholesale level. Lead out in the direction of higher living costs, it is to be hoped they will be resisted vigorously on all fronts.

# SASKATCHEWAN GOVERNMENT EMPLOYS SE50 SELECTOR AT HUMBOLDT

*The outstanding SE50 Selector, developed by The General Electric Co. Ltd. of England, was recently installed in the new telephone exchange at Humboldt, Saskatchewan.*

This is the first telephone exchange on the North American Continent using the new SE50 Selector. According to company officials the research and development of this new type selector goes back fifty years and only after comprehensive field testing was it placed on the market a short time ago. Tests on the SE50 Selector give 4,000,000 calls without replacement of any parts and with only a few minor readjustments.

Among the many features of the SE50 Selector are . . . easy accessibility for adjustment, quick and simple adjustment of all parts, and every adjustment on Selector SE50 is provided with positive locking to prevent drift from correct setting.

## Convertible Bonds

Supplied by Investment Dealers' Association of Canada:

	Bid	Ask
Ajax Petroleum 5s 1962	94	97
Anglo Araer Ex 5 1/2 1975	99	102
Atlas Steels Ltd 5 s 1967	104 1/2	107 1/2
Braz Tract L&P 4 1/2 s 1971	78	81
Brit Amer Oil 3 1/2 s 1961	170	178
Brit Amer Oil 3 1/2 s 1962	134	138
Can. South Oils. ss. 1961	82	85
Can Pac Ry 3 1/2 s 1966	106 1/2	109 1/2
Can Pac Rly 4 s 1969	110	113
Can. Petrofina 4 s 1972	106 1/2	109 1/2
Cent. Leduc Oils. 5s. 1965	87	90
Cochshut Fm. Eq. 5s. 1968	95 1/2	98 1/2
Dm. Sil. & Coal 4 1/2 s 1970	105 1/2	108 1/2
Dominion Textile 4s. 1966	95	98
Jupiter Oils. Ltd. 5s. 1967	90	95
Krcy Oils. 5s. 1967	96	99
N. Concord Oils 5 1/2 s 1965	92	96
New Superior Oils. 5s. 1964	96 1/2	99 1/2
Pathfinder Pete. 2-5s. 1962	80	85
Soury Oils. 5s. 1964	96	99
...ca. Ltd. 5 1/2 s. 1972	120	125
...n. Corp. 4 1/2 s 1969	115	121
...n. Oils 5 1/2 s 1967	97	100
Brew. 5s. 1967	133	140

# UAW CHANGES G.M. DEMANDS PROGRESS SEE

A new round of pe to end the nation's strike will begin this at the Royal York representatives of Motors of Canada Auto Workers' a

The talks continuing

took on

week-en

reappr

demand

made

Gene

shou

ment

man.

The

deman

tensiv

or me

have

in five

120

# ALBERTA CRUDE OUTPUT HIGHER PEMBINA LEADS

Calgary, Jan. 16—(CP)—An increase in Alberta oil production of nearly 70,000 barrels a day was shown in the week of the Alberta Petro Natural Gas Conserv

Production during ended Jan. 9 average of 366 pared with 29 during the p end-of-the-m backs kept

In the due

LARGEST Montreal, Jar tivity in Canadi mills was great in any year since ton Institute of Domestic m hales in 19 316,828 in Each h FAW

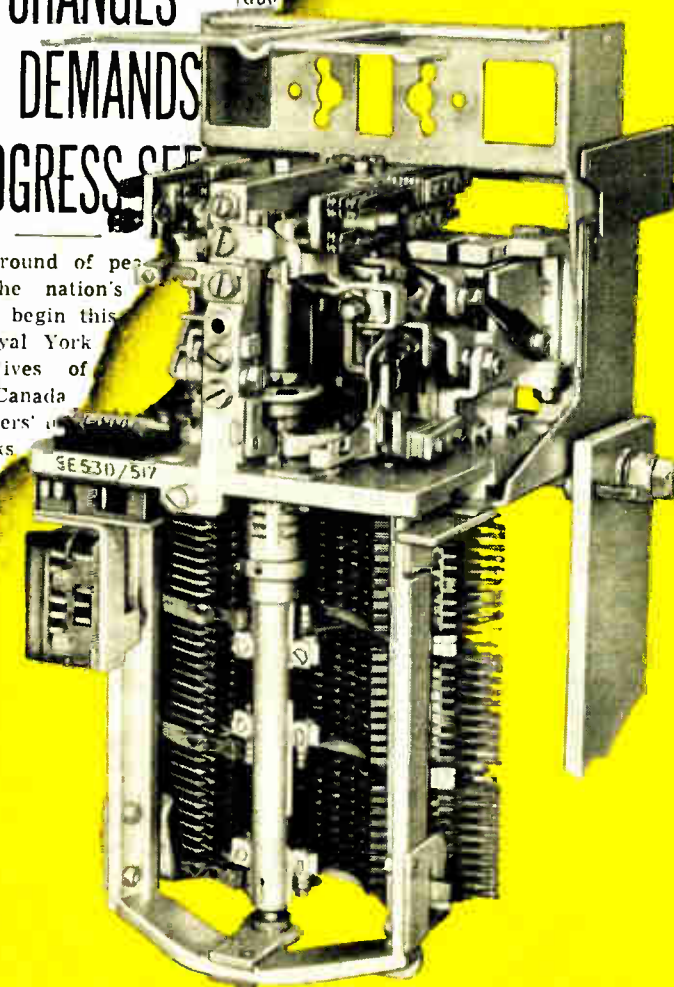

## AMALGAMATED ELECTRIC CORPORATION LTD.

an associate company of The General Electric Co. Ltd. of England

MONTREAL • TORONTO • WINNIPEG • CALAGRY • VANCOUVER

Agents for Communication Equipment in British Columbia, Alberta and the Yukon Electric Power Equipment Ltd., Vancouver



## **H**IGHLIGHTS ON **TRULY FINE MAGNET WIRE**

Magnet Wire insulation must meet the most exacting standards. No matter whether it be glass, cotton, paper, textile, or the ever-popular Formel—the covering must be compact, smooth and unbroken. The surface as nearly perfect as human skill can make it.

That is why, at Phillips, the greatest possible care goes into every phase of Magnet Wire manufacture. To maintain these high standards, fully-trained technicians, working with the newest equipment, produce a quality controlled product.

But that is not all. For the basic secret of Phillips Magnet Wire lies in the copper wire itself. The pure,

electrolytic copper is rolled, drawn, and processed until a high surface finish is obtained. And the dead soft quality of the copper, free from springiness, makes Phillips wire a wanted product.

These are the reasons why Phillips Magnet Wires rate with the finest wires made anywhere. Bare, shaped, or insulated, your best buy is Phillips.

*Phillips Electrical Company Limited. The Canadian Affiliate of the B.I.C.C. Group. Head Office—Brockville, Ontario. Sales Offices—Montreal, Ottawa, Toronto, Hamilton, Winnipeg, Regina, Edmonton, Vancouver.*

5602

SEE BACK OF THIS PAGE

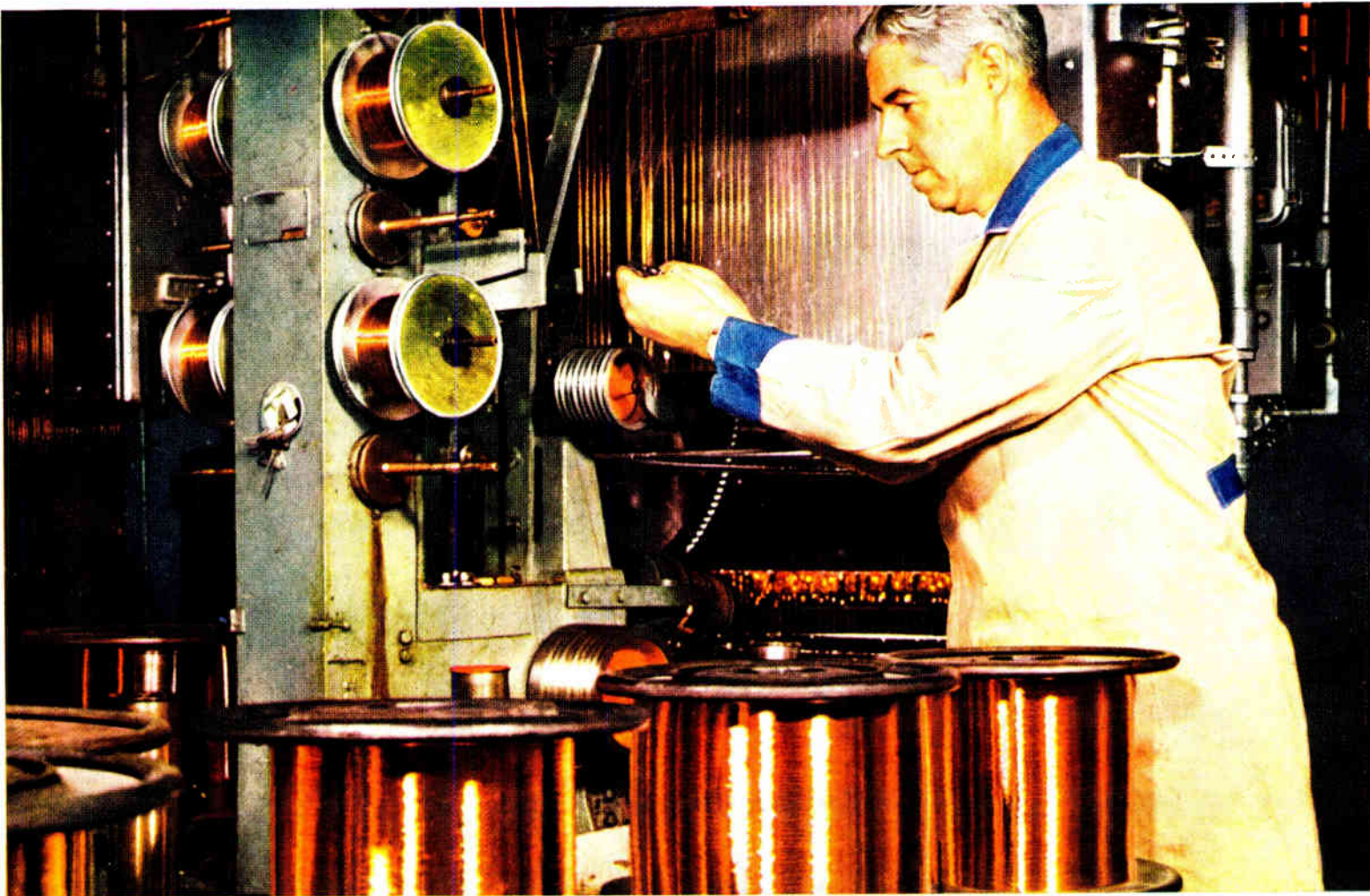

**Phillips**

**WIRES & CABLES**

for  
windability  
and trouble-free  
performance

...count on

**Phillips**

**MAGNET WIRE**



Whether you're winding relay coils, motor armatures or any other equipment requiring this type of wire, you'll find that Phillips Magnet Wire will do your job better . . . because it is a perfectly finished product, made of the finest materials. In its manufacture, the most modern methods of drawing and annealing are used. And, the wire is constantly inspected during production to ensure uniform gauge and softness. As a result, the Phillips Magnet Wire you buy is easier to wind and form on your product.

Phillips Magnet Wire can be supplied to standard or special specifications—in round, rectangular or square shapes—covered with glass, cotton, paper, asbestos or bare. Round shapes are also available in nylon, formel or enamel. And all types are conveniently packaged for the operator, in a range of spools and reels. Stocks are maintained at distributing centres across Canada to assure you prompt delivery.

Representatives and agents in all major centres from coast to coast.

**Phillips**  
ELECTRICAL COMPANY LIMITED  
**WIRES & CABLES**

THE CANADIAN AFFILIATE OF THE B. I. C. C. GROUP  
Head Office — Brockville, Ont.  
MONTREAL • OTTAWA • TORONTO • HAMILTON • WINNIPEG  
REGINA • EDMONTON • VANCOUVER

5505



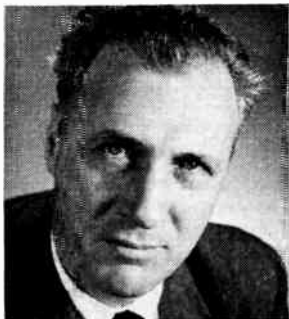

# The EDITOR'S PAGE

Editorial objection has recently been taken by some daily newspapers to the proposed plans for fitting closed circuit television in the new Peterborough Post Office. The purpose of the closed circuit TV system which will use sixteen units is for surveillance of the mail-handling staff, and the obvious reason for the use of the equipment is to discourage or detect theft from the mails.

The *Peterborough Examiner* says that "it is a civically revolting, personally humiliating scheme", but we have a sneaking suspicion that the *Peterborough Examiner* says this because it is a neatly turned phrase to include in an editorial.

We would be the first to agree that the use of closed circuit television will instil the employees of the post office with a captive feeling during the first weeks of its use, but this is a feeling that will wear off as the employees become accustomed to working under the new condition.

In raising its objection to the use of television in the post office, the *Peterborough Examiner* attempts to round out a case, inferring that the equipment is to be used for spying on the personal actions of the employees and berates the use of the equipment for spying on the men's toilets, although no one has been forthright enough to state that there is any intention of using it for this purpose.

The plan has also come under fire from the Canadian Postal Employees Association and Mr. Fred Whitehouse, national secretary of the association, has gone on record to state that this group "certainly resents" the new plan. Our advice to Mr. Whitehouse would be to consult with post office authorities who, we are sure, would be prepared to assure him on behalf of the association he represents that there is no intention of using the equipment for spying on the personal behavior of postal employees. It is, in our opinion, a little naive to believe that a federal department would resort to this type of practice.

Gordon K. Fraser, Progressive-Conservative Member of Parliament for Peterborough, has also moved to the defense of the postal employees' rights, charging in the House of Commons that the plan was another step by the Government to try to take away the rights of Canadian workers. Mr. Fraser compared the idea to the sort of thing that might happen in a dictatorship like Russia and said that "one will not be able to go to the washroom to clean up without a television camera on him. The next thing they will do will be to add a loud speaker to these television cameras so that they can say, 'Peekaboo, I spy on you'."

Personally, Mr. Fraser, we can't bring ourselves to believe that they will do this.

There seems to be little left in the world that has not come under the surveillance, analysis or control of the countless electronic gadgets that are being produced in ever-increasing quantities. This thought is brought to mind by the recent receipt of a photograph, the main subject matter of which is a disconsolate looking steer which has been wired for sound with an electronic recording device claimed to be capable of showing agricultural scientists how to obtain more milk from cows and more beef from steers. As publishers of a journal devoted to the advancement of the electronics industry, we are pleased to see the ever-increasing number of applications to which the science is being applied, but as an amateur artist admit to some concern over the prospects of what the pastoral scene of the future will look like with cows wired for milk, steers wired for beef, sheep wired for mutton and pigs wired for pork.

It's been a long conceded fact that the "old grey mare isn't what she used to be" but her metamorphosis, whatever its extent may have been, surely can't compare with the change in appearance that seems to be in store for her barn-yard associates when saddled with the electronic gadgetry of the agricultural scientist. How now brown cow!

\* \* \*

Ho Hum! The parade of novel developments in the field of electronics seems to have no end. Now it's an electronic teddy bear, conceived and produced by a British inventor. This furry little critter with its hide-full of tubes, rheostats and soldered connections has been developed to overcome the sleepless nights of the insomnia victim. When plugged into a socket, air is pumped by the teddy bear's artificial lung in and out of the teddy bear at the rate of 10 to 12 breaths a minute, the normal breathing rate of an adult when asleep. The inventor says that, "This slow, rhythmic breathing by the teddy bear aids the brain to slow down the user's breathing rate and also helps the body to relax". As an added inducement to the sale of this device may we suggest that any manufacturer considering the production of same to forget the teddy bear motif and produce them in the likeness of Marilyn Monroe or Gina Lollabrigidia, who cares which?

\* \* \*

Prime Minister Sir Anthony Eden, in a televised talk to the Canadian public, made mention of the shortage of engineers in both Great Britain and Canada. In his country, Sir Anthony said, the government took a grave view of the shortage and was acting positively to overcome it. Wonder if the Canadian government have considered acting in a similar manner or are they still hopeful of relying on imported brains to fill the gaps in this country?



# Navigation Utilizing The . . .

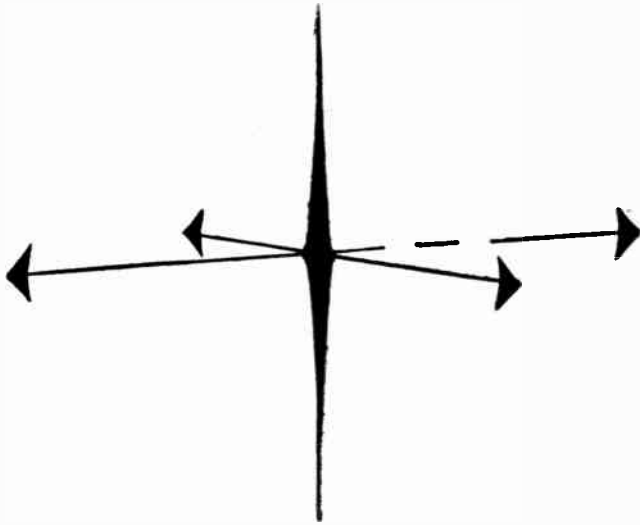

## Doppler Effect

By

LESLIE L. HILL, Ph.D.

Consulting Editor Electronics and Communications.

TO the non-technical person the name "Doppler" is frequently associated with the German "doppel", meaning double, and it is often not realized that Doppler is the name of a modest man, who lived in Salzburg, Austria, towards the turn of the 19th century.

Doppler effects were first observed in acoustics, and Doppler himself never dreamed, that his name would become famous in association with similar phenomena in astronomy and particularly in electronics (radar), a science then unknown.

A wave-source, moving with the speed  $\pm u$  shows to the stationary observer, not the original frequency  $F$ , but:

$$F_1 = F \left( 1 \pm \frac{u}{c} \right)$$

(the "plus" refers to a decreasing distance)

The above phenomenon concerning the transmission of waves ( $c$ ) in relation to the motion of receiver and transmitter is called the Doppler effect.

Any reduction of distance during the emission of sound increases the frequency observed by the receiver, while an increase of the distance would have the opposite effect.

Quantitatively observed, one would have to differentiate, whether the source or the receiver of sound was moving. The stationary observer finds:

$$F_1 = \frac{F}{1 \mp \frac{u}{c}}$$

(the "minus" refers to a decreasing distance)

The receiver "in motion", however, would meet, as mentioned before

$$F_1 = F \left( 1 \pm \frac{u}{c} \right)$$

(the "plus" refers to a decreasing distance)

We have a similar effect with electromagnetic waves. In this case, however,

there will be no difference observed, whether the receiver or the transmitter is moving.

Both equations applied for mechanics namely,

$$(1) F_1 = F \left( 1 \pm \frac{u}{c} \right) \text{ (moving}$$

receiver) and:

$$(2) F_1 = \frac{F}{1 \mp \frac{u}{c}} = F \left( 1 \pm \frac{u}{c} + \frac{u^2}{c^2} \pm \dots \right)^*$$

\* Upper "prefixes" stand for reduction of distance.

(moving transmitter) will have to be replaced by only one equation:

$$(3) F_1 = \left( 1 \pm \frac{u}{c} \right) \sqrt{1 - \frac{u^2}{c^2}} = F \cdot \left( 1 \pm \frac{u}{c} + \frac{1}{2} \frac{u^2}{c^2} \pm \dots \right)$$

(Lorentz transformations).

The quotient " $\frac{u}{c}$ " becomes very small, considering the speed of light ( $c = 187,500$  miles per sec.), therefore " $\frac{u^2}{c^2}$ " and all further links of the above mentioned equation could be neglected.

The change of frequency ( $F_1 - F$ ) is then only dependent on the relative speed "u" between transmitter and receiver:

$$F_1 = F \left( 1 \pm \frac{u}{c} \right).$$

One of the foremost application of the Doppler effects is found in navigation:

A navigation problem has always existed in aviation. A device is needed, accurate enough to guide a bomber and small enough to serve a fighter. It will

continuously measure ground speed, drift and even slopes to the accuracy commensurate with the precision equipment in use in today's high performance aircraft. It uses Doppler's principle and a novel antenna combined with the latest electronic art to give a very useful package.

Several solutions to the problem have been found, but nearly all have disadvantages. A great number of ideas seem feasible, but either the weight is too great, the amount of space needed for the equipment is excessive, or it is limited to operating under visually clear conditions.

A good example of this is the celestial navigation system. This system, in order to function accurately and well, must have celestial reference points, such as stars or the sun, and in the event that these are obscured, one would have to rely on memory circuitry, which does not produce the accuracy required. Certain navigation systems presently in use require that there be known fixed points on the route of travel against which the equipment may be checked.

Radar scanning systems allow observation of the terrain covered under virtually all conditions. They are practical, if the terrain features are known and can be compared to a map. This would require that a photo reconnaissance plane be dispatched to photograph these terrain features, or that the information be presented in some other method. This method is not suitable over water.

Another approach would be to have an advance plane drop a radar beacon set somewhere along the route to be followed. This would give good drift measurements, but would depend upon the equipment to remain operative after contact with the ground and upon the fact that it would not be discovered by opposing people (in the case of hostilities). This latter problem could be alleviated to some extent, by having the dropped equipment transmit only when triggered by a coded signal.

All these problems could be solved by utilizing the Doppler frequency shift of radar echoes. This shift can be readily adopted for rapid determination of the ground track of an aircraft. When radar waves are transmitted from a moving source, their reflections, as returned to the same source, make that source a moving observer. Here, the speed of the source in the direction of the observer is the component of the ground speed of the aircraft in the direction of the reflecting surface, which is fixed on the ground. This speed, at the maximum along the ground track of the aircraft is then equal to the speed of the aircraft. Therefore, the frequency received from any single point reflector is shown by the following relationships:

$$(4) \quad F_r = F_t \pm 2 \frac{V_g \cos \theta}{\lambda} = \\ = F_t \left( 1 \pm \frac{2 V_g}{c} \cos \theta \right)$$

The term  $\frac{2 V_g \cos \theta}{\lambda}$  represents the change in frequency of the received signal as compared with that transmitted. From this it can be assumed that the aircraft catches up with signals sent ahead of it with a resulting increase in frequency, and is going away from signals sent rearward, resulting in a decrease in frequency.

The selection of frequency to be used becomes fundamentally important, since radar at different frequencies produces quite different effects. It is obvious, that a radar signal of extremely high frequency cannot be used, because of cloud effect. Since the system must also be used over water, as well as over land, the selection of frequency becomes doubly important. A signal with a frequency of 10,000 Mc/s is not usable over water, because no indication is given. However 3000 Mc/s would be practicable under all conditions and a beat frequency could be used to provide the required accuracy.

The system could consist of a transmitter and receiver, where energy is provided by a klystron fitted directly to the transmitting antenna. The klystron would be preferable to the use of a magnetron because of its advantages of weight, size and lack of interference with the compass.

Various antenna arrangements could be used, as e.g. one single  $\frac{3}{4}\lambda$  antenna, enclosed within a metallic hemisphere with openings in the proper directions. These openings could contain focusing lenses of suitable dielectric material.

Alternatively, a conventional  $\frac{1}{4}\lambda$  antenna enclosed in an array of properly positioned parabolical reflecting surfaces could be arranged similarly as the receiving antennas, with the exception that for reception of the signal from each pair of transmitting antennas, a separate receiving array should be provided.

The difference of the aforementioned frequencies is directly proportional to the ground speed component in the direction of the plane of the correspondent pair and can be used to measure the ground speed component in this direction.

The effective ground speed and the side drift will result from the components of both planes after the aforementioned frequency differences have been properly processed by electronic devices (amplification, frequency transformation, etc.). Under average conditions, these frequency differences (beats) are to be expected in the order of 2,000 c/s.

A computer could be the ultimate device after the transformation into proportional voltages or currents by a frequency discriminator.

The discriminator stage may be replaced by an electronic counter, counting the beats caused by the interfering frequencies of each pair. These values within certain short time intervals will be again processed by the computer.

Summary figures can also be obtained by feeding the results of the discriminator into an oscilloscope. The resultant will appear as a straight line, the length of which will be proportional to the ground speed and the angle with reference to a center line, will indicate the side drift.

With the same arrangement further results, if required, can be obtained by means of the computer, e.g.

---

### With Current Developments In Aerial Navigation And Scatter Propagation It Is Considered That This Review Of The Doppler Formula Used To A Large Extent In These Developments Will Be Of Timely Interest

---

The radar echoes of signals transmitted simultaneously in two opposite directions will differ again of an amount twice the Doppler effect in one direction in which the resulting beats will correspond to:

$$(5) \quad F_r \left[ \frac{2 V_g}{c} \cos \theta - \left( \frac{-2 V_g}{c} \cos \theta \right) \right] \\ = F_t \frac{4 V_g}{c} \cos \theta$$

#### KEY

- c = Speed of light.
- $F_r$  = Received frequency.
- $F_t$  = Transmitted frequency.
- $\lambda$  = Wavelength of originally transmitted signal.
- $V_g$  = Airplane ground speed.
- $\theta$  = Angle between ground track and the direction in which antenna is pointed in the vertical plane.
- $t$  = Angle between ground track and the direction in the horizontal plane.

The beat frequency, therefore, will be directly proportional to the component of ground speed, which lies in the vertical plane of the radiation beam (cos  $\theta$ ). If the actual ground speed does not coincide with the horizontal component of the direction of the beam, a second cosine, cos  $t$  has to be considered.

The transmission would occur by radiation of simultaneous pulses in two narrow pairs of beams radiated from the aircraft. Each pair will cross the other in such a way that their planes intersect at preferably 90 degrees.

The intersecting line should stay vertical causing the beams to point downwards at approximately equal angles. Those angles should be chosen anywhere between 30 and 60 degrees, preferably greater than 45 degrees, because less energy is required, fewer discrepancies occur because of roll and pitch and there is less possibility of detection in case of hostilities.

The only disadvantage lies in the fact that if the angle  $\theta$  becomes too large, the resultant Doppler effect will be diminished.

Reception takes place as follows:

The beams will hit the ground at certain areas from which they are scattered in all directions much like radar. The parts of this scattered energy returning to the aircraft will be received by a similar arrangement of antennas.

The difference between transmitting and receiving system lies only in the fact that the transmission occurs simultaneously for both pairs of antennas, while for the reception of each pair a separate receiving array is provided.

The speed of the aircraft with reference to the ground will cause shifted frequencies higher and lower than the original radiated frequency (Doppler effect).

- (1) Actual height of aircraft over ground
- (2) Total distance covered by the aircraft (integration of speed over time)
- (3) Roll angle of the aircraft (replacing to a certain degree the artificial horizon)
- (4) Slope of ground, when combined with an existing or added gyroscope.

Another method of determining ground speed could be acoustical, incorporating continuous klystron oscillations. The beats are expected to be within the frequency range of 1000 to 2000 c/s. and therefore audible. The pitch of the sound will determine ground speed by comparing it with a standard oscillator calibrated in miles per hour. This system would be relatively inexpensive and could be easily used commercially.

Navigation in aircraft is only one of the numerous applications of the Doppler effects. In the case of light it becomes nearly impossible to distinguish between them. The slight abnormality (Doppler shift) in the positions of the spectrum lines from a star will afford a fairly accurate value of the relative speed with which the star and the earth are approaching or receding from each other.

Many double stars are recognized as such only by the doubling of their spectrum lines due to the components moving in opposite directions.

A New System Incorporating The Combined Effects Of Two Single Capsules With Uni-Directional Pattern Has Been Highly Developed And Will Take Its Place Alongside Such Well Proven Instruments As The Pressure Receiver Type Of Microphone.

# New Directional Moving-Coil Microphones

By DR. R. GORIKE

**D**IRECTIONAL microphones have a special significance in sound recording and especially so in radio and television studios. In this article, some of the problems met during the construction of such microphones will be considered. The research program carried out in the laboratories of A.K.G. Ltd., led to the development of a uni-directional moving-coil microphone, and another which combines the basic elements of two separate microphones whose combined patterns can be changed by electrical remote-control from omni-directional to figure 8 and to reverse or forward cardioid.

A major difficulty to overcome in the construction of dynamic microphones lies in the vibration system. Tests were made to increase the driving-force of the pressure gradient and, at the same time, to improve the directional characteristic by means of a tubular arrangement combined with acoustic filters. Earlier microphones were similarly

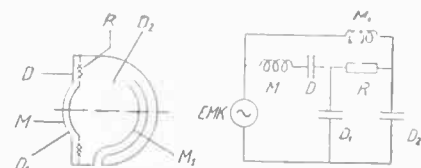

● **Figure 1.** Schematic construction of the "Western" moving-coil microphone with associated circuit diagram. The diaphragm M and the rim tension D is on one side subject to the sound field and on the other side joined to the vacuum D2 via the lower air chamber and an acoustic impedance R. The acoustic mass M1 in the tube, together with the chamber D2 constitutes a "Helmholz" resonator which is tuned to about 50 cycles. The pressure vibrations, at resonance in D2 are phase-delayed so that an additional driving force results on the reverse side of the diaphragm.

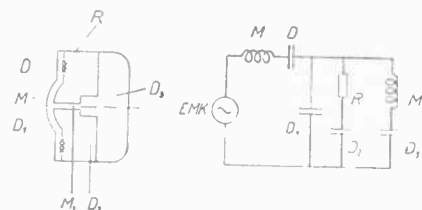

● **Figure 2.** In this arrangement of a moving-coil microphone, the diaphragm M is coupled by pronounced tension D1 to the acoustic mass M1 in the lower air chamber via the tube. The pressure in the lower part of the casing causes both masses to resonate at about 50 cycles. The frequency curve is held flat until 30 cycles.

handicapped so that it was difficult to keep the directional characteristic independent of frequency in an eight octave range. However, the capacitive system has made it possible to keep a tighter control over the acoustical and mechanical vibration.

The new system incorporating the combined effects of two single capsules with uni-directional pattern has been highly developed and will take its place alongside such well-proven instruments as the pressure receiver type of microphone.

In construction, the dynamic principle also provided a warning in certain of the principles of sound-conversion mechanics. In spite of mechanical sensitivity to wind and shock, the ribbon microphone still retains a foremost position especially in the U.S.A.

The moving coil system as a pressure microphone has been introduced throughout the world in two types. First, the "Western Electric" type construction whose frequency range is sufficient to satisfy the most stringent demands<sup>1</sup>.

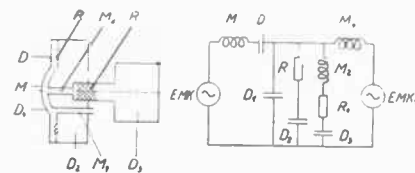

● **Figure 3.** The principle of velocity conversion. The diaphragm M is subjected to the acoustic mass in the tube M1. The vibrations of the diaphragm M, which lay in the acoustic range of frequencies by virtue of the tension D, will be at the lowest limit of the working range because of the additional acoustic mass M1.

The second principle, dating from 1940, provided the foundation for the development of the new directional moving-coil microphone and is shown in Fig. 2.<sup>2</sup> The difference between the two systems can be found in the layout of the Helmholtz resonator. Fig. 1 shows how the resonator cavity D2 is coupled to the rear side of the diaphragm via the frictional resistance R. Fig. 2 shows how the resonator neck is coupled with the rear side of the diaphragm so that its mass M is in close contact with the capsule mass in the lower air cavity D1. Both arrangements give practically the same result and have proven to be very efficient.

Fig. 3 shows an interesting acoustic layout. The diaphragm together with the moving-coil mass M, and tension D of the elastic retaining rim, has a resonant frequency which is substantially higher than the lower audio limits of the instrument. However, there is no effect as the rear of the diaphragm is coupled to the lower air chamber D1. This contains the tube mass M1 (for simplicity only one tube is shown in the diagram). Instead, the combined effects of the membrane mass, the tube perforations and the membrane tension produce a new point of resonance. The action of the air in the narrow gap on the diaphragm can be shown mathematically as:

$$M_1 = e \cdot l \cdot \frac{F^2}{f}$$

e = air specific gravity =  $1.2 \cdot 10^{-3} \text{ g/cm}^3$   
 l = length of tube bore in cm.  
 f = diameter of tube bore in cm<sup>2</sup>  
 F = diaphragm area in cm<sup>2</sup>

<sup>1</sup> Wente & Thuras, Jour. Acous. Soc. Amer. Vol. 3, No. 1, S.44, 1951.

<sup>2</sup> Alien Property Custodian, Serial No. 409 712, published May 18, 1943, Application filed September 5, 1941 (Gorika).

It is well-known that superposition of the omni-directional and figure 8 patterns will produce a uni-directional

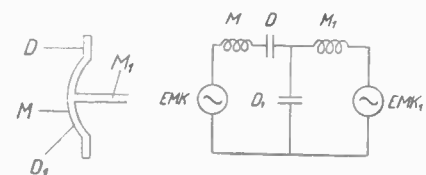

● **Figure 4.** The new moving-coil microphone with directional sensitivity illustrated diagrammatically. The electrical circuit diagram is also shown. The association of the arrangements is shown in Figures 2 and 3.



characteristic. The same effect can be achieved electrically by using two separate microphones of different directional characteristics. This can also be done acoustically by employment of the response of a single diaphragm to air pressure and the pressure - gradient. The latter, which is variable with frequency, in both cases provides the driving force. It increases with frequency and reaches maximum value when the distance from center front to center rear of the diaphragm via its edge, equals half-wave length. Conversely, minimum value is reached at low frequencies.

In order to compensate for driving force frequency variability, a constant EMK is produced by mass-impedance. With ribbon microphones this presents no difficulties. However, it is much more difficult to achieve in moving-coil microphones. Sufficient tension is necessary at the diaphragm rim to hold it exactly in the center of the magnet air

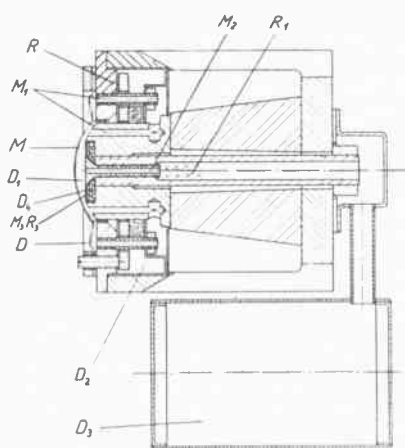

● **Figure 5.** The construction of a moving-coil microphone with directional sensitivity as a further development of the arrangements shown in Fig. 4. Instead of a single tube M1, eight are provided. By adjusting the acoustic elements it is possible to satisfy the high demands made of a studio-type microphone.

gap and to secure it against undue sensitivity to wind and shock. A natural resonance of 180 cycles was found to be most advantageous at the low frequency limit. This, with suitable damping at the low end of the frequency range is necessary to ensure uniform response at the lower audio frequencies down to 30 cycles. Any reduction in tension at the diaphragm mounting would increase susceptibility to shock and also reduce operational dependability. A very practical method of producing the necessary damping is to use the variation inphase-shift of air pressure velocity as shown in Fig. 3. This possibility was employed to shift diaphragm resonance resulting from the rim tension, to the low end of the audio range (see Table 1 for mathematical expression).

By combining pressure-receiver construction principles (Fig. 2) with those shown in Fig. 3, a microphone was developed which possessed all the desired advantages plus a directional characteristic. Figure 4 shows a schematic illustration of such an arrangement. The pertinent electrical circuit diagram is also shown.

The front side of the diaphragm M is directly coupled with the acoustic

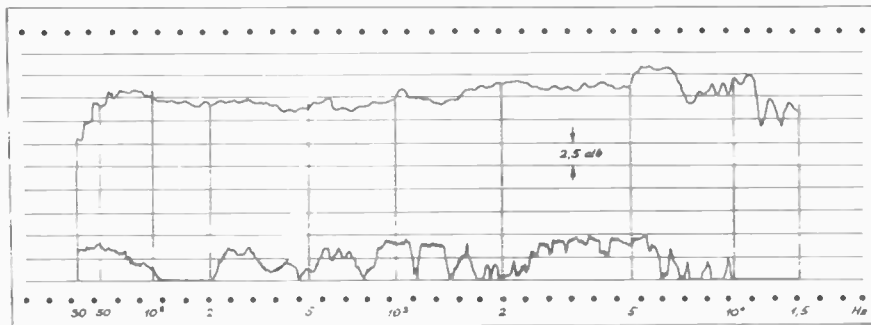

● **Figure 6.** The frequency characteristic of a studio-type microphone of the type shown in Fig. 5. Sound incidence is at 0 and 180 degrees. The cut-off at 180 degrees is particularly striking.

mass M<sub>1</sub> and also at the diaphragm rear-side via the narrow tube. The application of the combination principle to illustrate the action enables the separation of the pressure gradient and the pressure components and affords a clear picture of the connection. The vibration system, activated by the pressure gradient consists of the elements MDM, and is heavily attenuated. There are three tuned resonant circuits for the pressure components. MDD<sub>1</sub>, at the highest, the resonant circuit MDRD<sub>2</sub> tuned to a frequency at the middle of the range and the circuit MDM<sub>2</sub>R<sub>1</sub>D<sub>3</sub> resonates near the low end of the range.

In order to avoid standing waves in the tube M<sub>1</sub>, its length is kept sufficiently short. Then the lowest unwanted

resonant frequencies peak at  $1 = \frac{\lambda}{4}$

in a microphone whose operational range must include the most important frequencies — at a length of about 0.8 cm. Figure 5 shows a microphone which contains eight short tube-shaped perforations instead of one electrode M<sub>1</sub>. By increasing the number of these perforations and controlling their total diameter, it is possible to produce sufficient attenuation to keep the frequency response flat. Furthermore, another resonant circuit M<sub>2</sub>R<sub>1</sub>D<sub>3</sub> results from the

microphones whose sensitivity lies in opposite directions, it is possible to produce all patterns between omnidirectional and figure 8 by partial electrical re-adjustment of the individual systems. Figure 7 illustrates the various patterns.

By use of the pattern selector unit, it is possible to produce the various patterns shown in symbolic form under the selector switch, during actual performances. It perhaps seems paradoxical to use a system composed of elements of cardioid, omnidirectional or figure 8 patterns to reproduce new and similar patterns by electrical re-arrangement of the first set. Nevertheless, it has been found that here is an ideal solution to the problem of keeping the frequency characteristic and voltage constant in the direction of maximum sensitivity. The microphone diaphragm is not activated by any sound sources except those within the directional pattern in use at the time. Thus, only those sounds with sources in the direction of greatest directional sensitivity will activate the membrane.

With the advent of the remotely-controlled microphone, new possibilities have opened in the field of sound-reproduction. Some broadcasting companies are already using this new technique in the production of plays, with great success. Also the ability to select the

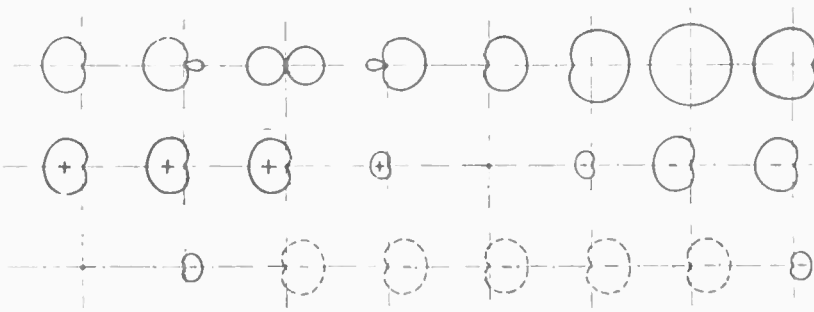

● **Figure 7.** Illustrates the formation of the various directional characteristics by the addition of vectors with oppositely directional characteristics and with variable amplitude and phase. **Top row:** The resultant patterns. **Center row:** Amplitude and phase of the system. **Bottom row:** Amplitude and phase of the second system.

tuned acoustic elements shown in Fig. 4 and serves to flatten the frequency curve.

The microphone response curves are shown in Figure 6. Sound incidences are 0 and 180 degrees.

By incorporating the combined effects of the directional properties of two

most advantageous pattern from the control booth during actual production is exceptionally welcome, especially when the microphone is inaccessible, i.e., should it be hanging over an orchestra. Besides all this, the time saving advantages of the pattern selector system cannot be over-estimated.

# Prototypes In Forty Minutes

**Apparatus Claimed  
Capable Of Making  
Prototype Electronic  
Circuits In Thirty To  
Forty Minutes.**

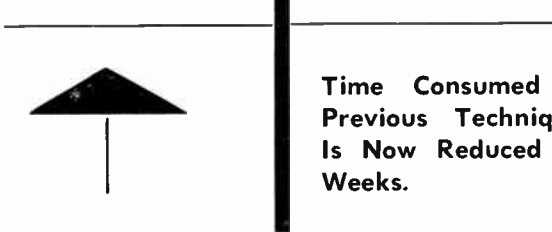

**A** UNIT for making production prototypes of printed electronic circuits and named by its manufacturers as the Protomaka measures only 60 inches long by 50 inches wide by 45½ inches high. Despite its small size the apparatus is capable of producing an average printed circuit in 30 to 40 minutes and circuits up to 10 inches by 16 inches in size can be manufactured.

The unit shortcuts circuit and product development time by weeks and, in many cases, months. Prototypes of printed circuits usually have been made by small sub-contracting firms from designs furnished by engineers. Information, changes and modifications had to be passed back and forth, with inevitable delays and mounting costs. With the new equipment a prototype of any printed circuit design can

● Shown below is a photograph of the Protomaka which is claimed by the manufacturers to be the first equipment for the production of printed circuits that has been designed into one compact unit.

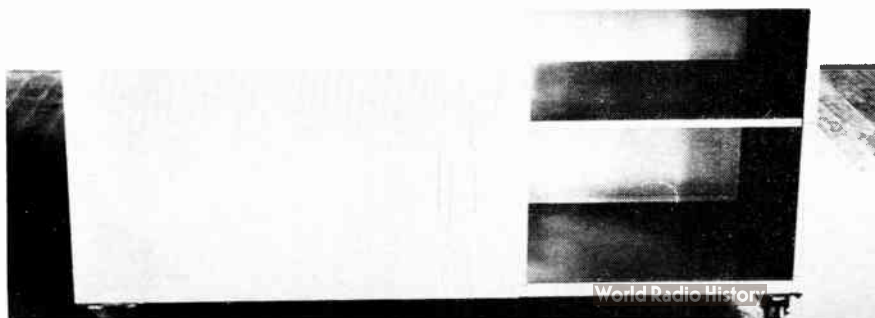
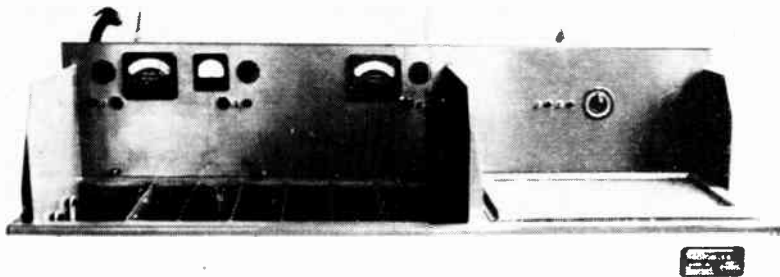

be in the testing laboratory in less than an hour.

A machine is simply plugged into a standard 110 volt line, one hose is connected to a cold water faucet and another to a waste drain. With these simple connections, the unit is ready to operate.

Cost is moderate — only a fraction of the cost involved in purchasing the component equipment separately.

The Protomaka produces etched wiring by the photographic process. Copper clad material is coated with photosensitive resist on a whirler. The board is held by a pair of quick-acting clamps while the solution is poured on the surface. Centrifugal force spreads the resist evenly, any excess flowing into the aluminum bowl in which the whirler spins. The stainless liner may be removed for cleaning. An infrared lamp dries the resist as the piece rotates.

The circuit board is then exposed on the light table where the negative is placed under the resisted panel, and pressed firmly to it by the vacuum frame table top. Exposure time is only 30 seconds. A developing tank with an overflow water rinse is conveniently located to complete the printing cycle.

If a plated surface is desired, the copper is cleaned, in a built-in reverse current alkali and hydrochloric acid tank, each with its own rinsing chambers. Silver or solder may be plated on the circuit pattern, as desired. Current densities may be varied by rheostat adjustment and checked on the plating ammeter.

Two etching baths are fabricated into the top assembly, both having air agitation and heating elements. Ferric chloride is available for plain copper surfaces and silver plated circuits, while the chromic acid tank is used on panels resisted with solder plate. The latter tank has a lead antimony liner. Here again overflow water rinses are situated next to each etching element.

The remaining area of the top is utilized by a sink used in stock preparation. A water spray nozzle is installed next to the sink together with an air hose for drying.

All controls are mounted on the panel which divides the two rows of tanks. Each operation is regulated by controls immediately above its particular section. The air compressor, vacuum pump, rheostats, etc., are located in the base, with additional space provided for chemical storage.

The top assembly is a solid unit of welded polyvinyl chloride of the high impact-resisting type. Baffle plates separate the various solutions.

Manufacturers of the equipment claim that this is the first time that the printed circuit process has been designed into a single compact unit.

# ACTUAL SIZE

complete with selector switch...

## TRIPLET

ELECTRICAL INSTRUMENT CO.  
Bluffton, Ohio

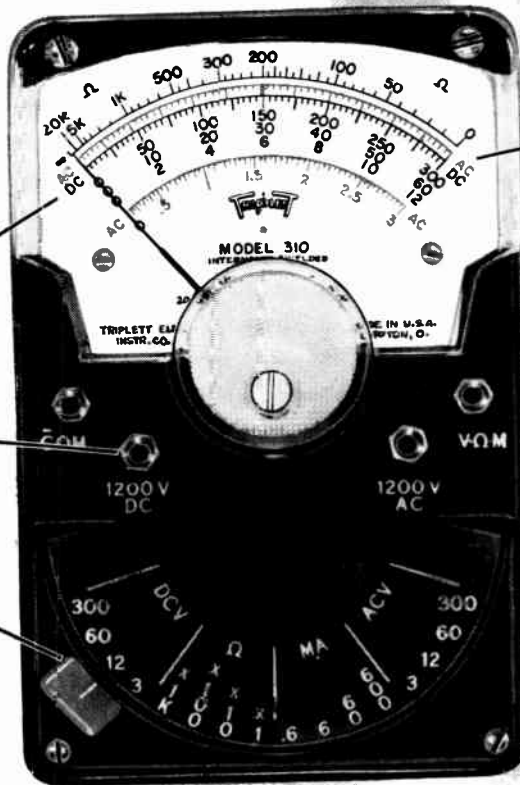

• 20,000 ohms per volt. D.C.

• BANANA-TYPE JACKS—positive connection and long life.

• EXCLUSIVE SELECTOR SWITCH speeds circuit and range settings. The first and only miniature VOM with this exclusive feature for quick, fool-proof selection of all ranges.

• 5,000 ohms per volt. A.C.



### CARRYING CASE

Handsome leather carrying case with adequate space for Model 310 tester and accessories. Trouser belt slips through loop on back of the case for out-of-the-way carrying. MODEL 369 CASE — Suggested Canadian Dealer Net \$4.05

Model **310** MIGHTY MITE

the only complete miniature  
**V-O-M** (AC-DC)

### LOOK AT ALL THESE RANGES

DC VOLTS: 0-3-12-60-300-1200 at 20,000 Ohms/Volt.  
AC VOLTS: 0-3-12-60-300-1200 at 5,000 Ohms/Volt.  
DC MICROAMPERES: 0-600 at 250 Millivolts.  
DC MILLIAMPERES: 0-6-60-600 at 250 Millivolts.  
OHMS: 0-20,000-200,000 (200-2000 at center scale).  
MEG OHMS: 0-2-20 (20,000-200,000 Ohms at center scale).  
OUTPUT: Convenient chart in instruction book.  
SEE IT AT YOUR JOBBER  
AND IT'S ONLY ONE OF TRIPLET'S MIGHTY NINE VOM LINE!

ONLY

**\$39.95**

Suggested  
Canadian  
Dealer Net



**631**  
Combination  
V-O-M—VTVM



**630-NA**  
For Best Testing  
Around The Lab,  
Production Line  
or Bench



**630**  
The Popular  
All-Purpose  
V-O-M



**630-A**  
A Good Lab and  
Production Line  
V-O-M



**630-T**  
For Telephone  
Service



**666-HH**  
Medium Size  
For  
Field Testing



**625-NA**  
The First V-O-M  
With 10,000  
Ohms/Volt AC



**666-R**  
Medium Size  
With  
630 Features

WILLIAM F. KELLY COMPANY  
2781 Yonge Street, Toronto 12, Ontario

C. M. ROBINSON COMPANY  
189 Market Street, Winnipeg 325 10th Avenue, Calgary  
550 Beatty Street, Vancouver



Flight Test Data  
Of Aircraft  
And Guided  
Missiles  
Necessary To  
The Design  
Engineer And  
Research  
Scientist Can  
Now Be Obtained  
At Distances  
Well Beyond  
The Range Of  
Telemetry  
Equipment  
By The  
Use Of . . . .

# Airborne Magnetic Tape Recorders

A HIGHLY accurate, portable magnetic tape recording system for airborne collection of test data has recently been developed.

The system will perform under extremely adverse environmental conditions and permit simultaneous recording of great quantities of data during a single flight. It will operate unattended aboard airplanes and guided missiles at distances well beyond the effective range of telemetering equipment.

The system, packaged in individual, compact, modular units, includes a recorder, amplifiers and modulators, a calibrator, a time-code generator, and remote-controlled power supply.

● The Consolidated Data Tape Recorder is the product of the largest development program ever undertaken by the manufacturer and shows the result of heavy emphasis on small size, reliability and accuracy.

A playback unit that re-creates the flight performance data in electrical form for ground analysis and computation has been developed as part of the system.

The system is a product of the largest development program ever undertaken by the manufacturers, and shows the result of heavy emphasis on small size, reliability, and accuracy.

Design engineers report the recorder unit will store 28 tracks of information on 1¼-inch tape, providing 24 data channels and 4 auxiliary channels, including a microphone input. It has tape capacity for 43 minutes of recording at a speed of 10 inches per second, when using tape of conventional thick-

ness. Play time can be extended to 70 minutes or longer using thinner tapes and reducing tape speed to 7½-inches per second or less.

The recording system operates with less than 1 per cent error, using pulse-duration modulation (PDM) or compound modulation (CM.) Error is less than 3 per cent using wide-band frequency modulation (FM).

Although the system was designed for airborne instrumentation, several features of its design make it equally adaptable to many other data recording applications.

## *Detects Own Faults*

The recorder detects its own malfunctioning. A single track data-monitor head readily detects such mechanical failures as broken tape, improper tracking, failure of the pinch rolls to close, failure of uniform tape motion, or end of the tape. Electronic failure is also readily detected. In any of the above situations, an indicator light warns the operator at local and remote control stations.

One of the unique design features of the tape transport is a rigid cast assembly — accurately machined — on which are mounted the capstan and all other precision elements in the tape feed path. The precision assembly is, in turn, shock-mounted to the top plate of the recorder. This type of construction minimizes tolerance build-up, and avoids the problems resulting from warpage. In addition, it provides much-improved isolation of the capstan assembly from high-frequency vibration.

The following performance figures were obtained on the prototype recorder at a tape speed of 10 inches per second: Low-frequency flutter has been consistently measured at 0.1 per cent peak-to-peak or less. High-frequency flutter (above 100 cps) varies from 0.2 per cent to 0.35 per cent peak-to-peak. Total peak-to-peak flutter may be expected to be under 0.4 per cent, measured with a 3500-cps pass-band discriminator.

The data collection and processing are simple. Physical parameters such as stress, pressure, acceleration, vibration, or temperature are converted into electrical analog signals by conventional transducers such as strain gauges and variable-reluctance units, velocity pickups, or thermocouples. The signals are amplified, modulated, and recorded on magnetic tape. The tape is removed from the recorder and placed on the playback unit. The electrical signals recovered from the tape may then be converted into digital form at high speed, using the Consolidated MillISADIC analog-to-digital conversion system. This equipment presents the raw data in a form directly acceptable by digital computers, which in turn provide final data in tabulated form for human interpretation.



- Engine Testing
- Wind Tunnel Experiments
- Hydraulic Engineering
- Oil Refining
- Chemical Engineering
- Process Industries

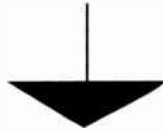

May Now Have Instrument Reading Data Recorded In Split-Second Time By The Use Of The . . . . .

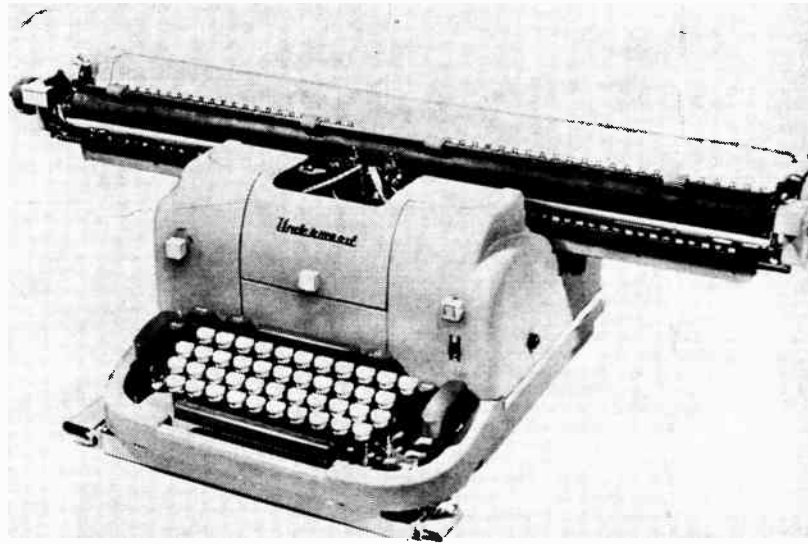

● The new solenoid operated slave typewriter gives split-second typewritten recordings of instrument readings. The automatically controlled typewriter has wide application in all phases of engineering and in such industries as oil refining, chemical manufacturing and other process fields.

# Slave Typewriter

**S**PLIT second typewritten recording of instrument readings and other scientific and business data by means of electric impulses is now possible with a new solenoid operated slave typewriter which has recently been developed.

In addition to its use as an electronic output unit, the automatically controlled slave typewriter is designed to provide typewritten records at the rate of 11 characters per second for engine testing, wind tunnel experimentation, hydraulic engineering, oil refining, chemical manufacturing and other process industries.

The slave machine is equipped with electro-magnetic solenoids that instantaneously respond to external signals. Solenoids — one for each keylever — are located in a compact control unit beneath the keyboard. As an impulse energizes a given solenoid, it depresses the appropriate key.

Wire from the solenoids are connected to two standard miniature Cannon connector plugs. When an electrical instrument, such as a pressure gauge, is attached to the connector, pressure readings are

recorded from electric impulses fed into the solenoids.

A feedback switch acts as an automatic governor assuring proper coordination of the input instrument and the slave typewriter. The feedback supplies the proper governing pulse on character typing, spacing, back spacing, carriage return and tabulating.

Available in carriage widths which provide writing lines up to 25 inches, the machine can also be used manually as a regular electric typewriter. Offered in 10 pitch Pica or 12 pitch Elite type, the solenoid typewriter has 43 typebars with 86 characters as standard equipment. All character keys, plus space bar, shift key, back space, carriage return and tabulator are solenoid actuated.

### Optional Features

Optional features include automatic solenoid controls to switch from black to red ribbon. Non standard keyboards for medical, chemical, mathematical, engineering and other purposes can be obtained. Non standard line space ratchets also are available as well as 8 or 9 pitch horizontal spacing and 44

or 46 typebar models.

Solenoid resistance is 1,000 Ohms. Inductance is 0.77 Henries, with an operating voltage of 100 volts DC and an operating current of 100 milliamps.

Carriage return and tabulation solenoids require an operating pulse with a minimum duration of 60 milliseconds. Shift and red ribbon solenoids must be energized 90 milliseconds before the solenoid for a shifted or red character is operated and energization must continue until the feedback switch is released. Other solenoids require an operating pulse with a minimum duration of 30 milliseconds. All solenoids have one terminal connected to a common circuit.

The operating range of the feedback control on character typing can be adjusted from 54 to 81 milliseconds, when it operates as the typebar rises, and releases as the typebar restores. Current carrying capacity is 0.5 amps at 125 volts DC.

The case shift switch is a single pole double throw switch, normally supplied, to indicate which shift is operating. It can be used to time the pulse of a shift character.



# DIRECT READING SPECTRUM ANALYZER

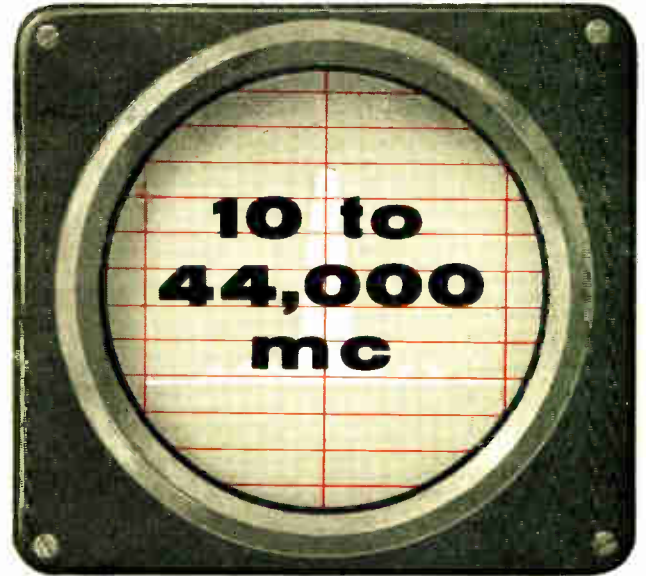

Years of day-in, day-out field operation by most exacting users, have proven the Polarad Model TSA Spectrum Analyzer to be a versatile test instrument of highest reliability and accuracy for both laboratory and production applications.

It is a broadband instrument with greatest pulse sensitivity over the band—10 to 44,000 mc. And each of its five interchangeable RF tuning heads operate with utmost simplicity and frequency stability. All tuning is by Uni-Dial control. Frequencies are read with 1% accuracy right on the linear dial as the set is tuned. No mode charts or interpolations necessary.

The Polarad Model TSA has been designed to save engineering manhours. Its 5 inch CRT display of the RF spectrum is bright and easily defined. And its 1 cycle sweep speed makes for fine resolution. For detailed specifications, contact your nearest Polarad Representative, or write directly to the factory.

## APPLICATIONS

- Transmitter characteristics tests
- Broadband receiver for AM, FM, CW, MCW, and pulse modulated signals
- Component tests
- Frequency measurements
- Leakage, interference and radiation measurements
- Bandwidth measurements
- Modulation tests
- Adjacent signal channel tests
- Attenuation measurements
- Filter measurements
- Standing wave measurements

## MULTI-PULSE SPECTRUM SELECTOR



MODEL SD-1

Increases the versatility of Polarad Spectrum Analyzers. It displays and allows selection for analysis of a specific train of microwave pulses, as well as any one pulse in the train; selects and gates a group of pulses up to 180  $\mu$ sec. in length; and is designed to work with fast, narrow pulses; can be adjusted to gate any pulse including the first at zero time. Special circuitry discriminates automatically once pulses have been selected. Operates at any of the frequencies accepted by Polarad Spectrum Analyzers.

### FEATURES:

Continuously variable sweep widths; 15 to 180  $\mu$ sec. • Continuously variable gate widths for pulse selection; 0.4 to 10  $\mu$ sec. • Continuously variable gate delays for pulse selection; .3 to 180  $\mu$ sec. • Automatic gating of spectrum analyzer during time of pulse consideration. • Intensified gate (brightening) to facilitate manual pulse selection. • Triggered sweep on first pulse in any train. • No sweep in absence of signal.

### SPECIFICATIONS:

Maximum Pulse Train Time 180  $\mu$ sec. • Pulse Rise Time .05  $\mu$ sec. Minimum • Minimum Pulse Separation .2  $\mu$ sec. • Repetition Rate 10–10,000 pps. • Minimum Pulse Width .1  $\mu$ sec. • Input Power 95 to 130 volts, 50/60 cps., 325 watts. • Input Impedance 50 ohms. • Output Impedance 50 ohms (to match TSA Spectrum Analyzer).

For further data on advertised products use page 83.



# BROADBAND SPECTRUM ANALYZER

## FEATURES

- Greatest signal sensitivity over entire frequency band.
- Single frequency control with direct-reading dial accurate to  $\pm 1\%$ .
- Complete frequency coverage from 10 mc to 44,000 mc.
- Internal RF attenuator (RF Tuning Unit Models STU-1, STU-2A, STU-3A).
- Adjustable frequency display from 400 kc to 25 mc.
- Frequency differences as small as 40 kc measurable by means of adjustable frequency marker with variable amplitude.
- 25-kc resolution for all bands.
- Stable klystron oscillators using non-contacting plungers to insure longer life.
- No klystron modes to set.
- 5-inch CRT display.
- Portable and completely self-contained.

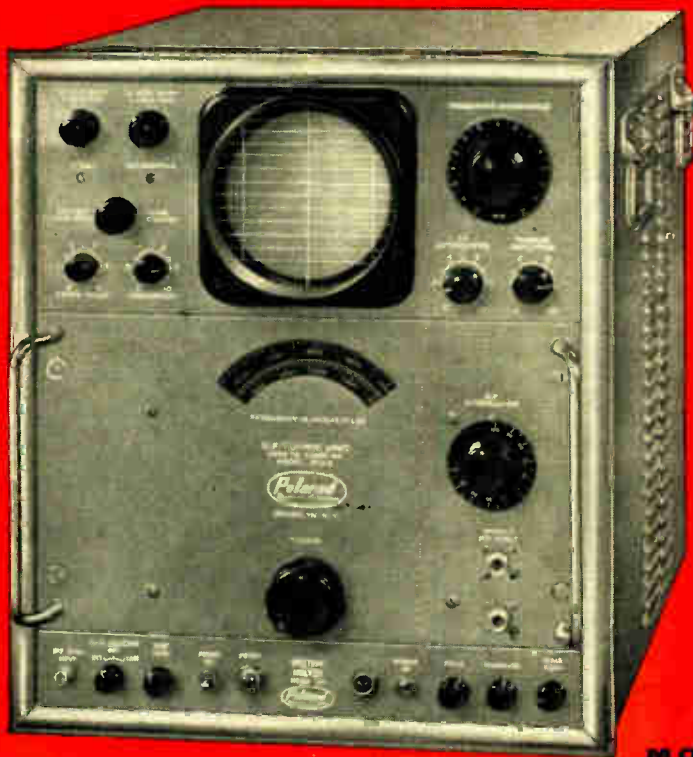

MODEL  
TSA

## SPECIFICATIONS

Model No.	Equipment
Model Du.....	Spectrum Display and Power Unit
Model STU-1...	RF Tuning Unit 10-1,000 mc.
Model STU-2A.	RF Tuning Unit 910-4, 560 mc.
Model STU-3A.	RF Tuning Unit 4,370-22,000 mc.
Model STU-4	RF Tuning Unit 21,000-33,000 mc.
Model STU-5...	RF Tuning Unit 33,000-44,000 mc.

### SPECIFICATIONS:

Frequency Range: 10 mc to 44,000 mc.

Frequency Accuracy:  $\pm 1\%$

Resolution: 25 kc.

Frequency Dispersion: Electronically controlled, continually adjustable from 400 kc to 25 mc per one screen diameter (horizontal expansion to 20 kc per inch)

Input Impedance: 50 ohms—nominal

Sensitivity:\*

STU-1 10-400 mcs—89 dbm

400-1000 mcs—84dbm

STU-2A 910-2,200 mcs—87 dbm

1,980-4,560 mcs—77 dbm

STU-3A 4,370-10,920 mcs—75 dbm

8,900-22,000 mcs—60 dbm

STU-4 21,000-33,000 mcs—55 dbm

STU-5 33,000-44,000 mcs—45 dbm

Overall Gain: 120 db

Attenuation:

\*\*RF Internal 100 db continuously variable,

IF 60 db continuously variable

Input Power: 400 Watts

\*Minimum Discernible Signal

\*\*STU-1, STU-2A, STU-3A



Write for your copy of the Polarad "Handbook of Spectrum Analyzer Techniques". 50c per copy. Includes discussion of Spectrum Analyzer operation, applications and formulae for analysis techniques.

AVAILABLE ON EQUIPMENT LEASE PLAN

FIELD MAINTENANCE SERVICE AVAILABLE  
THROUGHOUT THE COUNTRY

Consult us on your Spectrum Analysis Problems

**POLARAD**

PROVEN RELIABILITY

**ELECTRONICS CORPORATION** 43-20 34th STREET, LONG ISLAND CITY 1, N. Y.

REPRESENTATIVES IN CANADA: Measurements Engineering Limited, Arnprior, Ontario • Toronto, Ontario

# NEWS



## Third Annual Canadian Room Hotel Commodore, New York March 19-22

The third annual Canadian Room will be held this year in suites 114-116 Hotel Commodore, New York, during the four day run of the Institute of Radio Engineers Annual Convention and Show which will be held in New York, March 19th to March 22nd.

The Canadian Room is operated annually in New York during the I.R.E. Convention to provide a meeting place for the hundreds of Canadian businessmen and engineers engaged in the Canadian electronics and communications industries who visit the I.R.E. Convention and Show every year.

Facilities of the Canadian Room afford Canadians a convenient place of meeting other Canadian businessmen from coast to coast who are engaged in the electronics and communications industries and provides them also with a rendezvous in which to meet American associates if so desired.

Last year more than 250 Canadians, representative of the industry, visited the Canadian Room in the Hotel Commodore. In addition engineering personnel from the three Canadian armed services and other government depart-

ments registered as visitors in the Canadian Room together with officials of many American firms who used its accommodation to contact their Canadian representatives.

The Canadian Room is operated by a committee chosen from among the personnel of firms engaged in the Canadian electronics and communications industries. It is an enterprise run solely for the convenience of Canadians, their friends and business associates.

Members of this year's Canadian Room Committee, who extend to you a cordial invitation to come along and enjoy its amenities are as follows: Ray Peirce, Sperry Gyroscope Company of Canada Limited; Ken Davis, J. R. Longstaffe Company Limited; Dave Dalzell, PSC Applied Research Limited; Bill Deacon, Adams Engineering; John Root, R-O-R Associates Limited; Seymour Janikun, Atlas Radio Corporation Limited; Gerald Morello, Quality Hermetics Limited; Edward Lomas, E. G. Lomas Company; Bud Dallyn, ELECTRONICS AND COMMUNICATIONS and Thomas Lazenby, ELECTRONICS AND COMMUNICATIONS.

The Philips Industrial Development company will make available to Canadian industry the extensive manufacturing experience and technology resulting from the intensive and varied research activities of Philips laboratories in Eindhoven, Holland, and in countries throughout the Free World. The new company will function as a service organization concerned with encouraging the adoption by Canadian organizations of many Philips industrial processes and techniques which are not yet in use here.

The president of the Philips Industrial Development company is R. M. Brophy who has been associated with Philips interests in Canada since 1945. From 1951 to 1954 Mr. Brophy served in Ottawa as Co-ordinator of Defense Production and Deputy Minister of Defense Production.

At the Philips Industrial Development company Mr. Brophy will be assisted by specialists in patents, marketing and other fields. The knowledge of Philips scientists and production experts will also be at his disposal. The offices of the company are located in a new seven-storey building at 76 St. Clair Avenue West, Toronto.

## Hysol Products To Be Marketed In Canada

The Bate Chemical Corporation Ltd., Toronto, Ont., and Houghton Laboratories, Inc., Olean, N.Y., have formed a joint company in Canada to manufacture and market HYSOL products. The announcement emanated from G. H. Clifford Smith, president of the Bate Chemical Corporation Ltd.

HYSOL products, which consist of epoxy electrical insulating materials, adhesives and tooling compounds, have been manufactured for many years by Houghton Laboratories, Inc.

Mr. G. H. Clifford Smith of the Bate Chemical Corporation becomes president of the new Canadian company to be known as HYSOL (Canada) Ltd., and Mr. Russell H. W. Smith, an electrical engineer of Toronto, is sales manager.

Offices of HYSOL (Canada) Ltd. are located at 184 Laird Drive, Leaside, Toronto 17, Ontario.

## New Offices For Collins Radio Company

Official opening of the new offices of Collins Radio Company of Canada Ltd., took place during December, 1955. They are now located on the 9th floor of the Commonwealth Building, 77 Metcalfe St., Ottawa.

(Turn to page 38)

## Roy Adams Appointed Production Co-Ordinator For PSC

Roy L. Adams is to supervise production engineering on the Type T609 Auroral Recorder, one of Canada's contributions to the International Geophysical Year which starts in 1957. This was made known by J. M. Bridgman, managing director of PSC Applied Research Limited in announcing Mr. Adams' appointment as production co-ordinator of the Toronto company.

Mr. Adams will also be responsible for the engineering design on the company's own Airborne Profile Recorder and other products. The APR is an instrument which has proved its worth for aerial survey control and for other purposes.

The Auroral Recorder, which measures the light intensity of the Aurora Borealis or Northern Lights was developed by a group under Dr. Donald Hunten at the University of Saskatchewan with the aid of the National Research Council and the Defence Research Board. PSC Applied Research Limited has been given a contract by the Canadian Government to build the first unit.

## Unique Service Offered By Philips Canadian Industrial Development Co., Ltd.

A new Canadian company — Philips Canadian Industrial Development Company Limited — has been formed by the N. V. Philips concern of Eindhoven, Holland.



R. M. BROPHY

**1/2% voltage regulation . . .**  
**0.09-second response**  
 for your engine-driven alternators

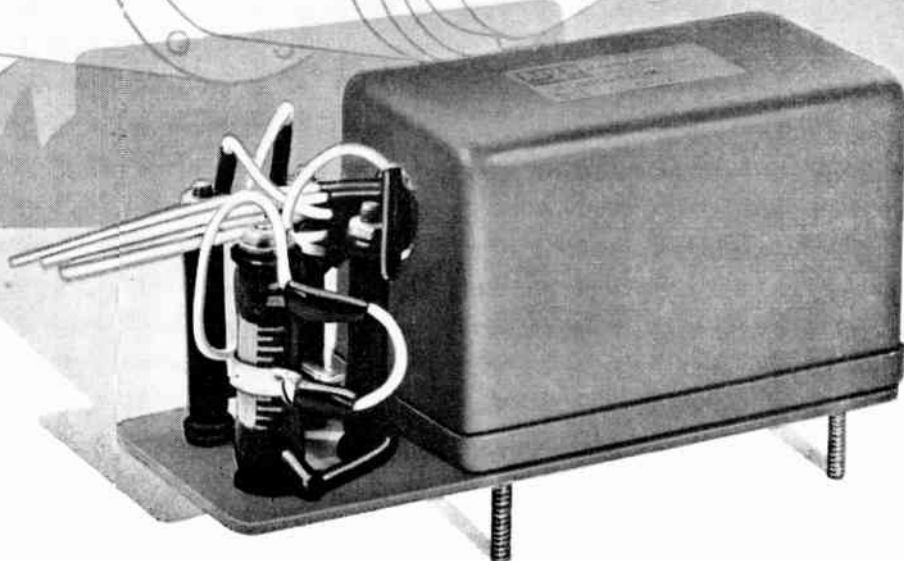

**ARGA A. C. VOLTAGE REGULATORS** do it every time . . .  
 no matter how rough the going . . . how limited the space . . . how critical the response.  
 They combine magnetic and transistor components  
 in rugged, compact units . . . no vacuum tubes or moving parts.

Three standard models provide responses from 0.09 second to  
 2.0 seconds . . . regulation from 1/2 to 1% over a load range from .0 to 125%  
 . . . with loads having power factors between 1.0 and 0.8.  
 Arga voltage regulators are designed for a life expectancy of 20 years . . .  
 our research and development program will obsolete them before they wear out.

*For complete details write for data file 205.*

*precision electrical and electronic components*



**BECKMAN** Instruments, Inc.  
**ARGA** Division, South Pasadena, Calif.



# NEW PRODUCTS

New Product specifications published in *Electronics and Communications* have been briefed for your convenience. If you require further information on any of the items published you may readily obtain such by using our Readers' Service, Page 83. Just mark the products you are interested in on the coupon on Page 83 and the information will be in your hands within a few days.

## ● New Developments For Airborne Radar

Item 972

Improved performance and better accessibility to all components, lighter weight, fewer tubes and lower power consumption are the result of changes to the RDR-1, BENDIX Airborne Weather Radar System.

The Synchronizer-power supply unit has been redesigned. Current size,  $\frac{1}{2}$  A.T.R. instead of previous full A.T.R. case. Weight of unit 21 pounds, which is 27 pounds lighter than its predecessor. The number of tubes has been reduced from 32 to 19.

Four types of antennas will be available: a 22-inch and a 30-inch cosecant squared antenna X-band, and both a 22-inch and a 30-inch antenna for C-band. Each antenna will weigh approximately 25 pounds.

The tilt control of the CON-1D (X-band with radar beacon switch) will be calibrated in one-degree increments.

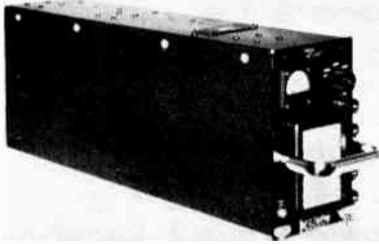

A new indicator (PPI-LD) will be the only one available. It is designed specifically to operate with the new synchronizer unit and uses a potentiometer to permit exact focusing of the cathode ray tube. A new permanent magnet decentering system completely eliminates any tendency towards the formation of a "hook" at the vertex of the sweep line.

Accessibility of all relays has been improved, and a removable cover protects the relays against dust. The receiver chassis for the C-band model is completely new and incorporates an improved contour circuit.

The C-band model also has a running-time meter on the front panel.

Power consumption is reduced to 790 VA for X-band and 880 VA for C-band. The complete system with a single indicator now weighs only 117 pounds.

## ● Direct Reading Counter Dial

Item 973

This recently designed direct-reading counter dial can be used with multivibrator devices such as potentiometers, microwave oscillators and amplifiers, wavemeters, or any other hand or servo operated mechanism, where direct reading to hundredths of a turn is desired. Two features contribute to the speed and easy operation of the instrument: (1) it has a driving ratio of  $1\frac{1}{2}$  to 1; (2) it allows complete, continuous rotation, in either direction, without obstruction. It has a four-digit counter and affords readings up to 9999, with up to 100 turns. The counter wheels are white with black numbers and have nylon stickers for extra durability and smooth, quiet operation. It is a compact unit of black anodized aluminum, measuring  $2\frac{1}{4}$ " in diameter and  $1\frac{3}{4}$ " in depth (including the counter face).

## ● Temperature Stable Hi-K Disc Ceramicon

Item 974

The new Type "H-A" Hi-K Disc Ceramicon, a result of continued basic research in Ceramics, exhibits the flattest temperature characteristic Hi-K material ever offered to industry at non-premium prices. The maximum capacity change is only 3 per cent over temperatures ranging from  $+10^\circ$  to  $+85^\circ\text{C}$ .

"H-A" Temperature Stable Ceramicons are available in production quantities in any normal capacitance value ranging from 150 mmf. to 4,250 mmf., with tolerances of  $\pm 10$  per cent and  $\pm 20$  per cent. Diameters range from  $\frac{1}{8}$ " to  $\frac{3}{4}$ ". Maximum thickness on all units is  $\frac{1}{32}$ ". They are available with 22 gauge wire leads; also with 20 gauge wire leads or spade leads for automatic insertion in printed circuit boards.

Because of its small size and convenient shape, the "H-A" Disc is ideally suited for critical applications that formerly required the use of expensive capacitors of other types.

## ● Distortion Factor Meter

Item 975

This instrument which is designed to measure directly the total harmonic distortion, uses a very sharply tuned filter circuit to separate the fundamental and harmonic voltages. The output from this filter at balance (i.e. the harmonic voltage) is compared with a fraction of the input voltage by means of a potential divider, using a high gain amplifier and rectifier voltmeter of excellent frequency characteristic as an indicator only. The harmonic percentage is read directly from a calibrated dial and multiplier. A wide continuous range of audio frequencies is covered while the amplifier response, extending to over 100 Kc/s., means that measurements include the fifth harmonic of 20 Kc/s. An input attenuator is fitted so that the instrument can accommodate a wide range of input power levels.



The equipment is sufficiently accurate for laboratory use, yet of robust construction to withstand rough and continuous service. The frequency range of the instrument is 20 c/s. to 20 Kc/s. directly calibrated in three ranges, with plus or minus 2% accuracy. The distortion range covers 0.1 to 50%, with the accuracy of plus or minus 10% or 0.1% distortion whichever is greater. The input impedance is 600 ohms with a continuously variable attenuator with a total range of 60 db.

## ● High Speed Recorder

Item 976

A new high-speed electronic recorder, capable of logging any changing variable within a "split second" has been developed by a mfr. of recording instruments. Designed primarily for research centers, laboratories and experimental stations where emphasis is on high-speed measurement and charting of changing conditions which can be measured by d-c output transducers, this new instrument narrows an important gap in recording between the slower speed, conventional, large chart recorders and oscillographic instruments of the photographic-galvanometer type.

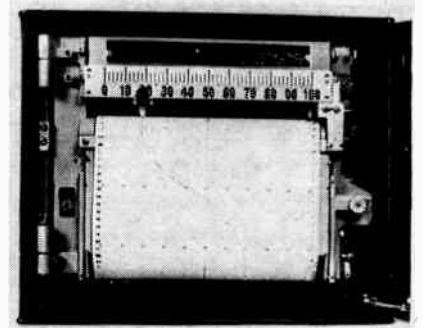

The amplifier, which is of "plug in" construction, has a high input impedance and increased output power, and all components can be replaced as a complete unit to facilitate range changing. A manual pen lifter prevents ink clogging or tearing of chart paper and permits the pen to cover the full 11-inch chart width in a quarter-second. Accelerated chart speeds, appropriate to the split-second pen speed, are available.

## ● Coaxial Cable Strippers

Item 977

The model No. 100 is suitable for all common types of wire, solid or stranded. The 5" tool has blades hardened and ground to give a smooth and clean shearing action. The stripping jaws strip off insulation anywhere along the wire. An adjusting stop on the gripping handles permits the user to adjust the stripping jaws to various wire sizes.

The model No. 101S is the same as the No. 100, except that it has a self-opening spring. They weigh three ounces.

The model No. 105S is a combination tool, similar to the 100 and 101S but, not only does it strip wire, it slits and cuts. It is designed specifically as a romex slitter and stripper, plus service entrance cable, such as 3-#8, or 3-#10. The slitting blade is of tool steel sharpened to a razor edge, it is adjustable and replaceable.

The No. 100 series of Miller Strippers are available through wholesale supply houses to the radio and electrical trades.

The model No. 200 is a completely new type of tool. Its effective stripping, slitting and cutting of co-axial cable is amazing.

Three operations utilizing the hardened steel blades remove off neatly and cleanly the insulation, the shielded braid and the outside jacket. The model No. 200 eliminates nicked conductors and frayed shielding.

## ● Small Relay Switches

Heavy Current

Item 978

Switching of heavy current in small space is achieved by a new Class 11D miniature relay.

The specially designed single pole, single throw, normally open, double break contacts reliably switch up to 20 amperes, non-inductive load.

Overall dimensions are  $1\frac{5}{8}$ " length,  $\frac{1}{8}$ " width, and  $1\frac{1}{16}$ " height. Minimum coil operating power is  $\frac{1}{2}$  watt.

The new relay is available for DC operation up to 150 volts. Other relays with similar heavy duty contacts are available for operation from alternating current. Literature on request.

**NEW PRODUCTS**

● **Quench/Amplifier Unit, Type No. 660**

*Item 979*

This dual purpose instrument enables the resolving time of counters to be accurately defined by applying to them a negative quenching pulse of known duration.

Designed for use with self-quenching Geiger-Müller counters, the unit is built on novel lines, which includes the provision of a switch to cut off quench pulse. It then acts as a pre-amplifier or pulse former. This is of importance when using counters where external quenching is not required.



Power supplies for operating this Quench/Amplifier unit are supplied from the Scaler, Type No. 500.

The construction and design of the box makes the unit suitable for counting above or below lead castles or shields.

The Quench Amplifier Unit, Type No. 660, together with the E.H.T. Supply Unit, Type No. 532 and the Scaler, Type No. 500, with suitable counters and leadware, form the basic units for precision Geiger-Müller counting requirements.

● **Radar Checker Echo Box**

*Item 981*

To meet commercial airline requirements for radar installation test equipment, a manufacturer is now producing a Model 833 Echo Box. This device is a high Q resonant cavity, specifically designed for rapid testing of the overall performance of C-Band (5350-5450 mcs) Airborne Weather Radars.

The 833 Echo Box is enclosed in an aluminum box measuring 7" x 10" x 14". The cavity is coupled to the radar transmission line through a directional coupler or with a pickup antenna placed near the radar antenna.

During the radar transmitted pulse, microwave energy is stored in the echo box. Immediately following the pulse, the energy is returned to the radar over the same path producing a signal or target on the radar indicator. At the end of the pulse the returned energy decays exponentially, finally disappearing into the background noise clutter at a point determined by the receiver sensitivity and transmitter power output. Therefore, the time interval between the beginning of the transmitted pulse and the point where the signal on the radar indicator disappears into the noise (called the "ring time") measures the overall performance of the radar.

● **Ultra-High Regulation**

**Power Supply**

*Item 982*

Model UHR-225 is a low priced, compact (7½" wide x 10" high) power supply for the most exacting d.c. regulation requirements. Its unsurpassed performance provides ultra-high-regulation and phenomenally low hum over the entire operating range (150-500 volts and 0-200 m.a.). For line voltages between 105 and 125 volts, full rated current can be drawn continuously with a substantial margin of safety. No load to full load regulation is 0.002 per cent and ripple is less than 100 microvolts. The internal impedance is less than 0.02 ohm for d.c. and low frequen-

cies and is less than 0.1 ohm for frequencies as high as 100 k.c. At higher frequencies the impedance is equivalent to 0.1 ohm in series with 4 inches of wire. Transient response is 0.001 millisecond. Typical ten-hour drift is 500 p.p.m. Drift is kept very low by the use of drift-cancelling differential amplifiers, a new high-stability reference tube and low temperature-coefficient wire-wound resistors.

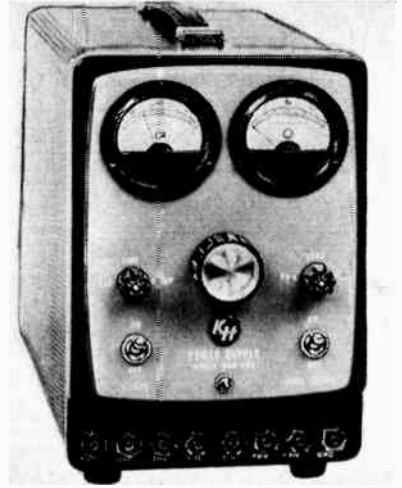

The d.c. output is controlled by a precision wire-wound potentiometer, ganged with a variac to obtain good efficiency at the lower output voltages. Two ruggedized hermetically-sealed 2½" meters are provided on the front panel for monitoring current and voltage. In addition to the d.c. output there are two independent 6.3 v. a.c. outputs each rated at 5 amps. Model UHR-225 is available either in a cabinet as shown for bench use or with a rack panel.

(Turn to page 44)



*No. 649 Milliammeter*

Here's **LOW COST Accuracy** in **MODERN Panel Meters** by

**HOYT**

- Clear Polystyrene, Anti-Static Treated Case.
- Long, Easy-to-Read, 2½" Scale.
- Standard Mounting Dimensions.
- AC or DC — D'Arsonval & Repulsion Movements.

**Handsome • Compact • Legible**

HOYT Electrical Indicating Instruments provide superior service at reasonable cost: Voltmeters, Ammeters, Microammeters — Panel and Portable — Moving-Coil, Repulsion or Rectifier Types. Write today for literature and prices, giving complete data.

**Hoyt Electrical Instrument Works**

Sales Division: Burton-Rogers Company  
42 Carleton St., Cambridge 42, Mass., U.S.A.

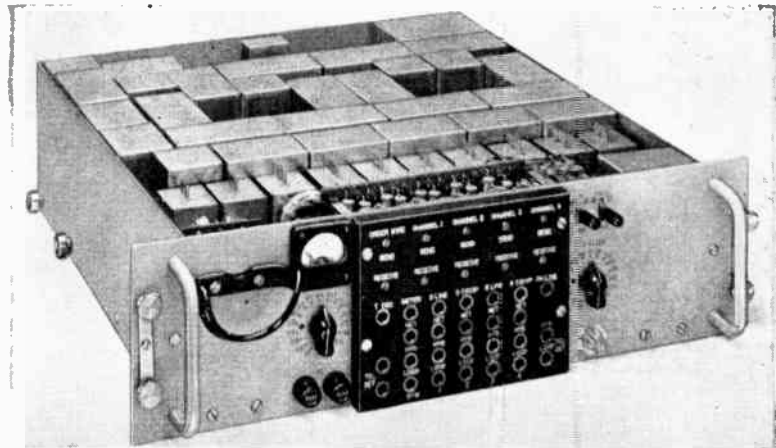

**FOUR-CHANNEL CARRIER-TELEPHONE TERMINAL FOR RADIO LINKS**

This is a miniaturized unit of advanced design which provides four voice channels on a frequency-division basis above a voice-frequency order-wire channel. Each of these five channels is provided with a 4-wire 2-wire termination and a voice-frequency ringing circuit for d-c or 20-cycle signals. Adjustable attenuators are provided in the 4-wire side of all channels, and a built-in test oscillator and meter permit complete line-up, maintenance and trouble-shooting checks to be made. Channel levels are from -9 to 0 dbm and line levels from -30 to 0 dbm. Channel width is 300 to 3500 cycles within 1 db.

This unit is only 5¼" high by 19" wide by 14" deep. It mounts on a standard rack and operates from 115 volts 50-60 cycles a.c.

**RADIO ENGINEERING PRODUCTS**

1080 UNIVERSITY ST., MONTREAL 3, CANADA

TELEPHONE CABLES  
University 6-6887 RADENPRO, MONTREAL



## NEWS

(Continued from page 34)

### Dr. R. M. Ryder Addresses Engineers

A meeting is announced for February 21st in the Masonic Temple, Belleville, at which Dr. R. M. Ryder of the Bell Telephone Laboratories will address a joint gathering of the Bay of Quinte Section of the Institute of Radio Engineers and the Belleville Branch of the Engineering Institute of Canada. The subject of Dr. Ryder's talk will be "Status of Transistors Today".



DR. R. M. RYDER

Dr. Ryder, in his work as a member of the technical staff of the Bell Labs, is currently in charge of a transistor design group particularly interested in the development of transistors for transmission — as opposed to switching — applications.

### Charles W. Pointon To Represent Stephens Manufacturing Corporation

Charles W. Pointon Limited, of 6 Alcina Avenue, Toronto 10, Toronto, have been appointed as Canadian sales agents for Stephens Manufacturing Corporation, Culver City, California, manufacturers of the Tru Sonic line of high quality audio products.

### Merritt W. Hotchkin Heads Professional Engineers Of Ontario

Merritt W. Hotchkin, Kirkland Lake mining executive, has been named 1956 president of the Association of Professional Engineers of Ontario. He succeeds John R. Montague, of Toronto.



M. W. HOTCHKIN

As chief executive officer of the Association, largest of its kind in Canada, Mr. Hotchkin, along with the new council will guide the body's policy-making throughout the present year affecting the more than 14,000 members in the province. The new president, well-known in Canadian and U.S. mining circles, is engineer-in-charge, Outside Exploration, for Wright-Hargreaves Mines Ltd.

### Dr. Bruce Billings Named General Manager Of Baird Associates

Announcement was recently made by Dr. Walter S. Baird, president of Baird Associates, Inc., Cambridge, Mass., of the appointment of Dr. Bruce H. Billings as general manager of the firm. Dr. Billings was formerly director of research.

Dr. Billings, who was also elected to the company's board of directors at the recent annual meeting, will continue to direct all technical programs at the firm's main plant in Cambridge and at the Baird transistorized products activity in Waltham, Mass. He assumes additional corporate and administrative responsibilities, and will assist Dr. Baird along these lines.

### J. R. Brinkley Appointed Managing Director Of Pye Telecommunications

J. R. Brinkley has been appointed managing director of Pye Telecommunications Limited, of Cambridge, England, and an executive director of Pye Limited.



J. R. BRINKLEY

Receiving his early training in the G.P.O. Line and Radio Department, Mr. Brinkley was later responsible for much of the development of police and fire service radio at the Home Office between 1942 and 1948. In 1948 he joined Pye Limited and became technical director of Pye Telecommunications a year later.

Mr. Brinkley was recently appointed by the Postmaster General to the G.P.O. Mobile Radio Committee.

### D. S. Simkins Speaker At IRE Meeting

The Institute of Radio Engineers, Toronto Section, held its final meeting for 1955 on December 19th, at the University of Toronto. The speaker of the evening was Mr. D. S. Simkins, Canadian Radio Manufacturing Corporation; the subject was "Power Tubes and Associated Rectifiers".

Mr. Simkins dealt in a most informative and amusing way with the development over the years of the modern transmitting tube, which plays such an important role in Communications and Industry. Many useful pointers were given as to the way in which high-power tubes should be specified and handled; it seems not to be generally known that tubes should be tailored for the job that they are to do, and it is most important not to operate them beyond their capabilities.

### Ken Wheeler To Manage B.C. Service Depot For Stark Electronic Instruments

Stark Electronic Instruments Ltd. announce the establishment of a service depot for Alberta and British Columbia for the purpose of servicing all Stark - Hickok test equipment. Located in North Vancouver at 627 Elstrie Place, this new service depot is known as Technical Services, under the management of Mr. Ken Wheeler. Mr. Wheeler has been in the electronics business for the past 17 years in such branches as radio operating, development engineering and teaching.



K. WHEELER

Technical Services are equipped to restore all types of test equipment to the accuracy intended by the manufacturer.

### Enfield Cables Ltd. Appoint J. Morgan Blades For Canada

Enfield Cables Ltd. announce the appointment of Mr. J. Morgan Blades as their Resident Engineer in Canada. Mr. Blades, who took up his appointment in December, 1955, is located in Montreal. For the last six years Mr. Blades has been with the Hydro-Electric Power Commission of Ontario.

### Data Processing Associates Appointed To Represent Telecomputing Corporation

Telecomputing Corporation of North Hollywood, California, has appointed Data Processing Associates Limited of Ottawa, as its Canadian engineering and sales representative.

The growing number of customers and potential users of Telecomputing equipment in Canada has necessitated a closer liaison with Canadian industry and research groups.

Telecomputing Corporation is a design and manufacturing pioneer in the electronic data processing field and has systems also in use in England, France, and Australia.

### Advance Components Ltd. Appoint J. B. Smyth of Montreal

Advance Components Limited of Walthamstow, London, England, have announced that they are represented for the sale and distribution of their products in Canada by Messrs. J. B. Smyth of 380 Craig Street West, Montreal 1.

(Turn to page 41)



# Lorain R.T.

ringing-talking power units for PBX and switchboards  
**END ALL MAINTENANCE!**



The R.T.2, one of 7 Lorain ringing-talking power units to meet all needs. The R.T.2 operates on 115-125 volts, 50 cycle supply. It has heavy overload capacity.

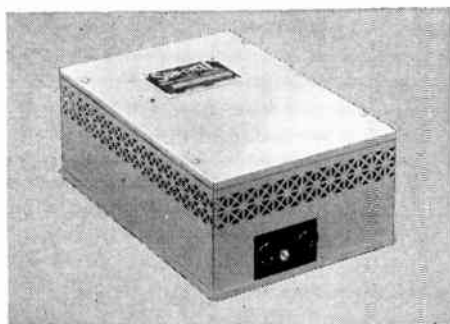

The BX-60, one of a complete range of Lorain ringing machines. It operates on 105-125 volts, 60 cycle supply. Lorain also make high quality auxiliary transformers, stand-by generators, ringing converters etc.

With Lorain R.T. Units there are no moving parts. No lamps, vibrators or brushes to cause service interruptions . . . to be continually replaced. An inductance containing a saturable magnetic core and a capacitor connected in the circuit, handle the frequency conversion. The stable circuit elements operate without any mechanical movement. They do not wear out. And there is no change in their characteristics—even after long use.

Lorain R.T. Units give absolutely reliable ringing and talking currents year after year—without maintenance, lubrication or replacements—without inspection of the ringing generator!

Write us today for your copy of Bulletin 159A. It gives you full details of the complete Lorain range of ringing-talking power units for PBX and switchboards.

5609

Distributor in Canada

## AUTOMATIC ELECTRIC

**SALES (CANADA) LIMITED**

Head Office: 185 Bartley Drive, Toronto 16

MONTREAL • OTTAWA • BROCKVILLE • HAMILTON • WINNIPEG • REGINA • EDMONTON • VANCOUVER

## IRE Show Section

# Attention Canadians

A Warm Welcome Awaits You  
At The New York IRE Show  
Exhibits Listed On This Page

## KINGSBRIDGE ARMOURY

New York City - March 19 - 22

### Insulated Circuits, Inc. 18 Palace

Printed wired boards. Printed circuit commutators and switches (raised and flush). Micro strip (microwave components). Printed circuit assembly. We feature carry-thru holes for continuity top to bottom.

### Condenser Products Div. of New Haven Clock and Watch Co.

140 Hamilton Street  
New Haven, Conn.

Manufacturers of glasslike capacitors, plasticon capacitors, 60 and 400 cycle high voltage power supplies, pulse forming networks, and introducing \*a new molded mylar capacitor.

### Tech Laboratories, Inc.

represented by

**Pylon Electronics Dev. Co.**  
161 Clement St., Montreal

\*Vertical attenuators, R.F. attenuators, \*Switches, manually and solenoid operated. Write for catalogue.

### Comar Electric Co. 314 Computer Ave.

A complete line of miniature, light, medium and heavy duty relays for commercial and military requirements. Also solenoids, coils, switches, transformers, hermetic sealing.

## BOMAC

LABORATORIES, INC.

**BOOTH 370-372**

A COMPLETE LINE OF  
MICROWAVE COMPONENTS

### Diamond Division

**Cannon Electric Company**

485 Electronics Ave.

Diamond production samples of popular and special R.F. Connectors. Sales engineers on hand to discuss your problems.



542-544 COMPONENTS AVE.

KLYSTRONS for every application

### Continental Carbon, Inc. 456 Electronic Ave.

Nobleloy Metal Film High Stability Resistors. Both Radial and Axial Lead Construction, Wire Wound Low Power Resistors,  $\frac{1}{3}$ ,  $\frac{1}{2}$  and 1 watt. 5 to 200 watts in fixed and adjustable types with Phenocote or high temperature Vitreous coatings. New Carbon Film Resistors in three wattage ratings. Also . . . a line of Rheostats, Potentiometers, Slide Switches.

### Kay Electric Co.

242-246 Instruments Ave.

Sweeping Oscillators • Marker Generators for Video, UHF & VHF Frequencies • Noise Figure Measurement & Gain Sets • Noise Generators, calibrated 5mc-26,500mc • Pulse Carrier Generators • VHF-UHF Low Power Color Transmitters • Color Bar & Dot Generators.

For further data on advertised products use page 83.

**NEWS**

(Continued from page 38)

**Appointments To Atlas Radio Sales Staff**

Three new appointments to the sales staff of the Atlas Radio Corporation Ltd., Toronto, well-known factor distributors of radio, television and electronic products, have been announced by general manager Fred Harris.



JACK BASS

Jack Bass joins the Western sales staff with headquarters in Winnipeg. He will be associated with his brother, Joe Bass, also a member of the Atlas staff, as sales representative for Western Canada. Mr. Bass has had experience in the radio and electronic parts jobbing business in the United States.



D. RICHARDSON

Dave Richardson will be calling on the industrial-manufacturer trade in Ontario. Mr. Richardson is a graduate of the Ryerson Institute of Technology (1953) Toronto, where he completed the electrical technology course.

E. K. "Al" Ogg will be contacting the distributor trade in Ontario. He has had extensive experience in the field of radio, television and electronics, dating back to the early days of the crystal set, when he was a "Do it yourself" fan and built sets as a hobby.



E. K. OGG

In 1933 he opened his own retail business in Toronto and continued as a retailer for 23 years.

**Promotion For William C. Otto Of Cornell-Dubilier Electric**

William C. Otto, one of the country's leading authorities on vibrators and vibrator converters, has been named industrial sales manager of the Indianapolis Division of the Cornell-Dubilier Electric Corporation. He was formerly chief engineer of the division.

All sales activities and sales engineering problems on vibrators and vibrator converters manufactured by Cornell-Dubilier are handled at Indianapolis. These represent the company's principal consumer items for domestic and industrial use in D-C areas as well as for military, marine, mobile, and railroad applications.

**Smith & Stone Signed Up To Manufacture Decca Radar Equipment**

Announcement is made of the signing of an agreement between Decca Radar (Canada) of Toronto and Smith & Stone of Georgetown, Ontario, under the terms of which the latter firm will manufacture the British Decca equipment for the Canadian market.

John W. Bell, a graduate of the University of Toronto, heads the special products division which will have charge of the production of the Decca equipment.

**Pylon Electronic Development Appointed Agents For Gray Radio**

Pylon Electronic Development Co. Ltd., Montreal have been appointed exclusive Canadian agents for the Gray Radio Company, West Palm Beach, Florida, manufacturers of marine radiotelephone equipment. Backed by over 17 years of experience in the field, Gray Radio manufactures a full line of radiotelephone equipment for marine service, which features high efficiency, simple operation and high reliability.

(Turn to page 48)

**Time-savers for the busy engineer!**

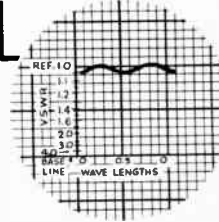
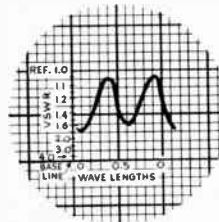
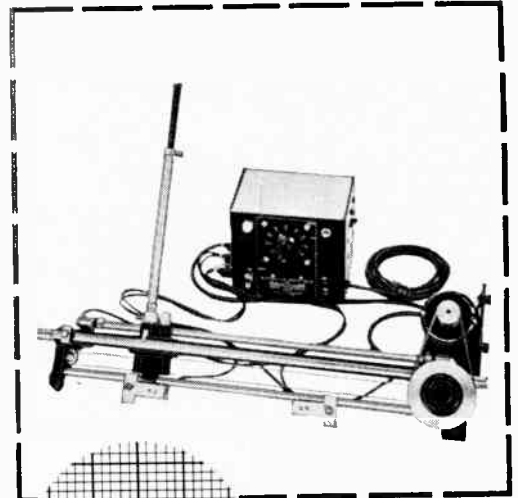

Above — Illustration of GR-874-MD Sweep Drive

GR Automatic Sweep for Measuring Equipment — fast, accurate, picture of VSWR in 45 seconds.

Until now, adjusting a 3-stub matching network for minimum VSWR at microwave frequencies, has been a time-consuming trial-and-error operation — as long as 15 minutes.

This adjustment can now be made in *only 45 seconds* and more accurately, with visual indication of data. The GR-874-MD Sweep Drive accomplishes this by providing automatic sweep for the GR-874-LBA Slotted Line.

ELECTRONIC INSTRUMENTS DEPT.,  
CANADIAN MARCONI COMPANY,  
MONTREAL 16, QUE. .

Please send brochure on Automatic Sweep for measuring equipment.

NAME.....  
ADDRESS.....  
CITY.....PROV.....

**Marconi**



CANADIAN MARCONI

COMPANY — MONTREAL 16, QUEBEC

Canada's Largest Electronic Specialists





Here are your  
**CANNON CONNECTORS**  
for PRINTED CIRCUITS

Available in 5 Sizes

1. DX-1052. Length 2-13/32". 10 contacts, spaced 5/32". For cards 0.057" to 0.067" thick.
2. DX-1852. Length 3-21/32". 18 contacts, spaced 5/32". For boards 0.060" to 0.071" thick.
3. DX-2252. Length 4-9/32". 22 contacts, spaced 5/32". For boards 0.060" to 0.071" thick.
4. DX-2842. Length 4-9/32". 28 contacts, spaced 1/8". For boards 0.060" to 0.071" thick.
5. DY-4453. Length 4-9/32". Double row, total of 44 contacts, spaced 5/32". For printed circuit boards 0.062" to 0.100" thick.



Nylon plastic shells ...  
gold plated contacts

DX contacts of phosphor bronze; DY of beryllium copper. All contacts "grip" the board, which enters to a depth of approximately 11/32". Each rated at 5-amp. Polarization studs provided. Flashovers 2000 and 2500 v. 60 cps ac rms.

Single-row types for boards printed on one side only, or both sides common. Double-row type for boards printed both sides having different circuits, not common.

**CANNON PLUGS**  
CANNON ELECTRIC CANADA LTD.  
160 BARTLEY DRIVE  
TORONTO 16, ONT.

5604



## Book Review



**Circuit Analysis By Laboratory Methods** by Carl E. Skroder and M. Stanley Hem. This book has been written with the thought that it will be used as a guide and as a text in conjunction with a laboratory course in electrical circuits. Accordingly it is assumed that the student is taking a theory course in d-c and a-c circuits concurrently with the laboratory course or has already completed such a course. Although the book is intended primarily for electrical engineering students, it contains a sufficient variety of experiments that it can be used by non-electrical engineering students.

From considerable experience gained in administering and teaching theory and laboratory courses in electrical circuits, the authors have a strong conviction that the circuits laboratory course should afford the student an opportunity to put to work his knowledge of electric circuit theory, should clarify and prove by experiment circuit phenomena about which he may be in doubt, should bring to light facts of which he may not have been aware, and should awaken him to the realization of the existence of practical limitations.

The foregoing objectives can be attained by presenting the so-called *experiment* in the form of a *problem* rather than as an experiment, if the word *experiment* is interpreted in the usual sense. When the experiment is presented as a problem, the student is confronted with three phases: (1) The analysis of the problem to determine the experimental data that are needed, (2) the determination of the circuits that must be used and the measurements that must be made in order to obtain the needed data, and (3) the analysis and synthesis of the observed and calculated data in order to arrive at a rational interpretation and explanation of the circuit performance. Thus the laboratory experiment with the preliminary planning and final study of the results is a problem of design, experiment, analysis, and synthesis.

This book is the result of the authors' efforts to make available a single volume containing a wide selection of laboratory circuit experiments, presented as much in the nature of problems as is feasible, and including a very comprehensive coverage of the related circuit theory and laws, the theory and limitations of instruments used in circuit measurements, and the methods of making measurements in circuits so that the student will have a ready source of information to which he can refer when preparing plans for the laboratory work and when analyzing the data and results.

**Circuit Analysis By Laboratory Methods** is published by Prentice-Hall Inc., 70 Fifth Avenue, New York 11, N.Y., contains 376 pages, hard cover bound, price \$5.75.

**Basic Synchros and Servomechanisms** by Van Valkenburg, Nooger and Neville, Inc. What has been called "the Second Industrial Revolution"—automation or automatic process control—is an outgrowth of the technical advances made during World War II in military equipment. The heart of the automatic, electronically controlled mechanisms for this purpose is the subject of these two volumes dealing with synchros and servomechanisms.

Besides the wide application of these devices in all types of modern military equipment, business and industry are making rapid strides in the use of synchros and servomechanisms in automatic process control, as in chemical plants, oil refineries, steel, textile and paper mills, in the manufacture and assembly of automotive and electronic equipment; and in the processing of data (sales, inventory, production, payroll, etc.) in offices and laboratories.

The text of this Basic Synchros and Servo-

mechanisms course, as currently taught at Navy specialty schools, has now been released for civilian use. This course is given to all Navy ratings whose duties require them to work with equipment which uses synchros and servomechanisms. It is a further extension of the background courses the trainee took in "Basic Electricity" and "Basic Electronics" (also by Van Valkenburg, Nooger & Neville, Inc.). This educational program has been an unqualified success. Since April, 1953, when it was first installed, over 25,000 Navy trainees have benefited by the instruction and the results have been outstanding.

This set of two volumes on "Basic Synchros and Servomechanisms" follows exactly the same format and method of presentation employed for "Basic Electronics." The unique simplification of an ordinarily complex subject, the exceptional clarity of illustrations and text, and the plan of presenting one basic concept at a time, without involving complicated mathematics, all combine in making this course a better and quicker way to learn (and teach) Basic Synchros and Servomechanisms.

**Basic Synchros and Servomechanisms Volumes 1 and 2** is published by John F. Rider Inc., 480 Canal Street, New York 13, N.Y., soft cover bound, price \$5.50 for the set of two.

**Transistor Electronics** by Lo, Endres, Zawels, Waldhauer and Cheng. Here is a fully integrated approach to both the theory and practice of transistors and transistor circuits. It is the combined work of five authorities in the field of electronics. They present here for the first time some of the results of their original research.

First it gives you a qualitative treatment of the physical concepts essential to understanding transistors. Then it explains the operation of the transistor as a four-terminal active network, which gives you a functional representation of the transistor in network parameter and equivalent circuits.

Among the outstanding features you will find are:

Analysis of fundamental transistor networks and circuits summarized in tabular form.

A large number of representative circuits to assist in an understanding of circuit operation.

Fully illustrated practical circuits to facilitate practical circuit design.

A wealth of information on circuit techniques and practical applications to facilitate design and development of working systems.

Over 365 illustrations, which make it the most completely illustrated book of its kind.

The authors clearly explain the use of transistors as basic amplifiers and thoroughly cover methods of operating point stabilization. In addition, you will find information on design considerations of low frequency, low level amplifiers, and the operation of power amplifiers.

The book discusses the operation of the transistor at high frequencies with the aid of equivalent circuits derived from the physical properties of the transistor.

You also receive practical design procedure for high frequency amplifiers, a detailed treatment of transistors in non-linear, large signal operation, and a full explanation of oscillators, modulators, detectors, and computer-type switching circuits.

This is a reference book that every electronics engineer or anyone interested in transistors should have.

**Transistor Electronics** is published by Prentice-Hall Inc., 70 Fifth Avenue, New York, N.Y., contains 521 pages, hard cover bound, price \$12.00.

connections simplified



For low level board applications.

Breakaway connector for instrument testing and control circuitry of guided missiles prior to launching.



For aircraft engine starting, commercial storage batteries, and stationary engine applications.

Sub miniatures. Same number of contacts as in a standard connector, but in 1/2 to 1/3 the space.



Miniatures. For radios, control, instrument uses, etc.

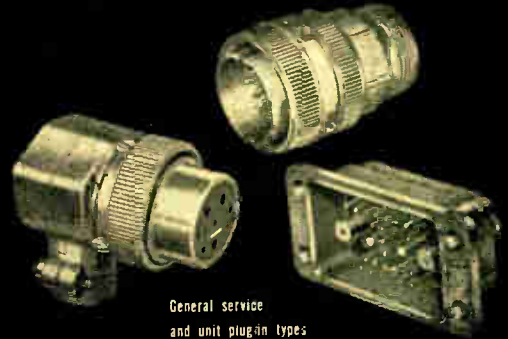

General service and unit plug-in types



Hermetically sealed All and B type connectors. Miniatures and sub miniatures.

Special K connectors for TV cameras.

Water tight and weather proof connectors for rugged service.



Heavy duty AG type, originally designed for U.S. Army Ordnance. Adaptable to commercial use. Flashback insulation. Special assemblies.

Greatest variety of firewall and high-temperature connectors.



Also—power plugs and receptacles for a wide range of applications.



first in connectors

# CANNON PLUGS

CANNON ELECTRIC CANADA LIMITED  
140 Bartley Drive, Toronto 16, Ont.  
Montreal Office—Montreal Airport,  
Dorval, P.Q.

Factories also in Los Angeles, East Haven, London, Melbourne, Licences in Paris, Tokyo.



## NEW PRODUCTS

(Continued from page 37)

### ● Hi-Fidelity Amplifier

Item 983

**Power Output** — The rated output of seven watts, sine wave (14 watt peak) is obtained with input voltages of .05 on the LO phono, 1.1 on the HI phono at 1 k.c., and approximately 5 volts on tuner and tape.

**Frequency Response** — On either HI or LO Phono equalization is provided for the four general types of recording in use. On the Tuner or Tape and with Bass and Treble controls approximately in center, a frequency coverage of 16 to 50,000 c.p.s., plus or minus, 1 d.b. will be obtained.

**Linearity** — Linearity, which is the ratio

of output voltage divided by the input voltage, is an indication of "Dynamic Range" and is very important in a high fidelity system. The linearity of the Wellington Seven, over all stages, is within ½ d.b. up to 2.1 watts and within 1 d.b. up to 4 watts.

**Hum and Noise** — At listening as well as at maximum output the hum and noise is at least 56 d.b. down. At listening levels of around 2 watts, the hum and noise of the amplifier only will measure less than fifteen one millionths of a watt. When in operation, the main source of distraction will be needle noise and turntable rumble.

**Distortion** — Distortion has been reduced to a point which is difficult to measure. At usual listening levels it is under ½ of 1 per cent and by careful selection of resistors in the phase inverter and final stage grids, this can be kept to less than 2 per cent at full output.

**Maintenance and Trouble Shooting** — Very little maintenance will be found necessary on the Wellington Seven. If, however, the Amplifier becomes inoperative or seems to distort, check voltages at plates of tubes. If they are all low, a new 6X4 should correct the trouble. Low plate voltage on any one tube indicates a defective tube, defective condenser or open plate resistor.

### ● Cutter-Splicers For Industrial And Wide Tapes

Item 984

A new Cutter-Splicer has been designed for repairing and editing computer, TV, industrial and special purpose magnetic recording tapes. Models are available for ¼", ½", ¾", 3/4" and 1" wide tapes. This instrument houses a knob controlled, moveable, cutter carriage which mounts three replaceable long life blades. With the knob moved to the back of the unit, the recording tape in the guide is cut diagonally. With the knob moved forward, the splice is trimmed

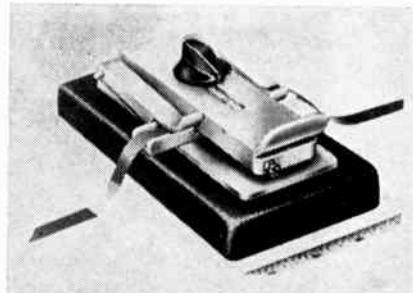

parallel to the tape (two concave cuts are made in the tape edges at the splice giving the tape a slightly narrow waist, eliminating the possibility of troublesome exposed adhesive). Tape ends to be spliced are held in the tape guide by toggle acting pressure fingers. The unit is mounted on a heavy cast base for bench use, but may be removed from the base and mounted directly on a recording machine. A blade centering adjustment is provided for precise maintenance adjustment.

### ● Lightweight Miniature Connector For Airborne Electronics

Item 985

Series "CCC 20" is a compact, lightweight miniature connector available in 37 contacts (15 and 25 contacts also available on special order). Electrical and mechanical functions are fully maintained in this versatile miniature design which is specially adaptable to airborne electronics.

Shells are stainless steel, passivated for extra strength and anti-corrosive properties. The flange provides a means of rack, panel, wall or box mounting.

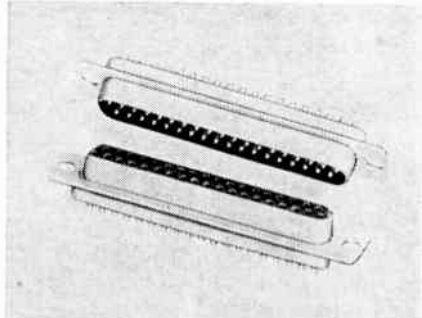

Insulated body is Orlon filled Diallyl Phthalate (MIL-P 4389) for high dimensional stability and superior dielectric properties. This material is non-hygroscopic and recommended for high altitude applications.

Pin contacts are gold plated brass; socket contacts are spring temper phosphor bronze, also gold plated. The "angle" end shape of the shells assures positive polarization.

(Turn to page 49)

## OUR BUSINESS . . . communications

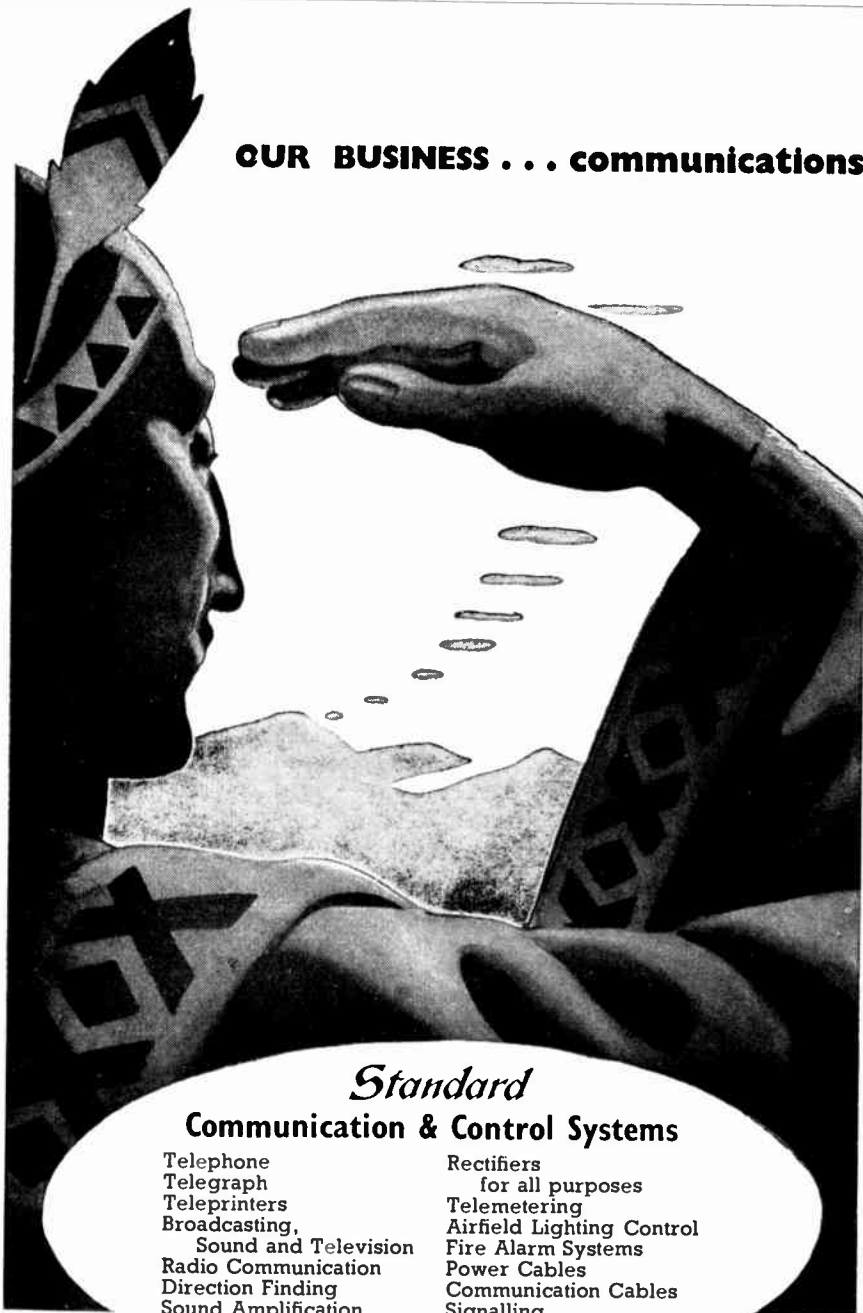

### Standard Communication & Control Systems

Telephone	Rectifiers
Telegraph	for all purposes
Teletypewriters	Telemetering
Broadcasting,	Airfield Lighting Control
Sound and Television	Fire Alarm Systems
Radio Communication	Power Cables
Direction Finding	Communication Cables
Sound Amplification	Signalling,
Remote Control	Office and Factory

## Standard Telephones & Cables

Mfg. Co. (Canada) Ltd.

9600 ST. LAWRENCE BLVD., MONTREAL

For further data on advertised products use page 83.



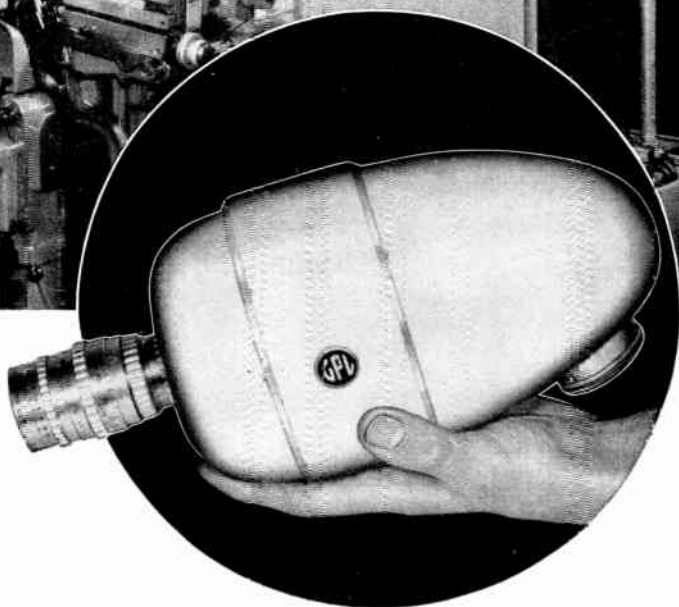
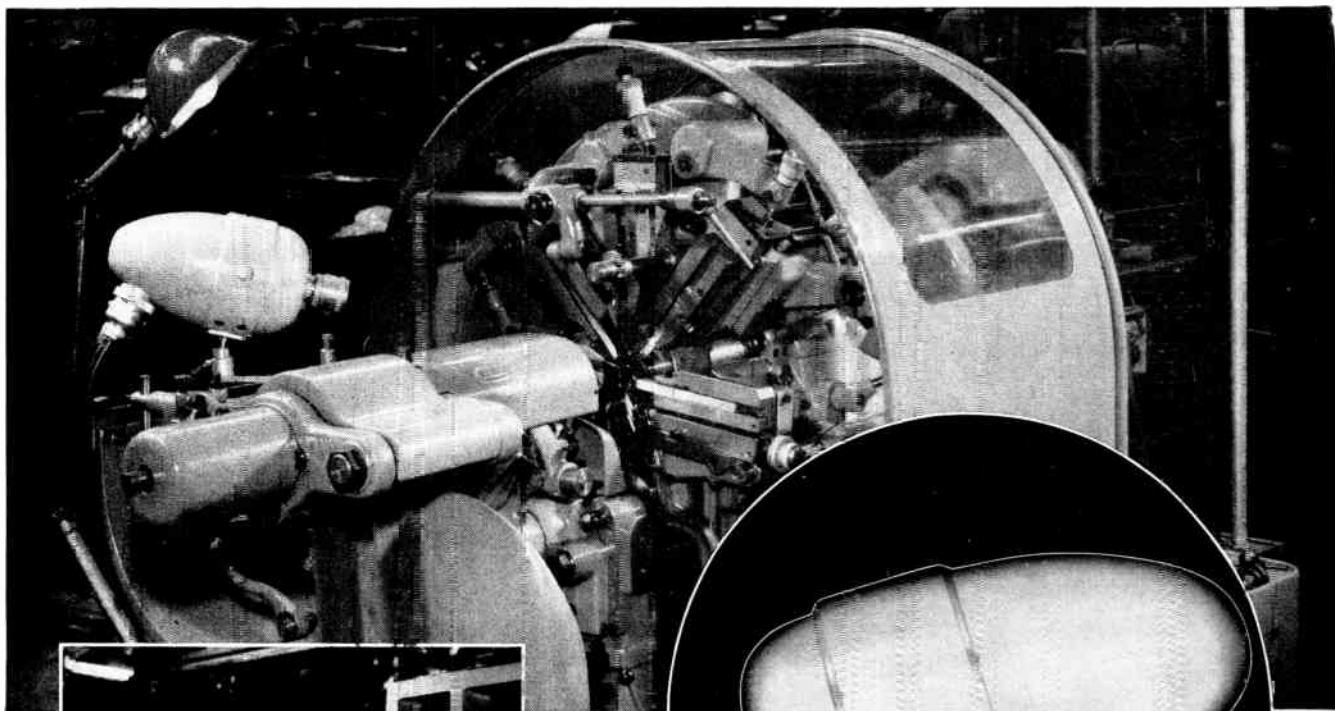

# YOU ARE THERE

with the  TV camera

... smaller than a football!

A lightweight camera that fits into your hand and a suitcase-sized control unit now bring the advantages of industrial TV within reach of every institutional and industrial operation. Cumbersome equipment and complicated wiring are no longer necessary. Remote supervision speeds inspection, and reduces accidents, operating costs, and capital investment.

- Camera operates on low light levels
- All camera controls are remote
- Complete line of remote lens controls available
- Several cameras can be operated from one control unit with a simple push-button switch
- High definition
- Low maintenance cost.

**For a demonstration, contact your nearest Westinghouse Branch Office.**

## CLOSED CIRCUIT TELEVISION by Westinghouse

CANADIAN WESTINGHOUSE COMPANY LIMITED, *Electronics Division*, HAMILTON, CANADA

Holifax • Moncton • Quebec • Montreal • Ottawa • Toronto • Hamilton • London • Windsor  
North Bay • Fort William • Winnipeg • Regina • Calgary • Edmonton • Lethbridge • Trail • Vancouver

36A745

SEE TELEVISION'S FINEST HOUR. "STUDIO ONE" MONDAY NIGHTS, 10:00 P.M.

Late In December A Telephone Emergency Reporting System Similar To The Ones Recently Installed In Some Major Cities In The United States Was Inaugurated In Kingston, Ontario. It Is Canada's First Telephone, Fire And Police Alarm System And Is . . . . .

# “The Most Modern System In Existence!”

ORIGINALLY a church, the sturdy Brock Street fire station in Kingston, Ontario, has seen many changes since 1891. In the past 38 years, Fire Chief “Vic” Brightman has seen his favorite team of “grays” replaced by streamlined engines and radio and root beer give way to “coke” and television. But the greatest “feather in his helmet” came on December 19th, 1955, when the first telephone fire and police alarm system in Canada went into operation in Kingston.

A one-position switchboard, set snugly into the wall beside the firemen's dormitory, and 25 bright red, white and blue call boxes have been installed by The Bell Telephone Company of Canada to supplement the city's 101 telegraph alarm boxes, which have been in use for nearly 60 years.

The non-dial telephones, enclosed in water-proofed steel boxes, are connected by a direct line to the new switchboard. A person reporting an emergency need only raise the 'phone from the hook to cause an audible signal, consisting of a buzzer and a six-inch bell that can be heard throughout the station. At the same time, a light flashes on the switchboard, over the “jack” representing the call box in use. All firemen on the station have been trained to operate the switchboard, with six required for day-and-

night duty. As a fire call comes through, they note the type, extent and location of the blaze and in a matter of minutes the proper equipment is on its way. All emergency calls are answered with equal speed. A citizen suffers a heart attack on the street — an ambulance speeds to the spot where he has fallen. The exact nature of a disturbance sends the proper amount of police protection swiftly to the source of trouble.

Annexation by Kingston in 1951 of several suburban areas requiring fire protection was an important factor in the decision by the city to begin a study of its fire alarm system, to determine the advisability of rehabilitating the telegraph alarm system. Their studies revealed there had been a sharp decline in the use of the alarm boxes and of the 683 fires reported in 1954 only 32 came from alarms, while 627 were made by telephone. This disuse was attributed to the tremendous increase in the number of telephones in Kingston where 21,000 phones serve a population of 50,000 persons.

Each of the corner telephone boxes operates on an individual set of two wires, and features automatic testing which causes a white light to flash over the switchboard in case of trouble on the line. Day and night contact with Bell Telephone assures immediate repair of any affected



● Twenty-five of these bright red, white and blue telephone call boxes have been installed to supplement Kingston's 101 telegraph alarm boxes. The non-dial telephones are enclosed in water-proofed steel boxes.

telephone alarm box and the disability of one cannot affect any other part of the system.

The final recommendation after careful study was to supplement the present system with 25 new telephone emergency call boxes. Locations for these have been chosen strategically with eight placed in suburban areas and the others in recommended “points of hazard” based on fire and police records. Particular attention was given to schools, hospitals, factories and large apartment dwelling areas.

Civic officials believe that within five years, 165 telephone emergency call boxes will have completely replaced the telegraph alarm system, which has been in use for more than half a century.

In this past decade, rapid expansion has made it increasingly difficult to match fire alarm systems to the growth of a city. Installation of an alarm box usually required the extension of city-owned cable, often at considerable expense. Under terms of the telephone contract, a call box can be quickly installed — using Bell cable, at the regular installation and monthly fee charges. Temporary installations, too, are possible on this basis, so that summer swimming pools, circuses and other transient entertainments can be protected for such time as they are in operation.

● Emergency calls to the police department can also be placed through the new telephone alarm system in Kingston. Seen at the far right is Chief Inspector Ready, of the Kingston Police Department, checking on the operation of the new switchboard as Fire Chiefs John Foote, Ottawa, and V. C. Brightman, Kingston, look on.





# Canada's Largest Private Wire System

- Uses The Latest Communication Technique
- At Less Cost
- Achieves Faster Increased Service

CANADA'S largest mechanized private wire teletype system, linking 65 cities and airports from coast to coast in Canada and in the United States, was inaugurated recently for Trans-Canada Air Lines by Canadian National Telegraphs.

The Montreal switching centre is one of two that will control the operation of the new 17,542-mile private network. The other centre is located at Winnipeg.

Installed by Canadian National Telegraphs, the system, newest of its type, and one of the largest in the world, is leased from that company and operated by T.C.A. employees to handle over 12 million messages a year. The equipment was designed by the Western Union Telegraph Company whose private wire network facilities will be used in the United States.

Officials of the two companies say that faster and increased service at less cost will result from the utilization of the latest techniques in communications engineering. T.C.A. offices at cities and airports in Canada and the U.S.A. are now connected by a chain of teletype machines. When a message is sent from one office to another at a distant point under the former method it oftentimes required manual relaying at intermediate points. In the new system with its

automatic switching centres the message requires manual transmission only by the originating office.

## How It Works

An example is cited of a message originating at a T.C.A. office in the Maritimes addressed to the company's office in Windsor. The message will be punched out at the originating office by an operator at a teletype machine. A perforated tape, containing the message transmits automatic impulses to carry the message to the switching centre at Montreal, where it is received in perforated tape form. The switching centre attendant notes the destination of the message, simply presses the "Windsor" button and the message is automatically switched to its destination. If the circuit to Windsor is already engaged the message momentarily "waits" and as soon as the circuit is free the message is automatically picked up and transmitted to its destination. As a safeguard, all messages are numbered by an automatic numbering machine in transmission from the switching centre, and these numbers, in sequence, appear on all messages arriving at the receiving office. Message losses are thus guarded against.

Frequently the same message or instruction is required to be sent to T.C.A. offices in a number of cities

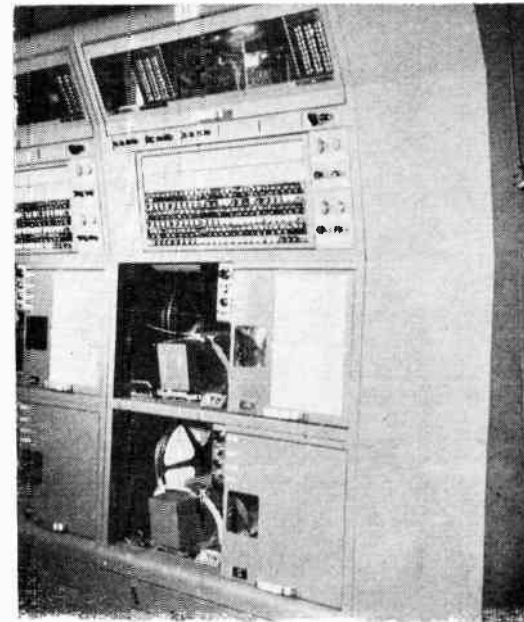

● The above photo shows one of the standard receiving and spillover positions in the T.C.A. — C.N.T. switching system installation at Montreal. In the upper portion of the panel behind the glass is the mechanism for numbering the messages in sequence.

and airports. In such cases transmission takes place from a master sending position at the switching centre. In some cities, airline operations might demand that an incoming message be received at more than one office. The system provides for this.

At the two switching centres signal lights indicate the operating conditions of all circuits and equipment and the transmission and reception of messages. These are safeguards to ensure proper functioning of the system.

This private network installed by C.N.T. includes 111 teleprinter machines, which in conjunction with the switching system, will bring T.C.A.'s most widely separated offices in instant contact with each other.

● *Left:* A view down the switching aisle showing staff at work. In the background are the number record printers which record the numbers of all messages sent for checking purposes. *Center:* The test-bench is located at the end of the switching aisle. Here a relay bank is being tested. Other pieces of the switching mechanism are lined up along the bench. *Right:* At a peak period, girls are shown operating the panels of the Trans-Canada Air Lines Switching System at Montreal. The girl second from left is pressing a button to route a message that has come into the center.







● Members of the committee responsible for the Canadian I.R.E. Convention and Exposition which will be held in the Automotive Building at the Canadian National Exhibition Park, Toronto, on October 1, 2 and 3, 1956. Shown above are: *Sitting*, left to right: Clive Eastwood, recording secretary; R. C. Poulter, chairman, advertising, publicity and program; E. O. Swan, chairman, exhibits and registrations; C. A. Norris, general convention chairman; Dr. George Sinclair, chairman, technical program; A. P. H. Barclay, chairman, Toronto Section I.R.E.; Claude Simmonds, corresponding secretary. *Standing*, left to right: F. H. R. Pounsett, I.R.E. Region 8; C. H. Hathaway, chairman, finances; Grant Smedmore, convention manager; E. L. Palin, chairman, social activities. The three-day event is expected to attract engineers from all over Canada and from neighboring states. The technical program will offer papers of interest to engineers in all branches of the electronics industry, including nuclear science. The exposition will present a wide range of electronic products, instruments and apparatus and the management reports that space reservations are already being received.

### Westinghouse Names T. B. Lounsbury To Sales Manager's Post

T. B. Lounsbury has been appointed manager of meter, instrument and relay sales for the Canadian Westinghouse Company's industrial products division at Hamilton, Ont.

An honor graduate in electrical engineering of McGill University and a graduate of the university's management and business administration course, Mr. Lounsbury joined Westinghouse in 1950 as a student engineer and until his recent appointment he

was attached to the apparatus sales department at Montreal.

He has been a member of the Engineering Institute of Canada since 1949.

### Communications Measurement Lab Represented In Canada By Measurement Engineering

It has been announced by Albert H. Carr, general manager of Communications Measurements Laboratory, Inc., Plainfield, N.J., that a representation agreement has been concluded with Measurement Engineering of Arnprior, Ontario.

### Conrad, Inc. Appoint D. F. Beechey

Customers of Conrad, Incorporated, Holland, Michigan, manufacturers of environmental (climatic testing) equipment are now enjoying the advantages of a Canadian based integrated sales service organization.

D. F. Beechey, 20 Nash Drive, Downsview, Ontario, has been appointed the Canadian representative. Mr. Beechey has been closely associated with environmental testing for several years.

(Turn to page 52)

## New **FREED** VARIABLE TEST VOLTAGE MEGOHMMETER NO. 1620

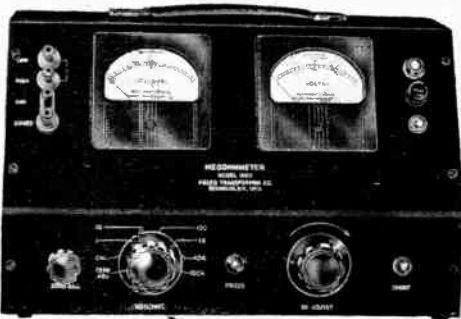

**A NEW COMPANION  
TO THE INDUSTRY  
ACCEPTED 1020-B  
MEGOHMMETER**

The Freed Type 1620 Megohmmeter is a versatile insulation resistance measurement instrument with a continuously variable DC test potential from 50 to 1000 volts. Components such as transformers, condensers, motors, printed circuits, cables and insulation material can be tested at their rated voltage and above, for safety factor.

- Resistance — 0.1 megohms to 4,000,000 megohms.
- Voltage — variable, 50 - 1000 volts.
- Accurate — plus or minus 5% on all ranges.
- Simple — for use by unskilled operators.
- Safe — high voltage relay controlled.

SEND FOR COMPLETE TRANSFORMER AND INSTRUMENT CATALOGS  
**FREED TRANSFORMER CO. INC.**  
1716 WEIRFIELD ST., BROOKLYN (RIDGEWOOD) 27, N.Y.

## K·L·G

## CORUNDITE<sup>™</sup> TERMINAL SEALS

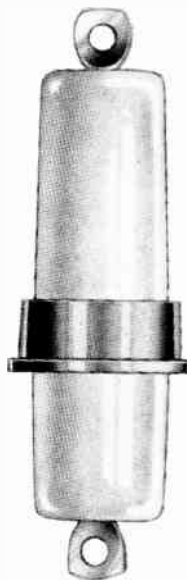

Alumina Oxide . . . .  
**THE WORLD'S FINEST**  
for  
Radar  
Telecommunications  
Co-axial cable terminations  
Television  
Radio  
Refrigerators  
Heating Elements

Large Canadian Stock of All Popular Types.

**CONSOLIDATED ELECTRONIC EQUIPMENT  
COMPANY LIMITED**  
1156 YONGE STREET TORONTO, ONTARIO

**NEW PRODUCTS**

(Continued from page 44)

● **Silicon Power Transistors**

Item 986

Airborne military and complex commercial electronics equipments — with their higher operating temperatures — are the big users of current TI silicon transistors. The newly announced Type 970 silicon power transistor — with a maximum power dissipation of 3.5 watts at the temperature of boiling water — will be especially useful for power stages, making possible the complete transistorization of many systems.

The Type 970 is ideally suited for the output stages of servo amplifiers, which convert small electrical variations into mechanical motion at a remote location. Through servo amplifiers, the signal from an automatic pilot can move the control surfaces of a huge bomber. The gyro compass and the automatic pilot already are being built using these instruments.

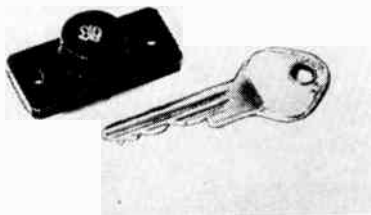

Physically, the Type 970 silicon transistor weighs less than three quarters of an ounce complete and is hermetically sealed in a disc approximately a half an inch in diameter by a half an inch high. The mounting plate "heat sink" extends outward from the transistor itself to cover an area of about three quarters of an inch by an inch and a quarter.

The transistor is of the grown junction, N-P-N type construction, wherein the layers of different conductivity silicon are produced in the large parent single crystal as it is "grown" in the TI-built equipment.

Power dissipation is 8.75 watts maximum at 25°C, with 3.5 watts maximum at 100°C. Power gain at 100°C ranges from a guaranteed 28 decibels at one watt output. Class A operation, to a guaranteed 18 decibels at 2.5 watts output, Class B operation.

● **25,000 Volt Multiplier**

Item 987

The wide range of the Model 8 Avometer is extended further by the introduction of a 25,000 volt D.C. multiplier, which also can be used with the AVO Electronic Testmeter and Electronic Multimeter. The body is of ceramic material and its construction generally provides high dielectric strength and

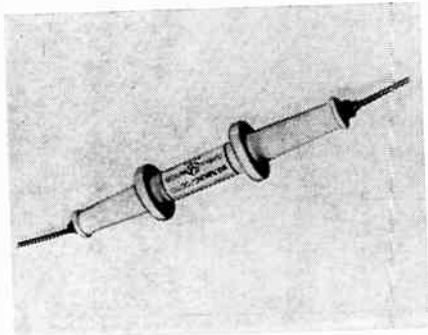

rigidity. Particular consideration has been given to the problem of corona discharge and the voltage gradient across the resistive unit.

The multiplier is designed for use in low power, high voltage circuits, (such as in television receivers, etc.), and is not intended for use in high power systems.

(Turn to page 54)

*I'm DALOHM...  
miniature but mighty!*

You can depend  
on the  
expanded line of



**TYPE DCH**  
**HERMETIC SEALED RUGGEDIZED**  
**DEPOSITED CARBON RESISTORS**

**NEW smaller sizes — NEW wattage ranges**

Ideal for use in UHF equipment where only the optimum of quality may be tolerated.

Completely high temperature alloy solder sealed in envelope of non-hydroscopic ceramic. Ruggedized for incorporation into snap-in clips. Production tested for resistance to thermal shock, salt-water immersion, and resistance to humidity.

DCH-1/8, 1/8 watt; DCH-1/4, 1/4 watt; DCSH-1/2, 1/2 watt; DCMH-1/2, 1/2 watt; DCH-1/2, 1/2 watt; DCH-1, 1 watt; DCH-2, 2 watts.

- Resistance ranges to 200 megohms
- Temperature coefficient 140 PPM to 500 PPM per degree C
- Standard tolerance 1% (other tolerances available) Meet MIL-R-10509B (proposed) Specifications

Write for  
Bulletin R-27A

**DALE PRODUCTS, INC.**



Export Dept.: Pan-Mar Corp.  
1270 Broadway, New York 1, N.Y.

In Canada: Charles W. Poynton,  
Ltd., 6 Alcina Ave., Toronto

1322 28TH AVE., COLUMBUS, NEB., U.S.A.      Phone 2139

**COMPONENTS FOR COMMUNICATION SYSTEMS**

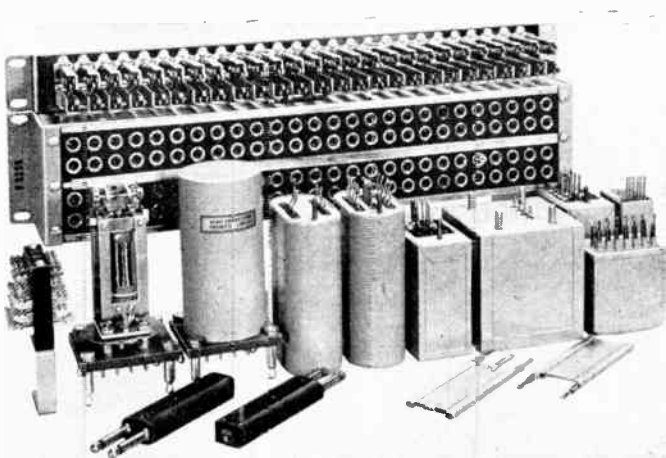

Radio Engineering Products produces a wide range of standard components for use in communication systems. In most cases these components can be delivered from stock.

**FILTERS:** Filters of advanced design are available for carrier telegraph, carrier telephone, and telemetering systems. These include channel filters, low-pass filters, and line filters.

**JACKS and MOUNTINGS:** Two standard 1 3/4" by 1 9/16" jack mountings are available. Type F6097A mounts 52 single jacks, and type F6097B 26 single jacks. Type F8410 jack is a double jack with parallel break contacts, interchangeable with type 410A.

**REPEATING and RETARDATION COILS:** A large number of standard types are carried in stock. These include voice-frequency and carrier-frequency line coils, hybrid coils, and retard coils for telephone and telegraph applications.

**RADIO ENGINEERING PRODUCTS**

1080 UNIVERSITY ST., MONTREAL 3, CANADA

TELEPHONE  
University 6-6887

CABLES  
RADENPRO, MONTREAL



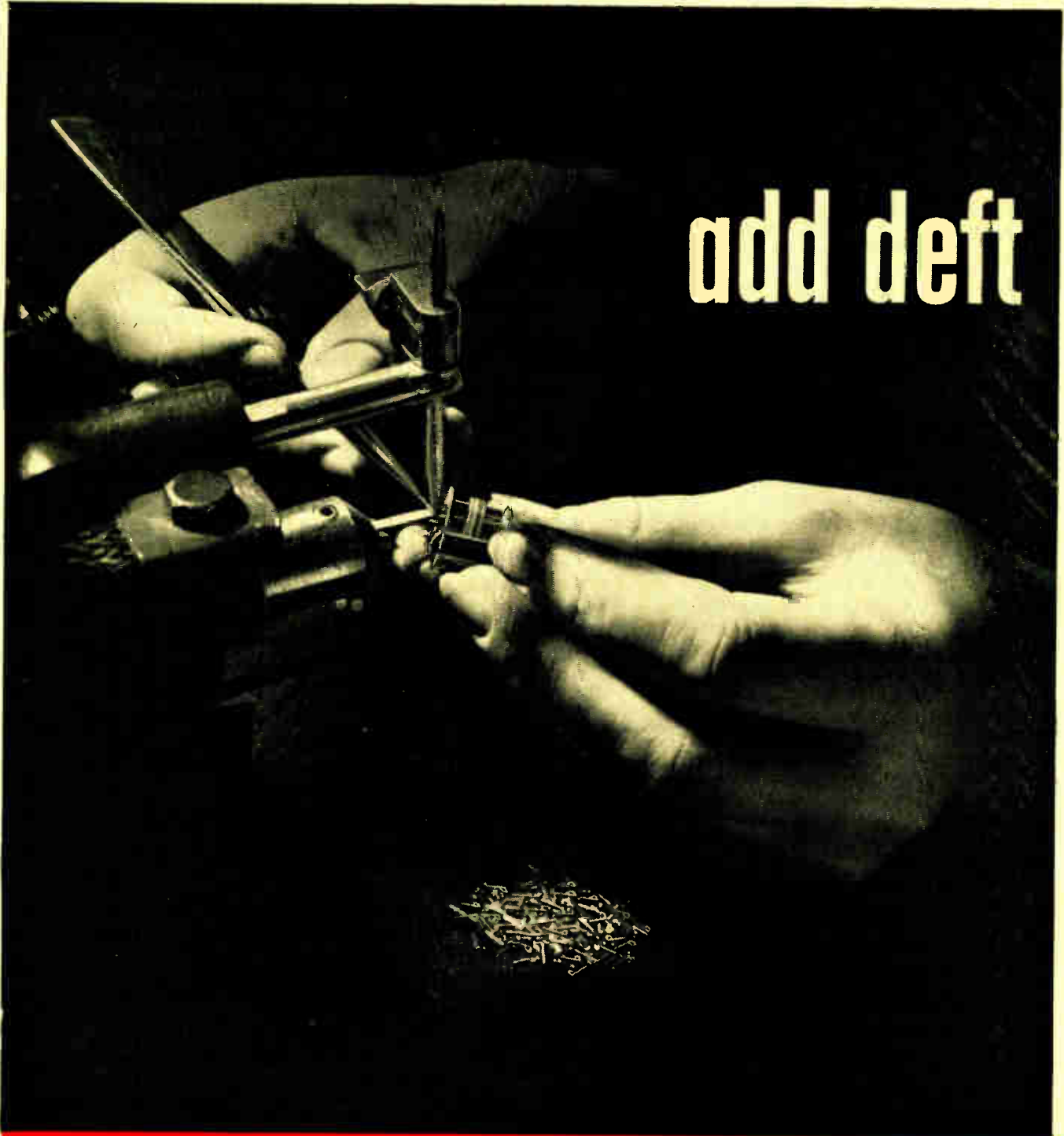

add deft

*Replace with guaranteed*

**ROGERS**  
ELECTRONIC TUBES



RECEIVING TUBES · PICTURE TUBES · TRANSMITTING TUBES · FERROXCUBE ·

For further data on advertised products use page 83.



# fingers... presto!

Deft fingers and a diminutive spot-welder are partners in this important phase of electronic tube manufacture.

In Rogers air-conditioned, dust-free mounting room, highly trained operators assemble the many tiny parts which go to make an electronic tube mount. Although jigs and fixtures are helpful in this operation, there is no substitute for the skill, experience and deft fingers of the operators.

High standards of engineering, rigid inspection and the thorough testing of every completed tube ensure the high quality and long-life performance of ROGERS electronic tubes.

Here is an assembled electronic tube mount. It is now ready for inspection. Later, the glass envelope will be added and then the tube is complete.

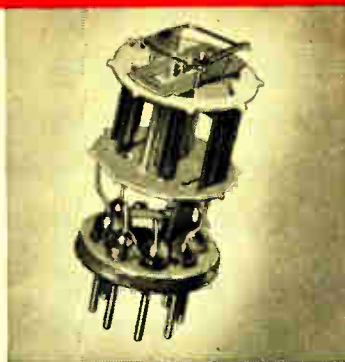

**GERMANIUM DIODES • SPECIAL PURPOSE TUBES**

## IMPROVED IGNITRONS for industry

TYPE AX 5551 and AX 5552

### OUTSTANDING FEATURES:

- Special igniter electrode having exceptionally high resistance to contamination, thereby ensuring rapidity of operation over a very long life.
- Rugged external metal-glass seal and separate high current connector with higher surface area for improved cooling and seal safety factor.
- Also available with heat-sensing plate.



### GENERAL CHARACTERISTICS

	AX 5552	AX 5551
Peak voltage drop, approx.	12 volts	12 volts
Net weights, approximate . . .	9 lbs.	4 lbs.
Type of cooling . . . . .	water	water
Maximum outlet water temperature . . . . .	40°C	40°C
Minimum flow . . . . .	1.5 gal. per min.	1 gal. per min.
Minimum inlet water temperature . . . . .	10°C	10°C
Pressure drop per tube at minimum flow . . . . .	4.5 lbs. per sq. inch	1.8 lbs. per sq. inch
Temperature rise at minimum flow, approx . . . . .	6°C	
(average current 100 amperes per anode)		
Temperature rise at minimum flow, approx . . . . .		4°C
(average current 40 amperes per anode)		

### MAXIMUM RATINGS

A-C Welder-Control Service-Frequencies from 25 to 60 cycles. Ratings are for any voltage from 250 to 600 Volts rms. Two tubes in inverse parallel

Maximum demand . . . . .	1200 kva	600 kva
Corresponding average anode current . . . . .	75.6 amp.	30.2 amp.
Maximum average anode current . . . . .	140 amp.	56 amp.
Corresponding demand . . . . .	400 kva	200 kva
Maximum time of averaging anode current 1		
At 600 volts rms . . . . .	5.8 sec.	7.5 sec.
At 250 volts rms . . . . .	14 sec.	18 sec.
Maximum surge current, peak amperes . . . . .	280% max. rms Demand current	280% max. rms Demand current

AX 5552—Rectifier Service—Frequencies from 25 to 60 cycles  
 AX 5551—Intermittent Rectifier Service—Frequencies from 25 to 60 cycles

For further information write —

# ROGERS

ELECTRONIC TUBE & COMPONENT DIVISION  
 11-19 Brentcliffe Road, Leaside, Toronto 17, Ontario  
 TORONTO • MONTREAL • VANCOUVER • WINNIPEG

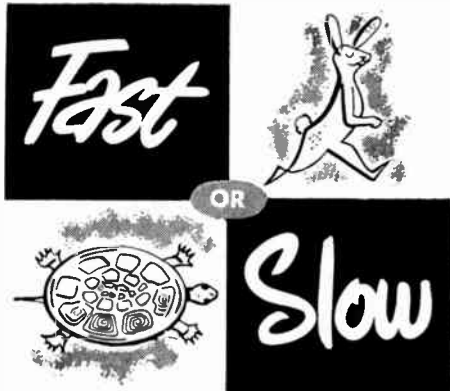

... any moving metal object  
**"AUTOMATES" YOUR OPERATION**  
 or **ACTUATES INSTRUMENTS**  
 through these  
**ELECTRO PICK-UPS**  
 ... without contact or "loading"

**PROXIMITY PICK-UP SYSTEM**



Ideal for use where actuating object moves slowly. A high frequency carrier-operated transducer that works on a principle like that of a military mine detector. Produces constant output as long as exciting metal is near the sensing unit. Output is independent of speed or clearance within pickup's range.

**2 Models:**

Model 4900R has built-in relay.  
 Model 4900 same as above except has a 5-volt DC output instead of relay.

**MAGNETIC PICK-UPS**



Model 3010-A

Produce AC voltage proportionate to rate of motion of any magnetic metal object traveling 3" per second or faster.



Model 3015

For use where space is limited—same speed ratio characteristic as the 3010-A ... up to 25% of its output.

Electro Pick-ups are actuating synchronized automatic operations in many industries—send today for details of how they can work for you!

**Electro**  
 Canadian Representative  
**ATLAS RADIO CORP., LTD.**  
 50 Wingold Ave., Toronto 10, Ont.

Name .....

Address .....

City ..... Province .....

**NEWS**

(Continued from page 48)

**Stuart Brownlee To Head Admiral Operations In Canada**

Vincent Barreca, president of Canadian Admiral Corporation, recently announced the appointment of Stuart D. Brownlee as executive vice-president of that corporation.

Mr. Brownlee was previously general manager and secretary of the Radio-Electronics-Television Manufacturers Association of Canada and also held



S. D. BROWNLEE

the position of president of Canadian Radio Patents Limited. In addition to his other affiliations, Mr. Brownlee had been secretary-treasurer of the Canadian Radio Technical Planning Board for a period of 10 years.

Mr. Brownlee will now be in charge of Admiral operations in Canada.

Mr. Barreca also announced the appointment of Edwin Whittaker as vice-president and general sales manager of Canadian Admiral Corporation.

Mr. Whittaker's twenty years in the appliance business began in 1935. Six years later he was appointed sales manager of the TV and Radio Division of Cochrane-Dunlop Hardware Ltd. In 1951 he joined Canadian Admiral Sales Limited as manager of the Toronto branch, becoming vice-president of the sales subsidiary in 1952. Since 1954 Mr. Whittaker has been supervisor of Admiral Sales branches at Canadian Admiral Corporation.

Mr. Barreca who was recently elected vice-president of the parent company, Admiral Corporation will go to Chicago to take up his new position. Mr. Barreca will retain his Canadian affiliation.

**Dr. L. Hill Joins Staff Of Canavionics Personnel Service**

Leslie L. Hill, Ph.D., has joined Canavionics Personnel Service Ltd. of Montreal in the capacity of Consulting Engineer. In this position Mr. Hill will be available for consultations with electronics concerns in Canada concerning supervision of engineering staff which, in case of shortage of personnel in Canada, will be available through Canavionics Personnel Service Ltd.

Mr. Hill's activities are well known to the electronics industry in Canada, the United States and England and his consulting services will be complemented by the services of a qualified staff to assist any large or small manufacturer with rush projects through periods of peak work load.

(Turn to page 55)



The Model 4201 Program Equalizer has been developed to provide utmost versatility for the compensation of sound recording and broadcast channels. High and low frequencies may be boosted or attenuated while the program is in progress with negligible effect on volume levels. It may be switched in or out instantaneously to permit compensation at predetermined portions of the program. This feature is especially useful in tape dubbing work.



Model 4201, Program Equalizer

**FEATURES:**

Equalization and attenuation in accurately calibrated 2 db. steps at 40, 100, 3000, 4000 and 10,000 cycles.  
 Insertion Loss: Fixed at 14 db. with switch "in" or "out."  
 Impedance: 500/600 ohms.  
 Low Hum Pickup: May be used in moderately low-level channels.

Send for Bulletin E for complete data

Net Price \$195.00  
 F. O. B. North Hollywood

Model 4201 Program Equalizer is also available for the custom builder in kit form with complete wiring instructions.

Send for Bulletin TB-4.

Representatives in Principal Cities



# Collins Mechanical Filters

**SUPERIOR SELECTIVITY, SMALL SIZE**

Collins Mechanical Filters are now available in six series for design needs where superior selectivity and small cubic volume are important. Permanently-tuned, hermetically-sealed and not affected by wide variations in ambient temperature, the Filters have greatly improved the selectivity characteristics of many commercial and military equipments. Mechanical Filters of special design can be supplied for most requirements in the range of 60 kc to 550 kc center frequencies and your inquiry is invited.

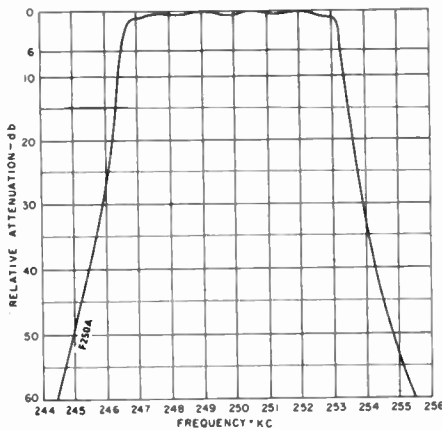

**F250A** A filter for double sideband signals at a center frequency of 250 kc. Bandwidth 6.7 kc at 6 db attenuation. Transmission loss 13 db.

Write for Technical Bulletin 201.

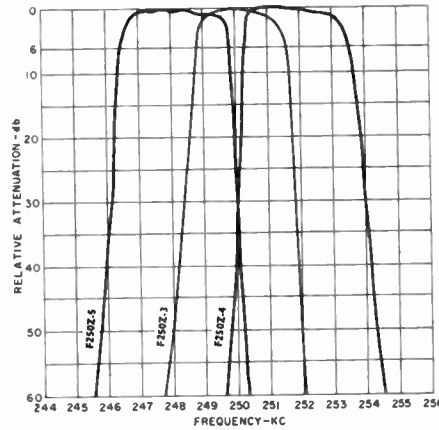

**F250Z** For single sideband signals at a carrier frequency of 250 kc. Bandwidths of 2.7 and 3.2 kc at 6 db attenuation. Transmission loss, 10 db.

Write for Technical Bulletin 202.

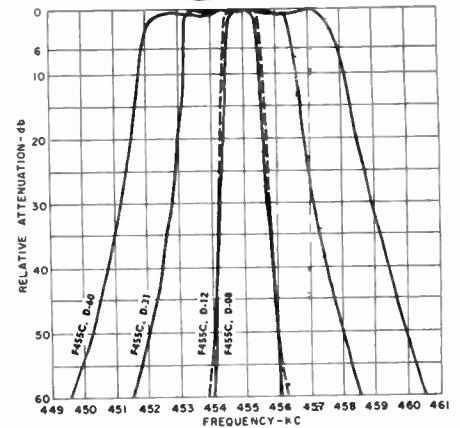

**F455C, F455D** Low insertion loss filters for AM, CW, RTTY and FSK signals at 455 kc. Bandwidth of 0.8, 1.2, 3.1 and 6.0 kc at 6 db attenuation. Transmission loss, 12 db.

Write for Technical Bulletin 203.

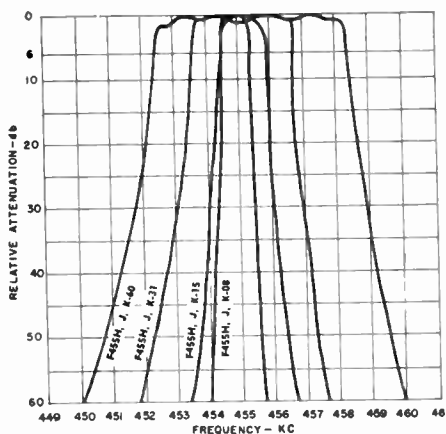

**F455H, J and K** New tubular case mounting, temperature compensated for signals at 455 kc. Bandwidths of 0.8, 1.5, 3.1 and 6.0 kc at 6 db attenuation. Transmission loss, 10 db.

Write for Technical Bulletin 204.

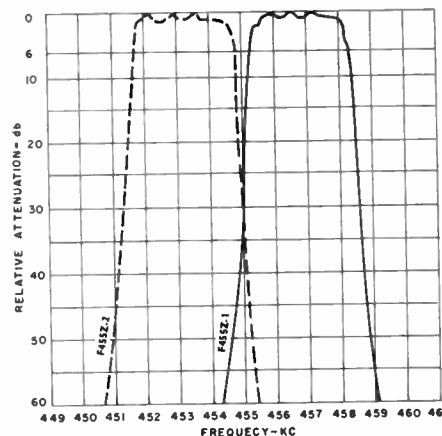

**F455Z** Mechanical Filters for single sideband signals at a carrier frequency of 455 kc. Bandwidth 3.3 kc at 6 db attenuation. Transmission loss, 10 db.

Write for Technical Bulletin 205.

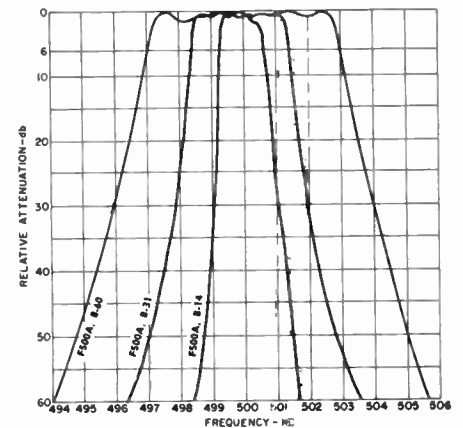

**F500** Mechanical Filters for AM, CW, RTTY signals at 500 kc. Bandwidths of 1.4, 3.1 and 6.0 kc at 6 db attenuation. Nominal transmission loss, 23 db.

Write for Technical Bulletin 206.

Write for a copy of Collins Mechanical Filter Theory and Application Bulletin #200 and for any of the Technical Bulletins described above.

**COLLINS RADIO COMPANY OF CANADA, LTD.**

11 BERMUNDSEY ROAD • TORONTO 16, ONTARIO





## NEW PRODUCTS

(Continued from page 49)

### ● Full Fidelity Tape-Playback Deck

#### Item 988

Faultless playback of pre-recorded tape at a professional sound reproduction level, yet at a popular price, is now possible with this FF75 model, which is capable of 40-14,000 c.p.s. frequency response at 7.5 inch tape speed (DYNAMU head).

Belt driven capstan eliminates all vibration and filters out motor interpole variations.

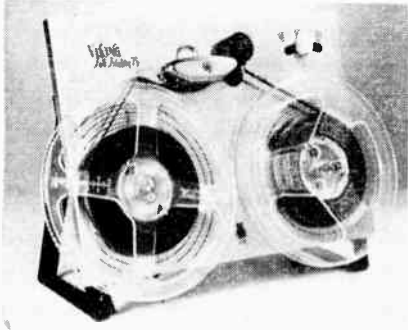

No puck drives to harden or flatten. Of simple mechanical design, the FF75 deck offers a completely dependable performance. Total harmonic distortion is less than 1 per cent with NARTB recorded tape.

This outstanding High Fidelity component will be available through all leading Canadian dealers of HIFI equipment and sound installations.

### ● Extended Range Vacuum Tube Voltmeters

#### Item 989

Like the popular Type 800-A, the 800-B Vacuum Tube Voltmeter combines the inherent accuracy of the basic voltmeter with a highly degenerative amplifier circuit, providing voltage transfer at a high input impedance level that results in negligible disturbance of the circuit to be measured. The development of feedback voltage across a simple precision resistance provides excellent stability. This unique circuitry also achieves long-term stability by eliminating the bothersome tube-aging problem and the effect of fluctuations of the coil resistance of the meter.

The rugged, portable 800-B is designed for field duty as well as precision laboratory work. The effects of ever-present line-voltage fluctuations are eliminated by means of the voltage regulated plate and filament supply of the 800-B. Meter indications on d.c. ranges do not vary by more than  $\pm 1$  per cent for line-voltage variations from 95 to 130 volts.

The new 800-B provides even greater range of measurement than the wide range 800-A. A specially-designed U.H.F. probe provides accurate measurements from 15 c.p.s. to 700 megacycles. Frequency response with this probe is within  $\pm 1$  d.b. of the measured voltage from 15 c.p.s. to 700 megacycles. In addition, provision is made in the 800-B for attaching an RCA High Voltage Probe for measurement of d.c. voltages above 1000 volts . . . up to a maximum of 30,000 volts.

### ● New Technique For Dividing Circles

#### Item 990

A new technique for marking dial graduations with a fine degree of accuracy never before possible in any scientific apparatus has been announced. Through optical generation, lines may be exposed on photographic

glass plates in a rotating camera. Each line is exposed over 200 times through the same optical system. This averaging effect eliminates any possibility of error. Thus absolute uniform accuracy as regards line width and spacing, length and their arrangement whether uniform, logarithmic or in accordance

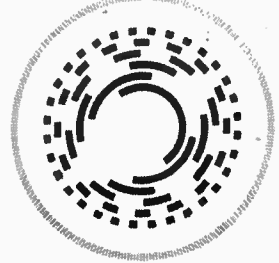

with special spacing requirements is produced. By this method circles from one to 12 inches diameter have been successfully divided into as many as 2000 lines per peripheral inch.

This is the only method by which fractional lines may be produced and by which prime or non-prime numbers in any frequency may be produced. No photographic reductions or pictures are required as it is with the old, mechanical method of marking calibrations. They may be of any size, color or combination of colors. Any style or type of legend may be permanently fashioned as part of the dial itself. Dials can be produced in any quantity with the same degree of accuracy. This greatly simplifies inspection and installation problems.

Reproduction is done on glass plated  $\frac{1}{16}$ ",  $\frac{1}{8}$ " or  $\frac{3}{16}$ " thick, cut with any size center hole for mounting.

(Turn to page 60)

Introducing To Canada

## MODEL 1446 VARIABLE FREQUENCY ELECTRONIC GENERATOR

4500 VA OUTPUT . . . 50-6000 C.P.S.

The Model 1446 is the highest powered standard unit in the C.M.L. line.

Basic Specifications as follows:

Power Output — 4500 VA, down 1 db at 6 Kc.  
Power Tube Complement: 2 No. 5762 Class B.  
Power Requirement: 208-230 volts, three phase 60 cps.  
Size 36" x 37" x 77" high.  
CML Generators from 50 to 4500 VA Output. Also available on special order to cover discreet portions of the 20 C.P.S. to 60 Kc range.

Write to our engineering department or our Canadian representatives for quotation covering your requirements.

Illustrated brochure on request.

PRICE MODEL 1446

\$6,500.00 NET

COMMUNICATION MEASUREMENTS LABORATORY INC.

PLAINFIELD, NEW JERSEY

CANADIAN REPRESENTATIVES



## MEASUREMENT ENGINEERING LIMITED

Field research engineers and equipment specialists in every phase of Electronics and Communications.  
ARNPRIOR, ONTARIO

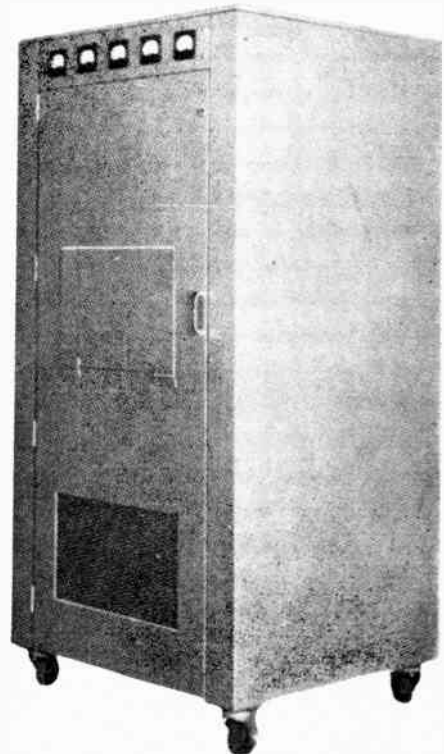

For further data on advertised products use page 83.

## NEWS

(Continued from page 52)

## Roy Cahoon Of Winnipeg Wins IRE Fellowship

Roy D. Cahoon, Prairie regional director for the CBC has been awarded a Fellowship in the Institute of Radio Engineers, and thus becomes one of approximately 25 radio engineers in Canada to achieve this distinction.



R. CAHOON

Mr. Cahoon, born in Alberta, graduated from the University of Toronto in 1934 with the degree of Bachelor of Applied Science in Electrical Engineering. He attended post-graduate studies at McGill University during 1943 and 1944, and attended post-graduate studies on transmitter design.

In 1934, following his graduation, Mr. Cahoon was associated with Baldwin International Radio of Toronto, and in 1935 joined the Engineering staff of the Canadian Radio Broadcasting Commission which later became the CBC. He held the position of Special Operations Engineer for three years, being promoted to Engineer-in-Charge of CBK Watrous at that time. He later was appointed senior engineer in the CBC International Short Wave Service, a position he held until his present appointment in 1948.

In addition to his association with the Institute of Radio Engineers, Mr. Cahoon is a Member of the Association of Motion Picture and Television Engineers, a Member of the Engineering Institute of Canada, a Member of the Association of Professional Engineers (Manitoba), and is a former Member of the same Association in Quebec. He is a past chairman of the Institute of Radio Engineers, Winnipeg Section.

### Micro-Tower Ltd. Provides Unique Service To Canadian Communications Industry

A valuable service is now available to the Canadian communications industry through Micro-Tower Limited, 831 O'Connor Drive, Toronto, George A. Collins, P.Eng., general manager of the company, states that Micro-Tower Limited is the first Canadian company to provide "packaged" tower and construction service to Canadian communications equipment manufacturers and communications operating companies. This company is equipped to design, fabricate and install communications towers of all types and perform associated construction services throughout Canada.

(Turn to page 61)

$$I_L = \frac{E - OC}{2R_a + 1.2R}$$

**SERVING INDUSTRY...**

$$W = I^2 L R = \frac{1}{2} (I_L)^2 R$$

$$= \frac{1}{2} \frac{(E - OC)^2}{(2R_a + 1.2R)^2} R$$

$$= \frac{1}{2} \frac{(E - OC)^2}{4R_a^2 + 4.8R_a + 1.44R}$$

electronic dreams—  
to order...

Tell us what you have in mind.

If your project involves wire in any shape or form, tell us all about it. As Canada's leading specialists in the design and manufacture of all types of wires and cables we have an unequalled wealth of experience to offer you.

Canada Wire engineering experience and extensive manufacturing facilities will help you meet and exceed specifications.

Whether it's an experimental electronic project or a large production run, consult Canada Wire — it pays!

LIFELINE OF INDUSTRIAL CANADA

**CANADA WIRE AND CABLE COMPANY** LIMITED

Postal Station "R" Toronto 17

A CANADIAN COMPANY MANUFACTURING AND SELLING COAST TO COAST



TRADE  
MARK  
REG'D

CWC-5523



**SMALL RECTANGULAR  
VITAMIN Q® CAPACITORS FOR 125°C**

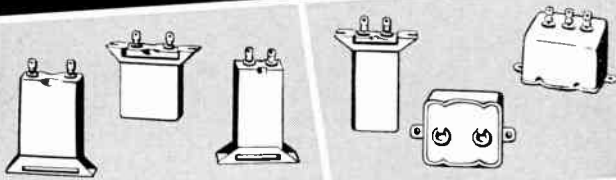

This new series of conservatively rated Sprague capacitors actually exceeds the performance requirements of Characteristic "K", Military Specification MIL-C-25A, and is available in a complete series of capacitance values through 600 WVDC.

Vitamin Q impregnation provides proven chemical inertness and stability at high temperatures. Consequently, there is no degradation in electrical characteristics following long storage at high temperatures. Cases are hermetically sealed, with terminal bushings and mechanical case closures designed to withstand low barometric pressures at high ambient temperatures.

Write for Engineering Bulletin 231 to Micarta Fabricators, Ltd. 18, Toronto St., Toronto, Ontario. Empire 8-4251

**SPRAGUE**® WORLD'S LARGEST  
CAPACITOR MANUFACTURER

**FOR PRECISION PUNCHING, NOTHING EQUALS THIS *New*, BETTER, TIME-*SAVING* UNIT!**

**"WHAM-BANG"  
RADIO  
CHASSIS  
PUNCH  
GUIDE**

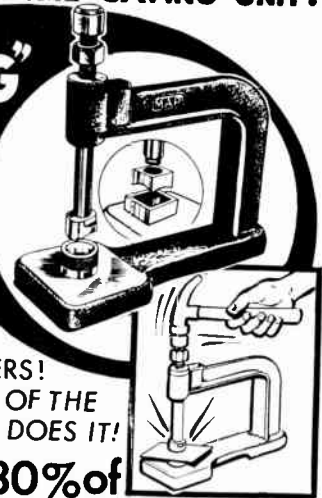

PATENT APPLIED FOR

MAP

**IMPROVED  
OVER ALL OTHERS!**

**ONE LICK OF THE  
HAMMER DOES IT!**

**Saves 80% of  
Time—and ELIMINATES ALL BORING  
OF GUIDE HOLES! Costs Less!**

**IDEAL  
Wherever  
A HOLE  
NEEDS  
PUNCHING  
in SHEET METAL**

Ask About  
**LITTLE GIANT**  
ANTENNA  
GUY WIRE  
STRETCHER

All sizes and shapes available. Inquire today about the WHAM-BANG Punch Guide — the finest yet for radio companies, radio service men, "inter-com" chassis work, etc. Write as today.

MADE IN CANADA BY  
**MODERN AIRCRAFT PRODUCTS Ltd**  
KINGSVILLE ONTARIO

**CASCADE  
RESEARCH  
CORPORATION**



**ferrite** MICROWAVE  
EQUIPMENT

- UNILINES (Unidirectional Transmission Line)
- GYRALINES (Microwave Amplitude Modulator)
- CIRCULATORS
- UNIPLEXERS
- SINGLE SIDE BAND MODULATORS
- PHASESHIFTERS
- POLARIZATION ROTATORS
- VARIABLE MISMATCH DEVICES
- BACKWARD WAVE OSCILLATORS
- AUTOMATIC IMPEDANCE PLOTTER
- CUSTOM DESIGN AND FABRICATION

SALES AND APPLICATION ENGINEERING IN CANADA BY

**MICROWAVE SYSTEMS**

891 O'CONNOR DRIVE

TORONTO

PLYMOUTH 7-4263

WRITE FOR FREE DETAILED TECHNICAL CATALOGUE

For further data on advertised products use page 83.



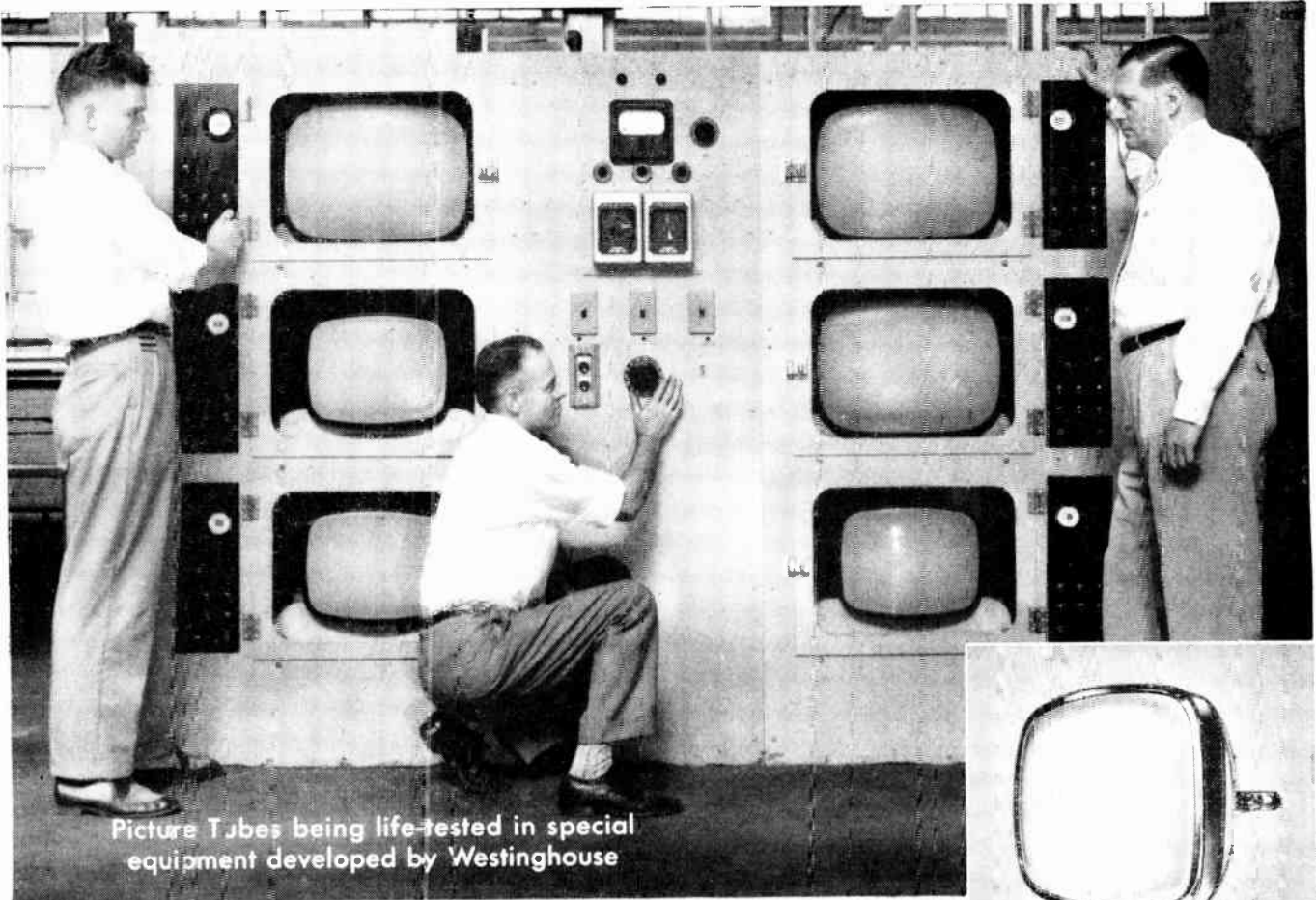

Picture Tubes being life-tested in special equipment developed by Westinghouse

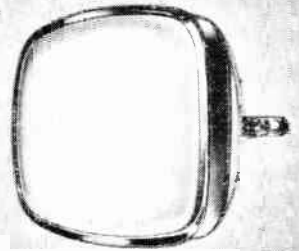

# From rigid inspections come perfect picture tubes

... and happy customers



Westinghouse picture tubes are tested to the Nth degree for your protection. You can be sure, every tube is quality first or it never would have passed the inspection tables. This is one way in which Westinghouse strives to give you the very best products available.

The people at Westinghouse know that by turning out quality tubes they keep your customers happy — and thereby they are pleasing you. Quality products today mean continued goodwill tomorrow.

Purchase Westinghouse tubes from your local tube jobber.

**YOU CAN BE SURE...IF IT'S** **Westinghouse**

**CANADIAN WESTINGHOUSE SUPPLY CO. LTD.**

Halifax - Quebec City - Montreal - Ottawa - Toronto - Hamilton - North Bay  
Fort William - Winnipeg - Regina - Saskatoon - Edmonton - Calgary - Vancouver

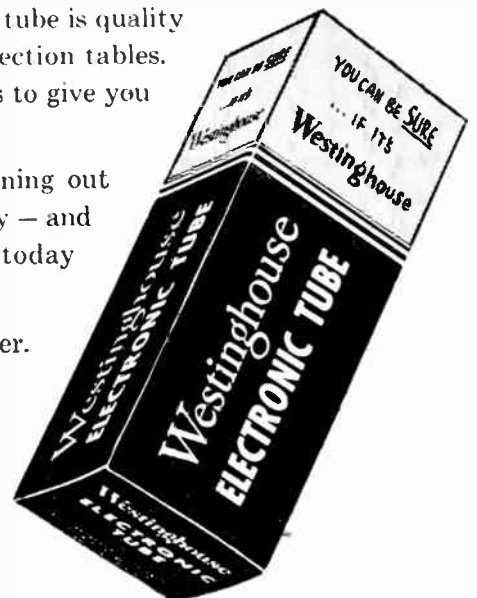

**A Capacitor Manufacturer Cuts Drying Time 70 Percent By Use Of New Ring-Jet Booster Pump With Increased Pumping Speed From 10 To 100 Percent Greater Than Conventional Pumps.**

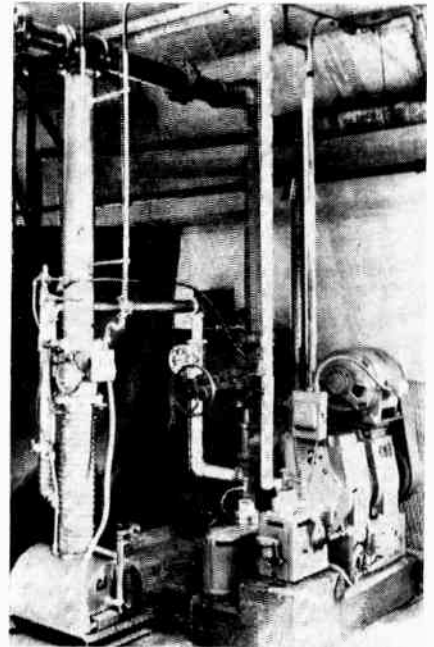

● Installing the 6-in. "Ring-Jet" booster pump (left) in combination with the Stokes "Microvac" rotary mechanical vacuum pump (right) reduced the drying time required for electrical capacitors from 106 hours to 30 hours for a Midwestern capacitor manufacturer.

# The Ring-Jet Booster Pump

A marked reduction in the time required to evacuate the last milligram of moisture from electrical capacitors — from 106 hours down to 30 hours — resulted from the installation of a 6-inch "Ring-Jet" booster pump in the drying and impregnating equipment of a Midwestern capacitor manufacturer.

High voltage breakdown tests showed that the capacitors dried in the much shorter period were in every respect equal to or superior to those dried in the considerably longer period when only a mechanical vacuum pump was used to evacuate the system.

These capacitors are the conventional paper-foil wound type, encased in steel. Before impregnating them with dielectric oil, they must be thoroughly dried, and all air removed, so that the impregnant can saturate the paper. The moisture can best be removed by applying heat under a very high vacuum. This must be maintained for a prolonged period, since the only opening through which the water vapor can escape is a small hole approximately ¼-in. to ½-in. in diameter in the top of the welded steel case of the capacitor.

The accompanying curves show the

striking reduction in time required to dry the capacitors to the desired level, as a result of adding the 6-inch "Ring-Jet" booster to the pumping system. Curve B (Cycle 3166) shows the duration of the former drying cycle, using the mechanical vacuum pump only. Curve A (Cycle 3173) shows the much shorter drying cycle obtained after the "Ring-Jet" pump was installed.

The new "Ring-Jet" pumps incorporate a revolutionary design feature in which a ring of jets replaces the

jet cone of conventional diffusion and booster pumps. This ring of jets permits the cross-sectional area of the air-flow path to be substantially increased, thus greatly increasing the volume of air that can be passed through the pump and hence increasing its pumping speed. Size for size, this "Ring-Jet" feature increases the pumping speed of the pumps by from 10 per cent to more than 100 per cent over conventional pumps of similar dimensions and heat input.

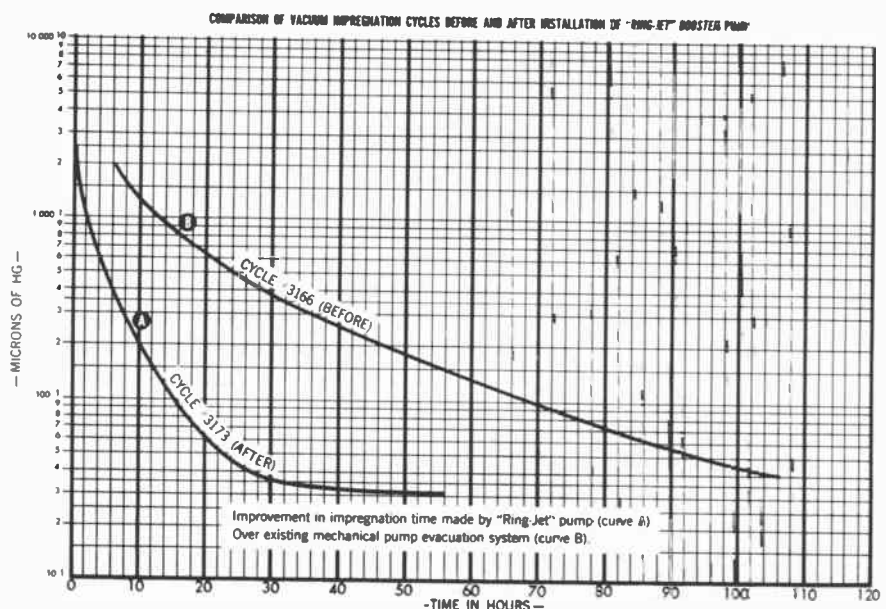

● Installation of a 6-in. "Ring-Jet" booster pump reduced the drying time required for electrical capacitors from 106 hours (curve B) to 30 hours (curve A) for a Midwestern capacitor manufacturer.



# ANNOUNCING . . .



Here is a completely new series of 1 KW and 500 Watt High Frequency Transmitters Canadian designed and manufactured to meet modern operating conditions. The HA series incorporates many desirable features such as *continuous frequency coverage and suppressed TV frequency harmonics.*

These new transmitters are available on a "building block" basis for a wide variety of applications.

- HA-1 CW and Frequency Shift Keying — single 1000 watt channel
- HA-2 CW and Frequency Shift Keying — 2 simultaneous 500 watt channels
- HA-3 CW and Frequency Shift Keying — 2 simultaneous 1000 watt channels
- HA-4 Radiotelephony — 1000 watts carrier 100% modulated (illustrated)

## DESIGN FEATURES

1. Continuous frequency coverage 2.0 – 27.5 Mc/s *without* band switching.
2. Switch selection of *ten* crystal frequencies.
3. Output impedance 600 or 300 ohms balanced over 2 to 27.5 Mc/s with continuously tunable balun circuit.
4. Keying speeds A1 — 600 words/min.  
F1 — 150 dot cycles/sec.  
Complete suppression of carrier radiation during "space" up to keying speed of 60 w.p.m.
5. Frequency response (HA4)  $\pm 2$  db from 350 – 3000 c/s.
6. Distortion (HA4) less than 7.5%, 350–3000 c/s, at 95% modulation.
7. Noise Level (HA4) more than 45 db below 100% modulation.
8. Rapid convenient tuning from five front mounted controls.
9. Highest quality components and conservative tube operating conditions ensure reliability under all extremes of temperature and humidity.
10. All components and tubes readily accessible.

COMMUNICATE WITH

# Westinghouse

ELECTRONICS DIVISION

CANADIAN WESTINGHOUSE COMPANY LIMITED • HAMILTON, CANADA

Halifax • Moncton • Quebec • Montreal • Ottawa • Toronto • Hamilton • London • Windsor • North Bay • Fort William • Winnipeg  
Regina • Calgary • Edmonton • Lethbridge • Trail • Vancouver

56D745

See Television's Finest Hour "STUDIO ONE" Monday Nights 10:00 p.m.



## NEW PRODUCTS

(Continued from page 54)

### ● Identichart

Item 991

The print wheel on this new device can have 8, 10, 12, 18 or 24 positions, with the position being selected from a remote point, then caused to print for the purpose of identifying events on the recorder chart. The unit, called the RI-3 IDENTICHART, is extremely useful for identifying range, chart speed, channel number or other variation that needs to be identified when the chart

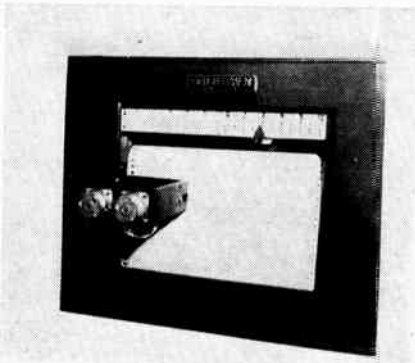

is reviewed. The device can have two print wheels if desired, each independently set by separate, remote switches. The printing pulse causes the device to print whatever characters have been selected. The RI-3 IDENTICHART can be obtained in easy-to-install kit form. The unit does not interfere with or obscure the recording procedure. It can be made to operate on any AC or DC voltage from 24 to 110 volts.

### ● Improved Photoelectric Counting Unit

Item 992

Increased reliability and simplified installation are featured in a new Counting Eye unit which comes assembled, equipped with cords, completely wired and adjusted ready to use.

Reliable counting is afforded with distances up to eight feet between the Counting Eye and Light Source. Each object to be counted should interrupt the light beam  $\frac{1}{16}$  second or more and space following each object should permit restoration of the light beam for  $\frac{1}{16}$  second or more.

Construction throughout is to heavy duty industrial standards. Cases are of cast aluminum, gasket sealed and tapped for  $\frac{1}{2}$ " conduit. Adjustable mounting brackets facilitate positioning and alignment of counting eye and light source.

Removal of two nuts frees the cover and permits access to tubes and lamps with mounting and alignment undisturbed. The counter is mounted on a plate which is secured by the cover bolts.

Dimensions of Counting Eye and Light Source are the same; height,  $5\frac{3}{8}$  to  $6\frac{1}{2}$ " depending on bracket adjustment; width,  $3\frac{3}{8}$ "; depth, less bracket, 3-17/32". The bracket may be reversed to fit under case. With counter attached depth of the counting eye is  $6\frac{1}{8}$ ".

### ● Single Sideband Application Bulletin Available

Item 993

"Single Sideband", Eimac Application Bulletin Number 9, is now available. This new 24-page bulletin, prepared by the Eimac Field Engineering Department, gives Single Sideband ratings for Eimac tubes and discusses other technical topics in this increasingly popular field.

### ● Broad Band Coaxial Directional Couplers

Item 994

Four new models of wide band coaxial directional couplers, extremely useful for microwave power monitoring and measurement, or as fixed attenuators, cover the range of 225 to 4000 m.c., each covering a full octave frequency range and available in 20 or 30 d.b. coupling values. The frequency range is so divided that each coupler covers the complete range of the most widely used bands, i.e.: 225-460, 460-950, 950-2000, and

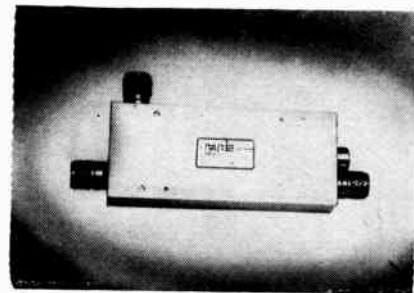

2000-4000 m.c. The coupling variation over the frequency range of each coupler is less than 1 d.b. while the directivity is higher than 20 d.b. over the full band. The VSWR of the primary arm is less than 1.15 in all models.

These couplers are provided with Type N female connectors on both ends of the primary line and the output end of the secondary line. The other end of the secondary line has a built-in coaxial termination. The coaxial transmission line is machined in a solid metal block fitted with the center conductors and connectors.

(Turn to page 65)

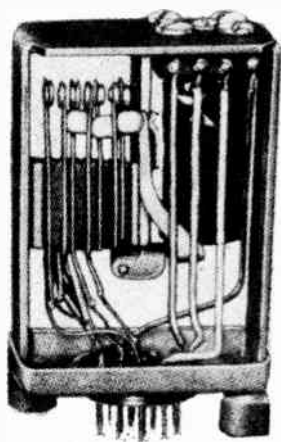

# NOW

## Relays made in Canada to meet military specifications

Hermetically sealed.

Plug-In or Solder Terminal Type.

Sizes of Can to accepted standards.

## RELAY PROBLEMS?

Let us help you solve your relay problems.

We are relay specialists — with the most advanced sources of information to place at your disposal.

Do you need help or data on Transformers — small Bearings — Blowers?

Our long experience here is also at your service — yours for the asking — without obligation.

# JOHN HERRING and COMPANY LTD.

3468 DUNDAS STREET WEST

TORONTO, ONTARIO

For further data on advertised products use page 83.

## NEWS

(Continued from page 55)

### Musimart Of Canada Appointment To Represent The Maico Company, Inc.

Fred R. Lesser, manager, Electronic Division of Musimart of Canada Limited, recently announced the appointment of his company as Canadian representative for The Maico Company, Inc. (Dyname Magnetronic Corp.), of Minneapolis, Minn., U.S.A.

### Dominion Electrohome Expands Operations

In keeping with the expanding scope of its operations, particularly in the electronics field, Dominion Electrohome Industries Limited has established a new Technical Products Division.

The new division replaces what was formerly named the Defense and Industrial Contracts Division and reflects the growing number of technical products now being distributed by the Kitchener company.

Most important change in the reorganization move is the establishment of a sales department, headed by Norman C. Wilson, which will merchandise industrial electronic and control equipment imported from the United Kingdom and the United States.

The division, of which F. A. O. Banks is manager, will continue to handle defense and industrial contracts and will maintain manufacturing facilities which can be expanded if necessary.

### W. F. Beattie Appointed Canadian Rep. For Punch Products Corp.

The appointment of Mr. William F. Beattie of Hamilton, Ontario as exclusive representative for Canada has been announced by Jerome F. Ferdinand, sales manager of the Punch Products Corporation, Niagara Falls, N.Y., manufacturers of Uni-tized hole-punching and notching equipment.



W. F. BEATTIE

Prior to this appointment, Mr. Beattie was vice-president, general manager and a director of Dominion Fasteners, Ltd., Hamilton, Ontario, Canadian licensee for Tinnerman Products, Inc. of Cleveland, Ohio, manufacturers of Speed Nut fasteners.

From 1944 to 1952, Mr. Beattie was vice-president, general manager and a director of Wales-Strippit of Canada Ltd., Hamilton, Ontario.



● Recent Bogue Electric of Canada Ltd. appointments are: left, E. P. Schinman, president of Bogue Electric Manufacturing Co., Paterson, New Jersey, who becomes vice-president of the company's Canadian subsidiary; center, Rear-Admiral (Ret.) John G. Knowlton, who has been elected president of Bogue Electric of Canada, Ltd.; and right, Grant A. Taylor, appointed general sales manager and a director of Bogue Electric of Canada Ltd.

## A CRYSTAL CALIBRATED A.M. PORTABLE RECEIVER TESTER



- ACCURATE
- VERSATILE
- LIGHTWEIGHT

Weighing only 17½ pounds, this low-cost and compact instrument combines a wide-range signal generator, a variable level tone source, and an a.f. power meter. (For battery operation, line power unit can be interchanged with battery unit.)

R.F. range: 70kc/s to 70 Mc/s. With built-in crystal checks at harmonics of 500 kc/s and 5 Mc/s. Attenuator provides calibrated outputs between 1µV and 10 mV at source impedances of 52 and 80 ohms. For general testing — higher, uncalibrated outputs up to 500mV are available.

For full details, write Marconi Instruments Department;

# Marconi



CANADIAN MARCONI

COMPANY — MONTREAL 16, QUEBEC

Canada's Largest Electronic Specialists

STOCKED IN CANADA

**SIEMENS**

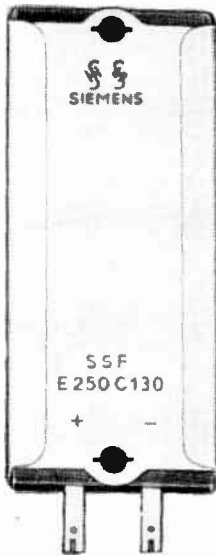
**FLAT SELENIUM RECTIFIERS**

- Exceptionally low forward resistance coupled with high inverse resistance
- High DC voltage supplied with minimal heating

- Wide range
- Minimum size
- Mount anywhere on chassis
- Inexpensive
- High Life endurance

For full information and prices, please write to:

**electrodesign**

736 Notre Dame W.  
Montreal — University 6-7367

INSTRUMENTS  
CONTROLS  
PRECISION  
COMPONENTS

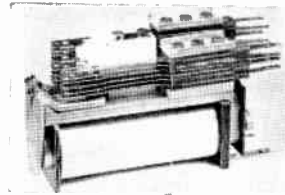

A Typical  
3000 Type  
Relay

**MAGNETIC RELAYS**

B.P.O. Types 3000 and 600 to your specification. Coils up to 100,000 ohms. Tropical Baking or Vacuum Impregnating also available. Speedy deliveries . . . Enquiries invited.

Full details and prices from our Canadian Agents:  
Electronic Research Co., 292 Glemount Ave., Toronto.

**KAYE ELECTRICAL MANUFACTURING CO.**  
Havelock Works, Havelock Place,  
HARROW, MIDDX., ENGLAND

VISIT



manufacturer  
of precision  
miniature resistors

and electronic components at the

**IRE show** BOOTHS  
769-771

**WIRE WOUND RESISTORS** • Types RS, RH, WWA and WWL (precision encapsulated), and RSE (ruggedized).

**DEPOSITED CARBON RESISTORS** • Types DC, DC-5 (high voltage), DCH (hermetic seal ruggedized).

Canadian Representative:  
**CHARLES W. POINTON LIMITED**  
6 Alcina Avenue, Toronto

**DALE PRODUCTS INC.**  
1322 28th Avenue  
Columbus, Nebr., U.S.A.

# TRANSFORMERS—

- FOR REPLACEMENT WORK
- FOR SOUND EQUIPMENT
- FOR TRANSMITTING EQUIPMENT
- FOR INDUSTRIAL APPLICATIONS
- FOR TEST AND DEVELOPMENT PURPOSES

Here's what the  
**HAMMOND**  
TRANSFORMER SERVICE  
offers you

Your enquiries are invited for small or large quantities.

- ★ Over 1,000 different stock items listed.
- ★ Over 38,000 different designs built.
- ★ Over 8,000 different fabricated metal types built.
- ★ Parts service from leading jobbers coast to coast.

**HAMMOND MANUFACTURING COMPANY LIMITED, GUELPH, CANADA**

For further data on advertised products use page 83.



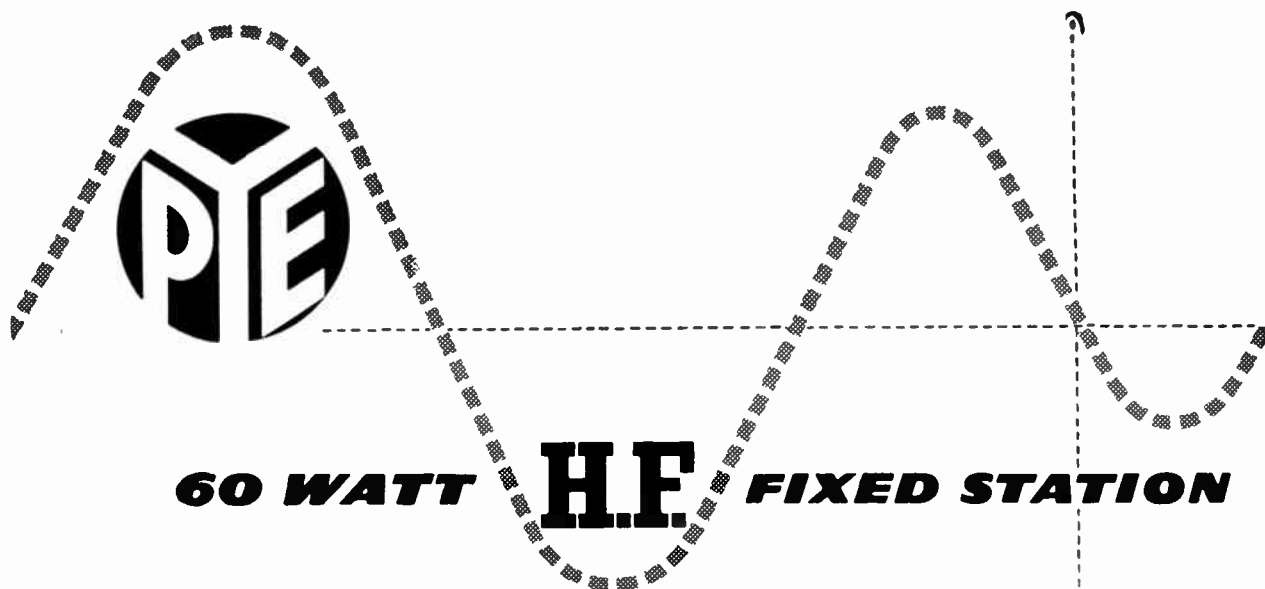

This completely new Pye station has been specifically designed for point-to-point communication and will fulfill equally well a ground-to-air role in air traffic control systems.

Push button control brings any one of four preselected channels into immediate operation; this facility is also available when the equipment is installed for remote unattended operation. The 60 watt Fixed Station Transmitter offers R/T, C/W, or M.C.W. operation with 'breakin' facilities on telegraphy.

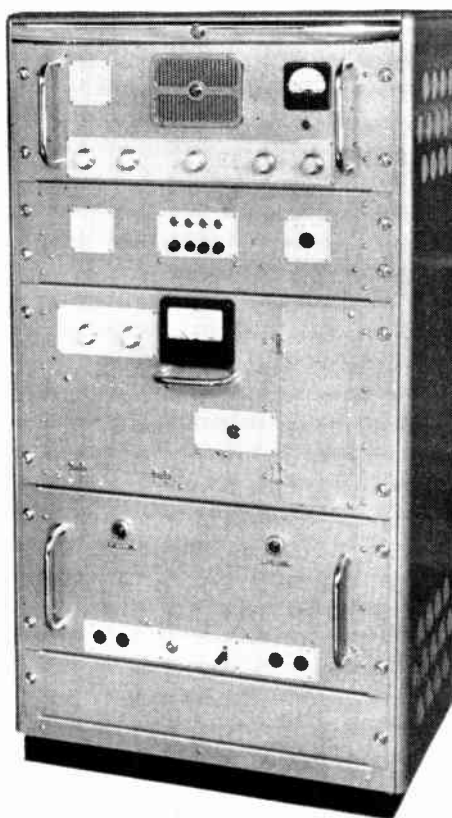

or to:  
1191 University St., Montreal, P.Q.  
193 E. Hastings St., Vancouver, B.C.  
3 Duke Street, Halifax, N.S.  
plant: Ajax, Ontario

Engineers and consultants on mobile, fixed-to-mobile, point-to-point and multi-channel radio communication systems; suppliers of telephone apparatus of all kinds; manufacturer and supplier of scientific instruments, industrial and commercial television cameras.

## NEWS

(Continued from page 61)

### Andrew Gilchrist Ltd. Canadian Sales Agents For Chase & Sons Inc.

Andrew Gilchrist, Ltd., 155 Decarie Boulevard, Ville St. Laurent, Montreal, Quebec, have been appointed exclusive sales agent in Canada by Chase & Sons Inc., Randolph, Mass., U.S.A., for their DuPont Mylar laminations for electrical insulation in motors, transformers and similar equipment.



● Electro Sonic appointments are left to right: Messrs. Ted Major, Colin Mackenzie and Val Galka.

### Three Electro Sonic Appointments

Three new appointments to the executive staff of Electro Sonic Supply Co. Ltd., 543 Yonge Street, Toronto, have been announced by J. B. Christie, general manager of the company.

Val Galka has been appointed dealer sales manager and will be responsible for dealer sales in his new capacity. In the radio parts jobbing business for the past ten years, he has also had considerable experience in the field of retail sales and service. Mr. Galka succeeds Len Finkler, who recently left the firm to enter his own business.

Colin D. MacKenzie has been promoted to the position of industrial sales manager. Formerly on the industrial sales force of the firm, Mr. MacKenzie is well known throughout the industry.

Ted Major has been appointed mail order manager, and will be responsible for mail order sales for the whole of Canada. Mr. Major has been associated with both the dealer sales and the industrial sales staffs and is well known across Ontario.

All three have been with the present firm since its inception.

### New Premises For Pylon Electronic Development Company Limited

Acquisition of new premises with over 3,000 square feet of fully-modern self-contained plant and office space has been announced by Stanley E. A. Pinnell, president of Pylon Electronic Development Company, Ltd., of Montreal. Specialists in the fields of industrial electronics, communications and defense electronics, the company maintains a highly skilled technical staff, including scientists and engineers who have made substantial contributions to the defense program in Canada.

At the same time, the appointment of Al Patterson, P.Eng., was announced as manager of the company's newly formed Toronto sales office.

(Turn to page 68)

# A lot depends on the spring

The electrical industry in all its phases, from intricate electronics through to small appliances, probably use more precision built springs than any other industry.

Bohne Industries Limited are proud that they supply the producers of electrical apparatus and equipment with precision springs manufactured and tested to meet exacting specifications.

Send blueprint or sample for quotation.

## BOHNE

### INDUSTRIES LIMITED

1153 QUEEN ST. WEST, TORONTO





**NEW PRODUCTS**

(Continued from page 60)

● **Integral Drive Fractional Horsepower Blower Motor**

Item 995

Increased efficiency with reduced size and weight are among the advantages offered by a completely new integral drive fractional horsepower blower motor.

The new motor differs from conventional motors in that the rotating member, or rotor, is on the outside and revolves around a stationary shaft and stator assembly. Lead wires pass through the hollow stationary shaft to the stator windings.

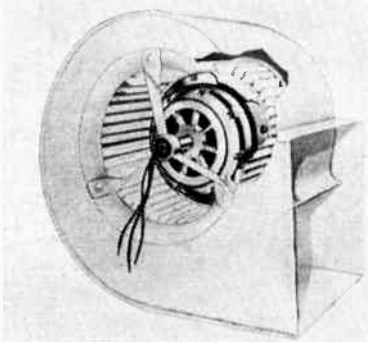

Integral drive of the blower wheel is accomplished by a flange on the rotor which connects directly to the wheel, eliminating all necessity for belts, pulleys, or special motor mounts. Wheel and motor share a common shaft and bearings; quiet-type precision ball bearings, which never require oiling, make it possible to mount the motor with the shaft vertical or in any desired position.

Over-all advantages of design and application are said to be greater air delivery in relation to size, weight, power input and cost of the blower-motor combination. First production models are rated at 1/4 horsepower. Weight is 12 1/2 pounds; diameter, 6 inches; width, 4 5/8 inches.

● **Turret Type Contact For Rotary Step-Type Switches**

Item 996

A new turret type contact for use on rotary step-type switches is a one-piece combination contact and turret lug. It is made of solid silver alloy, which, in turn, is gold plated to provide corrosion resistance and to facilitate soldering.

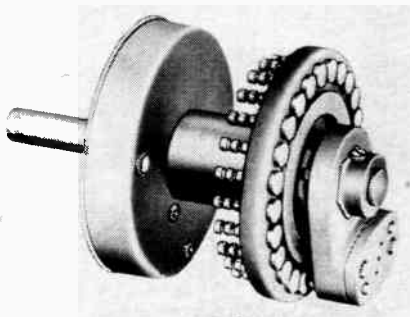

The new turret lug-contact combination is made with several notches to hold the wire mechanically as well as electrically. This added feature is now being supplied on all switches produced by this manufacturer, which are well suited for application in test equipment, instruments, guided-missile control stations and aircraft and airborne fire-control systems.

(Turn to page 78)

**The most complete line of AIRCRAFT INVERTERS**

**BY BENDIX**

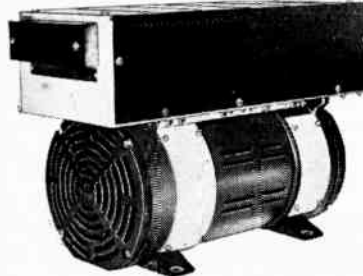

The Red Bank Division of Bendix Aviation Corporation can provide the answer to your aircraft inverter needs. BENDIX offers . . .

- A complete line of inverters.
- Unified mechanism design—incorporating inverter and control.
- Custom design facilities for special purpose inverters . . .

. . . presently developing inverters up to 5000VA and for high-temperature, high-altitude applications.

The reliability of Bendix inverters has been proved by the many Canadian users over the past years.

Current production models are described below. For further details on these and on special purpose design as well as on the complete line of aircraft accessories write: Aviation Electric Ltd., 200 Laurentien Blvd., Montreal.

**INVERTERS-400 CYCLE OUTPUT**

TYPE NUMBER	INPUT		OUTPUT			APPROX. WEIGHT LBS.	MAX. ALT. FEET	DESIGNED TO GOVT. PARTS NO.
	VOLTS	AMPS.	VOLTS	PHASE	V.A. RATING			
12128	27.5	1	26	1	6	2.2	35000	AN3496-1 AF
12126	27.5	2	26	3	10	2.3	35000	N1020-SK
MG-54	27.5	22	115/200	1	250	17	65000	E-5109
				3	250			
12142	27.5	22	115	1	250	13	35000	N-17158 NAVY
				3	250			
12146-1	27.5	22	115	1	250	13	35000	5386239 AF
12146-3	27.5	22	115	1	250	13	35000	—
				3	250			
MG-60	27.5	22	115	1	250	17	50000	5386239 AF
MG-62	27.5	22	115	3	250	17	50000	AN3532-2
32E01	27.5	35	115	1	500	25	50000	AN3533-1
				3	500			
32E00	27.5	45-54	115	1	500	34	50000	AN3534-1
				3	750			
MG-57	27.5	100	115/200	1	1250	42	50000	E1737-1 NAVY
				3	1500			
MG-61	27.5	100	115	1	1500	56	65000	53C6767
MG-64	27.5	100	115	3	1500	56	65000	—
MG-70	27.5	105	115/200	1	1500	56	65000	—
				3	1500			
1518 Mod. 1 & 2	27.5	130	115	1	1500	37.5	20000	—
				3	1800			
1518 Mod. 5	27.5	130	115	1	1500	37.5	35000	—
				3	1800			
32E06	27.5	180	115/200	1	2250	56	50000	E1725 NAVY
				3	2500			
32E03	27.5	160	115	1	2500	61	50000	5386227
				3	2500			
32E09	27.5	180	115	1	2500	56	50000	—
				3	3000			

NOTE: D.C. input voltage shown is a nominal value of 27.5 volts, but all units are designed to operate from 26 to 29 volts. Input amperes shown are values at 27.5 volt input.

Complete sales and service facilities on aircraft accessories and instruments.

**AVIATION ELECTRIC\***  
LIMITED

MONTREAL

VANCOUVER

AE-54-2 Rev.

\*Canadian Representative



# THERMOSTATIC DELAY RELAYS



STANDARD

Provide delays ranging from 2 to 150 seconds.

**MOST COMPACT  
MOST ECONOMICAL  
HERMETICALLY SEALED**

- Actuated by a heater, they operate on A.C., D.C., or Pulsating Current.

- *Hermetically sealed.* Not affected by altitude, moisture, or other climate changes.

- Circuits: SPST

only—normally open or normally closed.

Amperite Thermostatic Delay Relays are compensated for ambient temperature changes from  $-55^{\circ}$  to  $+70^{\circ}$  C. Heaters consume approximately 2 W. and may be operated continuously. The units are most compact, rugged, explosion-proof, long-lived, and — very inexpensive!

TYPES: Standard Radio Octal, and 9-Pin Miniature.

**PROBLEM? Send for Bulletin No. TR-81**

Also — a new line of Amperite Differential Relays — may be used for automatic overload, over-voltage, under-voltage or under-current protection.



MINIATURE



# BALLAST REGULATORS



T9 BULB

- Amperite Regulators are designed to keep the current in a circuit *automatically regulated* at a definite value (for example, 0.5 amp.).

- For currents of 60 ma. to 5 amps. Operates on A.C., D.C., or Pulsating Current.

- Hermetically sealed, light, compact; most inexpensive.

Amperite Regulators are the simplest, most effective method for obtaining *automatic regulation* of current or voltage. *Hermetically sealed*; not affected by changes in altitude, ambient temperature ( $-55^{\circ}$  to  $+90^{\circ}$  C), or humidity. Rugged; no moving parts; changed as easily as a radio tube.

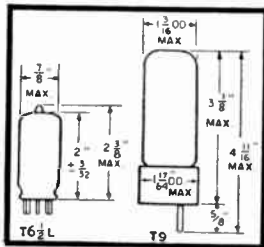
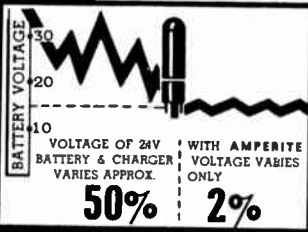

Write for 4-page Technical Bulletin No. AB-51

# AMPERITE CO., Inc.

561 Broadway, New York 12, N. Y.

In Canada: Atlas Radio Corp., Ltd., 560 King St., W., Toronto 2B

# A USE IT YOURSELF SECTION

will appear in the June 1956 issue of

## ELECTRONICS AND COMMUNICATIONS

as a special contribution to progress in the market it is dedicated to serve.

Its objective is to help expand the use of electronic and communications equipment throughout the entire industrial and commercial field in Canada.

The section will present brief, concise reports on many industrial and commercial applications of electronics and communications — informative material that should be the starting point of many sales.

Extra copies of the issue will be published and are being offered free on request to interested executive personnel — through a three months' advertising campaign, directed to over 25,000 establishments in Canada.

The more industrial electronic and communications equipment used in Canada — the more parts, components, materials and Canadian labor will be needed.

Your interested co-operation in this constructive effort will be greatly appreciated.  
35 Willcocks Street, Toronto

*Insulated*  
**TERMINAL LUGS**

USECO's quality insulated lugs give you ...

- Wide selection of types
- Phenolic or moulded melamine
- High dielectric strength
- Choice of various platings
- Standoffs and feed-thrus
- Immediate deliveries

Write for Engineering Manual and complete information. Please address Dept. 18

**U. S. ENGINEERING CO., INC.**  
A Division of Litton Industries, Inc.  
521 Commercial Street, Glendale 3, California

In Canada: LAKE ENGINEERING CO., LTD.  
36 Upton Road, Scarborough, Toronto, Ontario,

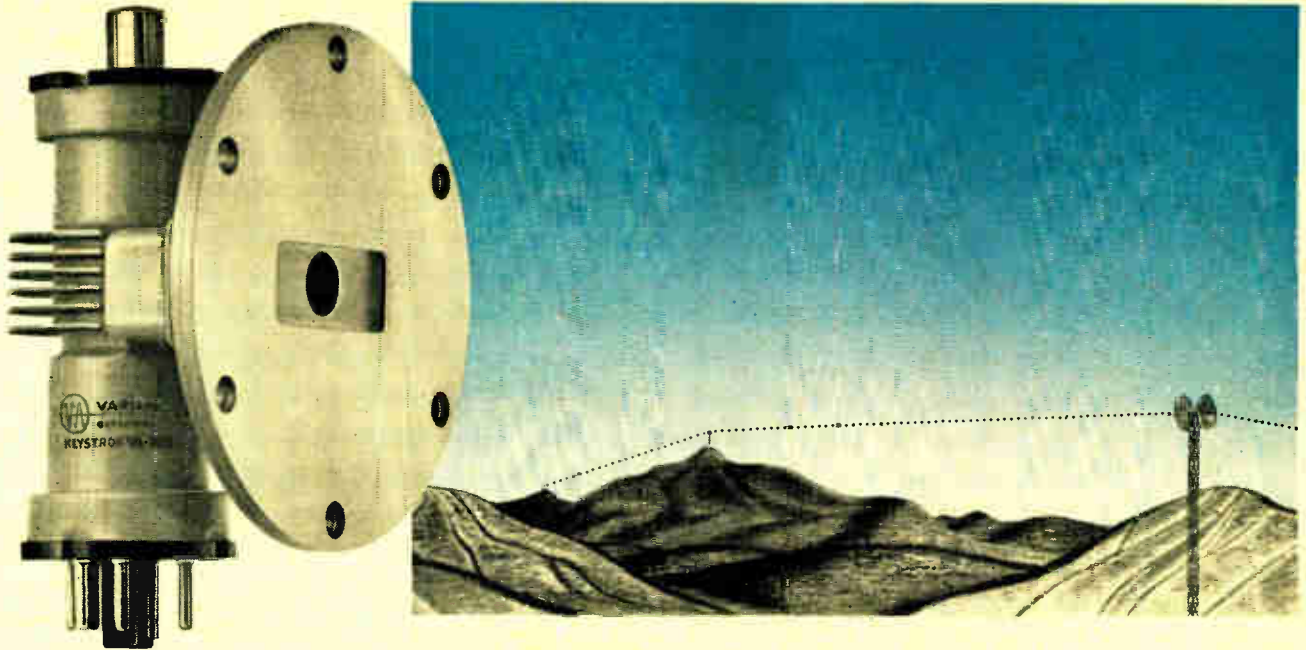

# NOW... at *half* the former cost

## VARIAN brings you

### A NEW, HIGH PERFORMANCE RELAY KLYSTRON

It's the VA-220, another outstanding example of Varian design leadership . . . research and product engineering that brings you the most dramatic cost reduction in the history of high performance klystrons — **with no compromise in quality.**

**UNSURPASSED  
FOR EVERY  
RELAY APPLICATION**

Microwave relay system designers and equipment buyers have long known that Varian relay klystrons are unmatched for frequency stability, power to override noise, reliability and long life. The VA-220 gives you performance that even exceeds the high standards set by Varian X-26 klystrons . . . at half the cost.

In the 6000 - 8000 megacycle band, VA-220 klystrons will consistently outperform all others. Here are six reasons why this sensational new klystron is your best buy for all relay applications:

**THESE ADVANTAGES  
MEAN TOP PERFORMANCE**

- **Greater Power**—VA-220 high power klystrons are conservatively rated. They will deliver more than rated power without failure.
- **Greater Frequency Stability**—VA-220 klystrons have negligible frequency drift.
- **Greater Uniformity**—Varian mass production techniques assure uniformity—every klystron is as reliable as a nut and bolt.
- **Longer Life**—VA-220 klystrons can be operated at full power for thousands of hours.
- **Less Distortion, Less Noise**—FM distortion and inherent noise are negligible—60 db below a 1-megacycle deviation.
- **Lower Cost**—VA-220 klystrons cost far less than any other relay klystron with comparable performance characteristics.

TYPE	FREQUENCY RANGE	RESONATOR VOLTAGE	POWER OUTPUT	BANDWIDTH	MODULATION SENSITIVITY
VA-220*	5925 - 7425 mc	750 v	1.2 watts	35 mc	375 kc/v
*VA 220 B, C, D, E and F each cover a frequency range of approximately 300 mc					

**FOR COMPLETE SPECIFICATIONS** . . . and technical data on the VA-220 and other Varian klystrons, write to the Varian Application Engineering Department today.

THE  
MARK OF  
LEADERSHIP

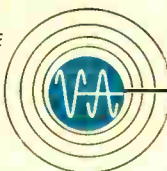

**VARIAN associates**  
OF CANADA, LTD. • GEORGETOWN, ONTARIO

KLYSTRONS, TRAVELING WAVE TUBES, BACKWARD WAVE OSCILLATORS, LINEAR ACCELERATORS, MICROWAVE SYSTEM COMPONENTS, R. F. SPECTROMETERS, MAGNETS, MAGNETOMETERS, STALOS, POWER AMPLIFIERS, GRAPHIC RECORDERS, RESEARCH AND DEVELOPMENT SERVICES



# shopping for capacitors?

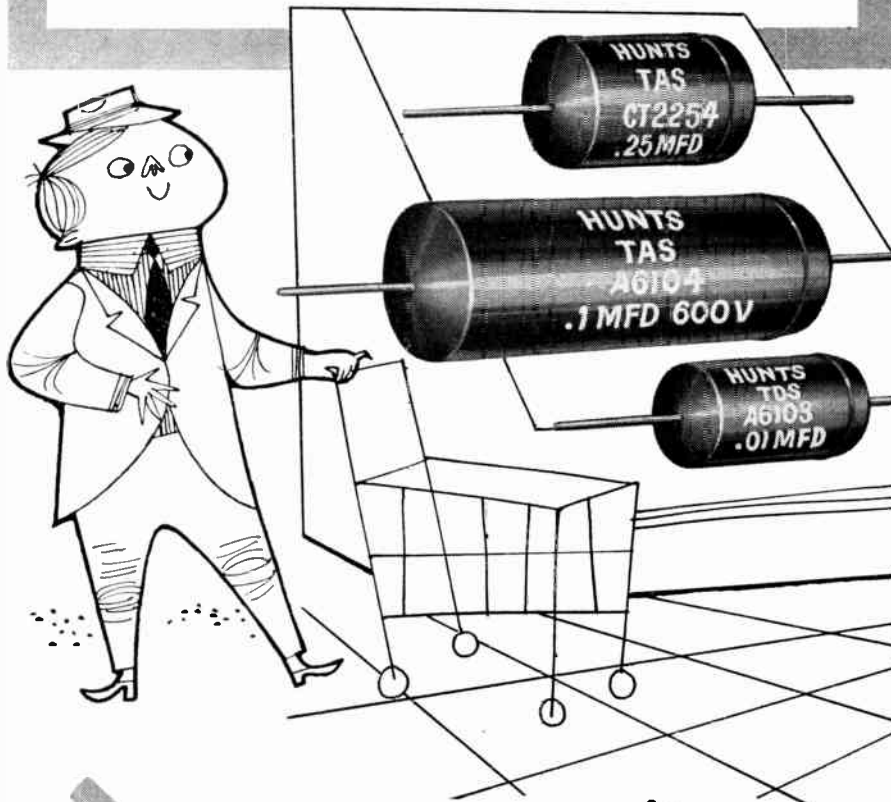

## HUNT capacitors can fill all your needs

engineered to meet  
Canadian requirements

### CAPACITOR RANGES\*

100 V	from .001 mfd to 2 mfd
200 V	from .001 mfd to 2 mfd
400 V	from .680 mmfd to 1 mfd
600 V	from 2.5 mmfd to .27 mfd
1000 V	from .001 mmfd to .1 mfd

\*If your requirements are other than shown, Hunt Capacitors (Canada) Limited is fully equipped to engineer and produce capacitors to your exact specifications.

Hunt Capacitors (Canada) Limited produce a wide range of finest quality capacitors in many shapes, sizes and materials to meet every need of the Canadian manufacturer. Standard Hunt Capacitors operate throughout the temperature range of  $-30^{\circ}\text{C.}$  to  $+85^{\circ}\text{C.}$  and tolerances of  $\pm 20\%$ . Closer tolerances are available on special order. See your Hunt representative or write us for information on the complete Hunt Capacitor line.

## HUNT CAPACITORS (CANADA) LIMITED

830 BAYVIEW AVENUE, TORONTO, ONT.

For further data on advertised products use page 83.

### NEWS

(Continued from page 64)

#### Toronto Section I.R.E. Host To Atomic Energy Of Canada Executive

The Toronto Section, I.R.E., held its first meeting of 1956 on January 16, at the University of Toronto. The speaker on this occasion was J. Hardwick, B.Sc., M.I.E.E., Atomic Energy of Canada, Limited.

Mr. Hardwick dealt in a most stimulating way with the trend of electronic development at Chalk River. With the ultimate aim of maximum reliability such development tends towards the almost complete elimination of thermionic tubes in favor of transistors, cold-cathode trigger tubes, Dekatrons, magnetic cores, etc. Circuit diagrams of several specialized units were shown and discussed and two types of modern switching tubes were passed around for inspection.



● The appointment of Robert E. Parrott to the sales staff of the John Herring Company has been announced by officials of the company. Mr. Parrott who will act in the capacity of a sales representative was previously employed in the purchasing Department, Electronic Equipment Division of the General Electric Company.

#### Aviation Electric Becomes Bendix Affiliate Operating In Canada

Fred Bandi, President of Aviation Electric Limited, has announced that the Bendix Aviation Corporation has acquired a substantial interest in Aviation Electric Limited and that the company will now operate in Canada as a Bendix affiliate. There will be no change in the policy or management of the company, but arrangements just concluded will allow Aviation Electric Limited to expand its activities in the aviation and marine fields.

Aviation Electric Limited will now have available the latest Bendix engineering and production techniques which can be provided for the fast growing Canadian aviation industry.

(Turn to page 74)



# Heathkit PRINTED CIRCUIT 5" COLOR TV Oscilloscope Kit

MODEL  
0-10  
**\$69<sup>50</sup>**  
Shpg. Wt. 27 lbs.

The technical specifications for this fine instrument speak for themselves. Vertical channel sensitivity is 0.025 volts RMS/inch at 1 Kc. Vertical frequency response is essentially flat to 5 Mc, and down only 1.5 db at 3.53 Mc. Ideal for Color TV work!

Extended sweep generator range is from 20 cps to 500 Kc in five steps, far beyond the range normally encountered at this price level.

Other features are: plastic-molded capacitors for coupling and by-pass—preformed and cabled wiring harness—Z axis input for intensity modulation—peak-to-peak voltage calibrating source built-in—retrace blanking amplifier—regulated power supply—high insulation printed circuit boards—step attenuated and frequency compensated vertical input circuit—push-pull horizontal and vertical amplifiers—excellent sync. characteristics—sharp, hairline focusing—uses 5U1 CRT—extremely attractive physical appearance.

An essential instrument for professional Laboratory, or for servicing mono-chrome or color TV.

## Heathkit PRINTED CIRCUIT 3" OSCILLOSCOPE KIT

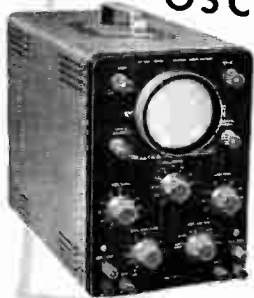

This light, portable 3" oscilloscope is just the ticket for the ham, for service calls, or as an "extra" scope in the shop, or lab. Measures only 9 1/2" H x 6 1/2" W x 11 3/4" D, and weighs only 11 lbs.

Employs printed circuit board for improved circuit performance. Vertical amplifiers flat within +3 db from 2 cps to 200 Kc. Vertical sensitivity 0.25 volts RMS/inch peak-to-peak, and sweep generator operates from 20 cps to 100,000 cps. R.F. connection to deflection plates.

**\$29<sup>50</sup>**

Shpg. Wt. 14 lbs.

## Heathkit PRINTED CIRCUIT 5" OSCILLOSCOPE KIT



This full-size 5" Oscilloscope incorporates many outstanding features.

Vertical channel flat within +3 db, 2 cps to 200 Kc. with 0.09 volts RMS/Sweep operation from 20 cps to 100,000 cps. Built-in peak-to-peak voltage calibration—3 step frequency compensated input attenuator—phasing control—push-pull deflection amplifiers. Printed circuits for reliable performance and reduced construction time.

**\$49<sup>50</sup>**

Shpg. Wt. 26 lbs.



## Heathkit PRINTED CIRCUIT VACUUM TUBE VOLTMETER KIT

MODEL V-7

**\$24<sup>50</sup>**

Shpg. Wt. 7 lbs.

This VTVM has set a new standard for accuracy and reliability in kit-form electronic instruments. Features modern, time-saving printed circuits, and functional arrangement of controls and scales. Includes new peak-to-peak scale for FM and TV work.

Measures AC (RMS) and DC voltage at 0-1.5, 5, 15, 50, 150, 500, and 1500; peak-to-peak AC voltage at 0-4, 14, 40, 140, 400, 1400, and 4000; center scale resistance readings of 10, 100, 1000, 10,000, 100 K, 1 meg., and 10 meg. DB scale provided also. Zero-center operation within range of front panel controls. Polarity reversal switch—200 ma 4 1/2 meter-transformer power supply—1 megohm input impedance—1% precision resistors—high quality components used throughout.



## Heathkit 20,000 ohms/volt MULTIMETER KIT

MODEL MM-1

**\$29<sup>50</sup>**

Shpg. Wt. 6 lbs.

Features comprehensive range coverage, 20,000  $\Omega/V$  D.C. and 5000  $\Omega/V$  A.C. Ranges: 0-1.5, 5, 50, 150, 500, 1500, and 5000 V. direct current from 0 to 150  $\mu$ a., 15 a. in 5 steps. Center-scale resistance of 15, 1500 and 150,000 ohms, and db from -10 to +65.

Uses 1% precision resistors—50  $\mu$ a. meter—molded bakelite case.

## Heathkit DIRECT-READING CAPACITY METER KIT



MODEL CM-1

**\$29<sup>50</sup>**

Shpg. Wt. 7 lbs.

Extremely valuable where speed and convenience are essential. Quality control work, production line checking, etc. Reads capacity directly on meter scale, from 0-100 mmfd, 1000 mmfd, .01 mfd, and .1 mfd. Residual capacity less than 1 mmfd. Not susceptible to hand capacity.



## Heathkit A. C. VACUUM TUBE VOLTMETER KIT

MODEL AV-2

**\$29<sup>50</sup>**

Shpg. Wt. 5 lbs

Measures AC voltage only, from 10 cps to 50 Kc. Covers the range from 1 millivolt to 300 volts in 10 steps at high impedance input. Incorporates full 10 ranges of db scale from -52 db to +52 db. Essential in the audio laboratory or for audio enthusiasts and experimenters. Provides sensitivity essential for low level audio measurements.

## Heathkit ELECTRONIC SWITCH KIT

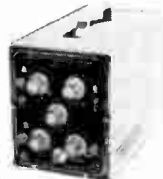

MODEL S-2

**\$23<sup>50</sup>**

Shpg. Wt. 11 lbs.

This device will electronically switch between 2 input signals to produce both signals alternately at the output. Used in conjunction with an oscilloscope, it will permit the observation of 2 signals simultaneously. Provides switching rates from 10 cps to 200 cps.

## Heathkit VOLTAGE CALIBRATOR KIT

Once calibrated, this instrument provides a known peak-to-peak voltage standard for comparison with unknown voltage values on an oscilloscope. Panel calibrated directly—no involved calculations required. Operates within a voltage range of .01 to 100 volts peak-to-peak.



MODEL VC-2

**\$11<sup>50</sup>**

Shpg. Wt. 4 lbs

# HEATH *Company*

A SUBSIDIARY OF DAYSTROM INC.

BENTON HARBOR 3, MICHIGAN



# SELECT YOUR NEXT HEATHKIT FROM

## Heathkit TUBE CHECKER KIT



**MODEL TC-2**  
**\$29.50**

Shpg. Wt.  
12 lbs.

Because of its low price this fine tube tester is available, not only to the service shop and laboratory, but to part-time servicemen, experimenters, and radio amateurs, as well. Will test all tubes commonly encountered in radio and TV service work. Simple "GOOD-BAD" scale on the 4 1/2" meter. Tests for open, short, and quality on the basis of total emission. Includes illuminated roll chart. Fourteen different filament voltage values available. Separate lever switch for each tube element.

Model TC-2P is the same electrically as TC-2, except that it is housed in a beautiful two-toned portable carrying case. Only \$34.50. Shpg. Wt. 15 lbs.

Portable carrying case available separately for Model TC-2, or older model TC-1. Cab. No. 91-8, \$7.50. Shpg. Wt. 7 lbs.

CRT Test Adapter, Model 355 for use with the TC-2, \$4.50. Shpg. Wt. 1 lb.

## Heathkit TV ALIGNMENT GENERATOR KIT

Here is the complete R.F. signal source for FM and TV alignment, (both monochrome and color). Provides output on fundamentals from 3.6 Mc to 220 Mc in four bands, with harmonic output usable up through the UHF channels. Electronic sweep circuit eliminates mechanical gadgets and accompanying noise, hum, and vibration. Continuously variable sweep up to 0-42 Mc, depending on base frequency.

Variable marker (19-60 Mc on fundamentals) and crystal marker (4.5 Mc and multiples thereof) generators built-in. Crystal included with kit. Provision for external marker if desired.

Packed with outstanding features. 50 ohm output impedance—exceptionally good linearity—effective AGC action—plenty of R.F. output. An essential instrument for the up-to-date service shop.



**\$49.50**

**MODEL TS-4**  
Shpg. Wt. 16 lbs.



**MODEL SG-8**  
**\$19.50**

Shpg. Wt.  
8 lbs.

## Heathkit SIGNAL GENERATOR KIT

This is one of our most popular kits, and is "serviceman engineered" to fulfill the signal source requirements of the radio serviceman and experimenter.

Covers 160 Kc to 1.0 Mc on fundamentals (5 bands), with output in excess of 100,000 microvolts. Calibrated harmonics extend usefulness up to 220 Mc. Choice of unmodulated R.F. output, 400 cps modulated R.F. output, or 400 cps audio output. Step-type and continuously variable output attenuation controls.

Coils are prewound, and construction manual is complete. Calibration unnecessary for service applications.

Model RS-1

## Heathkit RESISTANCE SUBSTITUTION BOX KIT



Provides switch selection of 36 RTMA 1 watt standard 10% resistors, ranging from 15 ohms to 10 megohms. Numerous applications in radio and TV work.

**\$5.50**

Shpg. Wt.  
2 lbs.

## Heathkit CONDENSER SUBSTITUTION BOX KIT

Very popular companion to Heathkit RS-1. Individual selection of 18 RTMA standard condenser values from .0001 mfd to .22 mfd. Aluminum panel, bakelite case, and includes 18" flexible leads with alligator clips.

**Model CS-1**  
**\$5.50**

Shpg. Wt.  
2 lbs.



## Heathkit CONDENSER CHECKER KIT

Measures capacity in four ranges from .00001 to 1000 mfd. Power factor control is provided for indication of electrolytic condenser efficiency.

Tests capacitors under actual load conditions. Checks resistance from 100 ohms to 5 megohms. Direct reading scales for all tests. No calculation necessary.



**Model C-3**  
**\$19.50**

Shpg. Wt. 7 lbs.

## Heathkit LABORATORY GENERATOR KIT

Here is a signal generator for use where high accuracy and metered performance are essential. Covers 150 Kc to 30 Mc on fundamentals in 5 bands, 400 cps modulation variable from 0 to 50%. R.F. output at 50 Hz from 100,000 to 1 μv. Meter reads R.F. output in μv. or modulation percentage. Fixed-step and variable output.



**\$39.50**

Shpg. Wt.  
16 lbs.

Model T-3

## Heathkit VISUAL-AURAL SIGNAL TRACER KIT



**\$23.50**

Shpg. Wt. 9 lbs.

This signal tracer features a high-gain R.F. channel and probe to permit signal tracing from the receiver antenna input through the R.F. and I.F. stages. Separate low gain channel for audio circuits. Both visual and aural indication by means of speaker and electron beam "eye" tube.

Also noise locator circuit, wattmeter, and terminals for "patching" output transformer or speaker into external circuit.

Model M-1

## Heathkit HANDITESTER KIT



**\$14.50**

Shpg. Wt.  
3 lbs.

The M-1 is literally pocket size to fit in your coat pocket, tool-box, glove compartment, or desk drawer. Measures A.C. or D.C. v. in 5 steps from a full scale minimum of 0-10 v. to a maximum of 0-5000 v. Measures direct current at 0-10 Ma and 0-100 Ma, and provides ohmmeter ranges of 0-3000 and 0-300,000 ohms. Sensitivity of 1,000 ohms/v. 1% precision divider resistors employed.

Model DR-1

## Heathkit DECADE RESISTANCE KIT



Twenty 1% precision resistors provide resistance from 1-99,999 ohms in 1 ohm steps. Indispensable around service shop, laboratory, ham shack, or home workshop.

**\$19.50**

Shpg. Wt.  
4 lbs.

## Heathkit DECADE CONDENSER KIT

Provides capacity values from 100 mmf to 0.111 mfd in steps of 100 mmfs. +1% precision silver-mica condensers used. High quality ceramic wafer switches for reduced leakage.



Shpg.  
Wt. 3 lbs.

**\$16.50**

# HEATH Company

A SUBSIDIARY OF DAYSTROM INC.  
BENTON HARBOR 3, MICHIGAN

# THESE HIGH QUALITY INSTRUMENTS

## Heathkit HARMONIC DISTORTION METER KIT



**MODEL HD-1**  
**\$49.50**  
Shpg. Wt. 13 lbs.

Performs the functions of more elaborate and much more expensive audio distortion testing devices and yet is simple to operate and inexpensive to own. Used with a sine wave generator, it will check the harmonic distortion output of audio amplifiers under a variety of conditions. Essential in audio design work.

The HD-1 reads harmonic distortion directly on the meter as a percentage of the original signal input. It operates from 20 to 20,000 cps in 3 ranges, and incorporates a VTVM circuit for initial reference settings and final harmonic distortion readings. VTVM ranges are 0-1, 3, 10, and 30 volts full scale. 1% precision voltage divider resistors used. Distortion meter scales are 0-1, 3, 10, 30 and 100% full scale. Having a high input impedance the HD-1 requires only .3 volt input for distortion tests.

## Heathkit AUDIO GENERATOR KIT

This basic audio reference generator deserves a place in your Laboratory. Complete frequency coverage is afforded from 20 cps to 1 Mc in 5 ranges, and output is constant within  $\pm 1$  db from 20 cps to 400 Kc, down only 3 db at 600 Kc., and 8 db at 1 Mc. An extremely good sine wave is produced, with a distortion percentage below 0.4% from 100 cps through the audible range.

Plenty of audio output for all applications; up to 10 v. under no load conditions. Output controllable with a continuously variable or step-type attenuator with settings of 1  $\mu$ v, 100  $\mu$ v, 1 v, and 10 v. Cathode follower output.



**MODEL AG-8**  
**\$29.50**  
Shpg. Wt. 11 lbs.

## Heathkit AUDIO ANALYZER KIT



**MODEL AA-1**  
**\$59.50**  
Shpg. Wt. 13 lbs.

The AA-1 consists of an audio wattmeter, an AC VTVM, and a complete IM analyzer, all in one compact unit. It offers a tremendous saving over the price of these instruments purchased separately.

Use the VTVM to measure noise, frequency response, output gain, power supply ripple, etc. Use the wattmeter for measurement of power output. Internal loads provided for 4, 8, 16, or 600 ohms. VTVM also calibrated for DBM units so db gain or loss can be noted quickly.

High or low impedance IM measurements can be made. High (6 Kc) and low (60 cps) frequency generators built-in. Only 4 meter scales are employed, and one of these is in color so that results are easily read on the scale. Full scale VTVM ranges are .01 to 300 volts in 10 steps, full scale wattmeter ranges are .15 mw to 150 w in 7 steps. IM analyzer scales are 1%, 3%, 10%, 30% and 100%.

## Heathkit VARIABLE VOLTAGE POWER SUPPLY KIT



**Model PS-3**  
**\$35.50**  
Shpg. Wt. 17 lbs.

Provides regulated DC output for B+, and 6.3 v. AC at 4 amps. for filaments. Output variable from 0 to 500 v. DC at no load, linear from 0-10 ma at 450 vdc and 0-130 ma at 200 vdc! Essential for circuit design and development. Voltage or current read on  $4\frac{1}{2}$ " meter.

## Heathkit "Q" METER KIT



**Model QM-1**  
**\$44.50**  
Shpg. Wt. 14 lbs.

Will measure Q of condensers, RF resistance and distributed capacity of coils, etc. Uses  $4\frac{1}{2}$ "  $50 \mu$ a meter for direct indication. Will test at 150 Kc to 18 Mc in 4 ranges. Measures capacity from 40 mmf to 450 mmf within  $\pm 3$  mmf. Useful for checking wave traps, chokes, peaking coils. Indispensable for coil winding and determining unknown condenser values.

## Heathkit AUDIO OSCILLATOR KIT



**MODEL AO-1**  
**\$24.50**  
Shpg. Wt. 10 lbs.

(SINE WAVE - SQUARE WAVE)

Features sine or square wave coverage from 20 to 20,000 cps in 3 ranges. An instrument specifically designed to completely fulfill the needs of the serviceman and high fidelity enthusiast. Offers high-level output across the entire frequency range, low distortion and low impedance output. Uses a thermistor in the second amplifier stage to maintain essentially flat output through the entire frequency range. Produces good, clean square waves with a rise time of only 2 microseconds.

## Heathkit IMPEDANCE BRIDGE KIT



Measures resistance, capacitance, inductance, dissipation factors of condensers, and the storage factor of inductance. Employs 2-section CRL dial. D, Q and DQ functions are combined in one control.  $\frac{1}{2}$ % resistors and capacitors used in critical circuits. 100-0-100 microammeter for null indications. 1000 cycle oscillator, 4 tube detector-amplifier, and power supply built-in.

**Model IB-2**  
**\$59.50**  
Shpg. Wt. 12 lbs.

## Heathkit 6-12 VOLT BATTERY ELIMINATOR KIT



Furnishes 6 or 12 volt output for the new 12 v. car radios in addition to 6 v. models. Two continuously variable output voltage ranges: 0-8 v. DC at 10 A. continuously or 15 A. intermittent. 0-16 v. DC at 5 A. continuously or 7.5 A. intermittent. Output voltage is clean and well filtered by two 10,000 mfd condensers. Panel meters read voltage and current output.

**Model BE-4**  
**\$31.50**  
Shpg. Wt. 17 lbs.

## Heathkit BROADCAST BAND RECEIVER KIT



**MODEL BR-2**  
**\$17.50**  
(Less Cabinet)  
Shpg. Wt. 10 lbs.

Build your own receiver with confidence. Complete instruction book anticipates your every question.

Features transformer-type power supply, high-gain miniature tubes, built-in antenna, planetary tuning from 550 Kc to 1600 Kc,  $5\frac{1}{2}$ " speaker. Also adaptable for use as AM tuner or phono amplifier. CABINET: Fabric covered plywood cabinet available, complete with aluminum panel and re-inforced speaker grille. Part No. 91-9, Shpg. Wt. 5 lbs., \$4.50

# HEATH Company

A SUBSIDIARY OF DAYSTROM INC.  
BENTON HARBOR 3, MICHIGAN



**New**

# Heathkit DX-100 PHONE AND CW TRANSMITTER KIT



MODEL DX-100

**\$189<sup>50</sup>**

Shpg. Wt. 120 lbs.

Shipped motor freight unless otherwise requested. \$50.00 deposit required for C.O.D. orders.

This one compact package contains complete transmitter, with built-in VFO, modulator, and power supplies. Provides phone or CW operation—VFO or crystal excitation—and hand-switching from 160 meters through 10 meters. R.F. power output 100—125 watts phone, 120—140 CW. Parallel 6146's modulated by push-pull 1625's. Pi network interstage and output coupling for reduced harmonic output. Will match non-reactive antennas between 50 ohms and 600 ohms. TVI suppressed with extensive shielding and filtering. Rugged metal cabinet has inter-locking seams.

The high-quality transmitter is packed with desirable features not expected at this price level. Copper plated chassis—potted trans-

formers—wide spaced tuning capacitors—ceramic insulation—illuminated VFO dial and meter face—remote control socket—preformed wiring harness—concentric control shafts—high quality, well rated components used throughout. Overall dimensions 20<sup>3</sup>/<sub>4</sub>" wide x 13<sup>3</sup>/<sub>4</sub>" high x 16" deep.

Supplied complete with all components, tubes, cabinet and detailed construction Manual. (Less crystals.) Don't be deceived by the low price! This is a top-quality transmitter designed to give you years of reliable service and dependable performance.

# Heathkit AMATEUR TRANSMITTER KIT



MODEL AT-1

**\$29<sup>50</sup>**

Shpg. Wt. 15 lbs.

Enjoy the trouble-free operation of commercially designed equipment while still benefiting from the economies and personal satisfaction of "building it yourself."

This CW Transmitter is complete with its own power supply, and covers 80, 40, 20, 15, 11 and 10 meters. Single knob handswitching eliminates coil changing. Panel meter indicates grid or plate current for the final. Crystal operation, or can be excited by external VFO. Crystal not included in kit. Incorporates features one would not expect in this price range, such as key-click filter, line-quality components throughout. Instruction Book simplifies assembly. Uses 6AC7 oscillator, 6L6 final and 5U4G rectifier. Up to 35 watts plate power input.



Model GD-1B

**\$19<sup>50</sup>**

Shpg. Wt. 4 lbs.

## Heathkit GRID DIP METER KIT

This is an extremely valuable tool for Hams, Engineers or Servicemen. Covering from 2 Mc to 250 Mc, it uses 500  $\mu$ a meter for indication. Kit includes pre-wound coils and rack. Will accomplish literally hundreds of jobs on all types of equipment.

## Heathkit ANTENNA IMPEDANCE METER KIT

Use in conjunction with a signal source for measuring antenna impedance, line matching purposes, etc. Will double, also, as a phone monitor or relative field strength indicator.

100  $\mu$ a meter employed. Covers the range from 0 to 600 ohms. An instrument of many uses for the amateur.



Model AM-1

**\$14<sup>50</sup>**

Shpg. Wt. 2 lbs.

## Heathkit VFO KIT



MODEL VF-1

**\$19<sup>50</sup>**

Shpg. Wt. 7 lbs.

Weigh the cost of this kit against the cost of crystals—and consider the convenience and flexibility of VFO operation. This is one of the most outstanding kits we have ever offered for the radio amateur.

Covers 160—80—40—20—15—11 and 10 meters with three basic oscillator frequencies. Illuminated and precalibrated dial scale clearly indicates frequency on all bands and provides more than two feet of dial calibration. Reflects quality design in the use of ceramic coil forms and tuning capacitor insulation, and copper plated chassis. Simply plugs into crystal socket of any modern transmitter to provide coverage of the bands from 160 meters through 10 meters. Uses 6AU6 Clapp oscillator, and OA2 voltage regulator for stability. May be powered from plug on Heathkit Model AT-1 Transmitter, or supplied with power from most transmitters.

## Heathkit ANTENNA COUPLER KIT



Model AC-1

**\$14<sup>50</sup>**

Shpg. Wt. 4 lbs.

Poor matching allows valuable communications energy to be lost. The Model AC-1 will match your low power transmitter to an end-fed long wire antenna. Also attenuates signals above 36 Mc, reducing TVI. 52ohm coaxial input—power up to 75 watts—10 through 80 meters.

## Heathkit COMMUNICATIONS RECEIVER KIT



Model AR-2

**\$25<sup>50</sup>**

Shpg. Wt. 12 lbs. (Less Cabinet)

Covers 550 Kc to 35 Mc in 4 bands. Features electrical handspread—separate R.F. and A.F. gain controls—noise limiter—AGC—BFO—phone jack—5<sup>1</sup>/<sub>4</sub>" PM speaker. CABINET: Fabric covered plywood cabinet. Part No. 91-10. Shpg. Wt. 5 lbs. \$4.50

**HEATH Company**  
A SUBSIDIARY OF DAYSTROM INC.  
BENTON HARBOR 3, MICHIGAN

For further data on advertised products use page 83.







*Symbol  
of  
Service  
in  
Communications*

*Bell communications services* are geared to your future as well as your present needs. By *leasing* your communications from Bell you tie up no capital, you are relieved of all maintenance problems and your equipment never becomes obsolete.

*Whatever your communications requirements* you can depend on Bell to recommend and install the type of system best suited to your needs. We will be glad to analyse *your* communications—there's no obligation, of course—just call our nearest Business Office.

**SPECIAL COMMUNICATIONS SERVICES SUPPLIED BY BELL**



BELL TELETYPE



INTERCOMMUNICATING AND PRIVATE LINE TELEPHONE SYSTEMS



MICROWAVE RADIO RELAY SYSTEMS

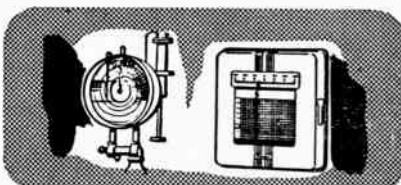

CHANNELS FOR TELEMETERING AND SUPERVISORY CONTROL



MOBILE TELEPHONE SYSTEMS



SPECIAL LONG DISTANCE TELEPHONE SERVICES



**THE BELL TELEPHONE COMPANY OF CANADA**

**NEWS**

(Continued from page 68)

**Canadian Marconi Send Robert E. Foreman To Berne Conference**

A conference of the Radio Marine Associated Companies (R.A.M.A.C.) is to be held at Berne, Switzerland, with Canadian Marconi Company acting as host company to the delegates from the various associated R.A.M.A.C. companies from all points of the globe. Robert E.



R. E. FOREMAN

Foreman, manager of Marconi's Marine Division, Montreal, will head the Canadian Marconi contingent and act as chief host during the conference.

Ways and means of improving marine radio service to shipping by international co-operation between the members will be discussed. R.A.M.A.C. delegates from all continents, except the Far East, will be in attendance at this important conference.

**Sanborn Company To Build \$1,500,000 Plant**

Sanborn Company, manufacturers of precise medical and industrial electronic equipment have announced plans to construct a new \$1,500,000 plant. This 122,000 sq. ft. office and manufacturing plant, to be built and leased under the Cabot, Cabot & Forbes Co. Package Plan, will front on the East Side of Route 128 in the Waltham Industrial Center.

Sanborn Company, a pioneer in profit sharing and employee ownership, have, since 1942, experienced a steady 12-fold growth in the production of medical diagnostic equipment and industrial multi-channel recorders, amplifiers and measuring devices. The new Waltham plant has been laid out to provide much needed facilities for increased engineering and production requirements.

**Microwave Systems Company Announces New Canadian Agency Appointment**

George A. Collins, P.Eng., general manager of Microwave Systems, 891 O'Connor Drive, Toronto, announces his company's appointment as Canadian representatives for the Cascade Research Corporation of Los Gatos, California. Cascade Research Corporation is engaged principally in the development and production of ferrite microwave equipment. Under the new agreement this equipment will be made available in Canada through Microwave Systems.

## S. C. Bird Becomes Vice-President And Director Of Automatic Electric Sales

C. R. Hughes, president of Automatic Electric Sales (Canada) Limited, has announced that, at a recent meeting of the board of directors, S. C. Bird was elected a vice-president and a director of the company.



S. C. BIRD

Mr. Bird joined the company in 1940, was appointed manager of industrial sales in 1945 and general manager in 1954. He will continue in this capacity with the title of vice-president and general manager.

## CAE Open New Branches In Eastern And Western Canada

CAE's Quebec Branch will operate from a newly constructed 19,000 sq. ft. building in Ville St. Laurent, Que., early in 1956. The modern office, service and warehousing facilities are located at 312, Montee de la Cote de Liesse, not far from CAE's \$3,000,000 head office and main plant.

In making the announcement. Mr. K. R. Patrick, OBE, president and managing director, stressed the fact that this will be the second new building to be occupied by a CAE branch in the New Year. A 16,000 sq. ft. building is at present being completed in Vancouver to house CAE's West Coast branch offices and factory.

The Quebec Branch is responsible for the marketing of all CAE consumer and commercial products in its territory which includes Quebec Province and the Ottawa, Cornwall and Kingston regions.

CAE's Quebec Branch is under the management of Mr. Guy Valois who has been associated for a number of years with the Company's Consumer Products operations.

(Turn to page 77)

## ALL SANBORN 150 SERIES OSCILLOGRAPHIC RECORDERS PROVIDE THESE

### SPECIFIC ADVANTAGES

The three foremost operating advantages of a Sanborn "150" are evident in the record, and are given at the right. Equally popular with industrial users is the wide versatility of these systems. Each one comprises a basic assembly to which the user adds his choice of an interchangeable, plug-in type preamplifier for each channel. Presently available different preamplifiers now number eleven.

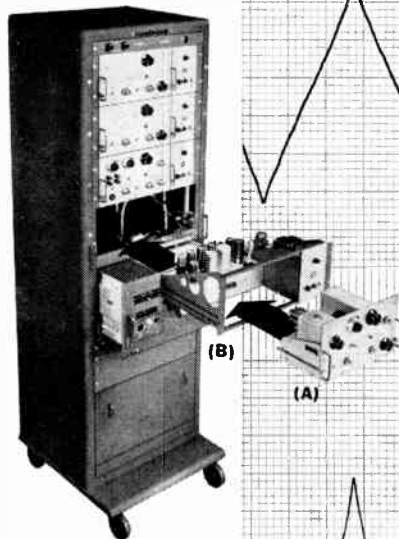

Preamplifier (A) shown in position to plug into a Driver Amplifier with Power Supply (B) which are normally already in place in the Basic Cabinet Assembly

SANBORN Recording Permapaper

### Rectangular Coordinate Recording

is a Sanborn feature that is especially valuable in multi-channel recording. The user of a 2-, 4-, 6- or 8-channel "150" system can record interrelated events simultaneously on one strip of record paper, and then correlate them against time quickly and accurately, even during the recording.

### Clear, Sharp, Inkless Tracings

The nichrome ribbon "150" heated stylus removes the white opaque surface of Sanborn recording paper (Permapaper) permitting the black undercoating to show. Tracings are permanent, will not fade or smudge.

### Improved Over-all Linearity

resulting from current feedback design of Driver Amplifiers and new shorted coil frame, high torque (200,000 dyne cm.) galvanometers. Maximum error over middle 4 cm. of chart: 0.25 mm . . . over entire 5 cm. chart width: 0.5 mm.

INDUSTRIAL DIVISION

**SANBORN CO.**

195 Massachusetts Ave., Cambridge Mass.

A new "150" Catalog provides complete descriptive data, specifications and prices on all 150 Systems, Accessories and Cabinets. A copy will be sent on request.

Canadian Representative: ROR ASSOCIATES, 290 Lawrence Ave. W., Toronto 12, Ont.



# Strowger Type 11 M-A-X GROWS WITH YOUR COMMUNITY—ECONOMICALLY!

**Add a Switch** and you take care of moderate growth, quickly, easily. Just jack it into place on one of the numerous extra banks provided with your initial equipment. No wiring. No soldering!

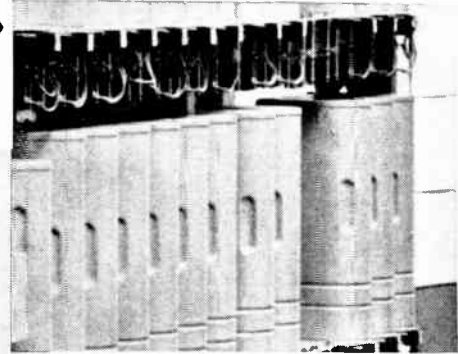
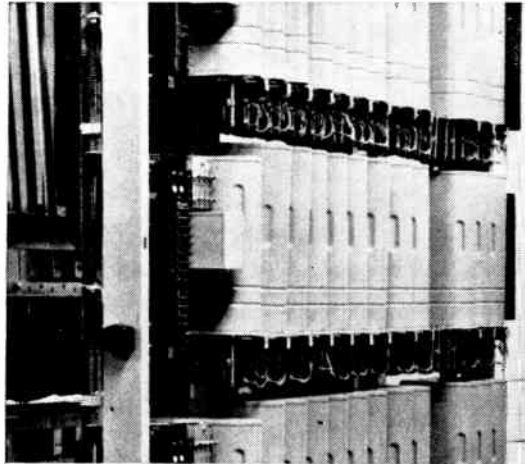

**Add a Shelf** of switches when larger growth occurs. Each shelf is complete with pre-wired banks. Your men can install it quickly and inexpensively.

**Add a Frame** with as many shelves of switches as you need, to meet heavy growth. There are no capacity limits to Strowger expansion.

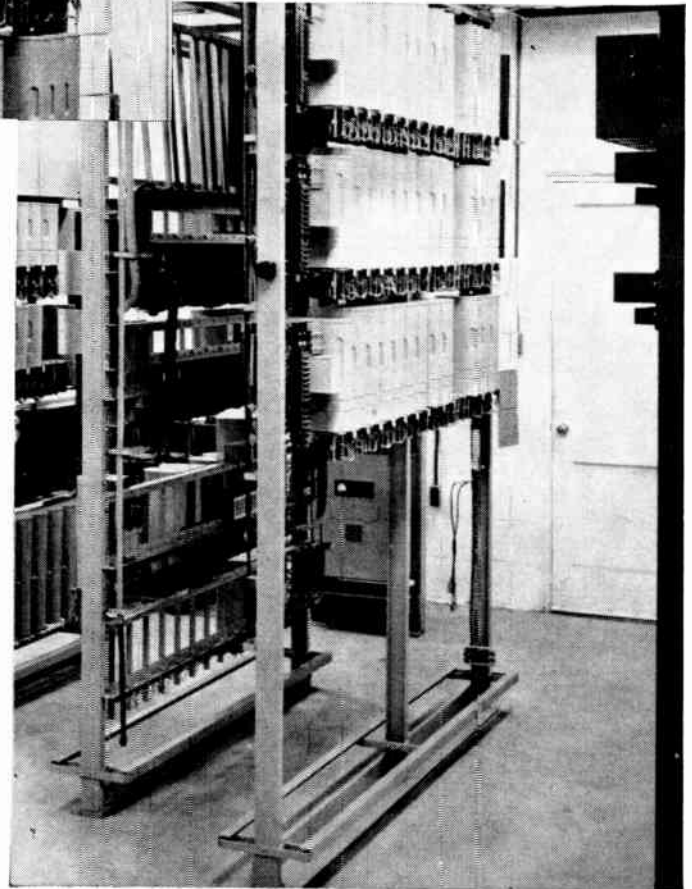

For installations up to 400 lines, with prospects of expansion, a Strowger Automatic Type 11 M-A-X is your best investment by far. Experience proves it expands economically to meet any need.

You will have no technical worries when you expand, no capacity limits to fret about. Merely order additional equipment when you need it—and put it in. It's as simple as that! Economical too, when you consider that each switch, each shelf, each frame is a pre-wired *unit*—made so more can be added with minimum time and labour.

Arrange for a  
consultation today!



**AUTOMATIC ELECTRIC**  
(CANADA) LIMITED

Distributor in Canada

**AUTOMATIC ELECTRIC SALES (CANADA) LIMITED**  
Head Office: 185 Bartley Drive, Toronto 16  
MONTREAL • OTTAWA • BROCKVILLE • HAMILTON • WINNIPEG • REGINA • EDMONTON • VANCOUVER

For further data on advertised products use page 83.

## NEWS

(Continued from page 75)

## CAE Acquires DuMont Canadian Patents

Canadian Aviation Electronics Limited recently concluded an agreement with the Allen B. DuMont Laboratories in the United States which allows CAE to occupy one of the foremost positions in the electronic patent field in Canada. According to the agreement, CAE has acquired the control of all DuMont Canadian patents, covering the manufacture and sale in Canada of cathode ray tubes, television sets, transmitters and other electronic instruments. Canadian Aviation Electronics Limited has been, and will continue to be, an exclusive licensee in Canada for the manufacture and sale of DuMont television sets which are now being manufactured by CAE in Canada under the trademark CAE-DuMont.



● D. F. Oakes has been appointed sales manager of Edwards High Vacuum (Canada) Ltd., it has been announced by Mr. F. J. Pearce, director and general manager. Mr. Oakes has been with the company since their opening in Canada as a subsidiary of Edwards High Vacuum Ltd., Crawley, Sussex, England.

## AMF Sets Up Canadian Atomic Subsidiary

In its first expansion of its atomic energy operations beyond the boundaries of the United States, American Machine & Foundry Company recently announced the establishment of AMF Atomics (Canada) Limited, a new subsidiary with headquarters in Toronto, Ontario.

The new AMF Canadian subsidiary will have General Walter Bedell Smith, vice-chairman of American Machine & Foundry Company and board chairman and president of AMF Atomics Inc., as its board chairman and president. Denton Massey, director of customer relations of AMF Atomics Inc., will serve as general manager.

(Turn to page 79)

MODEL VRSAC750  
0-750 VOLT RANGE

low  
cost

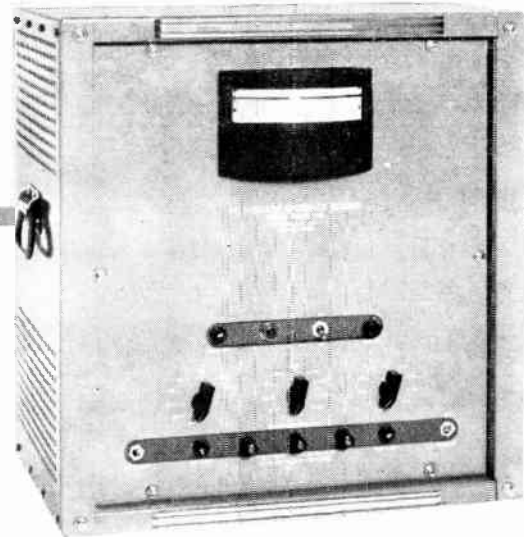

## VOLTAGE REFERENCE SOURCE

FOR RESEARCH LABORATORIES • SCHOOLS • PRODUCTION TESTING  
AMPLIFIER GAIN CHECKS • OSCILLOSCOPE CALIBRATION • SERVO TESTING

The Sorensen VRSAC750 Voltage Reference Source is a low cost, highly accurate regulator primarily designed for calibrating AC voltmeters in the 0-750 volt range. It is ideal for use with nearly every power meter commercially available.

Its compact design, simple operation and accurate performance make it extremely useful to the laboratory or the production shop. The VRSAC750 is specifically designed for bench-top operation . . . all controls are within easy reach of the operator, and the reference meter is clear, easy to read, and placed at eye level to insure maximum accuracy of adjustment.

Input voltage range	105-125 VAC, 1 $\phi$
Input frequency	60 $\pm$ 0.5 cps
Input current	7 amperes maximum
Output voltage	1-799 volts in 1-volt steps
Output voltage accuracy	$\pm$ 0.25% at any voltage in 20°-30°C ambient
Harmonic distortion	1% maximum introduced by the unit

SIZE 20 $\frac{5}{8}$ " high, 19 $\frac{3}{8}$ " wide, 12" deep WEIGHT 115 pounds net

VRSAC10 — A versatile instrument for lower voltage applications featuring high accuracy at extremely low cost.

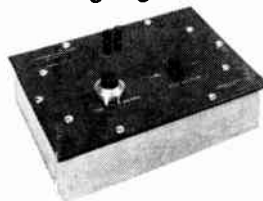

Output voltage range	10 mv to 10v RMS in three ranges
Calibration accuracy	$\pm$ 0.1% at full scale at 60 cps
Input voltage	115v $\pm$ 10%, single phase
Input frequency	50-60 cps; to 400 cps with slightly less accuracy
Waveform	Distortion is negligible
Regulation with load	0.25% max., with load resistance higher than 0.5 megohm
Regulation with line	$\pm$ 0.25% max.

Write today for complete specifications, performance data, and quotations.



SORENSEN & COMPANY, INC. • 375 FAIRFIELD AVE. • STAMFORD, CONN.

CONTROLLED POWER FOR RESEARCH AND INDUSTRY



## NEW PRODUCTS

(Continued from page 65)

### ● Servomation Building Blocks

Item 997

Servomation building blocks are a versatile array of electro-mechanical general purpose analog computer components. Various component combinations provide the means for industrial production control, problem solving for both equations and control system design, classroom demonstration and experiment and data processing.

These standardized interchangeable modular assemblies match each other in all the

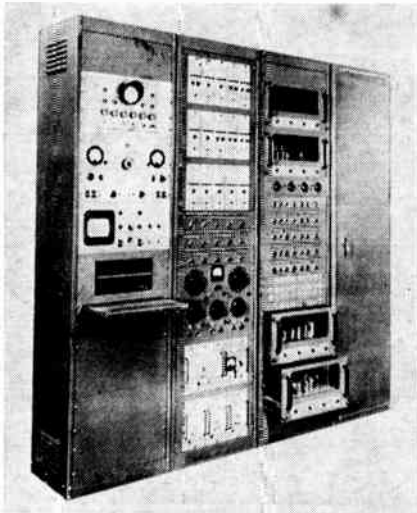

important mechanical and electronic specifications. Flexibility is achieved by plug-in units, internally wired cabinets, jack boards and external patch cord connections. Units may be rearranged and additional components added with ease at any time. Designed for rugged long life, Servomation Building Blocks are easily maintained — each assembly slides out of appropriate protective cabinetry. When intended only for a specific task, the desired units may be specially packaged to meet the demands of limited space or restricting ambients.

### ● Impedance Stabilization Networks For Radio Interference Measurements

Item 998

Series FSR-700 impedance stabilization networks meet the requirements of Air Force Spec. MIL-I-6181B and Navy Spec. MIL-I-16910A. These require one stabilization network to be placed in each power supply lead and electrical load lead (if used) when making tests of radiated and conducted RF interference.

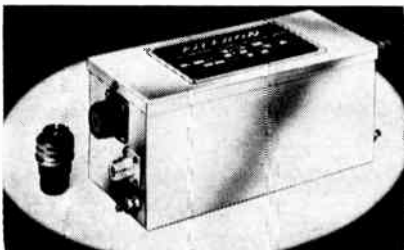

Networks are supplied in two designations, one for each specification, to permit their use in laboratories and screen rooms making RF interference measurements on equipments intended for the two services.

Four units are available under each specification. Each can measure maximum voltages of 440V-60 cycle, 230V-400 cycle and 115V-800 cycle AC, or 600V DC.

### ● New Magnetic And Playback Head

Item 999

Development of a new magnetic recording and playback head capable of handling over four million cycles a second at a tape speed of 20 feet per second has been announced.

This tiny component employs a non-metallic structure and will greatly extend the use of magnetic recording because of its extraordinary ability to record and reproduce densely stored magnetic information. Nearly 20,000 cycles can be recorded on each inch of a magnetic tape.

The new magnetic head will improve the techniques of recording television programs on magnetic tape, rather than on film, for later broadcast, and will more than double the amount of information that can be recorded in the magnetic storage devices which are essential parts of many electronic computers. It also opens new horizons in certain advanced types of military equipment.

Sample heads will soon be available to industry.

### ● Magnetic Tape Transports

Item 1000

A new series of magnetic tape transports for the recording and reproduction of information in digital form has been announced by the instrumentation division of a well-known corporation. Among the uses seen for the equipment in the field of data storage and processing are the direct recording of scientific or business data in digital form, recording the output of analog-to-digital converters, feeding recorded data to the input of digital computers and recording computer outputs. The units are able to accelerate tape to the full operational speed in less than five milliseconds and to stop the tape in the same time interval. This rapid starting and stopping permits high information storage density on the tape, making the transports adaptable to the majority of digital recording and computing systems now in use.

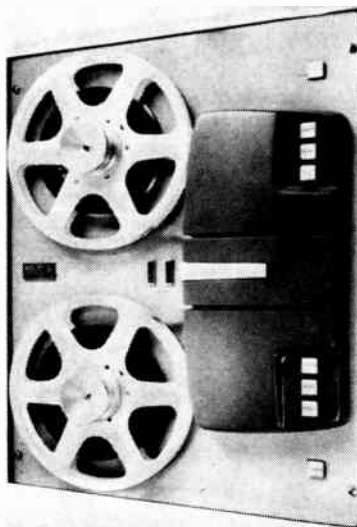

Known as the Series FR 200, the new units consist of four major subassemblies — the tape transport proper, the head assembly, the electronic control unit and a servo control system. Time ordinarily consumed in changing tape is considerably reduced by a single loop tape path.

### ● All-Metal Mount For Vibration, Shock And Noise Control

Item 1001

For the control of vibration, shock and noise, a new all-metal mount has been announced which features exclusive wire mesh resilient construction, known as Met-L-Flex. This mount is another in the expanding line of industrial mounts offered to industry

for isolation of vibration, and for control of shock and noise on all types of machinery. Performance is superior to the rubber style mounts and the life is said to be unlimited.

The mount, identified as Model No. W164, is a medium capacity mount of light-weight construction, ideally suited for general industrial applications. It is recommended for equipment such as fans and blowers, small

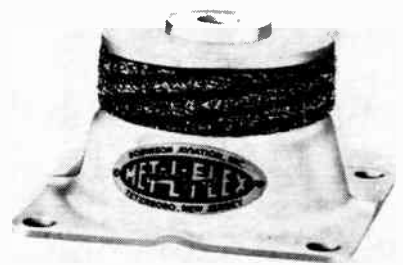

punch presses, air-conditioning equipment, pumps and compressors, refrigeration equipment, motors and generators and small machine tools. It is said to be equally effective when mounted in the upright position or when suspended from overhead supports.

### ● Multi-Purpose Power Supply

Item 1002

A new multi-purpose power supply designed to power all types of laboratory, field and factory electronic test setups has recently been developed.

The instrument is Model 711A, a completely new power supply offering a voltage range of 0 to 500 volts and no-load to full-load regulation of better than  $\pm 0.25\%$  or 0.5 volts. Ripple is less than 1 millivolt. There are separate current and voltage meters, with new push-button range switching for accurate measurement of very small voltages and currents. Additional features include complete overload protection and grounding of either positive or negative dc terminals.

The instrument is small and light, weighing just 18 pounds, and is enclosed in an all-metal case with carrying strap. The manufacturer states the instrument is unusually convenient to operate and particularly versatile for its type.

### ● Germanium Power Rectifier

Item 1003

Occupying a volume of only 190 cubic inches, this small, compact 30 k.w. liquid cooled germanium power rectifier has been especially designed for a.c. to d.c. power conversion where high power output, high efficiency, negligible aging and small unit size is required.

This new product may be connected as a three-phase half wave unit, for a six-phase star operation, three-phase center tap, or as a dual three-phase half wave unit to be used with interphase transformers. Depending on the circuit, output currents of 540 to 750 m.a.p.s. can be obtained. The assemblies can be supplied for input voltages of 26 v. to 66 v. r.m.s. maximum.

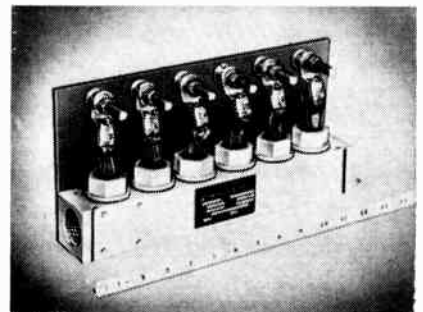

The improved rectifier design provides for superior cooling using a liquid coolant (water, oil, etc.) at a maximum inlet temperature of 30°C. and a volume of one to four gallons per minute.

(Turn to page 80)

**NEWS**

(Continued from page 77)

**Collins Radio Company Appoints Dr. Harold V. Gaskill**

Collins Radio Company have appointed Dr. Harold V. Gaskill of Iowa State College as vice-president in charge of planning.

As Dean of the Division of Science and Director of the Industrial Science Research Institute at Iowa State College since 1938, Dr. Gaskill has been in charge of the research planning of the institute. He has planned and directed research as the Director of the War Research Program at Iowa State during World War II; as Chief Scientist and Deputy for Research and Development, Office of Chief of Staff, United States Army, during the Korean emergency; and as a member of many important national and international committees. He has also served as a consultant on classified projects for the Department of Defense including the Manhattan Project.

**Canadian Westinghouse Electronics Division To Build Airport Transmitters**

Announcement has been made by John H. Fletcher, commercial sales manager of the Electronics Division of the Canadian Westinghouse Company Ltd., that this firm has received a \$600,000 order from the Department of Transport to build 36 VOR transmitters for installation at Western Canada airports.

The VOR transmitters (VHF Omnidirectional Radio Range equipment) are being installed by the Department of Transport across Canada to meet the needs of busier airports and faster aircraft, replacing the low frequency radio range method whereby an audio signal only is transmitted.

Under the VOR method the pilot can line up his position instantaneously on a visual instrument mounted on the instrument panel. The VOR indicating method is becoming the standard of civil radio navigational systems in the United States and Canada.

**General Electric Co. Sells Radio Equipment To U.S. Navy**

The largest single order ever placed for commercial two-way radio communication equipment has been awarded the General Electric Company by the United States Navy, G. P. Adamson, general sales manager of Canadian General Electric's Electronic Equipment and Tube Department, announced in Toronto.

(Turn to page 85)

**HI-Q TEMPERATURE COMPENSATING TUBULAR CAPACITORS**

**DISK CAPACITORS**  
1000-50 CAPACITORS—100 VDCW

**HI-Q TEMPERATURE COMPENSATING DISK CAPACITORS**

**HI-Q TUBULAR CERAMIC CAPACITORS—TYPE C1**

**SI-TV HI-VOLTAGE CERAMIC CAPACITORS**

**VIBRATOR BUFFER CAPACITORS—GMV**  
1600 VDCW

Type	Capacity	Diameter	Case	Type	Capacity	Diameter
BCD-2	1000	1.00	1/2"	BCD-10	1000	1.00
BCD-3	1000	1.00	1/2"	BCD-11	1000	1.00
BCD-4	1000	1.00	1/2"	BCD-12	1000	1.00
BCD-5	1000	1.00	1/2"	BCD-13	1000	1.00
BCD-6	1000	1.00	1/2"	BCD-14	1000	1.00
BCD-7	1000	1.00	1/2"	BCD-15	1000	1.00
BCD-8	1000	1.00	1/2"	BCD-16	1000	1.00
BCD-9	1000	1.00	1/2"	BCD-17	1000	1.00
BCD-10	1000	1.00	1/2"	BCD-18	1000	1.00
BCD-11	1000	1.00	1/2"	BCD-19	1000	1.00
BCD-12	1000	1.00	1/2"	BCD-20	1000	1.00
BCD-13	1000	1.00	1/2"	BCD-21	1000	1.00
BCD-14	1000	1.00	1/2"	BCD-22	1000	1.00
BCD-15	1000	1.00	1/2"	BCD-23	1000	1.00
BCD-16	1000	1.00	1/2"	BCD-24	1000	1.00
BCD-17	1000	1.00	1/2"	BCD-25	1000	1.00
BCD-18	1000	1.00	1/2"	BCD-26	1000	1.00
BCD-19	1000	1.00	1/2"	BCD-27	1000	1.00
BCD-20	1000	1.00	1/2"	BCD-28	1000	1.00
BCD-21	1000	1.00	1/2"	BCD-29	1000	1.00
BCD-22	1000	1.00	1/2"	BCD-30	1000	1.00
BCD-23	1000	1.00	1/2"	BCD-31	1000	1.00
BCD-24	1000	1.00	1/2"	BCD-32	1000	1.00
BCD-25	1000	1.00	1/2"	BCD-33	1000	1.00
BCD-26	1000	1.00	1/2"	BCD-34	1000	1.00
BCD-27	1000	1.00	1/2"	BCD-35	1000	1.00
BCD-28	1000	1.00	1/2"	BCD-36	1000	1.00
BCD-29	1000	1.00	1/2"	BCD-37	1000	1.00
BCD-30	1000	1.00	1/2"	BCD-38	1000	1.00
BCD-31	1000	1.00	1/2"	BCD-39	1000	1.00
BCD-32	1000	1.00	1/2"	BCD-40	1000	1.00
BCD-33	1000	1.00	1/2"	BCD-41	1000	1.00
BCD-34	1000	1.00	1/2"	BCD-42	1000	1.00
BCD-35	1000	1.00	1/2"	BCD-43	1000	1.00
BCD-36	1000	1.00	1/2"	BCD-44	1000	1.00
BCD-37	1000	1.00	1/2"	BCD-45	1000	1.00
BCD-38	1000	1.00	1/2"	BCD-46	1000	1.00
BCD-39	1000	1.00	1/2"	BCD-47	1000	1.00
BCD-40	1000	1.00	1/2"	BCD-48	1000	1.00
BCD-41	1000	1.00	1/2"	BCD-49	1000	1.00
BCD-42	1000	1.00	1/2"	BCD-50	1000	1.00
BCD-43	1000	1.00	1/2"	BCD-51	1000	1.00
BCD-44	1000	1.00	1/2"	BCD-52	1000	1.00
BCD-45	1000	1.00	1/2"	BCD-53	1000	1.00
BCD-46	1000	1.00	1/2"	BCD-54	1000	1.00
BCD-47	1000	1.00	1/2"	BCD-55	1000	1.00
BCD-48	1000	1.00	1/2"	BCD-56	1000	1.00
BCD-49	1000	1.00	1/2"	BCD-57	1000	1.00
BCD-50	1000	1.00	1/2"	BCD-58	1000	1.00
BCD-51	1000	1.00	1/2"	BCD-59	1000	1.00
BCD-52	1000	1.00	1/2"	BCD-60	1000	1.00
BCD-53	1000	1.00	1/2"	BCD-61	1000	1.00
BCD-54	1000	1.00	1/2"	BCD-62	1000	1.00
BCD-55	1000	1.00	1/2"	BCD-63	1000	1.00
BCD-56	1000	1.00	1/2"	BCD-64	1000	1.00
BCD-57	1000	1.00	1/2"	BCD-65	1000	1.00
BCD-58	1000	1.00	1/2"	BCD-66	1000	1.00
BCD-59	1000	1.00	1/2"	BCD-67	1000	1.00
BCD-60	1000	1.00	1/2"	BCD-68	1000	1.00
BCD-61	1000	1.00	1/2"	BCD-69	1000	1.00
BCD-62	1000	1.00	1/2"	BCD-70	1000	1.00
BCD-63	1000	1.00	1/2"	BCD-71	1000	1.00
BCD-64	1000	1.00	1/2"	BCD-72	1000	1.00
BCD-65	1000	1.00	1/2"	BCD-73	1000	1.00
BCD-66	1000	1.00	1/2"	BCD-74	1000	1.00
BCD-67	1000	1.00	1/2"	BCD-75	1000	1.00
BCD-68	1000	1.00	1/2"	BCD-76	1000	1.00
BCD-69	1000	1.00	1/2"	BCD-77	1000	1.00
BCD-70	1000	1.00	1/2"	BCD-78	1000	1.00
BCD-71	1000	1.00	1/2"	BCD-79	1000	1.00
BCD-72	1000	1.00	1/2"	BCD-80	1000	1.00
BCD-73	1000	1.00	1/2"	BCD-81	1000	1.00
BCD-74	1000	1.00	1/2"	BCD-82	1000	1.00
BCD-75	1000	1.00	1/2"	BCD-83	1000	1.00
BCD-76	1000	1.00	1/2"	BCD-84	1000	1.00
BCD-77	1000	1.00	1/2"	BCD-85	1000	1.00
BCD-78	1000	1.00	1/2"	BCD-86	1000	1.00
BCD-79	1000	1.00	1/2"	BCD-87	1000	1.00
BCD-80	1000	1.00	1/2"	BCD-88	1000	1.00
BCD-81	1000	1.00	1/2"	BCD-89	1000	1.00
BCD-82	1000	1.00	1/2"	BCD-90	1000	1.00
BCD-83	1000	1.00	1/2"	BCD-91	1000	1.00
BCD-84	1000	1.00	1/2"	BCD-92	1000	1.00
BCD-85	1000	1.00	1/2"	BCD-93	1000	1.00
BCD-86	1000	1.00	1/2"	BCD-94	1000	1.00
BCD-87	1000	1.00	1/2"	BCD-95	1000	1.00
BCD-88	1000	1.00	1/2"	BCD-96	1000	1.00
BCD-89	1000	1.00	1/2"	BCD-97	1000	1.00
BCD-90	1000	1.00	1/2"	BCD-98	1000	1.00
BCD-91	1000	1.00	1/2"	BCD-99	1000	1.00
BCD-92	1000	1.00	1/2"	BCD-100	1000	1.00

**new!**  
a complete line of Aerovox Ceramic Capacitors

Rugged, space-saving Aerovox Ceramic Capacitors are doing many jobs better—at lower cost. They also offer exciting possibilities for completely new uses to manufacturers of TV sets and electronic equipment.



**AEROVOX**  
Capacitors

Standardize with AEROVOX

Write for full details on this new line today! Ask for Aerovox Catalogue No. 5.

**AEROVOX CANADA LIMITED**  
HAMILTON, CANADA

Manufacturers of fixed capacitors for all radio, TV, and electrical uses  
WESTERN SALES IN U.S.A.  
Chas. L. Thompson Ltd., Vancouver, B.C. | Aerovox Corporation, New Bedford, Mass.

5506



# TRYLON<sup>®</sup>

## ANTENNA SYSTEMS

- Design Engineering
- Fabrication
- Installation

Modern communications often require more than just an assembly of conventional antennas, towers, and feed lines. That's why leading broadcasters find Trylon's sound engineering approach to every phase of antenna system design pays big dividends in terms of greater reliability . . . lower maintenance costs . . . longer life.

Trylon specialists welcome the opportunity to quote on your next job—design, fabrication, and installation of the complete antenna system, or of any component.

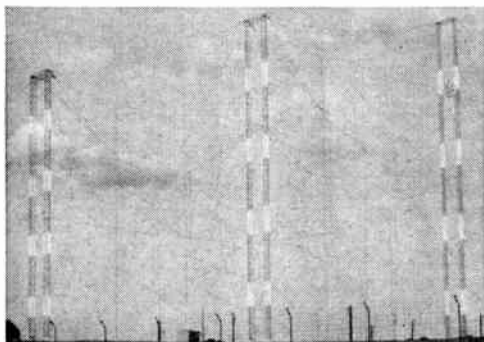

### First Successful Broadband Curtain Antenna

Designed, built and installed by Trylon, these two broadsides give 5% to 10% more reliable long-distance communications than comparable rhombics. Each covers a bandwidth  $\pm 15\%$  of center frequency with a VSWR of only 1.5.



### Galvanized Steel Ladder Towers

As specialists in antenna supports for over 20 years, Trylon offers a broad, thoroughly-proved line of towers for TV, FM, AM, microwave, and commercial communications antennas.

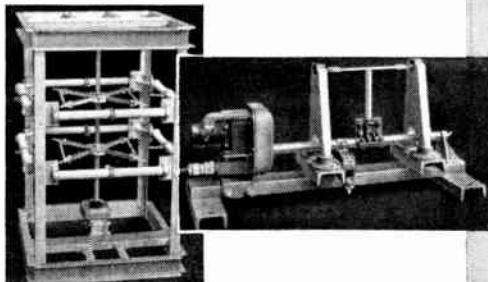

### Selector, Shorting & Slewing Switches

Illustrated above are typical Trylon motor-driven switches designed for flexible remote control selection of transmission lines, antennas, radiation patterns, etc., in antenna parks. Switches handle r-f up to 30KV wire-to-wire with minimum line disturbance.

**THE WIND TURBINE COMPANY OF CANADA, LTD., Toronto 9, Ontario**

See us at the New York I. R. E. Show — Booths 591-593

## NEW PRODUCTS

(Continued from page 78)

### • Model 315 Five Inch Oscilloscope

Item 1004

The Model 315 is a best buy as a low cost, high quality oscilloscope for general radio and TV applications. It features such innovations as frequency compensated vertical and horizontal attenuators along with identical vertical and horizontal amplifiers.

The Model 315 is rugged and simple to build. It uses a 5CP1 type tube with a post accelerator. Both the horizontal and vertical sections are cathode-follower input type and are a.c. coupled.

The instrument is housed in a grey steel cabinet. Attractive brushed aluminum with black lettering and a bezel comprise the front panel.

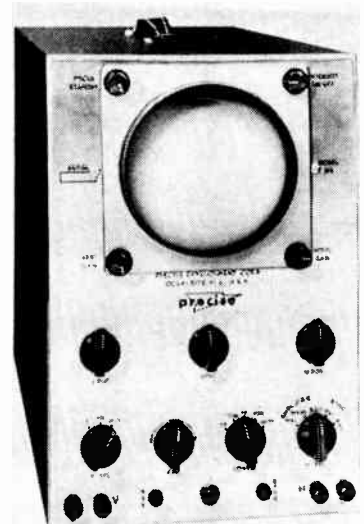

#### Specifications:

**VERTICAL** — The vertical amplifiers are within  $\pm 6$  d.b. through 500 k.c. Single ended, a.c. coupled, cathode follower, frequency compensated stepping attenuator input. Basic sensitivity is approximately 250 millivolts per inch. Outputs are push-pull.

**HORIZONTAL** — The same general specifications as the vertical amplifier.

**SYNCHRONIZATION** — External, internal.

**SWEEP RATE** — From approximately 10 cycles to 100 k.c. Hard vacuum type sweep circuit.

**CALIBRATION** — 6.3 volts sine wave.

**FOCUSING** — Focus, intensity and astigmatism controls. The astigmatism control is available from the rear. A standby switch is used to turn off CRT filaments when not in use.

### • Tachometer With Overspeed And Underspeed Controls

Item 1005

This new tachometer not only indicates speed, but actuates self-contained power relays that signal overspeeds and underspeeds. Ideal for use in sounding alarms, turning on light signals, stopping or starting equipment, opening or closing valves, controlling speeds or for many other similar applications.

High and low limit pointers are independently adjustable. These pointers act as a single-pole double throw switch with the regular speed pointer acting as the switch center arm. A manual reset push button is used to reset the tachometer after the relays have signalled a high or low speed.

(Turn to page 86)



choose the New Simpson  
**SHALLOW CASE  
PANEL METERS**

ONLY 1"  
IN DEPTH

1"

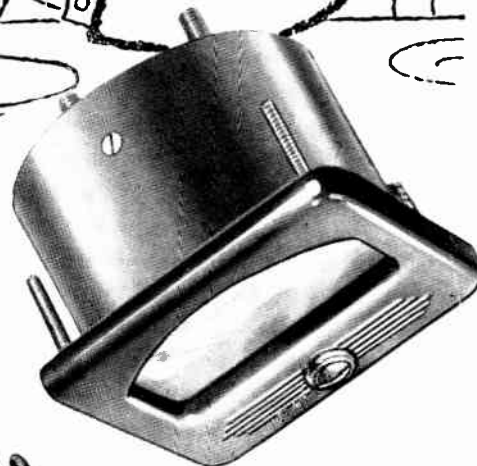

**SHALLOW CASE  
PANEL METERS  
are available —**

in 2½" or 3½" round or square designs, in all D.C. ranges: as Voltmeters, Ammeters, Milliammeters, and Microammeters down to 100 microamperes. A.C. Rectifier ranges are also included.

Although available only to special order, there is no increase in price over the conventional Simpson instrument of similar style and range.

Write for complete dimensional details.

With the trend towards miniaturization in electronic apparatus requiring instruments, and to much more compact design in general, the need for panel meters with conventional readable faces — yet using a minimum of space behind the panel — is growing greater.

Bach-Simpson have met this need with the new Simpson Shallow Case line of instruments, requiring only standard 2½" or 3½" panel mounting holes, yet using only 1" of depth behind the panel.

Such a space saving instrument is only made possible by the famous Simpson Core Magnet Movement, which, in addition reduces the weight by better than one-half and provides a fully shielded movement.

The Simpson Shallow Case instrument can be mounted on magnetic or non-magnetic panels without a change in calibration, and has no external field to affect C.R. tubes, navigation compasses or any other device sensitive to magnetic fields.



1255 Brydges St.  
London, Ontario

SIMPSON ELECTRIC COMPANY, 5200 W. KINZIE ST., CHICAGO 44, ILLINOIS





● The loud-speaking telephone, a revolutionary development in intercommunications permits a remote party to address his remarks to an entire gathering thus enabling absent members to participate in board meetings and conferences.

- Bankers ● Doctors ● Lawyers
- Editors ● Doctors ● Draughtsmen

To Benefit By—

# Loud-Speaking Telephone

SINCE 1895, when Almon B. Strowger invented the switching dial, there has been steady progress in telephone development. But probably one of the most spectacular steps forward was recently announced by Automatic Electric. It is the Loud-Speaking Telephone, permitting telephone conversation as if the other party was in the same room.

As the accompanying labelled illustration shows, the visible part of the assembly consists of a modern telephone and a loud-speaker. There is also a control unit which is usually mounted inconspicuously under the desk. The telephone itself has a number of additional features: clearly marked "ON" and "OFF" buttons, a compact microphone, a volume control knob and a signal light.

We recently saw a demonstration of this remarkable instrument in use, at Automatic Electric's Sales Office in Toronto. The caller dialled a number, without touching the handset. He simply pressed the "ON" switch (the signal light then glowed) and dialled the number. The ringing sound came over the loudspeaker for a few moments before we heard the voice answer. We already knew the owner of the voice and were pleasantly surprised at the clear, lifelike tone the loudspeaker produced. Sounds that would have been inaudible with an

● The loud-speaking telephone permits complete freedom of both hands and facilitates the recording of notes. If necessary the user may leave his desk to search for papers and still carry on his conversation.

ordinary handset could also be heard by turning up the volume control. Even though the caller walked fifteen to twenty feet from the telephone, still conversing in an ordinary tone, he was clearly heard by the other party. At the close of the conversation the other party hung up, but the signal light continued glowing on our telephone as a reminder to press the "OFF" button. When the telephone rang for an incoming call, it was only necessary to press the "ON" button and talk.

The advantages and uses of the instrument are obvious. People who continuously have to cradle the telephone between chin and shoulder while they rummage through papers, will welcome its "hands free" convenience. Bankers, draughtsmen, editors, lawyers, homemakers and busy executives who like to keep working as they talk, will quickly appreciate its advantages. As a conference telephone, it will prove especially useful, as any number of people may join in the conversation, simply by gathering around the table. Yet, for privacy, the telephone may be used in the conventional manner by lifting the handset. A new device will be available shortly on the Loud Speaking Telephone. By pressing the "ON" button all the way down the microphone is muted, so the voice of the user and those surrounding him, cannot be heard by the person at the distant end. Thus privacy can be assured, if a part of the conversation is not to be heard by the other party.

The telephone, loudspeaker and control unit are sold in a complete "package", wired where possible. The installer simply mounts the control unit, makes connections to the monophone speaker and line, and plugs into a power outlet. The control unit is only 9½" x 6½" x 4" in size and includes a plug-in amplifier. The amplifier is a small printed circuit unit. It contains four miniature vacuum tubes which are the only parts that will normally need replacement after long use. However the amplifier may be quickly removed for servicing or replacement if necessary. The whole Loud-Speaking assembly may not only be wired into the ordinary telephone system, but can be used with private internal systems (such as P-A-X) too.



# INDEX TO ADVERTISERS

Page number is on the right  
Key number for use with  
**READER SERVICE CARDS**  
is on the left.

Key No.	Page No.
1 Aerovox (Canada) Ltd.	79
2 Alpha Wire Corp.	90
3 Amalgamated Electric Corp. Ltd.	20
4 Amperite Co.	66
5 Ampex Corp.	4
6 Arga Div.	35
7 Automatic Electric Sales (Canada) Ltd.	6
8 Automatic Electric Sale (Canada) Ltd.	15
9 Automatic Electric Sales (Canada) Ltd.	39
10 Automatic Electric Sales (Canada) Ltd.	76
11 Aviation Electric Ltd.	65
12 Aviation Electric Ltd.	86
13 Bach-Simpson Ltd.	81
14 Bell Telephone Co. of Canada Ltd., The	74
15 Bendix Aviation Corp.	89
16 Bohne Industries Ltd.	64
17 Burton-Rogers Co.	37
18 Canada Wire & Cable Co. Ltd.	55
19 Canadian Aviation Electronics Ltd.	10
20 Canadian Electrical Supply Co. Ltd.	90
21 Canadian Marconi Co.	3
22 Canadian Marconi Co.	41
23 Canadian Marconi Co.	61
24 Canadian Marconi Co.	68
25 Canadian Stackpole Ltd.	94
26 Canadian Westinghouse Co. Ltd.	45
27 Canadian Westinghouse Co. Ltd.	57
28 Canadian Westinghouse Co. Ltd.	59
29 Cannon Electric (Canada) Ltd.	42
30 Cannon Electric (Canada) Ltd.	43
31 Centralab Division	14
32 Collins Radio Co.	53
33 Communications Measurements Laboratory Inc.	54
34 Computing Devices of Canada Ltd.	87

PLEASE SEND FURTHER INFORMATION ON THE FOLLOWING NEW  
PRODUCT ITEMS AS NUMBERED BELOW — USE PRODUCT ITEM NUMBERS

PLEASE SEND FURTHER INFORMATION ON THE FOLLOWING  
ADVERTISEMENTS AS NUMBERED BELOW — USE KEY NUMBER

Name \_\_\_\_\_ Position \_\_\_\_\_

Company \_\_\_\_\_

Street \_\_\_\_\_ City \_\_\_\_\_ Prov. \_\_\_\_\_  
1-2-56

PLEASE SEND FURTHER INFORMATION ON THE FOLLOWING NEW  
PRODUCT ITEMS AS NUMBERED BELOW — USE PRODUCT ITEM NUMBERS

PLEASE SEND FURTHER INFORMATION ON THE FOLLOWING  
ADVERTISEMENTS AS NUMBERED BELOW — USE KEY NUMBER

Name \_\_\_\_\_ Position \_\_\_\_\_

Company \_\_\_\_\_

Street \_\_\_\_\_ City \_\_\_\_\_ Prov. \_\_\_\_\_  
1-2-56

PLEASE SEND FURTHER INFORMATION ON THE FOLLOWING NEW  
PRODUCT ITEMS AS NUMBERED BELOW — USE PRODUCT ITEM NUMBERS

PLEASE SEND FURTHER INFORMATION ON THE FOLLOWING  
ADVERTISEMENTS AS NUMBERED BELOW — USE KEY NUMBER

Name \_\_\_\_\_ Position \_\_\_\_\_

Company \_\_\_\_\_

Street \_\_\_\_\_ City \_\_\_\_\_ Prov. \_\_\_\_\_  
1-2-56



**BUSINESS REPLY CARD**  
No Postage Stamp Necessary if Mailed in Canada

5c POSTAGE WILL BE PAID BY

**ELECTRONICS AND COMMUNICATIONS**

**31 - 35 Willcocks Street**

**Toronto 5, Ontario**



**BUSINESS REPLY CARD**  
No Postage Stamp Necessary if Mailed in Canada

5c POSTAGE WILL BE PAID BY

**ELECTRONICS AND COMMUNICATIONS**

**31 - 35 Willcocks Street**

**Toronto 5, Ontario**



**BUSINESS REPLY CARD**  
No Postage Stamp Necessary if Mailed in Canada

5c POSTAGE WILL BE PAID BY

**ELECTRONICS AND COMMUNICATIONS**

**31 - 35 Willcocks Street**

**Toronto 5, Ontario**



**INDEX — Continued**

Key No.	Name	Page No.
35	Consolidated Electronic Equipment Co.	48
36	Cossor (Canada) Ltd.	5
37	Dale Products Inc.	49
38	Dale Products Inc.	62
39	Daven Co., The	89
40	Eitel-McCullough Inc.	19
41	Electro Products Laboratories	52
42	Electro Sonic Supply Co. Ltd.	89
43	Electrodesign	62
44	Federal Wire & Cable Co. Ltd.	17
45	Freed Transformer Co. Inc.	48
47	Hammond Mfg. Co. Ltd.	62
48	Heath Co.	69-73
49	Helipot Corp.	2
50	Herring Co. Ltd., John	60
51	Hycor Co. Inc.	52
52	Jennings Radio Mfg. Corp.	85
53	Kaiser-Willys of Canada Ltd.	18
54	Kaye Electrical & Mfg. Co.	62
55	Magnetics Inc.	88
56	Marsland Engineering Ltd.	86
57	Micro Tower Ltd.	56
58	Minnesota Mining & Mfg. of Canada Ltd.	91
59	Modern Aircraft Products Ltd.	56
60	Ohmite Mfg. Co.	13
61	P.S.C. Applied Research Ltd.	93
62	Phillips Electrical Co. Ltd.	21-22
63	Polarad Electronics Corp.	32-33
64	Pye (Canada) Ltd.	63
65	Radio Engineering Products Ltd.	37
66	Radio Engineering Products Ltd.	49
67	Rogers Majestic Electronics Ltd.	50-51
68	Sanborn Co.	75
69	Snelgrove Co. Ltd., C. R.	90
70	Sorensen & Co. Inc.	77
71	Sprague Electric International Ltd.	56
72	Standard Telephone & Cable Mfg. Co. (Canada) Ltd.	44
73	Stark Electronic Instruments Ltd.	86
74	Triplett Electrical Instrument Co., The	29
75	U.S. Engineering Co.	66
76	Varian Associates	67
77	Wind Turbine Co.	80
78	Y. W. Small Parts Ltd.	8

**NEWS**

(Continued from page 79)

**Toronto Section, IRE Visits C.S.A. Laboratories**

More than 70 members of the Institute of Radio Engineers, Toronto Section, were recently dinner guests of the Canadian Standards Association at the Rexdale premises of the organization. After dinner G. R. Cates of the engineering staff outlined the purpose of C.S.A. and indicated what their jurisdiction covers. The speaker also gave a detailed description of the test procedure.

The talk was followed by a conducted tour of the various C.S.A. laboratories wherein members of the technical staff gave a brief description of the tests being conducted in each

**Servo Corp. Of America Appoints New Executive Officers**

Henry Blackstone, president of Servo Corporation of America, New Hyde Park, Long Island, N.Y., announces the promotion of: A. Eric Theis to vice-president in charge of manufacturing; Charles F. Healey to vice-president in charge of administration; and H. Gordon Hawthorne to treasurer. Dudley L. Miller continues as secretary of the company.

**Power Utilities To Require 10-Fold Communications Increase According To L. R. Vincent**

L. R. Vincent of the Radio Corporation of America's Engineering Products Division told a gathering of electric power utilities officials that a survey carried out by R.C.A. indicated that "generally the power industry is likely to require a 10-fold increase in communication facilities in the next five to ten years".

According to Mr. Vincent, "Views were obtained from top-level management, from engineering executives responsible for utility operations, from utility systems design engineers, from communication engineers, and from any other utility people in key positions having an interest in communication functions, using that word in its broadest sense, that is, the transmittal of all types of 'intelligence' as well as voice communication. Replies from the utilities were kept confidential as to which individual utility's views were expressed. RCA was supplied only with results for the nation as a whole . . ."

**JENNINGS VACUUM RELAYS**

**For Switching Antennas, Pulse Forming Networks, and Similar RF and DC Circuits**



**NOTE** the copper disk in the coil housing between the armature and coil. This disk provides a vacuum seal without shorting out the magnetic circuit.

The result is an efficient magnetic circuit that permits the use of a small, low wattage coil in a relay that will pass MIL-R-5757B vibration tests.

Other outstanding features common to all of these relays are:

- High voltage and current ratings because the series-break contacts are sealed in a high vacuum.
- Very low contact resistance (less than .01 ohms); a contaminating film cannot form on properly outgassed contacts sealed in a vacuum.
- An actuating coil that is easily removed.
- Simple flange mounting. If necessary, the high voltage terminal can be inserted into a pressurized or sealed container with the low voltage terminals accessible from the outside.

Continuous ratings are 10 and 12 KV, 10 to 15 amperes rms. Contact arrangements now available include NO, NC, SPDT, 2PDT, and 4PDT.

Send for catalog literature describing these and larger vacuum switches and relays with ratings up to 85 KV and several hundred amperes.

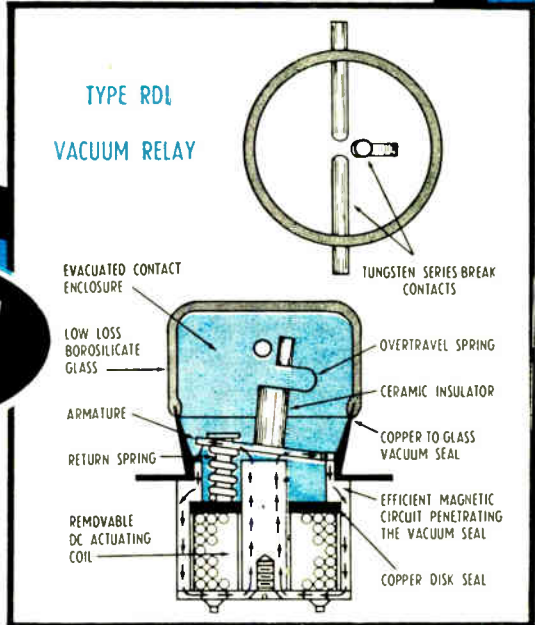

RE2



RM4



RD1



RM2

JENNINGS RADIO MANUFACTURING CORPORATION - 970 McLAUGHLIN AVE. P.O. BOX 1278 - SAN JOSE 8, CALIFORNIA



**TELEVISION TUNERS**

Switch Type  
Licencee of Sarkes-Tarzian Inc.

**LOUDSPEAKERS**

Domestic and Military Types

**WIRE WOUND RESISTORS**

Cement and Vitreous Enamelled  
Coatings - MIL Approved

**VARIABLE TUNING  
CAPACITORS**

Radio Tuning Types - Special  
Units For Military Application

**TRIMMER CAPACITORS**

Conventional Air Dielectric  
Glass and Ceramic

**LEDEX ROTARY  
SOLENOIDS AND  
SELECTOR SWITCHES**

**PERMEABILITY TUNERS  
PRECISION GEARS AND  
GEAR TRAIN ASSEMBLIES  
SERVO-LOOP SYSTEMS**

MICROWAVE  
COMPONENTS  
Filters, Antennas

ALL SYSTEMS  
AND  
COMPONENTS  
ENGINEERED

TOOLED AND  
MANUFACTURED IN  
OUR KITCHENER  
PLANT



**marsland  
ENGINEERING  
LIMITED**

KITCHENER, ONT., CANADA

**NEW PRODUCTS**

(Continued from page 80)

● **Resistors For  
Mechanized Production**  
Item 1006

The new Series "A" encapsulated resistors for use in printed wiring circuits are designed to conform to specifications proposed by RETMA for components to be used in automatic assembly equipment. The resistors are encapsulated in a tough epoxy compound for protection against extreme humidity, mechanical and thermal shock. The



plastic is filled with heat-conducting mineral which dissipates the heat and equalizes "hot spots" in winding. Sealed-in terminal connections are welded. They satisfy military requirements of MIL-R-93A and JAN-R-93. Temperature coefficient:  $\pm 0.0022$  per cent per degree C.; operating temperature:  $-65^{\circ}$  C. to  $+125^{\circ}$  C.; Wattage range from .25 watt to 1 watt with tolerances to 0.1 per cent.

● **Fully Automatic  
Record Changer**  
Item 1007

The new "Monarch" — Intermix — Automatic Record Changer incorporates the following new features: Provisions for a 45 r.p.m. record spindle adaptor; aluminum die cast pick-up arm; and a grey-hammer (dimenzo) finish with all plastic parts in coffee-brown.

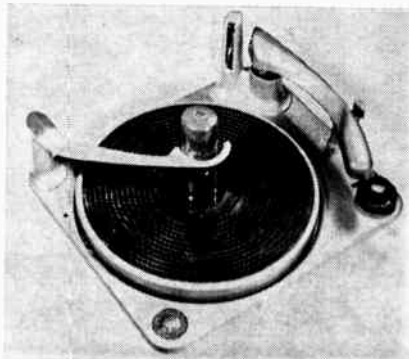

The robust construction and highly dependable mechanism of this changer, operated by a 4-pole motor and designed to play a stack of 10 records of different sizes, have placed the "Monarch" model into a class by itself.

● **Oscilloscope**

Item 1008

A new fully automatic oscilloscope camera, of special configuration and based on an adaptation of the Polaroid fast-print principle, has been developed. The new Recordoscope 1185 will provide an accurate and permanent photographic documentation of CRT phenomena 60 seconds after exposure of the scope image.

The 1185 Recordoscope is simple-to-operate using a standard Polaroid magazine and fast self-developing film. Delivers finished black field print in 60 seconds or less. The fully automatic magazine-shifting mechanism records three to 16 traces per 3" x 4" print. Automatic cycling, exposure plus automatic movement to next trace position can be accomplished in three ways: (1) manual shutter release, (2) cable release, (3) remote operating switch. Final print provides full size image on 3" scopes, half-size image on 5" scopes, with no reversal of image.

**VIBRATION  
ISOLATORS...**

by **ROBINSON AVIATION** \*

... are designed for vibration isolation and shock protection of airborne equipment, instruments and controls.



MET-L-FLEX  
UNIT MOUNT

● MET-L-FLEX unit mount by Robinson is an all-metal resilient element made of stainless steel which is rugged and compact . . . unaffected by oils, hydraulic fuels, temperature, altitude, vibration or moisture. High damping stability is maintained at all altitudes.

● MET-L-FLEX mounts are designed and built for the operating life of the equipment on which they are installed.

IN CANADA

**AVIATION ELECTRIC**  
LIMITED

MONTREAL

VANCOUVER

**STARK**

Canada's first  
manufacturer of **PANEL,  
PORTABLE and SWITCHBOARD  
METERS**



MODEL 605

MODEL 604

Available in Standard Sealed  
or Ruggedized Styles.



MODEL 46-250  
250 Degree

MODEL 804  
Standard Panel Type

**STARK ELECTRONIC INSTRUMENTS LTD.**

Factories and Sales Office: Ajax, Ont.  
Foreign Division: 276 West 43rd Street  
New York 36, N.Y., U.S.A.

## ELECTRONIC COMPUTERS *on* YOUR STAFF

Now, any business, large or small, can put electronic computers to work to cut costs and increase efficiency.

C.D.C. is proud to announce Canada's first Data Processing Centre established by private enterprise. Located at the Company's Head Office in Ottawa, this centre is available to serve government and industry in any part of Canada.

### USE OUR SERVICE . . .

- . . . If you are planning to obtain your own computing facilities, you can have C.D.C. test your procedures and solve specimen problems using this centre.
- . . . If you have your own computing facilities, you can transfer your peak loads or overloads to C.D.C.
- . . . If you cannot justify having your own computing facilities, you can make use of those at this centre.
- . . . If you are confronted with an unusually difficult research problem, you may find you have neither the necessary staff nor sufficient facilities — in such a situation, the C.D.C. Computing Centre will be found invaluable.
- . . . If you have continually recurring computing or data processing problems, you can arrange to lease communication facilities linking your office directly with the C.D.C. Centre.

Highly qualified and experienced applied mathematicians and engineers, backed by the latest computer facilities, both digital and analog, are at your service for problem formulation and analysis, programming, computation, data reduction, application of data processing equipment to business procedures, practical instruction in computer operation and programming.

5604

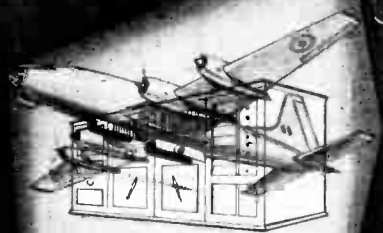

SIMULATION

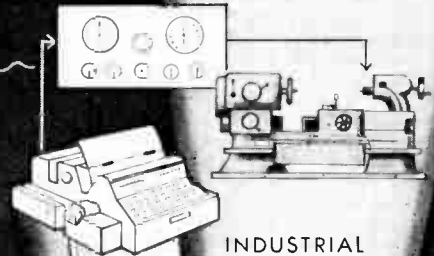

INDUSTRIAL AUTOMATION

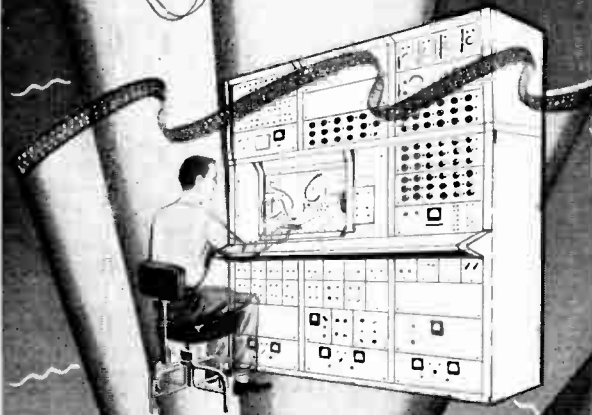

COMPUTERS

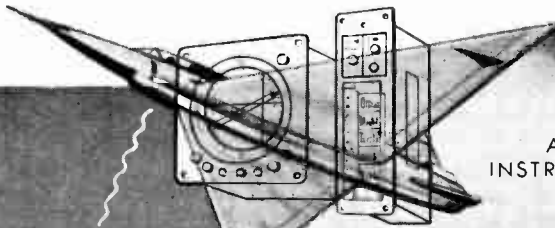

AIRCRAFT INSTRUMENTATION

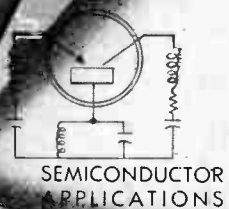

SEMICONDUCTOR APPLICATIONS

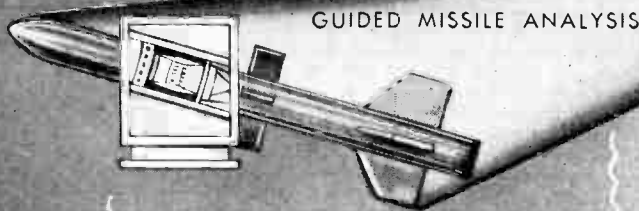

GUIDED MISSILE ANALYSIS



**COMPUTING DEVICES OF CANADA LIMITED**

P.O. BOX 508

OTTAWA

CANADA

WorldRadioHistory



*PERFORMANCE -*  
 .....  
*GUARANTEED*  
 .....

# Tape Wound Cores

*COST NO MORE - WHY TAKE LESS?*  
 .....  
 .....  
 .....

You save, because there can be no waste with the industry's only *Performance-Guaranteed* Tape Wound Cores. You also get the widest choice of standard sizes, and for a slight additional cost can specify your tape wound cores in the remarkable Aluminum Core Box\* in any size. For complete details, why not write for your copy of Magnetics, Inc. Catalog TWC-100 today?



MAGNETICS, INC., Dept. EC-25, Butler, Pa.

**MAGNETICS inc.**

\*patent pending



Canada's major supply house for Radio and Electronic components to Government and Commercial specifications. Write for new Industrial Catalogue No. 561.

**ELECTRO SONIC**  
SUPPLY CO. LTD.  
543 YONGE ST., TORONTO 5  
WA. 4-9301



*Only!* **DAVEN SWITCHES**

Have This Advanced Feature...

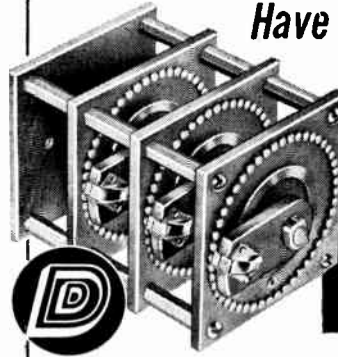

The "Knee-Action"  
**ROTOR**

DAVEN's patented "Knee-Action" Rotor permits a greater number of switch positions and poles in a smaller space than was ever possible before.

This exclusive DAVEN feature, developed by DAVEN's skilled engineering staff, is but one of the many contributions which DAVEN has made to solve difficult switch problems.

Daven also supplies switches from thousands of standard units or will engineer a special switch to meet your particular needs.

For any and every switch problem, CALL ON DAVEN!

THE **DAVEN** CO. 550 W. Mt. Pleasant Ave., Rt. 10, Livingston, N.J.

Write for FREE copy of DAVEN's new, 28-page brochure on SWITCHES!

IN CANADA: Adams Engineering Ltd. — Montreal and Toronto

For long life under extreme conditions  
of shock, vibration, corrosion,  
humidity and temperature

*Bendix* **W** TYPE  
HEAVY-DUTY  
**ELECTRICAL  
CONNECTOR**



Intended for use with jacketed cable and not requiring ground return through mating surfaces, this connector incorporates sealing gaskets at all mating joints.

W-Type Bendix\* Connectors also incorporate standard Scinflex resilient inserts

in established AN contact arrangements. Shell components are thick sectioned high-grade aluminum for maximum strength. All aluminum surfaces are grey anodized for protection against corrosion.

It will pay you to remember that for

the really tough jobs, where ordinary electrical connectors just won't do, be sure to specify the W-Type Connector.

Complete specifications and details on request.

\*REG. TRADE-MARK



**SCINTILLA DIVISION of**  
SIDNEY, NEW YORK



Export Sales and Service: Bendix International Division, 205 East 42nd St., New York 17, N. Y.

FACTORY BRANCH OFFICES: 117 E. Providencia Avenue, Burbank, California • 512 West Avenue, Jenkintown, Pennsylvania • Stephenson Building, 6560 Cass Avenue, Detroit 2, Michigan • 5906 North Port Washington Road, Milwaukee 17, Wisconsin • American Building, 4 S. Main St., Dayton 2, Ohio • 8401 Cedar Springs Road, Dallas 19, Texas • Boeing Field, Seattle 8, Washington • 1701 "K" Street, N. W., Washington 6, D. C.



the greatest number of  
**IN-STOCK WIRE ITEMS** for  
 the **ELECTRONICS INDUSTRY**

**NOW!**  
**IN-STOCK**  
 in  
**CANADA**  
 at

**ALPHA**  
**ARACON**  
**RADIO**

29 Adelaide St. W.  
 Toronto 1, Ont.

Write for  
**FREE catalog**



First in Quality Wire for over 34 years

**ALPHA WIRE CORPORATION**

430 BROADWAY, NEW YORK 13, N. Y.

**CESCO** . . . . .

- 
- **INDUSTRIAL**
- **ELECTRONIC**
- **HEADQUARTERS**
- 



**ONE SOURCE FOR ALL PURCHASES**

No matter what your requirements in Electronic components, we can supply it. CESCO provides one centralized source for all your electronic purchases, saving you time and money. Write for the latest catalogues! . . . *Mallory, Ohmite, Amphenol, Potter & Brumfield.*

Do you have our latest catalogues? Write for our 200-page *1955 Buying Guide*. Also ask for our *1955 Gift Catalogue* and *1956 TV Antenna & Accessory Guide*. All available **FREE** on request.

**EVERYTHING IN ELECTRONICS**

Wholesale Distributors

**CANADIAN ELECTRICAL SUPPLY CO. Ltd.**

**MONTREAL**  
 275 Craig St. W.  
 UN. 1-2411

**OTTAWA**  
 836 Somerset St. W.  
 8-5675

**TORONTO**  
 522 Yonge St.  
 WA. 1-5111

For Every Application

# QUARTZ CRYSTALS

(Precision Lowdrift)

**ALL TYPES AND FREQUENCIES** —  
 of Quartz Crystals prepared to exact specifications. Precision manufactured by experts — for emergency and other applications. Special requirements handled with speed and maximum efficiency. Snelgrove satisfies with the *exact* service you specify.

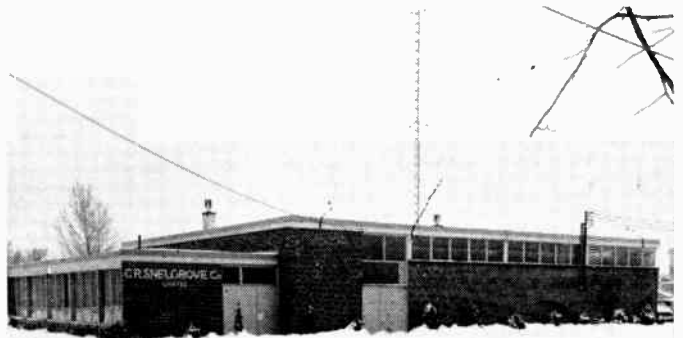

**THE ONLY CANADIAN-OWNED PLANT**  
 . . . owner-operated and exclusively devoted to the manufacture of precision low-drift quartz crystals.

•  
**APPROVED BY D.N.D.**

•  
**UNITS PREPARED TO COMMERCIAL  
 AND MILITARY SPECIFICATIONS**

•  
**FAST - ACCURATE - DEPENDABLE SERVICE**

**C. R. Snelgrove Co. Limited**

New Address: **BOND AVE., DON MILLS**

Mail Address: **P.O. BOX 10, STATION R, TORONTO**

For further data on advertised products use page 83.



*Now...record the whole performance...*  
**without a break!**

Got a favorite concert or opera program you'd like to preserve on tape? Symphony or dramatic production? Now, *record it all* using new "Scotch" Brand Extra Play Magnetic Tape. With 50% more tape wound on each reel, Extra Play Tape gives you as much recording time as 1½ reels of standard tape, plus strength to spare. This means annoying interruptions for reel change are sharply reduced to offer more perfect recording results.

You'll notice a crisper tone and higher fidelity, too—the result of "Scotch" Brand's exclusive oxide dispersion process. By packing minute, fine-grain oxide particles into a neater, thinner pattern, "Scotch" Brand has been able to produce a super-sensitive, high-potency magnetic recording surface. Hear the difference yourself. Try new "Scotch" Brand Extra Play Tape on your own machine.

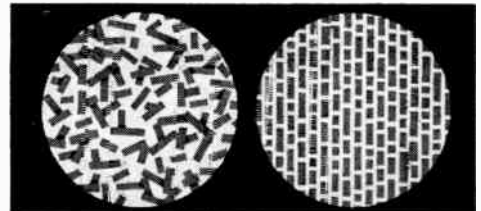

**Electron Photo Microscope Shows the Difference!**

At left, artist's conception of magnified view of old-fashioned oxide coating still used by most ordinary long play tapes. At right, "Scotch" Brand's new dispersion method lays fine-grain particles in an orderly pattern to give a super-sensitive recording surface that contains as much oxide as conventional tapes, yet is 50% thinner.

**NEW!**  
 REG. TRADE MARK  
**SCOTCH**  
 BRAND  
*Extra Play Magnetic Tape 190*



**MINNESOTA MINING & MANUFACTURING OF CANADA LIMITED • LONDON • CANADA**

Sales Offices: Halifax • Montreal • Toronto • Winnipeg • Saskatoon • Calgary • Vancouver  
 Resident Salesmen: Saint John • Quebec City • Ottawa • Hamilton • North Bay • Regina • Edmonton







● **GERALD MORELLO**  
Quality Hermetics  
Ltd.



● **BILL DEACON**  
Adams Engineering.



● **CLARE FRASER**  
PSC Applied  
Research Ltd.

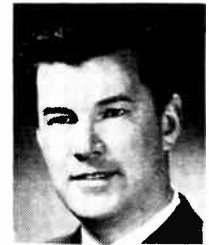

● **ED LOMAS**  
E. G. Lomas Co.

# Going To The New York IRE Convention & Show? If So—



● **T. W. LAZENBY**  
Electronics and  
Communications



● **RAY PEIRCE**  
Sperry Gyroscope  
Co. of Canada

● Your **CANADIAN ROOM** Committee invites you to visit the **CANADIAN ROOM**, Suites 114 - 116, Hotel Commodore, any time during the Convention and Show, March 19 to 22.

● Make the **CANADIAN ROOM** your Canadian Headquarters while in New York.

● Plan to meet your friends and business associates in the

## CANADIAN ROOM



● **SEYMOUR JANIKUN**  
Atlas Radio  
Corp. Ltd.



● **KEN DAVIS**  
J. R. Longstaffe  
Co. Ltd.



● **JOHN ROOT**  
R-O-R Associates  
Ltd.



● **BUD DALLYN**  
Electronics and  
Communications



**LONG NEEDED**

**NOW AVAILABLE**

Preparing to test a Company produced rocket-firing intervalometer at  $-65^{\circ}$  F. at 60,000 feet altitude

## A commercial environmental test lab in Canada!

One of Canada's first privately owned and commercially available environmental test laboratories is ready now— at your service. It is designed to test components and systems to military and commercial specifications. Here are two of the many test chambers. The left chamber tests at temperatures from  $-35^{\circ}$  F. to  $300^{\circ}$  F., and at humidities from 20% to 98%. The right chamber provides temperatures from  $-100^{\circ}$  F. to  $300^{\circ}$  F., at altitudes from sea level to 100,000 feet. If you have a qualification testing problem write for information on this new service to Canadian industry. Quotations are available on request.

Qualification testing for your products and research problems to current MIL Specs.:

- low temperature
- high temperature
- altitude
- humidity
- shock
- vibration
- salt spray
- sand and dust
- radio interference
- explosion
- fungus
- wind-tunnel



**PSC APPLIED RESEARCH LTD.**

1500 O'CONNOR DRIVE  
PLYMOUTH 5-3371

TORONTO 16, ONTARIO, CANADA

For further data on advertised products use page 83.



**TESTED 200%**

*plus!*

**Y**OU'VE probably noticed the steadily growing preference for Stackpole fixed composition resistors in critical military uses as well as in a high percentage of today's television, radio and industrial electronic equipment.

There are two main reasons: Outstandingly dependable products backed by equally dependable, personalized service.

Dependability is assured by the most modern manufacturing techniques *plus* constant testing. From preliminary sorting tests to the final 100% test and numerous quality control tests extending from raw materials through production, it is conservative to say that Stackpole resistors are tested well over 200%.

As for service in meeting resistor requirements accurately and when promised—this is a Stackpole factor that is just as carefully controlled and tested as the manufacturing processes themselves.

And it is our sincere aim to keep it that way.

*Electronic Components Division*

**CANADIAN  
STACKPOLE LTD.**

550 Evans Ave., Etobicoke, Toronto 14, Ont.

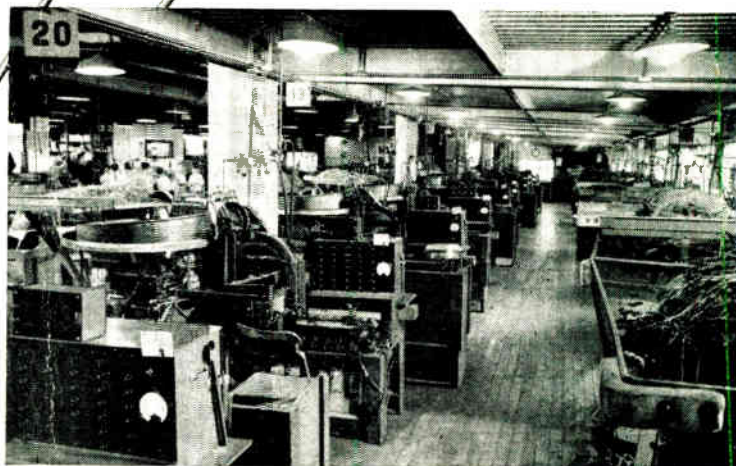

**ELECTRICAL TESTING**— Each Stackpole fixed composition resistor gets a final test on automatic machines like these. Other tests before and during production bring the total test percentage to well over 200%.



**SERVICE IN THE MAKING**— A portion of the huge fixed composition resistor stock Stackpole strives to maintain to assure prompt deliveries.



**STACKPOLE**

**FIXED COMPOSITION RESISTORS**

For further data on advertised products use page 83.