

ELECTRONICS *and* COMMUNICATIONS

DESIGN — MANUFACTURE — ENGINEERING — DISTRIBUTION — APPLICATION

New Ideas For Modern Management

- Scatter Propagation — At Certain Frequencies Links Up To More Than 1000 Miles Are Feasible . . . page 20
- The R-Theta Computer Meets The Need For A Compact Automatic Navigation System In High Speed Aircraft page 22
- Yearly Savings Of \$60,000 Looked Forward To With New Studio Control Switching Unit page 25
- Gear Gauge And Hobbing Machine Control Assures Accuracy Of Product At High Production Rate . . . page 26
- Analysis Of Complex Chemicals Possible Within Half An Hour With Mass Spectrometer page 32



Wing Commander J. C. Wright, D.F.C., R.C.A.F. inventor of the R-Theta Computer is shown above (left) with Bill Hachnel (center) and Jack McKelvie (right) PSC Applied Research engineers who worked on the development of the computer. (See story on page 22)

July-August, 1955 ★ \$5.00 a year
An AGE Publication, Toronto, Canada

Distribution Of This Issue
Over 10,000 Copies

REVERSIBLE SILICON MIXER DIODES

Here's another step forward by Bomac — a reversible silicon mixer diode. The 1N415 and 1N416 series are the first silicon diodes to have selective polarity.

Polarity is indicated by the letters REV located at one end of the diode. To change the polarity, just switch the position of the end cap.

With the end cap attached to the contact pin at the unmarked end of the cartridge, the diode will be of normal polarity. With the end cap attached to the end marked REV, the diode will be of reverse polarity. The complete assembly, with either polarity, is electrically the same as its equivalent type of regular silicon diodes.

The Bomac 1N415 and 1N416 series will meet all conditions of JAN 1A specifications.

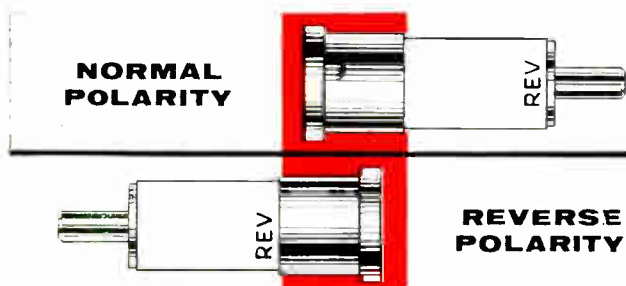

UNIQUE PACKAGE PROTECTION



For complete protection during shipment and storage Bomac has designed a reusable RF Protective Package* which conforms with MIL-E1B specification. Diodes stored in this package are completely protected no matter how many times they are handled after the original seal is broken.

*PAT. APPLIED FOR



1N415 - 1N416 SERIES

Band	Type	Equivalent Type	Frequency Mc	Max. Conversion Loss db	Noise Ratio Times	Max. VSWR	IF Imped. OHMS	Burnout erg
X	1N415B	1N23B	9375	6.5	2.7	—	—	1.0
		1N23BR	9375	6.5	2.7	—	—	1.0
X	1N415C	1N23C	9375	6.0	2.0	1.50	325-475	1.0
		1N23CR	9375	6.0	2.0	1.50	325-475	1.0
X	1N415D	1N23D	9375	5.0	1.7	1.30	350 450	1.0
		1N23DR	9375	5.0	1.7	1.30	350 450	1.0
S	1N416B	1N21B	3060	6.5	2.0	—	—	2.0
		1N21BR	3060	6.5	2.0	—	—	2.0
S	1N416C	1N21C	3060	5.5	1.5	—	—	2.0
		1N21CR	3060	5.5	1.5	—	—	2.0

We invite your inquiries regarding

- ENGINEERING
- DEVELOPMENT
- PRODUCTION

Bomac Laboratories, Inc.

BEVERLY, MASSACHUSETTS

GAS SWITCHING TUBES - TR, ATR and Pre-TR - QUAL TR and ATR TUBES - SILICON DIODES - WAVEGUIDE SWITCHES
REFERENCE CAVITIES - MAGNETRONS - PRESSURIZING WINDOWS - SHUTTER TUBES - HYDROGEN THYRATRONS
REFLEX KLYSTRONS - TRAVELING WAVE AMPLIFIER TUBES - SYSTEMS

Catalog on request.
Write (on your company letterhead) Dept. E-7
BOMAC Laboratories, Inc. Beverly, Mass., or phone Beverly 6000.

*every type
of tube you'll
ever need —*

receiving tubes

transmitting tubes

cathode ray tubes

sub-miniature tubes

image orthicons for TV cameras

tubes for all specialized purposes

Complete laboratory and engineering services for the study of tube problems of any kind are at your disposal. This technical assistance is backed by the ability to fill all your tube requirements promptly.

MARCONI  RADIOTRONS

Canada's finest radio and television tubes

CANADIAN MARCONI COMPANY

ST. JOHN'S NFLD., HALIFAX, MONTREAL, TORONTO, WINNIPEG, VANCOUVER



each telephone man will give you his own reason for buying **STROWGER AUTOMATIC**

But all their reasons can be summed up into one: they bought it because they *knew* it would meet today's needs best—and gives the best promise of meeting *tomorrow's*! Sixty years of experience with STROWGER AUTOMATIC has proved these facts:

Fact No. 1: STROWGER AUTOMATIC Maintenance Costs Less. Circuits are simple—permit fast routining by semi-skilled staff. The few wearing parts are quickly, easily and inexpensively replaced. STROWGER AUTOMATIC equipment is expertly made—stays trouble-free and needs little care.

Fact No. 2: STROWGER AUTOMATIC is Unequaled for Dependability. Now and then an old STROWGER AUTOMATIC exchange is replaced with more modern STROWGER AUTOMATIC equipment containing the latest circuits and features. But no STROWGER AUTOMATIC exchange has ever worn out.

Fact No. 3: STROWGER AUTOMATIC is Unequaled for Flexibility. Each switch is complete with its own control relays. All switches can be easily jacked in or pulled out as needed. The result is simplicity and speed in trunking changes and alterations to meet changing traffic needs.

Fact No. 4: STROWGER AUTOMATIC Grows Economically. You merely add switches, shelves or complete frames. Initial equipment and existing service are not disturbed. You can meet every growth requirement with STROWGER AUTOMATIC.

Fact No. 5: STROWGER AUTOMATIC Provides the Most Modern Toll Service. Intertoll connectors, automatic toll ticketing, digit-absorbing switches—every facility for both operator and subscriber toll dialing have been developed by Automatic Electric and found dependable in service.

A Canadian organization, backed by the world-wide facilities of the Automatic Electric Groups, provides complete sales, engineering, manufacturing, installation and service facilities. STROWGER AUTOMATIC equipment is made in Canada to meet Canadian requirements.

5534

AUTOMATIC ELECTRIC

(CANADA) LIMITED

Distributor in Canada

AUTOMATIC ELECTRIC SALES (CANADA) LIMITED

Head Office: 185 Bartley Drive, Toronto 16

MONTREAL • OTTAWA • BROCKVILLE • HAMILTON • WINNIPEG • REGINA • EDMONTON • VANCOUVER

For further data on advertised products use page 79

World Radio History



ELECTRONICS
and
COMMUNICATIONS

DESIGN - MANUFACTURE - ENGINEERING - DISTRIBUTION - APPLICATION

THE ONLY CANADIAN JOURNAL DEVOTED SPECIFICALLY TO
THE APPLICATIONS OF COMMUNICATIONS AND ELECTRONICS

JULY - AUGUST 1955
VOL. 3 No. 4

EDITORIAL CONTENTS

President and Publisher
NORTON W. KINGSLAND

*Vice-President and
Director of Advertising*
NORMAN MCHARDY

Editor
THOMAS W. LAZENBY

Editorial Director
PAUL RODNEY

Consulting Editor
LESLIE L. HILL, Ph.D.

Advertising Manager
H. E. DALLYN

Production Manager
NEVILL A. CAMPLING

Business Manager
CLIFFORD A. SPARKS

Circulation Manager
PAUL A. IRWIN

West Coast Representative
DUNCAN R. SCOTT & Co.,
Mills Building
San Francisco

FEATURES

	<i>Page</i>
Scatter Propagation	20
<i>A Recent Discovery Which Holds Promise of Great Possibilities.</i>	
The R-Theta Computer	22
<i>An Outstanding Canadian Achievement In The Field Of Aerial Navigation.</i>	
Studio Control Switching Unit	25
<i>Yearly Savings of \$60,000 Are Looked Forward To.</i>	
Automatic Gear Gauge And Hobbing Control	26
<i>Speed And Accuracy In Gear Cutting.</i>	
Design Data On Laminated Plastics	28
<i>A Versatile Material For Electronic Engineers.</i>	
TV Studio Techniques	30
<i>A Knowledge Of Fundamentals Is Necessary.</i>	
The Mass Spectrometer	32
<i>Chemical Analysis By "Fingerprint" Method.</i>	
A New Concept Of Aviation Fire Safety	34
<i>New Electronic System Looks For Fires.</i>	
Business Management And Automation	37
<i>An Explanation For Top Executives.</i>	

DEPARTMENTS

The Editor's Space	7
Editorial	11
Business Briefs And Trends	13
News	40
New Products	58
Book Review	61

PUBLISHED BY AGE PUBLICATIONS LIMITED

Also Publishers of Restaurants and Institutions, Hotel and Tavern, Heating,
Plumbing & Air Conditioning AGE, and Oil & Gas Heat

MONTREAL, QUE., CANADA
Room 504, Dominion Square Building
1010 St. Catherine Street West
Tel. UNiversity 6-7897

TORONTO, ONT., CANADA
31 Willcocks Street
Tel. WALnut 2-3115

Member Canadian Circulation
Audit Board, Inc.



PRINTED IN CANADA



Subscription Rates: Canada and British Possessions \$5.00 per year
United States of America \$7.50 per year • Foreign \$10.00 per year
Authorized as second class mail, Post Office Department, Ottawa

For Greater Television Development and Service

The Simpson 303 is a versatile instrument — use it as an electronic DC voltmeter, an ohmmeter, an AC voltmeter, an AF voltmeter, an RF voltmeter (with accessory probe), an output-meter, or a FM indicator.

Painstaking research by Simpson engineers in the laboratory, working closely with TV set manufacturers produced the model 303. Compact for greater portability, the 303 is also accurate and functional. Its large 4¼" meter is easy to read and its wide voltage and resistance ranges, as well as low current consumption, justify its claim to versatility.

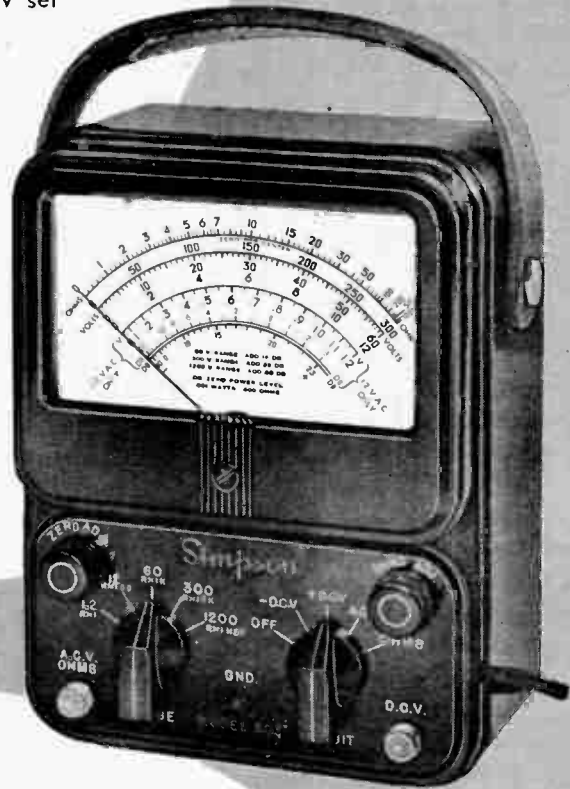

Simpson model 303

Vacuum tube Voltmeter

SPECIFICATIONS:

DC input Resistance 10 megohms
 AC input approximately 200 mmf shunted by 275K.
 Flat Frequency Response
 AC-25 cycle to 100 KC
 RF-20KC to 100 MC
 5 DC Voltage Ranges 1.2V to 1200V
 5 AC Voltage Ranges 1.2V to 1200V
 5 Ohm Ranges — to 1000 megohms.
 High Frequency and High Voltage Probe available
 as accessories.
 Available in 60 cycle or universal 25-60 cycle.
 Also available with roll top case, Model 303RT.

In U.S.A.
 Simpson Electric Company
 5200 W. Kinzie Street
 Chicago 44, Ill.

Bach-Simpson
 LIMITED

1255 BRYDGES ST.

LONDON, CANADA

For further data on advertised products use page 79

The Editor's Space



We've known for some time that the Royal Canadian Navy is planning on using closed circuit television systems in some of their new ships.

On making enquiries for more details of the application we were informed that it was another one of those top-secret hush-hush projects which, if mentioned, would bring the fury of the Official Secrets Act upon the offender's head.

Well, the closed-circuit television system is being fitted in H.M.C.S. Bonaventure, the new Canadian aircraft carrier being fitted out at Belfast and due for completion in 1956. The equipment has been produced by Pye and will be used on the large ship for intercommunication purposes. It is understood that the main function of the equipment will be the transmission of information from the operations room to some five or six key control stations in the ship. How do we know all this if the project is so highly classified? Well we found out the same way that we find out about a lot of other classified projects which, in our opinion, don't merit being wrapped up in so much of the cloak that goes with the dagger. We read about it in a paper that isn't even published in Canada.

Information of this nature, which surely could not afford any comfort or aid to a possible enemy, always seems to find its way into print in other than Canadian publications. Material of this nature would make highly interesting reading for Canadian industry, would afford the general public some idea of how their taxes are being spent in defense purchases, and would place credit where credit is due for the progressive thinking on the part of Canadian defense authorities who, in the case of applying closed-circuit television on board naval vessels have apparently chalked up a "first" and possibly opened up an entirely new field for this type of equipment.

* * *

"The Radio Industry Council cordially invite you to visit their National Radio and Television Exhibition at Earl's Court, London, England, from 23rd August, to 3rd September, 1955. Please show this invitation at the main entrance to obtain free admission."

That's what it says on the invitation recently received. If any kind reader would like to donate the amount of \$345 to defray the cost of transportation we would be more than pleased to attend. A highly colorful and interesting little brochure accompanying the invitation to the show points out that British radio exports have expanded from 7.8 million pounds sterling in 1946 to the record figure of 29.2 million pounds sterling last year.

* * *

Beauty and Brains will be the unbeatable combination on display when the 25th Anniversary Business Equipment Show opens at this year's Canadian National Exhibition. The beauty will be supplied by six of Canada's loveliest young women, Dorothy Fleming models, who will be seen twice daily in a fashion show for business girls. The brains — or at least a remembering and computing facsimile — are built into the hundreds of new office machines and systems that 32 exhibitors will be proudly showing at the exhibition. Business executives from across Canada will find the display of electronics

(Continued on page 19)

low distortion... no zero setting!



DAWE

WIDE RANGE OSCILLATORS

- Constant output over wide frequency range.
- Long effective scale length.
- Small Thermal drift.
- Output voltmeter incorporated.

The DAWE Wide Range Oscillators, Series 400, employ a frequency selective, resistance-capacitance network with positive feedback applied to provide regeneration. Negative feedback is used to stabilize the output amplitude over the wide frequency range.

As a result, the resistance-turned oscillator is fundamentally much more stable and produces less distortion than the common types of variable frequency audio oscillators on the market to-day.

DAWE Oscillators cover the ranges:

20 to 20,000 c/s
20 to 200,000 c/s
0.1 to 1,000 c/s

Write for further information on
DAWE Wide Range Oscillators and other DAWE Electronic Instruments.

5407

DAWE

INSTRUMENTS LIMITED

CANADIAN DIVISION — 59 CROWN CRESCENT, OTTAWA, ONTARIO

Sole Sales and Service Agency Across Canada

MJS Electronic Sales Limited, 2028 Avenue Road, Toronto

When the going's too rough for others

'Jeep' 4Wheel-drive VEHICLES

will get through!



Wherever the job, regardless of weather or ground conditions, a sure-footed 'Jeep' vehicle will get there, with men, equipment or payload. Shifting instantly from 2-wheel drive to the added traction of all four wheels, they go through sand, mud, snow and navigate the steepest grades with ease.

The most versatile vehicles ever built!



'JEEP' CARGO PERSONNEL CARRIER



CJ-5 'JEEP'



'JEEP' STATION WAGON

Every 'Jeep' vehicle has 3 power take-off points available. Each is a mobile power plant, delivers ready auxiliary power anywhere to operate compressors, generators, belt-driven equipment and winches. And there's over fifty pieces of special equipment to make 'Jeep' 4-wheel drive vehicles the handiest, most useful and profitable investment any business could make!

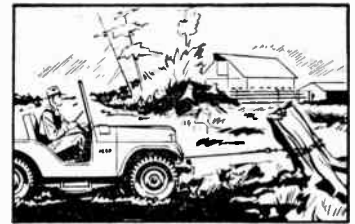

WINCH



'JEEP'-A-TRENCH

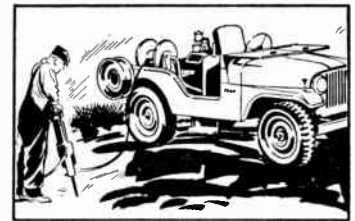

COMPRESSOR

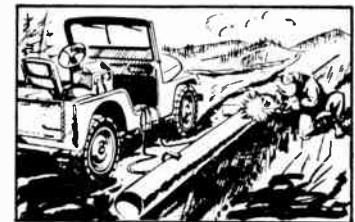

WELDER

**For the toughest "impossible" jobs
the world automatically thinks of 'Jeep'**

KAISER-WILLYS OF CANADA LTD.

WINDSOR • ONTARIO
Canada's most useful vehicles



KW-145

For further data on advertised products use page 79



cae* *electronics serve*

- Agriculture
- Aviation
- Mining
- Manufacturing
- Medicine
- Shipping

Equipment and Systems for:—

Multi-Channel
Microwave/Communication
Systems

Flight Simulators

Nuclear Instruments

Moisture Meters

Visual Omni-Direction Radio Range

Aviation Communication Systems

Marine Communication Systems

Radar Systems

Search and Rescue and Homing
Equipment

Automatic Flight Control Systems

Protection Systems

Hydraulic and Pneumatic Cylinder
Systems

Sintered Plate Batteries
(Nickel-Cadmium Type)



with FACILITIES FROM COAST-TO-COAST

The science of electronics is one of the major contributors to Canada's unprecedented economic expansion. Almost daily the electronics industry is discovering and developing more efficient and more economical means of performing many vital functions on land, at sea and in the air. Canadians everywhere are enjoying a higher standard of living and a more secure future through the practical application of electronics to every walk of life.

In skilled personnel, in modern precision equipment and in practical experience, CAE is qualified to undertake a wide variety of assignments in practically every phase of electronics.

CAE CONSUMER PRODUCTS

Dumont Television
Sonoramic
Radio-Phono Combinations

cae

*cae specialists are readily available for consultation
on your electronic problems*

***CANADIAN AVIATION ELECTRONICS, LTD.**

MONTREAL • OTTAWA • TORONTO • WINNIPEG • VANCOUVER

THE LARGEST CANADIAN-OWNED ELECTRONICS COMPANY

3842

800*
Motorola
MICROWAVE TERMINALS
now in and operating

The trouble free performance during almost a decade of operation of thousands of channel miles has won widespread industry acceptance for Motorola microwave systems. Motorola Microwave equipment has met the exacting standards of the telephone industry with regard to reliability and transmission characteristics. There are more than 800 terminals of Motorola microwave equipment being successfully operated at the present time.

This equipment is now manufactured in Canada and installed by Rogers Majestic Electronics Limited.

COMPLETE ENGINEERING AND DESIGN SERVICE
 Rogers Majestic Electronics Limited will assume complete responsibility for all phases of your communications system from the initial planning to the completed installation and final acceptance testing.

*Motorola is a registered trade mark, owned by Motorola, Inc., in the United States, and by Motorola Canada, Ltd., in Canada.

DISTRIBUTED BY

Equipment Division
ROGERS MAJESTIC ELECTRONICS
 LIMITED
 HALIFAX • MONTREAL • TORONTO • WINNIPEG • VANCOUVER

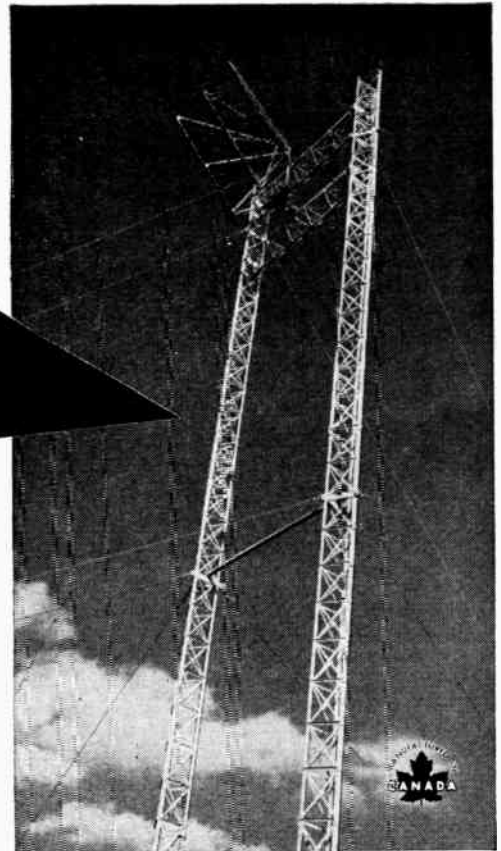

Motorola microwave equipment, supplied by Rogers Majestic Electronics Limited, on Hamilton (Ont.) Mountain, links studio to transmitter of Hamilton's new television station CHCH.



General Manager Ken S. Soble seated at CHCH's master control board. Ch. Engr. Wm. Jaynes looks on.

this booklet can save you money

Gentlemen:

Please send R.M.E.L.'s new 16-page systems planning booklet describing the major types of radio communication and control systems and their applications.



NAME.....

COMPANY.....

ADDRESS.....

R.M.E.L. COMMUNICATION SERVICES:
 MICROWAVE SYSTEMS • MOBILE 2-WAY RADIO SYSTEMS • POINT-TO-POINT 2-WAY RADIO SYSTEMS • SUPERVISORY CONTROL SYSTEMS • POWER LINE CARRIER SYSTEMS • TELEMETERING SYSTEMS • SELECTIVE SWITCHING SYSTEMS • COMMUNICATIONS CONSULTING SERVICE

Color TV For Canadians---

The recent announcement by the Canadian Broadcasting Corporation to the effect that it will commence broadcasting color television in the fall of 1956 will be received with enthusiasm by the television manufacturing industry and undoubtedly by the general public. An appropriation has been made in the C.B.C. budget to provide monies for the necessary alterations to equipment to permit the Montreal, Toronto and Ottawa stations to carry color programs originating in the United States. At a later date, no doubt, the required equipment will be installed by the C.B.C. for originating their own color programs.

Since it was inevitable that color television be started in Canada sooner or later it is more than a little surprising that certain sections of the Toronto press have adopted a reactionary attitude to the announcement. According to the editorial viewpoint of one Toronto paper, Canadians shouldn't allow themselves to get too excited about the announcement, claiming that color television is still a long way off for most viewers, that there are a lot of kinks to be ironed out, and that color receiving sets are expensive and not many people will feel like scrapping a good black-and-white receiver from which they get a lot of pleasure in order to invest twice as much in a color receiver.

Such a statement, to say the least, is surely based on unsound reasoning. If no one took the first step to initiate color television in Canada it would be a great deal farther off for most Canadian viewers. It is true, perhaps, that there are still some kinks to be ironed out in color television, but the same thing holds true for black-and-white. If we are to wait for perfection in color television—as indeed in any other thing—then we may as well resign ourselves to a very long wait!

The important aspect of the C.B.C. announcement lies in the fact that by scheduling color television for the fall of 1956 it provides a target date for the Canadian television manufacturing industry to aim at in the matter of setting up production facilities and getting Canadian-made color receivers on the market.

The question of whose responsibility it was to take the first action in establishing color television in Canada—the C.B.C. by making color programs available, or that of the television manufacturing industry by producing color sets for the Canadian market—has provided the subject of a controversial situation in the past. The question has been likened to the old mystery of which came first, the chicken or the egg. In the opinion of ELECTRONICS AND COMMUNICATIONS, this stand was a fatuous one. Since the Canadian Broadcasting Corporation is, figuratively speaking, the mother of Canadian radio and television, it seems only natural that its maternal function with regard to color television was to provide color programs. By its recent announcement the C.B.C. has lived up to the duty of all good mothers, and now the color baby is on the way. The manufacturing industry can now get on with the job of producing the equipment to handle it.

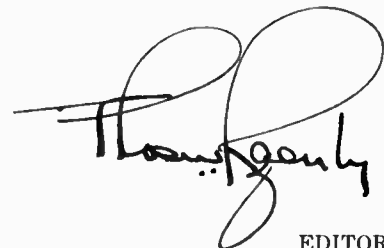

EDITOR

STRUTHERS-DUNN RELAYS NOW MANUFACTURED IN CANADA

* **5,348 RELAY Types**

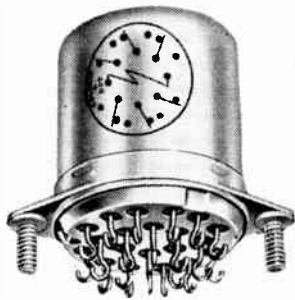

FC-6

- ✓ Withstands 2,000 foot-pounds shock without contact transfer.
- ✓ Available for both 85°C and 125°C ambient nominal coil voltage 26.5 volts D.C.

Designed from a background of 5 years experience with the Dunco 220XFX100, the FC-6 offers far greater simplicity in its moving parts; easier construction and adjustment; extreme rigidity for high vibration and shock; high contact pressures; low contact bounce; plenty of contact over-travel; and complete absence of internal gaseous materials which might cause contact unreliability.

... AND PRICED MATERIALLY LOWER than existing relays in its class!

NEW!

HERMETICALLY-SEALED GENERAL PURPOSE RELAY

Meets Mil Spec. Mil-R-575B

- ✓ Withstands vibration of 30 G's up to 2,000 cycles.
- ✓ Withstands up to 60 G shock without contact opening.

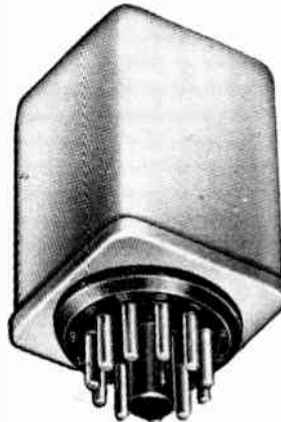

181 Frame

MINIATURE MULTI-POLE RELAYS FOR MILITARY APPLICATIONS

- ✓ Cubical frame construction — 4-corner bracing.
- ✓ Balanced armature suspension — minimizing false contact operation.
- ✓ 55% greater coil volume — utilizing nearly 100% of winding space.
- ✓ Trouble-free wire sizes — up to 7,000 ohms resistance using 40 gauge and larger.

Designed for military service and rough commercial applications, these are miniature multi-pole D-C relays you don't have to coddle. WITHSTAND 15 G's VIBRATION or 25 G's SHOCK WHILE OPERATING . . . UNHARMED BY 75 G's!! Contacts up to 6 P-DT. Open, plug-in, removable cover or hermetically sealed.

IF YOU HAVE A RELAY REQUIREMENT — WE CAN SUPPLY IT!!

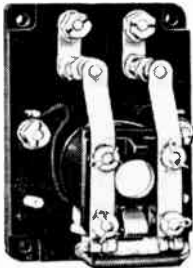

ABHXX

INDUSTRIAL POWER RELAYS

Large power relays, with contacts rated up to 30 amps for the control of motors, heaters, lights and a host of other applications in industry. Quiet in operation.

Coils available up to 230 volts DC or 550 volts AC. Common voltage ratings are 20-24V, 115V and 230V, 60 cycles AC or 115V DC.

Contacts are rated 30 amps at 115V, or 230V. AC non-inductive when mounted open, or 20 amps when enclosed. DC rating is 3 amps at 115V or single-break contacts, and 6 amps on double-break (H).

- ★ POWER, MIDGET, SENSITIVE, LATCH, SEQUENCE, INSTRUMENT CONTROLLED, SPECIAL PURPOSE, MILITARY PLUS THOUSANDS OF SPECIAL DESIGNS DEVELOPED TO MEET SPECIFIC REQUIREMENTS, HUNDREDS OF CONTACT, COIL AND CONSTRUCTION ARRANGEMENTS.



BIXBX

MIDGET RELAYS

Designed to the smallest size consistent with maximum dependability for industrial control applications. Ideal for use in control circuits and for operating auxiliary equipment, including small motor and lamp loads within their contact rating. "Midgets" are generally classified as auxiliary relays and are plain magnetic in operation; that is, the contacts transfer, open or close when the coil is energized and return to their "normal" position when the coil circuit is broken.

Coils available up to 230 volts 60 cycle AC or 115 volts DC. Common voltage ratings are 6, 12, 24, 115 and 230. Contacts rated 6 amps. at 115V AC or 24 volts DC, 3 amp. at 230V AC or 0.5 amps. at 115V DC.

Struthers-Dunn Relay Engineering Handbook

640 pages, profusely illustrated; the results of 30 years specialized relay experience. Helps you select the right relay and install and maintain it properly. 18,000 engineers already use it. 7th printing now available. \$3 per copy.

MANUFACTURED IN CANADA

QUEBEC, MARITIMES AND
EASTERN ONTARIO
E. W. PLAYFORD LIMITED
5851 Western Ave.
P.O. Box "E", Montreal 28, Que.

CENTRAL AND
NORTHERN ONTARIO
J. R. LONGSTAFFE CO. LTD.
300 Campbell Ave.
Toronto 9, Ont.

WESTERN
CANADA
RADIOVISION SALES LTD.
325 Tenth Ave. W.
Calgary, Alta.

For further data on advertised products use page 79

business briefs & trends



★ A year ago no one would have associated house maids with the possibility of creating the requirement for a second TV set in the home. Now however, reports from various employment agencies in the United States claim that the continuing shortage of house maids is influencing many house wives to offer prospective servants a television set for their rooms.

★ The General Electric Company of Syracuse is manufacturing a portable TV set that weighs 32 pounds. It is a 14 inch set and is made up of the vertical chassis type of construction. Most of the circuitry is on printed circuit boards. The set which is 10½ inches high, 13¾ inches wide and 17 deep has 15 tubes exclusive of the picture tube and has been designed for use in the primary reception areas.

★ On the 25th of April, 1955, the total number of ships of all classes for which Decca radar has been ordered exceeded 4,000. The achievement represents business conducted over a period of five years by the Decca company and equipment has been installed in ships of every class and size from the largest passenger liners to small river craft and launches for over 850 ship owners and authorities throughout the world.

★ Applications for approvals certification received by the Canadian Standards Association during the year 1954 numbered 4,008, which was an increase of over eight per cent over the previous year.

★ The Canadian government will contribute between seven and eight million dollars towards the construction of Canada's first atomic power plant which is expected to be in operation by mid-1958.

★ The Northwest Telephone Company have recently purchased the Department of Transport radiotelephone and teletype facilities in Prince Rupert and the Queen Charlotte Islands. Equipment included in the purchase is the radio telephone site and installations on Mount Hays and similar equipment at Sanspit.

★ A 30-day test to determine the value of closed circuit television as an aid to traffic control is being conducted by the Michigan Bell Telephone Company and the Detroit Department of Streets and Traffic. Site of the test is Detroit's new high-speed express highway system where two cameras viewed all six lanes of the two expressways for a distance of 800 feet in two directions while Bell Telephone and highway officials studied traffic conditions in a nearby building. The test will be carried on for a month in all kinds of weather.

★ According to the Dominion Bureau of Statistics, Canadians spent \$216,500,000 for television sets during 1954. Next to motor cars more money is spent on television sets than any other consumer product on the Canadian market.

★ Canadians pay a total of 25 per cent on every radio and television set they purchase. In addition to a 15 per cent Excise Tax there is also a 10 per cent Sales Tax.

★ The Canadian electronics industry which now employs 25,000 people has produced nearly one and a half million television receivers in less than five years and has put Canada third among the nations of the world in the number of sets in use.

★ In the not too distant future there will be 30 TV stations in operation in Canada, most of them privately owned affording a television coverage to more than 85 per cent of the population.

★ Two-way radio telephones have been fitted on the six giant tractor-drawn lawn mowers that cut the 1,100 acres of grass at London's airport. The two-way radio equipment has been installed to solve the problem of controlling the grass cutting operations at the airport where 400 aircraft arrivals and departures are handled daily.

★ What is believed to be the world's first radio-frequency heating plant for continuous wood drying on a conveyor system is now operating in Sussex- England. The plant has been developed and built by a London firm and is being employed to dry birch billets for broom heads.

★ A House Appropriation Sub-Committee in Washington has heard testimony indicating that close to one billion dollars will be spent by the United States armed forces for electronic equipment and communications equipment during the fiscal year 1956. A break down of this figure shows that the United States Air Force has estimated their requirements will cost \$594,236,000; while the navy has asked for \$136,000,000 and the army signal corps close to \$1,000,000.

★ According to the French Economic and Technical Journal the firm of La Verrerie Scientifique has developed a high-powered flash gun with a power of 40,000 joules and which contains about 1,000 300-microfarad condensers. With the use of the flash-gun it is claimed that photographs can be taken at night at a distance of 1,000 meters, 3,281 feet.

★ American television set owners paid 1.5 billion dollars for repair bills in a 12 month period according to the Service Committee of RETMA. The report states that this is the first time that the servicing bill for television receivers was equal to or exceeded the revenue from television receiver retail sales.

★ The United States Department of Commerce anticipates that the manufacture of electronic products in 1955 will reach \$6.2 billion. The forecast embraces all types of equipment including radio and TV receivers, tubes, components and military equipment.

★ Motorola engineers have developed a "radio time-piece" for the purpose of showing the advantages of transistor applications. Engineers claim that the time-piece is capable of 10 years continuous operation with no other servicing than the replacement of batteries.

★ A. F. Jacobson, President of the Northwestern Bell Telephone Co., claims that by the end of the next twenty years mobile radiotelephone service will be commonly used in planes, trains, and automobiles and that a small telephone will be available to carry on your person. The prediction which has been made for 1975 has been put in the vault of the new \$7,000,000 Prudential Life Insurance Building in Minneapolis.

★ The First Annual Report of the Ontario Telephone Authority states that "The number of Independent Telephone Systems within the jurisdiction of Ontario as of

(Turn to page 93)



CNT.

TR

CO. LTD.

BRIDGE

**ALREADY big enough
to tackle any job...**

**STILL young enough
to give every job our best**

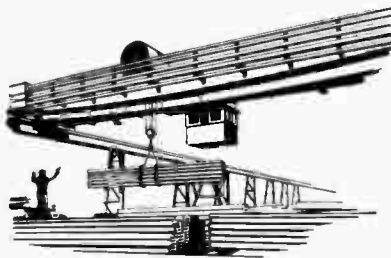

CENTRAL BRIDGE *Company, Limited*
Trenton, Ontario

**SPECIALISTS IN
TELEVISION AND MICROWAVE
TRANSMISSION TOWERS**

UB40U

At Last! A New, Self-Sufficient Canadian Company

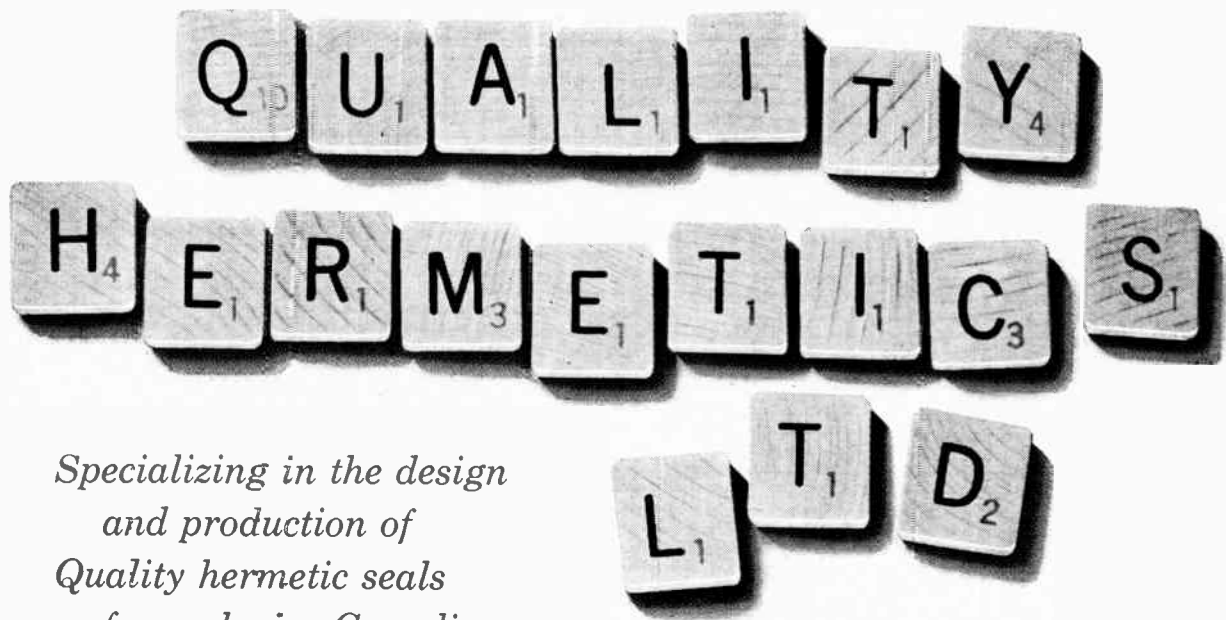

*Specializing in the design
and production of
Quality hermetic seals
for exclusive Canadian
industrial applications*

A self-sufficient company:

Quality HERMETICS, Ltd. is the shortest path to the surest solution of problems in hermetic sealing. Why? This new Canadian company is a self-contained organization with facilities for the manufacture of quality glass and ceramic components, for quantity and quality production and design and application engineering.

Management with successful pioneering know-how takes the puzzle out of hermetic sealing problems:

An engineering-management team which pioneered hermetically sealed crystal holders, multi-headers, transistor bases, condenser seals, relay and transformer seals and individual headers will be directing the activities of Quality HERMETICS, Ltd. No matter how rigid your specifications may be, this staff is qualified to offer the quickest and most economical solution to your procurement problem.

Write today for additional information on how Quality HERMETICS, Ltd. can be of definite assistance in the solution of your hermetic sealing problems.

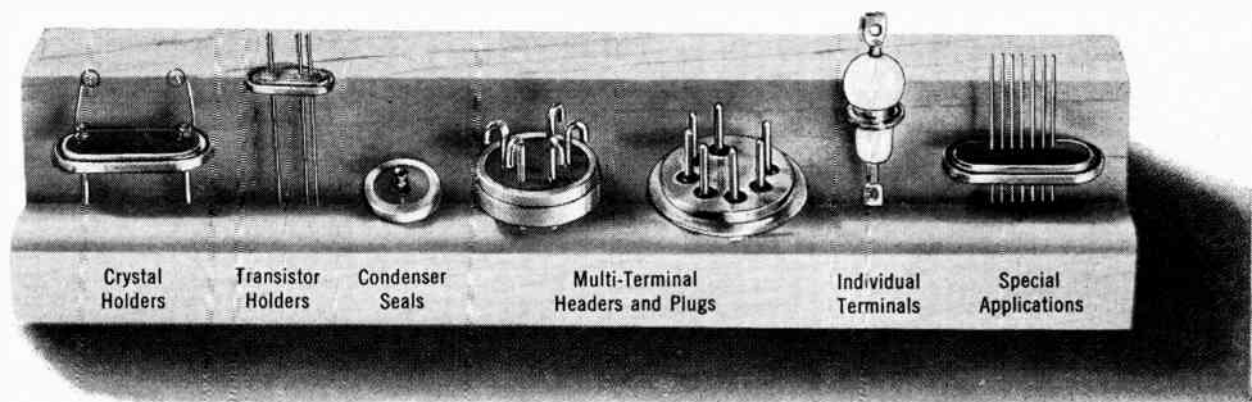

Just a partial listing of the most diversified selection of hermetic seals ever manufactured in Canada.

Quality

HERMETICS, LTD.

45 Hollinger Road
East York, Toronto, Ontario

QUALITY HERMETIC SEALS MANUFACTURED IN CANADA FOR EXCLUSIVE CANADIAN INDUSTRIAL APPLICATIONS



(Actual size)

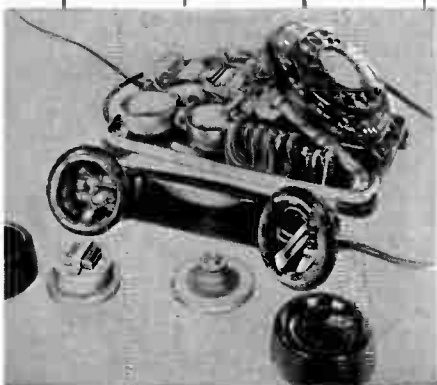

SUPERIOR TRANSMISSION: New short handset, new transmitter and receiver capsules, other new transmission components give extraordinary clarity, even on long party lines.

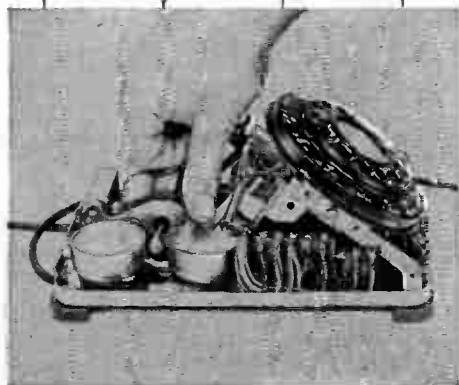

FASTER INSTALLATION: "Installer's Hooklock" keeps hook down during installation, leaves your man with both hands free. Restores itself when housing is replaced.



FEWER TROUBLE CALLS: "Walking Handset" cannot be hung up except in the cradle—makes "off-hook" trouble calls almost a thing of the past. Rugged construction cuts maintenance.

COMPLETELY NEW! AUTOMATIC ELECTRIC TYPE 80 MONOPHONE

It's all you've wanted... and more!

For the first time in many years, a completely new telephone is on the market!

When progressive, practical Automatic Electric engineers found out what telephone men in the field really wanted,

they took those facts and set to work. Result:

The Type 80 Monophone—newly designed from its non-skid feet right up to its lightweight handset.

With well over 30 unique, carefully engineered features that improve performance, simplify installation and reduce maintenance, Type 80 is all you've wanted . . . and more!

Get the full story on the completely new Type 80 Monophone now. Write Automatic Electric and ask for Circular 1841.

Check These Outstanding All New Type 80 Features!

MADE IN CANADA BY

AUTOMATIC  **ELECTRIC**
(CANADA) LIMITED

Distributor in Canada

AUTOMATIC ELECTRIC SALES (CANADA) LIMITED

Head Office: 185 Bartley Drive, Toronto 16

MONTREAL • OTTAWA • BROCKVILLE • HAMILTON • WINNIPEG • REGINA • EDMONTON • VANCOUVER

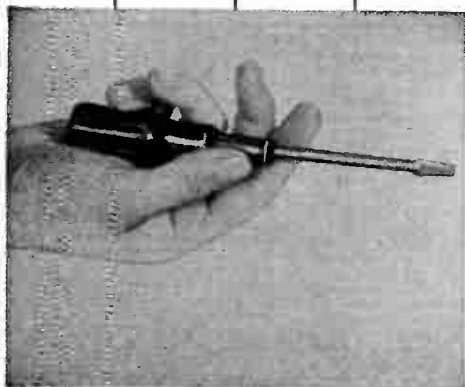

EASIER MAINTENANCE: A screwdriver's all you need. Connections made with spade terminals—no soldering! Components grouped in convenient, screw-mounted units.



EASIER, SURER DIALING: Slant of dial makes dialing easier from either sitting or standing position. Arrow-heads guide eye from fingerplate holes to numbers—help prevent errors.

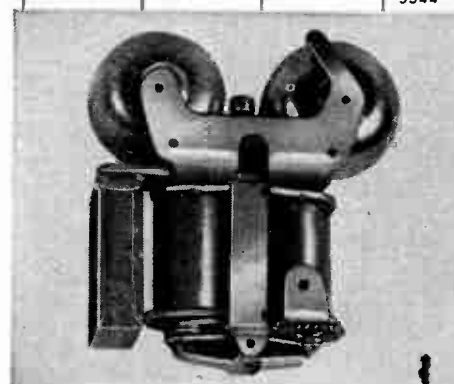

IMPROVED RINGING: Considerably increased volume of sound provided at higher ringing frequencies. Volume control available for SL ringer. Gongs pitched to give sound that carries well.

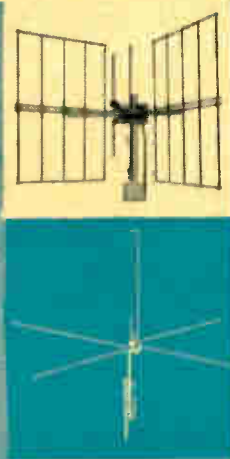

BARGAINS in POWER

No single piece of radio equipment can equal the antenna for economically increasing effective power.

One of the less expensive components in a radio communications installation is the antenna. Yet the antenna, which usually represents less than ten per cent of the total equipment cost, can multiply the effective power of every transmitter in the system *several hundred per cent*. Equally true, a poorly designed or inappropriate antenna can waste the power produced by the costly equipment behind it.

In planning a new system, selection of the proper antenna often will allow a lower power transmitter to achieve desired signal range. For existing systems, the use of a higher gain antenna will reduce "dead spots."

Andrew is a pioneer in designing and developing antennas. We make over 30 standard types for microwave, broadcast and mobile communications. Special models or adaptations of standard models are readily made to order.

Write or phone Andrew for a dollars-and-cents evaluation of the type of antenna that can give your installation the greatest bargain in power.

Manufacturers of
the UNIPOLE,
High Gain,
Corner Reflector,
Parabolic and Yagi
Antennas



Andrew
ANTENNA
CORPORATION LTD.
P. O. BOX 971 • WHITBY, ONTARIO



THE EDITOR'S SPACE

(Continued from page 7)

and other machines a perfect opportunity to assess their own office equipment needs thereby developing a fuller realization on the part of office management how costs can be reduced and how efficiency and economy is within reach of every office, large or small.

A transistorized "pocket" radio is now actually available to the Canadian consumer. The radio is 6 inches wide, 3½ inches high and 1¼ inches deep. Just as television has altered the home routine of the public, such as eating half the meal at the table and the other half on the living room floor, we are led to wonder whether the tailoring industry will be enterprising enough to recognize the sales potential of incorporating a special pocket for "pocket" radios in men's clothing. Pockets in Canadian-made and American-made men's clothing have always been too small and it would be next to impossible to accommodate a "pocket" radio in them. On the other hand, tailors could consider just making pockets larger all around like the pockets in English tailored clothing. Generally speaking pockets in British-made garments are large enough to use as a sleeping bag should the occasion arise all of which brings up the question as to whether it may not be advisable to set up to standardize on the size of pockets and "pocket" a joint committee of the tailoring and radio industries radios. This electronics business can sure get things involved!

Legislation brought down in the House of Commons a few years ago proposed that operators of vessels of specified size used for ferrying operations should employ certified engineers to run them. The measure, it is understood, was ratified and placed on the statute books in the interests of safety to both the cargos and the passengers carried by the vessels.

Though the legislation imposed an increased operating cost on the owners by the required employment of certified engineers it must certainly be regarded as a progressive act passed on behalf of the public.

Although management of large shipping companies, practically without exception, have recognized their responsibility in the matter of providing every means to assure the safety of passengers and cargo, the same cannot be claimed overall for the operators of smaller vessels engaged in short-haul ferry service. It is just this type of service, operating for the most part in confined harbor waters and inshore routes, both areas of possible traffic congestion, where collision hazards are most likely to occur. It is considered therefore, that the required use of small-type radar equipment, an item which has been greatly reduced in both size and cost, and surely now within the price range of most ferry and inshore ship operators, be considered by the appropriate authorities as further possible legislation in the interests of the safety of the public who use such services.

Radar, which should not be accepted as a means of navigation in itself, but rather an aid to navigation, should be regarded by all responsible ferry operators as a moral obligation to their passengers from whom they make their living.

All jobs have their sweet and sour sides. One of the more pleasant aspects of editing a trade paper is opening the morning mail. Quite frequently it contains some little gimmick or component connected with the electronics industry. So far no one has been kind enough to send a TV receiver under separate cover, but collectively the industry isn't doing too bad. In the course of two years or more there has accumulated in the office a box full of components which conceivably, if they could be put together, would constitute a reasonable likeness to a television set. Of course the picture tube and the cabinet hasn't arrived in the mail yet but we're ever hopeful.

WHY THE

"WEE MEGGER"

INSULATION TESTER IS SO POPULAR

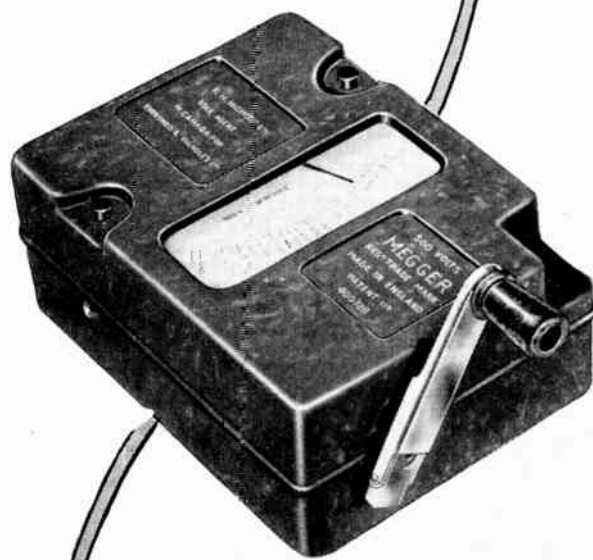

because . . .

- It's pocket-size, easy-to-read, "true" ohmmeter that warns of insulation weakness before breakdowns occur.
- Insulation effectiveness varies with humidity moisture or dirt. A progressive log of insulation behaviour is obtainable by the use of a Megger Tester.
- "Wee Megger Testers" come in three models—100, 250 and 500 volt testing pressures—larger Megger testers too, for whatever your needs.

Write to Dept. EC-7—ask for bulletin 211/3a.

"Megger" is a registered trade mark.

E541

R.H.
Nichols LIMITED
2781 DUFFERIN STREET • TORONTO

Scatter Propagation

Long Range VHF-UHF Radio Transmission

By H. GERKS
Collins Radio Co. of Canada Ltd.

A form of radio propagation is described in the following article which permits spacing of stations far beyond the optical range. Scatter propagation, resulting from turbulent variations in the refractive index of the atmosphere, generally requires high-power transmitters and large antennas, but it permits establishment of highly reliable links several hundred miles in length without intermediate relay stations. At certain frequencies, links up to more than 1,000 miles are feasible. The nature of the terminal equipment is discussed by the author and operational results are outlined.

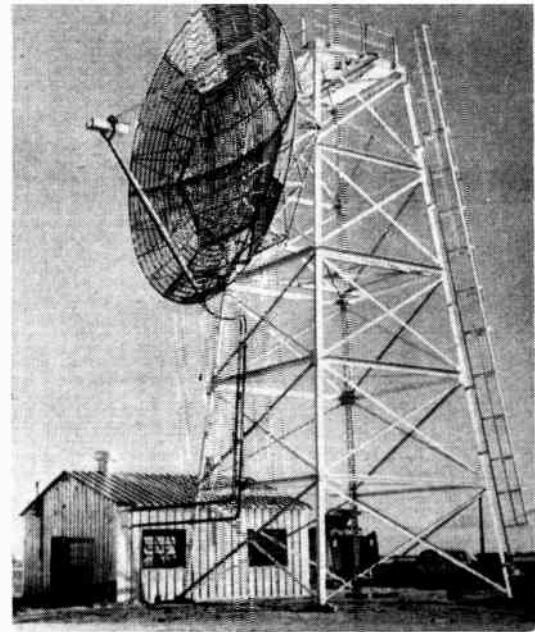

● Fig. 2 View of 28-foot Parabolic Antenna Mounted on a 50-Foot Tower.

The ever-expanding need for new radio channels has led to a phenomenal expansion of the useful spectrum to higher and higher frequencies. The most recent discovery, which holds promise of great potential usefulness, is scatter propagation. This effect permits a large extension in the range above 30 mc. Before discussing this subject in detail, let us consider briefly the limitations of radio propagation in the absence of scattering.

The wave radiated from a transmitting antenna in free space is

attenuated solely as a result of expansion in all directions. When the transmitting antenna is placed over a spherical earth of infinite conductivity, there is no loss due to surface currents, but the wave at distant points near the surface may suffer large additional attenuation because of the shadowing effect of the curved surface. This effect becomes more and more pronounced as the frequency becomes higher. When the perfectly conducting earth is replaced by a finitely conducting earth, there may again be a large additional

attenuation because of earth losses associated with the surface wave. Again this loss increases with increasing frequency.

Consequently, a rough working rule long applied to VHF and UHF stations was that reliable signals could not be received very far beyond the horizon of the transmitting antenna. This concept has led to the use of very tall supporting structures for FM and TV broadcast antennas, and to the careful location of moderately tall towers on high ground and at rather small spacing in radio relay services. The principles employed in these systems are entirely sound. The broad-band signals employed in television require large values of field strength which are difficult to establish far beyond the horizon; and line-of-sight microwave relay stations may use low-power transmitters and relatively low-cost antennas. There are, however, situations where it is inconvenient or impossible to establish a chain of line-of-sight relay stations. Examples are paths containing long water obstacles or passing through uninhabited and undeveloped terrain. In such cases, scatter propagation may be employed to good advantages. Still other cases may exist where only widely separated terminal stations are to be connected and no service to intermediate points is required. Here a single high-power scatter link may be found more economical than a chain of lower-power stations. It should be noted, however, that terminal equipment for a scatter system may be readily designed in such a way that a combination of scatter and line-of-sights links may be used compatibly.

It has been held until quite recently that propagation by way of the ionosphere could be achieved only at frequencies below the MUF (maximum usable frequency). The MUF increases with the distance, but it is rare that signals can be transmitted by regular ionospheric reflection at frequencies above 30 mc at any distance. The re-

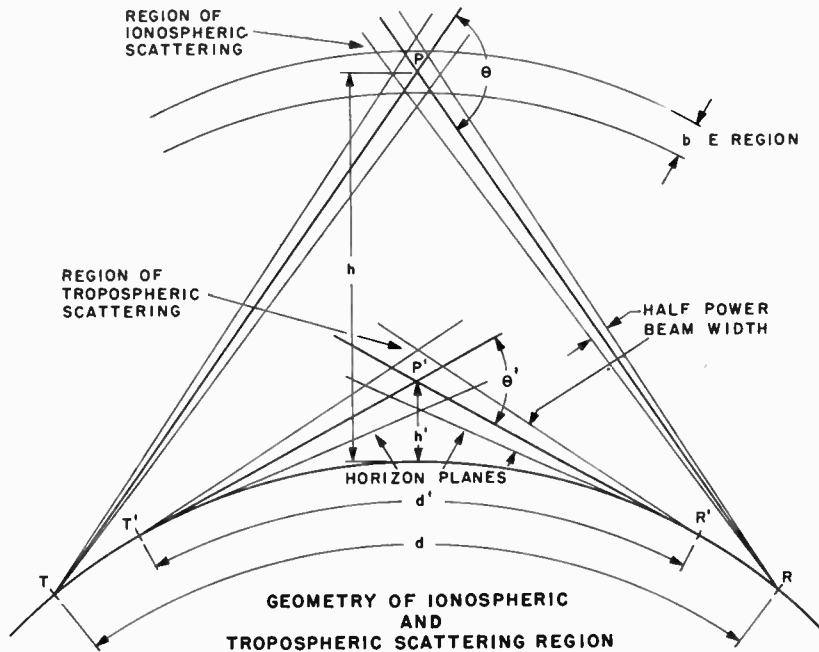

● Fig. 1. Sketch Illustrating Scattering in the Troposphere and the Ionosphere.

sultant congestion of services in the range below about 20 mc is such that further expansion is impossible. The service in this part of the spectrum is also degraded by the variability of the MUF, by high atmospheric noise levels, and by sporadic interruptions associated with unique solar phenomena.

Consequently, much interest has

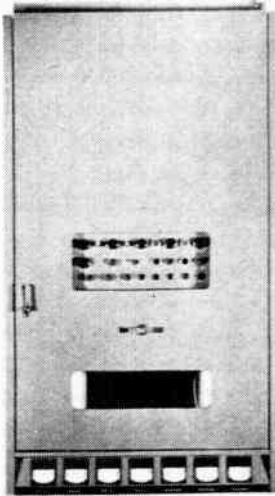

● Fig. 3 Collins 240C-1 UHF Transmitter and Power Supply
Frequency Range: 225 - 1000 mc
Power Output: 1 kw Class C, 500 watts, Class B
Exciting Power: 10 watts

been shown in the recent discovery of ionospheric scattering from a turbulent layer located at a height of 80 to 100 km. Useful propagation may be obtained at frequencies in excess of 50 mc at all times, with no need for frequency shifting due to diurnal and solar cycles, and with a minimum of atmospheric noise. The great height of the scattering layer in this case permits spacing of terminals as far apart as about 1200 miles.

Nature of Scatter Propagation

Ground wave propagation can occur in the absence of an atmosphere. The only effect of the atmosphere is a slight curvature of the ray toward the earth, the effect being equivalent to an increase of about 30 per cent in the effective earth radius. This model applies reasonably well up to about 20 mc. At relatively low frequencies, also, the reduction of refractive index in the ionosphere may be sufficient to cause total internal reflection. As the wavelength becomes shorter, one can no longer overlook the minute local variations in the refractive index of the atmosphere. In the troposphere, these variations result from density and humidity fluctuations induced largely by convection at the surface. In the ionosphere, they result in part from meteoric trails and in part from other sources of ionization not yet adequately identified. When a wave which is originally plane passes through such a region, its different

parts are advanced or retarded, so that the wave front becomes irregular. It resembles hilly terrain. When the wavelength is sufficiently small with respect to the dimensions of a "hill" in the wave front, the ray theory indicates propagation generally perpendicular to this irregular wave front and therefore a deviation from the original direction of the incident ray. Since only small distortions normally occur, the scattered power decreases quite rapidly with an increase in the angle measured from the direction of the incident ray. Consequently, useful scattering is limited to angles of only a few degrees measured from the forward direction. This effect explains the good preservation of small antenna beams angles and the usefulness of high-gain antennas.

As shown in Figure 1, the region in the troposphere which contributes most strongly to the scattered field lies near mid-path and just above the intersection of the horizon rays of the two antennas. When the antenna beams are tilted up, reception rapidly becomes poorer because of an increase in the forward scattering angle Θ , and because of reduced turbulence with increasing elevation. In the case of the ionosphere, however, the height of the scattering layer is approximately fixed, and an optimum vertical beam elevation angle exists for any given distance. Furthermore, ionospheric scattering at distances below 400 miles is poor because Θ is too large. At distances beyond 1000 miles, it is usually difficult to achieve beam elevations which are sufficiently low at the frequency involved because of impractical antenna heights. Hence, rather rapid decreases in received power may be expected beyond this range.

It is found that tropospheric scattering occurs almost equally well at all frequencies from about 30 mc to 4000 mc or more. In the ionosphere, however, the refractive index modification

results from the deflection of electrons by the radio field, and the electrons exhibit inertia. Hence, the scattered power decreases with increasing frequency. The most useful range has been found to lie between 30 and 60 mc. At frequencies much below 30 mc, regular ionospheric propagation may occur at times, with the resultant possibility of interference from other stations and from back-scatter.

System Considerations of a Scatter Link

It is found from experiment that the transmission loss relative to free space encountered in tropospheric propagation is given approximately by the formula

$$L = 60 + 0.12 (d-100) \quad (1)$$

where L is in decibels and d in statute miles. For distances less than 100 miles, the relation is no longer linear. The height of each antenna is assumed to be small, in the range 20 to 50 feet. Hence, for distances beyond 100 miles, a large part of the path is non-optical. The height of the antenna is unimportant so long as the beam clears nearby obstacles and the height in wavelengths is large enough to give a main lobe less than a degree above the horizon. If mountainous terrain raises the line-of-sight significantly above the horizontal plane, the antenna beam must, of course, be correspondingly elevated, with a resultant increase in Θ of Figure 1 and a reduction of received power.

Since the frequency in this case is usually hundreds or thousands of megacycles, an aperture antenna, such as a parabolic reflector, appears to be most suitable. Because of the large scattering loss encountered on long tropospheric links, a narrow-beam or high-gain antenna is required at each terminal. Beam angles of less than five degrees are readily obtainable. Figure 2 shows an experimental antenna 28 feet in diameter mounted on

(Turn to page 64)

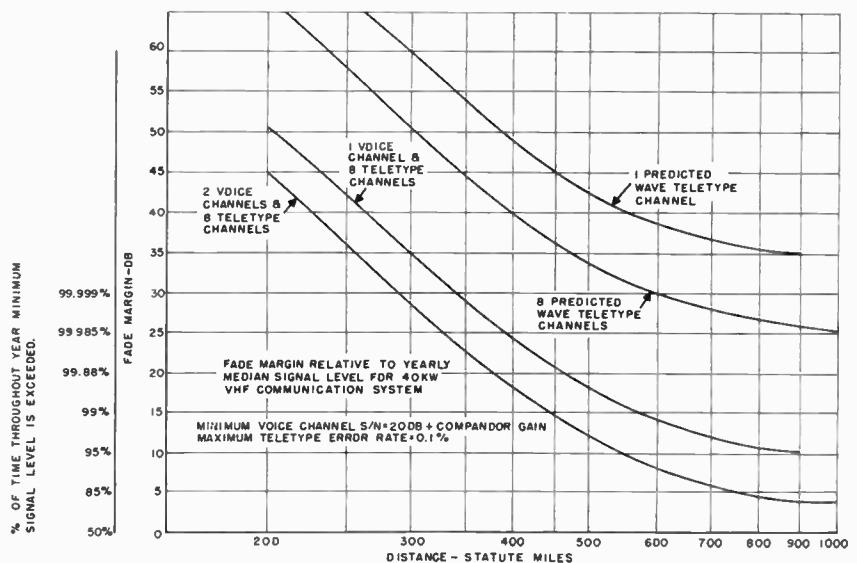

● Fig. 4. Fading Margin and Circuit Reliability as a Function of Distance for a VHF Scatter link.

The R-Theta Computer

A Canadian Achievement In The
Field Of Aerial Navigation

Designed for use in long-range, high-speed aircraft but capable of efficient operation in short-range slower planes the R-Theta Computer invented by Wing Commander J. C. Wright, D.F.C., R.C.A.F., and developed by engineers of PSC Applied Research Limited, Toronto, meets the pressing need for a compact electronic automatic navigation system. The device which has been termed "a significant and outstanding contribution to the science of air navigation" won for its inventor the McKee Trans-Canada Trophy presented annually to the person who has contributed the most toward the advancement of Canadian aviation. Development of the R-Theta Computer is an outstanding Canadian achievement in the field of electronics and the project marks the entry of Hunting Associates Limited, of which ARL is a member, into the electronics field.

THE increasing complexities of modern aircraft operation and the necessity of aerial navigation under combat conditions without radio aids have confronted pilot and navigator with many problems. With the advent of high-speed jet planes the range of aircraft has become greater and the time factor has decreased. Work on a 1500 mile flight which had previously taken approximately ten hours now has been compressed into less than three. There is neither time nor working space on today's jet planes to keep a "dead reckoning" plot, nor is it feasible for military planes to fly in the straight directions required to perform accurate navigation.

Work on automatic navigation systems began in various countries as early as 1935. Research went on in two directions, one intent on solving the problem by developing a "dead reckoning" instrument, capable of giving the navigator an approximate position, the other concentrating on radio aids to navigation.

Development of automatic navigation equipment culminated early in World War II with the introduction of the British Air Position Indicator. This device automatically computed the air position of the aircraft from the heading and airspeed of the aircraft being fed into it. To obtain the actual geographic position, wind speed and direction had to be applied manually to

the air position. Its great advantage was that the pilot had regained his tactical freedom, and no longer had to fly in a series of straight lines in order that the navigator could carry on with conventional navigation. Toward the end of World War II, an instrument known as the Ground Position Indicator was devised. This equipment was such that wind speed and direction could be added mechanically to it and project the aircraft's ground position as a spot of light on the appropriate map.

Aids to navigation such as Loran, radio range, and search radar are some of the developments helping to solve the pressing requirement for an automatic navigation system by concentrating on radio. Such systems are reliable and time-tested, but suffer from two distinct disadvantages.

The main disadvantage of these systems is the enormous expense of the large ground stations required for radio navigation. The second disadvantage is their dependency on radio transmission for operation, which in wartime could be of great advantage to the enemy.

All of the automatic deduced reckoning systems were basically the same. They all sensed the direction and distance the aircraft had gone, broke this information down into North-South, East-West components, and indicated the aircraft's present position as lati-



Wing Commander Wright

tude and longitude. Although the aircraft's present position can be valuable information for the navigator, he usually requires this information to compute the direction to go to reach his destination and the time required to get there. For this reason it is much more valuable to find a means of expressing position as a distance and bearing from a given point.

How It Works

The inventor of the new device reasoned that if an automatic machine were devised to calculate how far, and in what direction the aircraft had moved from its starting point, it only would be necessary to steer the reciprocal of the direction for the indicated distance to reach the starting point. Furthermore, he reasoned, that if the device was equipped with a set of gears and electrical circuits, it would be able to compute the distance and bearing of the position to which the aircraft is heading. Simply, that is what the R-Theta does. It computes automatically the combined effect of the aircraft's heading and airspeed and adds to this the distance the aircraft will be blown by the wind, expressing the resultant as a distance and bearing, rather than latitude and longitude. In addition, the 37-pound, compact instrument can be set to compute the distance and bearing of any other position desired, within the range limit of the device. Translated into the terms of a human navigator it is an automatic plotter and computer.

To visualize the operation of the computer, one must imagine an aircraft taking off with two long fishing lines tightly wound on their reels held by a spring and attached to its fuselage. One line is fixed to its takeoff point, while the other is attached to its destination. No matter what manoeuvres the aircraft performs during flight, the pilot need only follow one line back to his starting point or the other to his destination. Distances of course, can be read from the lines, marked off in miles.

(Turn to page 73)

for

service

satisfaction

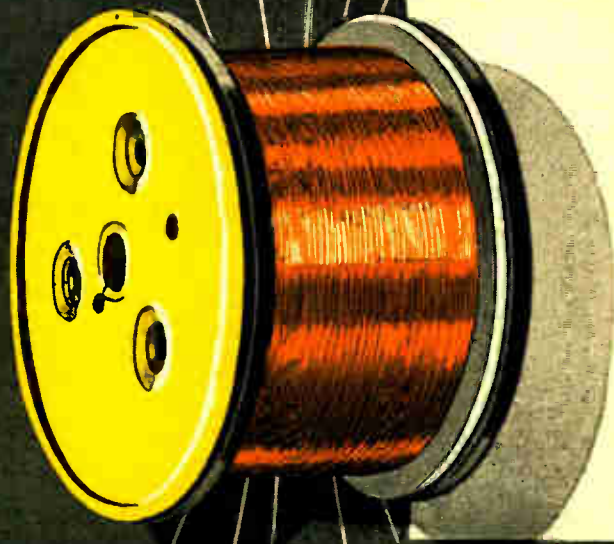

FEDERAL

Magnet

Wire



THE FEDERAL WIRE AND CABLE COMPANY LIMITED
GUELPH ONTARIO

INTRODUCING...



The NEW

COSSOR

OSCILLOSCOPES

For All
Applications

MODEL 1058

Single beam 4" tube
Post deflection acceleration

Wide band D.C. Y amplifier
Symmetrical X amplifier

Free running or triggered time base

Sweep expansion times 5

Automatic trigger and sync. control

Continuously variable trigger pulse attenuator.

Y AMPLIFIER

D.C. to 6 mc/s.

Sensitivity 25V to 125V per cm.
Gain continuously variable.

X AMPLIFIER

10 c/s to 150 Kc/s.
Sensitivity .5V to 50V per cm.
Gain continuously variable.

Weight — 42 lbs.

MODEL 1052

Double beam 4" tube.
Frequency Range
25 c/s to 3.5 mc/s
Matched amplifiers.

Full screen deflection at all positions of T.B.

Sweep duration — 5 microsecs to 200 milliseconds.

Weight — 42 lbs — portable.

MODEL 1056

Single beam post deflection acceleration.

Y AMPLIFIER

5 c/s to 40 mc/s.
Rise time 10 millimicrosecs.
Sensitivity — .2V to 60V per cm.
Gain continuously variable.
Signal delay 16 millimicrosecs.

TIME BASE

Triggered only
10 millimicrosec. to 30 microsec per cm. Sweep amplitude two screen diameters.
Timing wave 100 mc/s to 100 Kc/s

Weight — 65 lbs. approx.

MODEL 1059

Double beam
Post deflection acceleration

Y AMPLIFIER

10 c/s to 10 mc/s.
Sensitivity .2V to 180V per cm.
Gain continuously variable.

Signal delay 150 millimicrosecs.

Y1 PREAMPLIFIER

Gain 20 times over 20 c/s to 5 Kc/s.

Y2 AMPLIFIER

Same as Y1.

X AMPLIFIER

10 c/s to 500 Kc/s.
Sensitivity 3V to 15V per cm.
Gain continuously variable.

TIME BASE

Triggered with sync.
Free running without sync.

.1 microsec to 50 millisecc. per cm.

Expansion times 5.

Weight — 65 lbs. approx.

COSSOR (CANADA) LIMITED

301 Windsor St.,
HALIFAX, N. S.

758 Victoria Square
MONTREAL, QUEBEC

648A Yonge Street
TORONTO, ONTARIO

Broadcasting

Studio Control Switching Unit



Newly Developed Studio Control Switching Unit Is Expected To Reduce Studio Operating Cost By \$60,000 A Year.



A NEW device for the radio broadcasting industry known as the "STUDICON" is a studio control switching unit which enables studio operators to select particular channels for transmission of the studio output. The unit eliminates the necessity for a master control while retaining the advantages of a master control system.

Audio connections to the unit are made simply with patchcords, and installation can be made without interruption of programming. In a twelve studio, four channel operation, a control box located in each of the studios

permits the operator to select any or all of the four channels and feed the studio output to the appropriate channel. The control elements for a single channel include a lever key which activates the channel, a "channel in use" light which notifies operators in the other 11 studios, a "studio on" light which indicates to the operator whether or not his studio has control of a channel, an "emergency line amplifier" key which permits the operator to switch in a spare line amplifier in the event of failure of the operating line amplifier, and an



● STUDICON—MASTER CONTROL SECTION (shown at left with doors open), located in the master control room of Radio Station WOR, New York City. The master control section is the electro-mechanical heart of the Radio Studio Control Switching System.

indicating lamp which shows when a spare amplifier is being used. These controls are duplicated for each channel.

Year's Saving \$60,000

The "channel in use" lamp is lit at all 12 studios when any one of the studios is feeding that channel. An electrical interlock system permits only one studio to feed a particular channel at a time. However, if a studio wishes to interrupt a program originating from another point, the operator can take control of the channel by releasing a mechanical guard on the channel selector lever switch and throwing the switch to the "by pass" position. When the switch is returned to the off position by the interrupting studio, the original operating condition is restored. Also, for any reason should two studios wish to operate on the same channel, both studios would place the selector lever switch in the "by pass" position and then compensate for the change in program level.

Each control box is provided with a cable and plug. At a centrally located point the twelve studios are interconnected by a bank of relays. Also at this point are indicating lamps, an audio jack panel and terminal strips. The relays are part of the control and interlock system and the lamps indicate which channel is in use and at which studio the program is originating.

The first installation of STUDICON is being made at WOR-AM-FM where Charles Singer, Chief Engineer of WOR, estimates that this equipment will save \$60,000 a year in operating expenses for his station.

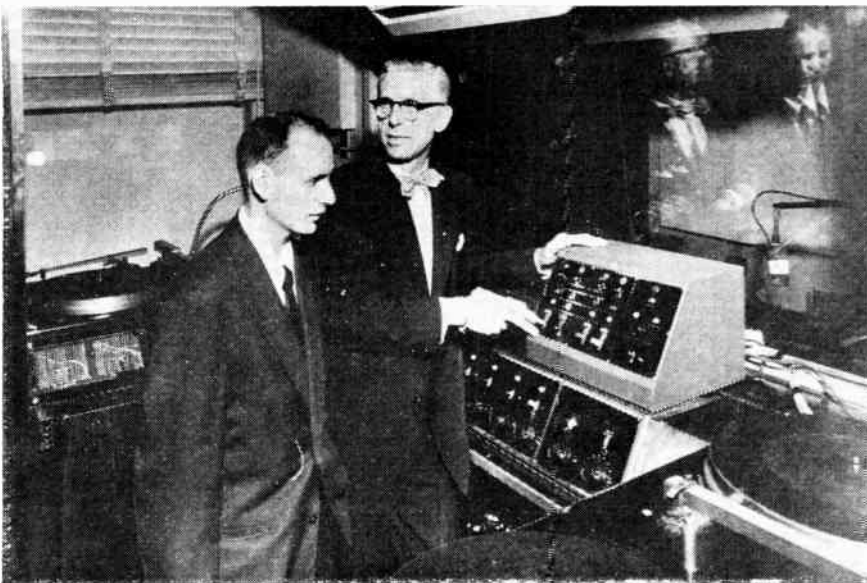

● In the control room of Studio 5 at WOR (The Mutual Broadcasting System) Mr. Ralph Schlegel, Technical Facilities Supervisor for WOR-AM-FM, operates the Studicon Control Box. Mr. Ernest Deutsch, Broadcast Engineer for the Standard Electronics Corporation, who designed and developed the Studicon, watches the ease of operation.

Automation

Automatic Gear Gauge And Hobbing Machine Control

Top-Flight Efficiency And Accuracy In
 Gear Cutting Is Achieved At A Production
 Rate Of 1000 Gears Per Hour With
 Automated Control.



AN automatic gear gauge designed to eliminate inspection by hand methods, to immediately detect machine setup errors, to automatically adjust machine to correct errors, to prevent production of scrap gears, to permit the working to closer tolerances, to increase hob life and to increase production efficiency and

reduce costs is one of the latest automatic controls that will be of interest to the gear manufacturing industry.

This automatic gear gauge and hobbing machine control represents a new concept in the inspection of gears and the control of hobbing machines. Operating completely automatically, it sorts gears according to production tolerance limits and permits control of the hobbing machine so as to prevent production of scrap and reduce the cost of making gears.

Each gear gauge is custom-designed for a particular customer requirement. Sorting gears according to tolerances established by the user, the Type 80 as the new device is called, is capable of handling as many as 1,000 gears per hour. Automatic indicators signal when the pitch diameter falls outside allowable limits, also indicating when the hob has begun to dull. An automatic circuit removes power from the hobbing machine if it produces too many gears outside the tolerance limits.

When used with a suitably equipped hobbing machine, the Type 80 automatically controls the machine both for pitch diameter and for hob shift to compensate for hob wear.

Pitch-Diameter Control

Pitch-diameter control is based on modified ball-type measurement of gears as they come from the hobbing machine. When the machine output shows a tendency to depart from mean pitch diameter, the Type 80 signals for pitch-diameter correction. Thus, corrections occur before errors become sufficient to result in scrap gears.

The unit provides automatic pitch-diameter correction in models for use

with hobbing machines having an electrically operated pitch-diameter correction mechanism. Otherwise, an automatic indicator in the Type 80 signals for manual adjustment of the hobbing machine.

Hob-Wear Control

Hob wear — that is, dulling of the hob cutting surfaces — causes a change in the shape of the root-fillet region of the gears. The Type 80 measures the amount of this change and signals for the hob to be shifted when the root-fillet build-up reaches a preset limit.

This basis for hob shift is highly preferable to older methods of shifting at predetermined intervals or at a predetermined rate, on the basis of assumptions as — to the rate at which the hob will wear. The principle used in the new equipment (of shifting on the basis of actual measured wear) results in more even wear of the hob and in utilization of the full potential hob life.

Automatic hob-shift control is available in models for use with hobbing machines having an electrically operated hob shifter. Otherwise, an automatic indicator signals for manual hob-shift.

Physical Description

The Type 80 consists of two separate units and an interconnecting cable. One unit mounts on a frame or pedestal adjacent to the hobbing machine. Hobbed gears are delivered to this unit either by an automatic chute or conveyor from the hobbing machine or by hand. After checking, each gear leaves the Type 80 through one of three chutes (acceptable, salvageable, or unsalvageable) suitable for feeding conveyors, storage bins, etc. The second unit mounts vertically on a post or panel in any available location.

Specifications

The automatic gear gauge and hobbing machine control is custom-designed for a particular application. The following specifications illustrate the range of characteristics available:

Size of gears: From less than 1 inch up to several inches diameter; any tooth type

Checking Rate: Up to 1,000 gears per hour

Tolerances: Adjustable from 0.0005 inch to 0.010 inch or more, each direction from mean gear dimensions; tolerance adjustments directly calibrated in thousandths

Accuracy: Repeatability of measurements better than 0.0001 inch

Operation: Unattended, completely automatic

Power requirements: 115 volts, 60 cps, single phase, 5 amperes

Accessories available (optional): Directly calibrated dimension indicators, rejection ratio indicators, totalizing counters, etc.



● The Automatic Gear Gauge has been designed and produced in order to: Eliminate inspection by hand methods; Immediately detect machine setup errors; Automatically adjust machine to correct errors; Prevent production of scrap gears; Permit working to close tolerances; Increase hob life; Increase production efficiency and reduce costs.

Consuming about the same amount of power as a kitchen stove this recent Canadian development in flight simulation enables Canada's Department of Transport to cut the cost of

Pilot Training By Electronics

Another "first" for Canada in the field of aviation electronics is a new kind of electro-mechanical flight trainer developed for the Department of Transport and put into service recently. The only one of its type in the world, the dual control instrument flying trainer has captured interest both in this country and abroad as a prototype of what will likely become standard equipment, providing airline operators with a relatively inexpensive means of training pilots in airways procedures, basic instrument flying and emergency conditions.

Built to the specifications of Department of Transport flight experts, the trainer has been designed for the general purpose of maintaining high standards of efficiency among the departmental pilots and flight inspectors. These fliers have to keep in the forefront of aviation progress since they must "check out" all civilian pilots in Canada. Pilots with the high "instrument rating" undergo testing every six months.

According to Wallace Larocque, officer in charge of Transport's simulated flight training, the equipment lends itself readily to modification so that new development in flying procedures can be incorporated with use in the trainer. Larocque, who is the departmental official most closely involved in the design of the trainer, pointed

out that it will enable him to assess pilot efficiency with an economy hitherto impossible.

The trainer consists of two main units, the aircraft "cockpit" and a radio aids console. It is a twin-seat, multi-engined trainer housing two pilots and having the performance and general characteristics of a twin-engined aircraft. It is a development of the basic American Link trainer, but incorporates completely new and improved systems. All normal flight and engine controls are provided whilst pitching and banking are reproduced by actual movement of the trainer upon its base.

Realistic Simulation

Simulation of the yawing plane is realistically reproduced through instrument indication coupled with movement in bank. Engines can be run up and tested on the ground during pre-flight cockpit check and the trainer must be "taken off and landed". Instrument indications respond to power settings, air speed, aircraft altitude, altitude and rough air conditions and these together with variable loading effects on the flying controls give the trainer an extremely realistic feel.

Flight instruments that are fully operative include among others: air speed indicators, artificial horizons, altimeters, direction gyros, vertical

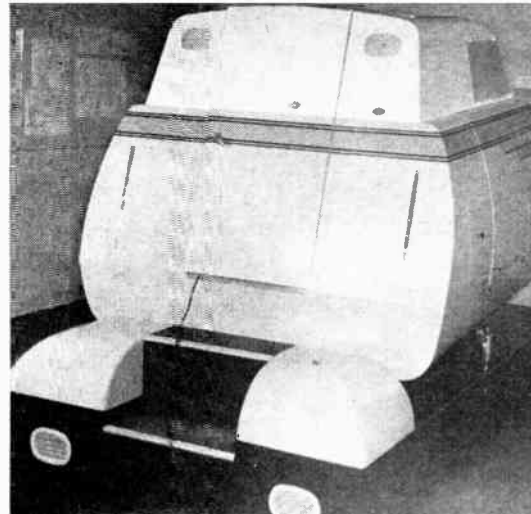

● Exterior view of Department of Transport's new electro-mechanical flight trainer and flight simulator which went into operation on July 6.

speed indicators, flux gate compasses, turn and bank indicators, zero reader course selector, zero reader indicator, course deviation indicator, dual automatic direction finder, Omni bearing selector, offset course bearing indicator, distance measuring equipment, airways marker lights.

An infinite number of frequencies and call letters are available and the equipment is adjustable to any radio facility in any part of the world. Thousand-mile en route test flights are registered on a single chart.

Certain engine and flight instruments are duplicated on the radio aids console portion of the trainer, giving similar indications to those in the trainer cockpit. By means of these and various indicator lights, the instructor is able to assess the pilot's accuracy in handling different flight and engine problems. Various switches also enable him to simulate engine and flight failures. These switches are duplicated on a special panel on the right of the second pilot's seat for the use of the instructor when he is occupying this position.

● Left: The cockpit of the new flight simulator installed for the Department of Transport at Ottawa, has been designed to D.O.T. requirements. Flying operations from the cockpit are registered on the flight recording map on the radio console. This records the en-route operations by the pilot in a cross-country flight or in local landing procedures. Right: New

electro-mechanical flight trainer or flight simulator in operation. The side flaps have been raised for demonstration. Captain S. Grant (foreground) of the Department of Transport is shown testing the new equipment which is the first of its kind and has been acquired by the Department.

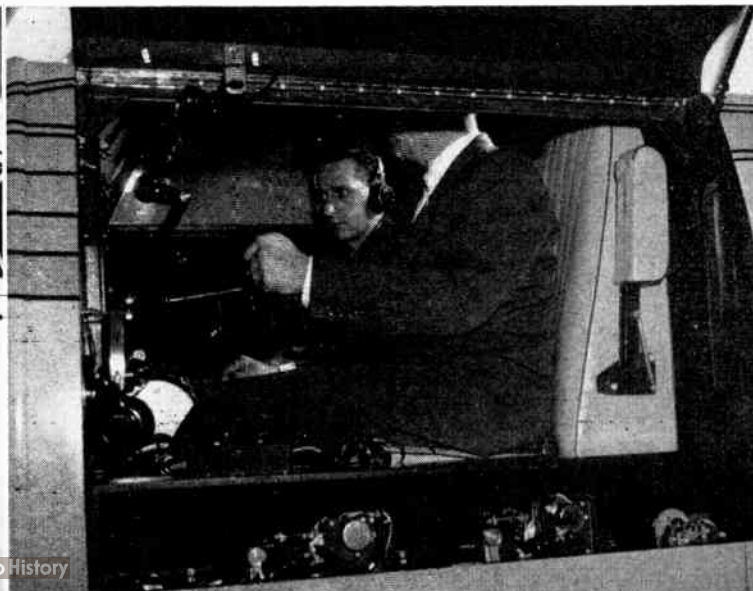

ANNOUNCING



...the Eimac 4X5000A Ceramic Radial-Beam Power Tetrode

The Eimac 4X5000A ceramic radial-beam power tetrode, with a 5kw plate dissipation rating and 16kw power output in typical Class-C telegraphy operation fills a power gap in the tetrode field. Rugged ceramic replaces glass, increasing immunity to damage by thermal and physical shock, and stack type production techniques assure uniform quality characteristics. Straightforward coaxial structure allows the advantages of low lead inductance. An integral finned anode permits improved cooling with low air pressure. Especially suitable for Single Sideband operation, the versatile 4X5000A handles high inputs without going into the positive grid region and delivers 10kw peak envelope power output with zero driving power in typical Class-AB₁ operation. High power gain, low inter-electrode capacitances, simple circuit needs and non-emitting grid wire, inherent Eimac tetrode features resulting from over 20 years of transmitting tube specialization are, of course, maintained.

TYPICAL OPERATING CONDITIONS

Frequencies up to 30 Mc

	Class-C Telegraphy	Class-C Plate Mod.	Class-AB ₁
D-C Plate Voltage	7500	5000	7500 volts
D-C Screen Voltage	500	500	1250 volts
D-C Plate Current	2.8	1.3	1.9 amps
D-C Screen Current	.500	.170	.200 amps
D-C Grid Current	.250	.045	0 amps
D-C Grid Voltage	-350	-400	-300* volts
Peak R-F Grid Voltage	590	520	300 volts
Driving Power	150	25	0 watts
Screen Dissipation	250	85	250 watts
Plate Power Input	21	6.5	14.2 kilowatts
Plate Power Output	16	5.5	10 kilowatts

*In the Class-AB₁ operating conditions listed, adjust grid bias to obtain 500 ma d-c plate current with zero driving voltage.

The above operating conditions show approximate grid driving power and plate power output. Allowance must be made for r-f losses in practical circuits.

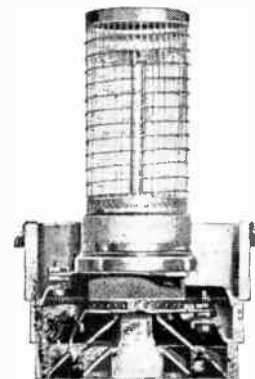

For further information, contact our Technical Services department.

EITEL-McCULLOUGH, INC.

SAN BRUNO, CALIFORNIA

The World's Largest Manufacturer of Transmitting Tubes

ONE of the most spectacular and, at the same time, bewildering undertakings in a world of fascinating novelties is the set-up of a television studio. The first glance of a visitor on entering is always caught by the brilliantly lit television scene, disregarding the numerous cameras and especially the purely scientific spectacle of an intricate electrical system, picking up from this scene its visual and aural intelligence and dispatching it to thousands of homes.

The root of fascination, however, lies in the occasional uneasy but still happy understanding between two factors—machine and art. In so many instances of life the machine is essential, without any attenuation of art, while in other spheres, such as the world of music, pictures and theatre, art is the sole paramount purpose. In television, both machine and art, merge.

Before entering into the fundamentals of studio technique, it is important to find out how television resembles or differs from other affiliated arts, like sound broadcast, theatre and cinema:

1. Double-channel intelligence:

Television approaches theatre and cinema in that intelligence is conveyed from artist to audience by sight and sound, in which respect it is different from sound broadcasting.

2. Audience isolation:

Television resembles here sound broadcasting and cinema, in that the audience, by being isolated by a technical system, is insensible to certain effects of the personality of the artist. Television may be rated higher than cinema in this respect, in view of the psychological effect of the immediacy of television.

3. Continuity of performance:

It is well known that a film is made in very small sections, which are rehearsed repeatedly, until the director is satisfied. In this way the film obtains a certain degree of subjective perfection, which is denied to the television producer. Television, in this instance, differs from known techniques of the film studio, but approaches theatre and sound broadcast, where continuity of performance, once started, is essential.

4. Image dimensions:

The theatre or cinema visitor views with two eyes. The scene arranged in the three dimensions of width, height and depth appears quite natural, i.e., one can tell whether one object is in front of another. Such vision is called stereoscopic vision. As we have not, except in the laboratory, stereoscopic television, in this art the camera views the scene in a monoscopic manner, i.e., with the equivalent of one eye, and consequently the screen of the home television receiver has width and height only. In television certain techniques are employed, similar to the cinema, with the intention of recreating an

illusion of the missing third dimension, and in this respect it differs from the theatre.

5. Colour:

At the moment, television differs from the theatre in that no colour is possible in the image, other than in the laboratory and certain advanced studios. Comparison with films will be difficult, since a great proportion of the films shown to the public are in colour.

6. Nature of audience:

From the various comparisons made, it appears that television has very little in common with sound broadcasting except its continuity, but it is still important to take into consideration the nature of the audience. At present the television audience is the home audience, just as for sound broadcasting. Program material, both in concept and presentation, has been profoundly studied to be suitable for an audience of millions of small home units. In this connection, therefore, we have a very close resemblance to sound broadcast and a marked difference from theatre, concert hall and cinema.

7. Cost:

Considering the factor of economics, it has to be said that television is very expensive. While it demands scenery, property, decor and costume of theatrical and film production, its economics work out quite differently. In the theatre the capital outlay for a production, if it is reasonably successful, will last for many performances, and the cost can therefore be spread out. Sound broadcast, being purely aural, requires no such expenditure. In television, however, a performance will be given only once, and there is a continual stream of new productions, and, therefore, a daily requirement for new studio dressings.

Fundamentals

In a television studio two electrical signals are generated, one carries a representation of the visual aspect of the scene, the other provides an

The Fundamentals Of

equivalent accompanying sound.

The vision signal will be generated by a camera, which is a device for receiving energy in the form of light emitted from the scene and transforming it either directly or indirectly into electrical energy.

The sound signal will be generated by microphones in the accustomed way.

Two principles are important both for vision and sound techniques:

1. No light will be received from a scene until light has been deliberately cast upon it, in order that reflection into the camera may result.

All sound, however, is self-generated within the scene (musical instruments or voices of actors).

2. Light travels in straight lines, but sound will travel along paths which are effectively curved.

Therefore, the camera must receive first choice of position, the microphone must take second place. As a result, the sound that accompanies television can rarely be of as good quality as we have grown accustomed to in sound broadcasts of the highest standard.

The fact that light travels in straight lines gives us two very useful assets:

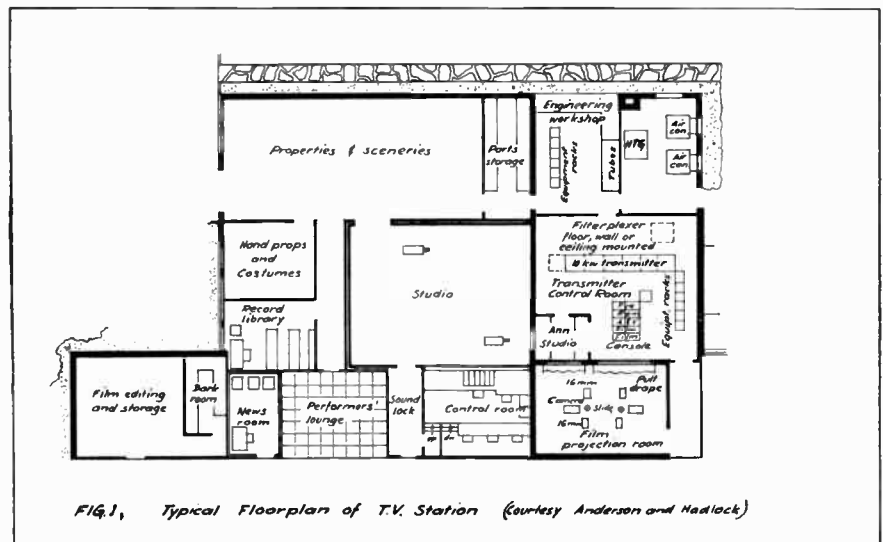

In so many instances of life, the machine is essential without any attenuation of art, while in other spheres such as the world of music, pictures and theatre, art is the sole paramount purpose. In television both machine and art merge Necessitating a knowledge of

By
Leslie L. Hill Ph.D.
Consulting Editor

- - -TV Studio Techniques

1. Scenes may be previewed. Supposing the studio is equipped with several cameras, if one camera is on transmission, it would be feasible to provide a second camera channel terminating in a picture receiver or monitor, which may be set up alongside the transmission monitor and viewed simultaneously without distraction.

This, of course, may cause trouble with regard to the conditions for sound, in which the simultaneous hearing of two sources of sound without distraction is extremely difficult.

2. An artist on the set can be provided with a picture monitor placed so as to be out of the field of the camera, by means of which he can see the picture as transmitted.

This is useful where a speaker is giving an illustrated talk. Illustrations, which may be sections of film, can be televised by other cameras during his remarks. It may be said that the vision equivalent of "talk-back" can be used during transmissions, whereas sound-talk-back, as far as is known, cannot.

Scenery

General design, construction and appearance of objects, at which the camera is aimed, are, generally speak-

ing, three dimensional, and, therefore, quite real. Attempts are increasingly made to artificially create distance and perspective by scene painting and other means. Cameras are now more consistent in their chromatic characteristics and no trouble is experienced with colour (an object viewed on one camera used to develop a change in monochromatic tone on mixing to a second camera).

The scenery tends to become more and more elaborate as television producers seek for a still further degree of artistic perfection.

Make-Up

This feature has several applications. First of all the proportion of the red component in the light reflected into the camera has to be reduced, secondly, other characteristics will have to be eliminated, which the camera tends to stress unkindly, and, in some instances special character make-up is needed. Very little make-up is used and the general technique is to put on a sun tan containing little red and then to model the features on the same lines as for any theatrical production, but with much less emphasis. Excessive darkness of the male chin and any other shadow or effect has to be eliminated. As to the

character make-up, this follows the general lines of theatre make-up.

Lighting

In lighting the scenery it must be borne in mind that a television camera, like most electronic devices, has an input-output characteristic, that is not completely linear. The curve relating input light-values with the output in volts has a bottom and a top bend, the blacks in the scene lying at the bottom bend of the curve and the whites at the top bend.

It is essential, therefore, in lighting the scenery, to get sufficient light on the darker parts of the scene, so that the blacks are lifted just above the bottom bend and, at the same time, to arrange that the high-lights are, so far as possible, not limited by the top bend.

There is an increasing effort to keep records of light values, taking into consideration the combined experience of scenery-designer and lighting engineer. Instruments called high-light photometers are used, in which a small area of the scene may be observed and the light emanating from it measured independently of the light values of any other parts of the scenery. The following table shows reflected light intensities varying between 3-foot lamberts* for the darkest parts to 200-foot lamberts for the brightest spots:

Electric lamp on scenery	320 ft. lamberts	
White flower in man's button-hole	220 " "	
Floor in centre of scenery	110 " "	
Top of scenery	100 " "	
Centre wall of set	38 " "	
Faces	35 " "	
Inside of arch in wall	12 " "	
Black suit on centre stage	4 " "	

*1 ft. lambert = $\frac{1}{\pi}$ candles per sq.

ft. = (brightness of perfectly diffusing surface emitting or reflecting 1 lumen p. sq. ft.).

(Turn to page 92)

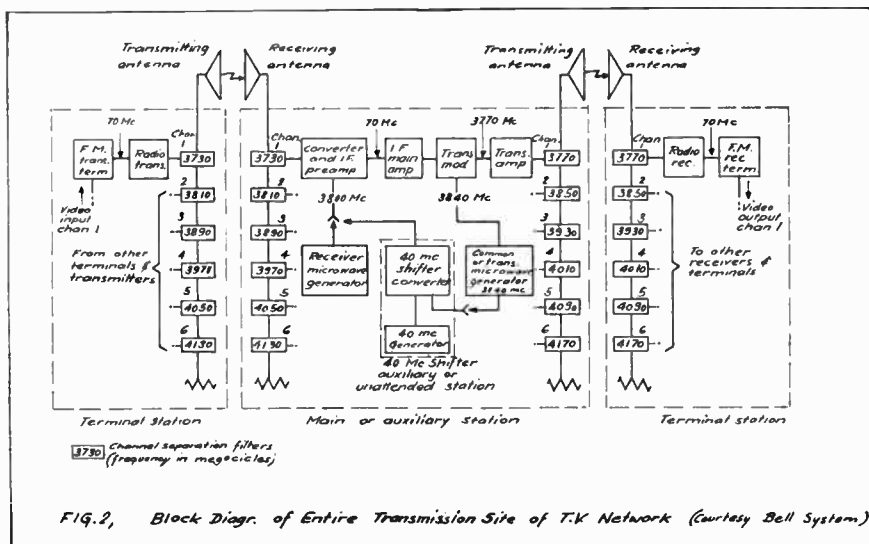

THIS new spectrometer supplements the infrared and ultraviolet spectrometers, which are used to analyze mixtures of organic compounds. Specifically, the mass spectrometer in many cases can analyze complex mixtures of organic compounds, in the form of vapors or volatile liquids, more accurately and more quickly than the infrared or ultraviolet light spectrometers.

For the identification of crystalline inorganic compounds, the X-ray diffraction spectrometer is utilized. With this apparatus, distinctive patterns or "fingerprints" of the compounds in a sample can be obtained in about half an hour. These patterns of known compounds are kept on file, much like the F.B.I. fingerprint file in Washington. Every day, through the effort of the American Society for Testing Materials in co-operation with other interested technical groups, more compounds are being charted and filed in a reference library which now contains the "fingerprints" of almost 10,000 different compounds. Of course, for the elemental analysis of inorganic materials to determine the percentage of metallic elements, the conventional light emission spectrometer is employed. Similar files of reference spectra are available for infrared, ultraviolet, and emission spectrometry.

In the mass spectrometer, molecules of a compound are broken into ionized fragments by *electron* bombardment. The number of ionized fragments of each mass is measured, and from this data the types and amounts of different organic compounds in a gas or vapor mixture can be determined.

The sample of gas or vapor admitted to the spectrometer is subjected to pressure-regulating devices so that the operating pressure in the analyzer unit is of the order of a few hundredths of a micron. Molecular flow of the sample is achieved by causing the gas or vapor to pass through a gold foil "leak" into the analyzer unit. The molecules are bombarded by a stream of electrons, and the resulting charged particles are separated into groups according to their masses (or more specifically, their mass-to-charge ratios).

The separation of the charged particles is effected by accelerating the fragments into a strong magnetic field. A charged particle travelling through a magnetic field will follow a curved path, the radius of which is determined by the mass of the particle, its charge, the strength of the magnetic field and the accelerating voltage. In a magnetic field of constant strength, any charged mass can be made to follow a desired path by correct adjustment of the accelerating voltage.

In the mass spectrometer, the entire analyzer unit is in the field of a strong permanent magnet. The path travel-

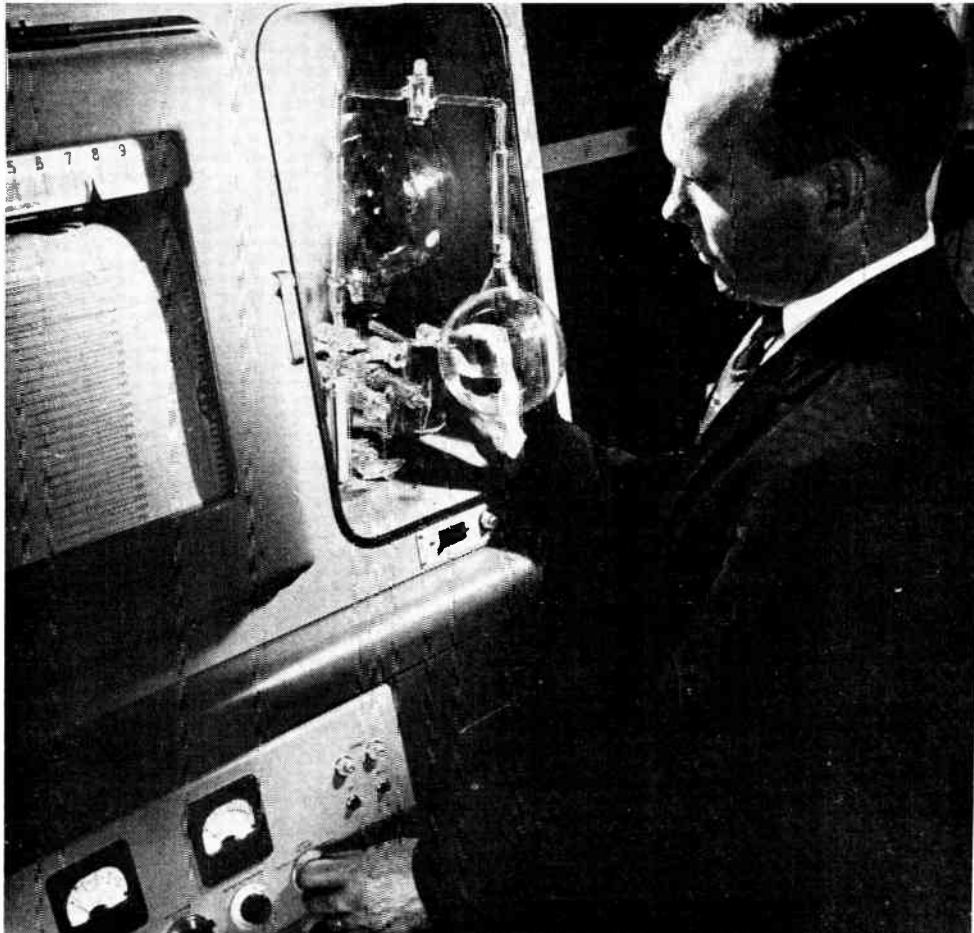

● A new Mass Spectrometer, recently installed at U.S. Steel's Applied Research Laboratory in Pittsburgh, Pennsylvania analyzes gases and vapors by smashing their molecules into fragments and weighing the resulting atoms and radicals. In the illustration, a research scientist has the spectrometer set for process monitoring. The graph shows a tracing and retracing of a peak of one given mass. This is the first instrument of its kind to be used in the steel industry.

The application of Electronic Circuitry with associated equipment enables scientists to perform the analysis of complex chemicals by a fingerprint method in less than half an hour with the use of

The Mass Spectrometer

led by a particle which is to be detected is determined by two fixed slits at an angle of 180 degrees with respect to each other. Thus, by adjusting only the accelerating voltage, any desired mass can be caused to impinge on the detector or target plate which is located behind the second, or exit, slit. By continuously varying the accelerating voltage through a specified range, particles of different masses are successively focussed on the target plate.

At the target plate the charged particles lose their positive charges by taking up electrons. By measuring the resulting electron flow, a quantitative measurement of the number of

particles of a specific mass is possible.

The electron flow is amplified and activates a pen on a moving chart. As the accelerating voltage is changed, automatically and at a specified rate, peaks representing all the masses produced by the fragmentation process are drawn on the chart.

Qualitative Identification

Because the arrangement of atoms in a given molecular species is unique, the manner in which a molecule breaks up under electron bombardment is also unique. The fragmentation, or "cracking pattern", is therefore characteristic and provides a

(Turn to page 80)

AUTOMATIC ELECTRIC • LEADERS IN CARRIER COMMUNICATION • *Lenkurt*

Lenkurt

**POLE MOUNTED
FILTER
ASSEMBLIES
for carrier circuits**

.....
**rugged and
really
weatherproof!**

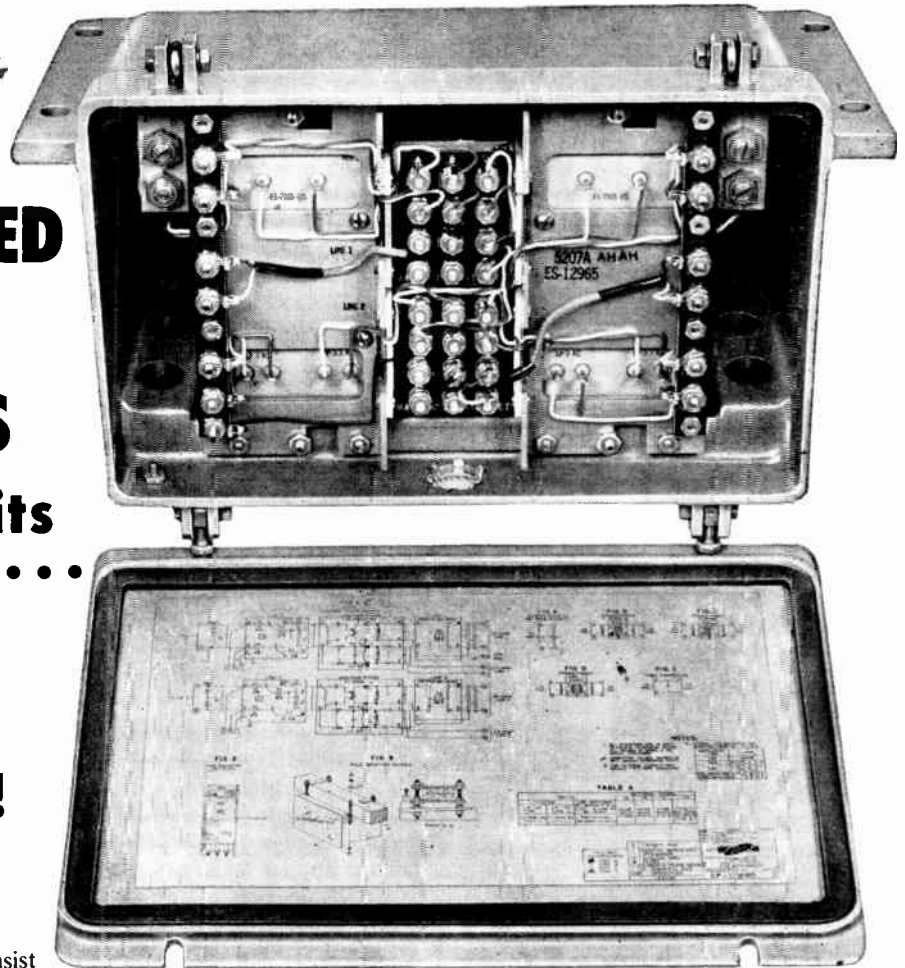

Type 5207A Junction Filter

These carrier circuit filter assemblies consist of low-pass and high-pass filter networks, line matching network, protection equipment and other optional components, inter-wired and connected to terminal strips.

The housing is a weatherproof cast aluminum enclosure with a hinged cover to provide easy access to the filter terminals and equipment. When fastened in place, the cover is sealed by a neoprene gasket for maximum protection and long life under extreme climatic conditions.

An attractive anti-corrosion finish protects the aluminum casting from corrosion due to coastal salt or industrial gases.

The cast aluminum construction is extremely durable as well as being light and easy to handle. The outside dimensions are: 13 $\frac{3}{8}$ inches wide, 8 $\frac{3}{8}$ inches high and 8 $\frac{3}{8}$ inches deep. The weight of a complete filter assembly is approximately 30 pounds. Threaded studs and clamps are provided for crossarm mounting.

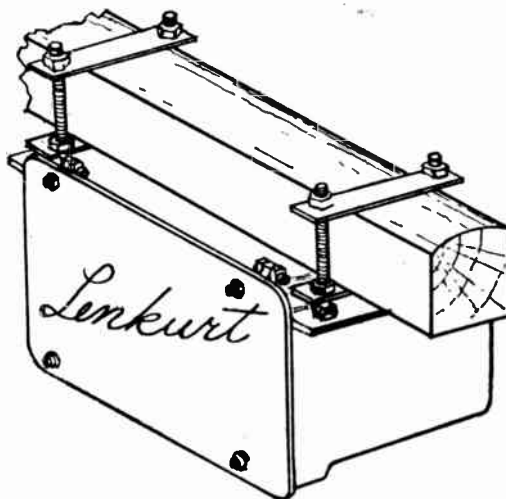

Mounting Arrangement on Crossarm
(Two enclosures may be mounted
back to back on a double crossarm)

TYPES AVAILABLE

Junction Filters

Type 5107A—3KC
Type 5207A—3KC (2 filters)
Type 5108A—5KC
Type 5208A—5KC (2 filters)
Type 4919A—38KC

**Terminal of Main Repeater
Station Line Filters**

Type 5119A—35.5KC
Type 4517A—38KC

**Auxiliary Repeater
Station Line Filters**

Type 5121A—35.5KC
Type 4528A—38KC
L5532

Consult our nearest office
for full details



AUTOMATIC ELECTRIC
(CANADA) LIMITED

Distributor in Canada

AUTOMATIC ELECTRIC SALES (CANADA) LIMITED

Head Office: 185 Bartley Drive, Toronto 16

MONTREAL • OTTAWA • BROCKVILLE • HAMILTON • WINNIPEG • REGINA • EDMONTON • VANCOUVER

Aircraft fire detection systems need no longer feel the heat of fire to register an alarm. New electronically activated equipment "Looks" for the fire visually and then reports its location by

A New Concept Of Aviation Fire Safety

THE first turbo-prop transport plane to be built for the United States Air Force, a Lockheed C-130, is to be fitted with one of the latest methods of flame detection, an electronic device which is the result of years of research on flame detection by the Electronic Corporation of America.

The fire detector is being used to protect all four engines of the C-130, and also its gas turbine compartment. The new plane, now coming off the production line at Lockheed Aircraft Corporation's plant at Marietta, Ga., has a cargo capacity of 20 tons and is noteworthy for its ability to take off and land in small areas.

The fireye system, with its instantaneous response to fire, offers an entirely new concept in aviation fire safety. The exceptional short reaction time of this type of protection becomes increasingly important the further we go into the high-speed jet age.

The visual system is a complement to the explosion and fire extinguishing system developed last year by ECA for the protection of fuel systems of combat planes, and now being installed on military aircraft.

In the airplane whose engines are to be protected by the visual system, the detecting elements (detectors) are installed in each compartmented zone of each engine. As many as nine detectors can be used in a single detection system. However, it is seldom that this many are needed.

The detector consists of a unit composed of the cell, its cover and its mounting. The control unit that interprets the signal from the detectors can be located anywhere in the air-

plane outside the fire zones. When the detecting elements indicate a fire, the control unit flashes a warning light in the cockpit, which advises the crew that a fire has started in a particular engine.

The heart of the new system is a miniature, rugged, lightweight, photoconductive cell, developed after years of research by engineers for the specific purpose of fire detection. Infrared sensitive, the photoconductor, or electronic eye, is ideally suited for spotting fires because infrared is emitted in considerably larger quantities by fires than by any other wavelength of radiation.

The photoconductive cells are not to be confused with photoelectric or

photovoltaic cells. The new cells have no internal mechanical structure, hence their resistance to vibration is a maximum, and insofar as can be determined, they have an unlimited life. Essentially they consist of a glass envelope internally coated with infrared sensitive material.

The cells accurately indicate, by very rapid resistance changes, the varying amounts of radiation emitted by a flame; they detect by responding to the flame flicker as does the human eye when it sees a fire. When a dc voltage is applied to the cell, the modulated radiation from the flame results in a pulsating signal being transmitted to the control unit, which, being sensitive to this signal, actuates an alarm or fire extinguishing system.

Eight years of intensive development by engineers have resulted in high temperature-resistant cells, capable of continuous exposure at temperatures up to 400° F. while maintaining rated sensitivity. Available data further indicates that short interval exposures, approximately 1/2-hour, are possible up to 550° F. with reasonable response and no permanent reduction in sensitivity, although engineers claim this is not at present a recommended condition for installation. Protection of compartments where the operating temperature is expected to exceed 400° F. may readily be accomplished by installing the detectors in adjacent cooler areas and allowing them to scan the excessive temperature zones through small quartz windows.

(Turn to page 73)



● Part of assembly line of the new detector. Watching the girls is E. Douglas Reddan, Vice-president in charge of Fireye Division, Electronics Corporation of America, Cambridge, Mass. Girl seated is making a final inspection while her associate performs a spot weld which connects the photoconductive cell to the electrical circuit of the detection head.

make sure you get the most important
TAPE WOUND CORE IMPROVEMENT
 in 6 years

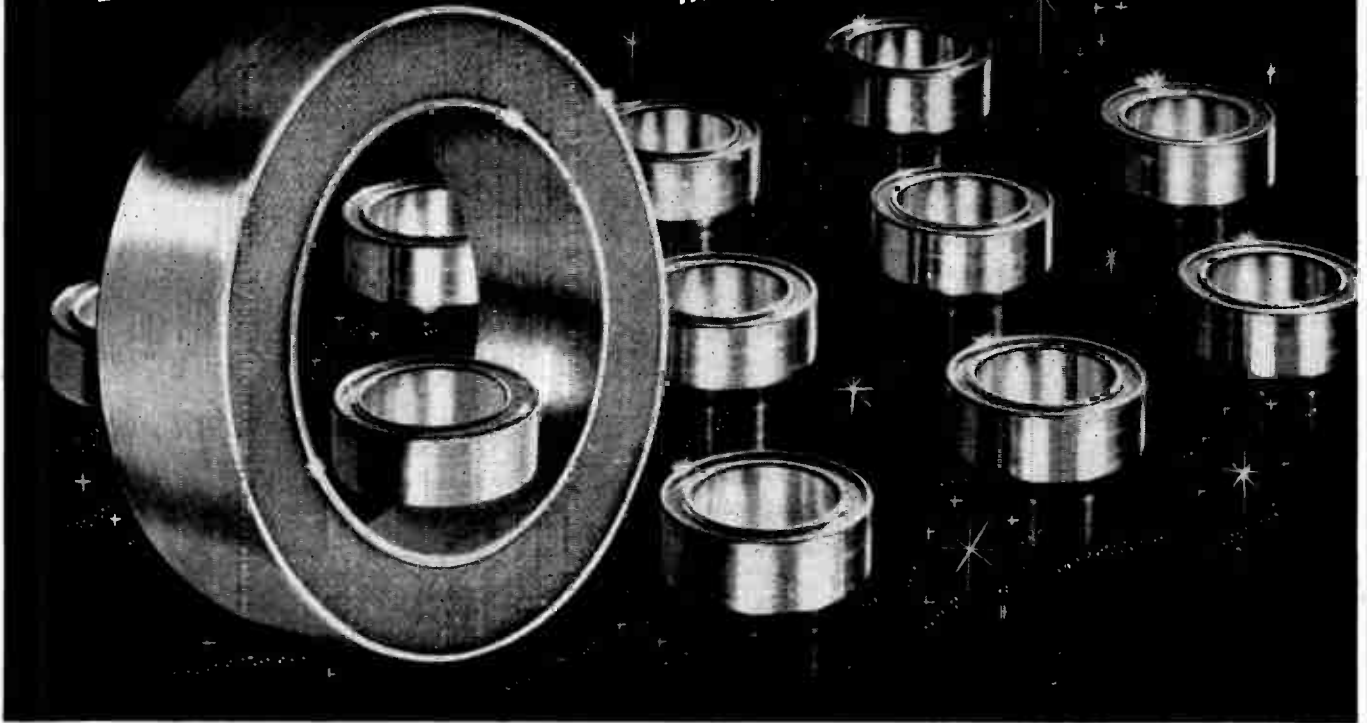

revolutionary **ALUMINUM CORE BOX[†]** construction

withstands **HIGH TEMPERATURE** • **VACUUM IMPREGNATION**
HEAVY WINDING STRESSES • **SHOCK and VIBRATION**

This is a development which calls for immediate changes in purchasing specifications for Tape Wound Cores, because introduction of the Aluminum Core Box means designing your toroids around four important new advantages:

1. Use of an aluminum core box means the new Magnetics, Inc. tape wound cores will withstand temperatures of *at least* 450° F.
2. Because of the unusual seal provided by forming the aluminum over the silicone glass seal, true vacuum impregnation of your coils is now possible. Varnish cannot penetrate the core box and affect magnetic properties of the tape.
3. The strong aluminum construction absolutely prevents deflection of the core box when coils are wound—a distortion-free construction which means no change of magnetic properties.
4. Cushioned with an inert material, the tape winding in the core box is protected against vibration and shock. In most cases it is so completely minimized that it is no longer a problem.

Because of the many advantages of these new Magnetics, Inc. Tape Wound Cores, it will pay you many times over to specify "Aluminum Core Boxes" on your next order.

[†]PATENT PENDING

ELECTRONICS & COMMUNICATIONS, JULY - AUGUST, 1955

Immediately available in 109 standard sizes, using all commercially available magnetic materials.

ALL *Performance - Guaranteed*

For full details, write for
 Bulletin TWC-200
 Catalog TWC-100.

MAGNETICS inc.

DEPT. EC-21, BUTLER, PENNSYLVANIA

For further data on advertised products use page 79



Electron photo microscope's view of conventional oxide coating used by many long play tapes. (Artist's conception.)

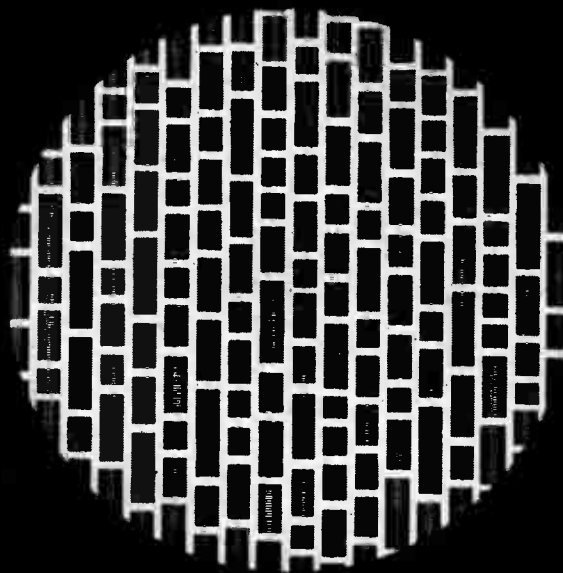

Similar enlarged view showing exclusive oxide dispersion method developed by "Scotch" Brand for new Extra Play Tape.

SEE

the difference . . .

then hear the difference . . .



You'll notice the difference at once—the way revolutionary "Scotch" Brand Extra Play Tape outperforms ordinary long play tapes with old-fashioned, *full-depth* oxide coatings. There's a crisper tone, higher fidelity on "Scotch" Brand . . . *and* a generous 3 db. boost in the high frequency range.

The secret of "Scotch" Brand's superiority? It's the completely new oxide dispersion process. By laying carefully filtered, fine-grain particles in a

neat, orderly pattern, "Scotch" Brand is able to produce a super-sensitive magnetic recording surface that contains the same amount of oxide as conventional tapes, yet is 50% thinner. That's important to remember when buying tape. Because recording experts are aware that a thinner, more potent oxide coating is essential for improved results with long play magnetic tapes.

Ask for "Scotch" Brand Extra Play Tape *today!*

NEW! REG. TRADE MARK **SCOTCH** BRAND

Extra Play Magnetic Tape 190



MINNESOTA MINING & MANUFACTURING OF CANADA LIMITED • LONDON • CANADA

Sales Offices: Halifax Montreal Toronto Winnipeg Calgary Vancouver

Resident Salesmen: Saint John • Quebec City • Ottawa • Hamilton • North Bay • Saskatoon • Regina • Edmonton

For further data on advertised products use page 79

World Radio History



Business Management And Automation

An Explanation For Top Executives



HENRY BLACKSTONE

by

*Henry Blackstone, President,
Servo Corporation of America,
New Hyde Park, N.Y.*

and

*Dr. Charles N. Kimball, President,
Midwest Research Institute,
Kansas City, Mo.*



DR. C. N. KIMBALL

**If You're Thinkng Of Automizing Your Plant
You Should Know What Automation Can Do
For You And What You Will Have To Do For It.**

Consider automation, first of all, as an extension of existing mass production techniques and systems. It is a new tool which has brought further advances in these techniques. Technical developments in the last decade, with principle emphasis on electronic measurement, computation, and control, have made automation possible.

But corporation presidents must realize that automation is not applicable to all manufacturing and processing plants without due considerations of economic factors. It cannot be put to work on production lines on a piecemeal basis. One cannot introduce a piece of a system here, or a shelf-purchased item there. What is of paramount importance, as far as top executives are concerned, is that close attention must be given, in any consideration of automation, to a strong operations research approach, including an extensive system analysis.

A good beginning is some knowledge of industrial history. The mass production system has developed historically through five steps up to the present time.

The first step was the age of the tote-box, and the single machine tool. This involved cumbersome and costly packing and unpacking of materials into the tote-boxes. The second step was the development of multiple spindle tools, performing like-operations. The third historical step came with

the development of multiplexed function tools, tools which combined the operations of drilling, grinding, milling and other similar processes in one machine for a particular product. Fourthly, followed the perfection of irregular tools capable of following irregularly shaped cams, templates and tracing machines. Finally, mass production rolled successfully into the moving belt line. On belts, machines and human operators were combined to perform operations in sequence, eliminating completely the packing and unpacking work of the original tote-box.

Now automation entered the industrial scene. By it, three additional steps were added to the manufacturing process. First of these, and the sixth step in industrial history, was the principle of automatic gauging and measurement, permitting the development of automatic inspection stations and their use in mass-production's belt lines. Second, and the seventh major industrial step, was the continuous flow of materials from the raw to finished stage from receiving to shipping ends of the factory. Third, and the eighth step in the application of automation to the mass production system, was the development of machines capable of performing irregular functions. These machines were made possible largely through the highly developed electronic computing techniques invented over the past

10 years, and the development of data processing and handling techniques such as magnetic tape computers and perforated tape readers.

Automation Means Changes

With this capsule history in the back of his mind, the corporation president may consider his company and automation. He may say to himself: "I want it." Here certain necessities arise. He will find, for instance, and this frequently happens, that it may be necessary for him to redesign his product as well as redesign his manufacturing process, in order to permit automatic filling of the bottles for example. A different type bottle was required to permit this one application of automation. Another, and better example of product change to meet an automatized situation, is involved in printed circuits. In the printed circuit, there are no longer any wires, or any soldered parts, or, in fact, three dimensional components. All the components and the wires are printed in two dimensional form. Thus, it can be seen that automation may require as much re-thinking of the process as it involves concept in design of the system components which provide the automation.

Probably because computers are so far advanced today, the corporation

(Turn to page 74)

what's this
paper-thin material
that's ending
design
problems?



Thin Fibre supports man's full weight. These corrugated sheets are used in duct forms for cooling electrical transformers—where a combination of good electrical properties, high mechanical strength and rigidity is essential.

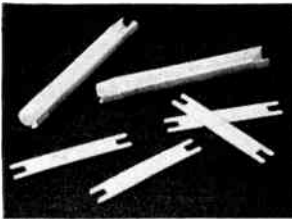

Suture Reels for Surgical Use must withstand immersion in alcohol or formaldehyde until used. Easy forming, slitting and chemical inertness are other advantages of vulcanized fibre.

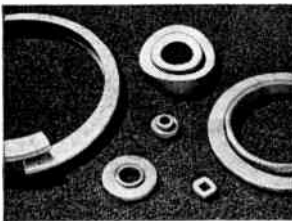

An Endless Variety of Washers and other punched parts can be made from vulcanized fibre. Machining steps include forming, punching, shaving, swedging, contouring.



Retaining Cups of Vulcanized Fibre are used to hold in place other insulating materials or adhesives. Easily drawn from thin fibre, these cups replace expensive molded plastic parts.

You've seen it before in critical applications. You may even have used it yourself without realizing its full potentials. Since 1873, its unmatched combination of properties has unscrambled thousands of design puzzles.

It's far more than an insulating material—although you can't buy a better insulator at the price. It's one of the strongest materials known—per unit of weight. It's tough, hard, resilient, resistant to wear and corrosion, and weighs only half as much as aluminum. And it's easy to draw, form or machine to virtually any shape.

Its name is *National Vulcanized Fibre*—the original time-tested plastic. Its uses are legion. Besides the parts shown here, it goes into such rough-duty products as textile-shuttle armor, abrasive discs, athletic guards, rail joint insulation, gears and cams. If there's a design problem defying you, learn how to lick it with this versatile material. Our new 16-page General Catalog—considered a handbook for designers—is yours for the asking.



NATIONAL

FIBRE COMPANY OF CANADA, LTD.

ATLANTIC & HANNA AVENUES, TORONTO

1411 CRESCENT STREET, MONTREAL

Send for your
free copy today.
Address Dept. AD-7.

Also Manufacturers of Peerless Insulation, Vul-Cot Waste-baskets, Materials Handling Receptacles and Textile Bobbins.

For further data on advertised products use page 79

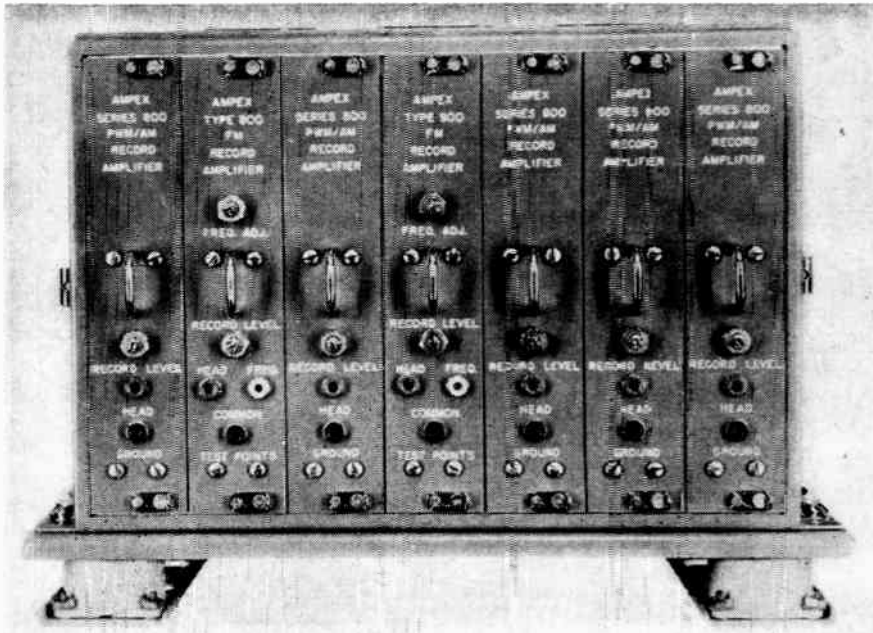

The Progress Of Research In Aeronautics — Dependent To A Large Degree On The Acquisition Of Accurate Flight Test Data Is Now Aided By The Use Of

Airborne Magnetic Tape Recorders

THE necessity for the acquisition of flight test data in the fast moving development of high speed aircraft and guided missiles has led some of the larger manufacturers of tape recording equipment to concentrate on the design and production of equipment that will meet the stringent requirements for this type of apparatus.

A recently announced series of airborne magnetic tape recorders engineered to meet the specific needs of gathering flight test data and known as the Series 800 equipment has been produced in a series of units capable of recording two channels of information on quarter inch tape to models intended for recording 28 tracks on two inch tape. In designing the units engineers have kept in mind the necessity of lightness and shock-resistant qualities.

Plug-in amplifiers permit recording, on any channel, of pulse-width modulation data, high accuracy transient information by means of wide-deviation frequency modulation or

● Use of plug-in recording amplifiers permits new airborne data recorder to record information in FM, AM or PWM form on any of its channels.

wide band direct data including mixed RDB/FM subcarriers. These various recording techniques can be used in any combination by the simple expedient of plugging in the correct type amplifier.

Material recorded on Series 800 equipment is compatible with and can be reproduced on the manufacturers standard laboratory recorders for analysis.

Typical of the new equipment is a Model 807 which records seven information tracks on tape one-half inch wide. It consists of five cable-connected units which can be mounted in any configuration desired, limited only by the length of the cables. The units are a tape transport mechanism, the record electronics, the electronics power supply, the tape transport power supply and a remote control unit.

The tape drive employs a closed loop design to reduce flutter and wow to a minimum. Essentially the unit is a single speed machine with the user able to select any of four speeds by shifting a belt-and-pulley drive system. The transports are available with speeds of 15, 7½, 3¾ and 1⅞ inches per second or 30, 15, 7½ and 3¾ inches per second. Unless specified by the user, the machines are equipped with belts on the 7½ ips position.

A housing providing space for seven plug-in record amplifiers contains the record electronics. Two types of amplifier are available. One is suitable for recording information directly or in PWM form; the other, for information in FM form. The amplifiers are interchangeable so that any combination of

(Turn to page 78)

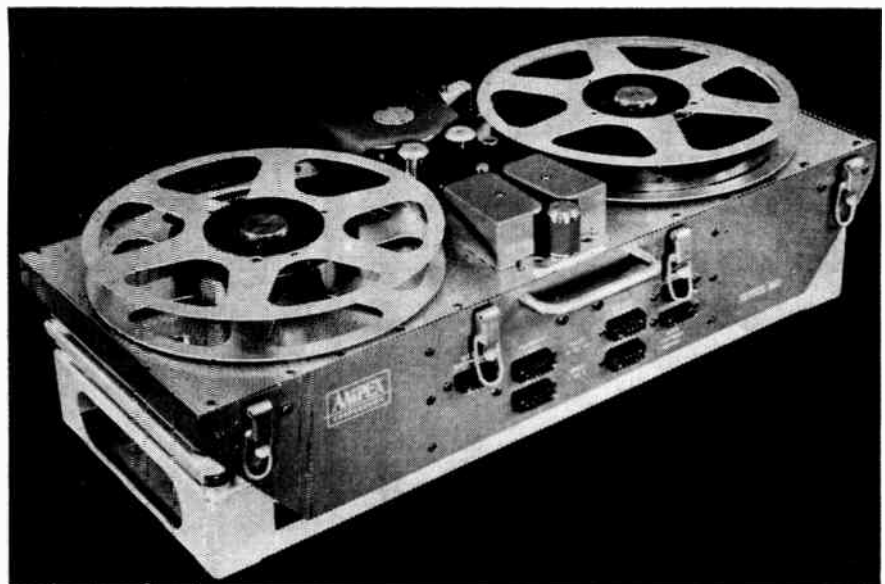

● Tape transport for the new airborne data recorder employs "closed loop" tape path to achieve minimum flutter and wow. Transport, including shock mounts, measures 25½ x 11 x 6 inches, weighs approximately 35 pounds.

NEWS



Canadian Marconi Open Calgary Sales And Service Office

A new sales and service office, with a floor space of 2,000 square feet, was opened early in July in Calgary by the Commercial Products Division of Canadian Marconi Company. Steve Keseredy is in charge of the sales office, with John Jonkman in charge of the service operation.

The sales staff, including Tony Elsdon in Edmonton, will handle all types of standard line products manufactured or distributed by Canadian Marconi's Commercial Products Division,



S. KESEREDY



J. Y. JONKMAN

including mobile and point-to-point radio equipment, electronic instruments, radio and TV station and studio equipment, and they will cover the entire province of Alberta.

The Service Section is completely equipped with test equipment for servicing all types of commercial communications equipment. They also have at their disposal a four-wheel drive vehicle which will permit them to operate efficiently anywhere in the province of Alberta in any kind of weather or under any condition. In addition, they are completely self-equipped to provide service of any kind to all types of customers, including service contracts.

Texas Instruments Appoints Canadian Agent

Texas Instruments Incorporated — Dallas-based manufacturer of electronic and electromechanical components and apparatus — has announced the appointment of Computing Devices of Canada Limited as its exclusive Canadian agent. CDC main offices are at 311 Richmond Road, Ottawa 4, Ontario.

Arrangements were completed recently in Ottawa by Mr. S. T. Harris, TI Marketing Vice-President, and Mr. C. F. Hembery, CDC President. According to the agreement, Computing Devices of Canada Limited will market Texas Instruments diodes and transistors, subminiature transformers, deposited carbon resistors, recorders, and other commercial electronic products.

Charles W. Pointon To Represent Bell Sound Systems

Charles W. Pointon Limited, have announced their appointment as Canadian representatives for Bell Sound Systems Inc., of Columbus, Ohio. Bell Sound Systems are manufacturers of high-fidelity audio amplifiers, tape and disc recorders, hi-fi radio tuners and public address amplifiers and systems.

Northern Radio Company Establish Canadian Subsidiary

Northern Radio Company Inc., of New York City, have announced the establishment of its Canadian subsidiary, Northern Radio Manufacturing Company Ltd., located in a new modern plant at 1950 Bank St., Ottawa, Ontario.

Northern Radio Manufacturing Company Ltd., will specialize in the engineering, manufacturing and sale of frequency shift radio and wireline teletype communications systems.

All future business in Canada will be carried out by or through the Canadian company. Although in the initial production phase of the new operation, certain sub-assemblies will be imported from New York, it is the aim of company officials to ultimately

achieve 100 per cent Canadian content in its products.

New West Coast Plant For Lenkurt Electric Company

Plans for construction of a new \$200,000 factory and office building in Burnaby near Vancouver, British Columbia, have been announced by the Lenkurt Electric Co. of Canada, Ltd. Construction will begin in June and should be completed in time for all operations to move there early in 1956 from the present plant in Vancouver.

The new building is an integral part of an accelerated program to increase the Canadian content of Lenkurt products, according to George F. Koth, Vice-President and Works Manager. He explained that the extra space would make it possible to add new manufacturing operations.

The building site is a 6½ acre plot approximately eight miles east of downtown Vancouver. The new building will be of modern construction and will have a total of 15,000 square feet of floor space. Two-thirds of this will be devoted to production operations and the remainder to offices.

Mark Swailes is Factory Superintendent of the Canadian plant and C. W. Hunter is Sales Engineering Manager.

(Turn to page 42)

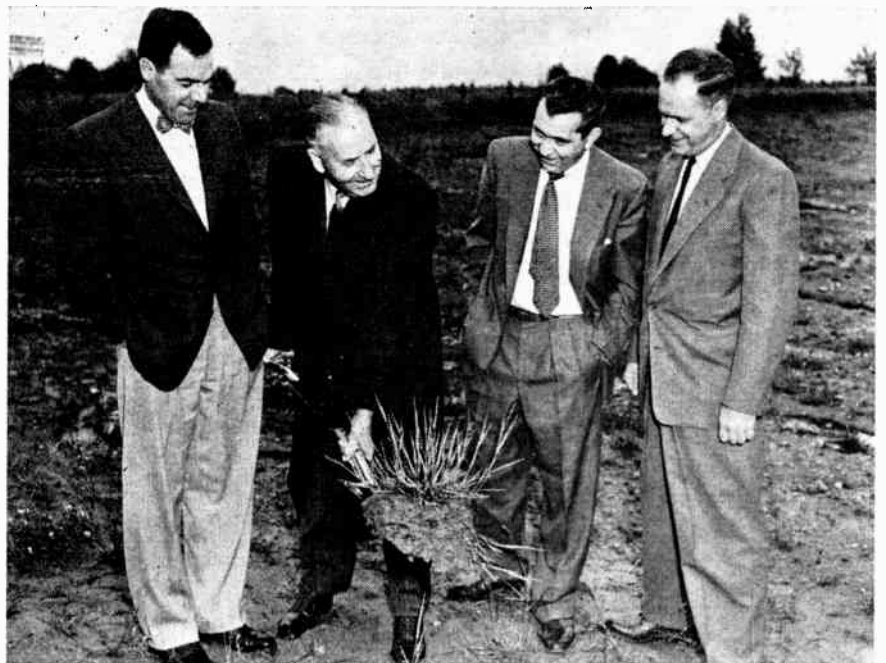

● Reeve Charles McSorley of Burnaby turns the first shovel of earth to signal the start of construction on the new \$200,000 factory and office building for Lenkurt Electric Co. of Canada, Ltd. Shown at the ground-breaking on the 9-acre site along Lougheed Highway in Burnaby are (left to right): A. M. Elliott, manager of Lenkurt's production control division in California; Reeve McSorley; Mark Swailes, factory superintendent of the Canadian plant, and C. W. Hunter, sales engineering manager for Lenkurt of Canada.



JACK MOUNTING PANELS

combined with PATCH CORDS

R5413

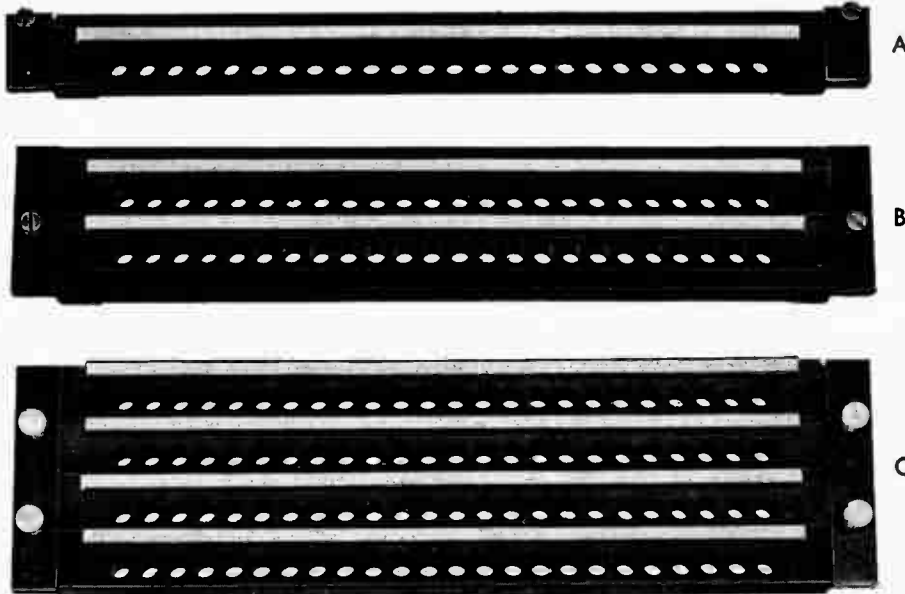

A

B

C

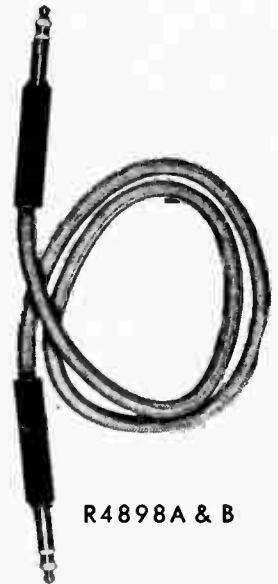

R4898A & B

an important
building
block...

The old concept of large, space consuming jack fields has been changed. Your requirements these days call for compactness and streamlining, and the R5413 Jack Panels are the answer to a minimum of space for the patching of circuits. Utilizing tip, ring and sleeve jacks, 24 shielded circuits can be handled in a $1\frac{3}{4}$ " space on the R5413A. The B version provides space for 48 jacks in $3\frac{1}{2}$ " and the C for 96 jacks in $5\frac{1}{4}$ ". The designation strips are not mounted on removable mats but are a part of each strip for convenience and also to ensure that the designation is always associated with the correct jack.

The R4898 Patch Cords come in standard lengths of two and four feet and are complete with tip, ring and sleeve plugs at both ends.

For further details ask for bulletins E6P-1 & E6PC-1.

Northern Electric
COMPANY LIMITED

1055-7

NEWS

(Continued from page 40)

Canadian Marconi Engineering Fellowships Awarded

Two new Fellowships for Canadian university engineering graduates have been announced by J. J. Kingan, General Manager of Canadian Marconi Company. To be known as "Canadian Marconi Engineering Fellowships", these will be conferred on two engineering graduates who have shown outstanding aptitude and ability in the field of electronic equipment engineering every year.

The first two Fellowship winners are Terence Arthur Cagney, of Montreal, who received his degree of B.A. (Science) from the University of British Columbia, and Charles Tiberghien, of Montreal, who received his degree of B.Eng. (Electrical) from McGill University. Both have been taken on the engineering strength of Canadian Marconi Company until later this summer, when they will sail for England. Cost of this transportation will be borne by the Company. On arrival in England, they will become associated with Marconi's Wireless Telegraph Co. Ltd., where they will secure on-the-job training in engineering and manufacturing as well as attending the Marconi College, where they will receive thorough post-graduate schooling on electronic equipment design.

At the end of two years' training and instruction, they will return to Canada at the expense of Canadian Marconi Company, when they will be offered employment in the engineering section of the Company; there is no compulsion for them to accept such an employment offer.

It is the aim of the Marconi organization by these means to increase interest among Canadian university students in the field of electronic engineering for their own benefit, as well as for that of the industry as a whole.

Charles W. Pointon To Handle Dale Products

Dale Product, Inc., of Columbus, Nebraska, U.S.A., manufacturer of precision resistors and electronic devices, announces the appointment of a new representative in the Canadian market.

The new representative, appointed as of August 1st, is Charles W. Pointon, Ltd., of 6 Alcina Avenue, Toronto.

Established in 1934, the Pointon organization now employs six men in covering the Canadian market. They include Mr. Charles W. Pointon, Mr. Charles G. Pointon, Mr. J. E. Jolley, Mr. R. McPherson, Mr. John MacDiarmid, and Mr. R. P. Mitchell.

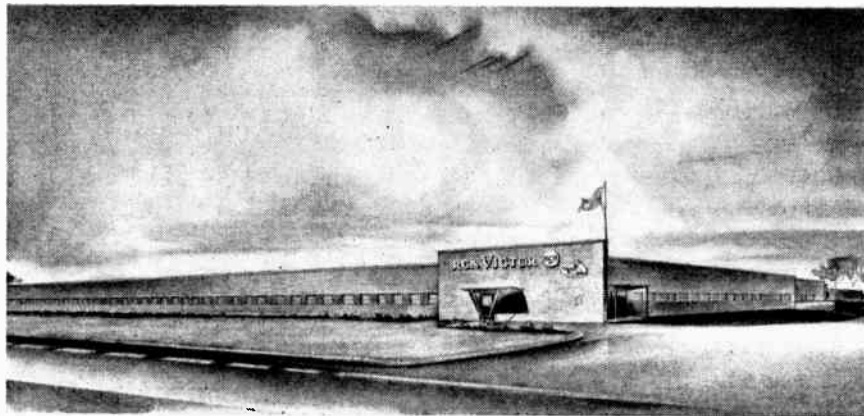

● Artists sketch of the proposed Renfrew, Ontario plant for the RCA Victor Company which will produce components for television and radio sets manufactured by the RCA Victor, Prescott plant. These components have been made at the firm's headquarters in Montreal but the operation will now be expanded at Renfrew. Located on a 30-acre site, the plant will be 336 feet long and 150 feet wide with an annex 32 by 72 feet, making a total floor space of 52,704 feet.

Ampex Announce Plans For Expanded International Operations

Ampex International has been formed as a new division of Ampex Corporation, manufacturer of magnetic tape recording equipment, George I. Long, Ampex President, has announced.

Designed to expand Ampex's business horizons to countries outside of the United States, the formation of Ampex International is another step forward in Ampex's expansion program, Long explained.



H. JOHNSTON

Managing director of Ampex International is T. Kevin Mallen, vice-chairman of the Ampex board of directors, presently located in Europe. Assisting him from the Redwood City plant is Harrison Johnston, director of the new division.

In outlining the program for development of Ampex International, Johnston says that sales offices will be set up in other countries, with the first new office scheduled for London, England. He added that studies are being made to determine the feasibility of establishing manufacturing facilities in other countries.

Aviation Electric Add To Plant Facilities

Aviation Electric Limited announces an addition to their main plant in Montreal. A second floor of 19,000 square feet will be added to the front section of the building. This will provide increased facilities for engineering and research and space for the expansion of other departments.

Construction is expected to be completed at the end of September.

Canadian General Electric Regroups Departments For More Specialized Service

A regrouping of product responsibilities within Canadian General Electric Company has been announced by James H. Goss, President. Put into effect internally some weeks ago, the new structure includes eight operating departments, each set up to serve a specific product field, and two centralized departments to perform over-all company functions.

Basic changes include the setting up of two new self-contained operating departments. These are Civilian Atomic Power, under Ian F. McRae, and Motor and Control, under Roy T. Bogle.

The new departments were created in line with the company's policy of decentralizing its operations into self-sufficient operating components in order to give more highly specialized service to its varied customer groups.

The eight operating departments of the company and their executives are: Apparatus (Archie M. Doyle, Vice-President and General Manager); Appliance (J. Herbert Smith, Vice-President and General Manager); Civilian Atomic Power (Ian F. McRae, Vice-President and General Manager); Industrial Products (John S. Keenan, Vice-President and General Manager); Electronic Equipment and Tube (Ronald M. Robinson, Vice-President and General Manager); Lamp (E. Howard Lindsay, Vice-President and General Manager); Motor and Control (Roy T. Bogle, General Manager); Wholesale (Charles A. Morrison, Vice-President and General Manager).

The centralized components are: Corporate Department, under Cecil E. Hipp, Vice-President, and Legal Department, under H. Ken Thompson, Counsel and Company Secretary.

(Turn to page 44)

From "The House of Resistors" **
 come . . .

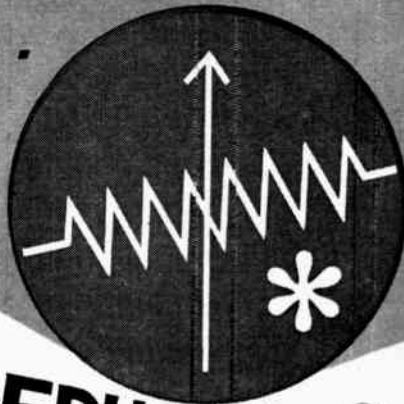

COST-REDUCING CONTROLS

So you must get cost down in designing that assembly? That's just the time to enlist Clarostat's cost-saving talents and facilities. The same superlative engineering and production skill that accounts for the finest quality in controls and resistors, is also available for designing and fabricating cost-reducing components. Three typical examples are presented herewith. These are standard items, promptly available in any quantities, at marked savings. And for any extraordinary requirements, special controls and resistors can be developed, tooled-up and produced.

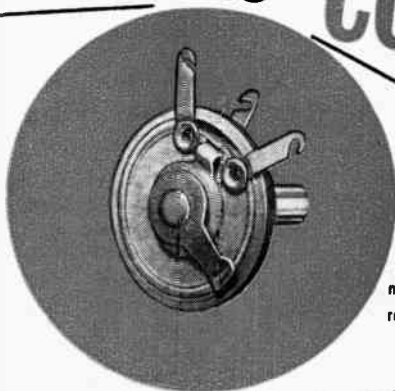

The original "Humdinger" Series MH. Compact, rugged, wire-wound control. Virtually millions in use. Fibre base holds resistance winding. Movable arm and shaft. 1-watt. 2 to 1000 ohms.

Latest "Humdinger" Series 39. Metal-case mounted with rivets or screws. Mounting surface serves as cover. Semi-fixed setting by screwdriver slipped into rotor slot - no shaft. 2-watt. 4 to 5000 ohms.

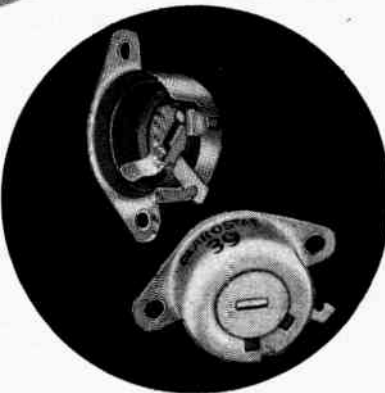

Twist-Tab Mounted Series 47. Eliminates usual bushing, lockwasher, nut. Composition-element control. Metal or plastic shaft. Plastic shaft has rear slotted protrusion, therefore adjustable from front or rear.

It's easy
 to solve control problems with CLAROSTAT!
 Send us that control spec, regardless how "special". Our engineering collaboration, quotations and delivery schedules are yours for the asking.

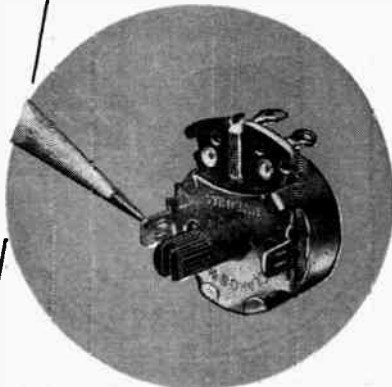

**Trade Mark

Ask your Distributor now or write to:

ELECTRONIC TUBE & COMPONENTS DIVISION
CANADIAN Marconi COMPANY
 830 Bayview Avenue, Toronto, Ontario.

Branches: Vancouver • Winnipeg • Montreal • Halifax • St. John's, Nfld.



Controls & Resistors

NEWS

(Continued from page 42)

Top Management Appointments Announced By C.G.E.

The Board of Directors of Canadian General Electric Company announced the election of Harold M. Turner as Chairman of the Board. Mr. Turner, who has been President of the company since 1946, is succeeded as President and Chief Executive Officer by James H. Goss, a widely experienced electrical industry executive



H. M. TURNER

who most recently held top managerial appointments with the General Electric Company in Louisville, Kentucky.

In his new post, Mr. Turner will be primarily responsible for top-level public and government liaison.



J. H. GOSS

Mr. Turner joined General Electric in Schenectady in 1921 and in 1926 was transferred to Canadian General Electric Company. In 1936 he was appointed Comptroller, in 1942 a Vice-President and in 1946, President. He is a director of the Canadian Bank of

Commerce, Canadian Pacific Railway, Underwood Limited, and the Mutual Life Assurance Company of Canada.

Mr. Goss joined General Electric as a student engineer on the company's famed "Test" Course in Schenectady in 1931. He was transferred to the Lynn, Mass., plant of the General Electric Company in 1931 in the Motor and Instrument Department and held various engineering assignments. From 1947 to 1951 he served as Assistant, and later as Manager of Engineering in the Industrial Control Department in Schenectady. In 1951 he was transferred to the Small Appliance Department in Lynn, Mass., and later in the same year to the Major Appliance Division in Louisville, as Division Manager for Manufacturing. On January 1, 1953, he was made General Manager of their Home Laundry Department from which position he moves to his present appointment.

Canadian General Electric employs over 13,500 in 14 manufacturing plants in eight Eastern Canadian cities and in 35 office-warehouse distribution centers in principal cities from coast to coast. Its sales in 1954 totalled \$210,912,045.

Lindsay And District To Be Served By New Radio Station

Lindsay, Ontario, is to be the locale of a new radio station serving Lindsay itself and reaching into the Kawartha Lakes and the Lake Simcoe area. The Greg-May Broadcasting Company Limited, owner of the station, includes brothers, E. N. Gregory and C. A. Gregory, Lindsay businessmen, who are President and Chief Engineer, respectively, and Herb May, well-known radio and TV personality, who is Manager.

The complete supply and installation contract has been awarded to Canadian General Electric Company. Transmitting equipment will operate on 910 kilocycles with a power of 1,000 watts and will employ a 3-tower directional array for both day-time and night-time programming. Studio equipment is comprehensive with an eye to flexible production and future expansion.

Permission to construct has been granted by the Department of Transport and the station will be on the air some time this fall. Application has been made for call letters CKLY.

Phillips Electrical Company Limited Announce Change In Name

Officials of the Phillips Electrical Company have announced that as from May 2, last the official name of the company will be Phillips Electrical Company Limited and not Phillips Electrical Company (1953) Limited.

Marconi Specialists To Service Northern Radar Installations

A stubby one hundred and forty foot freight ship, carrying twenty-four Canadian engineers and technicians, is now plowing its way to isolated sub-polar stations of the United States Air Force in Newfoundland, Labrador and Baffin Island.

The engineers and technicians are all specialists from Canadian Marconi Company.

The ship is a miniature floating electronics and diesel repair depot, and her mission is annual preventative maintenance for the Air Command's far-flung radar stations.

On arrival at the various stations, overhaul and radome repair teams and their equipment will be landed to perform their various duties. Site test equipment will be checked for proper operation and will then be calibrated in the shipborne laboratory. Instruments, sub-components and major items needing repairs will be serviced on the spot, while those in need of major repair or overhaul will be replaced and brought back to the major Marconi repair base at Pepperrell, Newfoundland.

Canadian Marconi officials have stated that the engineers and technicians concerned in this operation belong to the Company's Special Services Division. This is the same Division that has been responsible for the installation and maintenance of various radar defense belts in Canada. Their men who are now in the north aboard the USAF ship should return to home base in mid-September.

Narda Corporation Announces Plans For Expanded Advertising

The Narda Corporation, Mineola, New York, has appointed John Mather Lupton Company, Inc., New York, to direct an expanded advertising and public relations program, John C. McGregor, Narda's president, has announced. G. Bruce Richardson of the Lupton organization will be account supervisor.

According to Dr. McGregor, "The tremendous growth in microwave communications during the past five years has been reflected by a corresponding increase in the company's volume of work. Meanwhile, the steadily broadening field of commercial application for this type of equipment has created the need for a greater effort to inform the market of its potentialities.

Canadian representatives of the Narda Corporation is Measurement Engineering Limited of Arnprior and Toronto.

(Turn to page 46)

At the Mass. Institute of Technology Machine Tool Laboratory the effect of variables such as cutting fluid, tool geometry, speed and feeds, and tool material are measured and recorded, using a dynamometer and Sanborn two-channel System. Such records for various lathe operations, as well as many other cutting operations, provide valuable insight into the whole metal cutting process.



...from
lathe cutting
forces
to telemetered
aircraft data...

**SANBORN
Oscillographic
RECORDING
SYSTEMS
prove their
versatility**

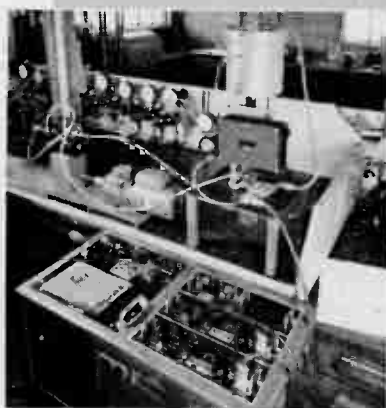

At Moore Products input and response of their Valve Positioner, a pneumatic instrument widely used on diaphragm top-work valves and power cylinders, are recorded on a Sanborn two-channel System. Impulses from a pneumatic sine wave generator, of frequencies as high as 20 cps, are fed through a transducer to one channel, with valve stem response recorded by the second channel from a strain gage pickup.



At Edwards Air Force Base, California, this U. S. Air Force telemetering van received and recorded information transmitted from various pickups and transducers in the new delta wing Convair YF-102A during flight. Photos of van interior show eight Sanborn four-channel recording systems in rear, and close-up of four of the systems. Thus equipped, the van could receive data which would affect the design and performance of the YF-102A, a faster-than-sound, all-weather interceptor built by the Convair Division of General Dynamics Corporation.

These typical two- to 32-channel applications of Sanborn oscillographic recording systems give an indication of the tremendous scope of this versatile equipment. Elsewhere, Sanborn 1-, 2-, 4-, 6- and 8-channel systems and components are used in meteorological research ... quality control programs ... instrument and machinery field testing.

Flexibility of Sanborn design permits interchangeable amplifiers and preamplifiers to meet *individual* recording requirements with greater over-all efficiency and economy. Other Sanborn features include *inkless* recording in true rectangular coordinates, high torque galvanometer movement, time and code marking, and numerous chart speeds.



CATALOG AND TECHNICAL DATA
AVAILABLE ON REQUEST



**SANBORN
COMPANY**

INDUSTRIAL DIVISION
CAMBRIDGE 39, MASS.

NEWS

(Continued from page 44)

Western Wire And Cable Incorporates Across Canada

Western Wire and Cable Company Limited has been incorporated in every province from B.C. to Ontario in order to carry out the cross-country expansion plans of Richmond Electric Company of Canada.

In making the announcement, J. E. Termeunde, President of both companies, said that Western Wire and Cable has opened an office and warehouse in Edmonton and plans to establish a manufacturing plant in Alberta in the near future. Alberta operations of the company are in charge of Vice-President, J. A. Kippan.

Stuart Smith of Vancouver has been named Sales Manager of the newly incorporated company which makes a wide range of electrical wire products of aluminum and copper with thermoplastic armor.

Western Wire and Cable is a pioneer in many applications of aluminum cables to effect economies in the distribution of electrical power. One recent application of particular interest in the field of town planning is the substitution of tiny plastic-coated cables for unsightly overhead wires. These new-type cables have just been installed at Medicine Hat, Alberta.

Brigadier F. C. Wallace Joins Decca Radar (Canada) Limited

Brigadier F. C. Wallace, D.S.O., M.C., has joined the Board of Decca Radar (Canada) Limited, it has been announced.

Brigadier Wallace, who is President of Canadian Pittsburgh Industries Limited and Smith & Stone Limited, and Executive Vice-President of Duplate Canada Limited in addition to holding Directorships in a number of other Canadian Corporations, was a leading figure in the Canadian radar field during the last war. At that time he was the Director of the Radio Division, National Research Council, and was responsible for radar production at Research Enterprises Limited, a Crown company, as well as occupying a key position in the military radar field.

Brigadier Wallace's new appointment is part of the Canadian expansion program of this subsidiary of Decca Radar Limited, England, one of the world's leading radar manufacturers.



Brig. F. C. Wallace

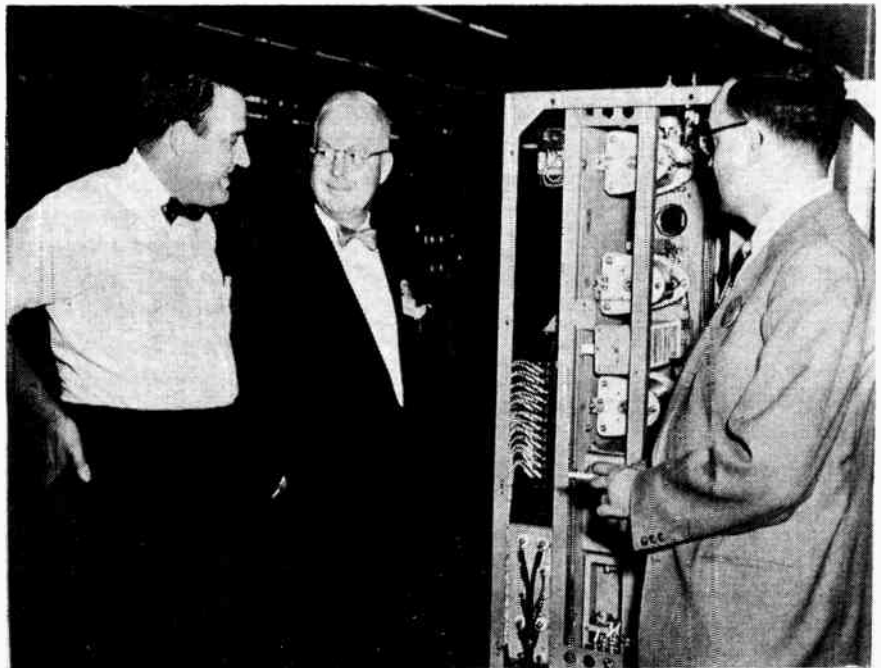

● Among the many guests from Government and Industry present at the first anniversary reception of Canadian Aviation Electronic's plant in Montreal which was officially opened on June 16, 1955, was the Assistant Deputy Minister of National Defense, Mr. L. M. Chesley, shown with C. J. Konzuk, Manager of Company Services, on the right, and Reginald Newman, Supervisor of the Telecommunications Section of C.A.E.

C.G.E. Announces Plans To Manufacture Scatter Type Communications Equipment

The Canadian General Electric Company has announced its entry into the field of a new type of electronic communication. This new concept, known as "Scatter", uses high power transmitters and sensitive receivers to send voice or other information over distances up to 200 miles without the use of intermediate repeater stations.

According to C.G.E. engineers, this system will be particularly useful where the terrain is such that the installation and maintenance of repeater stations is difficult and costly.

The system employs a very powerful transmitter which beams a concentrated signal from a giant parabolic antenna. This beam is directed toward the troposphere where it is "scattered" due to the changes in atmospheric conditions. A portion of the scattered signal returns to earth where it is picked up by sensitive receivers. In making this announcement, G. P. Adamson, general sales manager of the company's Electronic Equipment Department, stated that this new type of communication will have widespread commercial applications.

Honeywell Expands Aero Activity With New Leaside Division

Minneapolis - Honeywell Regulator Co. Ltd., has announced the establish-

ment of an Aeronautical Division at its Leaside plant.

Vice-President and General Manager W. H. Evans, has disclosed that the new Honeywell facilities are part of an expansion program to provide the Canadian Aircraft industry with "Made in Canada" equipment.

Named Manager of the new division is Carl A. Anderson, formerly Assistant Director of Service Engineering of Honeywell's Aeronautical Division in Minneapolis.

The new Canadian division will operate independently of Honeywell's main Aeronautical Division in Minneapolis, although it will look to the parent concern for any support it may need in serving its various Canadian customers.

CESCO To Have Modern Hi-Fi Demonstration Studio

Canadian Electrical Supply Co. Ltd., have made known their plans for rebuilding and enlarging the high-fidelity demonstration studio in their Montreal branch.

Max W. Roth, Arch., MRAIC, a prominent Montreal architect has been commissioned to design the new studio. When complete this coming Fall the new high-fidelity studio will be one of the finest in Canada, company officials state. It will contain every modern idea for sound demonstration and will be completely equipped with all the latest in high-fidelity merchandise.

Turn to page 48)

At WLAU, 250 watts, Laurel, Mississippi

"EVERYONE IS SOLD ON THE AMPEX 600"



Every week WLAU pays an "Ampex visit" to a different county school for a program called "Salute to Jones County Schools".

"If the Ampex 600 were paid a salary, the figure would run into the overtime column every week. It is used by the salesmen, announcers and the sports man. Everyone is sold on its performance and it's especially popular because it is so light and easy to handle. Since the success of a small station greatly depends on good local programs with the personal touch, we feel the Ampex 600 is the practical and economical answer to a real need."

Norma H. Leggett

Mrs. Norma H. Leggett, Manager
Radio Station WLAU, Laurel, Mississippi



For the grand opening of Sears Roebuck's newest and finest store in Mississippi (in Laurel), the Ampex 600 taped an interview with every department head.



Our program director interviewing the manager of Jones County Auto Sales at the showing of the new 1955 Mercury. We taped every new car showing in Laurel.

Broadcast stations of 250 and 1000 watts are today discovering that for them too the Ampex Standard of Excellence pays for itself.

Ampex 600 portable tape recorder

Weights just 28 pounds and has the Ampex standard of quality, reliability and durability throughout. Prices are \$669.80 unmounted or \$733.00 in portable case.

Ampex 620 portable amplifier-speaker

The perfect monitoring and demonstration unit, matches the 600 in quality, size and appearance, costs \$201.10 in portable case.

For full performance specifications on these machines, write Sect. BA21

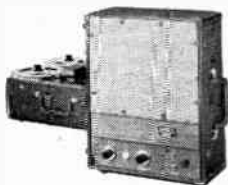

Ampex 350 studio tape recorder

"The big Ampex" — versatile, adaptable and durable, uses large or small reels, 7½ and 15 in/sec. tape speeds and connections for remote controls. Prices are \$1620.73 rack mountable and \$1768.68 console.

Signature of Perfection in Sound



ELECTRONIC EQUIPMENT AND TUBE DEPARTMENT

CANADIAN GENERAL ELECTRIC COMPANY LTD.
830 Lansdowne Ave. - Toronto 4, Ont.

NEWS

(Continued from page 46)

Canadian Marconi Co. Named Distributor For H. Tinsley Co.

Canadian Marconi Company has been named exclusive Canadian distributors for products of H. Tinsley & Company Limited, of London, England, and St. Jerome, Que., it has been announced by T. V. Sweeny, Sales Manager of Marconi's Commercial Products Division.

To meet the growing Canadian demand for Tinsley products, a branch factory was opened three years ago at St. Jerome, Que. and to this factory were sent skilled engineers and technicians whose knowledge, training and specialized technical equipment make possible the construction of precision instruments. They were also available for the design and construction of lower grade laboratory and industrial units with the result that the more simple and inexpensive Tinsley instruments offer an unusually high degree of accuracy and permanence of calibration.

The distribution of the Tinsley line will be handled through Canadian Marconi sales office throughout the country.

Field Takes Over MacDonald Brothers Agency

The acquisition of MacDonald Bros. Aircraft Limited's aviation "lines" has been announced by Field Aviation Company Limited, of Oshawa, Ontario.

Already a distributor for various makes of leading aircraft and aircraft

supplies, Field now becomes the foremost aviation supply house in Canada with the taking-over of MacDonald Bros. Aircraft's supply sales division, according to Gordon Duguid, Field's General Sales Manager. From their Winnipeg base, MacDonald Bros. have built up over the years a country-wide business for this equipment.

Field intend to make their Oshawa airport base the headquarters for their expanded business although they will continue to distribute items from the MacDonald Bros. base of operations at Stevenson Field at Winnipeg. Another sales branch will be run from Field's Calgary Airport base under Western Division Manager, Neil Parent. There will be a warehouse at Vancouver Airport and a sales office will be opened up in Ottawa in conjunction with PSC Applied Research Limited, an associate company.

Western Wire And Cable Names Sales Manager

President of the newly-incorporated Western Wire and Cable Company, J. E. Termuende announces the appointment of Stuart Smith as Sales Manager. Western Wire and Cable was formed to carry out the cross country expansion plans of the Richmond Electric Company of Vancouver and Mr. Smith's territory will extend from B.C. to Ontario.

Former district Merchandising Manager and later district Credit Manager of a large electrical supply and equipment firm, Mr. Smith also has had wide experience in finance and accountancy, both in private companies and in municipal corporations.

K. J. Farthing Appointed Consumer Products Advertising Manager

J. D. Campbell, General Manager, Consumer Products Group,, Canadian Westinghouse Company Limited, announces the appointment of K. J.



K. FARTHING

Farthing to the post of Advertising Manager, Consumer Products, where he administers and co-ordinates the consumer advertising and sales promotion operations for the company's appliance, television, radio, lamp

and tube divisions.

Nationally-known in advertising and electrical manufacturing circles, Mr. Farthing has been with Westinghouse for more than forty years. He was engaged in sales work for an extensive period before becoming head of the correspondence and order service section at Hamilton Head Office. In 1944 he was appointed manager of the General Advertising and Sales Promotion Department.

Mr. Farthing is a Director of the Association of Canadian Advertisers, and has served on the television-radio committee of that organization. He is also a member of the National Industrial Advertisers Association.

New Wing For Escco Nears Completion

Construction work on the 15,000 square foot addition to the premises of Electro Sonic Supply Company warehouse at 543 Yonge Street, Toronto is nearing completion according to an announcement by officials of the company. The new addition to the building will provide more office space, a new show room and a new and modern sound room. In addition to the new facilities which have been added to the four-storey building the entire front of the structure will be modernized.

Dominion Sound Takes Over New Building

The Vancouver District Office of Dominion Sound Equipment Limited have moved into their new building at 2162 West 12th Avenue, company officials have announced.

The new and much larger business premises will provide the extra office and warehouse facilities made necessary by the steady growth of Dominion Sound business in the British Columbia area.

(Turn to page 53)

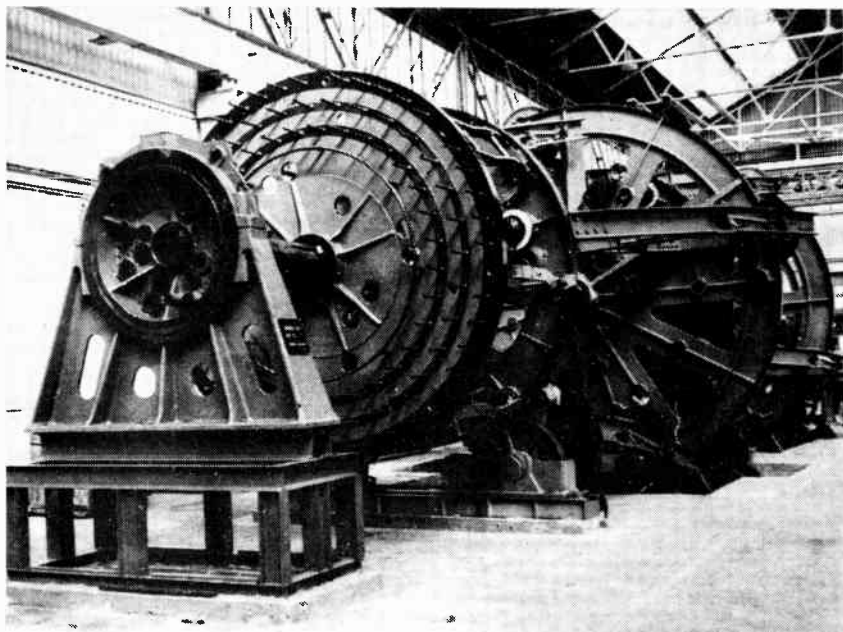

● This giant cable making machine, claimed to be the largest of its kind in the world, has been made at West Bromwich, Birmingham, for the Telegraph Maintenance Company of London. This company is producing the major part of the first transatlantic telephone cable which is to be laid between Oban, Scotland and Newfoundland. The cable making machine, which has taken two years to build, has been designed for making special cables mostly for telecommunications purposes providing for abnormal lengths and large dimensions.

It's NEWS for DESIGNERS!

 *announce*

KOLLSMAN MOTORS

with

NEW
integral gear head
in small servo motors



A new line of units has been added to the Kollsman "Special Purpose Motors" family. It consists of Induction Motors and Induction Generators that are supplied separately or combined in a single case one-inch in diameter. These new motors have been designed to give the maximum torque per watt ratio with the minimum rotor inertia. The generators give maximum output voltage with minimum residual voltage and phase shift.

A particularly interesting feature of Kollsman "Special Purpose Motors" is the interchangeability of parts permitting numerous electrically different combinations of motor and generator windings within the same case.

Principally, Kollsman "Special Purpose Motors" are for operation in 60 or 400 cycle systems. Power output does not exceed 1/100 horsepower. Gear ratios as high as 1:78,000 available.

**COMPLETE
INFORMATION
IS AVAILABLE
ON REQUEST
AND SPERRY
ENGINEERS WILL
GLADLY HELP
IN ANY PROBLEM
INVOLVING THESE
MOTORS.**



GYROSCOPE COMPANY OF CANADA LTD.

P.O. BOX 710

MONTREAL, QUE.

CANADIAN REPRESENTATIVES FOR KOLLSMAN INSTRUMENT CORPORATION, SUBSIDIARY OF STANDARD COIL PRODUCTS CO., INC.

electrons

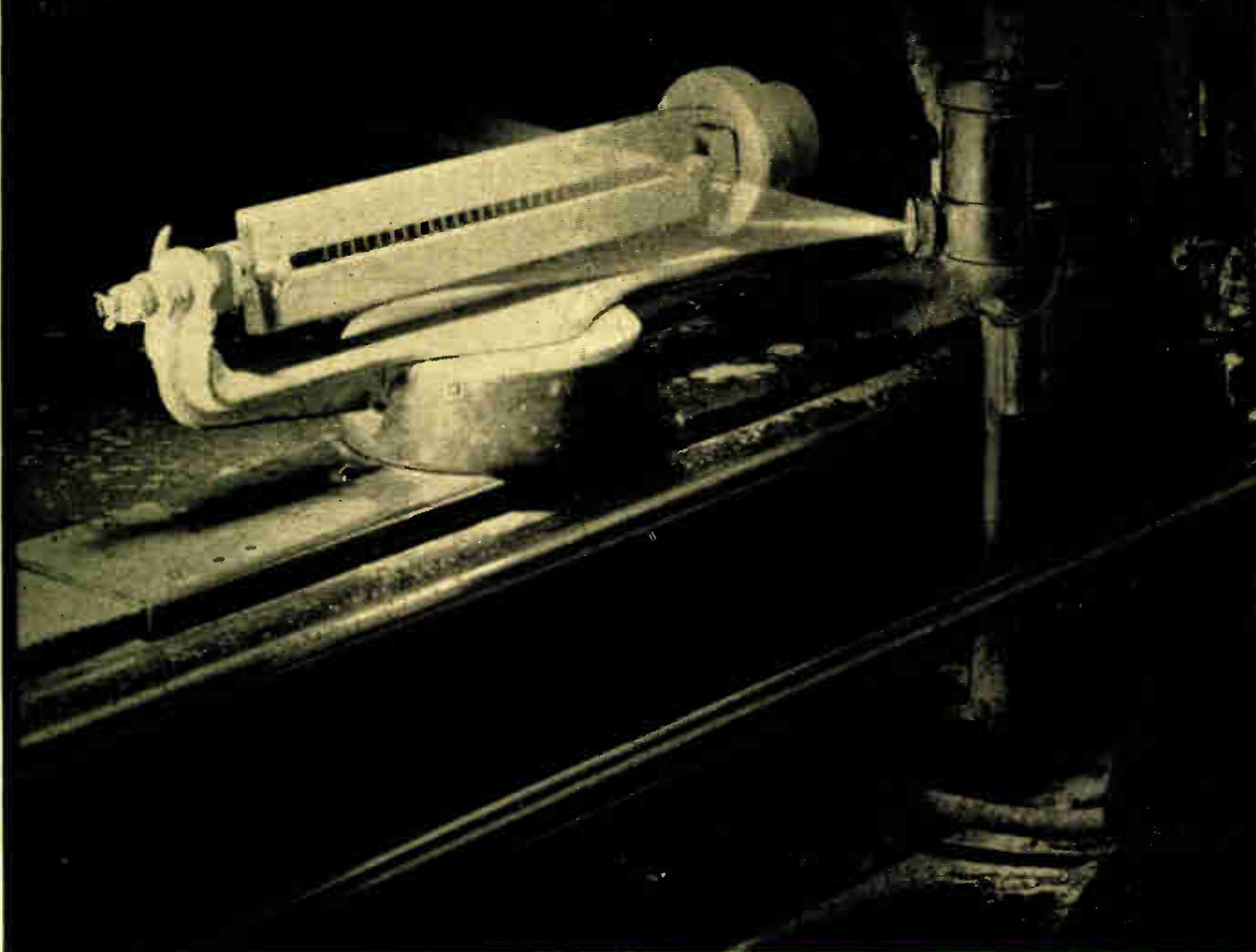

Replace with guaranteed

ROGERS

ELECTRONIC TUBES



RECEIVING TUBES • PICTURE TUBES • TRANSMITTING TUBES • FERROXCUBE •

For further data on advertised products use page 79

from a spray gun!

The very heart of every electronic tube is the cathode, both physically and theoretically. From the oxide solution coating comes the electron stream—first "base" in tube operation.

Extreme care is taken to ensure the quality and uniformity of this all important coating. This process is illustrated (left). In the spray booth a rack is loaded with cathodes. They travel back and forth in a special jig developed by ROGERS engineers. Each cathode receives up to thirty-two individual sprayings of the coating material . . . *from eight different directions.*

High standards of engineering, rigid inspection and the thorough testing of every completed tube ensure the high quality and long-life performance of ROGERS electronic tubes.

After spraying, the cathodes are checked for thickness to a tolerance of 8/10,000 of an inch. Note how the operator's fingers are covered with latex shields to prevent damage to the cathode coating.

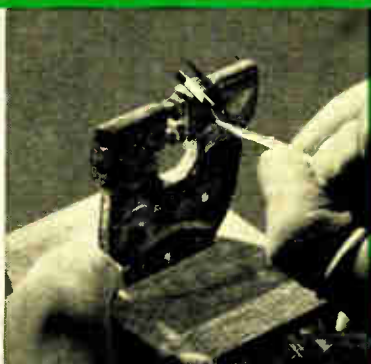

GERMANIUM DIODES • SPECIAL PURPOSE TUBES

866AX and 872AX Rectifiers . . . Stronger construction Longer life

Rogers 866AX and 872AX rectifiers are used as replacements for the 866A and the 872A. They are designed to perform exactly the same functions but to give substantially longer life. They require no alteration to the design of the circuit.

866AX and 872AX rectifiers have the following important features.

- Large area Kovar seal at plate connection gives greatly improved mechanical strength.
- Excess mercury has been eliminated in the glass envelope.
- Greatly improved mechanical construction.
- Excellent uniformity of arc voltage throughout life. This can be seen by the confined area of discharge and freedom from spreading and discoloration.
- Conservatively rated peak inverse voltage.

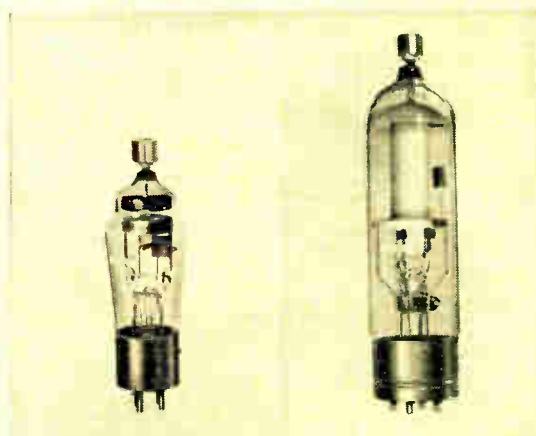

Characteristics	866AX	872AX
Heater Voltage.....	2.5V	5.0V
Heater Current.....	4.8 amps	7.0 amps
Plate Current Average..	0.25 amps	1.5 amps
Plate Current Peak.....	1.0 amp	6.0 amps
Peak Inverse.....	10 KV	12 KV
Ambient Temperature		
Range	15-40°C	15-40°C
Arc Voltage.....	16V (Ip .25 amps)	10V (Ip 1.5 amps)

For improved performance and longer life specify Rogers 866AX and 872AX rectifier tubes.

For further information write:—

ROGERS

ELECTRONIC TUBE & COMPONENT DIVISION
11-19 Brentcliffe Road, Leaside, Toronto 17, Ontario
TORONTO • MONTREAL • VANCOUVER • HALIFAX
A division of Canadian Radio Manufacturing Corporation Limited



WHEN you require precision to the ninth degree whether in silk screening, design engineering or any other specified field, clocks, dials, and all other precision instruments let the Experts do it.

D.I.F.L. are qualified expert technicians in precision instruments. They know and can solve the many intricate problems which confront your designers. Trained, tried and proven, their workmanship has been chosen for the designing and manufacturing of precision instruments for the major instrument manufacturers.

Let D.I.F.L. solve your precision problems.

Also for the finest in . . .

Precision Photo Engraving, machine engraving, edge lighting panels, plastic and metal laminates and name plates call

**DIAL AND
INSTRUMENT FINISHERS LTD.**
261 DAVENPORT RD. TORONTO
D.I.F.L.
1670 WILLIAMS ST.
MONTREAL

Business Equipment

Automation For The Office

THE simplification of automation for the business office is the result of seven years of research and development by one of the largest business machine manufacturers in the United States who have recently announced the production of an electronic sorting machine so simple to operate that anyone with typing experience can work it.

The machine is a high-speed electronic media sorter that operates from a standard typewriter keyboard and is capable of handling original forms in various weights and sizes. The equipment is a completely new concept in business machines and can process thousands of forms per hour. Unlike conventional punched card sorting equipment, the new machine sorts directly such original media as sales checks, tax bills and job tickets.

The operator simply glances at the top copy to determine the alphabetical or numerical classification. As the proper typewriter keys are depressed the media are whisked to the appropriate bins. Less than a third of a second is required for the complete cycle.

Important Step

According to accounting machine specialists the new machine is claimed to be an important step forward in automation of the office. It ends the tiresome and costly job of manual sorting.

On a recent test run, the sorter accomplished in a single day a job that required six days when old style conventional manual sorting methods were used.

Electronic controls select the proper letter or number bins automatically, stacking the original forms in neat piles ready for any subsequent routine operation.

Manufacturers of the equipment are producing several size models ranging from an eleven bin model to as many as 51 bins. The sorter accepts original forms measuring five-and-a-half to eight-and-a-half inches long and two-and-three-quarters to four-and-a-quarter inches wide. It will feed various weights of paper stock ranging from 15 to 90 pounds.

Named by its manufacturers as the "Rapid-Sort" this new unit is the type of equipment that will make automation possible for the small business owner.



● This new electronic sorting device which operates from a standard keyboard can handle forms of various weights and sizes at top speed.

For further data on advertised products use page 79

NEWS

(Continued from page 48)

Winchester Electronics To Establish Plant In Windsor

The Honorable W. K. Warrender, Q.C., Ontario Minister of Planning and Development has announced that a new manufacturing industry, The Winchester Electronics Co. Ltd. is being established in Windsor. The company will manufacture television tubes under licence from R.C.A. for replacement purposes to be sold under guarantee by franchise distributors.

The plant located at 362 Chilver Road is a modern, one-storey building of 8,300 sq. ft. Mr. Robert Hemstead has been named President, Wayne Shapiro, Vice-President, Robert Dishall, Secretary and Albert J. Kernerman, Treasurer.

Mr. Warrender reported that negotiations carried on by the Windsor Industrial Promotion Committee of the Chamber of Commerce, through Mr. Murray Elder, were instrumental in securing the industry for the Border City.

MJS Electronic Sales Ltd. Appointed Reps For Illinois Condenser Company

Louis W. Coleman, Sales Manager of MJS Electronics Sales Limited of Ajax, Ontario, has announced that his company has been appointed as the exclusive Canadian sales representatives for the Illinois Condenser Company, of Chicago. The Illinois Condenser Company are manufacturers of a wide range of electronic components for the television and industrial electronic industries.

Linde's New General Superintendent

The appointment of Richard A. Schmidt, as General Superintendent, Plants and Distribution has been announced by David S. Lloyd, President, Linde Air Products Company (formerly Dominion Oxygen Company) Division of Union Carbide Canada Limited. He will make his headquarters at the General Offices at 40 St. Clair Avenue East, Toronto.



R. A. SCHMIDT

Mr. Schmidt has a B.S. degree in Chemical Engineering, and has almost twenty years' experience in all phases of plant operation and distribution in the Linde organization. He succeeds Mr. F. L. Neuman whose appointment as Manager, New Products, of Linde Air Products Company was recently announced.



● Sir George Nelson, chairman and managing director of The English Electric Co. Ltd., of London, England, is shown the television assembly lines in the Canadian Marconi factory, Town of Mount Royal, P.Q. During Sir George Nelson's recent trip he visited each of the English Electric group of companies located in Canada. Above, left to right: T. Marshall, production manager broadcast and television receiver division; J. J. Kingan, general manager; Sir George Nelson; and S. J. Sinclair, manager broadcast and television division.

J. T. Turner Elected Chairman Vancouver Section A.I.E.E.

At the annual meeting of the Vancouver Section of the American Institute of Electrical Engineers, held in June, Mr. J. T. Turner, P.Eng., Manager, Transportation Maintenance for the B.C. Electric Railway Co. Ltd., was elected Chairman for 1955-56.



J. T. TURNER

Mr. Turner is the 44th chairman of the Vancouver Section which now boasts a membership of 312 electrical engineers throughout the province.

Other officers elected were: R. B. Carter, Vice-Chairman; C. J. Henriksen, Secretary-Treasurer; M. I. G. Bradwell, Assistant Secretary-Treasurer and W. W. Pullinger, P.Eng., Discussion Group Chairman.

ORRadio Sales Hits Record High

Atlas Radio Corporation, Toronto, Canadian representatives of ORRadio Industries report that the sales of their principals soared to new heights during the month of July. ORRadio's July volume of sales was 168 per cent higher than for the same month a year ago.

Canadian Westinghouse Making Guns For TV Tubes

In line with an expansion of TV picture tube production, Canadian Westinghouse has announced it will manufacture guns for TV cathode ray tubes at Grimsby, Ontario.

The company has leased 4,000

square feet of space and commenced production in the new department about July 1, according to H. E. Rice, Manager, Tube Division.

Westinghouse expects to triple production of TV picture tubes in Hamilton by September and the new Grimsby department will be expected to provide the guns to meet production schedules.

Musimart Of Canada Ltd. To Represent Connector Corporation Of Chicago

Fred R. Lesser, manager of the Electronic Division of Musimart of Canada Limited has announced that his company has recently been appointed as the Canadian representative of Messrs. Connector Corporation of Chicago, Illinois.

Messrs. Connector Corporation are manufacturers of high grade tube sockets, battery plugs and other components for the electronic and communication industries.

Westinghouse Appoints Micarta Products Representative

The appointment of R. W. Stanton Sales Company as representative for the Canadian Westinghouse Company's Micarta thermo-setting plastic products, has been announced by J. D. Houlding, Manager of the Industrial Products Division of Westinghouse.

R. W. Stanton, formerly associated with the Panelyte Division of the St. Regis Paper Co. (Canada) Limited, will head the newly formed sales outlet. Offices will be located at 2049 Dundas Street West, Toronto.

(Turn to page 54)

NEWS

(Continued from page 53)

Automation For Radio And TV

Complete automation of radio and television programs is now a reality, according to General Electric broadcast engineers.

In Washington recently, at the annual convention of the National Association of Radio and Television Broadcasters, company engineers demonstrated automation of television station film and slide programming equipment.

The experimental system is the first automation equipment designed for TV stations yet demonstrated. Once the system is set into operation, supervision of the equipment is not necessary. All station breaks, commercials and programs are handled automatically by the automation system. Key to the new system is inaudible tone signals recorded on magnetic tape.

The automation system was used to demonstrate new colour film and slide equipment for TV stations. In the system, the colour film equipment is first turned on, and then the tape playback unit. At the appropriate time during the colour sound film an inaudible tone signal causes the film to stop and a second tone activates the film centre's slide mechanism, putting a stationary colour picture on the TV screen. At the same time, an announcer's voice on the same tape as the tone signals, and keyed to the second tone, is broadcast. Additional tones cause other slides to appear at the proper times during the announcer's talk. At the end of the announcer's speech, a tone signal from the tape causes a new film to start running through the projector.

According to the engineers, the automation system would cut TV station operating costs substantially and could be used to control a TV station's complete programming schedule.

The new G-E film centre, which uses a continuous motion projector and a flying spot scanner system, can be automated because it uses a unique system for switching between film and slides, the engineers said.

New Addresses For Bakelite Sales Offices

The sales headquarters in Toronto has been moved to 40 St. Clair Avenue East. The facilities in these new offices make it possible to provide better service for customers in Ontario.

The new sales office in Montreal is located at 1425 Mountain Street. The decision to establish this office was made primarily to provide more complete service in Eastern Canada. In addition, this location will make possible close liaison with the new Polyethylene Plant under construction in Montreal East.

R. B. Finkle Named General Manager Of Hunt Capacitors

Mr. J. J. Kingan, president of Hunt Capacitors (Canada) Limited, has announced the resignation of Mr. K. A. Jackson as general manager and director of that organization. Mr. Jackson leaves to assume a senior position in a newly formed Canadian Marconi manufacturing facility.

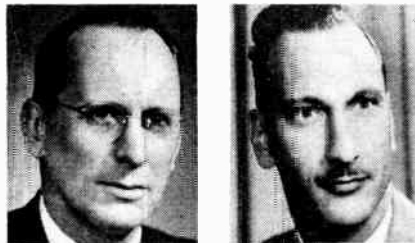

K. A. JACKSON

R. B. FINKLE

Mr. R. B. Finkle has been named to succeed Mr. Jackson. He was in charge of the Canadian representation of Hunt, England for several years prior to the formation of the Canadian company. He has since been closely associated with this operation as Merchandise Manager of the Electronic Tube and Components Division of Canadian Marconi Company.

Canadian Reps For Curtis-Wright Corporation

Officials of the Curtiss-Wright Corporation, Electronics Division, Carlstadt, New Jersey, have announced the purchase of the assets of the Elly Electronic Corporation. In the same announcement it was made known that the Consolidated Electronic Equip-

ment Company of 1156 Yonge Street, Toronto, has been retained by the Curtiss-Wright Corporation as their Canadian manufacturers representative for the Electronics Division. Mr. R. H. Rogers is the President of Consolidated Electronic Equipment Company.

American Firms Name Data Processing Associates As Canadian Reps.

The recent appointment of Data Processing Associates Limited of Ottawa, Ontario as exclusive sales representatives of ElectroData Corp., of Pasadena, California, and Mid-Century Instrumatic Corp., of New York City has been made known by officials of both principals.

Data Processing Associates Limited, a recently formed company, is an independent all-Canadian firm specializing in high speed data processing and data reduction.

Charles W. Pointon Ltd. Announce Staff Appointments

Charles W. Pointon Ltd. of Toronto, Sales Representative for Radio Receptor Co.'s Semi-Conductor Division, announces two new additions to their staff, R. P. Mitchell and E. W. Spence.

Mr. Mitchell was formerly on the Engineering staff of Stark Electronic Instruments Ltd. and with the Communications Sales and Service Division of Pye Canada Ltd. Mr. Spence was with Philco Corp. of Canada Ltd. in the Processing and Material Control Division for many years.

(Turn to page 57)



● Eight communications men from Canadian railroads were among those enrolled in one of Leukurt Electric Company's recent training classes in operation and maintenance of Type 45A carrier telephone equipment. The classes were conducted at Lenkurt's headquarters plant in San Carlos, Calif. Pictured above are: F. C. Hill of Lenkurt's Sales Division; H. H. Mason and O. J. Theisen, Canadian National Telegraph; and R. Allen and R. Oulton, Canadian Pacific Telegraph.

ORIGINAL DESIGN



Solving instrumentation problems by applying the principles of electronics or mechanics, combined with experience, patience and precision—this is PSC Applied Research Limited, where imagination is the keynote. The instruments, right, are examples of the original design work done by the Engineering division which engineers a project from original conception to quantity production. The unique tri-film processor which develops, fixes, washes and dries 16, 35 or 70 mm. film automatically, is another of this division's achievements. The constant objective is simple operation and maintenance, ease of production with quality materials, manufactured to permit the lowest possible selling price. These facilities are yours. Write us.



Automatic ice detection and shedding control system



Revolutionary R Theta navigation computer system



Aircraft rocket-firing control intervalometer



Type 333
Instrumentation
Camera



PSC APPLIED RESEARCH LTD.

1500 O'CONNOR DRIVE
TORONTO 16, ONTARIO, CANADA
PLYMOUTH 5-3371

precision Continental Connectors

MINIATURE

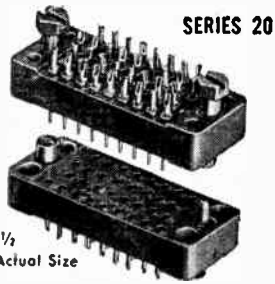

Contacts: 7, 8, 9, 11, 14, 18, 20, 21, 26, 34, 50, 75, 104. For #20 AWG wire. Current rating: 5 amps. Voltage: 2100V. RMS.

SUB-MINIATURE



Contacts: 7, 11, 14, 20, 26, 34. For #20 AWG wire. Current rating: 5 amps. Voltage: 1900V. RMS.

PRINTED CIRCUIT

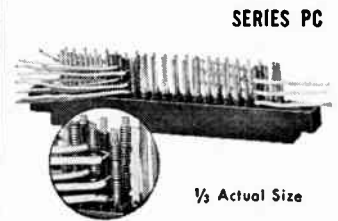

Solderless wire wrap (double rows of 22 contacts) or standard type printed circuit receptacle (6, 10, 15, 18, 22 contacts). Current rating: 10 Amps. Voltage: 2500V. RMS.

HIGH VOLTAGE AN-TYPE

SERIES 800

For AN-36 shell. 15 contacts. 3 high voltage contacts in center are removable. Current ratings: 10 and 20 Amps.

1/4 Actual Size

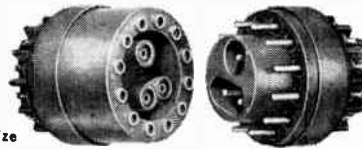

MINIATURE AN

SERIES 1300

One-piece molded inserts. Current rating: 7.5 Amps. Voltage: 3000V. RMS.

1/2 Actual Size



EASY RELEASE

SERIES E-Z

1/2 Actual Size



Solder cup contacts, taper pin cups for solderless wiring or turret terminals. Current rating: 10 Amps. Voltage: 4500V. RMS.

POWER

SERIES 14 & 16

1/3 Actual Size

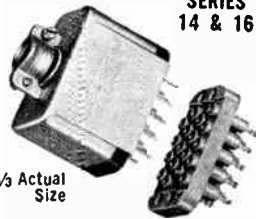

Contacts: 12, 18, 24, 34. Spring loaded contacts for easy release. Coaxial contacts and bayonet locks also available. Current rating: 10 and 25 Amps. Voltage: 4700V. RMS.

SPECIAL DESIGNS

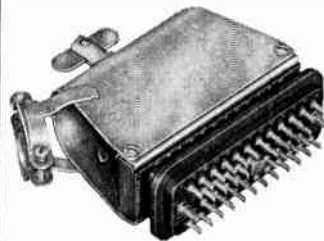

Our engineering department will be glad to design types to your exact specifications. Send us your requirements for analysis.

HERMETIC SEAL

SERIES HC 3/4 Actual Size

For high altitude applications. Plug contacts individually compression sealed in glass. Guide pin and guide socket, or polarizing screwlock available. Fits series 20 receptacles.



SERIES HC-20
3/4 Actual Size

Hexagonal hermetic plug has solid glass insert. For pressurized electronic equipment. 4, 5, 7, 9 and 10 contacts.

High precision, dependable Continental Connectors have achieved a reputation for excellence throughout the aircraft and electronics industries. The widest range of applications can be made from our standard line. For special requirements and technical data sheets on these Connector's write Electronic Sales Division, DeJUR-Amsco Corporation, 45-01 Northern Blvd., Long Island City 1, N. Y.

electronic
sales
division

DeJUR

NEWS

(Continued from page 54)

Varian Associates Establish Plant In Georgetown

The construction of modern manufacturing building that will provide 10,000 square feet of floor space has been started in Georgetown for the Varian Associates of Canada Limited, a subsidiary of the Palo Alto parent firm. It is anticipated that the firm will move into their new premises early in the fall.

The establishment of the branch plant in Georgetown will bring at least four executives of the firm to Georgetown including Wesley Carnahan who will be General Manager of the plant.

C.G.E. Executives Demonstrate Latest In Microwave Equipment

Executives and members of the staffs of electric utilities, telephone companies and pipeline companies in Western Canada recently witnessed a demonstration of modern communication equipment.

The demonstration took place at the Palliser Hotel in Calgary, and was sponsored by Canadian General Electric Company to show how modern

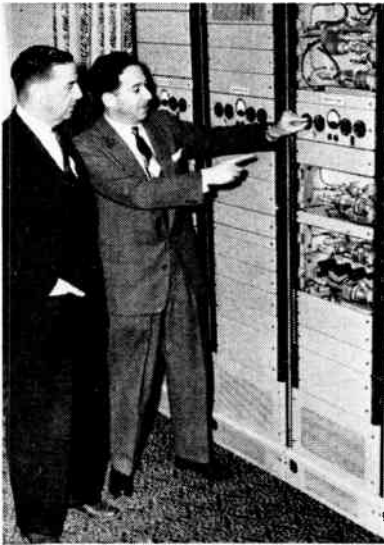

● Hon. Gordon E. Taylor, minister of telephones for the province of Alberta, shows keen interest in microwave equipment being demonstrated by W. A. Cole, C.G.E.'s microwave sales manager.

equipment plays an important part in Canada's progress by providing vital communications.

According to Walter A. Cole, CGE's Manager of microwave sales, the demonstration was very successful and a great deal of interest was shown in the equipment on display. This equipment, most of which was operating, included multi-channel uhf, radio-telephone, frequency division multiplex equipment, mobile and fixed station equipment, and intercity TV relay systems.



S. T. HARRIS



C. F. HEMBERY

● S. T. Harris, Vice-President of Texas Instruments Incorporated, Dallas, Texas, and C. F. Hembery, President of Computing Devices of Canada Ltd., have recently concluded an agreement for the exclusive Canadian representation of Texas Instruments Incorporated products. Texas Instruments Incorporated is a large electronics manufacturer in the United States, specializing in electronic components, instrumentation and semiconductor products.

Benson-Lehner Corporation Data Cruiser To Visit Canadian Cities

The Benson-Lehner Corporation "Data Cruiser" laid out and equipped to demonstrate the very latest in data reduction equipment will be brought to Canada by Computing Devices of Canada Limited, Canadian agents of the Benson-Lehner Corporation.

The "Data Cruiser" will visit Hamilton, Toronto, Ottawa, Montreal and Quebec City commencing early in August.

Musimart Of Canada Ltd. Take On New Lines

Fred R. Lesser, Manager of Musimart of Canada Limited has announced the company's appointment as Canadian representative for Messrs. Comar Electric Co., of Chicago and their associates, Messrs. Molon Motors and Coils Corp., also of Chicago, designers and manufacturers of relays and electronic control devices.

Musimart of Canada Limited are now also representing Messrs. P.X. Fox Limited, of Horsforth, Yorks., England, manufacturers of toroidal precision potentiometers.

Baird Appoints Representatives

Baird Associates, Inc., Cambridge, Mass., has appointed sales engineering representatives whose organizations will take over sales for the firm's transistorized products in this country and abroad. Measurement Engineering Limited of Arnprior, Ontario, has been named as the Canadian representative of the firm.

Bayly Engineering To Represent De Mornay Bonardi Of California

Bayly Engineering Ltd., Ajax, have been appointed exclusive sales and service representatives for De Mornay Bonardi of California.

De Mornay Bonardi offer a complete line of microwave and ultramicrowave equipment noted for its precision, dependability and operating ease. Expanded laboratory facilities are being installed by Bayly Engineering to cover the calibration and repair of microwave equipment used by the Armed Services as well as their new principals.

Pye Installs Communications System For Bathurst Power And Paper Company

One of Pye Canada's most recent installations was for the Bathurst Power and Paper Company, New Brunswick. This installation links their operations and mills at Bathurst and Great Falls, New Brunswick; New Richmond, Quebec; three tugs operating on the Bay of Chaleur and two motor vehicles. It is designed for maximum flexibility and future extensions to Berry Mountain Depot, Popple Depot and other woods camps as they are required.

The Pye A.M. radio system (operating in the 152-174 mc/s band) is expected to provide greatly improved communications over the company's operating area. It was completely engineered and installed by Pye personnel.

(Turn to page 70)

NEW PRODUCTS

New Product specifications published in *Electronics and Communications* have been briefed for your convenience. If you require further information on any of the items published you may readily obtain such by using our Readers' Service, Page 79. Just mark the products you are interested in on the coupon on Page 79 and the information will be in your hands within a few days.

● Capacitance-Resistance Analyzer

Item 722

A new deluxe Model BF-70 Capacitance-Resistance Analyzer for service shop and industrial testing purposes is available. This ten pound portable instrument, quickly and accurately, measures the important characteristics of essentially all types of capacitors and resistors. Its features include a direct reading calibration scale which provides simplified measurements, avoiding possible errors in using multipliers or charts.



The BF-70 quickly locates capacitor opens, shorts and intermittents; high and low capacities; also detects high leakage and high powerfactor in electrolytic capacitors, as well as low insulation resistance in paper, mica, and ceramic dielectric capacitors. Sensitive capacitance measurements between wires and shavings; transformer windings, cable wire and other similar conditions are also possible with the BF-70 new Capacitance-Resistance Analyzer. The built-in panel meter is arranged for independent external voltage measurements to 750 volts and current measurements to 75 milliamperes.

● High Performance Coil

Item 723

A new coil, recently announced provides new advantages in production and performance. The ceramic phenolic covering holds the coil and leads firmly in place. The need for terminals is eliminated.

Furthermore, the inexpensive covering protects the coil from damage of handling on the production line. Various colors may



be provided in the covering, thereby simplifying recognition in the stockroom and on the production line.

The company points out that the coil forms

have been further improved by the following (1) Grinding the outside diameter of the ceramic form to plus or minus .002" to insure uniform electrical characteristics. (2) The forms are Silicon impregnated. (3) Forms are held to mounting base by a new thermal type treatment which assures even, lasting mounting. (4) Iron cores are color coded and rust-proofed. (5) All metal parts are heavily bright alloy plated — a superior plating to cadmium or nickel.

● New Channelizing Equipment

Item 724

Five new 24-channel frequency allocations are now available in a new Type 45BX channelizing equipment for radio and microwave communications systems, it has been announced by the manufacturers.

The new allocations permit up to 120 voice and signalling channels to be transmitted and received over a single wideband radio system. The allocations are in the frequency range from 12 to 528 kc.

More than 120 channels can be achieved by additional stacking of the basic 24-channel carrier groups and extension of the frequency range beyond 528 kc.

The announcement pointed out that Type 45BX carrier provides an economical means of utilizing the available bandwidth of most point-to-point radio and microwave systems. This channelizing equipment can be used with systems having capacities as low as 4 or 12 channels, and it can be used over wideband systems with large channel capacities.

Each 12 and 24-channel group is separated from adjacent groups by a 4-kilocycle band, permitting groups of channels to be dropped or inserted at intermediate points between system terminals. Groups can be terminated at the intermediate point or be transferred to other carrier systems for transmission over wire lines, cables or other radio systems.

● The Brenell Tape Deck

Item 725

The Brenell tape deck is introduced as a high quality unit at a moderate price. It incorporates many of the unique features originally developed for the Sound Master

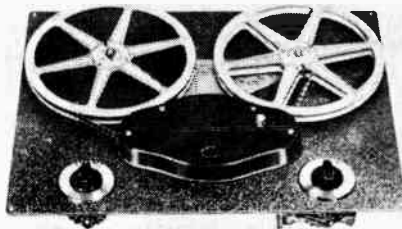

by Brenell Engineering which have already established their reputation in the field of Tape Recorder design.

Of particular interest is the new toggle-action grip between capstan and pinch wheel which ensures a tape drive completely free from slip and which at the same time eliminates one of the major causes of "wow" and flutter. The capstan is directly coupled to a heavy flywheel which is driven by a rubber

belt from a motor of adequate power.

Three independent motors are employed to ensure reliable operation with simple switching. Braking is arranged mechanically and gives an effective quick stop action with complete freedom from tape tearing yet leaving the tape correctly set for immediate recording or playback.

Three speeds are available with a playing time of:

2 hours	at 3¾ inches per second
1 hour	at 7½ inches per second
½ hour	at 15 inches per second

The Brenell Record/Playback head is a high impedance type and does not require a matching transformer. It is fitted with a heavy gauge Mumetal screen to ensure elimination of 50-cycle hum due to magnetic fields from motors, transformers, etc. The Brenell Erase Head is a low impedance type which requires to be fed from a low impedance winding on the oscillator coil.

The Tape drive is from left to right, using the upper track to conform to British Standards. Tape loading uses the simple "drop in" principle and reels, therefore, can be instantly exchanged or reversed.

● Cera-Mite Capacitors For Automation

Item 726

Three new designs of ceramic disc capacitors intended specifically for automation have just been announced. Closest to the conventional disc ceramic is the pin terminal type which has short, stiff terminals ⅜" long held at predetermined lead spacings. This is at the upper right in the photograph.

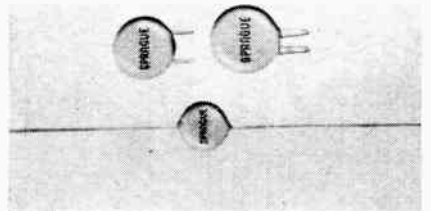

The capacitor is furnished either in bulk or in Tube-Paks for direct magazine loading in component insertion machines. The special pin terminal discs have closely controlled coating "pants" on their leads so that no resin extends beyond the tangent line of the disc and yet no bare disc is exposed between leads. Special production machinery has been developed for this purpose in order to eliminate "bare bottom discs" and the possibility of later failure in service through entry of moisture on the unprotected surface.

The taper tab terminal unit shown at the lower right is also intended for automatic insertion machines and is furnished in Tube-Paks if so required. The flat terminals are designed to jam into chassis slots so the capacitors will be held firmly during subsequent assembly operations prior to dip soldering.

The diametral lead disc capacitor shown at the left is intended for tape loading in magazines at the TV manufacturer's plant. Tape-loaded capacitors then have their leads precut to size and are automatically inserted by machinery.

● Resist And Flux

Item 727

A step saver for the production of printed circuits by silk screen process has recently been introduced by the Wornow Process Paint Company. This new material combines the properties of a sharp printing screen process resist and a flux for solder application. When printed on copper clad phenolics the circuit is etched and then directly soldered. The steps of washing off a conventional resist and then applying a flux prior to soldering are thus eliminated.

NEW PHOTOCELL OPERATES RELAY DIRECT

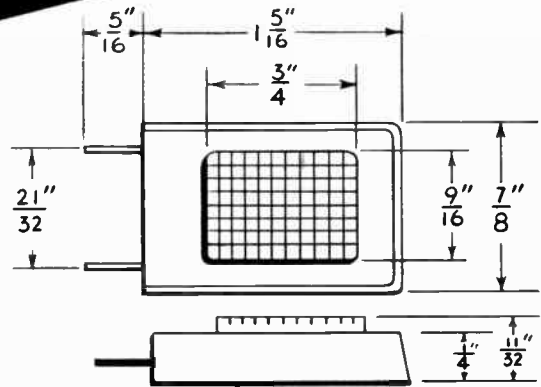
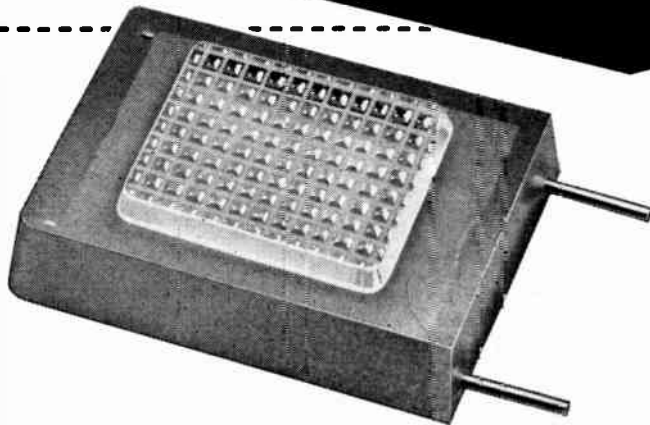

GENERAL DESCRIPTION

Sensitive area 1.45 cm x 1.85 cm
 Electrodes Interleaving combs
 Cell casing Cast Araldite
 Socket Special

MAXIMUM RATINGS

Dissipation **0.3 max. watt**
 Voltage 120 max. volts (a.c. or d.c.)
 Current **20 max. ma**
 Temperature range - 40°C to +75°C ambient

PHOTOELECTRIC CHARACTERISTICS

Wavelength at maximum response.....	5100°A		
	<u>MIN.</u>	<u>AVG.</u>	<u>MAX.</u>
Dark resistance.....	100	1000	10,000 megohms
*Resistance at 50 ft candles.....	1500	2000	3,000 ohms
*Sensitivity at 1 ft candle, 100 volts.....	0.25	0.4	0.5 amp./lumen
Capacitance.....	20	25	30 mmfd
Rise-time constant at 50 ft candles.....	5 m.sec		
Decay-time constant at 50 ft candles.....	10 m.sec		

*Measured with a 2854°K colour temperature tungsten lamp.

For further information, write for the C.M.C. Photocell Handbook to

PHOTOCELL DEPARTMENT

CANADIAN **Marconi** COMPANY

2442 TRENTON AVENUE, MONTREAL, P.Q., CANADA

HERE ARE **36** USES FOR Closed Circuit **INDUSTRIAL TELEVISION**

A new system of visual control for use in manufacturing plants, laboratories, hospitals, commercial establishments, training colleges — and wherever remote observation is desired.

INDUSTRY

Mixing processes whether in closed or open containers
Inaccessible moving mechanical parts
Time study of production or assembly line
Traffic flow at large loading platforms
Personnel movement for peak departmental operation
Staff training programmes
Central point observation of scattered process control instruments
Plant flow of materials
Process changes in materials
Personnel identification at plant entrances

COMMERCE

Property and personnel security
Staff training programmes
Dispatch and transport control
Pilferage control in stores and on wharves, etc.
Cheque signature verification for banks
Department stores sales demonstrations
Cooking schools
Traffic flow in exhibitions, public assemblies, etc.
Plant watching facilities at night
Visitor identification on restricted premises
Transmission of documentary information for central files

GOVERNMENT, PUBLIC AUTHORITIES AND INSTITUTIONS

Armed forces training programmes
Armed forces equipment
Personnel safety in munition plants
Forest-fire inspection
Submarine inspection of harbours, docks, wrecks, etc.
Scientific observation including microscopic or telescopic
Crowd and traffic control at public events
Hospital, clinical, medical and surgical demonstrations
Police line-up identification
Overflow audience at public events

EDUCATION

Child study
Vocational training
Examination supervision in practical subjects
Science demonstration — microscopic or telescopic
Group training and demonstration of techniques

**We could easily list 136 and still not hit on the
one application that makes sense in your operation
BUT YOU CAN!**

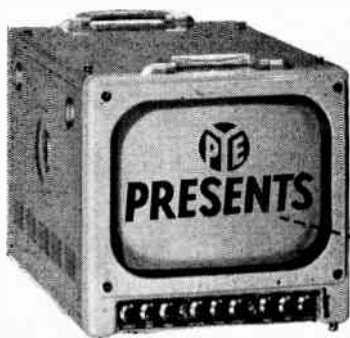

INDUSTRIAL TELEVISION FOR REMOTE OBSERVATION

The potentialities of industrial television are almost unlimited—each day brings news of a fresh application in plants, laboratories, aircraft, ships and technical colleges.

Installation of "remote visual control" through Pye industrial television costs less than you imagine. Pye industrial cameras and screening apparatus are built for long life and efficiency with all the "know-how" the world-wide Pye organization has at its command.

WE INVITE YOU

to study the list of known applications. If none of them suggests a solution to your problem, we will be happy to work out adaptations with you. Just write us on your business letterhead.

PYE CANADA LIMITED, 60 Front St. W., TORONTO, Ontario

or to: 1191 University St., Montreal, P.Q.
193 E. Hastings St., Vancouver, B.C.
83 Birmingham St., Halifax, N.S.



Engineers and consultants on mobile, fixed-to-mobile, point-to-point, and multi-channel radio communication systems; suppliers of telephone apparatus of all kinds; manufacturer and supplier of scientific instruments, industrial and commercial television cameras, radios, high-fidelity reproducers and television receivers.

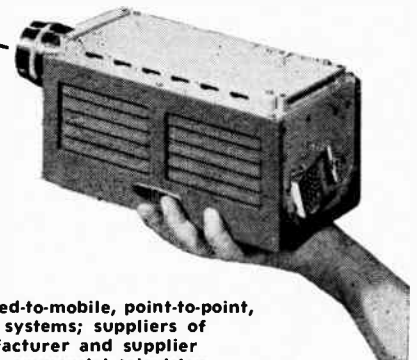

For further data on advertised products use page 79



Book Review



Electronic Circuits by Thomas L. Martin, Jr. presents the fundamental principles and techniques associated with electronic circuits without emphasizing particular components or system applications. If vacuum tube circuits seem to receive the greatest attention, it is only because the analysis of such circuits is more highly developed at the time of writing.

The book is subdivided into three parts, as follows: Part I: *Introduction*; Part II: *Class A Circuits*; Part III: *Operation in the Switching Mode*.

Part I is a brief introduction to the principles of equivalent circuits and the elements of electric theory based on the complex frequency and Laplace transform approach.

Parts II and III are the main sections of the book. Most of the usual and some unusual circuits using nearly all the various components are presented. All circuits covered in Part II require continuous operation of the electronic component. This is called *Class A operation* in this book. Nearly all the circuits in Part III require discontinuous operation of the electronic component. This is defined in this book as *operation in the switching mode*.

The approach is almost entirely analytical. Although many useful methods from advanced mathematics are avoided, the book is still unashamedly mathematical in nature.

Many useful and informative results, formulas, and design charts are obtained, but the emphasis is on the techniques used rather than the results themselves. No attempt has been made to write a handbook of formulas or to compile an encyclopedia of illustrative numerical problems. The book presents the methods of formulating circuits to obtain useful design formulas and performance criteria.

The book should appeal to a diversified group of readers. Practicing engineers and physicists will find it to be a usable reference in their everyday work with circuit design and development.

Electronic Circuits is published by Prentice-Hall Inc., 70 Fifth Avenue, New York II, contains 707 pages, hard cover bound, price \$12.00.

Networks, Lines and Fields, second edition by John D. Ryder is an introduction to the field of communication circuit engineering and electrical network theory from the standpoint of both currents and fields.

This book provides a basic coverage of the theory of transmission of electric energy in lumped-constant circuits, on distributed-constant lines, through wave guides and into space.

Much new material has been added to this Second Edition, including: a chapter (8) on the line as used at power frequencies; Foster's reactance theorem and canonic networks; a chapter (5) on the determination of the parameters of polyphase lines and a chapter (13) on basic antenna theory and simple antenna types to complete the study of electric energy transmission over lines, through guides, and into space. Coverage of matrix notation and solution of networks has been increased, circuit duality further emphasized, and the treatment of the Smith Chart for radio frequency lines has been expanded.

The author introduces vector notations into the material on fields and develops vector concepts where needed.

This book covers specific circuit material that is essential to an understanding of modern electronic circuits and operations. It also attempts to tie together the circuit and field viewpoints through extensive use of the transmission-line analogy.

Networks, Lines and Fields is published by Prentice-Hall Inc., 70 Fifth Avenue, New

York II, contains 593 pages, hard cover bound, price \$7.65.

Machine Translation of Language, edited by William N. Locke and Donald Booth is the collection of fourteen cogent and thought-provoking essays provides a fascinating account of what has been achieved to date in the application of machines to translation. Engineers, students of linguistics, and all readers interested in the scientific conquest of human communication problems, will find it a clear and informative survey of present accomplishment and a guidepost to future development.

Beginning with an historical introduction, the book goes on to cover such topics as the design of an automatic dictionary, problems of the "word", the operational analysis of Russian, speech input, storage devices, idioms and syntax, model English, and recent experiments. Of special interest is the inclusion of Warren Weaver's original memorandum, "Translation", which, when circulated in 1949, provided the original stimulus to this field.

"Translation from one language into another presents important, ancient, and difficult problems," declares Dr. Weaver in a special Foreword. These problems, however, are being overcome, day by day. "Students of languages and the structure of languages, the logicians who design computers, the electronic engineers who build and run them — and specially the rare individuals who share all of these talents and insights — are now engaged in erecting a new Tower of Anti-Babel. This new tower is not intended to reach to Heaven. But it is hoped that it will build part of the way back to that mythical situation of simplicity and power when men could communicate freely together, and when this contributed so notably to their effectiveness."

Machine Translation of Languages is co-published by the Technological Press of the Massachusetts Institute of Technology and by John Wiley and Sons Inc., 440 Fourth Avenue, New York 16, contains 243 pages, hard cover bound, price \$6.00.

Fundamental Formulas of Physics edited by Donald H. Menzel is an authoritative handbook and primary reference for all science majors who employ the methods or applications of mathematical physics.

Written by noted men in their fields, each of the thirty-one sections features the basic formulas used in major areas of modern science. Many of these formulas are heretofore unpublished.

Outstanding features are: Carefully chosen research workers. In addition, extensive topics such as Physical Chemistry and Biophysics, provide practical discussions for all references to journals and miscellaneous works guide the reader to particular developments.

A great portion of the material, i.e., Geometrical Optics and Physical Constants, illustrates the latest data. And the authors omit derivatives for the most common basic formulas so they may show many previously unavailable intermediate steps.

The authors achieve a completely modern mathematical approach by blending classical and recent viewpoints.

Fundamental Formulas of Physics is published by Prentice-Hall Inc., New York, contains 765 pages, hard cover bound.

Elements of Physics For Students of Science And Engineering by George Shortley and Dudley Williams, second edition.

In view of the favorable acceptance ac-

corded the first edition of this text, the publishers decided to bring out a second edition after just two years' use of the first, in order to permit the authors to take prompt advantage of the many constructive criticisms and suggestions that have been made by users of the text.

This new edition has been completely reset and incorporates extensive revisions and many additions. Subject matter in mechanics has been rearranged in more logical order; illustrative examples have been systematically included; and problem sets have been improved, expanded, and relocated at the ends of the chapters. New subjects treated include relative velocities, dynamical systems, fluid viscosity, surface phenomena in liquids, Gauss's law in electrostatics, thermionic vacuum tubes, transistors, and the newly discovered particles of modern physics. The Newtonian principle of relativity is emphasized, and the application of Newton's principles of motion in moving coordinate systems is illustrated in a number of chapters.

The text is intended for use in an introductory course for the student of science or engineering who is taking a concurrent course in the calculus. Mathematics is used as a tool, and no attempt is made to teach mathematics for its own sake. Plane trigonometry is used extensively from the beginning, but calculus is introduced gradually as the student acquires familiarity with this discipline.

Elements of Physics is published by Prentice-Hall Inc., New York, contains 880 pages, hard cover bound.

Introduction To Physics by Frank M. Durbin. This textbook has been prepared for an introductory course in physics for college students. The material is adequate for the standard eight-hour course as offered in most institutions. The approach is from the liberal arts viewpoint rather than from the purely technical. Certain topics may be studied with or without the aid of trigonometry. The appendix carries a discussion of these topics from the trigonometric viewpoint, and such discussions are referred to at the appropriate places in the body of the text.

The order of presentation differs only slightly from the order found in most textbooks on general physics. An attempt has been made to give the student a "breaking-in" period by delaying the introduction of accelerated motion and Newton's laws until Chapter 8. The first chapter includes a review of algebra and some geometry, introduces the student to the use of formulas as they apply to physical situations, and gives some practice in the analysis and solution of problems. Thereafter, the ideas are presented in what the author believes is a logical sequence.

Today most students are vitally interested in those topics so often listed as "modern physics". Yet every teacher of physics knows how often the end of the spring semester approaches long before the usual topics in classical physics have been covered. The chief aim of this text is to try to correct this situation. To make time for a study of modern physics — called "The Physics of Small Particles" in this book — several techniques have been employed. First, some purely descriptive topics usually presented in a text book on general physics have been entirely omitted. Second, some other topics and applications have been presented only as problems, except as related to a discussion of the underlying principles. Third, practical applications have been given less attention than is usually the custom. Fourth, discussion of situations that lend themselves to classroom demonstration have been left to the ingenuity of the instructor. In this way it is hoped that the material on Mechanics, Heat, and Sound may be covered in the first semester, leaving Electricity, Light, and The Physics of Small Particles for the second.

Introduction To Physics is published by Prentice-Hall Inc., New York, contains 780 pages, hard cover bound.

NEW PRODUCTS

(Continued from page 58)

● Model HD-1 Harmonic Distortion Meter Kit

Item 728

The HD-1 performs the functions of more elaborate and much more expensive audio distortion testing devices and yet is simple to operate and inexpensive to own. Used with an audio sine wave generator it will check harmonic distortion at the output of audio



amplifiers under a variety of conditions. Extremely valuable in determining characteristics of high fidelity amplifiers and associated equipment.

Operates within a frequency range of 20-20,000 cps in three ranges. Features VTVM circuit for initial reference settings and final harmonic distortion readings. Having a high input impedance, the HD-1 requires only 3 volt input signal for distortion tests. Uses 0A2, 6X4, 5879, 12AT7, 12AX7 and 12BY7. Measures 13" wide x 8½" high x 7" deep.

● Induction Heating Booklet

Item 729

A 12-page booklet "Induction Heating for the Metal Working Industries" is now available from a Canadian maker of this equipment.

Primarily intended to illustrate the extensive range of radio frequency audio frequency and line frequency induction heating equipment currently available from the Company, it contains much valuable information on the application of the process to the forging, hardening, annealing and brazing of metals.

Other sections of the publication describe standard accessories such as output transformers, capacitors, contactors and work stations which may be required for certain applications.

Also illustrated are standard and special work handling devices for a wide variety of components.

● 3K3000LQ Amplifier

Klystron

Item 730

A new high power ultra high frequency amplifier klystron, the 3K3000LQ, has been announced.

In CW operation at 760-980 mc, the

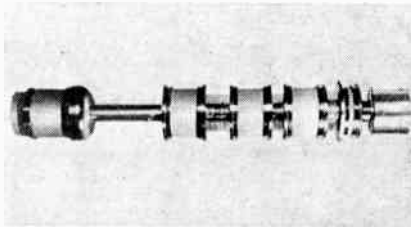

3K3000LQ delivers two kilowatts power output with a power gain of 1000 times and 40 per cent efficiency. The forced-air-cooled tube has a long life oxide cathode and

rugged ceramic and metal construction. Resonant cavities are completed external to the vacuum system, which is left free of RF circuitry, enabling wide range tuning, uncomplicated input and output coupling adjustment and ease of installation and maintenance.

The 3K3000LQ is available with Eimac circuit components comprising the essential elements of a complete final amplifier package.

● 20 Microsecond Delay Line

Item 731

Gudeman of California offers a new lumped parameter 20 microsecond delay line, XN-1, with rise time of 1 microsecond.

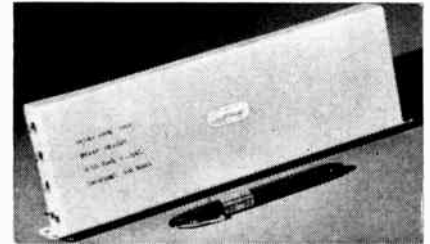

Impedance is 600 ohms. Unit is hermetically sealed in Epoxy resin, and operates through the temperature range from -70°C. to 135°C. Size: 10¼" (including terminal lugs) x 3⅝" x ⅜".

● High Quality Superlytic Condensers

Item 732

T.C.C. Superlytics fulfil the demand for a condenser having the electrical characteristic of a paper condenser together with the small size of an electrolytic. The leakage is so low that one can properly speak of Insulation Resistance. A figure in the order of 10,000 megohms — mfd is achieved at the rated working voltage.

LAST CALL

For

LISTING INFORMATION

For The

ANNUAL DIRECTORY ISSUE

of

ELECTRONICS & COMMUNICATIONS

The September - October Issue

If you have neglected to return your checked listings. Do so now — at once. If you failed to receive a check list for checking — wire, telephone or write for it at once.

Electronics & Communications

31 WILLCOCKS STREET — TORONTO



Got It Yet ?

Have you received your copy of the new ESSCO No. 551, 1955 general catalogue yet? This answer to the purchasing agent's prayer is really going over big . . . it has everything! Between the covers of this handy volume are listings of radio, television and industrial electronic parts, components and equipment usually found so complete only in manufacturers' literature. Just drop us a line and we'll send you one free.

ELECTRO SONIC
SUPPLY CO. LTD.
543 YONGE ST., TORONTO 5
WA. 3-2481



Additional advantages are: Exceptionally long working life. Operation up to 100°C. Small size.

Example: Type: SL 77H; Capacitance = 1 mfd; Working Volts = 250 vdc; Length = 1 5/8"; Diameter = 3/8".

● 50 And 75 Ohm Subminax RF Connectors

Item 733

These units are so small that all of the 26 connectors in the series easily fit in the palm of your hand! A result of the continuing development work in the field of miniaturization, the new SUBMINAX connectors have all the dependable features of their older, larger brothers compressed into a fraction of the space usually demanded in RF connectors.

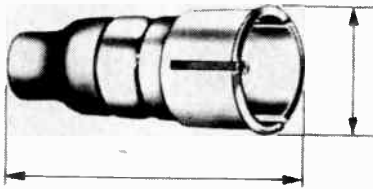

27-13 PLUG

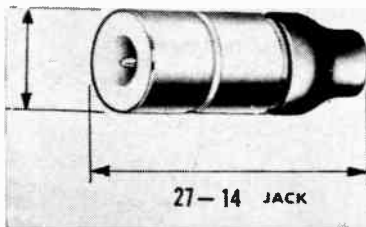

27-14 JACK

The SUBMINAX line is exceptionally complete. Connectors are available in both screw-on and push-on types in either 50 or 75 ohms. In each design here is a plug, jack, receptacle, jack bulkhead, feed through and right angle plug. In addition, hermetically sealed receptacles are available in the 50 ohm and 75 ohm screw-on connectors. SUBMINAX connectors have machined brass bodies with a tough and shining gold-plated finish.

Although SUBMINAX cable assemblies are available, assembly at your plant is both easy and practical. Inexpensive and easy-to-use "hand crimpers" are available along with the necessary lengths of miniature coaxial cable.

● High Speed Impulse Recorder

Item 734

This instrument recently developed records rapid impulse sequences and determines the duration of "live" and "dead" periods.

The record is produced on a circular piece of dry electrosensitive paper twelve inches in diameter, which is rotated at a predetermined speed on an aluminum turntable similar to a phonograph recorder. The recording head accommodates spring loaded styli which make direct contact with the paper disc. When in operation the recording head and styli rest lightly on the rotating disc but no mark appears until power is fed to an individual stylus, whereupon, the resistance of the surface coating on the paper is overcome permitting a black line to appear for the duration of the impulse. One stylus is supplied for each channel to be recorded.

By depressing the "enabling" push button, a control system automatically puts the device under test through its sequence, then shuts the equipment off. It also assures the correct turntable speed for recording.

(Turn to page 65)

KESTER

FAST
ACTING

EASIER
TO USE

LONGER
LASTING

THE
BEST

Absolutely non-corrosive and non-conductive, KESTER "RESIN-FIVE" CORE SOLDER contains an activated type of resin that gives you that fast, positive action on all your jobs . . . including the most difficult.

KESTER SOLDER COMPANY
OF CANADA, LTD.
Dept. U - Brantford, Canada

SOLDER

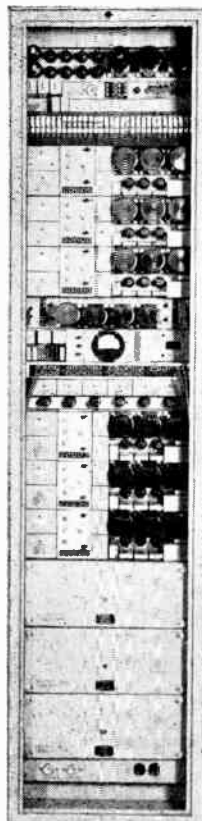

TYPE F2 CARRIER-TELEGRAPH SYSTEM

Provides up to 40 teletype circuits on a telephone channel.

This compact, economical, high-grade, long-haul, main-line voice-frequency carrier-telegraph system is available in two channel spacings. The type F2A system, employing 120-cycle spacing between channels, provides up to 40 channels in the band of 300 to 4980 cycles. The type F2B system, employing 170-cycle spacing, provides up to 28 channels in the band of 255 to 4835 cycles. Up to 15 channels with oscillators, relay test and metering facilities, jacks and bay terminals will mount on a single 8-ft. bay. A channel-terminal panel containing send and receive circuits for one channel requires only 5 1/4" and four channel oscillators only 1 3/4" of space on a 19" rack. A highly-developed level-compensation circuit provides practically undistorted signal reception over a wide variation of line net loss. Standard loop options are half- and full-duplex, battery normal and reversed.

New and exclusive techniques in the design and manufacture of filters and oscillator networks provide a higher degree of frequency stability than has previously been possible, with resultant reduction in signal distortion. This equipment is in current production, and early deliveries can be made of complete systems or of single panels.

Typical 6-channel packaged terminal of type F2 equipment. This is the type AN/FCC-12 (Channels 1-6) or AN/FCC-13 (Channels 7-12) Telegraph Terminal, as manufactured for the U.S. Army Signal Corps. It is complete with regulated-tube rectifiers for plate and bias supply, and positive and negative telegraph loop-current supplies, jack field, relay test panel, monitor circuits, fuses, spares, etc. The equipment is moisture- and fungus-proofed, and meets military standards where applicable. Up to four cabinets may be used together, to provide a completely self-contained 24-channel terminal.

RADIO ENGINEERING PRODUCTS

1080 UNIVERSITY STREET, MONTREAL 3, CANADA

Telephone: UNiversity 6-6887

Cable Address: Radenpro, Montreal

MANUFACTURERS OF CARRIER-TELEGRAPH, CARRIER-TELEPHONE AND BROAD-BAND RADIO SYSTEMS

LONG RANGE RADIO

(Continued from page 21)

a tower at a height of 40 feet. This antenna has a beamwidth at 1000 mc of a little more than two degrees. Similar antennas up to 60 feet in diameter have been proposed and are expected to be in production soon. It is found

that somewhat less than the full theoretical gain is realized in scatter propagation from antennas more than about 20 wavelengths in diameter. In spite of this loss, large antennas are found to be justifiable.

High transmitter power is essential. The limitation is generally set by the availability of power amplifier tubes

covering the pertinent frequency range. Figure 3 shows a production type transmitter rated at 1 kw output, employing a tetrode amplifier, and covering the frequency range of 225 to 1000 mc. Air cooling is employed. An air-cooled klystron amplifier of similar rating is under development. With water cooling, values of power output of 10 kw in this frequency range are obtainable. Similar power ratings at higher frequencies can be foreseen.

The receiver must have a low noise figure, since receiver noise and not atmospheric noise is governing. It must have a bandwidth only sufficient to pass the necessary modulation sidebands. Since multi-path propagation produces fading, an important improvement in reliability can usually be achieved by space diversity.

An important requirement if the signal-to-noise ratio is to be a minimum is a careful restriction of receiver bandwidth, and this in turn requires a high order of frequency stability in the transmitter and receiver carrier frequency. This has been achieved by designing a carefully stabilized crystal oscillator operating at a fixed frequency of 1 mc and then employing this signal to control the phase of a variable oscillator at appropriate small frequency steps. The oscillator has a rated stability of better than 1 part in 10^8 per day. This sta-

(Turn to page 68)

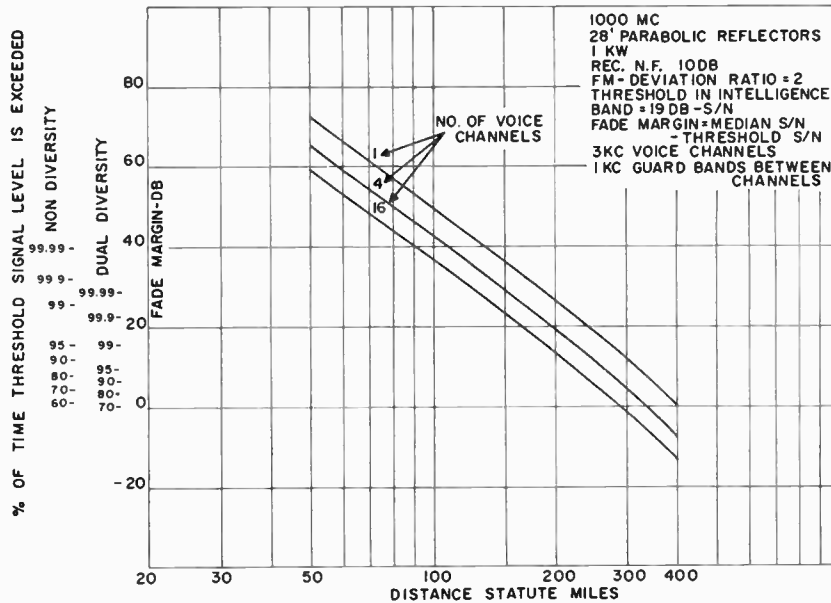

● Fig. 5. Fading Margin and Circuit Reliability as a Function of Distance for a UHF Scatter Link.

Physicist

Physicist with German Doctor of Engineering Degree and over twenty-five years' experience, holder of several patents and presently engaged in electronic development seeks responsible independent position preferably in the electronic industry.

Interested parties may address enquiries to Box C, Electronics and Communications, 31 Willcocks Street, Toronto 5, Ontario.

Don't Say
Resistors

Specify **DAVOHMS**

The Complete, Superior Line
of Precision

WIRE WOUND RESISTORS

Made Only By **DAVEN**

ELECTRONIC SPECIALISTS FOR MORE THAN A GENERATION



- Accuracies to .05%
- All Temperature Coefficients
- All Types of Mountings
- Hermetically Sealed Types
- Feature Resistance Wire,
- Specially Coated with Tough Formex Insulation
- Manufactured to Famous Daven Standards of Precision
- One Recognized Source for All Of Your Requirements in Resistors

Write for detailed bulletin

THE **DAVEN** CO.

193 Central Avenue • Newark 4, N.J.

In Canada: ADAMS ENGINEERING LTD., Montreal and Toronto

NEW PRODUCTS

(Continued from page 63)

● High Frequency Heat Sealing Equipment Item 735

A recent addition to a well known line of High Frequency Sealing Equipment is the new "package" installation. Available in power outputs of 1.5, 3.0, or 5 kw with either single or dual press, it is supplied complete with generator and all controls, ready for connection to the customer's air and power lines.

The press and pedestal are designed for use with standard floor-mounting "Nichols" generators, and can be readily adapted to existing units. Each press has a 12" throat and 9" daylight, and can be supplied with base platens up to 24" x 38" for area seals, and up to 6" x 72" for long bar seals. Since the platen is readily detachable from the press frame, the user is not limited to a single platen size. One inch guide rods assure a rigid press ram and both up and down stops control stroke length. Adjustable electrode holders are fitted to the rams, and can be designed to accommodate existing electrodes.

There is ample leg room for sit-down operation, but the press base is high enough (37") for most stand-up operations. On the dual press installation, a special switching arrangement allows for completely independent operation of each press. Individual timers and loading control permit seals of dissimilar size with the same generator settings.

● New Plastic Molded Coil And Condenser Item 736

Ideally suited for printed circuits and miniaturization, this new molded coil and condenser measures $\frac{3}{8}$ " thick by $1\frac{1}{2}$ " wide by $\frac{1}{8}$ " long.

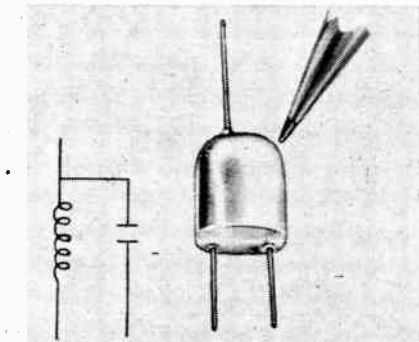

The product was designed to further minimize components by molding two parts that are connected in the same circuit in one compact package. Where desirable, resistors may be molded with the coils in place of the condenser or along with the other two to form a small, sealed unit. The items meet all Military Specifications.

● Diagnoster

Item 737

A diagnoster which not only detects failures in electronic equipment but which can predict failures in tubes is now available to the trade.

The machine developed for military electronic equipment — can be adapted to any type of electronic equipment, including commercial television, both black and white and color.

The diagnoster not only tells which parts are no longer usable but can detect weakening of tubes — which usually accounts for about 90 per cent of failures in electronic equipment.

The product is ready for commercial production. It was developed partially under a research contract with the office of Naval Research of the United States Navy.

● New Size D Ignitron

Item 738

A new heavy duty size D ignitron has been developed. The tube designated NL-1053 is of stainless steel construction, and includes a mounting plate for thermostat to provide thermal protection.



NL-1053 is the first repairable welding control ignitron developed and the first with an internal cooling coil. The increased cooling efficiency permits a greatly increased averaging time; 11 sec. at 500 volts and 22 sec. at 250 volts. The simplified construction enables it to be repaired at a cost much below the cost of a new tube.

NL-1053 other ratings are the same as the conventional size D ignitron: 2400 kva maximum demand, 355 amperes dc maximum anode current per tube, and at any voltage between 250 and 600 volts rms at 25 to 60 cycles. Cooling water required is three gal. per min. at a minimum inlet temperature of 0°C.

● Miniature Interstage Transistor Transformer Item 739

Redesign of a miniature interstage transistor transformer has produced a new model $\frac{1}{3}$ smaller than the recent prototype, according to a national manufacturer of hearing aids and electronic devices.

Now measuring only $\frac{3}{8}$ " x $\frac{3}{8}$ " x $\frac{3}{8}$ ", the transformer has numerous industrial uses in audio amplifiers, hearing aids, control circuits and other transistorized circuitry. Units are packaged in a clear lucite box for easy identification, and each box contains an insert label giving complete specifications on the transformer.

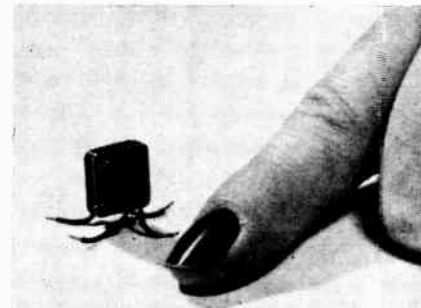

Only the No. 8901 Transistor Interstage model is available at the present time, but output and input models are available by special request. All three types are readily available in a fractionally larger size.

Impedance of the interstage primary is 20,000 ohms, and the secondary is 1,000 ohms. Frequency response is plus-or-minus 3 db from 150 to 15,000 cycles per second with .25 milliamperes (dc) in the primary. This transformer will handle up to .5 milliwatts.

(Turn to page 66)

CANADIAN BUILT 400 CYCLE ALTERNATORS

Incorporating the Latest Proven Techniques
Will Surpass Your Most Critical Requirements

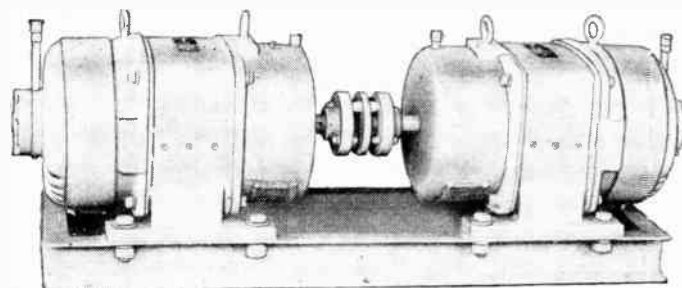

Field coils concentric with shaft provide ruggedness and minimum excitation requirements. Excellent wave form for the most exacting demand is as shown by this typical analysis.

Harmonic Analysis: 2.5 KVA, 400 Cycle Alternators

Harmonic	Line to Line		Line to Neutral	
	Output Volts	N.L.	Output Volts	N.L.
		Harmonic Millivolts		Harmonic Millivolts
1	208	—	120	—
3	208	—	120	3.85
5	208	1.4	120	.80
7	208	.8	120	.45
9	208	—	120	.53
11	208	4.4	120	2.50
13	208	.84	120	.47

Write For Full Details — Without Obligation Of Course

INDUSTRIAL ELECTRONICS OF CANADA, LTD.
83 TORBARRIE ROAD - TORONTO 15 - PHONE CH. 1-3501

NEW PRODUCTS

(Continued from page 65)

● Stoddart Current Probe

Item 740

A versatile new device for the accurate measurement of radio-frequency current and interference in conductors has been announced.

The 91129-1 Current Probe, illustrated, does not require direct connection to the conductor under measurement. It is a specially-designed radio-frequency current transformer of the inserted-primary type and has a nominal output impedance of 50 ohms. The probe consists of two semi-circular insulated windings on a hypersil core. These are hinged, and by opening the probe the conductors may be placed in its center. A locking arrangement holds the probe closed.

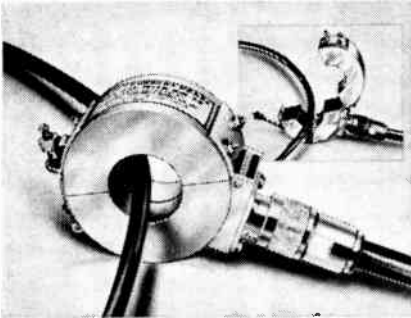

The probe is useable from 20 cps to 25 megacycles and is especially designed for use with the Stoddart NM-10A and NM-20B Radio Interference — Field Intensity Measuring equipments.

Interference measurements may be made on single and multi-conductor cables, on

ground and bonding straps, and on the external surfaces of shielding conduits and coaxial cables. Radio frequency currents, modulated or unmodulated, can also be measured by suitable operation of the NM-10A or NM-20B.

Any conductor or cable, up to one inch in diameter, in which the current is to be measured is simply placed in the probe to form the primary winding. The pickup sensitivity is unaffected by conductor location, orientation or straightness in the window, by power-voltage or frequency (within rating), by power-current magnitude or by the magnitude of the radio-interference or radio-frequency current or voltage in the primary. The probe completely rejects any external pickup from conductors not passing through the window.

● Linearizing Pyrometer Recorder For Servo Use

Item 741

A dynamaster thermocouple pyrometer can now be equipped with a linearizing cam which converts a non-linear thermocouple millivolt signal into a straight-line uniform form for recording and control, according to a recent announcement by the manufacturer.

The device converts a non-uniform analog into linear form suitable for feeding into a digital readout device. It should prove particularly valuable in processing problems requiring computer or servo system control.

Conversion is achieved through the use of a cam and linkage in the slidewire housing in the Dynamaster potentiometer. This cam positions the slidewire contact, depending on the millivolt response curve of the thermocouple involved.

With this mechanism, the rotation of the contactor shaft is linear with thermocouple temperature. The record and indication is also linear, and a uniformly graduated chart is used.

● Proved Answers To Successful Automation

Item 742

A new bulletin, "Proved Answers to Successful Automation" has been made available to industry.

The 20-page illustrated pamphlet contains specifications, descriptive data and operational charts of photoswitch photoelectric controls for numerous industrial uses including high-speed counting, inspection and sorting, smoke control, high-temperature measurement and control, machinery safeguards and conveyor control.

The bulletin points out that any job that depends on seeing and controlling the motion or position of objects . . . any operation that can be keyed to a change in the intensity of a beam of light . . . can be done efficiently, economically with photoswitch controls.

Use Coupon Page 79
To Obtain Further
Information

● Test Report On Counterpoise Relay

Item 743

A comprehensive 60 page report concerning the qualification tests of the Borg Counterpoise Relay to Military Specifications MIL-R 5757B has been published by the manufacturers of this unit and is available upon request to all interested parties. The relay is now being manufactured for use in guided missiles, aircraft, electronic computer systems and related applications.

(Turn to page 76)

DO WE HAVE YOUR ADDRESS CORRECT?

To the best of our ability, we spell your name right, use the correct address, and indicate your occupation.

Would you take a moment to check the address label? If it is wrong, mark it correctly, and return it to us. Not only will you, and the postman, appreciate the correct address label but also our auditor of circulation will appreciate it.

For we subscribe to an Audit by the Canadian Circulations Audit Board Inc. Once every year, they scrutinize our circulation books to prove, for our advertisers, where and to whom Electronics & Communications is being sent.

So, would you turn to the address label on the cover and check it for us. If wrong, please return it to:

ELECTRONICS & COMMUNICATIONS

31 Willcocks Street
Toronto 5, Canada



A member of Canadian Circulations Audit Board Inc.

FREED TYPE 1140-A



NULL DETECTOR AMPLIFIER USES

A sensitive null indicator for bridge measurements, providing visual null indications or aural when used in conjunction with headphones. The unit may also be used as a high gain amplifier for general laboratory work.

DESCRIPTION

Functionally the instrument consists of a high gain linear amplifier with a 30 db. input attenuator in addition to the variable gain control. A four-inch panel meter provides visual null indications, the response of the meter circuit is approximately logarithmic over a 40 db. voltage range. Resonant circuits tuned to 60, 400 and 1000 cycles limit the amplifier transmission characteristics to the three audio frequencies commonly used for bridge measurements or it may be used as a non-selective amplifier with filter "off."

SPECIFICATIONS

Input Impedance: 1 megohm in parallel with 25 mmf. GAIN: 98 db. with 1 megohm load (6 mmf. shunt capacity), down 1.5 db. at 25,000 cycles, down 5 db. at 50,000 cycles, down 2 db. at 20 cycles.
Null Detector Sensitivity: At 1 kc. 100 microvolts will give a 15% meter deflection.
Selective Amplifier: 26 db. second harmonic attenuation at 60, 400 and 1000 cycles.
Power Supply: 105-125 volts, 50-60 cycles, 35 watts consumption.
Dimensions: 13 1/2" x 8 1/2" x 10".

SEND FOR COMPLETE TRANSFORMER & INSTRUMENT CATALOGS

FREED TRANSFORMER CO., INC.

1716 Weirfield Street, Brooklyn (Ridgewood) 27, N.Y.

For further data on advertised products use page 79

NEW! Job-Tested!

Actual size

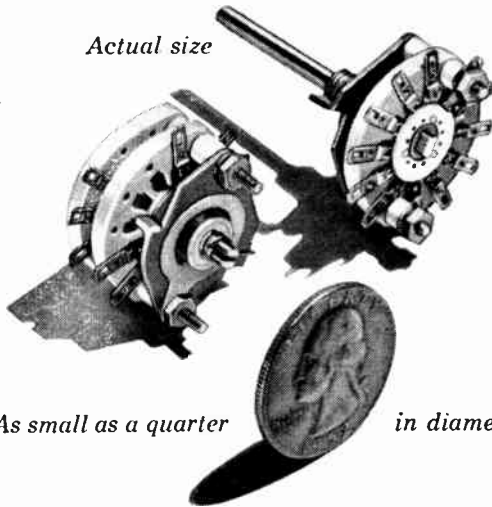

As small as a quarter in diameter

Want further facts?
Write for detailed engineering
bulletin EP-SW-1.

Centralab Series 100 Sub-Miniature Switch

The only one of its kind

Extra Small! An ultra-miniature switch with the electrical rating of larger switches. Shaft-length up to 2½" from end of bushing—maximum of 3 sections per shaft.

Field-Tested! Already proven in day-to-day use on military applications.

Extra Strong! Sections are ceramic—Centralab Grade L-5 Steatite (the best!).

Extra Quality! Meets the corrosion-resistance requirements—and exceeds the insulation resistance—specified by MIL-S-3786.

Versatile! Available up to 12 positions. Make and break, resistance load, 1 ampere at 6 volts d c.; 150 milliamperes at 110 volts a. c.; current-carrying capacity, 5 amperes.

**More proof that
if it's a job
for electronic components,
it's a job for Centralab**

Centralab's
advanced engineering
continues to create
the prototypes
of the components
industry



Volume Controls



Capacitors



Switches

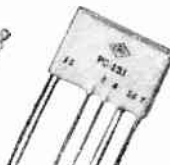

Printed
Electronic
Circuits



Ceramics

D-556



A DIVISION OF GLOBE-UNION INC.

964H E. Keefe Avenue • Milwaukee 1, Wisconsin
In Canada: 804 Mt. Pleasant Road, Toronto, Ontario

SINCE 1922, INDUSTRY'S GREATEST SOURCE OF STANDARD AND SPECIAL ELECTRONIC COMPONENTS

ELECTRONICS & COMMUNICATIONS, JULY - AUGUST, 1955

World Radio History

For further data on advertised products use page 79

NEW THIS MONTH!
Electroni-Kwiz No.6

**Big, three-in-one
1st Prize!**

1. Osterizer Liquefier-Blender
2. Wall-type Can Opener
3. Ice Crusher

Wouldn't you like to win? You can try, simply by answering this question in 50 words, more or less:

What do you want to know about a new product—and how do you like to have the facts presented?

A leading editor will pick the winner of this month's major prize.

Mail your entry to us before August 30.

* Nothing to buy. Employees of Centralab and their advertising agency not eligible. Duplicate prize; awarded in case of tie. Entries become the property of Centralab — none can be returned.



**I'm DALOHM...
miniature but mighty!**

You can depend on



**TYPE RSE RUGGEDIZED
MINIATURE
POWER RESISTORS**

Designed for trouble-free performance under the most exacting conditions of shock and vibration. Completely welded from terminal to terminal, sealed in silicone and housed in metal tubing. (Suggested mounting clip: Atlas E-E Corp.) Impervious to moisture, salt ions, vapor and gases.

**Three wattage ranges: RSE-2, 2 watts;
RSE-5, 5 watts; RSE-10, 10 watts.**

- Temperature coefficient 0.00002/Deg. C
- Ranges from 0.1 ohm to 55,000 ohms depending on type
- Tolerances 0.05%, 0.1%, 0.25%, 0.5%, 1%, 3%, 5%

Conform to Applicable JAN and MIL Specifications

WRITE FOR BULLETIN No. R-25
DALE PRODUCTS, Inc.
28th AVE., PHONE 1322
COLUMBUS, NEBRASKA, U.S.A.



LONG RANGE RADIO

(Continued from page 64)

bility is maintained in the variable oscillator because of the phase lock. Appropriate exciter and local oscillator frequencies are then derived from the variable oscillator by multiplication.

The transmission loss in an ionospheric scatter link cannot be simply expressed as a function of distance. It is always large except for the strong signals known as "bursts" and ascribed to the ionized trails of the larger meteors. Provision must be made for this large transmission loss by the use of high-gain antennas, high-power transmitters, and a restriction of modulation bandwidth. With suitable antennas and terminal equipment, such a link has been found to give reliable frequency-shift-keyed printing telegraph signals, with eight or more channels, as well as good single-side-band voice signals, with one or more channels. It is doubtful that consistently good signal-to-noise ratio can be maintained with wideband forms of modulation.

Since frequencies in the range of about 30 to 50 mc must be employed in this case, long-wire or array antennas are generally used, with the height chosen so as to yield the optimum vertical lobe angle. An antenna gain on the order of 20 db relative to a dipole has been found to be readily obtainable.

Because of the lower frequency involved, a transmitter power of 20 to 50 kw is practical. Provision has also been made for operation of two such transmitters into a single antenna with a 40 kw rating.

As in tropospheric scattering, a fading signal is encountered and space diversity reception is normally employed. Since in both cases the antennas may be large and costly, it has been considered desirable to employ only two antennas at each terminal and to duplex one of these antennas for simultaneous transmission and reception. This, however, requires that the transmitting and receiving frequencies be assigned 3 to 10 per cent apart depending upon frequency and transmitter power level. A closer spacing would require the use of impractical duplexing filters.

Operational Results

In the reception of scatter signals, a rapid and rather severe fluctuation in level is normally encountered. This fading may be ascribed to multipath propagation. An effective AGC system is required in the receiver to counteract such fading. In addition to the fast fading, there is also a slow variation caused by changes in the average gradient of the refractive index of the troposphere or ionosphere. In presenting values of transmission loss, received power, or signal-to-noise ratio for a radio circuit of this type, it is

24-CHANNEL PULSE-POSITION-MULTIPLEX RADIO SYSTEM OF ADVANCED DESIGN

This equipment provides 24 broad-band telephone channels in the frequency range 2450 to 2700 mc. with toll-grade transmission performance over very long systems. Full provision is made for branching, dropping and inserting channels, and elaborate fault-reporting and automatic changeover features are available. Transmitter has 5 watts average output power. Antennas, transmission line, 4-wire terminating, ringing and dialling sets and test equipment are available to form complete packaged systems of superb performance, reliability and quality.

A similar system is produced for the frequency band 235 to 328 mc.

Type PPM24/2500 Radio Bay is 22" wide by 18" deep by 64" high. The 24-channel multiplex bay has the same dimensions.

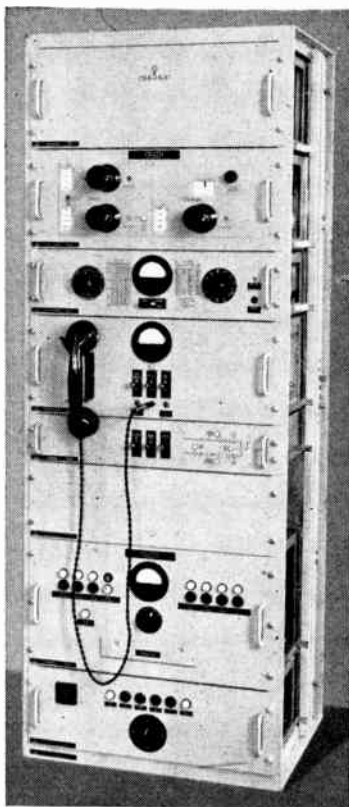

RADIO ENGINEERING PRODUCTS

1080 UNIVERSITY STREET, MONTREAL 3, CANADA

Telephone: University 6-6887

Cable Address: Radenpro, Montreal

MANUFACTURERS OF CARRIER-TELEGRAPH, CARRIER-TELEPHONE AND BROAD-BAND RADIO SYSTEMS

For further data on advertised products use page 79

customary to give the median level, i.e., the level which is exceeded 50 per cent of the time over a long period such as a year. Measurements have indicated that the tropospheric signal fades 24 db or more below the median level for one per cent of the time without diversity, and 16 db or more with dual diversity reception. A similar relation holds for ionospheric scatter propagation.

It should be emphasized that the interference capabilities of scatter signals can be made very small. The scattering is classified as forward scattering, and the power drops rapidly as the angle between the scattered ray and the incident ray increases. Measurements have indicated that narrow antenna beam angles are reasonably well maintained, so that reception of the signal at points well off the beam cannot occur unless the antenna has secondary lobes of objectionable amplitude. With proper design of high-gain antennas, the side-lobe level may be kept 25 to 30 db below the level of the main lobe. Because of the narrow beams and the smaller number of transmitters involved, a scatter propagation system should have lower interference capabilities than a multi-station, low-power relay chain. The principle causes of unusually strong signals at long ranges are tropospheric ducts, which may occur occasionally during the summer season, and such ionospheric effects as sporadic E propagation and F layer propagation which may occur infrequently in the lower VHF range.

It is well-known that the multipath propagation occurring on regular ionospheric links may cause severe distortion of voice signals. This is not the case with scattered signals. The relative time delays are so short that high-fidelity transmission is obtainable with very broad modulation bandwidths. In fact, television relaying by tropospheric scatter appears entirely feasible.

The approximate values of fading margin and circuit reliability for variable distance and various numbers of channels* are indicated for VHF propagation in Figure 4 and for UHF propagation in Figure 5. In the former, we have assumed single-sideband suppressed-carrier modulation, with a transmitter power of 40 kw, and with antennas each of which has a gain of 20 db relative to a dipole. The fading margin is the excess of the median received power over the power which is 20 db above the receiver noise level in the intelligence bandwidth. In Figure 5, we have assumed narrow-band frequency modulation, a frequency of 1000 mc, a transmitter power of 1 kw, and a 28-foot antenna at each terminal. In this case, the fading margin is the excess of the median received power over the power which is 19 db above the receiver noise level in the intelligence bandwidth. It should be noted that a circuit with a fading margin of 16 db has a reliability

of 99 per cent with dual diversity reception.

In summary, we note that scatter propagation opens up a vast region of the radio spectrum for communication far beyond the horizon. A properly designed system requires no frequency changes to maintain continuous communication, and the quality and reliability are comparable

* The predicted wave teletype system mentioned in Figure 8 is a Collins development in which the receiving equipment operates synchronously with the transmitting equipment, so that maximum advantage is taken of the predicted features of the received signal. In one form of this equipment, an improvement in signal-to noise ratio of about 8 db over standard frequency shift keying is realized.

with those of wire-line circuits. The narrow antenna beams and the wide spacing of terminals reduce interference capabilities and in many cases may lead to lower installation and maintenance costs than the more conventional low-power relay system.

WATCH
For The Sept. - Oct.
Directory Issue
of
**ELECTRONICS &
COMMUNICATIONS**



HIGH TEMPERATURE ACCELEROMETERS

for

2200° F. Temperature
Operation

**ENDEVCO MODEL
2205**

— Further Data Concerning Accelerometers
and Pickups available upon request —

DYNAMIC PRESSURE PICKUP

2200° F. Temperature
Operation

**ENDEVCO MODEL
2502**

Produced By

ENDEVCO CORPORATION
Pasadena, California

— EXCLUSIVE CANADIAN REPRESENTATIVES —



Computing DEVICES
OF CANADA LIMITED

311 Richmond Road — Ottawa, Ontario

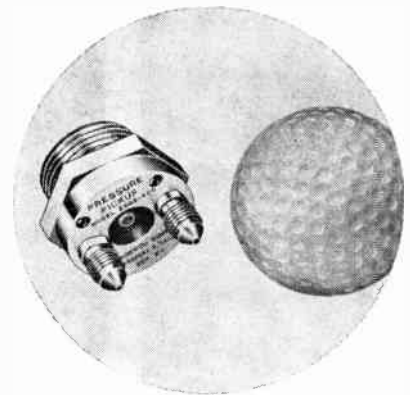

NEWS

(Continued from page 57)

Retirement Of Prominent Communications Pioneer

Arthur Salkeld Runciman, engineering consultant for Shawinigan Water and Power Company on transmission and communication problems, retires on September 1st after a long career in communications. He is one of the pioneers in the field of communications as affecting public utilities.



A. S. RUNCIMAN

In his capacity as first Chairman of the Canadian Electrical Communications Division, Mr. Runciman brought together the utilities of Eastern Canada and formed a body now regarded as the authority on communications ideas and co-ordination for the industry.

Mr. Runciman has acted on a number of Radio Technical Planning Board and for the International Electric Technical Commission. He is a member of The Engineering Institute of Canada, the American Institute of Electrical Engineers and the Canadian Electrical Association.

QUALITY HERMETICS OFFICIALS



G. R. MORELLO

M. N. GLICKMAN

H. LAEVSKY

Canada Gets First Plant For Exclusive Manufacture Of Hermetic Seals

A plant to manufacture various types of hermetic glass-metal seals in Canada is being set up at 45 Hollinger Road in East York, Toronto, Ontario. Quality Hermetics Limited is the first plant of its kind in Canada designed exclusively to supply hermetic seals of all types to Canadian manufacturers.

Mr. M. N. Glickman, President of Quality Hermetics Limited, has been the pioneer and founder of the hermetic seal industry of the United States, and as former president of Hermetic Seal Products Co., has been directly responsible for the development and engineering production of new designs, and for much of the growth of new industries that have sprung up around hermetic seals.

Mr. G. R. Morello, Sales Manager and Vice-President has been associated with the Canadian hermetic seal requirements for the past few years, and is well qualified to assist Canadian manufacturers with their design problems.

Mr. H. Laevsky, Plant Manager and Vice-President, brings to Canada a direct experience and know-how of hermetic seal manufacture. As former plant manager of Hermetic Seal Products Co. P.R., he was responsible for the manufacture and quality of many thousands of parts imported into Canada from the United States.

The scope of Quality Hermetics Limited will be unlimited as far as hermetic seal engineering and know-how is concerned and the company will bring to Canada what is best and new in the United States.

(Turn to page 72)

Micro the "Floating Drive"

Turntable

Suggested Price

\$65.45

Federal Sales and Excise Tax Inc.



A new concept in turntable engineering — a unique "Floating Drive" system isolated in rubber provides complete decoupling between motor, base and turntable both acoustically and mechanically. Exclusive MICRO shift enables instant selection of 3 speeds while turntable is operating, without damage to drive mechanism. The idler wheel of specially-formulated neoprene rubber eliminates wow and rumble, automatically disengages to prevent flat spots. Phenolic composition drive pulley, integrated to motor shaft, eliminates flutter. Heavy 4½ lb. precision aluminum 12" turntable, with ribbed rubber mat and line cord, brings flawlessly smooth performance. Superb craftsmanship.

WRITE FOR DETAILS AND BULLETIN ON COMPLETE MICROLAB LINE.

MICROLAB DEVICES LTD. 1195 LAWRENCE AVE. WEST, TORONTO, CANADA

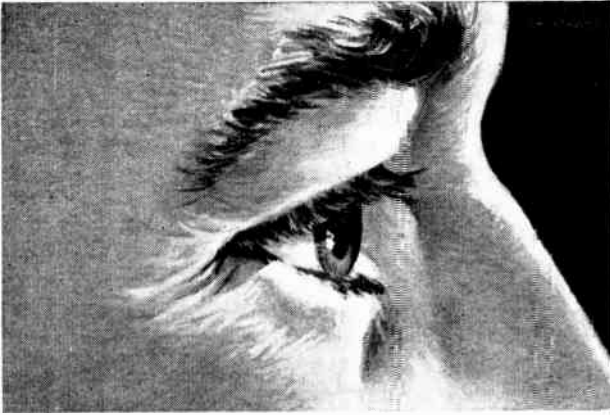

with an eye to economy
buy **AUTOMATIC ELECTRIC**
substation protectors

TYPE 18
OUTDOOR SUBSTATION PROTECTOR

"Dollar-Saver" Discharge Blocks

Self-grounding, self-restoring, rarely need replacement. Save costly trips after storms.

RUSTPROOF COVER

Solid aluminum. Keeps trouble-causing dust, rain and other moisture out.

SPEEDY MOUNTING BRACKET

Just two screws fasten protector to wall. Terminals easy to reach.

LONG-LIFE BASE

Heavy porcelain. Stands hard service. Helps ensure long service life.

Cat. No.	Dimensions	Fuses	Shipping Wt.
SB-18	2 3/4" x 2 3/4" x 7 1/2"	7 ampere	2 1/4 lbs.

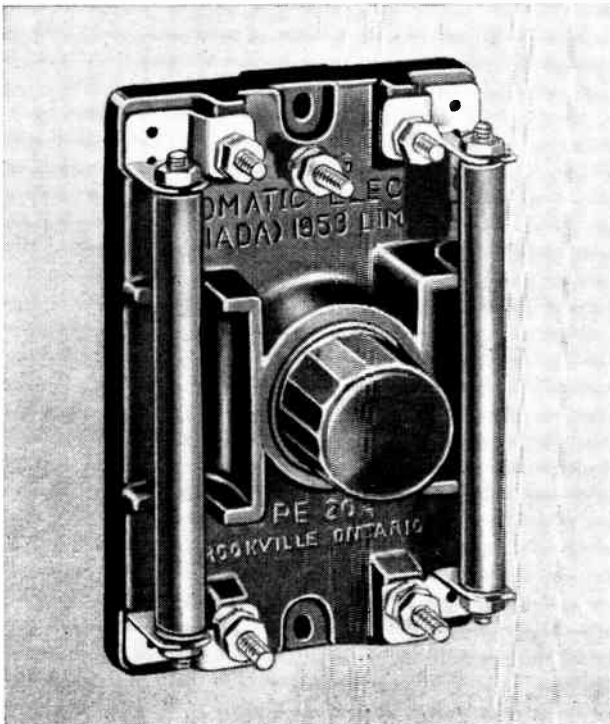
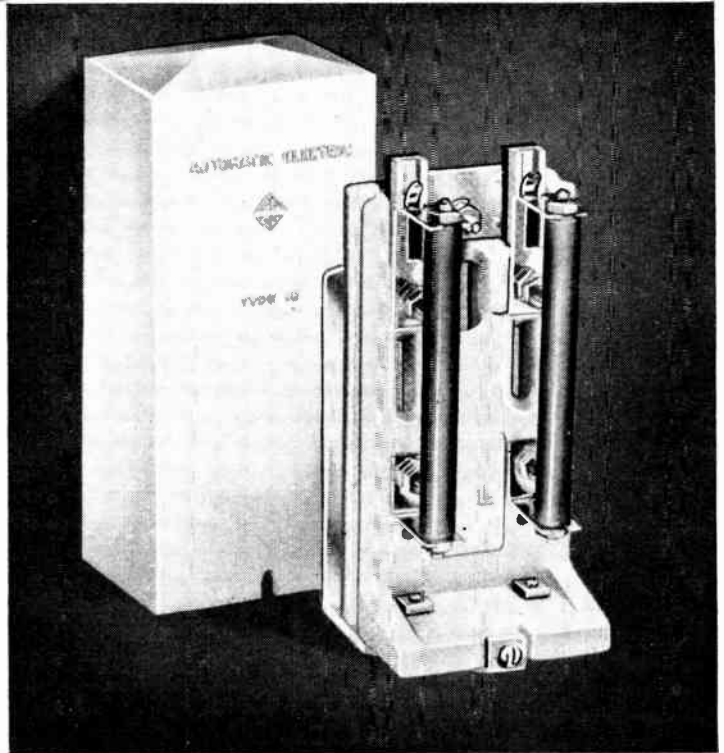

TYPES 20 AND 20A

Indoor and Outdoor Substation Protectors

Type 20A for indoor service illustrated. Equipped with "Dollar-Saver" discharge blocks, protected from dust and moisture by plastic cover. Heavy one-piece base with ample spacing between terminals and heavy walls between discharge blocks and fuses.

Type 20 for outdoor use furnished with heavy gauge metal base plate and cover, hot-dip galvanized for protection against rust and weather.

Cat. No.	Type	Dimensions	Fuses	Shipping Wt.
SB-91	20 (Outdoor)	5 1/2" x 3 1/4" x 8"	7 amp.	4 3/4 lbs.
SB-88	20A (Indoor)	3 1/2" x 2 3/4" x 5 1/2"	7 amp.	1 3/4 lbs.

Ask for Catalogue 4068-B, covering the complete line of AUTOMATIC ELECTRIC Protective Equipment.

553

AUTOMATIC ELECTRIC
(CANADA) LIMITED

Distributor in Canada
AUTOMATIC ELECTRIC SALES (CANADA) LIMITED

Head Office: 185 Bartley Drive, Toronto 16
MONTREAL • OTTAWA • BROCKVILLE • HAMILTON • WINNIPEG • REGINA • EDMONTON • VANCOUVER

NEWS

(Continued from page 70)

MJS Electronics Canadian Repts For Filtors Incorporated

Filtors, Inc. of Port Washington and New York . . . manufacturers of sub-miniature relays announce the appointment of MJS Electronic Sales, Ajax, Ontario as their Canadian representatives.

Filtors, Inc., is a major supplier of subminiature 6-pole and 4-pole relays, as well as other electronic parts for leading manufacturers of Avionic and Electronic Equipment.

Filtron Adds Three Engineering Repts.

The appointment of three sales-engineering representatives for territories in the Midwest and in the eastern part of Canada was announced by the Filtron Company, Inc., manufacturers of electronic components. The new sales staff will consult with manufacturers on the application of radio-frequency interference filters, as well as delay lines, pulse forming networks and capacitors.

Representing Filtron in Eastern Canada is R-O-R Associates Limited, of 290 Lawrence Ave. West, Toronto, Ontario, and 4650 Clanranald Ave., Montreal.

John W. Fenton To Manage RCA's New Renfrew Plant

The appointment of John W. Fenton as Manager of the RCA Victor television and radio components plant now under construction at Renfrew, Ont., is announced by F. R. Deakins, President, RCA Victor Company, Ltd.



J. W. FENTON

Formerly in charge of the company's home instruments components department, Montreal, Mr. Fenton is currently engaged in training personnel for the new plant. In temporary quarters at Renfrew, production of components of television receivers has already begun.

W. Evan-Jones Appointed To Westinghouse Post

W. Evan-Jones is now responsible for the sale of mobile radio equipment at the Canadian Westinghouse Company's Electronics Division. Formerly Ontario supervisor of broadcast and mobile radio at Canadian Marconi, Mr. Jones will now make his headquarters at Hamilton, Ontario.

Canadian Marconi Announce Sales Staff Changes

Tom P. Kelly has been appointed Assistant Sales Manager in the Broadcast and Television Receiver Division of Canadian Marconi Company it has been announced by L. M. "Bud" Daley, National Sales Manager of the Division, (Marconi Products).



T. P. KELLY



G. LEWINGDON

Mr. Kelly joined the company as a sales representative in Toronto in 1948. Four years later, he was named Supervisor of Jobber Sales in Montreal, and two years later he returned to Toronto as Ontario Sales Manager.

He is being replaced in that post by George Lewingdon, who joined Marconi as a sales representative in Toronto last year.

(Turn to page 85)

CESCO INDUSTRIAL ELECTRONICS H.Q.



BRANCHES:

MONTREAL
OTTAWA
TORONTO
EDMONTON

GEIGER COUNTERS

CESCO, headquarters for all Electronic components now are distributors for

PRECISION RADIATION INSTRUMENTS GEIGER COUNTERS & SCINTILLATORS

A complete range of instruments for all uranium prospecting needs. Write today for complete FREE information and literature.

One source of supply for all of your electronic requirements. CESCO has complete stocks on hand at all times. Prompt replies to your tenders.

Wholesale Industrial Electronic Components

CANADIAN ELECTRICAL SUPPLY CO. Ltd.

MONTREAL 275 Craig St. W. UN. 1-2411*
OTTAWA 836 Somerset St. W. 8-5675*
TORONTO 522 Yonge St. WA. 1-5111*
EDMONTON 9923 101A Ave. 41224-41321

Specify Cannon K Connectors!

All-Purpose • Versatile • Stable Design

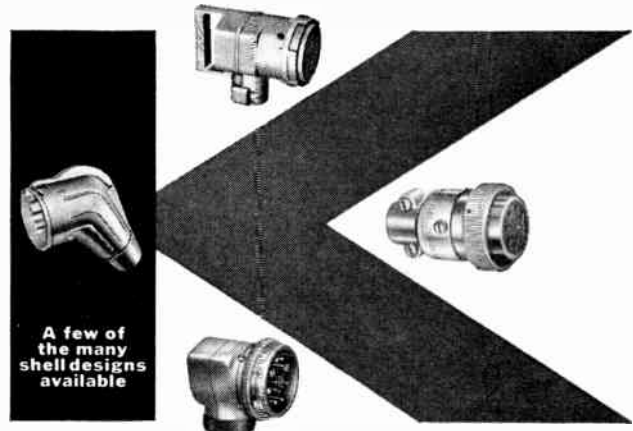

A few of
the many
shell designs
available

You'll find—

- Special Acme thread for rapid disconnect
- Improved insulating materials
- 10 to 200 amp. contacts
- Thermocouple contacts
- Integral clamps
- Miniatures
- Hermetic sealed units
- High temperature types
- Widest variety of circuitry
- Complete line of fittings and accessories
- Shielded single and twin co-axial contacts

Popular groups
of K units are
available near
you from many
Cannon distributors

CANNON PLUGS



CANNON ELECTRIC CANADA LIMITED, 160 Bartley Drive, Toronto 16, Ontario.
Montreal Office—Trans-Atlantic Bldg., Montreal Airport, Dorval, P.Q.

5503

For further data on advertised products use page 79

R-THETA

(Continued from page 22)

Calculations in the R-Theta Computer are performed automatically, entirely independent of radio transmissions. Distance and bearing of an alternate base can be set into the device by turning two knobs and depressing a switch, whereupon distance is indicated on a counter in the face of the instrument, and direction is shown by a double arrow. A single arrow in the display panel indicates the aircraft's track over the ground. When the pilot turns until he brings the single arrow over the double one he is flying toward his destination. Should the pilot wish to return to base, all he need do is lift a small lever marked "vector-add", and the double arrow swings around to the direction of the base from him.

One of the most interesting features of the instrument is what is referred to as its "memory", which remembers the aircraft's heading and speed during the time the navigator is adding or subtracting vectors.

The name "R-Theta" is derived from W/C Wright's concept of reporting position by distance and bearing rather than "Cartesian" co-ordinates (named after Rene Descartes, a French mathematician and philosopher of the 17th century). The new concept required plotting position in polar co-ordinates. This can be illustrated by a man standing on a plank and flying a model aircraft on the end of a string. The man represents the Pole. The position of the aircraft at any time during its flight can be expressed by the length of the string (the radius, "R"), and the angle between the string and the plant (direction) as the angle Theta. A computer indicating position and R and Theta co-ordinates was naturally called an R-Theta computer.

FIRE SAFETY

(Continued from page 34)

The new aircraft fire detection systems are designed to operate on 115 volts ac, 400 cycles. Requiring no flame contact or temperature increase, the equipment responds the instant it "sees" the radiant energy from the smallest of fires. This can be within micro-seconds of start of combustion. Maximum efficiency of coverage is obtained by an absolute minimum number of detectors, in most cases, only one or two per zone.

Effective positioning of the detectors is not the critical problem it has been in the past; the engineer charged with the design of the installation no longer must attempt to out-guess the fire, a three-dimensional phenomena, with equipment having one-dimensional characteristics.

(Turn to page 74)

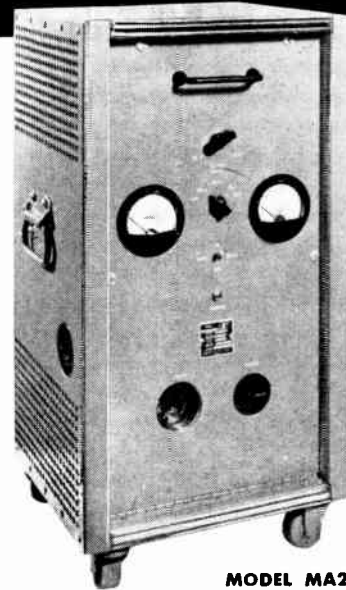

MODEL MA2850

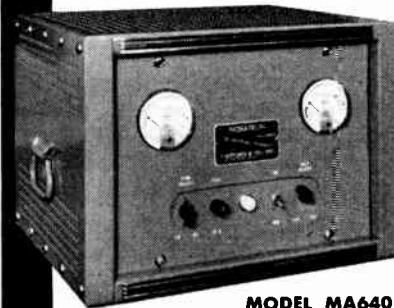

MODEL MA640



MODEL MA65

RUGGED • ACCURATE • TUBELESS

MAGNETIC AMPLIFIER DC SOURCES

(MA-NOBATRONS*)

Sorensen MA-NOBATRONS* have been designed for industrial applications and unattended installations where the utmost in maintenance-free service is required.

S P E C I F I C A T I O N S

	MODEL MA65	MODEL MA 640	MODEL MA 2850
INPUT	105-125VAC, 1Ø, 60 cycles		190-230VAC, 3Ø, 60 cycles 4-wire wye.
OUTPUT	6VDC, adj. ±10%	4.5-7.7VDC, adj.	23-32VDC, adj.
LOAD RANGE	0-5 amperes	0-40 amperes	0-50 amperes
REGULATION	±1.0% for any combination of line and load conditions		
RECOVERY TIME	0.15 seconds under worst conditions	0.2 seconds under worst conditions	0.5 seconds under worst conditions

Contact your local Sorensen representative, or write for further information. If you have special requirements in magnetic amplifier DC sources, write or call the Applications Engineering Department, and your problem will receive prompt attention.

Canadian Representative

CHARLES W. POINTON LTD., 6 Alcina Avenue, Toronto, Ont.

*Reg. U.S. Pat. Off.

CONTROLLED POWER FOR



S O R E N S E N

RESEARCH AND INDUSTRY

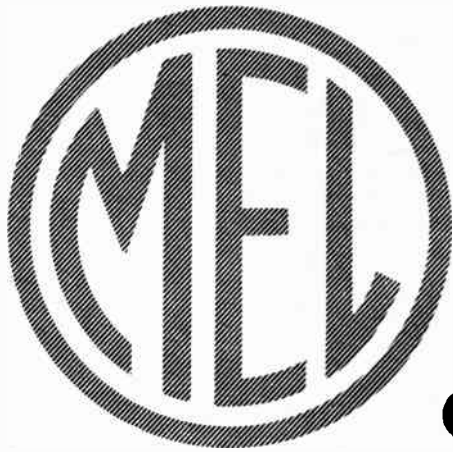

- ① IDEAS
- ② SKILL
- ③ KNOW-HOW
- ④ FACILITIES
- ⑤ EXPERIENCE

MEASUREMENT ENGINEERING LIMITED

Has All Five

Here at Measurement Engineering you will always find an "It can be done attitude". You will find the skill and manufacturing facilities to take care of your needs, large or small, plus special experience in filling the distinctive needs of the Canadian market.

•

INVITE US TO HELP YOU WITH YOUR PROBLEMS
OR REQUIREMENTS ON

MAGNETIC AMPLIFIERS - TOROIDS - FILTERS
RADIOTELEPHONES - AMPLIFIERS
FACTORY INSTRUMENTATION

•

Ask for our new *PRODUCT INDEX . . .*
A complete listing of products we can supply

We are also specialists in Aluminum, Brass and Steel Fabrication.

MEASUREMENT ENGINEERING LIMITED

Field research engineers and equipment specialists
in every phase of Electronics and Communications.

ARNPRIOR, ONTARIO

FIRE SAFETY

(Continued from page 73)

The new system has a fast reset. Requiring no heat dissipation, it provides instantaneous fire-out indication.

Installations can provide excellent coverage, regardless of the operating temperature. Detectors rated for as high as 400° F. are available, and efficient coverage of higher temperature zones may be effectively obtained by locating the detectors in adjacent cooler zones and monitoring through small quartz windows. This is possible since the equipment need only "see" the fire, not feel it.

The installations, because of the small number of detectors required, take a minimum of space.

The sturdy, potted construction of the detectors makes them well suited to withstand the exacting conditions of power plant operation and maintenance, company engineers claim. The minimum detector requirement, coupled with the flexibility of their location, still further decreases the possibility of damage. The detectors have accumulated thousands of hours of flight time without failure or false alarm under the most severe conditions of vibration to be encountered in today's airplanes.

AUTOMATION

(Continued from page 37)

president is likely to find that present applications of automation are best exemplified in the office, in the data handling aspects of today's industry. Here we have a new way of processing and presenting information rapidly. The problem is one of material handling, not merely a new way to sort the same number of papers or cards.

Here again it must be understood that the president cannot simply buy a computer, irrespective of its cost, and merely have the salesman plug it in. An elaborate study becomes essential. The president will wisely turn to the operations research or systems analysis approach previously mentioned, in order to fit the computer, irrespective of size or cost, into the problem being solved.

The president should also think of automation as not being merely a method of reducing costs, but also for improving quality and uniformity.

In reviewing what has been written so far, it will be realized that since the start of the industrial revolution there have been eight steps forward taken by industry. Today we are in a position where the ninth step is possible and will be taken.

This step, this ninth step, is the creation and complete exploitation of the basic concept of systems thinking, systems planning, and systems engineering. It is only through taking

(Continued on page 75)

— MADE IN CANADA —

VARIABLE RESISTORS

**2 WATT
COMPOSITION TYPE**

**High Stability!
Sturdy! Dust-Proof!**



**APPROVED FOR
JAN-R-94 type RV-4**

+

**PRECISION ELECTRONIC
COMPONENTS LTD.**

50 WINGOLD., TORONTO, ONT.
RU. 1-6174

STARK

**ELECTRICAL AND
ELECTRONIC INSTRUMENTS**

METERS SWITCHBOARD TYPES

Flush and Surface Mounting.
Available in all commercial ranges.



PANEL TYPES
Round and Rectangular from 2" to 9". AC and DC.
Ammeters-Milliammeters- Microammeters-Voltmeters,
etc.

TEST INSTRUMENTS
For Electrical, Radio and Television applications.
Analyzers-Signal Generators-Tube Testers
Vacuum Tube Voltmeters, etc.

STARK ELECTRONIC INSTRUMENTS LIMITED

General Offices and Factory: AJAX, Ontario
Export Division: 276 West 43rd St., New York 36, N.Y., U.S.A.
Cables: STARKEK, New York

AUTOMATION

From preceding page

this step, the analysis of the total problem through the systems approach, that the full benefits of automation can be achieved in factory design, manufacturing process, or office detail.

The Social Aspect

Having reached this ninth step, the question confronts the president of the social impact of automation. The principal concern of labor leaders that automation will result in widespread unemployment and decrease in jobs, we do not believe is valid. Our belief is based on the same reasons which have existed when each step of the industrial revolution were taken toward achievement of mass production. Specifically, as production becomes more automatic, costs decline, jobs become upgraded, and employees must become better educated and trained. As a result, wages will be increased. With wages increasing and prices declining, the purchasing power of the nation will continue its steady rise as it has from the very beginning of American industry. Automation will, in fact, fall into step with the concept of an ever-expanding American economy.

All great technological changes have brought about changes in sociological and philosophical concepts. Fortunately, automation will not hit the country at one fell swoop. It will only be gradually introduced into our society. Its year by year effect will not be felt. But just the same over a long pull, great responsibility is now being placed on other segments of our society than business.

Look at it this way: Automation, first of all, releases the human operator from many mental jobs, upgrades everybody's responsibilities, physically, mentally and ethically. It elevates the human being to new stations in life, which, of course, is the historic pattern throughout the entire industrial revolution.

Automation is going to require more and better trained technical people, engineers, physicists, chemists, economists, mathematicians, people skilled in systems analysis and operations research. It may be that our young people will not be able to get this kind of training in just four years of college. In all educational institutions, there will be a heavy demand for improved teachers of science and engineering.

In all likelihood the work week will be reduced. There will be more time for leisure. The motivation for increased study will arise. More emphasis will be put on adult education. So, all along the line, as automation flowers, not only the opportunities but the responsibilities for all will be upgraded.

eliminates
RADIO and TV noise
and improves reception



Each Aerovox Filter is individually tested and is guaranteed to end radio and TV annoyance caused by H.P. motors, oil burners, refrigerators, electric shavers and other appliances.

TYPE IN-310
*Bracket mounted
unit with high
inductance.*



TYPE IN-240
*For use in the most serious
cases of radio interference.*



TYPE IN-270
*Inexpensive type
for slight
interference.*



TYPE IN-290
*Designed for local
interference of
variable
character but
strong intensity.*



TYPE ANL-37
*Indicates the correct type
of IN filter to use.*





Standardize with AEROVOX

AEROVOX CANADA LIMITED
HAMILTON, CANADA
*Manufacturers of fixed capacitors
for all radio, TV and electronic equipment. 5507*

western sales CHAS. L. THOMPSON LTD.,
VANCOUVER, B.C.
in U.S.A. AEROVOX CORPORATION,
NEW BEDFORD, MASS.

NEW PRODUCTS

(Continued from page 66)

● **Miniature Soldering Iron**

Item 744

This iron is designed primarily for sub-miniature work, but will do work of a heavier nature than that for which it is designed. There are several models, and several voltage ranges.

Oryx is used by 90 per cent of the instrument makers in Great Britain, and is in heavy demand by the electronic aircraft industry in Britain and the U.S.A.

Oryx finds its main uses in Midget Radio, Radio and TV manufacture and repair, Hearing Aid and Electronic Instrument Assemblies, Miniature Relays, Hair Spring Movements, R.F. Coils, Speech Coils, Electro-medical Work, The Electronic Aircraft Industry, and Model Construction.

● **Television Broadcast Filter Bulletin**

Item 745

A new two-color bulletin describing a television broadcast filter used for diplexing visual and aural signals from a TV transmitter into a single transmission line leading to a TV broadcast antenna has been announced.

The unit described is the Type DNTV-25 Single Line VHF High-Band Notch Diplexer.

The bulletin, No. 429, contains application features, electrical and mechanical specifications and complete installation information. Front and back view photos of the unit are included in the bulletin as well as a pictorial schematic of the diplexer.

The Type DNTV-25 is mounted on an adjustable unistrut frame suitable for floor, ceiling or wall mounting. It weighs 250 pounds and is 24" wide, 36" deep and 72" high.

● **New Mounting For Automatic Electric Series PTW Polar Relay**

Item 746

The Automatic Electric Type 202 Series PTW Polar Relay is a sensitive, quick-acting, compact polarized relay. It is designed for use in composite signalling equipment, teletypewriter repeater circuits, teletypewriter switching schemes and other similar applications.

The usefulness of this relay has been increased by the provision of a new base, as illustrated, which enables it to be mounted

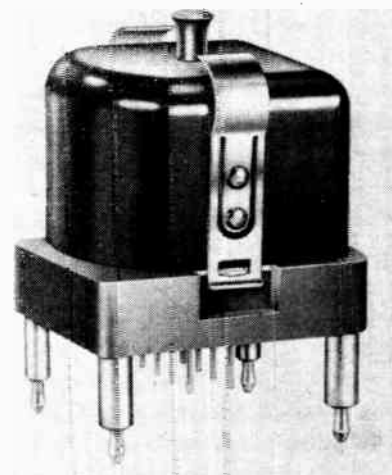

interchangeably with the Western Electric No. 255 Relay. Designated as the Type 203, the Series PTW Polar Relay with the new mounting is available with or without a matching socket, which is also illustrated. The cover, base, and plug housing are single black phenolic moldings that will not effect the magnet circuits they enclose. The snap-on cover is easily removed for visual inspection while the relay is still in use. The phenolic knob on the cover provides a simple means of lifting the entire relay out of its jack for bench inspection or routing. The Type 203 Series PTW Polar Relay extends only 3" (including knob) above the mounting surface.

● **Interference And Field Intensity Meter**

Item 747

The NM-10A Radio Interference and Field Intensity meter proves its ruggedness in being subjected to virtually complete immersion in water in accordance and with Navy specifications. The NM-10A covers a frequency range of 14 to 250 kilocycles. It is designed for lab or field use for field intensity measurements of carrier current systems, the signal level at points along the system, and for surveys of conducted or radiated interference.

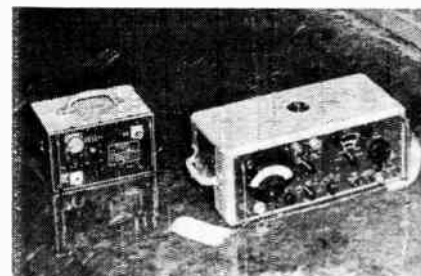

A complete selection of accessories is available, expanding its utility. The ac power supply permits operation from 105 to 125v or 210 to 250 v ac, 50 to 1600 cps. The NM-10A is identical to the Navy AN, URM-6B, a Class One Instrument, as shown in MIL-I-16910 (SHIPS).

FOCUS ON LEADERSHIP

'CATHODRAY'
HIGH VOLTAGE
PAPER CONDENSERS



The increasingly high voltages encountered in television receivers and allied equipment demand outstanding features in condenser design to ensure dependability and long service life.

The 'Visconol' process — exclusive to T.C.C. — gives maximum stability to the dielectric and enables it to withstand sharp-front, short-time surges. The leakage-path

between high and low potential terminals is the maximum possible and flash-over is virtually eliminated.

The fact that T.C.C. 'Visconol Cathodray' condensers are consistently used in leading equipments is indisputable proof that in every respect they are completely reliable under the most stringent conditions.

Max. Work'g Voltages (at 60°C.)	Cap. in μF.	T.C.C. Type No.	Max. Height above Chassis	Max. Diam.	Mounting Stud Diameter
2000	0.1	CP56X	2 1/2"	1 1/8"	O.B.A.
2500	1.0	CP59GO	6"	2 1/2"	3/8" Whit.
3000	0.025	CP56HO	2 1/2"	1 1/8"	O.B.A.
5000	0.1	CP57MO	5 1/2"	1 3/8"	3/8" Whit.
6000	0.001	CP55QO	2 1/2"	1 1/2"	2 B.A.
6000	0.01	CP56QO	2 1/2"	1 1/8"	O.B.A.
700L	0.1	CP58QO	5 1/2"	2"	3/8" Whit.
12500	0.0005	CP56VO	2 1/2"	1 1/8"	O.B.A.
12500	0.001	CP56VO	2 1/2"	1 1/8"	O.B.A.
15000	0.0005	CP56WO	2 1/2"	1 1/8"	O.B.A.
15000	0.001	CP56WO	2 1/2"	1 1/8"	O.B.A.
18000	0.002	CP57XO	5 1/2"	1 3/8"	3/8" Whit.
20000	0.001	CP56GOO	2 1/2"	1 1/8"	O.B.A.
25000	0.001	CP57HOO	5 1/2"	1 3/8"	3/8" Whit.
75000	0.0005	CP59ROO	6"	2 1/2"	3/8" Whit.

Details of complete range available on request.

THE GLENDON COMPANY, LTD.

44 WELLINGTON ST. EAST · TORONTO, ONT.

EMpire 6-5673



● Precision Subminiature Potentiometer

Item 748

A new series of subminiature precision potentiometers weighing only $\frac{1}{2}$ oz. and with a diameter of only $\frac{7}{8}$ " — just about the size of a penny. These potentiometers are designed to combine features a full-size potentiometers with substantial savings in both weight and space. They are excellent for use in computers, trimmers, guided missiles, portable and aircraft equipment.



Many of the advantages of full-size potentiometers, including multiple-finger contact brushes, gold connectors for trouble-free contacts and 320° electrical rotation are incorporated in this Series C-078. Housings are completed enclosed. Potentiometers can be ganged and independently phased. Despite their unusually small diameter, they are also available with special torque ratings, ball-bearings, sealed housings, special tolerances and other requirements for any linear or non-linear function.

● Sweep Drive For Oscillators

Item 749

This new system replaces point-by-point frequency analyses by using a mechanical hand which turns an oscillator dial back and forth. The Type 1750-A Sweep Drive is adjustable over a speed range from $\frac{1}{2}$ to 5 cycles per second. The sweep arc is independently adjustable from 30 to 300 degrees.

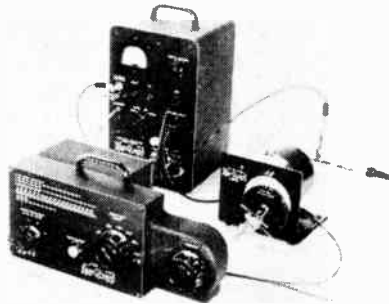

Flexible couplings are provided for attaching to knobs or shafts.

The Sweep Drive also provides a sweeping voltage, proportional to shaft angle, which is applied to the horizontal deflection plates of a cathode-ray oscilloscope. The output of the circuit under test supplies the vertical deflection voltage, and the frequency characteristic of a network can thus be displayed on the face of the oscilloscope.

Sweep-generator output voltage must be kept constant with frequency, and, for many oscillators, output regulation is necessary. The Type 1263-A Amplitude-Regulating Power Supply provides cathode and plate power for oscillators and adjusts the plate voltage to keep the oscillator output constant as the frequency is swept.

(Turn to page 84)

DEPEND ON

Bendix

Red Bank

RELIABLE ELECTRON TUBES



With electronic controls taking over more and more operational functions in military and industrial applications, it is becoming increasingly important that the electron tubes used be dependable under extremely severe conditions. This applies particularly to installations in aircraft where tubes must operate reliably at high altitudes, while subjected to continuous vibration, varying voltages and frequent shock. Because of their advanced design and construction . . . born of never-ceasing research and special production skills . . . Bendix Red Bank Reliable Electron Tubes have the dependability necessary to meet these severe operating conditions. You can depend on our long, specialized experience to give you the right answer . . . for all types of regular as well as special-purpose tube applications. Tubes can be supplied to both commercial and military specifications. Call on us for full details.

Manufacturers of Special-Purpose Electron Tubes, Inverters, Dynamotors, Voltage Regulators and Fractional D. C. Motors

DESIGNATION AND TYPE					TYPICAL OPERATING CONDITIONS		
Type	Proto-type	Bendix No.	Description	Base And Bulb	Heater Voltage	Plate Voltage Per Plate	M.A. Load
5838	6X5	TE-3	Full Wave Rectifier	Octal T-9	12.6	350.	70.
5839	6X5	TE-2	Full Wave Rectifier	Octal T-9	26.5	350.	70.
5852	6X5	TE-5	Full Wave Rectifier	Octal T-9	6.3	350.	70.
5993	6X4	TE-10	Full Wave Rectifier	9-Pin Miniature	6.3	350.	70.
6106	5Y3	TE-22	Full Wave Rectifier	Octal T-9	5.0	350.	100.

Type	Proto-type	Bendix No.	Description	Base And Bulb	Heater Voltage	Plate Voltage	Screen Voltage	Grid Voltage	Gm	Plate Current	Power Output
5992	6V6	TE-8	Beam Power Amplifier	Octal T-9	6.3	250.	250.	12.5	4000	45. MA	3.5 W
*6094	6AQ5 6005	TE-18	Beam Power Amplifier	9-Pin Miniature	6.3	250.	250.	12.5	4500	45. MA	3.5 W
6385	2C51 5670	TE-21	Double Triode	9-Pin Miniature	6.3	150.	—	—2.0	5000	8. MA	—

*Tube Manufactured with Hard (Nanex) Glass for High Temperature Operation (Max. Bulb Temp. 300°C.)

For additional data write to:
200 LAURENTIEN BLVD., MONTREAL

AE-54-12

AVIATION ELECTRIC

L I M I T E D

MONTREAL

VANCOUVER

SALES • SERVICE • MANUFACTURE • OVERHAUL of AIRCRAFT INSTRUMENTS & ACCESSORIES

AIRBORNE RECORDERS

(Continued from page 39)

the three basic recording techniques can be used. Approximately 45 channels of low frequency information can be recorded on each PWM track. One channel of transient information can be recorded on each FM channel. Direct recording channels are used for wide-range recording and for recording FM subcarriers in accordance with RDB standards. The electronics power supply provides necessary voltages to operate the record electronics.

Controlled by a Wien-bridge oscillator, the tape transport power supply furnishes the synchronous capstan motor with 60-cycle current.

Small enough to fit into the palm of a hand, the remote control unit can start and stop the tape, initiate recording and indicate the quantity of unused tape remaining at all times.

The five units required for seven channels of recorded information occupy a total of 2.3 cubic feet and weigh 88.5 pounds.

At a tape speed of 30 inches per second, frequency response of direct recording channels is ± 3 db from 300 to 35,000 cps and of FM channels, ± 1 db from 0 to 5,000 cps. PWM channels will accept pulse width from 60 to 1,000 microseconds with error of less than 4 microseconds.

Wow and flutter are below .1% rms. Average tape velocity is within .1% of the specified tape speed. Signal-to-noise ratio at 30 ips is 35 db below 1% distortion for direct recording channels and 40 db below the 1-volt level for FM tracks.

Power required to operate the unit is 400 cycle, 115-volt, AC, and 27.5-volt, DC.

LAMINATED PLASTICS

(Continued from page 28)

(various grades of paper, cotton, glass, nylon, or asbestos fabric) and consolidating a predetermined number of layers under heat and high pressure. During this process, a chemical reaction occurs which permanently changes the structure of the resin from a fusible and soluble state to a point where it becomes virtually infusible and insoluble. The fact that it cannot be re-softened by additional applications of heat differentiates "thermosetting" materials from "thermoplastic". Standard sheet size is 36" x 36" with thicknesses ranging from 0.005" up to and including 8". Sheet stock is used as panels, terminal boards, motor insulation, washers, wafers, tabs, etc. When bonded with a thin sheet of copper or aluminum, paperbase sheet

stock becomes the most widely used material in the design and production of printed circuits.

Tubing is produced by winding layers of impregnated material around a heated mandrel. The size of the mandrel establishes the inner diameter of the tube while the number of wraps determines the thickness. Diameters range from $\frac{3}{32}$ " inner diameter up to 26" outer diameter. Wall thicknesses vary from 0.0075" to 2". Tubes may be round, square, rectangular or oval and are universally used as insulators. They may be found in electronic equipment as spacers, washers, tube sockets, coil forms, etc.

Rods are produced in the same manner as tubes, except that the mandrel seldom exceeds $\frac{1}{4}$ " in diameter. After winding, the mandrel is pulled out and the tube is pressed in a mold to close up the center hole. Rods are used as mounting posts, spacers, etc.

Acknowledgment

Acknowledgment is extended to Mr. Jack Martin and Mr. Creighton Douglas of the Canadian Marconi Company for their assistance to Dr. Hill in the preparation of the article Technical Background Requirements For Maximum Broadcast Studio Efficiency which appeared in the May-June issue of ELECTRONICS AND COMMUNICATIONS.

The Editor:

RURAL COMMUNICATIONS

a vital link

TMC MAGNETO
TELEPHONE AND
SWITCHBOARD
EQUIPMENT
GIVES TWO-WAY
SATISFACTION

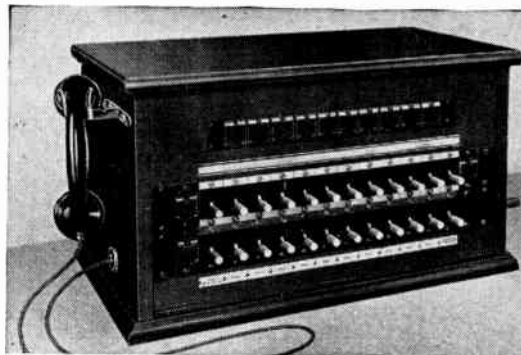

Cordless Switchboards, both C. B. and Magneto

Our Magneto Telephone Equipment is designed and built to operate at high efficiency in all climatic conditions for long periods without attention.

Maintenance is simple because all parts are easily accessible. Smart as well as rugged, the telephones have polished black moulded bakelite cases and combination handsets, with anti-side-tone circuits.

Magneto Switchboards, strongly constructed of seasoned hardwoods, having attractive modern designed cabinets are also available.

A full range of equipment is kept at our showrooms. We invite you to call or write for full details and technical data.

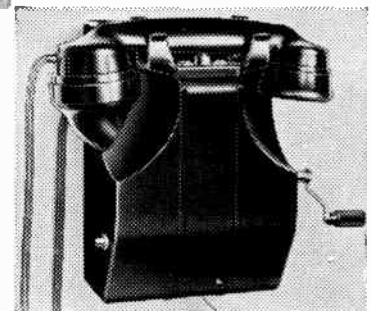

Magneto Wall Telephone



For further data on advertised products use page 79

READERS' SERVICE PAGE

We realize that our readers are busy people and may not always have time to write letters of enquiry to manufacturers regarding advertised products that are of interest to them. Therefore, to save you the time of writing a letter, we offer you the use of this Readers' Service Page. It is designed for your convenience in obtaining free and without obligation detailed information on any advertiser's product or New

Product appearing in this issue of *Electronics and Communications*.

Check as many New Products or Advertisements as you like on the attached coupons and send to *Electronics and Communications*, 31 Willcocks Street, Toronto 5, Ontario. We will see that detailed information concerning your enquiries is in your hands within a few days.

Check Advertiser's Name For Information

Advertiser	Page	Advertiser	Page
<input type="checkbox"/> Aeromotive Engineering electrical equipment components	82	<input type="checkbox"/> Federal Wire & Cable magnet wire	23
<input type="checkbox"/> Ampex interference filters	75	<input type="checkbox"/> Freed null detector amplifier	66
<input type="checkbox"/> Ampex monitoring and demonstration unit	47	<input type="checkbox"/> Glendon high voltage paper condensers	76
<input type="checkbox"/> Andrew antennas	18	<input type="checkbox"/> Heath electronic equipment kits	87-91
<input type="checkbox"/> Automatic Electric automatic telephone equipment	16-17	<input type="checkbox"/> Helipot helidelay line	83
<input type="checkbox"/> Automatic Electric substation protectors	71	<input type="checkbox"/> Hewlett-Packard industrial counter	81
<input type="checkbox"/> Aviation Electric autodyn synchros	94	<input type="checkbox"/> Industrial electronics 400 cycle alternators	65
<input type="checkbox"/> Bach-Simpson vacuum tube voltmeter	6	<input type="checkbox"/> Industrial electronics rectifier	8
<input type="checkbox"/> Bably Engineering test equipment	92	<input type="checkbox"/> Kaiser-Willys jeep	8
<input type="checkbox"/> Bendix electron tubes	77	<input type="checkbox"/> Kester solder	63
<input type="checkbox"/> Bendix Aviation vibration resistant electrical connectors	93	<input type="checkbox"/> Lenkurt filler assemblies	33
<input type="checkbox"/> Bohne springs	86	<input type="checkbox"/> Magnetic aluminum core box	35
<input type="checkbox"/> Bomac silicon mixer diodes	2	<input type="checkbox"/> Measurements Engineering	70
<input type="checkbox"/> Canada Wire & Cable radio frequency cables	85	<input type="checkbox"/> Micro turntable	74
<input type="checkbox"/> Canadian Aviation Electric electronic equipment	9	<input type="checkbox"/> Minnesota mining Scotch brand extra-play tape	36
<input type="checkbox"/> Canadian Electrical Supply Co. catalog	72	<input type="checkbox"/> Motorola microwave terminals	10
<input type="checkbox"/> Canadian General Electric electronic tubes	95	<input type="checkbox"/> National Fibre laminated plastic	38
<input type="checkbox"/> Canadian Marconi electronic tubes	3	<input type="checkbox"/> Nichols insulation tester	19
<input type="checkbox"/> Canadian Marconi photocell	59	<input type="checkbox"/> Northern Electric jack mounting panels	41
<input type="checkbox"/> Canadian Marconi universal bridge	84	<input type="checkbox"/> P.S.C. Applied Research engineering facilities	55
<input type="checkbox"/> Canadian Stackpole miniature controls	100	<input type="checkbox"/> Precision Electronic Components	75
<input type="checkbox"/> Canadian Westinghouse transmitters	97	<input type="checkbox"/> Pye closed circuit industrial television	60
<input type="checkbox"/> Cannon Electric K Connectors	72	<input type="checkbox"/> Quality Hermetics hermetic seals	15
<input type="checkbox"/> Central Bridge television and microwave transmission towers	14	<input type="checkbox"/> Radio Engineering Products 24-channel radio system	63
<input type="checkbox"/> Centralab sub-miniature switches	67	<input type="checkbox"/> Radio Engineering Products carrier telegraph system	88
<input type="checkbox"/> Clarostat controls and resistors	43	<input type="checkbox"/> Rogers Majestic electron tubes	50-51
<input type="checkbox"/> Collins microwave equipment	99	<input type="checkbox"/> Sanborn oscillographic recording systems	45
<input type="checkbox"/> Computing Devices high temperature accelerometers	69	<input type="checkbox"/> Sorensen magnetic amplifier D.C. sources	73
<input type="checkbox"/> Computing Devices transistorized radio	80	<input type="checkbox"/> Sperry Gyroscope Kollman motors	49
<input type="checkbox"/> Cossor oscilloscope	24	<input type="checkbox"/> Stark electrical and electronic instruments	75
<input type="checkbox"/> Dalohm miniature power resistors	68	<input type="checkbox"/> Strouger automatic telephone equipment	4
<input type="checkbox"/> Daven resistors	64	<input type="checkbox"/> Struthers-Dunn relays	12
<input type="checkbox"/> Daven wide range oscillators	7	<input type="checkbox"/> Tektronix oscilloscope	98
<input type="checkbox"/> De Jur-Ansco connectors	56	<input type="checkbox"/> Telephone Mfg. Co. rural communications equipment	78
<input type="checkbox"/> Eitel McCulloch ceramic radial-beam power tetrode	29	<input type="checkbox"/> X-Ray & Radium Industries precision silk screening	52
<input type="checkbox"/> Electro Sonic catalog	62		

Check New Product Item For Further Information

<input type="checkbox"/> 722	<input type="checkbox"/> 726	<input type="checkbox"/> 730	<input type="checkbox"/> 734	<input type="checkbox"/> 738	<input type="checkbox"/> 742	<input type="checkbox"/> 746	<input type="checkbox"/> 750
<input type="checkbox"/> 723	<input type="checkbox"/> 727	<input type="checkbox"/> 731	<input type="checkbox"/> 735	<input type="checkbox"/> 739	<input type="checkbox"/> 743	<input type="checkbox"/> 747	<input type="checkbox"/> 751
<input type="checkbox"/> 724	<input type="checkbox"/> 728	<input type="checkbox"/> 732	<input type="checkbox"/> 736	<input type="checkbox"/> 740	<input type="checkbox"/> 744	<input type="checkbox"/> 748	<input type="checkbox"/> 752
<input type="checkbox"/> 725	<input type="checkbox"/> 729	<input type="checkbox"/> 733	<input type="checkbox"/> 737	<input type="checkbox"/> 741	<input type="checkbox"/> 745	<input type="checkbox"/> 749	

Company Name _____
 Your Name _____
 Your Position _____
 Address _____

Check Advertiser's Name For Information

Advertiser	Page	Advertiser	Page
<input type="checkbox"/> Aeromotive Engineering electrical equipment components	82	<input type="checkbox"/> Federal Wire & Cable magnet wire	23
<input type="checkbox"/> Ampex interference filters	75	<input type="checkbox"/> Freed null detector amplifier	66
<input type="checkbox"/> Ampex monitoring and demonstration unit	47	<input type="checkbox"/> Glendon high voltage paper condensers	76
<input type="checkbox"/> Andrew antennas	18	<input type="checkbox"/> Heath electronic equipment kits	87-91
<input type="checkbox"/> Automatic Electric automatic telephone equipment	16-17	<input type="checkbox"/> Helipot helidelay line	83
<input type="checkbox"/> Automatic Electric substation protectors	71	<input type="checkbox"/> Hewlett-Packard industrial counter	81
<input type="checkbox"/> Aviation Electric autodyn synchros	94	<input type="checkbox"/> Industrial electronics 400 cycle alternators	65
<input type="checkbox"/> Bach-Simpson vacuum tube voltmeter	6	<input type="checkbox"/> Industrial electronics rectifier	8
<input type="checkbox"/> Bably Engineering test equipment	92	<input type="checkbox"/> Kaiser-Willys jeep	8
<input type="checkbox"/> Bendix electron tubes	77	<input type="checkbox"/> Kester solder	63
<input type="checkbox"/> Bendix Aviation vibration resistant electrical connectors	93	<input type="checkbox"/> Lenkurt filler assemblies	33
<input type="checkbox"/> Bohne springs	86	<input type="checkbox"/> Magnetic aluminum core box	35
<input type="checkbox"/> Bomac silicon mixer diodes	2	<input type="checkbox"/> Measurements Engineering	70
<input type="checkbox"/> Canada Wire & Cable radio frequency cables	85	<input type="checkbox"/> Micro turntable	74
<input type="checkbox"/> Canadian Aviation Electric electronic equipment	9	<input type="checkbox"/> Minnesota mining Scotch brand extra-play tape	36
<input type="checkbox"/> Canadian Electrical Supply Co. catalog	72	<input type="checkbox"/> Motorola microwave terminals	10
<input type="checkbox"/> Canadian General Electric electronic tubes	95	<input type="checkbox"/> National Fibre laminated plastic	38
<input type="checkbox"/> Canadian Marconi electronic tubes	3	<input type="checkbox"/> Nichols insulation tester	19
<input type="checkbox"/> Canadian Marconi photocell	59	<input type="checkbox"/> Northern Electric jack mounting panels	41
<input type="checkbox"/> Canadian Marconi universal bridge	84	<input type="checkbox"/> P.S.C. Applied Research engineering facilities	55
<input type="checkbox"/> Canadian Stackpole miniature controls	100	<input type="checkbox"/> Precision Electronic Components	75
<input type="checkbox"/> Canadian Westinghouse transmitters	97	<input type="checkbox"/> Pye closed circuit industrial television	60
<input type="checkbox"/> Cannon Electric K Connectors	72	<input type="checkbox"/> Quality Hermetics hermetic seals	15
<input type="checkbox"/> Central Bridge television and microwave transmission towers	14	<input type="checkbox"/> Radio Engineering Products 24-channel radio system	63
<input type="checkbox"/> Centralab sub-miniature switches	67	<input type="checkbox"/> Radio Engineering Products carrier telegraph system	88
<input type="checkbox"/> Clarostat controls and resistors	43	<input type="checkbox"/> Rogers Majestic electron tubes	50-51
<input type="checkbox"/> Collins microwave equipment	99	<input type="checkbox"/> Sanborn oscillographic recording systems	45
<input type="checkbox"/> Computing Devices high temperature accelerometers	69	<input type="checkbox"/> Sorensen magnetic amplifier D.C. sources	73
<input type="checkbox"/> Computing Devices transistorized radio	80	<input type="checkbox"/> Sperry Gyroscope Kollman motors	49
<input type="checkbox"/> Cossor oscilloscope	24	<input type="checkbox"/> Stark electrical and electronic instruments	75
<input type="checkbox"/> Dalohm miniature power resistors	68	<input type="checkbox"/> Strouger automatic telephone equipment	4
<input type="checkbox"/> Daven resistors	64	<input type="checkbox"/> Struthers-Dunn relays	12
<input type="checkbox"/> Daven wide range oscillators	7	<input type="checkbox"/> Tektronix oscilloscope	98
<input type="checkbox"/> De Jur-Ansco connectors	56	<input type="checkbox"/> Telephone Mfg. Co. rural communications equipment	78
<input type="checkbox"/> Eitel McCulloch ceramic radial-beam power tetrode	29	<input type="checkbox"/> X-Ray & Radium Industries precision silk screening	52
<input type="checkbox"/> Electro Sonic catalog	62		

Check New Product Item For Further Information

<input type="checkbox"/> 722	<input type="checkbox"/> 726	<input type="checkbox"/> 730	<input type="checkbox"/> 734	<input type="checkbox"/> 738	<input type="checkbox"/> 742	<input type="checkbox"/> 746	<input type="checkbox"/> 750
<input type="checkbox"/> 723	<input type="checkbox"/> 727	<input type="checkbox"/> 731	<input type="checkbox"/> 735	<input type="checkbox"/> 739	<input type="checkbox"/> 743	<input type="checkbox"/> 747	<input type="checkbox"/> 751
<input type="checkbox"/> 724	<input type="checkbox"/> 728	<input type="checkbox"/> 732	<input type="checkbox"/> 736	<input type="checkbox"/> 740	<input type="checkbox"/> 744	<input type="checkbox"/> 748	<input type="checkbox"/> 752
<input type="checkbox"/> 725	<input type="checkbox"/> 729	<input type="checkbox"/> 733	<input type="checkbox"/> 737	<input type="checkbox"/> 741	<input type="checkbox"/> 745	<input type="checkbox"/> 749	

Company Name _____
 Your Name _____
 Your Position _____
 Address _____

SPECTROMETER

(Continued from page 32)
means of qualitative identification of organic compounds. For example, methane (CH_4) will yield fragments with masses of 15 (CH_3), 14 (CH_2), 13 (CH); in addition, the unfragmented molecule (CH_4) will be represented with a mass of 16, as well as the pure components of hydrogen (mass of 2) and carbon (mass of 12).

For mixtures of substances, the resulting graph on the chart is a composite representation of all compounds present. This composite picture, through mathematical treatment, yields quantitative and qualitative data on the mixture.

In addition to its ability to analyze batch samples, this instrument can also be utilized as an integral part of a process stream to monitor or control a process. It can also be used as a leak detector.

In the infrared spectrophotometer, infrared light is generated by an infrared source known as a Nernst glower—a metallic oxide rod with high electrical resistance. An arrangement of mirrors in the housing breaks the light into two parallel beams which are reflected through two openings into a second section of the spectrophotometer known as the monochromator.

Into one of the openings in the

monochromator is placed an absorption cell containing a solution of the material to be analyzed and in the other opening is placed an identical cell containing a pure sample of the solvent used.

The cells are rock-salt plates separated by lead spacers of measured thickness. The thicknesses of the two cells must be carefully matched, for any variation would affect the amount of light absorbed. Concentrations of the material in the solvent are also carefully determined, for the percentage of the concentration also affects the absorption of light. This is in accordance with Beer's law.

After entering the monochromator through the two absorption cells, the parallel beams follow two paths to a rotating sector mirror which alternately reflects and transmits the two beams into a single optical system. The now single, alternating beam passes through an entrance slit and after passing through a rock-salt prism, impinges on a rotating Littrow mirror.

The prism breaks the beams into a spectrum from which the rest of the monochromator's optical system picks out light of one single wave length at any given instant. The position of the Littrow mirror is the governing factor in the wave length of the light passing to the rest of the optical system.

The single wave length is then focussed on a thermocouple, generating an electrical impulse which is amplified to actuate an electric motor. The motor drives an optical wedge into the reference beam.

The wedge controls the quantity of light that passes. When there is a difference in the intensity of the light in the two portions of the alternating beam, the wedge moves to compensate for the difference. The magnitude of this movement is transmitted to a graph. The X-axis of the graph gives the research technician data for qualitative analysis while the Y-axis translates into a quantitative analysis. The X-axis represents the wave length, the Y-axis the optical density or measure of absorbence.

For reference information for quantitative analysis, charts are usually prepared from synthetic mixtures of solutions of the pure materials being analyzed so that absorption characteristics can be established. For identification, or qualitative analysis purposes, libraries of reference spectra are available.

Analysis Of Complex Chemicals

Since no two compounds have the same spectrum, the infrared spectrophotometer provides a rapid, accurate means for analysis of complex chemicals.

To illustrate a typical laboratory problem, a jar of material may be received from the coal chemical department for analysis. This department wants to know how much the

... ANOTHER MILESTONE!



Tiny TRANSISTORIZED radio giant step in electronic growth!

Small enough to fit in your pocket, the world's first commercial transistor radio is a BIG milestone in Texas Instruments twenty-five years of planned growth. Pleasantly audible proof of TI's leadership in electronics, this superb little instrument gets better performance from a thimbleful of TI transistors than many larger sets get from a handful of vacuum tubes.

Transistors, scarcely larger than the buttons on your shirt, have already replaced vacuum tubes in many industrial and military applications. Until recently, the miraculous midgets have been too few and too expensive for use in reasonably priced consumer products. Now, unique transistor production techniques developed by Texas Instruments have made possible mass production of the revolutionary transistor radio . . . already on retail sale across the nation!

In many fields . . . petroleum instrumentation and geophysical exploration; electronic research, manufacture and supply; specialized military equipment . . . TI's 25-year success story is a continuing record of significant achievement.



COMPUTING DEVICES OF CANADA LIMITED

311 Richmond Road — Ottawa, Ontario

Exclusive Canadian Representatives

FOR — TEXAS INSTRUMENTS INCORPORATED

Dallas 9, Texas

sample contains of both anthracene and carbazole, two compounds used in the manufacture of dyes.

From a library of reference spectra, the patterns for anthracene and carbazole are established. Charts prepared from pure solutions of the two compounds gives absorption characteristics as a basis for computing degrees of concentration.

The sample of coal chemicals is then prepared and run through the spectrophotometer analysis. Any deviation from the established pattern prepared from pure materials is caused by interference from extraneous materials in the sample. Such deviations must be taken into account in interpretation of the final data.

Time involved from preparation of the sample to final answer is usually less than a half-hour.

Ultraviolet spectrometry is carried out in essentially this same way. The difference between ultraviolet and infrared spectrometry is, of course, that the range of light wavelengths used for ultraviolet work is considerably shorter (too short to be visible to the eye) than the wavelengths used in infrared work (too long to be seen with the eye). The source of ultraviolet light is a hydrogen discharge lamp. The optical parts are made of quartz (which transmits short wavelength light without undue losses), and the detector consists of a multiplier phototube.

The X-ray diffraction spectrometer aids in the analysis of unknown solid samples by providing information from which the analyst can determine the arrangement of atoms within the solid. Since no two known substances have exactly the same crystalline form (or atomic arrangement) this type of analysis can be used to identify the crystalline components in any sample. In practice this analysis is based on a measurement of the distances between planes of atoms in the crystalline solid.

The X-ray diffraction equipment consists of an X-ray generator, a spectrometer (spectro-goniometer), a Geiger counter tube and necessary electronic circuits. The spectrometer, the heart of the equipment, is used to support the sample and Geiger counter tube, and to permit an exact measurement of the angle between the Geiger tube and the X-ray beam which is incident on the sample. The Geiger counter and electronic circuits measure the intensity of the X-rays "reflected" by the sample at all angles between 0 and 165 degrees.

Chemical Fingerprints

The sample used in this analysis may be either a powder or bulk solid. The sample is placed in the spectrometer and the Geiger tube rotated through the complete range of angles. X-rays are "reflected" from planes of atoms, giving sharp peaks at certain specific angles. These angles and the (Turn to page 82)

New, low cost, versatile

INDUSTRIAL COUNTER

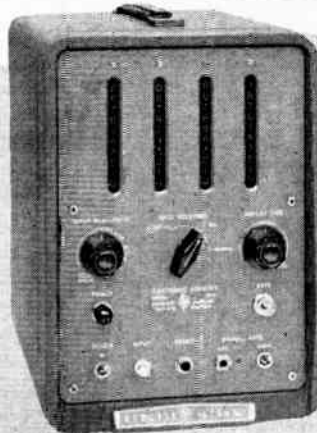

Measures frequency, speed, rpm, rps, random events

Measures weight, pressure temperature, acceleration*

Direct numerical readings, range 1 cps to 120 KC

Accurate, compact, rugged, easy for anyone to use

-hp- 521A Industrial Counter—\$475.00

Newest of the high quality, precision Hewlett-Packard counters is Model 521A, a low cost, multi-purpose instrument specifically designed for industrial use. Model 521A makes possible all the measurements listed above, plus many more. It reads directly in cycles per second, rpm, or rps; has connections for photocell and external standard. Uses power circuit for time base or has plug-in crystal time base (extra) for precision accuracy. Accessory power supplies of —150 v dc, +300 v dc, and 6.3 v ac. Most broadly useful low cost electronic counter ever made. \$475.00. (with crystal time base, \$575.00).

*With transducers

OTHER PRECISION -hp- ELECTRONIC COUNTERS

Instrument	Primary Uses	Frequency Range	Price
-hp- 521A Industrial Electronic Counter	Measure frequency, speed, time interval	1 cps to 120 KC	\$ 475.00
-hp- 522B Electronic Counter	Frequency, period, time interval measurements	10 cps to 100 KC	915.00Δ
-hp- 524B Frequency Counter	Frequency, period measurements	.01 cps to 10 MC	2,150.00 ■
-hp- 525A Frequency Converter	Extends 524B's range to 100 MC	10 cps to 100 MC	250.00
-hp- 525B Frequency Converter	Extends 524B's range from 100 to 220 MC	100 MC to 220 MC	250.00
-hp- 526A Video Amplifier	Increases 524B's sensitivity to 10 millivolts	10 cps to 10 MC	150.00
-hp- 526B Time Interval Unit	Measures interval 1 μsec to 100 days	1 μsec to 10 ⁷ sec	175.00

-hp- TRANSDUCERS for RPM/RPS MEASURING

Instrument	Primary Uses	Frequency Range	Price
-hp- 506A Optical Tachometer Pickup	rps and rpm measurement	300 to 300,000 rpm	\$ 100.00
-hp- 508A/B Tachometer Generator	Shaft speed measurement	15 to 40,000 rpm	100.00

Δ Rack mounted instrument available for \$15.00 less. ■ Rack mounted instrument available for \$25.00 less.



Electronic Measuring Instruments
Quality, value, complete coverage

FOR COMPLETE DETAILS ON ANY -hp- EQUIPMENT, SEE YOUR -hp- FIELD ENGINEER, OR WRITE DIRECT

HEWLETT-PACKARD COMPANY

3346G Page Mill Rd. • Palo Alto, Calif. • Cable: 'HEWPACK'

PLEASE SEND DATA ON _____ 521A _____ 522B
_____ 524B with Plug-ins _____ 506A _____ 508A/B

Name _____

Company _____

Street _____

City _____ Zone _____ State _____

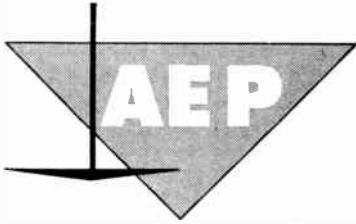

A technical sales and engineering design organization staffed by graduate engineers and offering a wide range of electronic and avionic components.

ELECTRICAL EQUIPMENT COMPONENTS



TRANSISTORS

Multiple transistor socket strips by Hydro-Aire Inc.

CAPACITORS

By Vitramon. Tiny and tough. Porcelain. Low loss—long life.

POTENTIOMETERS

Ultra low torque. Extreme precision. Made by Electro-Mec.

TRANSFORMERS

Miniature, sub-miniature, micro-miniature and standard. Made by the Microtran Company.

SYNCHROS

Reliable, interchangeable units, used in closed loop servo systems. Made by American Electronic Mfg.

RELAYS

A wide range of midget and standard DC and AC types. Made by Sterling Engineering and Potter & Brumfield.

SWITCHES

Miniature, snap-acting for control and indicating circuits. Made by Unimax. Waterproof and Thermal switches by Control Products Inc.

Ask for details from

AEROMOTIVE
Engineering Products

MONTREAL ELWOOD 9602
5257 Queen Mary Road

TORONTO EMPIRE 4-1017
P.O. Box 760, Brampton, Ont.

SPECTROMETER

(Continued from page 81)

intensity of X-rays at each angle are recorded continuously and automatically on a chart.

The pattern on the graph is a series of sharp peaks and is always identical for any one compound or element. Thus, when once this element or compound is charted and recorded, it can be filed as another chemical "fingerprint" for future reference.

The graph is classified by the recorded peaks, from which the distance between planes of atoms can be calculated. Identity cards in the reference file are also classified according to these distances and the intensities of the peaks. By matching the graph to the reference cards, the material being analyzed can be identified. Usually only three reference points are necessary to identify the substance. Extraneous materials in a sample can complicate the graph pattern, so that the time involved in identifying an unknown substance may vary from a few minutes to as much as two hours, depending on its purity.

Recently, the steel sheathing of a building under construction was plagued with unsightly stains of unknown origin. A sample of the discolored steel was submitted for analysis. The X-ray diffraction spectrophotometer showed that the staining was associated with the presence of calcium sulphate, an ingredient of plaster. The problem was solved and corrected when it was found that plaster was spilling from the upper floors of the building.

With faster and more accurate chemical analysis through the application of spectrometry to everyday problems, the technicians of U.S. Steel's Applied Research Laboratory are contributing to better manufacturing techniques and controls; safer and more economical uses of steel for better living, and more reliable coal-chemical products for better drugs, dyes, synthetics and other necessities created from the raw materials of the coke ovens.

Dawe Instruments Move To Larger Home

Continued expanding operation of Dawe Instruments Ltd., (Canadian Division) has necessitated a move to new and larger premises at 1654 Bank Street, Ottawa, Ontario.

The parent company in London, England, are manufacturers of a wide range of electronic instruments for communications and industrial applications. The entire range of these instruments are available to the Canadian market from the new Dawe plant in Ottawa. Full servicing and repair facilities, for all types of electronic instruments, are also available at the new Canadian plant.

RECTIFIERS

**DRY PLATE
AND
ELECTRONIC**



**INDUSTRIAL
AND
MILITARY**



SPECIFY

"DYNAMATIC"

**FOR QUIET,
DEPENDABLE,
EFFICIENT
SERVICE**



**INDUSTRIAL
ELECTRONICS
OF CANADA, LTD.**

**83 TORBARRIE ROAD
TORONTO 15**



time on our hands

Here's a handful of microtime... doled out in hundredths of a millimicro-second. It's our new HELIDEL* delay line.

It's precise... wide-band... continuously variable. This is not an adwriter's pipedream... it's an engineer's, come true.

Which means that definitions are in order.

Precise = delay increments of only 2×10^{-11} sec; resolution 0.01% and better; linearity "better than $\pm 1\%$ "... actually, so fine it can't be measured.

Wide-band = transmission of pulse signals up to 20 mc with negligible phase-distortion, overshoot, or distortion of waveshape.

Continuously variable = a distributed-constant, electromagnetic type... dreamed up in 1946... developed in helical form since 1951, by Helipot and DuMont.

The HELIDEL is already used successfully in color-TV broadcasting and oscilloscopes... and as a trimmer in transmission systems.

What can you dream up?



Factory: No. 3 Six Points Road, Toronto 18, Ont.
 Representative: R-O-R Associates, Ltd.
 290 Lawrence Avenue West, Toronto 12, Ont.



*To help you dream,
 there's a 10-page technical
 paper on the HELIDEL,
 presented at the 1954
 WESCON... and a new data
 sheet, with complete specs.
 For your copies, write
 for Data File 807.*

444 *TRADEMARK

NEW PRODUCTS

(Continued from page 77)

● Multi-Track Magnetic Recording/Reproducing Heads

Item 750

Now, for the first time, multi-track magnetic recording and reproducing heads with adequate inter-track shielding and precise gap alignment have become available for general use. Designed and manufactured specifically for data recording applications, these heads provide improved data reproduction.

Each head stack is cast in plastic and mounted in a metal housing. This guarantees

immunity to such adverse conditions as shock, vibration, and wide ranges of temperature and humidity. Complete interchangeability of the various models permits use of a single tape transport for varied operations.

Special production techniques make possible extreme flexibility in track spacing, track width, and gap width without loss of quality. From 7 to 21 tracks per inch are available depending on crosstalk and track width requirements with gaps to .00015 inches. Careful shielding permits narrow track spacing with a minimum of crosstalk, eliminating the necessity for interlacing, tracks in most cases.

These heads are available for direct, FM, or digital recording with a maximum width of two inches. Special heads can also be developed to suit the customers' particular requirements.

● Plug-In Tubular Capacitors For Printed Circuits

Item 751

A new "Type BC" phenolic-cased plug-in paper tubular capacitors especially designed for use with printed circuits has been announced. These new capacitors are encased in molded phenolic shells with two parallel lead wire terminals. These terminals are brought out from the end of the capacitor through a thermo setting plastic end fill compound, and are spaced at fixed distance so that they may be plugged directly into printed circuits and dip soldered.

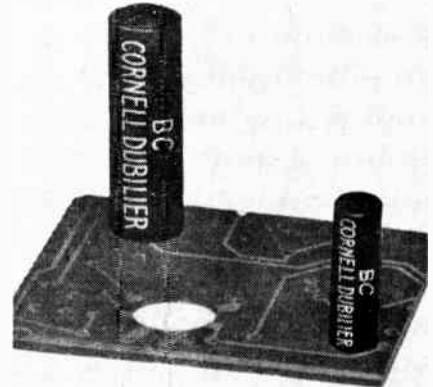

Distortion and stresses inherent in pressure-molded assemblies are entirely eliminated by inserting the capacitor section in a pre-molded, mineral-filled phenolic shell. The capacitor element, which is wound from pure aluminum foil and high quality tissue, is sealed within the case by C-D Polykare which bonds to the container wall and wire leads, barring moisture creepage, while at the same time holding the lead wires rigidly in place.

● Linearity Pattern Generator

Item 752

The Heath Company announces another new kit — The Model LP-1 Linearity Pattern Generator. This brand new instrument has been designed especially for accurately adjusting monochrome or color TV receivers. The Model LP-1 is a real time-saver, and is essential for the up-to-date service shop.



An extra feature of the Model LP-1 is its extended operating range. It covers all television channels from 2 to 13, so that an unused TV channel can always be used for linearity adjustments, even in metropolitan areas with several TV stations in operation. It employs a regulated power supply for stability, and features high quality components throughout.

Compact and self-contained, the Model LP-1 functions to produce vertical or horizontal bar patterns, a cross-hatch pattern or a white dot pattern on the television receiver under

The latest UNIVERSAL BRIDGE with dual-frequency internal oscillator/detector



BY **Marconi**

Provides instant, directly-read, more accurate L, C and R measurement

Through this completely self-contained unit, measurement of inductance, capacitance and resistance values of practically all electronic equipment components may be instantly ascertained.

Through the use of a single L, C and R dial, a system of rotatable discs is viewed through windows automatically showing the actual value of the component under test . . . eliminates human error . . . no multiplying factors involved . . . no confusion.

You can get all the information on the new Marconi Universal Bridge by writing to us today.

Inductance: $1\mu\text{H}$ to 100 henrys
Capacitance: $1\mu\text{fd.}$ to $100\mu\text{fd.}$
Resistance: 0.1 ohm to $10\text{M}\Omega$
Dimensions: $11\frac{1}{2}'' \times 19'' \times 10''$
Weight: 33 lbs.

Marconi Instruments Department

Marconi



CANADIAN MARCONI COMPANY

CANADA'S LARGEST ELECTRONIC SPECIALISTS
MONTREAL 16. QUE.

For further data on advertised products use page 79

test. No internal connections to the receiver required. Special clip on the shielded output cable is merely attached to the antenna terminals of the TV set. Function switch provides instant selection of the pattern desired for adjustment of vertical and horizontal linearity, picture size, overall aspect ratio, and focus. Individual horizontal and vertical frequency controls provided to allow synchronizing and for establishing aspect ratio. Will produce 6 to 12 vertical bars or 4 to 7 horizontal bars. Gain control sets output level to TV receiver. Physical dimensions and weight make it ideal for outside service calls.

Uses 6X4, 0A2, (2) 6J6's and 12AT7. Provides RF carrier modulated with video and sync signals, and will also check television sound. Can be built in one evening to give many years of reliable service.

NEWS

(Continued from page 72)

Western Appointments For MJS Electronic Sales

MJS Electronic Sales Limited announce the appointment of Bob Morrison Limited as Western Canadian representatives of the complete line of Electronic equipment distributed in Canada by MJS Electronic Sales.



B. MORRISON



F. MORRISON

The Morrison brothers, Bob and Fred, will cover the territory from Winnipeg, Manitoba to Victoria, B.C. Their head office is in Edmonton, Alberta with a branch in Royston, B.C. This additional representation for MJS Electronic Sales now adds to the service the firm will be able to render to its Western customers.

Data Processing Associates Exclusive Canadian Reps For Dian Laboratories Inc.

Officers of Data Processing Associates Limited, Ottawa, have announced their appointment as the exclusive Canadian representatives of Dian Laboratories Inc.

Dian Laboratories Inc., operate a complete analog computing center for the analysis and solution of problems and companies interested in using this service are invited to write to Data Processing Associates, Ltd., whose personnel have had many years of experience in this specialized field. All work will be carried out at the Dian Laboratories by highly qualified engineers with extensive experience in the field of engineering, physics, aerodynamics and mathematics.

(Turn to page 86)

4

leads to efficient reception

CW-TELCON

Canada's Radio and Television industry depends on CW-TELCON radio frequency cables for the latest in design development and the utmost in efficient performance. Canada Wire produces a full range of high frequency balanced and coaxial cables to the most exacting specifications. Write for CW-TELCON pamphlet for complete information.

CANADA WIRE™ CABLE COMPANY LIMITED

FACTORIES:
Toronto, Montreal, Smiths Falls, Vancouver
Sole Offices from Coast to Coast

Canadian IRE Convention For October, 1956

Plans are well under way for the Canadian I.R.E. Convention which will be held in Toronto on October 1, 2 and 3, 1956.

The convention will be by far the largest of its kind ever held in Canada and in addition to the technical sessions at which papers on important subjects in the electronics field will be presented, will feature an engineering exhibition with upwards of 200 exhibits.



C. A. NORRIS

The convention which is expected to draw thousands of engineers from all parts of Canada and the adjacent States, will be held in a new ultra - modern building to be erected at the Canadian National Exhibition.

The Canadian I.R.E. Convention will be the first to be held in the new building.

Grant Smedmor Limited has been appointed show manager.

The convention committee is headed by C. A. Norris, General Chairman. Committee Chairmen are: Exhibits and Registration—E. O. Swan; Social

Activities—E. L. Palin; Advertising Publicity and Program—R. C. Poulter; Technical Program—Dr. Geo. Sinclair; Finances—C. H. Hathaway; Recording Secretary—C. Eastwood; Corresponding Secretary — Claude Simmonds; Liaison with I.R.E. Region 8—F. H. R. Pounsett. A. P. H. Barclay, Chairman of the Toronto Section of I.R.E., is an ex-officio member of the committee.

Further details of the convention will appear in this publication from time to time.

C.G.E. To Build TV Station At Timmins

Canadian General Electric Company has announced the signing of a contract with J. Conrad Lavigne for a complete television transmitter and studio installation at Timmins, Ontario.

The locale of this new television station serving Timmins, Cochrane and the environs, will be approximately one-half mile north of Timmins. Planned as a show place, the combined AM-TV operation will be constructed on a picturesque rock bluff overlooking Timmins.

The transmitting equipment will operate on Channel 5 with a radiated power of approximately 18 kw. The studio equipment includes complete film and slide projection along with live programming facilities.

Aerovox Announces New Sales Appointment



LARRY McNABB

● News of the appointment of Lawrence McNabb to the sales staff of Aerovox Canada Limited, Hamilton, has been released by Jack Cartwright, Sales Manager. In his new position, Mr. McNabb will be contacting both set manufacturers and jobbers throughout Ontario.

BOHNE
Precision Built Springs for Industry
 Compression, Tension
 Torsion and Formed

BOHNE INDUSTRIES LIMITED, 1153 QUEEN STREET W., TORONTO 3

For further data on advertised products use page 79



Heathkit PRINTED CIRCUIT 5" COLOR TV Oscilloscope Kit

MODEL
0-10
\$69⁵⁰
Shpg. Wt. 27 lbs.

The technical specifications for this fine instrument speak for themselves. Vertical channel sensitivity is 0.025 volts RMS/inch at 1 Kc. Vertical frequency response is essentially flat to 5 Mc. and down only 1.5 db at 3.58 Mc. Ideal for Color TV work!

Extended sweep generator range is from 20 cps to 500 Kc in five steps, far beyond the range normally encountered at this price level.

Other features are: plastic-molded capacitors for coupling and by-pass—preformed and cabled wiring harness—Z axis input for intensity modulation—peak-to-peak voltage calibrating source built-in—retrace blanking amplifier—regulated power supply—high insulation printed circuit boards—step attenuated and frequency compensated vertical input circuit—push-pull horizontal and vertical amplifiers—excellent sync. characteristics—sharp, hairline focusing—uses 5UP1 CRT—extremely attractive physical appearance.

An essential instrument for professional Laboratory, or for servicing mono-chrome or color TV.

Heathkit PRINTED CIRCUIT 3" OSCILLOSCOPE KIT



This light, portable 3" oscilloscope is just the ticket for the ham, for service calls, or as an "extra" scope in the shop, or lab. Measures only 9 1/2" H x 6 1/2" W x 11 1/4" D, and weighs only 11 lbs.
Employs printed circuit board for improved circuit performance. Vertical amplifiers dat within +3 db from 2 cps to 200 Kc. Vertical sensitivity 0.25 volts RMS/inch peak-to-peak, and sweep generator operates from 20 cps to 100,000 cps. R.F. connection to deflection plates.

MODEL OL-1
\$29⁵⁰
Shpg. Wt. 14 lbs.

Heathkit PRINTED CIRCUIT 5" OSCILLOSCOPE KIT



This full-size 5" Oscilloscope incorporates many outstanding features.
Vertical channel flat within +3 db, 2 cps to 200 Kc, with 0.09 volts RMS/inch peak-to-peak sensitivity at 1 Kc. Sweep operation from 20 cps to 100,000 cps. Built-in peak-to-peak voltage calibration—3 step frequency compensated input attenuator—phasing control—push-pull deflection amplifiers. Printed circuits for reliable performance and reduced construction time.

MODEL OM-1
\$49⁵⁰
Shpg. Wt. 26 lbs.

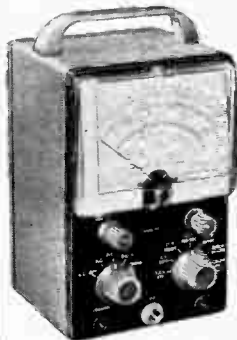

Heathkit PRINTED CIRCUIT VACUUM TUBE VOLTMETER KIT

MODEL V-7
\$24⁵⁰

Shpg. Wt. 7 lbs.

This VTVM has set a new standard for accuracy and reliability in kit-form electronic instruments. Features modern, time-saving printed circuits, and functional arrangement of controls and scales. Includes new peak-to-peak scale for FM and TV work.

Measures AC (RMS) and DC voltage at 0-1.5, 5, 15, 50, 150, 500, and 1500; peak-to-peak AC voltage at 0-4, 14, 40, 140, 400, 1400, and 4000; center-scale resistance readings of 10, 100, 1000, 10,000, 100 K, 1 meg., and 10 meg. DB scale provided also. Zero-center operation within range of front panel controls. Polarity reversal switch—200 μ a 4- μ meter-transformer power supply—11 megohm input impedance—1% precision resistors—high quality components used throughout.

Heathkit VOLTAGE CALIBRATOR KIT

Once calibrated, this instrument provides a known peak-to-peak voltage standard for comparison with unknown voltage values on an oscilloscope. Panel calibrated directly—no involved calculations required. Operates within a voltage range of .01 to 100 volts peak-to-peak.



MODEL VC-2
\$11⁵⁰

Shpg. Wt. 4 lbs



MODEL MM-1
\$29⁵⁰

Shpg. Wt. 6 lbs.

Heathkit 20,000 ohms/volt MULTIMETER KIT

Features comprehensive range coverage, 20,000 Ω /V D.C. and 5000 Ω /V A.C. Ranges: 0-1.5, 5, 50, 150, 500, 1500, and 5000 V, direct current from 0 to 150 μ a., 15 a. in 5 steps. Center-scale resistance of 15, 1500 and 150,000 ohms, and db from -10 to +65.

Uses 1% precision resistors—50 μ a. meter—molded bakelite case.

Heathkit DIRECT-READING CAPACITY METER KIT

Extremely valuable where speed and convenience are essential. Quality control work, production line checking, etc. Reads capacity directly on meter scale, from 0-100 mmfd, 1000 mmfd, .01 mfd, and .1 mfd. Residual capacity less than 1 mmfd. Not susceptible to hand capacity.



MODEL CM-1
\$29⁵⁰

Shpg. Wt. 7 lbs.



MODEL AV-2
\$29⁵⁰

Shpg. Wt. 5 lbs.

Heathkit A. C. VACUUM TUBE VOLTMETER KIT

Measures AC voltage only, from 10 cps to 50 Kc. Covers the range from 1 millivolt to 300 volts in 10 steps at high impedance input. Incorporates full 10 ranges of db scale from -52 db to +52 db. Essential in the audio laboratory or for audio enthusiasts and experimenters. Provides sensitivity essential for low level audio measurements.

Heathkit ELECTRONIC SWITCH KIT

This device will electronically switch between 2 input signals to produce both signals alternately at the output. Used in conjunction with an oscilloscope, it will permit the observation of 2 signals simultaneously. Provides switching rates from 10 cps to 200 cps.

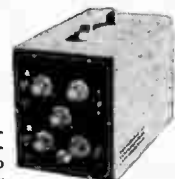

MODEL S-2
\$23⁵⁰

Shpg. Wt. 11 lbs.

HEATH Company

A SUBSIDIARY OF DAYSTROM INC.
BENTON HARBOR 3, MICHIGAN

SELECT YOUR NEXT HEATHKIT FROM

Heathkit TUBE CHECKER KIT

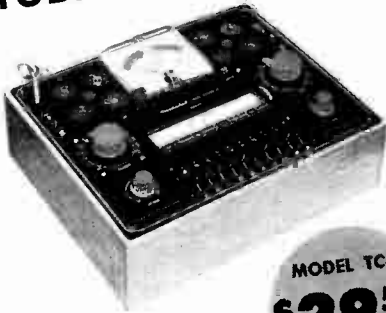

MODEL TC-2
\$29.50

Shpg. Wt.
12 lbs.

Because of its low price this fine tube tester is available, not only to the service shop and laboratory, but to part-time servicemen, experimenters, and radio amateurs, as well. Will test all tubes commonly encountered in radio and TV service work. Simple "GOOD-BAD" scale on the 4 1/2" meter. Tests for open, short, and quality on the basis of total emission. Includes illuminated roll chart. Fourteen different filament voltage values available. Separate lever switch for each tube element.

Model TC-2P is the same electrically as TC-2, except that it is housed in a beautiful two-toned portable carrying case. Only \$34.50. Shpg. Wt. 15 lbs.

Portable carrying case available separately for Model TC-2, or older model TC-1. Cab. No. 91-8, \$7.50. Shpg. Wt. 7 lbs.
CRT Test Adapter, Model 375 for use with the TC-2, \$4.50. Shpg. Wt. 1 lb.

Heathkit TV ALIGNMENT GENERATOR KIT

Here is the complete R.F. signal source for FM and TV alignment, (both monochrome and color). Provides output on fundamentals from 3.6 Mc to 220 Mc in four bands, with harmonic output usable up through the UHF channels. Electronic sweep circuit eliminates mechanical gadgets and accompanying noise, hum, and vibration. Continuously variable sweep up to 0-42 Mc, depending on base frequency.

Variable marker (19-60 Mc on fundamentals) and crystal marker (4.5 Mc and multiples thereof) generators built-in. Crystal included with kit. Provision for external marker if desired.

Packed with outstanding features. 50 ohm output impedance—exceptionally good linearity—effective AGC action—plenty of R.F. output. An essential instrument for the up-to-date service shop.



\$49.50

MODEL TS-4
Shpg. Wt. 16 lbs.



Shpg. Wt.
8 lbs.

MODEL SG-8
\$19.50

Heathkit SIGNAL GENERATOR KIT

This is one of our most popular kits, and is "serviceman engineered" to fulfill the signal source requirements of the radio serviceman and experimenter.

Covers 160 Kc to 110 Mc on fundamentals (5 bands), with output in excess of 100,000 microvolts. Calibrated harmonics extend usefulness up to 220 Mc. Choice of unmodulated R.F. output, 400 cps modulated R.F. output, or 400 cps audio output. Step-type and continuously variable output attenuation controls.

Coils are prewound, and construction manual is complete. Calibration unnecessary for service applications.

Model RS-1 Heathkit RESISTANCE SUBSTITUTION BOX KIT



Provides switch selection of 36 RTMA 1 watt standard 10% resistors, ranging from 15 ohms to 10 megohms. Numerous applications in radio and TV work.

\$5.50
Shpg. Wt.
2 lbs.

Heathkit CONDENSER SUBSTITUTION BOX KIT

Very popular companion to Heathkit RS-1. Individual selection of 18 RTMA standard condenser values from .0001 mfd to .22 mfd. Aluminum panel, bakelite case, and includes 18" flexible leads with alligator clips.

Model CS-1
\$5.50
Shpg. Wt.
2 lbs.



Model DR-1 Heathkit DECADE RESISTANCE KIT



Twenty 1% precision resistors provide resistance from 1-99,999 ohms in 1 ohm steps. Indispensable around service shop, laboratory, ham shack, or home workshop.

\$19.50
Shpg. Wt.
4 lbs.

Heathkit DECADE CONDENSER KIT

Provides capacity values from 100 mmf to 0.111 mfd in steps of 100 mmfs. +1% precision silver-mica condensers used. High quality ceramic wafer switches for reduced leakage.



Model DC-1
Shpg.
Wt. 3 lbs.
\$16.50

Heathkit CONDENSER CHECKER KIT

Measures capacity in four ranges from .00001 to 1000 mfd. Power factor control is provided for indication of electrolytic condenser efficiency. Tests capacitors under actual load conditions. Checks resistance from 100 ohms to 5 megohms. Direct reading scales for all tests. No calculation necessary.



Model C-3
\$19.50
Shpg. Wt. 7 lbs.

Heathkit LABORATORY GENERATOR KIT

Here is a signal generator for use where high accuracy and metered performance are essential. Covers 150 Kc to 30 Mc on fundamentals in 5 bands. 400 cps modulation variable from 0 to 50%. R.F. output at 50 Ω from 100,000 to 1 μ v. Meter reads R.F. output in μ v. or modulation percentage. Fixed-step and variable output.



Model LG-1
\$39.50
Shpg. Wt.
16 lbs.

Model T-3 Heathkit VISUAL-AURAL SIGNAL TRACER KIT



\$23.50
Shpg. Wt. 9 lbs.

This signal tracer features a high-gain R.F. channel and probe to permit signal tracing from the receiver antenna input through the R.F. and I.F. stages. Separate low gain channel for audio circuits. Both visual and aural indication by means of speaker and electron beam "eye" tube.

Also noise locator circuit, wattmeter, and terminals for "patching" output transformer or speaker into external circuit.



Model M-1
\$14.50
Shpg. Wt.
3 lbs.

Heathkit HANDITESTER KIT

The M-1 is literally pocket size to fit in your coat pocket, tool-box, glove compartment, or desk drawer. Measures A.C. or D.C. v. in 5 steps from a full scale minimum of 0-10 v. to a maximum of 0-5000 v. Measures direct current at 0-10 Ma and 0-100 Ma, and provides ohmmeter ranges of 0-3000 and 0-300,000 ohms. Sensitivity of 1,000 ohms/v. 1% precision divider resistors employed.

HEATH Company
A SUBSIDIARY OF DAYSTROM INC.
BENTON HARBOR 3, MICHIGAN

THESE HIGH QUALITY INSTRUMENTS

Heathkit HARMONIC DISTORTION METER KIT



MODEL HD-1
\$49.50
Shpg. Wt. 13 lbs

Performs the functions of more elaborate and much more expensive audio distortion testing devices and yet is simple to operate and inexpensive to own. Used with a sine wave generator, it will check the harmonic distortion output of audio amplifiers under a variety of conditions. Essential in audio design work.

The HD-1 reads harmonic distortion directly on the meter as a percentage of the original signal input. It operates from 20 to 20,000 cps in 3 ranges, and incorporates a VTVM circuit for initial reference settings and final harmonic distortion readings. VTVM ranges are 0-1, 3, 10, and 30 volts full scale. 1% precision voltage divider resistors used. Distortion meter scales are 0-1, 3, 10, 30 and 100% full scale. Having a high input impedance the HD-1 requires only .3 volt input for distortion tests.

Heathkit AUDIO GENERATOR KIT

This basic audio reference generator deserves a place in your Laboratory. Complete frequency coverage is afforded from 20 cps to 1 Mc in 5 ranges, and output is constant within ± 1 db from 20 cps to 400 Kc. down only 3 db at 600 Kc., and 8 db at 1 Mc. An extremely good sine wave is produced, with a distortion percentage below 0.4% from 100 cps through the audible range.

Plenty of audio output for all applications; up to 10 v. under no load conditions. Output controllable with a continuously variable or step-type attenuator with settings of 1 μ v, 100 μ v, 1 v, and 10 v. Cathode follower output.



MODEL AG-8
\$29.50
Shpg. Wt. 11 lbs.

Heathkit AUDIO ANALYZER KIT



MODEL AA-1
\$59.50
Shpg. Wt. 13 lbs.

The AA-1 consists of an audio wattmeter, an AC VTVM, and a complete IM analyzer, all in one compact unit. It offers a tremendous saving over the price of these instruments purchased separately.

Use the VTVM to measure noise, frequency response, output gain, power supply ripple, etc. Use the wattmeter for measurement of power output. Internal loads provided for 4, 8, 16, or 600 ohms. VTVM also calibrated for DBM units so db gain or loss can be noted quickly.

High or low impedance IM measurements can be made. High (6 Kc) and low (60 cps) frequency generators built-in. Only 4 meter scales are employed, and one of these is in color so that results are easily read on the scale. Full scale VTVM ranges are .01 to 300 volts in 10 steps, full scale wattmeter ranges are .15 mw to 150 w in 7 steps. IM analyzer scales are 1%, 3%, 10%, 30% and 100%.

Heathkit VARIABLE VOLTAGE POWER SUPPLY KIT



Model PS-3
\$35.50
Shpg. Wt. 17 lbs.

Provides regulated DC output for B+, and 6.3 v. AC at 4 amps. for filaments. Output variable from 0 to 500 v. DC at no load, linear from 0-10 ma at 450 vdc and 0-130 ma at 200 vdc! Essential for circuit design and development. Voltage or current read on 4 1/2" meter.

Heathkit "Q" METER KIT



Model QM-1
\$44.50
Shpg. Wt. 14 lbs.

Will measure Q of condensers, RF resistance and distributed capacity of coils, etc. Uses 4 1/2" 50 μ a meter for direct indication. Will test at 150 Kc to 18 Mc in 4 ranges. Measures capacity from 40 mmf to 450 mmf within ± 3 mmf. Useful for checking wave traps, chokes, peaking coils. Indispensable for coil winding and determining unknown condenser values.

Heathkit AUDIO OSCILLATOR KIT



MODEL AO-1
\$24.50
Shpg. Wt. 10 lbs.

(SINE WAVE - SQUARE WAVE)

Features sine or square wave coverage from 20 to 20,000 cps in 3 ranges. An instrument specifically designed to completely fulfill the needs of the serviceman and high fidelity enthusiast. Offers high-level output across the entire frequency range, low distortion and low impedance output. Uses a thermistor in the second amplifier stage to maintain essentially flat output through the entire frequency range. Produces good, clean square waves with a rise time of only 2 microseconds.

Heathkit IMPEDANCE BRIDGE KIT



Model IB-2
\$59.50
Shpg. Wt. 12 lbs.

Measures resistance, capacitance, inductance, dissipation factors of condensers, and the storage factor of inductance. Employs 2-section CRL dial. D, Q and DQ functions are combined in one control. 1/2% resistors and capacitors used in critical circuits. 100-0-100 microammeter for null indications. 1000 cycle oscillator, 4 tube detector-amplifier, and power supply built-in.

Heathkit 6-12 VOLT BATTERY ELIMINATOR KIT



Model BE-4
\$31.50
Shpg. Wt. 17 lbs.

Furnishes 6 or 12 volt output for the new 12 v. car radios in addition to 6 v. models. Two continuously variable output voltage ranges; 0-8 v. DC at 10 A. continuously or 15 A. intermittent, 0-16 v. DC at 5 A. continuously or 7.5 A. intermittent. Output voltage is clean and well filtered by two 10,000 mfd condensers. Panel meters read voltage and current output.

Heathkit BROADCAST BAND RECEIVER KIT



MODEL BR-2
\$17.50
(Less Cabinet)
Shpg. Wt. 10 lbs.

Build your own receiver with confidence. Complete instruction book anticipates your every question.

Features transformer-type power supply, high-gain miniature tubes, built-in antenna, planetary tuning from 550 Kc to 1600 Kc. 5 1/2" speaker. Also adaptable for use as AM tuner or phono amplifier.

CABINET: Fabric covered plywood cabinet available, complete with aluminum panel and re-inforced speaker grille. Part No. 91-9, Shpg. Wt. 5 lbs., \$4.50

HEATH Company

A SUBSIDIARY OF DAYSTROM INC.

BENTON HARBOR 3, MICHIGAN

New

Heathkit DX-100 PHONE AND CW TRANSMITTER KIT



MODEL DX-100

\$189.50

Shpg. Wt. 120 lbs.

Shipped motor freight unless otherwise requested. \$50.00 deposit required for C.O.D. orders.

This one compact package contains complete transmitter, with built-in VFO, modulator, and power supplies. Provides phone or CW operation—VFO or crystal excitation—and hand-switching from 160 meters through 10 meters. R.F. power output 100—125 watts phone, 120—140 CW. Parallel 6146's modulated by push-pull 1625's. Pi network interstage and output coupling for reduced harmonic output. Will match non-reactive antennas between 50 ohms and 600 ohms. TVI suppressed with extensive shielding and filtering. Rugged metal cabinet has inter-locking seams.

The high-quality transmitter is packed with desirable features not expected at this price level. Copper plated chassis—potted trans-

formers—wide spaced tuning capacitors—ceramic insulation—illuminated VFO dial and meter face—remote control socket—preformed wiring harness—concentric control shafts—high quality, well rated components used throughout. Overall dimensions 20 7/8" wide x 13 3/4" high x 16" deep.

Supplied complete with all components, tubes, cabinet and detailed construction Manual. (Less crystals.) Don't be deceived by the low price! This is a top-quality transmitter designed to give you years of reliable service and dependable performance.

Heathkit AMATEUR TRANSMITTER KIT

Enjoy the trouble-free operation of commercially designed equipment while still benefiting from the economies and personal satisfaction of "building it yourself."

This CW Transmitter is complete with its own power supply, and covers 80, 40, 20, 15, 11 and 10 meters. Single knob handswitching eliminates coil changing. Panel meter indicates grid or plate current for the final. Crystal operation, or can be excited by external VFO. Crystal not included in kit. Incorporates features one would not expect in this price range, such as key-click filter, line-quality components throughout. Instruction Book simplifies assembly. Uses 6AG7 oscillator, 6L6 final and 5U4G rectifier. Up to 35 watts plate power input.

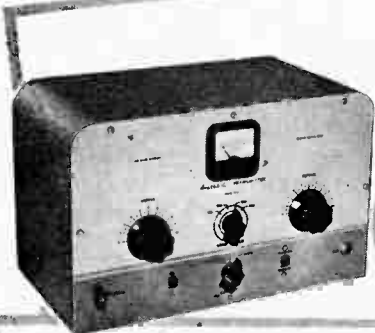

MODEL AT-1

\$29.50

Shpg. Wt. 15 lbs.



Heathkit GRID DIP METER KIT

Model GD-1B

\$19.50

Shpg. Wt. 4 lbs.

This is an extremely valuable tool for Hams, Engineers or Servicemen. Covering from 2 Mc to 250 Mc, it uses 500 μ a meter for indication. Kit includes prewound coils and rack. Will accomplish literally hundreds of jobs on all types of equipment.

Heathkit ANTENNA IMPEDANCE METER KIT



Model AM-1

\$14.50

Shpg. Wt. 2 lbs.

Use in conjunction with a signal source for measuring antenna impedance, line matching purposes, etc. Will double, also, as a phone monitor or relative field strength indicator.

100 μ a meter employed. Covers the range from 0 to 600 ohms. An instrument of many uses for the amateur.

Heathkit VFO KIT



MODEL VF-1

\$19.50

Shpg. Wt. 7 lbs.

Weigh the cost of this kit against the cost of crystals—and consider the convenience and flexibility of VFO operation. This is one of the most outstanding kits we have ever offered for the radio amateur.

Covers 160—80—40—20—15—11 and 10 meters with three basic oscillator frequencies. Illuminated and precalibrated dial scale clearly indicates frequency on all bands and provides more than two feet of dial calibration. Reflects quality design in the use of ceramic coil forms and tuning capacitor insulation, and copper plated chassis. Simply plugs into crystal socket of any modern transmitter to provide coverage of the bands from 160 meters through 10 meters. Uses 6AU6 Clapp oscillator, and OA2 voltage regulator for stability. May be powered from plug on Heathkit Model AT-1 Transmitter, or supplied with power from most transmitters.



Heathkit ANTENNA COUPLER KIT

Model AC-1

\$14.50

Shpg. Wt. 4 lbs.

Poor matching allows valuable communications energy to be lost. The Model AC-1 will match your low power transmitter to an end-fed long wire antenna. Also attenuates signals above 36 Mc, reducing TVI. 52 ohm coaxial input—power up to 75 watts—10 through 80 meters.

Heathkit COMMUNICATIONS RECEIVER KIT



Model AR-2

\$25.50

Shpg. Wt. 12 lbs. (Less Cabinet)

Covers 550 Kc to 35 Mc in 4 bands. Features electrical bandspread—separate R.F. and A.F. gain controls—noise limiter—AGC—BFO—phone jack—5 1/4" P.M speaker. CABINET: Fabric covered plywood cabinet. Part No. 91-10. Shpg. Wt. 5 lbs. \$4.50

HEATH Company

A SUBSIDIARY OF DAYSTROM INC.
BENTON HARBOR 3, MICHIGAN

STUDIO TECHNIQUES

(Continued from page 31)

Lighting is also used to recreate in the television picture a sense of the depth, which exists in the original scene. The average incident intensity of light employed is of the order of 150/250 ft. candles requiring a power of 60 watts per square foot. In case of an elaborate production, there may be as much as a hundred connected kilowatts of lighting in use, though not necessarily at the same time.

Cameras

Cameras used in the television studio contain the known Image Orthicon pick-up tube, a tube with a single-sided, non-transparent mosaic scanned obliquely. The mosaic operates as photo-emissive surface and as the secondary emissive surface. A separate photo-cathode undertakes the function of photo emission and the resulting electron image by means of mosaic exists solely to increase the secondary emission. The sensitivity of a camera using an image orthicon approaches that of the eye down to scene brightness levels of a few hundredths of a foot-lambert (approx. full moonlight). It exceeds that of a camera with equivalent optics, using Super XX film.

Unfortunately, television perspective is not quite correct, at present.

The viewer normally sits so that his screen subtends an angle of about 15° at his eyes, but the scene subtends an angle of 30° at the camera, so that studio perspective or respectively outside-broadcast close-up perspective are subject to permanent errors. The only remedy seems to be to operate cameras with 13 inch lenses and place them much farther away from the scene than at present. In short, one would require larger studios.

Viewfinders

All cameras are equipped with focusing viewfinders, which enables the cameraman to determine when the taking lens is properly focused.

In television, with the shallow depth of focus and especially the continuity of performance the cameraman must have a continuous indication of correct focus.

The general tendency is to fit the camera with a miniature picture monitor called an electronic viewfinder. This gives a bright picture whatever the degree of scene illumination, but gives the cameraman no information beyond the limits of the scene as transmitted, and in many instances tends to obscure inaccuracies of focus.

The use of an optical viewfinder, therefore, has its advantages, giving the cameraman a view of the scene outside the limits of the area being viewed by the taking lens. In this way,

he has advanced information of the presence of anything which is undesirable to transmit and can control the movement of his camera accordingly.

Obliterator

It seems very important to devise some means of creating artificial background without physical scenery. In theory it should be possible for one camera televising in front of a plain background to be superimposed upon, and, to obliterate where necessary, a picture from a second camera set-up to provide from a photograph or other medium the scenic background, without disclosing the unreality of such artificial scene effects.

Sound Techniques

Moving-coil microphones are used. Each microphone has an individual pre-amplifier, which raises its output to a standard level, after which mixing takes place. In each microphone circuit, there are two volume controls in cascade, the first to pre-set the volume from any microphone in accordance with experience gained at rehearsal and the second to fade the microphone in and out at any speed desired.

The level settings of a microphone vary considerably during a production (about 10 db during a play and about 25 db during a light entertainment performance).

(Turn to page 94)

No.

1

IN TEST EQUIPMENT IN REPAIR FACILITIES IN TOROIDS, FILTERS, MAGAMPS

WE OFFER
Complete Sales and
Service for

Representative for . . .
Service

Design and
Manufacture of

ALLEN B. DUMONT LABORATORIES - Instrument Division
BOONTON RADIO CORP. - Q meters, test equipment
BOESCH MANUFACTURING CORP. - Toroidal winding equipment
CONTINENTAL CARBON INC. - Nobleloy resistors
M. C. JONES INC. - R. F. Watt meters and couplers
De MORNAY-BONARDI, INC. - Microwave Equipment

GENERAL RADIO COMPANY
WESTON ELECTRICAL INSTRUMENT CORP.

Toroids, Filters, Magnetic Amplifiers to your specifications.

Consult us **FIRST** with your instrumentation problems.

BAYLY ENGINEERING LIMITED
FIRST STREET
AJAX, ONTARIO

BUSINESS BRIEFS

(Continued from page 13)

December 31st, 1954 was 435, a net reduction through sales, consolidations, etc., of 30 from 1953. Telephones operated by the Independents were 176,583 as of the 31st of December, 1953. Of this number 12,625 were operated by the 30 companies which went out of business in 1954. On the other hand, it is expected that there will be an increase in the number of telephones operated by the remaining 435 companies and while accurate figures are not yet available for 1954 it is estimated that the number of telephones operated by the Independents at the end of 1954 will be 171,000."

★ Some indication of the need for trained television technicians is evident in the report that the Western Radio Electronic Television Schools is graduating 1,000 students a year from their Toronto training center and plans of the organization calls for the establishment of further training centers at Vancouver, Winnipeg, Regina, Calgary and Edmonton.

★ R. M. Brophy, President of Phillips Canadian Industrial Development Company Limited, in an address to the Trade and Economic Progress Conference, Canadian Manufacturers' Association said that: . . . "Technological changes, and that concept of work organization which goes under the name of automation, give every promise of stimulating a new surge in industrialization both at home and abroad. Furthermore, if we take the broad view of Automation, we have a productivity multiplier that cuts across all aspects of industrialization. The newer tools and ideas which are required for application of the automation concept, either collectively or singly, are applicable in almost every industry."

★ A new, portable military telephone system designed to handle three times as many conversations over a single cable as its counterpart used in Korea and World War II combat systems, has been developed for the US Army Signal Corps by the Bell Telephone Laboratories. The new military carrier system, which allows 12 conversations to share the same cable by using a different frequency for each, has recently been placed in production by the Western Electric Co. It can be used for distances up to 200 miles.

★ A record \$27,000 was awarded to employees of Canadian General Electric Company during 1954 for 1,761 useful suggestions adopted under the company's suggestion award program. Since the company's suggestion program was initiated in 1926, Canadian General Electric has paid out close to \$200,000 for suggestions from employees.

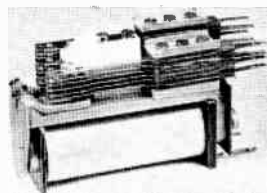

A Typical
3000 Type
Relay

MAGNETIC RELAYS

B.P.O. Types 3000 and 600 to your specification. Coils up to 100,000 ohms. Tropical Baking or Vacuum Impregnating also available. Speedy deliveries . . . Enquiries invited.

Full details and prices from our Canadian Agents:
Electronic Research Co., 292 Glebe Mount Ave., Toronto.

KAYE ELECTRICAL MANUFACTURING CO.
Havelock Works, Havelock Place,
HARROW, MIDDXX., ENGLAND



Pioneers in Development of Vibration-Resistant Electrical Connector

The unsatisfied demand for a rugged, dependable connector capable of meeting the exacting requirements of modern aircraft led the Scintilla Division of Bendix* to develop the first vibration-resistant electrical connector. These connectors using the revolutionary new insert material known as Scinflex were first used on Scintilla Division's ignition equipment for piston engines.

So outstanding was the performance of this new and better connector that its acceptance and use have now become world-wide. Today the Scintilla Division is a major contributor to the electrical connector industry.

This pioneering has never stopped. Bendix was first in the field with cadmium plated connectors, which were later made a requirement of military specifications. Our latest contribution is the best engineered closed entry socket contact available anywhere—one which cannot be mechanically overstressed.

*TRADE-MARK

Bendix SCINTILLA DIVISION OF **Bendix**
SIDNEY, NEW YORK AVIATION CORPORATION

Export Sales:
Bendix International Division • 205 East 42nd St., New York 17, N.Y.

For Engineering Specifications and Application Details Consult:

AVIATION ELECTRIC LIMITED

200 Laurentien Blvd.
Montreal 9, P. Q.

PRICE IS RIGHT! DELIVERY IS RIGHT!

ECLIPSE-PIONEER AUTOSYN* SYNCHROS

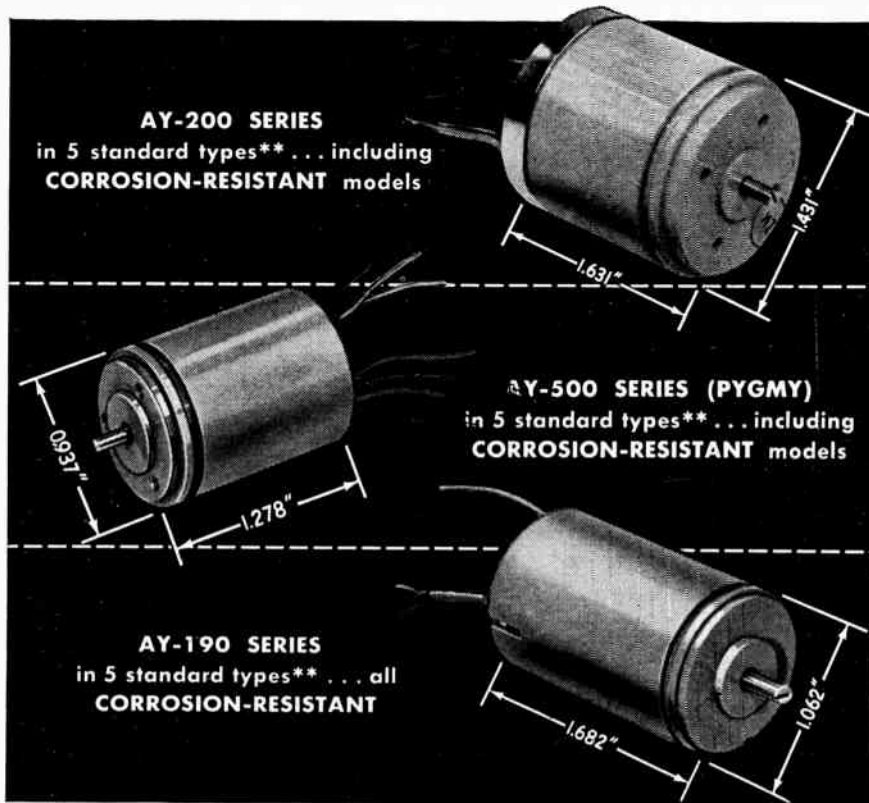

**TRANSMITTERS, RECEIVERS, CONTROL TRANSFORMERS, DIFFERENTIALS AND RESOLVERS

And there's a Bendix autosyn to meet every need!

Eclipse-Pioneer's experience, facilities, and production techniques make possible the following important advantages:—

- Significant *price* reductions
- *Delivery* of standard types from stock
- A complete *range* of standard and special types

Whatever your synchro requirements, it

will benefit you to request further information from AVIATION ELECTRIC, 200 Laurentian Boulevard, Montreal.

• • •

OTHER STANDARD AND SPECIAL ECLIPSE-PIONEER AUTOSYN SYNCHROS INCLUDE models 1, 11, 15, 18, 23 and 2R as well as high temperature, high frequency, linear, and other types for special needs.

*REGISTERED TRADE-MARK BENDIX AVIATION CORPORATION

AVIATION ELECTRIC
LIMITED

MONTREAL

VANCOUVER

SALES • SERVICE • OVERHAUL • MANUFACTURE OF AIRCRAFT INSTRUMENTS & ACCESSORIES

STUDIO TECHNIQUE

(Continued from page 92)

Standard rules for television microphones are as follows:

- (1) the microphone must not appear in the shot.
- (2) it must not throw shadows on any part of the scene appearing in the shot.
- (3) it must be so placed as to correlate visual and aural perspective.

Point 3 is the most difficult to fulfill. Unfortunately, we do not pick up the sound with two microphones, spaced like the ears of the human observer and transmit those sounds by separate channels to separate loudspeakers. For reasons of economy we made one sound channel do the work of two.

But, just as the sound channel is not yet stereophonic, the vision channel is not yet fully stereoscopic either.

But, it is just because there are problems to solve and because each production has to be contrived specifically for the television screen, that the work is so interesting. And behind it all there is the profound realization that the final result will be to improve upon a system, which brings pleasure to the large and increasing number of people who form the viewing public, an achievement, which brings its own satisfaction.

WATCH

For The Sept. - Oct.
Directory Issue

of

Electronics and
Communications

Confidential Applications

Communications Engineer

Wanted for general and technical sales work in the Canadian Communications field. Should have experience in Carrier Telephone Applications either with a manufacturer or large carrier operator and preferably be a graduate engineer. Salary commensurate with experience and ability. Benefits include Group Insurance and Medical Plan. Applications should include resume of experience, education, age, marital status, salary expected and be directed to the

Personnel Department
LENKURT ELECTRIC CO.
OF CANADA, LTD.
926 East Hastings St., Vancouver 4, B.C.

Canadian Representation Wanted Dielectric Heating and Sealing Equipment

by top U.S. manufacturer of electronic generators and presses for sealing vinyl plastics, etc. Write in detail to:

Box 731
ELECTRONICS & COMMUNICATIONS
31 Willcocks Street, Toronto 5, Ont.

For further data on advertised products use page 79

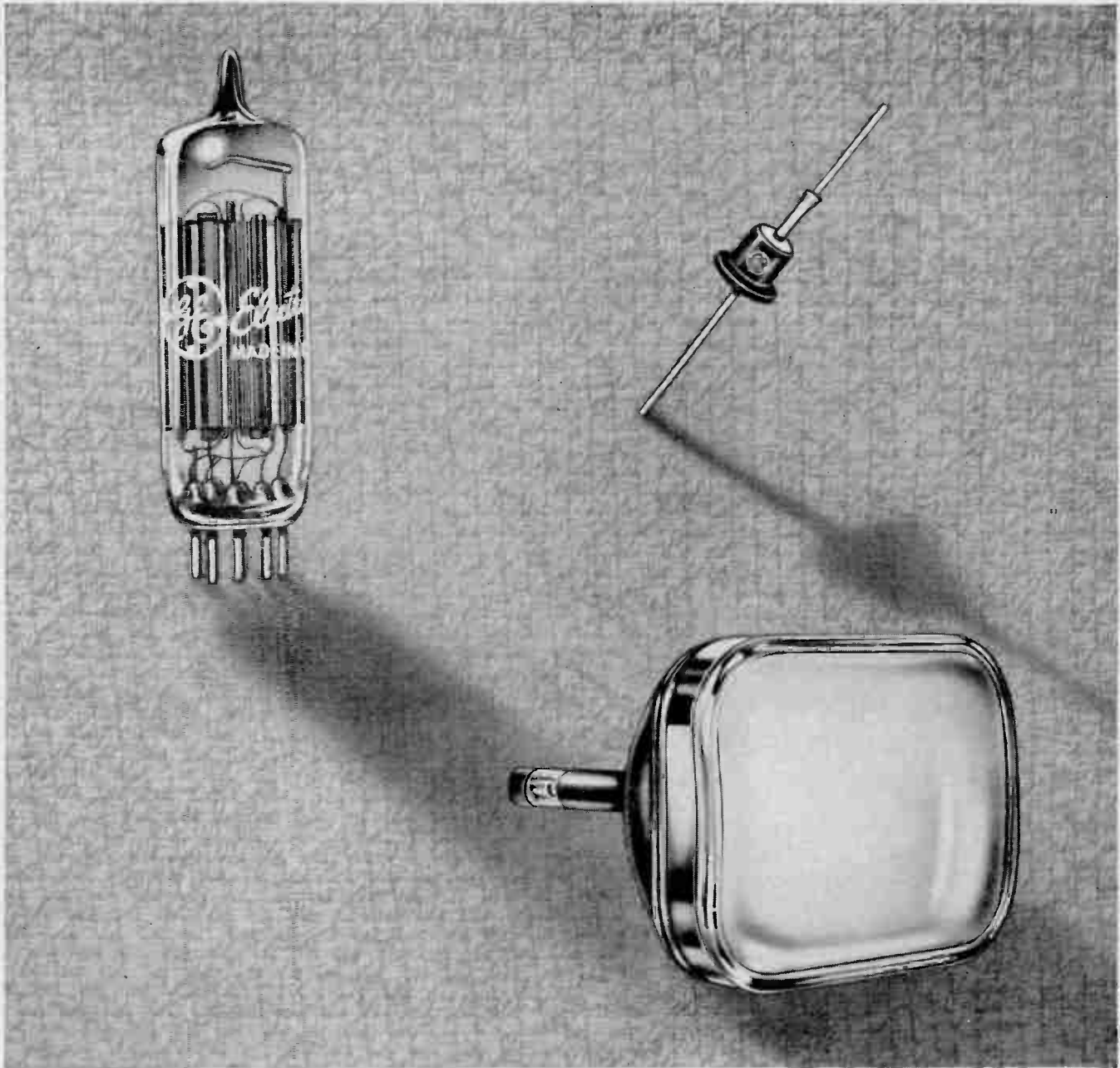

Ahead by Research . . .

Canadian General Electric has always put emphasis on development and research. This continuous search has resulted in new and improved materials, new applications and new methods of production. When carried out under rigid inspection and minute quality control practices, these advanced engineering and design features are your assurance that G-E Electronic Tubes and Devices are always a step ahead . . .

will always give longer life and maximum performance in radio, television and electronic equipment.



Electronic
TUBES

Progress Is Our Most Important Product

CANADIAN GENERAL ELECTRIC COMPANY LIMITED



ELECTRONICS *and* COMMUNICATIONS

Is Going
MONTHLY

Beginning with the January 1956 issue, ELECTRONICS AND COMMUNICATIONS will move up from a bi-monthly to a monthly publication.

It is little more than two years ago that the first issue was published amid the acclaim of the comparatively new market it was to serve.

We are happy however that we had the courage or the foresight to pioneer a publication in this field because ELECTRONICS AND COMMUNICATIONS has progressed even beyond our first hopes.

In fact, we know of few new publications which so quickly won the friendship and esteem of its readers and the confidence of so many advertisers. We confidently expect in 1955 to carry over three times the advertising carried in 1953.

The rapid growth of ELECTRONICS AND COMMUNICATIONS has been partly due to the rapid expansion of the market it serves and we have been told that Electronics and Communications has made a worthy contribution to that expansion.

Now we sense an even greater forward surge, a swifter pace of developments within the entire field of electronics and communications. Therefore, to keep pace with this increasing tempo of activity ELECTRONICS AND COMMUNICATIONS deems it both an obligation and a challenge to increase its service as announced. It is an obligation we gladly honor and a further challenge we look forward to with pleasure.

In arranging your schedule for 1956 then — keep this in mind. In 1956 ELECTRONICS AND COMMUNICATIONS will be published every month.

ELECTRONICS *and* COMMUNICATIONS

AGE PUBLICATIONS LIMITED

TORONTO, ONTARIO, CANADA

31 Willcocks Street

Telephone WALnut 2-3115

The design of
STANDARD ELECTRONICS
 transmitters embodies every
 feature of significance to the
 TV broadcaster.

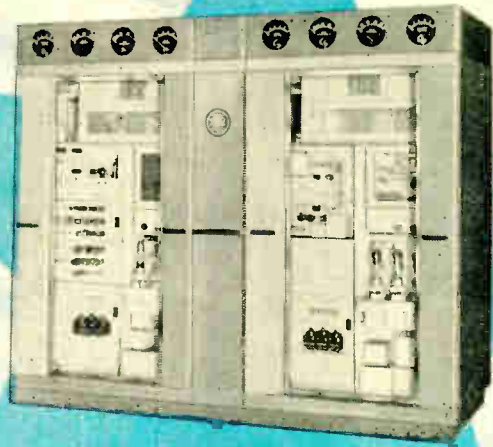

**500
 WATTS**

e-x-p-a-n-d-a-b-l-e to
50 KILOWATTS

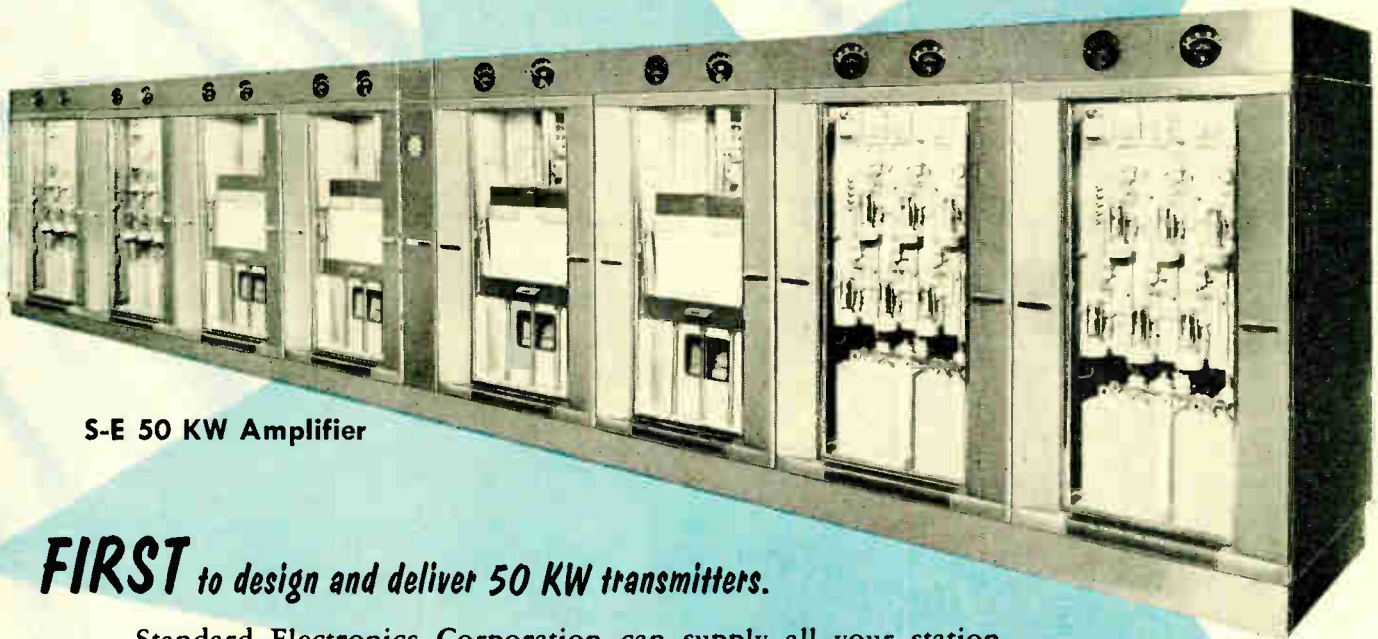

S-E 50 KW Amplifier

FIRST to design and deliver 50 KW transmitters.

Standard Electronics Corporation can supply all your station requirements including complete video equipment, film chains, film projectors, camera chains, studio accessories, master control and monitoring equipment, high gain antennas. Complete stations delivered on short schedule!

Distributed by

Canadian Westinghouse Company, Ltd.

Electronics Division

HAMILTON, ONTARIO

Halifax - Moncton - Quebec - Montreal - Toronto - Hamilton
 London - Windsor - North Bay - Fort William - Winnipeg - Regina
 Calgary - Edmonton - Lethbridge - Trail - Vancouver





Performance... Convenience ...Versatility

The Tektronix Type 535 Oscilloscope handles many more applications than the ordinary laboratory oscilloscope. Some of its possibilities in your work are indicated in the following brief description.

DUAL-TRACE APPLICATIONS — The Type 535, with the Type 53C Plug-In Unit, offers two identical channels electronically switched either free running at about 100 kc, or triggered by the oscilloscope sweep, with calibrated sensitivity from 0.05 v/cm to 20 v/cm and dc to 8.5 mc passband. Other available plug-in units provide for wide-band, high-gain, differential-input, and micro-sensitive applications. Plug-in feature offers prospects of future capabilities in other applications.

SWEEP CHARACTERISTICS — Miller-runup circuitry generates linear calibrated sweeps in the extremely wide range of 0.1 μ sec/cm to 5 sec/cm, with accurate 5x magnification on all ranges. Full sweep range is 0.02 μ sec/cm to 12 sec/cm (600,000,000-to-1 ratio).

SWEEP DELAY — Conventional or triggered, 1 μ sec to 0.1 sec in 12 calibrated ranges accurate within 2%, incremental accuracy within 0.2% of full scale.

TRIGGERING FACILITIES — Amplitude level selection, automatic triggering, and 30-mc sync in addition to all standard triggering modes.

WRITING CHARACTERISTICS — New Tektronix precision metallized crt with 10-kv accelerating potential provides high brightness, improved focus, and excellent linearity. (Recorded writing rate exceeds 175 cm/ μ sec.)

Type 535 Oscilloscope—\$1300 Type 53C Plug-In Unit—\$275

Prices f.o.b. Portland (Beaverton), Oregon

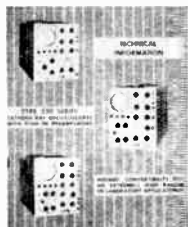

New 16-page booklet contains full specifications on the Type 535 and Type 53C, as well as all Plug-In units and other Oscilloscopes in the Type 530 Series. Write for free copy.

EASTERN CANADA. The Tektronix Syracuse Field Office can now arrange demonstrations of Type 535 Oscilloscopes and Type 181 Time-Mark Generators in the "Industrial Belt" of Eastern Canada.

Tektronix, Inc., 313 Nottingham Road, Syracuse 10, N. Y. Phone: 72-3339.

BRITISH COLUMBIA. Tektronix Engineering Representative, Hawthorne Electronics, can arrange demonstrations of Tektronix Instruments in British Columbia.

Hawthorne Electronics, 700 S. E. Hawthorne Blvd., Portland 14, Oregon. Fillmore 9375.

Tektronix, Inc.

P. O. BOX 831 • PORTLAND 7, OREGON

ADVERTISERS' INDEX

Aeromotive Eng. Products	82
Aerovox (Canada) Limited	75
Ampex Corporation	47
Andrew Corporation	18
Automatic Electric Sales (Canada) Ltd.	4; 16-17; 33; 71
Aviation Electric Ltd.	77; 94
Bach-Simpson Ltd.	6
Bayly Engineering Ltd.	92
Bendix Aviation Corp.	93
Bohne Industries Ltd.	86
Bomac Laboratories Inc.	2
Canada Wire & Cable Ltd.	85
Canadian Aviation Electronics Ltd.	9
Canadian Electrical Supply Co. Ltd.	72
Canadian General Electric Co. Ltd.	95
Canadian Marconi Co.	3; 43; 59; 84
Canadian Stackpole Ltd.	100
Canadian Westinghouse Co. Ltd.	97
Cannon Electric Canada Ltd.	72
Central Bridge Co. Ltd.	14
Centralab (Div. of Globe Union Inc.)	67
Collins Radio Co.	99
Computing Devices of Canada Ltd.	69; 80
Cossor (Canada) Ltd.	24
Dale Products Inc.	68
Daven Co., The	64
Dawe Instruments Ltd.	7
De Jur-Amsco Corp.	56
Eitel-McCullough, Inc.	29
Electro Sonic Supply Co. Ltd.	62
Federal Wire & Cable Co. Ltd.	23
Freed Transformer Co. Inc.	66
Glendon Co. Ltd., The	76
Heath Co.	87-91
Helipot Corporation	83
Hewlett-Packard Co.	81
Industrial Electronics of Canada Ltd.	65; 82
Kaiser-Willys of Canada Ltd.	8
Kaye Electrical & Mfg. Co. Ltd.	93
Kester Solder Co.	63
Longstaffe Co. Ltd., J. R.	12
Magnetics Inc.	35
Measurement Eng. Ltd.	74
Microlab Devices Ltd.	70
Minnesota Mining & Mfg. of Canada Ltd.	36
National Fibre Co. of Canada Ltd.	38
Nichols Ltd., R. H.	19
Northern Electric Co. Ltd.	41
P.S.C. Applied Research Ltd.	55
Precision Electronic Components Ltd.	75
Pye (Canada) Ltd.	60
Quality Hermetics Ltd.	15
Radio Engineering Products Ltd.	63; 68
Rogers Majestic Electronics Ltd.	10; 50
Sanborn Co.	45
Sorensen & Co. Inc.	73
Sperry Gyroscope Co.	49
Stark Electronic Instruments Ltd.	75
Tektronix Inc.	98
Telephone Mfg. Co. Ltd.	78
Wholesale Radio & Electronics Ltd.	62; 66
X-Ray & Radium Industries Ltd.	52

FACILITIES ECONOMICALLY EXPANDED

with *Collins* MICROWAVE

A Collins microwave link can be utilized in conjunction with existing wire line carrier equipment. The broadband Collins RF equipment will transmit your present carrier channels in the 4—160 kc range. Additional channels may be added by employing Collins mechanically filtered multiplex channels in the 300—600 kc range. Expansion by microwave results in lower initial investment and maintenance costs, especially when transversing difficult terrain. Unit construction allows maximum installation flexibility to meet a user's specific needs. Articulated swing-out hinges permit access to the rear of each unit. Units may be mounted back-to-back without impairing component accessibility.

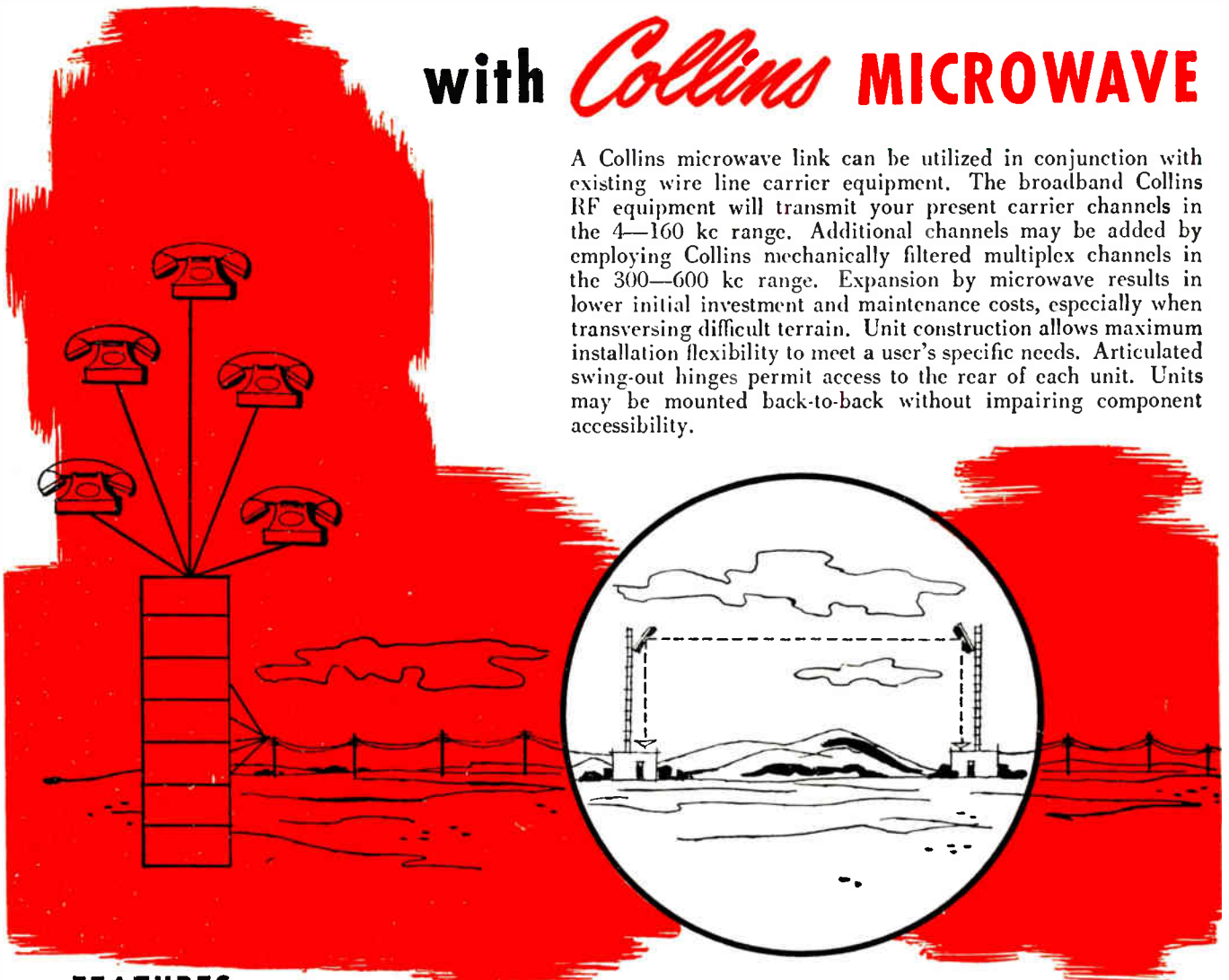

FEATURES

- Tubeless power supplies employ magnetic-amplifiers for regulation
- Only five tube types, including reflex-klystron
- Built-in metering and control elements to facilitate routine maintenance
- Single sideband suppressed carrier multiplex equipment
- Designed for reliable unattended operation, optional automatic switchover to standby equipment with fault alarm
- Rugged, permanently tuned mechanical filters for selectivity
- Flexibility of drop-outs
- Facilities may be expanded at minimum cost

The services of Collins microwave engineering staff are available for assistance in evaluating, planning or installing your microwave equipment.

Write Microwave Dept. C for descriptive literature.

COLLINS RADIO COMPANY OF CANADA, LTD.

74 Sparks Street
OTTAWA 4, ONTARIO



