

# **THE RADIO AMATEUR'S HANDBOOK**

**by A. FREDERICK COLLINS**

**REVISED BY E. L. BRAGDON**

# THE RADIO AMATEUR'S HANDBOOK

A COMPLETE  
AND PRACTICAL GUIDE TO RADIO  
CONSTRUCTION AND REPAIR *by*

**A. FREDERICK COLLINS** AUTHOR OF

WIRELESS TELEGRAPHY **EIGHTH EDITION**

**REVISED BY E. L. BRAGDON** RADIO

EDITOR OF THE NEW YORK SUN

NEW YORK  
**THOMAS Y. CROWELL COMPANY**

COPYRIGHT 1922, 1924, 1926, 1927, 1930, 1933, 1940

BY THOMAS Y. CROWELL COMPANY

ALL RIGHTS RESERVED. NO PART OF THIS BOOK MAY BE REPRODUCED  
IN ANY FORM EXCEPT BY A REVIEWER WHO MAY QUOTE BRIEF  
PASSAGES IN A REVIEW TO BE PRINTED IN A MAGAZINE OR NEWSPAPER

*Eighth Edition*  
*Sixth Printing*

MANUFACTURED IN THE UNITED STATES OF AMERICA

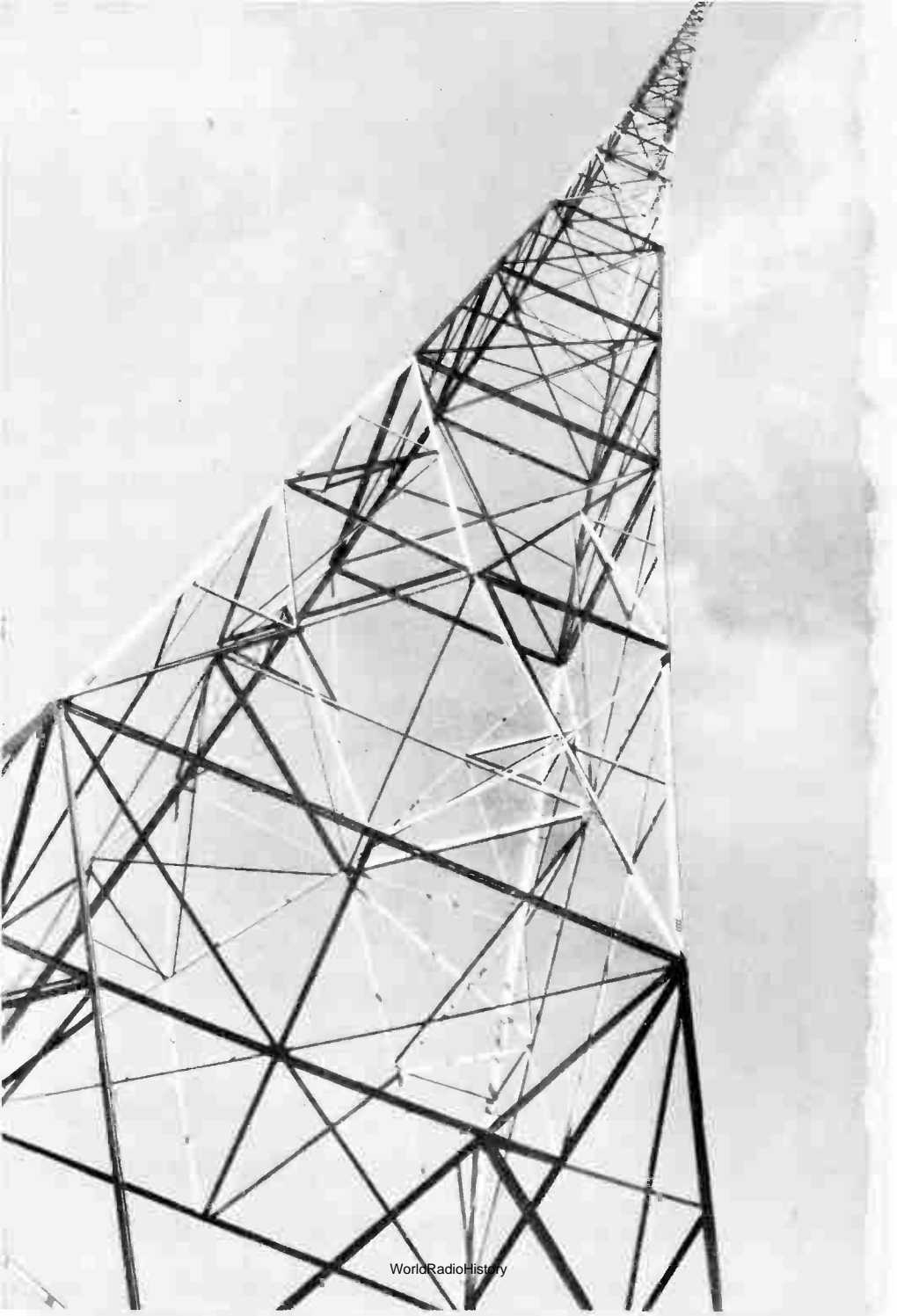

## PREFACE TO THE EIGHTH EDITION

---

IN any science which is as wide awake as radio there are changes going on all the time. The loose coupler and the highly temperamental crystal detector, once dear to the heart of every beginner, are scarcely known at all now, for they have been replaced by finer and more modern instruments. *The Radio Amateur's Handbook* itself has been constantly improved to keep abreast of the times.

Yet, through all its editions scrupulous care has been taken to keep the book a practical one, to keep it as simple as possible and *not* to assume that the reader already knows a great deal about the subject. The Eighth Revised Edition is a particularly thorough job. At every possible turn the old has been replaced by the new. More drawings have been added; diagrams have been redrawn; there are newly written chapters on television, facsimile and other up to the minute topics. Every word of the book has been reset.

We want to acknowledge with appreciation the assistance of the Meissner Manufacturing Company, the United Transformer Corporation, the RCA Manufacturing Company, and the National Board of Fire Underwriters, whose materials are reproduced.

THE PUBLISHERS

August 1, 1940

## CONTENTS

---

1	Fundamentals of Radio . . . . .	3
2	Erecting the Antenna . . . . .	15
3	Component Parts of Radio Equipment . . . . .	29
4	Electricity Simply Explained . . . . .	35
5	Mechanical and Electrical Tuning . . . . .	47
6	A Simple Vacuum Tube Receiving Set . . . . .	54
7	Operation of Vacuum Tube Receivers . . . . .	69
8	The Characteristics of Vacuum Tubes. . . . .	89
9	Headphones and Loud Speakers . . . . .	106
10	Power Supply . . . . .	119
11	Receiver and Amplifier Methods . . . . .	127
12	Assembling Your Own Radio Receivers . . . . .	141
13	A 15-Watt Audio Power High Gain Pushpull Amplifier . . . . .	179
14	Learning to Telegraph . . . . .	186
15	Wavelengths and Frequency Measurements . . . . .	190
16	A 20-Watt Radiotelephone and C.W. Transmitter	198
17	Ultra-High Frequencies . . . . .	213
18	The Photoelectric Cell and Its Uses . . . . .	226
19	Television . . . . .	240
20	Frequency Modulation . . . . .	251
21	Radio Facsimile . . . . .	260
	Appendix . . . . .	269
	Index . . . . .	329

## LIST OF INSERTS

---

Acorn tube . . . . .	104
Wincharger. A generator and windmill combined for recharging storage batteries . . . . .	122
Gascharger. A small gasoline engine directly connected to a generator for recharging storage batteries . . . . .	122
1-3 Tube Meissner Midget Receiver . . . . .	142
4-Tube A.C.-D.C. Meissner Tuned/ Radio Frequency Receiver . . . . .	154
Meissner 7-Tube Superheterodyne Receiver . . . . .	160
Meissner 6-Tube 6-Volt Battery Superheterodyne Receiver . . . . .	172
U. T. C. 15-Watt Audio Power High Gain Pushpull Amplifier . . . . .	180
The Teleplex for Teaching Code . . . . .	188
The Instructograph for Teaching Code . . . . .	188
The underside of the chassis of the Stancor 20-P Transmitter . . . . .	198
Rear view of Stancor 20-P Transmitter with cabinet removed . . . . .	198
The completed Stancor 20-P Transmitter . . . . .	202
The completed facsimile recorder as viewed from above . . . . .	264
RCA Characteristics Chart for Receiving Tubes . . . . .	278

# THE RADIO AMATEUR'S HANDBOOK



# FUNDAMENTALS OF RADIO

---

## CHAPTER 1

**S**INCE Guglielmo Marconi first published the results of his epic experiments in wireless telegraphy forty-three years ago, the art of radio has been of absorbing interest to a constantly increasing army of amateurs. There are many reasons for this attraction but it is probable that experimenters were drawn to the new industry in the majority of instances simply because they could acquire their experience in a perfectly normal manner by starting in a limited, inexpensive way, then expanding the scope of their activities as skill and knowledge came to them. Neither in the beginning of wireless nor in radio as we know it today is a great expenditure of money necessary for a start. As a matter of fact, any handy worker may easily assemble the majority of the parts needed for a workable apparatus even though radio manufacturers are now supplying all the necessities at prices that often make home construction inadvisable.

This book will attempt to guide the beginner from the fundamentals of the art through the somewhat more intricate multi-tube radio sets and amateur transmitters into the latest developments which embody television and facsimile apparatus. The radio world expands rapidly, spreading yearly into new fields, yet an understanding of the basic rules is all

that is necessary to appreciate each new application as it comes along. This is one of the reasons for the wide appeal of Marconi's discovery.

The earliest radio experimenters were forced to make their apparatus, step by step, but today there are stores in every large city where well-made components of high efficiency may be purchased at reasonable cost, thereby saving much time and trouble. Amateurs living in rural sections may obtain similar service from mail-order houses that have recognized the large number of persons, old as well as young, absorbed in the hobby and in consequence have created special departments to supply their wants. In addition, scores of individual manufacturers offer catalogs, booklets, data sheets, etc., containing information designed to smooth the path of the amateur. One of the first moves of every amateur should be the formation of a small library comprising modern books and other forms of publications to which he can refer when facing the need for authoritative facts. The cost is slight but the value is untold.

### **Radio Telephony and Radio Telegraphy**

Before proceeding further the reader should understand the scope of radio as applied to all forms of wireless communication. Actually, except for the means used to modulate or shape the electrical waves which carry the message or signal, there is but little difference between radio telephony and radio telegraphy. While a radio telegraph transmitter cannot always be used for telegraphy the reverse is not true. Any radio-telephone sending set can be used to transmit the dots and dashes of code. But for music and other intelligible sounds of any description, a microphone is essential before the variations in sound waves can be converted into the purely

electrical equivalents which are transmitted through the air. For code, a telegraph key suffices to chop the signals into the necessary long and short pulses that are internationally recognized as the Continental Morse Code.

### **Parts of Radio Systems**

In analyzing radio transmitters and receivers we find an interesting resemblance. Each unit embodies a source of energy, an amplifying means and an elevated wire called the antenna or aerial. In a transmitting system the antenna radiates the energy; in a receiver the raised wire collects the electrical pulses. The telegraph key or microphone gives a recognized shape or character to the signal so that it may be recreated at the receiving end by headphones or the more powerful loud speaker. In between the extremes of each unit are vacuum tubes each of which performs a distinctive function that will be described in detail in later chapters.

At one time the work of the vacuum tube was done by a jump spark or electric arc in the case of transmitters and a piece of natural crystal in the case of receivers but today these devices are seldom used. In the transmitting field, the arc and spark are outlawed because of their generally inefficient styles of operation, while the vacuum tube, because of its amazing flexibility and accomplishments, has become truly the Aladdin's Lamp of Radio.

The ultimate objective of every amateur is to own and operate a transmitting station in order to communicate with other amateurs, hundreds and even thousands of miles away, but before discussing this aspect of radio, the experimenter should acquire a solid groundwork in receiving apparatus, its theory, assembly, and operation. Once this has been accomplished it is a simple step to the acquisition of a government

license without which no station may be operated at any time or in any place. Violation of this rule carries with it a heavy penalty and possibly even more severe punishment.

### Simple Antenna

Whatever the type of receiving set used, some form of antenna is essential. For the simple receiver which we will discuss first, an equally simple antenna will be sufficient. This may take the form of a single wire strung in the open between two supports with one end as high as possible. Trees, buildings or poles will provide good supporting points. The receiver

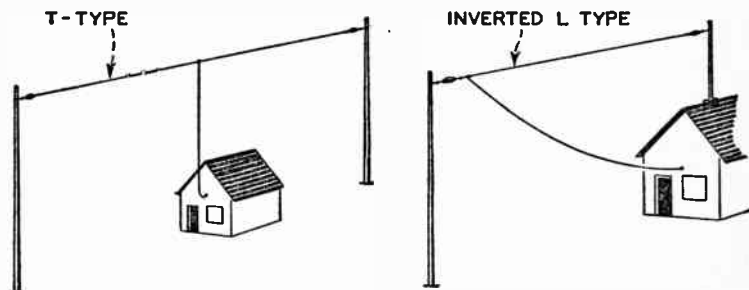

1. Two simple types of antennas most frequently used in reception

is then connected to the antenna by another single wire leading to one end or the center of the span. Although not the most efficient type of collector for all purposes the single wire L or T type will give good enough results until we are more advanced in our work. Modern forms of antennas including those advised for ultra high frequencies, television, and facsimile reception will be described later on.

In addition to the antenna, every receiving set requires a ground of some description. Usually a cold water pipe is handiest; but occasionally an earth connection of this nature

is not available. In such installations the amateur must "build" his ground by burying a piece of wire netting or copper plate in the dampest earth obtainable nearby his radio set. The depth of such a ground varies with the consistency of the soil but four feet is ordinarily sufficient. If preferred, a copper rod one-half inch in diameter may be driven into the earth to take the place of a water supply ground. However, the absence of an efficient ground does not mean so much today with our modern electric radio sets. A reasonably good earth connection is obtained through the power line. As a matter of fact, in the small a-c-d-c receivers this is the only ground used.

### **Simplest Receiving Set**

In the early days of wireless and even after broadcasting had commenced in 1920, the crystal was the accepted means of receiving radio signals but the perfection of the vacuum tube soon relegated the small pieces of silicon, galena, and carborundum to the status of museum exhibits. Today a crystal receiving set would have a range limited to a few miles and would be so lacking in its ability to distinguish between one station and another that it would provide no entertainment whatsoever. The same criticism applies to the cumbersome tuning coils, called loose couplers, which were once considered a necessary adjunct to every crystal set. Replacing these components are the vacuum tube, the small compact tuning inductance and the efficient variable condenser, a combination which is ever surprising experimenters who apply them in any of the circuits which have been devised for radio purposes.

The simplest receiving set consists of (1) a tuning coil, (2) a variable condenser, (3) a battery operated vacuum

tube, (4) batteries for filament and plate of tube, (5) small fixed condenser and resistance for grid leak, and (6) headphones. Under average conditions this simple collection of parts will detect signals originating many hundreds of miles away while, if the additional connection represented by the dotted line, *Fig. 2*, is combined with the basic set, the sensi-

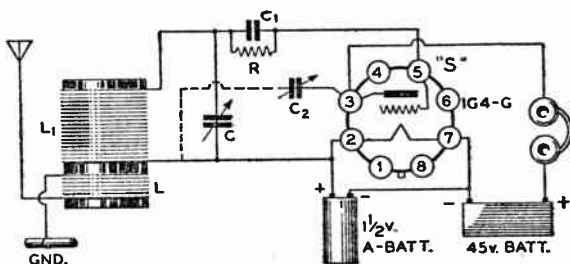

2. One-tube receiving set with regeneration supplied by the dotted circuit; several types of tubes may be used but for the beginner a 1G4-G is recommended because of its simplicity and low current drain.

L and L1 are fixed coils  
 C and C2 are variable condensers  
 C1 is a fixed condenser  
 R is a fixed resistance  
 S is an octal socket

tiveness of the little set is doubled or even tripled. But more of these circuits when the construction of actual sets is discussed.

Although the majority of receiving sets for broadcast reception comprise six tubes or more, a large percentage of amateurs have found that smaller sets and a pair of headphones work out to better advantage as far as code signals are concerned. The reason for this preference merits some space here.

Actually, a vacuum tube used as a detector in an efficient circuit has no limit to the distance over which it can detect a signal. It functions with such an infinitesimally small pulse of energy that no meters have yet been devised sensitive enough to operate on the transmitted energy. On this basis, then it would seem that any receiving set should be able to pick up a signal from the Antipodes at any time. This might be so if there were no electrical storms anywhere in the world, no motors, automobiles, hospitals, telephone lines, etc., for each of these classifications contributes to the cloud of "static" which permeates the atmosphere everywhere and limits the distance over which a radio station can be heard. The electrical noises generated wherever electric devices operate, pass through the air to any radio antennas that may lie in their path or frequently directly from one house to another through power and light lines. The character of both the foreign impulses and the radio signals are much the same, hence they are treated in the same way by any radio receiving apparatus they may happen to reach. It is then merely a question of which is the stronger. For normal reception, it is usually considered that the radio impulse must be at least four times as powerful as the noise in order to make reception agreeable to the listener. This relation between noise and signal is called the "signal-noise ratio" and it plays an important part in the design of all radio receiving apparatus. If too many stages of amplification are included in a receiver, the noise will increase in undue proportion to the signal and finally reach a point where the signal-noise ratio becomes too small to give good audible reception. This is why the great proportion of receivers both for the broadcast listener and the amateur are rarely supplied with more than one stage of audio-frequency

amplification. It also explains why many amateurs are satisfied with fewer tubes and a pair of headphones as against the broadcast listener with his multi-tube set and loud speaker.

### Types of Transmitters

There are several methods to use in producing a radio signal and transmitting it but the increased exactions of government agencies and the crowded condition of the usable channels have gradually outlawed all sources of radio energy excepting the vacuum tube. When radio was young, the majority of amateurs vibrated the ether with spark coils of various sizes. A few operated arc transmitters, and while the characteristics of both types sufficed in those days, the rapid progress of the art of radio which included the development of the vacuum tube, eventually emphasized the inefficiency of spark coil and arc as transmitters of oscillating energy. The spark coil produced a rough note under normal reception conditions and occupied too many cycles in the radio spectrum. It could not be tuned sharply and therefore was a frequent cause of interference between stations. The arc was better than the spark coil in some respects and might have come into wider use if the vacuum tube had not appeared on the scene. The tube was economical to operate, quiet and compact. Moreover, it could be embodied in a circuit which permitted extremely sharp tuning of the transmitted wave. More and more ships were adopting radio for communication purposes, thereby creating a problem of finding sufficient wave lengths for everyone with a minimum of interference. The vacuum tube was the solution.

As a result, spark coils and arcs are now outlawed for use by amateurs. Amateur stations must generate their energy



by means of tubes which are also further controlled as to wave length by small crystals ground to a definite frequency. In this way, the maximum number of amateurs succeed in conducting their conversations with the minimum of clashing and the commercial services are enabled to continue their radio traffic without finding it necessary to criticize amateurs because of their wandering from their legally proper frequency.

### **Requirements for a License**

The United States is the most lenient of all governments in its attitude toward radio amateurs, yet Federal supervision includes a series of regulations which are strictly enforced for the benefit of all users of the air. The first and most important of the rules requires that every owner and operator of a transmitter demonstrate his knowledge and fitness before being allowed to operate. This entails two licenses, one for himself and one for the station. Operating a transmitter without a license violates the law and is subject to heavy penalties. The licenses which are free are issued by the Federal Communications Commission after examinations conducted by its agents at any one of numerous offices established in the principal cities of the country.

The operator's license is based on a test of his knowledge of code plus an examination into his technical ability. The prospective amateur must be able to send and receive international code at the minimum rate of thirteen words a minute, each word being based on five characters. The written examination consists of a few basic questions covering radio theory, the construction and operation of radio receivers and transmitters, and the most important points in the radio law

and regulations. Any American citizen may own and operate an amateur radio station and the only physical infirmity which bars one from this interesting hobby is deafness.

The station license is the government's official acknowledgment of the individual's ability to operate without causing confusion in the ether spectrum and embodies the call letters by which he will be known to his radio confreres and the government. Both licenses must be available at all times when the station is being operated by its owner.

It is not necessary to own transmitting apparatus in order to obtain an operator's license but the station license will not be awarded until equipment has been assembled.

There are three classes of amateur operator licenses. Class A is the advanced grade. It grants all the privileges of the B and C licenses and in addition permits the holder to operate a radiophone transmitter in the restricted bands of 3,900-4,000 kilocycles and 14,150-14,250 kilocycles.

Class B and C licenses do not entitle the holder to operate a radiophone in the two frequency bands noted above. In other respects the privileges of the B and C licenses are identical with Class A privileges. The difference between a B and C license is that Class B is issued only when the license examination is taken in the presence of the radio inspector, while Class C is issued upon passing an examination by mail.

Only those persons who live more than one hundred and twenty-five miles (airline) from an examining point may take the mail examination and obtain a Class C license. As soon as the holder of a Class C license moves within one hundred and twenty-five miles of an examining point he must, within four months, take a Class B examination or forfeit his Class C license.

There are thirty-two examining points scattered about the

United States, one in Puerto Rico and one in Hawaii. Twenty-two of these are the regular Inspection Offices of the Federal Communications Commission and a list of them appears in the appendix of this book. Examinations are given at these points once or twice a week and quarterly in the following cities:

Cincinnati, Ohio	Pittsburgh, Pennsylvania
Cleveland, Ohio	St. Louis, Missouri
Columbus, Ohio	San Antonio, Texas
Des Moines, Iowa	Schenectady, New York
Nashville, Tennessee	Winston-Salem, North Carolina
Oklahoma City, Oklahoma	

At less frequent intervals similar examinations are held at:

Albuquerque, New Mexico	Jacksonville, Florida
Billings, Montana	Little Rock, Arkansas
Bismarck, North Dakota	Phoenix, Arizona
Boise, Idaho	Salt Lake City, Utah
Butte, Montana	Spokane, Washington

If you live within one hundred and twenty-five miles airline of any of the cities in the above list or any of the Offices of the Federal Communications Commission given in the appendix, you should write or visit the inspector of the district in which you live. Ask for an application blank for an amateur operator and station license and the date when examinations will be held in the city where you are to appear. Fill out the application form and return it to the inspector's office. Appear at the time specified for examination and you will be given a code test. If you pass this you will be given the written examination. Those who pass receive their combination license by mail several weeks later. Those who fail to pass are so notified and have the privilege of taking the examination again after an interval of two months.

If you live more than one hundred and twenty-five miles from any of the thirty-four examining points and do not care to appear for examination, write to the inspector of the district in which you live and ask for application blank, etc., for a Class C amateur operator. When you receive the application, it will be accompanied by a sealed set of examination questions and an instruction sheet. Do not open the sealed envelope containing the examination. Read the instruction sheet first and do exactly as it tells you.

Your code test must be given by a licensed Class A or Class B amateur operator, or a professional radio telegraph operator who will then certify whether or not you can send and receive code at the rate of thirteen words per minute. Your examination questions must be answered in writing before a witness who will open the sealed questions and certify that you wrote the answers without assistance. The application form and the examination are then returned to the Federal Communications Commission. If you have followed all the instructions and have passed the examination and test, you will receive your license in about three weeks. If you have failed, you will be notified and in two months you can try it again.

# ERECTING THE ANTENNA

---

## CHAPTER 2

IT IS doubtful if any individual component of an amateur station has been altered so radically in form as the antenna. When amateurs were not so closely supervised in their method of operation almost any elevated wire would do for both transmission and reception but as international governments moved the sphere of the amateur from 200 meters (1,500 kilocycles) to 100 meters and then to 80, 40, and 20 meters, it became evident that special types of transmitting antennas were essential if any distances were to be covered by radio signals. New types of receiving antennas were also in order but they were not so vital since signals could be received on almost any type of collector. But amateurs soon discovered that the best station in the world would not reach far if its antenna were erected in a haphazard manner. This applies to the sending of code as well as voice.

### Selection of Antenna Type

The type of antenna must be selected on the basis of its location and the desires of its owner. If short wave *reception* is the goal then one form of antenna, the duplex, is indicated. If amateur *transmission* is to be attempted the owner has a choice of several simple types of antennas or one of the more

elaborate forms which are highly recommended for their efficiency. On the other hand, if the receiving antenna must also be used occasionally for broadcast band reception, the amateur is no longer advised to erect a separate collector for these frequencies. The short wave duplex will provide plenty of signal strength, thanks to the high amplification or gain in the modern broadcast set.

Residents in thickly populated districts such as the apartment house sections of the larger cities are the ones who will find it most difficult to raise an antenna for transmission as well as reception, but particularly the former. Broadcast antennas are so thickly clustered on most structures today that it requires the skill of a magician to spot an area where another may be added. Then, too, if the projected antenna is for amateur transmission, much thought must be given to the possibilities of interference with the b.c.l., as amateurs refer to the broadcast listener. When b.c.l.'s discover an amateur interfering with their favorite comedian or news commentator they are prone to register a complaint with the nearest representative of the Federal Government's radio inspection force. Although the amateur may be working well within his rights, the government is likely to take the benign attitude that broadcast listeners being in the majority should be satisfied first. This means that the amateur is told to remain inactive until the interference can be eliminated in some way such as by a higher antenna or one that is stretched at some more distant spot. Knowing this, it behooves the man breaking into amateur radio to select his antenna location with the utmost care in order to forestall any of these irritating episodes. Even then, some further tests and alterations may be needed before perfect operation is assured.

Simple Antenna Types

The simplest antennas of all are the L or T types.

The L type is shown in *Fig. 3* and is better known as the Zeppelin or Zepp. It will be noted that while the double line

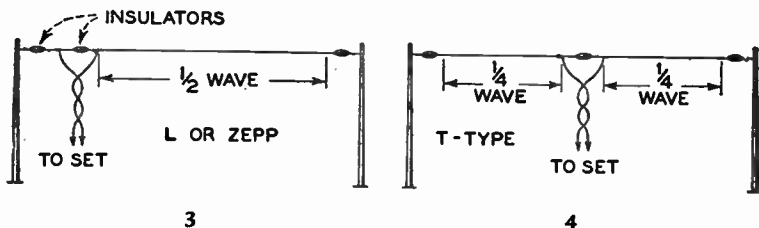

connecting the transmitter with the antenna is "alive" on both sides, one terminal only is connected to the horizontal wire, the other terminating or "dead-ending" between two insulators. The simplest form of the T antenna is indicated in

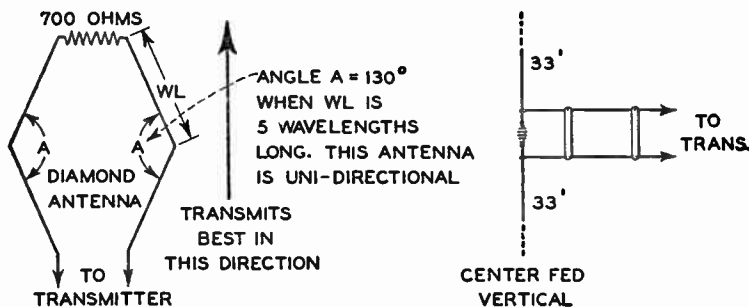

5

*Fig. 4* but there are numerous variations which the amateur may try out for better radiation after the transmitter is in working order.

Because of the greater space demanded and the difficulties

encountered in long antennas the length of the elevated wires is usually kept at a minimum consistent with efficiency. Usually, the beginner starts with a half wave antenna, that is, with the total length equal to one-half the wave length he intends to use. This does not mean that it will be necessary to erect a separate antenna for each frequency used since the amateur bands have been chosen in exact multiples so that a one-half wave antenna for 40 meters is a full wave length for 20 meters. Actually, satisfactory radiation will be obtained even if the matching is not perfectly accurate but eventually the amateur will discover the two bands on which he prefers to operate and adjust his radiators for best results on those frequencies.

For a simple half wave antenna the computations are not at all difficult. Since a meter is equal to 39.37 inches the proper overall length for 40 meter transmission would be 20 ( $\frac{1}{2}$  of 40 meters) times 39.37 inches or 65.6 feet long. On the same basis the length of wire for the 80 meter band, assuming a half wave antenna, would be 131 feet.

Where space is extremely limited such as in populated cities it is often necessary to use a quarter wave radiator which would halve the figures given above for the corresponding operating frequencies.

Experienced amateurs have expended so much thought on efficient antennas that the variations are almost beyond number. In addition to the two basic types mentioned previously there are other forms known as "V," Bent, Vertical, Rhombic, and Rotary to name only a few. Since each type has special applications and requires more extensive knowledge of the fundamentals of radiation it is not possible to treat each style here. The amateur, when he is ready for this phase of his hobby, should obtain one of the several excellent treatises on



this subject and then carry out his experiments with the aid of instruments which he will have acquired. At the start he is advised to select the simplest of the many forms and concentrate on that until his operating technic has reached the point where he can proceed with full knowledge of his aims. Too many amateurs have become discouraged by attempting to swim beyond their technical depth when the hobby is new and relatively obscure.

### Feeder Lines to the Antenna

Once the amateur has made his selection of antenna type he will be concerned with the problem of feeding the transmitter energy to the radiator with the least loss of energy along the way. This brings up the subject of "feeder lines."

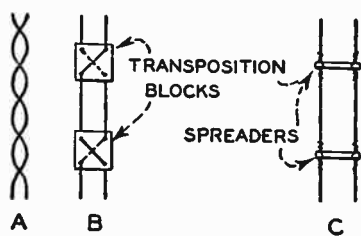

6

Feeders are the wires—or sometimes a single wire—leading from the output of the transmitter to the antenna. These may be the twisted pair shown in *Fig. 6-A*, the transposed feeder of *Fig. 6-B*, or the parallel feeder of *Fig. 6-C*. Here again, assuming that the beginner will be content to start with low power, the simplest form is the best. This is the twisted pair. The principal warning here is to secure the best quality of conductor available. The insulation in particular must consist of good, live rubber and the conductors should be at least #16 in size.

Another widely used form of transmission line feeder comprises two conductors separated from 4 to 6 inches by insulating spreaders. See *Fig. 6-C*. One type is known as the Q antenna and consists of two parallel conductors of rather heavy dimensions connected to the center points of a half wave antenna as in *Fig. 6-C*. This arrangement is somewhat more complicated since a definite relation exists between the

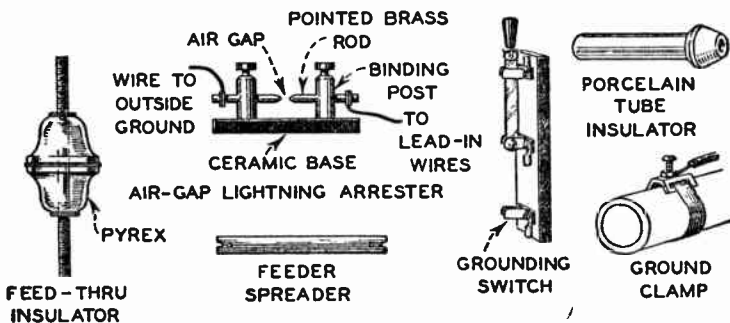

7. Some of the necessary equipment for an antenna

lengths of the antenna proper and feeder lines and the spacing between the latter. The preferred dimensions of these items have been worked out theoretically and are given in detail in the publications on antennas mentioned previously.

### Protection of Antenna

Transmitting antennas not only carry a high voltage requiring adequate protection of life and property but they are also erected in the open where they are subject to direct and induced strokes of lightning. This means that the amateur must arrange for suitable termination of the feeder lines at the house end supplemented by approved lightning protective devices. In the open country the latter precaution is not only

desirable but mandatory because of insurance regulations.

Since the feeder lines, whatever the type used, must be prevented from undue swaying because of its effect on the stability of the radiated signals, it is vital that the lower terminals be anchored to sturdy supports near the point where the wires enter the transmitting room. Many amateurs use stiff coil springs between each feeder line and the eyelet or

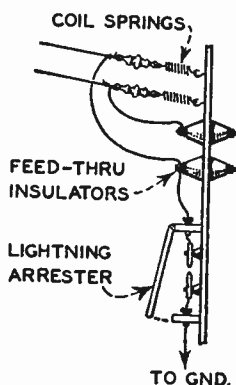

8. Only one arrester layout is shown

other anchor adopted. This makes for a secure, permanent terminus for the lines. A wire is then attached to each down lead adjacent to the insulator separating feeder and coil spring and carried downward to the standoff insulator through which the antenna passes on its way to the inside room. One way of doing this is shown in *Fig. 8*. It should be kept in mind that the feeder lines, if spaced, should be maintained with this identical spacing at all times even when passing through the walls of the house. Where conditions permit, the standoff insulator may be attached to the glass window pane by means of holes drilled through the glass. However, house panes if of

large area will not have the ruggedness to withstand the strain and must be replaced with plate glass of substantial thickness when this method of entry is preferred.

For the sake of safety and efficiency it is recommended that the feeder lines inside the transmitting room be carried direct and with the minimum of supports to the output terminals of the transmitter. Certainly they should be kept high and out of reach of inquisitive visitors.

In installing lightning protection it is a wise amateur who foregoes any attempt to be economical. Lightning arresters for amateur use are available at any store dealing in radio accessories and they should be procured in preference to home-made gaps. For efficient operation these devices should be enclosed in an asbestos-lined box or in one of the ample-dimensioned outlet boxes made of metal and sold in electrical supply stores. Under any circumstances an outside ground entirely independent of the transmitter and receiver grounds must be established. This may be a four-foot copper rod driven into the earth directly beneath the lightning arresters and connected with the latter by heavy copper conductors which pass downward without sharp bends.

Another precautionary measure is the installation of grounding switches inside the transmitting room at the point where the feeder or feeders enter. Usually these are manually operated and are thrown to the ground position at all times when the station is not in operation.

Because of the many special problems involved, the Bureau of Standards has prepared a valuable booklet on "Safety Rules for Radio Installations" which may be obtained from the Superintendent of Documents, Government Printing Office, Washington, D.C., at a cost of ten cents. Every amateur should procure a copy before commencing his operations.

## The Receiving Antenna

So far the transmitting antenna has received prominence in the text because of the necessity for getting the maximum amount of generated energy into the radiating antenna. A few per cent of gain in the transmitting antenna well repays the amateur for his efforts and may mean the difference of hundreds and even thousands of miles in the distance covered. The receiving antenna on the other hand is not so important on the short waves. Inspection of many amateur stations reveals that an indoor wire is sufficient to pick up most of the other amateur stations which can be reached by the transmitter. This however, is not to be recommended generally. As a matter of fact it is not always necessary to erect a separate collector for received signals. The transmitting antenna installed properly provides the owner with an excellent receiving antenna, a simple switching device being all that is required to shift the outside radiator from transmitter output to receiver input.

In the beginner's installation the switchover is handled by a manually operated switch arranged in such a manner that there is no chance for receiver and transmitter to become interconnected. In more advanced installations, the switchover takes place by means of relays so connected as to shift from receiver to transmitter automatically. Here again the problems involved both from the standpoint of safety as well as utility suggest that the beginner adopt the hand operated changeover switch until he has mastered the intricacies of the art.

Where it is believed desirable to erect a separate antenna for receiving it will be found preferable to place it as far as possible from the transmitting antenna and at right angles.

to it. Obviously with the transmitter radiating considerable energy any receiving antenna nearby will pick up a signal far greater in intensity than that received from a typical broadcasting station and the impulses accordingly will crash into the receiver unless thwarted. Since the receiver is functioning at all times while the transmitter is active amateurs usually arrange for some form of silencing circuit on earphones or loudspeaker when calling. This may be a shortcircuiting relay

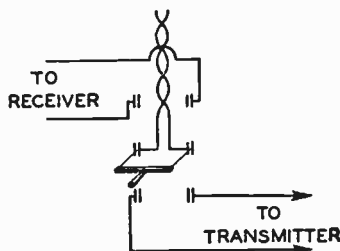

9

on the receiver input or an open circuiting switch on the phone leads. These accessories are normally installed to operate in conjunction with the key or by means of a hand or foot controlled device.

The simplest switching device between transmitter and receiver is shown in *Fig. 9*, but as his skill increases and his knowledge of radio technic expands the amateur will develop his own system for accomplishing the same ends.

There is no difference between the antenna used for amateur reception and that found best for all-wave broadcast reception. For the reasons outlined above, the most condensed collector will provide the best reception under all conditions. Thus the familiar double doublet consisting of a wire about sixty-five feet in length, split in the middle, and connected to

the receiver by a twisted pair will be found to perform satisfactorily. Modern short wave receiving circuits and tubes have been so highly developed in their effects on sensitivity and selectivity that a usable signal from great distances can be detected when almost any type of antenna is employed. The only limiting factor is the noise that is customarily found on the high frequency bands. This noise may be due to atmospheric disturbances—otherwise known as static—or it may come from electrical devices such as automobile ignition systems, defective power lines, diathermic apparatus, and domestic appliances including oil burners, vacuum cleaners, electric shavers, etc. With these noise-making sources on the increase it behooves the amateur to select the antenna that picks up the maximum signal and the minimum noise. The double doublet is one of the types that meets these demands.

### **Theory of Double Doublet**

Tests have shown that the majority of spurious noise impulses are picked up by the antenna lead-in. There are several reasons for this including the fact that much of the man-made static that infests the air is vertically polarized and therefore exerts its greatest effects on vertical collectors. Another reason is that the lead-in by its very nature is closest to the earth where the majority of the sources are located, whereas the antenna is likely to be elevated above the zones of greatest noise intensity. Realizing this situation it is easy to understand that if the lead-in can be made noise-free the desired signal in the antenna will reach the receiver at an intensity that will override the unwanted impulses. This condition can be established by using two lead-in wires, one from each half of the antenna, twisted around each other throughout their entire length from antenna to terminals of receiver. The radio

signals in each half of the doublet are  $180^\circ$  out of phase with the other which means that when the signal in one half is maximum, the other half is minimum, thus they pass down the lead-in to the receiver without any mutual effect. The noise on the other hand is impressed on the two conductors of the lead-in simultaneously and induce equal voltages in both wires. Then by twisting the wires continually a transposing effect is produced with one signal voltage canceling the other.

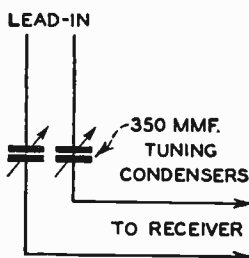

10

In the majority of double doublets of the manufactured type, the length of lead-in supplied with the kit has been matched to the antenna for optimum results and the user is warned not to remove the excess length but to coil it up and hang it behind the receiver. However, in practice it will be found that a considerable number of feet can be removed without having a discernible effect on the received signal.

Where the utmost in receiving efficiency is desired a tuning arrangement on the receiver end of the lead-in has been found extremely useful. One form frequently employed is shown in *Fig. 10* where a small variable condenser is inserted in each side of the lead-in. By trial, the amateur will soon find the best relative setting for each condenser for the individual bands to which he tunes.



### **The Ground System**

Every radio system whether for sending or receiving requires some form of connection with the earth. For the receiver the demands are not exacting. A cold water pipe to which a ground clamp is first attached will do for all purposes, but if the stretch of wire needed to reach such a pipe is extreme, a steam pipe will often do as well. Keep away from all fuel lines such as oil and gas for obvious reasons. If the home is in a remote location or in rural areas where water and steam piping are not available, establish your own ground by driving a rod into the dampest earth immediately available. The effect will often be equal to that of the more elaborate earthing methods. Direct grounds are not always essential to operation as witness the case of a-c-d-c receivers which are not equipped with a ground wire, but the tenets of safety call for adequate grounding in some manner, particularly in amateur work.

For the transmitter, where a direct ground connection is advised, recourse should be had to a cold water pipe or to an outside earth contact. When the transmitter chassis serves as an immediate neutral point for all current returns, the operator should see that the metal of the chassis is connected with a ground in order that any accidental disarrangement of the high voltage components does not set up a voltage difference between chassis and earth, a condition that might lead to a fatal shock through careless operation of the equipment.

### **Some Antenna Precautions**

In latitudes where sleet is likely to collect on exposed wires don't stint on the size of wire used. Number 12 enameled covered copper wire with a steel core will withstand almost

any tension that will be applied to it under any seasonal condition. Moreover, it will not stretch or sag.

Never use a power line pole for an antenna support.

Don't run the transmitting antenna parallel to a nearby power line, or over or under other wires.

Protect the external feeder line terminals including lightning protective devices against easy access by children or even adults. Safety will be promoted by keeping such apparatus as high as possible above ground. In addition, place a sign, "High Voltage: Dangerous," on or near the feeder lines both inside and outside the transmitting room.

Don't adjust the antenna until you have taken every precaution against the accidental or unexpected application of transmitter power. It is only when every care has been taken against accident that amateur radio becomes an enjoyable hobby rather than a hazardous experiment.

# COMPONENT PARTS OF RADIO EQUIPMENT

---

## CHAPTER 3

**WHEN** the art of radio was new, a receiving set consisted of (1) an antenna, (2) a tuning circuit usually comprising a variable inductance or tuning coil, (3) a piece of natural crystal as a rectifier or detector, (4) a pair of headphones, and (5) one or two small fixed condensers. Seldom was it necessary to use a battery or other power source although some crystal detectors worked better with a low voltage primary cell. The passage of time with the natural development of substitutes for most of the aforementioned components has made the crystal receiver a mere museum exhibit. The tuning coil or loose coupler, as it was termed, was both inefficient in the forms then available and bulky besides. Of the equipment used in pioneer stations, only the headphones remain as an essential part of amateur apparatus and even then only as an adjunct to the loud speaker for the reception of extremely weak signals.

Similarly, the transmitter has passed through innumerable stages with the amateur station of today bearing no resemblance whatsoever to the bulky, inefficient, and noisy stations of yesteryear. For one thing, the spectacular crash of the spark gap is no longer heard. Governments outlawed that item

because it contributed to chaos in an ether that was rapidly becoming over-populated with radio services of a dozen different types. To take its place, scientists perfected the vacuum tube which, operating almost silently, managed to originate, modulate, and transfer much greater volumes of power in much smaller space. The rise of amateur radio is coincidental with the introduction and perfection of the vacuum tube.

### Components of Receivers

Instead of the variable tuning inductance for selecting the desired wave length, amateurs now depend mainly on fixed inductances and variable condensers. This combination not only gives finer control but the relation between inductance and capacity can be held at the point of maximum efficiency. In short wave work, this ideal is approached by changing the value of the inductance in the circuit by shifting coils as the switchover is made from one band of frequencies to another. Exchangeable coils, called plug-in coils, came into use first because of the electrical losses encountered when several sets of coils were interconnected with a selector switch. However, in the last few years, low loss switches have been developed which overcame this drawback. As a result, the majority of modern receivers comprises an array of four or five sets of coils so placed in an assembly that a rotary switch selects the group desired for a given frequency range.

### Condensers, Fixed and Variable

Condensers are of several types, fixed as well as variable in capacity. The variable condenser consists of a series of metal plates, one set fixed and the other variable, and so disposed that the latter interleave with the former when the common shaft is rotated. The plates may be semi-circular in

shape or they may take odd shapes, depending on the purpose for which they are to be used. New insulating materials have been discovered which produce variable condensers with extremely low electrical loss. This means sharper tuning and stronger signals. In addition, modern manufacturing methods have made it possible to reduce the spacing between the plates and thereby gain the desired capacitance in less space.

The modern radio receiver embodies a number of fixed capacities to accomplish a variety of effects. The fixed condenser may be a combination of a conductor, usually aluminum or tin foil, with mica or paper as a dielectric or separator. Or it may be one of the forms of electrolytic condensers in which the dielectric is formed by the effect of electric charges on a moist or wet chemical. The latter are commonly employed where large capacities must be compressed into a small space.

Mica type fixed condensers should be chosen where the extremes of voltage are high, the paper type where the voltages are more moderate, although paper dielectric condensers are available for almost any purpose today. These capacities are usually inserted in radio circuits to by-pass currents of low voltage and of certain frequencies or to balance resonant circuits with other variable capacities.

Electrolytic condensers will be found in the filter circuits of power supplies where large capacities are essential in smoothing out the ripples in rectified alternating currents. One basic limitation of these condensers requires that they be used only where the dominant current is direct. An electrolytic condenser will be ruined speedily if subjected to an alternating current.

Because of their chemical make-up electrolytic condensers possess the property of self-healing if through an unusual con-

dition the dielectric film is broken down. Mica and paper condensers must be discarded once they have been punctured by a voltage exceeding their rated value. On the other hand, an electrolytic condenser must never be located too near a source of intense heat such as a rectifier tube since the film will be destroyed and the voltage limit thereby reduced.

## Resistors

Accurate resistors are employed frequently in all receiving and transmitting sets. They are rated by the watts of electrical energy which must pass through them. They may be formed

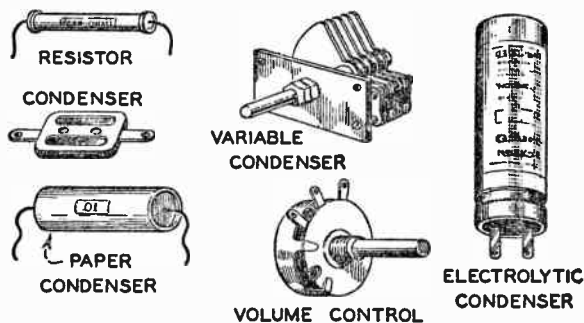

II

from compressed carbon mixtures or they may take the form of many turns of fine wire wound around an insulating rod. The exact type needed is invariably specified in the construction of any piece of radio apparatus. One type of resistance is the variable volume control which alters the voltage in any one of several circuits to establish the desired signal gain. These potentiometers, for that is what they are, are sometimes made by winding a large number of turns of very fine wire on a circular form with a sliding contact operated through a shaft to vary the tapping point of the voltage network. Other styles

comprise impregnated fiber with a similar sliding contact moving around the periphery of the control. There are innumerable other styles of both condensers and resistors, all of which follow the basic outlines given here, but since the variations have been developed for special purposes it would not aid the amateur to outline them at this time. As refinements in receiver and transmitter are conceived the need for an unusual component will arise but by that time the amateur will have made himself acquainted with the field and will know the exact type for his work.

### **Headphones**

At one time there was a continual controversy over the best type of phones to use in amateur reception but so many other factors are more important today that it is sufficient to point out that headphones made by any reputable firm, with a total weight that is not unbearable and a resistance of either 2,000 or 3,000 ohms, will perform to the full satisfaction of the amateur. As a matter of fact, the amateur operator will soon discover that modern tubes and circuits will create an audible signal from far distant stations sufficient in strength to operate a loud speaker, thereby eliminating the need for headphones altogether. It is only in periods of heavy atmospheric noise when the audio gain of a loud speaker circuit amplifies the noise out of all proportion to the radio signal that recourse must be had to phones. With better antennas and more powerful transmitters, these periods will occur with lessening frequency.

### **Getting the Most Out of Your Hobby**

In the preceding pages, you have been introduced to radio and have become acquainted with receiving sets in their

simplest form. In order to understand the assembly and operation of more elaborate receivers and of transmitters it is necessary to be familiar with some of the elementary principles of physics and electricity. Of course you can follow instructions implicitly and succeed in assembling receiving sets and you can learn to turn knobs in mechanical fashion without any knowledge of electricity. But if you wish to experiment intelligently and enjoy your hobby to the utmost learn all that you can about the elementary principles upon which it all is based.

The next two chapters therefore deal with electricity and electrical tuning. Since it is impossible to discuss electricity thoroughly in such a limited space, the reader is urged to consult also one of the many books on this subject to be found in the public libraries.



# ELECTRICITY SIMPLY EXPLAINED

---

## CHAPTER 4

IT IS easy to understand how electricity behaves and what it does if you get the right idea of it at the start. In the first place, if you will think of electricity as being a fluid like water, its fundamental actions will be greatly simplified. Both water and electricity may be at rest or in motion. When at rest, under certain conditions, either one will develop pressure, and this pressure when released will cause them to flow through their respective conductors and thus produce a current.

### Electricity at Rest and in Motion

Any wire or a conductor of any kind can be charged with electricity, but a Leyden jar, or other condenser, is generally used to hold an electric charge because it has a much larger *capacitance*, as its capacity is called, than a wire. As a simple analogy of a condenser, suppose you have a tank of water raised above a second tank and that these are connected together by means of a pipe with a valve in it, as shown at A in *Fig. 12*.

Now if you fill the upper tank with water and the valve is turned off, no water can flow into the lower tank but there is a difference of pressure between them, and the moment you

turn the valve a current of water will flow through the pipe. In very much the same way when you have a condenser charged with electricity the latter will be under *pressure*, that is, a *difference of potential* will be set up, for one of the sheets of metal will be charged positively and the other one, which is insulated from it, will be charged negatively, as shown at *B*.

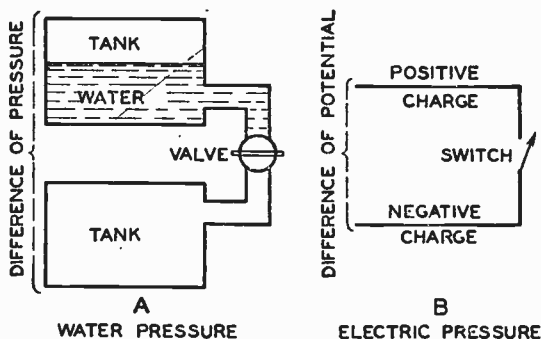

12. Water analogy for electric pressure

On closing the switch the opposite charges rush together and form a current which flows to and fro between the metal plates.<sup>1</sup>

### An Electric Current and Its Circuit

Just as water flowing through a pipe has *quantity* and *pressure* back of it and the pipe offers friction which tends to hold back the water, so, likewise, does electricity flowing in a circuit have: (1) *quantity*, or *current strength* (or just *current*, as it is called for short), or *amperage*, and (2) *pressure*, or *potential difference*, or *electromotive force*, or *voltage*, as it is variously called, and the wire, or circuit, in which the

<sup>1</sup> Strictly speaking, it is the difference of potential that sets up the electromotive force.

current is flowing has (3) *resistance* which tends to hold back the current.

A definite relation exists between the current, the electromotive force and the resistance of the circuit; and if you will get this relationship clearly in your mind you will have a very good insight into how direct and alternating currents

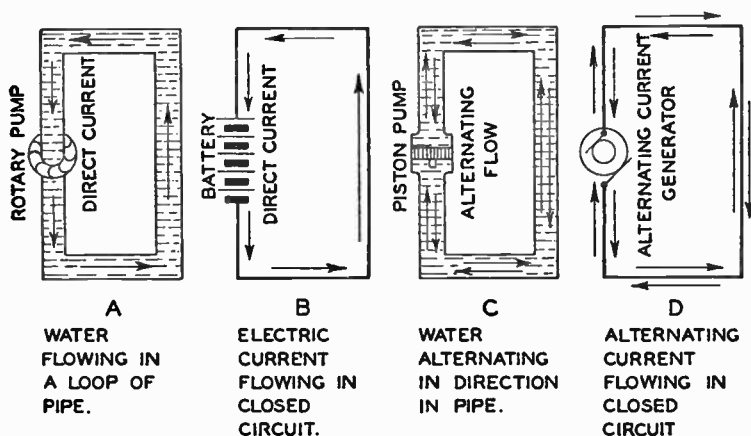

13. Water analogies for direct and alternating currents

act. To keep a quantity of water flowing in a loop of pipe, which we will call the circuit, pressure must be applied to it and this may be done by a rotary pump as shown at *A* in *Fig. 13*; in the same way, to keep a quantity of electricity flowing in a loop of wire, or circuit, a battery or other means for generating electric pressure must be used, as shown at *B*.

If you have a closed pipe connected with a piston pump, as at *C*, as the piston moves to and fro the water in the pipe will move first one way and then the other. So also when an alternating current generator is connected to a wire circuit, as at *D*, the current will flow first in one direction and then in the other, and this is what is called an *alternating current*.

## Current and the Ampere

The amount of water flowing in a closed pipe is the same at all parts of it and this is also true of an electric current, in that there is exactly the same quantity of electricity at one point of the circuit as there is at any other.

The amount of electricity, or current, flowing in a circuit in a second is measured by a unit called the *ampere*,<sup>1</sup> and it

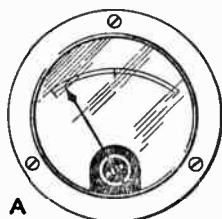

A

AMMETER



B-AMMETER CONNECTED IN CIRCUIT

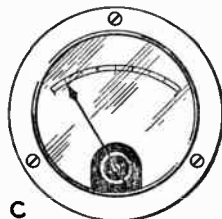

C

VOLTMETER

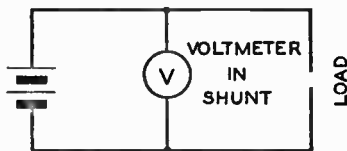

D-VOLTMETER CONNECTED ACROSS THE CIRCUIT

### 14. How the ammeter and voltmeter are used

is expressed by the symbol  $I$ .<sup>2</sup> Just to give you an idea of the quantity of current in an *ampere*, we will say that a dry cell when fresh gives a current of about 20 amperes. To measure the current in amperes an instrument called an *ammeter* is used, as shown at *A* in *Fig. 14*, and this is always connected in *series* with the line, as shown at *B*.

<sup>1</sup> For definition of *ampere* see *Appendix*.

<sup>2</sup> This is because the letter *C* is used for the symbol of *capacity*.

## Electromotive Force and the Volt

When you have a pipe filled with water or a circuit charged with electricity and you want to make them flow you must use a pump in the first case and a battery or a dynamo in the second case. It is the battery or dynamo that sets up the electric pressure as the circuit itself is always charged with electricity.

The more cells you connect together in *series* the greater will be the electric pressure developed and the more current it will move along just as the amount of water flowing in a pipe can be increased by increasing the pressure of the pump. The unit of electromotive force is the *volt*, and this is the electric pressure which will force a current of *1 ampere* through a resistance of *1 ohm*; it is expressed by the symbol *E*. A fresh dry cell will give a reading of about 1.5 volts. To measure the pressure of a current in volts an instrument called a *voltmeter* is used, as shown at *C* in *Fig. 14*, and this is always connected across the circuit, as shown at *D*.

## Resistance and the Ohm

Just as a water pipe offers a certain amount of resistance to the flow of water through it, so a circuit opposes the flow of electricity in it and this is called *resistance*. Further, in the same way that a small pipe will not allow a large amount of water to flow through it, so, too, a thin wire limits the flow of the current in it.

If you connect a *resistance coil* in a circuit it acts in the same way as partly closing the valve in a pipe, as shown at *A* and *B* in *Fig. 15*. The resistance of a circuit is measured by a unit called the *ohm*, and it is expressed by the symbol *R*. A #10, Brown and Sharpe gauge soft copper wire, 1,000

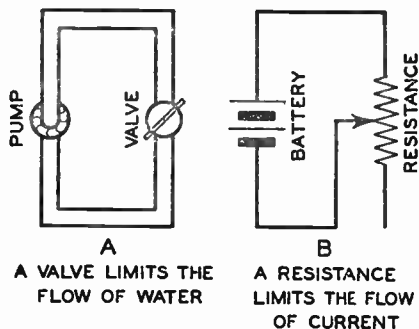

### 15. Water valve analogy of electrical resistance

feet long, has a resistance of about 1 ohm. To measure the resistance of a circuit an apparatus called a *resistance bridge* is used. The resistance of a circuit can, however, be easily calculated, as the following shows.

#### What Ohm's Law Is

If, now, (1) you know that the current flowing in a circuit is in *amperes*, and the electromotive force, or pressure, is in *volts*, you can then easily find what the resistance is in *ohms* of the circuit in which the current is flowing by this formula:

$$\frac{\text{Volts}}{\text{Amperes}} = \text{Ohms, or } \frac{E}{I} = R$$

That is, if you divide the electromotive force in volts by the current in amperes the quotient will give you the resistance in ohms.

Or (2) if you know what the electromotive force of the current is in *volts* and the resistance of the circuit is in *ohms* then you can find what the current flowing in the circuit is in *amperes*, thus:

$$\frac{\text{Volts}}{\text{Ohms}} = \text{Amperes, or } \frac{E}{R} = I$$

That is, by dividing the electromotive force in volts by the resistance of the circuit in ohms you will get the amperes flowing in the circuit.

Finally (3) if you know what the resistance of the circuit is in *ohms* and the current is in *amperes* then you can find what the electromotive force is in *volts* since:

$$\text{Ohms} \times \text{Amperes} = \text{Volts, or } R \times I = E$$

That is, if you multiply the resistance of the circuit in ohms by the current in amperes the result will give you the electromotive force in volts.

From this you will see that if you know the value of any two of the constants you can find the value of the unknown constant by a simple arithmetical process. This relation between these three constants is known as *Ohm's Law* and it is very important that you should memorize it.

### What the Watt and Kilowatt Are

Just as *horsepower*, or *H.P.*, is the unit of power indicating the rate at which steam can do work, so the *watt* is the unit of power indicating the rate at which an electric current can perform work. To find the *watts* developed by the flow of an electric current you need only to multiply the *amperes* by the *volts*. There are 746 *watts* to 1 *horsepower*, and 1,000 *watts* are equal to 1 *kilowatt*.

### Electromagnetic Induction

To show that a current of electricity sets up a magnetic field around it you have only to hold a compass over a wire whose ends are connected with a battery. The needle will swing at right angles to the length of the wire. By winding an

insulated wire into a coil and connecting the ends of the latter with a battery you will find, if you test it with a compass, that the coil has developed magnetic properties.

This is due to the fact that the energy of an electric current flowing in the wire is partly changed into magnetic lines of

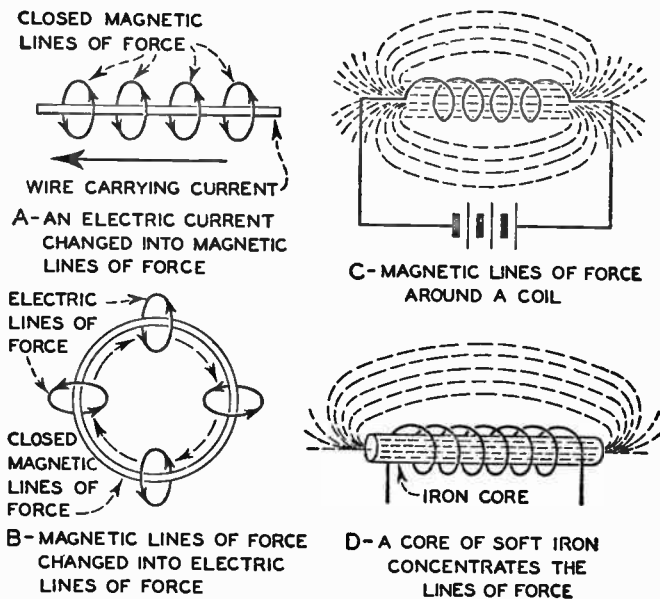

16. Illustrating one of the most important electrical properties of a wire and showing the effect on the magnetic lines of force when an iron core is inserted in the coil

force which rotate at right angles about it as shown at *A* in *Fig. 16*. The magnetic field produced by the current flowing in the coil is precisely the same as that set up by a permanent steel magnet. Conversely, when a magnetic line of force is set up a part of its energy goes to make up electric currents which whirl about in a like manner, as shown at *B*.



### Self-induction or Inductance

When a current is made to flow in a coil of wire the magnetic lines of force produced are concentrated, as at *C*, so that each turn of wire sets up action in the one next to it, and this action is called *self-induction*, *self-inductance* or just *inductance*. The self-induction, or inductance, forms a concentrated *magnetic field*, see *C*, as it is called, and if a bar of soft iron is slipped into the coil it will be magnetized, as at *D*, and it will remain a magnet until the current is cut off.

### Mutual Induction

When two loops of wire, or better, two coils of wire, are placed close together the electromagnetic induction between them is reactive; that is, when a current is made to flow through one of the coils, closed magnetic lines of force are set up and when these cut the other loop or turns of wire of the other coil, they in turn produce electric currents in it.

It is the mutual induction that takes place between two coils of wire which makes it possible to transform *low-voltage currents* from a 110-volt source of alternating current into high-pressure currents, or *high-potential currents*, as they are called, by means of a spark coil or a transformer.

### High-Frequency Currents

High-frequency currents, or electric oscillations as they are called, are currents of electricity that surge to and fro in a circuit a million times, more or less, per second. Currents of such high-frequencies will *oscillate*, that is, surge to and fro, in an *open circuit*, such as an antenna system, as well as in a *closed circuit*.

### Constants of an Oscillation Circuit

An oscillation circuit, as pointed out before, is one in which high-frequency currents surge or oscillate. Now the number of times a high-frequency current will surge forth and back in a circuit depends upon two factors called the constants of the circuit, namely: (1) its *capacity*, and (2) its *inductance*.

#### What Capacity Is

The word *capacity* means the *electrostatic capacity* of a condenser or a circuit. The capacity of a condenser or a circuit is the quantity of electricity which will raise its pressure, or potential, to a given amount. The capacity of a condenser or a circuit depends on its size and form and the materials of which it is made.

The capacity of a condenser or a circuit is directly proportional to the quantity of electricity that will charge it to a given potential. The *farad* is the unit of capacity and a condenser or a circuit to have a capacity of one farad must be of such size that one *coulomb*, which is the unit of electrical quantity, will raise its charge to a potential of one volt. Since the farad is far too large for practical purposes, a millionth of a farad, or *microfarad*, whose symbol is *mfd.*, is used.

#### What Inductance Is

Under the sub-caption of *Self-Induction* and *Inductance* in the beginning of this chapter it was shown that it was the inductance of a coil that makes a current flowing through it produce a strong magnetic field, and here, as one of the constants of an oscillation circuit, it makes a high-frequency current act as though it possessed *inertia*.

Inertia is that property of a material body that requires

time and energy to set in motion, or stop the body. Inductance is that property of an oscillation circuit that makes an electric current take time to start and time to stop. Because of the inductance, when a current flows through a circuit it causes the electric energy to be absorbed and changes a large part of it into magnetic lines of force. Where high-frequency currents surge in a circuit the inductance of it becomes a powerful factor. The practical unit of inductance is the *henry* and it is represented by the symbol *L*.

### What Resistance Is

The resistance of a circuit to high-frequency currents is different from that for low-voltage direct or alternating currents, as the former do not sink into the conductor to nearly so great an extent; in fact, they stick practically to the surface of it, and hence their flow is opposed to a very much greater extent. The unit of resistance is, as stated, the *ohm*, and its symbol is *R*.

### Effect of Capacity, Inductance and Resistance on Electric Oscillations

If an oscillation circuit in which high-frequency currents surge has a large resistance, it will so oppose the flow of the currents that they will be damped out and reach zero gradually, as shown at *A* in *Fig. 17*. But if the resistance of the circuit is small—and in radio circuits it is usually so small as to be negligible—the currents will oscillate until their energy is damped out by radiation and other losses, as shown at *B*.

As the capacity and the inductance of the circuit, which may be made of any value you wish, determine the *time period*, that is, the length of time for a current to make one complete oscillation, it must be clear that by varying the

values-of the condenser and the inductance coil you can make the high-frequency current oscillate as fast or as slow as you

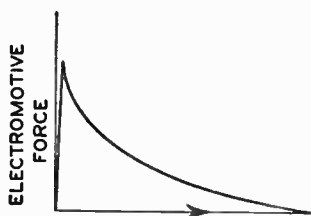

A-ELECTRIC DISCHARGE  
THROUGH A LARGE  
RESISTANCE

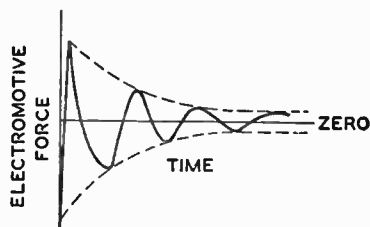

B-DISCHARGE THROUGH A  
SMALL RESISTANCE

17. The effect of resistance on the discharge of an electric current

wish within certain limits. If the electric oscillations that are set up are very fast, and are applied between an antenna and ground, the wave transmitted will be short; conversely, where the oscillations are slow the waves emitted will be long.

# MECHANICAL AND ELECTRICAL TUNING

---

## CHAPTER 5

**T**HERE is a strikingly close resemblance between *sound waves* and the way they are set up in *the air* by a mechanically vibrating body, such as a steel spring or a tuning-fork, and *electric waves* and the way they are set up in *the ether* by a current oscillating in a circuit. As it is easy to grasp the way that sound waves are produced and behave, something will be told about them in this chapter together with an explanation of how electric waves are produced and behave. Thus you will be able to get a clear understanding of them and of tuning in general.

### Damped and Sustained Mechanical Vibrations

If you will place one end of a flat steel spring in a vice and screw it up tight as shown at *A* in *Fig. 18*, and then pull the free end over and let it go, it will vibrate to and fro with decreasing amplitude until it comes to rest as shown at *B*. When you pull the spring over you store up energy in it, this being called *potential* energy, and when you let it go, the stored-up energy is changed into energy of motion or *kinetic* energy and the spring moves forth and back, or *vibrates* as we call it, until all of its stored-up energy is spent.

If it were not for the air surrounding it and other frictional losses, the spring would vibrate for a very long time as the

stored-up energy and the energy of motion would practically offset each other and so the energy would not be used up. But as the spring beats the air, the latter is set into motion and the conversion of the vibrations of the spring into waves in the air soon uses up the energy imparted to it and it comes to rest.

In order to send out *continuous waves* in the air instead of *damped waves* as with a flat steel spring, you can use an

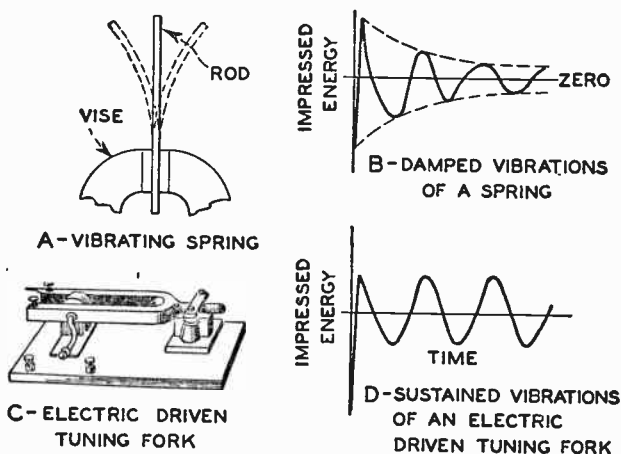

18. Illustrating damped and sustained mechanical vibrations

electrically-driven *tuning-fork*, see *C*, in which an electro-magnet is fixed on the inside of the prongs and when this is energized by a battery current the vibrations of the prongs of the fork are kept going, or are *sustained*, as shown in the diagram at *D*.

### Damped and Sustained Electric Oscillations

The vibrating steel spring described above is a very good analogue of the way that damped electric oscillations which

surge in a circuit set up and send out periodic electric waves in the ether, while the electrically-driven tuning-fork, just described, is likewise a good analogue of how sustained oscillations surge in a circuit, and set up and send out continuous electric waves in the ether, as the following shows.

Now the inductance and resistance of a circuit, such as is shown at *A* in *Fig. 19*, slows down, and finally damps out en-

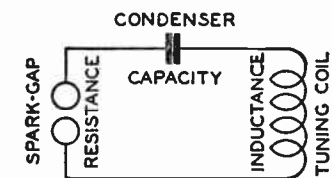

A - A SPARK GAP OSCILLATION CIRCUIT

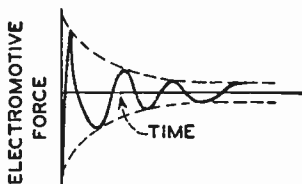

B - DAMPED OSCILLATIONS SET UP BY A SPARK-GAP

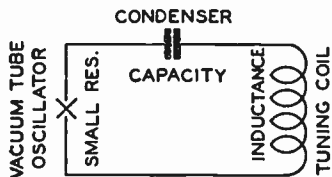

C - A VACUUM TUBE OSCILLATION CIRCUIT

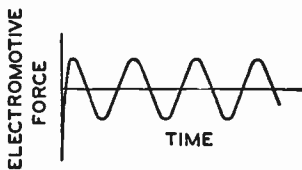

D - SUSTAINED OSCILLATIONS SET UP BY A VACUUM TUBE

19. Damped and sustained electrical vibrations

tirely, the electric oscillations of the high-frequency currents, see *B*, where these are set up by the periodic discharge of a condenser, precisely as the vibrations of the spring are damped out by the friction of the air and other resistances that act upon it. As the electric oscillations surge to and fro in the circuit they are opposed by the action of the ether which surrounds it. Electric waves are set up in it and sent out through it and this transformation soon uses up the energy of the current that flows in the circuit

To send out *continuous waves* in the ether such as are needed for radio telephony, instead of *damped waves*, a *vacuum tube oscillator* must be used, see *C*. Where a vacuum tube is used, the condenser is charged as rapidly as it is discharged, hence the oscillations are sustained as shown at *D*.

### About Mechanical Tuning

A tuning-fork is better than a spring or a straight steel bar for setting up mechanical vibrations. As a matter of fact, a tuning-fork is simply a steel bar bent in the middle so that the two ends are parallel. A handle is attached to the middle point of the fork so that it can be held easily and allowed to vibrate freely, when the ends of the prongs alternately approach and recede from one another. When the prongs vibrate, the handle vibrates up and down in unison with it, and imparts its motion to the *sounding box*, or *resonance case* as it is sometimes called, where one is used.

If, now, you will mount the fork on a sounding box, which is constructed so that it will be in resonance with the vibrations of the fork, there will be a direct reinforcement of the vibrations. The note emitted by it will thus be augmented in strength and quality. This is called simple resonance. Now if you mount a pair of identical forks, each on a sounding box tuned to the same vibrating frequency, you may observe another physical phenomenon known as sympathetic resonance. Set the boxes a foot or so apart, as shown at *A* in *Fig. 20*, then strike one of the forks with a rubber mallet. It will vibrate at its natural frequency setting up sound waves of a given length. When the latter pass over the short distance to the adjacent fork, the impact of the molecules of air of which the sound waves are formed will set its prongs vibrating and this in turn will cause the emission of sound waves of the same



length. As mentioned previously, this effect is called sympathetic resonance in physics. In radio, we would say that the forks are *in tune*.

Tuning forks are made with adjustable weights on their prongs and by sliding these to different positions the frequency with which the forks vibrate can be changed, since the frequency varies inversely with the square of the length and directly with the thickness<sup>1</sup> of the prongs. Knowing this, one

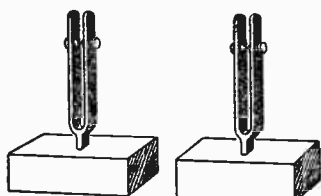

RECEIVER                  SENDER  
A - VARIABLE TUNING FORKS  
FOR SHOWING SOUND  
WAVE TUNING

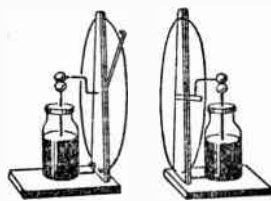

RECEIVER                  SENDER  
B - VARIABLE OSCILLATION  
CIRCUITS FOR SHOWING  
ELECTRIC WAVE TUNING

#### 20. Sound wave and electrical wave tuned transmitters and receivers

of the forks can be adjusted so that it vibrates at a frequency of, say, 16 per second but if the other fork is not similarly adjusted the latter will not be in tune with the former and there will be no sympathetic resonance between them. The difference in frequency may be slight yet there will be no mutual reaction, one to the other.

### About Electric Tuning

Electric resonance and electric tuning are very like those of acoustic resonance and acoustic tuning which have just been described. Just as acoustic tuning may be simple or

<sup>1</sup> This law is for forks having a rectangular cross-section. Those having a round cross-section vary as the radii.

sympathetic so electric resonance may be simple or sympathetic. *Simple acoustic resonance* is the direct reinforcement of a simple vibration. This condition is arrived at when a tuning fork is mounted on a sounding box. In simple electric resonance an oscillating current of a given frequency flowing in a circuit having the proper inductance and capacity may increase the voltage until it is several times greater than its normal value. Tuning the receiver circuits to the transmitter circuits are examples of electric resonance. This can be demonstrated with two Leyden jars (capacity) connected in circuit with two loops of wire (inductance) whose inductance can be varied as shown at *B* in *Fig. 20*. When you make a spark pass between the knobs of one of them by means of a spark coil, a spark will pass over the gap of the other one provided the inductance of the two loops of wire is the same. But if you vary the inductance of the one loop so that it is larger or smaller than that of the other loop no spark will occur in the second circuit.

When a tuning fork is made to vibrate it sends out waves in the air, or sound waves, in all directions. In the same way, when high frequency currents surge in an oscillation circuit they send out electric waves in the ether that travel in all directions. For this reason, electric waves from a transmitting station cannot be sent to one and only one particular receiver although they may travel farther in one direction than another according to the way the antenna is constructed.

In recent years, engineers have devised antennas which concentrate the major portion of the station energy in a narrow beam but the rays of this beam not being parallel diverge or spread out once they are in the air so that when they have passed over the earth for hundreds of miles, the beam has assumed a width of many miles. *Beam antennas*,

as they are called, are being adopted by amateurs and arranged so that they may be rotated to give the maximum effect in the direction of the intended receiving station.

Since electric waves, unless specially directed, tend to travel out in all directions, any receiving set properly tuned to the wave length of the transmitter will receive the signals providing there is enough power in the wave and providing also that the receiving set is sensitive enough to detect and amplify the weak signal as it arrives.

To do this, the receiver must be tuned to the transmitter just as one tuning fork was adjusted to the other, although in the case of radio, this must be done by varying the capacity of a condenser or the tuning inductance or both. Because it is so much simpler and quicker to alter the frequency at the receiver, the transmitter is likely to be maintained at a given frequency which has been found by test to give the best results.

# A SIMPLE VACUUM TUBE RECEIVING SET

---

## CHAPTER 6

**WHILE** it is possible to receive code and voice or music from amateur and broadcasting stations by means of a coil, condenser, piece of crystal, and a pair of headphones, the sensitivity and reliability of such a device are so poor that crystal receivers are no longer used. The vacuum tube has replaced the crystal and in doing so has extended the range of reception from a few miles to thousands of miles. That is why the beginner starts his experiments with a one-tube receiver, then, when he has explored the magic of radio for a short time, he can add more tubes for greater distance and louder volume.

The vacuum tube detector requires batteries or other source of current before it can perform its functions. When the proper current is supplied to the tube it becomes the most sensitive signal detector ever discovered, and improvements in design are constantly increasing this sensitivity. But the tube's possibilities do not cease with its ability to detect waves. It is also an admirable amplifier of weak signals both before and after the detector tube. When enough tubes have been added the resulting volume is great enough to operate one or more loud speakers, thus eliminating any need for headphones.

Although one-tube receiving sets can be purchased the as-

sembly is so simple that most amateurs construct their own. Later in this chapter, there will be complete instructions to aid the beginner in laying out all the necessary parts for a workable receiving set.

### The Two-Electrode Vacuum Tube Detector

The simplest form of vacuum tube is the so-called Fleming Valve. It is a bulb containing two elements, a *filament* and a *plate*. After the elements have been positioned all the air is

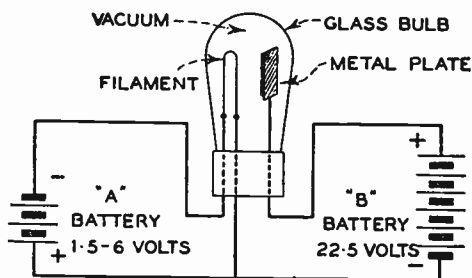

21. How a two-electrode vacuum tube is connected

withdrawn, from which process we get the term *vacuum tube*.

The filament of a Fleming Valve is similar to that of an incandescent lamp and located close beside it is a small sheet of metal called the plate. In operation, the filament is heated to incandescence by an external battery while a second battery is connected to the plate. *Fig. 21* shows the relative positions of the components but the connections to antenna and headphones are omitted since this tube is no longer used in radio sets due to its limitations.

For the sake of simplicity the batteries used with vacuum tubes are distinguished by letters. The *A* battery supplies current to the filament; the *B* battery to the plate. There is

also a C battery, not shown here, which has an important part in the operation of the more modern types of vacuum tubes.

### Three-Electrode Vacuum Tube Detector

When Dr. Fleming had developed his valve, experimenters turned their efforts to ways of improving it. An American, Dr. Lee deForest, hit on the idea of adding a third element which he called the *grid*, because of its shape. He realized that the Fleming Valve was too inflexible in itself for the demands of radio reception and believed that if a third element could be inserted between filament and plate, the current in the latter could be minutely controlled. He realized that a solid sheet of metal inserted between the two basic elements would catch all the electrons flying off the filament and none would reach the plate in the circuit of which the phones are connected. So he made a gridiron-shaped element much like a coarse piece of window screening, and the results were exactly as he anticipated. Thus was born the three-element tube which completely transformed the transmission of radio signals from a local affair to one of international scope. With the grid in place and charged with a certain voltage the stream of electrons flowing from heated filament to positive plate could be accelerated or lessened at the whim of the operator. The grid also made it possible for the vacuum tube to be used either as a detector or amplifier of radio signals as will be seen in later chapters.

The use and application of vacuum tubes have become so widespread that the different types now number well over four hundred, each with its own characteristics which are considered best for a special task. Before setting out on the design of radio equipment, the amateur must study the available types and select the one which will work best and most

economically for his purpose. In a broad sense, however, the tubes are divided into two general classes, viz., those for use on 110-volt alternating current lighting circuits and those which can derive their energy from batteries. The former class consumes too much current for battery operation while the latter is likely to produce as much hum as signal if at-

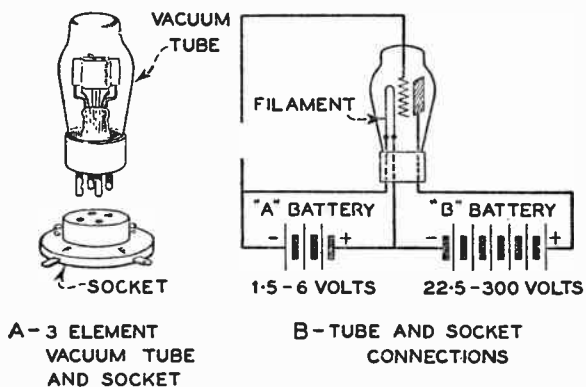

**22. Three-electrode vacuum tube and its connections**

tached to a lighting supply line. Battery tubes are supplied with filaments which draw small voltages up to 6 or 7 volts. On the other hand, tubes intended for heating by alternating current may be designed for voltages from 2.5 to 117 and currents from less than one ampere up to four or more amperes.

**Batteries for V. T. Operation**

The *A* or filament battery may be a simple dry cell of the type used to operate door bells and buzzers or it may be the familiar storage battery found in every motor car. At one time the storage cell was predominant in amateur work because of the current demands of the tubes then available but with the

refinements in vacuum tubes, the newest 1.4-volt types have come into use and the storage battery is no longer essential. Since the normal maximum voltage of the #6 dry cell is 1.5 the tube can be operated direct from the cell terminals without any intervening control such as rheostats. If more than one tube is incorporated in a receiver, economy calls for the addition of other cells connected in parallel. These cells can be used until the chemical action within them has caused their internal resistance to become so high that the maximum voltage at their terminals is too little to force sufficient current



1



2



3

23. Radio Batteries—1, *B* Battery (45 volts); 2, Air Cell *A* Battery (2 volts); 3, Dry Cell *A* Battery (1½ volts)

through the filaments. Then they must be discarded and replaced with new ones.

The *B* or plate battery is available in units of 22½ and 45 volts. This higher voltage, as compared to the 1½ volts of the #6 filament cell, is obtained by stringing together enough cells to produce the desired total. Thus the 22½-volt *B* battery contains 15 individual cells connected in series; the 45-volt battery has 30 cells. But since the amateur is interested in the current output as well as the voltage it behooves him to acquire the largest battery (in mechanical dimensions) consistent with his pocketbook.



A *C* battery is really a smaller version of the *B* battery and usually produces a maximum of 9 volts with taps at  $4\frac{1}{2}$  and  $1\frac{1}{2}$  volts.

### The Filament Rheostat

In some receiving circuits and also in some transmitter diagrams the amateur will find that the assembly calls for a resistance in the filament wiring. This resistance may be variable, in which case it is called a rheostat or it may be fixed, and be known as a ballast. One form of rheostat is

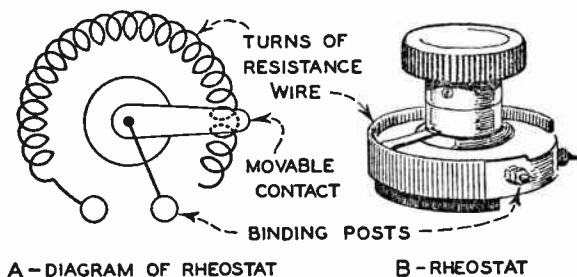

24. Rheostat for filament control

shown in *Fig. 24*. It consists of numerous turns of rather fine wire of a special composition, wound on an insulating circular form with a sliding contact which permits the variation of the total resistance used. The maximum resistance of a rheostat is selected after a survey of the tube circuit in which it is to be used. If there is a great difference between the voltage of the battery and the filament voltage of the tube the rheostat will have a relatively higher value than when the voltages of battery and filament are approximately the same. A simple application of Ohm's Law will determine the proper value.

For instance, if a storage battery of 6 volts is to be used to

heat the filament of a 1.4 volt tube, the rheostat must be of such a value of resistance that it will radiate enough energy in heat to dissipate the equivalent of 4.6 volts. Assuming that the tube draws .06 amperes, then 4.6 divided by .06 gives approximately 77 ohms as the correct value. Probably the nearest commercial unit would be one of 75 or 100 ohms, either of which would be satisfactory.

### Simple Vacuum Tube Receiving Set

When the amateur considers his first receiver he should concentrate on the simplest circuit with the minimum of parts, then, after he has learned how to operate it, the addition of amplifying tubes will present few problems. For the one-tube short-wave receiver shown in *Fig. 25* the following parts will be needed:

- 1 140 mmf (.00014 mfd) variable condenser, C1
- 1 250 mmf (.00025 mfd) variable condenser, C2
- 1 Compression type condenser (optional), C
- 1 100 mmf (.0001) fixed mica condenser, C3
- 1 Fixed resistance, 5 megohms, R
- 1 Type 1E4G vacuum tube, T
- 1 Octal socket for T
- 1 45-volt B battery
- 1 #6 dry cell for A battery
- 1 Phone jack (optional)
- 1 Pair headphones, 2,000 or 3,000 ohms
- 1 Coil form, 1½" in diameter, preferably of fiber or bakelite
- 1 4-prong socket for coil
- 1 On-off switch
- 8 Binding posts

### Assembling the Parts

Secure a piece of dry hardwood about 7" long, 6" deep, and ½" thick for the base on which the parts are to rest. For a

front panel to support the knobs and present a good-looking appearance, get a piece of composition wood such as masonite or a piece of fiber or plastic material. The size should be 7"

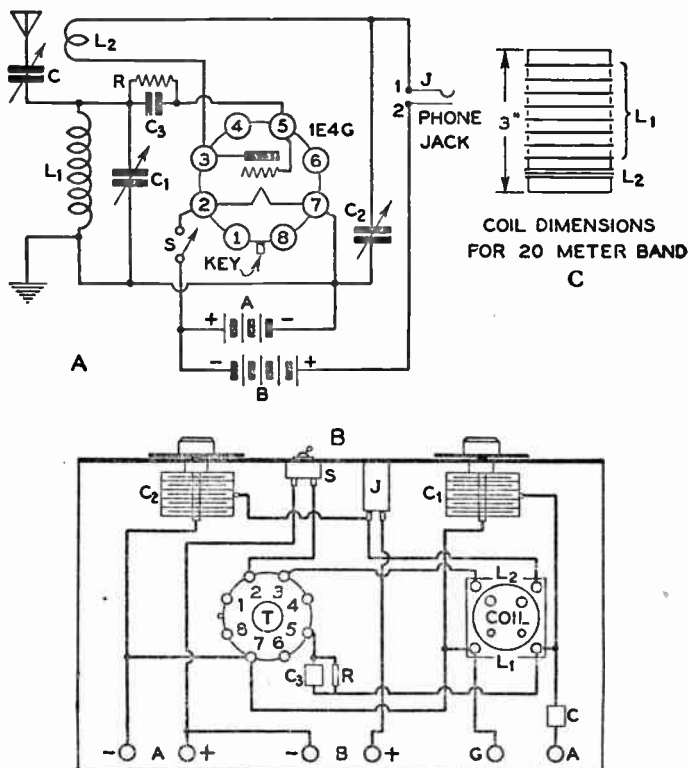

25. Schematic diagram (A) and baseboard layout (B) of simple one-tube battery operated regenerative receiver; (C) Coil dimensions for 20-meter band

long and 6" high. This panel should not be attached to the base until later.

The first move is to lay out the sockets for coil and tube in about the respective positions shown in *Fig. 25-B* making

sure that the terminals are spotted as indicated. Then drill the holes for the six binding posts toward the rear edge of the baseboard. Beginning with the antenna post wire the parts exactly as shown, using either bus bar or #18 annunciator wire. Bus bar is sturdier and makes a better-looking job but it will not work any better than ordinary copper wire, bare or covered. The grid leak and condenser should be placed close to the tube socket. Keep wires in different circuits as far apart as possible but arrange the wiring so that it goes direct from one point to another. With this done and checked for errors, proceed to the panel.

Measure the diameters of the condenser shafts and bore holes in the panel just large enough to take the shafts without excess play. Do the same for the switch and phone jack if one is used. Put the condensers in place and set them up tightly by means of the hexagonal nuts supplied by the manufacturer. Finally, attach the panel to the baseboard by four or more screws or, if you prefer, by means of L-shaped brackets similar to shelf supports. Complete the connections from the baseboard to the condensers and jack and the job is done.

Small knobs will come with the variable condensers but for fine tuning and for logging stations, the amateur will want to secure graduated dials 3" or 4" in diameter.

### Construction of Coils

Although the wiring of the set is now complete, reception is not possible until the proper coil or coils have been obtained. Coils for the several short-wave bands are available in any radio store and in general are more efficient than those made at home but for those amateurs who prefer to construct all possible parts, the coil winding data is given below:

WAVE BAND	L1	L2
20 meters	8 turns	4
40 "	17 "	6
80 "	36 "	15
160 "	65 "	22
Broadcast	130 "	24

In preparing the coils, the amateur will find it easier to purchase the socket type coil forms so that the prongs will be available for socket support. This arrangement permits instantaneous shifts from one band to the other when desired.

As shown at *C* in *Fig. 25*, the primary inductance *L1* is at the top of the coil with the tickler or feed back winding of fewer turns below. Both windings should be in the same direction but the size of wire varies. For the primary use #22 or #24 enameled copper wire; for the tickler use #34 double silk covered.

The primary windings with the exception of the 20-meter coil are not spaced but are wound close together. The 20-meter coil must be spaced between turns so that the entire 8 turns occupy approximately  $1\frac{1}{2}$ ". See *Fig 25-C*. All tickler windings are close together.

In bringing the ends of each winding through the coil form to the prongs at the base be sure that the corresponding prongs are used for primary and tickler so that the coils will be interchangeable. Solder all connections well and remove excess soldering flux with alcohol or carbona.

### Operating the Receiver

It is always a good idea to make one final check of the wiring before subjecting the tube and other associated circuits to the current from the batteries. One fool-proof method which

many amateurs have found infallible is to lay out the diagram beside the chassis and trace each lead from point to point, checking it off the diagram with a colored pencil as each move is completed. If a wire is missing it will show up immediately on the diagram as an uncolored line. When this step in the procedure has been carried out the set is ready for its first test.

Connect the antenna lead-in to the "Ant" post on the set and do the same with the ground wire. If the antenna is a duplex with a double lead-in connect them to antenna and ground respectively. In the case of a Zeppelin antenna the lead from the antenna proper should go to "Ant," while the lead that is dead-ended at its upper end should be attached to the "Gnd" post. In the event that the two wires are not color coded, making it difficult to trace the individual leads, connect the wires as they come and reverse them later if reception is not as it should be.

Insert the 1E4G tube into its socket by placing the tube base over the socket opening and twirling the tube until the key slips through the keyway, then push gently downward until the tube is sitting firmly. Do not twist the tube once it is in place. Modern tubes are gripped securely by pressure of the socket contacts on the tube prongs, in contrast to early tubes which had a pin fitting into a slot in the side of the socket.

Connect the two batteries to their proper binding posts, making sure that the leads from the *B* battery do not touch the *A* binding posts. Even a slight touch to the wrong terminals will ruin the vacuum tube. Then throw the "on-off" switch to the "on" position. See that the tube lights up a dim red. If it does not, turn off the switch and check all wiring once more. If all seems in good order, place the phones on the

head, turn the dial of condenser *C2* until the plates are about half meshed. Then rotate condenser *C1* very slowly until a sound is heard. If the sound is voice or music, readjust *C2* one way or the other until the response in the phones is at maximum. Readjust *C1* and perhaps alter *C2* again. The sound should now be loud and clear. If garbled, it is a sign that *C2* is too far advanced. The latter condenser, being the regenerative control, is also the volume control in this simple set.

If the sound heard is code, the amateur will notice that the tone of the code will change as *C2* is rotated. This feature will come in handy because it permits the operator to select the tone that is easiest to read through any other sounds that may be coming through the phones. This variation in pitch is the result of heterodyning or beating, a phenomenon which will be described in the chapter devoted to superheterodynes.

The amateur should be warned here against an over-use of the regenerative or feedback condenser, since a one-tube set of this type radiates a signal that may affect all radio sets within a quarter mile, and can be very annoying to radio listeners in the vicinity. Be considerate of others.

### Logging the Dials

After the builder has become familiar with the operation of the one-tube receiver he should jot down the dial markings for stations which he has recognized. In a regenerative receiver there will be some variations in the dial settings from day to day since regeneration affects the main-tuned circuit, but the approximate locations of stations once logged will always be found again within a degree or two of the first settings. This procedure, obviously, must be carried out for each coil.

It will be found, also, that the tuning of broadcast stations on the coil with the largest number of turns will not be sharp. In fact, if the set is used within a few miles of a powerful broadcaster, it will be difficult to prevent interference or "cross talk" between stations. In a one-tube set of this type, there is no relief from this condition but the difficulty will be cleared up when the amateur has added another tube and a stage of radio frequency amplification. On all waves below 100 meters, the tuning should be as sharp as necessary for good reception.

### Audio Frequency and Radio Frequency Amplifiers

An audio frequency amplifier increases the energy of currents of audio frequency, that is, those from about 60 to 4,000 cycles per second. In a radio receiver, it amplifies the fluctuating direct currents flowing through the plate circuit of the detector tube to which it is coupled by two resistances and a condenser or by an audio transformer. In amateur receivers the transformer method is preferred. Such a transformer consists of two windings around a core of soft iron with from three to five times as many turns on the secondary as on the primary. The primary is placed in the plate circuit of the detector tube, replacing the phones. The greater the step-up ratio of the turns the greater the gain in signal strength; but if the ratio is made too large, the quality will suffer through distortion of the signal.

The second type of amplification takes place *before* the incoming signal reaches the detector and is called radio frequency amplification. Here again a transformer is needed to transfer the energy in the r-f tube to the detector, but this transformer is similar to *L1* in *Fig. 35* except that it has two windings. Moreover, it does not ordinarily contain a metal



core although some of the more recent types of r-f coils contain small cores of a special metallic compound in order to produce more gain per stage.

### Audio Frequency Amplifier

It is a simple matter to add a stage of audio frequency amplification to the receiver just described. This will increase the signals measurably and will even make loud speaker operation possible on powerful stations. Because audio amplification is likely to add noise to reception it is unwise to use more than two stages in a receiver.

For a single stage of a-f amplification the amateur will need the following items:

- 1 1E4G tube
- 1 Octal socket
- 1 a-f transformer, ratio 3-1 or 5-1
- 1 45-volt *B* battery
- 1 #6 dry cell

The transformer and socket should be placed on the same baseboard shown in *Fig. 25*, locating them at the extreme left when viewed from the rear. *Fig. 26* gives the wiring details.

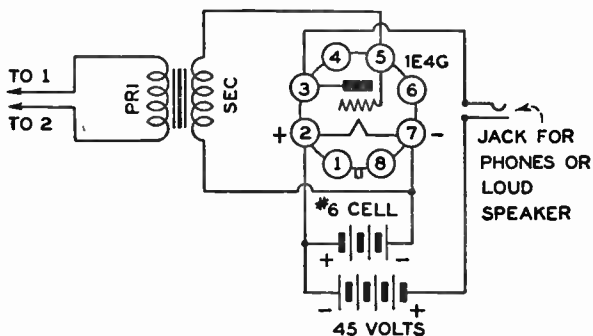

26. Diagram of 1-stage audio amplifier to be used with 1-tube detector set

Since the transformer replaces the phones, the two wires connected to the jack should go instead to the two primary terminals of the transformer. The jack terminals are then transferred to the plate circuit of the new 1E4G as shown in *Fig. 26*.

# OPERATION OF VACUUM TUBE RECEIVERS

---

## CHAPTER 7

**B**EFORE trying to understand how a vacuum tube acts in a circuit, it is necessary to learn something about what makes it operate. In order to comprehend this, we must start at the very root of all matter—the *electron*.

We know that all matter exists in three forms: solids, liquids or gases. It is also known that any form of matter is not solid, but is composed of small parts of whatever material it may be, these small parts being called *molecules*. It is assumed that all molecules are composed of *atoms*, which are the chemical element particles. The kind of a molecule that will result depends on how many and what kind of atoms are grouped together.

Science also tells us that the atoms are composed of positive and negative *charges of electricity*, the number of these charges determining what chemical atom it is.

Every atom has a central core of *positive* particles of electricity, called *protons*, and around this *positive nucleus* are rotating *negative* electrical charges, named *electrons*. It is rather difficult to comprehend the lack of size of electrons, but an idea may be gained from the estimate that in a very tiny globule of copper, having a diameter of  $\frac{1}{100,000}$  of an inch, there are about twenty billion electrons. See *Fig. 27*.

The arrangement of electrons and protons in an atom may be compared to a miniature solar system, like that great one in which the planet on which we live is a part. We know that the Earth travels about the Sun once a year. In the same way in every atom one or more electrons are rapidly rotating about the positive nucleus, as the Earth does about the Sun. It is the number of protons and electrons in an atom that determine whether it be iron, gold, chlorine or hydrogen. The last-named

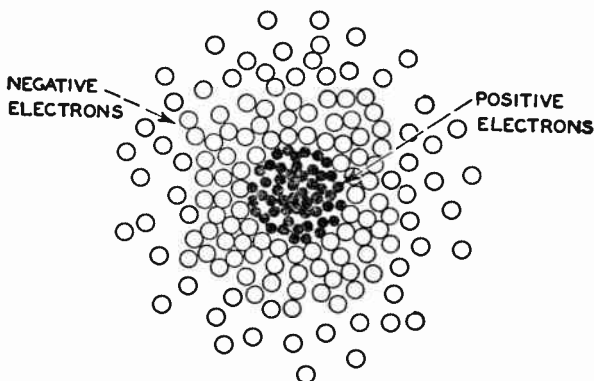

27. The grouping of electrons around the positive electrons (protons) in an atom

element is the simplest in its makeup of the whole chemical table, as it has one proton for a positive nucleus and a single electron rotating about it, while uranium, the heaviest known element, has 92 protons in its nucleus.

The speed with which the electrons travel about the positive nucleus depends on the temperature. The hotter the substance of which the atom is a part, the faster go the electrons. And, of course, the reverse is true: the colder the atom the slower the electrons travel, until at *absolute zero*, which is  $-273^{\circ}$  C., theoretically all motion ceases entirely.

## Ionization

As long as all of the electrons remain within the influence of the positive nucleus of an atom its positive and negative charges are equalized and it will be therefore perfectly neutral, electrically speaking. When, however, one or more of its electrons are removed from it, and there are several ways in which this can be done, the atom will show a positive charge and in that state it is called a *positive ion*.

In other words, a *positive ion* is an atom that has lost some of its electrons, while a *negative ion* is one that has acquired some additional electrons, it being borne in mind that electrons are charges of *negative* electricity.

Therefore, ionization may be defined as *the addition or subtraction of one or more electrons from a neutral atom*.

## The Relation of the Electron to Current Flow

It seems advisable to explain the differences between the three types of current flow and how the electron acts in each one. These three currents are: Conduction, displacement, and space or emission.

The fact has already been mentioned that in every atom there are one or more electrons whirling at a high speed about the positive nucleus, these electrons being kept in their orbits by magnetic attraction. Some of these electrons are attracted more strongly by the positive nucleus than others, which are called *loose* or *free* electrons, as they are rather easily removed from the atom by means of an external electrical force.

Now we know that some metals are better conductors of electricity than others, which means that these conductors have atoms which contain more free electrons than the others. When an electrical force, such as a battery or generator, is

applied to a wire, for example, these free electrons in the wire begin to move from one atom to another toward the source of the force. This movement of electrons is called *conduction current* or *electronic drift*.

It should be remembered that the atoms remain fixed in their positions in the wire; *it is only the electrons that move*. Also the direction of current is from *negative* to *positive*, as the electrons are the negative portion of the atom.

### Displacement Current

It is also a well-known fact that some materials, commonly called *insulators*, do not conduct current to any appreciable extent. It was explained previously that condensers were composed of two plates of a conducting material with an insulator between them.

We have learned just above that in a conductor there are many free electrons in the atoms composing the material; the opposite is true in an insulator. The atoms have few if any free electrons, so that when an electrical force is applied to the material the electrons will not jump from atom to atom and so no current will flow.

Although the electrons will not move from atom to atom, yet there is a definite force applied to them so that they are moved slightly from their original places. Now in a condenser we have a conducting wire attached to each plate. When an electrical force is applied to the wires, there is a conduction current set up that sets in motion the electrons in the wire. These electrons travel along until they come in contact with the electrons of the insulator. As more electrons are coming from behind, the negative charge on the positive side of the insulator, or dielectric, is increased, so that the electrons in the dielectric are strained or pushed out of their regular places

in their respective atoms. They will remain in this strained position, or as we say, the condenser maintains its charge, even after the electrical force that charged it is removed.

Now what happens when we discharge the condenser by bringing in contact the ends of the wires, which are connected to the two plates? The electrons that have been strained from their original positions within the atoms of the dielectric at once tend to return to their previous state of neutrality and so the electrons, that have been forced in, are now pushed out and are carried around through the connecting wire to the other plate of the condenser, which had been drained of its electrons to a certain extent. In other words, the whole system returns to a neutral state.

Therefore, the shifting of the electrons within the dielectric is called *displacement current*.

### **Space or Emission Current**

Under ordinary conditions existing in a copper or tungsten wire electrons will flow along easily, when a proper electrical force is applied. However, it is difficult to remove these free electrons from the metal. If we change conditions somewhat we can make these free electrons jump from the surface of the metal out into space. We can increase the amount of current so that the temperature of the wire is raised until the wire becomes incandescent. Now the electrons of the wire will whirl about in their orbits more quickly and this increase of speed will also increase their orbits, or distances that they travel around the positive nucleus. These orbits will increase with the temperature and at a certain point the electrons will be traveling so fast that they will leave their atom and jump to another. This transfer from atom to atom will continue until the electron reaches one on the surface of the filament.

When this occurs then the fast-moving electron jumps from the metal into space. This process of removing electrons from atoms is called *ionization by heat*, being different from *ionization by impact*, which occurs in the case of conduction current.

Now if we enclose the filament in a glass tube from which the air has been removed, and insert a metal plate to which a wire is connected, we can control this stream of electrons by giving the plate a positive charge, so that the electrons will be attracted to it. This stream of electrons between the filament and plate of a vacuum tube is called *space* or *emission current*. The source of electrons (the filament) is called the *cathode* and the plate, or destination of the negative charges of electricity, is called the *anode*.

### The Two-Electrode Vacuum Tube

We have just learned that when the filament of a vacuum tube is heated so that it glows, it emits electrons. As these electrons are charges of *negative* electricity they are attracted to the plate of the tube, which is charged *positively* by connecting it to the positive pole of a battery. This is what is meant by saying that the plate is positive with respect to the filament.

Now as the filament is hot and the plate is cold, the latter cannot emit electrons—it can only attract them, as stated above. Therefore, in the two-electrode tube *current passes in one direction only, i.e.*, from the filament to the plate. In other words, we have a *direct* or *unidirectional current* flowing from filament to plate.

An alternating current is one that changes its polarity periodically, from positive to negative then positive again. The number of changes or cycles that the current undergoes



per second is called *frequency*. Radio-frequency currents are those which the human ear cannot hear and, as the name implies, a-f currents can be heard.

If we had an instrument called an oscillograph it would be possible to see an alternating or direct current. The former would have the appearance of a *sine wave*, illustrated in *Fig. 29*. The halves of the wave above the horizontal line are considered to be positive and the lower halves negative.

If we connect a source of alternating current to the elements (the filament and plate) of a vacuum tube, as well as the filament and plate batteries, so that we will have an electronic stream flowing, and looked at the output of the tube through an oscillograph we would find that there was a change in the appearance of the a-c wave. Only the top halves of the wave would come through the tube. This is because during half the cycle (a cycle is one complete wave) the plate has a positive charge, which attracts the electrons emitted from the filament, and during the other half of the cycle, the plate is negatively charged so that it will repel the electrons and no current flows. Such an output from a tube is called *pulsating direct current*, as it is not a steady flow, such as is obtained from a dry cell battery.

Dr. John Fleming, of University College, London, discovered that a two-electrode vacuum tube could be used as a detector of radio-frequency currents, transforming them to currents that are audible to the human ear when a telephone receiver was connected in the output (between the plate of the tube and the plate battery).

The word "detector," although commonly used, is apt to mislead the reader. The action above described is really *rectifying*. At the present time the two-electrode vacuum tube is

no longer used in a radio receiver as a detector; it is more efficient when used as a *rectifier* in the power units, about which more will be told later.

### The Three-Electrode Vacuum Tube

The two-electrode tube had many limitations as a detector, but with the addition of a third electrode, or *grid*, the vacuum tube was found to be the most efficient detector yet discovered, and with a few minor changes it could be used for amplifying.

### The Action of the Grid

Let us see how a three-element tube operates as a detector in a receiving circuit. Connected to the grid and the filament of the tube is the output of the antenna circuit, consisting of a coil shunted by a variable condenser, so that the circuit can be tuned to resonance with the incoming signal. The signal current is at radio frequency and is alternating, that is, changing from positive to negative thousands of times per second.

As the grid is connected to this oscillating current, its polarity changes with the polarity of the r-f current. Let us now follow one complete cycle through the tube and see how it affects the electron stream coming from the filament. See *Fig. 28*.

During half the cycle the grid has a positive charge. This charge, in addition to the positive charge maintained on the plate, will attract more electrons that are being thrown off the filament in the direction of the plate. In other words, *when the grid has a positive charge, the plate current is increased*. Some electrons, of course, strike the wire grid and are absorbed in the grid circuit, but the majority of them reach the plate through the relatively large spaces between the grid wires.

When the negative half of the wave charges the grid, then the reverse is true. As the electrons are negative, so the grid, having the same polarity, will repel some of them back toward the filament and, therefore, fewer will reach the plate of the tube, thus reducing the plate current.

Summing up, the grid of a vacuum tube permits more or fewer electrons to reach the plate depending on whether the

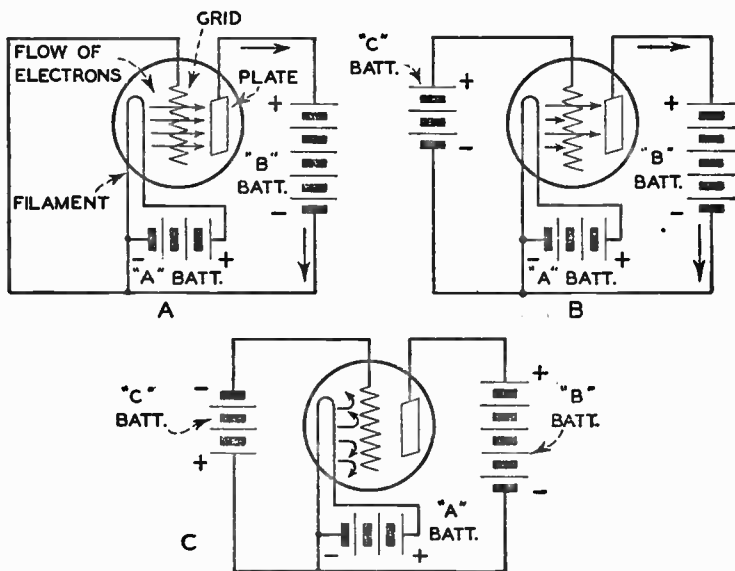

28. How the grid affects the electronic flow from filament to plate. A, no charge on grid; B, positive charge on grid, and C, negative charge on the grid

grid is charged positively or negatively. Also the degree of these charges must be taken into consideration, as the variations of the incoming signal currents to the tube are very slight, and it is on these minute changes that the efficiency of the tube as a detector depends.

### How the Vacuum Tube Acts as an Amplifier

If you connect up the filament and the plate of a three-electrode tube with the batteries and do not connect in the grid, you will find that the electrons which are thrown off by the filament will not get farther than the grid, regardless of how high the voltage is that you apply to the plate. This is due to the fact that a large number of electrons which are thrown off by the filament strike the grid and give it a negative charge, and consequently, they cannot get any farther. Since the electrons do not reach the plate the current from the *B* battery cannot flow between it and the filament.

Now with a properly designed amplifier tube a very small negative voltage on the grid will keep a very large positive voltage on the plate from sending a current through the tube, and conversely, a very small positive voltage on the grid will let a very large plate current flow through the tube. This being true, it follows that any small variation of the voltage from positive to negative on the grid and the other way about will vary a large current flowing from the plate to the filament.

In the Morse telegraph the relay permits the small current that is received from the distant sending station to energize a pair of magnets, and these draw an armature toward them and close a second circuit when a large current from a local battery is available for working the sounder. The amplifier tube is a variable relay in that the feeble currents set by the incoming waves constantly and proportionately vary a large current that flows through the headphones. This, then, is the principle on which the amplifying tube works.

## The Operation of a Simple Vacuum Tube Receiving Set

A simple vacuum tube detector receiving set works thus: when the filament is heated it gives off electrons as previously described. Now when the electric waves impinge on the aerial wire they set up oscillations in it, and these surge through the tuning coil.

The energy of these oscillations sets up oscillations of the same frequency in the secondary circuit, and these high-frequency currents, whose voltage is first positive and then negative, surge in the closed circuit, which includes the secondary coil and the variable condenser. At the same time, the alternating positive and negative voltage of the oscillating currents is impressed on the grid; at each change from + to — and back again it allows the electrons to strike the plate and then shuts them off; as the electrons form the conducting path between the filament and the plate the larger direct current from the *B* battery is permitted to flow through the detector tube plate and the headphones.

## Operation of Regenerative Receiver

Soon after experimenters began to work with the vacuum tube detector, two of them noticed that when an additional circuit was added between tube and its resonant circuit, the signals in the headphones were increased many fold. Both Major Armstrong and Dr. deForest observed this phenomenon and the former immediately incorporated his findings in patent papers. The improvement was called *regeneration*, and for many years was incorporated in every receiving set. With the introduction of the superheterodyne its importance decreased although it still plays a part in many amateur receivers and transmitters.

The process of regeneration is not difficult to understand. If part of the pulsating direct current in the output (phone) circuit of the detector is led back to the tuning coil supplying the detector with the incoming radio impulses, the latter are increased in amplitude with much the same effect as though the transmitting station were much nearer the receiver. By this action a signal so weak that it could scarcely be heard with a plain detector will be magnified until it becomes per-

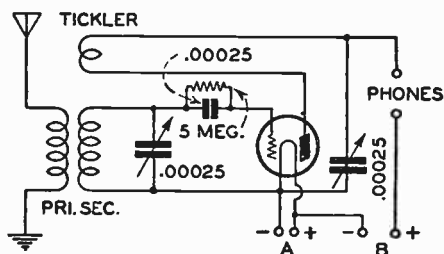

28-A. Typical regenerative or feedback circuit

fectly readable. Because of the reversing action created by the regenerative circuit, the latter is often called a feedback circuit. See *Fig. 28-A*.

It may seem at first hand that the feedback could be increased indefinitely, but this is far from the truth. Since the energy fed back to the tuned circuit is impressed upon the tube grid along with the basic incoming signal, the detecting action of the tube is soon destroyed by the tendency of the tube to act as an oscillator at a frequency determined by the number of turns of wire in plate and grid circuits. The maximum signal gain is reached when the regeneration is carried to a point just previous to the point of oscillation. However, this tremendous gain in signal strength obtained through regeneration led Major Armstrong to the development of still another

type of receiver called the superregenerative set, which has found favor in aviation and amateur fields.

### Operation of the Short-Wave, Superregenerative Receiver

When an ordinary regenerative receiving set, as described above, reaches a certain point of amplification, the detector tube begins to set up oscillations, and this puts an end to

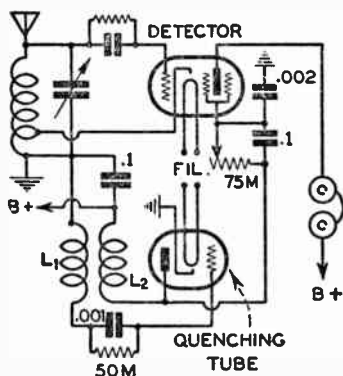

28-B. Two-tube superregenerator with separate quenching tube

further useful regeneration. Up to this critical point, and especially just before it is reached, the effects of regeneration are enormously increased, but they cannot go beyond it.

The reason for this is that the oscillation circuit has so small an effective resistance that after the initial energy of the feedback sets up the amplifying oscillations in the tube these oscillations continue to surge and with such persistency that the oscillations, which follow from the feedback, have very little effect upon them. The energy of the oscillations set up by the incoming waves is, naturally, less and, it follows, the signal, speech or music is weaker when this condition is

reached, than when the effective resistance of the circuit is small enough to allow the current rectified by the detector tube to get back to the same value after each variation of the oscillations set up by the incoming waves.

Now the purpose of the superregenerative system is to circumvent this limitation of the original regenerative circuit so that amplification can go on beyond it, and this is the way it is done: in this new system the factors of the circuits are so

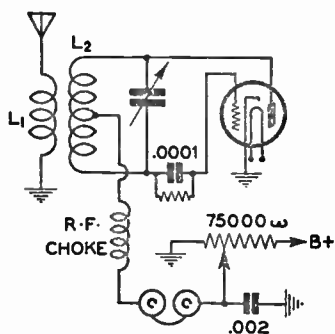

28-C. One-tube superregenerator in which the functions of detector and oscillator are combined in a single three element tube

arranged that the amplifying oscillations set up by the tube do not depend so much on the feedback oscillations as on those which the oscillator tube itself sets up. This is caused by alternating the values of positive and negative resistance from moment to moment; that is, an alternating positive and a negative resistance are set up by the oscillations of the oscillator tube.

The result is that while the initial, or first, oscillations set up by the incoming waves are amplified, as long as the negative resistance is larger than the positive resistance, the oscillations are instantly cut off by reversing these resistances,



when the next incoming wave sets up fresh oscillations. In other words, the tube is kept from setting up oscillations when the critical point is reached, by changing the negative resistance to the positive and then changing them about the other way.

The oscillating tube which provides the quenching frequency, as it is called, must operate at such a rate that the

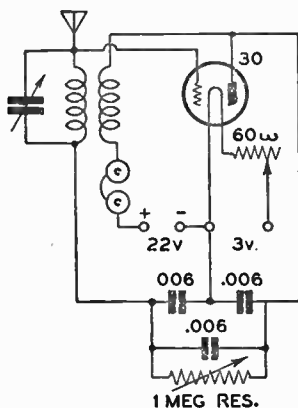

28-D. Flewelling superregenerative circuit which was highly popular at one time. The quenching frequencies were supplied by the array of .006 mfd. condensers and the variable resistance

resulting sound is near or above the audible limit of the ear, otherwise the noise thus produced will ruin the signal it is desired to receive. This is not a simple task in the case of broadcast receivers but the difficulties decrease as the frequency of the incoming signal increases. This, obviously, makes the superregenerator ideal for short and ultra-short waves.

*Fig. 28-B* shows a standard form of a two-tube superregenerative receiver with one of the tubes acting solely as an

oscillator. This form is best for the amateur since the control of the quenching frequency can be easily adjusted for best results. However, for portable sets or where space is a consideration, the functions of detector and oscillator may be combined in a single tube as in *Fig. 28-C*. There are many variations of this one-tube self-quenching superregenerator but the principles are alike. Usually the constructor must discover the best operating components by trial. The placement of the wiring, the length of leads and the value of the grid leaks are all important. When the set is not functioning properly a loud hiss appears in the headphones and it is only when this hiss is reduced to a barely audible sound that the receiver will give the tremendous amplification that is possible from it.

### Operation of Autodyne and Heterodyne Receiving Sets

At *A* in *Fig. 20* is shown a picture of two tuning-forks mounted on sounding boxes to illustrate the principle of electrical tuning. When a pair of these forks is made to vibrate exactly the same number of times per second there will be a condensation of the air and the sound waves that are sent out will be augmented. But if you adjust one of the forks so that it will vibrate 256 times a second, and the other fork so that it will vibrate 260 times a second, then there will be a phase difference between the two sets of waves, and the latter will augment each other 4 times every second and you will hear these rising and falling sounds as *beats*.

Now electric oscillations set up in two circuits that are coupled together act in exactly the same way as sound waves produced by two tuning forks that are close to each other. Since this is true, if you tune one of the closed circuits so that the oscillations in it will have a frequency of 1,000,000, and

tune the other circuit so that the oscillations in it have a frequency of 1,001,000 a second, then the oscillations will augment each other 1,000 times every second.

As these rising and falling currents act on the pulsating currents from the *B* battery which flow through the detector

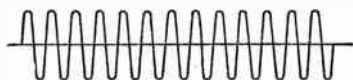

A - 1,000,000 OSCILLATIONS PER SECOND SET UP BY INCOMING WAVES



B - 1,001,000 OSCILLATIONS PER SECOND SET UP BY SEPARATE HETERODYNE TUBE.

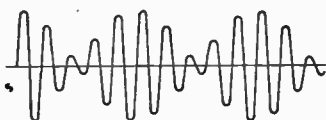

C - 1,000 BEATS PER SECOND BY SUPER-POSITION.



D - 1,000 PULSATING CURRENTS IN THE HEADPHONES

29. Illustrating the operation of a heterodyne receiver

tube and the headphones you will hear them as *beats*. A graphic representation of the oscillating currents set up by the incoming waves, those produced by the heterodyne oscillator, and the beats they form is shown in *Fig. 29*. To produce these beats a receiver can use: (1) a single vacuum tube for setting

up oscillations of both frequencies when it is called an *autodyne*, or *self-heterodyne* receptor, or (2) a separate vacuum tube for setting up the oscillations for the second circuit when it is called a *heterodyne* receptor.

### The Autodyne, or Self-Heterodyne, Receiving Set

Where only one vacuum tube is used for producing both frequencies, you need only a regenerative, or feedback receptor; then you can tune the aerial wire system to the incoming waves and tune the closed circuit of the secondary coil so that it will be out of step with the former by 1,000 oscillations per second, more or less—the exact number does not matter in the least. From this you will see that any regenerative set can be used for autodyne, or self-heterodyne, reception.

### Separate Heterodyne Receiver

For ease of operation it is best to use a separate vacuum tube as a generator of oscillations for heterodyning purposes. The latter then acts on the oscillations of the incoming waves

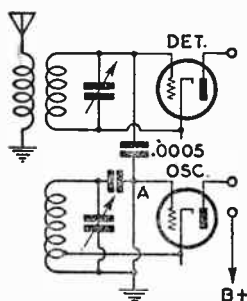

30. Diagram of external oscillator and detector showing one of many methods of leading the locally generated oscillations into the grid circuit of the detector tube

so that the mixed frequencies are impressed upon the grid of the detector tube. One form of oscillator and mixer circuit is shown in *Fig. 30*. Here the oscillating voltage appearing at point *A* is transferred to the grid of the detector tube where it encounters the voltage of the incoming signal and mixes with it before detection. The oscillations may also be injected into the detector tube by means of the cathode if one is available or by one of the grids in a multi-grid tube.

### Operation of Superheterodyne Receiver

It was the inefficiency of the tuned radio frequency circuit both as regards its sensitivity and selectivity that caused Major Edwin H. Armstrong to experiment with the heterodyne system of short-wave reception. Fessenden had done some work on the same thought earlier but had not carried the basic ideas through to a point where they could be generally applied to commercial receivers. Armstrong developed a method whereby the incoming signal of high frequency was changed by heterodyning to another signal of lower frequency. This was essential at that time because little research had been carried out on the amplification of waves below 200 meters.

You have learned from preceding chapters that a definite wavelength corresponds to a definite frequency and that the longer the wave the lower the frequency and vice versa. You have also learned that in order to receive continuous wave signals on a vacuum tube receiver it is necessary to employ the *autodyne* or *heterodyne* method, wherein a second frequency or wavelength is impressed on the receiving circuit so as to produce a *beat note* of the original signal that would be audible.

The separate heterodyne method is used in conjunction

with the superheterodyne receiver, only instead of adjusting it so as to produce an audible beat note, a *radio-frequency* beat note is produced having a frequency that corresponds with the wavelength upon which the intermediate frequency transformers are designed to work. In this way the incoming signal is actually converted to a longer wavelength, passed through the first detector or mixer tube and then through a series of i-f amplifier stages and finally into the second detector where the signal is rectified or demodulated, emerging as a pure signal of audible frequency. All of this takes place without noticeably affecting the characteristics of the transmitted signal, even though the final impulse may be a million times as strong as the same impulse when it was first intercepted by the antenna. It is this ability of the superheterodyne to accomplish tremendous amplification without distortion that has caused it to become the heart of the majority of all radio receivers.

# THE CHARACTERISTICS OF VACUUM TUBES

---

## CHAPTER 8

**T**HE radio tube is a marvelous device. It is one of the most important contributions that science has made to civilization in recent years. It serves as a rectifier of alternating currents, an amplifier, and an oscillator or generator of alternating currents. These qualities make it extremely useful in other fields besides radio. More and more applications are being found for this so-called "20th Century Aladdin's Lamp," and some of them will be described in a later chapter.

### Radio Tube Characteristics

Engineers use the term "characteristics" to identify the distinguishing electrical features and values of a radio tube. These values may be tabulated or shown in curve form.

The amateur operator should know something about the characteristics of certain tubes. Since there are nearly 453 different types of receiving tubes available and since the complete characteristics of tubes are highly technical in nature, it is not possible to go thoroughly into the subject in this book. But here will be found an outline of the principal differences in the more important types of tubes, also tables showing some of their characteristics. More comprehensive data on receiv-

ing tubes are contained in the several excellent Tube Manuals published at low cost by the principal tube manufacturers and distributed either direct from the head offices or through stores selling radio parts.

The early tubes were designed to operate only from batteries, either dry or storage, but the disadvantages of these methods of power supply were at once evident and engineers turned their attention to new tube designs which could draw their filament energy from alternating current lines which are quite generally available.

The principal obstacle in the operation of tubes from a-c was the tendency of the 60 cycle current to creep into the wires containing the signal. The result was a low-pitched, annoying hum which sometimes was louder than the signal. Finally, the laboratory experts discovered that a balanced filament wound inside a thin-walled cylinder which had been coated with radioactive material was a solution to their problem. In this design, the electrons do not come from the filament itself but from the coated sleeve surrounding it. This type of tube is known today as the *indirect heater* and the sleeve rather than the filament is the cathode of the tube. There are direct filament heater tubes in use today, but their application is limited to receivers fed from batteries, or to rectifiers.

One of the earliest of the indirect heater types of tubes was the 27 which, with its twin, the 56, is still favored by some amateurs as a detector. This tube has five prongs extending through its base distributed as follows: two for the filament supply of 2.5 volts a-c; one for the control grid; one for the plate; and one for the cathode.

In late years, the majority of all new tubes have been indirectly heated, and tube design has been carried forward so



expertly that the problem of hum is no longer difficult to solve. Such hum as creeps into a receiver is more likely to come from the *B* power supply than from the numerous tubes that comprise the receiver.

### The Screen Grid Vacuum Tube

This type of vacuum tube was first investigated in Germany by Schottky and later by Dr. A. W. Hull of the General Electric Company Research Laboratory. Because of the more ac-

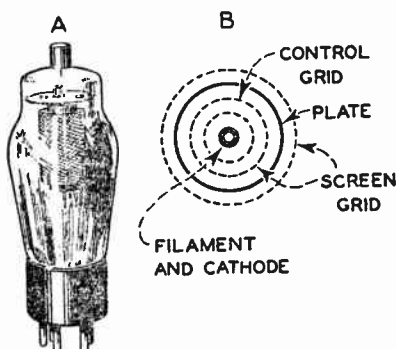

31. The screen grid tube is shown at A; in B the four elements are arranged in their respective positions

curate control of electronic action it makes possible, the screen grid tube has almost completely superseded the three-element or triode type of tube. One of the earliest types in which the screen grid appeared was the 24A and from this pioneer has grown an extensive collection, a fact that can be proved by a glance at the tube types in the appendix.

Using the 24A as an example, see *Fig. 31*, it will be seen that the control grid is brought out through an isolated terminal at the top of the bulb. This reduces the harmful capacity between the leads as they are brought down through the

element supports and out through the base. Capacity thus formed lessens the value of the tube as an amplifier, particularly on the higher frequencies. But the relative location of the remaining elements gives to this tube and its later derivatives their main advantages.

The actual construction of the individual elements varies with different manufacturers but in general the filament is coiled within the oxide-coated cathode and the grids consist of many turns of fine wire wound in spiral form. The screen grid is actually a double grid (*Fig. 31-B*) in order to provide a complete coverage for both sides of the plate. By varying the pitch of the screen grid wires, the characteristics of the tube can be changed to meet the particular purpose for which the tube is to be designed.

In fact, this point of design has been adopted to manufacture a so-called variable mu or super-control tube which is widely used in modern receivers. In such tubes, the screen grid is spaced unevenly from top to bottom of its form, the purpose being to make the tube react differently to different strengths of r-f signals imposed on the control grid. Thus such a tube could be and is designed to give lower amplification on strong signals and much higher gain on weak signals. One advantage of this arrangement is to prevent overloading of the detector tube by unusually strong signals.

The question naturally arises: why is a tube like this necessary? The usual three-element tube when employed in a r-f. amplifier circuit needs a form of neutralizing or balancing to stop the generation of oscillations which are caused by the capacity between the grid and plate. There have been heretofore two general methods of preventing oscillations due to this small capacity—the *losser* method and the *neutralization* method. In the former, sufficient losses were introduced into

the circuit to keep the amplification down to a safe value, while in the latter, the feedback due to the internal capacity of the tube is balanced by a feedback of equal magnitude, but opposite in phase, introduced outside the tube. This bothersome internal capacity is eliminated by the introduction of the fourth element, the screen grid.

How this capacity is practically eliminated may be understood better by reference to the following example. Between two parallel plates, *P* and *G*, in *Fig. 32-A*, there exists a capacity which can be measured by the alternating current which

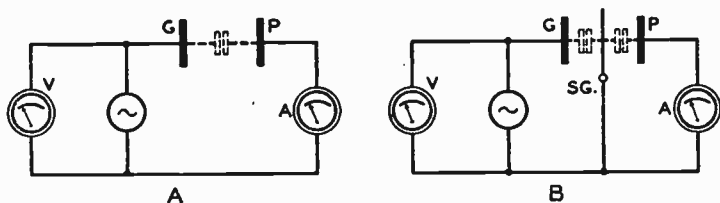

32-A. and B. Showing the condenser action caused by the insertion of a second element between the filament and plate in a screen-grid tube

flows through the ammeter *A* for some voltage measured by the voltmeter *V*. (These two plates represent the plate and grid elements of an ordinary three-electrode tube and the dotted condenser symbol the capacity existing between them.) If another plate, *SG* (representing the screen-grid element), is placed between the other two (see *Fig. 32-B*) and connected as shown, the effect is now of two condensers in series, but the capacity between *SG* and *P* is shorted out of the circuit and the current indicated by the ammeter drops to zero. Therefore, we may say that the effective capacity between *P* and *G* has been reduced to zero by the addition of the plate *SG* connected as shown. It may be said that *P* is *shielded* or *screened* by *SG*.

When the 24A is employed as a r-f amplifier the control grid is connected in the usual manner to the output of the coil and condenser, and should have a negative bias of about 3 volts, which can be supplied by a C battery. As will be seen, the *positive* voltage necessary on the screen grid is between 60 and 90 volts. Ninety to 250 volts are necessary on the plate.

Because of the higher amplification obtained through the use of the screen grid tube it is essential that the effect of one of its circuits on another be minimized. This is done by shielding. The r-f coupling transformers are encased in metal shields and the control grid wire is surrounded by a metal sheath. More often than not, the tube itself is inserted within a metal enclosure, sometimes a metal coating is deposited directly on the glass. Such shields are always well grounded to the chassis to keep their potentials at zero.

Screen grid tubes are now available for all uses from those having to do with transmitters to the light-weight portable sets operated from batteries.

### Rectifying Tubes

Batteries are satisfactory for the small radio sets of the beginner or the picnicker but the more extensive receivers require so high a plate potential and so much current for the greater output that some other source of high direct current voltage is essential. The rectifying tube is the answer.

As mentioned previously, the filaments of a tube may be supplied with alternating current without affecting the quality of the signal but the plate and screen grid must be fed direct current only. This is absolutely necessary. The rectifying tube accepts the a-c of the power line, changes it to a pulsating direct current, and this in turn is smoothed out by

a device called a filter so that the final output is practically pure d-c. However, the standard supply line is only 110 volts and modern tubes function at their best with from 180 to 300 volts on their plates. This higher potential is easily obtained by stepping up the 110 volts to the desired amount by means of a transformer. Since the current is actually low despite the higher voltage the power transformer need not be anywhere near as large as the transformers observed on poles

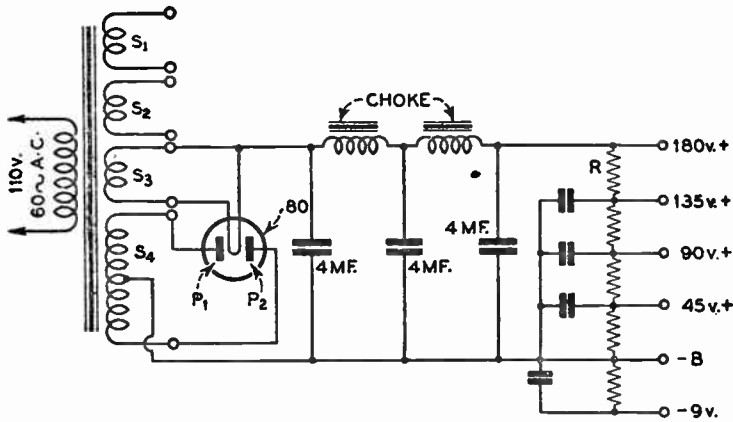

33. Diagram of a circuit in which the 80 rectifier transforms a-c into pulsating d-c, which the filter smooths out

outside homes. A power transformer for a ten-tube receiver may easily be held in the hand.

Rectifier tubes are discussed at length in the chapter on power supplies but let us consider briefly at this point the type known as the 80, a full-wave rectifier tube widely used in all branches of radio.

The 80 has two filaments in series heated by alternating current supplied by the secondary winding of a power transformer S3, in Fig. 33. (Note: The other two windings, S1 and

*S2*, are those supplying power for operation of the a-c tubes in the amplifier and receiver.) Two plates are in the tube, each being connected to one end of the winding, *S4*, of the power transformer. The center tap of this winding represents the negative side of the d-c supply.

As has been explained heretofore, when the filament of the 80 is heated, electrons are emitted. Now we must imagine conditions during one complete cycle of the alternating current. When the positive half of the wave is induced in *S4* we will assume that the plate *P1* is charged positively. The stream of electrons will therefore be attracted toward that plate and current will flow through it, around through the upper half of *S4* and out through the center tap to the filter circuit. At this same instant the plate *P2* is charged negatively and will repel electrons.

Now when the other half of this same wave strikes *S4* conditions will be reversed. *P1* will be negative and *P2* will have a positive charge. Therefore the stream of electrons will be attracted to the latter plate and the current will flow through the lower portion of *S4* and out into the filter circuit through the center tap, as it did in the former case. Thus it may be seen that current always flows in the same direction through the center tap of the secondary *S4*.

### The Operation of the Filter

The function of the filter system shown in *Fig. 33* is to smooth out the pulsating direct current delivered from the rectifying tube, so that it will be as nearly like that delivered from a battery as is possible.

The two choke coils have a high self-inductance, usually 20 to 30 henries, and their function is to keep the *current*

flowing through the system unchanged. If the current fluctuates the magnetic lines of force produced about the windings of the chokes tend to induce a current that will buck the other and keep it constant. Also this counter e.m.f., set up within the choke will charge the large condensers shunted across them with a higher voltage. Therefore, whenever the rectifier's output lowers in value, the voltage of the output will be less than that at which the condensers are ordinarily charged and the condensers will discharge so that the line will come back to its normal condition.

This happens every cycle, as the output of the rectifier is not a smooth line but a series of humps. The action of the filter system smooths out these irregularities and delivers to the resistor,  $R$ , a current sufficiently unvarying so that the difference between it and the output from a battery is negligible.

The tapped resistor,  $R$ , called a *bleeder*, is inserted in the circuit in order that a number of different voltages may be obtained for the various requirements of plate and grids in the receiver and amplifier. It is a simple matter to calculate the amount of resistance necessary to obtain the drop in voltage needed and to take a tap off at those particular points.

## Power Tubes

Power tubes are an essential part of every radio receiver in which the output is used to actuate a loud speaker. These tubes comprise the last audio frequency amplifying stage and their function is to convert the strong a-f voltage variations obtained by several consecutive stages of r-f and a-f amplifiers into identical variations of current with minimum distortion. Loud speakers being in effect, a form of electric motor

require definite watts of energy in their operation. The power tube with its high voltage and high plate current produces this power.

Power tubes have a low amplification factor, in the majority of cases from 3 to 8, and their grids can handle large voltage swings which in turn give wide but identical variations in the plate current.

In appearance, power tubes are similar to other tubes in their corresponding class except that they may be enclosed in a slightly larger envelope. Typical power tubes are the 1G6, 45, 50, 42, and 6L6. Their individual characteristics will be found in the Tube Chart in the appendix.

### The Pentode

Just as the addition of the screen grid was a step forward when it was added to the triode, so the adding of the suppressor<sup>1</sup> makes the tetrode (four elements) into a five-element tube (the pentode) that will do things that have not been done with the same ease before.

It will be remembered that when electrons collide with atoms the tendency is for them to dislodge an electron from the atom, if the first electron is traveling at sufficient speed. When the plate voltage is high in a tube the electrons move from the filament or the cathode to the plate at a high velocity and when they strike the plate, dislodge other electrons. In the ordinary triode these free electrons so dislodged do no particular harm, because there is no other positively charged body in the vicinity that they can affect. However, in the case of the screen-grid tube, where the screen is at a positive potential with respect to the filament (cathode), this element

<sup>1</sup> The "Suppressor" is similar to the screen grid in construction and is located between the screen grid and the plate.



offers a strong attraction for these free electrons and in some cases the plate current is reduced in strength because of them.

In order to remove these so-called secondary electrons from the path of the main electronic stream from the cathode to the plate, the suppressor is placed between the screen grid and plate and is usually connected to the cathode. This element is greatly negative with respect to the plate, hence the secondary electrons moving out from the plate encounter this

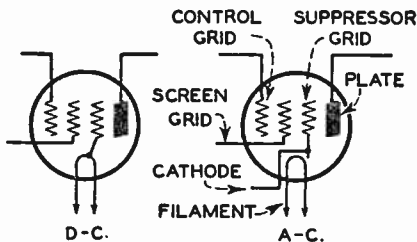

34. The suppressor grid is connected to the cathode in the pentode tube, for the purpose of removing the secondary electrons

negative charge and are diverted back again to the plate, where they cause no trouble.

Pentodes are used in several places at the present time and there is little doubt that as further experimentation is carried on, still more uses will be found for them. Tubes such as the 1A5, 33, 47, and 6F6 are used as power output tubes, where the suppressor element makes possible a large power output with a low grid voltage.

Radio frequency pentodes such as the 34, 58 and 6K7 use the suppressor grid as a means of obtaining a high voltage gain with moderate limits of plate voltages. Schematic diagrams of the pentode tube for both d-c and a-c operation are shown in *Fig. 34*.

### Tubes Classed by Filament Voltages

As radio applications have widened in scope the demand for tubes which operate from varied voltages has increased. As a result, the amateur has at his command an assortment of vacuum tubes with filament demands from 1.4 volts to 2-, 6.3- and on up to the maximum of 117 volts. The filament current drain varies likewise from .05 amperes to as high as 1.25 amperes for some types of power tubes.

The lowest voltage filaments find their principal use in battery operated receivers. This includes the 1.4- and 2-volt classes. Other tubes, in general, are designed for use on storage batteries or direct from the a-c or d-c lighting lines. The 6.3-volt series, for instance, was originally introduced for automobile radio sets where the storage battery is depended upon for the filament supply; but its characteristics proved to be so favorable that many of this class are now found in a-c receivers.

When the combination a-c-d-c receiver came into wide use there arose a demand for tubes with higher voltage filaments which, when connected in series, would more nearly approximate in total voltage the potential of the supply line. Accordingly, the tube manufacturers brought out the 25Z5 with its 25-volt filament—and later, the 35-volt series. One manufacturer has now offered a 117-volt tube which can be applied directly across the supply line without intervening transformer or series resistance.

### The Duplex-Diode Triode

This is one of the revolutionary types of tubes that have come out of the research laboratory in recent years. Actually, it is three tubes in one. The 55, for instance, consists of two

diodes and a medium mu triode, while the 2A6 comprises the same two diodes combined with a high mu triode. Still another type, the 2B7, has the double diode plus a pentode, all within the single envelope. In explanation of the above it should be understood here that a diode consists of two elements, a plate and a filament, while a triode has filament, plate, and grid.

As commercially designed the duplex-diode triode has independent elements except for a common cathode with one emitting surface for the diodes and another for the triode.

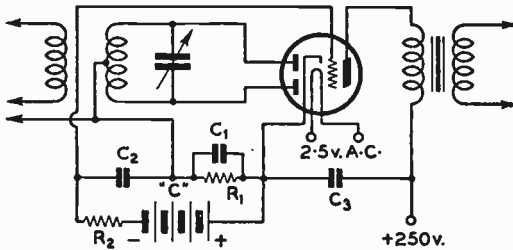

35. The two diodes can be connected as shown to obtain full-wave rectification

It has been stated heretofore that the simplest form of a vacuum tube detector was a diode, which depends for its rectifying properties on the fact that current will flow only from the cathode (filament) to the plate, when the plate is positive with respect to the cathode. As the diode is a simple rectifier, it has no amplifying properties and if an increased current is desired then other tubes must be introduced into the circuit. This will be explained later.

The two diodes in the 55 tube can be used for full-wave rectification, see *Fig. 35*, or their plates may be connected in parallel for half-wave rectification, see *Fig. 36*. The former has some advantages, one being that no carrier frequency gets

through to the grid of the following tube, but the latter gives about twice the output, necessitating some carrier-frequency filtering.

For amplifying the rectified signal, the triode is employed in the usual circuit arrangement, see *Fig. 35*. The necessary grid-bias voltage may be obtained from a fixed voltage tap on the d-c power supply or the variable voltage drop caused by the rectified current flowing through a resistor in the de-

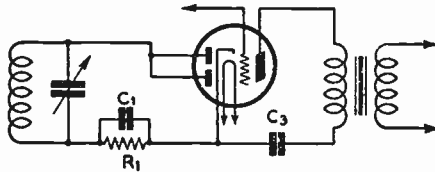

36. Plates of the duplex-diode tube connected for half-wave rectification

tector circuit can be utilized. The values of the various condensers and resistors in *Fig. 35* are given herewith: *C1* has a capacity of 150 mmf.; *C2*, 0.01 mfd.; *C3*, .1 mfd.—1.0 mfd.; *R1* and *R2*, approximately 0.5 megohm. The *C* battery, supplying the negative grid bias, should be —20 volts, and the plate voltage should be 250, with 2.5 volts a-c on the heater element.

### Beam Power Tubes

Most recent of all new types of tubes is the beam power tube, so called because the stream of electrons from the emitting surface of the cathode are formed into thin beams which then pass between the spiraled turns of the screen grid. Because of the low current drawn by the screen, the beam power tube gives an output of high power and a generally high overall efficiency. It is not unusual for a single beam power tube

to be used in a circuit which permits it to deliver as high as ten watts of output power or for two such tubes in push-pull arrangement to produce an output of 47 watts. *Fig. 37-A* illustrates the manner in which the beam-forming plates of these tubes turn the electron stream into thin sheets which have no difficulty in passing through the screen without interception. Beam power tubes are also coming into wider use in short wave amateur transmitters.

### Multi-Unit Tubes

Space does not permit the individual description of all variations in tube design but mention should be made here of the multi-element tubes which have found growing favor among designers of modern radio receivers. Most of these are in-

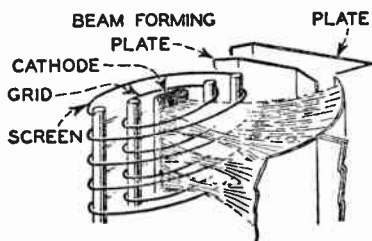

37-A. Schematic action of beam power tube showing shaping effect of beam forming plates

tended for very special applications. For instance, the 6L7 has seven individual elements and a heater or filament. These are the plate, cathode, two separate control grids shielded from each other, a suppressor grid, and two shield grids connected together within the tube. Called *pentagrids* because of their five grids, these tubes find their maximum usefulness when serving as mixers in superheterodynes.

So far in this chapter and those preceding it, the tubes under consideration have been the standard types with glass envelopes. In the last few years the metal tube has gained some prominence, although the earliest predictions for its success have not always materialized. Yet the metal tube has some characteristics which make it preferable to the glass tube. In some ultra high frequency circuits, for example, the lower inter-element capacitance of the metal tube gives it greater amplifying ability. Moreover, the metal covering acts as a perfect shield and makes additional shields unnecessary. The specific choice of glass or metal tubes, as far as the amateur is concerned, will depend on the use he will make of it and this calls for a study of the tube chart in the back of this book.

When the metal tube was first introduced in 1934, it brought with it a new type socket called the *octal*, a name derived from the eight terminals arranged symmetrically on the socket edge. With the octal base and socket, the positioning of the tube was simplified by the addition of a small rib or key on the base and a corresponding slot in the socket. This arrangement insured economy in manufacture since the same base could be used for all types of tubes with some of the prongs left unused in tubes where the number of elements was less than eight.

Of the other special forms of vacuum tubes, the one that will be most often adopted by the amateur is the *acorn* tube shown in *Fig. 37-B*. This tube has no base, the terminals of the elements extending from the glass envelope in such a manner that contact is made direct with a special socket or soldered permanently to the circuit leads in which it is to be used. The principal advantage of the acorn tubes (types 954

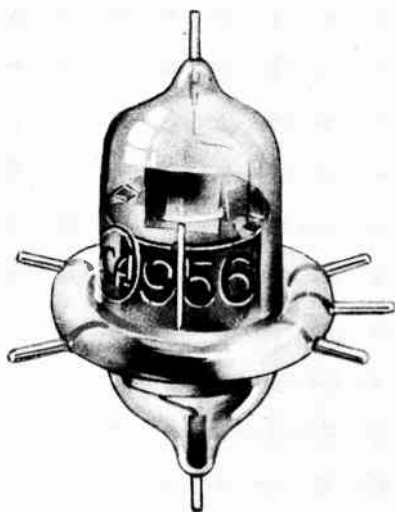

37-B. Acorn tube





and 955) exists primarily in the extremely low capacity between the element terminals due to the absence of a base. They are therefore used frequently in the detection and amplification of frequencies above 30 megacycles.

# HEADPHONES AND LOUD SPEAKERS

---

## CHAPTER 9

### Radio Headphones

**A** TELEPHONE receiver for a radio receiving set is made exactly on the same principle as an ordinary Bell telephone receiver. The chief difference between them is that the former is made flat and compact so that a pair of them can be fastened together with a band and worn on the head (when it is called a *headset*), while the latter is long and cylindrical so that it can be held to the ear. A further difference between them is that the radio headphone is made as sensitive as possible so that it will respond to very feeble currents, while the ordinary telephone receiver will respond only to larger currents.

### How a Bell Telephone Receiver Is Made

An ordinary telephone receiver consists of three chief parts: (1) a hard-rubber, or composition, shell and cap; (2) a permanent steel bar magnet, one end of which is wound with a coil of fine insulated copper wire; and (3) a soft iron disk, or *diaphragm*, all of which are shown in the cross-section in *Fig. 38*. The bar magnet is securely fixed inside of the handle so that the outside end comes to within about  $1/32$  of an inch of the diaphragm when this is laid on top of the shell and the cap is screwed on.

The ends of the coil of wire are connected with two binding posts which are in the end of the shell, but are shown in the picture at the sides for the sake of clearness. This coil usually has a resistance of about 75 ohms, and the meaning of the

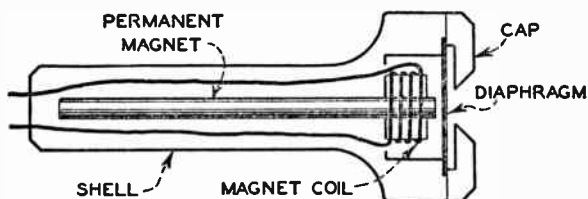

38. The cross-section of a unipolar telephone receiver

*ohmic resistance* of a receiver and its bearing on the sensitiveness of it will be explained a little farther along. After the disk, or diaphragm, which is generally made of thin, soft sheet iron that has been tinned or japanned, is placed over the end of the

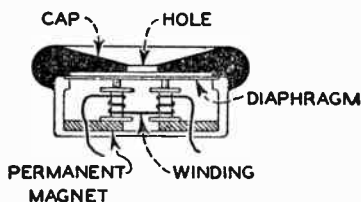

39. The cross-section of a bipolar type of receiver, which is in general use for radio work

magnet, the cap, which has a small opening in it, is screwed on and the receiver is ready to use.

### How a Radio Headphone Is Made

For radio work a receiver of the watch-case type is used and nearly always two such receivers are connected with a headband. It consists of a permanent magnet shaped so that

it will fit into the shell of the receiver as shown in *Fig. 39*. The ends of this magnet, which are called *poles*, bend up, and hence this type is called a *bipolar* receiver. The electromagnets are wound with fine insulated wire as before and the diaphragm is held securely in place over them by screwing on the cap.

When no signal is being received, the diaphragm is under a constant pull or attraction exerted on it by the permanent magnet. When a current flows through the winding, the pull on the diaphragm is increased or decreased, depending upon the polarity of the current. The resultant motion of the diaphragm produces sounds.

#### About Resistance, Turns of Wire, and Sensitivity of Head-phones

If you are a beginner in radio you will hear those who are experienced speak of a telephone receiver as having a resistance of 75 ohms, 1,000 ohms, 2,000 or 3,000 ohms, as the case may be; from this you will gather that the higher the resistance of the wire on the magnets the more sensitive the receiver is. In a sense this is true, but it is not the *resistance* of the magnet coils that makes it sensitive—in fact, it cuts down the current—but it is the *number of turns* of wire on them that determines its sensitiveness. It is easy to see that this is so, for the larger the number of turns the more often will the same current flow round the cores of the magnet, and so magnetize them to a greater extent.

But to wind a large number of turns of wire close enough to the cores to be effective, the wire must be very small and so, of course, the higher the resistance will be. Now the wire used for winding good receivers is usually No. 40, and this has a diameter of .0031 inch; consequently, when you know

the ohmic resistance you get an idea of the number of turns of wire and from this you gather in a general way what the sensitivity of the receiver is.

A receiver that is sensitive enough for radio work should be wound to not less than 1,000 ohms (this means each ear phone), while those of a better grade are wound to as high as 3,000 ohms for each one. A high-grade headset is shown in *Fig. 40*. Each phone of a headset should be wound to the

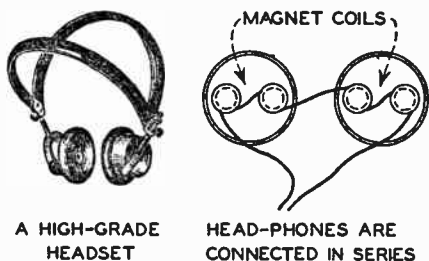

40. A radio headset and its connections

same resistance, and these are connected in series as shown. Where two or more headsets are used with one radio receiving set they should all be of the same resistance and connected in series, that is, the coils of one headset are connected with the coils of the next headset, and so on to form a continuous circuit.

### The Impedance of Headphones

Telephone receivers possess in addition to resistance, a characteristic called *impedance*. The impedance of the receivers causes them to offer more resistance to the passage of an alternating current than to direct current. When a current is flowing through a circuit, the material of which the wire is made not only opposes its passage—this is called its *ohmic resistance*—but a *counter electromotive force* to the current

is set up due to the inductive effects of the current on itself and this is called *impedance*. Where a wire is wound in a coil the impedance of the circuit is increased, and where an alternating current is used the impedance grows greater as the frequency gets higher. The impedance of the magnet coils of a receiver is so great for high-frequency oscillations that the latter cannot pass through them; in other words, they are choked off. Radio engineers take the impedance of a telephone headset into consideration in making a selection. In practice, a receiver is generally chosen whose total impedance is about equal to the a-c resistance from plate to filament of the tube to which the receiver is to be connected.

### How the Headphones Work

As you will see from the cross-sections in *Figs. 38 and 39* there is no connection, electrical or mechanical, between the diaphragm and the other parts of the receiver. Now when either feeble oscillations, which have been rectified by a detector, or small currents from a *B* battery, flow through the magnet coils the permanent steel magnet is energized or de-energized to a certain extent, depending upon the polarity of the current flowing through the coils. Added magnetic energy increases the pull on the diaphragm. If, on the other hand, the current is cut off, the pull of the magnet is lessened and as its attraction for the diaphragm is decreased the latter springs back to its original position. When varying currents flow through the coils the diaphragm vibrates accordingly and sends out sound waves.

### The Baldwin Receiver

A type of receiver more recently developed, known as the Baldwin receiver, has the advantage that the diaphragm is

not initially stressed. Thus it may be more responsive and sensitive to the pull exerted upon it by the magnetic changes caused by the signal current.

The armature of the receiver is a small piece of iron pivoted between the poles of a permanent magnet. It is in a neutral position and the pull upon it is equal from both sides. It is therefore not under stress. The armature is connected to a mica diaphragm and is surrounded by a coil winding. When a current flows through this winding there is no longer an equal magnetic pull on both sides of the armature. The armature becomes unbalanced, moves, and in so doing moves the mica diaphragm.

### Crystal Phones

In general appearance, crystal phones are the same as the ordinary radio headphones. In principle they are quite different. The fact that a piezo-crystal changes its shape when an electric charge is impressed upon it is utilized. A crystal is mechanically connected to a diaphragm so that its motion will produce sounds. Crystal phones are very sensitive over the entire audio frequency range and have the advantage of possessing high impedance. In a high impedance circuit where for maximum results it is necessary for the impedance of the phones to match the impedance of the rest of the circuit, crystal phones are used to advantage.

### About Loud Speakers

The simplest acoustic instrument ever invented is the *megaphone*, derived from Greek words meaning *great sound*. It is a very primitive device. Our Indians made it out of birch bark before Columbus discovered America. In its simplest form it consists of a cone-shaped horn and as the speaker talks

into the small end the concentrated sound waves pass out of the large end in whatever direction it is held.

In the early days of radio broadcasting the megaphone idea was employed in the loud speakers; that is, an ordinary watch-case receiver or pair of receivers was placed at the throat of a horn, which threw the sound in one direction, thus making it possible for a group of people to listen-in on one receiver.

However, in order to make the volume sufficiently loud so that a large number of people could hear with ease, it was

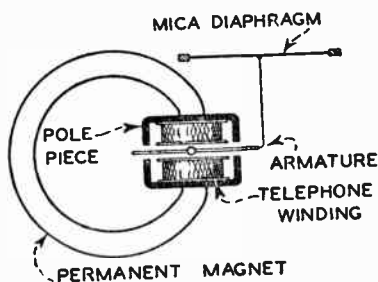

41. Essential elements of the Baldwin balanced-armature telephone receiver

necessary to add to the receiving set audio-frequency amplification, as the output of the detector tube was too low. When such amplification was used the resulting music was far from pleasing. There was too great a current for the receivers and distortion resulted. Then engineers started on a quest for a loud speaker that would faithfully reproduce amplified music and speech.

To understand fully the different types of loud speakers that are today obtainable it might be well to consider for a moment the theory of reproducers in general. As has been explained previously sounds are reproduced from a phone by the to-and-fro movement of the metal diaphragm. Now the greater the distance that this diaphragm moves the greater



will be the sound. In order to increase the volume we can therefore increase the movement of the diaphragm, keeping its size the same, or we can increase its size, so that it will set in motion a larger amount of air, and cut down on its movement.

Both these systems were tried, giving us the *paper diaphragm* or *cone* type of speaker, wherein is used the larger diaphragm, and the *dynamic* type, which uses a relatively small diaphragm and a relatively great movement. Let us look at each of these different types.

The diaphragm of the cone type of speaker is usually about 16 inches in diameter. To the apex of the cone is attached a slender stiff wire, which is known as the driving rod. This rod is attached to the armature of the unit, which is caused to move back and forth due to the changes in magnetic flux induced in the bar magnet by means of the two coils of fine wire wound about it and connected to the output of the receiving set.

The operation is as follows: due to the changes in the plate current of the last tube of the audio-frequency amplified in the receiver, there is a corresponding change in the flux of the magnet. This causes the armature to move back and forth, which in turn moves the driving rod and so the diaphragm or cone. Thus we have the paper diaphragm moving in accordance with the various wave forms going through the set and setting in motion a large volume of air in the room which reaches the listeners' ears as sound waves.

The cone speaker was an interesting development but it possessed certain faults which are missing in speakers of the dynamic type.

The *electrodynamic* type of loud speakers produce even better results than the cone type and have the added advan-

tage that the entire speaker's physical proportions are much smaller, making it easier to place in a cabinet or console. In general the diaphragm is also of heavy paper and varies from 5 to 16 inches in diameter. The larger diameter of the cone, as may be seen in *Fig. 42*, is attached to a panel or baffle board by means of a ring of thin, flexible fabric or leather. This permits the cone to vibrate back and forth with hardly any

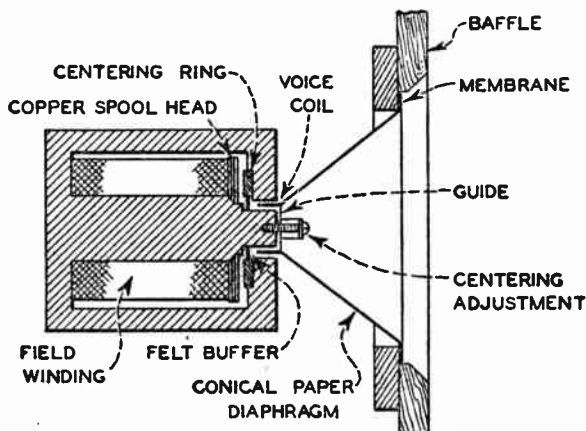

42. Cross-section of an electrodynamic loud speaker

mechanical resistance. On the smaller diameter of the cone there is a coil of very fine wire, supported in a magnetic field set up by a field winding. This coil carries the signal current delivered by the audio amplifier and is acted upon by the magnetic field moving the cone back and forth.

This field has to be excited by means of an outside source of current, which is supplied by a 6-volt storage battery or by utilizing the direct current which flows in the power supply filter circuit.

It might be of interest to note in passing that this type of

loud speaker is one generally used in connection with talking motion pictures. In order to get away from troublesome echoes and other acoustical problems in theaters the sound waves are directed by means of large horns, having a throat equal in diameter to the diaphragm of the unit and a mouth several square feet in area. These speakers are employed in this work as they are capable of reproducing faithfully a large volume of music with minimum distortion.

One of the most interesting types of speakers but one that

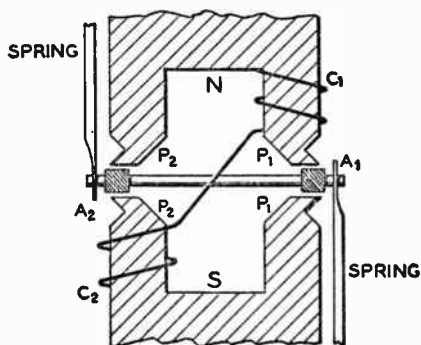

43. Sketch showing mechanism of the inductor dynamic speaker

is now seldom used, is the inductor dynamic, developed by C. L. Farrand.

This unit has two horseshoe magnets and the moving mechanism, as may be seen from *Fig. 43*, is free to float between the pole-pieces, giving to the cone a movement as much as  $\frac{1}{8}$  inch at low frequencies for maximum volume on a sufficient input. The principle is quite simple, being based on a changing magnetic flux, due to the signal current flowing through a pair of coils, *C1* and *C2*, *Fig. 43*, acting on a pair of armature bars, *A1* and *A2*, connected by tie-rods, each bar working between its respective pole-piece, *P1* or *P2*. The rod

that imparts the motion of the armature to the cone is connected to the piece holding *A1* and *A2* together. The cone is suspended from its baffle board in the manner described heretofore in the case of dynamic speakers.

Another type of speaker which gave great promise but is no longer manufactured is the condenser speaker. More than sixty years ago in Europe the "singing condenser" was discovered, this being nothing more mysterious than a lightly rolled condenser made by placing a paper dielectric between two sheets of tin foil and using one electrode in opposition to the other sheet. When an alternating current was impressed across the electrodes the condenser would give forth a musical note depending upon the frequency of the impressed voltage.

This type of loud speaker functions because there is a mechanical stress generated between the two electrodes as they are electrically charged and when these charges vary, the electrodes are moved back and forth according to the variations of the current. If the two plates of this condenser have considerable size then the sounds emitted by the movement of the electrodes will have sufficient volume to fill the requirements of a loud speaker.

This speaker employed a flexible dielectric between the two plates of the condenser. The rear plate of the speaker had a series of vents to secure the necessary freedom of motion to the dielectric, which was made of a substance nearly as elastic as rubber and with high insulating properties. The second plate of the condenser was a metallic-paint sprayed on the other side of the dielectric.

A loud speaker is judged by the volume of air it can set in motion so that sound waves will be reproduced faithfully. In order to do this it must have a wide range of musical fre-

quencies. Certain loud speakers have peaks—points at which certain notes are stressed more than others, thus giving the resulting sounds distortion.

A new loud speaker has been developed, which uses Rochelle salt crystals instead of the more usual magnets and coils. It was found quite a number of years ago that certain crystals convert electrical energy into mechanical energy and vice versa. Loud speakers are constructed from especially grown Rochelle salt crystals, by clamping three corners of the crystal firmly and attaching to the fourth a rod which in turn is fastened to the apex of a diaphragm. When a varying voltage is impressed across the proper axis of the crystal the free corner will vibrate at the same rate as the impressed voltage. It is claimed by Dr. C. Baldwin Brush Sawyer, the inventor, that such loud speakers can reproduce music of the order of 9,000 cycles per second, which will include the great majority of the harmonics so essential for the faithful reproduction of music.

### **The Permanent Magnet Dynamic Speaker**

The loud speaker in growing use today is the permanent magnet type of dynamic speaker. Recent developments in magnetic alloys have greatly increased the strength of permanent magnets. Consequently there is a tendency to avoid the use of a field coil and to use powerful permanent magnets in its place. The saving in cost is considerable due to the absence of a field coil and the means required to excite it. Permanent magnetic speakers—PM, as they are called—find favor with amateurs for the reasons given above.

An electric generator delivers the greatest amount of power when its impedance is the same as the impedance of the circuit and load to which it is supplying energy. This same prin-

ciple applies in the case of a loud speaker connected to a radio receiving set or amplifier. The impedance of the voice coil in the speaker must be matched to the impedance of the plate circuit of the tube which is to supply energy to the speaker. This matching is most easily accomplished by means of a suitable transformer.

In the permanent magnet dynamic speaker the current flowing through the coils will aid the magnetism when flowing in one direction and impede it if reversed. Generally the leads to the speaker are so marked that the proper lead can be connected to the positive side of the output. If not, then try the leads in reverse order to find the optimum results.

Nearly any speaker of a reputable make on the market today will give good results, the whole matter more or less depending on the amateur's pocketbook and the amount of volume desired.

# POWER SUPPLY

---

## CHAPTER 10

### Sources of Power

**T**HE power supply, and by that is meant the current for the filaments and the plate circuits, is an important adjunct of every vacuum tube receiving set and transmitter.

In some instances batteries must be used. When power from a commercial lighting circuit is available it will prove most satisfactory. Portable installations must necessarily depend upon batteries.

### Dry Cells

Two types of batteries are available, dry cells and storage cells. Dry cells will not deliver current at as great a rate as storage cells and consequently are satisfactory only for sets containing a small number of battery type tubes.

Two No. 6 dry cells connected in series will deliver approximately three volts. Together with the proper ballast resistance to regulate the current, they operate 1.4 and 2-volt filaments satisfactorily.

Special 3-volt dry *A* batteries called *air-cells* are on the market. The 3-volt flat type will deliver  $\frac{1}{2}$  ampere, three hours per day for six months. A larger size, called the "reg-

ular" type, will deliver the same amount of current for approximately one year.

The small dry cells put up in sealed boxes called *B* batteries are a satisfactory source of power for the plate circuits of battery type tubes.

### Storage Cells

A 2-volt storage cell may be used to light the filaments of 2-volt tubes provided the usual 3-volt ballast resistance is replaced with a 2-volt adapter ballast. A large capacity 6-volt storage battery will operate 6-volt tubes satisfactorily.

### Vibrator-Transformers

When a storage battery is used for filament lighting, it can also be used to supply current for the plate circuits. By means

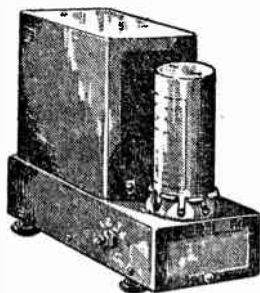

44. Vibrator and transformer for changing low-voltage battery current into high-potential *B* current

of a vibrator-transformer, *Fig. 44*, outputs as high as 300 volts and 100 milliamperes can thus be secured.

A vibrator-transformer consists of a transformer combined with a vibrating interrupter. When this unit is connected to



a storage battery, the pulsating current from the interrupter flows through the primary of the transformer and causes a high voltage alternating current to be developed in the secondary. This high voltage is then rectified, that is, changed back to a direct current by means of a vacuum tube rectifier or an additional synchronized pair of vibrator contacts. Vibrator-transformers are used in automobile and motor-boat radios.

Before the rectified current can be used in the plate circuit it must be filtered by suitable inductances and condensers. Filter systems are explained in detail later in this chapter.

### Recharging Storage Cells

Storage cells must be recharged when exhausted by connecting to a source of direct current. Alternating current can be conveniently changed into direct current by means of a rectifier, either of the vacuum tube or copper oxide type. Suitable rectifiers are on the market.

If it is impractical to transport a storage battery to a service station for recharging and no lighting circuit is available for the purpose, a wind- or engine-operated direct current generator may be used. See *Fig. 45-A*.

There are available inexpensive 6-volt direct current generators fitted with an airplane type propeller which will start recharging in an 8-mile wind.

Small  $\frac{1}{2}$  horsepower, air-cooled gasoline engine powered battery chargers offer certain advantages over wind-driven plants. Power is available at all times and an automatic stop protects the storage battery from overcharging. When the battery becomes completely recharged the engine stops and disconnects the battery from the generator.

### Power Packs

The 110-volt alternating current electric light and power mains are the most satisfactory source of current for radio use. Alternating current obtained from the house current through a step-down transformer may be used for the filaments. However, before power from an alternating current supply can be used in the plate circuit of a vacuum tube, it must be rectified or changed into direct current and filtered. The filament supply is simple; power for the plate circuit is more complicated. The equipment required for adapting the 110-volt alternating current for use in a radio set is known as a power pack.

### Rectifier Tubes

There are two general types of rectifier tubes: (1) the high vacuum and (2) the gaseous. The latter has a small quantity of mercury vapor added after the air has been removed from the tube. The high vacuum or Kenotron type of tube is similar to a Fleming Valve in principle. Conduction across the space between the filament and plate (cathode and anode) is purely by means of a stream of electrons passing from the filament to the plate. When a rectified tube of the mercury vapor type is in operation, the mercury vapor becomes ionized and increases the conductivity between the anode and cathode.

The high vacuum type has a comparatively large voltage drop between the filament and plate whereas the mercury vapor type, on account of greater conductivity, has a relatively small voltage loss. This difference in characteristic makes it necessary to use a slightly different circuit arrangement for each type of rectifier tube.

The efficiency of the mercury vapor rectifier tube is greater



45-A. Wincharger: a generator and windmill combined for recharging storage batteries

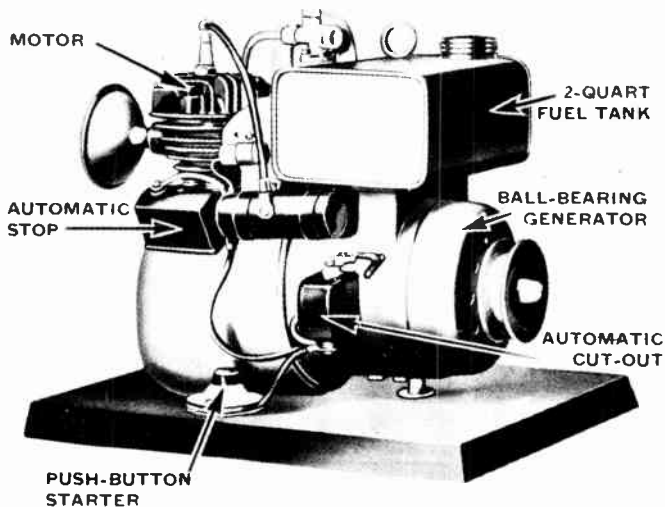

45-B. Gascharger: a small gasoline engine directly connected to a generator for recharging storage batteries

than that of the high vacuum type, but these are seldom used to supply current for receiving purposes. Rectifiers for receivers are nearly always of the high vacuum type because mercury-vapor rectifiers are likely to cause noise in the receiver.

Rectifiers for transmitters are usually of the mercury vapor type, since efficiency and voltage regulation are important.

### Half-wave and Full-wave Rectifiers

There are two types of rectifier circuits: half-wave and full-wave. Tubes made for voltages above 500 usually have but one plate and are known as half-wave rectifiers. For volt-

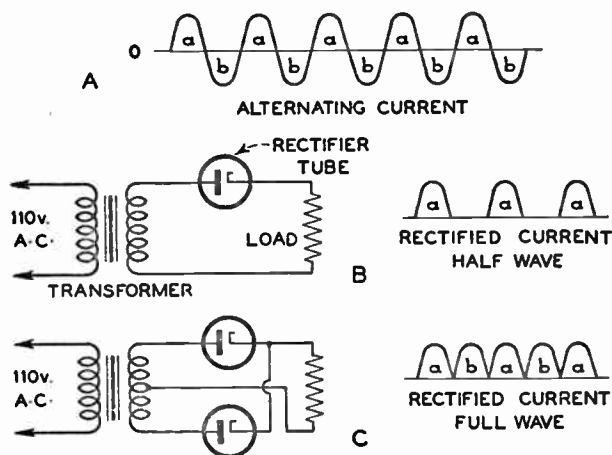

46. Fundamental rectifier circuits employing rectifier tubes to change a-c into d-c

ages up to 500 they are made with two plates and are called full-wave rectifiers. An example of the half-wave rectifier tube is the type known as the 81. The 80 is a full-wave tube.

The difference between half-wave and full-wave rectifier

systems is explained by *Fig. 46*. At *A* is shown a representation of a typical alternating current in which the current and voltage go through two complete reversals in each cycle. The portions of the curve above the line marked *a* are alternations in one direction and those marked *b* are alternations in the opposite direction.

In a half-wave rectifier system (*B*) the valve action of the tube merely eliminates all alternations (*b*) in one direction, the resulting rectified current being *intermittent* direct current in the form of a series of impulses. Only one-half of each cycle is useful in furnishing power to the load.

In a full-wave rectifier system (*C*) the full cycle is used to furnish power to the load. The action of the tubes results in a continuous series of impulses. The amount of power which can be realized for the load is doubled and the rectified current is more like a true direct current.

## Filters

Although the rectified current from a full-wave rectifier is direct current in the sense that it always flows in the same direction, it is not uniform but varies continually as shown by the series of humps (*a, b, a, b*) at *C*.

Such a current is full of ripples and if used in a radio receiving set would produce a humming noise. Used in a transmitter, especially one having poor frequency stability, it would be the cause of broad signals. The current must therefore be "filtered" to turn it into "pure direct current."

*Fig. 47* shows four representative filter circuits. A single condenser across the line as at *A* will do considerable smoothing but is not a satisfactory filter for radio work.

The addition of an inductance and another condenser as shown at *B* is an improvement and adequately smooths out

the current but has the disadvantage that the voltage varies considerably with the load. *C* and *D* are what are known as choke input filters and in most cases are the ideal type for all-around use in the amateur station.

### Condensers and Inductances for Filters

Two types of condensers are available for filter circuits: (1) electrolytic condensers using a dielectric which is an extremely thin oxide film formed on aluminum foil and (2)

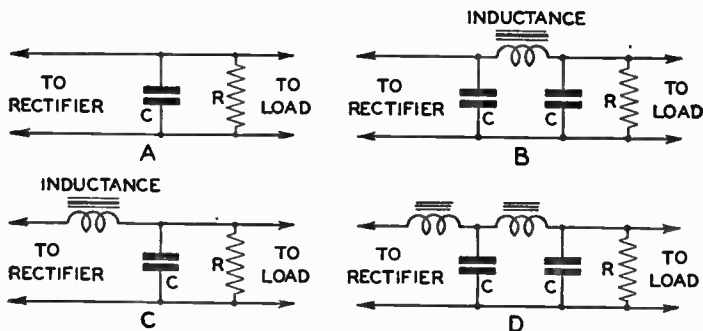

47. Filter circuits

paper condensers using paper as a dielectric. A good paper condenser will last indefinitely if not abused, but once punctured is useless. Electrolytic condensers must be “reformed” if allowed to stand idle for a time and must be connected correctly in respect to polarity but if broken down due to excessive voltage, the film can be restored. The negative leads are usually black.

Small inductances or “chokes” are obtainable from radio dealers.

Designing a power pack for a particular receiver or transmitter is not a job for the novice. It is distinctly work for an



# RECEIVER AND AMPLIFIER METHODS

---

## CHAPTER 11

**A** GREAT many amateurs prefer to buy rather than build their own receivers. Factory-made and -assembled apparatus is usually more efficient than a home-made product and, in the case of the more complicated sets, can usually be purchased more economically than the parts can be acquired and assembled. Nevertheless there is a great deal of pleasure and certainly a great deal of useful experience to be gained from the home construction of receiving sets.

Before you can either buy or build a receiver intelligently you must at least know the basic differences in receivers. The characteristics or behavior of vacuum tubes are the principal factors in receiver design. The frequencies embraced by the bands for which the receiver is built are an important consideration.

A vacuum tube is more sensitive than a crystal detector because while the latter merely rectifies the oscillating current, the former acts as an amplifier at the same time. The vacuum tube can be used as a separate amplifier and will amplify either radio-frequency currents, that is, high-frequency oscillating currents, or it will amplify audio-frequency currents, that is, low frequency currents.



In order to amplify radio-frequency currents or audio-frequency currents some sort of coupling device must connect the amplifier tube to the circuit. Two or more amplifier tubes may be coupled together so as to accomplish what is known as cascade amplification. In cascade amplification a coupling device is used to connect the plate circuit of the first amplifier tube and the grid circuit of the next amplifier tube.

### Radio-Frequency Amplification

The coupling device used in a radio-frequency amplifier is usually a *radio-frequency transformer* consisting of two coils having an air core. Several radio-frequency amplifiers may be connected in cascade or stages. The radio-frequency cur-

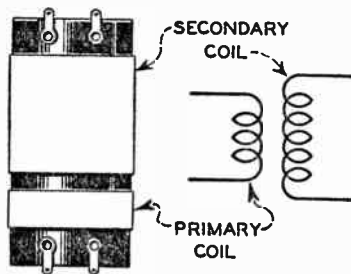

49. A radio-frequency transformer

rents pass through each stage of radio-frequency amplifier without being changed into low-frequency until they encounter the detector.

A radio-frequency amplifier ahead of the detector brings an increase in sensitivity to the receiver. It also separates the detector from the antenna and reduces radiation from the detector when the latter is in an oscillating condition. There are two types of radio-frequency amplification, *tuned* and *untuned*. The tuning is accomplished by variable condensers.

Tuned radio-frequency amplification requires complete shielding of the tubes and transformers. It was tuned radio frequency that led to the development of gang condensers, *i.e.*, two or more condensers varied by turning one shaft.

### Audio-Frequency Amplification

This type of amplification can be divided into three groups, as follows:

Transformer coupling  
Resistance coupling  
Impedance coupling

There is also a fourth type of coupling, capacity coupling, but it is seldom used.

Each type of coupling has its own advantages and disadvantages. Transformer coupling gives the greatest gain because there is a step up in voltage in the transformer itself. A

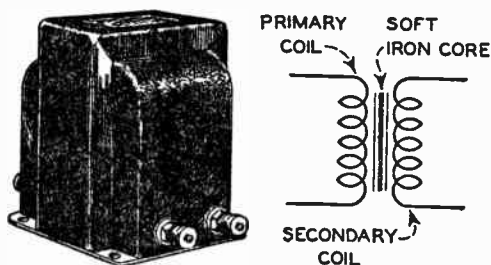

50. An audio-frequency transformer

gain in both the tube and the transformer thus makes fewer stages necessary. One of the disadvantages of transformer coupling is the difficulty of securing a uniform gain over a wide range of frequencies. This is mainly because there is a change in the impedance of a transformer with a change in frequency. An ideal transformer would be one having a con-

stant impedance at all frequencies, but that is not possible.

The only amplification that takes place with resistance coupling is in the tube itself. However, since the value of the coupling resistance does not change with frequency, a properly designed resistance-coupled amplifier has little distortion. Resistance coupling also has the advantage of being comparatively inexpensive.

Impedance coupling, accomplished by using a suitable coil having an iron core, overcomes some of the objections of resistance coupling.

### Pushpull Amplification

When it is desirable to obtain more power than one tube is capable of giving without objectionable distortion, a push-

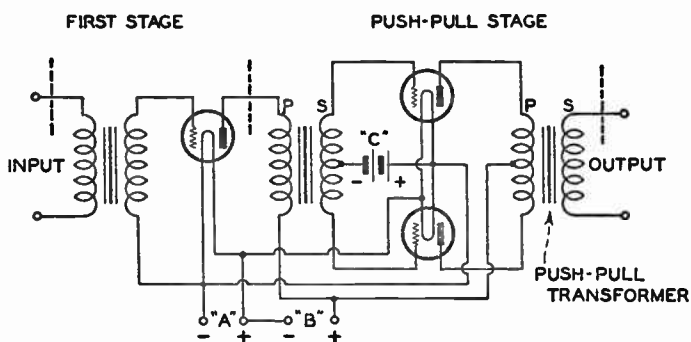

51. Diagram of a pushpull a-f amplifier

pull circuit is employed. In this arrangement the energy from a single stage amplifier is fed into two tubes "in pushpull," the grids and plates of the two tubes being connected to opposite ends of the circuit, respectively. The energy is evenly distributed between the two tubes. When an alternating cur-

rent is fed into the system, the grid of one of the pushpull tubes is positive when the other is negative and vice versa. The plate current of one tube is therefore rising while the other is falling.

### **Classes of Amplifiers**

In addition to the different methods of coupling, amplifiers are distinguished by the class of service into which they fall. There are three distinct classes of service recognized by radio engineers, Classes A, B, and C. These are covered by definitions standardized by the Institute of Radio Engineers.

The amateur will see amplifiers described in radio catalogs as A, B, or C and may wonder what this classification means. The definitions will, however, be clear only to those who thoroughly understand tube characteristics and operation.

A Class A amplifier is one in which the grid bias voltage and the exciting voltage are such that the plate current flows through the tube at all times. A Class A amplifier is low in efficiency and output. A Class A power amplifier is used in the output stage of radio receivers to supply relatively large amounts of power to the loud speaker.

A Class B amplifier is one in which the grid bias voltage is such that the plate voltage is practically zero when no exciting grid voltage is applied. Class B amplifiers for audio applications are of interest where large power output is required.

A Class C amplifier is one in which the grid bias voltage is high enough so that the plate current is zero when no exciting grid voltage is present and also so that the plate current flows in each tube for appreciably less than one-half of each cycle when an exciting grid voltage is present.

## The Tuned Radio-Frequency Receiver

There are a great many variations of this type of circuit. The basic circuit is shown in *Fig. 52*. This particular receiver

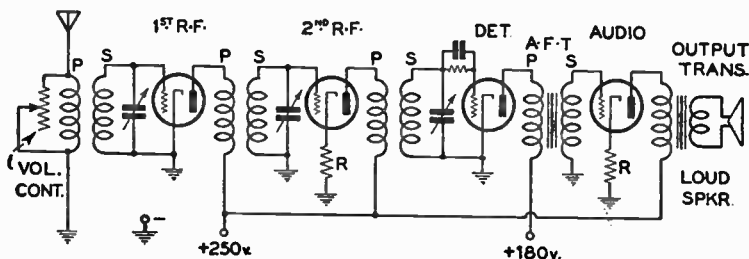

52. Tuned radio-frequency receiver using indirect heated tubes but with the filaments omitted for simplicity. The proper biases on the grids are obtained by the resistors R in the cathode leads

is illustrated because it is simple and more easily understood by the novice than modern receivers of the same type.

## The Neutrodyne Receiver

The neutrodyne circuit was invented by Professor L. A. Hazeltine of Stevens Institute of Technology in order to provide a radio-frequency amplifying receiver for certain manufacturers who did not have a license under the Armstrong patent. During the early days of broadcasting it was an extremely popular type of receiver.

The neutrodyne kills two birds with one stone. First, small condensers called neutralizing condensers are employed to neutralize the inter-element capacity of the vacuum tubes which is the cause of the circuit oscillating. Second, since the circuit cannot oscillate after once being neutralized, advantage is taken of tuned-plate radio-frequency amplification.

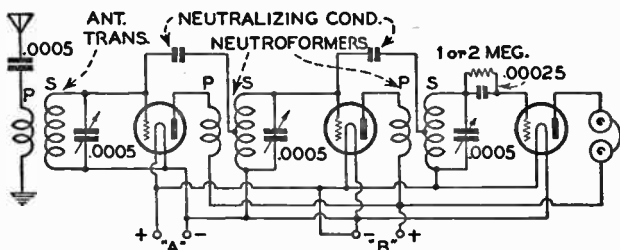

53. A simple schematic circuit for a neutrodyne receiver using three tubes

### Regenerative Receivers

While a vacuum tube detector has an amplifying action of its own, and this accounts for its great sensitiveness, its amplifying action can be further increased to an enormous extent by making the radio-frequency currents that are set up in the oscillation circuits react on the detector.

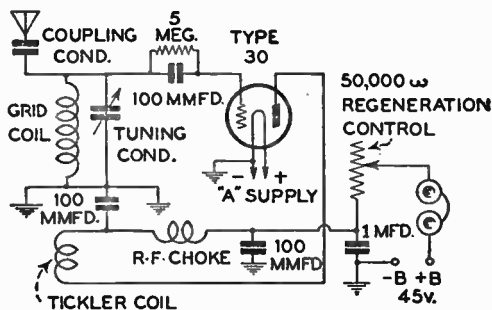

54. Short-wave regenerative detector circuit with resistance control of feedback

Such currents are called *feedback* or *regenerative* currents and when circuits are so arranged as to cause the currents to flow back through the detector tube the amplification keeps on increasing until the capacity of the tube itself is reached.

It is like using steam over and over again in a steam turbine until there is no more energy left in it. A system of circuits which will cause this regenerative action to take place is known as the *Armstrong circuit* and is so called after the man who discovered it.

### What the Heterodyne, or Beat, Method Is

The word *heterodyne* was coined from the Greek words *heteros* which means *other*, or *different*, and *dyne* which means *power*; in other words, it means when used in con-

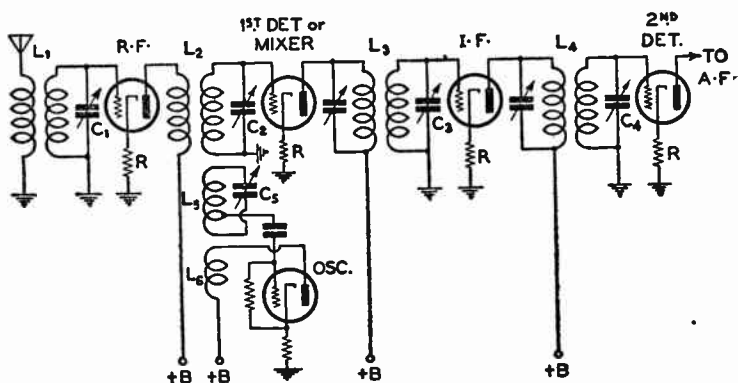

55. Basic diagram of a superheterodyne circuit with one stage of radio frequency amplification and one stage of intermediate frequency amplification. In practice, condensers  $C_1$ ,  $C_2$ , and  $C_6$  would be placed on a single shaft for simultaneous tuning. Filaments are omitted for simplicity. Resistors (R) provide necessary grid biases.  $L_3$  and  $L_4$  are double-tuned i-f transformers

nection with a radio receiver that another and different high-frequency current is used besides the one that is received from the sending station. In music a *beat* means a regularly recurrent swelling caused by the reinforcement of a sound and this is set up by the interference of sound waves which have slightly different periods of vibration as, for instance, when

two tones take place that are not quite in tune with each other. This, then, is the principle of the heterodyne, or beat, receptor.

In the heterodyne, or beat, method, separate sustained oscillations, that are just about as strong as those of the incoming waves, are set up in the receiving circuits, and their frequency is just a little higher or a little lower than those that are set up by the waves received from the distant transmitter. The intended clash of these two frequencies creates a third or beat frequency which is the exact difference between the first two. A similar effect can be produced on a piano keyboard by simultaneously pressing two keys several octaves apart. A third tone which will be found to be the difference between the two notes will resound in the room.

### The Superheterodyne Receiver

The difficulty of amplifying short waves (high frequencies) has been mentioned previously. But in the early days of radio, the problem was even more difficult because of the lack of

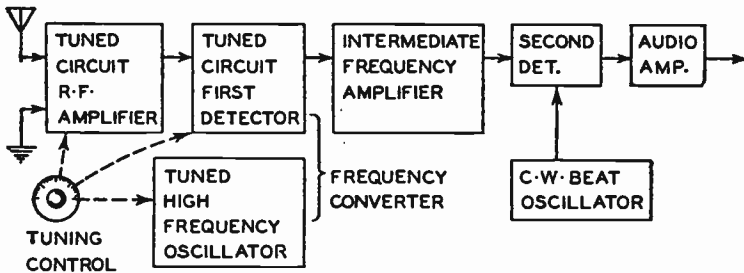

56. Block diagram of a superheterodyne receiver with a c. w. beat oscillator

suitable tubes. The World War created a sudden demand for highly sensitive short-wave apparatus and radio experts turned to the heterodyne principle as the means of satisfying



the requirements. Here again the genius of Major Armstrong showed itself with his perfection of the superheterodyne which has proved so flexible that it is now the basic circuit of ninety-five percent of the world's receivers.

The step-by-step progress of a signal in a superheterodyne is best explained by a block diagram as in *Fig. 56*. In order to eliminate some of the atmospheric noise, the incoming signal is first amplified at its normal frequency and then passed on to the mixer tube which is also called the first detector. It is in this tube that the clashing of frequencies (signal and local oscillator) creates the new frequency which is then amplified further until it is powerful enough to supply the second detector with the desired voltage amplitude. After that the signal goes through the audio stages in the usual manner.

### Receiver Construction Practice

In the early days of amateur radio, the component parts of receiving sets were usually mounted on the back of a bakelite panel forming the front of a suitable wooden dust-protecting cabinet. Very little, if any, shielding was used. A large number of tuning controls, consisting of variable condensers, variable inductances, variable couplers, resistors, potentiometers, wave-change switches, etc., made tuning a radio set beyond the grasp of the beginner.

To permit general merchandising of radio receivers to the average citizen, simplifications in tuning controls were imperative. So receivers were developed, in which the component parts are mounted on a metal chassis, behind a metal or composition panel and provided with a nominal single-dial control.

The amateur experimenter has the choice of two schemes of construction: one, the "bread-board method" in which the

apparatus is fastened to a flat wooden base and the connecting wires are above the base, and two, the metal chassis method in which the component parts are mounted on a metal chassis and the wiring kept underneath as in most commercial receivers.

The "bread-board method" lends itself to experimental work. The design and layout can be easily changed. The metal chassis system of construction is more permanent.

Component parts for every conceivable purpose in radio receivers and transmitters are available to the amateur at reasonable prices and the construction of an amateur-built receiver or transmitter really resolves into assembling and wiring.

No one but an experienced radio engineer is capable of designing a receiver of maximum efficiency of the superheterodyne or tuned radio-frequency type. These contain a number of tubes and that fact complicates matters. A receiver consisting of a single detector or a detector and an audio amplifier is of course a simple affair and it is not as important, for the component parts to be properly matched as in the case of multiple tube sets. But even when building a single tube set it is best to assemble it from a carefully engineered kit of parts rather than from a somewhat heterogeneous collection of coils, condensers, etc.

Given a properly selected set of component parts, the successful operation of the set will depend largely upon how well it has been wired. Wiring resolves itself into arrangement of wires and soldering the joints and connections.

### **Soldering**

All joints in radio circuits must be well soldered to insure good electrical connections. The secret of good soldering is

*sweating*. This consists in applying the hot tip of the iron to the joint for sufficient time so that the joint becomes hot enough to melt the solder without the necessity of touching the solder to the iron. When the solder has cooled, test the joint by pulling or wiggling it to be sure that it is tight. If the joint breaks or the wire wiggles in the soldered connection, it is not perfect. Probably the joint was not clean or insufficient flux or heat was used. In any event, it should be resoldered.

It is not safe to use any available soldering paste as a flux in radio work. Almost all pastes are slightly corrosive and slightly conductive. Use only rosin-cored solder and plenty of heat. Even then it is best to wipe away any residue in or around the completed joint.

### Wiring

All wires connecting the component parts of a radio set should be kept as short as convenient and as a general rule should be placed close to the metal chassis. Wiring, especially plate and grid leads that stand out from the chassis too far, furnish objectional coupling or regeneration. Grid wires in particular should be clipped as short as possible—fractions of inches make a difference—and under no circumstances be placed near or parallel to plate and filament wires.

Most paper by-pass condensers have one terminal marked "ground" to indicate the outside foil of the unit and, to insure best operation, this terminal should always be connected to the ground or to the part of the circuit with the lowest voltage. Such condensers will work in either position but occasionally hum will be picked up if the above instructions are not followed.

Normally, the can of a wet electrolytic condenser is always negative but the functioning of this type of capacitance is so

dependent on several points that the amateur should always read its label. For instance, the gas generated in electrolytic condensers must have an outlet which is provided on one end. If the can is supported upside down the gas will be prevented from escaping, sometimes with ruinous results.

The labels of all dry electrolytic condensers likewise give the operating data including the polarity of the flexible leads coming from the interior electrodes. Follow these instructions implicitly.

The insides of both windings in an intermediate-frequency transformer are usually intended by the manufacturer to be the high potential ends of the coils so that the outside ends will be the low potential terminals and automatically act as spacers to keep high-potential wiring away from the high-potential ends of the coils.

### **Construction Hints**

When fastening sockets on a chassis, be sure that the position of the keyway or the large locating prong is the same as that shown in the circuit diagram. Use lockwashers under all nuts so that they may be adequately fastened and made vibration proof.

### **Aligning**

Modern radio receivers employing several tubes comprise a number of circuits in order to achieve the necessary sensitivity and selectivity. Unless these circuits are adjusted so that they operate at their proper frequencies simultaneously, the receiver will not give its maximum performance. In fact, if the alignment is poor enough, no signal will succeed in passing through and the receiver will be "dead." In a turned r-f receiver, the alignment of the several stages is not so difficult

as in the case of a superheterodyne and can be carried out by ear using a screw driver to adjust the relative positions of the ganged variable condensers. But "superhets" present a different problem.

Before a superheterodyne can be successfully aligned, the amateur must have a signal generator which in itself has been calibrated or checked against an accurate generator. Then he must know how to use the signal generator so that he will not detune the very circuits he is trying to line up. Actually, such work should be done by a competent service man or by an accomplished amateur who understands the procedure and the instruments he must use. There is no economy in building a fine receiver and then attempting to use it at a point below its best performance. Have it expertly aligned after completion and make frequent checks on it thereafter. Poor reception is often due to misalignment and nothing else.

# ASSEMBLING YOUR OWN RADIO RECEIVERS

---

## CHAPTER 12

**T**HE regenerative type of receiver is a favorite with amateurs. It is used chiefly because of its low cost and because it is easy to construct and put together.

The Meissner 1-, 2-, and 3-tube regenerative receivers, described in the next few pages, are designed to supply the beginner with the simplest possible types of efficient vacuum-tube receivers. By means of four plug-in coils they will cover the following bands:

- 15 to 35 meters or 17630 to 8580 kilocycles
- 35 to 70 meters or 8580 to 4280 kilocycles
- 70 to 200 meters or 4280 to 1500 kilocycles
- 200 to 545 meters or 1500 to 545 kilocycles

All of the sets made from these kits operate on a single 1½ volt dry cell for *A* battery. The 1-tube set requires in addition only a single 45-volt *B* battery, while the 2- and 3-tube sets require two 45-volt *B* batteries and one 7½-volt *C* battery.

The one-tube receiver consists of a regenerative detector only. The two- and three-tube receivers include, in addition to the detector, respectively one and two stages of amplification. The designs have been arranged so that the two-tube receiver

can be made from the one-tube receiver by adding the amplifier tube and a few parts. Nothing is discarded. In the same fashion, the three-tube receiver can be built from the two-

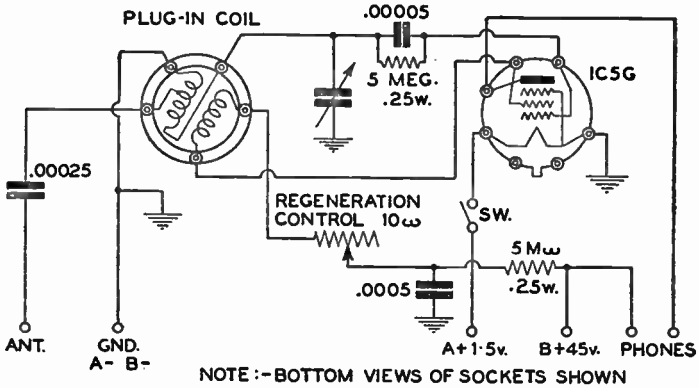

57. Schematic circuit for Meissner 1-tube regenerative receiver

tube without discarding any parts. The chassis and the panels are identical for all receivers, it being necessary only to knock

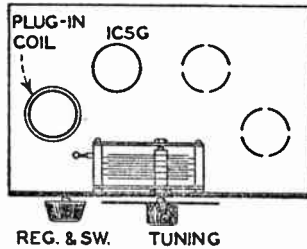

58. Top view of 1-tube regenerative receiver

out the special plugs in order to provide the necessary number of socket holes in the metal chassis.

All of the parts necessary for assembling a complete receiver, including the chassis and panel, are put up in kit form

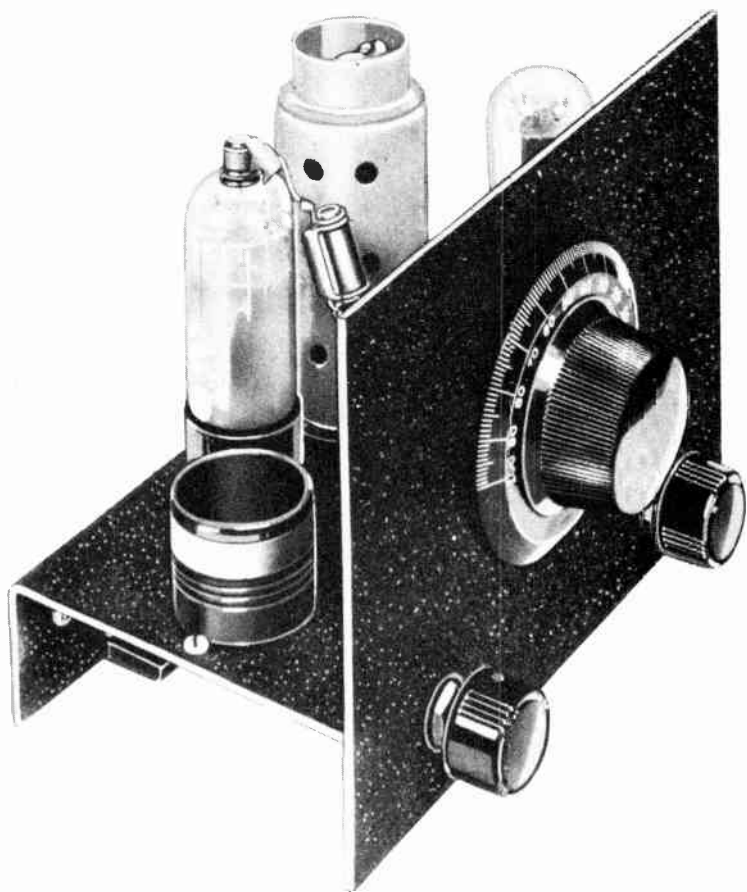

59. 1-3 Tube Meissner Midget Receiver



and available in many radio stores. The kits do not include the tubes. These must be purchased separately. The detector tube is a 1C5G. The amplifiers are 1H5G's. One plug-in coil

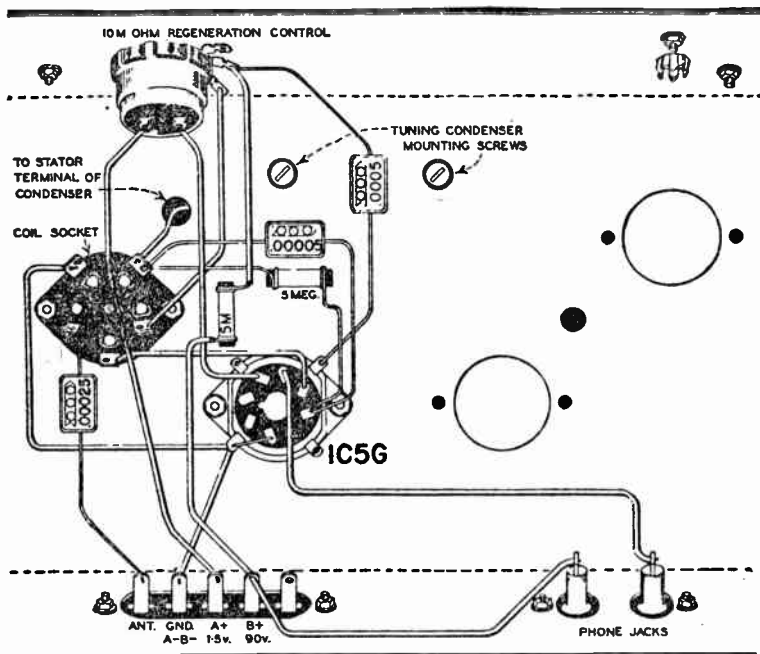

60. Pictorial diagram showing arrangement of parts and wiring on underside of chassis of Meissner 1-tube regenerative receiver

covering the broadcast band (200 to 545 meters) comes with each kit. The other coils, if desired, must be purchased separately.

### PARTS FOR 1-TUBE RECEIVER

- |                                |   |
|--------------------------------|---|
| 1 Punched steel panel          | 1 5-prong wafer socket                        |
| 1 Punched steel chassis        | 1 Phone-tip connection plate                  |
| 1 360-mmfd. variable condenser | 1 5-terminal connection strip                 |
| 1 Broadcast band plug-in coil  | 1 10,000-ohm regeneration control with switch |
| 1 Molded bakelite octal socket |   |

- |                                 |                                |
|---------------------------------|--------------------------------|
| 1 .00005-mfd. mica condenser    | 2 No. 8-32 x 1/4" brass screws |
| 1 .00025-mfd. mica condenser    | 2 No. 8 steel lockwashers      |
| 1 .0005-mfd. mica condenser     | 1 3/8" panel hole plug         |
| 1 5-megohm fixed resistor       | 1 1" black bakelite knob       |
| 1 5,000-ohm resistor            | 1 3" bakelite dial             |
| 11 No. 6-32 hexagon nuts        | 5 lengths colored hook-up wire |
| 11 No. 6-32 x 1/4" steel screws | 1 length insulating tubing     |
| 11 No. 6 steel lockwashers      | 1 length rosin-core solder     |

## PARTS FOR 2-TUBE RECEIVER

- |   |                                 |
|---|---------------------------------|
| 1 Punched steel panel                         | 1 5-megohm fixed resistor       |
| 1 Punched steel chassis                       | 1 250,000-ohm fixed resistor    |
| 1 360-mfd. variable condenser                 | 1 500,000-ohm fixed resistor    |
| 1 Broadcast band plug-in coil                 | 13 No. 6-32 hexagon nuts        |
| 2 Molded bakelite octal sockets               | 13 No. 6-32 x 1/4" steel screws |
| 1 5-prong wafer socket                        | 13 No. 6 steel lockwashers      |
| 1 Phone-tip connection plate                  | 2 No. 8-32 x 1/4" brass screws  |
| 1 5-terminal connection strip                 | 2 No. 8 steel lockwashers       |
| 1 Tie-lug, single insulated terminal          | 1 Grid clip                     |
| 1 10,000-ohm regeneration control with switch | 1 3/8" panel hole plug          |
| 1 .00005-mfd. mica condenser                  | 1 1" black bakelite knob        |
| 1 .00025-mfd. mica condenser                  | 1 3" bakelite dial              |
| 1 .0005-mfd. mica condenser                   | 5 lengths colored hook-up wire  |
| 1 .01-mfd., 200-volt paper condenser          | 1 length insulating tubing      |
|   | 1 length rosin-core solder      |

## PARTS FOR 3-TUBE RECEIVER

- |   |  |
|---|--|
| 1 Punched steel panel                         | 1 16-mfd., 150-volt electrolytic condenser |
| 1 Punched steel chassis                       | 1 5-megohm fixed resistor                  |
| 1 360-mfd. variable condenser                 | 2 250,000-ohm fixed resistors              |
| 1 Broadcast band plug-in coil                 | 1 500,000-ohm fixed resistor               |
| 3 Molded bakelite octal sockets               | 14 No. 6-32 hexagon nuts                   |
| 1 5-prong wafer socket                        | 14 No. 6-32 x 1/4" steel screws            |
| 1 Phone-tip connection plate                  | 14 No. 6 steel lockwashers                 |
| 1 5-terminal connection strip                 | 2 No. 8-32 x 1/4" brass screws             |
| 1 Tie-lug, single insulated terminal          | 2 No. 8 steel lockwashers                  |
| 1 10,000-ohm regeneration control with switch | 2 Grid clips                               |
| 1 500,000-ohm volume control                  | 2 1" black bakelite knobs                  |
| 1 .00005-mfd. mica condenser                  | 1 3" bakelite dial                         |
| 1 .0005-mfd. mica condenser                   | 1 2-piece tube shield                      |
| 1 .00025-mfd. mica condenser                  | 1 length shielded wire                     |
| 2 .01-mfd., 200-volt paper condensers         | 5 lengths colored hook-up wire             |
|   | 1 length insulating tubing                 |

The three-tube receiver has sufficient power output to operate a loud speaker. If it is desired to use a speaker, the latter must be purchased extra as it does not come with the kit.

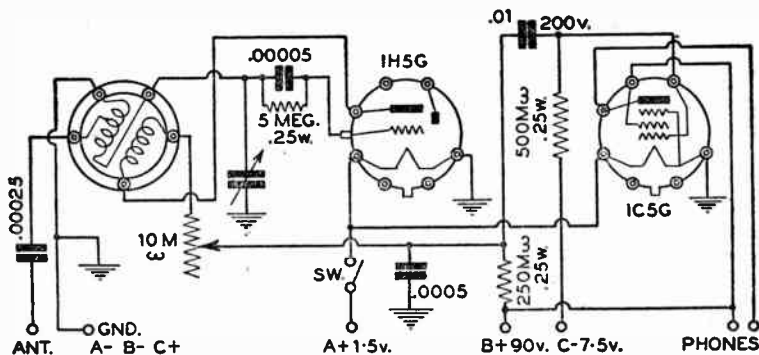

61. Schematic circuit for Meissner 2-tube regenerative receiver

Either a magnetic type or a permanent-magnet dynamic speaker may be used. Phone tips should be soldered to the ends of the wires used to hook up the speaker. A magnetic type

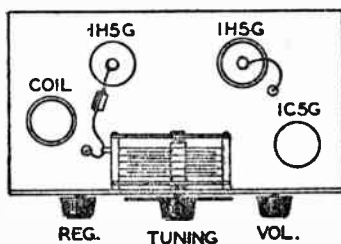

62. Top view of the 3-tube regenerative receiver

loud speaker may be substituted directly for the phones, but if a permanent-magnet dynamic speaker is used, it must be connected to the output circuit through the medium of an output transformer having a primary impedance of 10,000 to

20,000 ohms, and a secondary impedance corresponding to the impedance of the speaker.

The same procedure in assembling and wiring is followed in the case of all three sets. The parts should be assembled in

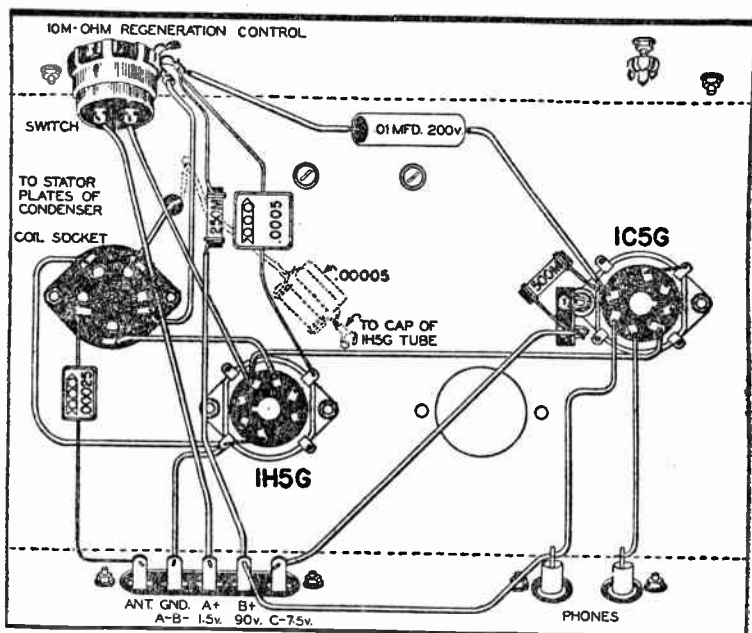

63. Pictorial diagram showing arrangement of parts and wiring on underside of chassis of Meissner 2-tube regenerative receiver

accordance with the bottom view of the chassis shown in the pictorial wiring diagram. For the sake of clarity the pictorial diagrams are not drawn true to scale. The components are shown slightly out of proportion to the chassis and panel.

Do not knock out the plugs from more than the required number of socket holes. Be careful to install all the sockets with the keyway in the correct position.

Do not attempt to wire a radio receiver unless you know how to solder. Wire a Meissner receiver by following the physical arrangement of the parts and leads shown in the pictorial diagram. Close adherence to the arrangement shown will bring freedom from trouble and give results that cannot be improved upon. The pictorial diagram shows a color for each wire. The corresponding colors of wire are furnished in

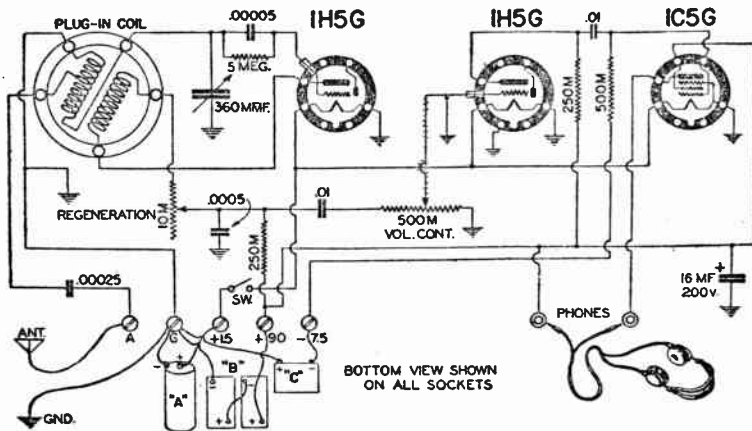

64. Schematic circuit for Meissner 3-tube regenerative receiver

the kit in sufficient quantities to make the required connections. The wires marked "tubing" are covered with braided insulated sleeving or "spaghetti" tubing. This is indicated wherever there is chance for a short-circuit to occur between that lead and some other object. Sufficient tubing is furnished with each kit.

To avoid errors in wiring, it is a good plan, as each wire is put in place, to mark over the corresponding wire on the pictorial diagram with a colored pencil. The progress of the wire is then obvious at a quick glance and the unfinished por-

tion quickly identified. The order of wiring is of no importance. All parts are sufficiently accessible so that you may follow your own plan in that respect.

Four soldering lugs are provided on the metal mounting devices used to hold the sockets. It is important to bend down against the chassis all of these that are not required for wiring so that they will be out of the way of the wires to be attached to the socket lugs.

When all the connections have been securely made using rosin core solder and no paste or other chemical flux, care-

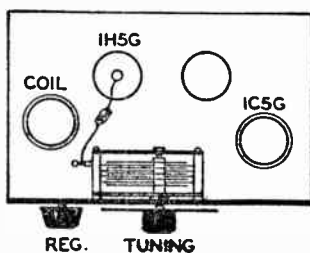

65. Top view of the 2-tube regenerative receiver

fully re-check the wiring for accuracy. If correct, the receiver is ready to connect and operate.

The average antenna for the Meissner 1-, 2-, and 3-tube regenerative receivers should be from 50-75 feet long and 20 feet or more above ground. It should be well away from trees, buildings, and power lines. If located relatively close to powerful broadcasting stations, the selectivity of the receiver can be improved by using a shorter antenna. On the other hand, if far away from the nearest powerful station, an antenna up to 200 feet long may be used with resultant increase in signal strength.

The ground connection should be made to a water pipe, to

a sheet of copper three square feet or more in area buried in the ground at a place that is usually damp, or to a piece of pipe driven down several feet into damp ground.

In order to put the receiver which you have just assembled into operation, connect a 1½ volt *A* battery to the terminal

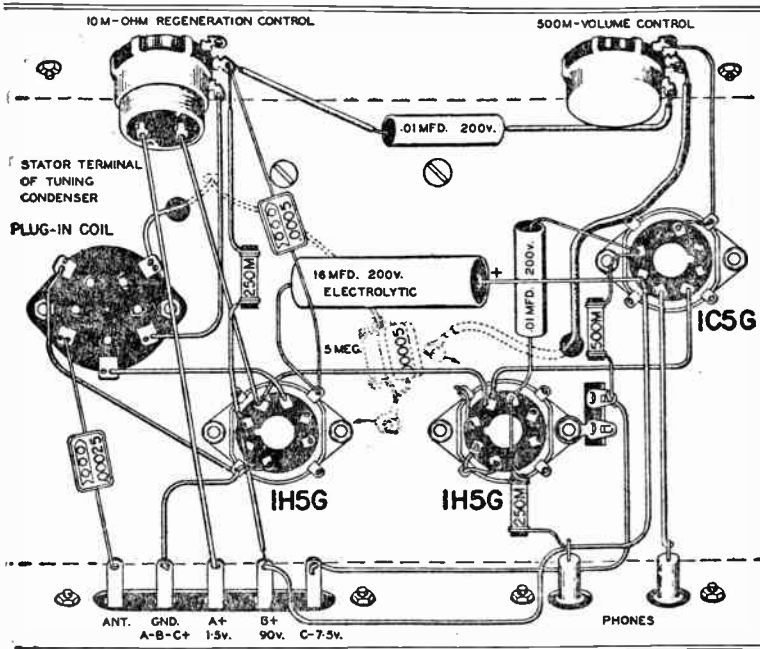

66. Pictorial diagram showing arrangement of parts and wiring on underside of chassis of Meissner 3-tube regenerative receiver

connection strip as shown in the pictured connection diagram. Turn on the regeneration control. This automatically lights the tube filaments and a very dim red filament glow should be visible when looking down into the center of the tube if light is excluded from the tube by putting the hand around the bulb.

Attach the *B* battery leads next. They should be connected to the proper terminals on the receiver before being attached to the batteries. After the antenna and ground connections have been made and the headphones plugged into the pin jacks provided for the phone tips, check the wires attached to the terminals to see that they are firmly attached around the screws and that they cannot touch an adjacent terminal. When this has been done the *B* battery leads may be attached to the battery as shown in the picture.

Plug into the left-hand socket a coil covering the wavelengths desired. The broadcasting stations operate between 200 and 545 meters. The amateur phone stations operate near 160, 80, 20, and 10 meters. The short-wave broadcasting stations have wavelengths of approximately 49, 31, 25, and 19 meters.

Turn the regeneration control clockwise to turn on the filaments and increase regeneration. Turn the receiver tuning dial slowly back and forth while advancing the regeneration control clockwise. When a whistle is heard in the phones, set the tuning dial so that the whistle is at its lowest pitch and reverse the rotation of the regeneration control until the whistle stops and the station is heard.

Do not permit the receiver to whistle longer than is necessary to tune in a station. When whistling, it is radiating, that is, acting as a miniature transmitter and interfering with good reception on any receiver in the neighborhood tuned to the same station.

The operation of the three receivers is identical except that in the case of the 3-tube receiver, a volume control has been provided in addition to the regeneration control. The volume control should be turned clockwise before beginning the operations described above.



When listening to local stations, the regeneration control is inadequate to control the volume of the signals of the 3-tube receiver. The best selectivity is obtained when the regeneration control is set just below the point of whistling and the volume control employed to regulate the signal volume.

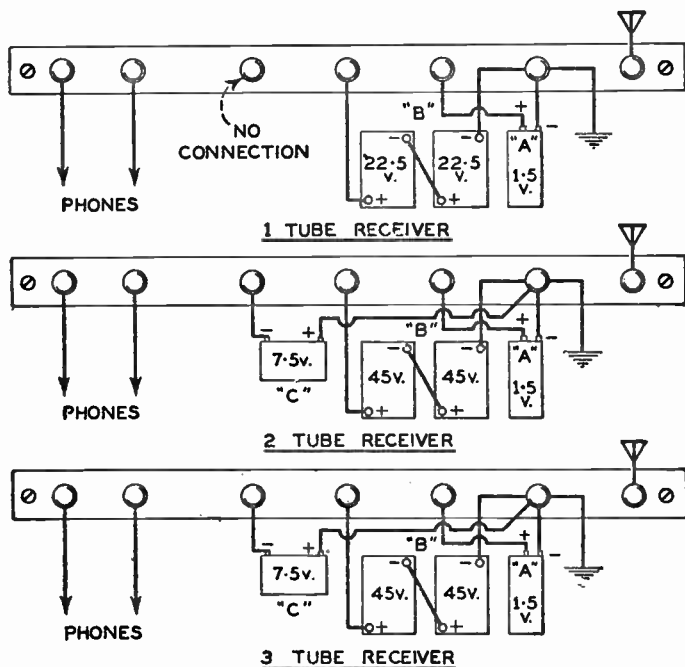

67. Connections to the terminal strips on the back of the receiver

The amplification is so great in the 3-tube receiver that it is necessary to shield the middle tube and the lead connected to the grid cap of that tube. A two-piece shield and a shielded wire for the grid connection are provided in the kit. The connecting lug should be pressed on the proper pin in accordance with the view of the tube base shown in the diagram of con-

nections for the 3-tube set. The shield should then be pressed on the tube making firm contact with the connecting lug just assembled. If the connection is pressed over the wrong lug, considerable damage may be done to some part of the receiver.

The grid lead should have the shield cut back from the ends of the wire after the shielding has been soldered all around the wire for a length of  $\frac{3}{16}$ " to  $\frac{1}{4}$ " at the point to which the shield is to be stripped off. This holds the shielding in place and prevents fraying.

When using a loudspeaker in connection with the 3-tube receiver, a Celotex baffle or a cabinet for the speaker will greatly improve the quality of the sound output.

When through using the receiver, be sure to turn the regeneration control back so that the *A* battery is disconnected and the tube filaments are not lighted.

### The Meissner 4-Tube A-C D-C Tuned Radio Frequency Receiver

Here is a chance for the amateur radio constructor to use some of his own ingenuity. No specifications or dimensions for panel or cabinet are given and the arrangement and construction of these parts are left to the owner of the set. The unusually small size and the ability of the receiver to operate from 110-volt power outlets, whether they are a-c or d-c, present interesting possibilities. A small, compact carrying case will make the receiver a handy companion when traveling, touring, or on vacation.

"Universal" operation, that is, service on either d-c or a-c, is secured by using a 25Z6 tube. This is a full-wave, high vacuum metal rectifier of the heater cathode type. No transformer is required, or for that matter, could be used, since a transformer will not work on d-c. All of the tubes are of the

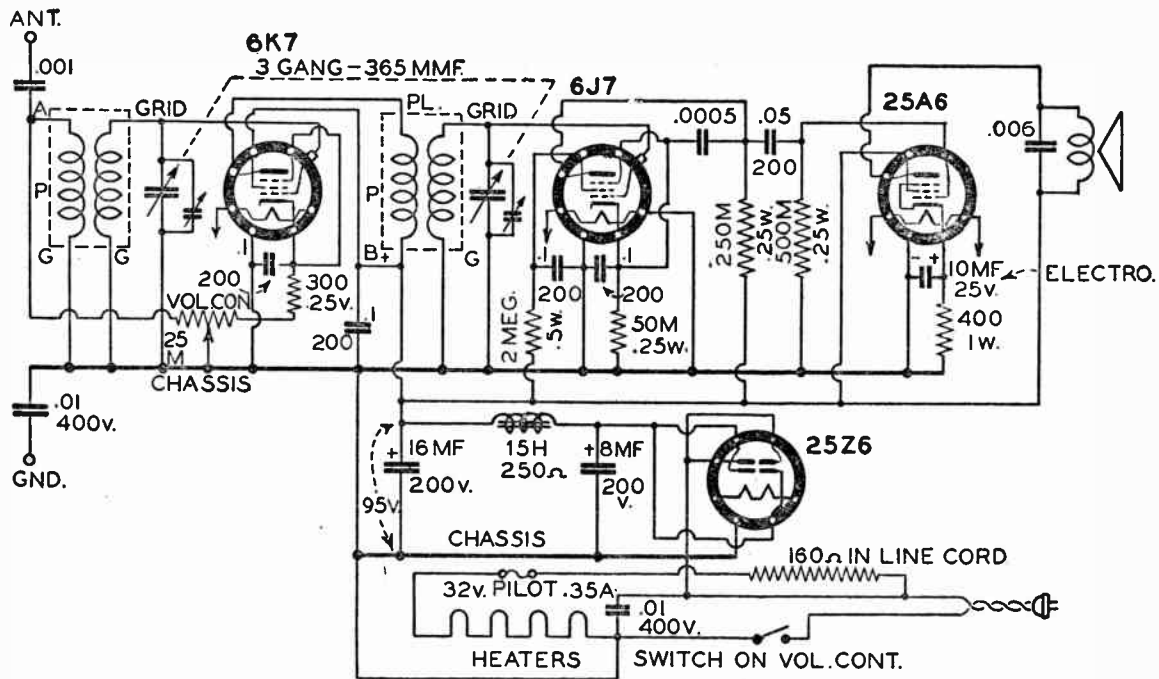

68. Schematic circuit diagram for Meissner 4-tube tuned radio-frequency universal receiver

metal heater cathode type and operate at 25 volts. Thus the tubes may be operated from the 110-volt power outlet, either a-c or d-c by connecting in series with a suitable resistance.

In this case the heaters of all four tubes are connected in series and a resistance connected between them and one side of the line. The resistance is built into the linecord and it will be noticed that the cord becomes quite warm in operation. It should never be cut short for to do so would change the resistance and damage the tubes. The receiver should not be operated with the cord all bunched up but should be spread out for proper cooling.

The component parts for the Meissner 4-tube A-C D-C tuned radio frequency broadcast receiver come in kit form. The kit consists of the following:

#### PARTS FOR 4-TUBE A.C.-D.C. TRF RECEIVER

1 A.C.-D.C. speaker dial	1 300-ohm, $\frac{1}{4}$ -watt resistor
1 3.2-volt dial light, screw-type base	1 400-ohm, 1-watt resistor
1 2-gang, 365-mmfd. tuning condenser	1 50,000-ohm, $\frac{1}{4}$ -watt resistor
1 Condenser shield	1 250,000-ohm $\frac{1}{4}$ -watt resistor
1 Antenna coil, No. 14-2436	1 500,000-ohm, $\frac{1}{4}$ -watt resistor
1 R.-F. coil, No. 14-2437	1 2-megohm, $\frac{1}{2}$ -watt resistor
4 Molded Bakelite octal sockets	1 160-ohm resistance linecord and plug
1 25,000-ohm volume control with switch	2 Metal tube grid clips
1 Filter choke, No. 19341	2 1" black bakelite knobs
1 16-mfd. 200wv dry electrolytic condenser	1 $\frac{1}{2}$ " rubber grommet
1 8-mfd. 200wv dry electrolytic condenser	1 $\frac{3}{8}$ " rubber grommet
1 .0005-mfd. mica condenser	2 $\frac{1}{4}$ " rubber grommets
1 .001 mfd. mica condenser	2 Shakeproof soldering lugs
1 .006-mfd. 600-volt paper condenser	3 Tie lugs, two insulated terminals
2 .01-mfd. 400-volt paper condensers	1 Tie lug, single insulated terminal
1 .05-mfd. 200-volt paper condenser	30 6-32 x $\frac{1}{4}$ " hexagon steel nuts
4 .1-mfd. 200-volt paper condensers	15 6-32 x $\frac{1}{4}$ " long RH steel screws
1 10-mfd. 25-volt dry electrolytic condenser	28 #6 lockwashers
	4 8-32 x $\frac{1}{4}$ " long RH brass screws
	4 6-32 x $\frac{3}{8}$ " long RH steel screws
	1 Length No. 20 solid hook-up wire, black

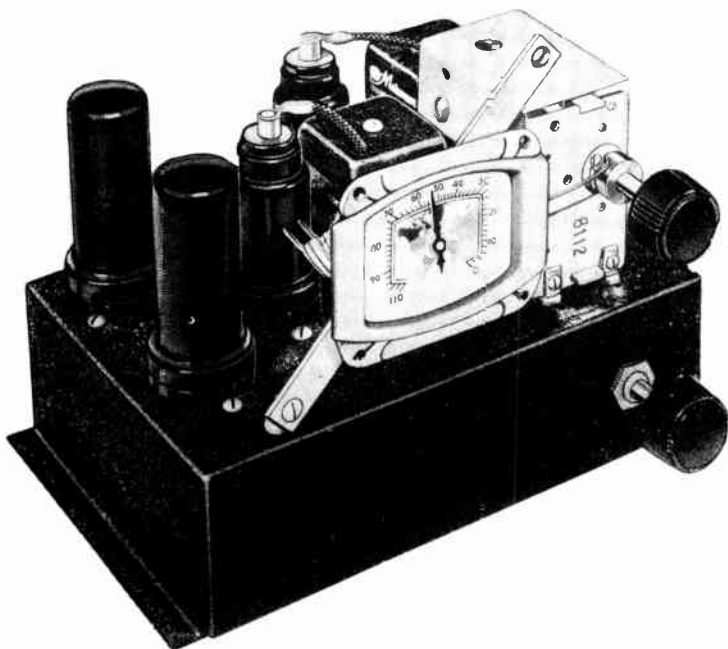

69. 4-Tube A.C.-D.C. Meissner Tuned Radio Frequency Receiver



## Assembling Your Own Radio Receivers 155

- |  |   |
|--|---|
| 1 Length No. 20 solid hook-up wire, red    | 1 Length No. 20 solid hook-up wire, white |
| 1 Length No. 20 solid hook-up wire, blue   | 1 Length No. 20 stranded wire, green      |
| 1 Length No. 20 solid hook-up wire, brown  | 1 Length No. 20 stranded wire, black      |
| 1 Length No. 20 solid hook-up wire, green  | 1 Length No. 20 stranded wire, red        |
| 1 Length No. 20 solid hook-up wire, orange | 1 Length rosin core solder                |
|  | 1 Length black insulating sleeving        |

### ADDITIONAL PARTS REQUIRED

- |                   |  |
|-------------------|--|
| 1 6K7 Metal tube  | 1 5" Magnetic or P.M. speaker, with output transformer to match a 25A6 |
| 1 6J7 Metal tube  |  |
| 1 25A6 Metal tube |  |
| 1 25Z6 Metal tube |  |

### MEISSNER CHASSIS

No. 11-8288, completely punched, black wrinkle finish, dimensions  $4\frac{1}{2}" \times 7"$  x 2",  $\frac{3}{8}"$  flange each end.

The parts for the receiver should be mounted on the chassis according to the top view and the bottom view shown in the pictorial diagram. Take care that the sockets are installed in the proper places so that the numbers stamped on them will correctly indicate the type of tube to be installed. The key-way in each socket must be properly placed. It will be necessary to remove all of the wires from the socket if it is later found to be reversed.

Solder at least one spot on each socket saddle to the chassis, preferably adjacent to a mounting screw. Many ground connections are made to the lugs on the saddle and trouble due to poor contact may develop unless a good contact is insured by soldering.

The order of assembly is of little importance as long as the choke is installed last. It is mounted on one end of the chassis and overhangs some of the parts.

Treat the gang condenser with respect. It has been ad-

justed at the factory to very close limits of uniformity so that your set will "track" and have accurate calibration. In order to afford a gang condenser protection when working on a

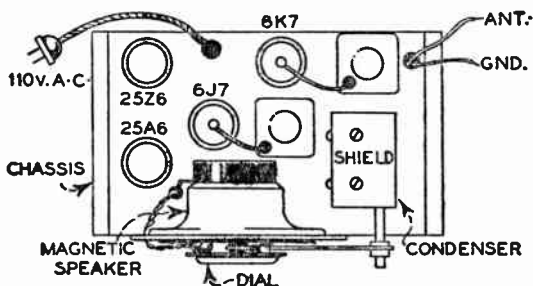

70. Top view of the tuned radio-frequency receiver

chassis, keep the condenser closed, that is, plates fully meshed.

Start wiring by bending down all the socket-saddle-ground lugs not required for wiring. Wire the filament circuit complete. The rest of the wiring may be carried out in any con-

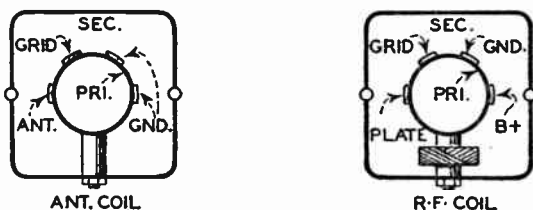

71. Details of the antenna and radio-frequency coils showing terminals

venient sequence. Follow all the instructions and suggestions given about soldering and wiring in the first part of this chapter and in connection with the Meissner 1-, 2-, and 3-tube receiver. Follow the physical arrangement of the parts and leads shown in the pictorial diagram. Make all wiring as short as convenient and keep it as close to the chassis as possible.



Use rosin core solder and no other flux except the rosin contained in the solder. As each wire in the set is installed mark over the corresponding wire in the pictorial diagram with a colored pencil.

Upon checking, if all the connections are found to be correct, the tubes and pilot light should be inserted in their respective sockets. The receiver should be set upon a table and insulated from any grounded objects and the line-cord plugged into a 110-volt a-c or d-c receptacle. Do not stand on a damp floor or touch any grounded object when any part of the body is in contact with the receiver chassis. The chassis is connected to one side of the power line and can administer an unpleasant shock if these precautions are not followed. Be sure the line cord is disconnected when working on this receiver.

A slight turn of the volume control to the right closes a switch in the heater circuit. When the receiver is first turned on, the pilot light will burn brightly, after which its brilliance will diminish as the set warms up.

After a brief warm-up, the voltage across the terminals of the 16-mfd. dry electrolytic condenser may be checked with a high resistance voltmeter, if one is available. A good service man can do this for you. If the receiver is used on d-c it may be necessary to reverse the line plug to obtain proper operation and to cause voltage to appear. The voltage across the terminals of the 16 mfd. condenser should be 95 volts with the chassis as the negative terminal. If the voltage is materially different, a thorough recheck of the circuit should be made.

Before the receiver will give satisfactory performance, it must be aligned. The best alignment is secured with the aid of a service oscillator. Set the tuning condenser so that its plates are nearly all the way open (out of mesh). Connect the

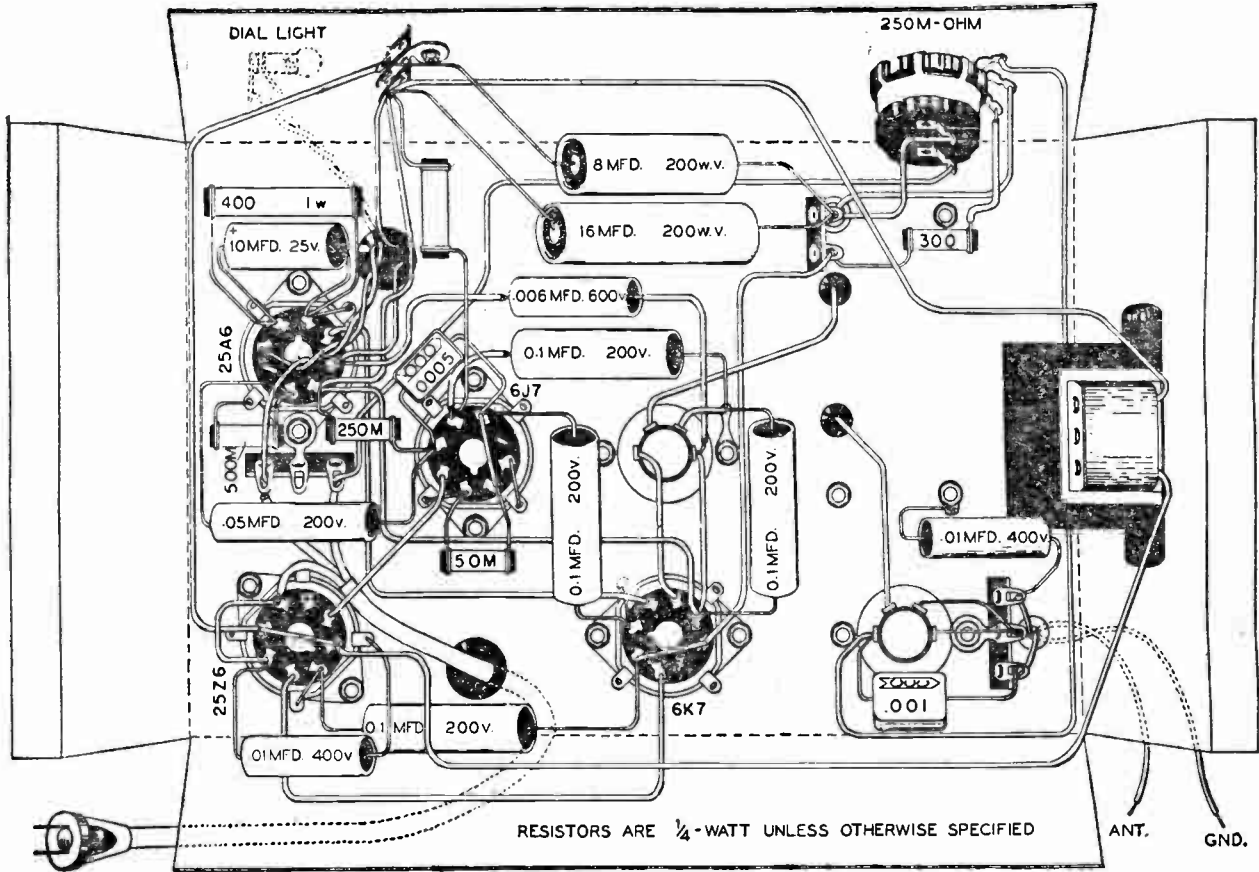

72. Pictorial diagram showing wiring and arrangement of parts on under-side of chassis, 4-tube t.r.f. receiver

service oscillator to the receiver, using a 200-mmf. condenser between the high side of the generator and the antenna connection of the receiver to act as a dummy antenna. Turn up the volume control on the receiver and tune the service generator until a signal is heard. Adjust the two trimmers on top of the gang condenser for maximum response.

If no service oscillator is available, you can align the receiver by listening to a broadcasting station between 1,300 and 1,500 kilocycles. Tune in the station and adjust the two trimmers on top of the gang condenser until maximum signal response is secured. As adjustment makes the receiver more sensitive and the volume louder, reduce the volume by setting the volume control. Keep the output low because more accurate alignment can be made with weak signals.

It is recommended that the receiver be installed in a wooden cabinet to avoid accidental shocks to those not acquainted with the fact that the chassis is connected to the line.

### **The Meissner 7-Tube Broadcast, Police, and Short-wave Superheterodyne Receiver**

The parts for this receiver are available in kit form. A list will be found on another page. In addition to the parts included in the kit, tubes, dynamic speaker, output transformer, panel and cabinet are required.

The receiver answers the requirements of a three-band receiver of wide utility at low cost. It covers the following frequency ranges:

- 550 kilocycles to 1770 kilocycles
- 1.76 megacycles to 5.3 megacycles
- 5.2 megacycles to 18.5 megacycles

thus giving reception of the American broadcast band and all short waves to 18.5 megacycles.

The receiver has the conventional manual volume control and tone control and in addition AVC (automatic-volume-control) obtained through the use of a 6Q7 high mu tube which consists of two diodes and a high mu triode in one envelope. This tube acts as a combined detector, amplifier, and automatic-volume control in receivers designed for its characteristics. It acts as a diode detector. The automatic-volume control action is secured in the AVC circuit by the tube's behavior when a signal increases in strength. It reduces the radio-frequency and intermediate-frequency gain by increasing the negative bias of the radio-frequency, intermediate-frequency, and frequency-mixer stages when a signal at the antenna is fading in and out, and when the set is tuned to a strong signal from a weak signal for which the volume control has been turned up high. Thus, unpleasant blasts of loud volume are prevented.

A "Magic Eye" Cathode Ray tuning indicator is provided by a 6G5 tube. This is a triode with a fluorescent target mounted in the dome of the bulb. It is connected so that the AVC voltage is applied to the grid of the triode. Electrons striking the target produce a glow in a fluorescent coating on the target. When electrons are flowing to the whole circumference of the target, the target has the appearance of a ring of light. The maximum area of glow is obtained when the set is tuned to give a maximum response to the station (the AVC voltage is then at a maximum). Thus the electro-ray tube gives a convenient visual indication of correct tuning.

Excellent selectivity and sensitivity over the entire tuning range are obtained. One stage of radio-frequency amplification and two stages of intermediate-frequency with high gain transformers are provided. A sensitivity control furnishes adjustment to secure the maximum sensitivity of the receiver

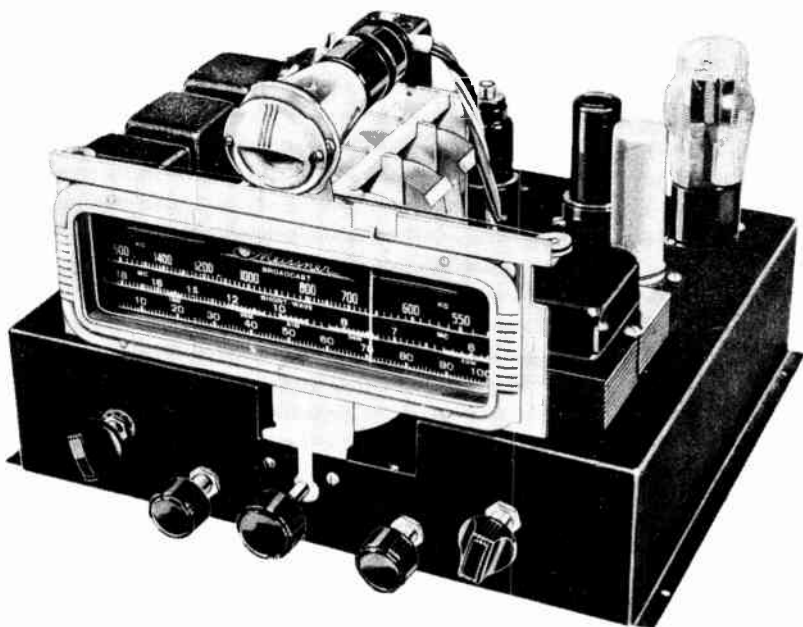

73. Meissner 7-Tube Superheterodyne Receiver



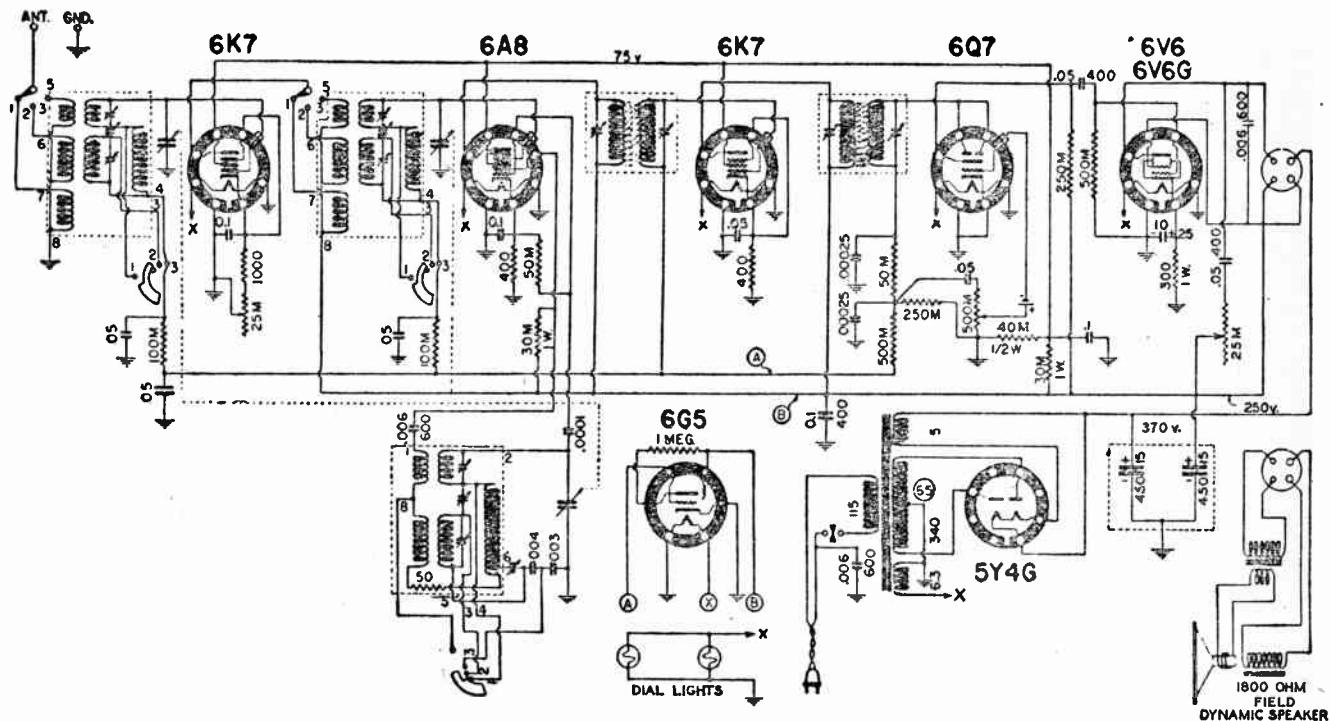

74. Schematic circuit diagram

commensurate with the prevailing noise level at the place of operation.

The component parts of the receiver should be mounted on the chassis in accordance with the top view of the receiver and the bottom view shown in the pictorial diagram. The range switch should not be put in place until the wiring around the radio-frequency and converter sockets (6K7 and 6K8) and the wiring on the terminal strips under the range switch has been completed. After that, the order of assembly is of little importance.

The range switch is designed so that the self-wiping contacts keep themselves clean if the switch is in a closed cabinet. The greatest threat to satisfactory operation is rosin, smeared or spattered on the contacting surfaces during the wiring of the receiver. When soldering connections to the switch lugs, keep the quantity of solder small and the chances for rosin to spatter or flow onto the contacts will be minimized. Heat the lug and wire quite hot before applying solder, so that when the solder is applied, it will quickly flow around the wire.

#### PARTS FOR 7-TUBE BROADCAST, POLICE AND SHORT-WAVE RECEIVER

- |   |   |
|---|---|
| 1 Calibrated slide-rule dial and escutcheon | 1 Ferrocart input I. F. transformer, 16-5740  |
| 1 Set No. 2 screws, nuts and lock-washers   | 1 Ferrocart Output I. F. transformer, 16-5742 |
| 2 6.3-volt dial lights, bayonet base        | 1 Power transformer, 110-volt 60-cycle        |
| 1 Tuning indicator assembly and cable       | 6 Molded bakelite octal tube sockets          |
| 1 3-Gang, 365 mmfd. tuning condenser        | 1 4-prong wafer socket for speaker            |
| 1 Range Switch, 3-gang, 3-position          | 1 Ant.-Gnd. terminal strip                    |
| 1 BC-Pol.-SW band antenna coil, 14-1012     | 1 500,000-ohm volume control                  |
| 1 BC-Pol.-SW band R. F. coil, 14-1013       | 1 25,000-ohm tone control and switch          |
| 1 BC-Pol.-SW band Oscillator coil, 14-1014  | 1 25,000-ohm sensitivity control              |
|   | 1 Adjustable padding condenser, 22-7008       |
|   | 1 .0001-mfd. mica condenser                   |



- |   |   |
|---|---|
| <ul style="list-style-type: none"> <li>2 .00025-mmfg. mica condenser</li> <li>1 .003-mfd. mica condenser</li> <li>1 .004-mfd. mica condenser</li> <li>3 .006-mfd., 600-volt paper condenser</li> <li>5 .05-mfd., 200-volt paper condenser</li> <li>2 .05-mfd., 400-volt paper condenser</li> <li>3 .1-mfd., 200-volt paper condenser</li> <li>1 .1-mfd., 400-volt paper condenser</li> <li>1 10-mfd., 25-volt electrolytic condenser</li> <li>1 300-ohm, 1-watt resistor</li> <li>2 400-ohm, 1/4-watt resistor</li> <li>1 1,000 ohm, 1/4-watt resistor</li> <li>2 30,000-ohm, 1-watt resistors</li> <li>1 40,000-ohm, 1/2-watt resistor</li> <li>2 50,000-ohm, 1/4-watt resistors</li> <li>2 100,000-ohm, 1/4-watt resistors</li> <li>2 250,000-ohm, 1/4-watt resistors</li> <li>2 500,000-ohm, 1/4-watt resistors</li> <li>1 Mallory bias-cell and holder</li> <li>2 Tie-lug, single insulated terminals</li> <li>7 Tie-lugs, two insulated terminals</li> <li>1 AC linecord and plug</li> <li>4 Metal tube grid clips</li> <li>3 Shakeproof soldering lugs</li> <li>1 Dual 15-mfd. 450-volt electrolytic condenser</li> </ul> | <ul style="list-style-type: none"> <li>1 Condenser mounting plate</li> <li>5 Black bakelite knobs</li> <li>2 3/8" rubber grommets</li> <li>1 1/4" rubber grommet</li> <li>2 No. 6 brass washers</li> <li>40 No. 6-32 x 1/4" hexagon steel nuts</li> <li>37 No. 6 steel lockwashers</li> <li>25 No. 6-32 x 1/4" RH steel screws</li> <li>4 No. 6-32 x 1" RH black screws</li> <li>4 Wood panel spacers, 1/2" dia. x 1 1/16" long</li> <li>1 Length black insulating sleeving</li> <li>1 Length rosin-core solder</li> <li>1 Length No. 20 hook-up wire, black</li> <li>1 Length No. 20 hook-up wire, red</li> <li>1 Length No. 20 hook-up wire, white</li> <li>1 Length No. 20 hook-up wire, blue</li> <li>1 Length No. 20 hook-up wire, green</li> <li>1 Length No. 20 hook-up wire, yellow</li> <li>1 Length No. 20 hook-up wire, orange</li> <li>1 Length No. 20 stranded wire, green</li> <li>1 Punched steel chassis, 10" x 12" x 3"</li> </ul> |
|---|---|

### ADDITIONAL PARTS

- |  |   |
|--|---|
| <ul style="list-style-type: none"> <li>2 6K7 Metal tubes</li> <li>1 6A8 Metal tube</li> <li>1 6Q7 Metal tube</li> <li>1 6V6 or 6V6G tube</li> <li>1 5Y4G rectifier tube</li> <li>1 Dynamic speaker with 4-prong</li> </ul> | <ul style="list-style-type: none"> <li>plug; 1,500 to 2,000 ohms field resistance; output transformer to match single 6V6; power handling capacity, 5 watts minimum.</li> </ul> |
|--|---|

### ACCESSORIES

- |   |   |
|---|---|
| <ul style="list-style-type: none"> <li>No. 11-8217 punched steel panel, black wrinkle finish, 9 1/2" x 14 1/2" x 1/16"</li> </ul> | <ul style="list-style-type: none"> <li>No. 11-8212 steel cabinet complete with hinged lid, black wrinkle finish, 9 1/2" x 14 1/2" x 1 1/8" deep.</li> </ul> |
|---|---|

Before the wiring is actually under way, install the gang condenser, dial and all controls temporarily so that their

proper shaft lengths may be determined when the receiver is placed in the cabinet intended for it. Mark the shafts with a three-cornered file. Do not attempt to cut the shaft of any of the units to proper length while it is mounted on the chassis. Remove the controls from the chassis and saw off any surplus shaft length with the shaft clamped in a vice.

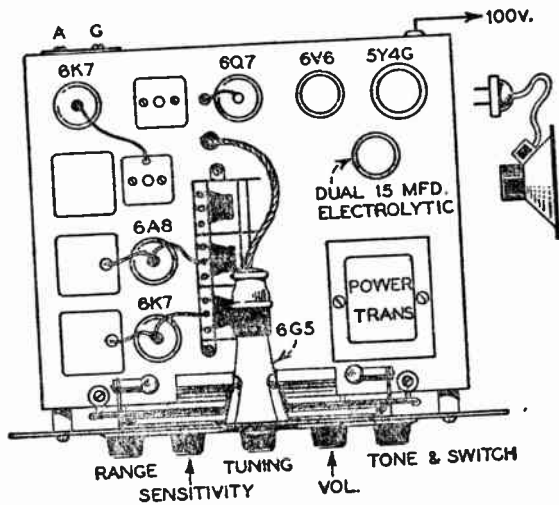

75. Top view of the 7-tube superheterodyne showing the arrangement of the parts

When mounting the sockets, observe that the keyway in each socket is properly oriented and that the sockets are installed in the proper places so that the numbers on them will correctly indicate the type of tube to be installed therein. Solder at least one spot adjacent to a mounting screw on each socket saddle to the chassis and bend down all socket-saddle-ground lugs not required for wiring.

When handling the gang condenser, turn the rotor so that all the plates are enmeshed. The chances of throwing it out

of adjustment will be smaller. Fasten the power transformer in place on the chassis by means of the nuts provided for the purpose. Check to see that the terminals on the transformer are properly placed according to the pictorial diagram.

Follow the wiring diagram exactly, making the leads as short as possible and carrying out the same color scheme. Use only rosin as the soldering flux. Test each connection by pulling and twisting it after it has cooled. Keep the leads to the range switch short and direct and as well spaced from each other and from metal objects as possible.

In order to simplify the schematic diagram, the "Magic Eye" and the dial lights are not shown as connected. Connect the five-wire cable of the "Magic Eye" tuning indicator to the points marked *A*, *X*, *B*, and ground in the diagram. Connect one side of the dial lights to the ground and the other to the terminal of the power transformer marked *X*.

If, after a careful check, all connections are found to be correct, the tubes may be inserted in their respective sockets, the line-cord plug connected to a 110-volt 60-cycle receptacle, and the speaker plugged in. The speaker should be of the dynamic type, provided with a four-prong plug and having a 1,500 to 2,000 ohms field resistance. The output transformer should match a single 6V6 tube and have a power handling capacity of at least five watts.

A slight turn of the tone control knob to the right closes the switch which turns on the receiver. After a warm-up period of ten or fifteen minutes the voltages at the several points indicated in the schematic circuit diagram should be checked with a high-resistance voltmeter. The voltages are measured from the point shown to the chassis, with the chassis as the negative terminal. If the voltages indicated by the meter are materially different from those shown on the diagram, a thor-



service man do this for you. The proper procedure is as follows:

Connect the service oscillator to the chassis and the grid of the 6A8 tube. Do not remove the grid clip. The high side of the service oscillator should be connected to the grid with a .0005—.25 mfd. condenser between. Turn the range switch to the broadcast band and set the tuning dial near 600 kilocycles; then proceed with alignment at 456 kilocycles.

Turn the audio volume control and the sensitivity control on full and increase the output of the service oscillator until a signal is just audible. Adjust the trimmer on each intermediate frequency transformer until the maximum signal volume is obtained. It is best to repeat this procedure two or three times on each trimmer to obtain the most accurate adjustment. The trimmers are adjusted with a small screw driver through the openings in the top of the shield on each intermediate frequency transformer. Because of the small size of the threads on the trimmers, the strength is limited and the adjustment screws should not be forced.

In order to make allowance for the effect that the outside antenna will have on the alignment of the receiver, a substitute for the antenna called a "dummy antenna" is used to connect the service oscillator to the antenna connection of the receiver. On frequency ranges up to 1700 kilocycles the dummy should represent a capacity of 200 micro-microfarads. On frequencies above 1700 kilocycles, the average antenna can be represented by a 400-ohm carbon resistor. Turn the gang condenser until the plates are completely enmeshed. See that the dial pointer position coincides with the last line at the low-frequency end of the dial. Adjustment can be made by loosening the set-screw on the dial drum, making the necessary correction. Then firmly tighten the screw.

To align the receiver for the short-wave band the service oscillator should next be connected to the antenna and ground terminals of the receiver, through the proper dummy antenna, in this case a 400-ohm resistor between the oscillator and the antenna binding post. Turn the range switch to the short-wave (extreme clockwise) position, set the dial on the receiver and the service oscillator both to 17 megacycles, and turn the output of the service oscillator up to maximum. Tighten the *top* trimmer in the oscillator coil (No. 14-1014) until just snug, then loosen it four turns. Tighten the trimmer again very slowly, setting it at the position of maximum response and reducing the output of the service oscillator as alignment proceeds. If two responses of nearly equal intensity are found, adjust for the one with the trimmer farthest open.

Align the top trimmers in the radio-frequency coil next. Since the radio-frequency adjustment has some effect on the oscillator frequency, it will be necessary to rock the dial slightly to keep the signal tuned in. Otherwise a shift in oscillator frequency may shift the heterodyned signal out of the range of the intermediate-frequency amplifier.

When the oscillator and radio frequency circuits have been aligned, adjust the top trimmer in the antenna coil for maximum sensitivity, reducing the output of the service oscillator as the receiver becomes progressively more sensitive.

To align the middle range, turn the range switch to "Police" and set the service oscillator and tuning dial at 4.8 megacycles. First align the oscillator, then the radio frequency and antenna coils on the band (adjust the lower trimmer on all three coils) in exactly the same manner as used on the short-wave band. Both the short-wave and the police-band ranges have fixed padding condensers, but the padding condenser, for the broadcast waves is adjustable.

To align the receiver to broadcast waves, turn the range switch to the extreme counter-clockwise position, and substitute a 200 micro-microfarad condenser for the 400-ohm resistor as a dummy antenna. Set the tuning dial and the service oscillator to 600 kilocycles and tune the receiver dial for maximum response in the neighborhood of 600 kilocycles. Rock the dial back and forth across the signal, at the same time adjusting the broadcast padding condenser (No. 22-7008 in the schematic diagram), turning continuously in one direction, until the output of the receiver, as it is rocked across the signal, becomes maximum. If the padder is turned too far, the output will drop off again. This operation is somewhat difficult to explain and a few minutes of experimenting with the adjustment will show the procedure better than a lengthy description. When the padding adjustment has been made, return the receiver and service generator to 1400 kilocycles and realign as before.

This completes the alignment of the receiver and it is ready to connect to the conventional antenna and ground for operation.

### **The Meissner 6-volt Broadcast and Short-wave Superheterodyne Receiver**

This receiver covers the frequency ranges:

540 kilocycles to 1600 kilocycles

5.9 megacycles to 18.8 megacycles

thus providing reception of the American broadcast and the short-wave entertainment bands. It operates from a 6-volt storage battery and so provides superheterodyne reception where 110-volt power is not available. An ordinary 6-volt automobile starting battery is a suitable power source. *B* power for the receiver is obtained from a conventional type

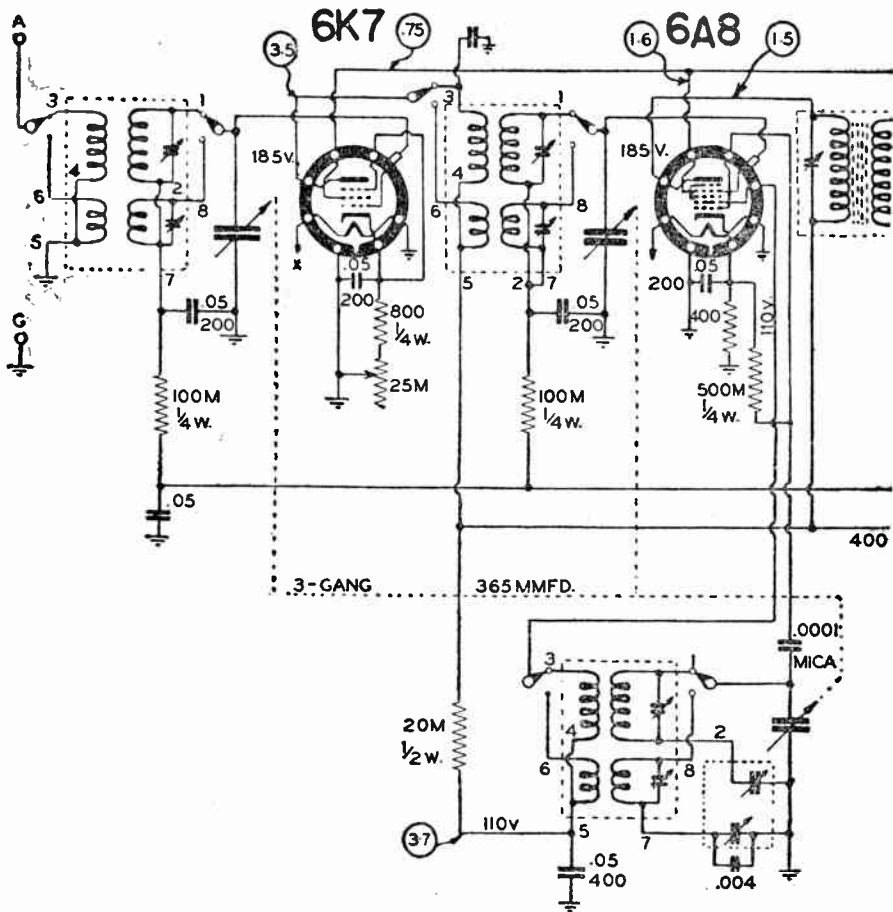

NUMBERS IN ○ DESIGNATE MILLIAMPERES CURRENT.  
 INDICATED VOLTAGES & CURRENTS ARE APPROX. VALUES

DIAGRAMS SHOW BOTTOM VIEW  
 OF TUBE SOCKETS





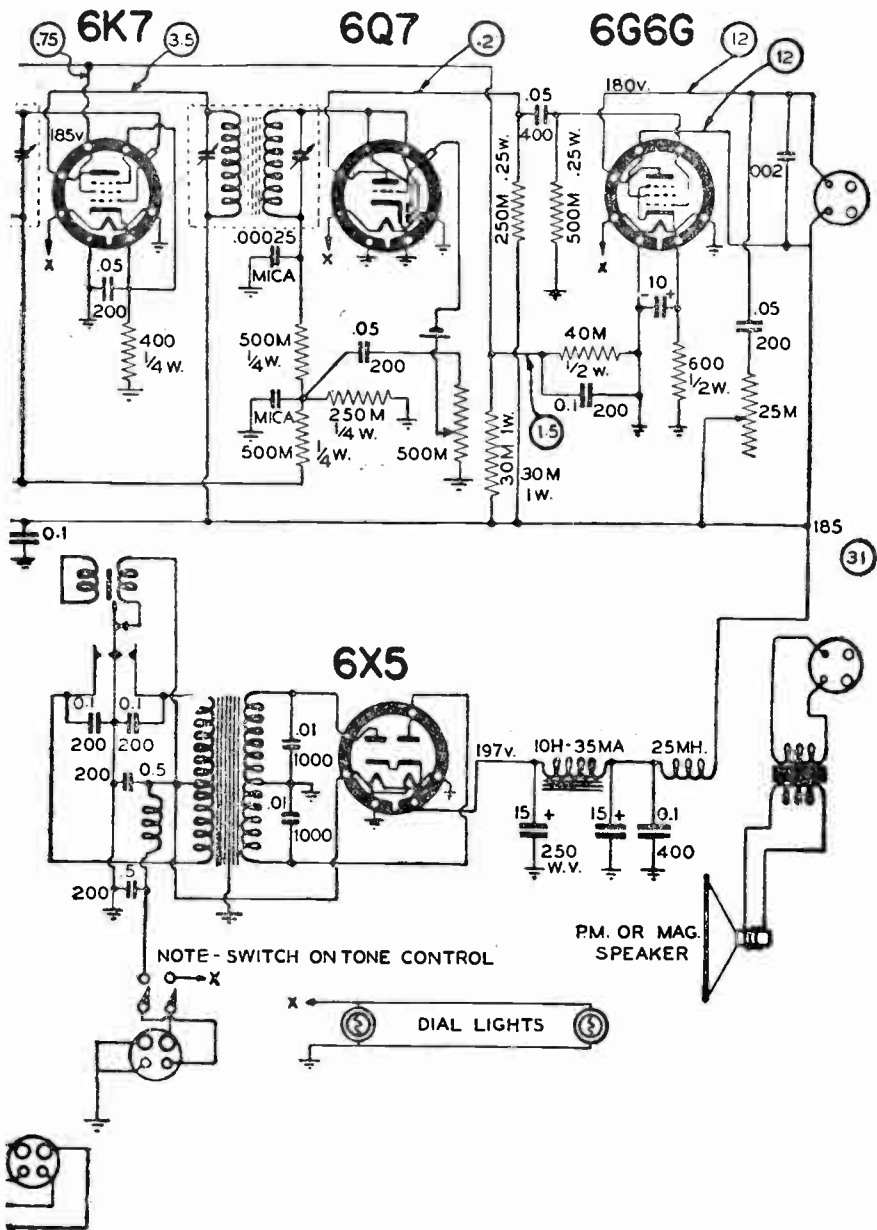

77. Schematic circuit diagram for 6-volt, 6-tube superheterodyne

vibrator power supply exhibiting unusually low vibrator "hash."

The storage battery can be kept charged by using a wind-driven generator such as a "Wincharger" or a small engine-driven generator such as the "Gascharger." If such devices are used, installation should be made in accordance with instructions furnished by the manufacturer and leads run to the storage battery which should be located near the receiver.

One stage of radio-frequency amplification on both bands with two high-gain intermediate-frequency transformers give excellent selectivity and sensitivity over the entire tuning range of the receiver. A sensitivity control is provided to adjust the maximum sensitivity of the receiver to an amount commensurate with the prevailing noise level at the place of operation.

The parts for this receiver are available in kit form. A list will be found at the end of the chapter. Besides the parts included in the kit, tubes, punched steel panel, cabinet, and a dynamic or magnetic speaker with four-prong plug and an output transformer to match a single 6G6G tube are required.

Dial lights are provided. If there is an adequate supply of power they may be connected, but if battery drain is important, the dial lights may be discarded.

The assembling procedure is the same as in the case of the superheterodyne receiver which has just been described. The parts which are to be mounted on the panel should be put into position temporarily to have the shaft lengths adjusted before wiring is commenced. Observe precautions to install the right socket in the right place and to see that the numbers stamped on them will correctly indicate the type of tube to be installed therein. The range switch should not be installed until the

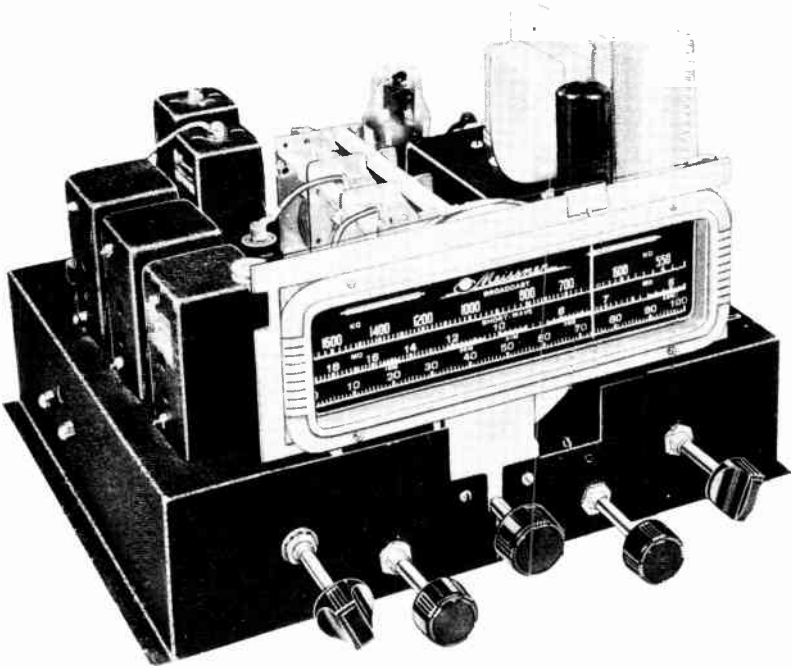

78. Meissner 6-Tube 6-Volt Battery Superheterodyne Receiver



wiring around the radio-frequency and converter sockets and on the terminal strips mounted under the range switch has been completed. When all the wiring has been finished except the leads to the range switch, install and wire that part, keep-

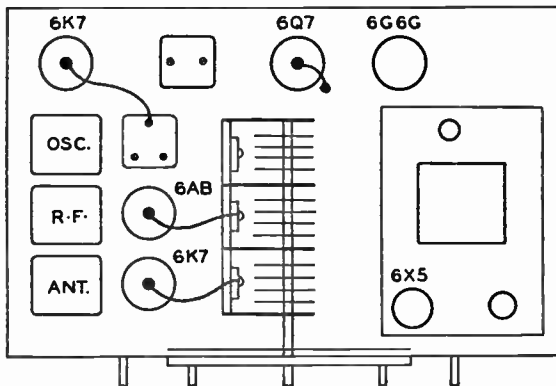

79. Top view of 6-volt, 6-tube superheterodyne

ing all wires short and direct, and as well spaced from each other and from metal objects as possible.

The wiring should be carried out in the manner already

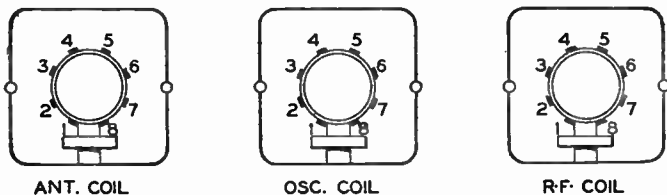

80. Terminal connections of the coils

explained in connection with the receivers which have been described. It will be noticed that the pictorial wiring diagram specifies No. 14 enamel wire with insulating sleeving in several places. The wire should be scraped with a knife until all

enamel has been removed from the point of soldering, so that the wire will "tin" easily.

The first step in assembling the power unit is to remove the black crackle lacquer finish from the chassis over the area covered by the vibrator grounding clip. Temporarily assemble the clip on the chassis and scratch around it with a sharp pointed instrument so as to mark its outline. Then remove the clip and scrape off the lacquer with a sharp knife. Do not remove the finish too far back from the hole or it will mar the appearance of the chassis. It is especially important to have good soldered connections in the power unit. All condenser leads should be as short as possible. Long condenser leads may cause vibrator "hash," a very objectionable sound when listening to weak signals. When the wiring of the power unit is completed put the bottom in place and mount the finished unit on the receiver chassis by means of the various screws, nuts and grommets furnished in the kit for that purpose.

The usual voltage tests and alignment are necessary before the receiver is ready for operation. When the power cord is connected to the six-volt storage battery the polarity of connection is not important as the receiver will work equally well with either polarity of connection.

The alignment of the receiver is carried out in the same manner as that of the 7-tube broadcast, police and short-wave 110-volt superheterodyne. To align the intermediate frequency amplifier, a service oscillator is connected between the chassis and the grid of the 6A8 tube, using a .0005-.25 mfd. condenser between the grid and the high side of the oscillator. Do not remove the grid clip. The range switch should be turned to the broadcast band and the dial set near 600 kilocycles. Then proceed with the alignment at 456 kilocycles.



Adjust the intermediate frequency trimmers for maximum volume in the usual manner.

To align the oscillator for short waves, use a 400-ohm resistor between the service oscillator and the antenna binding post as a dummy antenna. Turn the range switch to the short-wave position (extreme right) and adjust the top trimmer on the oscillator coil. Align the radio-frequency trimmer while rocking the tuning condenser to keep the signal tuned in. Then adjust the antenna circuit.

The short-wave padding condenser should be adjusted at 6 megacycles. The short-wave padding condenser is the one across which is connected the fixed mica condenser. Set the service oscillator at 6 megacycles and tune in the signal with the receiver dial. Rock the condenser back and forth across the signal and turn the padding condenser continuously in one direction until the signal is strongest.

To complete the alignment, turn the range switch to the broadcast position and substitute a 200 micro-microfarad condenser for the 400-ohm resistor as a dummy antenna. Set the tuning dial and service oscillator to 1400 kilocycles and align the circuits by adjusting the bottom trimmers in the same manner as described above. Then set the service oscillator at 600 kilocycles and tune the receiver dial to obtain maximum response. Now adjust the long-wave padding condenser in the oscillator circuit in the same manner as the short-wave padding described above. This adjustment will be much sharper than was the case with the short waves. Return the service oscillator and the receiver to 1400 meters and re-align at that frequency.

The set is now ready for operation on a good antenna and ground. A ground is essential for this receiver.



## PARTS FOR 6-TUBE B.C. AND SW 6-VOLT RECEIVER

- |   |  |
|---|--|
| <ul style="list-style-type: none"> <li>1 Calibrated slide-rule dial and es-cutcheon</li> <li>1 Set No. 2 screws, nuts and lock-washers</li> <li>2 6.3-volt dial lights, bayonet base</li> <li>1 3-gang, 365 mmfd. tuning condenser</li> <li>1 BC and SW band antenna coil, 14-7476</li> <li>1 BC and SW band R. F. coil, 14-7478</li> <li>1 BC and SW band oscillator coil, 14-7480</li> <li>1 Ferrocart input I. F. transformer, 16-5740</li> <li>1 Ferrocart output I. F. transformer, 16-5742</li> <li>1 3-gang range switch, 2 pole, 2 position</li> <li>1 Vibrator power supply unit, No. 10-1120</li> <li>5 Molded bakelite octal tube sockets</li> <li>1 4-prong wafer socket for speaker</li> <li>1 4-prong male receptacle</li> <li>1 Ant-gnd. terminal strip</li> <li>1 500,000-ohm volume control</li> <li>1 25,000-ohm tone control with DPST switch</li> <li>1 25,000-ohm sensitivity control</li> <li>1 Adjustable padding condenser, 22-5211</li> <li>1 .00005-mfd. mica condenser</li> <li>1 .0001-mfd. mica condenser</li> <li>2 .00025-mfd. mica condenser</li> <li>1 .002 mfd. mica condenser</li> <li>1 .004-mfd. mica condenser</li> <li>8 .05-mfd. 200-volt paper condensers</li> <li>2 .05-mfd. 400-volt paper condensers</li> <li>1 .1-mfd. 200-volt paper condenser</li> <li>1 .1-mfd. 400-volt paper condenser</li> <li>1 10-mfd. 25-volt electrolytic condenser</li> <li>2 400-ohm <math>\frac{1}{4}</math>-watt resistor</li> <li>1 600-ohm <math>\frac{1}{2}</math>-watt resistor</li> </ul> | <ul style="list-style-type: none"> <li>1 800-ohm <math>\frac{1}{4}</math>-watt resistor</li> <li>1 20,000-ohm <math>\frac{1}{2}</math>-watt resistor</li> <li>1 30,000-ohm, 1-watt resistor</li> <li>1 40,000-ohm, <math>\frac{1}{2}</math>-watt resistor</li> <li>2 50,000-ohm, <math>\frac{1}{4}</math>-watt resistors</li> <li>2 100,000-ohm, <math>\frac{1}{4}</math>-watt resistors</li> <li>2 250,000-ohm, <math>\frac{1}{4}</math>-watt resistors</li> <li>2 500,000-ohm, <math>\frac{1}{4}</math>-watt resistors</li> <li>1 Mallory bias-cell and holder</li> <li>2 Tie-lug, single insulated terminals</li> <li>6 Tie-lug, two insulated terminals</li> <li>1 Battery cord and plug assembly</li> <li>4 Metal tube grid clips</li> <li>2 Shakeproof soldering lugs</li> <li>3 1" black bakelite knobs</li> <li>2 Black bakelite bar knobs</li> <li>1 <math>\frac{1}{4}</math>" rubber grommet</li> <li>2 No. 6 brass washers</li> <li>39 No. 6-32 x <math>\frac{1}{4}</math>" hexagon steel nuts</li> <li>23 No. 6-32 x <math>\frac{1}{4}</math>" RH steel screws</li> <li>38 No. 6 steel lockwashers</li> <li>4 No. 6-32 x 1" RH black screws</li> <li>4 Wood panel spacers, <math>\frac{1}{2}</math>" dia. x <math>1\frac{1}{16}</math>" long</li> <li>1 Length black insulating sleeving</li> <li>1 Length rosin-core solder</li> <li>1 Length No. 20 hook-up wire, black</li> <li>1 Length No. 20 hook-up wire, red</li> <li>1 Length No. 14 enameled wire</li> <li>1 Length No. 20 hook-up wire, white</li> <li>1 Length No. 20 hook-up wire, blue</li> <li>1 Length No. 20 hook-up wire, brown</li> <li>1 Length No. 20 hook-up wire, green</li> <li>1 Length No. 20 hook-up wire, yellow</li> <li>1 Length No. 20 hook-up wire, orange</li> <li>1 Length No. 20 stranded wire, green</li> <li>1 Punched steel chassis, 10" x 12" x 3"</li> </ul> |
|---|--|

## ADDITIONAL PARTS

- |                              |                                  |
|------------------------------|----------------------------------|
| 2 6K7 Metal tubes            | 1 PM dynamic or magnetic speaker |
| 1 6A8 Metal tube             | with 4-prong plug; output trans- |
| 1 6Q7 Metal tube             | former on PM type to match sin-  |
| 1 6G6G octal-base glass tube | gle 6G6G.                        |
| 1 6X5 rectifier tube         |                                  |

## ACCESSORIES

- |  |  |
|--|--|
| No. 11-8218 punched steel panel,<br>black wrinkle finish, $9\frac{1}{2}$ " x $14\frac{1}{2}$ "<br>x $\frac{1}{16}$ " | No. 11-8121 steel cabinet complete<br>with hinged lid, black wrinkle fin-<br>ish, $9\frac{1}{2}$ " x $14\frac{1}{2}$ " x $11\frac{1}{8}$ " deep. |
|--|--|

## A 15-WATT AUDIO POWER HIGH GAIN PUSHPULL AMPLIFIER

---

### CHAPTER 13

**T**HIS type of amplifier is ideal for the amateur to use in connection with a small public address system, a phonograph or for modulator service. It is arranged with two input jacks so that either high gain or low gain can be secured by shifting the position of a standard plug. A tone control (mounted on the front of the chassis) is provided.

The amplification system used is that known as pushpull. This gives large volume with less distortion than can otherwise be simply obtained. The circuit is so arranged that in the final stage, the energy is fed into two amplifying tubes connected to a special choke or reactance and an output transformer. Thus the input and output load is evenly distributed between the two tubes. The tubes are connected so that the grid of one is swung positive at the same instant that the grid of the other is swung negative. This causes the plate current of one tube to rise while the plate current of the other is falling and gives the circuit the name "pushpull."

The amplifier illustrated in *Fig. 82* was assembled from parts put up in kit form by the United Transformer Corporation and is known as type S-15A. While it is not the purpose of this book to recommend the parts of any particular manu-

facturer, it is, however, advisable to explain that a well-engineered kit of parts will give far better results than separate parts bought indiscriminately. It is absolutely necessary for the various resistors, condensers, chokes, etc., to have proper electrical values in order for the circuits to function properly. A complete kit can be purchased at smaller cost than the component parts separately. In the case of a kit the parts come completely mounted on a metal chassis. In addition to the parts which are listed below, or a complete kit, the following tubes are required to complete the amplifier: one 6J7, two 6V6G's, and one 83.

## List of Parts

DESCRIPTION	CHART DESIGNATION	SCHEMATIC DESIGNATION
1 single circuit open jack	A	1
1 " " closing jack	B	2
1 500,000-ohm potentiometer	C	12
1 100,000-ohm potentiometer with switch	D	19
1 pushpull choke, 500 hy., 3 ma.	E	21
1 30-watt output transformer	F	23
1 filter choke, 30 hy., 75 ma.	G	24
1 flush-type power transformer	H	28
1 input swinging choke $\frac{5}{25}$ hy., 175 ma.	I	25
2 4-pin wafer socket	J, O	31
4 8-pin wafer socket	K-N	32-35
1 grid resistor		3
1 2,500-ohm $\frac{1}{2}$ -watt bias resistor	P	4
1 10-mfd. 25-volt by-pass condenser		5
1 .25-mfd. 400-volt tubular by-pass condenser		6
1 2-meg. $\frac{1}{2}$ -watt resistor		7
1 .5-mfd. 400-volt by-pass condenser		8
1 250,000-ohm $\frac{1}{2}$ -watt plate resistor		9
1 100,000-ohm $\frac{1}{2}$ -watt plate resistor		10
1 2,500-ohm $\frac{1}{2}$ -watt bias resistor		13
1 10-mfd. 25-volt cathode by-pass condenser		14
1 30,000-ohm $\frac{1}{2}$ -watt plate resistor		16
1 175-ohm 20-watt bias resistor	P	22
1 .002-mfd. mica tone control condenser	Q	20



**82. U. T. C. 15-Watt Audio Power High Gain Pushpull Amplifier**



## A 15-Watt Audio Power Pushpull Amplifier 181

1 8-mfd. 630-volt filter condenser	T	26-27
1 .25-mfd. 400-volt coupling condenser	V	18
1 line cord	W	30
1 .01-mfd. 400-volt coupling condenser	X	11

### Wiring

The wiring should be carried out in the manner usual with radio receiving equipment, using the standard flexible conductor employed for this purpose. Only rosin should be used as a flux and the connections should be "sweated." All the wiring is kept beneath the chassis.

Wires connected to the socket terminal which makes contact with the grid in a tube are called grid leads. Grid leads

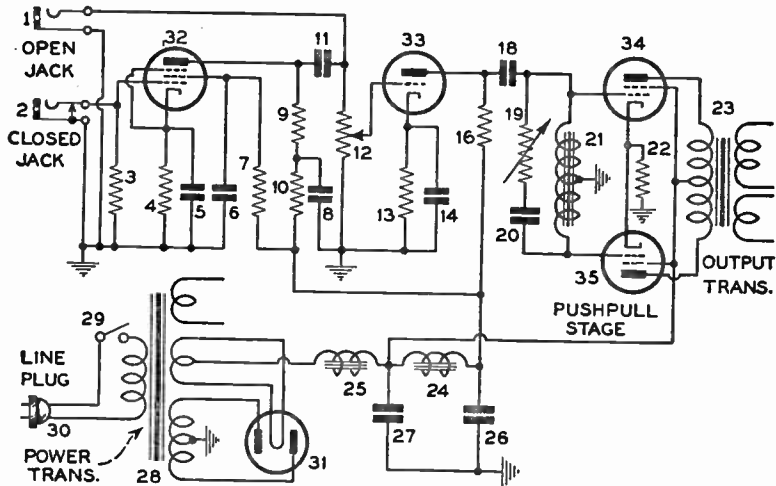

83. Schematic circuit for United Transformer Co., 15-watt audio power high gain pushpull amplifier

should not be allowed to run parallel to the filament current wires or any other a-c wiring. All input wiring (wiring connected to the first stages) should be kept away from the output stage wiring.

The ground returns (see 2, 8, 21, 22, 28, 26, and 27 in the schematic diagram) are probably the most important single cause of trouble in a high gain amplifier such as this. Do not use the chassis as a ground return under any circumstances.

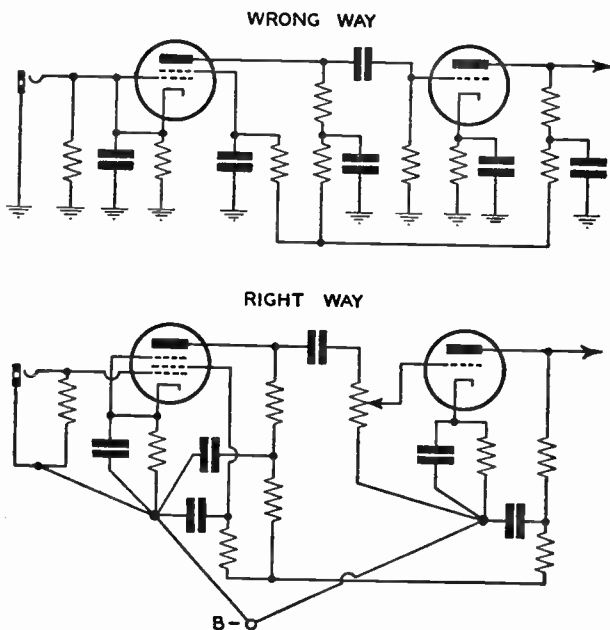

84. Right and the wrong ways of making ground returns

If you do, you are almost certain to have trouble from hum, pick-up, and the tubes going into oscillation. All ground leads should be brought to a single point and then these points should be connected to *B* negative (the negative side of the plate current supply). This is explained in a nearby diagram. The wrong way represents all the ground returns as being connected to the chassis.



# A 15-Watt Audio Power Pushpull Amplifier 183

## Wiring Chart

Refer to the chart diagram for key to the letters and numbers.

### Connect:

N2 to M2 to L2 to K2  
N7 to M7 to L7 to K7  
N1 to M1 to L1 to K1  
K2 to H1 } Twisted wires  
K7 to H5 }  
J1 to H14 } Twisted wires  
J4 to H15 }  
J2 to H13  
J3 to H11  
H14 to I1  
I2 to G2  
G1 to P1  
G4 to F4  
Both T black to H12  
T Red 1 to 12  
T Red 2 to G1  
F3 to K3  
F5 to L3  
F4 to K4 to L4  
  
K8 to L8 to P2  
  
P3 to L1  
F2 to L1  
H3 to H12  
E1 to L5 } Twisted  
E3 to K5 }  
K5 to D2  
D3 to Q1  
Q2 to L5  
E3 to V1

### Connect:

M3 to P6  
M8 to P4  
P5 to M1  
M1 to Y  
M1 to H12  
C1 to M1  
M5 to C2  
C3 to A1  
A1 to X1  
X2 to N3  
A2 to M1  
N3 to P8  
N4 to P9  
N5 to N8  
N8 to P7  
P10 to N1  
B3 to N1  
B2 to B3  
B1 to grid of 6J7 shield to B2  
B1 to B3 with 2 meg. resistor  
O4 to F0  
O3 to F8  
O2 to F15  
O1 to F500  
  
(line cord) W1 to H9  
(line cord) W2 to D4  
D5 to H10  
V2 to M3

Note: To obtain 2-ohm output connect speaker to O3 and O2.

## Testing

When the wiring has been completed, the next step is to check back to be certain that no connections have been over-

looked and that all are properly made. Then with a continuity meter, check from grid to cathode of each tube to see that the grid circuits are not open. Also check from the plate of each tube to ground to be sure that the *B* plus (positive side of the plate current supply) is not shorted to ground at any point. If any "opens" or "shorts" show during these tests, they must be corrected before the next step can be taken.

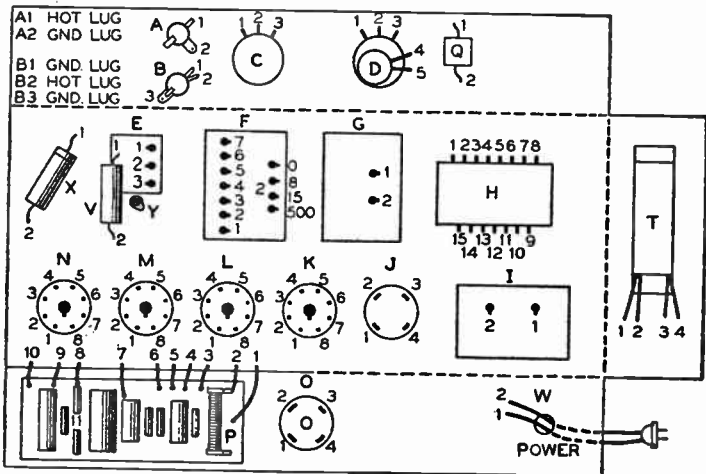

85. Arrangement of parts looking at the underside of the chassis

When it has been ascertained that all circuits are properly connected, place the tubes in the proper sockets and short the grid of the first tube to ground and load the output circuit with a 500-ohm resistor connected across the 500-ohm output winding. Plug the line cord into the 110-v.a.c supply and with a voltmeter measure the voltage across the following points. If you do not have a continuity meter and a suitable voltmeter for making these tests and cannot borrow them,

## A 15-Watt Audio Power Pushpull Amplifier 185

take the amplifier to a radio service station and have the tests made.

### Voltage Chart

From F1 to L8	280 volts
L8 to L1	285 "
M8 to P1	290 "
M8 to M1	7 "
N8 to P11	225 "
N8 to N1	2 "

The voltages are known as the no-signal voltages and in this type of amplifier will be slightly higher than the maximum voltages registered by incoming signals.

The greatest gain or amplification will be secured when the plug connected to the leads from phonograph, the pick-up, or the microphone is inserted in the Jack marked *B* in the chart and 2 in the schematic diagram. The leads to an amplifier of this type are sometimes shielded, but this should not be done unless absolutely necessary and then only with low-capacity shielding. Some types of shielded wire have so much capacity that they cause a serious loss in high-frequency response.

# LEARNING TO TELEGRAPH

---

## CHAPTER 14

**I**T IS not difficult to acquire sufficient skill to pass the code test necessary to obtain an amateur license. The government examination requires the ability to send and receive Continental Morse Code at the rate of thirteen words per minute. Five letters count as one word. Each numeral or punctuation mark is counted as two letters. Learning to send and receive code is mostly a matter of practice. There is nothing difficult about the art. Speed and skill come with experience.

The first act is to memorize the code. You must know the characters for all the letters of the alphabet, the numerals and punctuation marks. As in everything else, there is a right and wrong way of doing this. Memorize the *letters* of the alphabet first. Study them in groups of five or six. When you have learned one group go on to the next. Notice that some letters are the reverse of others. "A" is the reverse of "N"; "B" is the reverse of "V," etc. This will help fix them in your memory. Learn to think of the letters in terms of sound rather than as visual dots and dashes. A dot sounds like *dit* and a dash like *dah* when heard on a radio receiver. So think of "A" as the sound "dit-DAH" instead of a printed "dot-dash." Repeat the sounds of the letters to yourself either audibly or mentally. Keep everlastingly at it. Don't lose patience. Prac-

tice fifteen or twenty minutes at a session several times a day.

The secret of learning a language is to acquire the ability to think in that language without translating it. Telegraphic code is a language. Learn to understand it without mental translation. A key and a buzzer will help to fix the sounds in your mind. Connect a telegraph key to a radio buzzer and one or two dry cells. Pressing the key will operate the buzzer and produce the sounds of dots or dashes.

It is important to form correct habits when beginning. If you acquire the proper technique of grasping and manipulat-

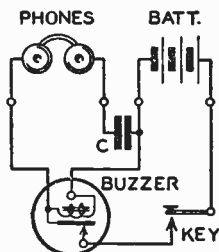

86. Buzzer code practice set. If phones are used with the buzzer code practice set the capacity of condenser, C, will determine the strength of the signal in the phones.

ing a key at the start, you will not have to “unlearn” a bad habit later.

The telegraph key should be mounted on a table thirty to thirty-two inches high and back from the front edge about eighteen to twenty-four inches, thus providing room for the elbow to rest on the table. The key knob should be grasped lightly with the thumb and first two fingers. An up-and-down motion is given to the key, using as little movement of the forearm as possible but flexing the wrist. The fingers should not leave the key knob and tap. Movements should be firm, not jerky.

A beginner should not attempt to send fast. Speed will come automatically with practice. A smooth, clean-cut, steady rate of sending is the mark of a good operator. A dot is made with a quick, firm, down-and-up motion of the key. In making a dash, the key should be held down three times as long as in making a dot. The space between the parts of the same letter is equal to one dot. The space between letters is equal to three dots and the space between two words is equal to five dots.

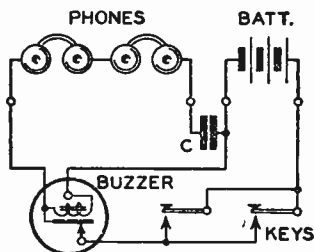

87. Two keys arranged to control the same buzzer for code practice

If someone can be found to send to you, skill will come faster. Even another beginner will be helpful. You can rig up a good practice set by arranging two keys so that they control the same buzzer. Two pairs of phones can also be connected. This arrangement will make it convenient to send messages back and forth with a fellow code student.

Another method of acquiring code practice is to listen to messages with a short-wave receiver. Tune in on amateur or commercial stations. See if you cannot recognize some letters or characters and write down as many as possible. Probably the first letters and numerals you will be able to identify will be the call letters of various stations. After a while you will be able to pick out short words. The proper way to "copy" messages with a pencil and paper is to "lag." Try to listen to a

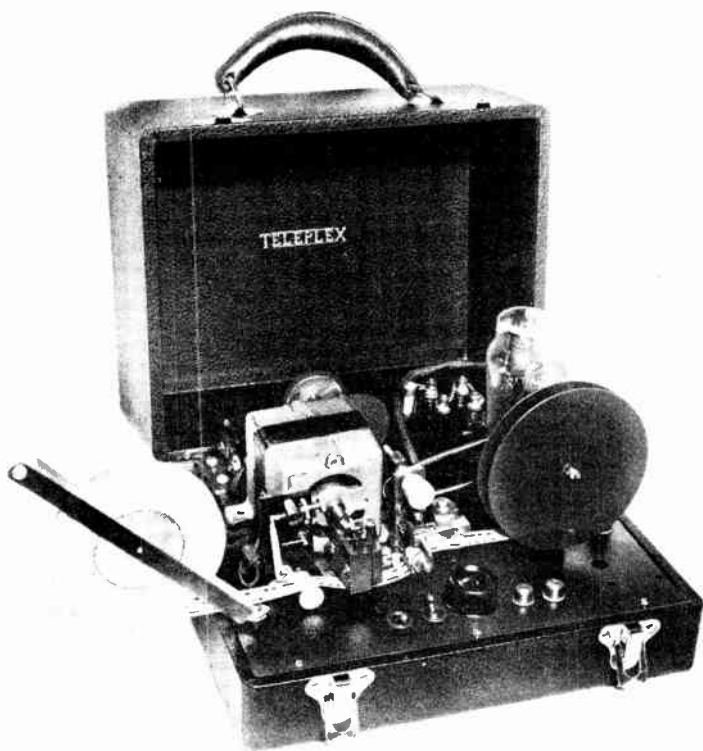

88. The Teleplex for teaching code



89. The Instructograph for teaching code





whole word before writing it down. Do the actual writing of a word while you are listening to the next one.

Since it is not always possible to get the help of another person to send to you, it may be desirable to use a "machine." You can buy one outright or rent one for approximately \$3.00 per month. The machine will send telegraphic characters perfectly at any desired speed by means of a perforated tape. Some models of these code-instructing devices are provided with an attachment to record signals which you send. Not only can you hear your own signals but you can send them as well. By comparing your own recordings with those which come with the machine, you can see and correct your mistakes in timing.

It is more difficult to learn to send properly than it is to receive.

A word in regard to keys. A radio key is usually heavier and more ruggedly built than an ordinary telegraph key. Radio telegraph signals therefore have a slight characteristic "heaviness" compared to line telegraph signals. It is well to practice radio code with a radio key so that your ear becomes used to the slightly different sending.

There are keys on the market designed to operate sideways instead of up and down. These are for speed sending. They save wrist motion, since they make dots automatically. Such a device is popularly called a "bug." "Bugs" are for skilled operators. Leave these special devices alone until you have become expert with an ordinary key.

# WAVELENGTH AND FREQUENCY MEASUREMENTS

---

## CHAPTER 15

**T**HERE was a period in amateur radio when the instrument called a wavemeter (absorption type) was used for tuning and checking transmitters, for measuring the wavelength of received signals, the capacity of condensers, and the inductance of coils. New regulations of the Federal Communications Commission make it necessary to have some means of monitoring the frequency of a transmitter and for this purpose an absorption type instrument is not sufficiently accurate to comply with today's standards. It is necessary to resort to the device known as a heterodyne frequency meter. This will be described later. We are continuing to discuss the wavemeter because it embodies fundamental principles of interest and instructive value to the amateur and young student.

### Absorption Type Frequency Meter

The simplest type of wavemeter consists of a coil connected across the terminals of a variable condenser, tunable over the wavelength range desired. The instrument is a wavemeter if it is calibrated so that its indications denote wavelength and a frequency meter if the calibrations indicate frequency. When the wavemeter or frequency meter is put into use, the variable

condenser is turned until the neon lamp glows at maximum intensity or if a milliammeter or voltmeter is used, until the meter shows a maximum reading. The lamp or meter is an indicating device for determining the point of resonance. The phenomenon of resonance is the principle underlying absorption type wavemeters and frequency meters.

If a relatively small electromotive force is applied to a circuit, it is possible to induce in this circuit a fairly large current, provided that the latter circuit is in tune, or in *resonance*, with the circuit in which the e.m.f. is flowing. A wavemeter or

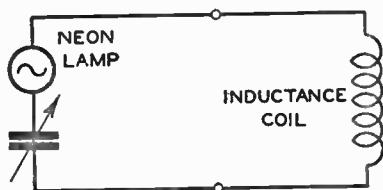

90. Basic circuit of an absorption frequency meter

frequency meter working on the absorption principle indicates when the point of resonance is reached at some particular frequency or indicates the frequency at which a circuit is in resonance. This is the same thing, it will be remembered, that occurs when you receive a station on your receiver—you “tune in” the signals until you get them with maximum volume and clarity. This means that your receiver circuit is in resonance with the transmitter.

A wavemeter or frequency meter of the absorption type, when loosely coupled to the tank coil of a transmitter, will extract a small amount of energy from the tank. This energy will light a small flashlight lamp, a neon lamp, or move the needle of a suitable voltmeter or ammeter. The maximum current will flow when the wavemeter or frequency meter is

tuned exactly to the transmitter frequency. Hence the brightness of the lamp or the movement of the indicating needle on the voltmeter or ammeter indicates resonance.

### Building an Absorption Wavemeter

As already stated, the essential parts of this type of wavemeter are but three: a variable condenser, a coil, and an indicating device. The condenser should be of high-quality workmanship, enclosed in a metal case if possible, thus eliminating hand capacity effects. It should have a maximum capacity of 0.0005 mfd. The coil may be homemade. The indicating device may be a small neon lamp, this being the cheapest form of visual indicator and sufficiently sensitive for ordinary use.

As with any circuit where resonance is concerned, different coils must be used for the different wave bands to be covered. Since the amateur is likely to have a collection of 1½" coil forms among his spare parts these will be satisfactory for the wavemeter.

Assuming the use of the .00014 mfd. variable condenser the coils for the principal amateur bands will have the following number of turns:

20 meters	7½ turns
40 "	16 "
80 "	33 "
160 "	67 "

The wire may be of almost any size within reason and either bare, enameled, or insulated with cotton or silk. Spread the turns apart in each case so that the winding occupies about 1¼" in length. If the turns tend to slip, a minute dab of collo-dion at several spots will prevent any considerable movement.

If the wavemeter condenser is enclosed in a metal case the neon lamp or the flashlight bulb may also be placed inside. A small hole about  $\frac{1}{8}$ " in diameter may then be drilled in the top of the case so that the lamp may be viewed through it. This method is recommended as the glow lamp is in darkness and the maximum intensity can be more readily recognized.

### Calibrating the Meter

The most important thing about a wavemeter is that it must be calibrated accurately or it will not serve its purpose. That

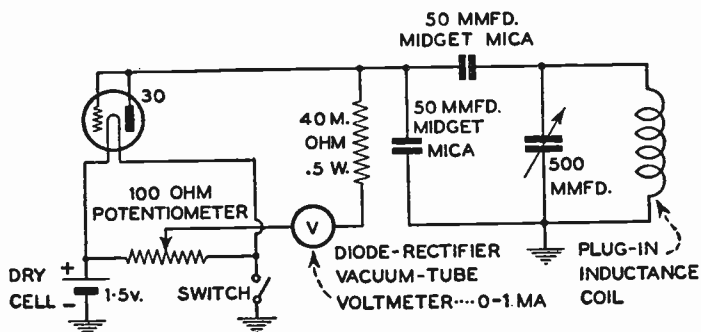

91. Schematic circuit for an absorption-frequency meter with vacuum-tube voltmeter resonance indicator

is, you must know exactly at what frequency the wavemeter circuit is in resonance for every reading of the condenser with a particular coil. This may be done in several ways. After the wavemeter is built according to the specifications given below you can take it to someone who has a wavemeter, and by using his transmitter operating at certain frequencies, your instrument can be calibrated. Several broadcast stations also transmit standard frequencies at regular periods each month. These you can pick up on your receiver and then calibrate your meter. For accurate guide points, however, no home-

made means can ever equal the official frequency tests transmitted on regular schedule by WWV, Bureau of Standards, Washington, D.C. These signals are sent out at various times on continuous wave as well as i.c.w., and are accurate to better than one part in five million. The Bureau will supply its schedule upon request.

Another method makes use of a regenerative type receiver to which the coil in the meter can be coupled. Adjust the receiver so that the detector is oscillating very feebly. Then bring the meter near the receiver so that the meter coil is close to the detector coil. Vary the condenser through its range until a setting is found which causes the detector tube to stop oscillating. Then loosen the coupling by increasing the distance between the meter coil and the detector coil until the detector stops oscillating at only one point on the meter condenser dial. The meter is then tuned to the same frequency at which the receiver is set. If you know the various settings of the receiver you thus have a means of calibrating the meter. If the receiver is set on a number of different stations of known frequency or wavelength, a number of points for making a calibration curve for each meter coil can be obtained.

With these points, a curve may be drawn on regular graph or cross-section paper by means of a "French curve," such as is used for drawing curves of varying diameter. Or if the amateur wishes to be more accurate, he may draw the calibration curve on logarithmic paper, in which case it will be a straight line.

If you make two sets of curves, one showing wavelengths and the other frequency settings, you will have a combination wavelength and frequency meter.

The method of building and calibrating a meter as just described does not result in an accurate or an entirely depend-

able instrument. The calibration is rough and is not retained over long periods of time. However, as already stated, it should be of instructive value to the young amateur or radio student and for that same reason instructions are given below for roughly calibrating a transmitter, a receiver and measuring capacity or inductance.

### **Calibrating a Transmitter**

Attach the coil to the wavemeter that will cover the waveband in which you wish to transmit. From your calibration curve find the exact setting for the wavemeter condenser and set it at this reading. Now bring the wavemeter near enough to the closed circuit of the transmitter so that the neon lamp just glows when the two circuits are in resonance. The condenser of the transmitter is varied until maximum glow occurs in the neon lamp.

### **Calibrating a Receiver**

As the majority of the receivers for short waves employ an oscillating detector, you can calibrate your receiver so that you will know upon what wave you are listening. This is done in the same manner as you calibrated the wavemeter's standard coil. Set the wavemeter to a certain reading and bring it near the coil of the receiver. When a click is heard then the two circuits will be in resonance. Sometimes it is wise to have the wavemeter at such a distance that two clicks will be heard very close together. Dial readings are taken of each click and the point of resonance will be half-way between them.

### **Measuring Capacity or Inductance**

It has been stated previously that a wavemeter may be used for the measurement of a capacity or inductance. If you



have an oscillating circuit in which there is a known capacity, then it is possible to determine the inductance of the circuit. The same is true if the inductance of a coil is known, the capacity being then easily determined. This is based on the formula:

$$\text{Wavelength } (\lambda) = 59,600 \times \sqrt{LC}$$

If the wavelength of a certain circuit is known together with either one of the two variables,  $L$  or  $C$ , then the other can be found by the following formulae:

$$C = \frac{\lambda^2}{3.56 \times 10^9 \times L} \qquad L = \frac{\lambda^2}{3.56 \times 10^9 \times C}$$

In these formulae,  $L$  is the inductance in millihenries,  $C$ , the capacity in microfarads, and  $\lambda$  is the wavelengths in meters.

It might also be mentioned that a number of companies manufacture wavemeters having the same characteristics that have been described in this chapter. They are obtainable already accurately calibrated.

### Monitoring a Transmitter

In order to monitor the frequency of a transmitting station in accordance with the regulations of the Federal Communications Commission—and you must do so if you wish to retain your license—you can use an accurately calibrated receiver. With this you can check the quality of the emitted signal and ascertain whether or not the station is operating within its legal frequency band. A receiver may be calibrated so as to give a quite accurate idea of band limits by listening to other amateur stations and noting where amateur activity ceases at the end of each band. By listening to your own transmitter with your receiver you can ascertain your position in the band.

If operation near the edges of a band is intended, the Fed-

eral Communications Commission requires more accurate methods and it is necessary to monitor with a receiver which has been checked against standard frequency transmissions such as those of the American Radio Relay League. A schedule of these transmissions appears regularly in the League's magazine "QST." Do not attempt to calibrate a receiver or use it for monitoring unless it has first been warmed up by an hour or so of operation.

In order to measure the exact frequency of a transmitter, you must resort to what is known as a heterodyne frequency meter.

### A Heterodyne Frequency Meter

This device is a small oscillator, completely shielded and electron coupled. Anyone who is going to build a frequency meter of this type must have ability and experience beyond that of the average amateur in order to succeed. The device must be very carefully constructed so that its frequency characteristics are extremely stable.

This oscillator, after being calibrated, is heterodyned with the frequency of the transmitter. A detector is used to pick the beat or indicate zero beat between the transmitter and the oscillator. Zero beat indicates that the frequency of the transmitter and the frequency of the heterodyne meter are the same.

# A 20-WATT RADIOTELEPHONE AND C.W. TRANSMITTER

---

## CHAPTER 16

### A Reminder

**T**HIS is undoubtedly a good place to remind the reader again that the radio law of the United States demands that anyone operating a radio transmitter of any type must possess a license for the transmitter or station. Furthermore, if he operates it himself, an operator's license is necessary. The owner of a station may obtain the services of a licensed operator for his station, but if the operator is an amateur, he must not be paid.

It makes no difference whether the transmitter is of very low power with signals that can be heard for a few feet only, or whether the transmitter is put on the air for a second or for a long period of time. A license must be obtained. Operating without it subjects the offender to a penalty up to \$5,000 and imprisonment.

### Caution

A radio transmitter is not a plaything. If misused it can cause a great deal of interference with other stations. If carelessly handled, transmitter power can electrocute. Every year radio experimenters are killed because they did not take proper precautions for their own safety.



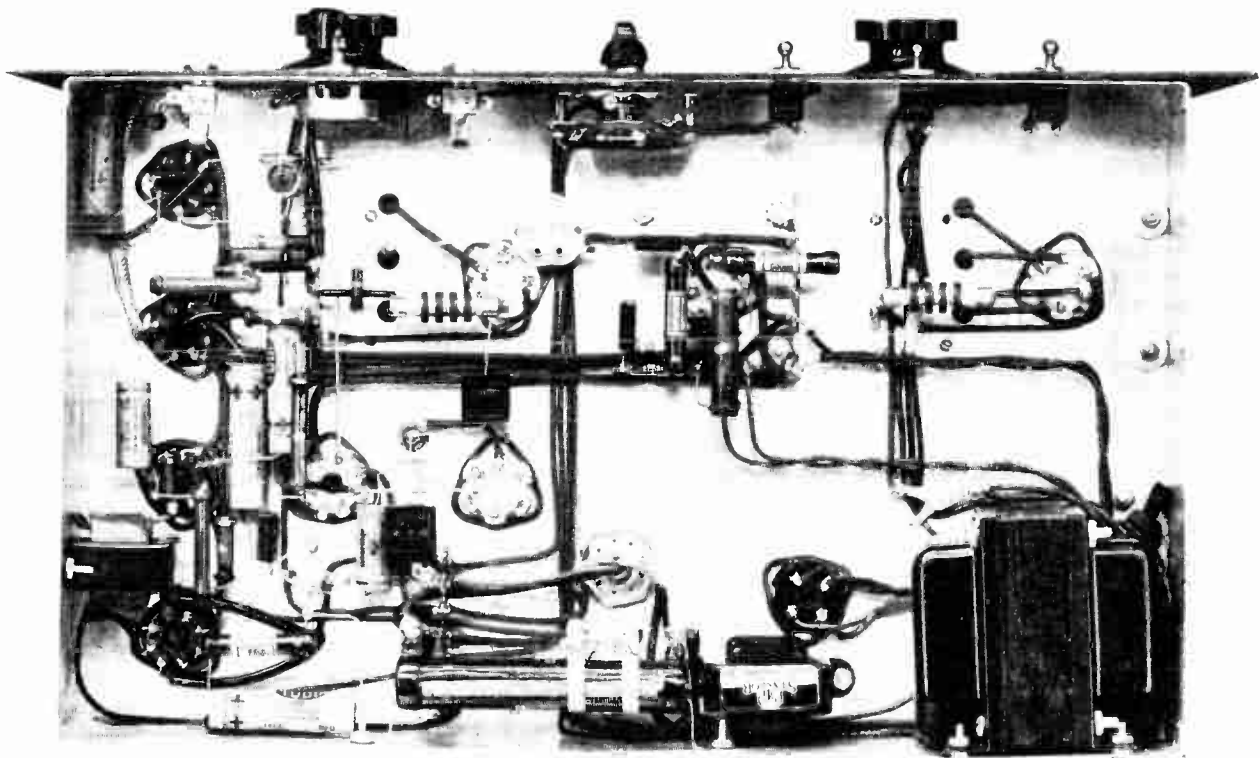

92. The underside of the chassis of the Stancor 20-P Transmitter  
WorldRadioHistory



93. Rear view of Stancor 20-P Transmitter with cabinet removed

## A 20-Watt Radiotelephone and Transmitter 199

The constructor or operator should be absolutely certain that the current is shut off before making any major adjustments. Not only can transmitter power electrocute under some conditions but the radio-frequency currents from the tank coils of buffers and power amplifiers can cause severe burns. These burns are deep and difficult to cure. If burned by radio, apply oil or grease as first aid treatment and put the case in a doctor's hands.

A radio transmitter converts low-frequency alternating or direct current into high-frequency power and radiates it through a suitable radiating system. By controlling the transmitter with a key, it will send telegraph signals. If the radiation is properly modulated at voice frequencies the transmitter becomes a radiotelephone transmitter.

Building and operating an amateur transmitter is not a job for a youngster. It is a hobby for older boys and men possessed of proper engineering knowledge and mechanical ability.

A transmitter must be designed and operated so as to comply with certain requirements imposed by present-day regulations and operating conditions; the frequency which it generates must not vary appreciably, its radiation must be free from the effects of an a-c power supply.

Government regulation limits the power of amateur transmitters to one kilowatt input. It requires an elaborate, expensive apparatus to convert 1,000 watts of a-c or d-c power into radio frequency current, keep the frequency constant and modulate it properly. A one K.W. "rig" is for the advanced amateur whose knowledge qualifies him as a professional and who can also pay for costly "bottles" (tubes) and other equipment.

### The Stancor 20-P Transmitter

You cannot assemble a miscellaneous lot of condensers, tubes, and resistors and have a transmitter. Parts must have suitable electrical and physical characteristics. Satisfactory operation and, in the long run, economy, are achieved by assembling a transmitter from a well-engineered kit of parts.

The Stancor 20-P Transmitter comes in kit form and when assembled results in a complete phone and C.W. transmitter, including its a-c power supply contained in a cabinet measuring 19" x 13" x 8 $\frac{3}{4}$ " overall. The rated input is 20 watts at all frequencies, although this can be increased to 30 watts if desired. The modulator delivers 10 watts of audio-frequency power which is sufficient to modulate the radio-frequency output of the transmitter 100 percent. The transmitter is capable of operation on any frequency from 1.6 to 60 megacycles and is crystal controlled. Practically any type of antenna may be used.

Frequency change can be accomplished in 30 seconds or less by means of two plug-in coils, and a plug-in crystal.

During actual tests the "20-P" performed very creditably on all the amateur frequencies from 1.75 to 60 MC. Telegraph signals were clean and without "chirps." Phone modulation was excellent. Checking the frequency stability showed it to be practically perfect. When used as a phone no frequency modulation was apparent.

### General Description of the Circuit

A type 6F6G tube acting as a crystal controlled oscillator drives a type 807 amplifier tube in the radio-frequency section. Split stator type condensers in both the oscillator and the amplifier tank circuits provide proper inductance to ca-



## A 20-Watt Radiotelephone and Transmitter 201

capacity ratio for all frequencies. The sections of both condensers are automatically switched when the plug-in coils are inserted. A 2-volt 60 MA pilot light bulb is connected in series

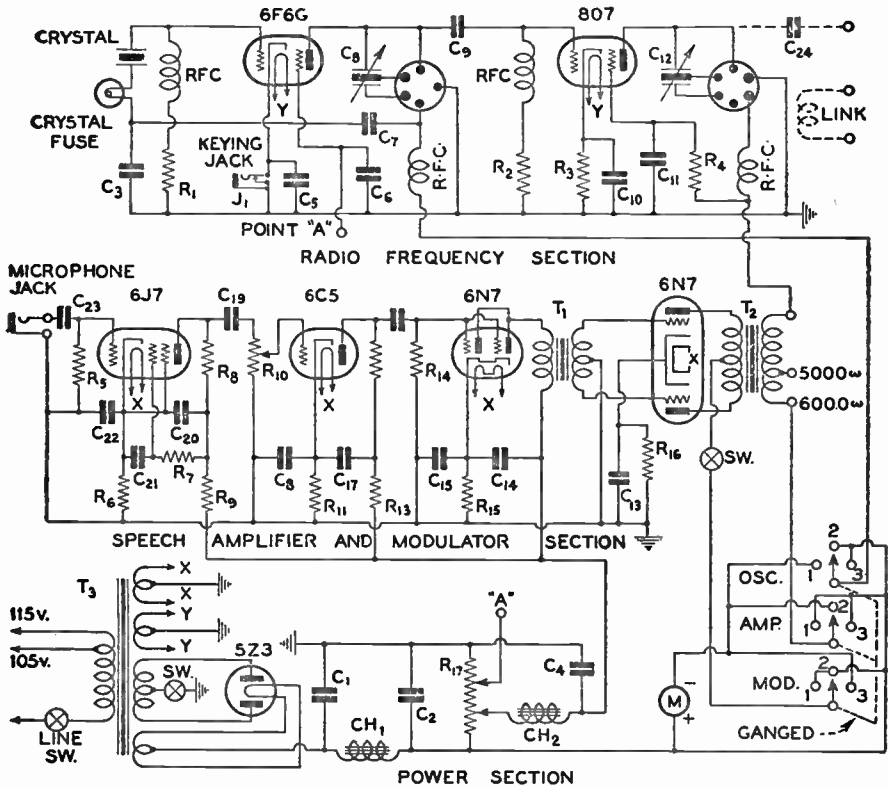

94. Schematic circuit for Meissner 20-p radiotelephone and c. w. transmitter

with the crystal to indicate the crystal current and also act as a fuse.

Antenna coupling is by means of a link or by capacity coupling to the amplifier tank circuit.

The tube lineup of the speech amplifier and modulator is as

follows: a 6J7 input, 6C5 voltage amplifier, 6N7 driver (Class "A"), and a 6N7 modulator (Class "B"). Different load impedances are available through taps in the secondary of the modulation transformer. Sufficient gain for a crystal microphone or similar high impedance input is provided.

The power filter employs condenser input. A type 5Z3 full-wave rectifier tube delivers approximately 400 volts d-c out of the filter. Power to the three speech amplifier stages is supplied through an additional filter section to insure hum-free operation. A tapped voltage divider of 20,000 ohms (50 watts) provides 300 volts for the speech amplifier and 175 volts to the oscillator screen grid. The screen of the 807 amplifier tube in the radio-frequency section is supplied through a voltage-dropping resistor of 50,000 ohms.

### The Layout

All controls, including the meter, microphone, and keying jacks, are mounted on the front panel. A built-in meter switch permits the same meter to be used for reading oscillator, amplifier, and modulator plate currents without plugs or jacks.

Reading from left to right across the front of the panel, the controls are as follows: at the top, oscillator plate tank tuning dial, plate circuit meter, and amplifier plate tank tuning dial; at the bottom, microphone jack, gain control, keying jack, meter switch, modulator "on-off" switch, filament switch, and plate switch.

Looking at the chassis from above, the parts are arranged as follows, along the panel from left to right: the amplifier tank coil, amplifier tank condenser *C12*, 807 amplifier tube and shield, oscillator tank coil, and oscillator tank condenser *C8*. The four metal tubes at the right end of the chassis are



95. The completed Stancor 20-P Transmitter



## A 20-Watt Radiotelephone and Transmitter 203

those of the speech amplifier and modulator. Along the rear of the chassis from left to right: the power transformer *T3*, *5Z3* rectifier tube, filter condensers *C1*, *C2*, and *C4*, and the modulation transformer *T2*. The *6F6G* oscillator tube is directly in front of *C8* and in back of the modulation transformer. The crystal is at the left of the oscillator tube and the pilot light crystal fuse is between it and the tube.

The layout of each section (r-f, a-f, and power) follows as closely as possible that shown in the schematic circuit diagram. The radio-frequency and audio-frequency sections are spread out so as to prevent feedback and interaction between circuits but at the same time kept close enough together to keep the plate and grid leads reasonably short. The arrangement of the power transformers and filter chokes with respect to the audio transformers is designed so that a minimum of inductive coupling exists and no noticeable hum is induced in the audio system.

### Parts List for Stancor 20-P Transmitter

#### CONDENSERS

<i>Condenser</i>	<i>Capacity</i>	<i>Working Voltage</i>	<i>Manufacturer's</i>	<i>No.</i>
<i>C1-C4</i>	8-8 mfd.	450	Solar	D-820
<i>C2</i>	16 mfd.	450	Solar	D1-859
<i>C8</i>	.00037 mfd.	1000	Aerovox	1450
<i>C5-C7-C25</i>	.002 mfd.	1000	Aerovox	1450
<i>C6-C11-C21</i>	.1 mfd.	400	Solar	S-0238
<i>C8</i>	100-100 mfd.	...	Cardwell	EU-100-AD
<i>C9-C24</i>	.0001 mfd.	1000	Aerovox	1450
<i>C10</i>	1.0 mfd.	400	Solar	S-0267
<i>C12</i>	50-50 mfd.	...	Cardwell	ER-50-AD
<i>C13-C15-C18-C22</i>	10 mfd.	25	Solar	DT-879
<i>C14-C17-C20</i>	4.0 mfd.	450	Solar	DT-858
<i>C16-C19-C28</i>	.01 mfd.	400	Solar	S-0219

## RESISTORS

<i>Resistor</i>	<i>Resistance Value</i>	<i>Wattage</i>	<i>Manufacturer</i>	<i>Type No.</i>
R <sup>1</sup> -R <sup>9</sup>	50,000 ohms	1	IRC	BT-1
R <sup>2</sup>	50,000 ohms	2	IRC	BT-2
R <sup>3</sup>	1,250 ohms	10	Ohmite	Wirewound
R <sup>4</sup>	50,000 ohms	10	Ohmite	Wirewound
R <sup>5</sup>	1 megohm	½	IRC	BT-½
R <sup>6</sup> -R <sup>11</sup>	3,000 ohms	1	IRC	BT-1
R <sup>7</sup>	2 megohms	½	IRC	BT-½
R <sup>8</sup> -R <sup>14</sup>	250,000 ohms	1	IRC	BT-1
R <sup>10</sup>	500,000 ohms	..	Centralab	N-103
R <sup>12</sup>	100,000 ohms	1	IRC	BT-1
R <sup>13</sup>	20,000 ohms	1	IRC	BT-1
R <sup>15</sup>	1,000 ohms	1	IRC	BT-1
R <sup>16</sup>	100 ohms	10	Ohmite	Wirewound
R <sup>17</sup>	20,000 ohms	50	Ohmite	Wirewound

*Transformer*

## TRANSFORMERS

*No.*

T <sup>1</sup>	Driver transformer	Stancor	A-4712
T <sup>2</sup>	Modulation transformer	Stancor	A-3845
T <sup>3</sup>	Power transformer	Stancor	P-4004

*Choke*

## CHOKES

*No.*

CH <sup>1</sup>	Filter choke	Stancor	C-1412
CH <sup>2</sup>	Filter choke	Stancor	C-1515

## MISCELLANEOUS PARTS

<i>Quantity</i>	<i>Part</i>	<i>Manufacturer's</i>	<i>No.</i>
3	S.P.S.T. Toggle Sws	Bud	1003
1	Open Cir. Jack (J)	Yaxley	A-1
1	Closed Cir. Jack (J)	Yaxley	A-2
1	0-200 ma.—D.C.—2" meter	Triplet	221
4	2.5 mh. R. F. Chokes	Hammarlund	CHX
2	1¼" Bar Knobs	Yaxley	366
1	4 prong socket	Amphenol	S-4
2	5 prong socket	Amphenol	RSS-5
2	6 prong socket	Amphenol	RSS-6
5	Octal socket	Amphenol	S-8
2	Nameplates	Gordon	...
2	2¾" dials	Gordon	294

## A 20-Watt Radiotelephone and Transmitter 205

2	Feedthru Insulators	Johnson	44
1	Tube Shield (Special)	National	J-30
1	Pilot Light Socket	Drake	317-H
1	2 V. 60 ma Bulb	Mazda	48
1	3 Pos. 3-circuit switch	Yaxley	1313-L
1	6 ft. cord and plug	.....	....
1	Small grid cap	Amer. Rad. Hdw.	92
1	5 prong 1½" coil form	Hammarlund	SWF-5
1	6 prong 1½" coil form	Hammarlund	SWF-6
1	Metal Cabinet	Par-Metal	SC-128
1	Set of Hardware	Stancor	20-P
1	No. F-20. Foundation kit (drilled panel and chassis) with complete instructions.	Stancor	F-20

*Note: The parts used in the original model are shown above. Parts having identical electrical and physical characteristics may be substituted. This applies to all but the variable condensers, sockets, meter, transformers, and chokes.*

### Assembling

The sockets are the first parts to mount on the chassis. Bakelite sockets may be used in the audio-frequency and power supply sections. Amphenol sockets are preferable in the radio-frequency circuits. The socket for the 807 tube has five prongs and the 6F6G tube socket has eight prongs, while the socket for the plug-in crystal has six prongs and those for the oscillator coil socket and the amplifier coil socket have five and six prongs respectively. All the tubes in the audio-frequency section use octal sockets and the 5Z3 rectifier uses a four-prong socket. It is important to mount all the sockets so that the shortest leads can be made to adjoining circuits. This not only adds to the appearance of the finished wiring job but is a considerable factor in securing the best operation of the completed unit.

The rubber grommets furnished with the kit are to insulate the wires which pass through the chassis. The six  $\frac{3}{16}$ " grom-

mets are used to insulate the tank circuit leads of the oscillator and amplifier tank tuning condensers and they mount in two rows of three each, just to the right of each condenser. The two  $\frac{3}{8}$ " grommets are for the 110-volt a-c line cord where it passes through the back of the chassis, and for the leads to the meter at the center and near the front edge of the chassis. The  $\frac{1}{2}$ " grommet mounts in the  $\frac{1}{2}$ " hole between the 6F6G and crystal sockets. The small socket, which holds the bulb connected in series with the crystal, mounts in this grommet.

Each tuning condenser is mounted with four 4-36 screws and four 1" bushings.

The two small porcelain feed-through insulators mount on top of the chassis at the righthand edge of the chassis beside the amplifier coil socket and the power and modulation transformers.

The filter condensers and the 807 tube shield (actually a coil shield with the top sawed off) should be put in their respective places. The shield for the 807 tube should be the same height as the coil forms so that it will shield the 807 from the field of the oscillator coil. Then when the modulation and power transformers have been fastened in place the parts which mount on the panel (except the dials) can be assembled in their proper place. The six parts which mount in a row across the bottom of the panel, hold the latter to the chassis.

The chassis can now be turned over and the wiring started. Other parts, such as the four 5-lug mounting strips, can be added as the wiring progresses. The mounting feet of each strip should be bent in or out to fit the screws already on the chassis.



## Wiring

The primary circuit of the power transformer and the filament circuits of all the tubes should be wired first. Needless to say, all connections should be soldered, all leads should be as short as convenient, and all the precautions to be observed in wiring a receiving set should be followed. When the primary circuit of the transformer and the filament circuits have been connected, connect the line cord to the 110-volt a-c and check to see if the proper voltage is present at the filament prongs of each circuit. Then the wiring for the high voltage power supply can be put in place and the supply tested for output with the 5Z3 rectifier tube in its socket.

The wiring of the radio-frequency section should begin with the oscillator and progress to the amplifier. The socket used for the plug-in crystal has six prongs whereas only two are actually required. However, connect three in a row on each side, so that no matter which way the crystal is inserted in the socket, it will always make the proper connections.

All of the radio-frequency leads should be No. 14 B.S. gauge wire and should be raised about  $\frac{3}{4}$ " away from the chassis in order to avoid the losses due to capacitive effects between the wiring and the chassis. The three tank circuit leads for each radio-frequency stage pass through the  $\frac{3}{16}$ " rubber grommets which insulate them from the base. The small parts, such as the radio-frequency chokes, resistors, and fixed condensers, are mounted with their own leads so as to be self-supporting, being mounted about  $\frac{3}{4}$ " away from the chassis in the same manner as the radio-frequency leads. When all of the radio-frequency connections have been made, the meter switching connections can be put in and the wiring

between the power supply and the radio-frequency stages put in.

When the dials have been added, the radio-frequency section of the transmitter is ready to be tested. It will be necessary to make up one pair of coils. These are wound on 1½" Hammarlund forms. One 5-prong (No. SWF-5) and one 6-prong (No. SWF-6) are required. It will be necessary to have a pair of coils for each wavelength band. The data given below in the coil chart holds good only for condensers of the capacity given in the parts list. If other types or values are used, changes must be made in the coil data. The schematic circuit diagram and the coil chart show bottom views of the coil sockets.

The condenser *C25* shown in the amplifier chart but not in the circuit diagram is used only in the four lower frequency bands. It is mounted inside the coil form for each of these bands and is automatically plugged in or out of the circuit with each coil.

To test the radio-frequency section, insert an oscillator coil, crystal, rectifier, and radio-frequency tubes, plug in the line cord, and turn on the filaments. When the tubes have warmed for two or three minutes, switch the meter to the oscillator plate circuit. Then turn the plate voltage switch on and tune the oscillator plate tank until the meter indicates resonance by a current dip. The current should drop to 20–40 ma. The actual value will depend upon a number of factors, such as frequency, tube, crystal, voltage, etc. When the oscillator has been tuned, insert the amplifier coil and switch the meter to the amplifier plate circuit. Tune the amplifier circuit to resonance as indicated by a current dip to 5–15 ma. When loaded, the amplifier plate current should be from 50–75 ma.

In making up the oscillator and amplifier coils, it is a good

## A 20-Watt Radiotelephone and Transmitter 209

idea to use a calibrated absorption type wavemeter to check them, to be sure that the proper harmonic is being picked off when doubling or quadrupling. Frequency doubling or quadrupling can be employed in both stages of this transmitter, making it possible to cover all bands with 160, 80, and 40 meter crystals. The value of the small condenser indicated as

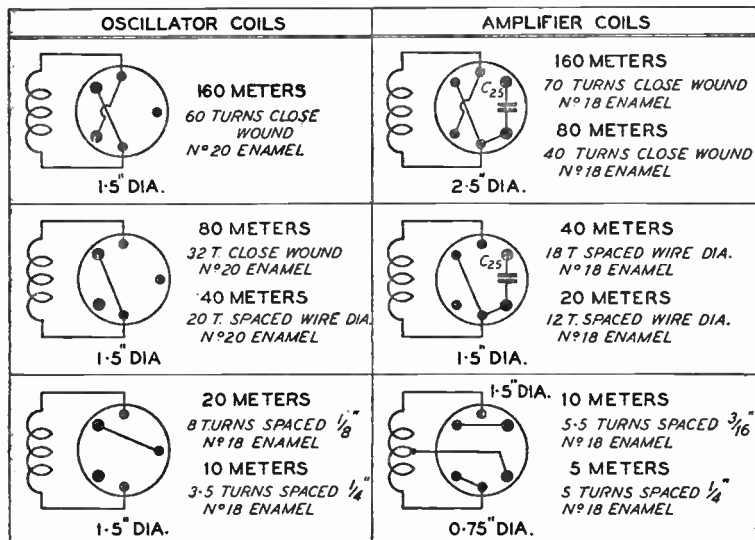

96. Details of the oscillator and amplifier coils for the Meissner 20-P transmitter

C3 in the schematic diagram of the radio-frequency section is fairly critical and can be varied either way to obtain the greatest harmonic output. The best value to use with a type 6F6G tube is approximately .00035 to .00037 mfd.

The resonant points are rather sharp in both tuned circuits and care must be used in tuning them, especially when doubling or quadrupling. The pilot light bulb in series with the crystal control indicates the crystal current. This should

be kept to the lowest value consistent with good output.

In wiring the speech amplifier and modulator, most of the connections can be made with the resistors and condensers themselves, thus helping to maintain short leads. When the connections to the driver transformer *T1* are made, the primary center tap lead can be taped up or cut off. It is not needed. The total primary winding is used.

The grid and plate leads of the three speech amplifier stages should be shielded to prevent feedback and pickup. The leads going to the gain control should also be shielded.

The amplifier can be tested before it is connected to the modulator by placing a pair of phones in the plate circuit of the *6N7* driver stage in place of the primary winding of the driver transformer. The total plate current drain of these three stages should be approximately 15 ma.

When the amplifier has been checked, the *6N7* Class B modulator may be connected. It should draw about 30 ma when idling and up to 100 ma on peaks. The audio output can be checked by means of a load in the form of a 10-watt lamp connected across the secondary of the modulation transformer. The proper tap to use on the secondary of transformer, *T2*, depends upon the load impedance of the *807* amplifier stage. Use the tap which will give a transformer impedance which will most nearly match the load impedance. The load impedance is equal to the plate voltage on the *807* tube divided by the current that it draws when loaded to the point at which it will be operated.

The two brass couplings and section of bakelite rod which are included in the kit are used as insulating tuning shaft extensions. The two tuning dials are fastened to the bakelite shafts, which project through the front panel and the couplings connect the other end of these shafts to the condensers.

### Microphone and Key

The leads from the microphone and key are connected to the transmitter by telephone plugs inserted in the jacks. The keying jack (*J1*) is in the oscillator circuit. The microphone jack (*J*) is in the amplifier circuit.

Use a piezo-electric or crystal microphone of the amateur communication type. Unlike other microphones, the crystal type requires no separate source of current, polarizing voltage, or magnetic field. The sensitivity of this type of microphone is affected by the length of the leads connecting it to the input of the first amplifier stage. For amateur work, the leads should not be over 6 or 7 feet long. Wide frequency response is not required for voice transmission, it is therefore satisfactory to choose a microphone intended particularly for speech transmission rather than one designed for broadcast programs. Program transmission requires a uniform response over a range of audio-frequencies up to 10,000 cycles or more, but in amateur phone work audio-frequency responses over 3000 cycles are largely wasted.

### A Word About Operating

One of the best ways to learn how to operate and how not to operate a radio transmitter is to be a good listener. The fellow who sits down and listens in, covering the whole amateur spectrum thoroughly, will soon notice the mistakes of the other fellows. He will learn that it is applied common sense:

1. Not to operate too near the edge of any amateur band
2. To check frequency often
3. Not to make a plaything of a radio transmitter
4. Not to CQ fifty times and sign twice
5. To send clean-cut steady stuff rather than try to show speed.

Some people only obey the traffic laws because they are afraid of a traffic cop. If you are that kind of person it would be beneficial to everyone else if you would stay off the air. However, it is only a matter of time before one of the checking stations maintained by the Federal Communications Commission will catch you if you are off frequency or a smart alec. You will be cited and under certain circumstances you may cease to be a radio operator by order of your Uncle Sam.

### Watch Your Frequency

Don't work too close to the edge of an amateur band. If you do not own a frequency meter check your spot with your own receiver. There is a commercial station at the end of each band. Tune for it. It will give you a good idea of the band limits.

If you want to calibrate your receiver or a homemade frequency receiver you can use the commercial broadcasting stations as a standard for some of your calibrations. A broadcasting station must maintain very close frequency adjustment. It must keep within a few cycles of its assigned frequency, hence its signals are always dependable markers for the amateur.

# ULTRA-HIGH FREQUENCIES

---

## CHAPTER 17

**T**HAT portion of the radio spectrum that lies below the ten-meter (30,000–28,000 kilocycles) band is a region of great possibilities for the experimenter. It is the field of ultra-high frequencies, about which there is much still to be learned.

Ultra-short waves do not behave in all respects as do the waves produced by lower frequencies. They can be made to do a great number of things of which lower frequency waves are incapable. They can be reflected and refracted in much the same manner as visible light waves; in fact, they are sometimes called quasi-optical waves.

There are several applications for ultra-high frequencies outside of the communication field. Use has been found for them by the physiologist and the botanist. In some diseases it is advisable to create a fever in the patient in order that the increase in body temperature will combat the malignant bacteria. Heretofore this was accomplished by deliberately giving the patient another disease which would raise the temperature of the body, but now it has been found that if the patient is exposed to ultra-high frequency radiations the body temperature will be increased without resorting to a second disease. The tissue of the body can be destroyed by the use of the so-called *radio knife*, which permits practically blood-

less surgical operations. Small animal and insect life can be destroyed, so that vermin extermination is a possibility. On the other hand, plants that have been exposed to ultra-short wave radiations have grown faster and larger than those raised under ordinary conditions. In short, the list of possibilities is too long to include in limited space.

However, it is the chief concern of the radio amateur to know about ultra-short wave communication, for this is the phase of the matter in which he is interested, these other applications being more or less by-products. Let us consider some of the main differences in the apparatus and its functionings.

For many years the 5-meter (60,000–56,000 kilocycles) band was considered to be useful only for local and short-distance communications. It appeared to be limited to distances under 30 miles. But with the development and better understanding of directive antennas, the usefulness of the 5-meter band was greatly extended. Consistent communication over distances of one hundred miles became common, and finally occasional work over several thousand miles became possible. These periods when long-distance communication becomes possible usually occur during the summer and fall and are times when the ionosphere exerts its influence.

### The Ionosphere

The ionosphere, also called the Kennelly-Heaviside layer after Dr. A. E. Kennelly in America and Oliver Heaviside in England, who simultaneously proposed its existence, is a supposed region of rarefied and ionized atmosphere surrounding the earth and located fifty to two hundred and fifty miles above it.

Radio waves emitted by the ordinary antenna not only



travel along the surface of the earth but also through the upper atmosphere. That part of the wave or energy from the antenna which travels along the surface of the earth is called the *ground wave*; that which goes out at an angle above the horizontal is the *sky wave*.

The ground wave becomes rapidly weaker as it progresses away from the antenna until it no longer has any useful strength. Sky waves travel on outward into space and do not become as quickly attenuated as the ground waves. This is especially true of ultra-short waves.

It may seem at first that the sky waves would be lost and therefore of no value in communication, but actually this strange behavior is the fundamental reason for the great distance-covering characteristic of short waves. As these waves are impelled from the transmitting antenna at angles depending on the frequency and the type of radiator, they travel until they meet one of the ionized layers far in the sky. At one time it was believed that there was but one such layer, but intensive and prolonged tests carried out by the U.S. Bureau of Standards have shown the presence of at least three layers and perhaps more. The transmitted wave striking one of these regions of ionized particles is bent or reflected back toward the earth in much the same manner as a ray of light striking a mirror. Thus instead of passing off into some remote region in the ionosphere the signal eventually comes back to earth at a point hundreds and sometimes thousands of miles from the starting place. The distance between the transmitter and the return point is called the *skip distance* and comprises the area over which the station cannot be heard. A powerful signal often returns to the earth's surface several times before its strength is so reduced that it can no longer be detected.

The approximate positions of the principal ionized layers

are illustrated in *Fig. 97*. Tests have shown that most of the waves transmitted at night pass through the E layer and on to one of the F layers before they are reflected back to earth. During the daytime, each of the three layers is effective depending on the frequency of the waves; hence scientists have compiled tables which show communications engineers exactly what they may expect in the performance of transmitters

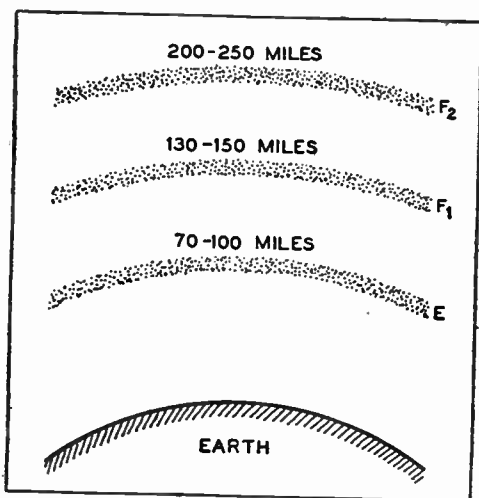

97. Locations of the principal ionized layers which affect the transmission of radio waves of different frequencies

at different times of the day. Thus at any hour, the wavelength of a station would be one figure for a transmission of one thousand miles and another figure for a signal that was to be sent thousands of miles away, to China or Australia, for instance. That is one reason for the wide variation in frequencies assigned to the amateurs. For strictly local traffic, the amateur will resort to 160 or 80 meters, but when his objective

is a brother amateur in a foreign country he will turn to his 20-meter wave.

Although waves of ultra-high frequency (above 30,000 kilocycles or shorter than 5 meters in length) are rarely deflected back to earth by the ionosphere, there are apparently other conditions which frequently bend the sky waves in the lower atmosphere. Normally the air close to the earth is warm and is colder at higher altitudes. But there are times of temperature inversion, that is, occasions when warm, moist air overruns colder layers underneath. This condition is found almost every night.

The useful strength of an ultra-high frequency ground wave is practically limited to little more than the range of vision from the station. Ordinarily, during the daytime, unless there is temperature inversion in the vicinity, the communication range of an ultra-high frequency station of low power is limited to the optical range of vision from the station. At night, however, with a bending of the waves due to temperature inversion, distances are often increased to one hundred-five hundred miles.

Ultra-short wave transmission varies greatly from day to day. Temperatures, season of the year, sun spots, magnetic storms, and direction of transmission, all are believed to exert an effect upon the range of a station.

With a proper directive antenna and sufficient power the daylight range of an ultra-short-wave station may be extended considerably beyond the optical or visual range.

On ultra-short waves, the antenna becomes increasingly important. Due to its much smaller dimensions it is possible to secure directional properties from an antenna not possible with longer waves. Natural static is a smaller problem in

ultra-short-wave reception than it is in the case of longer waves, but man-made static is a greater problem. The ignition systems of automobiles, diathermy, and X-ray machines used by doctors, as well as many other electrical devices, sometimes cause intense man-made interference.

Ultra-short waves which are vertically polarized, that is, emitted from an antenna perpendicular to the surface of the earth, and received on a vertical antenna are more subject to man-made static than horizontally polarized waves (emitted by a horizontal antenna). The fundamental form of antenna for ultra-high frequency work is a single wire approximately one-half wave long. Energy is not emitted uniformly in all directions from a half-wave antenna. It is zero along the direction of the wire itself and most intense at right angles to the wire. Therefore if the antenna is vertical, the waves will be uniform in all horizontal directions, but if the antenna is horizontal the greatest horizontal radiation will be in a direction at right angles to the wire.

Signals will be received best when a vertical receiving antenna is used for receiving vertically polarized waves and a horizontal antenna for horizontally polarized waves.

Because man-made static interferes less with horizontally polarized waves; because a horizontal antenna has a marked directional effect; and because horizontally polarized waves seem to provide better signals over long indirect paths, the trend in ultra-short-wave work is away from vertical antennas.

All of the electrical principles discussed in other chapters apply equally well to ultra-high frequencies, but in this specialized field the apparatus changes in size and appearance. Tubes, condensers, and inductances become very much smaller. The variable condensers have only a few plates; inductance coils but a few turns. In some cases the inductances are

straight rods. With frequencies of 30,000 kilocycles (this is 30,000,000 cycles) and upward, the materials used for insulation become highly important. Losses that are negligible at broadcast frequencies assume important proportions at ultra-high frequencies.

Since the capacities and inductances used in ultra-high frequency apparatus are of relatively small dimensions, the capacity and inductance of connecting wires may be a large proportion of the total capacity and inductance in the circuit. In the construction of transmitters, receivers, and antennas for use on ultra-high frequencies, the utmost care is necessary in arrangement and layout.

### Building a Receiver for the 112 Megacycle Band

The superregenerative receiver is particularly suited to ultra-high frequency reception. It is tremendously sensitive

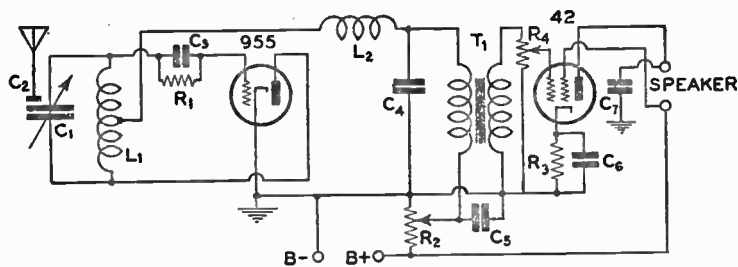

98. Schematic circuit diagram for self-quenched (superregenerative) acorn tube ultra-short-wave receiver

and has operating characteristics which discriminate against man-made static.

Fig. 98 shows the schematic circuit diagram for a superregenerative receiver. Below is a list of the component parts for building a receiver for the 112 mc band.

## List of Parts for Ultra-High Frequency Receiver

<i>Part No. in Diagram</i>	<i>Quantity</i>	<i>Description</i>
C1	1	15 micro-microfarad Cardwell Trim-Air Midget Tuning Condenser with Mounting Bracket
	1	Shaft Coupling with Isolantite insulation to fit condenser
	1	Precision Dial and Knob to fit Condenser
C3	1	50 micro-microfarad Midget Fixed Condenser
C4	1	.002-.006 microfarad Fixed Condenser. The most satisfactory value for C4 is determined by experiment.
C5	1	.25 microfarad Fixed Condenser of 200 volt rating or better
C6	1	25 microfarad 50 volt Electrolytic Condenser
C7	1	.002 microfarad Fixed Condenser
R1	1	5 to 10 megohm Gridleak
R2	1	50,000-ohm Potentiometer
R3	1	500-ohm 2 watt Resistor
L1	1	Coil consisting of 4 turns of wire (See text)
L2	1	Ohmite ultra-high-frequency Choke consisting of about 50 turns of No. 30 Wire (See text)
T1	1	Ordinary audio-frequency Transformer
955	1	No. 955 Tube and Socket
42	1	No. 42 Tube and Socket

The layout of a receiver developed from this circuit and specifications is illustrated in Fig 99. It is assembled on a metal chassis and a metallic panel so as to avoid "body capacity" effects when tuning.

Inductance,  $L1$ , consists of four turns of No. 14 copper wire spaced to occupy one inch. The position of the tap on this coil is quite critical and very erratic behavior will result until the proper position is found.

Inductance,  $L2$ , is an ohmite ultra-high-frequency choke. A coil consisting of about fifty turns of No. 30 wire wound on

an insulating rod in a space of one inch may be substituted.

It may be necessary to use a resistor of 200,000 to 500,000 ohms across the secondary of the audio-frequency transformer. This is not shown in the schematic circuit diagram.

It is very important to group all the components of the radio-frequency circuits closely around the detector tube socket so that all leads are very short. Short leads, in fact, are

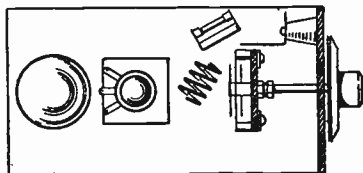

99. Baseboard arrangement of ultra-short-wave receiver for 112 megacycle band

the first and most important feature of an ultra-high-frequency set.

The tuning condenser is not mounted directly on the panel but is supported by a bracket far enough back so that a flexible isolantite insulated coupling can be used between the condenser and dial. Both sides of the tuning condenser carry high potential radio-frequency current and the insulating coupling is necessary.

### Building an Ultra-High-Frequency Transmitter

The inductance and capacity in the tank circuit of an ultra-high-frequency oscillator may be furnished by two suitable



100. A  $2\frac{1}{2}$  meter ultra-short-wave transmitter

copper rods or pipes. Such an arrangement is called a linear oscillator. It is simple to build and adjust.

Almost any of the usual triode tubes will serve in a linear oscillator circuit at 112 megacycles. No.'s 10, 801, and 45 are to be recommended.

### List of Parts for Ultra-High-Frequency Transmitter

<i>Circuit Designation</i>	<i>Quantity</i>	<i>Description</i>
	2	½ dia. copper tubes 36 inches long
	5	Small porcelain standoff Insulators
L1 and L2	2	Radio-frequency Chokes, National R100
R	1	10,000-ohm wirewound Grid Leak
	1	Tube Socket
	1	Filament Transformer
	1	Modulation Transformer
L3 and L4	1	35 to 50 micro-microfarad feeder Condenser
	2	Chokes. These are homemade and consist of 25 to 30 turns #14 wire wound around a pencil

The filament transformer should be mounted on one end of a wooden base approximately four inches wide and forty inches long. Next to it mount the tube socket, leaving space between it and the transformer terminals for the filament lead chokes. The socket should be mounted on a stand-off insulator so that it is raised to the same height as the copper pipes.

The copper pipes are mounted on standoff insulators and connected to the grid and plate terminals of the socket. The space between the pipes should be approximately equal to the diameter of the pipes. The adjustable contacts (1 and 2) leading from the radio-frequency chokes to the copper pipes are "universal" clips. The proper position for the clips is at the voltage node point. This is found by experiment. Connect





### The Transceiver

A combination transmitter-receiver, commonly called a transceiver, has come into wide use among amateurs, especially for portable equipment and for emergency applications. Its range, obviously, is limited to a few miles at best, but it has worked out well where it is necessary to establish an operating point quickly or where the terrain would not permit

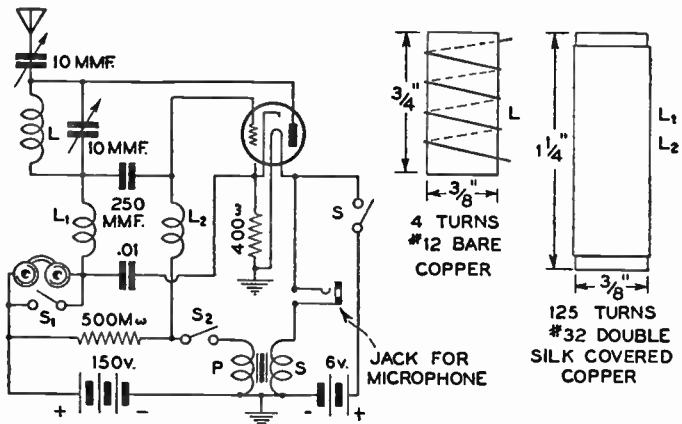

102. One-tube transceiver for use on 116,000 kc.

the passage of a vehicle carrying a more powerful unit. With a little ingenuity the entire station can be compressed into a space scarcely larger than a lunch box.

The diagram, *Fig. 102*, shows such a transceiver. More intricate combinations have been devised, but the one illustrated will serve to introduce the amateur to the characteristics and mode of operation peculiar to a transceiver.

If the circuit is traced first as a receiver it will be noticed that it then functions as a superregenerator. As a transmitter it is a grid modulated oscillator. The type 76 tube which is

shown here functions well on the 116 megacycle band for which the circuit is intended. The switches *S1* and *S2* are operated simultaneously to change-over from "send" to "receive" and should therefore be ganged as a double-pole-double-throw switch. *S3* is merely an on-off switch of any handy type. Since the transceiver is not intended for continual use the batteries should be the smallest size obtainable.

For the microphone, a sturdy carbon mike will suffice, with the modulation transformer selected to match microphone (primary) and grid circuit (secondary). After winding coil *L* it may be removed from its form and soldered directly and permanently by its end turns.

An antenna can be arranged as a rod on top of the transceiver cabinet. For best results the rod should be fifty inches long.

# THE PHOTOELECTRIC CELL AND ITS USES

---

## CHAPTER 18

**T**HE light-sensitive cell is not new. It is about fifty years old and was used for two generations by scientists who deplored its bad characteristics. When a large market for photocells was furnished by the motion picture industry, intensive development work was encouraged and produced great improvements. The vacuum tube amplifier in connection with a phototube made it really practical to use a beam of light as a medium of control. The phototube makes it possible to employ light for purposes other than illumination.

There are three types of light-sensitive cells. All are called indiscriminately "photocells," "photoelectric cells," and "phototubes." In popular language, they are "electric eyes." But they are far from that. Although a light-sensitive cell responds to light, it seldom sees as the eyes see. Its action differs radically.

### Light into Electricity

The function of a photoelectric cell is to transform light energy into electrical energy. This is done by three different methods, resulting, as already stated, in three different types of cells, namely:

1. *Photo-conductive cells*, in which the resistance of a ma-

terial to the flow of current is changed when illuminated by a beam of light. Selenium is the best example of this type of light sensitive material. Selenium is one of the chemical elements which belong to the sulphur family.

2. *Photo-voltaic cells*, in which the passage of electrons from one surface to another is increased by illumination.

3. *Photo-emissive cells*, in which a beam of light causes a surface to emit electrons.

### The Selenium Cell

Selenium is, in its crystalline state, very sensitive to light. Originally, selenium cells were made by winding a piece of slate, porcelain or some other suitable insulating material with two parallel, bare platinum wires. In such an arrangement the wires do not touch each other but have a space between. They form the electrodes of the cell and lead to the terminals. Over the wires is painted a thin layer of molten selenium. After undergoing a heat-treating process, during which the selenium is crystallized and then annealed, the cell is ready for operation. When illuminated, the resistance between the two parallel conductors decreases and more current flows from a battery through a relay.

Such an amateurish form of selenium cell had disadvantages. It suffered by aging, was affected by temperature, was slow in response, and the same cell did not always deliver the same current under the same change in illumination.

Modern technique involves placing the selenium element in a vacuum tube and using methods of manufacture which eliminate the undesirable effects of moisture and oxygen during the formation and annealing of the crystalline layer. Cells made in this way have very little time lag, that is, respond practically instantly, show small temperature changes, and

remain practically constant in characteristics over a long period. Such cells are rugged and, where an "on-and-off" function is required and a slight lag in response is not objectionable, have an important place in controlling many machines and industrial processes.

### The Photo-voltaic Cells

These are of two types, *dry* and *liquid*. The liquid type utilizes the Becquerel effect, a phenomenon in which an electromotive force or potential is created in an electrode or electrolyte when illuminated. The electrodes are usually a cathode of cuprous oxide and an anode of lead immersed in a dilute solution of lead nitrate. A good cell of this type will deliver as much as 3 milliamperes through 100 ohms in direct sunlight.

The dry type of photo-voltaic cell has the advantage of portability. It consists of two dissimilar elements or compounds in contact. The Westinghouse Photox is a copper oxide photo-voltaic cell which consists essentially of a copper disk, oxidized on one surface, a transparent film of metal being deposited on the oxide. The transparent conducting film is connected to one terminal while the bare copper is connected to the other.

When illuminated so that light passes through the transparent film and strikes the copper oxide, the copper becomes positive with respect to the film.

The Weston Photronic Cell is a dry self-generating cell which delivers current when illuminated and operates on the same electronic principle as the Photox.

Such cells, connected to a suitable meter, have great value as simple portable measuring instruments for the determination of light intensity.

### **Photo-emissive Cells**

The two types of light sensitive tubes which have been described will operate sensitive relays directly. The photo-emissive cell will not operate a conventional electromagnetic relay directly. It will, however, produce a large voltage change which may be led to the grid of an amplifier tube having a relay in the plate circuit. By means of a power amplifier tube, a heavy relay may be operated.

### **The Structure of a Photo-emissive Tube**

A photo tube of the emissive type consists essentially of two elements, a cathode and an anode, in an exhausted glass bulb, either spherical or cylindrical in shape, and in which there may, or may not, be an inert gas at a low pressure.

The cathode, which may be a metal plate or a thin film of silver deposited on the glass wall of the tube, is coated with a thin layer of one of the alkaline metals. Both the cathode and the anode are connected by wires to the prongs in the base of the cell, so that connections can be made to them from the external circuits.

Experimenters in photoelectricity found that the metals of the alkali group (lithium, sodium, potassium, rubidium, and caesium) have the property of emitting electrons when light that is visible to the human eye, as well as the so-called invisible light, falls upon them. From the structure of the atoms of these metals it was found that there were one or more electrons in each atom that were not as much under the influence of the positive nucleus as the others. Therefore, when light impinged on one of these alkali metals, the energy possessed by the light was transferred to the electrons in such a way that they became detached from their parent atom and went out into space. These electrons having a negative charge,

would be attracted to a positively charged body in the same way that the electrons emitted by the filament of a vacuum tube travel to the plate, which is positively charged with respect to the filament.

According to the latest theories advanced by scientists, light possesses a certain amount of energy, the unit of which is called a quantum, and the more intense the light the greater the number of quanta.

Summing up, light can be considered to be a series of drops of energy that is raining upon the light-sensitive surface of a photoelectric cell. Every time one of these drops of energy, a quantum, encounters an electron, the latter is released from the atom of metal with a certain amount of energy, which it uses to move towards the anode.

A great deal has been accomplished within the past few years in developing phototubes whose greatest response lies in particular parts of the spectrum. For general control purposes the gaseous cell, being more sensitive, is most frequently used. The gaseous tubes usually contain argon. For measuring light intensities, vacuum type phototubes are used because their response is more directly proportional to the light intensity.

### High-Vacuum and Gas-Filled Photoelectric Cells

When a given light ray of a certain color impinges on the cathode of a cell, a certain number of electrons are released from the cathode and go to the positively charged anode. It is important that their path between the cathode and the anode be as free from obstructions as possible, so that the resistance will be low and likewise the consequent losses. For this reason, all the molecules of air that possibly can be removed from the interior of the glass bulb are pumped out



after the photosensitive surface is prepared. Such tubes having a comparatively small amount of gas in the bulb are called high-vacuum photoelectric cells.

On the other hand, it was found that when some gas of a nature that did not react with the chemicals of the cathode was left in the cell, the current from the anode was greater for a given amount of light than it was when a high-vacuum cell was used. The reason advanced for this action was that when the electrons in their journey from the cathode to anode encountered an atom of the gas, the resulting collision liberated another electron, which in turn went toward the anode. Perhaps this second electron collided with another gas atom and a third electron joined the other two. Of course, the more electrons coming to the anode and so going out to the external circuit meant an increase in current output. Therefore, the gas introduced into the cell really supplies additional electrons, which are called secondary electrons, as they are the result of collisions by the primary electrons emitted from the cathode due to the action of the impinging light energy.

### Action of a Photoelectric Cell

In *Fig. 103* an electric lamp, *L*, is powered by the battery and the current going to the filament can be regulated by the rheostat, *R*. *P* is a photoelectric cell with its window opposite *L* and to its cathode, *C*, is connected the negative side of the battery, *B*, the plus side of which is connected to a microammeter (measuring millionths of an ampere). The anode *A* of the cell, *P*, has impressed on it a positive potential from *B* through the microammeter, *MA*

Let us assume that all the resistance of *R* is cut out so the lamp *L* will give out as much light energy as possible. This will pass to the photoelectric cell, *P*, and be received on *C*,

the cathode, as a certain intensity of light. This intensity will vary with the distance  $P$  is from  $L$ , the proportion being the square of the distance; that is to say, if an intensity of perhaps 10 lumens is reaching  $C$  when  $P$  is 1 foot from  $L$ , if the distance be increased to 2 feet then the intensity will drop to 2.5 lumens. Let us assume further that with 10 lumens the microammeter will read 20 microamperes.

Now resistance is introduced in the filament circuit of  $L$  by cutting in some turns on the rheostat and the light energy

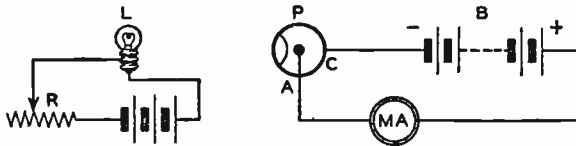

103. Light energy from the lamp,  $L$ , can be varied by the rheostat,  $R$ , as well as the distance between  $L$  and  $P$ . Note that the positive terminal of the battery is connected to the anode,  $A$ , of  $P$  and the negative side to the cathode,  $C$

passing to  $P$  is reduced. This will result at once in a reduction of the current indicated on  $MA$ . The more resistance that is cut into the circuit of  $L$ , the less light will fall upon  $C$  and as a result, the less current will flow through  $MA$ . The same reduction in current could be obtained by keeping the light source constant and increasing the distance between  $L$  and  $P$ , as was mentioned above.

However, this will show that the less light that impinges on  $C$  will result in a smaller flow of electrons to  $A$  and so a smaller current in the output, as indicated on  $MA$ . This action can be thought of in terms of an increased resistance between  $C$  and  $A$ ; the less light coming to  $C$ , the greater is the resistance in the  $C$ -to- $A$  circuit, and therefore, the less current flow. The amount of voltage in the battery  $B$  is of importance and the

value recommended by the manufacturer should never be exceeded. If it is, it is liable to reduce considerably the useful life of the cell.

### Utilizing the Photoelectric Cell

The output current of a photoelectric cell is measured in microamperes, which is an extremely small unit. (For example, the current consumption of the filament of a 201-A vacuum tube is 0.25 ampere, which is equivalent to 250,000

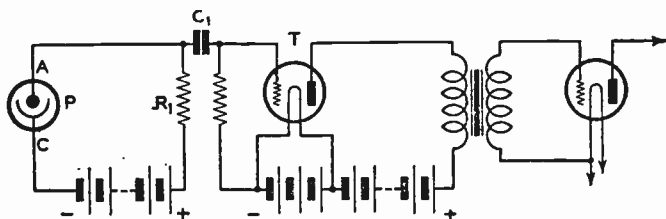

104. Circuit for amplifying the output of a photoelectric cell, so that the current will have sufficient strength to actuate a relay

microamperes.) Such a minute current and a consequent small voltage must be amplified before it can be put to any useful work, so the output of a cell can be connected to a circuit such as is shown in part in *Fig. 104*. This will be recognized as a combination of resistance and transformer coupling. The necessary anode voltage is impressed on that element *A* of the cell *P* through the resistor, *R1*, the negative terminal of that battery being connected to the cathode, *C*. The variations of the current coming from *A* act on the condenser, *C1*, like alternating current and charge and discharge *C1*, producing a varying voltage on the grid of the amplifying tube, *T*. The output of this tube is connected to an a-f transformer through which the voltage is further amplified by one or more stages if necessary.

Of course, the use to which the current from the photoelectric cell is to be put will determine the type and amount of amplification necessary. If the cell is being used in conjunction with the reproduction of sound-on-film motion pictures, then a great deal of amplification must be introduced before the currents are of a sufficient size to actuate the loud speakers. Also the amplification must be carefully controlled to see that no distortion enters. However, when cells are used for controlling the starting or stopping of certain operations

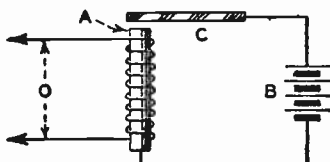

105. When current flows through the coil, the armature *A* sets up magnetic lines of force which pull down the contact *C* and so closes a circuit. *O* is the output of a photoelectric cell.

or for counting operations, then the amount of amplification is not so large nor is distortion an important factor.

In the latter operations use is made of a device that is called a relay. This consists of a coil of wire through which the current from the anode of the cell flows, after amplification. Let this output circuit of the cell be *O*, as in *Fig. 105*. Within the coil of wire is a movable piece of iron called the armature, *A*. When current flows through the coil, the magnetic lines of force set up by the current will cause the iron to move upward (or downward, as the case may be) and so close a circuit, one contact of which is *C*, and the other is perhaps through the armature. Thus a relatively small current can control one of great magnitude, because as soon as the current

stops flowing or falls below a certain level in the coil, the armature will drop, opening the second circuit.

In *Fig. 106* is a diagram of an amplifier circuit that is designed for d-c operation, although if desired the filament of the vacuum tube may be heated by a-c. *P* is the photoelectric cell with the anode connected to one side of the milliammeter, *MA*, and the cathode connected to the resistor, *R*<sub>2</sub>, known as the grid resistor. This same side of *R*<sub>2</sub> is connected to the grid of the amplifying vacuum tube, *T*, the plate of which is con-

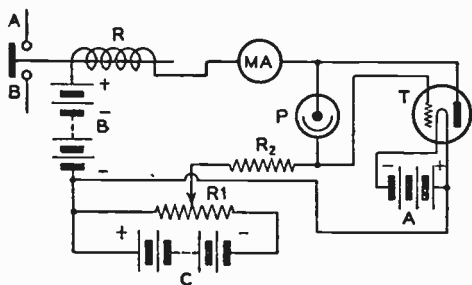

106. When light impinges on the cathode of *P*, the resulting current flow causes the grid of *T* to become positive with respect to the filament and so an increased current will flow from the plate.

ected to the anode of *P* and *MA*. *R*<sub>1</sub> is a potentiometer that is shunted across a 45-volt battery, *C*, the plus side of which is connected to the minus side of a 90-volt battery, *B*. The plus side of *B* is connected to one side of the relay's coil, *R*, the other end of which is connected to the milliammeter. The small circles, *A* and *B*, at the relay indicate the terminals for the external circuit which the current in *R* will control through the movements of the armature. It is assumed that when a current flows through *R* the armature will be pulled to the right and close the circuit from *A* to *B*.

First assume that no light is falling on the photoelectric cell,  $P$ . The circuit through the cell then can be said to have maximum resistance, making the grid of  $T$  negative with respect to the filament, which bias has been established by the setting of  $R1$  and the value of the battery  $C$ . Thus, no current—or perhaps a minimum current—will flow through  $R$ . If light energy be allowed to impinge on the cathode of  $P$ , then a certain current will flow in accordance with the intensity of the light. This current will flow because of the positive potential impressed on the anode from  $B$ , through  $R$  and  $MA$ , with its return circuit through  $B$ , a portion of  $R1$  and the whole of  $R2$ . In this latter resistor there will occur a voltage drop, and this is an important point. This voltage, or  $IR$  drop, will cause the grid of  $T$  to become more positive with respect to the filament, and when this occurs it results in an increased flow of plate current. The increased flow of plate current will mean an increased flow through the relay's coil,  $R$ , and this will be sufficient to energize the relay so that the armature will move to the right and close the circuit through  $A$  and  $B$ . As long as this larger current flows the relay armature can be made to stay toward the right, but when the current is decreased, due to the lessening of the light intensity falling on the cell's cathode, then by means of a spring the armature is released, opening the circuit through  $A$  and  $B$ .

Such a circuit can also be made to function in the reverse manner, *i.e.*, when the light is increased on the cathode, the plate current of  $T$  can be made to decrease, thus opening the relay and the  $A$ - $B$  circuit.

### Practical Uses

If all the known uses to which the photoelectric cell is put were now to be listed, by the time this book was in the reader's

hands, that list would be incomplete. In the research laboratories of every large electrical company experiments are being conducted wherein new uses for cells are being discovered.

In general, the functions of a photoelectric cell can be divided into two groups: starting and stopping operations; and continuous operations.

Under the first classification would be placed counting operations. Here the objects to be counted intercept a beam of light falling on the cathode, and each time the beam is shut off the plate current of a vacuum tube may be made to decrease and so open a circuit through the medium of a relay, which would actuate a counting or tally device. Such objects might be wooden boxes on an endless belt, or barrels. On the other hand, if the objects being counted would reflect light to the cathode of the cell, the light source could be on the same side of the objects as the cell and when one of the objects passed through the beam of light, it would be reflected to the cell, causing a relay to function, as described above, and so actuating a counter. If the objects themselves emit light energy, as is the case of red-hot ingots in a foundry, then the light source could be eliminated.

Photoelectric cells have proven to be accurate when used in counting devices; more accurate, in fact, than a man, because they do not make mistakes. They have been successfully used in counting vehicles passing a given point, and in hundreds of different types of factories.

Under this same classification of uses might be placed that of initiating an operation, as opening a door, starting machinery, ringing an alarm, etc., by means of either the interception or impinging of a beam of light on a cell. For instance, one of the latest safeguards used by banks is to have a beam of light passing before the door of the safe. If the light be

interrupted, a change will occur in the cell's circuit and an alarm rung. It is also of interest to note that the light need not be visible to the human eye. It can be ultra-violet or infra-red light, which is only visible to the cathode of the photoelectric cell and photographic plates. Therefore, a burglar, even though he knew that such a safeguard were in place, would be unable to avoid it, as he would not know where the beam of light was.

Stopping an operation also comes under this head of uses. In paper mills where large rollers press the pulpy mass into thin sheets, a break in the paper means an expensive delay, especially if the rollers are allowed to run even for a very short time after the break has occurred. A photoelectric cell on one side of the paper and a light source on the other can be arranged to give immediate notice of a break by ringing an alarm, or, if desired, the power can be shut off and the rollers stopped.

### Continuous Operations

The differences between the two classifications of photoelectric-cell operations are very slight, as an increase or decrease in the anode current of the cell determines the action of a relay or some other delicate device. However, due to the fact that the cell is influenced by very slight changes in color or light intensity, they can be employed in ways that differ to a certain extent from those already described.

When certain liquids are being mixed, as dyes, inks, etc., the proper proportions are determined generally by the color of the mixture. While some human eyes are quite sensitive to small changes in color, yet the photoelectric cell can detect these same slight variations and without fatigue. Such uses of



a cell can be made in the grading of objects by their color, as selecting oranges, bananas, etc., or putting cigars into different groups; in short, almost any job that the human eye can do, the photoelectric cell and its attendant apparatus can do also.

# TELEVISION

---

## CHAPTER 19

**T**ELEVISION in America dates from April 30, 1939, when the first regular programs were instituted by the Radio Corporation of America in cooperation with its subsidiary, the National Broadcasting Company, the two organizations jointly operating a powerful video-sound transmitter located in the 1,200-foot tower of the Empire State Building in New York. Since that time, this station, WNBT, has been transmitting daily programs for the benefit of all television set owners within a radius of seventy-five miles. Although it was expected at the time that many other transmitters would follow, economic conditions aided by a controversy over standards have combined to slow up the general acceptance of radio's latest adjunct. However, the interest in television has been increasing and televised programs are now available in several principal cities.

As with any new development which depends on public support, the promoters of television devoted the first year of activities to an attempt to find out what viewers preferred in entertainment. Not all types of features were adaptable to television because of the limitations of iconoscopes (cameras) and receivers. In outdoor pickups such as sporting events, news happenings, and the like, the intensity of available light

proved to be the limiting factor. Thus football games, played as they are in the fall of the year when the sun is low, proved to be good television material for the first half of the games. After that, the lessened light and the long shadows interfered with the enjoyment of the reproduced images. On the other hand, studio productions, either those based on stage plays or variety shows, appealed to the audience in direct ratio to the skill with which they were produced. Films, too, when obtainable worked out to good effect but the reluctance of motion picture producers to release their latest long features for what they expect ultimately will become a rival for the patronage of the public, served to limit the televised film fare to importations from abroad or to industrial short subjects. Nevertheless, these films, because of their fine contrast and detail, have contributed many hours of amusement to the six thousand<sup>1</sup> users of televisors in America.

### Television Technic

Because of the intricate nature of the television system now in use plus the fact that numerous technical books are available in which all phases of the subject are treated in detail, no attempt will be made here to analyze television transmitters and receivers in their essentials. Moreover, it is probable that the cost of erecting a television transmitter will preclude any great amateur activity in this field, but numbers of amateurs are already exploring the possibilities of television reception on the bands allotted to them.

The television system of transmission and reception by means of rotating Nipkow disks was standard up to 1930, but at that time several laboratories had succeeded in developing a method of sending and receiving video signals by the cath-

<sup>1</sup> As of 1941.

ode ray tube. It is this electronic system that is now considered superior to all others and all receivers embody it.

When the first demand for television frequencies was made by interested firms, the F.C.C. set aside several series of adjacent channels to one of which each applicant was assigned. Those frequencies are as follows:

Channel #1—50 to 56 m.c.	#5—84 to 90 m.c.
#2—60 to 66 m.c.	#6—96 to 102 m.c.
#3—66 to 72 m.c.	#7—102 to 108 m.c.
#4—78 to 84 m.c.	

Additional channels have been allotted to television but they are much higher in frequency and will not be assigned for this purpose until more is known about their availability.

It will be noticed from the above table that each channel is 6 megacycles in width. The six million cycles embraced in each is therefore wide enough to accommodate a picture signal

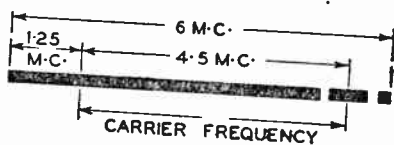

107. Arrangement of picture and sound signals in each television channel

4,500,000 cycles wide and still leave room for the audio or sound wave. By a general working agreement between the F.C.C. and the Radio Manufacturers Association, standards have been established which all experimental groups must follow. Thus the individual channels are utilized by every station in the manner shown in *Fig. 107*.

A study of this arrangement will reveal one unusual feature. For instance, the wave band assigned to the video signal is

unequal on the sides of its carrier. This is caused by the fact that only a portion of one side band is used while the entire width of the other falls within the channel. This is called vestigial side band transmission. By adopting it, a great deal of spectrum space is saved. It also has other advantages in transmission and reception.

### The Cathode Ray Tube

The heart of every television receiving set is the cathode ray tube. This tube, which is familiar to many amateurs through its use in oscilloscopes, consists essentially of a long, conically shaped glass envelope with a screen of fluorescent material on the inner surface of the large end, a generator of electrons at the other end and some means of focusing and deflecting the electron ray located either within the neck of the tube or outside it. The screen and cathode gun are similar in most types, but the method of deflecting the beam in order to create an image may differ greatly.

In amateur use, where the *C.R.* tube is likely to be one of the smaller types, deflection is accomplished by means of plates placed inside the tube. Such a tube is called an Electrostatic Type in contrast to the Electromagnetic Type, which depends for deflection on coils wrapped around the tube neck.

*Fig. 108* shows the essential parts of an Electrostatic tube. The electrons thrown off by the heated cathode are drawn toward a positively charged electrode which contains a pin-hole through which a very small beam of the fast moving electrons can pass on their way to the screen. A short distance farther on, the electron beam encounters another electrode which further shapes the beam to a small diameter and gives it added impetus toward its destination. Emerging from this

electrode, the beam passes between two sets of plates—one set placed horizontally and the other vertically. These are the deflecting plates. After passing these plates the beam encounters the heavily charged second anode which gives it a terrific velocity so that when the electrons strike the fluores-

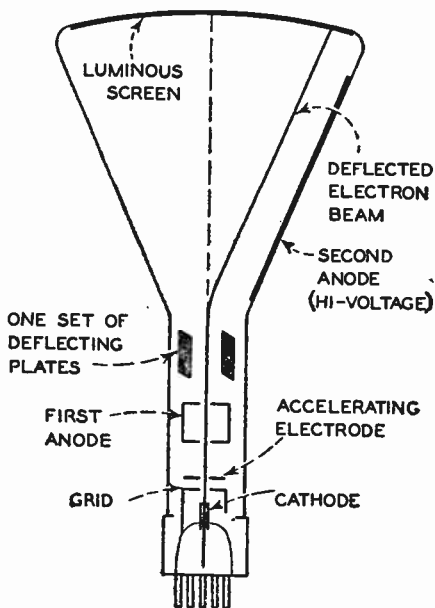

108. Details of television type cathode ray tube

cent screen, their impact creates a luminous spot, thus providing visual evidence of their presence.

Let us return now to the deflecting plates. We know that any body charged, for example, with a positive charge, will be attracted by the negative pole of a magnet and deflected or repelled by the positive pole. The deflecting plates of a cathode ray tube work in the same way. The electron beam, being negative, will be turned one way or another if it encounters a

positive or negative field. This is shown with one set of plates in *Fig. 108*.

Two sets of plates are required in order to scan a television image. One set moves the beam sidewise from left to right while the other exerts its varying force to shift the beam up and down. By a combination of the two forces, the electron beam can be made to create any desired pattern on the screen.

So much for the movement of the beam. It now becomes necessary in television to vary the brightness of the spots on the screen in order to have a half-tone picture. This is done by placing a control grid very close to the hot cathode of the *C.R.* tube. The grid position is shown in *Fig. 108*. This grid is controlled by the signal transmitted from the sending station, and when properly adjusted will alter the number of electrons, leaving the cathode from maximum (bright screen spot) to minimum (black).

The voltages required to operate the various electrodes of a cathode ray tube are dependent on the screen size and extend from a maximum of 7,500 volts in the case of the 12" diameter tube to 500 volts or less for the 3" tube. This high voltage is applied to the second anode only and determines the brilliance of the picture. The voltages on the other electrodes are increased gradually, beginning with the accelerating electrode which is closest to the cathode.

Each set of deflecting plates is connected to a pushpull amplifier which in turn is fed by voltage impulses originating in an oscillator tube adjusted to function at a definite frequency. Thus the horizontal oscillator works at a frequency of 15,750 cycles per second, while the oscillator intended to energize the vertical plates of the *C.R.* tube works at only 60 cycles per second. The reason for these particular frequencies will be discussed under the section on Scanning.

## The Scanning Process

Television transmission consists in breaking up an image into minute units, and reforming these units in the same order at the receiver. The process is called Scanning. There are several methods in use but only the American system will be mentioned here.

Just as in a newspaper illustration the finer the dots the clearer the picture, so in television the better image will be

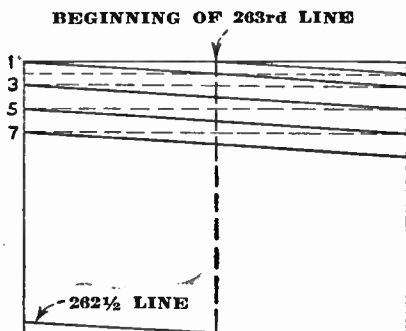

109. Interlaced scanning system used in America

produced when the maximum number of individual pin points of light are present on the luminous screen of the cathode ray tube. But there is an electrical limit to the fineness of detail which can be transmitted since roughly each dot represents a cycle in the allotted band. Realizing this, many tests were carried out by the firms interested in television and it was finally agreed that a satisfactory picture could be transmitted using 525 lines. On this basis a square image would be the equivalent of a picture with close to 275,000 individual gradations of light. However, this is not believed to be the ultimate fineness of television images, a prophecy which is bolstered by



the activities of several research groups who are working on a 625-line picture in the belief that television images of outdoor sports will not be acceptable until they have become as fine in detail as the best of newspaper illustrations.

In scanning an object at the transmitter, use is made of a camera device called an iconoscope or orthicon, which, like the cathode ray tube, makes use of an electron gun. First the image is focused on a sensitized plate within the tube after

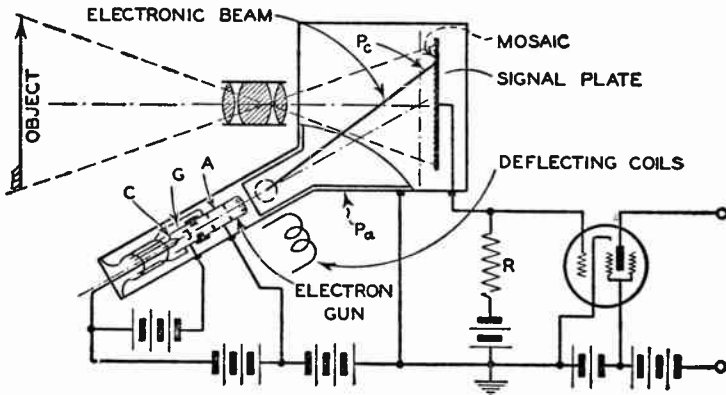

110. Simplified circuit of an Iconoscope tube and signal amplifier

which a fine beam of electrons is played back and forth across the plate. The reflected light from the object striking the sensitized plate generates small charges which, when struck by the electron beam, are released into an amplifying circuit and eventually, when sufficiently strengthened, are used to modulate the transmitter. *Fig. 110* shows a typical iconoscope arrangement.

The American system of television does not build up its image by transmitting the 525 lines in consecutive order because of the bad flicker effect that would then be produced. Instead, the camera scans one line, skips the second and scans

the third and so on until  $262\frac{1}{2}$  lines have been scanned after which the beam returns to Line #2 and proceeds to complete the image at the 525th line. In reality, this system transmits sixty half pictures or *fields* per second or thirty complete *frames* per second.

At the receiving end, the procedure is reversed with the beam of electrons painting narrow strips of the picture in alternate sequence from top to bottom of the screen and then returning to the second line to fill in the open spaces.

In a preceding paragraph it was stated that one of the deflection oscillators of the receiver was adjusted to generate a frequency of 15,750 cycles per second. This figure is arrived at by multiplying the number of lines per frame by the number of frames per second. Thus 525 times 30 gives 15,750. The other oscillator functions at a frequency of 60 cycles per second because of the half frames which are transmitted during that time.

### Television Receiver Circuits

Either the tuned radio frequency or superheterodyne circuit is adaptable to television but the tendency is to select the "superhet" for the following reason. Because of the standard arrangement of video and sound channels, *Fig. 111*, receiver operation can be simplified by so arranging tuning controls that both picture and image are brought in with one motion. By admitting the full 6 megacycle band width to the receiver and heterodyning video and sound signals simultaneously with a single local oscillator, it is possible to produce two new frequencies (intermediate frequencies) which can then be separated and carried to loud speaker (for the sound) and cathode ray tube (for the image). If, on the other hand, a tuned radio frequency circuit is selected, two separate re-

ceivers must be assembled for sound and image and both tuned independently. Moreover, the large number of r-f stages that are necessary for the video would complicate the assembly.

The normal circuit for a television receiver with a five-inch C.R. tube embodies eighteen tubes, thirteen of which are for the

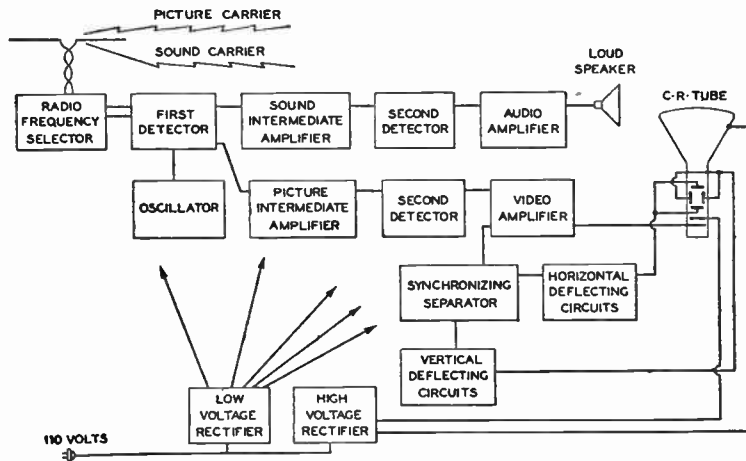

III. Block diagram of a television receiver of the superheterodyne type

picture and five for the sound. Included in this array are two power supplies. One provides the high voltage of about 2,000 for the second anode of the C.R. tube and the other delivers all remaining plate and screen potentials for the vacuum tubes in video and audio circuits.

### Television Antennas

Because of the necessity for a powerful signal free from noise with which to actuate a television set, a tuned half-wave dipole has come into general use. In its simplest form this consists of a metal rod about ten feet long, split in the center

and connected from its inner ends by means of a high efficiency lead-in to the input of the televisior. Where noise is rampant, such as in heavily populated areas or where the signal is weak as would be the case at all listening posts more

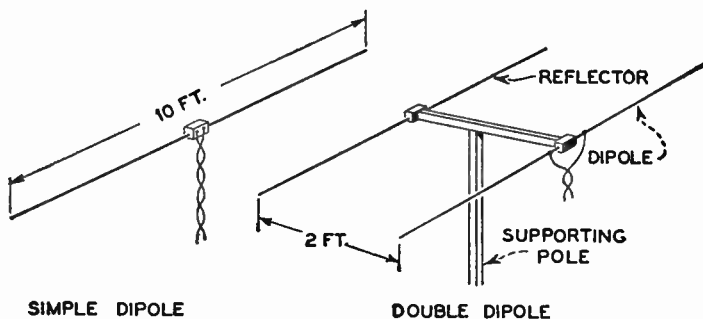

112. Two popular forms of television antennas

than forty miles from the transmitter, a more elaborate double dipole is recommended. Both types of collectors are shown in *Fig. 112*. The dipole must be erected with the rods at right angles to the line of sight from the antenna location to the transmitter and it should be elevated as high as possible above all buildings, trees, and other structures.

# FREQUENCY MODULATION

---

## CHAPTER 20

**ALTHOUGH** frequency modulation does not represent an entirely new form of radio transmission it was not ready for general usage until 1939 when Major Edwin H. Armstrong, already accredited with the regenerative and superheterodyne circuits, succeeded in convincing a sizable proportion of the industry of its advantages over the established system of amplitude modulation. And since it is likely that the amateur will discover in FM a solution to many of his problems, the experimenter should understand its fundamentals both as regards transmission and reception.

*Fig. 113* shows the comparative action of AM and FM when applied to a simple sine wave transmitted by both systems. Under our present method, the sine wave signal (a) is caused to modulate a continuous carrier (b) with the result shown at (c). But when the transmitting system is based on FM, the wave sent out from the sending station has the characteristic shown at (d). It will be noticed from these curves that while the modulated AM wave changes its height or amplitude to correspond with the sine wave, the FM system varies the number of alternations according to the extent of the sine wave while maintaining a uniform amplitude at all times.

There are obvious transmitting advantages in FM, such as a lower first cost of equipment, but the principal gain is found in reception. Outstanding is the freedom from atmospheric and man-made static enjoyed by the owner of an FM receiver. Briefly, this highly valuable feature is made possible because

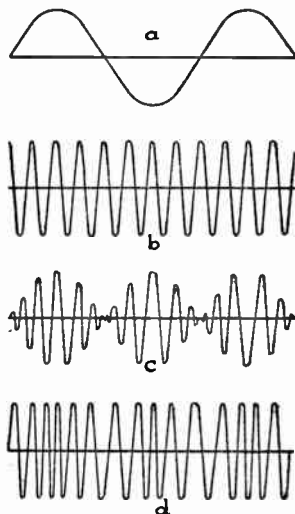

113. Comparative action of amplitude modulation (am) and frequency modulation (fm)

the majority of static is *amplitude modulated*; hence it has little or no effect when encountering the circuits of an FM receiver. Frequency modulated receivers may be operated throughout a local thunderstorm with scarcely a trace of noise, whereas an amplitude modulated signal would be overridden by the bursts of static.

Another feature which FM insures is the detection and amplification of high quality programs, an important point for the broadcast listener if not for the amateur. The wide

frequency swing of FM signals—sometimes as much as 75 kilocycles either side of the median frequency—permits reproduction of all tones and overtones up to and even beyond the normal hearing limit of the human ear. Contrasted with the 5,000 cycles permitted standard broadcasts, the improvement is obvious.

The secret of an FM receiver lies in two circuits, the Limiter and the Discriminator, the latter being in effect the second detector of a superheterodyne, following immediately after the Limiter circuit. The forepart of the receiver is the familiar superheterodyne designed in oscillator and intermediate frequency stages to work on the ultra short-wave length of approximately 7 meters. Because of the small gain per stage even with the latest types of tubes such as the 1852 complicated by the necessity for loading each i-f stage to pass a broad frequency band, a number of stages must be included in order to provide the necessary signal strength at the second detector.

One of the simplest FM receiver circuits is shown in *Fig. 114*. The amateur will discover that the majority of the components outside of the i-f transformers are standard and will be found in his box of spare parts. The procedure to follow in altering existing i-f transformers to pass the wide frequency band is described in the following text. If desired the FM portion of the circuit may be assembled as a unit with the output lead of the detector arranged to feed into any existing audio amplifier. In this case, it might be desirable to include a separate power supply for the FM tuner rather than depend on the amplifier power supply for the various voltages for filaments plates and screens, but such a move is not essential to the satisfactory functioning of the FM receiver.

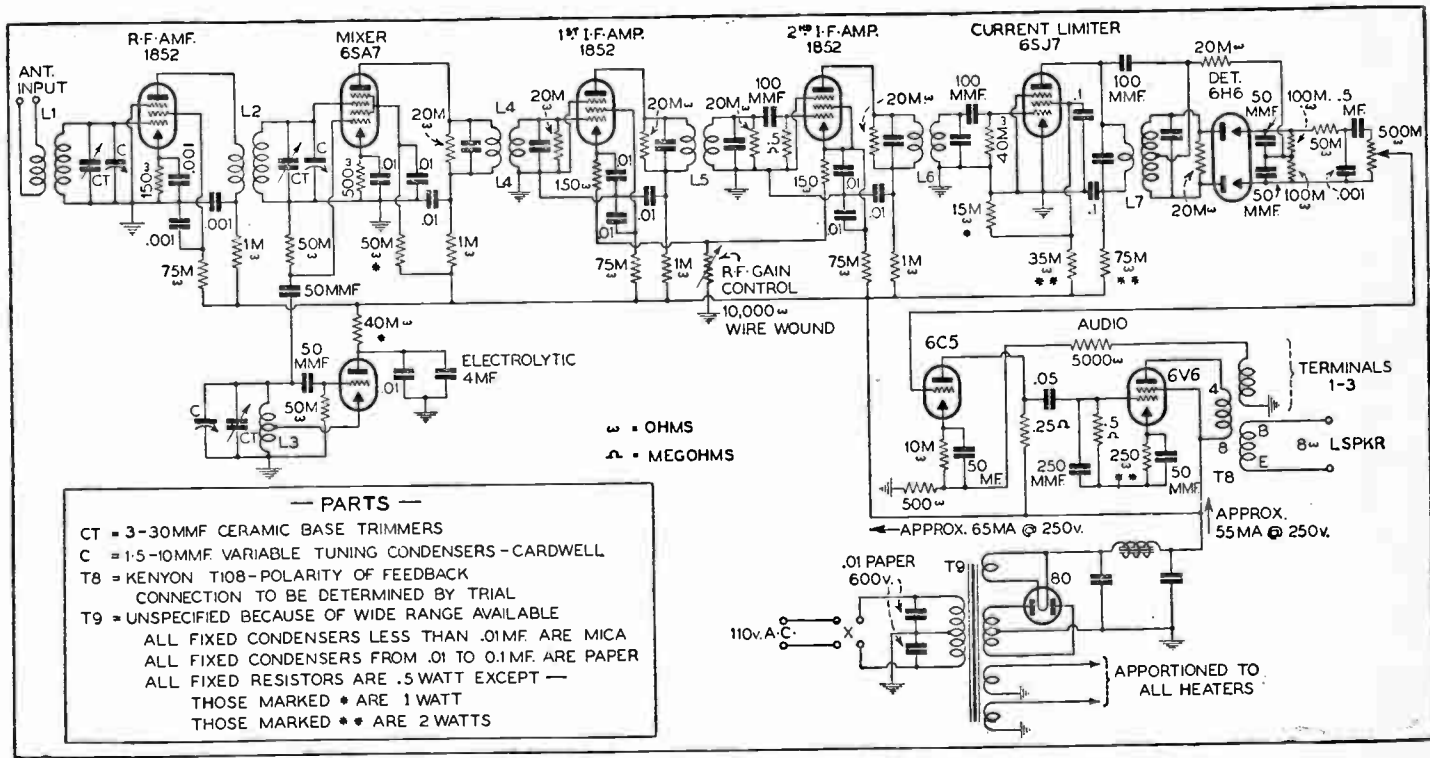

114. Complete frequency modulated receiver

From RadioHistory



### The Limiter Stage

Before beginning the actual assembly of an FM set, the builder should understand the function and arrangement of the limiter stage which in brief is an amplifier that is practically insensitive to amplitude variations while being very sensitive to variations in carrier frequency.

Such an amplifier may be formed by any pentode tube with a sharp cut-off characteristic if the plate and screen voltages are held low. Under such conditions, the tube saturates rapidly with increasing grid voltage and therefore causes little or no variation in the plate current. The stage thus becomes a current limiter and no matter how powerful the incoming signal-plus-noise voltage may be, the plate current will reach a predetermined level and remain there. From the foregoing, it can be seen that if the limiter or gate is made to operate too quickly the plate current will be too small to supply the needed signal to the detector or discriminator while if the gate is opened too wide, a higher percentage of noise will accompany the desired signal. A satisfactory compromise has been reached in the receiver about to be described.

### An FM Receiver

This receiver consists of 10 tubes of which two are a standard high quality audio-amplifier. For greater signal strength the antenna feeds into a stage of radio frequency and then passes to the mixer tube (6SA7), where it encounters the locally generated oscillations from the 6J5. The intermediate frequency selected is 1700 k.c. although there is some argument for a higher frequency of 2100 or even 3000 k.c. After the two i-f stages comes the current limiter and then the detector which in this case is the 6H6, a double diode. After the

signal passes the 6H6 it has lost its FM characteristics and in its place is an audio signal with a shape that corresponds precisely with the originally transmitted train of FM impulses. Hence, the signal removed from the cathodes of the 6H6 may be led to any suitable audio amplifier and treated exactly like the output of any detector. If an existing radio receiver possesses good tonal qualities, this output may be fed into the first audio stage, thereby making it unnecessary to build another audio amplifier unit.

### Coil Construction

Since FM for some time will be used within a narrow band of frequencies, it is not necessary to arrange for covering several bands as in all-wave sets or amateur receivers. Amateurs are likely to operate near 112 megacycles, while the broadcast listener will find his program fare between 42 and 50 megacycles. The coil data given here are for the latter band.

For the coil forms, secure three pieces of  $\frac{5}{8}$ -inch low-loss tubing such as polystyrene or steatite. The secondaries of *L1* and *L2* consist of  $4\frac{1}{2}$  turns of #18 bare wire spaced to occupy  $\frac{1}{2}$  inch. *L3* also has  $4\frac{1}{2}$  turns with a tap  $1\frac{1}{2}$  turns from the ground end. The primaries of *L1* and *L2* consist of 2 turns of #26 double cotton-covered wire wound with the turns close together at the ground end of each secondary. To prevent interaction each coil should be enclosed in a can shield at least three times the diameter of the inductance forms.

The i-f transformers *L4*, *L5*, and *L6* are identical and while they may be purchased in kit form they may be made easily from existing transformers by the simple expedient of altering the coupling between primary and secondary. First it is necessary to obtain three i-f transformers with a designed fre-

quency of 1700 k.c. Then insert a warm, not hot, soldering iron into the coil forms until the wax holding the two coils is softened sufficiently to permit it to be chipped off. With the coils thus freed, they may be pushed closer together with a distance of only half an inch or less from the center of one

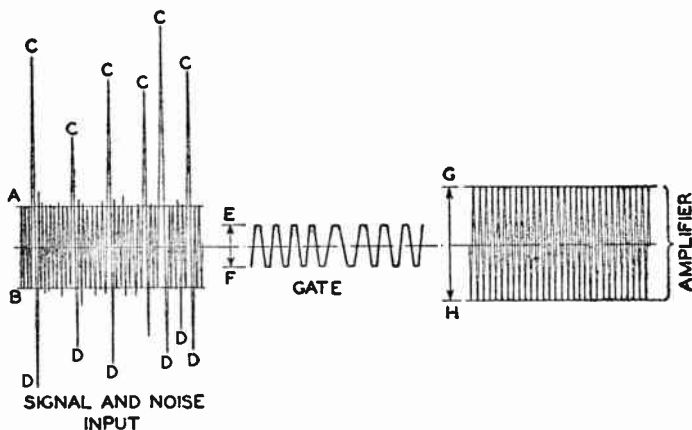

115. How the limiter circuit of an fm receiver operates to exclude noise

coil to the center of the other. A little wax melted and dropped back on the coils will hold them in this position.

For the discriminator coil, the builder must secure a 1700 k.c. i-f transformer with a center-tapped secondary and proceed in the same manner to tighten the coupling.

In wiring the receiver, the amateur should keep in mind the absolute necessity for shortening each and every lead to the utmost. Here as in any circuit dealing with ultra-high frequencies, a fraction of an inch of lead may make the difference between a perfectly working set and one that is so temperamental due to regeneration that all the fun of using it is lost.

It is not necessary to give the step-by-step procedure in wiring the parts for this set, since it is assumed that its assembly will not be attempted by an amateur until he has acquired considerable experience in receiver construction. A general understanding of radio principles, an insistence on neat work with careful soldering and wiping of joints and a fair amount of patience are the ingredients that make for a workmanlike product.

### Aligning the FM Receiver

Because of the need for a good signal generator and a high resistance voltmeter, the alignment should be turned over to a qualified service man. He will set his generator to 1700 k.c. and feed the impulse to the first 6SA7 so that the three intermediate transformers are properly peaked. He will then adjust the primary of *L7* while he swings his signal generator 75 k.c. to either side of the mid frequency.

Although the oscillator may be ganged with the r-f stage, the experimenter will find that a separate control at this point will tend toward sharper tuning besides simplifying the adjustments which will be necessary before the two circuits can be made to track perfectly over the entire FM band.

### Coils for Amateur Band

If the experimental amateur band of 112 m.c. rather than the broadcast FM band is the objective, the r-f and oscillator coils may be wound for the proper frequency range by altering the diameter of the low loss forms from  $\frac{5}{8}$  inches to  $\frac{3}{8}$  inches and keeping the number of turns the same for primary and secondary. However, for this purpose there will be some considerable gain in amplification as well as a better image

ratio if the intermediate frequency is selected as 3 megacycles or more. It is probable that any current amateur publication will reveal the names of manufacturers equipped to supply such i-f transformers.

# RADIO FACSIMILE

---

## CHAPTER 21

**FACSIMILE** is a relatively new term to many radio amateurs and experimenters but it is now destined to appear more frequently in the periodicals devoted to radio transmission and reception. The word itself means an exact copy of an original object; when applied to radio it means the transmission from one point and the reproduction at a distant point of the still image of a scene, individual or a sheet of printed words. Facsimile has been used for many years by commercial firms for the transmission of weather maps to ships at sea and photographs from one country to another. Over wire lines it has found increasing use in the sending of telegrams as written in the handwriting of the sender. Because of the fact that a successful transmission places a permanent copy of the original object in the possession of the receiver, radio facsimile has been called the "newspaper of tomorrow" and many tests have been carried out in recent years to examine its possibilities in this field.

### Transmitting the Image

In sending a picture by radio facsimile the procedure is closely akin to that of television. The photographic print is wrapped around a revolving cylinder while a pin point of

light is focused on the print's surface and moved across it. A sensitive photoelectric cell catches the reflected light, converts it into electric energy, and passes the impulses to an amplifier which in turn modulates a carrier wave of considerable power. In other words, the picture is broken down into a great number of elemental areas and the average light value of each area transmitted in the form of an electrical impulse to the receiving equipment. By taking each area in a predetermined order and arranging to have the receiver repro-

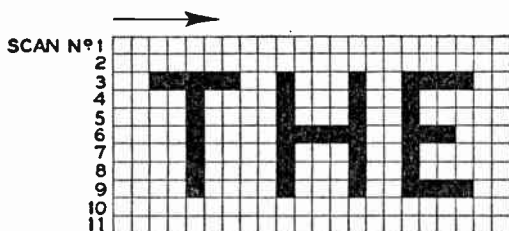

116. How an area to be scanned is broken up into many elemental units

duce each area in the same order the result is a duplicate of the original, providing that the sender and receiver are in step or in synchronism, as it is called, and also providing that spurious impulses such as static do not register on the receiving apparatus.

*Fig. 116* shows how a portion of a word would be scanned at the transmitting end with each of the small squares representing one of the elemental areas. Here because of the black and white characteristics of the object the light reflected onto the photoelectric cell would be either maximum or zero, a condition met with in transmitting newspaper pages. But it is not difficult to see that this condition is changed when a photograph or other half-tone object is transmitted. In such a case, the reflected light would vary by minute degrees as it

encountered all gradations of tone from solid black to perfect whiteness. This, obviously, creates the most difficult problem of radio facsimile transmission and reception.

As in newspaper and magazine printing where the fineness of an illustration depends to a great extent on the half-tone screen, so does the facsimile result depend on the number of elemental areas per square inch into which the picture is divided by the scanning spot. Tests have shown that 150 dots per linear inch or 22,500 per square inch give excellent reproductions, but when this detail is reduced to less than 100 a linear inch (10,000 a square inch) the legibility of the facsimile suffers acutely.

### Facsimile Programs

Because of the future possibilities of radio facsimile in sending printed intelligence from one point to another, the Federal Communications Commission has set aside several bands in different parts of the ether spectrum for experiments. In addition, permission has been granted to existing broadcasting stations to utilize their facilities from midnight to morning for the transmission of experimental programs. As a result, facsimile signals are available over most of the country for those amateurs who wish to assemble the necessary apparatus for receiving the material. A list of stations in the broadcast band that conduct such tests and whose signals can be picked up on any standard receiver located within their normal service area, is given below:

<i>Station</i>	<i>Place</i>	<i>K.C.</i>
WLW,	Cincinnati, O. ....	700
WOR,	New York, N. Y. ....	710
WGN,	Chicago, Ill. ....	700
WHO,	Des Moines, Ia. ....	1000
WSM,	Nashville, Tenn. ....	650



KSTP, St. Paul, Minn. ....	1460
WWJ, Detroit, Mich. ....	920
WSAI, Cincinnati, O. ....	1330
WCLE, Cleveland, O. ....	610
WHK, Cleveland, O. ....	1390
WGH, Newport News, Va. ....	1310

Because of the growing interest in this field, the number of stations is constantly increasing. The amateur who intends to investigate facsimile should obtain the working schedules of all stations near him by writing to the station directors. Reception reports are eagerly sought and full cooperation a simple matter to obtain.

### Types of Transmissions

Since the facsimile art is young there are no definite standards but activities have narrowed down to the Finch and RCA systems. The former is a development of William G. H. Finch of New York while the latter is the result of research by a group of RCA technicians headed by Charles J. Young.

The RCA system can transmit copy up to a width of approximately eight inches. The tones of the elemental areas selected at the transmitter are recreated at the receiving unit by a stylus which forces a strip of carbon paper against a strip of white paper, the force of the stylus varying according to the desired shade of each small area. This system, while in wide use, is not available to the amateur because of the cost of equipment, but it has been employed by several newspaper-owned radio stations to transmit condensed editions of their regular issues.

### The Finch System

In this facsimile system, use is made of the effect of heat on special sensitized rolls of paper. The received impulses are

led to a fine wire stylus which sweeps back and forth on the white surface of the paper. The paper itself is impregnated with a carbon compound so that the passage of current impulses from the stylus burns away the white surface and reveals the black backing. The extent of the burning effect varies proportionately with the current, hence the depth of the dark areas can be made to conform with the tones of the original. The Finch system has been adapted to both eight- and four-inch copy, but for amateur use the latter has been selected as the more suitable of the two.

### Assembling the Reado Kit

In the belief that facsimile held considerable interest for the amateur experimenter, Powel Crosley, Jr., one of America's leading radio manufacturers, secured a license from the Finch Telecommunications Laboratories for the design and sale of a facsimile kit, sufficiently simplified for home use and yet retaining the ability to make good reproductions of transmitted programs. Thousands of the kits are now in regular use, giving their owners a working acquaintance with this new branch of radio. The kits include all essential parts and can be built into a complete unit in a few hours with the aid of simple tools found in every workshop.

In assembling the Reado, the bracket which supports the roll of paper is first anchored in position on the steel base plate followed by the cam and gear box and then the driving motor. When a sub chassis holding the input transformer and rectifier tube is bolted in place, the facsimile mechanism is complete except for a few wires that must be soldered and some minor adjustments. Step-by-step instructions expressed in simple terms accompany each kit of parts for the benefit of those whose mechanical experience is limited.

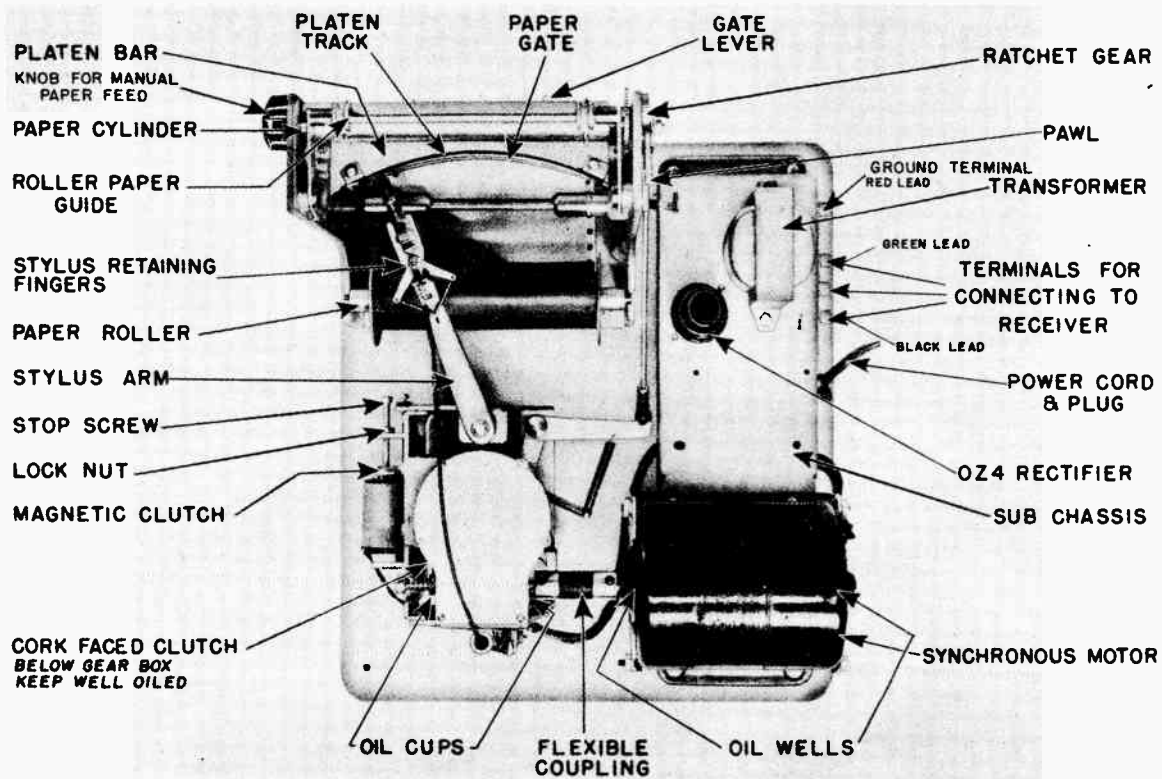

117. The completed facsimile recorder as viewed from above

When the last adjustment has been made to cams and ratchets, the roll of special paper is placed on the lower drum of the paper bracket and threaded carefully through the gate and over the toothed guide rolls at the top. The unit is then ready for attaching to the radio receiver.

### Receiving the Facsimile Signal

Although the Reado will function after a fashion with almost any type of receiver, best results are obtained with a set

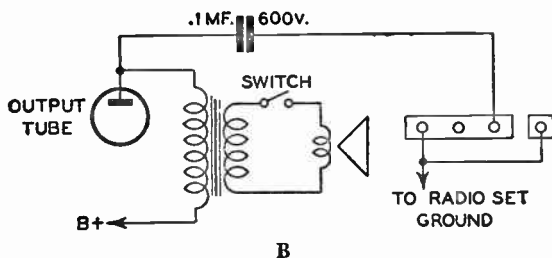
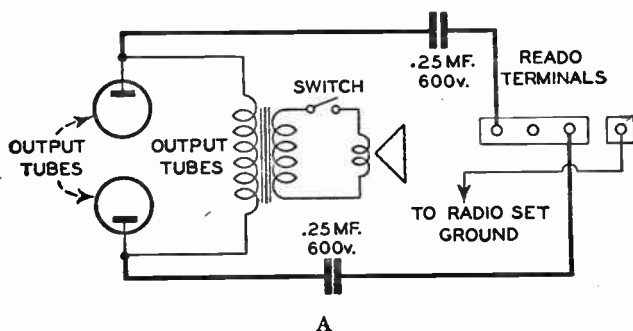

118. Methods of drawing facsimile signals from output circuits of standard broadcast receivers

having a good automatic volume control (AVC) and an output of at least five watts. If the unit is to be used within a score of miles of a powerful station the AVC becomes of less

importance, but a good black-and-white image is obtained only when a powerful signal is fed into the Reado.

There are several methods of removing the facsimile signals from a receiver, depending on the type of output incorporated in the latter. One method which is to be followed in the case of pushpull output is shown in *Fig. 118A*. If a single output tube feeds the loud speaker, *Fig. 118B* shows the connections.

Since the transmissions on standard broadcast stations take place after midnight, it will be desirable to insert a switch in the voice coil of the loud speaker so that the operation will be quiet. A further refinement is to secure an inexpensive time clock to turn both set and Reado on and off at the proper time. If this is done, all arrangements can be made for the normal operation of the facsimile system before the owner retires for the night, leaving the actual work to be done automatically by the clock and the radio receiver. In the morning the entire production of news, pictures, and allied material will be found on the strip of paper which has passed through the machine during the preceding hours.

The Reado functions with very little noise, but the slight hum of the motor and the movement of the cams and ratchets may prove annoying to light sleepers. In this case the entire unit may be enclosed in a ventilated box lined on the inside with celotex or other sound-absorbing material.

### Synchronizing the Signal

So far nothing has been said about the means used to keep the Reado in step or in synchronism with the transmitter. In early days, experimenters depended on the use of synchronous motors deriving their speed regulation from the same power line feeding the transmitter, but this limited the use of receivers to the immediate vicinity of the sending stations. To

remove this limitation, Finch arranged his transmitting scanner so that a special pulse was sent out at the beginning of each scanned line. The Reado works on this idea. As the receiver scanner carrying the printing stylus reaches the extreme left side of the paper strip, it is locked in that position until the arrival of the synchronizing pulse. This pulse is rectified by the type OZ4 gaseous rectifier tube and the direct current impulse passes through a magnet which releases the clutch and allows the scanner arm to resume its movement. This assures that the receiver is in perfect step with the transmitter at the beginning of each line. If this condition were not maintained, the images would be distorted and the type matter hard to read.

The motor also drives a ratchet rod which moves the paper ahead one one-hundredth of an inch during the return trace of the stylus. This produces a facsimile roughly equivalent to a picture detail of 100 lines per linear inch or 10,000 dots per square inch. At the normal speed of travel, the Reado will turn out copy at the rate of one inch a minute or five feet of paper strip each hour. Since the paper width is equivalent to two newspaper columns, five hours of operation will deliver about thirty newspaper columns, a good night's accomplishment for an apparatus that can be assembled by anyone in a few hours of pleasant work.

# APPENDIX





## USEFUL INFORMATION

### Abbreviations of Units

<i>Unit</i>	<i>Abbreviation</i>	<i>Unit</i>	<i>Abbreviation</i>
ampere .....	amp.	kilometers .....	km.
ampere-hours .....	amp.-hr.	kilowatts .....	kw.
centimeter .....	cm.	kilowatt-hours .....	kw.-hr.
centimeter-gram-second .	c.g.s.	kilovolt-amperes .....	kv.-a.
cubic centimeters .....	cm. <sup>3</sup>	meters .....	m.
cubic inches .....	cu. in.	microfarads .....	$\mu f$ .
cycles per second .....	~	micro-microfarads .....	$\mu\mu f$ .
degrees Centigrade .....	°C.	millihenries .....	mh.
degrees Fahrenheit .....	°F.	millimeters .....	mm.
feet .....	ft.	pounds .....	lb.
foot-pounds .....	ft.-lb.	seconds .....	sec.
grams .....	g.	square centimeters .....	cm. <sup>2</sup>
henries .....	h.	square inches .....	sq. in.
inches .....	in.	volts .....	v.
kilograms .....	kg.	watts .....	w.

### Prefixes Used with Metric System Units

<i>Prefix</i>	<i>Abbreviation</i>	<i>Meaning</i>
micro	$\mu$	1 millionth
milli	m.	1 thousandth
centi	c.	1 hundredth
deci	d.	1 tenth
deka	dk.	10
hekto	h.	1 hundred
kilo	k.	1 thousand
mega	m.	1 million

## Symbols Used for Various Quantities

Quantity	Sym- bol	Quantity	Sym- bol
capacity .....	<i>C</i>	magnetic field intensity .	<i>A</i>
conductance .....	<i>g</i>	magnetic flux .....	$\varphi$
coupling co-efficient .....	<i>k</i>	magnetic induction .....	<i>B</i>
current, instantaneous value .....	<i>i</i>	period of a complete os- cillation .....	<i>T</i>
current, effective value ...	<i>I</i>	potential difference .....	<i>V</i>
decrement .....	$\delta$	quantity of electricity ..	<i>Q</i>
dielectric constant .....	$\alpha$	ratio of the circumference of a circle to its diam- eter = 3.1416 .....	$\pi$
electric field intensity ....	<i>e</i>	reactance .....	<i>X</i>
electromotive force, instan- taneous value .....	<i>E</i>	resistance .....	<i>R</i>
electromotive force, effec- tive value .....	<i>F</i>	time .....	<i>t</i>
energy .....	<i>W</i>	velocity .....	<i>v</i>
force .....	<i>F</i>	velocity of light .....	<i>c</i>
frequency .....	<i>f</i>	wavelength .....	$\lambda$
frequency $\times 2\pi$ .....	$\omega$	wavelength in meters ..	$\lambda_m$
impedance .....	<i>Z</i>	work .....	<i>W</i>
inductance, self .....	<i>L</i>	permeability .....	$\mu$
inductance, mutual .....	<i>M</i>	square root .....	$\sqrt{\quad}$

## Table of Enameled Wire

No. of Wire, B. & S. Gauge	Turns per Linear Inch	Turns per Square Inch	Ohms per Cubic Inch of Winding	No. of Wire, B. & S. Gauge	Turns per Linear Inch	Turns per Square Inch	Ohms per Cubic Inch of Winding
20	30	885	.748	32	116	13,430	183.00
22	37	1,400	1.88	34	145	21,000	456.00
24	46	2,160	4.61	36	178	31,820	1,098.00
26	58	3,460	11.80	38	232	54,080	2,968.00
28	73	5,400	29.20	40	294	86,500	7,547.00
30	91	8,260	70.90				

## Table of Frequency and Wavelengths

$\lambda$ —Wavelengths in Meters. F.—Number of Kilocycles per Second. O. or  $\sqrt{L.C.}$  is called Oscillation Constant. C.—Capacity in Microfarads. L.—Inductance in Centimeters. 1,000 Centimeters = 1 Microhenry.

$$F = \frac{V}{\lambda}$$

where V is the speed of electromagnetic waves, 300,000,000 meters per second.

$\lambda$	F.	O. or $\sqrt{L.C.}$	L.C.	$\lambda$	F.	O. or $\sqrt{L.C.}$	L.C.
1	300,000	.0173	.0003	1,300	230	21.81	475.70
2	150,000	.0331	.0011	1,400	214	23.49	551.80
3	100,000	.0424	.0018	1,500	200	25.17	633.50
4	75,000	.0671	.0045	1,600	187	26.84	720.40
5	60,000	.0755	.0057	1,700	176	28.52	813.40
6	50,000	.101	.0101	1,800	166	30.20	912.00
7	42,900	.1174	.0138	1,900	157	31.88	1,016.40
8	37,500	.134	.0180	2,000	150	33.55	1,125.60
9	33,330	.151	.0228	2,100	142	35.23	1,241.20
10	30,000	.168	.0282	2,200	136	36.91	1,362.40
20	15,000	.336	.1129	2,300	130	38.59	1,489.30
30	10,000	.504	.2530	2,400	125	40.27	1,621.80
40	7,500	.671	.450	2,500	120	41.95	1,759.70
50	6,000	.839	.7039	2,600	115	43.62	1,902.60
100	3,000	1.68	2.82	2,700	111	45.30	2,052.00
150	2,000	2.52	6.35	2,800	107	46.89	2,207.00
200	1,500	3.36	11.29	2,900	103	48.66	2,366.30
250	1,200	4.19	17.55	3,000	100	50.33	2,533.20
300	1,000	5.05	25.30	4,000	75	67.11	4,504.00
350	857	5.87	34.46	5,000	60	83.89	7,038.00
400	750	6.71	45.03	6,000	50	100.7	10,130.00
450	666	7.55	57.00	7,000	41	117.3	13,630.00
500	600	8.39	70.39	8,000	37	134.1	18,000.00
550	545	9.23	85.19	9,000	33	151.0	22,820.00
600	500	10.07	101.41	10,000	30	167.9	28,150.00
700	428	11.74	137.83	11,000	27	184.8	34,150.00
800	375	13.42	180.10	12,000	25	201.5	40,600.00
900	333	15.10	228.01	13,000	23	218.3	47,600.00
1,000	300	16.78	281.57	14,000	21	235.0	55,200.00
1,100	272	18.45	340.40	15,000	20	252.0	63,500.00
1,200	250	20.13	405.20	16,000	18	269.0	72,300.00

## Table of Sparking Distances

In Air for Various Voltages Between Needle Points

Volts	Distance		Volts	Distance	
	Inches	Centimeter		Inches	Centimeter
5,000	.225	.57	60,000	4.65	11.8
10,000	.470	1.19	70,000	5.85	14.9
15,000	.725	1.84	80,000	7.10	18.0
20,000	1.000	2.54	90,000	8.35	21.2
25,000	1.300	3.30	100,000	9.60	24.4
30,000	1.625	4.10	110,000	10.75	27.3
35,000	2,000	5.10	120,000	11.85	30.1
40,000	2.450	6.20	130,000	12.95	32.9
45,000	2.95	7.50	140,000	13.95	35.4
50,000	3.55	9.00	150,000	15.00	38.1

## Feet Per Pound of Insulated Magnet Wire

No. of B. & S. Gauge	Single Cotton, 4-Mils	Double Cotton, 8-Mils	Single Silk, 1¾-Mils	Double Silk, 4-Mils	Enamel
20	311	298	319	312	320
21	389	370	403	389	404
22	488	461	503	493	509
23	612	584	636	631	642
24	762	745	800	779	810
25	957	903	1,005	966	1,019
26	1,192	1,118	1,265	1,202	1,286
27	1,488	1,422	1,590	1,543	1,620
28	1,852	1,759	1,972	1,917	2,042
29	2,375	2,207	2,500	2,485	2,570
30	2,860	2,534	3,145	2,909	3,240
31	3,500	2,768	3,943	3,683	4,082
32	4,375	3,737	4,950	4,654	5,132
33	5,390	4,697	6,180	5,689	6,445
34	6,500	6,168	7,740	7,111	8,093
35	8,050	6,737	9,600	8,534	10,197
36	9,820	7,877	12,000	10,039	12,813
37	11,860	9,309	15,000	11,666	16,110
38	14,300	10,636	18,660	14,222	20,274
39	17,130	11,907	23,150	16,516	25,519
40	21,590	14,222	28,700	21,333	32,107

## International Morse, Code and Conventional Signals

TO BE USED FOR ALL GENERAL PUBLIC SERVICE RADIO COMMUNICATION

1. A dash is equal to three dots.
2. The space between parts of the same letter is equal to one dot.
3. The space between two letters is equal to three dots.
4. The space between two words is equal to five dots.

A	..-	Period	.....
B	....	Semicolon	.....
C	....	Comma	.....
D	....	Colon	.....
E	..	Interrogation	.....
F	....	Apostrophe	.....
G	....	Hyphen	.....
H	....	Bar indicating fraction	.....
I	..	Parenthesis	.....
J	....	Inverted commas	.....
K	....	Double dash	.....
L	....	Distress call	.....
M	---	Attention call to precede every transmission	.....
N	---	General inquiry call	.....
O	---	From (de)	.....
P	....	Invitation to transmit (go ahead)	.....
Q	....	Warning—high power	.....
R	....	Question (please repeat after .....)	.....
S	....	Wait	.....
T	---	Break (Bk.) (double dash)	.....
U	---	Understand	.....
V	....	Error	.....
W	....	Received (O. K.)	.....
X	....	Position report (to precede all position messages)	.....
Y	....	End of each message (cross)	.....
Z	....	Transmission finished (end of work) (conclusion of correspondence)	.....
Ä (German)	....		
Á or Å (Spanish-Scandinavian)	....		
CH (German-Spanish)	....		
É (French)	....		
Ñ (Spanish)	....		
Ö (German)	....		
Ü (German)	....		
1	....		
2	....		
3	....		
4	....		
5	....		
6	....		
7	....		
8	....		
9	....		
0	....		











































## Q Signals

The following three-letter code words, all beginning with Q have been devised to simplify the handling of messages between stations. They are recognized by ship and shore stations of all nations and serve as a readily understood form of telegraphic shorthand. When a Q signal is followed by a question mark (. . . -- . . .) a question is being asked; if the Q signal stands alone, it is translated as an affirmation or reply.

<i>Signal</i>	<i>As a Question</i>	<i>As a Reply</i>
QRA	What is your station?	My station is . . .
QRB	How far distant are you?	My distance is . . .
QRC	Who handles your accounts?	My accounts handled by . . .
QRD	Where from and where bound?	I am from . . . and bound for . . .
QRG	What is my frequency?	Your frequency is . . .
QRH	Is my frequency steady?	Your frequency is steady.
QRI	How is my tone?	Your tone changes.
QRJ	Are my signals weak?	Your signal is weak.
QRK	Are my signals legible?	Legibility is (1 to 5).
QRL	Are you free to handle traffic?	I am busy now.
QRM	Are you meeting interference?	I am being interfered with.
QRN	Are atmospherics bothering you?	Atmospherics are bothering me.
QRO	Shall I increase power?	Increase your power.
QRP	Shall I use less power?	Decrease power.
QRQ	Shall I send faster?	Send faster.
QRS	Shall I send slower?	Send slower.
QRT	Shall I stop sending?	Stop sending.
QRU	Have you any messages for me?	No traffic for you.
QRV	Are you ready?	I am ready.
QRW	Shall I notify . . . that you are calling him?	Notify . . . I am calling him.
QRX	Shall I stand by?	Stand by until I call you.
QRY	What is my turn?	Your turn is number . . .
QRZ	Who is calling me?	You are being called by . . .
QSA	What is my signal strength (1 to 5)?	Your signal strength is (1 to 5).
QSB	Does my signal strength vary?	Your signal strength varies.
QSD	Are my signals distinct?	Your signals are bad.
QSG	Shall I send . . . telegrams at a time?	Send . . . telegrams at a time.
QSJ	What is the word charge?	The word charge is . . .
QSK	Shall I continue?	Continue with traffic.

QSL	Will you acknowledge receipt?	I acknowledge receipt.
QSM	Shall I repeat last message?	Repeat last message.
QSO	Can you communicate with . . . direct?	I can communicate with . . . direct.
QSP	Will you retransmit to . . . gratis?	I will retransmit to . . . free.
QSR	Has distress call from . . . been cleared?	Distress call from . . . has been cleared.
QSU	On what wave and type of transmission shall I reply?	Reply on . . . k.c. with . . . type emission.
QSV	Shall I send V's?	Send a series of V's.
QSW	Will you send on . . . k.c. with . . . type transmission?	I will send on . . . k.c. with . . . type emission.
QSX	Will you listen for . . . on . . . k.c.?	I will listen for . . . on . . . k.c.
QSY	Shall I change to . . . k.c.?	Change to . . . k.c.
QSZ	Shall I duplicate each word?	Duplicate each word.
QTA	Shall I cancel message # . . . ?	Cancel message # . . .
QTB	Do you check number of words?	I do not check.
QTC	How many messages have you?	I have . . . messages.
QTE	What is my true bearing?	Your true bearing is . . .
QTF	Will you give me my position as determined by direction finder?	Position of your station by direction finder is . . .
QTG	Will you send your call while I take bearings?	I will transmit my call while you take bearings.
QTH	What is your position in longitude and latitude?	My position is . . . latitude and . . . longitude.
QTI	What is your true course?	My true course is . . . degrees.
QTJ	What is your speed?	My speed is . . .
QTM	Will you send submarine sound signals for my bearings?	I will send submarine sound signals for your bearings.
QTO	Have you left port?	Have just left port (or dock).
QTP	Are you entering port?	Am entering port (or dock).
QTT	Can you communicate in International Code?	I will communicate by International Code.
QTR	What time is it?	Exact time is . . .
QTU	What are your hours of operation?	I am operating from . . . to . . .
QUA	Have you heard from . . . ?	I have heard following news from . . .
QUM	Is distress call ended?	Distress traffic is ended.

## SYMBOLS USED FOR APPARATUS

ALTERNATOR -----  OR 	RESISTOR ----- 
AMMETER ----- 	VARIABLE RESISTOR ----- 
ANTENNA ----- 	SWITCH - S.P.S.T. ----- 
BALLAST ----- 	SWITCH - S.P.D.T. ----- 
BATTERY ----- 	SWITCH - D.P.S.T. ----- 
BUZZER ----- 	SWITCH - D.P.D.T. ----- 
CONDENSER -----  OR 	SWITCH REVERSING ----- 
VARIABLE CONDENSER ----- 	PHONE RECEIVER -----  OR 
CONNECTION OF WIRES ----- 	MICROPHONE ----- 
NO CONNECTION ----- 	THERMOELEMENT ----- 
COUPLED COILS ----- 	TRANSFORMER -----  OR 
VARIABLE COUPLING ----- 	VACUUM TUBE ----- 
DETECTOR - CRYSTAL ----- 	SCREEN GRID TUBE ----- 
BINDING POST ----- 	HEATER TYPE TUBE ----- 
LOUD SPEAKER ----- 	DOUBLE DIODE TUBE ----- 
GROUND ----- 	VOLTMETER ----- 
INDUCTOR ----- 	CHOKE COIL ----- 
VARIABLE INDUCTOR ----- 	LOOP AERIAL ----- 
KEY ----- 	TELEPHONE JACK ----- 



# **RCA CHARACTERISTICS CHART FOR RECEIVING TUBES**

COURTESY OF RCA MANUFACTURING CO., INC.  
HARRISON, N. J.

TYPE	NAME	DIMENSIONS SOCKET CONNECTIONS		CATHODE TYPE AND RATING			USE  Values to right give operating conditions and characteristics for indicated typical use	PLATE SUPPLY  VOLTS	GRID BIAS ■  VOLTS	SCREEN SUPPLY  VOLTS	SCREEN CURRENT  MA.	PLATE CURRENT  MA.	A-C PLATE RESISTANCE  OHMS	TRANS- CONDUCTANCE (GRID- PLATE)  μMHOES	AMPLIFI- CATION FACTOR	LOAD FOR STATED POWER OUTPUT OHMS	POWER OUT- PUT  WATTS	TYPE
		DIMEN.	S. C.	C. T.	VOLTS	AMP.												
00-A	DETECTOR TRIODE	D12	4D	D.C. F	5.0	0.25	CRID-LEAK DETECTOR	45	Grid Return to (-) Filament			1.5	30000	666	20	—	—	00-A
01-A	DETECTOR* AMPLIFIER	D12	4D	D.C. F	5.0	0.25	CLASS A AMPLIFIER	90 135	- 4.5 - 9.0	—	—	2.5 3.0	11000 10000	725 800	8.0 8.0	—	—	01-A
0A4-G	GAS-TRIODE	D3	G-4V	Cold	—	—	RELAY SERVICE	Peak Cathode Current, 100 max. ma. D-C Cathode Current, 25 max. ma. Starter-Anode Drop, 60 approx. volts. Anode Drop, 70 approx. volts.										0A4-G
0Z4	FULL-WAVE GAS RECTIFIER	B3	4R	Cold	—	—	RECTIFIER	Starting-Supply Voltage per Plate, 300 min. peak volts. Peak Plate Current, 200 max. ma. D-C Output Current, 75 max., 30 min. ma. D-C Output Voltage, 300 max. volts.										0Z4
0Z4-G	FULL-WAVE GAS RECTIFIER	B1	G-4R	Cold	—	—	RECTIFIER											0Z4-G
1A4-P	SUPER-CONTROL R-F AMPLIFIER PENTODE	D8	4M	D.C. F	2.0	0.06	AMPLIFIER	For other characteristics, refer to Type 1D5-GP.										1A4-P
1A5-G	POWER AMPLIFIER PENTODE	D1	G-4X	D.C. F	1.4	0.05	CLASS A AMPLIFIER	85 90	- 4.5 - 4.5	85 90	0.7 0.8	3.5 4.0	300000 300000	800 850	—	25000 25000	0.100 0.115	1A5-G
1A6	PENTAGRID CONVERTER	D8	6L	D.C. F	2.0	0.06	CONVERTER	For other characteristics, refer to Type 1D7-G.										1A6
1A7-G	PENTAGRID CONVERTER	D8	G-7Z	D.C. F	1.4	0.05	CONVERTER	For other characteristics, refer to Type 1A7-GT.										1A7-G
1A7-GT	PENTAGRID CONVERTER	C3	G-7Z	D.C. F	1.4	0.05	CONVERTER	90	0	45	0.6	0.55	600000	Anode-Grid (#2): 90 max. volts, 1.2 ma. Oscillator-Grid (#1) Resistor, 0.2 meg. Conversion Transcond., 250 micromhos.			1A7-GT	
1B4-P	R-F AMPLIFIER PENTODE	D8	4M	D.C. F	2.0	0.06	AMPLIFIER	For other characteristics, refer to Type 1E5-GP.										1B4-P
1B5/25S	DUPLEX-DIODE TRIODE	D6	6M	D.C. F	2.0	0.06	TRIODE UNIT AS AMPLIFIER	For other characteristics, refer to Type 1H6-G.										1B5/25S
1C5-G	POWER AMPLIFIER PENTODE	D1	G-4X	D.C. F	1.4	0.10	CLASS A AMPLIFIER	83 90	- 7.0 - 7.5	83 90	1.6 1.6	7.0 7.5	110000 115000	1500 1550	—	9000 8000	0.20 0.24	1C5-G
1C6	PENTAGRID CONVERTER	D8	6L	D.C. F	2.0	0.12	CONVERTER	For other characteristics, refer to Type 1C7-G.										1C6
1C7-G	PENTAGRID CONVERTER	D8	G-7Z	D.C. F	2.0	0.12	CONVERTER	135 180	- 3.0 - 3.0	67.5 67.5	2.5 2.0	1.3 1.5	600000 700000	Anode-Grid (#2): 180 max. volts, 4.0 ma. Oscillator-Grid (#1) Resistor = . Conversion Transcond., 325 micromhos.			1C7-G	
1D5-GP	SUPER-CONTROL R-F AMPLIFIER PENTODE	D8	G-8Y	D.C. F	2.0	0.06	CLASS A AMPLIFIER	90 180	{ - 3.0 min. }	67.5 67.5	0.9 0.8	2.2 2.3	600000 1000000	720 750	—	—	—	1D5-GP
1D7-G	PENTAGRID CONVERTER	D8	G-7Z	D.C. F	2.0	0.06	CONVERTER	135 180	{ - 3.0 min. }	67.5 67.5	2.5 2.4	1.2 1.3	400000 500000	Anode-Grid (#2): 180 max. volts, 2.3 ma. Oscillator-Grid (#1) Resistor = . Conversion Transcond., 300 micromhos.			1D7-G	
1D8-GT	DIODE-TRIODE-POWER AMPLIFIER PENTODE	C3	G-8AJ	D.C. F	1.4	0.1	PENTODE UNIT AS CLASS A AMPLIFIER	45 90	- 4.5 - 9.0	45 90	0.3 1.0	5.0	300000 200000	650 925	—	20000 12000	0.035 0.200	1D8-GT
							TRIODE UNIT AS CLASS A AMPLIFIER	45 90	0 0	—	—	1.1	77000 43500	325 575	25 25	—	—	
1E5-GP	R-F AMPLIFIER PENTODE	D8	G-8Y	D.C. F	2.0	0.06	CLASS A AMPLIFIER	90 180	- 4.5 - 3.0	67.5 67.5	0.7 0.6	1.6 1.7	1000000 1500000	600 650	—	—	—	1E5-GP

1E7-G	TWIN PENTODE POWER AMPLIFIER	D3	G-6C	D.C. F	2.0	0.24	CLASS A AMPLIFIER	135	—	7.5	135	—	—	—	—	—	—	—	—	—	24000	0.575	1E7-G								
1F4	POWER AMPLIFIER PENTODE	D12	6K	D.C. F	2.0	0.12	AMPLIFIER	For other characteristics, refer to Type 1F5-G.														1F4									
1F5-G	POWER AMPLIFIER PENTODE	D10	G-6X	D.C. F	2.0	0.12	CLASS A AMPLIFIER	90	—	3.0	90	1.1	4.0	240000	1400	—	20000	0.11	135	—	4.5	135	2.4	8.0	200000	1700	—	16000	0.31	1F5-G	
1F6	DUPLEX-DIODE PENTODE	D8	6W	D.C. F	2.0	0.06	PENTODE UNIT AS AMPLIFIER	For other characteristics, refer to Type 1F7-GV.														1F6									
1F7-GV	DUPLEX-DIODE PENTODE	D8	G-7AD	D.C. F	2.0	0.06	PENTODE UNIT AS R.F. AMPLIFIER	180	—	1.5	67.5	0.7	2.2	1000000	650	—	—	—	—	—	—	—	—	—	—	—	—	—	1F7-GV		
							PENTODE UNIT AS A-F AMPLIFIER	135	—	2.0	Screen Supply, 135 volts applied through 0.8-megohm resistor. Grid Resistor, ** 1.0 megohm. Voltage Gain, 46.																				
1G4-G	DETECTOR AMPLIFIER TRIODE	D1	G-5S	D.C. F	1.4	0.05	CLASS A AMPLIFIER	90	—	6.0	—	—	2.3	10700	825	8.8	—	—	—	—	—	—	—	—	—	—	—	—	1G4-G		
1G5-G	POWER AMPLIFIER PENTODE	D10	G-6X	D.C. F	2.0	0.12	CLASS A AMPLIFIER	90	—	6.0	90	2.5	8.5	133000	1500	—	8500	0.25	135	—	13.5	135	2.5	8.7	160000	1550	—	9000	0.55	1G5-G	
1G6-G	TWIN TRIODE AMPLIFIER	D1	G-7AB	D.C. F	1.4	0.10	CLASS B AMPLIFIER	90	0	—	—	—	—	Power Output is for one tube at stated plate-to-plate load.				12000	0.675	—	—	—	—	—	—	—	—	1G6-G			
1H4-G	DETECTOR+ AMPLIFIER	D3	G-5S	D.C. F	2.0	0.06	CLASS A AMPLIFIER	90	—	4.5	—	—	2.5	11000	850	9.3	—	—	—	—	—	—	—	—	—	—	—	—	1H4-G		
							CLASS A AMPLIFIER	135	—	9.0	—	—	3.0	10300	900	9.3	—	—	—	—	—	—	—	—	—	—	—	—		—	—
							CLASS B AMPLIFIER	180	—	13.5	—	—	3.1	10300	900	9.3	—	—	—	—	—	—	—	—	—	—	—	—		—	—
1H5-G	DIODE HIGH-MU TRIODE	D6	G-5Z	D.C. F	1.4	0.05	TRIODE UNIT AS AMPLIFIER	For other characteristics, refer to Type 1H5-GT.														1H5-G									
1H5-GT	DIODE HIGH-MU TRIODE	C3	G-5Z	D.C. F	1.4	0.05	TRIODE UNIT AS CLASS A AMPLIFIER	90	0	—	—	0.15	240000	275	65	—	—	—	—	—	—	—	—	—	—	—	—	1H5-GT			
1H6-G	DUPLEX-DIODE TRIODE	D3	G-7AA	D.C. F	2.0	0.06	TRIODE UNIT AS CLASS A AMPLIFIER	135	—	3.0	—	—	0.8	35000	575	20	—	—	—	—	—	—	—	—	—	—	—	1H6-G			
1J6-G	TWIN TRIODE AMPLIFIER	D3	G-7AB	D.C. F	2.0	0.24	CLASS B AMPLIFIER	135	0	—	—	—	—	Power Output is for one tube at stated plate-to-plate load.				10000	2.1	—	—	—	—	—	—	—	1J6-G				
1N5-G	R-F AMPLIFIER PENTODE	D6	G-5Y	D.C. F	1.4	0.05	AMPLIFIER	For other characteristics, refer to Type 1N5-GT.														1N5-G									
1N5-GT	R-F AMPLIFIER PENTODE	C3	G-5Y	D.C. F	1.4	0.05	CLASS A AMPLIFIER	90	0	—	90	0.3	1.2	1500000	750	—	—	—	—	—	—	—	—	—	—	—	—	1N5-GT			
1Q5-GT	BEAM POWER AMPLIFIER	C3	G-6AF	D.C. F	1.4	0.1	CLASS A AMPLIFIER	90	—	4.5	90	1.6	9.5	—	2100	—	8000	0.27	—	—	—	—	—	—	—	—	—	1Q5-GT			
1R5	PENTAGRID CONVERTER	B0	7AT	D.C. F	1.4	0.05	CONVERTER	45	0	45	1.9	0.7	600000	Grid #1 Resistor, 100000 ohms.				—	—	—	—	—	—	—	—	—	—	1R5			
							CONVERTER	90	0	45	1.8	0.8	750000	Conversion Transcond., 250 micromhos.				—	—	—	—	—	—	—	—	—	—		—		
1S4	POWER AMPLIFIER PENTODE	B0	7AV	D.C. F	1.4	0.1	CLASS A AMPLIFIER	45	—	4.5	45	0.8	3.8	250000	1250	—	8000	0.065	—	—	—	—	—	—	—	—	—	1S4			
1S5	DIODE PENTODE	B0	6AU	D.C. F	1.4	0.05	PENTODE UNIT AS A-F AMPLIFIER	Plate Supply, 41 volts applied through 1 megohm resistor. Screen Supply, 41 volts. Grid Bias, 0 volts. Grid Resistor, 10 megohms. Voltage Gain, 30 approximately.														1S5									
1T4	SUPER-CONTROL R-F AMPLIFIER PENTODE	B0	6AR	D.C. F	1.4	0.05	CLASS A AMPLIFIER	45	0	45	0.7	1.9	350000	700	—	—	—	—	—	—	—	—	—	—	—	—	—	1T4			
							CLASS A AMPLIFIER	90	0	45	0.65	2.0	800000	750	—	—	—	—	—	—	—	—	—	—	—	—	—		—	—	—
1T5-GT	BEAM POWER AMPLIFIER	C3	G-6X	D.C. F	1.4	0.05	CLASS A AMPLIFIER	90	—	6.0	90	1.4	6.5	—	1150	—	14000	0.17	—	—	—	—	—	—	—	—	—	1T5-GT			
1-V	HALF-WAVE RECTIFIER	D5	4Q	H	6.3	0.3	WITH CONDENSER-INPUT FILTER	Max. A-C Plate Volts (RMS), 325				Min. Total Effective Plate-Supply Impedance: Up to 117 volts, 0 ohms; at 150 volts, 30 ohms; at 325 volts, 75 ohms.				—	—	—	—	—	—	—	—	—	—	—	1-V				
2A3	POWER AMPLIFIER TRIODE	E3	4D	F	2.5	2.5	CLASS A AMPLIFIER	250	—	45.0	—	—	60.0	800	5250	4.2	2500	3.5	—	—	—	—	—	—	—	—	—	2A3			
							PUSH-PULL CLASS AB AMPLIFIER	300	Cath. Bias, 780 ohms	80.0	—	—	—	—	—	—	—	—	—	—	—	—	—	—	—	—	—		—	—	—
2A5	POWER AMPLIFIER PENTODE	D12	6B	H	2.5	1.75	AMPLIFIER	For other characteristics, refer to Type 6F6-G.														2A5									
2A6	DUPLEX-DIODE HIGH-MU TRIODE	D9	6Q	H	2.5	0.8	TRIODE UNIT AS AMPLIFIER	For other characteristics, refer to Type 6SQ7.														2A6									

TYPE	NAME	DIMENSIONS SOCKET CONNECTIONS		CATHODE TYPE AND RATING		USE  Values to right give operating conditions and characteristics for indicated typical use	PLATE SUP- PLY VOLTS	GRID BIAS $\mu$ VOLTS	SCREEN SUPPLY VOLTS	SCREEN CUR- RENT MA.	PLATE CUR- RENT MA.	A-C PLATE RESIS- TANCE OHMS	TRANS- CONDUCT- TANCE (GRID- PLATE) $\mu$ MMHRS	AMPLIFI- CATION FACTOR	LOAD FOR STATED POWER OUTPUT OHMS	POWER OUT- PUT WATTS	TYPE	
		DIMEN.	S. C.	C. T.	VOLTS													AMP.
2A7	PENTAGRID CONVERTER	D9	7C	H	2.5	0.8												2A7
2B7	DUPLEX-DIODE PENTODE	D9	7D	H	2.5	0.8												2B7
3Q5-GT	BEAM POWER AMPLIFIER	C3	G-7AQ	D.C. F	1.4 2.8	0.1 0.05												3Q5-GT
5T4	FULL-WAVE RECTIFIER	D7	8T	F	5.0	2.0												5T4
5U4-G	FULL-WAVE RECTIFIER	E2	G-5T1	F	5.0	3.0												5U4-G
5V4-G	FULL-WAVE RECTIFIER	D10	G-8L1	H	5.0	2.0												5V4-G
5W4	FULL-WAVE RECTIFIER	C2	8T	F	5.0	1.5												5W4
5X4-G	FULL-WAVE RECTIFIER	E2	G-8Q	F	5.0	3.0												5X4-G
5Y3-G	FULL-WAVE RECTIFIER	D10	G-8T1	F	5.0	2.0												5Y3-G
5Y4-G	FULL-WAVE RECTIFIER	D10	G-8Q	F	5.0	2.0												5Y4-G
5Z3	FULL-WAVE RECTIFIER	E3	4C	F	5.0	3.0												5Z3
5Z4	FULL-WAVE RECTIFIER	C2	8L	H	5.0	2.0												5Z4
6A4/LA	POWER AMPLIFIER PENTODE	D12	9B	F	6.3	0.3												6A4/LA
6A6	TWIN TRIODE AMPLIFIER	D12	7B	H	6.3	0.8												6A6
6A7	PENTAGRID CONVERTER	D9	7C	H	6.3	0.3												6A7

Values to right give  
operating conditions  
and characteristics for  
indicated typical use

For other characteristics, refer to Type 6A8.

For other characteristics, refer to Type 6B8-O.

90 — 4.5 90 1.6 9.5 100000 2100  
90 — 4.5 90 1.0 7.5 110000 1800

Max. A-C Volts per Plate (RMS), 450  
Max. Peak Inverse Volts, 1550  
Max. D-C Output Ma., 225  
Max. Peak Plate Ma., 675  
Min. Total Effect. Supply Imped. per Plate, 150 ohms

Max. A-C Volts per Plate (RMS), 550  
Max. Peak Inverse Volts, 1550  
Max. D-C Output Ma., 225  
Max. Peak Plate Ma., 675  
Min. Value of Input Choke, 3 henries

Max. A-C Volts per Plate (RMS), 450  
Max. Peak Inverse Volts, 1550  
Max. D-C Output Ma., 225  
Max. Peak Plate Ma., 675  
Min. Total Effect. Supply Imped. per Plate, 75 ohms

Max. A-C Volts per Plate (RMS), 550  
Max. Peak Inverse Volts, 1550  
Max. D-C Output Ma., 225  
Max. Peak Plate Ma., 675  
Min. Value of Input Choke, 3 henries

Max. A-C Volts per Plate (RMS), 375  
Max. Peak Inverse Volts, 1400  
Max. D-C Output Ma., 175  
Max. Peak Plate Ma., 525  
Min. Total Effect. Supply Imped. per Plate, 65 ohms

Max. A-C Volts per Plate (RMS), 500  
Max. Peak Inverse Volts, 1400  
Max. D-C Output Ma., 175  
Max. Peak Plate Ma., 525  
Min. Value of Input Choke, 4 henries

Max. A-C Volts per Plate (RMS), 350  
Max. Peak Inverse Volts, 1400  
Max. D-C Output Ma., 100  
Max. Peak Plate Ma., 300  
Min. Total Effect. Supply Imped. per Plate, 25 ohms

Max. A-C Volts per Plate (RMS), 500  
Max. Peak Inverse Volts, 1400  
Max. D-C Output Ma., 100  
Max. Peak Plate Ma., 300  
Min. Value of Input Choke, 6 henries

For other ratings, refer to Type 5U4-G.

Max. A-C Volts per Plate (RMS), 350  
Max. Peak Inverse Volts, 1400  
Max. D-C Output Ma., 125  
Max. Peak Plate Ma., 375  
Min. Total Effect. Supply Imped. per Plate, 10 ohms

Max. A-C Volts per Plate (RMS), 500  
Max. Peak Inverse Volts, 1400  
Max. D-C Output Ma., 125  
Max. Peak Plate Ma., 375  
Min. Value of Input Choke, 5 henries

For other ratings, refer to Type 5Y3-G.

For other ratings, refer to Type 5U4-G.

Max. A-C Volts per Plate (RMS), 350  
Max. Peak Inverse Volts, 1400  
Max. D-C Output Ma., 125  
Max. Peak Plate Ma., 375  
Min. Total Effect. Supply Imped. per Plate, 30 ohms

Max. A-C Volts per Plate (RMS), 500  
Max. Peak Inverse Volts, 1400  
Max. D-C Output Ma., 125  
Max. Peak Plate Ma., 375  
Min. Value of Input Choke, 5 henries

100 — 6.3 100 1.6 9.0 83250 1200  
180 — 12.0 180 3.9 22.0 45500 2200

WorldRadioHistory  
For other characteristics, refer to Type 6N7-G.

For other characteristics, refer to Type 6A8.

6A8	PENTAGRID CONVERTER	C1	8A	H	6.3	0.3	CONVERTER	100	— 1.5	100	1.3	1.1	600000	ANODE-GRID (#2): 250 max. volts, 4.0 ma. Oscillator-Grid (#1) Resistor = Conversion Transcond., 550 micromhos.	6A8	
6A8-G	PENTAGRID CONVERTER	D8	G-8A1	H	6.3	0.3	CONVERTER	For other characteristics, refer to Type 6A8.								6A8-G
6A8-GT	PENTAGRID CONVERTER	C3	G-8A:	H	6.3	0.3	CONVERTER	For other characteristics, refer to Type 6A8.								6A8-GT
6AB5/6N5	ELECTRON-RAY TUBE	D4	8R	H	6.3	0.15	VISUAL INDICATOR	Plate & Target Supply = 135 volts. Triode Plate Resistor = 0.25 meg. Target Current = 2.0 ma. Grid Bias, — 10.0 volts; Shadow Angle, 0°. Bias, 0 volts; Angle, 90°; Plate Current, 0.5 ma.								6AB5/6N5
6AB7/1853	TELEVISION AMPLIFIER PENTODE	B3	8N	H	6.3	0.45	CLASS A AMPLIFIER	300	— 3.0	200	3.2	12.5	700000	5000	6AB7/1853	
6AC5-G	HIGH-MU POWER AMPLIFIER TRIODE	D3	G-4Q:	H	6.3	0.4	CLASS B AMPLIFIER	250	0	—	—	5.0	—	—	10000	8.0
							DYNAMIC-COUPLED AMPLIFIER WITH TYPE 6P5-C DRIVER	250	Bias for both 6AC5-G and 6P5-G is developed in coupling circuit. Average Plate Current of Driver = 5.5 milliamperes. Average Plate Current of 6AC5-G = 32 milliamperes.							
6AC7/1852	TELEVISION AMPLIFIER PENTODE	B3	8N	H	6.3	0.45	CLASS A AMPLIFIER	300	Cath. Bias	150	2.5	10.0	750000	9000	Cathode-Bias Resistor, 160 ohms	6AC7/1852
6AE5-GT	AMPLIFIER TRIODE	C3	G-8Q:	H	6.3	0.3	CLASS A AMPLIFIER	95	—15.0	—	—	7.0	3500	1200	4.2	6AE5-GT
6AF6-G	ELECTRON-RAY TUBE Twin Indicator Type	B2	7AG	H	6.3	0.15	VISUAL INDICATOR	Target Voltage, 100 volts. Control-Electrode Voltage, 0 volts; Shadow Angle, 100°; Target Current, 0.9 ma. Control-Electrode Voltage, 60 volts; Angle, 0°.								6AF6-G
								Target Voltage, 135 volts. Control-Electrode Voltage, 0 volts; Shadow Angle, 100°; Target Current, 1.5 ma. Control-Electrode Voltage, 81 volts; Angle, 0°.								
6AG7	VIDEO AMPLIFIER PENTODE	C2	8Y	H	6.3	0.65	CLASS A AMPLIFIER	250	— 2.0	140	8.5	33.0	Load Resistance, 1700 ohms. Peak-to-Peak Volts Output, 70 approx.			6AG7
6B5	DIRECT-COUPLED POWER AMPLIFIER	D12	8AS	H	6.3	0.8	CLASS A AMPLIFIER	For other characteristics, refer to Type 6N6-G.								6B5
6B6-G	DUPLEX-DIODE HIGH-MU TRIODE	D8	G-7V:	H	6.3	0.3	TRIODE UNIT AS AMPLIFIER	For other characteristics, refer to Type 6SQ7.								6B6-G
6B7	DUPLEX-DIODE PENTODE	D8	7D	H	6.3	0.3	PENTODE UNIT AS AMPLIFIER	For other characteristics, refer to Type 6B8-G.								6B7
6B8	DUPLEX-DIODE PENTODE	C1	8E	H	6.3	0.3	PENTODE UNIT AS AMPLIFIER	For other characteristics, refer to Type 12C8.								6B8
6B8-G	DUPLEX-DIODE PENTODE	D8	G-8E:	H	6.3	0.3	PENTODE UNIT AS R-F AMPLIFIER	100	— 3.0	100	1.7	5.8	300000	950	—	—
							PENTODE UNIT AS A-F AMPLIFIER	250	— 3.0	125	2.3	9.0	600000	1125	—	—
6C5	DETECTOR AMPLIFIER TRIODE	B3	8Q	H	6.3	0.3	CLASS A AMPLIFIER	90	Cath. Bias, 3500 ohms. Screen Resistor = 1.1 meg. Grid Resistor, **		Gain per stage = 55					
							300	Cath. Bias, 1600 ohms. Screen Resistor = 1.2 meg. Grid Resistor, **		Gain per stage = 79						
6C5	DETECTOR AMPLIFIER TRIODE	B3	8Q	H	6.3	0.3	CLASS A AMPLIFIER	250	— 8.0	—	8.0	10000	2000	20	—	—
							BIAS DETECTOR	300	Cath. Bias, 6400 ohms. Grid Resistor, ** 0.25 megohm.		Gain per stage = 11					
6C5	DETECTOR AMPLIFIER TRIODE	B3	8Q	H	6.3	0.3	CLASS A AMPLIFIER	250	Cath. Bias, 5300 ohms. Grid Resistor, ** 0.25 megohm.		Gain per stage = 13					
							BIAS DETECTOR	250	Plate current to be adjusted to 0.2 milliamperes with no signal.							
6C5-G	DETECTOR AMPLIFIER TRIODE	D3	G-8Q:1	H	6.3	0.3	AMPLIFIER DETECTOR	For other characteristics, refer to Type 6C5.								6C5-G
6C6	TRIPLE-GRID DETECTOR AMPLIFIER	D13	8F	H	6.3	0.3	AMPLIFIER DETECTOR	For other characteristics, refer to Type 6J7.								6C6
6C8-G	TWIN TRIODE AMPLIFIER	D8	G-8G	H	6.3	0.3	EACH UNIT AS AMPLIFIER	250	— 4.5	—	—	3.2	22500	1600	36	6C8-G
6D6	TRIPLE-GRID SUPER-CONTROL AMPLIFIER	D13	8F	H	6.3	0.3	AMPLIFIER MIXER	For other characteristics, refer to Type 6U7-G.								6D6
6D8-G	PENTAGRID CONVERTER	D8	G-8A:	H	6.3	0.15	CONVERTER	135	— 3.0	67.5	—	—	600000	Anode-Grid (#2): 250 max. volts, 4.3 ma. Oscillator-Grid (#1) Resistor = Conversion Transcond., 550 micromhos.		6D8-G
								250	— 3.0	100	—	—	400000			

TYPE	NAME	DIMENSIONS SOCKET CONNECTIONS		CATHODE TYPE AND RATING			USE Values to right give operating conditions and characteristics for indicated typical use	PLATE SUPPLY VOLTS	GRID BIAS VOLTS	SCREEN SUPPLY VOLTS	SCREEN CURRENT MA.	PLATE CURRENT MA.	A-C PLATE RESISTANCE OHMS	TRANS-CONDUCTANCE (GRID-PLATE) $\mu$ MMHO	AMPLIFICATION FACTOR	LOAD FOR STATED POWER OUTPUT OHMS	POWER OUTPUT WATTS	TYPE
		DIMEN.	S. C.	C. T.	VOLTS	AMP.												
6E5	ELECTRON-RAY TUBE	D8	8R	H	6.3	0.3	VISUAL INDICATOR	Plate & Target Supply = 100 volts. Triode Plate Resistor = 0.5 meg. Target Current = 1.0 ma. Grid Bias, -3.3 volts; Shadow Angle, 0°. Bias, 0 volts; Angle, 90°. Plate Current, 0.19 ma. Plate & Target Supply = 250 volts. Triode Plate Resistor = 1.0 meg. Target Current = 4.0 ma. Grid Bias, -8.0 volts; Shadow Angle, 0°. Bias, 0 volts; Angle, 90°. Plate Current, 0.24 ma.										6E5
6F5	HIGH-MU TRIODE	C1	5M	H	6.3	0.3	AMPLIFIER	For other characteristics, refer to Type 6SF5.										6F5
6F5-G	HIGH-MU TRIODE	D8	G-5M1	H	6.3	0.3	AMPLIFIER	For other characteristics, refer to Type 6SF5.										6F5-G
6F5-GT	HIGH-MU TRIODE	C3	G-5M1	H	6.3	0.3	AMPLIFIER	For other characteristics, refer to Type 6SF5.										6F5-GT
6F6	POWER AMPLIFIER PENTODE	C2	7S	H	6.3	0.7	AMPLIFIER	For other characteristics, refer to Type 6F6-G.										6F6
6F6-G	POWER AMPLIFIER PENTODE	D10	G-7S1	H	6.3	0.7	PENTODE CLASS A AMPLIFIER	250	-16.5	250	6.5	34.0	80000	2500	—	7000	3.2	6F6-G
							TRIODE CLASS A AMPLIFIER	285	-20.0	285	7.0	38.0	78000	2550	—	7000	4.8	
							PENTODE PUSH-PULL CLASS A AMPLIFIER	250	-20.0	—	—	31.0	2600	2600	6.8	4000	0.85	
							PENTODE PUSH-PULL CLASS A AMPLIFIER	315	Cath. Bias -24.0	285	12.0	62.0	Cath. Bias Resistor, 320 ohms		10000	10.5		
							PENTODE PUSH-PULL CLASS AB <sub>2</sub> AMPLIFIER	315	Cath. Bias -26.0	250	8.0	54.0	Cath. Bias Resistor, 340 ohms		10000	19.0		
							TRIODE PUSH-PULL CLASS AB <sub>2</sub> AMPLIFIER	375	Cath. Bias -26.0	250	5.0	34.0	—		10000	18.5		
6F7	TRIODE-PENTODE	D9	7E	H	6.3	0.3	TRIODE UNIT AS CLASS A AMPLIFIER	100	-3.0 min.	—	—	3.5	16000	500	8	—	6F7	
							PENTODE UNIT AS CLASS A AMPLIFIER	100	-3.0 min.	100	1.6	6.3	290000	1050	—	—		
							PENTODE UNIT AS MIXER	250	-10.0	100	0.6	2.8	850000	1100	—	—		
							EACH UNIT AS AMPLIFIER	90	0	—	—	10.0	6700	3000	20	—		
6F8-G	TWIN TRIODE AMPLIFIER	D8	G-8G	H	6.3	0.6	EACH UNIT AS AMPLIFIER	250	-8.0	—	—	9.0	7700	2600	20	—	6F8-G	
6G6-G	POWER AMPLIFIER PENTODE	D3	G-7S1	H	6.3	0.15	PENTODE CLASS A AMPLIFIER	135	-6.0	135	2.0	11.5	170000	2100	—	12000	0.6	6G6-G
							TRIODE CLASS A AMPLIFIER	180	-9.0	180	2.5	15.0	175000	2300	—	10000	1.1	
							TRIODE CLASS A AMPLIFIER	180	-12.0	—	—	11.0	4750	2000	9.5	12000	0.25	
6H6	TWIN DIODE	A1	7Q	H	6.3	0.3	DETECTOR RECTIFIER	Maximum A-C Voltage per Plate.....117 Volts, RMS Maximum D-C Output Current..... 4 Milliamperes										6H6
6H6-G	TWIN DIODE	D3	G-7Q11	H	6.3	0.3	DETECTOR RECTIFIER	For other ratings, refer to Type 6H6.										6H6-G
6J5	DETECTOR AMPLIFIER TRIODE	B3	8Q	H	6.3	0.3	CLASS A AMPLIFIER	90	0	—	—	10.0	6700	3000	20	—	6J5	
6J5-G	DETECTOR AMPLIFIER TRIODE	D3	G-8Q1	H	6.3	0.3	AMPLIFIER	250	-8.0	—	—	9.0	7700	2600	20	—	6J5-G	
6J5-GT	DETECTOR AMPLIFIER TRIODE	C3	G-8Q1	H	6.3	0.3	AMPLIFIER	WorldRadioHistory For other characteristics, refer to Type 6J5.										6J5-GT

6J7	TRIPLE-GRID DETECTOR AMPLIFIER	C1	7R	H	6.3	0.3	PENTODE CLASS A R-F AMPLIFIER	100	- 3.0	100	0.5	2.0	1000000	1185	—	—	—	6J7						
							250	- 3.0	100	0.5	2.0	1.0 + †	1225	—	—	—								
							PENTODE CLASS A A-F AMPLIFIER	90	—	100	1.6	9.0	1040000	1500	—	12000	0.35		Gain per stage = 85 Gain per stage = 140					
							300	—	100	1.6	9.0	1040000	1500	—	12000	0.35								
PENTODE BIAS DETECTOR	250	- 4.3	100	—	—	—	—	—	—	—	—	—	—	—	—	6J7								
TRIODE CLASS A AMPLIFIER	180	- 5.3	—	—	—	—	—	—	—	—	—	—	—	—	—									
6J7-G	TRIPLE-GRID DETECTOR AMPLIFIER	D8	G-7R†	H	6.3	0.3	AMPLIFIER DETECTOR	For other characteristics, refer to Type 6J7.										6J7-G						
6J7-GT	TRIPLE-GRID DETECTOR AMPLIFIER	C3	G-7R †	H	6.3	0.3	CLASS A AMPLIFIER	100	- 3.0	100	0.5	2.0	1000000	1185	—	—	—	6J7-GT						
6K5-G	HIGH-MU TRIODE	D8	G-8U	H	6.3	0.3	CLASS A AMPLIFIER	100	- 1.5	—	—	0.35	78000	900	70	—	—	6K5-G						
6K6-G	POWER AMPLIFIER PENTODE	D3	G-7S†	H	6.3	0.4	CLASS A AMPLIFIER	250	- 18.0	250	5.6	32.0	68000	2300	—	—	—	6K6-G						
6K6-GT	POWER AMPLIFIER PENTODE	C3	G-7S†	H	6.3	0.4	CLASS A AMPLIFIER	180	- 13.5	180	3.0	18.5	81000	1850	—	—	—	6K6-GT						
6K7	TRIPLE-GRID SUPER-CONTROL AMPLIFIER	C1	7R	H	6.3	0.3	CLASS A AMPLIFIER	250	- 3.0	90	1.3	5.4	68000	2200	—	—	—	9000	1.50					
							MIXER IN SUPERHETERODYNE	250	- 10.0	100	—	—	—	—	—	—	—	—	—	—	—	—	—	
6K7-G	TRIPLE-GRID SUPER-CONTROL AMPLIFIER	D8	G-7R†	H	6.3	0.3	AMPLIFIER MIXER	For other characteristics, refer to Type 6K7.										6K7-G						
6K7-GT	TRIPLE-GRID SUPER-CONTROL AMPLIFIER	C3	G-7R †	H	6.3	0.3	CLASS A AMPLIFIER	100	- 3.0	100	1.6	6.5	250000	1325	—	—	—	6K7-GT						
6K8	TRIODE-HEXODE CONVERTER	C1	8K	H	6.3	0.3	TRIODE UNIT AS OSCILLATOR	100	—	—	—	3.8	Triode-Grid & Hexode-Grid Current, 0.15 ma.					6K8						
							HEXODE UNIT AS MIXER	100	- 3.0	100	6.2	2.3	400000	Conversion Transcond., 325 micromhos.										
6L5-G	DETECTOR AMPLIFIER TRIODE	D3	G-4Q†	H	6.3	0.15	CLASS A AMPLIFIER	135	- 5.0	—	—	3.5	11300	1500	17	—	—	6L5-G						
6L6	BEAM POWER AMPLIFIER	D7	7AC	H	6.3	0.9	SINGLE-TUBE CLASS A AMPLIFIER	250	- 14.0	250	5.0	72.0	—	—	—	—	—	2500	6.5					
							250	—	—	5.4	75.0	—	—	—	—	—	—	2500	6.5					
							PUSH-PULL CLASS A AMPLIFIER	270	- 17.5	270	11.0	134.0	—	—	—	—	—	—	—	—	5000	17.5†		
							270	—	—	11.0	134.0	—	—	—	—	—	—	—	—	—	5000	18.5†		
							PUSH-PULL CLASS AB <sub>1</sub> AMPLIFIER	360	- 22.5	270	5.0	88.0	—	—	—	—	—	—	—	—	—	6600	26.5†	
							360	—	—	5.0	88.0	—	—	—	—	—	—	—	—	—	—	9000	24.5†	
							PUSH-PULL CLASS AB <sub>2</sub> AMPLIFIER	360	- 18.0	275	3.5	78.0	—	—	—	—	—	—	—	—	—	—	6000	31.0†
							360	- 22.5	270	5.0	88.0	—	—	—	—	—	—	—	—	—	—	—	3800	47.0†
SINGLE TRIODED CLASS A AMPLIFIER	250	- 20.0	—	—	—	—	—	—	—	—	—	—	—	—	—	—	—							
6L6-G	BEAM POWER AMPLIFIER	E2	G-7AC†	H	6.3	0.9	AMPLIFIER	For other characteristics, refer to Type 6L6.										6L6-G						
6L7	PENTAGRID MIXER A AMPLIFIER	C1	7T	H	6.3	0.3	MIXER IN SUPERHETERODYNE	250	- 3.0	100	7.1	2.4	Oscillator-Grid (#3) Bias, -10 volts. Grid #3 Peak Swing, 12 volts minimum. Conversion Transcond., 375 micromhos.					6L7						
							CLASS A AMPLIFIER	250	- 3.0	100	6.5	5.3	600000	1100	—	—	—							

TYPE	NAME	DIMENSIONS SOCKET CONNECTIONS		CATHODE TYPE AND RATING		USE  Values to right give operating conditions and characteristics for indicated typical use	PLATE SUPPLY VOLTS	GRID BIAS VOLTS	SCREEN SUPPLY VOLTS	SCREEN CURRENT MA.	PLATE CURRENT MA.	A-C PLATE RESISTANCE OHMS	TRANS- CONDUCTANCE (GRID- PLATE) μMHOS	AMPLIFI- CATION FACTOR	LOAD FOR STATED POWER OUTPUT OHMS	POWER OUT- PUT WATTS	TYPE	
		DIMEN.	S. C.	C. T.	VOLTS													AMP.
6L7-G	PENTAGRID MIXER & AMPLIFIER	D8	G-7T1	H	6.3 0.3	MIXER AMPLIFIER												
6N5	ELECTRON-RAY TUBE	D8	8R	H	6.3 0.15	VISUAL INDICATOR												6L7-G
6N6-G	DIRECT-COUPLED POWER AMPLIFIER	D10	G-7AU	H	6.3 0.8	CLASS A AMPLIFIER												6N5
6N7	TWIN TRIODE AMPLIFIER	C2	8B	H	6.3 0.8	AMPLIFIER												6N6-G
6N7-G	TWIN TRIODE AMPLIFIER	D10	G-8B1	H	6.3 0.8	CLASS A AMPLIFIER (As Driver)⊙	250 294	- 5.0 - 6.0			6.0 7.0	11300 11000	3100 3200	35 35	20000 or more	exceeds 0.4		6N7
6P5-G	DETECTOR AMPLIFIER TRIODE	D8	G-4Q1	H	6.3 0.3	CLASS A AMPLIFIER	250 300	- 5.0 - 13.5			2.5 5.0	12000 9500	1150 1450	13.8 13.8	8000 8000	8.0 10.0		6N7-G
6Q7	DUPLEX-DIODE HIGH-MU TRIODE	C1	7V	H	6.3 0.3	BIAS DETECTOR	250	- 20.0 approx.										6P5-G
6Q7-G	DUPLEX-DIODE HIGH-MU TRIODE	D8	G-7V1	H	6.3 0.3	TRIODE UNIT AS CLASS A AMPLIFIER	100 250	- 1.5 - 3.0			0.35 1.1	87500 58000	800 1200	70 70				6Q7
6Q7-GT	DUPLEX-DIODE HIGH-MU TRIODE	C3	G-7V1	H	6.3 0.3	TRIODE UNIT AS AMPLIFIER												6Q7-G
6R7	DUPLEX-DIODE TRIODE	C1	7V	H	6.3 0.3	TRIODE UNIT AS AMPLIFIER												6Q7-GT
6R7-G	DUPLEX-DIODE TRIODE	D8	G-7V1	H	6.3 0.3	TRIODE UNIT AS CLASS A AMPLIFIER	250	- 9.0			9.5	8500	1900	16				6R7
6S7	TRIPLE-GRID SUPER-CONTROL AMPLIFIER	C1	7R	H	6.3 0.15	CLASS A AMPLIFIER	135 250	- 3.0 - 3.0	67.5 100	0.9 2.0	3.7 8.5	1000000 1000000	1250 1750					6R7-G
6S7-G	TRIPLE-GRID SUPER-CONTROL AMPLIFIER	D8	G-7R1	H	6.3 0.15	AMPLIFIER												6S7
6SA7	PENTAGRID CONVERTER	B3	8R	H	6.3 0.3	MIXER	100 250		100 100	8.0 8.0	3.2 3.4	500000 800000						6S7-G
6SC7	TWIN TRIODE AMPLIFIER	B3	8S	H	6.3 0.3	EACH UNIT AS AMPLIFIER	250	- 2.0			2.0	53000	1325	70				6SA7
6SF5	HIGH-MU TRIODE	B3	6AB	H	6.3 0.3	CLASS A AMPLIFIER	100 250	0 - 2.0			1.8 0.9	50000 66000	1520 1500	80 100				6SC7
							90 300	90 300	Cath. Bias, 6500 ohms. Cath. Bias, 6400 ohms.									6SF5
							90 300	90 300	Cath. Bias, 7600 ohms. Cath. Bias, 3000 ohms.									6SF5
							90 300	90 300	Cath. Bias, 4400 ohms. Cath. Bias, 3800 ohms.									6SF5
							90 300	90 300	Cath. Bias, 6000 ohms. Cath. Bias, 3200 ohms.									6SF5

For other characteristics, refer to Type 6L7.

See superseding Type 6AB5/6N5.

Output Triode: Plate Volts, 300; Plate Ma., 42; Load, 7000 ohms. Input Triode: Plate Volts, 300; Grid Volts, 0; A-F Signal Volts (RMS), 15; Plate Ma., 9. 4.0

For other characteristics, refer to Type 6N7-G.

Power Output is for one tube at stated plate-to-plate load. Gain per stage = 9 Gain per stage = 10 Plate current to be adjusted to 0.2 milliamperere with no signal. Grid Resistor, \*\* 0.25 megohm.

For other characteristics, refer to Type 6Q7.

For other characteristics, refer to Type 6Q7.

For other characteristics, refer to Type 6R7-G.

For other characteristics, refer to Type 6S7.

Grid #1 Resistor, 20000 ohms. Conversion Transcond., 450 micromhos.

For other characteristics, refer to Type 6S7.

Gain per stage = 43 Gain per stage = 63



6SJ7	TRIPLE-GRID DETECTOR AMPLIFIER	83	8N	H	6.3	0.3	CLASS A AMPLIFIER	100	— 3.0	100	0.9	2.9	700000	1575	—	—	—	6SJ7			
								250	— 3.0	100	0.8	3.0	1500000	1650	—	—	—				
								90 x Cath. Bias, 1700 ohms.	Grid Resistor, ** 0.5 megohm.				Gain per stage = 93								
								300 x Cath. Bias, 860 ohms.					Gain per stage = 167								
6SK7	TRIPLE-GRID SUPER-CONTROL AMPLIFIER	83	8N	H	6.3	0.3	CLASS A AMPLIFIER	100	— 3.0	100	2.6	8.9	250000	1900	—	—	—	6SK7			
								250	— 3.0	100	2.4	9.2	800000	2000	—	—	—				
6SQ7	DUPLIX-DIODE HIGH-MU TRIODE	83	8Q	H	6.3	0.3	TRIODE UNIT AS CLASS A AMPLIFIER	90 x Cath. Bias, 11000 ohms.	Grid Resistor, ** 0.5 megohm.				Gain per stage = 40								
								300 x Cath. Bias, 3900 ohms.					Gain per stage = 53								
6T7-G	DUPLIX-DIODE HIGH-MU TRIODE	D8	G-7V1	H	6.3	0.15	TRIODE UNIT AS CLASS A AMPLIFIER	250	— 3.0	—	—	0.9	91000	1100	100	—	—	6T7-G			
								90 x Cath. Bias, 8300 ohms.	Grid Resistor, ** 0.5 megohm.				Gain per stage = 30								
								300 x Cath. Bias, 4580 ohms.					Gain per stage = 40								
6U5/6G5	ELECTRON-RAY TUBE	D4	8R	H	6.3	0.3	VISUAL INDICATOR	Plate & Target Supply = 100 volts. Triode Plate Resistor = 0.5 meg. Target Current = 1.0 ma. Grid Bias, —8 volts; Shadow Angle, 0°. Bias, 0 volts; Angle, 90°; Plate Current, 0.19 ma.										6U5/6G5			
								Plate & Target Supply = 250 volts. Triode Plate Resistor = 1.0 meg. Target Current = 4.0 ma. Grid Bias, —22 volts; Shadow Angle, 0°. Bias, 0 volts; Angle, 90°; Plate Current, 0.24 ma.													
6U7-G	TRIPLE-GRID SUPER-CONTROL AMPLIFIER	D12a	G-7R1	H	6.3	0.3	CLASS A AMPLIFIER	100	— 3.0	100	2.2	8.0	250000	1500	—	—	—	6U7-G			
								250	— 3.0	100	2.0	8.2	800000	1600	—	—	—				
								100	— 10.0	100	—	—	Oscillator Peak Volts = 7.0								
								250	— 10.0	100	—	—									
6V6	BEAM POWER AMPLIFIER	C2	7AC	H	6.3	0.45	CLASS A AMPLIFIER	180	— 8.5	180	3.0	29.0	58000	3700	—	—	5500	2.0			
								315	— 13.0	225	2.2	34.0	77000	3750	—	—	8500	5.5			
								250	— 15.0	250	5.0	70.0	—	—	10000	10.0					
6V6-G	BEAM POWER AMPLIFIER	D10	G-7AC1	H	6.3	0.45	AMPLIFIER	For other characteristics, refer to Type 6V6.										6V6-G			
6V6-GT	BEAM POWER AMPLIFIER	C3	G-7AC1	H	6.3	0.45	CLASS A AMPLIFIER	180	— 8.5	180	3.0	29.0	58000	3700	—	—	5500	2.00			
								250	— 12.5	250	4.5	45.0	52000	4100	—	—	5000	4.25			
								250	— 15.0	250	5.0	70.0	—	—	10000	8.5					
								300	— 20.0	300	5.0	78.0	—	—	8000	13.0					
6W7-G	TRIPLE-GRID DETECTOR AMPLIFIER	D8	G-7R1	H	6.3	0.15	CLASS A AMPLIFIER	250	— 3.0	100	0.5	2.0	1500000	1225	—	—	—	6W7-G			
6X5	FULL-WAVE RECTIFIER	C2	8S	H	6.3	0.6	For other ratings, refer to Type 6X5-G.										6X5				
6X5-G	FULL-WAVE RECTIFIER	D3	G-8S	H	6.3	0.6	WITH CONDENSER-INPUT FILTER	Max. A-C Volts per Plate (RMS), 325				Max. D-C Output Ma., 70				Min. Total Effect. Supply Imped. per Plate, 150 ohms					
								Max. Peak Inverse Volts, 1250				Max. Peak Plate Ma., 210									
								WITH CHOKE-INPUT FILTER				Max. D-C Output Ma., 70				Min. Value of Input Choke, 8 henries					
								Max. Peak Inverse Volts, 1250				Max. Peak Plate Ma., 210									
6X5-GT	FULL-WAVE RECTIFIER	C3	G-8S	H	6.3	0.6	For other ratings, refer to Type 6X5-G.										6X5-GT				
6Y6-G	BEAM POWER AMPLIFIER	D10	G-7AC1	H	6.3	1.25	SINGLE-TUBE CLASS A AMPLIFIER	135	— 13.5	135	3.5	58.0	9300	7000	—	—	2000	3.6			
								200	— 14.0	135	2.2	61.0	18300	7100	—	—	2600	6.0			
6Z7-G	TWIN TRIODE AMPLIFIER	D3	G-8B	H	6.3	0.3	CLASS B AMPLIFIER	135	0	—	—	Power Output is for one tube at stated plate-to-plate load.				9000	2.5				
								180	0	—	—					12000	4.2				
6ZY5-G	FULL-WAVE RECTIFIER	D3	G-8S	H	6.3	0.3	WITH CONDENSER-INPUT FILTER	Max. A-C Volts per Plate (RMS), 325				Max. D-C Output Ma., 40				Min. Total Effect. Supply Imped. per Plate, 225 ohms					
								Max. Peak Inverse Volts, 1250				Max. Peak Plate Ma., 120									
								WITH CHOKE-INPUT FILTER				Max. D-C Output Ma., 40				Min. Value of Input Choke, 13.5 henries					
								Max. Peak Inverse Volts, 1250				Max. Peak Plate Ma., 120									
7A6	TWIN DIODE	B5	7AJ	H	6.3	0.15	DETECTOR RECTIFIER	Maximum A-C Voltage per Plate ..... 150 Volts, RMS										Maximum D-C Output Current ..... 10 Milliamperes			

TYPE	NAME	DIMENSIONS SOCKET CONNECTIONS		CATHODE TYPE AND RATING		USE <small>Values to right give operating conditions and characteristics for indicated typical use</small>	PLATE SUPPLY VOLTS	GRID BIAS VOLTS	SCREEN SUPPLY VOLTS	SCREEN CURRENT MA.	PLATE CURRENT MA.	A-C PLATE RESISTANCE OHMS	TRANS- CONDUCTANCE (GRID- PLATE) μMMHOS	AMPLIFI- CATION FACTOR	LOAD FOR STATED POWER OUTPUT OHMS	POWER OUT- PUT WATTS	TYPE	
		DIMEN.	S. C.	C. T.	VOLTS													AMP.
7A7-LM	TRIPLE-GRID SUPER-CONTROL AMPLIFIER	B4	8V	H	6.3	0.3	CLASS A AMPLIFIER	250	{ - 3.0 min. }	100	2.0	8.6	800000	2000	—	—	—	7A7-LM
7A8	OCTODE CONVERTER	B5	8U	H	6.3	0.15	CONVERTER	250	{ - 3.0 min. }	100	2.8	3.0	700000	Anode-Grid (#2): 250 max. volts, 4.5 ma. Oscillator-Grid (#1) Resistor = Conversion Transcond., 600 micromhos.			7A8	
7B7	TRIPLE-GRID SUPER-CONTROL AMPLIFIER	B5	8V	H	6.3	0.15	CLASS A AMPLIFIER	250	{ - 3.0 min. }	100	2.0	8.5	700000	1700	—	—	—	7B7
7C6	DUPLEX-DIODE HIGH-MU TRIODE	B6	8W	H	6.3	0.15	TRIODE UNIT AS CLASS A AMPLIFIER	250	— 1.0	—	—	1.3	100000	1000	100	—	—	7C6
7Y4	FULL-WAVE RECTIFIER	B5	5AB	H	6.3	0.5	WITH CONDENSER- INPUT FILTER	Max. A-C Volts per Plate (RMS), 350 Max. Peak Inverse Volts, 1000					Max. D-C Output Ma., 60 Max. Peak Plate Ma. per Plate, 250					7Y4
10	POWER AMPLIFIER TRIODE	E4	4D	F	7.5	1.25	CLASS A AMPLIFIER	350 425	-32.0 -40.0	—	—	16.0 18.0	5150 5000	1550 1600	8.0 8.0	11000 10200	0.9 1.6	10
11	DETECTOR* AMPLIFIER	D2	4F	D.C.			CLASS A AMPLIFIER	90	- 4.5	—	—	2.5	15500	425	6.6	—	—	11
12	TRIODE	D11	4D	F	1.1	0.25	CLASS A AMPLIFIER	135	-10.5	—	—	3.0	15000	440	6.6	—	—	12
12A7	RECTIFIER- PENTODE	D9	7K	H	12.6	0.3	PENTODE UNIT AS CLASS A AMPLIFIER	135	-13.5	135	2.5	9.0	102000	975	—	13500	0.55	12A7
12A8-GT	PENTAGRID CONVERTER	C3	G-8A	H	12.6	0.15	HALF-WAVE RECTIFIER	Maximum A-C Plate Voltage ..... 125 Volts, RMS Maximum D-C Output Current ..... 30 Milliamperes										12A8-GT
12C8	DUPLEX-DIODE PENTODE	C1	8E	H	12.6	0.15	CONVERTER	For other characteristics, refer to Type 6A8-GT.										12C8
12F5-GT	HIGH-MU TRIODE	C3	G-5M	H	12.6	0.15	PENTODE UNIT AS R-F AMPLIFIER	250	- 3.0	125	2.3	10.0	600000	1325	—	—	—	12C8
12J5-GT	DETECTOR AMPLIFIER TRIODE	C3	G-6Q	H	12.6	0.15	PENTODE UNIT AS A-F AMPLIFIER	90 μ Cath. Bias, 3500 ohms. Screen Resistor = 1.1 meg. Grid Resistor, ** Gain per stage = 55 300 μ Cath. Bias, 1600 ohms. Screen Resistor = 1.2 meg. / 0.5 megohm. Gain per stage = 79										12C8
12J7-GT	TRIPLE-GRID DETECTOR AMPLIFIER	C3	G-7R	H	12.6	0.15	AMPLIFIER	For other characteristics, refer to Type 6SF5.										12F5-GT
12K7-GT	TRIPLE-GRID SUPER-CONTROL AMPLIFIER	C3	G-7R	H	12.6	0.15	AMPLIFIER	For other characteristics, refer to Type 6J5.										12J5-GT
12K8	TRIODE-HEXODE CONVERTER	C1	8K	H	12.6	0.15	OSCILLATOR MIXER	For other characteristics, refer to Type 6J7-GT.										12J7-GT
12Q7-GT	DUPLEX-DIODE HIGH-MU TRIODE	C3	G-7V	H	12.6	0.15	TRIODE UNIT AS AMPLIFIER	For other characteristics, refer to Type 6K7-GT.										12K7-GT
12SA7	PENTAGRID CONVERTER	B3	8R	H	12.6	0.15	MIXER	For other characteristics, refer to Type 6K8.										12K8
12SC7	TWIN TRIODE AMPLIFIER	B3	8S	H	12.6	0.15	AMPLIFIER	For other characteristics, refer to Type 6Q7-GT.										12Q7-GT
12SF5	HIGH-MU TRIODE	B3	8AB	H	12.6	0.15	AMPLIFIER	For other characteristics, refer to Type 6SA7.										12SA7
								WorldRadioHistory								For other characteristics, refer to Type 6SC7.		12SC7
								For other characteristics, refer to Type 6SF5.										12SF5

12SJ7	TRIPLE-GRID DETECTOR AMPLIFIER	B3	8N	H	12.6	0.15	AMPLIFIER	For other characteristics, refer to Type 6SJ7.										12SJ7			
12SK7	TRIPLE-GRID SUPER-CONTROL AMPLIFIER	B3	8N	H	12.6	0.15	AMPLIFIER	For other characteristics, refer to Type 6SK7.										12SK7			
12SQ7	DUPEX-DIODE HIGH-MU TRIODE	B3	8Q	H	12.6	0.15	TRIODE UNIT AS AMPLIFIER	For other characteristics, refer to Type 6SQ7.										12SQ7			
12SR7	DUPEX DIODE TRIODE	B3	8Q	H	12.6	0.15	TRIODE UNIT AS AMPLIFIER	For other characteristics, refer to Type 6R7-G.										12SR7			
12Z3	HALF-WAVE RECTIFIER	D5	4G	H	12.6	0.3	WITH CONDENSER-INPUT FILTER	Max. A-C Plate Volts (RMS), 235				Min. Total Effective Plate-Supply Impedance: Up to 117 volts, 0 ohms; at 150 volts, 30 ohms; at 235 volts, 75 ohms.						12Z3			
15	R-F AMPLIFIER PENTODE	D9	5F	D.C. H	2.0	0.22	CLASS A AMPLIFIER	67.5 135	- 1.5 - 1.5	67.5 67.5	0.3 0.3	1.85 1.85	630000 800000	710 750	—	—	—	—	—	—	15
19	TWIN TRIODE AMPLIFIER	D5	6C	D.C. F	2.0	0.26	AMPLIFIER	For other characteristics, refer to Type 1J6-G.										19			
20	POWER AMPLIFIER TRIODE	D2	4D	D.C. F	3.3	0.132	CLASS A AMPLIFIER	90 135	- 16.5 - 22.5	—	—	3.0 6.5	8000 6300	415 525	3.3 3.3	9600 6500	0.045 0.110	—	—	—	20
22	R-F AMPLIFIER TETRODE	E1	4K	D.C. F	3.3	0.132	SCREEN-GRID R.F. AMPLIFIER	135 135	- 1.5 - 1.5	45 67.5	0.6* 1.3*	1.7 3.7	725000 325000	375 500	—	—	—	—	—	—	22
24-A	R-F AMPLIFIER TETRODE	E1	5E	H	2.5	1.75	SCREEN-GRID R.F. AMPLIFIER	180 250	- 3.0 - 3.0	90 90	1.7* 1.7*	4.0 4.0	400000 600000	1000 1050	—	—	—	—	—	—	24-A
							BIAS DETECTOR	250	—	20 to approx. 45	—	Plate current to be adjusted to 0.1 milliamperes with no signal.									
25A6	POWER AMPLIFIER PENTODE	C2	7S	H	25.0	0.3	CLASS A AMPLIFIER	95 160	- 15.0 - 18.0	95 120	4.0 6.5	20.0 33.0	45000 42000	2000 2375	—	—	4500 5000	0.9 2.2	—	—	25A6
25A6-G	POWER AMPLIFIER PENTODE	D10	G-7S	H	25.0	0.3	AMPLIFIER	For other characteristics, refer to Type 25A6.										25A6-G			
25A7-G	RECTIFIER-PENTODE	D10	8F	H	25.0	0.3	PENTODE UNIT AS CLASS A AMPLIFIER	100	- 15.0	100	4.0	20.5	50000	1800	—	—	4500	0.77	—	—	25A7-G
							HALF-WAVE RECTIFIER	Maximum A-C Plate Voltage ..... 125 Volts, RMS Maximum D-C Output Current ..... 75 Milliamperes													
25AC5-GT	HIGH-MU POWER AMPLIFIER TRIODE	C3	G-6Q	H	25.0	0.3	CLASS B AMPLIFIER	180	0	—	—	4.0	—	—	—	—	4800	6.0	—	—	25AC5-GT
							DYNAMIC COUPLED AMP WITH TYPE 6AE5-GT DRIVER	110	Bias for both 25AC5-GT and 6AE5-GT developed in circuit. Average Plate Current of Driver = 7 milliamperes. Average Plate Current of 25AC5-GT = 45 milliamperes.						2000	2.0					
25B6-G	POWER AMPLIFIER PENTODE	D10	G-7S	H	25.0	0.3	CLASS A AMPLIFIER	105 200	- 16.0 - 23.0	105 135	2.0 1.8	48.0 62.0	15500 18000	4800 5000	—	—	1700 2500	2.4 7.1	—	—	25B6-G
25L6	BEAM POWER AMPLIFIER	C2	7AC	H	25.0	0.3	AMPLIFIER	For other characteristics, refer to Type 50L6-GT.										25L6			
25L6-G	BEAM POWER AMPLIFIER	D10	G-7AC	H	25.0	0.3	AMPLIFIER	For other characteristics, refer to Type 50L6-GT.										25L6-G			
25L6-GT	BEAM POWER AMPLIFIER	C3	G-7AC	H	25.0	0.3	AMPLIFIER	For other characteristics, refer to Type 50L6-GT.										25L6-GT			
25Z5	RECTIFIER-DOUBLER	D5	6E	H	25.0	0.3	RECTIFIER-DOUBLER	For other ratings, refer to Type 25Z6.										25Z5			
25Z6	RECTIFIER-DOUBLER	C2	7O	H	25.0	0.3	VOLTAGE DOUBLER	Max. A-C Volts per Plate (RMS), 117				Min. Total Effective Plate-Supply Impedance: Half-Wave, 30 ohms; Full-Wave, 0 ohms.						25Z6			
							HALF-WAVE RECTIFIER	Max. A-C Volts per Plate (RMS), 235				Min. Total Effect. Supply Imped. per Plate: Up to 117 volts, 0 ohms; at 150 volts, 40 ohms; at 235 volts, 100 ohms.									
25Z6-G	RECTIFIER-DOUBLER	D3	G-7Q	H	25.0	0.3	RECTIFIER-DOUBLER	For other ratings, refer to Type 25Z6.										25Z6-G			
25Z6-GT	RECTIFIER-DOUBLER	C3	G-7Q	H	25.0	0.3	RECTIFIER-DOUBLER	For other ratings, refer to Type 25Z6.										25Z6-GT			

TYPE	NAME	DIMENSIONS SOCKET CONNECTIONS		CATHODE TYPE AND RATING		USE Values to right give operating conditions and characteristics for indicated typical use	PLATE SUPPLY VOLTS	GRID BIAS VOLTS	SCREEN SUPPLY VOLTS	SCREEN CURRENT MA.	PLATE CURRENT MA.	A-C PLATE RESISTANCE OHMS	TRANS-CONDUCTANCE (GRID-PLATE) $\mu$ MMHRS	AMPLIFICATION FACTOR	LOAD FOR STATED POWER OUTPUT OHMS	POWER OUTPUT WATTS	TYPE	
		DIMEN.	S. C.	C. T.	VOLTS													AMP.
26	AMPLIFIER TRIODE	D12	4D	F	1.5	1.05	CLASS A AMPLIFIER	90 180	- 7.0 -14.5	---	---	2.9 6.2	8900 7300	935 1150	8.3 8.3	---	---	26
27	DETECTOR* AMPLIFIER TRIODE	D5	5A	H	2.5	1.75	CLASS A AMPLIFIER	135 250	- 9.0 -21.0	---	---	4.5 5.2	9000 9250	1000 975	9.0 9.0	---	---	27
							BIAS DETECTOR	250	{ - 30.0 approx.	---	---	Plate current to be adjusted to 0.2 milliampere with no signal.						
30	DETECTOR* AMPLIFIER TRIODE	D5	4D	D.C. F	2.0	0.06	AMPLIFIER	For other characteristics, refer to Type 1H4-G.										30
31	POWER AMPLIFIER TRIODE	D5	4D	D.C. F	2.0	0.13	CLASS A AMPLIFIER	135 180	-22.5 -30.0	---	---	8.0 12.3	4100 3600	925 1050	3.8 3.8	7000 5700	0.185 0.375	31
32	R-F AMPLIFIER TETRODE	E1	4K	D.C. F	2.0	0.06	SCREEN-GRID R-F AMPLIFIER	135 180	- 3.0 - 3.0	67.5 67.5	0.4* 0.4*	1.7 1.7	950000 1200000	640 650	---	---	32	
							BIAS DETECTOR	180	{ - 6.0 approx.	67.5	---	Plate current to be adjusted to 0.2 milliampere with no signal.						
33	POWER AMPLIFIER PENTODE	D12	5K	D.C. F	2.0	0.26	CLASS A AMPLIFIER	180	-18.0	180	5.0	22.0	55000	1700	---	6000	1.4	33
34	SUPER-CONTROL R-F AMPLIFIER PENTODE	E1	4M	D.C. F	2.0	0.06	SCREEN-GRID R-F AMPLIFIER	135 180	{ - 3.0 min.	67.5 67.5	1.0 1.0	2.8 2.8	600000 1000000	600 620	---	---	34	
35	SUPER-CONTROL R-F AMPLIFIER TETRODE	E1	5E	H	2.5	1.75	SCREEN-GRID R-F AMPLIFIER	180 250	{ - 3.0 min.	90 90	2.5* 2.5*	6.3 6.5	300000 400000	1020 1050	---	---	35	
35A5-LT	BEAM POWER AMPLIFIER	C5	8AT	H	35.0	0.15	SINGLE-TUBE CLASS A AMPLIFIER	110	- 7.5	110	3.0	40.0	14000	5800	---	2500	1.5	35A5-LT
35L6-GT	BEAM POWER AMPLIFIER	C3	G-7AC	H	35.0	0.15	SINGLE-TUBE CLASS A AMPLIFIER	110	- 7.5	110	3.0	40.0	13800	5800	---	2500	1.5	35L6-GT
35Z3-LT	HALF-WAVE RECTIFIER	C6	4Z	H	35.0	0.15	WITH CONDENSER-INPUT FILTER	Max. A-C Plate Volts (RMS), 235 Max. D-C Output Ma., 100		Min. Total Effective Plate-Supply Impedance: Up to 117 volts, 0 ohms; at 150 volts, 40 ohms; at 235 volts, 100 ohms.								35Z3-LT
35Z4-GT	HALF-WAVE RECTIFIER	C3	G-5AA	H	35.0	0.15	WITH CONDENSER-INPUT FILTER	Max. A-C Plate Volts (RMS), 250 $\nabla$ Max. Peak Inverse Volts, 720		Max. D-C Output Ma., 100 Max. Peak Plate Ma., 600								35Z4-GT
35Z5-GT	HALF-WAVE RECTIFIER Heater Tap for Pilot	C3	G-6AD	H	35.0	0.15	WITH CONDENSER-INPUT FILTER	Max. A-C Plate Volts (RMS), 235. ohms; at 235 volts, 45 ohms. Max. D-C Output Ma.: With Pilot and No Shunt Res., 60; With Pilot and Shunt Res., 100; Without Pilot, 100.		Min. Total Effect. Plate-Supply Imped.: Up to 117 volts, 0 ohms; at 235 volts, 45 ohms. Max. D-C Output Ma.: With Pilot and No Shunt Res., 60; With Pilot and Shunt Res., 100; Without Pilot, 100.								35Z5-GT
36	R-F AMPLIFIER TETRODE	D9	5E	H	6.3	0.3	SCREEN-GRID R-F AMPLIFIER	100 250	- 1.5 - 3.0	55 90	---	1.7*	1.8 3.2	550000 550000	850 1080	---	---	36
							BIAS DETECTOR	100 250	- 5.0 - 8.0	55 90	---	Grid-bias values are approximate. Plate current to be adjusted to 0.1 milliampere with no signal.						
37	DETECTOR* AMPLIFIER TRIODE	D5	5A	H	6.3	0.3	CLASS A AMPLIFIER	90 250	- 6.0 -18.0	---	---	2.5 7.5	11500 8400	800 1100	9.2 9.2	---	---	37
							BIAS DETECTOR	90 250	- 10.0 -18.0	---	---	Grid-bias values are approximate. Plate current to be adjusted to 0.2 milliampere with no signal.						
38	POWER AMPLIFIER PENTODE	D9	5F	H	6.3	0.3	CLASS A AMPLIFIER	100 250	- 9.0 -25.0	100 250	1.2 3.8	7.0 22.0	140000 100000	875 1200	---	15000 10000	0.27 2.50	38

39/44	SUPER-CONTROL R-F AMPLIFIER PENTODE	D9	8F	H	6.3	0.3	CLASS A AMPLIFIER	90 250	{ - 3.0 min. }	90	1.6	5.6	375000	960 1050	—	—	—	39/44
40	VOLTAGE AMPLIFIER TRIODE	D12	4D	D.C. F	5.0	0.25	CLASS A AMPLIFIER	135K 180K	- 1.5 - 3.0	—	—	0.2 0.2	150000 150000	200 200	30 30	—	—	40
41	POWER AMPLIFIER PENTODE	D6	6B	H	6.3	0.4	AMPLIFIER	For other characteristics, refer to Type 6K6-G.										41
42	POWER AMPLIFIER PENTODE	D12	6B	H	6.3	0.7	AMPLIFIER	For other characteristics, refer to Type 6P6-G.										42
43	POWER AMPLIFIER PENTODE	D12	6B	H	25.0	0.3	AMPLIFIER	For other characteristics, refer to Type 25A6.										43
45	POWER AMPLIFIER TRIODE	D12	4D	F	2.5	1.5	CLASS A AMPLIFIER	180 275	-31.5 -56.0	—	—	31.0 36.0	1650 1700	2125 2050	3.5 3.5	2700 4600	0.82 2.00	45
							PUSH-PULL CLASS AB <sub>2</sub> AMPLIFIER	275 275	Cath. Bias, 775 ohms - 68.0 volts, fixed bias		36.0 28.0	—	—	—	—	5060 3200	12.0† 18.0†	
							WITHOUT PILOT WITH PILOT	Max. A-C Plate Volts (RMS), 250 ♯		Max. Peak Plate Ma., 600		Max. D-C Output Ma., 100		Max. A-C Plate Volts (RMS), 250 ♯		Max. D-C Output Ma., 60		
4575-GT	HALF-WAVE RECTIFIER Heater Tap for Pilot	C3	G-8AD	H	45.0	0.15	CLASS A AMPLIFIER □	250	-33.0	—	—	22.0	2380	2350	5.6	6400	1.25	4575-GT
							CLASS B AMPLIFIER †	300 400	0 0	—	—	8.0 12.0	—	—	—	5200 5800	16.0† 20.0†	
46	DUAL-GRID POWER AMPLIFIER	E3	6C	F	2.5	1.75	CLASS A AMPLIFIER □	250	-16.5	250	6.0	31.0	60000	2500	—	7000	2.7	46
47	POWER AMPLIFIER PENTODE	E3	6B	F	2.5	1.75	CLASS A AMPLIFIER	250	-16.5	250	6.0	31.0	60000	2500	—	7000	2.7	47
48	POWER AMPLIFIER TETRODE	E3	8A	D.C. H	30.0	0.4	TETRODE	96	-19.0	96	9.0	52.0	—	3800	—	1500	2.0	48
							CLASS A AMPLIFIER	125	-20.0	100	9.5	56.0	—	3900	—	1500	2.5	
							TETRODE PUSH-PULL CLASS A AMPLIFIER	125	-20.0	100	—	100.0	—	—	—	3000	5.0†	
49	DUAL-GRID POWER AMPLIFIER	D12	6C	D.C. F	2.0	0.12	CLASS A AMPLIFIER □	135	-20.0	—	—	6.0	4175	1125	4.7	11000	0.17	49
							CLASS B AMPLIFIER †	180	0	—	—	4.0	—	—	—	12000	3.5†	
50	POWER AMPLIFIER TRIODE	F1	4D	F	7.5	1.25	CLASS A AMPLIFIER	300 400 450	-54.0 -70.0 -84.0	—	—	35.0 55.0 55.0	2000 1800 1800	1900 2100 2100	3.8 3.8 3.8	4600 3670 4350	1.6 3.4 4.6	50
							SINGLE-TUBE CLASS A AMPLIFIER	110 110	- 7.5 - 7.5	110 110	4.0 4.0	49.0 49.0	10000 10000	8200 8200	—	1500 2000	2.1 2.2	
							CLASS B AMPLIFIER †	180	0	—	—	4.0	—	—	—	12000	3.5†	
50L6-GT	BEAM POWER AMPLIFIER	C3	G-7AC1	H	50.0	0.15	SINGLE-TUBE CLASS A AMPLIFIER	110 110	- 7.5 - 7.5	110 110	4.0 4.0	49.0 49.0	10000 10000	8200 8200	—	1500 2000	2.1 2.2	50L6-GT
53	TWIN TRIODE AMPLIFIER	D12	7B	H	2.5	2.0	AMPLIFIER	For other characteristics, refer to Type 6N7-G.										53
55	DUPLIX-DIODE TRIODE	D9	6G	H	2.5	1.0	TRIODE UNIT AS AMPLIFIER	For other characteristics, refer to Type 85.										55
56	DETECTOR AMPLIFIER TRIODE*	D6	5A	H	2.5	1.0	AMPLIFIER DETECTOR	For other characteristics, refer to Type 6P5-G.										56
57	TRIPLE-GRID DETECTOR AMPLIFIER	D13	6F	H	2.5	1.0	AMPLIFIER DETECTOR	For other characteristics, refer to Type 6J7.										57
58	TRIPLE-GRID SUPER-CONTROL AMPLIFIER	D13	6F	H	2.5	1.0	AMPLIFIER MIXER	For other characteristics, refer to Type 6U7-G.										58
59	TRIPLE-GRID POWER AMPLIFIER	E3	7A	H	2.5	2.0	TRIODE † CLASS A AMPLIFIER	250	-28.0	—	—	26.0	2300	2600	6.0	5000	1.25	59
							PENTODE † CLASS A AMPLIFIER	250	-18.0	250	9.0	35.0	40000	2500	—	6000	3.0	
							TRIODE † CLASS B AMPLIFIER	300 400	0 0	—	—	26.0 26.0	—	—	—	4600 6000	15.0† 20.0†	
71-A	POWER AMPLIFIER TRIODE	D12	4D	F	5.0	0.25	CLASS A AMPLIFIER	90 180	-19.0 -43.0	—	—	10.0 20.0	2170 1750	1400 1700	3.0 3.0	3000 4800	0.125 0.790	71-A
75	DUPLIX-DIODE HIGH-MU TRIODE	D9	6G	H	6.3	0.3	AMPLIFIER	For other characteristics, refer to Type 6SQ7.										75

TYPE	NAME	DIMENSIONS		CATHODE TYPE AND RATING		USE Values to right give operating conditions and characteristics for indicated typical use	PLATE SUPPLY VOLTS	GRID BIAS m VOLTS	SCREEN SUPPLY VOLTS	SCREEN CURRENT MA.	PLATE CURRENT MA.	A-C PLATE RESISTANCE OHMS	TRANS-CONDUCTANCE (BIAS-PLATE) $\mu$ MMMS	AMPLIFICATION FACTOR	LOAD FOR STATED POWER OUTPUT OHMS	POWER OUTPUT WATTS	TYPE	
		DIMEN.	S. C.	C. T.	VOLTS													AMP.
76	DETECTOR AMPLIFIER TRIODE*	D6	5A	H	6.3	0.3											76	
							For other characteristics, refer to Type 6P5-G.										76	
77	TRIPLE-GRID DETECTOR AMPLIFIER	D9	6F	H	6.3	0.3	CLASS A AMPLIFIER	100	- 1.5	60	0.4	1.7	600000	1100			77	
								250	- 3.0	100	0.5	2.3	1.0 + $\frac{1}{2}$	1250				
							BIAS DETECTOR	250	- 1.95	50	Cathode current 0.65 ma.		Plate Resistor, 250000 ohms. Grid Resistor, ** 250000 ohms.					
78	TRIPLE-GRID SUPER-CONTROL AMPLIFIER	D9	6F	H	6.3	0.3											78	
							For other characteristics, refer to Type 6K7.										78	
79	TWIN TRIODE AMPLIFIER	D9	6H	H	6.3	0.6	CLASS B AMPLIFIER	180	0					Power Output is for one tube at stated plate-to-plate load.		7000	5.5	79
								250	0					14000	8.0			
80	FULL-WAVE RECTIFIER	D12	4C	F	5.0	2.0	For other ratings, refer to Type 5Y3-G.										80	
81	HALF-WAVE RECTIFIER	F1	4B	F	7.5	1.25	WITH CONDENSER-INPUT FILTER	Max. A-C Plate Volts (RMS), 700 Max. Peak Inverse Volts, 2000				Max. D-C Output Ma., 85 Max. Peak Plate Ma., 500				81		
82	FULL-WAVE $\triangleright$ RECTIFIER	D12	4C	F	2.5	3.0	WITH CONDENSER-INPUT FILTER	Max. A-C Volts per Plate (RMS), 450 Max. Peak Inverse Volts, 1550		Max. D-C Output Ma., 115 Max. Peak Plate Ma., 345		Min. Total Effect. Supply Imped. per Plate, 50 ohms.				82		
							WITH CHOKE-INPUT FILTER	Max. A-C Volts per Plate (RMS), 550 Max. Peak Inverse Volts, 1550		Max. D-C Output Ma., 115 Max. Peak Plate Ma., 345		Min. Value of Input Choke, 6 henries						
83	FULL-WAVE $\triangleright$ RECTIFIER	E3	4C	F	5.0	3.0	WITH CONDENSER-INPUT FILTER	Max. A-C Volts per Plate (RMS), 450 Max. Peak Inverse Volts, 1550		Max. D-C Output Ma., 225 Max. Peak Plate Ma., 675		Min. Total Effect. Supply Imped. per Plate, 50 ohms.				83		
							WITH CHOKE-INPUT FILTER	Max. A-C Volts per Plate (RMS), 550 Max. Peak Inverse Volts, 1550		Max. D-C Output Ma., 225 Max. Peak Plate Ma., 675		Min. Value of Input Choke, 3 henries						
83-v	FULL-WAVE RECTIFIER	D12	4AD	H	5.0	2.0	For other ratings, refer to Type 5V4-G.										83-v	
84/6Z4	FULL-WAVE RECTIFIER	D6	5D	H	6.3	0.5	WITH CONDENSER-INPUT FILTER	Max. A-C Volts per Plate (RMS), 325 Max. Peak Inverse Volts, 1250		Max. D-C Output Ma., 60 Max. Peak Plate Ma., 180		Min. Total Effect. Supply Imped. per Plate, 65 ohms.				84/6Z4		
							WITH CHOKE-INPUT FILTER	Max. A-C Volts per Plate (RMS), 450 Max. Peak Inverse Volts, 1250		Max. D-C Output Ma., 60 Max. Peak Plate Ma., 180		Min. Value of Input Choke, 10 henries						
85	DUPLEX-DIODE TRIODE	D9	6G	H	6.3	0.3	TRIODE UNIT AS CLASS A AMPLIFIER	135	-10.5		3.7	11000	750	8.3	25000	0.075	85	
							250	-20.0			8.0	7500	1100	8.3	20000	0.350		
89	TRIPLE-GRID POWER AMPLIFIER	D9	6F	H	6.3	0.4	AS TRIODE $\nabla$ CLASS A AMPLIFIER	160	-20.0		17.0	3300	1425	4.7	7000	0.30	89	
								250	-31.0		32.0	2600	1800	4.7	5500	0.90		
							AS PENTODE $\equiv$ CLASS A AMPLIFIER	100	-10.0	100	1.6	9.5	104000	1200		10700		0.33
								250	-25.0	250	5.5	32.0	70000	1800		6750		3.40
						AS TRIODE $\circ$ CLASS B AMPLIFIER	180	0			6.0 $\uparrow$			13600	2.50 $\uparrow$			
														9400	3.50 $\uparrow$			
V-99 X-99	DETECTOR* AMPLIFIER TRIODE	C4 D1	4E 4D	D.C. F	3.3	0.063	CLASS A AMPLIFIER	90	- 4.5			2.5	15500	425	6.6		V-99 X-99	
112-A	DETECTOR* AMPLIFIER TRIODE	D12	4D	D.C. F	5.0	0.25	CLASS A AMPLIFIER	90 180	- 4.5 - 13.5			5.0 7.7	5400 4700	1575 1800	8.5 8.5		112-A	

874	VOLTAGE REGULATOR	E4	4S	—	—	—	Minimum D-C Starting Supply Voltage.....125 Volts	D-C Operating Current Maximum Current (Continuous).....10-50 Ma.	874
876	CURRENT REGULATOR	G1	—	F	—	—	Voltage Range.....40 to 60 Volts	Operating Current.....1.7 Amperes	876
886	CURRENT REGULATOR	G1	—	F	—	—	Voltage Range.....40 to 60 Volts	Operating Current.....2.05 Amperes	886
1851	TELEVISION AMPLIFIER PENTODE	C7	7R	H	6.3	0.45	CLASS A AMPLIFIER	For other characteristics, refer to Type 6AC7/1852.	1851

★ For Grid-leak Detection—plate volts 45, grid return to + filament or to cathode.

■ Either A. C. or D. C. may be used on filament or heater, except as specifically noted. For use of D.C. on A-C filament types, decrease stated grid volts by  $\frac{1}{2}$  (approx.) of filament voltage.

▲ Supply voltage applied through 20000-ohm voltage-dropping resistor.

▶ Mercury-Vapor Type.

•• Grid #1 is control grid. Grid #2 is screen. Grid #3 tied to cathode.

¶ Grid #1 is control grid. Grids #2 and #3 tied to plate.

• Grids #1 and #2 connected together. Grid #3 tied to plate.

• Grids #3 and #5 are screen. Grid #4 is signal-input control grid.

▲ Grids #2 and #4 are screen. Grid #1 is signal-input control grid.

•• For grid of following tube.

○ Both grids connected together; likewise, both plates.

† Power output is for two tubes at stated plate-to-plate load.

♣ For two tubes.

‡ This diagram is like the one having the same designation without the prefix G, except that Pin No. 1 has no connection.

◆ This diagram is like the one having the same designation without the prefix G, except that Pin No. 2 is omitted and Pin No. 1 has no connection.

♣ Obtained preferably by using 70000-ohm voltage-dropping resistor in series with a 90-volt supply.

✱ This diagram is like the one having the same designation without the prefix G, except that base sleeve is connected to Pin No. 1.

✠ Grids #2 and #3 tied to plate.

‡ This diagram is like the one having the same designation without the prefix G, except that Pin No. 1 is connected to internal shield.

• Applied through plate resistor of 250000 ohms or 500-henry choke shunted by 0.25-megohm resistor.

♥ Applied through plate resistor of 100000 ohms.

✱ Applied through plate resistor of 250000 ohms.

• 50000 ohms.

• Requires different socket from small 7-pin.

□ Grid #2 tied to plate.

♦ Grids #1 and #2 tied together.

† Plate voltages greater than 125 volts RMS require 100-ohm (minimum) series-plate resistor.

∞ Applied through plate resistor of 150000 ohms.

¶ For signal-input control-grid (#1); control-grid #3 bias, -3 volts.

■ Applied through 200000-ohm plate resistor.

▲ Grids #2 and #4 are screen. Grid #3 is signal-input control grid.

☒ Nominal voltage: 7.0 volts; current: 0.16 ampere.

♦ Nominal voltage: 7.0 volts; current: 0.32 ampere.

♦ Nominal voltage: 7.0 volts; current: 0.53 ampere.

Note 1: Types with octal bases have *Miniature Metal Cap*; all others have *Small Metal Cap*.

Note 2: Subscript 1 on class of amplifier service (as AB<sub>1</sub>) indicates that grid current does not flow during any part of input cycle.

Subscript 2 on class of amplifier service (as AB<sub>2</sub>) indicates that grid current flows during some part of the input cycle.

## KEY TO TUBE DIMENSIONS

Symbol	Minimum Overall Length x Diameter	Symbol	Maximum Overall Length x Diameter	Symbol	Minimum Overall Length x Diameter	Symbol	Maximum Overall Length x Diameter	Symbol	Minimum Overall Length x Diameter
A1	1 $\frac{1}{2}$ " x 1 $\frac{1}{8}$ "	C1	3 $\frac{1}{2}$ " x 1 $\frac{1}{8}$ "	D1	4" x 1 $\frac{1}{8}$ "	D8	4 $\frac{11}{16}$ " x 1 $\frac{1}{8}$ "	E1	5 $\frac{11}{16}$ " x 1 $\frac{1}{8}$ "
B0	2 $\frac{1}{2}$ " x 1"	C2	3 $\frac{1}{2}$ " x 1 $\frac{3}{16}$ "	D2	4 $\frac{1}{2}$ " x 1 $\frac{1}{8}$ "	D9	4 $\frac{11}{16}$ " x 1 $\frac{1}{8}$ "	E2	5 $\frac{11}{16}$ " x 2 $\frac{1}{16}$ "
B1	2 $\frac{1}{2}$ " x 1 $\frac{1}{16}$ "	C3	3 $\frac{3}{8}$ " x 1 $\frac{3}{16}$ "	D3	4 $\frac{1}{2}$ " x 1 $\frac{1}{8}$ "	D10	4 $\frac{1}{2}$ " x 1 $\frac{11}{16}$ "	E3	5 $\frac{1}{2}$ " x 2 $\frac{1}{16}$ "
B2	2 $\frac{3}{8}$ " x 1 $\frac{1}{8}$ "	C4	3 $\frac{1}{2}$ " x 1 $\frac{1}{8}$ "	D4	4 $\frac{1}{16}$ " x 1 $\frac{1}{8}$ "	D11	4 $\frac{11}{16}$ " x 1 $\frac{1}{8}$ "	E4	5 $\frac{1}{2}$ " x 2 $\frac{1}{16}$ "
B3	2 $\frac{1}{2}$ " x 1 $\frac{1}{8}$ "	C5	3 $\frac{1}{2}$ " x 1 $\frac{1}{2}$ "	D5	4 $\frac{1}{16}$ " x 1 $\frac{1}{8}$ "	D12	4 $\frac{11}{16}$ " x 1 $\frac{11}{16}$ "	F1	6 $\frac{1}{2}$ " x 2 $\frac{1}{16}$ "
B4	2 $\frac{1}{2}$ " x 1 $\frac{1}{2}$ "	C6	3 $\frac{3}{8}$ " x 1 $\frac{1}{2}$ "	D6	4 $\frac{1}{16}$ " x 1 $\frac{1}{8}$ "	D12a	4 $\frac{1}{2}$ " x 1 $\frac{1}{8}$ "	G1	8" x 2 $\frac{1}{16}$ "
B5	2 $\frac{11}{16}$ " x 1 $\frac{1}{8}$ "	C7	3 $\frac{1}{2}$ " x 1 $\frac{1}{8}$ "	D7	4 $\frac{1}{16}$ " x 1 $\frac{1}{2}$ "	D13	4 $\frac{11}{16}$ " x 1 $\frac{1}{8}$ "		

## Definitions of Electric and Magnetic Units

The *ohm* is the resistance of a thread of mercury at the temperature of melting ice, 14.4521 grams in mass, of uniform cross-section and a length of 106.300 centimeters.

The *ampere* is the current which when passed through a solution of nitrate of silver in water according to certain specifications, deposits silver at the rate of 0.00111800 of a gram per second.

The *volt* is the electromotive force which produces a current of 1 ampere when steadily applied to a conductor the resistance of which is 1 ohm.

The *coulomb* is the quantity of electricity transferred by a current of 1 ampere in 1 second.

The *ampere-hour* is the quantity of electricity transferred by a current of 1 ampere in 1 hour and is, therefore, equal to 3,600 coulombs.

The *farad* is the capacity of a condenser in which a potential difference of 1 volt causes it to have a charge of 1 coulomb of electricity.

The *henry* is the inductance in a circuit in which the electromotive force induced is 1 volt when the inducing current varies at the rate of 1 ampere per second.

The *watt* is the power spent by a current of 1 ampere in a resistance of 1 ohm.

The *joule* is the energy spent in 1 second by a flow of 1 ampere in 1 ohm.

The *horsepower* is used in rating steam machinery. It is equal to 746 watts.

The *kilowatt* is 1,000 watts.

The units of capacity actually used in radio work are the *microfarad*, which is the millionth part of a farad, because the farad is too large a unit; and the *c.g.s. electrostatic unit of capacity*, which is often called the *centimeter of capacity*, which is about equal to 1.11 microfarads.

The units of inductance commonly used in radio work are the *millihenry*, which is the thousandth part of a henry; and the *centimeter of inductance*, which is one one-thousandth part of a microhenry.

## Reference Books

### FUNDAMENTALS OF RADIO

*The A.R.R.L. Antenna Book*; American Radio Relay League, Inc.  
*Communication Engineering*, by W. L. Everitt; McGraw-Hill Book Co., Inc.



- Electrolytic Capacitors*, by P. M. Deeley; The Cornell-Dubilier Electric Corp.
- Electron Tubes and Their Application*, by J. H. Morecroft; John Wiley and Sons, Inc.
- Electron Tubes in Industry*, by Keith Henney; McGraw-Hill Book Co., Inc.
- Electronics*, by Harold Pender and Knox McIlwain; John Wiley and Sons, Inc.
- Electronics and Electron Tubes*, by E. D. McArthur; John Wiley and Sons, Inc.
- Elements of Radio Communication*, by J. H. Morecroft; John Wiley and Sons, Inc.
- Elements of Radio Communication*, by O. F. Brown and E. L. Gardiner; Oxford University Press
- Fundamental Electronics and Vacuum Tubes*, by A. L. Albert; Macmillan
- Fundamentals of Radio*, by F. E. Terman; McGraw-Hill Book Co., Inc.
- Fundamentals of Vacuum Tubes*, by A. V. Eastman; McGraw-Hill Book Co., Inc.
- How to Pass Radio License Examinations*, by C. E. Drew; John Wiley and Sons, Inc.
- The Low Voltage Cathode Ray Tube, and Its Applications*, by G. Parr; Chapman & Hall, Ltd.
- Measurements in Radio Engineering*, by F. E. Terman; McGraw-Hill Book Co., Inc.
- Practical Radio Communication*, by A. R. Nilson & J. Hornung; McGraw-Hill Book Co., Inc.
- Principles of Radio*, by Keith Henney; John Wiley and Sons, Inc.
- The Radio Amateur's Handbook*; American Radio Relay League, Inc.
- Radio Antenna Handbook*, by the Technical Staff of "RADIO"; Radio, Ltd.
- Radio Facsimile*; RCA Institutes Technical Press.
- The 'Radio' Handbook*, by F. C. Jones; Radio, Ltd.
- Radio Manual*, by Geo. E. Sterling; D. Van Nostrand Co., Inc.
- Radio Operating, Questions and Answers*, by A. R. Nilson & J. L. Hornung; McGraw-Hill Book Co., Inc.
- Radio Receiving and Television Tubes*, by J. A. Moyer & J. F. Wostrel; McGraw-Hill Book Co., Inc.
- Radio Telegraphy and Telephony*, by R. L. Duncan & C. E. Drew; John Wiley & Sons, Inc.
- Short-Wave Radio*, by J. H. Reyner; Pitman Publishing Corp.

- Standards of the Institute of Radio Engineers; The Institute of Radio Engineers*  
*Theory and Applications of Electron Tubes*, by H. J. Reich; McGraw-Hill Book Co., Inc.  
*200 Meters and Down*, by C. B. DeSoto; American Radio Relay League

## TELEVISION

- Cathode Ray Tubes*, by Manfred von Ardenne; Pitman Publishing Corp.  
*Electron Optics in Television*, by I. G. Maloff and D. W. Epstein; McGraw-Hill Book Co., Inc.  
*Electronic Television*, by G. H. Eckhardt; Goodheart-Willcox Co., Inc.  
*Look and Listen—The Television Handbook*, by M. B. Sleeper; Norman W. Henley Publishing Co.  
*Television*; RCA Institutes Technical Press.  
*Television*, by V. K. Zworykin and G. A. Norton; John Wiley and Sons, Inc.  
*Television and Short-Wave Handbook*, by F. J. Camm; Fortuny's  
*Television Engineering*, by J. C. Wilson; Isaac Pitman & Sons  
*Television in American*, by Ralph Batcher and John Rider; Published by John Rider  
*Television Reception*, by Manfred von Ardenne; Chapman and Hall, Ltd.  
*Television Reception Technique*, by P. D. Tyers; Isaac Pitman and Sons, Ltd.  
*Television, Theory and Practice*, by J. H. Reyner; Chapman and Hall, Ltd.  
*Testing Television Sets*, by J. H. Reyner; Chapman and Hall, Ltd.

## Abbreviations of Common Terms

Ant. ....	Antenna
A.C. ....	Alternating Current
A.F. ....	Audio-Frequency
B. and S. ....	Brown & Sharpe Wire Gauge
C. ....	Capacity or Capacitance
C.G.S. ....	Centimeter-Gram-Second
Cond. ....	Condenser
C.W. ....	Continuous Waves
D.C. ....	Direct Current
D.P.D.T. ....	Double Pole Double Throw

D.P.S.T. ....	Double Pole Single Throw
DX. ....	Distance
E. ....	Short for Electromotive Force (Volts)
E.M.F. ....	Electromotive Force
F. ....	Filament or Frequency
G. ....	Grid
Gnd. ....	Ground
I. ....	Current Strength (Amperes)
I.C.W. ....	Interrupted Continuous Waves
I.F. ....	Intermediate Frequency
KW. ....	Kilowatt
L. ....	Inductance
Litz. ....	Litzendraht
Mfd. ....	Microfarad
Neg. ....	Negative
P. ....	Plate
P.A. ....	Public Address System
Pri. ....	Primary
Pos. ....	Positive
R. ....	Resistance
R.F. ....	Radio-Frequency
R.M.S. ....	Root-Mean-Square
Sec. ....	Secondary
S.L.F. ....	Straight Line Frequency
S.P.D.T. ....	Single Pole Double Throw
S.P.S.T. ....	Single Pole Single Throw
T. ....	Telephone or Period (time) of Complete Oscillation
V. ....	Voltage
Var. Cond. ....	Variable Condenser
V.T. ....	Vacuum Tube
W.L. ....	Wavelength
X. ....	Reactance
Z. ....	Impedance

## Glossary

A BATTERY. See *Battery, A.*

ABBREVIATIONS, CODE. Abbreviations of questions and answers used in wireless communication. The abbreviation of a question is usually in three letters of which the first is *Q*. Thus *QRB* is the code abbreviation of "What is your distance?" and the answer "My distance is . . ."

ABBREVIATIONS, UNITS. Abbreviations of various units used in radio electricity. These abbreviations are usually lower case letters of the Roman alphabet, but occasionally Greek letters are used and other signs. Thus *amperes* is abbreviated *amp.*, *micro*, which means *one millionth*,  $\mu$ , etc.

ABBREVIATIONS OF WORDS AND TERMS.

Letters used instead of words and terms for shortening them up where there is a constant repetition of them, as a-c for *alternating current*; c-w for *continuous waves*; v-t for *vacuum tube*, etc. See page 281.

AERIAL. Same as ANTENNA.

AIR CORE TRANSFORMER. See *Transformer, Air Core.*

ALTERNATOR. An electric machine that generates alternating current.

ALPHABET, INTERNATIONAL CODE. A modified Morse alphabet of dots and dashes originally used in Continental Europe and, hence, called the *Continental Code*. It is now used for all general public service radio communication all over the world and, hence, it is called the *International Code*. See page 275.

ALTERNATING CURRENT (a-c). See *Current.*

ALTERNATING CURRENT TRANSFORMER. See *Transformer.*

AMMETER. An instrument used for measuring the current strength, in terms of amperes, that flows in a circuit. Ammeters used for measuring direct and alternating currents make use of the *magnetic effects* of the currents. High-frequency currents as measured by the *heating effects* of the currents.

AMMETER, ANTENNA. See *Ammeter, Hot-Wire.*

AMMETER, HOT-WIRE. High-frequency currents are usually measured by means of an instrument which depends on heating a wire or metal strip by the oscillations. Such an instrument is often called a *thermal ammeter*.

AMMETER, RADIO. See *Ammeter, Hot-Wire.*

AMPERE. The current which, when passed through a solution of nitrate of silver in water according to certain specifications, deposits silver at the rate of 0.00111800 of a gram per second.

AMPERE-HOUR. The quantity of electricity transferred by a current of 1 ampere in 1 hour and is, therefore, equal to 3,600 coulombs.

AMPERE-TURNS. When a coil is wound up with a number of turns of wire and a current is made to flow through it, it behaves like a magnet. The strength of the magnetic field inside of the coil depends on (1) the strength of the current and (2) the number of turns of wire on the coil. Thus a feeble current flowing through a large number of turns

will produce as strong a magnetic field as a strong current flowing through a few turns of wire. This product of the current in amperes times the number of turns of wire on the coil is called the *ampere-turns*.

**AMPLIFICATION, AUDIO FREQUENCY.**

The increase in strength of varying currents having frequencies in the audible range from zero to 15,000 cycles a second.

**AMPLIFICATION, CASCADE.** See *Cascade Amplification*.

**AMPLIFICATION, RADIO FREQUENCY.**

The increase in strength of varying currents having frequencies in the superaudible range above 15,000 cycles per second.

**AMPLIFICATION, REGENERATIVE.** Amplification obtained by returning a portion of the output of a vacuum tube detector to the input of the same tube, thus increasing the signal strength without additional tubes. Also used in some transmitter circuits.

**AMPLIFIER, AUDIO-FREQUENCY.** A tube or series of tubes for building up the strength of signals after they have passed the detector. Also used to amplify the minute electrical impulses generated in microphones and phonograph pickups.

**AMPLIFIER, MULTI-STAGE.** A receiving set using two or more amplifiers. Also called *cascade amplification*. Two or more vacuum tubes with suitable coupling devices to magnify minute currents.

**AMPLIFIER, VACUUM TUBE.** A vacuum tube that is used either to amplify radio-frequency currents or audio-frequency currents.

**AMPLIFYING TRANSFORMER, AUDIO.**

See *Transformer, Audio Amplifying*.

**AMPLIFYING TRANSFORMER, RADIO.** See *Transformer, Radio Amplifying*.

**AMPLITUDE OF WAVE.** The distance of the crest from the zero line.

**ANODE.** (1) An electrode toward which electrons flow in a tube. (2) A positively charged electrode. See *Cathode*.

**ANTENNA.** A wire or series of wires, a metal rod or metal surface usually elevated above the earth and insulated from it for the purpose of propagating or intercepting radio waves.

**ANTENNA, AMATEUR.** An antenna erected for the purpose of sending or receiving signals in the short-wave and ultra-short-wave portions of the spectrum (180 to 2½ meters).

**ANTENNA, INDOOR.** An antenna erected within a building, usually for the reception only of the most powerful stations.

**ANTENNA, CAPACITY.** See *Capacity, Antenna*.

*Counterpoise.* A substitute for the earth connection of a transmitter. It may consist of a grid-work of wires spread beneath the antenna or it may comprise a similar grid work buried several feet deep in the ground directly underneath the antenna.

*Directional.* An antenna designed and erected to shape the transmitted waves so that the major portion of the energy is propagated in one general direction. With the exception of the compact loop, few receiving antennas have outstanding directional characteristics.

- Ground.** A wire or series of wires, heavily insulated and buried in the ground for reception purposes. Used rarely and then only for conditions where noise can be eliminated in no other way.
- Loop.** Many turns of wire wound on a small frame either flat or circular in form. Because of its sharp directional properties, it forms the basis of direction-finding devices.
- Resistance.** See *Resistance, Antenna*.
- Switch.** See *Switch, Antenna*.
- Wire.** Conductors of copper or phosphor bronze with adequate cross-sectional size for electrical efficiency and strength. Seldom smaller than #18 and usually stranded for greater tensile strength.
- APERIODIC CIRCUIT.** One which has no natural period of oscillation; an untuned circuit.
- APPARATUS SYMBOLS.** See *Symbols, Apparatus*.
- ARMSTRONG CIRCUIT.** See *Circuit, Armstrong*.
- ATMOSPHERICS.** Same as *Static*, which see.
- ATTENUATION.** In sending radio telegraph and telephone messages the energy of the electric waves decreases as the distance increases. This is called *attenuation* and it varies with the seasons of the year, night and day, etc.
- AUDIBILITY METER.** See *Meter, Audibility*.
- AUDIO-FREQUENCY.** See *Frequency, Audio*.
- AUDIO-FREQUENCY AMPLIFICATION.** See *Amplification, Audio-Frequency*.
- AUDIO-FREQUENCY AMPLIFIER.** See *Amplifier, Audio-Frequency*.
- AUDIO-FREQUENCY CURRENT.** See *Current, Audio-Frequency*.
- AUDION.** An early trade name given to the vacuum tube detector.
- AUTODYNE RECEIVER.** See *Receiver, Autodyne*.
- AUTO-TRANSFORMER.** See *Transformer, Auto*.
- BAKELITE.** A phenolic insulating compound.
- B BATTERY.** See *Battery, B*.
- BATTERY, A.** The battery used to heat the filament of a vacuum tube.
- BATTERY, B.** The battery used to energize the plate of a vacuum tube.
- BATTERY, C.** A small battery used to give the grid of a vacuum tube an extra negative, or bias, potential.
- BATTERY, EDISON STORAGE.** A storage battery in which the elements are made of nickel and iron and immersed in an alkaline *electrolyte*.
- BATTERY, LEAD STORAGE.** A storage battery in which the elements are made of lead and immersed in an acid *electrolyte*.
- BATTERY POLES.** See *Poles, Battery*.
- BATTERY, PRIMARY.** A battery that generates current by chemical action.
- BATTERY, STORAGE.** A battery that develops a current after it has been charged.
- BEAT RECEPTION.** See *Heterodyne Reception*.
- BLUE GLOW DISCHARGE.** See *Discharge*.
- BROADCASTING.** Sending out intelligence and music from a central station for the benefit of all who live within range of it and who have receiving sets.

- BROAD WAVE.** See *Wave, Broad.*
- BRUSH DISCHARGE.** See *Discharge.*
- BUZZER MODULATION.** See *Modulation, Buzzer.*
- CAPACITIVE COUPLING.** See *Coupling, Capacitive.*
- CAPACITY.** The capacity of a condenser, inductance coil, or other device capable of retaining a charge of electricity, hence an aerial wire, a condenser; or a metal plate is sometimes called a *capacity*. Capacity is measured in terms of the *farad*.
- CAPACITY, ANTENNA.** The capacity between the aerial wires and the ground or the counterpoise.
- CAPACITY, DISTRIBUTED.** A coil of wire not only has inductance, but also a certain capacity.
- CAPACITY REACTANCE.** See *Reactance, Capacity.*
- CAPACITY UNIT.** See *Farad.*
- CARBON RHEOSTATS.** See *Rheostat, Carbon.*
- CARRIER CURRENT TELEPHONY.** See *Wired-Wireless.*
- CARRIER FREQUENCY.** See *Frequency, Carrier.*
- CARRIER FREQUENCY TELEPHONY.** See *Wired-Wireless.*
- CASCADE AMPLIFICATION.** Two or more amplifying tubes in a receiver having some type of coupling device between them.
- CATHODE.** (1) An electrode from which electrons flow in a tube.  
(2) A negatively charged electrode. See *Anode.*
- CAT WHISKER.** A long, thin wire which makes contact with the crystal of a detector.
- CELLULAR COILS.** See *Coils, Inductance.*
- CENTIMETER OF CAPACITY.** Equal to 1.11 *microfarads*.
- CENTIMETER OF INDUCTANCE.** Equal to one one-thousandth part of a *microhenry*.
- C.G.S. ELECTROSTATIC UNIT OF CAPACITY.** See *Centimeter of Capacity.*
- CHANNEL.** A narrow band of radio frequencies.
- CHARACTERISTICS.** The special behavior of a device such as an antenna, vacuum tube, or microphone, etc.
- CHARACTERISTICS, GRID.** See *Grid, Characteristics.*
- CHOKE COILS, R.F.** Coils of wire usually wound on an air core and used to impede or prevent the passage of high-frequency currents from one circuit to another.
- CHOPPER MODULATION.** See *Modulation, Chopper.*
- CIRCUIT.** A conductor or series of conductors through which a current can flow. Low-frequency currents require a circuit closed at both ends while currents of high frequency will surge in a wire that is open at one end, such as an antenna.  
*Closed Circuit.* A continuous circuit.  
*Open Circuit.* A discontinuous circuit.  
*Coupled Circuit.* Circuits mutually linked by coils, condensers, and/or resistors.  
*Close-Coupled Circuit.* A circuit in which the members are compactly coupled.  
*Loose-Coupled Circuit.* A circuit in which the members are loosely linked.  
*Standby Circuit.* A broadly tuned circuit sometimes used when

it is desired to monitor a wide band of frequencies simultaneously.

*Armstrong Circuit.* A term frequently given to the regenerative, superregenerative, superheterodyne, and frequency modulated arrangements used in receiving sets. Named after their inventor, Major Edwin Howard Armstrong.

*Closed Circuit.* See *Circuit, Closed.*

CLOSED-CORE TRANSFORMER. See *Transformer, Closed-Core.*

CLOSE-COUPLED CIRCUITS. See *Circuits, Close-Coupled.*

CODE. Continental: same as International.

*International.* The telegraphic shorthand used throughout the world for communication purposes. Once known as the Continental Morse.

*Morse.* The code devised by Samuel F. B. Morse and which is used on the land lines in the U. S.

*National Electric.* A set of rules and requirements devised by the *National Board of Fire Underwriters* for the electrical installations in buildings on which insurance companies carry risks. This code also covers the requirements for wireless installations. A copy may be had from the *National Board of Fire Underwriters*, New York City, or from your insurance agent.

*National Electric Safety.* The *Bureau of Standards*, Washington, D.C., have investigated the precautions which should be taken for the safe operation of all electric equipment. A copy of the *Bureau of Standards Handbook No. 3* can

be had for 40 cents from the *Superintendent of Documents.*

COEFFICIENT OF COUPLING. See *Coupling, Coefficient of.*

COIL ANTENNA. See *Antenna, Loop.*

COIL, INDUCTION. An apparatus for changing low-voltage, interrupted direct currents into high-voltage, alternating currents. When fitted with a spark gap the high-voltage currents are converted into high-voltage, high-frequency currents. It is then also called a *spark coil* and a *Ruhmkorff coil.*

COIL, LOADING. A coil connected in the aerial or closed oscillation circuit so that longer wavelengths can be received.

COILS, INDUCTANCE. The tuning coils used in sending and receiving sets. Some tuning inductance coils have more than one layer; they are then called *lattice wound, cellular, basket wound, honeycomb, dualateral, stagger wound, and spiderweb* coils.

CONDENSER. All conducting objects with their insulation form capacities, but a *condenser* is understood to mean two sheets or plates of metal placed closely together but separated by some insulating material.

*Antenna Condenser.* A condenser connected in the antenna circuit.

*Air Condenser.* Where air only separates the sheets of metal.

*By-Pass Condenser.* A condenser connected in a circuit so that oscillating currents will have an alternative path to flow through.

*Filter Condenser.* A condenser of large capacity used in combination with a choke coil or resistor for smoothing out the pulsating



direct currents as they come from the rectifier.

*Fixed Condenser.* Where the plates are fixed relatively to one another.

*Grid Condenser.* A condenser connected in series with the grid lead.

*Mica Condenser.* Where mica is used as a dielectric.

*Oil Condenser.* Where the plates are immersed in oil.

*Paper Condenser.* Where paper is used as the insulating material.

*Variable Condenser.* Where alternate plates can be moved and so made to interleave more or less with a set of fixed plates.

*Vernier.* A small condenser with a vernier on it so that it may be accurately varied. It is connected in parallel with the variable condenser used in the primary circuit and is used for the reception of continuous waves where sharp tuning is essential. A small variable condenser used for receiving continuous waves where very sharp tuning is desired.

**CONDENSER, ANTENNA SERIES.** A condenser placed in the antenna wire system to cut down the wavelength.

**CONDUCTIVELY COUPLED.** Two circuits connected together by means of a single tuning coil.

**CONDUCTIVITY.** The conductance of a given length of wire of uniform cross section. The reciprocal of *resistivity*.

**CONTINENTAL CODE.** See *Code, Continental*.

**CONVENTIONAL SIGNALS.** See *Signals, Conventional*.

**COULOMB.** The quantity of electricity

transferred by a current of 1 ampere in 1 second.

**COUNTER ELECTROMOTIVE FORCE.** See *Electromotive Force, Counter*.

**COUNTERPOISE.** A duplicate of the aerial wire that is raised a few feet above the earth and insulated from it. Usually no connection is made with the earth itself.

**COUPLED CIRCUITS.** See *Circuit, Coupled*.

**COUPLING.** When two oscillating circuits are connected together either by the magnetic field of an inductance coil, or by the electrostatic field of a condenser.

**COUPLING, CAPACITIVE.** Oscillation circuits connected together by condensers instead of inductance coils.

**COUPLING, COEFFICIENT OF.** The measure of the closeness of the coupling between two coils.

**COUPLING, INDUCTIVE.** Oscillation circuits connected together by inductance coils.

**COUPLING, RESISTANCE.** Oscillation circuits connected together by a resistance.

**CRYSTAL RECTIFIER.** A crystal detector.

**CURRENT, ALTERNATING (A.C.).** A current that surges to and fro in a circuit.

**CURRENT, AUDIO-FREQUENCY.** A current whose frequency is low enough to be heard in a telephone receiver. Such a current usually has a frequency between 60 and 15,000 cycles per second.

**CURRENT, DIRECT.** An electric current that flows in one direction only.

**CURRENT, PLATE.** The current that flows between the cathode and plate of a vacuum tube.

**CURRENT, PULSATING.** A direct current

- whose voltage varies from moment to moment.
- CURRENT, RADIO-FREQUENCY.** A current whose frequency is so high it cannot be heard in a telephone receiver. Such a current may have a frequency from 15,000 upward.
- CURRENTS, HIGH-FREQUENCY.** (1) Currents that oscillate from 10,000 to 300,000,000 times per second. (2) Electric oscillations.
- CURRENTS, HIGH-POTENTIAL.** (1) Currents that have a potential of more than 2,000 volts. (2) High-voltage currents.
- CYCLE.** (1) A series of changes which when completed are again at the starting point. (2) A period of time at the end of which an alternating or oscillating current repeats its original direction of flow.
- DAMPING.** The degree to which the energy of an electric oscillation is reduced. In an open circuit the energy of an oscillation set up by a spark gap is damped out in a few swings, while in a closed circuit it is greatly prolonged, the current oscillating many times before the energy is dissipated by the sum of the resistances of the circuit.
- DECREMENT.** The act or process of gradually becoming less. The quantity lost by diminution.
- DETECTOR.** Any device that will (1) change the oscillations set up by the incoming waves into direct current, that is, which will rectify them, or (2) that will act as a relay.
- DIELECTRIC.** An insulating material between two electrically charged plates in which there is set up an *electric strain*, or displacement.
- DIELECTRIC STRAIN.** The electronic displacement in a dielectric.
- DIRECTION FINDER.** See *Antenna, Loop*.
- DIRECTIONAL ANTENNA.** See *Antenna, Directional*.
- DISCHARGE.** (1) A faintly luminous discharge that takes place from the positive pointed terminal of an induction coil, or other high potential apparatus; is termed a *brush discharge*. (2) A continuous discharge between the terminals of a high potential apparatus is termed a *convective discharge*. (3) The sudden breaking-down of the air between the balls forming the spark gap is termed a *disruptive discharge*; also called an *electric spark*, or just *spark* for short. (4) When a tube has a poor vacuum, or too large a battery voltage, it glows with a blue light and this is called a *blue glow discharge*.
- DISTRESS CALL. . . --- . . . (SOS).**
- DISTRIBUTED CAPACITY.** See *Capacity, Distributed*.
- DOUBLE HUMP RESONANCE CURVE.** A resonance curve that has two peaks or humps which show that the oscillating currents which are set up when the primary and secondary of a tuning coil are closely coupled have two frequencies.
- DUO-LATERAL COILS.** See *Coils, Inductance*.
- DUPLEX COMMUNICATION.** A radio telephone system with which it is possible to talk between both stations in either direction without the use of switches.
- EARTH CONNECTION.** Metal plates or wires buried in the ground or immersed in water. Any means by which the sending and receiving

- apparatus can be connected with the earth.
- ELECTRIC ENERGY.** The power of an electric current.
- ELECTRIC OSCILLATIONS.** See *Oscillations, Electric.*
- ELECTRICITY, NEGATIVE.** The opposite of *positive electricity*. Negative electricity is formed of electrons which make up the inside particles of an atom.
- ELECTRICITY, POSITIVE.** The opposite of *negative electricity*. Positive electricity is formed of positive charges which make up the inside particles of an atom.
- ELECTRODES.** Usually the parts of an apparatus which dip into a liquid and carry a current. The electrodes of a dry battery are the zinc and carbon elements. The electrodes of an Edison storage battery are the iron and nickel elements, and the electrodes of a lead storage battery are the lead elements.
- ELECTROLYTES.** The acid or alkaline solutions used in batteries.
- ELECTROMAGNETIC WAVES.** See *Waves, Electric.*
- ELECTROMOTIVE FORCE.** Abbreviated *emf*. The force that drives an electric current along a conductor. Also loosely called *voltage*.
- ELECTROMOTIVE FORCE, COUNTER.** The *emf* that is set up in a direction opposite to that in which the current is flowing in a conductor.
- ELECTRON.** (1) A negative particle of electricity that is detached from an atom. (2) A negative particle of electricity thrown off from the incandescent filament of a vacuum tube.
- ELECTRON FLOW.** The passage of electrons between the incandescent filament and the cold positively-charged plate of a vacuum tube.
- ELECTRON RELAY.** See *Relay, Electron.*
- ENERGY, ELECTRIC.** See *Electric Energy.*
- ENERGY UNIT.** The *joule*, which see, page 292.
- FADING.** The variation in strength of signals received from a transmitting station caused by changes in the atmosphere. Also called *swinging*.
- FARAD.** The capacity of a condenser in which a potential difference of 1 volt causes it to have a charge of 1 coulomb of electricity.
- FEED-BACK ACTION.** Feeding back the oscillating currents in a vacuum tube to amplify its power. Also called *regenerative action*.
- FILAMENT.** The wire in a vacuum tube that is heated to incandescence and which throws off electrons. Also used to heat the cathodes of indirectly heated tubes.
- FILAMENT RHEOSTAT.** See *Rheostat, Filament.*
- FILTER.** Inductance coils or condensers or both which (1) prevent troublesome voltages from acting on the different circuits, and (2) smooth out alternating currents after they have been rectified.
- FILTER REACTOR.** See *Reactor, Filter.*
- FIRE UNDERWRITERS.** See *Code, National Electric.*
- FLEMING VALVE.** A two-electrode vacuum tube, containing filament and plate only.
- FORCED OSCILLATIONS.** See *Oscillations, Forced.*
- FREE OSCILLATIONS.** See *Oscillations, Free.*
- FREQUENCY, AUDIO.** (1) An alter-

nating current whose frequency is low enough to actuate the human ear. (2) Audio frequencies range from zero to 15,000 cycles per second.

**Carrier.** A radio frequency wave on which is superposed two or more audio frequencies separated one from the other and capable of being removed individually at the receiving end.

**Natural.** The natural vibrating rate of a body such as a pendulum or spring or of an electrical circuit containing inductance and capacity.

**Radio.** (1) An oscillating current with a frequency too high to actuate the human ear. (2) Radio frequencies range from 15,000 cycles per second to 300,000,000 cycles or more.

**GRID.** (1) The metal gauze element placed between the filament and the plate of a vacuum tube. It controls the current flowing from the filament to the plate. (2) One of the perforated lead plate elements of a storage battery.

**GRID BATTERY.** See *Battery, C.*

**GRID CIRCUIT.** The circuit to which the grid of a vacuum tube is connected.

**GRID CHARACTERISTICS.** The various relations that could exist between the voltages and currents of the grid of a vacuum tube, and the values which do exist between them when the tube is in operation. These characteristics are generally shown by curves.

**GRID COIL.** An inductance coil connected in series with the grid circuit.

**GRID CONDENSER.** See *Condenser, Grid.*

**GRID LEAD.** The wire or conductor that leads to the grid.

**GRID LEAK.** A high-resistance unit connected in the grid lead of both transmitting and receiving sets. In a transmitter it keeps the voltage of the grid at a constant value and so controls the output of the aerial. In a receiving set it controls the current flowing between the plate and filament.

**GRID MODULATION.** See *Modulation, Grid.*

**GRID POTENTIAL.** The negative or positive voltage of the grid of a vacuum tube.

**GRID VOLTAGE.** See *Grid Potential.*

**GROUND.** See *Earth Connection.*

**GROUND, WATER-PIPE.** A common method of grounding by amateurs is to use the water-pipe or radiator.

**GUIDED WAVE TELEPHONY.** See *Wired Wireless.*

**HARD TUBE.** A vacuum tube in which the vacuum is *high*, that is, exhausted to a high degree.

**HENRY.** The inductance in a circuit in which the electromotive force induced is 1 volt when the inducing current varies at the rate of 1 ampere per second.

**HETERODYNE RECEPTION.** (1) Receiving by the *beat* method. (2) Receiving by means of superposing oscillations generated at the receiving station on the oscillations set up in the aerial by the incoming waves.

**HETERODYNE RECEIVER.** See *Receiver, Heterodyne.*

**HIGH-FREQUENCY CURRENTS.** See *Currents, High-Frequency.*

HIGH-FREQUENCY RESISTANCE. See *Resistance, High-Frequency*.

HIGH-POTENTIAL CURRENTS. See *Currents, High-Potential*.

HIGH-VOLTAGE CURRENTS. See *Currents, High-Potential*.

HONEYCOMB COILS. See *Coils, Inductance*.

HORSEPOWER. Used in rating steam machinery. It is equal to 746 watts.

HOT-WIRE AMMETER. See *Ammeter, Hot-Wire*.

IMPEDANCE. An oscillation circuit has *reactance* and also *resistance*, and when these are combined the total opposition to the current is called *impedance*. Similar to resistance in direct-current work.

INDUCTANCE COILS. See *Coils, Inductance*.

INDUCTION COIL. See *Coil, Induction*.

INDUCTION, MUTUAL. Induction produced between two coils.

INDUCTIVE COUPLING. See *Coupling, Inductive*.

INDUCTIVE REACTANCE. See *Reactance, Inductive*.

INDUCTIVELY COUPLED. Circuits that are coupled together by means of a primary and secondary coil. Transformers are inductively coupled.

INSPECTOR, RADIO. A U. S. inspector whose business it is to issue both station and operators' licenses in the district of which he is in charge.

INSULATION. Materials used on and around wires and other conductors to keep the current from leaking away.

INTERFERENCE. The crossing or superposing of two sets of electric waves of the same or slightly different

lengths which tend to oppose each other. It is the interference between electric waves from different stations that makes selective signaling so difficult a problem.

INTERNATIONAL CODE. See *Code, International*.

JACK. A spring contact receptacle into which a plug is inserted completing a circuit through the device connected to the plug.

JOULE. The energy spent in 1 second by a flow of 1 ampere in 1 ohm.

JOULE'S LAW. The relation between the heat produced in a circuit and the resistance of the circuit. The amount of current flowing and the number of seconds the current flows.

KICK-BACK. Oscillating currents that rise in voltage and tend to flow back through a low-voltage circuit.

KICK-BACK PREVENTION. See *Prevention, Kick-Back*.

KILOCYCLES. A thousand cycles. See *Cycle*.

KILOWATT. 1,000 watts.

LATTICE-WOUND COILS. See *Coils, Inductance*.

LEAD. A wire or other conductor that leads to and is connected with a piece of apparatus.

LIGHTNING SWITCH. See *Switch, Lightning*.

LINE RADIO COMMUNICATION. See *Wired Wireless*.

LINE RADIO TELEPHONY. See *Wired Wireless*.

LITZENDRAHT. A conductor formed of a number of fine insulated copper

- wires either twisted or braided together. It is used to reduce the *skin effect*. See *Resistance, High-Frequency*.
- LOADING COIL. See *Coil, Loading*.
- LONG WAVES. See *Waves, Electric*.
- LOOP ANTENNA. See *Antenna, Loop*.
- LOOSE-COUPLED CIRCUITS. See *Circuits, Loose-Coupled*.
- LOUD SPEAKER. A device that changes electrical energy into sound energy and reproduces the incoming signals, words, or music loud enough to be heard by a room or an auditorium full of people, or by large crowds outdoors.
- MAGNETIC POLES. See *Poles, Magnetic*.
- MEGOHM. One million ohms.
- METER, AUDIBILITY. An instrument for measuring the loudness of a signal by comparison with another signal.
- MHO. The unit of conductance. As conductance is the reciprocal of resistance it is measured by the *reciprocal ohm* or *mho*.
- MICA. A transparent mineral having a high insulating value and which can be split into very thin sheets. It is largely used in making condensers both for transmitting and receiving sets.
- MICROAMPERE. A millionth of an ampere.
- MICROFARAD. The millionth part of a *farad*.
- MICROHENRY. The millionth part of a *henry*.
- MICROHM. The millionth part of an *ohm*.
- MICRO-MICROFARAD. The millionth part of a *microfarad*.
- MICROPHONE TRANSFORMER. See *Transformer, Microphone*.
- MILLIAMMETER. An ammeter that measures a current by the one-thousandth of an ampere.
- MILLIAMPERE. The one-thousandth of an ampere.
- MILLIHENRY. The thousandth part of a *henry*.
- MODULATION. (1) Inflection or varying the voice; (2) Varying the amplitude of oscillations by means of the voice.
- MODULATION, BUZZER. The modulation of radio-frequency oscillations by a buzzer which breaks up the sustained oscillations of a transmitter into audio-frequency impulses.
- MODULATION, CHOPPER. The modulation of radio-frequency oscillations by a chopper which breaks up the sustained oscillations of a transmitter into audio-frequency impulses.
- MODULATION, GRID. The scheme of modulating an oscillator tube by connecting the secondary of a transformer, the primary of which is connected with a microphone, in the grid lead.
- MODULATION, PLATE. Modulating the oscillations set up by a vacuum tube by varying the current impressed on the plate.
- MODULATOR TUBE. A vacuum tube used as a modulator.
- MOTION, WAVE. (1) The to-and-fro motion of water at sea. (2) Waves transmitted by, in, and through the *air*, or sound waves. (3) Waves transmitted by, in, and through the *ether*, or *electromagnetic waves*, or *electric waves* for short.
- MOTOR-GENERATOR. A motor and a

dynamo built to run at the same speed and mounted on a common base, the shafts being coupled together. In radio it is used for changing commercial direct current into alternating current or vice versa.

**MULTI-STAGE AMPLIFIERS.** See *Amplifier, Multi-Stage.*

**MUTUAL INDUCTION.** See *Induction, Mutual.*

**NATIONAL ELECTRIC CODE.** See *Code, National Electric.*

**NATIONAL ELECTRIC SAFETY CODE.** See *Code, National Electric Safety.*

**NEGATIVE ELECTRICITY.** See *Electricity, Negative.*

**OHM.** The resistance of a thread of mercury at the temperature of melting ice, 14.4521 grams in mass, of uniform cross-section and a length of 106.300 centimeters.

**OHM'S LAW.** The important fixed relation between the electric current, its electromotive force and the resistance of the conductor in which it flows.

**OPEN CIRCUIT.** See *Circuit, Open.*

**OPEN-CORE TRANSFORMER.** See *Transformer, Open-Core.*

**OSCILLATION TRANSFORMER.** See *Transformer, Oscillation.*

**OSCILLATION VALVE.** See *Vacuum Tube.*

**OSCILLATIONS, ELECTRIC.** A current that surges through an open or closed circuit. (1) Electric oscillations may be set up by a spark gap, electric arc, or a vacuum tube, when connected with a circuit having inductance and capacity. (2) When electric waves impinge

on an antenna wire they are transformed into electric oscillations of a frequency equal to those which emitted the waves, but since a very small amount of energy is received their potential or voltage is likewise very small.

*Sustained.* Oscillations in which the damping factor is small.

*Damped.* Oscillations in which the damping factor is large.

*Free.* When a condenser discharges through an oscillation circuit; where there is no outside electromotive force acting on it, the oscillations are said to be *free*.

*Forced.* Oscillations that are made to surge in a circuit whose natural period is different from that of the oscillations set up in it.

**OSCILLATOR TUBE.** A vacuum tube which is used to produce electric oscillations.

**OSCILLOGRAPH.** A device for making visible, or photographing the wave forms, of alternating voltages or currents.

**PERIOD.** The length of time needed for one complete cycle of oscillation.

**PERMEABILITY, MAGNETIC.** The degree to which a substance can be magnetized. Iron has a greater magnetic permeability than air.

**PHASE.** The angular relation between current and voltage in a circuit containing inductance and capacity.

**PLATE.** One of the elements of a vacuum tube.

**PLATE CIRCUIT.** The circuit in which the plate of a vacuum tube is connected.

- PLATE CIRCUIT REACTOR.** See *Reactor, Plate Circuit.*
- PLATE CURRENT.** See *Current, Plate.*
- PLATE MODULATION.** See *Modulation, Plate.*
- PLATE VOLTAGE.** See *Voltage, Plate.*
- PLUG.** A device for connecting another device into a circuit in which a jack is wired.
- POLES, BATTERY.** The positive and negative terminals of the elements of a battery. On a storage battery these poles are marked + and - respectively.
- POLES, MAGNETIC.** The ends of a magnet.
- POSITIVE ELECTRICITY.** See *Electricity, Positive.*
- POTENTIAL DIFFERENCE.** The electric pressure between two charged conductors or surfaces.
- POTENTIOMETER.** A variable resistance used for subdividing a voltage. A *voltage divider.*
- POWER TRANSFORMER.** See *Transformer, Power.*
- PREVENTION, KICK-BACK.** A choke coil placed in the power circuit to prevent the high-frequency currents from getting into the transformer and breaking down the insulation.
- PRIMARY.** The input coil or circuit of a transformer.
- PRIMARY BATTERY.** See *Battery, Primary.*
- QST.** An abbreviation used in wireless communication for (1) the question "Have you received the general call?" and (2) the notice, "General call to all stations."
- RADIATION.** The emission, or throwing off, of electric waves by an antenna system.
- RADIO AMMETER.** See *Ammeter, Hot-Wire.*
- RADIO BEACON.** A transmitter used in direction finding.
- RADIO COMPASS.** A receiver using a loop antenna calibrated to indicate the direction from which a signal comes.
- RADIO-FREQUENCY.** See *Frequency, Radio.*
- RADIO-FREQUENCY AMPLIFICATION.** See *Amplification, Radio-Frequency.*
- RADIO-FREQUENCY CURRENT.** See *Current, Radio-Frequency.*
- RADIO INSPECTOR.** See *Inspector, Radio.*
- RADIO WAVES.** See *Waves, Radio.*
- REACTANCE.** The retarding effect of a current flowing in a circuit when the latter embodies capacity and/or inductance.
- REACTANCE, CAPACITY.** The retarding effect on a current of a condenser in the circuit. Capacitive reactance varies inversely with the capacity and with the frequency.
- REACTANCE, INDUCTIVE.** The retarding effect on a current of any inductance in the circuit. Varies directly with the inductance and the frequency.
- REACTOR.** A coil of wire wound with or without an iron core and intended to provide inductive reactance in a circuit.
- REACTOR, FILTER.** A reactance coil with an iron core for use in smoothing out the pulsating direct current in the output circuit of a rectifier tube. More commonly called a choke coil.
- REACTOR, PLATE CIRCUIT.** A reactance



- coil inserted in the plate circuit of a vacuum tube to retard the passage of alternating or pulsating currents.
- RECEIVER. (1) A telephone receiver. (2) An apparatus for receiving signals, speech or music.
- RECEIVER, AUTODYNE. A receiver that has a regenerative circuit and the same tube is used as a detector and as a generator of local oscillations.
- RECEIVER, BEAT. A heterodyne receiver.
- RECEIVER, HETERODYNE. A receiving set that uses a separate vacuum tube to set up the second series of waves for beat reception.
- RECEIVER, LOUD SPEAKING. See *Loud Speakers*.
- RECEIVING TUNING COILS. See *Coils, Inductance*.
- RECTIFIER. An apparatus for changing alternating current into pulsating direct current.
- REGENERATIVE ACTION. See *Feed-Back Action*.
- REGENERATIVE AMPLIFICATION. See *Amplification, Regenerative*.
- RELAY, ELECTRON. A vacuum tube when used as a detector or an amplifier.
- RESISTANCE. The opposition offered by a wire or other conductor to the passage of a current.
- RESISTANCE, ANTENNA. The resistance of the antenna wire to oscillating currents. This is greater than its ordinary ohmic resistance due to the skin effect. See *Resistance, High-Frequency*.
- RESISTANCE BOX. See *Resistor*.
- RESISTANCE BRIDGE. An apparatus for measuring the resistance (in ohms) of a circuit.
- RESISTANCE COIL. A coil made of wire that has a high resistance, as German silver, and which is used to vary the strength of the current flowing through a circuit.
- RESISTANCE COUPLING. See *Coupling, Resistance*.
- RESISTANCE, HIGH-FREQUENCY. When a high-frequency current oscillates on a wire two things take place that are different than when a direct or alternating current flows through it, and these are (1) the current inside of the wire lags behind the current on the surface, and (2) the amplitude of the current is largest on the surface and grows smaller as the center of the wire is reached. This uneven distribution of the current is known as the *skin effect*. It amounts to the same thing as reducing the size of the wire, hence the resistance is increased.
- RESISTIVITY. The resistance of a given length of wire of uniform cross section. The reciprocal of *conductivity*.
- RESISTOR. A fixed or variable resistance unit or a group of such units. Variable resistors are also called *resistance boxes* and more often *rheostats*.
- RESONANCE. (1) Simple resonance of sound is its increase set up in one body by the sympathetic vibration of a second body. (2) By extension the increase in the amplitude of electric oscillations when the circuit in which they surge has a *natural* period that is the same, or nearly the same, as the period of the first oscillation circuit.
- RHEOSTAT. A variable resistance unit. See *Resistor*.
- RHEOSTAT, FILAMENT. A variable resistance used primarily to adjust the

- voltage supply to the needs of the filaments of vacuum tubes.
- ROTATING COIL. See *Coil*.
- RUHMKORFF COIL. See *Coil, Induction*.
- SATURATION. The maximum plate current reached in a vacuum tube.
- SCREEN GRID VACUUM TUBE. See *Vacuum Tube*.
- SECONDARY. The output coil or circuit of a transformer.
- SHIELD. A metal barrier or complete enclosure placed around one or more components of a circuit to prevent interaction between circuits.
- SHORT WAVES. See *Waves*.
- SIGNALS, CONVENTIONAL. The International Morse alphabet and numeral code, punctuation marks, and a few important abbreviations.
- SKIN EFFECT. See *Resistance, High-Frequency*.
- SOCKET POWER UNIT. A device that will furnish *A*, *B*, and *C* battery power from the houselighting line. Usually consists of a rectifier, filter, and voltage divider.
- SOFT TUBE. A vacuum tube in which the vacuum is *low*; one that is not highly exhausted.
- SPACE CHARGE EFFECT. The electric field created by the excess of electrons in the space between the filament and plate which at last equals and neutralizes that due to the positive potential of the plate so that there is no force acting on the electrons near the filament.
- SPARK. See *Discharge*.
- SPARK COIL. See *Coil, Induction*.
- SPIDER-WEB INDUCTANCE COIL. See *Coil, Spider-Web Inductance*.
- SPREADER. A stick of wood, or spar, that holds antenna wires apart.
- STAGGER WOUND COILS. See *Coils, Inductance*.
- STAND-BY CIRCUITS. See *Circuits, Stand-By*.
- STATIC. Also called *atmospherics, grinders, strays, X's*, and, when bad enough, by other names. It is an electrical disturbance in the atmosphere which makes noises in the receiver.
- STATOR. The fixed or stationary coil of a variometer or a variocoupler.
- STRAIGHT-LINE FREQUENCY. The term applied to condensers whose variable plates are cut in such a shape that if the frequency is plotted on graph paper against the dial settings the result will be a straight line. There are also dials for rotating the movable plates of the ordinary type of condenser, in such a way that the distance they move per scale unit varies throughout the length of the scale, giving the same effect as a S.L.F. condenser.
- STRAYS. See *Static*.
- SWINGING. See *Fading*.
- SWITCH, ANTENNA. A switch used to change over the antenna lead from transmitter to receiver where the same antenna is used for both purposes.
- SWITCH, LIGHTNING. The switch that connects the antenna lead-in direct to ground when the station is not in use. Recommended as a protective measure.
- SYMBOLS, APPARATUS. Also called *conventional symbols*. These are diagrammatic lines and signs representing various pieces of apparatus in a schematic diagram of a receiver or transmitter.

**TELEVISION.** Literally, sight-at-a-distance. The name applied to a system of radio communication whereby the image of an object is broken down into small details, transmitted by electrical impulses from one point to another and then reconstructed in identical order to re-compose the original image.

**THERMAL AMMETER.** See *Ammeter, Hot-Wire.*

**THREE-ELECTRODE VACUUM TUBE.** See *Vacuum Tube, Three-Electrode.*

**TICKLER.** A coil forming part of a tuned circuit which permits the feeding back of part of the oscillations from plate to grid circuit of a detector tube. The basis of every regenerative receiver.

**TICKER.** A slipping contact device that breaks up the sustained oscillations (c.w.) at the receiving end so that the signals may become audible in phones or loud speaker.

**TRANSFORMER.** A primary and a secondary coil for changing the amplitude of alternating currents.

*Air Cooled.* A transformer in which the coils are cooled by contact with the air.

*Air Core.* A transformer in which the coils are wound over a hollow form without the presence of iron. Used primarily in circuits of high frequencies.

*Auto.* A single coil of wire in which one part forms the primary and the other part the secondary.

*Audio Amplifying.* This is a transformer with an iron core and is used for frequencies up to 15,000.

*Closed Core.* A transformer in which the path of the magnetic flux is entirely through iron. Power

transformers have closed cores.

*Microphone.* A small transformer for modulating the oscillations set up by a vacuum tube oscillator.

*Oil Cooled.* A transformer in which the coils are immersed in oil.

*Open Core.* A transformer in which the path of the magnetic flux is partly through iron and partly through air. Induction coils have open cores.

*Oscillation.* A coil or coils for transforming or stepping down or up oscillating currents.

*Power.* A transformer for altering the amplitude of the commercial supply current for use in radio apparatus.

*Radio Amplifying.* A transformer with an air core or a small core of high permeability iron. Used to couple vacuum tubes in the radio frequency stages.

**TRANSMITTING TUNING COILS.** See *Coils, Inductance.*

**TUNING.** The act of varying inductance or capacity or both in a radio circuit for the purpose of arriving at a condition of resonance, said condition being essential in preparing a receiver or transmitter to operate most effectively and efficiently at a given frequency.

**TUNING COILS.** See *Coils, Inductance.*

**TWO-ELECTRODE VACUUM TUBE.** See *Vacuum Tube, Two-Electrode.*

**VACUUM TUBE.** A bulb with two or more electrodes from which the air has been exhausted, or which is filled with an inert gas, and used as a detector, an amplifier, an oscillator, or a modulator in wireless telegraphy and telephony.

- Amplifier.** See *Amplifier, Vacuum Tube.*
- Gas Content.** A tube made like a vacuum tube which contains an inert gas instead of being exhausted.
- Hard.** See *Hard Tube.*
- Heater Type.** A tube having its cathode heated by radiation from a separate filament.
- Power.** A tube especially designed for use in the last stage of an audio-frequency amplifier.
- Rectifier.** (1) A vacuum tube detector. (2) A vacuum tube used for changing commercial alternating current into direct current.
- Screen-Grid.** A tube in which the plate is surrounded by a wire mesh.
- Soft.** See *Soft Tube.*
- Three Electrode.** A vacuum tube with three electrodes, namely a *filament*, a *grid*, and a *plate*.
- Two Electrode.** A vacuum tube with two electrodes, namely, the *filament* and the *plate*.
- VALVE.** See *Vacuum Tube.*
- VALVE, FLEMING.** See *Fleming Valve.*
- VARIABLE CONDENSER.** See *Condenser, Variable.*
- VARIOCOUPLER.** A tuning device for varying inductance. It consists of a fixed and a rotatable coil whose windings are not connected with each other.
- VARIOMETER.** A tuning device for varying inductance. It consists of a fixed and a rotatable coil with the coils connected in series.
- VERNIER CONDENSER.** See *Condenser, Vernier.*
- VOLT.** The electromotive force which produces a current of 1 ampere when steadily applied to a conductor, the resistance of which is one ohm.
- VOLTAGE DIVIDER.** See *Potentiometer.*
- VOLTAGE, PLATE.** The voltage used to energize the plate of a vacuum tube.
- VOLTMETER.** An instrument for measuring voltage.
- WATER-PIPE GROUND.** See *Ground, Water-Pipe.*
- WATT.** The power spent by a current of 1 ampere in a resistance of 1 ohm.
- WAVE, BROAD.** A wave having a high decrement, when the strength of the signals is nearly the same over a wide range of frequencies.
- WAVELENGTH.** The distance between the crests of two successive waves.
- WAVEMETER.** An instrument for measuring the length of electric waves generated by any oscillating device.
- WAVE MOTION.** Disturbances set up in any medium such as water, air, or ether.
- WAVES.** See *Wave Motion.*
- WAVES, ELECTRIC.** Electromagnetic waves transmitted through the ether.
- Broadcast.** Waves from 200 to 550 meters in length.
- Continuous-Abbreviated to C.W.** Trains of waves having equal and unchanging amplitude.
- Interrupted Continuous.** A C.W. wave which is modulated by a sustained note of audible frequency. Called I.C.W.
- Intermediate.** Waves from 600 to 2,000 meters in length.
- Long.** Waves above 2,000 meters.
- Short.** Waves from 200 meters down to 10 meters.
- Ultra-Short.** Waves below 10 meters.

*Undamped.* Same as C.W.

**WIRED WIRELESS.** The process of transmitting intelligence by superimposing one or more high-frequency waves on a telephone or power line. Also called carrier frequency and guided wave telephony.

**WIRE, ENAMELED.** Wire coated with an insulating enamel.

**WIRE, PHOSPHOR BRONZ.** A wire drawn from an alloy of copper and a trace of phosphorus. Known for its high tensile strength.

## Radio Don'ts

### ANTENNAS

**DON'T**—use any old piece of wire for your antenna. For long spans choose copper wire with a steel core or one of the heavier stranded cables.

—**STINT** on insulators, particularly when transmitting. Poor quality insulators will prevent any success in making distant contacts.

—**FAIL** to install a lightning arrester especially if your location is in the country or in an open space in the city. And once installed, inspect it before thunder storms are due each year. A good arrester will also help to reduce noise by draining inductive charges from the antenna.

—**TRY** to get a good ground connection via a gas pipe line. Such piping is usually insulated from the earth, and while it might function for a receiving set it would constitute a hazard if selected for a transmitter ground.

—**LEAVE** joints unsoldered, particularly where lead-ins join the antenna proper. Joints that are merely twisted together are responsible for much of the noise that creeps into radio receivers.

—**BRING** the lead-in through the house walls without using an insulator.

—**LET** antenna or lead-in come in contact at any time with trees, structures, wires, or other antennas.

—**ERECT** an antenna within twenty feet of a power line and *never* string the wire so that it passes over or under power or telephone wires.

—**PUT UP** a transmitting antenna in such a way that it cannot be lowered easily for repairs, inspection, or alteration.

## TRANSMITTERS

- DON'T—attempt to transmit until you have received your license.
- OPERATE until you have become acquainted with every important rule and regulation of the Federal laws governing Amateur Radio.
  - USE more power than permitted even for a brief instant. That might be the one time when your signal is being checked by an inspector.
  - OVERLOOK every safety precaution in the arrangement and operation of your station. Only a *live* amateur is a credit to his craft.
  - ASSUME an overbearing attitude toward complaints by BCLs. You have some rights; they have many rights and are in the majority. A friendly approach will do more for you and amateur radio than all the technical arguments you can advance.
  - TRANSMIT until you have first listened in.
  - HOG the air with long calls. Give a short call and wait for a response, then call again.
  - TRY to show your cleverness and speed with key or bug. The man who moves traffic is the operator with a smooth, clean fist who leaves his show of speed to the speed contests.
  - FORGET to keep your log up to date. The more complete the data the higher your standing as an amateur. The FCC requires that each amateur keep his log for one year. To do otherwise is to risk a citation.
  - OVERLOOK the possibility of an emergency in your vicinity and be prepared for it with at least the “makings” of a low-powered transmitter.
  - FAIL to monitor your signal frequently, particularly if you know you are working near one end of the allotted band.

## RECEIVERS

- DON'T—expect to get the same results from an old receiver even if it was the best of its kind when new. With more amateurs operating, the receiver must be more selective if traffic is to be moved freely.
- OVERLOOK the new tubes, many of which can be incorporated in an old receiver with only slight alterations.
  - CONDEMN a commercial receiver over the air merely because you may have had bad luck with it. Talk about something else.
  - OVERDO the transmitting just because you have a station available,

Do a fair amount of listening and leave the air to those who have more important business to transact.

- LAY out a new circuit on panel and permanent baseboard at first. Set up the parts on a breadboard and check its operation, make any alterations that are advisable and THEN transfer the components to the final chassis and panel.
- HESITATE to rearrange parts if an inch of grid wiring can be eliminated thereby, particularly in the r-f and i-f circuits.
- CONTINUE to use a power transformer that becomes too hot to touch after continuous operation. Replace it with one of sufficient output.
- USE an underrated rectifier tube if you expect stable operation of the tubes in your receiver.
- WASTE time in replacing an electrolytic condenser in the filter unit if it shows signs of overloading. If the metal case gets hot or if a white deposit appears around the "breather" ring, a breakdown with possible damage to tube and transformer is in the offing.
- ENVY the man who owns a super-super receiver of 14 tubes if you can't afford one. Many a highly rated amateur is doing yeoman work with a pair of headphones on the rear end of a five-tube, homemade receiver.

### International Call Letters

Under international agreement, the first letter of the first two letters of radio call signals indicates the nationality of the station. According to Section 1, Article 14 of the International Radio Conference at Cairo in 1938, as annexed to the International Telecommunications Convention at Madrid in 1932:

"All stations open to the international service of public correspondence and all aircraft stations not open to the international service of public correspondence as well as amateur stations, private experimental stations and private radio stations, must have call signals from the international series assigned to each country. . . ."

As a general rule, land stations use three letters, ship stations four letters, and aircraft stations five letters. One or two letters and a single figure followed by a group of not more than three letters identify amateur stations and private stations.

The allocation of call signals fixed by the Cairo convention is as follows:

<i>Call Signals</i>	<i>Country</i>	<i>Call Signals</i>	<i>Country</i>
CAA-CEZ ...	Chile	J .....	Japan
CFA-CKZ ...	Canada	K .....	United States
CLA-CMZ ...	Cuba	LAA-LNZ ...	Norway
CNA-CNZ ...	Morocco	LOA-LWZ ...	Argentina
COA-COZ ...	Cuba	LXA-LXZ ...	Luxemburg
CPA-CPZ ...	Bolivia	LYA-LYZ ...	Lithuania
CQA-CRZ ...	Portuguese Colonies	LZA-LZZ ...	Bulgaria
CSA-CUZ ...	Portugal	M .....	Great Britain
CVA-CXZ ...	Uruguay	N .....	United States
CYA-CZZ ...	Canada	OAA-OCZ ...	Peru
D .....	Germany	ODA-ODZ ...	Syria and Lebanon
EAA-EHZ ...	Spain	OEA-OEZ ...	Austria
EIA-EJZ ...	Ireland	OFA-OJZ ...	Finland
EKA-EKZ ...	Japan	OKA-OMZ ...	Czechoslovakia
ELA-ELZ ...	Liberia	ONA-OTZ ...	Belgium and Colonies
EPA-EQZ ...	Iran	OUA-OZZ ...	Denmark
ERA-ERZ ...	Japan	PAA-PIZ ...	Netherlands
ESA-ESZ ...	Estonia	PJA-PJZ ...	Curaçao
ETA-ETZ ...	Ethiopia	PKA-POZ ...	Netherlands Indies
EUA-EYZ ...	Japan	PPA-PYZ ...	Brazil
EZA-EZZ ...	Germany	PZA-PZZ ...	Surinam
F .....	France and Colonies	Q .....	(Abbreviations)
G .....	Great Britain	R .....	U.S.S.R.
HAA-HAZ ...	Hungary	SAA-SMZ ...	Sweden
HBA-HBZ ...	Switzerland	SNA-SRZ ...	Poland
HCA-HDZ ...	Ecuador	SSA-SUZ ...	Egypt
HEA-HEZ ...	Switzerland	SVA-SZZ ...	Greece
HFA-HFZ ...	Poland	TAA-TCZ ...	Turkey
HGA-HGZ ...	Japan	TDA-TDZ ...	Guatemala
HHA-HHZ ...	Haiti	TEA-TEZ ...	Costa Rica
HIA-HIZ ...	Dominican Republic	TFA-TFZ ...	Iceland
HJA-HKZ ...	Colombia	TGA-TGZ ...	Guatemala
HLA-HMZ ...	Japan	THA-THZ ...	France and Colonies
HNA-HNZ ...	Iraq	TIA-TIZ ...	Costa Rica
HOA-HPZ ...	Panama	TJA-TZZ ...	France and Colonies
HQA-HRZ ...	Honduras	U .....	U.S.S.R.
HSA-HSZ ...	Siam	VAA-VGZ ...	Canada
HTA-HTZ ...	Nicaragua	VHA-VNZ ...	Australia
HUA-HUZ ...	El Salvador	VOA-VOZ ...	Newfoundland
HVA-HVZ ...	Vatican City	VPA-VSZ ...	British Colonies
HWA-HYZ ...	France and Colonies	VTA-VWZ ...	British India
HZA-HZZ ...	Saudi Arabia	VXA-XYZ ...	Canada
I .....	Italy and Colonies	XZA-VZZ ...	Australia



<i>Call Signals</i>	<i>Country</i>	<i>Call Signals</i>	<i>Country</i>
W . . . . .	United States	YOA-YRZ . . .	Rumania
XAA-XFZ . . .	Mexico	YSA-YSZ . . .	El Salvador
XGA-XUZ . . .	China	YTA-YUZ . . .	Yugoslavia
XVA-XWZ . . .	France and Colonies	YVA-YWZ . . .	Venezuela
XXA-XXZ . . .	Portuguese Colonies	YXA-YZZ . . .	U.S.S.R.
XYA-XZZ . . .	Burma	ZAA-ZAZ . . .	Albania
YAA-YAZ . . .	Afghanistan	ZBA-ZJZ . . .	British Colonies
YBA-YHZ . . .	Netherlands Indies	ZKA-ZMZ . . .	New Zealand
YIA-YIZ . . .	Iraq	ZNA-ZOZ . . .	British Colonies
YJA-YJZ . . .	New Hebrides	ZPA-ZPZ . . .	Paraguay
YKA-YKZ . . .	U.S.S.R.	ZQA-ZQZ . . .	British Colonies
YLA-YLZ . . .	Latvia	ZRA-ZUZ . . .	Union of South Africa
YMA-YMZ . . .	Danzig	ZVA-ZZZ . . .	Brazil
YNA-YNZ . . .	Nicaragua		

### U. S. Radio Districts

#### *District*

<i>No.</i>	<i>Territory Included</i>	<i>Address</i>
1	States of Connecticut, Maine, Massachusetts, New Hampshire, Rhode Island, and Vermont.	Customhouse, Boston, Mass.
2	Counties of Albany, Bronx, Columbia, Delaware, Dutchess, Greene, Kings, Nassau, New York, Orange, Putnam, Queens, Rensselaer, Richmond, Rockland, Schenectady, Suffolk, Sullivan, Ulster, and Westchester of the State of New York; and the counties of Bergen, Essex, Hudson, Hunterdon, Mercer, Middlesex, Monmouth, Morris, Passaic, Somerset, Sussex, Union, and Warren of the State of New Jersey.	Federal Building, 641 Washington St., New York, N.Y.
3	Counties of Adams, Berks, Bucks, Carbon, Chester, Cumberland, Dauphin, Delaware, Lancaster, Lebanon, Lehigh, Monroe, Montgomery, Northampton, Perry, Philadelphia, Schuylkill, and York of the State of Pennsylvania; and the counties of Atlantic, Burlington, Camden, Cape May, Cumberland, Gloucester, Ocean, and Salem of the State of New Jersey; and the county of Newcastle of the State of Delaware.	Room 1200, U. S. Customhouse, Second and Chestnut Sts., Philadelphia, Pa.

<i>District No.</i>	<i>Territory Included</i>	<i>Address</i>
4	State of Maryland; the District of Columbia; the counties of Arlington, Clark, Fairfax, Fauquier, Frederick, Loudoun, Page, Prince William, Rappahannock, Shenandoah and Warren of the State of Virginia; and the counties of Kent and Sussex of the State of Delaware.	Fort McHenry, Baltimore, Md.
5	State of Virginia except that part lying in District 4, and the State of North Carolina except that part lying in District 6.	402 New Post Office Bldg., Norfolk, Va.
6	States of Alabama, Georgia, South Carolina, and Tennessee; and the counties of Ashe, Avery, Buncombe, Burke, Caldwell, Cherokee, Clay, Cleveland, Graham, Haywood, Henderson, Jackson, McDowell, Macon, Madison, Mitchell, Polk, Rutherford, Swain, Transylvania, Watauga, and Yancey of the State of North Carolina.	411 Federal Annex, Atlanta, Ga.
7	State of Florida.	312 Federal Bldg., Miami, Fla.
8	States of Arkansas, Louisiana, and Mississippi; and the city of Texarkana in the State of Texas.	326 Customhouse, New Orleans, La.
9	Counties of Arkansas, Brazoria, Brooks, Calhoun, Cameron, Chambers, Fort Bend, Galveston, Goliad, Harris, Hidalgo, Jackson, Jefferson, Jim Wells, Kenedy, Kleberg, Matagorda, Nueces, Refugio, San Patricio, Victoria, Wharton, and Willacy of the State of Texas.	404-406 Federal Bldg., Galveston, Tex.
10	State of Texas except that part lying in District 9 and in the city of Texarkana; and the States of Oklahoma and New Mexico.	302 U. S. Terminal Annex Bldg., Dallas, Tex.
11	State of Arizona; the county of Clarke in the State of Nevada; and the counties of Imperial, Inyo, Kern, Los Angeles, Orange, Riverside, San Bernardino, San Diego, San Luis Obispo, Santa Barbara, and Ventura of the State of California.	1105 Rives-Strong Building, Los Angeles, Calif.
12	State of California except that part lying in District 11; the State of Nevada except the county of Clarke.	328 Customhouse, San Francisco, Calif.

<i>District No.</i>	<i>Territory Included</i>	<i>Address</i>
13	State of Oregon; and the State of Idaho except that part lying in District 14.	207 New U. S. Courthouse Bldg., Portland, Ore.
14	Territory of Alaska; the State of Washington; the counties of Benewah, Bonner, Boundary, Clearwater, Idaho, Kootenai, Latah, Lewis, Nez Perce, and Shoshone of the State of Idaho; the counties of Beaverhead, Broadwater, Cascade, Deerlodge, Flathead, Gallatin, Glacier, Granite, Jefferson, Lake, Lewis & Clark, Lincoln, Madison, Meagher, Mineral, Missoula, Pondera, Powell, Ravalli, Sanders, Silver Bow, Teton, and Toole of the State of Montana.	808 Federal Office Building, Seattle, Wash.
15	States of Colorado, Utah, and Wyoming; and the State of Montana except that part lying in District 14.	504 Customhouse, Denver, Colo.
16	States of North Dakota, South Dakota, and Minnesota; the counties of Alger, Baraga, Chippewa, Delta, Dickinson, Gogebic, Houghton, Iron, Keweenaw, Luce, Mackinac, Marquette, Menominee, Ontonagon, and Schoolcraft of the State of Michigan; and the State of Wisconsin except that part lying in District 18.	927 New P. O. Bldg., St. Paul, Minn.
17	States of Nebraska, Kansas, and Missouri; and the State of Iowa except that part lying in District 18.	609 Pickwick Bldg., 903 McGee Street, Kansas City, Mo.
18	States of Indiana and Illinois; the counties of Allamakee, Buchanan, Cedar, Clayton, Clinton, Delaware, Des Moines, Dubuque, Fayette, Henry, Jackson, Johnson, Jones, Lee, Linn, Louisa, Muscatine, Scott, Washington, and Winneshiek of the State of Iowa; the counties of Columbia, Crawford, Dane, Dodge, Grant, Green, Iowa, Jefferson, Kenosha, Lafayette, Milwaukee, Ozaukee, Racine, Richland, Rock, Sauk, Walworth, Washington, and Waukesha of the State of Wisconsin.	246 U. S. Courthouse Bldg., Chicago, Ill.
19	State of Michigan except that part lying in District 16; the States of Ohio, Kentucky, and West Virginia.	1025 New Federal Bldg., Detroit, Mich.

<i>District No.</i>	<i>Territory Included</i>	<i>Address</i>
20	State of New York except that part lying in District 2, and the State of Pennsylvania except that part lying in District 3.	514 Federal Building, Buffalo, N.Y.
21	Territory of Hawaii, Guam, and American Samoa.	Aloha Tower, Honolulu, T.H.
22	Puerto Rico and the Virgin Islands.	303 Ochoa Bldg., San Juan, P.R.

### REGULATIONS APPLICABLE TO AMATEUR RADIO STATIONS

The Communications Act of 1934 created a Federal Communication Commission composed of seven commissioners appointed by the President. The commissioners are empowered to issue such regulations not inconsistent with the law as it may deem necessary to properly regulate radio and wire communication. General regulations for amateurs have been drafted and those in effect at the present time are printed here.

It is not necessary to memorize the exact wording but every amateur should be thoroughly familiar with these regulations.

**SEC. 12.1. *Amateur service.*** The term "amateur service" means a radio service carried on by amateur stations.

**SEC. 12.02. *Amateur station.*** The term "amateur station" means a station used by an "amateur," that is, a duly authorized person interested in radio technique solely with a personal aim and without pecuniary interest. It embraces all radio transmitting apparatus at a particular location used for amateur service and operated under a single instrument of authorization.

**SEC. 12.03. *Amateur portable station.*** The term "amateur portable station" means an amateur station that is portable in fact, that is so constructed that it may conveniently be moved about from place to place for communication, and that is in fact so moved from time to time, but which is not operated while in motion.

**SEC. 12.04. *Amateur portable-mobile station.*** The term "amateur portable-mobile station" means an amateur station that is portable in fact, that is so constructed that it may conveniently be transferred to or from a mobile unit or from one such unit to another, and that is in fact so transferred from time to time and is ordinarily used while such mobile unit is in motion.

**SEC. 12.05. *Amateur radio communication.*** The term "amateur radio communication" means radio communication between amateur stations solely with a personal aim and without pecuniary interest.

**SEC. 12.06. *Amateur operator.*** The term "amateur operator" means a person holding a valid license issued by the Federal Communications Commission authorizing him to operate licensed amateur stations.

## LICENSES; PRIVILEGES

SEC. 12.21. *Eligibility for license.* The following are eligible to apply for amateur operator license and privileges:

*Class A*—A United States citizen who has within five years of receipt of application held license as an amateur operator for a year or who in lieu thereof qualified under Section 12.46.

*Class B*—Any United States citizen.

*Class C*—A United States citizen whose actual residence, address, and station, are more than 125 miles airline from the nearest point where examination is given at least quarterly for Class B; or is shown by physician's certificate to be unable to appear for examination due to protracted disability; or is shown by certificate of the commanding officer to be in a camp of the Civilian Conservation Corps or in the regular military or naval service of the United States at a military post or naval station and unable to appear for Class B examination.

SEC. 12.22. *Classification of operating privileges.* Amateur operating privileges are as follows:

*Class A*—All amateur privileges.

*Class B*—Same as Class A except specially limited as in Section 12.4116.

*Class C*—Same as Class B.

SEC. 12.23. *Scope of operator authority.* Amateur operators' licenses are valid only for the operation of licensed amateur stations; *provided, however, any person holding a valid radio operator's license of any class may operate stations in the experimental service licensed for, and operating on, frequencies above 300,000 kilocycles.*

SEC. 12.24. *Posting of license.* The original operator's license shall be posted in a conspicuous place in the room occupied by such operator while on duty or kept in his personal possession and available for inspection at all times while the operator is on duty, except when such license has been filed with application for modification or renewal, or has been mutilated, lost, or destroyed, and application has been made for a duplicate.

SEC. 12.25. *Duplicate license.* Any licensee applying for a duplicate license to replace an original which has been lost, mutilated, or destroyed, shall submit to the Commission such mutilated license or affidavit attesting to the facts regarding the manner in which the original was lost or destroyed. If the original is later found, it or the duplicate shall be returned to the Commission.

SEC. 12.26. *Renewal of amateur operator license.* An amateur operator license may be renewed upon proper application and a showing that within three months of receipt of the application by the Commission the licensee has lawfully operated an amateur station licensed by the Commission, and that he has communicated by radio with at least three other such amateur stations. Failure to meet the requirements of this section will make it necessary for the applicant to again qualify by examination.

SEC. 12.27. *Who may operate an amateur station.* An amateur station may

be operated only by a person holding a valid amateur operator's license, and then only to the extent provided for by the class of privileges for which the operator's license is endorsed. When an amateur station uses radiotelephony (type A-3 emission) the licensee may permit any person to transmit by voice, provided a duly licensed amateur operator maintains control over the emissions by turning the carrier on and off when required and signs the station off after the transmission has been completed.

## EXAMINATIONS

SEC. 12.41. *When required.* Examination is required for a new license as an amateur operator or for change of class of privileges.

SEC. 12.42. *Elements of examination.* The examination for amateur operator privileges will comprise the following elements:

1. Code test—ability to send and receive, in plain language, messages in the International Morse Code at a speed of not less than thirteen words per minute, counting five characters to the word, each numeral or punctuation mark counting as two characters.

2. Amateur radio operation and apparatus, both telephone and telegraph.

3. Provisions of treaty, statute, and regulations affecting amateurs.

4. Advanced amateur radiotelephony.

SEC. 12.43. *Elements required for various privileges.* Examinations for Class A privileges will include all four examination elements as specified in Section 12.42.

Examinations for Classes B and C privileges will include elements 1, 2, and 3 as set forth in Section 12.42.

SEC. 12.44. *Manner of conducting examination.* Examinations for Class A and Class B privileges will be conducted by an authorized Commission employee or representative at points specified by the Commission.

Examinations for Class C privileges will be given by volunteer examiner(s), whom the Commission may designate or permit the applicant to select; in the latter event the examiner giving the code test shall be a holder of an amateur license with Class A or B privileges, or have held within five years a license as a professional radiotelegraph operator or have within that time been employed as a radiotelegraph operator in the service of the United States; and the examiner for the written test, if not the same individual, shall be a person of legal age.

SEC. 12.45. *Additional examination for holders of Class C privileges.* The Commission may require a licensee holding Class C privileges to appear at an examining point for a Class B examination. If such licensee fails to appear for examination when directed to do so, or fails to pass the supervisory examination, the license held will be canceled and the holder thereof will not be issued another license for the Class C privileges.

Whenever the holder of Class C amateur operator privileges changes his actual residence or station location to a point where he would not be eligible

to apply for Class C privileges in the first instance, or whenever a new examining point is established in a region from which applicants were previously eligible for Class C privileges, such holders of Class C privileges shall within four months thereafter appear at an examining point and be examined for Class B privileges. The license will be canceled if such licensee fails to appear, or fails to pass the examination.

SEC. 12.46. *Examination abridgment.* An applicant for Class A privileges, who holds a license with Class B privileges, will be required to pass only the added examination element No. 4. (See Section 12.42.)

A holder of Class C privileges will not be accorded an abridged examination for either Class B or Class A privileges.

An applicant who has held a license for the class of privileges specified below, within five years prior to receipt of application, will be credited with examination elements as follows:

<i>Class of license or privileges</i>	<i>Credits</i>
Commercial extra first .....	Elements 1, 2, & 4
Radiotelegraph 1st, 2nd, or 3rd .....	Elements 1 & 2
Radiotelephone 1st or 2nd .....	Elements 2 & 4
Class A .....	Elements 2 & 4

No examination credit is given on account of license of Radiotelephone 3rd Class, nor for other class of license or privileges not above listed.

SEC. 12.47. *Examination procedure.* Applicants shall write examinations in longhand—code tests and diagrams in ink or pencil, written tests in ink—except that applicants unable to do so because of physical disability may typewrite or dictate their examinations and, if unable to draw required diagrams, may make instead a detailed description essentially equivalent. The examiner shall certify the nature of the applicant's disability and, if the examination is dictated, the name and address of the person(s) taking and transcribing the applicant's dictation.

SEC. 12.48. *Grading.* Code tests are graded as passed or failed, separately for sending and receiving tests. A code test is failed unless free of omission or other error for a continuous period of at least one minute at required speed. Failure to pass the required code test will terminate the examination. (See Sec. 12.49.)

A passing grade of 75 per cent is required separately for Class B and Class A written examinations.

SEC. 12.49. *Eligibility for reexamination.* An applicant who fails examination for amateur privileges may not take another examination for such privileges within two months, except that this rule shall not apply to an examination for Class B following one for Class C.

## LICENSES

SEC. 12.61. *Eligibility for amateur station license.* License for an amateur station will be issued only to a licensed amateur operator who has made a satisfactory showing of control of proper transmitting apparatus and control of the premises upon which such apparatus is to be located; provided, however, that in the case of an amateur station of the military or Naval Reserve of the United States located in approved public quarters and established for training purposes, but not operated by the United States Government, a station license may be issued to a person in charge of such a station although not a licensed amateur operator.

SEC. 12.62. *Eligibility of corporations or organizations to hold license.* An amateur station license will not be issued to a school, company, corporation, association, or other organization; nor for their use; *provided, however*, that in the case of a bona fide amateur radio society a station license may be issued in accordance with Section 12.61 to a licensed amateur operator as trustee for such society.

SEC. 12.63. *Location of station.* An amateur radio station, and the control point thereof when remote control is authorized, shall not be located on premises controlled by an alien.

SEC. 12.64. *License period.* License for an amateur station will normally be for a period of three years from the date of issuance of a new, renewed, or modified license.

SEC. 12.65. *Authorized operation.* An amateur station license authorizes the operation of all transmitting apparatus used by the licensee at the location specified in the station license and in addition the operation of portable and portable-mobile stations at other locations under the same instrument of authorization.

SEC. 12.66. *Renewal of amateur station license.* An amateur station license may be renewed upon proper application and a showing that, within three months of receipt of the application by the Commission, the licensee thereof has lawfully operated such station in communication by radio with at least three other amateur stations licensed by the Commission, except that in the case of an application for renewal of station license issued for an amateur society or reserve group, the required operation may be by any licensed amateur operator. Upon failure to comply with the above requirements, a successor license will not be granted until two months after expiration of the old license.

SEC. 12.67. *Posting of station license.* The original of each station license or a facsimile thereof shall be posted by the licensee in a conspicuous place in the room in which the transmitter is located or kept in the personal possession of the operator on duty, except when such license has been filed with application for modification or renewal, or has been mutilated, lost, or destroyed, and application has been made for a duplicate.



## CALL SIGNALS

SEC. 12.81. *Assignment of call letters.* Amateur station calls will be assigned in regular order and special requests will not be considered except that a call may be reassigned to the latest holder, or if not under license during the past five years to any previous holder, or to an amateur organization in memoriam to a deceased member and former holder, and particular calls may be temporarily assigned to stations connected with events of general public interest.

SEC. 12.82. *Call signals for member of U.S.N.R.* In the case of an amateur licensee whose station is licensed to a regularly commissioned or enlisted member of the United States Naval Reserve, the Commandant of the naval district in which such station is located may authorize in his discretion the use of the call-letter prefix N in lieu of the prefix W or K, assigned in the license issued by the Commission, provided that such N prefix shall be used only when operating in the frequency bands 1715-2000<sup>1</sup> kilocycles, 3500-4000 kilocycles, 56,000-60,000 kilocycles, and 400,000-401,000 kilocycles in accordance with instructions to be issued by the Navy Department.

SEC. 12.83. *Transmission of call signals.* An operator of an amateur station shall transmit its assigned call at the end of each transmission and at least once every ten minutes during transmission of more than ten minutes' duration: *provided, however,* that transmission of less than one minute duration from stations employing break-in operation need be identified only once every ten minutes of operation and at the termination of the correspondence. In addition, an operator of an amateur portable or portable-mobile radiotelegraph station shall transmit immediately after the call of the station the fraction-bar character (DN) followed by the number of the amateur call area in which the portable or portable-mobile amateur station is then operating, as for example:

Example 1. Portable or portable-mobile amateur station operating in the third amateur call area calls a fixed amateur station: W1ABC W1ABC W1ABC DE W2DEF DN3 W2DEF DN3 W2DEF DN3 AR.

Example 2. Fixed amateur station answers the portable or portable-mobile amateur station: W2DEF W2DEF W2DEF DE W1ABC W1ABC W1ABC K.

Example 3. Portable or portable-mobile amateur station calls a portable or portable-mobile amateur station: W3GHI W3GHI W3GHI DE W4JKL DN4 W4JKL DN4 W4JKL DN4 AR.

If telephony is used, the call sign of the station shall be followed by an announcement of the amateur call area in which the portable or portable-mobile station is operating.

SEC. 12.91. *Requirements for portable and portable-mobile operation.* A licensee of an amateur station may operate portable amateur stations (Section

<sup>1</sup> Subject to change to "1,750 to 2,050" kilocycles in accordance with the "Inter-American Arrangement Covering Radio Communication," Havana, 1937.

12.3) in accordance with the provisions of Sections 12.82, 12.83, 12.92, and 12.136. Such licensee may operate portable and portable-mobile amateur stations without regard to Section 12.92, but in compliance with Sections 12.82, 12.83, and 12.136, when such operation takes place on authorized amateur frequencies above 28,000 kilocycles.

SEC. 12.92. *Special provisions for portable stations.* Advance notice in writing shall be given by the licensee to the inspector in charge of the district in which such portable station is to be operated. Such notices shall be given prior to any operation contemplated, and shall state the station call, name of licensee, the date of proposed operation, and the locations as specifically as possible. An amateur station operating under this Section shall not be operated during any period exceeding one month without giving further notice to the inspector in charge of the radio-inspection district in which the station will be operated, nor more than four consecutive periods of one month at the same location. This Section does not apply to the operation of portable or portable-mobile amateur stations on frequencies above 28,000 kilocycles. (See Section 12.91.)

SEC. 12.93. *Special provisions for non-portable stations.* The provisions for portable stations shall not be applied to any non-portable station except that:

a. An amateur station that has been moved from one permanent location to another permanent location may be operated at the latter location in accordance with the provisions governing portable stations for a period not exceeding sixty days, but in no event beyond the expiration date of the license, provided an application for modification of license to change the permanent location has been made to the Commission.

b. The licensee of an amateur station who is temporarily residing at a location other than the licensed location for a period not exceeding four months may for such period operate his amateur station at his temporary address in accordance with the provisions governing portable stations.

#### USE OF AMATEUR STATIONS

SEC. 12.101. *Points of communication.* An amateur station shall communicate only with other amateur stations, except that in emergencies or for testing purposes it may be used also for communication with commercial or Government radio stations. In addition, amateur stations may communicate with any mobile radio station which is licensed by the Commission to communicate with amateur stations, and with stations of expeditions which may also be authorized to communicate with amateur stations. They may also make transmissions to points equipped only with receiving apparatus for the measurement of emissions, observation of transmission phenomena, radio control of remote objects, and similar purely experimental purposes.

SEC. 12.102. *No remuneration for use of station.* An amateur station shall not be used to transmit or receive messages for hire, nor for communication for material compensation, direct or indirect, paid or promised.

SEC. 12.103. *Broadcasting prohibited.* An amateur station shall not be used for broadcasting any form of entertainment, nor for the simultaneous retransmission by automatic means of programs or signals emanating from any class of station other than amateur.

SEC. 12.104. *Radiotelephone tests.* The transmission of music by an amateur station is forbidden. However, single audio-frequency tones may be transmitted by radiotelephony for test purposes of short duration in connection with the development of experimental radio telephone equipment.

#### ALLOCATION OF FREQUENCIES

SEC. 12.111. *Frequencies for exclusive use of amateur stations.* The following bands of frequencies are allocated exclusively for use by amateur stations:

1,715 to 2,000 kc. <sup>1</sup>	28,000 to 30,000 kc.
3,500 to 4,000 kc.	56,000 to 60,000 kc.
7,000 to 7,300 kc.	112,000 to 116,000 kc.
14,000 to 14,400 kc.	224,000 to 230,000 kc.
	400,000 to 401,000 kc.

SEC. 12.112. *Use of frequencies above 300,000 kilocycles.* The licensee of an amateur station may, subject to change upon further order, operate amateur stations, with any type of emission authorized for amateur stations, on any frequency above 300,000 kilocycles without separate licenses therefor.

SEC. 12.113. *Individual frequency not specified.* Transmissions by an amateur station may be on any frequency within the bands above assigned. Side-band frequencies resulting from keying or modulating a transmitter shall be confined within the frequency band used.

SEC. 12.114. *Types of emission.* All bands of frequencies allocated to the amateur service may be used without modulation (type A-1 emission).

SEC. 12.115. *Additional bands for types of emission using amplitude modulation.* The following bands of frequencies are allocated for use by amateur stations using additional types of emission as shown:

1715 to 2000 kilocycles <sup>2</sup>	—	—	A-4	—
1800 to 2000 kilocycles	—	A-3	—	—
28500 to 30000 kilocycles	—	A-3	—	—
56000 to 60000 kilocycles	A-2	A-3	A-4	—
112000 to 116000 kilocycles	A-2	A-3	A-4	A-5
224000 to 230000 kilocycles	A-2	A-3	A-4	A-5
400000 to 401000 kilocycles	A-2	A-3	A-4	A-5

<sup>1</sup> Subject to change to "1,750 to 2,050" kilocycles in accordance with the "Inter-American Arrangement Covering Radiocommunication." Havana, 1937.

<sup>2</sup> Subject to change to "1750 to 2050" kilocycles in accordance with the "Inter-American Arrangement Covering Radiocommunication," Havana 1937.

SEC. 12.116. *Additional bands for radiotelephony.* Amateur stations, may use radiotelephony with amplitude modulation (type A-3 emission) in the frequency bands 3900 to 4000 kilocycles and 14150 to 14250 kilocycles, provided the station is licensed to a person who holds an amateur operator license endorsed with class A privileges, and actually is operated by an amateur operator holding class A privileges.

SEC. 12.117. *Frequency modulation.* The following bands of frequencies are allocated for use by amateur stations for radiotelephone frequency modulation transmissions: <sup>1</sup>

58500 to 60000 kilocycles  
112000 to 116000 kilocycles  
224000 to 230000 kilocycles  
400000 to 401000 kilocycles

#### EQUIPMENT AND OPERATION

SEC. 12.131. *Maximum power input.* The licensee of an amateur station is authorized to use a maximum power input of 1 kilowatt to the plate circuit of the final amplifier stage of an oscillator-amplifier transmitter or to the plate circuit of an oscillator transmitter. An amateur transmitter operating with a power input exceeding nine-hundred watts to the plate circuit shall provide means for accurately measuring the plate power input to the vacuum tube, or tubes, supplying power to the antenna.

SEC. 12.132. *Power supply to transmitter.* The licensee of an amateur station using frequencies below 60,000 kilocycles shall use adequately filtered direct-current plate power supply for the transmitting equipment to minimize frequency modulation and to prevent the emission of broad signals.

SEC. 12.133. *Requirements for prevention of interference.* Spurious radiations from an amateur transmitter operating on a frequency below 60,000 kilocycles shall be reduced or eliminated in accordance with good engineering practice and shall not be of sufficient intensity to cause interference on receiving sets of modern design which are tuned outside the frequency band of emission normally required for the type of emission employed. In the case of A-3 emission, the transmitter shall not be modulated in excess of its modulation capability to the extent that interfering spurious radiations occur, and in no case shall the emitted carrier be amplitude-modulated in excess of 100 per cent. Means shall be employed to insure that the transmitter is not modulated in excess of its modulation capability. A spurious radiation is any radiation from a transmitter which is outside the frequency band of emission normal for the type of transmission employed, including any component whose frequency is an integral multiple or submultiple of the carrier fre-

<sup>1</sup> When using frequency modulation no simultaneous amplitude modulation is permitted.

quency (harmonics and subharmonics), spurious modulation products, key clicks, and other transient effects, and parasitic oscillations. The frequency of emission shall be as constant as the state of the art permits.

SEC. 12.134. *Modulation of carrier wave.* Except for brief tests or adjustments, an amateur radiotelephone station shall not emit a carrier wave on frequencies below 112,000 kc. unless modulated for the purpose of communication.

SEC. 12.135. *Frequency measurement and regular check.* The licensee of an amateur station shall provide for measurement of the transmitter frequency and establish procedure for checking it regularly. The measurement of the transmitter frequency shall be made by means independent of the frequency control of the transmitter and shall be of sufficient accuracy to assure operation within the frequency band used.

SEC. 12.136. *Logs.* Each licensee of an amateur station shall keep an accurate log of station operation, including the following data:

(a.) The date and time of each transmission. (The date need only be entered once for each day's operation. The expression "time of each transmission" means the time of making a call and need not be repeated during the sequence of communication which immediately follows; however, an entry shall be made in the log when "signing off" so as to show the period during which communication was carried on.)

(b.) The signature of the person manipulating the transmitting key of a radiotelegraph transmitter or the signature of the person operating a transmitter of any other type (type A-3 or A-4 emission) with statement as to type of emission, and the signature of any other person who transmits by voice over a radiotelephone transmitter (type A-3 emission). (The signature need only be entered once in the log provided the log contains a statement to the effect that all transmissions were made by the person named except where otherwise stated. The signature of any other person who operates the station shall be entered in the proper space for his transmissions.)

(c.) Call letters of the station called. (This entry need not be repeated for calls made to the same station during any sequence of communication, provided the time of "signing off" is given.)

(d.) The input power to the oscillator, or to the final amplifier stage where an oscillator-amplifier transmitter is employed. (This need be entered only once, provided the input power is not changed.)

(e.) The frequency band used. (This information need be entered only once in the log for all transmissions until there is a change in frequency to another amateur band.)

(f.) The location of a portable or portable-mobile station at the time of each transmission. (This need be entered only once provided the location of the station is not changed. However, suitable entry shall be made in the log upon changing location, showing the type of vehicle or mobile unit in which the station is operated and the approximate geographical location of the station at the time of operation.)

(g.) The message traffic handled. (If record communications are handled in regular message form, a copy of each message sent and received shall be entered in the log or retained on file for at least one year.)

The log shall be preserved for a period of at least one year following the last date of entry. The copies of record communications and station log, as required under this section, shall be available for inspection upon request by an authorized Government representative.

#### SPECIAL CONDITIONS

SEC. 12.151. *Additional conditions to be observed by licensee.* An amateur station license is granted subject to the conditions imposed in Sections 12.152 to 12.155 inclusive, in addition to any others that may be imposed during the term of the license. Any licensee receiving due notice requiring the station licensee to observe such conditions shall immediately act in conformity therewith.

SEC. 12.152. *Quiet hours.* In the event that the operation of an amateur station causes general interference to the reception of broadcast programs with receivers of modern design, such amateur station shall not operate during the hours from 8 o'clock P. M. to 10:30 P. M., local time, and on Sunday for the additional period from 10:30 A. M. until 1 P. M., local time, upon such frequency or frequencies as cause such interference.

SEC. 12.153. *Second notice of same violation.* In every case where an amateur station licensee is cited a second time within a year for the same violation under Section 12.111, 12.113, 12.116, 12.117, 12.132, or 12.133, the Commission will direct that the station remain silent from 6 P. M. to 10:30 P. M., local time, until written notice has been received authorizing full-time operation. The licensee shall arrange for tests at other hours with at least two amateur stations within fifteen days of the date of notice, such tests to be made for the specific purpose of aiding the licensee in determining whether the emissions of his station are in accordance with the Commission's Regulations. The licensee shall report under oath to the Commission at the conclusion of the tests as to the observations reported by amateur licensees in relation to the reported violation. Such reports shall include a statement as to the corrective measures taken to insure compliance with the Regulations.

SEC. 12.154. *Third notice of same violation.* In every case where an amateur station licensee is cited the third time within a year for the same violation as indicated in Section 12.153, the Commission will direct that the station remain silent from 8 A. M. to 12 midnight, local time, except for the purpose of transmitting a prearranged test to be observed by a monitoring station of the Commission to be designated in each particular case. Upon completion of the test the station shall again remain silent during these hours until authorized by the Commission to resume full-time operation. The Commission will consider the results of the tests and the licensee's past record in

determining the advisability of suspending the operator license and/or revoking the station license.

Sec. 12.155. *Operation in emergencies.* In the event of widespread emergency conditions affecting domestic communication facilities, the Commission may confer with representatives of the amateur service and others and, if deemed advisable, will declare that a state of general communications emergency exists, designating the licensing area or areas concerned (in general not exceeding 1,000 miles from center of the affected area), whereupon it shall be incumbent upon each amateur station in such area or areas to observe the following restrictions for the duration of such emergency:

(a.) No transmissions except those relating to relief work or other emergency service such as amateur nets can afford, shall be made within the 1715-2000<sup>1</sup> kilocycle or 3500-4000 kilocycle amateur bands. Incidental calling, testing, or working, including casual conversation or remarks not pertinent or necessary to constructive handling of the general situation shall be prohibited.

(b.) The frequencies 1975-2000, 3500-3525, and 3975-4000 kilocycles shall be reserved for emergency calling channels, for initial calls from isolated stations or first calls concerning very important emergency relief matters or arrangements. All stations having occasion to use such channels shall, as quickly as possible, shift to other frequencies for carrying on their communications.

(c.) A five-minute listening period for the first five minutes of each hour shall be observed for initial calls of major importance, both in the designated emergency calling channels and throughout the 1715-2000<sup>1</sup> and 3500-4000 kilocycle bands. Only stations isolated or engaged in handling official traffic of the highest priority may continue with transmissions in these listening periods, which must be accurately observed. No replies to calls or resumption of routine traffic shall be made in the five-minute listening period.

(d.) The Commission may designate certain amateur stations to assist in promulgation of its emergency announcement, and for policing the 1715-2000<sup>1</sup> and 3500-4000 kilocycle bands and warning non-complying stations noted operating therein. The operators of these observing stations shall report fully the identity of any stations failing, after due notice, to comply with any section of this regulation. Such designated stations will act in an advisory capacity when able to provide information on emergency circuits. Their policing authority is limited to the transmission of information from responsible official sources, and full reports of non-compliance which may serve as a basis for investigation and action under Section 502 of the Communications Act. Policing authority extends only to 1715-2000<sup>1</sup> and 3500-4000 kilocycle bands. Individual policing transmissions shall refer to this Section by number, shall specify the date of the Commission's declaration, the area and nature of the emergency, all briefly and concisely. Policing-observer

<sup>1</sup> Subject to change to "1750 to 2050" kilocycles in accordance with the "Inter-American Arrangement Covering Radiocommunication," Havana, 1937.

stations shall not enter into discussions beyond essentials with the stations notified, or other stations.

(e.) These special conditions imposed under this Section will cease to apply only after the Commission shall have declared such emergency to be terminated.

#### GENERAL RULES APPLICABLE TO AMATEUR SERVICE

1.71. Each application for an instrument of authorization shall be made in writing, under oath of the applicant, on a form prescribed and furnished by the Commission. . . . Separate application shall be filed for each instrument of authorization requested. . . . The required forms may be obtained from the Commission or from any of its field offices. (For a list of such offices and related geographical districts, see rule 30.)

1.351. Each application for . . . station license, with respect to the number of copies and place of filing, shall be submitted as follows: . . . g. Amateur . . . 1 copy to be sent as follows: (a) To proper district office if it requires personal appearance for operator examination under direct supervision from that office; (b) Direct to Washington, D.C., in all other cases, including examinations for class C privileges.

1.360. Unless otherwise directed by the Commission, each application for renewal of license shall be filed at least 60 days prior to the expiration date of the license sought to be renewed.

1.391. Any licensee receiving official notice of a violation of the terms of the Communications Act of 1934, any legislative act, Executive order, treaty to which the United States is a party or the rules and regulations of the Federal Communications Commission, which are binding upon licensee or the terms and conditions of a license, shall, within 3 days from such receipt, send a written reply direct to the Federal Communications Commission at Washington, D.C., and a copy thereof to the office of the Commission originating the official notice, when the originating office is other than the office of the Commission in Washington, D.C. *Provided, however,* That if an answer cannot be sent nor an acknowledgement made within such 3-day period by reason of illness or other unavoidable circumstances, acknowledgement and answer shall be made at the earliest practicable date with a satisfactory explanation of the delay. The answer to each notice shall be complete in itself and shall not be abbreviated by reference to other communications or answer to other notices. If the notice relates to some violation that may be due to the physical or electrical characteristics of the transmitting apparatus, the answer shall state fully what steps, if any, are taken to prevent future violations, and if any new type apparatus is to be installed, the date such apparatus was ordered, the name of the manufacturer, and promised date of delivery.

If the notice of violation relates to some lack of attention or improper operation of the transmitter, the name and license number of the operator in charge shall be given.



1.401. Whenever the Commission shall institute a revocation proceeding against the holder of any radio station construction permit or license under section 312(a), it shall initiate said proceeding by serving upon said licensee an order of revocation effective not less than 15 days after written notice thereof is given the licensee. The order of revocation shall contain a statement of the grounds and reasons for such proposed revocation and a notice of the licensee's right to be heard by filing with the Commission a written request for hearing within 15 days after receipt of said order. Upon the filing of such written request for hearing by said licensee the order of revocation shall stand suspended and the Commission will set a time and place for hearing and shall give the licensee and other interested parties notice thereof. If no request for hearing on any order of revocation is made by the licensee against whom such an order is directed within the time hereinabove set forth, the order of revocation shall become final and effective, without further action of the Commission.

1.411. *Order of suspension.* No order of suspension of any operator's license shall take effect until 15 days' notice in writing thereof, stating the cause for the proposed suspension, has been given to the operator licensee who may make written application to the Commission at any time within said 15 days for a hearing upon such order. The notice to the operator licensee shall not be effective until actually received by him, and from that time he shall have 15 days in which to mail the said application. In the event that physical conditions prevent mailing of the application at the expiration of the 15-day period, the application shall then be mailed as soon as possible thereafter, accompanied by a satisfactory explanation of the delay. Upon receipt by the Commission of such application for hearing, said order of suspension shall be held in abeyance until the conclusion of the hearing which shall be conducted under such rules as the Commission shall deem appropriate. Upon the conclusion of said hearing the Commission may affirm, modify, or revoke said order of suspension.

1.412. *Proceedings.* Proceedings for the suspension of an operator's license shall in all cases be initiated by the entry of an order of suspension. Respondent will be given notice thereof together with notice of his right to be heard and to contest the proceeding. The effective date of the suspension will not be specified in the original order but will be fixed by subsequent motion of the Commission in accordance with the conditions specified above. Notice of the effective date of suspension will be given respondent, who shall send his operator license to the office of the Commission in Washington, D.C., on or before the said effective date, or, if the effective date has passed at the time notice is received, the license shall be sent to the Commission forthwith.

2.53. *Operators, place of duty.* (a) Except as may be provided in the rules governing a particular class of station, one or more licensed operators of the grade specified by these rules and regulations shall be on duty at the place where the transmitting apparatus of each station is located and in actual

charge thereof whenever it is being operated; *Provided, however, That—*

(1) Subject to the provisions of paragraph (b) of this section, in the case of a station licensed for service other than broadcast, where remote control is used, the Commission may modify the foregoing requirements upon proper application and showing being made so that such operator or operators may be on duty at the control station in lieu of the place where the transmitting apparatus is located.

(2) In the case of two or more stations, except amateur and broadcast, licensed in the name of the same person to use frequencies above 30000 kilocycles only, a licensed radio operator of any class except amateur, radio-telephone third class, or holder of restricted operator permit who has the station within his effective control, may be on duty at any point within the communication range of such stations in lieu of the transmitter location or control point during the actual operation of the transmitting apparatus and shall supervise the emissions of all such stations so as to insure the proper operation in accordance with the station license.

(b) Authority to employ an operator at the control point in accordance with paragraph (a) (1) of this section shall be subject to the following conditions:

(1) The transmitter shall be so installed and protected that it is not accessible to other than duly authorized persons.

(2) The emissions of the transmitter shall be continuously monitored at the control point by a licensed operator of the grade specified for the class of station involved.

(3) Provision shall be made so that the transmitter can quickly and without delay be placed in an operative condition in the event there is a deviation from the terms of the station license.

(4) The radiation of the transmitter shall be suspended immediately when there is a deviation from the terms of the station license.

## Examining Points

Amateur operator examinations are given frequently, under announced schedules, at the Commission's office in Washington, D.C., and at each of its district offices.

Examinations are also given frequently, by appointment, at the Commission's offices at the following points:

Cleveland, Ohio.

Tampa, Fla.

Savannah, Ga.

Juneau, Alaska.

San Diego, Calif.

Examinations are also given at greater intervals at the places named below, which are visited for that purpose by Commission examiners from the district offices for such locations. For current schedules, exact time, place, and

other details, inquiry should be addressed to the office conducting examinations at the chosen point.

#### Quarterly Examinations

Cincinnati, Ohio.	Pittsburgh, Pa.
Columbus, Ohio.	St. Louis, Mo.
Des Moines, Iowa.	San Antonio, Tex.
Nashville, Tenn.	Schenectady, N.Y.
Oklahoma City, Okla.	Winston-Salem, N.C.

#### Semi-Annual Examinations

Albuquerque, N. Mex.	Jacksonville, Fla.
Billings, Mont.	Little Rock, Ark.
Bismarck, N. Dak.	Phoenix, Ariz.
Boise, Idaho.	Salt Lake City, Utah.
Butte, Mont.	Spokane, Wash.

Arrangements have also been made, including cooperation of other Federal agencies, for classes A and B examinations in outlying areas as follows:

Alaska: United States Signal Corps stations; at other points by coast guard officers.

Guam: District communications officer, United States naval station.

Hawaii: At not exceeding one point on any island, by the inspector in charge (Honolulu).

## Insurance Requirements

### STANDARDS OF THE NATIONAL BOARD OF FIRE UNDERWRITERS FOR ELECTRIC WIR- ING AND APPARATUS AS RECOMMENDED BY THE NATIONAL FIRE PROTECTION ASSOCIATION

#### Article 810—Radio Equipment

**8101. Scope.** This article shall apply to radio receiving equipment and to amateur radio transmitting equipment, but shall not apply to equipment and antennas used for coupling carrier current to power line conductors.

It is recommended that the authority enforcing this code be freely consulted as to the specific methods to be followed in any case of doubt relative to installation of antenna and counterpoise conductors and that the National Electrical Safety Code, Part 5, be followed.

**8102. Application of Other Articles.** Wiring from the source of power to and between devices connected to the interior wiring system shall comply with Chapters 1 to 4, inclusive, except as modified by sections 6403, 6404 and 6405. Wiring for radio-frequency and audio-frequency equipment and loud speakers shall comply with Article 640.

#### Antenna Systems—General

**8111. Material.** Antenna, counter-poise, and lead-in conductors shall be of hard-drawn copper, bronze, copper-clad steel, or other high-strength, corrosion-resistant material. Soft-drawn or medium-drawn copper may be used for lead-in conductors where the maximum span between points of support is less than 35 feet.

**8112. Supports.** Outdoor antenna and counter-poise and lead-in conductors shall be securely supported. They shall not be attached to poles or similar structures carrying electric light or power wires or trolley wires of more than 250 volts. Insulators supporting the antenna or counter-poise conductors shall have sufficient mechanical strength to safely support the conductors. Lead-in conductors shall be securely attached to the antenna.

**8113. Avoidance of Contacts with Conductors of Other Systems.** Outdoor antenna, counter-poise and lead-in conductors from an antenna to a building shall not cross over electric light or power circuits and shall be kept well away from all such circuits so as to avoid the possibility of accidental contact. Where proximity to electric light and power service conductors of less than 250 volts cannot be avoided, the installation shall be such as to provide a clearance of at least two feet. It is recommended that antenna and counter-poise conductors be so installed as not to cross under electric light or power conductors.

**8114. Splices.** Splices and joints in antenna and counter-poise span shall be made with approved splicing devices or by such other means as will not appreciably weaken the conductors.

Soldering may ordinarily be expected to weaken the conductor. Therefore, when soldering is employed it should be independent of the mechanical support.

**8115. Indoor Antenna.** There are no requirements for indoor antennas except that they shall have the same clearance from the conductors of electric light and power circuits and signaling circuits as is required for lead-in conductors.

#### Antenna Systems—Receiving Station

**8121. Size of Antenna and Counter-poise.** Outdoor antenna and coun-

ter-poise conductors for receiving stations shall be of a size not less than given in the following table:

<i>Material</i>	<i>Minimum Size of Conductors</i>		
	<i>When Maximum Open Span Length Is</i>		
	<i>Less Than</i>	<i>35 Feet to</i>	<i>Over</i>
	<i>35 Feet</i>	<i>150 Feet</i>	<i>150 Feet</i>
Hard-drawn copper . . . .	19	14	12
Copper-clad steel, bronze or other high strength material . . . . .	20	17	14

For very long span lengths larger conductors will be required, depending on the length of the span and the ice and wind loading.

**8122. Size of Lead-In.** Lead-in conductors from outside antenna, and counter-poise for receiving stations, shall, for various maximum open-span lengths, be of such size as to have a tensile strength at least as great as that of the conductors for antenna as specified in Section 8121. When the lead-in consists of two or more conductors which are twisted together or are enclosed in the same covering or are concentric, the conductor size shall, for various maximum open span lengths, be such that the tensile strength of the combination will be at least as great as that of the conductors for antenna as specified in Section 8121.

**8123. On Buildings.** Lead-in conductors attached to buildings shall be so installed that they cannot swing closer than two feet to the conductors of circuits of 250 volts or less, or ten feet to the conductors of circuits of more than 250 volts, except in the case of circuits not exceeding 150 volts, if all conductors involved are supported so as to insure permanent separation, the clearance may be reduced but shall not be less than four inches. The clearance between lead-in conductors and any conductor forming a part of a lightning rod system shall be not less than six feet.

**8124. Electric Supply Circuits Used in Lieu of Antenna.** If an electric supply circuit is used in lieu of an antenna, the device by which the radio receiving set is connected to the supply circuit shall be specially approved for the purpose.

#### Antenna System—Transmitting Stations

**8131. Size of Antenna.** Antenna and counter-poise conductors for

transmitting station shall be of a size not less than given in the following table:

<i>Material</i>	<i>Minimum Size of Conductors</i> <i>When Maximum Open Span Length Is</i>	
	<i>Less Than</i> <i>150 Feet</i>	<i>Over</i> <i>150 Feet</i>
Hard-drawn copper . . . . .	14	10
Copper-clad steel, bronze, or other high-strength material	14	12

For very long span length larger conductors will be required, depending on the span length and the ice and wind loading.

8132. **Size of Lead-In Conductors.** Lead-in conductors for transmitting stations shall, for various maximum span lengths, be of a size at least as great as that of conductors for antenna as specified in Section 8131.

8133. **Clearance on Building.** Antenna and counter-poise conductors for transmitting stations, attached to buildings, shall be firmly mounted at least 3 inches clear of the surface of the building on non-absorptive insulating supports, such as treated pins or brackets, equipped with insulators having not less than 3-inch creepage and air-gap distances for transmitters having a licensed power of 1,000 watts or less. For transmitters having a licensed power of more than 1,000 watts, the clearance from the building and the creepage and air-gap distances shall be sufficiently increased to be safe. Lead-in conductors attached to buildings shall also conform to these requirements, except when they are enclosed in a continuous metallic shield which is permanently and effectively grounded. In this latter case the metallic shield may also be used as a conductor.

8134. **Entrance to Building.** Except where protected with a continuous metallic shield which is permanently and effectively grounded, lead-in conductors for transmitting station shall enter buildings by one of the following methods:

- a. Through a rigid, non-combustible, non-absorptive insulating tube or bushing.
- b. Through an opening provided for the purpose in which the entrance conductors are firmly secured so as to provide a clearance of at least 2 inches.
- c. Through a drilled window pane.

## Protectors

**8141. Lightning Arresters—Receiving Stations.** Each conductor of a lead-in from an outdoor antenna shall be provided with a lightning-arrester approved for the purpose, except where the lead-in conductors from antenna to entrance to building are protected by a continuous metallic shield which is permanently and effectively grounded. Lightning arresters shall be located outside the building, or inside the building between the point of entrance of the lead-in and the radio set or transformers, and as near as practicable to the entrance of the conductors to the building. The lightning arrester shall not be located near combustible material nor in a hazardous location.

**8142. Lightning Arresters—Transmitting Stations.** Except where protected by a continuous metallic shield which is permanently and effectively grounded, or the antenna is permanently and effectively grounded, each conductor of a lead-in for outdoor antenna shall be provided with a lightning arrester or a grounding switch or other suitable means which will drain static charges from the antenna system.

## Grounding Conductors—General

**8151. Material.** The grounding conductor shall, unless otherwise specified, be of copper, copper-clad steel, bronze, or other corrosion-resistant material.

**8152. Insulation.** The grounding conductors may be uninsulated.

**8153. Supports.** The grounding conductors shall be securely fastened in place and may be directly attached to the surface wired over without the use of insulating supports.

**8154. Mechanical Protection.** The grounding conductor shall be protected where exposed to mechanical injury.

**8155. Run in Straight Line.** The grounding conductor shall be run in as straight a line as practicable from the equipment to the grounding electrode.

**8156. Ground Electrode.** The grounding conductor shall be connected to a grounding electrode as specified in Sections 2581 and 2582 of Article 250.

## Grounding Conductors—Receiving Stations

**8161. Inside or Outside Building.** The grounding conductor may be run either inside or outside the building.

**8162. Size of Protective Ground.** The protective grounding conductor for receiving stations shall be not smaller than No. 14 copper or No. 17 copper-clad steel or bronze, provided that where wholly inside the building it shall not be smaller than No. 18.

**8163. Common Ground.** A single grounding conductor may be used for both protective and operating purposes.

If a single conductor is so used, the ground terminal of the equipment should be connected to the ground terminal of the protective device.

#### Grounding Conductors—Transmitting Stations

**8171. Size of Protective Ground.** The protective ground conductor for transmitting stations shall be as large as the lead-in, but not smaller than No. 14 copper, bronze, or copper-clad steel.

**8172. Size of Operating Grounding Conductor.** The operating grounding conductor for transmitting stations shall be not less than No. 14 copper or its equivalent.

#### Interior Installation—General

**8181. Clearance From Other Conductors.** Except as provided in Article 640, all conductors inside the building shall be separated at least 4 inches from the conductor of any other light or signal circuit unless separated therefrom by conduit or some firmly fixed non-conductor such as porcelain tubes or flexible tubing.

#### Transmitting Stations

**8191. General.** Transmitters shall comply with the following:

**a. Enclosing.** The transmitter shall be enclosed in a metal frame or grille, or separated from the operating space by a barrier or other equivalent means, all metallic parts of which are effectually connected to ground.

**b. Grounding of Controls.** All external metallic handles and controls accessible to the operating personnel shall be effectually grounded.

No circuit in excess of 150 volts should have any parts exposed to direct contact. A complete dead-front type of switchboard is preferred.

**c. Interlocks on Doors.** All access doors shall be provided with inter-



locks which will disconnect all voltages in excess of 350 volts when any access door is opened.

**d. Audio-Amplifiers.** Audio-amplifiers which are located outside the transmitter housing shall be suitably housed and shall be so located as to be readily accessible and adequately ventilated.

# INDEX

---

- A battery, use of, 57-58, 119, 141, 149, 285
- Abbreviations of common terms, 281-282, 283
- Absolute zero, 70
- Absorption-type frequency meter, 190-196, 209  
building of, 192-193  
calibrating the, 193-195
- A-c-d-c receivers, 27, 152-159
- Acorn tube, 104-105
- Acoustic resonance, 296  
simple, 50  
sympathetic, 50-51
- Aerial, use of, 5
- Air-cells, 119
- Air condenser, 287
- Air-cooled transformer, 298
- Air-core transformer, 298
- Aligning of receivers, 139-140, 157-159, 166-169, 176-178
- Alkali metals, 229
- Alternating current, 37, 74, 288
- Alternator, 283
- Amateur radio stations, regulations for, 307-322
- American Radio Relay League, 197
- Ammeter, use of, 38, 283
- Amperage, 36, 38
- Ampere, 39, 40-41, 279, 283
- Ampere-hour, definition of, 279, 283
- Ampere-turns, 283
- Amphenol sockets, 205
- Amplification, 9-10, 78, 127-140  
and photoelectric cells, 234-235
- Amplifier coils, 208-209
- Amplifier plate tank tuning dial, 202
- Amplifiers, 284  
audio-frequency, 66, 67-68, 129-130, 283, 284  
cascade, 128, 284, 286  
classes of, 131  
for Meissner receivers, 143  
multi-stage, 284  
pushpull, 130-131, 179-185  
radio-frequency, 66-67, 128-129, 284  
for transmitters, 210  
vacuum-tube, 284
- Amplitude modulation, 251, 252
- Amplitude of wave, 284
- Anode, 74, 284
- Antenna, 5, 284, 300  
dummy, 167-169, 177  
equipment for, 20  
erecting the, 15-28  
feeder lines to, 19-20, 21  
insurance regulations on, 322-325  
protection of, 20-22  
receiving, 23-26, 148; construction of, 23-24; double doublet, 25-26; precautions, 27-28  
simple, how to make a, 6-7, 17-18  
television, 249-250  
transceiver, 225  
transmitter, 17-22; length of, 18; types, 15-16, 17-18, 52-53  
ultra-short wave, 217-218
- Antenna condenser, 287
- Antenna resistance, 296
- Antenna switch, 297
- Aperiodic circuit, 285
- Apparatus, symbols used for, 278, 297-298

- Arc, electric, 5  
 Arc transmitter, 10  
 Armstrong, Edwin H., 79, 80-81, 87, 132, 136, 251  
 Armstrong circuit, 134, 286-287  
 Arrestors, lightning, 22, 300, 325-326  
 Atmospheric; *see* static  
 Atoms, definition of, 69-70  
 Attenuation, 285  
 Audibility meter, 293  
 Audio frequency, 290-291  
 Audio-frequency amplifier, 66, 67-68, 129-130, 283, 284  
 Audio-frequency currents, 75, 288  
 Audio-frequency transformer, 66, 67, 129-130, 298  
 Audion, 285  
 Autodyne receiving sets, 84-86, 296  
 Automatic volume control, 32-33, 150, 159, 160, 265  
 Auto transformer, 298  
  
 Bakelite, 285  
 Bakelite sockets, 205  
 Baldwin receiver, 110-111  
 Ballast, 59  
 Bands, covered by Meissner receivers, 141, 143, 150, 159, 168-169, 169-171  
 Batteries, use of, 8, 54, 55, 57-59, 119-120, 141  
   A, 57-58, 119, 141, 149, 285  
   B, 58, 120, 141, 150, 285  
   C, 59, 141, 285  
 Battery poles, 295  
 B battery, use of, 58, 120, 141, 150, 285  
 Beam antennas, 52-53  
 Beam power tubes, 102-103  
 Beats, definition of, 84, 85  
   radio-frequency, 88, 134-135  
 Becquerel effect, 228  
 Bipolar receiver, 108  
 Bleeder, use of, 97  
 Blue-glow discharge, 289  
 Books, reference, 279-281  
 Bread-board method of receiver construction, 136-137  
 Broadcast band, of Meissner receivers, 141, 143, 150, 159, 169-171  
 Broadcasting, 285  
   Broadcasting stations, as standard for calibrations, 212  
   Broadcast listeners, 16  
   Broadcast waves, 299  
   Brush discharge, 289  
   "Bugs," 189  
   Bureau of Standards, 22, 193, 215, 287  
   Burns, how to treat, 199  
   Buzzer, radio, 187  
   Buzzer modulation, 293  
   By-pass condenser, 287  
  
 Cabinet, for loud speaker, 152  
   for receivers, 159, 163, 171  
 Calibrating a receiver, 195  
   a transmitter, 195  
   a wavemeter, 193-195  
 Calibration curve, 194, 195  
 Call letters, 12, 312-313  
   international, 302-304  
 Capacity, 44, 286  
   measuring, 195-196  
   units of, 279  
 Capacity coupling, 129, 288  
 Capacity reactance, 295  
 Carrier frequency, 291  
 Cascade amplification, 128, 284, 286  
 Cathode, 74, 286  
 Cathode-ray tube, 241-242, 243-245  
 Cathode-ray tuning indicator, 160, 165  
 Cat whisker, 286  
 C battery, use of, 59, 141, 285  
 Cells connected in series, 38, 39, 154  
 Celotex baffle, 152  
 Centimeter of capacity, 279, 286  
 Centimeter of inductance, 279, 286  
 Changeover switch, 23  
 Channel, definition of, 286  
 Characteristics, of radio tubes, 89-91, 286  
 Charges, of electricity, 69  
 Chassis, for receivers, 136-137, 142, 155, 163  
 Choke input filters, 125, 155, 204, 286  
 Chopper modulation, 293  
 Circuit, electrical, 36-37, 286  
   aperiodic, 285  
   Armstrong, 134, 286-287

- closed, 43, 286
- closed-coupled, 286
- constants, 44; capacity, 44; inductance, 44-45; resistance, 45
- coupled, 286
- discriminator, 253
- feedback, 79-81, 133-134, 290
- grid, 291
- limiter, 253, 255, 257
- loose-coupled, 286
- open, 43, 286
- plate, 294-295
- silencing, 24
- standby, 286
- Cities, difficulty with antennas in, 16, 18
- Closed circuit, 43, 286
- Closed-core transformer, 298
- Closed-coupled circuit, 286
- Code and conventional signals, International Morse, table of, 275
- Code-instructing devices, 189
- Code signals, receiving sets for, 8-10
- Coils, amplifier, 208-209
  - construction of, 62-63
  - for frequency modulation, 256-259
  - grid, 291
  - inductance, 287
  - induction, 287
  - loading, 287
  - oscillator, 208-209
  - plug-in, 30, 141, 143
  - resistance, 39, 296
  - Ruhmkorff, 287
  - spark, 10, 287
  - tuning, 7
  - for wavemeter, 192
- Collodion, use of, 192
- Communications Act (1934), 307
- Condenser, 287-288
  - antenna, 287
  - air, 287
  - bypass, 287
  - electrolytic, 31-32, 125
  - filter, 125-126, 287
  - fixed, 8, 30-32, 287-288
  - gang, 129, 155-156, 164-165
  - grid, 288
  - oil, 288
  - padding, 168, 169, 177-178
  - paper, 31, 32, 125, 288
  - tuning, 26, 221
  - ultra-high frequency, 218
  - variable, 7, 30-32, 128-129, 192, 288
  - vernier, 288
  - working of, 35-36
- Condenser loud speaker, 116
- Conduction current, 72
- Conductivity, 288
- Conductors, 19-20, 71-72
- Cone loud speaker, 113
- Constants, of the circuit, 44
- Continental Morse Code, 5, 186
- Continuity meter, use of, 183-184
- Continuous operations, of photoelectric cells, 238-239
- Continuous waves, 299
- Convective discharge, 289
- Conventional signals, 297
- Copper plate, as a ground, 7, 22
- Coulomb, definition of, 44, 279, 288
- Counterpoise, 284, 288
- Counting operations, of photoelectric cells, 237
- Coupled circuit, 286
- Coupling, 128, 129, 288
  - capacity, 129, 288
  - impedance, 129, 130
  - inductive, 292
  - resistance, 129, 130, 288
  - transformer, 129-130
- Crosley, Powel, Jr., 264
- Crystal, natural, use of, 5, 7, 127
- Crystal control, 200-201, 209
- Crystal microphone, 211
- Crystal phones, 111
- Crystal receiving set, 7, 127, 288
- Current, electric, 36-38
  - alternating, 37, 74, 288
  - audio-frequency, 75, 288
  - conduction, 72
  - direct, 37, 74, 288; pulsating, 75, 288
  - displacement, 72-73
  - emission, 73-74
  - high-frequency, 43-44, 289
  - high-potential, 43, 289
  - low-voltage, 43
  - of photoelectric cell, 233
  - plate, 288

- Current (*Continued*)  
 radio-frequency, 75, 289  
 relation of electrons to, 71-74  
 space, 73-74  
 Cycle, 289
- Damped electric oscillations, 48-50, 294  
 Damped mechanical vibrations, 47-48  
 Damping, 289  
 Decrement, 289  
 De Forest, Lee, 56, 79  
 Detector tube, definition of, 289  
 Dial lights, 165, 171-174  
 Dials, logging the, 65-66  
 Diaphragm, of headphone, 107-108  
 Dielectrics, 31, 72, 125, 289  
 Dielectric strain, 289  
 Diode; *see* two-element vacuum tube  
 Dipole, double, 250  
 single, 250  
 Direct current, 37, 74, 288  
 pulsating, 75, 288  
 Direct grounds, 27  
 Directional, 284  
 Discharges, 289  
 Discriminator circuit, 253  
 Disease, treatment with ultra-short waves, 213  
 Displacement current, 72-73  
 Disruptive discharge, 289  
 Distance, of transmission of radio waves, 9  
 Double doublet, 24-26  
 Double-hump resonance curve, 289  
 Dry cells, 38, 119-120  
 Dummy antenna, 167-169, 177  
 Duplex antenna, 15-16  
 Duplex communication, 289  
 Duplex-diode triode, 100-102
- Earth connection, 289  
 Edison storage battery, 285  
 80 rectifier tube, 95-96  
 Electrical resistance, 8, 37, 39-40, 45, 59-60, 296  
 Electrical storms, 9  
 Electric arc, use of, 5  
 Electric current, and its circuit, 36-37  
 and the ampere, 38  
 Electric energy, 290  
 Electric eyes, 226  
 Electricity, 35-46  
 at rest and in motion, 35-36  
 capacity, 44  
 current of, 36-38  
 electromagnetic induction, 41-42  
 inductance, 43, 44-45  
 negative, 290  
 oscillation, 43-44, 45-46  
 positive, 290  
 resistance, 39-41, 45  
 voltage of, 39  
 Electric oscillations, 43-44, 45-46, 48-50, 84-85, 294  
 Electric pressure, 35-36, 39  
 Electric tuning, 51-53  
 Electric units, definitions of, 279  
 Electric waves, 47, 299-300  
 Electrodes, 290  
 Electrodynamical loud speaker, 113-115, 159, 165, 171  
 Electrolytes, 290  
 Electrolytic condensers, 31-32, 125  
 Electromagnetic induction, 41-42  
 Electromagnetic-type cathode tube, 243  
 Electromotive force, 36, 39, 290  
 Electron, function of, 69-70, 229-230, 290  
 relation of, to current flow, 71-74  
 Electron flow, 290  
 Electronic drift, 72  
 Electrostatic capacity, 44  
 Electrostatic-type cathode tube, 243-244  
 Emission current, 73-74  
 Empire State Building, 240  
 Enameled wire, 300  
 table of, 272  
 Energy, 47, 229-230, 290  
 Equipment, radio, 29-33  
 government regulations over, 315-317  
 where to purchase, 4  
 Examinations, for radio license, 13-14, 309-310, 321
- Facsimile, radio, 260-267  
 procedure, 260-262

- programs, 262-263  
 reception, 265-267  
 transmission, 263-264
- Fading, 290
- Farad, 44, 279, 290
- Farrand, C. L., 115
- Federal Communications Commission, 11, 13, 14, 190, 196-197, 212, 242, 262, 307
- Feedback circuit, 79-81, 133-134, 290
- Feeder lines to the antenna, 19-20, 21
- Fessenden, Reginald A., 87
- 15-watt audio power high-gain push-pull amplifier, 179-185  
 parts for, 180-181  
 testing of, 183-185  
 voltage chart for, 185  
 wiring of, 181-183
- Filament, of vacuum tube, 55, 290
- Filament battery, use of, 57-58
- Filament rheostat, 59-60, 296-297
- Filament switch, 202
- Filament transformer, 222
- Filament voltages, of tubes, 100
- Filter condenser, 287
- Filter reactor, 295
- Filter systems, 94-95, 96-97, 121, 124-126, 202, 290
- Finch, William G. R., 263, 267
- Finch system of facsimile, 263-264
- Finch Telecommunications Laboratories, 264
- Fixed condenser, use of, 8, 30-32, 287-288
- Fleming, Sir John A., 56, 75
- Fleming Valve, 55, 56, 122, 290
- Forced electric oscillations, 294
- 4-tube a-c-d-c tuned frequency receiver, 152-159
- Free electric oscillations, 294
- French curve, 194
- Frequency, 75  
 allocation of, to amateurs, 314-315  
 audio, 290-291  
 carrier, 291  
 measurement of, 190-197  
 natural, 291  
 quenching, 83  
 radio, 291  
 straight-line, 297
- Frequency and wave lengths, table of, 273
- Frequency change, 200
- Frequency meter, absorption type, 190-196, 209  
 heterodyne, 190, 197
- Frequency modulation, 251-259  
 aligning of, 258  
 coil construction for, 256-259
- Frequency signals, 193, 196-197
- Frequency tests, 193
- Full-wave rectifiers, 123-124
- Gain control, 202
- Gang condensers, 129, 155-156, 164-165
- Gascharger, 171
- Gas-content tube, 299
- Gas-filled photoelectric cells, 230-231
- General Electric Company, 91
- Generator, engine-operated, 121, 171
- Grid, of vacuum tube, 56, 76-77, 291
- Grid characteristics, 291
- Grid circuit, 291
- Grid coil, 291
- Grid condenser, 288
- Grid leads, 181, 291
- Grid leak, 8, 291
- Grid modulation, 293
- Grid potential, 291
- Grommets, use of, 205-206
- Ground, 284, 300  
 depth of, 7  
 direct, 27  
 how to make a, 6-7, 22, 27  
 for Meissner receivers, 148-149, 178  
 insurance regulations over, 326-327
- Grounding switches, 22
- Ground returns, 182
- Ground waves, 215, 217
- Half-wave antenna, 18
- Half-wave rectifiers, 123-124
- Hard tube, 291
- Hazeltine, L. A., 132
- Headphones, 5, 8, 29, 33, 106  
 how made, 107-108  
 how they work, 100  
 types of, 110-111
- Headsets, 109

- Heater-type vacuum tube, 299  
 Heaviside, Oliver, 214  
 Henry, 45, 279, 291  
 Heterodyne frequency meter, 190, 197  
 Heterodyne receiving sets, 84-87, 134-135, 296  
 Heterodyne reception, 291  
 High-frequency currents, 43-44, 289  
 High-frequency resistance, 296  
 High-potential currents, 43, 289  
 High-vacuum photoelectric cells, 230-231  
 High-vacuum rectifier tube, 122-123  
 Horizontal antennas, 218  
 Horsepower, definition of, 279, 292  
 Hull, A. W., 91  
 Hum, removal of, 90-91
- Iconoscope, 240, 247  
 Impedance, 109-110, 292  
 Impedance coupling, 129, 130  
 Indirect heater tubes, 90  
 Inductance, 43, 44-45, 125-126  
   measuring of, 195-196  
   for ultra-high frequency, 218-219, 220-221  
   units of, 279  
 Inductance coil, 287  
 Induction, electromagnetic, 41-42  
   mutual, 43, 292  
   self-, 43, 44-45  
 Induction coil, 287  
 Inductive coupling, 292  
 Inductive reactance, 295  
 Inductor dynamic loud speaker, 115-116  
 Inertia, 44-45  
 Inspector, radio, 292  
 Institute of Radio Engineers, 131  
 Insulated magnet wire, feet per pound of, table of, 274  
 Insulating spreaders, 20  
 Insulation, importance of, 19, 219, 292  
 Insulators, 72  
 Insurance requirements, for radio stations, 322-327  
 Interference, 217-218, 292  
 Intermediate waves, 300  
 International call letters, 302-304
- International Morse, code and conventional signals, table of, 275  
 International Radio Conference, 302  
 International Telecommunications Convention, 302  
 Ionization, 71, 74  
 Ionosphere, 214-218
- Jacks, 292  
   keying, 202, 211  
   microphone, 202, 211  
 Joule, definition of, 279, 292  
 Joule's law, 292  
 Jump spark, use of, 5
- Kennelly, A. E., 214  
 Kennelly-Heaviside layer, 214  
 Kenotron tube, 122  
 Key, radio, 189  
   telegraph, 5, 187, 189  
   transmitter, 211  
 Keying jacks, 202, 211  
 Keyway, position of, 139, 146, 155, 164  
 Kick-back, 292  
   prevention, 295  
 Kilocycles, 292  
 Kilowatt, 41, 279, 292  
 Kinetic energy, 47  
 KSTP, 263
- Lead-in wires, 25-26, 181, 291, 292  
 Leyden jar, use of, 35  
 Library, need for, 4  
 License, operator's, 5-6, 11-14, 186, 198, 308-309, 311  
 Light, transformation of, into electricity, 226-230  
 Light energy, 229-230  
 Light intensity, measurement of, 228  
 Lightning arrestors, 22, 300, 325-326  
 Lightning switch, 297  
 Light-sensitive cells, 226-239  
 Limiter circuit, 253, 255, 257  
 Linear oscillator, 221  
 Litzendraht, 293  
 Load impedance, 210  
 Loading coil, 287  
 Lockwashers, use of, 139  
 Logging the dials, 65-66

- Long waves, 300  
Loop, 284-285  
Loose couplers, use of, 7, 286  
Loud speaker, 5, 111-118, 293  
  cabinet for, 152  
  condenser, 116  
  cone, 113  
  electrodynamic, 113-115, 159, 165, 171  
  inductor dynamic, 115-116  
  for Meissner 7-tube receiver, 159, 165  
  for Meissner 6-volt receiver, 171  
  for Meissner 3-tube receiver, 145-146  
  paper-diaphragm, 113  
  peaks in, 117  
  permanent-magnet, 117-118  
Low-loss switch, for receivers, 30  
Low-voltage currents, 43  
L-type antenna, how to make, 17  
Lugs, 148, 151-152, 156, 164
- “Magic Eye” cathode-ray tuning indicator, 160, 165  
Magnetic field, 41-43  
Magnetic permeability, 294  
Magnetic units, definitions of, 279  
Magnet wire, insulated, feet per pound of, table of, 274  
Marconi, Guglielmo, 3, 4  
Mechanical tuning, 50-51  
Megaphone, 111-112  
Megohm, 293  
Meissner 4-tube a-c-d-c tuned radio-frequency receiver, 152-159  
  parts for, 154-155  
Meissner 1-tube regenerative receiver, 141-151  
  parts for, 143-144  
Meissner 7-tube broadcast, police, and short-wave superheterodyne receiver, 159-169  
  parts for, 162-163  
Meissner 6-volt broadcast and short-wave superheterodyne receiver, 169-178  
  parts for, 169-171  
Meissner 3-tube regenerative receiver, 141-152  
  parts for, 144  
Meissner 20-p radiotelephone and c.w. transmitter, 201  
Meissner 2-tube regenerative receiver, 141-142, 145-151  
  parts for, 144  
Mercury-vapor rectifier tube, 122-123  
Metal-chassis method of receiver construction, 137  
Metal tubes, 104  
Meter switch, use of, 202  
Metric-system units, prefixes used with, table of, 271  
Mho, 293  
Mica, 293  
Mica-type fixed condensers, 31, 32, 288  
Microamperes, 233, 293  
Microfarad, 44, 279, 293  
Microhenry, 293  
Microhm, 293  
Micro-microfarad, 293  
Microphone, use of, 4-5, 202, 211  
  for transceiver, 225  
  Microphone jacks, 202, 211  
  Microphone transformer, 298  
Milliammeter, use of, 191, 293  
Milliampere, 293  
Millihenry, 279, 293  
Modulation, 293  
  amplitude, 251, 252  
  buzzer, 293  
  chopper, 293  
  frequency, 251-259  
  grid, 293  
  plate, 293  
Modulators, 200, 202, 210, 293  
Modulator service, amplifier for, 179  
Molecules, definition of, 69  
Monitoring a transmitter, 196-197  
Morse Code, Continental, 5, 186  
Morse telegraph, 78  
Motion pictures, loud speaker for, 115  
Motor-generator, 294  
Multi-stage amplifier, 284  
Multi-unit tubes, 103-105  
Mutual induction, 43, 292  
Mu tube, 92, 160



- National Board of Fire Underwriters, 287, 322
- National Broadcasting Company, 240
- National Electric Code, 287
- National Electric Safety Code, 287
- National Fire Protection Association, 322
- Natural crystal, use of, 5, 7
- Natural frequency, 291
- Negative electricity, 290
- Negative ion, 71
- Neon lamp, 191, 192, 193, 195
- Neurodyne receivers, 132-133
- Nipkow disks, 241
- Noise interferers, 25
- Octal socket, 104
- Ohm, 39-41, 45, 279, 294
- Ohmic resistance, 107, 109
- Ohm's Law, 40-41, 59, 294
- Oil condenser, 288
- Oil-cooled transformer, 298
- 1-tube regenerative receiver, 141-151
- "On-off" switch, 202
- Open circuit, 43, 286
- Open-core transformer, 298
- Orthicon, 247
- Oscillations, electric, 43-44, 45-46, 84-85, 294
- damped and sustained, 48-50
- Oscillation transformer, 298
- Oscillator, service, 157-159, 166-169, 177-178
- vacuum-tube, 50
- Oscillator coils, 208-209
- Oscillator plate tank tuning dial, 202
- Oscillator tube, 82-83, 195, 221, 294
- Oscillograph, 75, 294
- Oscilloscopes, 243
- Output transformer, 145-146, 159, 165
- Padding condenser, 168, 169, 177-178
- Panels, for receivers, 136-137, 142, 163, 171
- for transmitters, 202
- Paper-diaphragm loud speaker, 113
- Paper-type fixed condensers, 31, 32, 125, 288
- Peaks, in loud speakers, 117
- Pentagrids, 104
- Pentode, 98-99
- Period, definition of, 294
- Permanent-magnet dynamic speaker, 117-118
- Phase, definition of, 294
- Phone tips, use of, 145
- Phonograph, amplifier for, 179
- Phosphor bronze wire, 300
- Photocells, 226
- Photo-conductive cells, 226-227
- Photoelectric cell, 226-239
- action of, 231-233
- photo-emissive, 227, 229
- photo-voltaic, 227, 228
- selenium, 226-228
- uses of, 233-239
- Photo-emissive cells, 227, 229
- Photo-emissive tube, structure of, 229-230
- Phototube, 226, 230
- Photo-voltaic cells, 227, 228
- Piezo-electric microphone, 211
- Pilot light, 157, 201, 209
- Plate, of vacuum tube, 55, 294
- Plate battery, use of, 58
- Plate circuit, 294-295
- Plate-circuit meter, 202
- Plate-circuit reactor, 295-296
- Plate current, 288
- Plate modulation, 293
- Plate switch, 202
- Plate voltage, 299
- Plug, 295
- Plug-in coils, use of, 30, 141, 143
- Poles, battery, 295
- magnetic, 295
- Police broadcasts, 168
- Portable equipment, 223
- Positive electricity, 290
- Positive ion, 71
- Potential difference, 36, 39, 295
- Potential energy, 47
- Potentiometers, 32, 295
- Power packs, 122, 125-126
- Power supply, 119-126
- Power transformer, 298
- Power tubes, 97-98, 299
- Pressure, electric, 35-36, 39
- Primary, 295
- Protons, function of, 69-70

- Public-address system, amplifier for, 179
- Pulsating direct current, 75, 288
- Pushpull amplification, 130-131, 179-185
- Q signals, table of, 276-277
- QST, 295
- "QST," 197
- Quantum, 230
- Quarter-wave antenna, 18
- Quasi-optical waves, 213
- Quenching frequency, 83
- Radiation, 295
- Radio beacon, 295
- Radio buzzer, 187
- Radio compass, 295
- Radio Corporation of America, 240
- Radio districts, U.S., 304-307
- Radio don'ts, list of, 300-302
- Radio equipment, 4, 29-33, 315-317
- Radio facsimile, 260-267
  - procedure, 260-262
  - programs, 262-263
  - reception, 265-267
  - transmission, 263-264
- Radio frequency, 291
- Radio-frequency amplifier, 66-67, 128-129, 284
- Radio-frequency beats, 88
- Radio-frequency currents, 75, 289
- Radio-frequency transformer, 128, 298
- Radio key, 189
- Radio knife, 213-214
- Radio license, 5-6, 11-14, 186, 198, 308-309, 311
- Radio Manufacturers Association, 242
- Radio systems, parts of, 5-6
- Radio telegraphy, definition of, 4-5
- Radiotelephone and c.w. transmitter, 20-watt, 198-212
- Radio telephony, definition of, 4-5
- Radio terms, abbreviations of, 281-282
- Radio-tube characteristics, 89-91
- Range switch, 162, 165, 174-175
- RCA system of facsimile, 263
- Reactance, 295
- Reactor, 295
- Reado kit, 264-267
- Receivers, 5, 127-140, 296, 301-302
  - a-c-d-c, 27, 152-159
  - aligning of, 139-140, 157-159, 166-169, 176-178
  - assembling of, 141-178
  - autodyne, 84-86, 296
  - Baldwin, 110-111
  - bipolar, 108
  - cabinet for, 159, 163, 171
  - calibrating, 195
  - chassis for, 136-137, 142, 155, 163
  - components of, 30-33
  - construction of, 136-137
  - crystal, 7, 127, 288
  - for facsimile, 265-266
  - frequency-modulation, 253-259
  - heterodyne, 84-87, 134-135, 296
  - Meissner 4-tube, 152-159
  - Meissner 1-tube, 141-151
  - Meissner 7-tube, 159-169
  - Meissner 6-volt, 169-178
  - Meissner 3-tube, 141-152
  - Meissner 2-tube, 141-142, 144, 145-151
  - neutrodyne, 132-133
  - for 112 mc band, 219-221
  - panels for, 136-137, 142, 163, 171
  - regenerative, 79-81, 133-134, 141
  - simple, 6-10, 54-68; operation of, 69-88
  - superheterodyne, 87-88, 135-136, 140
  - superregenerative, 81-84, 219
  - telephone, 106-107
  - television, 248-249
- Receiving antenna, 23-26
- Recharging storage cells, 121
- Rectifiers, 75-76, 121, 122-124, 296
- Rectifying tubes, 94-96, 299
- Reference books, for radio, 279-281
  - for television, 281
- Regeneration control, 150, 151
- Regenerative amplification, 284
- Regenerative receiver, 79-81, 133-134
  - Meissner 1-tube, 141
  - Meissner 3-tube, 141
  - Meissner 2-tube, 141

- Regulations, for amateur radio stations, 307-322
- Relay, use of, 234-236, 296
- Resistance, electrical, 8, 37, 39-40, 45, 59-60, 296
- Resistance boxes, 296
- Resistance bridge, 40, 296
- Resistance coil, 39, 296
- Resistance coupling, 129, 130, 288
- Resistivity, 296
- Resistors, 32-33, 59-60, 204, 221, 296
- Resonance, 296  
 simple, 50  
 sympathetic, 50-51
- Resonance indicator, 192, 193
- Rheostat, 296  
 filament, 59-60, 296-297
- Rochelle salt crystals, used in loud speaker, 117
- Rosin-core solder, 138, 148, 157, 165, 181
- Rotary switch, for receivers, 30
- Ruhmkorff coil, 287
- Safety precautions, 198-199  
 "Safety Rules for Radio Installations," 22
- Saturation, 297
- Sawyer, C. Baldwin Brush, 117
- Scanning process, 246-248
- Schottky, 91
- Screen-grid vacuum tube, 91-94, 299
- Secondary, 297
- Selectivity, 160, 171
- Selenium, 227
- Selenium cells, 227-228
- Self-heterodyne receiving set, 84-86
- Self-induction, 43, 44-45
- Sensitivity control, 160-162, 171
- Sensitivity of headphones, 108-109
- Series, cells connected in, 38, 39, 154
- Service oscillator, 157-159, 166-169, 177-178
- 7-tube broadcast, police, and short-wave heterodyne receiver, 159-169
- Shielding, 151-152, 185, 206, 210, 297
- Ships, use of radio by, 10
- Short-circuits, 147
- Short-wave band, of Meissner receivers, 159, 168
- Short-wave duplex antenna, 15-16
- Short waves, 215, 300
- Signal generator, use of, 140
- Signal-noise ratio, 9
- Signals, conventional, 297  
 frequency, 193, 196-197
- Silencing circuit, 24
- Simple antenna, how to make a, 6-7
- Simple acoustic resonance, 50
- Simple electric resonance, 52
- Simple vacuum-tube receiving set, 54-68  
 how to assemble, 60-63  
 how to operate, 63-65  
 operation of, 79  
 parts needed, 60
- Sine wave, 75, 251
- 6-volt broadcast and short-wave superheterodyne receiver, 169-178
- Skin effect, 296
- Skip distance, 215
- Sky waves, 215-216, 217
- Socket power unit, 297
- Sockets, 146, 155, 164, 205  
 amphenol, 205  
 octal, 104
- Soft tube, 297
- Soldering, 137-138, 148, 155, 156-157, 162, 164, 165, 181, 207
- Sounding box, 50
- Sound-on-film motion pictures, 234
- Sound waves, 47
- Space-charge effect, 297
- Space current, 73-74
- Spark coil, 10, 287
- Spark gap, 29-30
- Sparking distances, table of, 274
- Spreader, 297
- Stancor 20-p transmitter, 200-212  
 assembling of, 205-206  
 circuit of, 200-202  
 layout of, 202-203  
 microphone of, 211  
 operation of, 211-212  
 parts for, 203-205  
 wiring of, 211-212
- Standby circuit, 286

- Starting operations, of photoelectric cells, 237-238
- Static, 9, 25, 217-218, 252, 297
- Stator, 297
- Stopping operations, of photoelectric cells, 237-238
- Storage battery, use of, 57-58, 120, 171, 285  
recharging of, 121
- Storms, electrical, 9
- Straight-line frequency, 297
- Strain, dielectric, 289
- Super-control tube, 92
- Superheterodyne receiving set, 87-88, 135-136, 140  
Meissner 7-tube, 159-169
- Superregenerative receiver, 81-84, 219
- Suppressor grid, 98-99
- Sustained electric oscillations, 48-50, 294
- Sustained mechanical vibrations, 47-48
- Sweating, as soldering method, 138, 181
- Swinging, 290
- Switch, antenna, 297  
changeover, 23  
filament, 202  
grounding, 22  
lightning, 297  
low-loss, 30  
meter, 202  
"on-off," 202  
plate, 202  
range, 162, 165, 174-175  
rotary, 30
- Switchover, from transmission to reception, 23-24
- Symbols, apparatus, 278, 297-298
- Symbols used for various quantities, table of, 272
- Sympathetic resonance, 50-51
- Synchronizing facsimile signals, 266-267
- Telegraph, Morse, 78
- Telegraph key, use of, 5, 187, 189
- Telegraphy, radio, 4-5  
how to learn, 186-189
- Telephone receiver, 106-107
- Telephony, radio, 4-5
- Television, 240-250, 298  
antennas, 249-250  
receivers, 248-249  
technic, 241-243
- Tetrode, 98
- Thermal ammeter, 283
- Three-electrode vacuum tube, 56-57, 76-78, 299
- 3-tube regenerative receiver, 141-152
- Tickler, 298
- Tikker, 298
- Time period of the circuit, 45-46
- Tone control, 160, 165, 179
- Transceiver, 223-225
- Transformer, 95, 298  
air-cooled, 298  
air-core, 298  
audio-frequency, 66, 67, 129-130, 298  
auto, 298  
closed-core, 298  
filament, 222  
microphone, 298  
oil-cooled, 298  
open-core, 298  
oscillation, 298  
output, 145-146, 159, 165  
power, 298  
radio-frequency, 128, 298
- Transformer coupling, 129-130
- Transmission antennas, 17-22
- Transmitter key, 211
- Transmitters, 5, 301  
arc, 10  
calibrating, 195  
insurance regulations of, 327  
monitoring of, 196-197  
for 112 mc band, 221-223  
panels for, 202  
Stancor 20-p, 200-212  
types of, 10-11  
for ultra-high frequencies, 221-223
- Trimmers, on transformers, 167, 168, 177
- Triode; *see* three-element vacuum tube
- T-type antenna, how to make, 17

- Tubing, use of, 147
- Tuned radio-frequency amplification, 128-129, 132
- Tuning, 47-53, 298  
 electric, 51-53  
 mechanical, 50-51
- Tuning coil, 7
- Tuning condensers, 26, 221
- Tuning fork, 48, 50-51
- Tuning indicator, cathode-ray, 160, 165
- Tuning inductance, 7, 30
- Turns of wire, 108-109
- 24A tube, 91-92, 94
- 20-p radiotelephone and c.w. transmitter, 201
- 20-watt radiotelephone and c.w. transmitter, 198-212
- Two-electrode vacuum tube, 55-56, 299  
 working of, 74-76
- 2-tube regenerative receiver, 141-142, 144, 145-151
- Ultra-high frequencies, 213-225  
 receiver for, 219-221  
 transmitter for, 221-223
- Ultra-short waves, 213, 215, 217-219, 300
- Undamped waves, 300
- U.S. radio districts, 304-307
- United Transformer Corporation, 179
- Units, table of, 271
- Untuned radio-frequency amplification, 128
- Vacuum-tube amplifier, 284
- Vacuum-tube oscillator, 50
- Vacuum-tube receivers, operation of, 69-88  
 simple, 54-68
- Vacuum tubes, 5, 7-9, 10, 30, 54-68, 69-88, 127, 298-299  
 characteristics of, 89-105  
 classing of, 100  
 screen-grid, 91-94, 299  
 three-electrode, 56-57, 76-78, 299  
 two-electrode, 55-56, 74-76, 299
- Variable condenser, 7, 30-32, 128-129, 192, 288
- Variocoupler, 299
- Variometer, 299
- Vernier condenser, 288
- Vertical antennas, 218
- Vestigial side band transmission, 243
- Vibrations, 47-48
- Vibrator "hash," 171, 175
- Vibrator-transformer, use of, 120-121
- Video-sound transmitter, 240
- Volt, 39, 41, 279, 299
- Voltage, 36, 39, 299  
 chart, for pushpull amplifier, 185
- Voltmeter, 39, 157, 165, 184, 299
- Volume control, 32-33, 150, 159, 160, 265
- Water pipe, as a ground, 6, 27, 291
- Watt, 41, 279, 299
- Wave length, 46, 216, 299  
 control of, 11  
 measurements, 190-197
- Wave lengths and frequency, table of, 273
- Wavemeter, 190-196, 209, 299
- Wave motion, 293-294, 299
- Waves, broadcast, 299  
 continuous, 299  
 electric, 47, 299-300  
 ground, 215, 217  
 intermediate, 300  
 long, 300  
 quasi-optical, 213  
 short, 215, 300  
 sine, 75, 251  
 sky, 215-216, 217  
 ultra-short, 213, 215, 217-219, 300
- WCLE, 263
- Westinghouse Photox, 228
- Weston Photronic Cell, 228
- WGH, 263
- WGN, 262
- Whistling, 150-151
- WHK, 263
- WHO, 262
- Wincharger, 171
- Wind-operated generator, 121, 171
- Wire, enameled, table of, 272

- Wire, turns of, 108-109
- Wired wireless, 300
- Wire netting, as a ground, 7
- Wiring, of pushpull amplifier, 181-183
  - of receivers, 146-148, 156, 165, 175
  - of transmitters, 207-210
- WLW, 262
- WOR, 262
- WSAI, 263
- WSM, 262
- W2XBS, 240
- WWJ, 263
- WWV, 193
- Young, Charles J., 263
- Zeppelin antenna, 17
- Zero beat, 197

