

GENE
RADIO COMPANY WEST CONCORD, MASSACHUSETTS



HANDBOOK OF NOISE MEASUREMENT

GENERAL RADIO COMPANY

WEST CONCORD, MASSACHUSETTS

NEW YORK • PHILADELPHIA • SYRACUSE • WASHINGTON
CHICAGO • DALLAS • ORLANDO
LOS ANGELES • SAN FRANCISCO • TORONTO

GENERAL RADIO COMPANY (OVERSEAS)

ZURICH, SWITZERLAND

REPRESENTATIVES IN PRINCIPAL COUNTRIES

acc No. 2005 11.00



HANDBOOK OF NOISE MEASUREMENT

(Fifth Edition)

by

Arnold P. G. Peterson

and

Ervin E. Gross, Jr.

*Library of
Allen Vinegar*

Price: \$1.00

GENERAL RADIO COMPANY

WEST CONCORD, MASSACHUSETTS

NEW YORK • PHILADELPHIA • SYRACUSE • WASHINGTON • ORLANDO
CHICAGO • DALLAS • LOS ANGELES • SAN FRANCISCO • TORONTO

GENERAL RADIO COMPANY (Overseas), ZURICH, SWITZERLAND

Copyright 1963 by General Radio Company,
West Concord, Massachusetts, U.S.A.

LIBRARY
KETTERING LABORATORY

FORM 8

Printed in U.S.A.

TABLE OF CONTENTS

	<u>Page</u>
CHAPTER 1 INTRODUCTION	1
CHAPTER 2 THE DECIBEL — WHAT IS IT?	3
2.1 Sound Pressure	3
2.2 Power Level.	5
2.3 Sound-Pressure Level	7
2.4 Sound Level	7
2.5 Combining Decibels	9
2.6 Summary.	9
CHAPTER 3 MAN AS A NOISE-MEASURING INSTRUMENT	11
3.1 Why We Measure Noise	11
3.2 Psychoacoustical Experiments	11
3.3 Thresholds of Hearing and Tolerance	13
3.4 Rating the Loudness of a Sound	15
3.5 Masking	20
3.6 "What Noise Annoys an Oyster?"	21
3.7 Speech-Interference Level	21
3.8 Additional Hearing Characteristics	23
3.9 Effects of Noise on Work Output	24
3.10 Hearing Loss from Noise Exposure	24
CHAPTER 4 DESCRIPTION OF A SOUND-MEASURING SYSTEM	27
4.1 General	27
4.2 The Sound-Survey Meter	27
4.3 The Sound-Level Meter	28
4.4 Microphones	29
4.5 Analyzers	30
4.6 Acoustical Calibration	34
4.7 Graphic Level Recorder	35
4.8 Random-Noise Generator	37
4.9 Magnetic Tape Recorder.	38
4.10 Cathode-Ray Oscilloscope.	39

Copyright 1963 by General Radio Company,
West Concord, Mass., USA

CHAPTER 5 APPLICATIONS FOR A SOUND-MEASURING SYSTEM	40
5.1 Introduction	40
5.2 Uses for the Sound-Survey Meter	41
5.3 Uses for the Sound-Level Meter	43
5.4 Loudness and Loudness Level	48
5.5 Speech-Interference Level	48
5.6 Hearing Loss from Exposure to Noise	48
5.7 Summary	50
CHAPTER 6 MEASUREMENT OF SOUND LEVEL AND SOUND-PRESSURE LEVEL	51
6.1 Introduction	51
6.2 Measurement of Sound Level -- Weighting Networks	51
6.3 Measurement of Sound-Pressure Level	55
6.4 Choice of Microphone	63
6.5 Additional Effects on Measured Data	68
6.6 Calibration and Corrections	77
6.7 Other Auxiliary Instruments	81
6.8 Record of Measurements	87
6.9 A Noise Problem	88
CHAPTER 7 NOISE SOURCE CHARACTERISTICS	96
7.1 Introduction	96
7.2 Sources in Free Sound Field	97
7.3 Calculation of Power Level	105
7.4 Sound Source in a Reverberant Room	107
7.5 Comparison Method	109
7.6 Predicting Noise Levels	110
CHAPTER 8 LOUDNESS, SPEECH INTERFERENCE, HEARING DAMAGE, AND NEIGHBORHOOD REACTION TO NOISE	111
8.1 Introduction	111
8.2 Loudness	111
8.3 Speech-Interference Level	115
8.4 Hearing Damage from Exposure to Noise	122
CHAPTER 9 NOISE CONTROL	125
9.1 Introduction	125
9.2 Control at the Source	125
9.3 Control of the Path of Sound	127
9.4 Summary	131

CHAPTER 10 INTRODUCTION TO VIBRATION MEASUREMENTS	132
10.1 General	132
10.2 Vibration Terms	133
CHAPTER 11 DESCRIPTION OF VIBRATION-MEASURING INSTRUMENTS	137
11.1 Introduction	137
11.2 The Vibration Meter	137
11.3 Vibration Pickup System	140
11.4 Analyzers	141
11.5 Vibration Calibrator	144
11.6 Stroboscopes	145
11.7 Graphic Level Recorder	147
11.8 Random-Noise Generator	148
11.9 Cathode-Ray Oscilloscopes	148
11.10 Magnetic Tape Recorder	149
11.11 Recording Galvanometer	149
11.12 Vibration Shakers	150
CHAPTER 12 APPLICATIONS FOR VIBRATION-MEASURING EQUIPMENT	151
12.1 General	151
12.2 Examples of Typical Vibration Measurements	153
CHAPTER 13 VIBRATION MEASUREMENT TECHNIQUES	158
13.1 Introduction	158
13.2 Orientation of Pickup	158
13.3 Hand-Held Pickup	159
13.4 Pickup Fastening Methods	161
13.5 Effect of the Pickup on the Vibration	164
13.6 Calibration	164
13.7 A Simple Two-Pickup Method for Determining the Rotational Vibration of Rotating Machinery	165
CHAPTER 14 EFFECTS OF MECHANICAL VIBRATION	167
14.1 General	167
14.2 Effects of Vibration on Man	167
14.3 Other Effects	170
APPENDIXES	
I Decibel Conversion Tables	175

II	Chart for Combining or Subtracting Decibels	184,5
III	Table for Converting Loudness to Loudness Level	186
IV	Vibration Conversion Charts	187-196
V	Effects of Atmospheric Pressure	197,8
VI	Interpretation of the Behavior of the Pointer of a Noise-Measuring Instrument .	199-204
VII	Definitions	205-216
VIII	Words Commonly Used to Describe Sounds	217
IX	References	218-224
X	Catalog Section	225-242
INDEX		243

ACKNOWLEDGEMENT

This edition has been extensively revised to bring it up to date, but it is naturally based on the earlier editions. We should like to acknowledge our indebtedness to Leo L. Beranek, who determined the format and much of the substance of those earlier editions. We also are pleased to acknowledge the help of our associates and of many users of General Radio Company sound-measuring equipment. They are now too numerous to mention individually. But, because of his extensive editorial help on this edition, we wish to single out Frederick Van Veen for our special thanks.

We have, of course, based much of this book on published material, which is outlined in part in the list of references. In addition, we have learned much from various miscellaneous publications and from the work of various American Standards Association Sectional Committees sponsored by the Acoustical Society of America.

We have acted as the transducers for all this information, filtering it and altering it in various ways; we cannot, therefore, transfer any of our responsibility for this book to our sources.

Arnold P. G. Peterson
Ervin E. Gross, Jr.

INTRODUCTION

During the past decade more and more people have become concerned with the problem of noise in everyday life. Manufacturers of home appliances, such as vacuum cleaners, mixers, and washers, have found that a noisy product meets sales resistance. Manufacturers of large industrial equipment, such as distribution transformers that must be located in or near residential areas, have found that care must be taken in the construction and installation in order that noise levels do not annoy the residents. Trucking companies receive complaints when mufflers are inadequate or defective. Manufacturers of airplane propellers and engines, and particularly of jet engines, have found that the noise from their test stands has created a serious community problem.

There is danger of permanent hearing loss when exposure to an intense sound field is long and protective measures are not taken. This problem has become a matter of serious concern to industrial corporations, labor unions, and insurance companies.

Lack of proper sound treatment in the classroom may lead to excessive noise levels and reverberation, with resulting difficulties in adequate communication between teacher and class. The grade-school teacher's job may become a nightmare because a few corners were cut to decrease, by some small fraction, the initial cost of the classroom.

The General Radio Sound-Measuring System has been developed to help the many people whose job it is to determine the noise output from machines, trucks, airplanes, and appliances, or the noise environment in homes, schools, factories, and recreation centers.

In addition to the measurement of noise, this equipment has many applications in measuring the performance of systems transmitting music and speech, in evaluating the characteristics of acoustic materials, in psychoacoustical studies, and in many other fields of physical science, engineering, and the social sciences.

To the physicist, noise is a sound, whose character can be defined and whose properties can be measured with the same equipment that measures other sounds. To the psychologist, who is also interested in all types of sounds, noise is an undesired sound, as contrasted with music and speech, which are usually desired sounds. Whenever we study the effects of physical phenomena on human beings, we are working in a field where the interests of the psychologist and those of the physicist overlap. The result is usually a happy collaboration,

and in no field has this collaboration been more fruitful than in the measurement and evaluation of the effect of noise.

The evolution of a system of measurement and interpretation involves the creation of a framework of definitions and descriptive terms and also a standardized system of measuring instruments. Both are necessary, the former in order that all workers in the field may understand one another, the second in order that results of different investigators may be compared and that procedures may be standardized.

The purpose of this booklet is to help those who are faced, possibly for the first time, with the necessity of making sound and noise measurements. It attempts to clarify the terminology and definitions used in sound measurement, to describe the measuring instruments and their use, to aid the prospective user in selecting the proper equipment for the measurements he must make, and to show how these measurements can be interpreted to solve typical problems.

THE DECIBEL---WHAT IS IT?

2.1 SOUND PRESSURE.

Air-borne sound is a variation in normal atmospheric pressure. For a simple tone (i.e., a sound characterized by a singleness of pitch), the number of times per second that the pressure changes through a complete cycle is the frequency of the sound. Thus, the standard tone "A" has a frequency of 440 cycles per second (frequently called "cycles" and abbreviated "cps," "c/s" or "c").

The extent of variation in pressure is measured in terms of a unit called the microbar, which is a pressure of one dyne per square centimeter or approximately one-millionth of the normal atmospheric pressure (standard atmospheric pressure = 1,013,250 microbars). Actually, this unit is not often mentioned in giving the results of a noise measurement, but, as will soon appear, it is usually implied when the more common term, the "decibel", is used.

Although to many laymen the decibel (abbreviated "db") is uniquely associated with noise measurements, it is a term borrowed from electrical communication engineering, and it represents a relative quantity. When it is used to express noise level, a reference level is implied. Usually, this reference value is a sound pressure of 0.0002 microbar (abbreviated μ bar). For the present, the reference level can be referred to as "0 decibels", the starting point of the scale of noise levels. This starting point is about the level of the weakest sound that can be heard by a person with very good hearing in an extremely quiet location. Other typical points on this scale of noise levels are shown in Figure 2-1. For example, the sound level in a large office usually is between 60 and 70 decibels. Among the very loud sounds are those produced by nearby airplanes, railroad trains, riveting machines, thunder, and so on, which frequently are in the range above 100 decibels. These typical values should help the newcomer to develop a feeling for this term "decibel" as applied to sound level.

For some purposes it is not essential to know more about decibels than the above general statements. But when we need to modify or to manipulate the measured "decibels", it is desirable to know more specifically what the term means. There is then less danger of misusing the measured values. From a strictly technical standpoint, the decibel is a logarithm of a ratio of two values of power, and equal changes in decibels represent equal ratios.

Although we shall use decibels for giving the results of

TYPICAL OVER-ALL SOUND LEVELS

AT A GIVEN DISTANCE FROM NOISE SOURCE

ENVIRONMENTAL

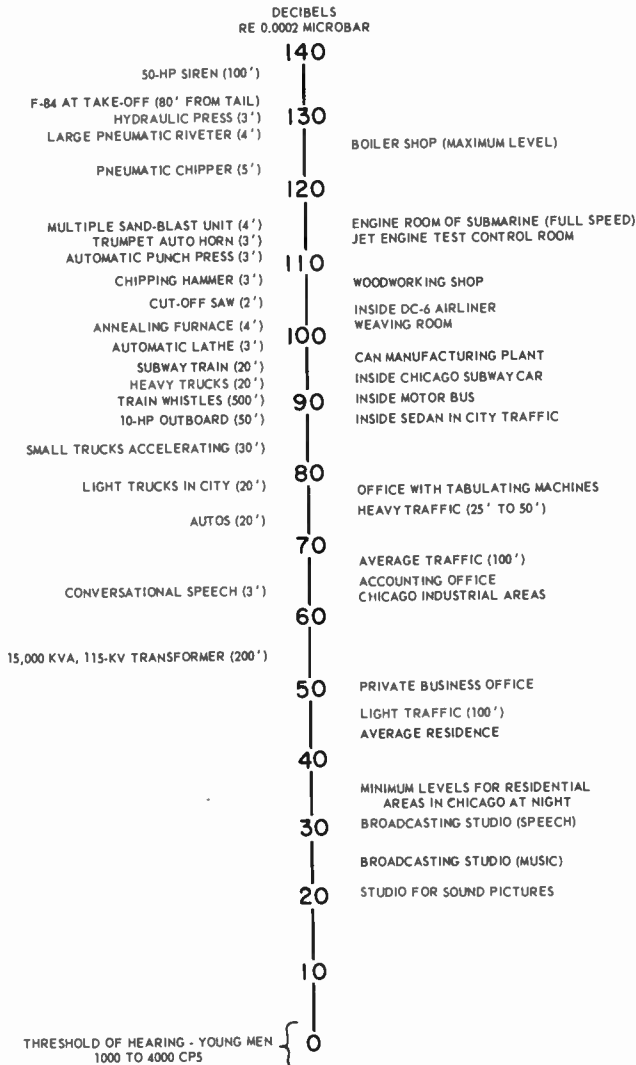

Figure 2-1. Typical over-all sound levels measured with a sound-level meter (levels below 85 db are weighted according to the method given in Section 2.4). Sound-level measurements give only part of the information usually necessary to handle noise problems, and are often supplemented by analysis of the noise spectra and by oscillographic studies. These values are taken from the literature.

power level calculations, the decibel is most often used in acoustics for expressing the sound-pressure level and the sound level. These are extensions of the original use of the term, and all three expressions will be discussed in the following sections. First, however, it is worthwhile to notice that the above quantities include the word "level". Whenever "level" is included in the name of the quantity, it can be expected that the value of this level will be given in decibels or in some related term and that a reference power, pressure, or other quantity is stated or implied.

2.2 POWER LEVEL.

Because the range of acoustic powers that are of interest in noise measurements is about one billion billion to one ($10^{18}:1$), it is convenient to relate these powers on the decibel scale, which is logarithmic. The correspondingly smaller range of numerical values is easier to use, and, at the same time, some calculations are simplified.

The decibel scale can be used for expressing the ratio between any two powers; and tables for converting from a power ratio to decibels and vice-versa are given in Appendix I of this book. For example, if one power is four times another, the number of decibels is 6; if one power is 10,000 times another, the number is 40 decibels.

It is also convenient to express the power as a power level with respect to a reference power. Throughout this book the reference power will be 10^{-12} watt. Then the power level (PWL) is defined as

$$\text{PWL} = 10 \log \frac{W}{10^{-12}} \text{ db re } 10^{-12} \text{ watt}$$

where W is the acoustic power in watts, the logarithm is to the base 10, and re means referred to. This power level is conveniently computed from

$$\text{PWL} = 10 \log W + 120$$

since 10^{-12} as a power ratio corresponds to -120 db. The quantity $10 \log W$, which is the number of decibels corresponding to the numerical value of W watts, can be readily obtained from the decibel tables in the Appendix. For example, 0.02 watt corresponds to a power level of

$$-17 + 120 = 103 \text{ db.}$$

Some typical power levels for various acoustic sources are shown in Figure 2-2.

No instrument for directly measuring power level of a source is available. Power levels can be computed from the sound-pressure measurements described in Chapter 7.

ACOUSTIC POWER

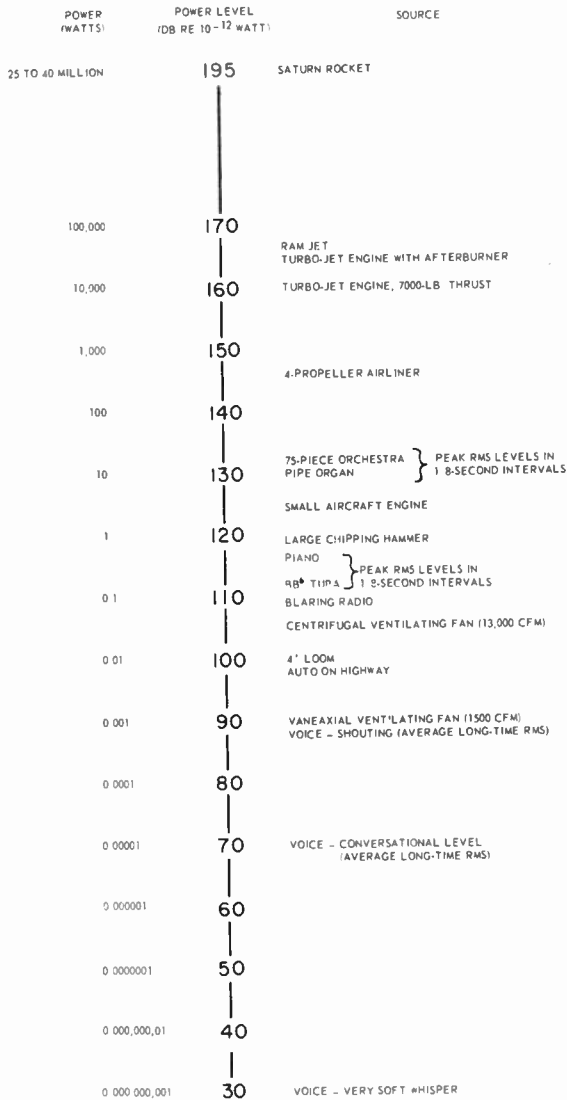

Figure 2-2. Typical power levels for various acoustic sources. These levels bear no simple relation to the sound levels of Figure 2-1. See Chapter 7.

2.3 SOUND-PRESSURE LEVEL.

It is also convenient to use the decibel scale to express the ratio between any two sound pressures; and tables for converting from a pressure ratio to decibels and vice-versa are given in the Appendix. Since sound pressure is usually proportional to the square root of the sound power, the sound-pressure ratio for a given number of decibels is the square root of the corresponding power ratio. For example, if one sound pressure is twice another, the number of decibels is 6; if one sound pressure is 100 times another, the number is 40 decibels.

The sound pressure can also be expressed as a sound-pressure level with respect to a reference sound pressure. For air-borne sounds this reference sound pressure is, generally, 0.0002 microbar. For some purposes a reference pressure of one microbar has been used, but throughout this book the value of 0.0002 microbar will always be used as the reference for sound-pressure level. Then the definition of sound-pressure level (SPL) is

$$\text{SPL} = 20 \log \frac{P}{0.0002} \text{ db re } 0.0002 \text{ microbar}$$

where P is the root-mean-square sound pressure in microbars for the sound in question. For example, if the sound pressure is one microbar, then the corresponding sound pressure ratio is

$$\frac{1}{0.0002} \text{ or } 5000.$$

From the tables, we find that the pressure level is 74 db re 0.0002 microbar. If decibel tables are not available, the level can, of course, be determined from a table of logarithms.

The instrument used to measure sound-pressure level consists of a microphone, attenuator, amplifier, and indicating meter. This instrument must have an over-all response that is uniform ("flat") as a function of frequency, and the instrument is calibrated in decibels according to the above equation.

2.4 SOUND LEVEL.

The apparent loudness that we attribute to a sound varies not only with the sound pressure but also with the frequency (or pitch) of the sound. In addition, the way it varies with frequency depends on the sound pressure. This effect can be taken into account to some extent for pure tones by including certain "weighting" networks in an instrument designed to measure sound-pressure level, and then the instrument is called a sound-level meter. In order to assist in obtaining reasonable uniformity among different instruments of this type, the American Standards Association, in collaboration with scientific and en-

gineering societies, has established a standard to which sound-level meters should conform.

The current American Standard for Sound-Level Meters (S1.4, 1961) requires that three alternate frequency-response characteristics be provided in the instrument (see Figure 2-3). These three responses are obtained by weighting networks designated as A, B, and C. Responses A, B, and C selectively discriminate against low and high frequencies in accordance with certain equal-loudness contours, which will be described in a later section. It has been customary to use response A for sound levels below 55 db; response B between 55 and 85 db, and response C for levels above 85 db. When sounds are measured according to this practice, the reading obtained is said to be the sound level. Only when the over-all frequency response of the instrument is "flat" are sound-pressure levels measured. As mentioned before, a scale of sound levels for typical noise sources is shown in Figure 2-1.

Values derived from the above procedure can be misleading or ambiguous, and we recommend that each noise be measured with all three weighting networks. (Refer to paragraph 6.2.) For many noises, even this is only preliminary to further analysis.

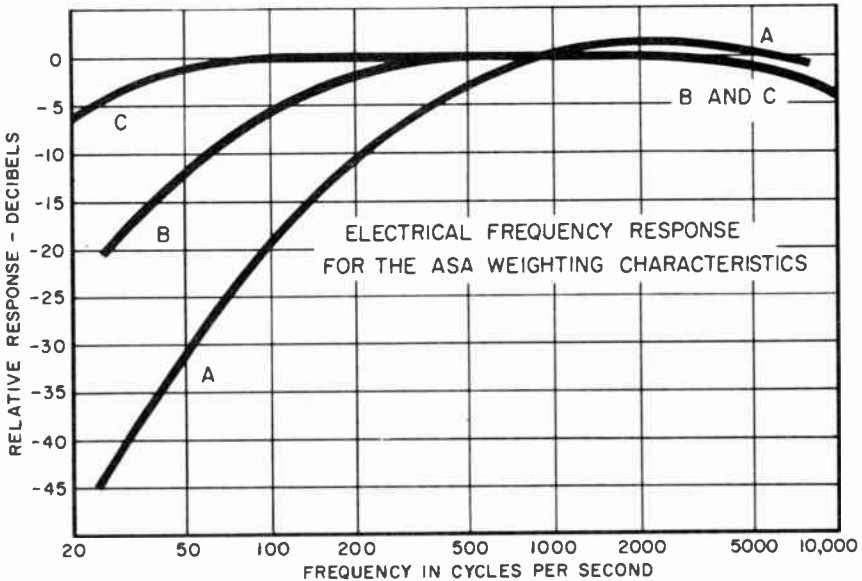

Figure 2-3. Frequency-response characteristics in the American Standard for Sound-Level Meters, S1.4, 1961.

2.5 COMBINING DECIBELS.

There are a number of possible situations that require combining several noise levels stated in decibels. For example, we may want to predict the effect of adding a noisy machine in an office where there is already a significant noise level, to correct a noise measurement for some existing background noise, to predict the combined noise level of several different noise sources, or to obtain a combined level of several levels in different frequency bands.

In none of these situations should the numbers of decibels be added directly. The method that is usually correct is to combine on an energy basis. The procedure for doing this is to convert the numbers of decibels to relative powers, to add or subtract them, as the situation may require, and then to convert back to the corresponding decibels. By this procedure it is easy to see that a noise level of 80 decibels combined with a noise level of 80 decibels yields 83 decibels and not 160 db. A table showing the relation between power ratio and decibels appears in Appendix I. A chart for combining or separating different decibel levels is shown in Appendix II.

2.6 SUMMARY.

Reference levels and relations presented in this chapter included the following:

Reference sound pressure: 0.0002 microbar.*

Reference power: 10^{-12} watt.**

Power level (PWL):

$$\underline{PWL} = 10 \log \frac{W}{10^{-12}} \text{ db re } 10^{-12} \text{ watt.}$$

where W is the acoustic power in watts.

Sound-pressure level (SPL):

$$\underline{SPL} = 20 \log \frac{P}{0.0002} \text{ db re } 0.0002 \text{ microbar}$$

where P is the root-mean-square sound pressure in microbars.

(Logarithms are taken to the base 10 in both PWL and SPL calculations.)

Important concepts that aid in interpreting noise measurement results can be summarized as follows:

To measure sound level, use a sound-level meter with one or more of its frequency response weightings (A, B, and C).

To measure sound-pressure level, use a sound-level meter with the controls set for as uniform a frequency response as possible.

Decibels are usually combined on an energy basis, not added directly.

Speed of sound in air:

at 0°C is 1087 ft/sec or 331.4 m/sec

at 20°C is 1127 ft/sec or 343.4 m/sec

Pressure	Pressure Level re 0.0002 microbar
1 microbar	74 db
1 pound/sq ft	147.6 db
1 pound/sq in.	170.8 db
1 atmosphere	194.1 db

*At one time the reference for a sound-level meter was taken as 10^{-16} watt/square centimeter or 10^{-12} watt/square meter. For most practical purposes, this reference is equivalent to the presently used pressure of 0.0002 microbar. This earlier reference value is not a reference for power, since it is power divided by an area. The pressure 0.0002 microbar is also expressed as 2×10^{-5} Newton/square meter or 20 micro-newtons/square meter.

**A reference power of 10^{-13} watt is also used in the USA, and has been used in previous editions of this handbook, but the reference power of 10^{-12} watt is used here because of its increasing acceptance internationally.

Note: The reference pressure and the reference power have been selected independently because they are not uniquely related.

MAN AS A NOISE-MEASURING INSTRUMENT

3.1 WHY WE MEASURE NOISE.

That we are annoyed by a noisy device and a noisy environment, that noise may interfere with our sleep, our work, and our recreation, or that very intense noise may cause hearing loss is frequently the basic fact that leads to noise measurements and attempts at quieting. In order to make the most significant measurements and to do the job of quieting most efficiently, it is clearly necessary to learn about these effects of noise.

Unfortunately, not all the factors involved in annoyance, interference, and hearing loss are known at present. Nor are we yet sure how the known factors can best be used. But a brief discussion of our reactions to sounds will serve to show some of the factors and their relative significance. This information will be useful as a guide for selecting electronic equipment to make the most significant measurements for the problem at hand.

3.2 PSYCHOACOUSTICAL EXPERIMENTS.

Scientists and engineers have investigated many aspects of man's reactions to sounds. For example, they have measured the levels of the weakest sounds that various observers could just hear in a very quiet room (threshold of hearing), they have measured the levels of the sounds that are sufficiently high in level to cause pain (threshold of pain), and they have measured the least change in level and in frequency that various observers could detect (differential threshold). These experimenters have also asked various observers to set the levels of some sounds so that they are judged equal in loudness to reference sounds (equal loudness), and they have asked the observers to rate sounds for loudness on a numerical scale.

In order to get reliable measures of these reactions, the experimenters have to simplify the conditions under which people react to sounds. This simplification is mainly one of maintaining unchanged as many conditions as possible while a relatively few characteristics of the sound are varied. Some of the conditions that have to be controlled and specified are the following: the physical environment of the observer, particularly the background or ambient noise level; the method of presenting the changing signals, including the order of presen-

tation, duration, frequency, and intensity; the selection of the observers; the instructions to the observers; the experience of the observers in the specific test procedure; the normal hearing characteristics of the observers; the method of getting the responses; and the method of handling the data.

Variations in the conditions of the measurement will affect the result. Such interaction is the reason for requiring controlled and specified conditions. It is desirable to know, however, how much the various conditions do affect the result. For example, small changes in room temperature are usually of little significance. But if the observer is exposed to a noise of even moderate level just before a threshold measurement, the measured threshold level will, temporarily, be significantly higher than normal.

The basic method used by the observer to present his reaction to the signals is also important in the end result. Numerous methods have been developed for this presentation. Three of these psychophysical methods are as follows: 1. In the method of adjustment the observer sets an adjustable control to the level he judges suitable for the test. 2. In the method of the just noticeable difference the observer states when two signals differ sufficiently so that he can tell they are different. 3. In the method of constant stimuli the observer states whether two signals are the same, or which is the greater, if they seem to differ.

When psychoacoustical experiments are performed, the resultant data show variability in the judgments of a given observer as well as variability in the judgments of a group of observers. The data must then be handled by statistical methods to obtain an average result as well as a measure of the deviations from the average. In general it is the average result that is of most interest, but the extent of the deviations is also of value, and in some experiments these deviations are of major interest.

The deviations are not usually shown on graphs of averaged psychoacoustical data, but they should be kept in mind. To picture these deviations one might think of the curves as if they were drawn with a wide brush instead of a fine pen.

The measured psychoacoustical responses also have a certain degree of stability, although it is not the degree of stability that we find in physical measurements. In the normal course of events, if one's threshold of hearing is measured today, a similar measurement tomorrow should give the same threshold level within a few decibels.

In the process of standardizing the measurement conditions for the sake of reliability and stability, the experiments have been controlled to the point where they do not duplicate the conditions encountered in actual practice. They are then useful mainly as a guide in interpreting objective measurements in subjective terms, provided one allows for those conditions that seriously affect the result. As a general rule, the trend of

human reactions to changes in the sound is all that can be estimated with validity. A conservative approach in using psychoacoustical data with some margin as an engineering safety factor is usually essential in actual practice.

3.3 THRESHOLDS OF HEARING AND TOLERANCE.

Many experimenters have made measurements of the threshold of hearing of various observers. When young persons with good hearing are tested, a characteristic similar to that labeled MAF (minimum audible field) in Figure 3-1 is usually obtained. This shows the level of the simple tone that can just be heard in an exceptionally quiet location under free-field conditions (see Section 7.2.1.2 for an explanation of "free-field") as a function of the frequency of the tone. For example, if a simple tone having a frequency of 250 cps (about the same as the fundamental frequency of middle C) is sounded in a very quiet location, and if its sound-pressure level is greater than 12 db re 0.0002 microbar at the ear of the listener, it will usually be heard by a young person. In addition to the restrictions mentioned above there are a number of other factors that need careful attention. For example, what is meant by "can just be heard" needs definition. References on these experiments can be found in the bibliography at the end of this handbook.

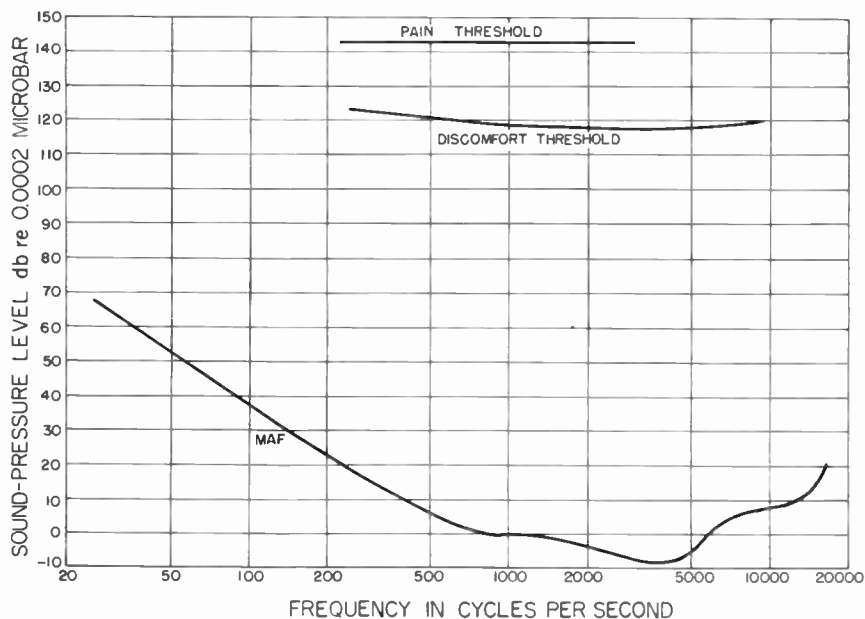

Figure 3-1. Thresholds of hearing and tolerance.

Some variation in the threshold of a person can be expected even if the experiments are carefully controlled. Threshold determinations made in rapid succession may possibly differ by as much as 5 db, and with longer intervals more variation between particular values is possible. But the average of a number of threshold measurements will generally be consistent with the average of another set to within less than 5 db.

The variability among individuals is, of course, much greater than the day-to-day variability of a single individual. For example, the sensitivity of some young people is slightly better than that shown in Fig. 3-1 as the minimum audible field, and, at the other extreme, some people have no usable hearing. Most noise-quieting problems, however, involve people whose hearing characteristics, on the average, are only somewhat poorer than shown in Fig. 3-1.

The threshold curve (Figure 3-1) shows that at low frequencies the sound-pressure level must be comparatively high before the tone can be heard. In contrast we can hear tones in the frequency range from 200 to 10,000 cps even though the levels are very low. This variation in acuity of hearing with frequency is one of the reasons that in most noise problems it is essential to know the frequency composition of the noise. For example, is it made up of a number of components all below 100 cps? Or are they all between 1000 and 5000 cps? The importance of a given sound-pressure level is significantly different in those two examples.

The upper limit of frequency at which we can hear airborne sounds depends primarily on the condition of our hearing and on the intensity of the sound. This upper limit is usually quoted as being somewhere between 16,000 and 20,000 cps. For most practical purposes the actual figure is not important. It is important, however, to realize that it is in this upper frequency region where we can expect to lose sensitivity as we grow older.

The aging effect (called "presbycusis") has been determined by statistical analysis of hearing threshold measurements on many people. A recent analysis of such data* has given the results shown in Figure 3-2. This set of curves shows, for a number of simple tones of differing frequencies, the extent of the shift in threshold that we can expect, on the average, as we grow older.

Many threshold measurements are made by otologists and other hearing specialists in the process of analyzing the condition of a person's hearing. An instrument known as an audiometer is used for this purpose. Its calibration is made with respect to a "normal" threshold. This "normal" level is some-

*American Standards Association Subcommittee Z24-X-2, The Relations of Hearing Loss to Noise Exposure, January, 1954, New York.

what different from the curve labeled MAF in Figure 3-1. The difference between the audiometer threshold and the minimum audible field can be ascribed to the differences in technique used in the tests, to the selection of a different sample of observers, and to generally prevailing ambient noise conditions during audiometer tests.

When a sound is very high in level, one can feel very uncomfortable listening to it. The "Discomfort Threshold" (Silverman) shown in Figure 3-1 is drawn in to show the general level at which such a reaction is to be expected. At still higher levels the sound may become painful, and the order of magnitude of these levels (Silverman) is also shown in Figure 3-1.

3.4 RATING THE LOUDNESS OF A SOUND.

Many psychoacoustical experiments have been made in which listeners have been asked to rate the loudness of a sound. As a result of these experiments involving all sorts of sounds in various arrangements much has been learned about the concept of loudness in laboratory situations. The way in which the judgment of loudness has been obtained seems to affect the results sufficiently, however, so that it seems unwise at the present time to try to scale the sounds of everyday life on an absolute basis. In particular, it does not seem possible to give a numerical value to the loudness ratio of two sounds and have this ratio be reasonably independent of the conditions of comparison. It does seem possible, however, to rank a sound with

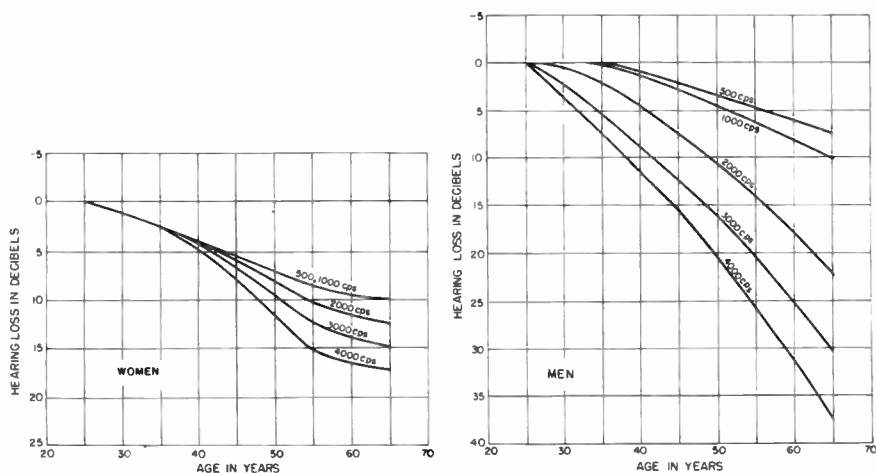

Figure 3-2. Presbycusis curves for women and men. These sets of curves show the average shifts with age of the threshold of hearing for pure tones (ASA Subcommittee Z24-X-2, "The Relations of Hearing Loss to Noise Exposure," New York, 1954, pp 16-17).

satisfactory reliability according to its loudness. For example, if sound A is judged louder than sound B and if sound B is judged louder than sound C, then, in general, sound A will also be judged louder than sound C.

3.4.1 EQUAL-LOUDNESS CONTOURS AND LOUDNESS LEVEL. One step in the direction of rating the loudness of a sound has been to determine the sound-pressure levels of simple tones of various frequencies that sound just as loud to an observer as a 1000-cps tone of a given sound-pressure level. The results of this determination by Robinson and Dadson are given as equal-loudness contours in Figure 3-3. The number on each curve is the sound-pressure level of the 1000-cycle tone used for comparison for that curve. To use

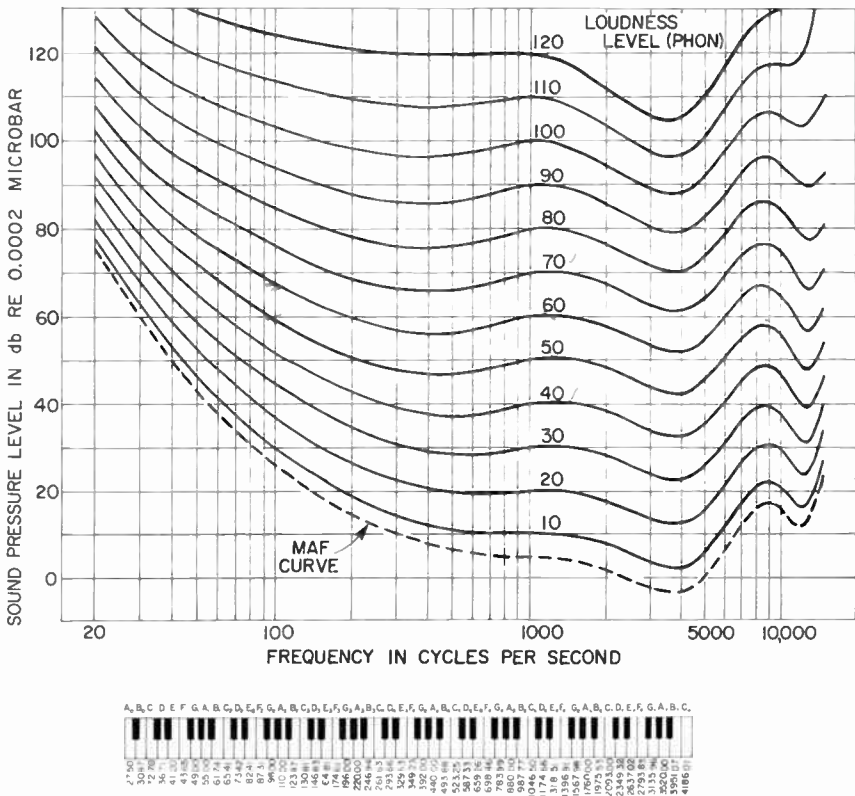

Figure 3-3. Free-field equal-loudness contours for pure tones (observer facing source), determined by Robinson and Dadson at the National Physical Laboratory, Teddington, England. Piano keyboard helps identify the frequency scale. Only the fundamental frequency of each piano key is indicated.

the contours for determining the equally loud levels at other frequencies, we find the point on the curve corresponding to the desired frequency and read off the corresponding sound-pressure level as the ordinate. For example, the 60-db contour line shows that a 67-db level at 100 cycles is just as loud as a 60-db 1000-cycle tone. We can also interpolate to find that a 60-db 100-cycle tone is equal in loudness to a 51-db 1000-cycle tone. The corresponding sound-pressure level in db for the 1000-cycle tone has been defined as the loudness level in phons. Therefore, a 100-cycle tone at a sound-pressure level of 60 decibels has a loudness level of 51 phons.

The weighting networks for the standard sound-level meter are based on similar contours, developed much earlier by Fletcher and Munson. The "A" and "B" weighting characteristics are in accordance with the 40 and 70-phon Fletcher-Munson contours, but with modifications to take into account the usually random nature of the sound field in a room.

A set of equal-loudness contours (Pollack) for bands of random noise are shown in Figure 3-4. Random noise is a common type of noise that occurs in ventilating systems, jets, blowers, combustion chambers, etc. It does not have a well defined pitch, such as characterizes a tone with the energy concentrated in components of definite frequencies. Rather, random noise has energy distributed over a band of frequencies. If the noise energy is uniform over a wide range, it is called "white noise", being analogous in spectrum characteristics to white light. When the energy is distributed over a very wide band, it is a sort of hissing sound. When the broadband noise has little energy at low frequencies, it is more of a hissing sound. When it is concentrated in narrower bands, the sound takes on some aspects of pitch. For example, low-frequency random noise may be a sort of roar.

The contours shown in Figure 3-4 are for relatively narrow bands of noise, such that 11 bands cover the range from 60 to 5800 cps. They are distributed uniformly on a scale of pitch for simple tones (see Section 3.8.2). The numbers on the curves are phons, that is, the sound-pressure levels of equally loud 1000-cycle tones, and the levels are plotted according to the centers of the bands. For example, one band covers the range from 350 to 700 cps. From the curves we can see that when the sound-pressure level of the noise in that band is 43 db re 0.0002 microbar, the indicated loudness level is about 34 phons.

3.4.2 LOUDNESS AND LOUDNESS LEVEL. Although we may remark that some sounds are louder than others, we do not ordinarily rate sounds for loudness on a numerical basis. Experimenters have asked observers to make judgments of the loudness ratio of sounds, that is, to state when one sound is twice, four times, one-half, etc, as loud as another. The resultant judgments depend to a considerable extent on how the problem is presented to the observer. But on the basis of

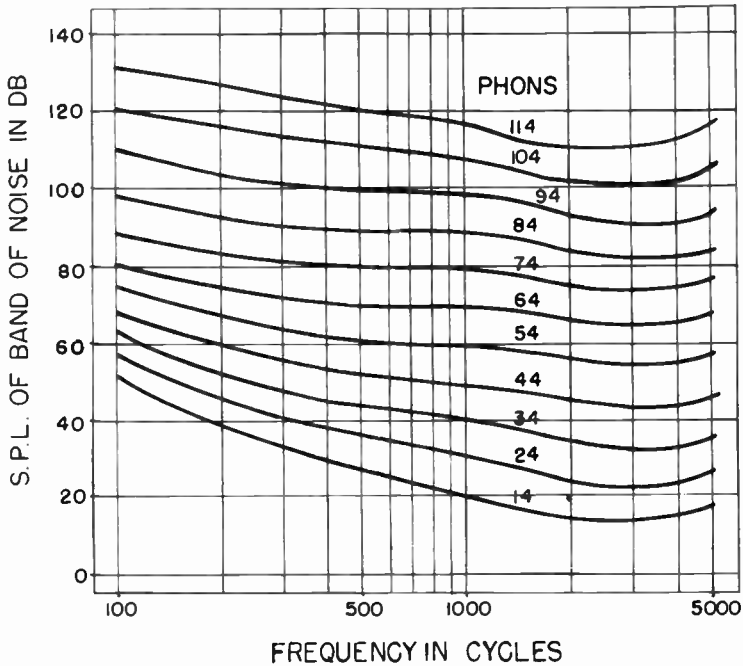

Figure 3-4. Equal-loudness contours for relatively narrow bands of random noise. The center frequency of the band is shown as the abscissa, and the numbers on the curves are phons (Irwin Pollack, "The Loudness of Bands of Noise," *Journal of the Acoustical Society of America*, Vol 24, Sept 1952, pp 533-538).

such judgments several scales of loudness have been devised, which rate sounds from "soft" to "loud" in units of sones. As a reference, the loudness of a 1000-cycle tone with a sound-pressure level of 40 decibels re 0.0002 microbar (a loudness level of 40 phons) is taken to be 1 sone. A tone that sounds twice as loud has a loudness of 2 sones. This scale is shown on the vertical axis of Figure 3-5, and the horizontal scale is the sound-pressure level of the sound in decibels. The curve shown in this figure relates the loudness in sones to the sound-pressure level for a 1000-cycle simple tone. This relation was developed as a useful engineering approximation by Stevens as a result of his analysis of the data reported by many experimenters, who used a wide variety of techniques. He also performed a series of experiments in which the loudness estimates were made on an unusually direct basis, and these experiments confirmed the relation shown. Robinson has also suggested this relation, which is published as a Recommendation

of the International Standards Organization. See Appendix VI.

Above a sound-pressure level of 40 db (re 0.0002 μ bar), the relation shown in Figure 3-5 approximates that given in a former American Standard for Noise Measurement, Z24.2-1942, so that, over most of the useful range, values obtained from the new relation will not differ greatly from those previously obtained.

Incidentally, the relation shown in Fig. 3-5 tends to refute the point of view that the decibel is used in acoustics because we respond to sound pressure in a logarithmic manner. Actually, the loudness is approximately proportional to the sound pressure raised to the 0.6 power.

3.4.3 LOUDNESS LEVEL CALCULATIONS FROM MEASUREMENTS. If the sound to be measured is known to be a simple tone, the procedure for determination of loudness level is relatively easy. The sound-pressure level and the frequency of the tone are determined, and the equal-loudness contours of Figure 3-3 then indicate the loudness level. Since the weighting networks on a sound-level meter approximate two of the

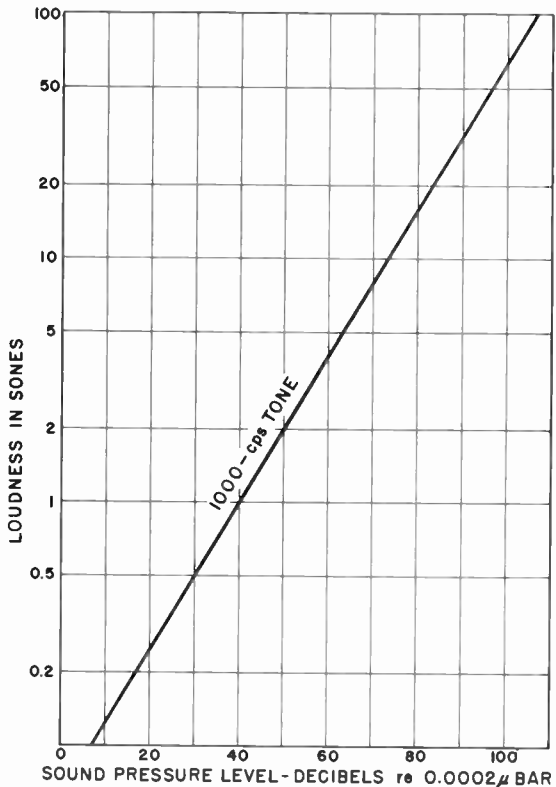

Figure 3-5. Loudness vs sound-pressure level for a pure tone of 1000 cps.

equal-loudness contours, a determination of the weighted level (sound level) can be used to give an estimate of the loudness level of a simple tone. Thus, the sound level (see Section 6.2) is approximately the loudness level when a simple tone is being measured.

For any other type of sound, however, the measured sound level will be lower than the loudness level. The error in estimating loudness level will depend on the type of sound; and the error for many noises is more than 10 phons. For example, if we have a uniform wide-band noise from 20 to 6000 cps of 80 db sound-pressure level, the sound level would be about 79 db, whereas the actual loudness level of such a noise is about 100 phons. Here we see that the sound level is not only misleading, but is farther from the loudness level than is the sound-pressure level. This result, for most noises, illustrates the fact that we need to know more about a sound than just its sound-pressure level or its sound level. If we know how the energy in a sound is distributed as a function of frequency we can make a more useful estimate of its probable subjective effect than we can be knowing just its sound pressure level. One of the ways such knowledge is used is in the calculation of loudness level.

For steady, wide-band noises, a technique developed by Stevens has been found to give good results. The sound is divided by an analyzer into frequency bands covering the audio spectrum. The loudness level is then calculated according to the procedure given in Section 8.2.

As progress is made in the study of loudness we can expect the development of new techniques in the translation of measured data into reliable indications of human reaction.

3.5 MASKING.

It is common experience to have one sound completely drowned out when another, louder noise occurs. For example, during the early evening when a fluorescent light is on, the ballast noise may not be heard, because of the usual background noise level in the evening. But late at night when there is much less activity and correspondingly less noise, the ballast noise may become relatively very loud and annoying. Actually, the noise level produced by the ballast may be the same in the two instances. But psychologically the noise is louder at night, because there is less of the masking noise that reduces its apparent loudness.

Experimenters have found that the masking effect of a sound is greatest upon those sounds close to it in frequency. At low levels the masking effect covers a relatively narrow region of frequencies. At higher levels, above 60 db, say, the masking effect spreads out to cover a wide range, mainly for frequencies above the frequencies of the dominating components. In other words, the masking effect is asymmetrical with re-

spect to frequency. Noises that include a wide range of frequencies will correspondingly be effective in masking over a wide-frequency range.

3.6 "WHAT NOISE ANNOYS AN OYSTER?"

No adequate measures of the annoyance levels of noises have yet been devised. Various aspects of the problem have been investigated, but the psychological difficulties in making these investigations are very great. For example, the extent of our annoyance depends greatly on what we are trying to do at the moment, it depends on our previous conditioning, and it depends on the character of the noise.

The annoyance level of a noise is sometimes assumed to be related directly to the loudness level of the noise. Although not completely justifiable, this assumption is sometimes helpful because a loud sound is usually more annoying than one of similar character that is not so loud.

Psychologists have found that high-frequency sounds (above about 2000 cps) are usually more annoying than are lower-frequency sounds of the same sound-pressure level. Therefore, when it is determined, by methods to be explained later, that a significant portion of the noise is in the higher frequency bands, considerable effort at reducing these levels from the viewpoint of annoyance may be justified.

A further effect concerns localization of sound. When a large office has acoustically hard walls, floor, and ceiling, the room is "live", reverberant. The noise from any office machinery then is reflected back and forth, and the workers are immersed in the noise with the feeling that it comes from everywhere. If the office is heavily treated with absorbing material, the reflected sound is reduced, and the workers then feel that the noise is coming directly from the machine. This localized noise seems to be less annoying. While no adequate measures of this effect have been developed, the general principle discussed here seems to be accepted by many who are experienced in noise problems.

3.7 SPEECH-INTERFERENCE LEVEL.

It is becoming relatively common to be in a place so noisy that conversation is difficult or impossible. Because of the annoyance of interference with speech and also because noise interferes with work where speech communication is necessary, a noise rating based on the speech-interference level is frequently useful. We should know how to improve speech communication in a noisy place. In order to effect this improvement we shall find it useful to evaluate the speech-interference level of a noise. How this can be done will appear from a consideration of how noise interferes with speech.

Noise interference with speech is usually a masking process

(see Section 3.5). The background noise increases our threshold of hearing, and, as a result, we may hear only a few or perhaps none of the sounds necessary for satisfactory intelligibility.

The consonants contain most of the information in speech; but, unfortunately, they are more readily masked than vowels, because the consonants are weaker than vowels. Noise of a certain level may then mask some speech sounds and not others, depending on the talking level, the particular sound, and the relative frequency distribution of the sound and of the noise.

The energy of the various speech sounds is distributed over the frequency range from below 100 to above 10,000 cps. The actual instantaneous distribution depends on the particular speech sound. For example, the "s" sound has its energy broadly distributed in the range from 4000 to beyond 8000 cps. In contrast, most of the energy in the "ee" sound of "speech" is distributed in fairly definite groups (called "formants") below 4000 cps. All the frequency range of speech sounds is not necessary, however, for complete intelligibility. A number of experimenters have shown that nearly all the information in speech is contained in the frequency region from 200 to 6000 cps.

In any frequency subdivision that we may make of this range, the sound-pressure levels vary over a range of about 30 decibels as successive sounds occur. Tests on the intelligibility of speech show that if we can hear the full 30-decibel range in each of the frequency bands into which speech is divided, the contribution to intelligibility by that band will be 100 percent. If, however, noise limits the range that can be heard to only 15 decibels, the contribution will be about 50 percent, and so forth. Furthermore, if the range between 200 to 6000 cps is divided into a large number of frequency bands of equal importance to speech intelligibility, the total contribution to speech intelligibility is equal to the average of the contributions from the individual bands. This quantity is called the articulation index, because it is a measure of the percentage of the total possible information which we might have perceived of importance to speech intelligibility.

For many noises the measurement and calculation can be simplified even further by the use of a three-band analysis. The bands chosen are 600-1200, 1200-2400 and 2400-4800 cps. The arithmetic average of the sound-pressure levels in these three bands gives the quantity called the speech-interference level. One can use this level for determining when speech communication or telephone use is easy, difficult, or impossible; and one can determine what changes in level are necessary to shift from one order of difficulty to a lower order. The calculations and rating methods for making these determinations are given in Section 8.3.

3.8 ADDITIONAL HEARING CHARACTERISTICS.

In addition to the characteristics already described, numerous others have been investigated, and a few of these are of interest in noise-measurement problems. Therefore, we shall discuss briefly differential sensitivity for intensity and the pitch scale.

3.8.1 DIFFERENTIAL SENSITIVITY FOR INTENSITY. One question that comes up in quieting a noisy place or device is: "Just how little a change in level is worth bothering with? Is a one-decibel change significant, or does it need to be twenty decibels?" This question is partially answered in the section on loudness, but there is additional help in the following psychoacoustical evidence. Psychologists have devised various experiments to determine what change in level will usually be noticed. When two different levels are presented to the observer under laboratory conditions with little delay between them, the observer can notice as small a difference as 1/4 decibel for a 1000-cycle tone at high levels. This sensitivity to change varies with level and the frequency, but over the range of most interest, this differential sensitivity is about 1/4 to 1 decibel. For a wideband random noise (a hissing sound) a similar test gives a value of about 1/2 decibel for sound-pressure levels of 30 to 100 decibels (re 0.0002 microbar). Under everyday conditions, a one-decibel change in level is likely to be the minimum detectable by an average observer. On the basis of these tests, we can conclude that 1 decibel total change in level is hardly worth much, although 6 is usually significant. It should be remembered, however, that many noise problems are solved by a number of small reductions in level. There is also the importance of a change in character of the noise. For example, the high-frequency level of a noise may be reduced markedly by acoustic treatment, but, because of strong low-frequency components, the over-all level may not change appreciably. Nevertheless, the resultant effect may be very much worth while. This example illustrates one reason for making a frequency analysis of a noise before drawing conclusions about the noise.

3.8.2 PITCH AND MELS. Just as they have done for loudness, psychologists have experimentally determined a scale for pitch. The unit for this scale is the "mel" (from "melody"), and a 1000-cycle tone at a level of 40 db is said to have a pitch of 1000 mels. In terms of frequency, this pitch scale is found to be approximately linear below 1000 cycles and approximately logarithmic above 1000 cycles. Some people have suggested that a frequency analysis with bands of equal width in mels would be more efficient for some types of noise analysis than would one with bands of other widths. At the present time there are no commercial analyzers of this type available,

but some work has been done using such an analysis. In addition, the pitch scale has been found useful for some types of charts.

3.9 EFFECTS OF NOISE ON WORK OUTPUT.

Noise can influence work output in many ways; there is the obvious interference with communication (paragraph 3.7), the occasional condition where noise is useful as a means of masking distracting conversations, and the deterioration in quality of work output that can occur when the background noise level is above 90 db.

Broadbent and others have found that the effects of noise on work output depend greatly upon the nature of the work; a long-term job requiring constant vigilance is especially susceptible. The effect of noise is more likely to be a higher rate of errors and accidents than an actual reduction in total output. This result and other findings lead to the interpretation that attention wanders from the work at hand more often as the noise level increases.

From the standpoint of noise reduction, two findings are worth noting: first, noise is more likely to lead to increased errors in susceptible tasks if it is above 90 db; and second, high-frequency audible noise seems more harmful in this respect than does low-frequency noise.

3.10 HEARING LOSS FROM NOISE EXPOSURE*.

Exposure to intense noises may lead to a loss in hearing, which will appear as a shift in the hearing threshold. Some of the loss is usually temporary with partial or complete recovery in some minutes, hours, or days. Any remaining hearing loss that persists indefinitely is called "permanent". The extent of the permanent loss will depend on many factors: the susceptibility of the individual; the duration of the exposure, including the time patterns; the intensity of the noise; the spectrum of the noise; the type of noise (impact, random, or simple-tone); and the nature of the ear protection used, if any.

Because of the many complicating factors, it is not possible to set up a single, simple relation between hearing loss and exposure to noise. Furthermore, adequate data regarding comparative audiograms and a complete history of exposure including noise levels, type of noise, time pattern, and frequency characteristics are not available. It should be remembered also that noise is not the only cause of permanent hearing loss. There is the normal loss of hearing with age (refer to

*ASA Subcommittee Z24-X-2, The Relations of Hearing Loss to Noise Exposure, January, 1954.

Section 3.3), and some types of infection may produce permanent hearing loss.

Nevertheless, because of the importance of the problem, certain tentative ratings are given in Section 8.4. These suggested ratings should be revised when a better understanding of the damage problem is available.

For those concerned with the problem of noise-induced hearing loss, we recommend that they request the latest information on this subject from the Research Center, Subcommittee on Noise of the Committee on Conservation of Hearing of the American Academy of Ophthalmology and Otolaryngology, 327 South Alvarado St., Los Angeles, California.

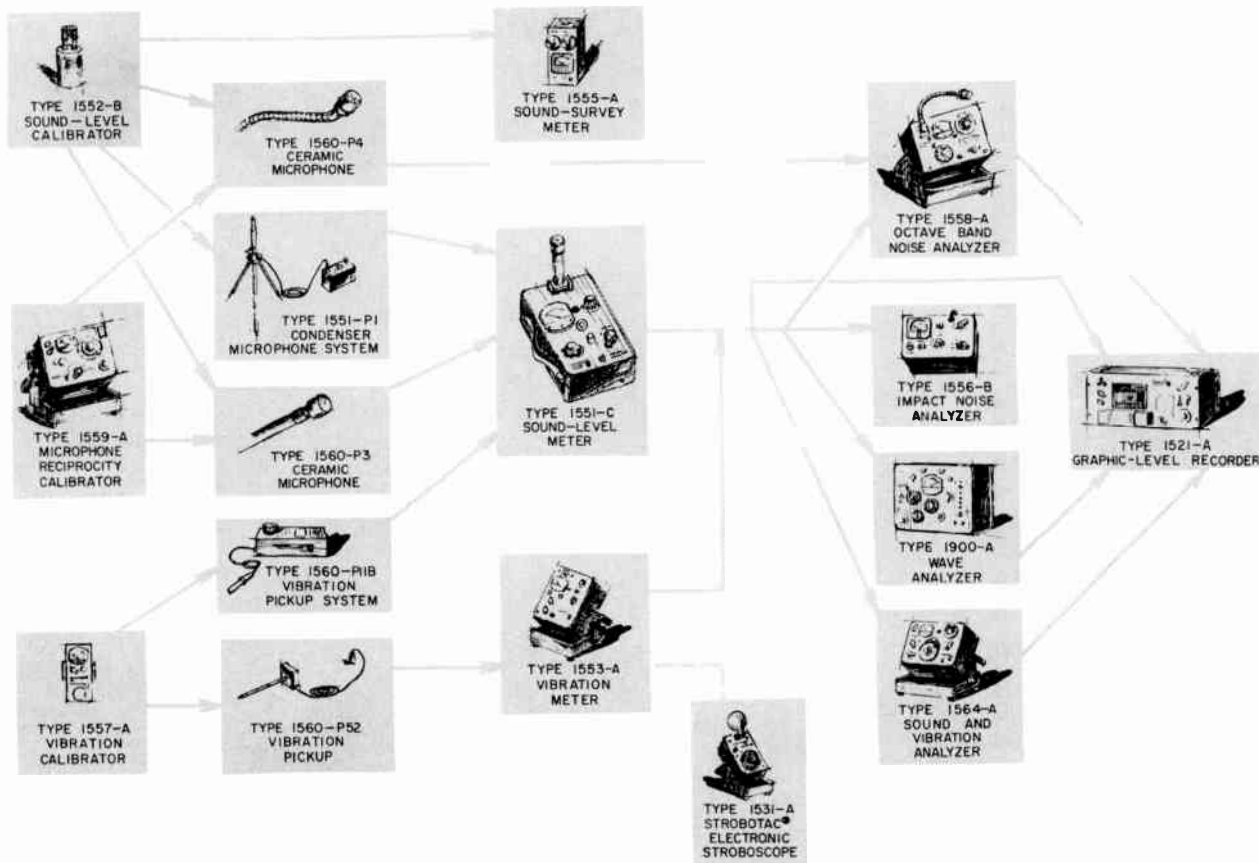

Figure 4-1. The General Radio sound- and vibration-measuring system.

DESCRIPTION OF A SOUND-MEASURING SYSTEM

4.1 GENERAL.

A competent sound-measuring system comprises a general-purpose sound-level meter and associated equipment. In addition, the small, lightweight Sound-Survey Meter is widely used for surveys.

The functional relation among the various instruments of the system is shown in Figure 4-1. A brief description of each instrument is given below (for complete descriptions and specifications, see latest General Radio Catalog), and the applications are discussed in Chapter 5.

4.2 THE SOUND-SURVEY METER.

The Sound-Survey Meter is a small, simple meter for indicating the level of noise and other sounds in terms of a standard reference level. It consists of a microphone, a calibrated



Figure 4-2. The Type 1555-A Sound-Survey Meter.

attenuator, weighting networks, an amplifier, and an indicating meter. As described in Chapter 5, the Sound-Survey Meter is well-suited to a wide variety of general sound measurements.

The Sound-Survey Meter is small, light in weight, easy to use, and inexpensive. It slips easily into a suit-coat pocket. Control settings and panel meter indication can be read at a glance. It can be mounted on a tripod, hand held, or placed on table or bench with equal facility. Readings and settings are easily made with microphone in vertical or horizontal position.

4.3 THE SOUND-LEVEL METER.

The basic instrument of a sound-measuring system is the sound-level meter. This instrument conforms to the requirements set forth in the ASA American Standard Specification for General-Purpose Sound Level Meters (S1.4, 1961)¹, and IEC Recommendation R123. It is an accurate, portable, low-priced meter for reading in terms of a standard reference level (0.0002 microbar at 1000 cps) the sound level at its microphone. Fundamentally, the instrument consists of a non-



Figure 4-3. The Type 1551-C Sound-Level Meter.

¹American Standards Association, 70 East 45th Street, New York 17, New York.

directional microphone, a calibrated attenuator, an amplifier, an indicating meter, and weighting networks.

The amplifier is stabilized by means of inverse feedback and has a flat frequency response range of 20 cycles to 20 kilocycles. In addition to the three common-sound-level meter responses A, B and C, which are specified between 25 cycles and 8000 cycles, this instrument has a fourth weighting-switch position which permits use of wide-band or high-fidelity microphones at its input, with the overall frequency response being determined by the microphone.

4.4 MICROPHONES.

Two different types of microphones are available for use with the sound-level meter. The one most suitable for a given application should be selected on the basis of the characteristics of the different microphones.

4.4.1 PZT MICROPHONE. The microphone regularly supplied with the latest Sound-Level Meter is a PZT (lead titanate-lead zirconate) piezoelectric-ceramic diaphragm type. This stable and rugged microphone has a smooth frequency response and is relatively unaffected by normal temperature and humidity changes. It can be mounted directly on the instrument or separately with connection by extension cable when it is necessary to avoid the effects of the observer and the instrument case on the acoustical measurement.

4.4.2 CONDENSER MICROPHONE SYSTEM. The amplifier, attenuator, and meter frequency-response characteristics of the sound-level meter, with the weighting switch at "20 KC," are flat from 20 cycles to 20 kilocycles. This makes it possible to derive full benefit from some of the wide-range microphones that are available. These microphones have high sensitivity and have excellent response characteristics well beyond 10 kilocycles. They are small in size and so create a minimum disturbance to the sound field at these higher frequencies. They are useful in testing the over-all response of high-fidelity systems or in other wide-frequency-range acoustical investigations.

Two such microphones are used in the Type 1551-P1 Condenser Microphone System, which is an assembly of preamplifier, power supply, microphone, and tripod. The Altec Type 21-BR-150 Microphone, used with Type 1551-P1L System, is capable of measuring levels up to 150 db; and the Altec Type 21-BR-180 Microphone, used with the Type 1551-P1H System, is capable of measuring levels up to 170 db. Both systems have excellent frequency response from 20 cycles to 18 kc.

4.4.3 VIBRATION PICKUP. The Type 1560-P52 Vibration Pickup is an inertia-operated lead zirconate - lead titanate

device which generates a voltage proportional to the acceleration of the vibrating body. By means of integrating networks in a control box, voltages proportional to the velocity or the displacement as well as to the acceleration of the vibrating body may be delivered to the input of a sound-level meter. This combination, called the Type 1560-P11B Vibration Pickup System, plugs into a sound-level meter in place of the microphone. For vibration measurements below a frequency of 20 cycles the vibration meter is better suited. (See Chapter 11.)

4.4.4 HYDROPHONE. Underwater sound can also be measured by means of the sound-level meter, provided a suitable hydrophone is used in place of the microphone supplied. The type of hydrophone that has an attached cable (such as the "Oyster Type O," Clevite Ordnance, 540 East 105th St., Cleveland 8, Ohio, or the Type SSQ23 "Lollipop," Gulton Industries, Inc., 212 Durham Avenue, Metuchen, New Jersey) is convenient to use for measurements up to a few kilocycles. Although its sensitivity is low (-90 db re 1 volt per microbar, compared with a level of -60 db for the PZT microphone), the high gain and low noise level of the sound-level meter make it possible to make many measurements with such low-cost underwater transducers.

4.5 ANALYZERS.

Even if a sound-level meter were perfect (i.e. fit with no tolerance all the design objectives of the ASA Standards), the reading obtained by it in any given noise field is inadequate for a complete understanding of the problem. It is easy to see why this is so. The number of decibels indicated by a sound-level meter tells nothing about the frequency distribution of the noise. It is true that by judicious use of the weighting networks in a sound-level meter one can learn something about the frequencies present, but this knowledge is only qualitative. For most important problems it is necessary to use some type of frequency analyzer to determine the noise spectrum.

A number of analyzers are available for use with the sound-level meter so that its range of usefulness can be extended. These analyzers vary in cost, complexity and ease of operation. Choice between them is generally determined by the amount of detailed information needed to solve a particular problem. In general, the more information required, the more selective the analyzer needed. The more selective the analyzer, the more time is required to gather the information.

4.5.1 OCTAVE-BAND NOISE ANALYZER. The Octave-Band Noise Analyzer shown in Figure 4-4 makes possible the simple and rapid analysis of noises having complex spectra. It operates directly from the output of a microphone or sound-level meter. It can be used for all frequency analyses, except those

Figure 4-4. The Type 1558-A Octave-Band Noise Analyzer.



requiring a detailed knowledge of the frequency spectrum.

This analyzer consists of a set of band-pass filters, selected by means of a rotary switch, followed by an attenuator and an amplifier, which drives both an indicating meter and a monitoring output.

4.5.2 THIRD-OCTAVE AND CONSTANT-PERCENTAGE-BANDWIDTH ANALYZER. For more detailed analysis of noise a third-octave band analyzer, such as that shown in Fig-



Figure 4-5. The Type 1564-A Sound and Vibration Analyzer.

ure 4-5, is used. This instrument can be tuned to any third-octave band or to any eight-percent frequency band between 2.5 and 25,000 cps. The frequency is indicated by a single dial and a multiplier switch.

Since the bandwidth is always a constant percent of the center frequency, one can readily measure characteristics of machines that do not run at constant speed. An output jack permits connection to headphones or to a recorder such as a graphic-level recorder. The recorder can also be chain-connected to drive the Analyzer's frequency dial and thus to plot (on special chart paper) the spectrum of the input signal.

When component sound levels are in the range of 44 to 150 db, the Sound and Vibration Analyzer can be driven directly by a piezoelectric microphone.

4.5.3 IMPACT-NOISE ANALYZER. The impact-noise analyzer shown in Figure 4-6 operates directly from the output of a sound-level meter to measure significant properties of impact noise, such as its peak level and duration. It is also useful as an accessory for spectrum analyzers, such as octave-band analyzers, for magnetic tape recorders, and for vibration meters.



Figure 4-6. The Type 1556-B Impact-Noise Analyzer, shown attached to sound-level meter.

Through the use of electrical storage systems, three characteristics are measured by the analyzer for every impact noise. They may be read individually on the same meter by means of a selector switch. A RESET position of the selector switch restores the meter to its initial condition.

The three characteristics of an impact noise that the analyzer measures are the maximum instantaneous level, an average level, and a continuously indicating measure of the peak sound levels. The duration of the impact sound can be estimated from the difference of the maximum instantaneous level reading and the average level reading and from the position of a time constant selector switch.

This battery-operated instrument rapidly and conveniently measures characteristics of impact noises that heretofore required extensive laboratory equipment.

4.5.4 WAVE ANALYZER. An audio-frequency wave analyzer uses a fixed-frequency filter in a tunable heterodyne system similar in principle to the common superheterodyne radio receiver. It is continuously tunable from below 20 cycles throughout the audio band in a single sweep of the main tuning dial. The resulting filter characteristic is constant in response with respect to the number of cycles per second deviation from the center frequency over the entire tuning range.

This characteristic is convenient for analyzing random noise, because the spectrum level (refer to paragraph 6.3.3) is obtained by a constant correction of the indicated level. Most such analyzers are narrow in bandwidth (such as 4 cps, for the older Type 736-A Wave Analyzer), however, and an analysis of noise must then proceed slowly because of the long averaging time required. A significantly wider band, such as 50 cps, which is available on the Type 1900-A Wave Analyzer, is very much faster and relatively easy to use for noise analysis.

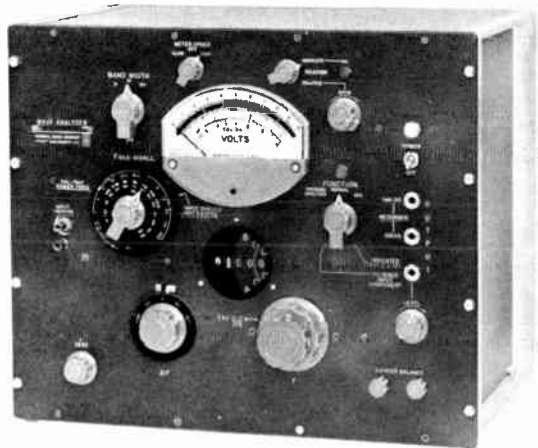

Figure 4-7. The Type 1900-A Wave Analyzer.

This analyzer has an output for recording and a linear frequency scale. When an analysis that is linear in frequency scale is made, one can readily track down harmonic relations, since successive integral harmonics are spaced uniformly. Thus the analysis of rotating or reciprocating machinery, including gear trains, electric motors, and turbines, by a wave analyzer is often to be preferred to other types of analysis.

The analyzer has an electrical output arranged so that the system is a continuously tunable filter. Thus one can listen by means of earphones to the component or band selected by the analyzer. Furthermore, if one applies a broad-band noise signal to the input, one can obtain at the output a narrow band of noise, preferably 50 cycles wide for most acoustic measurements, whose center frequency is continuously tunable over the full range of the analyzer. This signal is desirable for some acoustic tests of rooms, walls, and hearing.

Another mode of operation of the analyzer yields a sine-wave signal at the output that is always at the frequency to which the analyzer is tuned. This is then a convenient source (to drive an amplifier and speaker) and detector for over-all electrical or acoustical response measurements.

4.6 ACOUSTICAL CALIBRATION.

4.6.1 GENERAL. Much is to be gained from the use of an accurately calibrated acoustical measurement system. When an accurate calibration is possible, the consistency of comparison measurements can be improved, a closer approach to an allowed performance specification is possible, and careful attention to measurement techniques will be repaid by more accurate measurements.

4.6.2 RECIPROCITY CALIBRATOR. Frequent, accurate calibrations, even in the field, are now possible by the use of the Microphone Reciprocity Calibrator shown in Figure 4-8. This instrument uses the reciprocity technique, which is widely accepted as the preferred one for the absolute calibration of standard microphones, to calibrate the General Radio PZT microphones and to make an over-all calibration of the system used with them.

This Microphone Reciprocity Calibrator uses a small acoustic cavity as an acoustic impedance reference and an accurate electrical capacitor as the electrical impedance reference. The calculations necessary to determine microphone sensitivity are automatically performed by an analog computer, so that microphone sensitivity can be read from a dial on the panel after four simple adjustments are made at any one frequency.

This calibrator can be operated from an oscillator that supplies at least 5 volts into a 600-ohm load. A sound-level meter can be used as the detector.

Figure 4-8. The Type 1559-A Microphone Reciprocity Calibrator.



4.6.3 SOUND-LEVEL CALIBRATOR. When only a simple, over-all acoustical check of a system at 400 cps is desired, the sound-level calibrator can be used. An internal calibration system is included within the sound-level meter and conveniently permits standardization of the electrical circuits, but this does not include a check on microphone sensitivity. It was to include the microphone in the calibration that the acoustical calibrator was devised. It comprises a small, stabilized, and rugged loudspeaker mounted in an enclosure which fits over the microphone of the sound-levelmeter. The chamber is so designed that the acoustic coupling between loudspeaker and microphone is fixed and can readily be repeated. The level is high enough so that readings are unaffected by normal background noises.

The calibrator can be operated from any audio oscillator having reasonably good wave form (harmonic content should be 5% or less) and capable of supplying 2 volts at 400 cycles across an impedance of 600 ohms. Most users find that they have available a suitable audio oscillator and a voltmeter for use with the calibrator. Figure 4-9 shows a small, simple oscillator that can supply this signal. It has an output voltmeter and a connecting cord that plugs into the terminals of the Calibrator.

4.7 GRAPHIC LEVEL RECORDER.

The graphic level recorder shown in Figure 4-10 makes a permanent chart record of the level of an electrical signal supplied to it. In the field of noise measurement, such a sig-



Figure 4-9. Type 1552-B Sound-Level Calibrator on the microphone of a sound-level meter for calibration. Type 1307-A Transistor Oscillator is audio source.

nal is usually obtained from the output of a sound-level meter. The recorder can be used to record over periods of time the sound level near highways, airports, industrial sites, or other locations where maximum or minimum levels are being investigated. It is also extensively used to trace frequency response curves and to measure reverberation time.

Used with an analyzer, the recorder can plot the curve of amplitude vs frequency of a noise source. For this and other applications, special chart papers are imprinted with the frequency scales of several General Radio instruments. The combination of recorder and beat-frequency oscillator shown in Figure 4-11 produces records having a true logarithmic frequency scale, and is ideal for plotting frequency characteristics of analyzers, recording systems, networks, filters, and



Figure 4-10. The Type 1521-A Graphic Level Recorder.

Figure 4-11. The Type 1521-A Graphic Level Recorder and the Type 1304-B Beat-Frequency Oscillator comprise a convenient system for plotting frequency response.

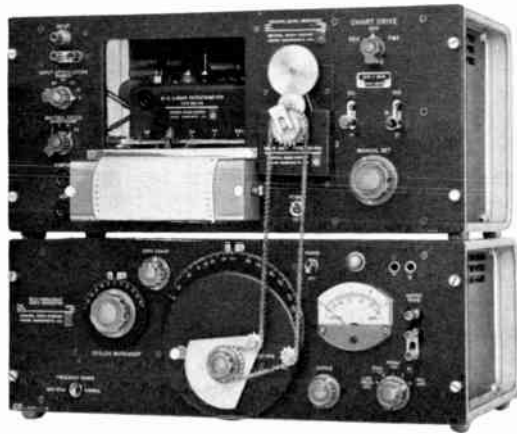

equalizers, as well as of loudspeakers, microphones, vibration pickups, and other transducers. The combination of recorder and sound and vibration analyzer or wave analyzer permits rapid analysis of sound spectra and response measurements on networks excited by white noise.

4.8 RANDOM-NOISE GENERATOR.

The random-noise generator shown in Figure 4-12 is a source of high-level, broad-band electrical noise, which can be converted to acoustic noise by means of a loudspeaker or earphone. Such acoustic noise is useful in psychoacoustic experiments, in the measurement of reverberation and noise transmission, in loudspeaker and microphone response measurements, in microphonic testing, and for calibration procedures.

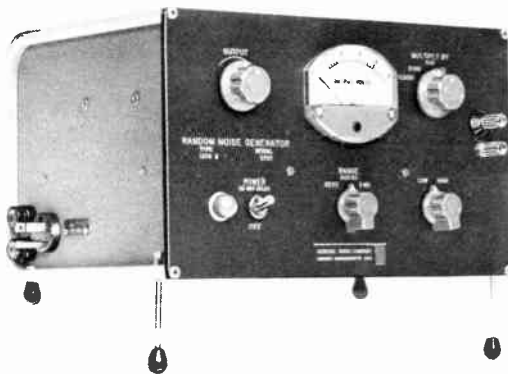

Figure 4-12. The Type 1390-B Random-Noise Generator.

The output of a random-noise generator can be filtered by one of the analyzers to provide a band of noise that is tunable over the audio range. This type of signal is sometimes preferred to the broadband noise signal for the measurements mentioned above.

The output of the random-noise generator can also be converted to a random mechanical motion by an electromechanical shaker. Random motion is used in the mechanical testing of components and structures.

4.9 MAGNETIC TAPE RECORDER.

The magnetic tape recorder such as shown in Figure 4-13 has become a very useful tool for the acoustical engineer both in research and in development. It stores a signal as variations in the magnetic state of the particles on the tape. The time scale then becomes a length scale on the tape.

The signal to be stored must be supplied to the recorder as an electrical signal; and, for recording noise as a function of time, this electrical signal is usually obtained from a high-quality microphone. When measurements are to be made on the stored signal, the recorded tape is played back on the recorder and measurements are made on the electrical output signal.

The magnetic tape recorder is being used to perform the following functions in the field of noise measurements.

1. The preservation of a noise for later analysis or for comparison with a reference noise.
2. The obtaining of a series of short samples which may be analyzed in detail and compared with each other to determine statistical indexes.



Figure 4-13. A magnetic tape recorder.

The recorder selected must be a high quality instrument if accurate analyses are desired. This means a flat frequency characteristic, low hum and noise level, low nonlinear distortion, wide dynamic range, and constant speed.

4.10 CATHODE-RAY OSCILLOSCOPE.

The cathode-ray oscilloscope is part of the equipment of almost any laboratory. It is a useful means for observing the wave form of a noise or other output signal from the sound-level meter. The oscilloscope shows the amplitude of the signal as a function of time; in other words, it gives a time display of the signal. It is particularly useful for observing short-duration or impact noises. It can be used to measure the peak amplitude, the rate of decay, and the shape of a wave.

APPLICATIONS FOR A SOUND-MEASURING SYSTEM

5.1 INTRODUCTION.

We have already seen that a sound-measuring system may consist of the sound-survey meter or of the basic sound-level meter operated alone or with a wide variety of microphones, analyzers and recorders (see Figure 4-1). Confronted with so many possible choices, we ask, "What instruments should we select to do our job?"

The selection of the components of the sound-measuring system will depend entirely on what we wish to obtain from the measurements. If we are interested simply in comparing the noise in one office with that in another, the Sound-Survey Meter may be used. On the other hand, if we must determine the effect at all frequencies of adding a muffler to the exhaust of an automobile engine, a sound-level meter and an analyzer must be used. Similarly, we may want a measure of the loudness of the noise, the sound level, the sound-pressure level, the dominant pitch, the overtone structure, the extent to which it interferes with conversation, or some other characteristic, and for each of these we must use a certain instrument or combination of instruments. It will be helpful in considering these possible end results to review the uses for the Sound-Survey Meter and the sound-level meter. Although the uses



Figure 5-1. The Sound-Survey Meter being used for a preliminary investigation of machine noise.

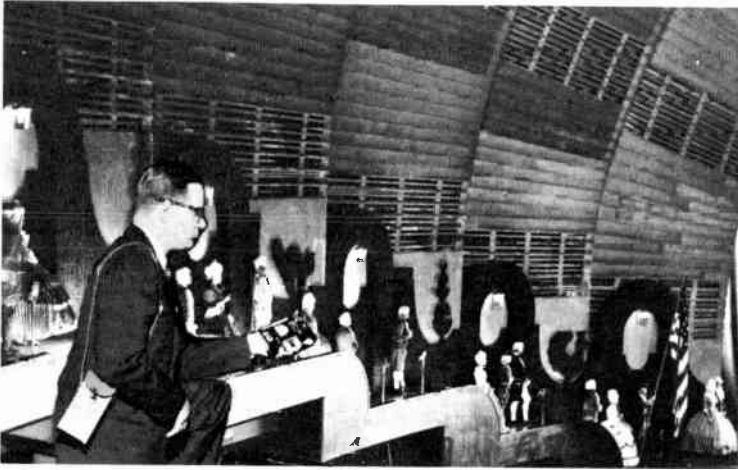

Figure 5-2. Performance checks of sound reinforcement system at Radio City Music Hall being made with Sound-Survey Meter.

cited will not be all-inclusive, they should indicate the basis for a choice of equipment.

5.2 USES FOR THE SOUND-SURVEY METER.

5.2.1 IN INDUSTRY. There are many places where a sound survey is needed. For example, an industrial hygienist may be interested in measuring the noise levels in a factory so as to locate areas where there is a possibility of hearing damage. The Sound-Survey Meter is a very convenient instrument to use for this measurement. It makes possible a quick, initial survey, and, if the levels are low enough, no more is needed. It can also quickly show where more detailed measurements, including frequency analysis, are necessary. Even with the Sound-Survey Meter alone, an estimate of the frequency distribution of the noise is possible by the use of the weighting networks provided.

5.2.2 BY ARCHITECTS. The architect finds the Sound-Survey Meter useful in studying sites for office buildings, homes, and factories. He often considers noise in his selection of a proper place to put a building, in the same way that he considers other environmental factors such as prevailing winds, smoke nuisance, the nearness of schools, and so forth. The architect occasionally must determine the noise produced by ventilating systems to see if they conform to specifications or to see if remedial measures are necessary to quiet an existing system.

Another example of a problem that the architect may encounter is locating a broadcast studio within an existing building. With the Sound-Survey Meter he can measure the noise conditions on each floor of a building and from these data select the most suitable floor for locating the studio. Obviously, vibration may also have to be considered in this problem, necessitating the use of a vibration meter.

5.2.3 BY ENGINEERS AND CONSULTANTS. Engineers and consultants use the Sound-Survey Meter as a preliminary guide to later, more detailed, measurements of sound fields. The meter is a rapid means of collecting statistical data on a noise where a detailed knowledge of the spectrum is not needed.

5.2.4 IN THEATERS AND FOR SOUND SYSTEMS. The Sound-Survey Meter, because of its small size and ease of operation, is particularly useful in checking the level of reproduced sound in theaters and other sound systems. Sine-wave response characteristics of loudspeakers and rooms can be measured. On high-fidelity divided-speaker sound systems the survey meter is useful for determining the response characteristics through the crossover point and for measuring the dynamic range.

5.2.5 IN SCHOOLS. Simple Sound-Survey-Meter measurements will indicate whether the noise in the classrooms is likely to affect the efficiency of the teachers. If the noise levels exceed approximately 40 db with "A" weighting, the students may have difficulty in understanding their teacher.

Two other effects influence the acoustical quality of a classroom. In a highly reverberant room, the speech syllables are smeared by the reflected sounds, so that the intelligibility is

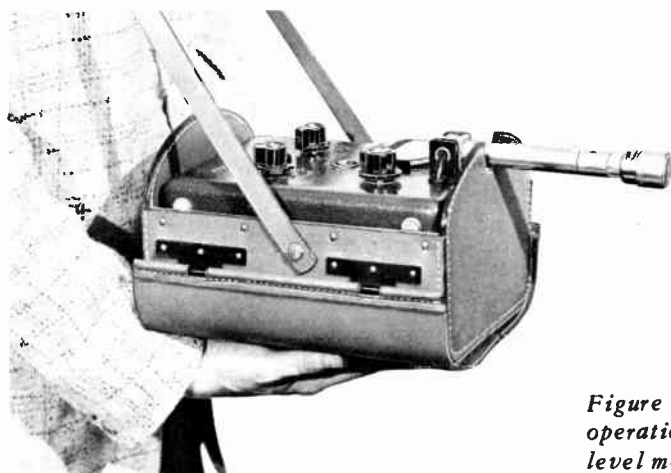

Figure 5-3. Hand-held operation of the sound-level meter.

reduced. In a room with heavy acoustical treatment, the attenuation may be so great that at the rear of the room the teacher's voice is but poorly heard through the background noise.

In the physics or science laboratories, the teacher can demonstrate with the Sound-Survey Meter the relation between sound levels and the sensation of hearing, and he can also use it for acoustical experiments. Teachers of psychology can use it to demonstrate the relation between loudness and loudness level and the dependence of hearing on the intensity of the sound.

5.2.6 IN DRAMATICS AND MUSIC. Directors of musical and dramatic productions can use the Sound-Survey Meter to help actors and musicians to find the correct voice level for a given auditorium or theater. Similarly, teachers of voice and dramatics find it an aid in teaching students to use microphones properly.

The Sound-Survey Meter and its uses are described in the nontechnical, easy-to-read "Primer of Noise Measurement," available on request from General Radio Co.

5.3 USES FOR THE SOUND-LEVEL METER.

The sound-level meter is a precision instrument used to measure noise and other sounds accurately. It can be used in the same way that the Sound-Survey Meter is used, because it includes the same type of weighting networks and is nearly as simple to use. Furthermore, it is more stable, and it is built to closer tolerances than is the Sound-Survey Meter. It meets the requirements of the American Standard Specification for Sound-Level Meters. In addition it supplies a low-distortion output signal, and it has a sufficient dynamic range so that analyzing equipment may be used with it.

The sound-level meter can be used without an analyzer for many types of surveys, for measurement of the over-all sound level as required by test codes, for production tests of equipment noise, or for intercomparing two machines of similar design and performance. For example, if a maximum acceptable noise level has been established for a given model of electric motor, then the sound-level meter can be used with the weighting network in the most appropriate one of its three positions to determine whether other similar motors are sufficiently quiet to meet the production standards. As another example, the noise due to the operation of a particular jet engine test cell in the vicinity of a manufacturing plant may be measured frequently to see that wind and operating conditions do not cause the sound to exceed an acceptable level.

5.3.1 NOISE TEST CODES. Some special groups have pre-



Figure 5-4. Sound-level meter being used to check noise at flight line.

pared test codes for making noise measurements on various devices. Examples of these devices are fans, blowers, water-cooling towers, transformers and airplanes. Almost invariably the code specifies the use of a sound-level meter conforming to the requirements of the American Standard Specification for General-Purpose Sound-Level Meters, S1.4, 1961. When a device must be tested according to such a code, it is recommended that the Type 1551-C Sound-Level Meter be used.

The code usually specifies the conditions of the test, for example, the mounting and location of the device and the microphone placement. The American Standard Method for the Physical Measurement of Sound, S1.2, 1962, discusses these points as well as measurement procedures.

It is usually important for reliability of measurement as well as from the standpoint of obtaining a favorable result to test in as anechoic (dead) a room as practical and to have the background noise level low. Paragraphs 6.5.1 and 6.5.3 will show how far it is necessary to go in these respects.

These codes have been prepared to permit noise ratings to be made in a relatively uniform manner. When different models of the same type of device have the same noise rating, however, they will not necessarily give the same noise level in a given room, even if mounting and operating conditions are carefully controlled. In order to be able to predict how two different models will compare in the noise level they produce in a live room, it is often necessary to determine the acoustic power rating and the directivity index of each device as a function of frequency. The methods for determining these are given in Chapter 7.

5.3.2 ANALYSIS OF THE NOISE. When the effect of noise on the hearer is to be predicted, an analyzer is ordinarily used with the sound level meter. Analysis is also useful in determining changes in behavior of machines and their parts, the characteristics of sound sources, and the effects of rooms on noise.

In general, the narrow-band type of analyzer is used when the noise has a characteristic pitch, such as that produced by rotating machinery, when there are resonant structures in the noise source that produce marked peaks of energy in the spectrum, when the noise source is a multiple one that includes strong pitched components, and when the levels from separate sources of different frequencies are required. The octave-band-type analyzer is usually more suitable for noises of a broad-band character, such as hissing, swishing, and sizzling noises, rattles, and buzzes, as well as many machinery noises and aircraft noises. Examples of this type are ventilating systems, oil burners, jets, blowers, cooling towers, looms, tumbling mills. It is also useful when more information about a noise is required than can be given by a sound-level meter directly, but when a more detailed analysis than eight band levels cannot be justified because of the time required. Furthermore, the sound-pressure levels determined in the eight bands form the basis for the approximate calculation of the loudness level of a noise, and they give the speech-interference level. Refer to paragraphs 8.2 and 8.3.

As another example, the background noise in an audiometric room should be low in level in order that accurate audiometric examinations can be made. It is particularly important to have a low noise level at low frequencies. An octave-band analysis of the background noise is then desirable in order to insure that these levels are satisfactory.

Figure 5-5. The sound-level meter, being used to measure noise level in a machine shop.

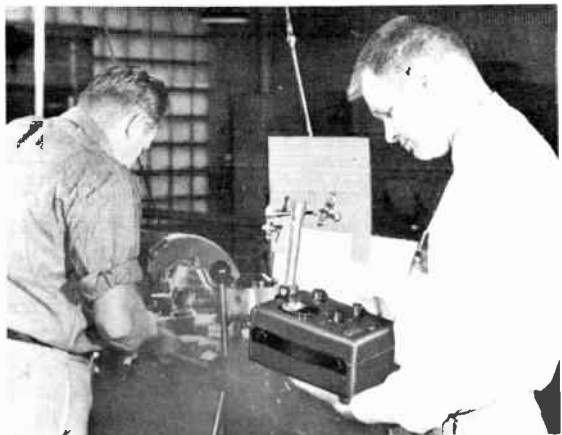

5.3.3 QUIETING MACHINE NOISES. In the development of a new machine it may be necessary to determine accurately the noise components that are radiated by the machine and that are principally important in the production of noise. As an example, let us consider an air-conditioning machine that produces too high a noise level. Analysis with a narrow-band sound analyzer may reveal that the frequencies of the principal noise components can be associated with certain time-periodic rotating or reciprocating actions in the machine. When it has been determined which of these noise sources predominate, the Engineering Design Department can quiet them. Here the graphic level recorder is a great help in plotting the spectra produced by the machine before and after modifications. In this example it is not necessary, from the engineer's standpoint, to know the magnitude of the sound pressure or the total acoustic power radiated by the device. He needs to know only which are the loudest components and how many decibels he must reduce them to make them no more intense than other noises from the machine.

Impact noises, such as those produced by punch presses, drop forges, hammers, typewriters, trippers, chain drives, and riveters, should be measured with an impact-noise analyzer at the output of a sound-level meter. Then the engineer can quickly determine the effect of various treatments or design modifications on the peak level of the noise.

A common use for the sound-level meter is to determine the noise level produced by competitive machines. If the machines are of similar design so that they radiate sound in much the same manner, it is necessary only that the microphone be located in the same position relative to each machine. The sound-pressure levels are determined as a function of frequency either with an octave-band noise analyzer or a sound analyzer. An example of noise spectra measured with an octave-band analyzer is shown in Figure 6-5.

If the machines under comparison are dissimilar in design, it is necessary to determine the total acoustic power radiated by the machine as a function of frequency. The method of measurement will be discussed in Chapter 7. Acoustic power data are particularly important when a machine is to be operated in a closed room, such as an office, factory space, or schoolroom. The noise spectrum built up in a closed room is dependent principally on the spectrum of the acoustic power from the machine, the size of the room, the acoustic absorption in the room, and the number of people in the room.

If a machine is used indoors in a reverberant room and if the noise level produced by it is of importance only at a distance of 15 or more feet from the machine, the only information needed is the total radiated acoustic power as a function of frequency. If, however, this same machine is to be operated out-of-doors or in a room that is not highly reverberant, the directivity pattern of the noise becomes important and must

Figure 5-6. Another example of the sound-level meter in use: measuring noise level at a construction site.



be determined. By the directivity pattern we mean the acoustic power radiated by the machine in various directions. Obviously, there is no point in reducing the noise if the people who are subjected to it are at such an angle from the machine that very little acoustic power is radiated toward them.

5.3.4 MEASUREMENTS OF ACOUSTICAL PROPERTIES OF ROOMS, STUDIOS, ACOUSTIC MATERIALS. The sound-level meter is an important tool for physicists or engineers who wish to measure the acoustical properties of rooms and studios. It can be used, for instance, to measure the noise level built up in a room by a source of known power output, or to determine the uniformity of sound distribution in a room.

If the output of the sound-level meter is fed to the graphic level recorder, the decay rate or reverberation time can be plotted. The addition of an analyzer to the array enables the user to plot amplitude-vs-frequency of a noise source, the sound-pressure spectrum of the ambient noise in a room, and many other amplitude-vs-frequency measurements so important to complete acoustical evaluation. Special linkages connect the Type 1521-A Graphic Level Recorder to the Type 1900-A Wave Analyzer and Type 1554-A Sound and Vibration Analyzer, so that the frequency scale of the Analyzer will be effectively reproduced on the chart paper.

5.3.5 GRAPHIC PRESENTATION OF NOISE LEVELS. The graphic level recorder can be used to record not only the frequency spectrum of a noise, but also noise levels over a period of time. Such use is often helpful in the investigation of residential noise problems, such as those caused by vehicular traffic, airplanes, electrical substations, and factories.

5.4 LOUDNESS AND LOUDNESS LEVEL.

A number of workers in noise measurements have found it useful to translate their noise measurements into loudness terms. Then they can say the measured sound was, for example, about equal in loudness to another, more familiar, sound. To some groups, such as executives and lay clients, this type of statement is seemingly more meaningful than quoting levels in decibels.

In a general way we discussed in paragraph 3.4.3 the procedure for calculating the loudness level from measured levels in octave bands. These levels are determined by use of an octave-band analyzer, and the calculation procedure is given in detail in Section 8.2.

5.5 SPEECH-INTERFERENCE LEVEL.

Most of us have been in locations where it was impossible to hear over a telephone because the noise level was too high; and, in order to hear, production machinery had to be turned off, resulting in time and money lost. Even direct discussions can be difficult and tiring because of excessive noise. Excessive noise may make it impossible to give danger warnings by shouting or to give directions to workers. How serious these conditions are and how much change in noise level is necessary to shift to a less serious condition can be determined by the speech-interference level as described in Section 3.7. Then it is possible to prepare a plan of acoustical treatment on an engineering basis to remedy the situation, if possible.

The speech-interference level is calculated from the results of a frequency analysis of the noise, by means of an octave-band analyzer. The methods for using this level are discussed in Section 8.3.

5.6 HEARING LOSS FROM EXPOSURE TO NOISE.

As described in Section 3.10, the noise near some machines is intense enough to cause permanent hearing damage if the exposure to the noise continues for months or years. Noises of the same over-all level but with different amounts of energy in various frequency bands differ in ability to produce hearing loss. Therefore, a thorough frequency analysis of the noise is usually necessary if the noise level is high.

For an initial survey a Sound-Survey Meter or a sound-level meter can be used to measure the noise level at the person's ears. With these instruments alone there will be a considerable range of level for which predictions about damage will be uncertain, because the frequency spectrum of the noise is unknown.

In the doubtful range, therefore, the spectrum should be determined by analysis with an octave-band analyzer or a

ENVIRONMENTAL NOISE

Environment — Street, Neighborhood, Office, Factory, Vehicle, etc.

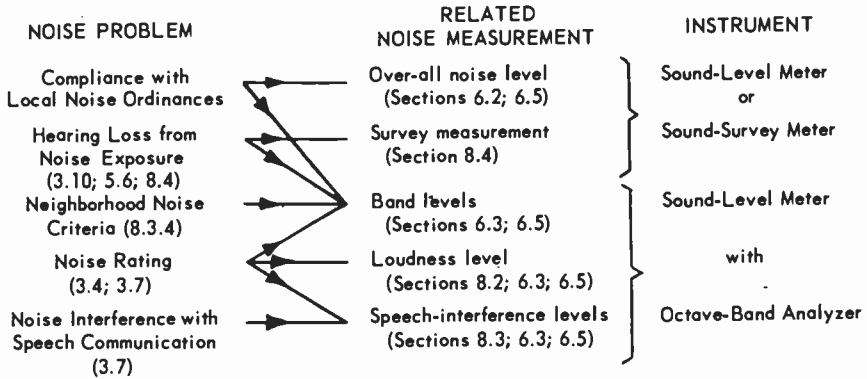

Figures 5-7 (above) and 5-8 (below). A summary of noise measurements as applied to environmental noise (above) and noisy devices (below). The arrows are used to suggest the noise measurements that may help in understanding the noise problem and in doing something about it.

MEASUREMENTS ON NOISY DEVICES

Truck, Bus, Automobile, Airplane, or Marine Engine
Equipment Used by Utilities (Transformers, Gas Regulators, etc.)
Consumer Appliances — Industrial Machines — Airplane Jets or Screws

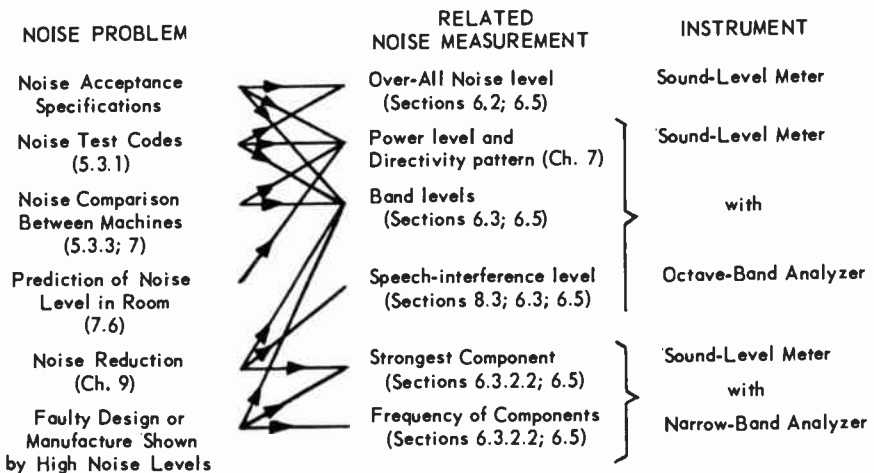

narrow-band sound analyzer.

Impact noises, such as those produced by drop forges, should be measured with an impact-noise analyzer, such as the Type 1556-B (refer to paragraph 4.5.3), or with a cathode-ray oscilloscope, to determine the magnitude and duration of the peak levels.

As a preliminary aid to determining possible damaging noise level conditions, a tentative rating method is given in Section 8.4.

5.7 SUMMARY.

Some of the measurement applications discussed in this chapter are summarized in the charts of Figures 5-7 and 5-8 concerning environmental noise and measurements on noisy devices. In addition, a summary of suggested steps in following apparatus test code requirements and for evaluating product noise are given in the charts below.

Steps in Following Apparatus Test Code Requirements

Successive Steps

1. Selection of location for measurements
2. Apparatus Mounting
3. Selection of Microphone
4. Location of Microphone
5. Number of Measurements
6. Weighting Characteristics
7. Maintenance Checks
8. Background Noise
9. Measurement
10. Repeat of Maintenance Checks
11. Recording Data

Steps in Evaluating Product Noise

1. Selection of location for measurements
 - a. Outdoors, Large Room
 - b. Reverberant Room
2. Apparatus Mounting
3. Selection of Microphone
4. Measurement Locations for Microphone
 - a. Points on Sphere or Hemisphere
 - b. Distance compared with source diameter and lowest frequency
5. Maintenance checks of sound-level meter and analyzer
6. Background Noise in each Band
(For each microphone location)
7. Measurement in each Band
(For each microphone location)
8. Repeat Maintenance Check
9. Recording Data
10. Calculation of Acoustic Power and Directivity Pattern for each Band

MEASUREMENT OF SOUND LEVEL AND SOUND-PRESSURE LEVEL

6.1 INTRODUCTION.

Most of the applications discussed in the previous chapter require a measurement of either sound-pressure level as a function of frequency or of sound level. These quantities are measured at a single point or at a number of points that are determined by the conditions of the application. The method of measuring these quantities is discussed in this chapter, and in Chapter 7 we discuss the more difficult problem of predicting from the measured data the noise level that a noise source will produce when placed in any location. The procedure for determining from the measured data the calculated loudness level, the speech-interference level, and the possibility of hearing damage is given in Chapter 8.

The basic procedure for measuring the sound level or the sound-pressure level at a given point is to locate the sound-level meter microphone at that point and to note the reading of the sound-level meter. Some preliminary exploration of the sound field is usually necessary to determine that the point selected is the correct one, and this exploration is discussed later in this chapter. Other practical details regarding this measurement are also given in this chapter, but the actual manipulation of the individual instrument controls is discussed in the instruction books that are furnished with the instruments.

We shall discuss the selection of the basic instruments for the job, the choice of microphone and auxiliary apparatus, the effects of extraneous influences, the recording of adequate data, the calibration of the instruments, and the interpretation of the data. Finally, an example of a measurement problem is given. Much of this discussion is necessary because no ideal instrument or combination of instruments and accessories is available that would be suitable for all conditions. For example, microphones of different types differ in uniformity of response, in susceptibility to damage, and in cost.

6.2 MEASUREMENT OF SOUND LEVEL— WEIGHTING NETWORKS.

When a single reading of sound level is desired in conformance with the established standard¹, a sound-level meter should

¹ ASA, S1.4, 1961.

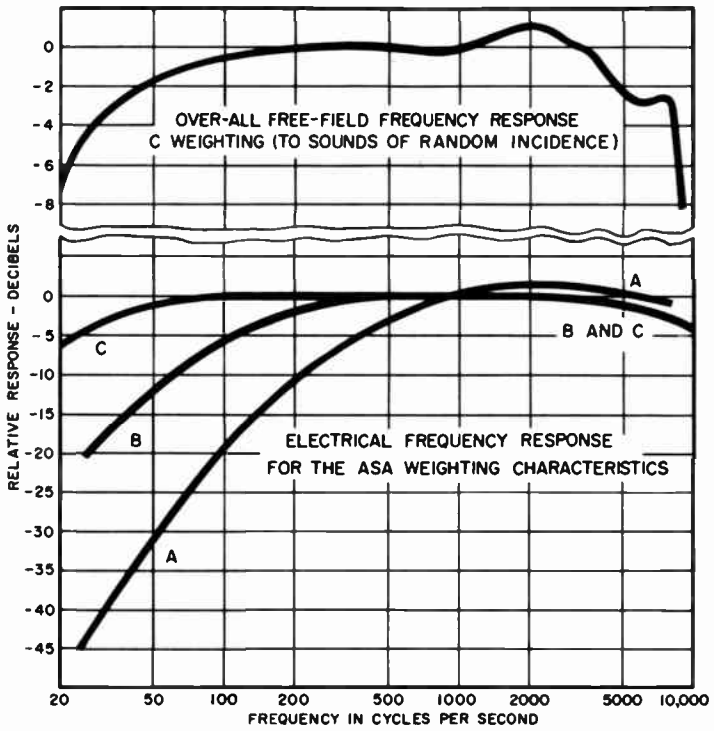

Figure 6-1. Typical acoustical and electrical response curves for the Type 1551-C Sound-Level Meter.

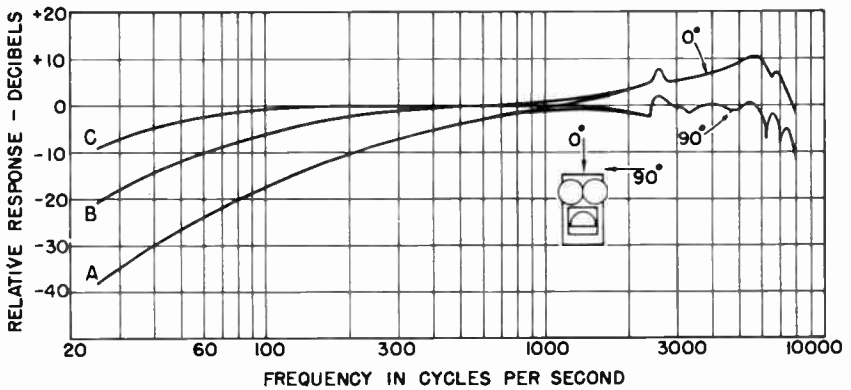

Figure 6-2. Typical over-all free-field response characteristics for the Type 1555-A Sound-Survey Meter.

be used. For many applications, however, the Sound-Survey Meter can be used instead to obtain an equivalent measurement.

Typical frequency response curves for the two instruments, shown in Figures 6-1 and 6-2, illustrate the characteristics provided.

If a single sound-level reading (not sound pressure level) is desired, it has been customary to select the weighting position according to level, as follows: for levels below 55 db, A weighting; for levels from 55 to 85 db, B weighting; and for levels above 85 db, C weighting.²

For example, on a particular noise, sound-level meter readings were as follows: 60 db with C weighting, 50 db with B weighting, and 40 db with A weighting. The quoted sound level is then 40 db, the only reading that falls into the range specified for the weighting network used.

The weighting position used should always be recorded with the observed level.

Some test codes specify the weighting network to be used, and when tests according to such a code are made, that specification should be followed. There are also applications where specific weighting networks should be used, regardless of level.

In general, it is recommended that readings on all noises be taken with all three weighting positions. This procedure avoids the ambiguities mentioned above, and, at the same time, the three readings provide some indication of the frequency distribution of the noise. If the level is essentially the same on all three networks, the sound probably predominates in frequencies above 600 cps. If the level is greater on the C network than on the A and B networks by several decibels, much of the noise is probably below 600 cps.

A more complete statement of this approximate analysis is given by the charts of Figure 6-3, which can be used to give an approximation of the sound distribution in three frequency bands. These charts should be used only as a guide for determining in a preliminary way what the spectrum might be, and they should not be regarded as obviating a complete octave-band analysis. There are occasions, however, when it is impractical to make more than this preliminary analysis, and then the charts of Figure 6-3 may help in making a more sat-

²When the noise is predominantly of low-frequency components, this method may become ambiguous. Then some experimenters have recommended the following schedule:

Sound Level Range	Weighting
below 45 db	A
45-65 db	Average of A and B
65-75 db	B
75-90 db	Average of B and C
above 90 db	C

Figure 6-3. Curves for calculating an approximate frequency analysis in three bands from level readings taken using the three weighting networks. Enter the abscissa of each graph with the measured value $L_C - L_A$. Then proceed vertically to the curve labeled with the measured value of $L_C - L_B$, then horizontally to the ordinate value for each of the three bands corresponding to the difference between the individual band levels and the over-all level. (This method of analysis was developed by J. R. Cox, Jr.)

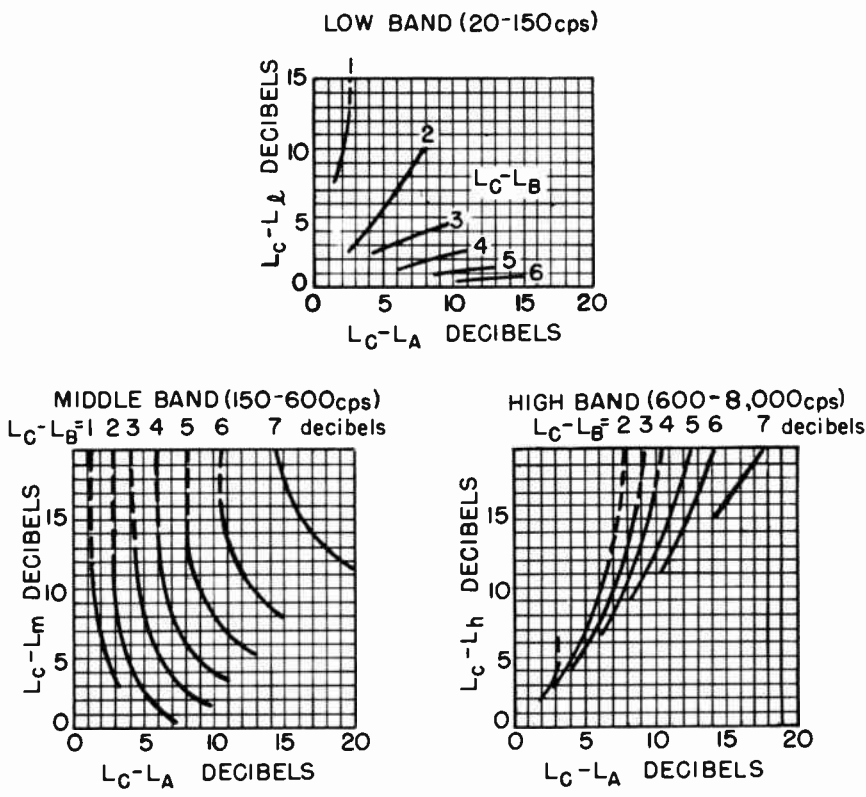

- L_C = Level obtained using C weighting (over-all level).
- L_C = Level obtained using C weighting (over-all level).
- $L_C - L_A$ = Difference between C- and A- weighted readings.
- $L_C - L_B$ = Difference between C- and B- weighted readings.
- $L_C - L_l$ = Level to be subtracted from C-weighted level to obtain "low-band" (20-150 cps) level.
- $L_C - L_m$ = Level to be subtracted from C-weighted level to obtain "middle-band" (150-600 cps) level.
- $L_C - L_h$ = Level to be subtracted from C-weighted level to obtain "high-band" (600-8000 cps) level.

isfactory decision about a noise problem than can be done with only one reading of a noise meter.

Certain noises in which the energy is localized at one end or the other of the lower and middle bands of this approximate analysis cannot be analyzed by this method. This type of spectrum will usually give sound-level readings that do not fit on the charts. Similarly, the dotted portions of the curves are regions of poor accuracy of analysis.

The level in the "high" band (above 600 cycles), as determined from the charts of Figure 6-3, is usually the most important, and for preliminary surveys one can estimate the speech-interference level as 6 db lower than this high-band level. This approximate speech-interference level can then be used according to the methods given in Section 8.3.

In the measurement of the noise produced by distribution and power transformers, the difference in readings of level with the C-weighting and A-weighting networks ($L_C - L_A$) is frequently noted. This difference in decibels is called the "harmonic index". It serves, as indicated above, to give some idea of the frequency distribution of the noise.

6.3 MEASUREMENT OF SOUND-PRESSURE LEVEL.

The sound-pressure level of a noise is measured with the sound-level meter operating with a uniform frequency-response characteristic. This uniform response requirement can only be approximated in practice, because all microphones exhibit some variation in response with frequency. For most noises the low-frequency components dominate, and the excellent response of the PZT microphones at low and middle frequencies permits one to obtain an accurate measurement of the sound-pressure level. When frequencies above 8 kc are important, a wider frequency range microphone should be used (refer to paragraph 6.4.4). The weighting switch of the sound-level meter should be placed in the position for the most nearly uniform frequency response. This position is often called "20-kc" to indicate the wide frequency range that is covered.

6.3.1 OVER-ALL SOUND-PRESSURE LEVEL. The sound-level meter with a "flat" over-all response is used independent of any frequency analyzer to determine the over-all sound-pressure level, given directly by the reading of the sound-level meter in decibels. This over-all level is adequate if the frequency distribution of the sound is of no importance or if it is a single, known frequency. For most applications, however, a frequency analyzer should be used with the sound-level meter, and then this over-all level is commonly used as the reference level for the levels in the various bands of the analyzer.

6.3.2 FREQUENCY SPECTRUM AND BAND LEVELS. An analyzer is required to obtain the frequency spectrum, that is,

the distribution of sound pressure as a function of frequency. For field measurements either an octave-band analyzer or a third-octave analyzer is commonly used. The analyzer is usually connected to a microphone or to the output of the sound-level meter, which is set for a uniform response characteristic. In the laboratory a wave analyzer with a 50-cps band is often more convenient to use than either of the other types of analyzers, especially when the spectrum level of a noise is desired (see paragraph 6.3.3).

6.3.2.1 Octave-Band Analyzer. The octave-band analyzer divides the audio spectrum into bands one octave (2:1 frequency ratio) in width. The American standard bands (Z24.10-1953) have nominal cut-off frequencies of 75 cps low pass, 75-150, 150-300, 300-600, 600-1200, 1200-2400, 2400-4800, and 4800-9600 cps. Because of the importance of the low-frequency end, the Type 1558-A Octave-Band Noise Analyzer also has bands from 18.75 to 37.5 and 37.5 to 75, as well as 9600-19,200 cps.

The above series of octave bands has been widely used for the past twenty years in the U.S.A., but a series that is centered on "preferred frequencies" (American Standards Association S1.6-1960) is coming into use. The Type 1558-AP Octave-Band Noise Analyzer has this series of bands, which are centered on 31.5, 63, 125, 250, 500, 1000, 2000, 4000, 8000, and 16,000 cps. Typical response characteristics are shown in Figure 6-4.

These analyzers may be used either directly with a PZT microphone or on the output of a sound-level meter. The sound-pressure levels obtained in these bands are called octave-band pressure levels.

As mentioned above, the frequency-response weighting used

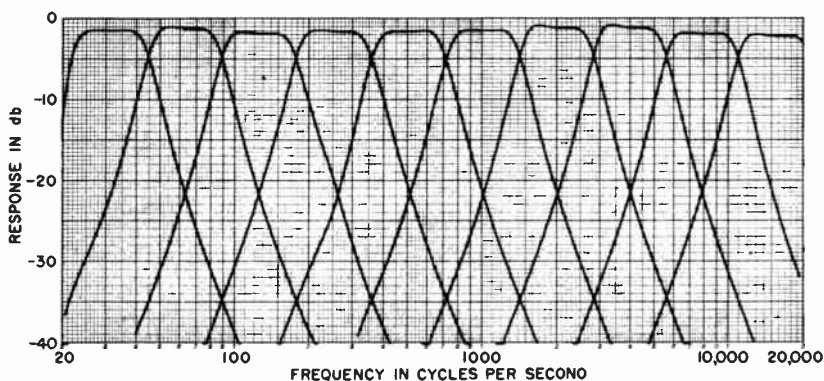

Figure 6-4. Typical response characteristics, Type 1558-AP Octave-Band Noise Analyzer.

should be as uniform as possible to obtain true pressure levels. It has been customary, however, to use the "C" weighting for octave-band measurements. If this is done, for instruments meeting the latest American and International standards there will be small differences in level at the low- and high-frequency ends compared to the levels that would be obtained with a more nearly uniform response, because of the specified roll-offs in response for the C weighting. Thus, the C-weighted octave-band level is less by about 4 db for the 18.75-37.5, 1.5 db for the 37.5-75, and 2 db for the 4800-9600 cps band than with the uniform response weighting. The corresponding level shifts for the other series are about 3 db for the bands centered at 31.5 and 8000 cps and 0.8 db for the bands at 63 and 4000 cps. The shifts in level for the bands in between are too small to be significant.

It is good practice to check that the sum of the individual band levels (see Appendix II) is equal within 1 or 2 db to the over-all level. If this result is not obtained, an error exists, either in the summing or the measurement procedure, because of faulty or incorrectly used equipment, or because the noise is of an impact type. Impact-type noises sometimes give over-all levels appreciably less than the sum of the levels in the individual bands even when the "FAST" position of the meter switch is used. This result is obtained because of the inability of the meter to indicate the instantaneous levels occurring in very short intervals. The narrow-band levels at low frequencies tend to be nearer the peak value in those bands, while the over-all and high-frequency bands are significantly less than the peak value. When this type of discrepancy is noted, the Type 1556-A Impact-Noise Analyzer should be used.

When a graph is made of the results of octave-band pressure level measurements, the frequency scale is commonly divided into equal intervals between the position designated for each band and the position for the band adjacent to it in frequency. The pressure level in each band is plotted as a point on each of these positions along the other axis. Adjacent points are then connected by straight lines. An example of a plot of this type is given in Figure 6-5.

6.3.2.2 Third-Octave and Narrow-Band Analyzer. The Type 1564-A Sound and Vibration Analyzer is continuously tunable from 2.5 to 25,000 cps, in four ranges. A third-octave band and a narrower band are provided, and typical responses of this analyzer at some representative settings of the tuning control are shown in Chapter 11.

On the tuning dial, the calibration shows the frequency of maximum response, and the dots show the location of the standardized third-octave center frequencies (American Standards Association S1.6 - 1960).

The third-octave band divides each 10-to-1 tuning range into ten bands. In each band, the ratio of the upper cut-off

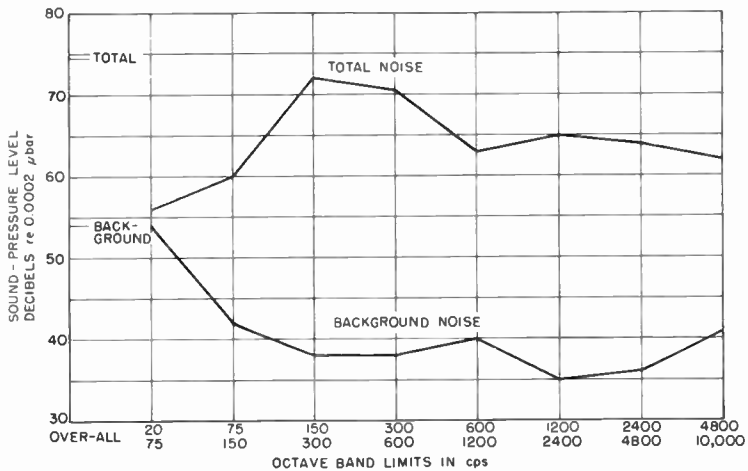

Figure 6-5. A plot of the octave-band analysis of noise from a calculating machine. Graph paper for plotting octave and one-third-octave band levels is available from Codex Book Co., Inc., Norwood, Mass., as Forms 31460 and 31462, respectively.

frequency to the lower cut-off frequency is 1.26 to 1. The narrower band in effect divides the range into about three times as many bands. The detail of the analysis is consequently much finer and more information is obtained than for the octave bands, but the time required for this analysis is correspondingly greater.

The sound-pressure levels obtained from this analyzer used on the output of a sound-level meter are usually plotted as a function of frequency with the frequency coordinates on a logarithmic scale. An example of this type of graph is shown in Figure 6-6.

6.3.2.3 Wave Analyzer. The Type 1900-A Wave Analyzer is continuously tunable from 20 to 50,000 cps. It has bandwidths of 3, 10, and 50 cps and is particularly useful in conjunction with a sound-level meter for measuring the sound-pressure level of discrete components in a sound. Because of the ease of calculation and the uniformity of response, it is also well suited to noise analysis, especially when the spectrum level of a noise is needed.

The sound-pressure levels obtained from the wave analyzer used on the output of a sound-level meter are usually plotted as a function of frequency with a linear frequency scale. This type of plot helps in distinguishing harmonic and sum and difference relations among the frequencies of the discrete components.

Figure 6-6. Plot of one-third-octave analysis of noise from calculating machine.

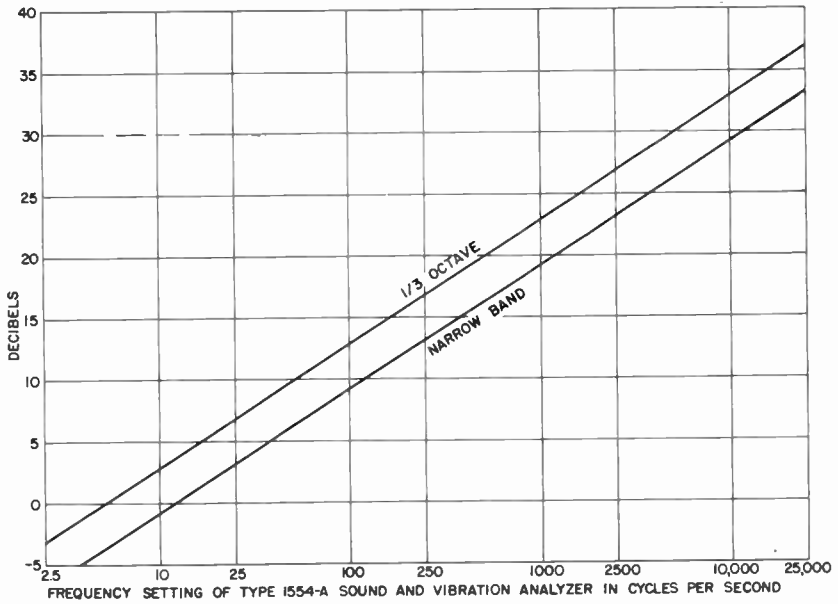
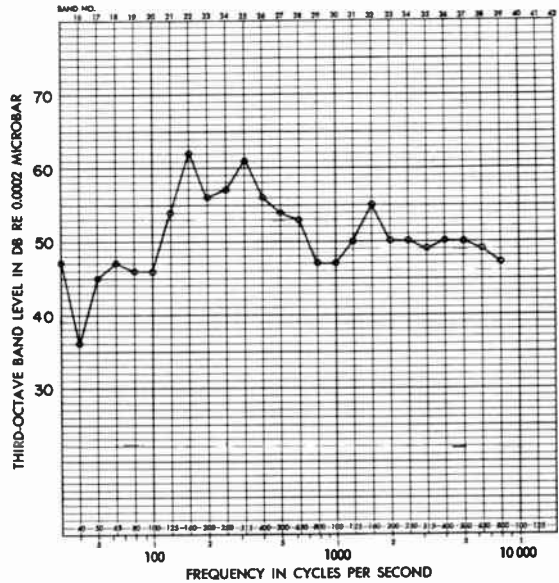

Figure 6-7. Plot showing number of decibels to be subtracted from Type 1564-A readings to obtain spectrum level.

6.3.3 SPECTRUM LEVEL. The spectrum level of a noise is the level that would be measured if an analyzer had an ideal response characteristic with a bandwidth of 1 cycle. The main uses of this concept are comparing data taken with analyzers of different band widths and checking compliance with specifications given in terms of spectrum level. Charts for converting to this spectrum level from the band levels obtained with the Types 1558-A, 1558-AP, and 1564-A Analyzers are given in the accompanying table and in Figure 6-7.

The corrections for spectrum level for a wave analyzer are independent of the center frequency to which it is tuned but do depend on the bandwidth used. For the 3-cycle band subtract 3.7 db; 10-cycle, subtract 9 db; 50-cycle, subtract 15.9 db to obtain the spectrum level. (These correction numbers take into account the metering characteristic as well as the bandwidth.)

<u>Band</u>	<u>Decibels*</u>	<u>Geometric Mean Frequency</u>
18.75 - 37.5	12.7	26.5
37.5 - 75	15.7	53
75 - 150	18.8	106
150 - 300	21.8	212
300 - 600	24.8	424
600 - 1200	27.8	849
1200 - 2400	30.8	1700
2400 - 4800	33.8	3390
4800 - 9600	36.8	6790
9600 - 19,200	39.8	13,580

*To be subtracted from Type 1558-A readings to obtain spectrum level.

<u>Band Center</u>	<u>Decibels*</u>
31.5	13.5
63	16.5
125	19.5
250	22.5
500	25.5
1000	28.5
2000	31.5
4000	34.5
8000	37.5
16,000	40.5

*To be subtracted from Type 1558-AP readings to obtain spectrum level.

This conversion has meaning only if the spectrum of the noise is continuous within the measured band and if the noise does not contain prominent pure-tone components. For this reason the results of using this conversion should be interpreted with great care to avoid drawing false conclusions.

The sloping characteristic given for the Type 1564-A Analyzer in Figure 6-7 results from the fact that this analyzer is a constant-percentage-bandwidth analyzer; that is, its bandwidth increases in direct proportion to the increase in the frequency to which the analyzer is tuned. For that reason a noise that is uniform in spectrum level over the frequency range will give higher-level readings for high frequencies than for lower frequencies, with this analyzer.

6.3.4 FLUCTUATING SOUNDS. Two ballistic characteristics are provided for the meter on the sound-level meter: The "FAST" position is normally used. It will be noticed, however, that most sounds do not give a constant level reading. The reading fluctuates often over a range of a few decibels and sometimes over a range of many decibels, particularly in analysis at low frequencies. The maximum and minimum readings should usually be noted. These levels can be entered on the data sheet as, say, 85-91 db or 88 ± 3 db.

When an average sound-pressure level is desired and the fluctuations are less than 6 db, a simple average of the maximum and minimum levels is usually taken. If the range of fluctuation is greater than 6 db, the average sound-pressure level is usually taken to be three decibels below the maximum level. In selecting this maximum level, it is also customary to ignore any unusually high levels that occur infrequently.

The "SLOW" meter speed should be used to obtain an average reading when the fluctuations on the "FAST" position are more than 3 or 4 db. On steady sounds the reading of the meter will be the same for either the "SLOW" or "FAST" position, while on fluctuating sounds the "SLOW" position provides a long-time average reading.

For a detailed discussion of the interpretation of pointer behavior, see Appendix VI.

6.3.5 GRAPHIC LEVEL RECORDER. The graphic level recorder can be connected to the output of a sound-level meter or analyzer to record the level of a noise as a function of time or frequency. The resulting information is more complete than that obtainable from a few readings of the meter; and when observations over a long period are desired, the recorder can be unattended for most of the time.

The range of levels that can be recorded depends on which of three plug-in potentiometer assemblies is used. For most level recordings, the 40-db unit, supplied with the recorder, should be used.

For the recording of sound-pressure level vs time the re-

recorder can be connected either to a sound-level meter or, if the levels are high enough, directly to a microphone. The Type 1551-P1 Condenser Microphone can be used directly with the recorder at levels above 80 db. A series resistance may be necessary to avoid distortion at high levels.

When the recorder is used to record the output of a sound-level meter, a short, shielded wire should be used to interconnect the two instruments, as isolation against hum and other extraneous noise. The gain of the recorder should usually be set so that a signal that is 0 db on the meter scale is recorded 20 db below full scale on the chart. This setting can be made by means of the built-in calibrating signal of the Sound-Level Meter or the signal from a sound-level calibrator. The level from these signals usually produces a meter deflection of other than 0 db, and the difference should be taken into account. For instance, if the meter indicates +4 db, the recorded level with this signal applied should be 16 db below full scale on the recorder chart paper.

Before the recorder is used, it is desirable to apply an acoustic reference signal to the sound-level meter and to observe the recorded level as the setting of the attenuator switch (of the sound-level meter) is changed. The minimum observable level will be determined by the amount of background noise present, and the maximum level should be beyond full scale on the recorder. Except near these extremes, the recorded level should shift 10 db as the attenuator setting is changed by 10 db. This check will serve to determine that stray pickup is low enough and that the instruments are operating satisfactorily. The attenuator on the sound-level meter should then (for recording) be set so that the recorded signal will be within the range of the recorder; the signal level should never be allowed to exceed full scale by as much as 10 db.

The chart paper supplied with the recorder (Type 1521-9428) has a linear time base, with a division every 1/4 inch. There are 40 divisions on the level scale, with every fifth line accented. Thus, with the 40-db potentiometer in use, each division on the level scale equals 1 db. The top division should be labeled as a sound-pressure level 20 db higher than the attenuator setting on the sound-level meter.

The recorder offers a choice between fast and slow writing speeds. For most recordings, the fast (20 in./sec) speed should be used. However, the slower writing speed can often be used to advantage as a means of filtering out abrupt changes in level.

Several paper speeds, from 2.5 inches per minute to 75 inches per hour (with a slow-speed motor) are available to the user, and choice will be based on the application at hand. Slow paper speeds can be used for long-period studies of noise produced by traffic, office machinery, industrial processes, etc.

The recorder can also be used to plot the output of a sound analyzer, thereby recording a curve of the amplitude vs frequency of a noise source. Special link units couple the recorder

to the Type 1304-B Beat-Frequency Audio Generator, Type 1564-A Sound and Vibration Analyzer, and Type 1900-A Wave Analyzer. Also available are chart papers specially calibrated for use with these analyzers.

6.3.6 IMPACT SOUNDS. For many impact sounds it is desirable to know the value of the peak sound-pressure level that occurs as a result of the impact. This peak level should be measured by an impact-noise analyzer since on drop-forge impacts, for example, the peak sound-pressure level may be as much as 30 db above the maximum deflection observed on the sound-level meter. The metering system of the impact-noise analyzer is specially designed to indicate the peak levels. The amplifier of the impact-noise analyzer drives three measuring circuits simultaneously. Two of these circuits include storage capacitors, so that the signal can be stored electrically for a number of seconds. This arrangement makes possible the use of an ordinary indicating instrument for measurements on sounds whose levels rise and fall very rapidly.

The impact-noise analyzer will measure the output signal from a sound-level meter, an octave-band analyzer, or a magnetic-tape recorder. The controls of any of these instruments should be set so that the peak of the impact sound is within the normal operating range of the instrument. This setting cannot always be estimated from the maximum reading of the indicating meter on the instrument, because the peak value may be 30 db above that reading. If the impact-noise analyzer is used at the time of occurrence of the impact sound, it can be used to check that level.

If a tape recorder is used in the field without an impact-noise analyzer, the level controls should be set so that the indicating instrument reads at least 20 db (0.1) below full scale during the impact noise. Unless such a setting is used, the recorded signal may be seriously distorted and the value of the peak level measured will be too low. (See paragraph 6.7.1.)

6.4 CHOICE OF MICROPHONE.

No single type of microphone is suitable for use under all the conditions encountered in noise measurement problems. The microphones supplied with the sound-level meter and Sound-Survey Meter, nevertheless, are suitable for most applications. However, the measurement of high sound levels, the use of long cables between the microphone and the sound-level meter, and the measurement of high-frequency sounds with good accuracy may require the use of different types of microphones. These problems, as well as others that influence the choice of the microphone, are discussed in the following paragraphs.

6.4.1 LOW SOUND LEVELS. A microphone used to measure low sound levels must have low "self-noise", and it must produce an output voltage sufficient to override the circuit noise of the amplifier in the sound-level meter. The type of microphone supplied with the sound-level meter is very good in this respect, and sound levels down to about 24 db can be measured with it. The Type 1551-P1L Condenser Microphone System is not suitable because even under the best conditions its self noise is equivalent to about 40-db sound-pressure level.

Microphone manufacturers build some units that have a better signal-to-self-noise ratio than the microphones regularly used for noise measurements, but this advantage is obtained with a considerable sacrifice in uniformity of frequency response. Microphones of this type are then not strictly suitable for sound-level measurements, but they might be considered for some special low-level measurements.

6.4.2 HIGH SOUND LEVELS. The sound-level meter microphone and the Type 1551-P1L Condenser Microphone System can be used for the measurement of sound pressure levels up to 150 db. The Type 1551-P1H System can be used up to 170 db. Certain blast microphones (such as those made by Atlantic Research Corporation, Alexandria, Va.; Chesapeake Instrument Corporation, Shadyside, Md., and Massa Laboratories, Hingham, Mass.) can be used directly with the sound-level meter for sound-pressure levels up to about 190 db.

6.4.3 LOW-FREQUENCY NOISE. The PZT, Rochelle-salt-crystal, and condenser-type microphones are well suited for measuring low-frequency noise. In fact, with any one of these microphones, measurements may be made down to only a few cycles per second if special amplifiers, such as that provided by the Type 1553-A Vibration Meter, are used. The sound-level meter is designed to cover the frequency range down to 20 cps, and even at 10 cps the response is down only 10 db. This 20-cps limit is adequate for almost all types of low-frequency noise.

6.4.4 HIGH-FREQUENCY NOISE. The primary requirements on the microphone for accurate measurement of high-frequency sounds are small size and uniform frequency response at high frequencies. The three microphones in the General Radio Sound Measuring System arranged in the order of high-frequency performance are: 1. Condenser microphone, 2. PZT microphone, and 3. Rochelle-salt microphone. This fact is brought out most clearly by comparison of the two typical response curves of Figure 6.8.

Most machinery noises do not include strong high-frequency components, so that for measuring over-all sound levels the high-frequency characteristic is not so important. In contrast, some noises have much energy in the high-frequency end of the

spectrum. Examples of these are noises produced by high-speed production equipment, textile looms and knitters, braiders, wood-working machinery, and jet and air blasts. Then the high-frequency performance determines the ultimate accuracy to be expected from the measurement. Similarly, if good accuracy is required in the region above 2000 cps in determining the frequency spectrum by analysis, the microphone performance must be good or accurately known. When such a frequency analysis is made, corrections can be applied for the frequency characteristic of the microphone as described in paragraph 6.6.5.

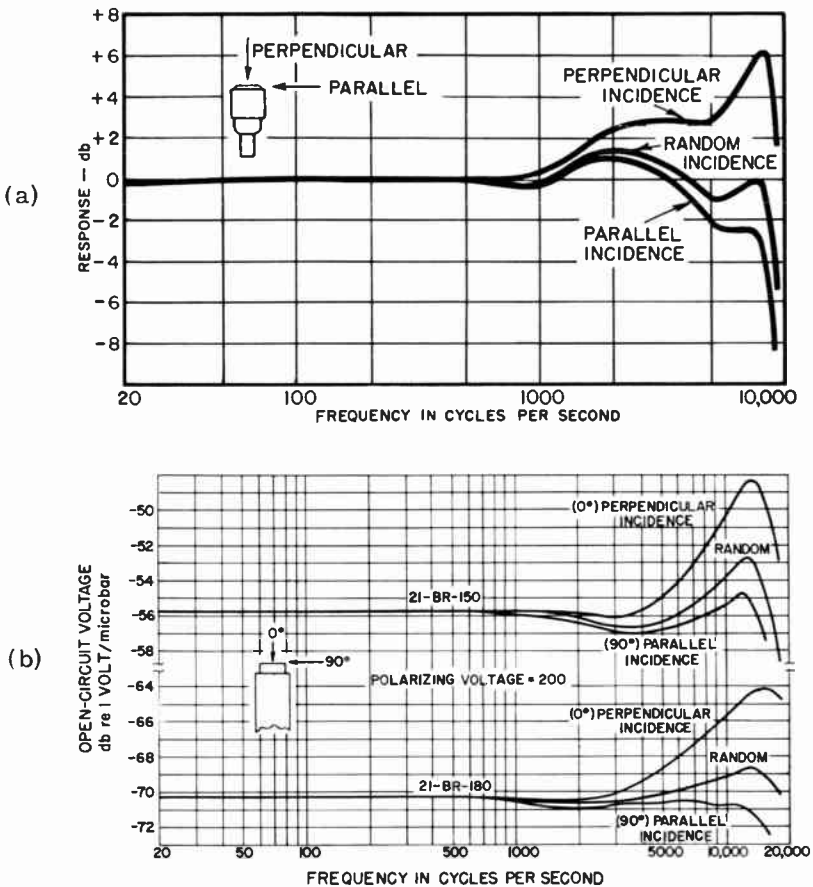

Figure 6-8. Typical response curves for two different microphones when used with the Type 1551-C Sound-Level Meter. (a) PZT microphone assembly supplied with the Type 1551-C; (b) the Type 1551-P1L Condenser Microphone. Random response assumes that the microphone is placed in a diffuse sound field.

The condenser microphone system can be used for measurements up to 20,000 cps, and measurements rarely need to be made on air-borne sounds at frequencies higher than 20,000 cps. For some research investigations much higher frequencies have been measured by use of microphones specially designed for the purpose.

6.4.5 HIGH OR VARYING TEMPERATURE. Although most noise measurements are made indoors at average room temperatures, some measurement conditions expose the microphone to much higher or lower temperatures. When these conditions are encountered, it is essential to know the temperature limitations of the equipment.

The microphone supplied with the Type 1551-C Sound-Level Meter and the Type 1560-P4 PZT Microphone Assembly will withstand temperatures of -30 to +95 C without damage. In contrast, the maximum safe operating temperature for Rochelle-salt crystal microphones is about 45 C (113 F). At 55.6 C (132 F) the Rochelle-salt crystal is permanently changed. It is, therefore, not safe to put a Rochelle-salt microphone in the trunk or back of a car that is to be left standing in the sun.

The maximum safe operating temperature for the microphone probe of the Type 1551-P1 Condenser Microphone System is about 100 C (212 F).

Fortunately, it is usually possible to keep the sound-level meter itself at more reasonable temperatures. Its behavior at extreme temperatures is limited by the batteries. Temperatures of even 130 F will result in much-shortened battery life. Operation below -10 F is not ordinarily possible without special low-temperature batteries.

Microphones are usually calibrated at normal room temperatures. If a microphone is operated at other temperatures, its sensitivity will be somewhat different, and a correction should be applied. The correction for sensitivity for the PZT microphone is only about -0.01 db per degree Celsius, so that for most purposes the correction can be neglected.

The condenser microphone used on the Type 1551-P1 Condenser Microphone System has a temperature coefficient of sensitivity of about -0.02 db/°F.

6.4.6 HUMIDITY. Long exposure of any microphone to very high or very low humidity should be avoided. The PZT microphones, however, are not damaged by extremes of humidity. The chemical Rochelle salt, which is used in microphones furnished with the earlier Types 1551-A, 1551-B, and 759-B Sound-Level Meters and in the Type 1555-A Sound-Survey Meter, however, gradually dissolves if the humidity is too high (above about 84 percent). The Rochelle-salt crystal unit in the microphone, however, is protected by a coating so that it is relatively unaffected by high humidity. Nevertheless, it is wise to avoid unnecessary exposure. A Rochelle-salt micro-

phone should not be stored for long periods in a very dry atmosphere, since it can dry out.

The condenser microphone on the Type 1551-P1 Condenser Microphone System is not damaged by exposure to high humidity, but its operation may be seriously affected unless proper precautions are taken. For proper operation it is essential that very little electrical leakage occur across the microphone. The exposed insulating surface in the microphone has been specially treated to maintain this low leakage even under conditions of high humidity. In spite of this precaution, the leakage may become excessive under some conditions. Then it may be advisable to keep the microphone at a temperature higher than the ambient temperature to reduce the leakage. In climates where the humidity is normally high, it is recommended that the microphone itself be stored in a small jar containing silica gel.

6.4.7 HUM PICKUP. Dynamic microphones can readily pick up undesired electrical signals by induction from the external magnetic field of equipment such as transformers, motors, and generators (see paragraph 6.5.5).

6.4.8 LONG CABLES. Frequently, at the time of the measurement, it is impossible or inadvisable for the observer to be near the microphone, which must be placed at the point where the sound-pressure level is desired. Then an extension cable is ordinarily used to connect the microphone to the instruments. If this cable is short, any of the microphones can be used. A correction for level is necessary, however, when the PZT microphone is used with an extension cable. This correction is about 7 db when a 25-foot cable (650 pf) is used between the microphone and the instrument, so that 7 db should be added to the indicated level to obtain the level at the microphone. For longer cables the correction is greater. For Rochelle-salt microphones the correction is a function of the temperature of the microphone; values are given in the instruction manuals for instruments using Rochelle-salt microphones.

The Type 1551-P1 Condenser Microphone System includes a 10-foot cable between the microphone base and the power supply. If more separation between the microphone and the sound-level meter is required, another cable, such as the Type 1560-P73 Extension Cable, should be used between the Type 1551-P1 Power Supply and the sound-level meter. The use of this cable will result in a slight reduction in sensitivity at high frequencies as explained in the instruction book for the condenser microphone system.

6.4.9 DIRECTION OF ARRIVAL OF SOUND AT THE MICROPHONE. Some microphones are designed to be directional at all frequencies. That is, the response of the microphone depends on the direction of arrival of the sound wave. Most of

the microphones used for sound measurements, however, are essentially nondirectional at low frequencies (below about 1 kc). At frequencies so high that the size of the microphone is comparable to the wave length of the sound in air, even these microphones will show directional effects. This variation in response with direction should be considered in positioning the microphone for a measurement. The extent of these variations is shown by the frequency response characteristics of the different microphones (see Figure 6-8). The microphone is usually positioned so that the response to the incident sound is as uniform as possible.

When sound-pressure level is measured in a reverberant room at a point that is not close to a noise source, the sound arrives at the microphone from many different directions. Then the orientation of the microphone is not critical, and the response is assumed to be that labeled "RANDOM" incidence. Under these conditions, nevertheless, it is usually desirable to avoid having the microphone pointing at a nearby hard surface from which high-frequency sounds could be reflected to arrive perpendicular (0° incidence) to the plane of the diaphragm. (For all the microphones used in the General Radio Sound Measurement System this perpendicular incidence is along the axis of cylindrical symmetry of the microphone. This axis is used as the 0° reference line.) If this condition cannot be avoided, the possibility for errors from this effect can be reduced by some acoustic absorbing material placed on the reflecting surface.

When measurements are made in a reverberant room at varying distances from a noise source, the microphone should generally be oriented so that a line joining the microphone and the source is at an angle of about 70° from the axis of the microphone. When the microphone is near the source most of the sound comes directly from the source, and a 70° incidence response applies. On the other hand, near the boundaries of the room the incidence is more nearly random, and the random-incidence response applies. These two response curves are nearly the same so that there is little change in the effective response characteristic as the microphone is moved about the room. This desirable result would not be obtained if the microphone were pointed at the noise source.

6.5 ADDITIONAL EFFECTS ON MEASURED DATA.

6.5.1 EFFECT OF ROOM AND NEARBY OBJECTS. The sound that a noise source radiates in a room is reflected by the walls, floor, and ceiling. The reflected sound will again be reflected when it strikes another boundary, with some absorption of energy at each reflection. The net result is that the intensity of the sound is different from what it would be if these reflecting surfaces were not there.

Close to the source of sound there is little effect from these

reflections, since the direct sound dominates. But far from the source, unless the boundaries are very absorbing, the reflected sound dominates, and this region is called the reverberant field. The sound-pressure level in this region depends on the acoustic power radiated, the size of the room, and the acoustic absorption characteristics of the materials in the room. These factors and the directivity characteristics of the source also determine the region over which the transition between reverberant and direct sound occurs.

If we are interested in completely evaluating the characteristics of the source of noise, all these factors are important, and they will be considered more completely in Chapter 7. If, in this evaluation, we are merely trying to follow a test code, the problem reduces to satisfying the strict requirements of the code and to arranging the room characteristics and other extraneous influences so that the measurement is reliable and reproducible. For uniformity, then, it is customary to insist that reflected sound does not contribute appreciably to the measured value. This requirement usually means that the room should be heavily treated with absorbing material. Acoustic absorbing material, however, is not uniformly absorbing over the full audio range, so that the effect of reflected sound may vary with frequency.

In order to check on the effect of reflected sound, it is customary to compare the sound level at the measuring points with the level at a much greater distance from the source. If the measured level is at least 8 db higher on the average than it is at more distant points, it is generally assumed that the contribution of the reflected sound is less than 1 db.

A second effect of reflected sound is that measured sound does not necessarily decrease steadily as the measuring position is moved away from the source. At certain resonant frequencies of a live room, marked patterns of variations of sound pressure with position may be observed. Variations of up to 10 db are common and, in particular situations, much more may be found. These variations are usually of the following form: As the measuring microphone is moved away from the source, the measured sound pressure decreases to a minimum, rises again to a maximum, decreases to a minimum again, etc. These patterns are called standing waves. They are noticeable mainly when the sound source has strong frequency components in the vicinity of one of the very many possible resonances of the room. They also are more likely to be observed when a frequency analysis is made; and the narrower the bandwidth of the analyzer, the more marked these variations will be.

The measurement room used for evaluating a noise source should be sufficiently well treated so that no appreciable standing wave exists. If any small standing-wave pattern remains, the average of the maximum and minimum decibel readings should be taken. If the differences are more than 6 db, the

level should be taken as 3 db below the maximum readings that occur frequently. This standing-wave pattern, however, should not be confused with the normal decrease in level with distance from the source or with the directivity pattern of the source, which is considered in Chapter 7.

Objects in the room reflect the sound waves just as do the walls of the room. Consequently, all unnecessary hard-surface objects should be removed from the measurement room. In general, no objects, including the observer, should be close to the microphone. If it is impractical to follow this principle, the objects should usually be treated with absorbing material.

One troublesome but not frequent effect of nearby objects results from sympathetic vibrations. A large, thin metal panel if undamped can readily be set into vibration at certain frequencies. If one of these frequency components is present in the noise, this panel can be set into motion either by air-borne sound or by vibration transmitted through the structure. This panel vibration can seriously upset the noise field in its vicinity. One way of checking that this effect is not present to any important degree is to measure the sound field as a function of the radial distance from the source. The sound should decrease, when not very close to the source, about 6 db as the distance is doubled. This procedure also checks for reflections in general; for careful measurements, the check should be made in each octave band.

When the acoustical environment is being measured, no change should be made in the usual location of equipment, but the sound field should be carefully explored to make sure that the selected location for the microphone is not in an acoustic shadow cast by a nearby object or is not in a minimum of the directivity pattern of the noise source.

6.5.2 EFFECT OF OBSERVER AND METER CASE ON MEASURED DATA. As mentioned in the previous section, the observer can affect the measured data if he is close to the microphone. When measurements are made in a live room and not close to a source, the effect is usually not important. But if measurements are made near a source, it is advisable for the observer to stand well to the side of the direct path between the source and the microphone. For precise measurements in a very dead room, such as an anechoic chamber, it is customary to have the instruments and the observer in another room with only the source, the microphone, the extension cable, and a minimum of supporting structure in the dead room.

For many measurements, however, it is most convenient to be able to carry the sound-level meter or sound-survey meter around. When held in the hand, the sound-level meter should be held in front of the observer with the sound coming in from the side. The magnitude of the error that can be

Figure 6-9. Effect on frequency response as a result of using the microphone directly on the swivel post of the instrument (in two positions) without an observer present, and the extent of the effect with an observer present. A single-frequency, plane, acoustic wave was used in an anechoic chamber, and the decibel values are the differences between the response under the conditions noted and the response of the microphone alone.

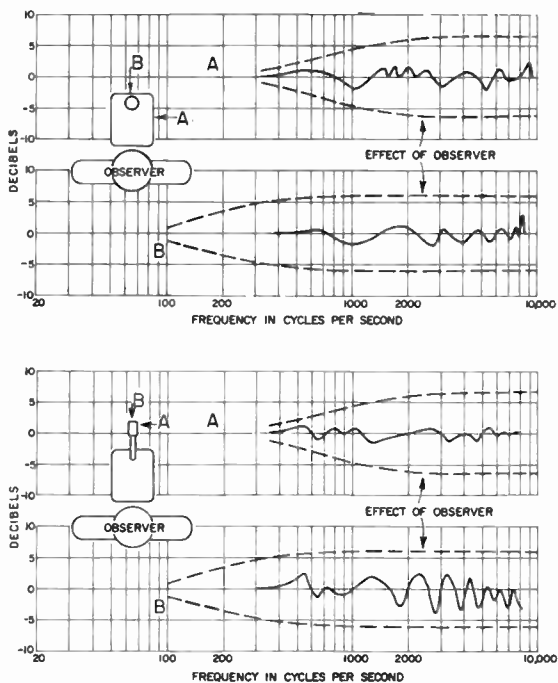

caused by the way the instrument is held can be evaluated from the data shown in Figure 6-9. These data show the difference between the readings of the meter with and without the observer present, as a function of frequency. Two locations are shown: (1) the sound-level meter is between the observer and the noise source, (2) the noise source is located to one side of the observer, and the sound-level meter is held in front of the observer. It is apparent that if the instrument is held properly, little error in reading of the over-all level will occur for most noises.

For additional information on this subject, refer to R. W. Young, "Can Accurate Measurements be Made With a Sound-Level Meter Held in Hand?," Sound, Vol 1 No. 1, pp 17-24, January-February 1962.

The meter case itself may also disturb the sound field at the microphone as shown by the other characteristic curves in Figure 6-10. There is practically no effect below 1000 cps, and, again, on most noises, little error in measuring overall level will result if the microphone is left on the instrument. When an analyzer is used with the sound-level meter, however, it is advisable to separate the microphone from the instruments and to use an extension cable. This refinement is not necessary, however, if the only data that are of interest are below 1000 cps or if only comparative data from one machine to a similar one are desired.

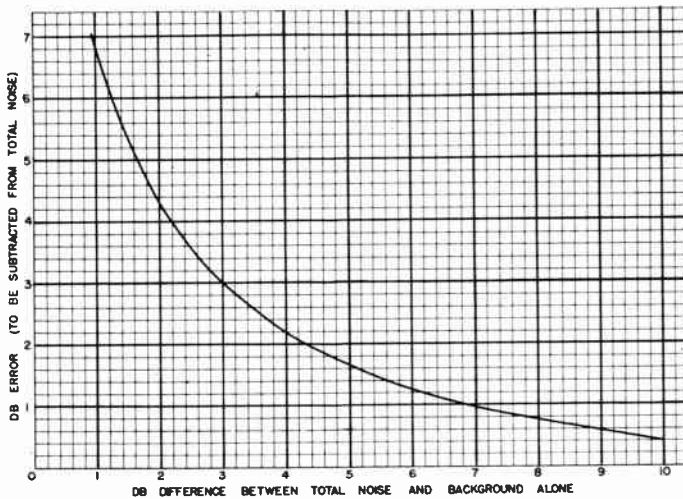

Figure 6-10. Background noise correction for sound-level measurements.

6.5.3 EFFECT OF BACKGROUND NOISE. Ideally, when a noise source is measured, the measurement should determine only the direct air-borne sound from the source, without any appreciable contribution from noise produced by other sources. In order to insure isolation from other sources, the measurement room may need to be isolated from external noise and vibration. As a test to determine that this requirement has been met, the American Standard-Method for the Physical Measurement of Sound, S1.2, specifies the following:

"If the increase in the sound pressure level in any given band, with the sound source operating, compared to the ambient sound pressure level alone is 10 decibels or more, the sound pressure level due to both the sound source and ambient sound is essentially the sound pressure level due to the sound source. This is the preferred criterion."

If the background noise level and the apparatus noise level are steady, a correction may be applied to the measured data according to the graph of Figure 6-10. The procedure is as follows: After the test position has been selected according to the test code and after exploration of the field as outlined in paragraph 6.5.1, the background noise level is measured in the test position. Then the sound level is measured with the apparatus operating. The difference between the sound level with the apparatus operating and the background level determines the correction to be used. If this difference is less than 3 db, the apparatus noise is less than the background noise; and the level obtained by use of the correction should be regarded as only indicative of the true level and not as an accu-

rate measurement. If the difference is greater than 10 db, the background noise has virtually no effect; and the reading with the apparatus operating is the desired level. An example of a situation intermediate between these two is as follows: The background noise level is 77.5 db, and the total noise with the machine under test operating is 83.5 db. The correction, from the graph of Figure 6-10, for a 6.0-db difference, is 1.2 db, so that the corrected level is 82.3 db.

When apparatus noise is analyzed, the background noise level in each band should also be analyzed to determine if correction for the level in each band is necessary and possible. The spectrum of the background noise is usually different from that of the noise to be measured, and the corrections in each band will be different.

If this difference between background level and total noise level is small, an attempt should be made to lower the background level. Usually the first step is to work on the source or sources of this background noise to reduce the noise directly. The second step is to work on the transmission path between the source and the point of measurement. This step may mean simply closing doors and windows if the source is external to the room or it may mean erecting barriers, applying acoustical treatment to the room, and opening doors and windows if the source is in the room. The third step is to improve the difference by the method of measurement. It may be possible to select a point closer to the apparatus, or an exploration of the background noise field may show that the measuring position can be shifted to a minimum of this noise. The latter possibility is more likely when an analysis is being made and the background level in a particular band is unusually high. It may also be possible to point the microphone at the apparatus to obtain an improvement at high frequencies (see Figure 6-8); it may be necessary to use a directional microphone; or it may be desirable to use a vibration pickup (see paragraph 6.7.3).

6.5.4 EFFECT OF CIRCUIT NOISE WHEN LOW NOISE LEVELS ARE MEASURED. When low noise levels are to be measured, the inherent circuit noise may contribute to the measured level. This effect is usually noticeable in the range below 40 db when the Type 1551-P1 Microphone System is used or a PZT microphone is used on the end of a very long cable. If the microphone is directly on the sound-level meter, the level at which this effect may be important is below 30 db if the C weighting is used or even lower if the A or B weighting is used. To measure the circuit noise the microphone may be replaced by a well-shielded capacitor of 6 picofarads for the Type 1551-P1 or of 470 picofarads for the PZT microphone on the Type 1551-C. A correction can then be made for this noise, if necessary, by the same procedure as outlined for background noise in paragraph 6.5.3. If the circuit noise is comparable to the noise

being measured, some improvement in the measurement can usually be obtained by use of an octave-band analyzer. The circuit noise in each band should be checked also to see if correction is necessary. (See also paragraph 6.3.2.)

6.5.5 HUM PICKUP. When noise is measured near electrical equipment, a check should be made that there is no appreciable pickup of electro-magnetic field in the sound-measuring system. The procedure depends on the directional character of the field. The orientation of the instruments should be changed to see if there is any significant change in level. If an analyzer is used, it should be tuned to the power-supply frequency, usually 60 cps, which would be the 20 to 75 c band for the octave-band analyzer, when this test is made. If no analyzer is included, the C-weighting should be used in this test to make the effect of hum most noticeable, and a good quality pair of earphones with tight-fitting ear cushions should be used to listen to the output of the sound-level meter.

If a dynamic microphone is used, tests should be made with different orientations of the microphone, with the microphone disconnected, and with the sound-level meter disconnected from the analyzer. If there is pickup in the microphone, proper orientation may be adequate to make a measurement possible, or electromagnetic shielding may be necessary.

If the hum pickup is in the instruments, they can usually be moved away from the source of the electromagnetic field, or, alternatively, a proper orientation is usually sufficient to reduce the pickup to a negligible value.

When ac operated instruments are used as part of the measuring setup, a check should be made for 120-cycle as well as 60-cycle hum. This hum may be in the instruments, or it may appear as a result of the interconnection of different instruments. These two possibilities may be distinguished by a check of the instruments individually. If each is separately essentially free from hum, different methods of grounding, balancing, or shielding should be tried. Sometimes reversal of the power-plug connection to the line helps to reduce the hum.

6.5.6 MICROPHONICS AT HIGH SOUND LEVELS. All vacuum tubes and some transistors are affected by mechanical vibration. Those used in the sound-measuring equipment have been selected to be less sensitive to vibration than the usual types. But at sufficiently high sound levels, even these can be vibrated to such an extent that they contribute an undesired signal to the output. Trouble from this effect, which is called microphonics, is not usually experienced until the sound levels are above 100 db, unless the instruments are placed on supports that carry vibrations directly to the instruments.

The usual test for microphonics is to disconnect the microphone and observe whether or not the residual signal is appreciably lower than the signal with the microphone connected.

For the octave-band analyzer, the input cord can be disconnected to see if the indicated level comes from the input signal or if it is generated within the instrument. The instruments can also be lifted up from the support on which they have been placed to see whether or not the vibrations are transmitted through the supports or if it is the air-borne sound that is causing the tube vibration.

Possible remedies for microphonic troubles are as follows: 1. Place the instruments on soft rubber pads. 2. Remove the instruments from the strong field to another room and interconnect with long cables. 3. Put in deadened sound barriers between the instruments and the sound source. 4. Mount the instruments in well sealed boxes with glass covers and tight-fitting drive shafts to manipulate the controls.

Mechanical vibration also affects the microphone itself, in that the output of the microphone is dependent on the air-borne and solid-borne vibrations that are impressed upon it. The effects of the solid-borne vibrations are not usually important in the standard, sensitive microphones because of the type of construction used; but these vibrations are usually of great importance for the low-sensitivity microphones used in the measurement of high sound levels. A mechanically soft mounting should generally be used for such a microphone in order to avoid trouble from these vibrations. Often merely suspending the microphone by means of its connecting cable is adequate.

6.5.7 HUMIDITY EFFECTS. High humidity can affect the operation of some microphones (see paragraph 6.4.6) and of some instruments. Of those instruments regularly used in noise measurements, only those having exceptionally high impedances are seriously affected by humidities ordinarily encountered. In general, humidity is not a problem with transistorized instruments.

6.5.8 MOUNTING OF THE DEVICE UNDER TEST. It is common to notice that the noise level produced by a machine is highly dependent on its mounting. A loose mounting may lead to loud rattles and buzzes, and contact to large resonant surfaces of wood or sheet metal may lead to a sounding-board emphasis of various noise components. For these reasons particular care should be given to the method of mounting. In general, the mounting should be as close to the method of final use as possible. If the machine is to be securely bolted to a heavy concrete floor, it should be tested that way. If the actual conditions of use cannot be duplicated, the noise measurements may not be sufficient to predict the expected behavior, because of the difference in transmission of noise energy through the supports. The usual alternative is to use a very resilient mounting so that the transmission of energy to the support is negligible.

6.5.9 POSITION OF MICROPHONE. In previous sections of this chapter some comments have been made on various aspects of the problem of placing the microphone in the most satisfactory position for making the noise measurement. Because of the importance of this placement, this section will summarize these comments. In general, the location is determined by the type of measurement to be made. For example, the noise of a machine is usually measured with the microphone placed near the machine according to the rules of a test code, or if its characteristics as a noise source are desired, a comparatively large number of measurements are made according to the methods and the placement given in Chapter 7.

The locations specified in typical test codes (1/2 to 3 feet) are generally too close to the source for use in determining the acoustic power radiated by the machine, and the requirements for that measurement will be given in Chapter 7.

It is important to explore the noise field before deciding on a definite location (see paragraph 6.5.1) for the microphone.

Many measurement locations may be necessary for specifying the noise field, particularly if the apparatus produces a noise that is highly directional. Further discussion of directionality will be given in Chapter 7.

The microphone should also be kept out of any appreciable wind, if possible. Wind on the microphone produces a noise, which is mainly a low-frequency noise. This added noise may seriously upset the measurement, particularly when the microphone has a good low-frequency response. If it is not possible to avoid wind on the microphone, a wind screen should be used. This screen can be made of a single layer of silk or nylon cloth on a wire frame that encloses the microphone. The frame should be much larger than the microphone.

If the noise level is measured for calculation of the speech-interference level or loudness level or for determination of deafness risk, it is important also to explore the noise field to make sure that the measurement made is representative. The possible effects of obstacles in upsetting the distribution of sound, particularly at high frequencies, should be kept in mind during this exploration.

At first thought, it seems logical, when measurements regarding noise exposure are made, to mount the microphone at the operator's ear. Actually, because of the variables introduced by the effect of the operator's head being close to the microphone, this technique is not used, except in certain scientific tests with special probe microphones. All ratings of speech-interference, loudness, and deafness risk are based on a measurement with no person in the immediate vicinity of the microphone. The microphone should, however, be about where the operator's ear would normally be.

6.6 CALIBRATION AND CORRECTIONS.

Satisfactory noise measurements depend on the use of measuring equipment that is kept in proper operating condition. Although the instruments are inherently reliable and stable, in time the performance of the instruments may change. In order to insure that any important changes will be discovered and corrected, certain simple checks have been provided for the General Radio line of sound-level equipment, and these will be discussed in this section. These checks can be made as routine maintenance checks, and some of them (paragraphs 6.6.1 and 6.6.2) should usually be made before and after any set of noise measurements.

In addition to these routine checks, more complete calibration of the system may be desirable for accurate measurements, particularly above 1000 cps. These calibrations are also discussed in this section.

6.6.1 ELECTRICAL CIRCUIT CALIBRATION. All General Radio sound-level meters have built-in calibration circuits for checking amplifier gain. The method used in earlier models required voltage from a power line, but the Type 1551-C simplifies the procedure by an internal comparison method. In each case the gain of the amplifier is compared with the attenuation of a stable, resistive attenuator.

This test does not check the sensitivity of the microphone and the indicating instrument; these tests are discussed in the next section. The indicating instrument is rugged and relatively unaffected by temperature changes. Its temperature coefficient is about $-0.02 \text{ db}/^{\circ}\text{F}$.

6.6.2 ACOUSTICAL CALIBRATION AT 400 CPS. The Type 1552-B Sound-Level Calibrator (see Figure 4-8) provides a single calibration of the over-all system at 400 cps. When driven by a 400-cycle oscillator at a 2-volt level and mounted on the microphones supplied with the Types 1551-B and -C Sound-Level Meters, this calibrator produces a 120-db sound-pressure level. It can be used also on the Type 1551-A Sound-Level Meter, Type 1555 Sound-Survey Meter, on the Type 759-P25 Dynamic Microphone (Altec Type 633), on the Brush BR-2S (used on some early Type 759-A Sound-Level Meters), and on the Type 1551-P1 Condenser Microphone System; but the level developed for each microphone type will be different. The level to be expected is stated in the instruction sheets for the calibrator or the microphone.

When the calibrator is used, it is desirable to check the background noise level with the calibrator in place but with no signal applied. This level should be 10 db or more below the level produced by the calibrator, or a correction should be applied (see Figure 6-10). If the total level with the signal applied to the calibrator is not at least 4 db higher than the

background level, the instrument should be moved to a quieter location for calibration.

Although this calibrator is unusually stable considering its low cost, it should not be regarded as completely unchangeable, and it should be handled with care. It does provide an extra check, so that one is not completely dependent on the microphone stability. If, after the electrical circuit calibration, the acoustical calibration agrees within about 1 db, including temperature corrections, the system can be assumed to be operating correctly. Then the routine corrections should be used and, usually, not the level indicated by the calibrator. If, however, the acoustical check differs by 2 or more db, the level determined by the calibrator should be temporarily accepted as correct. Then as soon as possible an investigation should be made to find the cause of the discrepancy. If the reason for the discrepancy cannot be located, the problem should be discussed with the nearest branch office or the service department at West Concord.

In the interests of maintaining accuracy in sound measurements, another calibration service is provided for owners of General Radio sound-level meters and Sound-Survey Meters. If these instruments are brought in to one of the General Radio offices, the level at 400 cps will be checked by means of an acoustic calibrator. This calibration will usually show if the instrument is operating correctly. If there is a serious discrepancy, the situation will have to be handled as a regular service problem.

The calibrator can also be used to measure the microphone cable correction (see paragraph 6.4.8) provided the background noise is sufficiently low. The procedure is as follows: 1. After the noise measurement has been made, the calibrator is put on the microphone with the microphone at the end of the cable, and a level reading is taken on the sound-level meter. 2. The microphone is removed from the end of the cable and put directly on the sound-level meter. The calibrator is put on the microphone at the sound-level meter, and a second level reading is taken. 3. The difference between these two level readings is the cable correction.

The acoustic calibrator makes possible a test of the sensitivity at 400 cps. If this test shows the microphone to be operating normally, there is some assurance that the microphone has not changed appreciably at other frequencies. It must be realized, however, that this test is not a complete check of the system; and a more complete knowledge of the performance is necessary for maximum accuracy.

The performance of the microphone is less uniform with frequency than that of any other element of the sound system. For high accuracy, it is usually essential to have a calibration of the microphone response characteristic as a function of frequency. When this calibration is available and an analysis of a noise is made, correction can be made for the microphone

frequency-response characteristic. This correction can be applied only if the noise is analyzed or if the sound is dominated by a component of known frequency, as, for example, in the measurement of loudspeaker response. Otherwise, one must check the uniformity of response of a system to be sure that the measured level of a noise is correct.

6.6.3 ACOUSTICAL CALIBRATION FROM 20 TO 8000 CPS.
A much more accurate over-all calibration is possible by the use of the microphone reciprocity calibrator. With an auxiliary oscillator, this instrument permits, at any frequency from 20 to 8000 cps, a rapid and accurate calibration of the General Radio PZT microphone and the associated equipment.

For the most accurate noise measurement, the measurement system should be calibrated by means of the microphone reciprocity calibrator either before or after the measurement is made. Unless the system is already known to be operating properly, it may be desirable to make a preliminary check by using the microphone reciprocity calibrator as a sound-level calibrator. Then, after the noise measurement, the complete reciprocity calibration should be made at the frequencies of interest. These frequencies should be those at which the important energy is concentrated, as indicated by analysis of the noise. Of course, it is wise to check the calibration at a number of points over the full range of interest to make certain that any apparent lack of energy at low or high frequencies is not a result of loss in sensitivity at those frequencies.

When there is no other indication of what is necessary, a more general calibration along the following lines is suggested: (1) Set the microphone reciprocity calibrator to operate as a simple calibrator. Sweep the frequency of the source oscillator from 20 to 2000 cps and note the variation in response of the system under calibration. Unless intentional weighting or filtering is introduced, this response should be reasonably uniform and calibration at only a few frequencies in this range is necessary. (2) If this response is nearly uniform, calibrate at the extremes of the range and a few points between to check the uniformity, for example, at 20, 100, 400, 1000, and 2000 cps. If the response below 1 kc is faulty, calibrate the microphone at a number of frequencies and compare the results with previous calibrations. Next check the response of the various other elements. By proceeding in this way one can track down the reason for the faulty behavior. (3) Above 2 kc, calibrate the system at the ASA preferred frequencies, 2000, 2500, 3150, 4000, 5000, 6300, and 8000 cps.

Any laboratory that attempts to make accurate acoustical measurements should calibrate its microphones periodically by means of the microphone reciprocity calibrator. These calibrations should be kept on file, so that it will be readily apparent if a microphone has been damaged by rough treatment.

6.6.4 CALIBRATION AT HIGH FREQUENCIES. The accurate calibration of a microphone at high frequencies in terms of sensitivity vs frequency requires elaborate facilities. Only a few laboratories (e.g., The National Bureau of Standards) offer such calibration as a regular service. General Radio Company will calibrate response vs frequency only for those microphones that it supplies. Such calibration is less expensive if included in the original order for the microphone than if the microphone is returned for calibration. (The frequency-response characteristic of the Type 1551-P1 Condenser Microphone is supplied with the microphone, at no additional cost.)

At General Radio, a free-field perpendicular-incidence calibration is made by comparison with laboratory-standard condenser microphones (American Standard Specification for Laboratory Standard Pressure Microphones, Z24.8-1949), according to the methods given in American Standard Method for the Free-Field Secondary Calibration of Microphones, Z24.11-1954. The working standard microphones are periodically compared with a condenser microphone that has been calibrated at the National Bureau of Standards. They are also periodically calibrated on an absolute basis by the reciprocity method given in American Standard Method for the Pressure Calibration of Laboratory Standard Pressure Microphones Z24.4-1949.

Since the sound-level-meter standard is based on a random-incidence specification, data for converting the perpendicular-incidence calibration to random incidence and to grazing incidence are included with calibrations supplied by General Radio.

6.6.5 CORRECTION FOR FREQUENCY-RESPONSE CHARACTERISTIC. It is customary to set the calibration of an acoustical measurement system to indicate the correct level at 400 cps. At other frequencies, the differences between true and indicated levels, as determined by means of the microphone reciprocity calibrator, can be applied as corrections to the results of a noise measurement. At frequencies above 1000 cps the directional characteristic of the microphone should be taken into account. The Type 1559-A Microphone Reciprocity Calibrator is designed to provide the random-incidence calibration of the microphone. If the microphone is used under conditions where a different response applies, for example, perpendicular-incidence response; the difference between perpendicular-incidence and random-incidence response must be included in the correction to the results of the noise measurement.

6.6.6 COMPARISON TESTS AMONG DIFFERENT SOUND-LEVEL METERS. When measurements are made on the same noise with two different sound-level meters, it is commonly found that the readings differ by a significant amount. The preceding material in this chapter should indicate most of the

possible sources of discrepancy between the two. Differences in the microphone characteristics are usually the chief cause of this discrepancy. For example, if one sound-level meter uses a dynamic microphone and the other uses a PZT microphone and if the noise contains strong low-frequency components, large differences can occur because of the generally poorer low-frequency response of the dynamic microphone. When these effects are understood, most of the discrepancies are readily explained.

Another factor that can contribute to this discrepancy concerns the average level. For purposes of meeting certain tolerances the average level of an instrument made by one manufacturer may be set slightly differently from that made by another.

If the instruments are not operating properly or if standing waves are not averaged out, serious discrepancies can, of course, be expected.

In order to set an upper limit to these differences among sound-level meters, the "American Standard Specification for General-Purpose Sound Level Meters", S1.4, 1961, sets certain tolerances on the prescribed frequency characteristics. Representative values for C weighting are as follows:

<u>Frequency - cps</u>	<u>Tolerances, db</u>
25	+2, -2.5
40	+1, -1.5
50 to 800	+1
1600	+2
2500	+3.5, -3
4000	+5, -4
6300	+6, -5
8000	+6

6.7 OTHER AUXILIARY INSTRUMENTS.

In addition to the regular instruments in the General Radio Sound-Measuring System, other instruments have been mentioned in Chapter 4 as useful auxiliary equipment. The use of these instruments will now be discussed. The instruments to be discussed have many controls, which must be properly set in order to obtain useful information. It is wise, therefore, to become thoroughly familiar with the instruments, by using known signals for practice, before attempting to use them on a noise problem.

6.7.1 MAGNETIC TAPE RECORDERS. A magnetic tape recorder is a useful and convenient instrument for obtaining a permanent record of a noise, as discussed in Chapter 4. When measurements are to be made on the recorded noise, a high-

quality instrument must be used to insure accurate results. The recorder should have a flat frequency characteristic over a wide frequency range, low hum and noise level, low nonlinear distortion, constant-speed drive, and good mechanical construction, and it should be kept in good operating condition. A tape speed of 15 inches/second is recommended, since these required characteristics are more readily obtained and maintained at high tape speeds.

The frequency response controls on the tape recorder should generally be set and left at the position giving the most uniform response. Corrections should be made for any nonuniformity.

The gain of a magnetic tape recorder should be set, in general, according to the instructions supplied with the recorder. If an impact type of noise is to be recorded, however, it is usually desirable to set the gain 10 to 30 db lower than normal in order to avoid overloading the system on the peak of the impact. When possible, it is desirable to make a series of recordings of impact sounds at several different settings of the gain control.

6.7.1.1 Reference Signal. At the time the recording of a noise is made, a signal of known sound-pressure level should also be recorded for the same setting of recorder gain, so that the absolute level of the recorded noise may be determined. It is sometimes desirable to record this reference signal several times during the course of the recording. A sound-level calibrator can supply this signal. It should be used on the microphone that supplies the electrical signal to the recorder, and at the time of recording the signal, the background noise level should be kept as low as possible. The level of this reference signal can frequently be accurately determined on playback, even if the background noise is relatively high, by use of a narrow-band analyzer tuned to the calibrating frequency of 400 cps. Alternatively, the octave-band analyzer set to the 300-600 cps band can be used. When a narrow-band analyzer is used for this purpose, it is important to make certain that the fluctuations in speed (flutter) of the tape are sufficiently low and the bandwidth of the analyzer sufficiently great that the signal is accurately measured. For example, if the flutter of the tape is 0.3% rms, the apparent recorded 400-cycle frequency will fluctuate over a total range of about 3.4 cycles ($2\sqrt{2} \times 0.003 \times 400$). The Type 1564-A Sound and Vibration Analyzer, when tuned to 400 cycles, is uniform in response to within 1 db of the peak value over a band of 16 cycles. Therefore its response will be satisfactory for measuring this 400-cycle signal with a flutter of 0.3%.

6.7.1.2 Direct Connection of Microphone. When signal levels over a wide range are to be recorded, or when analysis of the recorded noise is required, direct connection of the microphone output to the recorder is often desirable. This connection

avoids the circuit noise that invariably must reduce the dynamic range when a sound-level meter is inserted between the microphone and the recorder amplifier. When the Type 1551-P1 Condenser Microphone System is used, the sound-level meter and the recorder can be connected in parallel, by means of the two outputs provided on the case. When this is done, however, the combined impedance of the two connecting cables and the input circuit of the tape recorder should be kept as high as practical. This usually means that short cables should be used. The effect on the measured sound level of adding the recorder circuit is indicated by the difference in measured noise level with and without the recorder plugged into the Type 1551-P1 Power Supply.

6.7.1.3 Analysis of Recorded Noise. When an analysis is to be made of the recorded noise, it is usually desirable to select a number of representative samples from the tape. The length selected should usually be equivalent to at least several seconds. Each of these lengths is then spliced into an endless loop, which is played back continuously through the recorder, and the output is analyzed. If the absolute level is desired, a sample of the recorded reference signal should be measured with the same control settings that are used for the noise samples.

If the recorded noise is sufficiently uniform with time, it is often simpler to make a long recording and analyze on playback directly without the use of a loop. An octave-band analysis can be made directly even on short recordings if the playback is repeated a few times. On each playback the level in one or more bands can usually be noted if the over-all level is essentially constant with each playback.

The apparent convenience of merely recording the noise in the field and doing all subsequent measurements in the laboratory may lead one to assume that the field equipment should be limited to a magnetic tape recorder, a suitable microphone, and an acoustic calibrator. This assumption may be correct if the noise problem is already well understood. But in many situations it is desirable to analyze in the field to some extent to make certain that the desired data have been taken. Otherwise, subsequent analysis in the laboratory may show that the recordings are useless, because they do not contain the required information.

6.7.1.4 Subjective Comparisons. Magnetic tape recordings can be used for the subjective comparison of various noises. The direct subjective comparison of noises may be impractical in some instances because the noises are not available at the same place or at times that permit comparisons without long delays. When tape recordings are made of such noises, these recordings can be played back and compared with relative ease. These recordings may frequently be made of noise from a machine during different stages of work designed to

quiet it, and then a subjective evaluation of the progress is possible. Binaural recordings seem to be more satisfactory for this comparison test than single-channel recordings, because the noise seems to sound more realistic.

Whenever noise is recorded for the purpose of making a subjective comparison, it is desirable also to record a known acoustic reference signal. Then on playback the output level for each recording can be set to the proper level without relying on complete stability of recording gain characteristics for all the recordings.

6.7.2 CATHODE-RAY OSCILLOSCOPE. A cathode-ray oscilloscope having a tube with a long-persistence screen and a sweep range extending down to at least 2 seconds sweep time is the most useful type for acoustic measurements. For impact sounds the type that stores the trace on the screen is particularly useful. A five-inch oscilloscope is ordinarily used when the wave form is to be photographed. Otherwise, for field use, one of the smaller oscilloscopes is frequently more convenient.

6.7.2.1 Connections and Adjustments. The vertical-amplifier input terminals of the cathode-ray oscilloscope should be connected to the output of the sound-level meter by means of a short, shielded cable. The controls on the oscilloscope should usually be set as explained in the instruction book for the oscilloscope. The gain of the vertical amplifier can be set in a number of ways. For those who are inexperienced, the following procedure may be found useful. A reference sine-wave signal should be applied to the sound-level meter (for example, the calibrating signal in the sound-level meter or the 400-cycle signal from a sound-level calibrator). Note the reading on the meter, and then adjust the vertical-amplifier gain to obtain a peak-to-peak (total vertical excursion) deflection according to the following schedule for a five-inch screen.

<u>Meter reading</u> db	<u>Peak-to-peak deflection</u> inches
0	1
1	1.12
2	1.26
3	1.41
4	1.59
5	1.78
6	2.0
7	2.24
8	2.51
9	2.82
10	3.16

The gain control on the oscilloscope should not be changed after this setting has been made, and only the attenuator on the sound-level meter is used to adjust the gain when the noise signal is applied.

The attenuator on the sound-level meter should be set so that maximum deflection produced by the noise signal is within the range shown on the above schedule. The decibel value corresponding to this deflection is then obtained from the above schedule. The equivalent sine-wave level is sometimes given as that decibel value plus the setting of the sound-level-meter attenuator. The peak-to-peak sound-pressure level for the noise is then that decibel value plus the sound-level meter attenuator setting plus 9 db. The 9 db is added because the original calibration is in terms of a sine wave, and the peak-to-peak value of a sine wave is 9 db higher than the rms value used for the meter calibration. This difference between the peak-to-peak value as determined on an oscilloscope and the value indicated on the meter will depend on the type of noise being measured. For most noises it will be in the range of 6 to 15 db, but for impact sounds it can be as high as 30 db.

The most convenient means of measuring impact noises is by use of an impact noise analyzer (see paragraph 6.3.6).

6.7.2.2 Wave-form Observations. The oscilloscope is also useful for observing the wave form of the noise. For example, on an impact sound it is usually most important to know the peak level reached by the noise, but it is also important to know how rapidly this level is reached and how rapidly the level decays after the peak. The time measurements that are required to determine this rate may be difficult, but a fairly good estimate can be made in many instances by selection of a sweep rate that displays the wave form with good separation of the rise and decay transient. Then this sweep can be calibrated by use of a sine-wave signal of known frequency. Usually both of these displays should be photographed in order that suitable length measurements can be made. These length measurements are then related to amplitude and time by the calibration procedures suggested. An alternative timing signal can usually be put on the Z-axis (the beam intensity) as explained in the oscilloscope instruction book. When it can be used, this timing system is usually more accurate than one that depends on sweep stability.

6.7.3 VIBRATION MEASURING INSTRUMENTS. Many air-borne sounds are produced as a result of the vibration of solid materials. The amplitude and spectrum of these sounds are determined in large part by the vibrating system, but the relations between the vibration and the resulting sound are so complicated that computing one from the other is not usually attempted. Vibration measuring equipment, nevertheless, can be of considerable help in the solution of some noise problems.

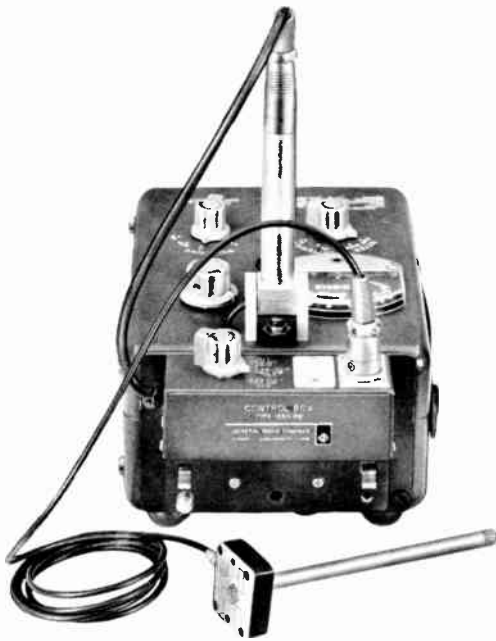

Figure 6-11. The Type 1560-P11B Vibration Pickup System used with the Type 1551-C Sound-Level Meter.

One class of these problems concerns reduction of the noise radiated by machinery, appliances, and other equipment. The vibration amplitude of the parts of the equipment can be measured, and in that way the parts that need most attention can usually be determined. The procedure for making these measurements is given in the Vibration Section of this handbook.

Another noise-measuring problem that can sometimes be solved by the use of a vibration pickup is the following. The noise output of nearly identical machines must sometimes be compared as a production control. Frequently, the background acoustic noise is so high that no satisfactory acoustical measurement can be made. In contrast, it is sometimes possible by suitable vibration mounts to keep background vibration from other sources down to a sufficiently low level so that the vibration of the machine itself can be satisfactorily measured. Then a study of the problem may show that some vibration measurements will provide the essential information needed for a noise comparison of the machines.

6.7.4 EARPHONES AND STETHOSCOPE. A pair of high-quality earphones with tight-fitting earphone cushions is a useful accessory for noise measurements, and high-impedance dynamic or crystal-type phones are recommended. Good earphone cushions are essential to improve the low-frequency

response and to help reduce the leakage of external noise under the earphone.

When a measurement system is being set up, the earphones should be plugged into the output of the sound-level meter. Then a listening test should be made to determine that the noise heard in the earphones is the same type of noise heard without the earphones. It is possible to detect trouble from microphonics (usually a ringing sound) or stray pickup in this fashion.

When the noise level is high, say, 90 db or higher, the leakage of external noise under the earphone may be sufficient to mask the sound from the earphones. Then the earphone cushions should be checked for tightness of fit. In addition, the signal from the earphones can be increased by use of an attenuator setting on the sound-level meter 10 db lower than that required for a satisfactory reading on the meter. This change of 10 db is usually not enough to overload the output, but a larger change should be avoided. It may also be desirable to have a long cord available so that it is possible to listen to the output of the earphones far from the noise source.

The earphones can also be used on the output of the analyzer to detect troubles from microphonics and stray pickup. In addition, a listening test may help one to determine which frequency bands contain the noise that is most objectionable in a given situation.

When the noise level is very high, the earphones on the sound-level meter may be useful in improving speech communication between observers during a measurement run. One observer wears the earphones, then the other observer shouts into the sound-level meter microphone. A definite improvement in speech communication usually results.

A similar procedure using a nonelectrical, medical stethoscope is also possible. One observer has the ear tips in place, and the other speaks into the receiver of the stethoscope.

The stethoscope can also be useful for tracking down sources of noise on a machine, because with it the pickup of sound can be confined to a relatively small local area.

6.8 RECORD OF MEASUREMENTS.

One important part of any measurement problem is obtaining sufficient data. The use of data sheets designed specifically for a noise problem helps to make sure that the desired data will be taken and recorded, and sample data sheets are shown in Figures 6-12 and 6-13. The following list of important items may be found helpful in preparing data sheets of this type:

1. Description of space in which measurements were made.
Nature and dimensions of floor, walls, and ceiling.
Description and location of nearby objects and personnel.

2. Description of device under test (primary noise source).
 Dimensions, name-plate data and other pertinent facts including speed and power rating.
 Kinds of operations and operating conditions.
 Location of device and type of mounting.
3. Description of secondary noise sources.
 Location and types.
 Kinds of operations.
4. Type and serial numbers on all microphones, sound-level meters and analyzers used.
 Length and type of microphone cable.
5. Positions of observer.
6. Positions of microphone.
 Direction of arrival of sound with respect to microphone orientation.
 Tests of standing-wave patterns and decay of sound level with distance.
7. Temperature of microphone.
8. Results of maintenance and calibration tests.
9. Weighting network and meter speed used.
10. Measured over-all and band levels at each microphone position.
 Extent of meter fluctuation.
11. Background over-all and band levels at each microphone position.
 Device under test not operating.
12. Cable and microphone corrections.
13. Date and time.
14. Name of observer.

When the measurement is being made to determine the extent of noise exposure of personnel, the following items are also of interest:

1. Personnel exposed--directly and indirectly
2. Time pattern of the exposure.
3. Attempts at noise control and personnel protection.
4. Audiometric examinations.
 Method of making examinations.
 Keeping of records.

6.9 A NOISE PROBLEM.

In order to illustrate some of the procedures given in this chapter, this closing section will describe how an industrial noise problem might be handled.

An oil pump, used in a production setup to supply oil at high pressure to a number of hydraulic presses, was so noisy that the workmen objected to using it. This pump had been installed to speed up production with new presses, but the men preferred to use an earlier production method because it was

SOUND SURVEY

ASSURED _____ DATE _____

ADDRESS _____

INSTRUMENTS USED

SOUND-LEVEL METER - TYPE _____ MODEL # _____

MICROPHONE _____ TEMP. _____ CABLE (Length) _____

ANALYZER - TYPE _____ MODEL # _____

OTHERS _____

NOTE: If noise is directional, record - Distance of the source, microphone position, incidence on microphone (Normal, Grazing, Random).

INDUSTRY _____ TYPE OF MACHINE _____

MACHINE MODEL # _____ NUMBER OF MACHINES _____

LOCATION OF MACHINE IN ROOM _____

ENVIRONMENT (Type of building, walls, ceiling, etc. ; other operations, any attempts at sound control)

PERSONNEL EXPOSED - DIRECTLY _____ INDIRECTLY _____

EXPOSURE TIME PATTERN _____

ARE EAR PLUGS WORN _____ TYPE _____

ARE THERE AUDIOMETRIC EXAMINATIONS _____

PREPLACEMENT _____ PERIODIC _____

Note information as to who makes these examinations, conditions under which they are made, time of day they are made, where records are kept.

DATE _____

SOUND LEVEL VALUES (DECIBELS)

NOTE: Record A, B and C Networks on the Sound-Level Meter

LOCATION	FREQUENCY RANGES (cycles per second)								
	Flat 0	20-75	75-150	150-300	300-600	600-1200	1200-2400	2400-4800	4800-Flat 0

Figure 6-12. A sound-survey data sheet, courtesy of Loss Prevention Department, Liberty Mutual Insurance Company.

NOISE LEVEL FIELD DATA SHEET (ALTERNATE FORM)

FIRST SHEET	TEST NO	LOCATION OPERATION		SKETCH						
	DATE									
	METER									
	ANALYZER									
	MICROPHONE									
RECORDED BY				○	○	○	○	○	○	
SECOND SHEET	TEST NO.	○	REC. BY	○	SECOND SHEET NO.				○	○
	Decibel Range Re 0.0002 Microbar - C Network - Fast Position									
	TIME	Overall	To 75	75 - 150	150 - 300	300 - 600	600 - 1200	1200 - 2400	2400 - 4800	4800 UP
	1									
	2									
3										
COMMENTS, DURATION, HRS./WK., NO. WORKERS ETC.										
1										
2										
3										

Figure 6-13. A noise-level field data sheet, courtesy of Illinois Committee on Noise in Industry, sponsored by the Industrial Hygiene Unit, Factory Inspection Division, Illinois State Department of Labor.

not then necessary to use the noisy pump. The problem was to find out what should be done to make the noise less objectionable.

In this example, it was assumed that the pump itself could not be modified to reduce the noise, since correcting basic design faults would be a major problem. Errors in alignment or looseness of mounting, as the source of the high noise levels, however, should be taken into consideration. On that basis, the apparent procedure was to investigate these possibilities, to measure the noise produced by the machine, to measure the background noise level, and then to decide what recommendations should be made.

The following instruments* were chosen to take to the factory:

- Type 1551 Sound-Level Meter (with regular microphone).
- Type 1558-A Octave Band Noise Analyzer.
- Type 1555-A Sound Survey Meter.
- Type 1554-A Sound and Vibration Analyzer.
- Type 1560-P11B Vibration Pickup System, comprising Type 1560-P52 Vibration Pickup and Type 1560-P21B Control Box.
- Pair of high-fidelity earphones.
- Two sponge rubber pads.

Before going to the factory each instrument was given a maintenance check to see that it was operating properly, since it is easier to correct any faults at the home office than it is to correct them in a noisy factory where service facilities are limited. The procedure was as follows:

1. All equipment was turned on.
2. Batteries were checked.
3. The Sound-Level Meter was calibrated by means of its own built-in calibration circuits.
4. The octave-band analyzer was connected to the sound-level meter, and, with the 1000-cycle signal from that instrument, its gain was set properly on the over-all band. The band switch was switched through the bands to see that the expected behavior was obtained.
5. The Sound and Vibration Analyzer was connected to the sound-level meter, and the general procedure of Step 4 was repeated.
6. A Type 1552-B Sound-Level Calibrator and a Type 1307-A Transistor Oscillator were used to check the over-all calibration of the sound-level meter.
7. The earphones were connected to the output of the Sound-Level Meter. The attenuator was set at 90 db, the approximate expected level of measurement. Then the case of the instrument was gently tapped with one finger. Listening to the output indicated that the vacuum tubes were not particularly microphonic.

The instruments were taken in an automobile to the factory, where they were loaded on a rubber-tired cart and taken to

*Some of the instruments actually used in the problem have been superseded by newer models, and where this is so, the latest equipment is named. The principles and techniques illustrated remain unchanged, and the slight departure from authenticity is made up for by the greater usefulness of the revised instrument list.

the noisy pump on the ground floor. Incidentally, this type of cart is a convenient support for instruments during measurements. At the pump, the obvious data were recorded. It was rated at 5 gallons per minute at 3000 psi, and it was 6 inches long and 5 1/2 inches in diameter with seven knobs projecting from the outer cylinder. These knobs apparently corresponded to the seven cams of the pump. The pump was driven through a three-pronged flexible coupling by a 10-hp, 60-cycle, 1730-rpm, induction motor. This motor was air cooled. The oil storage and heat exchanger tank was about 25 inches long and 15 inches in diameter. These three main items, the pump, the motor, and the tank, as well as a mounting board, some gages and a line switch, were mounted on a 37-inch-square, heavy, steel base. Steel I-beams were welded underneath as a part of this base and these were securely bolted to the floor, which was a reinforced cement slab. Four heavy, brass, pipe lines were connected to the storage tank. Two of these were for water cooling, and the other two were for the oil. These lines ran directly to the heavy masonry wall nearby, and they were securely anchored in many places to the wall as they ran to the different presses.

The factory itself was of heavy reinforced concrete construction with no acoustical treatment. Numerous small machines, benches, storage racks, cartons, and other items were arranged in orderly fashion throughout the large factory space where this pump was located.

When the pump was turned on, it was clear why the men complained. It was very noisy. There were no obvious rattles from loose pieces, however, and there seemed to be no mounting troubles. The floor did not seem to be transmitting vibration, and this conclusion was verified later. The vibration in the oil lines could be felt by touch, but they did not seem to be an important source of noise. For example, a check using the Sound-Survey Meter carried along near the lines showed that the noise level dropped noticeably as one went away from the pump. The units mounted on the steel frame appeared to be the main source of noise, and listening nearby indicated that the pump itself was the major source.

A preliminary survey around and over the structure but some 5 feet away was made using the Sound-Survey Meter. As expected there was no obvious directional pattern, even with A weighting.

The first measurement was made close to the pump. The microphone, only 16 inches from the pump shaft, was on the octave-band analyzer, which in turn was set on an empty cardboard packing case on the concrete floor. This first position was selected at this point to make certain that the background noise from other machines would not obscure any significant components.

With the pump turned on, the output from the analyzer was monitored by the pair of earphones. In the over-all position,

there was no indication of microphonics in the noise heard from the earphones. Listening to the output of the various bands showed that the noise in the 600 to 1200 and 1200 to 2400 cps bands was the dominating part of the annoying, loud noise heard from the machine.

The complete analysis was made at this point as shown in the data sheet of Figure 6-14. Then the pump was turned off, and the background noise was analyzed. In all frequency bands but the lowest (20-75 cps), this background noise was so low that it could be neglected. It was obvious from this analysis that most of the noise was in the range from 150 to 2400 cps.

There were no apparent characteristic, pitched sounds in the noise heard from the machine, but it could be expected that some would be present. Just to make sure that nothing important would be overlooked, an analysis of the noise was also made with the Type 1554-A Sound and Vibration Analyzer in the narrow-band mode. The only discrete components (definite peaks in response as the analyzer was tuned) that were observed are listed on the data sheet. Of these components, the one at 205 cps was the basic pumping rate of seven times the rotational speed. A comparison of the levels from this analysis with that in octave-bands showed that most of the energy in the range from 150 to 600 cps was from discrete components, but above that the noise was generally unpitched.

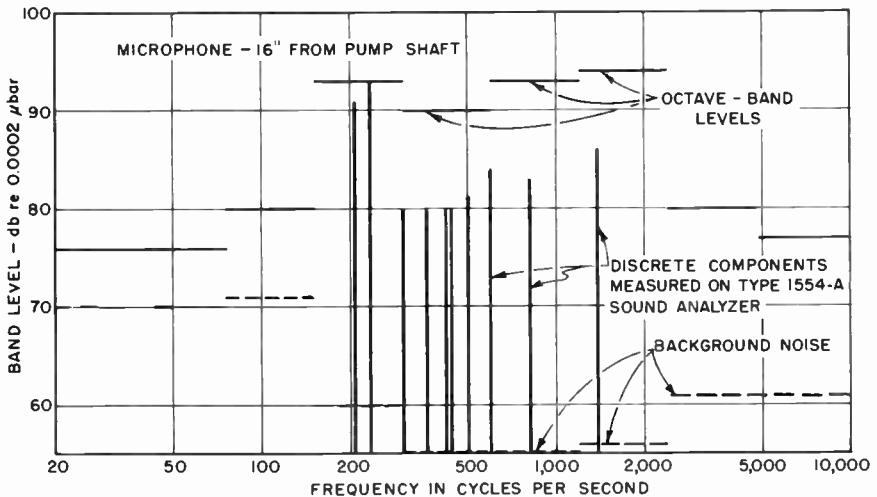
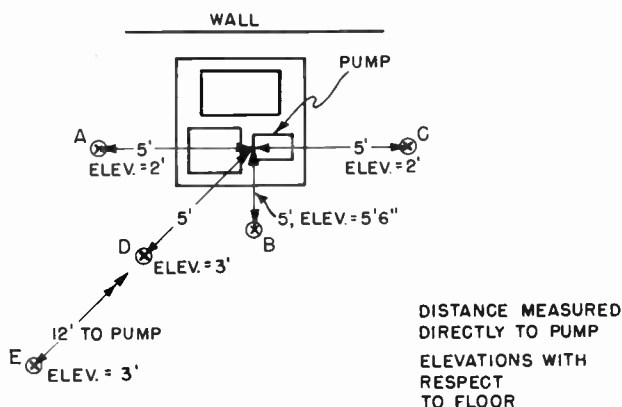

Figure 6-14. Frequency analysis of the noise produced by a pump. Levels measured with the octave-band analyzer are shown together with components measured on the Type 1554-A Sound and Vibration Analyzer. Background band levels are shown by horizontal dashed lines; solid horizontal lines represent pump noise plus background.



MICROPHONE LOCATION	SOURCE	OVER-ALL	20 75	75 150	150 300	300 600	600 1200	1200 2400	2400 4800	4800 10000
A	Pump + Bkgd*	86	72-76	78	76	80	78	81	76	74
A	Bkgd	76-78	72-76	72	65	61	58	58	62	63
B	Pump + Bkgd	89	72-76	74-78	81	85-86	81-83	82-83	76	75
B	Bkgd	76	70-74	66	62	61	59	64	70	66
C	Pump + Bkgd	88	74-78	76-78	80	84	82	82-83	77-78	75
C	Bkgd	76-78	72-74	72-74	60	57	56	56	62	62
D	Pump + Bkgd	87-88	72-76	75-77	82	82	79	82	74	72
E	Pump + Bkgd	84-85	70-74	74	78	80	76	76	72	71

*Bkgd = Background

Figure 6-15. A diagram of the several positions used in making octave-band analyses of pump noise. Results obtained at the various locations are given in the table.

The next step was to use a vibration test to find out if the mounting was satisfactory. The vibration pickup and control box were connected to the sound-level meter, and the sound analyzer was also used. Exploration with the pickup and the analyzer showed the following behavior. The pump itself was vibrating most strongly; the high-frequency components and the low-frequency ones were all present. The driving motor was not vibrating seriously. The storage tank vibrated most strongly at low frequencies. As the probe was moved about the mounting base toward the concrete floor the amplitude of motion decreased. At the floor the motion was insignificant. This vibration test confirmed that the mounting was not faulty.

The final measurements were octave-band analyses at a number of points 5 feet from the pump and one point 12 feet away. The results of these analyses are shown in the data sheet of Figure 6-15.

The nearest workmen were about 7 feet from the pump, so that the levels at 5 feet were nearly representative of the conditions they encountered. A comparison of the levels from the pump with the background data and with the speech-interference criteria given in Chapter 8 indicated that a 20-db reduction in noise level in the bands from 300 to 2400 cps would have been desirable.

Therefore, as a solution to the problem, the following suggestions were made:

One possible solution is to use a different pump based on a principle of operation that produces less noise as a by-product.

Another possible solution is to enclose the whole pump in a tight housing with lined ducts for air ventilation. The housing should be treated on the inside with acoustic absorbing materials.

A third solution is to move the pump to another location outside the working area, and this solution was adopted. The pump was moved to a nearby boiler room.

The use of earplugs, sometimes a solution to noise problems, was not adopted here because of the need for communications and the reluctance of personnel to wear such devices except as a last resort.

What had been accomplished by these measurements? First, they had ruled out the possibility of a simple solution, such as isolating the whole structure by vibration mounts, putting flexible couplings in the pipe lines, or using acoustic baffles. Second, they provided the data needed for a preliminary design of a housing, so that its probable cost could be weighed against other possible solutions. In short, these measurements provided the necessary data for a decision by management.

NOISE SOURCE CHARACTERISTICS

7.1 INTRODUCTION

More and more apparatus is being rated for noise. This rating is usually intended to make possible the prediction of the noise level that the apparatus will produce when installed. In order for the rating to be adequate for this purpose, the total acoustic power radiated by the source and the acoustic directivity pattern of the source should be included as part of the rating. We shall explain in this chapter how the power and directivity can be determined; but first we shall discuss the limitations of the usual method of noise rating.

For example, an air compressor may be rated by the manufacturer as producing a noise level of 85 db at a distance of three feet. This level may have been calculated by an averaging of a few sound level readings three feet from the compressor. When it is installed and the level is measured, the new level may be, say, 90 db at three feet. Naturally, the purchaser feels that he should complain because the machine was incorrectly rated; perhaps he returns the compressor, or he decides that he can no longer trust the manufacturer. Actually, the manufacturer may have been entirely correct in his noise measurements, but the rating was inadequate. The difference of 5 db may have been caused by incorrect installation, but usually such a difference is a result of the acoustical characteristics of the factory space. By the use of an adequate rating system and a knowledge of acoustical room characteristics, it would have been possible to predict this effect.

Another part of this problem is the prediction of levels at places in the factory other than at the three-foot distance. For example, the nearest worker may be 20 feet away, and the level at a distance of 20 feet is then more important than at 3 feet. Again, a knowledge of the acoustic power radiated and the acoustical characteristics of the factory space will be needed to predict the probable level at this distance.

The procedure suggested here for determining the power and directivity is based on measurements of the sound-pressure level at a number of points around the noise source. The technique for measuring sound-pressure level has already been discussed in Chapter 6. We shall discuss here the selection of the points at which the sound-pressure level is measured, the method of calculating the power and directivity, and the requirements on the characteristics of the space in which the measurement is to be made. We shall introduce this discus-

sion by considering the behavior of noise sources under various conditions.

7.2 SOURCES IN FREE SOUND FIELD.

7.2.1 SIMPLE SOURCE IN FREE FIELD.

7.2.1.1 Point Source. Any vibrating object will radiate sound into the air. The amount of sound radiated depends on (1) the amplitude of vibration of each vibrating part, (2) the area of each part, and (3) the time pattern of the vibrations, including the relative time pattern compared with that of the other parts.

The simplest form of source is a sphere that vibrates uniformly over its entire surface. We can think of this source as a round balloon with air in it. We periodically pump some more air into it and then let the same amount of air out. If the surface of the balloon then expanded and contracted uniformly, the balloon would be a simple, spherical source. This source radiates sound equally in all directions from an apparent center, which is the center of the balloon. It then is a "point" source, insofar as sound radiation is concerned.

7.2.1.2 Free Field. If such a point (or spherical) source is in the air far from any other objects, including the ground, the

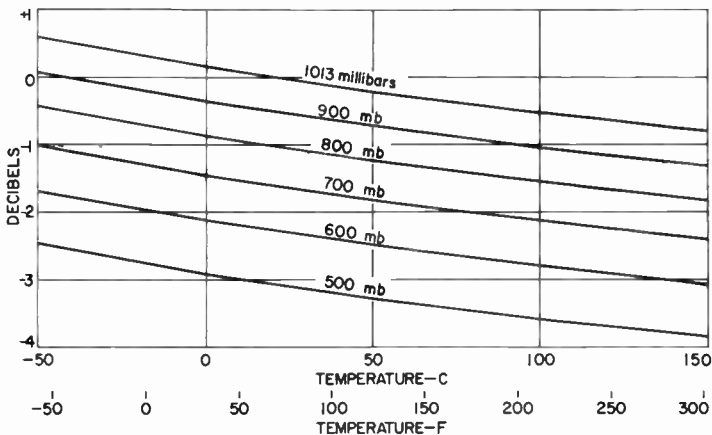

Figure 7-1. Corrections for temperature and barometric pressure to be applied when the equations relating power level (PWL) and sound-pressure level (SPL) are used. The correction is to be added to, if positive, or subtracted from, if negative, the sound-pressure level computed by the equation from the power level. If the power level is to be computed from a given sound-pressure level, the correction should be subtracted from, if positive, or added to, if negative, the given sound-pressure level before the numerical value is substituted in the equation.

sound-pressure produced by the source in every direction is the same at equal distances from the point source. Furthermore, the sound pressure is halved for each doubling of distance from the point. This change is usually expressed as a decrease in sound-pressure level of 6 db. The sound field produced under these idealized conditions is called a free sound field or, simply, a free field; because it is uniform, it is free from all bounding surfaces, and it is undisturbed by other sources of sound.

7.2.1.3 Power Level in Free Field. Under free-field conditions, a single measurement¹ of the sound-pressure level at a known distance from a point source is enough to tell us all about the sound field radiated by the source. For example, we can then predict the level at any other point, since the sound pressure varies inversely as the distance from the source. We can also compute the total sound power radiated by the point source. This calculation is usually made in terms of the power level re 10^{-12} watt (PWL) of the source (Section 2.2). Then the required relation to the sound-pressure level (SPL) is:

$$\text{PWL} = \text{SPL} + 20 \log r + 0.5 \text{ db}$$

where r is the distance in feet from the point source to the point where the sound-pressure level is measured. This relation is correct for a point source in a free field at normal room temperature and barometric pressure, that is, 20C and 1013 millibars. At other temperatures and pressures, the correction shown in the graph of Figure 7-1 applies. This correction is usually unimportant.

As an example, suppose that we measured a sound-pressure level of 73.5 db re 0.0002 microbar at a distance of 20 feet from a point source. Then

$$\text{PWL} = 73.5 + 20 \log 20 + 0.5 = 100 \text{ db re } 10^{-12} \text{ watt.}$$

The value for $20 \log r$ can be found from a table of logarithms or from the decibel tables in the Appendix, where the columns labeled as pressure ratios should be used for this distance.

The power level can be converted to actual acoustic power in watts as explained in Section 2.2. For the example above, the 100 db corresponds to an acoustic power of 0.01 watt.

¹The concept of a point source is an idealized one. It is not reasonable to assume that an actual source is a true point source, so that one should never be content with a single measurement (refer to paragraph 7.2.4).

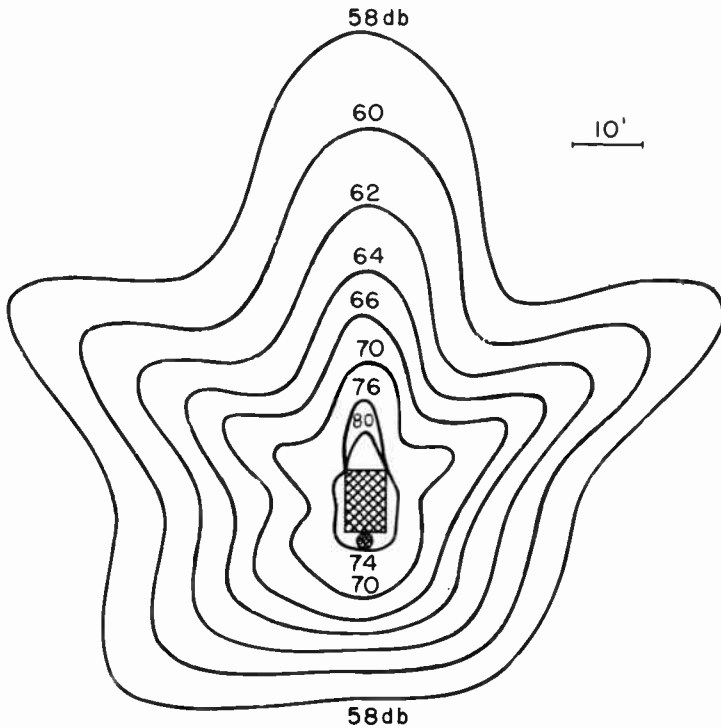

Figure 7-2. Simplified contours of equal sound-pressure level around a large power-distribution transformer.

We can also use the equation to predict sound-pressure levels at any distance in the free field if we know the acoustic power radiated. Thus, this point source radiating 0.01 watt, corresponding to a power level of $100 \text{ db re } 10^{-12} \text{ watt}$, produces a sound-pressure level of $100 - 20.5 = 79.5 \text{ db re } 0.0002 \text{ microbar}$ at 10 feet from the source.

7.2.2 DIRECTIONAL SOURCE IN FREE FIELD

7.2.2.1 Directional Source. In actual practice, most noise sources are not as simple as point sources. The sound is not usually radiated uniformly in all directions, either because the shape of the sound source is not spherical or because the amplitude and time phase of the vibrations of the different parts are not uniform or both. The net result is that more sound is radiated in some directions than in others.

7.2.2.2 Sound-Pressure Contours. In other words, the sound-pressure level for a given distance is different in different

directions. As an example, let us observe the sound field surrounding a large 60-cycle power-distribution transformer, as shown in Figure 7-2. The contours around the transformer correspond to the indicated values of sound-pressure level. This source is obviously directional, since the contours are not circular.

When such a directional sound source is far from any other objects, however, it behaves in some ways like a point source. For example, the sound-pressure level decreases 6 db for each doubling of distance, provided we start our measurements at a distance away from the source that is several times the largest dimension of the source, and provided we move directly away from the source. For the example of the transformer in Figure 7-2 we see that, at distances greater than several times the length of the transformer, the contours are similar in shape and the levels decrease approximately 6 db for each doubling of distance. In actual practice this idealized behavior is upset by the effects of variations in terrain, atmospheric conditions, and the interference of nearby objects.

7.2.2.3 Near Field and Far Field. We can also see that at locations close to the transformer the sound-level contours are different in shape from those at a distance. Furthermore, there is no apparent center from which one finds the 6-db drop for each doubling of distance. Consequently, this "near field" behavior cannot readily be used to predict the behavior at a distance. The differences between the "near field" and "far field" can be described in part as follows: Assume we have a source in which one part moves outwardly while another moves inwardly and vice versa. The air pushed away by one part will then tend to move over to compensate for the decrease in air pressure at the inward moving part. If the air can move over quickly enough, there will be considerable motion of air between the two parts, without contributing much to radiation of sound away from the source. The time factor in this motion of air can be expressed as a relation between the distance to be covered and the wavelength of the sound in air. The wavelength, λ , at normal temperature is as follows:

$$\lambda = \frac{1130}{f} \text{ feet}$$

where f is the frequency in cycles per second. Then, in order that the "near field" effect should not be very important, one should be at least one wavelength away from the source. This dimension should be determined on the basis of the lowest frequency of interest. For the example of the 60-cycle transformer, the lowest frequency of sound is 120 cycles, which corresponds to a wavelength of about 10 feet.

Another factor that enters into the differences between the "near field" and "far field" behavior is the way the sound waves

spread out from a source. The sound waves from a large source vary with distance differently from waves produced by a small source. But at a distance of several (3 to 4) times the largest dimension of the radiating source, "spherical spreading" is said to exist, and the behavior is then essentially independent of the size of the source.

7.2.2.4 Measurement of Contours of Sound-Pressure Level.

When it is important to know the characteristics of both the near field and the far field, it is useful to make contour plots similar to those shown for the transformer. These contours should usually be made for each octave band, since the characteristics for the different frequency bands will be different.

It is possible to determine these contours by measurements at a large number of fixed stations around the noise source. Often, however, after the data have been taken in this fashion, it is found that the number of points is not adequate to ensure satisfactory interpolation. A preferred procedure is to set up the measuring equipment on a small cart. First, explore in a large circle around the source to find the directions of the maxima and minima. Then observe readings as the measuring station is moved radially away from the noise source. At each point where the level reaches a certain value, the corresponding distance on a steel tape laid out along the radial line is noted. A number of these readings should be taken along different directions. Many readings at relatively small intervals of sound-pressure level can be made in a short time when this procedure is possible.

7.2.2.5 Directivity Factor.

When we are interested in sound-pressure levels beyond the immediate vicinity of the source, any sound can be treated as a point source provided we introduce a directivity factor. This factor takes into account the variation in sound-pressure level with direction to the source. This directivity factor, which is a function of direction and frequency, is usually labeled Q . It can be expressed as the ratio of two acoustic powers. One of these powers is that which would be radiated by a point source in order to produce the observed sound-pressure level in the specified direction. The other power is the total acoustic power radiated by the actual source.

7.2.2.6 Sound-Pressure Level for a Directional Source.

When we know this directivity factor for the direction of interest, we can use it, in the earlier equation for a point source, as a multiplying factor on the power. Expressed in terms of level the new equation is as follows:

$$\text{SPL} = \text{PWL} + 10 \log Q - 20 \log r - 0.5 \text{ db}$$

This equation relates the power level of the source, the sound-

pressure level in a given direction at a distance r feet from the source, and the directivity factor for that direction. (This equation is also subject to the minor corrections for temperature and pressure shown in Figure 7-1.)

For example, let us assume that an auto horn whose measured power level is 104 db is sounded. We are interested in the sound-pressure level at a distance of 20 feet in the horizontal plane of the horn, but at an angle of 20° from the principal axis of the horn. Along this direction of 20° from the axis the directivity factor is 5, say. Then we have

$$\text{SPL} = 104 + 10 \log 5 - 20 \log 20 - 0.5 = 84.5 \text{ db}$$

at 20 feet in the required direction.

7.2.3 SIMULATED FREE FIELD. The free-field condition does not occur in practice, because of the effects of sound reflected from the ground or floor, from nearby objects, and from walls and ceiling. As described in paragraph 6.5.1, the result of these reflections is that the sound-pressure level measured at a distance from the source is different from that predicted by the free-field equations. The reflections can be reduced by acoustic absorbing materials applied to the reflecting surfaces. By the proper design and application of this treatment, one can produce in a room a limited space having the essential characteristics of a free field over a wide frequency range. Many such rooms, called "anechoic" or "free-field" rooms, have been built and are described in the literature. When accurate measurements of the radiated sound power and directivity are required, the measurements should be made in such an environment.

7.2.4 MEASUREMENT PROCEDURES. The source characteristics are obtained by use of the principles discussed earlier in this chapter.² Generally, the following characteristics must be determined:

- (1) The total sound power radiated by the source, as expressed by the power level, as a function of frequency.
- (2) The directional characteristics of the source, as expressed by the directivity factor, as a function of direction and frequency.

7.2.4.1 Measurement Positions.

²The procedures outlined here and in sections 7.3, 7.4, and 7.5 are similar to those given in ASA S1.2-1962, American Standard Method for the Physical Measurement of Sound, and that should be consulted for specific details on the standard method.

7.2.4.1.1 Measurements Around the Source. If free-field conditions can be closely approximated, the power level and directivity can be calculated from the sound-pressure levels measured at a number of points. These measurements are made at points at equal distances from the source and all around the source. The points can be considered as being on the surface of a hypothetical sphere surrounding the source. The radius of this sphere should be at least three times the largest dimension of the source, and should exceed the wavelength corresponding to the lowest noise frequency of interest (refer to paragraph 7.2.2 3).

Theoretically, the sound-pressure levels over the entire surface of the sphere should be measured. The practical procedure for approximating this exploration is to select a number of points at which measurements will be made. Areas on the sphere are then associated with these points. These areas have the measurement points as their centers, and the extent of each area is determined by the nearness of the other measuring points. In the process of making the basic measurements the microphone should be moved around to determine the variation in sound-pressure level within each area. If the variations in sound-pressure level within any one area are greater than 2 db, it is advisable to select additional measuring points in that area. However, if no attempt is being made to obtain an accurate picture of the directivity pattern, the extent of the variation can be noted. Then, provided the variation is less than 6 db, the average level can be used as a representative value for the area.

7.2.4.1.2 Uniformly Distributed Measuring Points. The calculations for the radiated power are simplified if the measuring points are uniformly distributed on the surface of the sphere. Because of the nature of the geometric pattern, only six such sets of points are possible. These six sets have 2, 4, 6, 8, 12, and 20 uniformly distributed points. The locations for the sets of 8, 12, and 20 points are shown in Figures 7-3, 7-4 and 7-5. The particular orientation of the points shown was first published in the 1953 edition of this handbook; these are now generally used, although a different orientation with respect to the ground plane may be found desirable for some particular applications. The areas associated with the sets of 8, 12, and 20 points are regular spherical triangles, regular spherical pentagons, and regular spherical triangles, respectively.

Other sets of points that may be useful are those that correspond to the vertices of an Archimedean semiregular polyhedron. The most interesting of these have 24 (see R. M. Robinson, "Arrangement of 24 Points on a Sphere," Math. Annalen, 144, 17-48 (1961)), 48, and 60 points. Although these points are not uniformly distributed, they are all of equal importance, because the distribution of points around any one point is the same for all points.

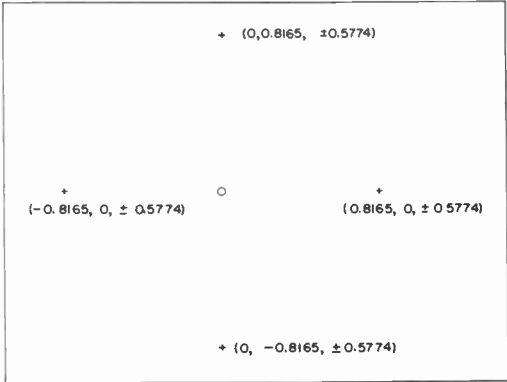

Figure 7-3. Plan view of eight points uniformly distributed on a sphere of unit radius. Coordinates are given in terms of distances from center along three mutually perpendicular axes (x, y, z). The "±" refers to the existence of two points, one above the x - y reference plane and one below. When measurements are to be made on a hemisphere, only the four points above the plane are used.

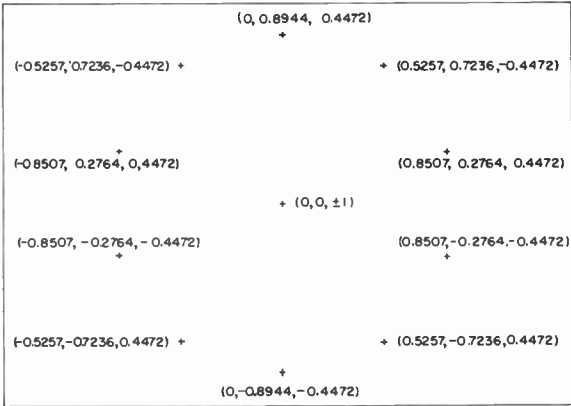

Figure 7-4. Plan view of 12 points uniformly distributed on a sphere of unit radius. Coordinates are given as in the previous figure. When measurements are to be made on a hemisphere, only the six points above the x - y reference plane (positive values of Z) are used.

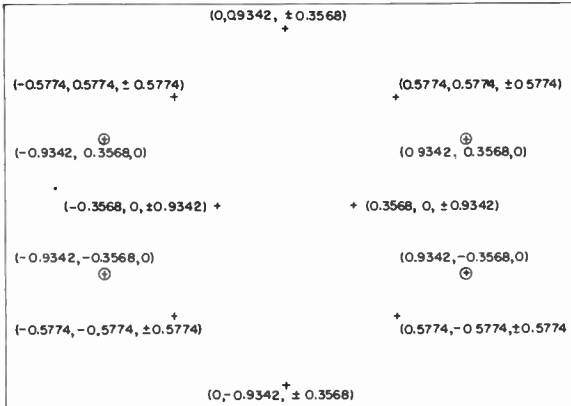

Figure 7-5. Plan view of 20 points uniformly distributed on a sphere of unit radius. Coordinates are given as in Figure 7-3. When measurements are to be made on a hemisphere, 12 points are used, eight above the reference plane and four in the plane ($Z = 0$, shown encircled). The four in the plane are weighted by a factor of $1/2$ in power (see text).

7.2.4.1.3 Hemispherical Measurements. When the device to be tested is normally mounted on a concrete foundation or on the ground, it is often desirable to test it while it is so mounted. Then the sound-pressure level measurements should be made at points on a hypothetical hemisphere surrounding the source. The sets of points that lead to simple calculations of power level are now modified. A set of four points (half the set of eight) can be properly used, and a set of six points (half the set of 12) can be used even though the distribution is not exactly uniform. A set of 12 can also be used, but then four of the set must be weighted by a factor of one-half (or, 3 db is subtracted from the levels at these four points). (See Figure 7-5.)

When the hemisphere is used, the procedure for calculating power is the same as that described for the sphere (paragraph 7.3). But 3 db should be subtracted from the power level finally obtained, because the area of the hemisphere is just one-half that of the sphere.

7.2.4.1.4 Rotation of Source. Another way of simplifying the calculations is to rotate the source, with the microphones placed on the surface of a hypothetical sphere surrounding the source, so that the projections of their positions on the axis of rotation are uniformly distributed. A variation of this method, practiced by the Bell Telephone Laboratories, calls for the rotation of a set of microphones about a stationary source.

7.3 CALCULATION OF POWER LEVEL.

7.3.1 GENERAL. If exploration shows that the basic set of points yields representative data, the calculations of the power level and directivity factor can be made. For a uniformly distributed set of points, first calculate the average level on a power basis. If the total range of sound-pressure levels is less than 6 db, a simple arithmetical average is usually adequate. The accurate method for any situation is as follows: Convert the decibel readings at each of the points of measurement to power ratios by using the tables in the Appendix, add these power ratios, and convert back to a decibel level. Then subtract the decibel value corresponding to a power ratio numerically equal to the number of levels used (for 8, 12, and 20 readings subtract 9, 10.8, and 13 db respectively). The result is then the average level, which we shall call \overline{SPL} . Provided free-field conditions exist, the power level is then calculated from the equation:

$$PWL = \overline{SPL} + 20 \log r + 0.5 \text{ db}$$

where r is the radius, in feet, of the measuring sphere. When the rotating source or rotating microphones are used as described in paragraph 7.2.4.1.4, the average energy during a complete rotation as well as for all the microphone positions

should be taken, and the corresponding average sound-pressure level used in the above formula.

7.3.2 CALCULATION OF DIRECTIVITY FACTOR. After the average sound-pressure level, \overline{SPL} , has been determined, the directivity factor can also be calculated. If it is desired for a particular direction, the sound-pressure level on the measuring sphere corresponding to that direction, SPL_1 , is measured. The difference between this level and the average level is called the directional gain, DG_1 . Thus,

$$DG_1 = SPL_1 - \overline{SPL} \text{ db}$$

To determine the directivity factor, Q , convert the DG_1 value in decibels into a power ratio by using the decibel tables in the Appendix. Thus, a directional gain of -2 db corresponds to a directivity factor of 0.63.

7.3.3 EFFECT OF ROOM ON MEASUREMENTS. The space in which power level and directivity are to be determined must be carefully considered. As explained previously and in paragraph 7.3.3.1, the measurement should ordinarily be made in an anechoic chamber. Sometimes the measurement can be made outdoors, far from other objects. If the device under test is normally mounted on the ground, this outdoor measurement may be ideal, provided that the location is free from interfering objects and the background noise level is low enough.

7.3.3.1 Requirements on Room Characteristics. If the measurement is to be made in a room, it should be a large room, with extensive acoustic treatment. The measurement points should not be closer to the acoustic treatment than one-fourth wavelength at the center frequency for the lowest required band (approximately 5 feet for the lowest standard octave). Large

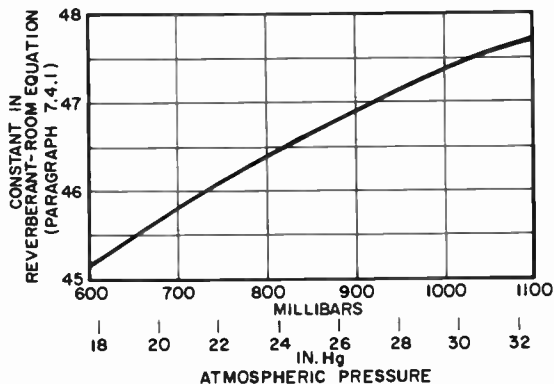

Figure 7-6. Variation of numerical constant in equation relating power level and sound-pressure level for a reverberant room.

acoustic absorption is particularly important if the directivity characteristics must be accurately determined. In order to obtain satisfactory results in moderate-sized rooms, extraordinarily good acoustic treatment must be used. Many of these special anechoic chambers have been built, and some of them have been described in the Journal of the Acoustical Society of America.

7.4 SOUND SOURCE IN A REVERBERANT ROOM³.

All sources that radiate sound as discrete tones or as very narrow-band components and all sources whose directivity must be determined can be measured only by the above "free-field" procedure. The total power radiated by a source whose sound energy is distributed over a wide band of frequencies can, however, be determined in a reverberant room -- that is, a room with hard walls, floor, and ceiling.

7.4.1 MEASUREMENTS IN A REVERBERANT ROOM. In a reverberant room, sound power can be determined from measurements of average sound pressure in the room and of the total absorption. The absorption is determined from a measurement of the rate at which a transient sound in the room decays. The procedure is as follows: The sound source in the room is turned on and the sound is allowed to reach a steady value. The sound is picked up by the microphone of a sound-level meter whose output is recorded on a graphic level recorder. The sound source is abruptly turned off, the sound in the room decays, and this decay is plotted by the graphic level recorder. The initial slope of the decay curve in db per second is the rate of decay, D.

For a highly reverberant room, that is, where D is small (say 50 db/sec or less), the sound power level of the source is then given by the following expression.

$$PWL = \overline{SPL} + 10 \log V + 10 \log D - 47.3$$

³The procedures given in Sections 7.4 and 7.5 are based to a great extent on R. W. Young, "Sabine Reverberation Equation and Sound Power Calculations", Journal Acoust Soc Am, Vol 31, No. 7, July, 1959, pp 912-921; H. C. Hardy, "Standard Mechanical Noise Sources," Noise Control, Vol 5, No. 3, May, 1959, pp 22-25; R. J. Wells and F. M. Wiener, "On the Determination of the Acoustic Power of a Source of Sound in Semi-Reverberant Spaces", Noise Control, Vol 7, No. 1, Jan-Feb, 1961, pp 21-29, and on the work of Am Stds Assoc Committee S1-W-25, F. M. Wiener, Chairman.

where V is the volume of the room in cubic feet and \overline{SPL} is the average sound-pressure level in the reverberant field. The numerical value of 47.3 in the above formula varies with atmospheric pressure, as shown in Figure 7-6. For most measurements at sea level the value of 47.3 can be used.

7.4.2 ROOM REQUIREMENTS. In order for the measurement to be accurate, the room must satisfy the following conditions:

1. If the source has a broad spectrum and the measurements are made in octave bands, the smallest dimension of the room should be at least equal to a wavelength at the center frequency of the lowest octave band of interest.

2. No two dimensions of the room should be alike. A ratio of $1 : \sqrt[3]{2} : \sqrt[3]{4}$ for the height, width, and length is often recommended.

3. The walls of the room should be hard and smooth. Large, hard objects should be near the boundaries of the room to help diffuse the sound.

4. The absorption should be small so that the decay rate is less than about 50 db/sec for a room of 1000 cubic feet, and less than about 30 db/sec for a room of 10,000 cubic feet. For the lowest frequency band, these decay rates may be doubled.

5. The source should be mounted on the floor or other surface if normally used that way. Otherwise, it may be suspended in the room, but not in the center, at least one-fourth wavelength from the walls. No large surface of the source should be parallel to any nearby wall.

7.4.3 SAMPLING AND AVERAGING PROCEDURE. The desired sound-pressure level is an average taken at several positions about the source but at a distance from the source at least equal to the largest dimension of the source and yet not closer to any wall than one-fourth wavelength. The measurement positions should also be at least one-half wavelength apart. The average sound-pressure level should be determined on an energy basis, as described in paragraph 7.3.1.

The initial decay rates at the same set of measurement positions should be averaged for each measured band. If the ultimate measurements are to be in octave bands, an octave-band noise source should be used; for instance, a random noise generator, filtered by an octave-band analyzer, may be used as the source. The decay rate for a given set of room conditions will remain constant over a considerable time, except at the high audio frequencies where air absorption is critically dependent on relative humidity.

In a well designed reverberation room fewer measurement points are needed than for the free-field measurement. If the source is not highly directional, and if large rotating vanes are used to alter the standing-wave pattern during the measurement, one microphone position may be adequate for the measurement.

This procedure in effect averages the sound-pressure level over a large area. The single-microphone method is not recommended, however, unless extensive experience has shown that the results are the same as those obtained with several microphone positions.

Another method of exploring the sound field to obtain an average is to swing the microphone around a wide area. Still another is to rotate the source.

7.5 COMPARISON METHOD.

The procedures given above require special rooms for the measurement of radiated power. When such measurements must be made in an ordinary room, a different technique has been proposed by Hardy, Wiener, Wells, and others. This is a comparison method, in which a standard sound source similar to that to be measured is used as a reference. The radiated power of this standard source must have been determined by one of the preceding techniques.

7.5.1 MEASUREMENT PROCEDURE. The measurement procedure is as follows:

1. The standard source is turned on in the room. Sound-pressure level is measured at several places around the source at a distance from the source equal to at least the maximum dimension of the source. The measurements are usually made in octave bands. The measured levels are averaged on an energy basis for each band.

2. The unknown source is operated in place of the standard source. The sound-pressure levels are measured at the same points as before and averaged for each octave band.

3. For each octave band the difference in average level between the standard and the unknown is applied to the known power level of the unknown source.

7.5.2 REQUIREMENTS FOR STANDARD SOURCE. The standard source should produce a stable and reproducible sound. Such sources have been developed for the Compressed Air and Gas Institute and for the fan and blower industry. The spectrum and directional properties of the standard source should be nearly the same as those of the unknown source.

7.5.3 REQUIREMENTS FOR ROOM. The measurement room should be large, and its characteristics should approach those of a reverberant room. No obstructing object should be in the immediate vicinity of the source or the microphone positions.

7.6 PREDICTING NOISE LEVELS.

When the acoustic power output and the directivity pattern of a device are known, the noise levels that it will produce under a variety of conditions can be predicted on the average with fair accuracy. These predictions are based on the principles discussed earlier in this chapter.

If a noisy device is placed in a room that is not anechoic, it is desirable to measure the decay rate of sound, D , in the room; and then the following formula, adapted from one by Young, can be used to predict the average level of sound in that part of the room where the reverberant field dominates:

$$\overline{\text{SPL}} = \text{PWL} - 10 \log V - 10 \log D + 47.8$$

where V is the volume of the room in cubic feet, PWL is the source power level, and the constant 47.8 varies with atmospheric pressure (to determine the variation add 0.5 db to the values shown in Figure 7-6).

Close to the source the level is almost as if free-field conditions existed. The level decreases with increasing distance from the source and the average approaches the reverberant field level. Here standing waves will exist, and it is only the average level that can ordinarily be predicted. At points less than one-fourth wavelength from a hard wall, the level will be higher than the average in the reverberant field. Very near a hard wall the increase may be as much as 3 db; very close to an edge, 6 db; and right at the vertex of a corner, 9 db.

When the decay rate in the room cannot be measured, it can be estimated from a detailed knowledge of the room and its surface conditions. The procedures are given in books on architectural acoustics. There the calculation procedure is normally given for reverberation time, T . The decay rate, D , is then easily obtained as follows:

$$D = \frac{60}{T}$$

The sound-pressure level produced by the source is also affected by its position in the room — that is, if it is suspended in the middle of the room, or mounted on the floor, wall, or ceiling, or in a corner. It is often very difficult to predict the exact effect, however. Ordinarily the level is higher where the source is very near a hard surface than when it is in the middle of the room, and, as explained earlier, if the source is generally mounted on a hard surface it should be measured that way so that the effect on the source is taken into account. Then the levels in another room can be predicted with better accuracy.

LOUDNESS, SPEECH INTERFERENCE, HEARING DAMAGE, AND NEIGHBORHOOD REACTION TO NOISE

8.1 INTRODUCTION.

This section gives the specific details for calculating the loudness level and the speech-interference level of noise. It also gives some suggested methods for estimating, from measured octave-band levels, the possibilities of hearing loss as a result of exposure to certain noises and for estimating the reactions of people to noise in a residential area.

8.2 LOUDNESS.

The charts of Figures 8-1 and 8-2 have been prepared to simplify the calculation of loudness from octave-band levels. The procedure is as follows:

1. The band level in db for each of the octave bands is first used to determine a band loudness index. The measured sound-pressure levels in the bands are changed according to the table of Figure 8-1 or 8-2, and the shifted levels are then entered on the line charts to obtain a loudness index for each band. (Because of the variability of loudness judgments, accurate interpolation on the charts is not ordinarily necessary.)
2. The loudness of the noise is then the loudness index of the loudest band plus 0.3 times the sum of the loudness indexes of the remaining bands.
3. This total loudness can be converted to loudness level in phons by the table in Appendix III.
4. The calculated loudness is labeled sones (OD) and loudness level, phons (OD) to designate that they have been calculated from octave-band levels (O) for a diffuse field (D). A similar calculation can be made for third-octave bands, and they are labeled (TD).

For steady noises having a broad frequency spectrum, the loudness calculated by means of the charts, which are based on Stevens's¹ method, agrees reasonably well with direct as-

¹The method used here is that given in S. S. Stevens, "Procedure for Calculating Loudness: Mark VI," Journal of the Acoustical Society of America, Vol 33 No. 11, November 1961, pp 1577- 1585.

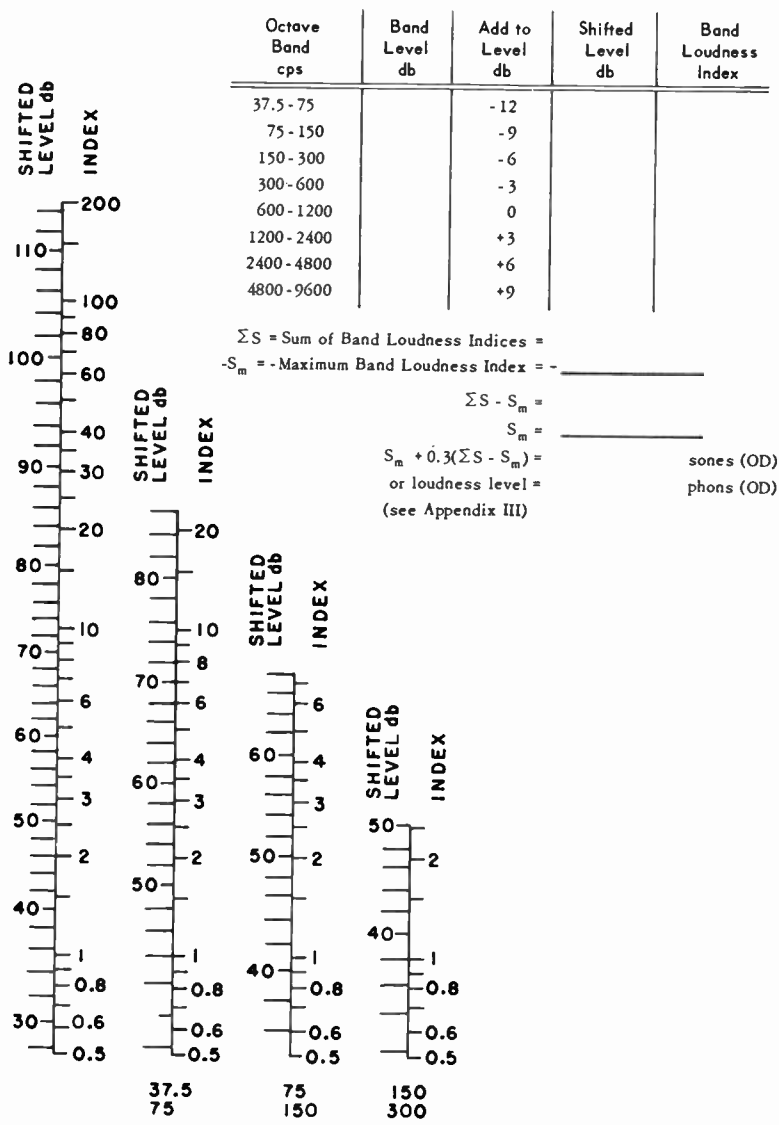

Figure 8-1. Chart for calculating loudness from an analysis of the noise in the octave bands, 37.5 - 75, 75 - 150, 150 - 300, 300 - 600, 600 - 1200, 1200 - 2400, 2400 - 4800, and 4800 - 9600 cps. For each of the three lower octave bands, enter the shifted level in the appropriate line chart to obtain the loudness index. For levels outside the range of these charts, and for all other octave bands, use the left-hand line chart to obtain loudness indexes. The noise is assumed to be coming at the listener from many directions (diffuse field).

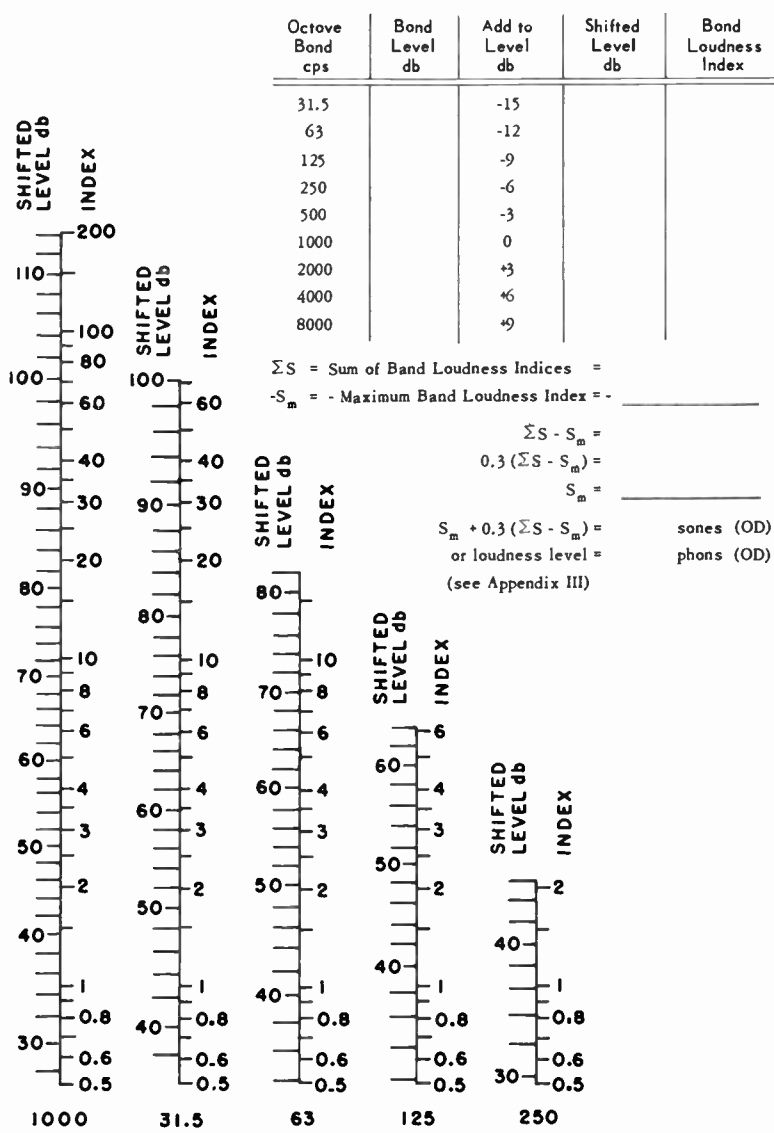

Figure 8-2. Chart for calculating loudness from an analysis of the noise in octave bands centered at 31.5, 63, 125, 250, 500, 1000, 2000, 4000, and 8000 cps. For each of the four lower octave bands, enter the shifted level in the appropriate line chart to obtain the loudness index. For levels outside the range of these charts, and for all other octave bands, use the left-hand line chart to obtain loudness indexes. The noise is assumed to be coming at the listener from many directions (diffuse field).

assessments made by loudness balances against a 1000-cps tone. But the calculation will probably give too low a value for the loudness of intermittent or impact sounds when the band levels are measured with an "averaging" meter of the type commonly employed.

To illustrate this procedure, consider the following calculations based on octave-band measurements of the noise in a factory:

Octave Band cps	Band Level db	Add to Level db	Shifted Level db	Band Loudness Index
37.5 - 75	76	-12	64	4.5
75 - 150	77	-9	68	7.5
150 - 300	82	-6	76	12
300 - 600	82	-3	79	14.7
600 - 1200	79	0	79	14.7
1200 - 2400	82	+3	85	21.9
2400 - 4800	74	+6	80	15.6
4800 - 9600	72	+9	81	16.7

$$\Sigma S = \text{Sum of Band Loudness Indexes} = 107.6$$

$$-S_m = \text{-Maximum Band Loudness Index} = \underline{-21.9}$$

$$\Sigma S - S_m = 85.7$$

$$0.3 (\Sigma S - S_m) = 25.7$$

$$+S_m = +21.9$$

$$0.3 (\Sigma S - S_m) + S_m = 47.6 \text{ sones (OD)*}$$

$$\text{or computed loudness level} = 95.7 \text{ phons (OD)*}$$

(from Appendix)

*OD = Octave Diffuse (an octave-band analysis for a diffuse field).

It is useful to note that one can often tell, merely from the highest shifted level, which is the band that contributes most to the loudness. The exceptions occur when the levels are low and the low bands dominate. Then one must resort to the charts to be sure of the result.

For a quick check to find the dominant band, add 3 db to the band level in the second octave, 6 db to the third, 9 db to the fourth, and so on. Then the highest shifted level is usually the dominant band. This check will often be all that is needed to tell where to start in a noise reduction program, if one doesn't have the loudness calculation charts at hand.

The concept of "perceived noise level" has been developed by Kryter² as an alternative way of rating noise. This concept is preferred by some, particularly for rating aircraft noise. The calculation procedure is similar to that of Stevens, and the end result is expressed in "PN db."

Another and more elaborate loudness calculation procedure has been developed by Zwicker³ for third-octave analysis. That this more difficult calculation results in a calculated loudness that is in better agreement with subjective data is not at all clear, however.

8.3 SPEECH-INTERFERENCE LEVEL.

The average of the band levels in db for the three octave bands, 600-1200, 1200-2400, and 2400-4800, is called the speech-interference level. For example, in Section 8.2, the levels given in these bands for a factory noise are 79, 82, and 74 db, and the speech-interference level is then 78.3 db.

8.3.1 SPEECH INTELLIGIBILITY. For satisfactory intelligibility of difficult speech material, maximum permissible values of speech-interference levels for men with average voice strengths are given in Table 8-1.

Table 8-1.

Speech-interference levels (in db re 0.0002 microbar) should be less than the values given below in order to have reliable conversation at the distances and voice levels shown.

Distance (Feet)	Voice Level			
	Normal	Raised	Very Loud	Shouting
0.5	71	77	83	89
1	65	71	77	83
2	59	65	71	77
3	55	61	67	73
4	53	59	65	71
5	51	57	63	69
6	49	55	61	67
12	43	49	55	61
24	37	43	49	55

2. K. D. Kryter, "The Meaning and Measurement of Perceived Noise Level," Noise Control, Vol 6, No. 5, September-October, 1960, pp 12-27.

3. E. Zwicker, "Ein Verfahren zur Berechnung der Lautstärke," Acustica, Vol 10, No. 1, 1960, pp 304-308.

It is assumed in this chart that there are no reflecting surfaces nearby, that the speaker is facing the listener, and that the spoken material is not already familiar to the listener. For example, the speech-interference level of 78.3 db, computed above, is high, and the chart indicates that shouting is usually necessary and that the two people must be closer to each other than two feet in order to be understood satisfactorily. If the words spoken are carefully selected and limited in number, intelligible speech will be possible at greater distances.

If a number of conversations are to be held in the same reverberant room, the procedure is more complicated. This chart cannot be used on the basis of the background noise level before the conversations are in progress, because a given conversation will be subject to interference from the noise produced by all the other conversations. The general procedure for calculating a speech-interference level under those conditions has not been completely worked out.

8.3.2 TELEPHONE USABILITY IN NOISY AREAS. The speech-interference level can also be used to predict the expected usability of a telephone under given noise conditions. The following schedule has been found generally satisfactory, when the F-1 Western Electric handset is used for long-distance or suburban calls.

<u>Speech-Interference Level</u>	<u>Telephone Use</u>
less than 60 db	Satisfactory
60 to 75 db	Difficult
above 75 db	Impossible

For calls within a single exchange, the permissible speech-interference levels are 5 db greater than those shown in the table.

8.3.3 CRITERIA FOR INDOOR NOISE LEVELS. A suggested rating system for offices, based on a number of psychological and acoustical tests, is shown in Figure 8-3. The curves on this graph relate the measured speech-interference level of the background noise and the subjective rating of the noise ranging from "very quiet" to "intolerably loud." The two different rating curves illustrate that the environment influences the subjective rating. In order to be rated "noisy" the noise level must be appreciably higher in a large office than in a private office.

It can be expected that the probability of receiving complaints about noise will be high for subjective ratings above "Moderately Noisy" and low for subjective ratings below "Moderately Noisy." Furthermore, because of direct interference with transferring information, efficiency may be reduced for levels appreciably above the criterion points marked A and B.

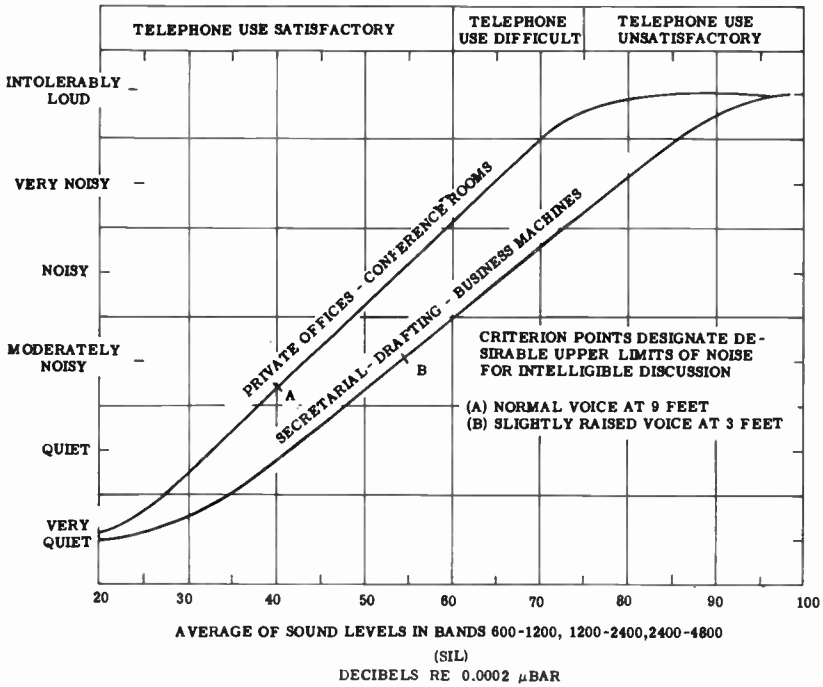
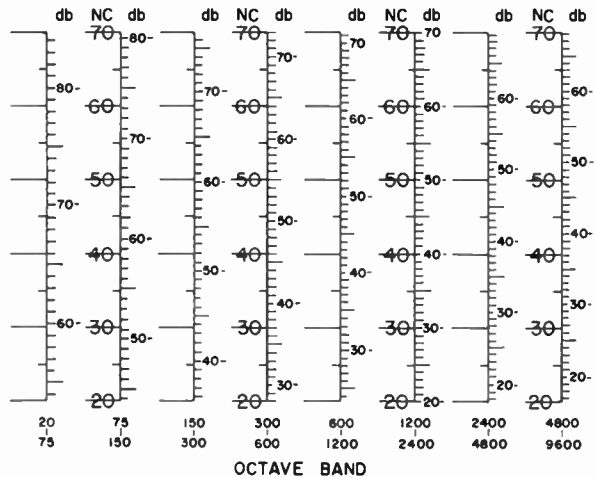

Figure 8-3. Rating chart for office noises. Data were determined by an octave-band analysis and correlated with subjective tests. (Courtesy Beranek and Newman.)

Figure 8-4. Chart for establishing "Noise Criterion" (NC) values by octave-band analysis.



Suggested criteria for noise control in terms of maximum permissible speech-interference level (SIL), measured when the room is not in use, are given in the following table:

Table 8-2. Criteria for Noise Control

Type of Room	Maximum Permissible SIL (measured when room is not in use)
Small Private Office	40
Conference Room for 20	30
Conference Room for 50	25
Movie Theatre	30
Theatres for Drama (500 seats, no amplification)	25
Coliseum for Sports Only (Amplification)	50
Concert Halls (No amplification)	20
Secretarial Offices (Typing)	55
Homes (Sleeping Areas)	25
Assembly Halls (No amplification)	25
School Rooms	25

The purpose of these criteria will be shown by the following example. Assume that we are to put a small conference room in a factory space. We measure the speech-interference level at that location and find it to be 64 db, whereas the suggested speech-interference level criterion for a small conference room is 30 db. The room must then be designed to attenuate the noise from the factory space by about 34 db in order to have a conference room that will be satisfactory as far as background noise level is concerned (such an attenuation is provided by a double-plastered, three- or four-inch thick stud wall, or by a hollow-tile wall plastered on one side).

When a complete octave-band analysis is made, the noise can be rated by the use of a "Noise Criterion" (NC) rating. A number of these have been developed, and the chart shown in Figure 8-4 is based on the work of Beranek and his associates.⁴ The measured octave-band levels are plotted on this chart, and the noise is rated according to the highest NC value in any band, as shown by a peak on the chart. The numerical values of the criteria shown in Table 8-2 apply for this system of noise rating also. Thus, for example, a rating of NC25 or less is recommended for school rooms. Because this system takes into account the noise energy in the lower-frequency bands as well as in the SIL bands, it should be a more reliable method of

⁴L. L. Beranek, editor, Noise Reduction, New York, McGraw-Hill, 1960, pp 518ff.

rating. It will be obvious from the data plotted on the chart what regions of the frequency spectrum need most attention in a noise-control program.

8.3.4 RESIDENTIAL NOISE LEVELS. Some factories, recreation halls, electrical substations, trucks, and airplanes are so noisy that they annoy people living near them. The reactions of those that are annoyed may range from mild remarks to legal action. Those that are responsible for the noise would naturally like to avoid the expense of court action; and, in order to maintain the good will of the neighborhood, they are often willing to put considerable effort into controlling the noise so as to avoid anything but mild annoyance.

In order to put this noise control on a systematic basis, a number of engineering groups have analyzed the experiences obtained in many different situations. They have found that reactions of annoyance cannot be successfully predicted on the basis of a single measurement, or even of computed loudness ratings, but that many factors enter into the problem. In addition to the range of reactions to be expected from different individuals, some other factors are the following: The level and spectrum of the noise; whether or not there are strong, pure-tone components; the time pattern of the noise, including the rate of repetition and the actual time of occurrence during the day; and the general background noise level in the residential area affected. So far the data that is available is limited primarily to the reactions of people in residential areas of single-family houses surrounding industrial plants. We can expect that, because of the conditioning to noises that occur in multiple-family dwellings, the reactions of the people there would be modified.

A tentative rating⁵ for these residential noise problems is obtained in the following way: The octave-band noise levels are measured in the neighborhood. Under difficult circumstances, depending on the type of noise source and atmospheric conditions, particularly wind, such a measurement may require surveys for long periods of time. These measured levels are then plotted on the chart of Figure 8-5 to determine a "level rank."

⁵W. A. Rosenblith and K. N. Stevens, Handbook of Acoustic Noise Control, Vol II, Noise and Man, WADC Technical Report 52-204, PB 111274, Office of Technical Services, Department of Commerce, Washington 25, D. C., June, 1953, pp 181-200. L. L. Beranek, Acoustics, McGraw-Hill: New York, 1954, Part XXXII.

K. N. Stevens, W. A. Rosenblith, and R. H. Bolt, "A Community's Reaction to Noise: Can It Be Forecast?", Noise Control, Vol 1, No. 1, January, 1955, pp 63-71.

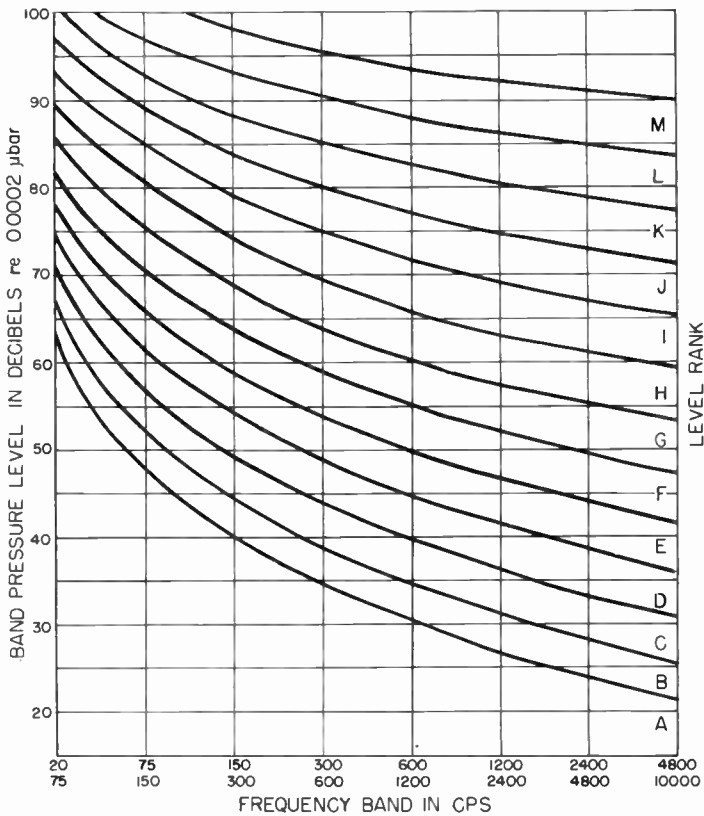

Figure 8-5. Set of curves for assigning a level rank to a residential noise. The octave-band levels of the noise are plotted on this chart. The highest of the alphabetically labeled zones into which any of the band levels penetrates is the level rank of the noise.

For example, assume that the octave-band levels produced at night by a newly erected power substation at the nearest house in a suburban area are as follows.

<u>Octave Band-cps</u>	<u>Band Level-db</u>
25- 75	30
75- 150	48
150- 300	47
300- 600	38
600- 1200	34
1200- 2400	28
2400- 4800	22
4800-10000	22

Table 8-3

List of Correction Numbers to be Applied to Level Rank to Give Noise Rating

<u>Influencing Factor</u>	<u>Possible Conditions</u>	<u>Correction Number</u>
Noise Spectrum Character	Pure-tone components	+1
	Wide-band noise	0
Peak Factor	Impulsive	+1
	Not Impulsive	0
Repetitive Character (about one-half minute noise duration assumed)	Continuous exposures to one per minute	0
	10-60 exposures per hr	-1
	1-10 exposures per hr	-2
	4-20 exposures per day	-3
	1-4 exposures per day	-4
	1 exposure per day	-5
Background Noise	Very quiet suburban	+1
	Suburban	0
	Residential Urban	-1
	Urban near some industry	-2
	Area of heavy industry	-3
Time of Day	Nighttime	0
	Daytime only	-1
Adjustment to Exposure	No previous conditioning	0
	Considerable previous conditioning	-1
	Extreme conditioning	-2

When these levels are plotted on Figure 8-5, it is seen that, in this particular case, the level rank of the 150-300 cps band is the highest of any of the bands. The noise is then assigned that rank. The level rank of this assumed noise is then "C". This rank is then corrected by the numbers in Table 8-3, according to the factors listed. For the assumed noise the spectrum has strong pure-tone components (+1); it is a steady noise (0) not impulsive (0), in a suburban neighborhood (0), at nighttime as well as daytime (0), and we shall assume that this neighborhood has no previous conditioning to a noisy nighttime background (0). The net correction is then a shift upward of one level to a corrected "level rank" or noise rating of "D". Then from the chart of Figure 8-6 we predict that probably only a few people would complain about this noise. If there were many houses in a region of this noise level, the power company would probably try to reduce the noise level in order to avoid losing the good will of the neighborhood.

This rating system can also be handled in the opposite se-

RESPONSE

VIGOROUS
COMMUNITY
ACTION

THREATS OF
COMMUNITY
ACTION

WIDESPREAD
COMPLAINTS

SPORADIC
COMPLAINTS

NO OBSERVED
REACTION

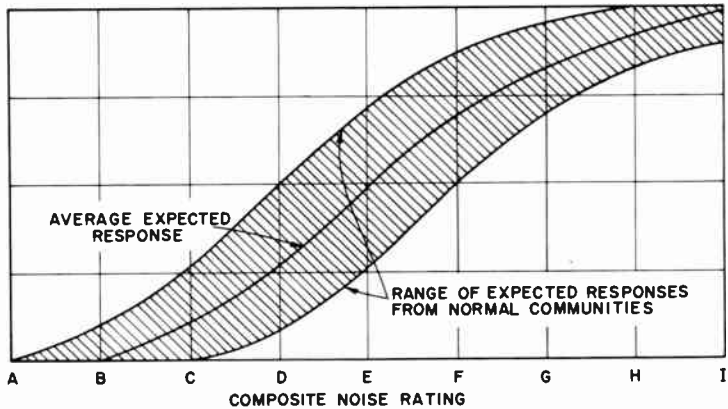

Figure 8-6. Relation between the noise rating and the expected response from the residents exposed to the noise.

quence. Thus, we could decide on the sort of response that we would be willing to have or to risk and proceed from that to the maximum allowable levels in each band.

Sometimes a noisy device is in a building where there are also bedrooms. The noise level produced by that device in the bedrooms should then be rated one rank higher than that given in Figure 8-5, since engineering experience indicates that the residents are less tolerant of noise generated within the same building.

The procedure given here is intended mainly as a guide. As more experience is obtained in this field of neighborhood noise problems, it can be expected that some revision of the numerical values will be found desirable.

8.4 HEARING DAMAGE FROM EXPOSURE TO NOISE.

As described in Sections 3.9 and 5.6, all noise ratings concerning the possibility of hearing damage are tentative at present. Many ratings have been suggested but no standards have yet gained acceptance, and all that can be done here is to indicate the order of magnitude of noise levels that are being considered as safe for lifetime exposures. More complete information is necessary before a widely acceptable rating can be given. In addition, general agreement must be reached on answers to the following questions:⁶

"(1) What kind and amount of hearing loss constitutes a suf-

⁶ ASA Subcommittee Z24-X-2, The Relations of Hearing Loss to Noise Exposure, American Standards Association, 70 East 45th Street, New York, January, 1954.

ficient handicap to be considered undesirable? What role should presbycusis play in the setting of such a figure?

"(2) What percentage of the people exposed to industrial noise should a standard be designed to protect? In view of the large individual differences in susceptibility to noise exposure, should a noise standard be aimed at preventing hearing loss in 50, 90, or 99 percent of the population?

"(3) How should noises be specified and exposures measured? Since different types of noises are apparently not equally effective in producing hearing losses, agreement must be reached on a standard specification of the spectral and temporal characteristics of the noise."

The noise-level ratings to be given here apply only to continuous exposure during a regular working day for a number of years and to steady noises, not to impact or impulsive sounds, such as gunfire. Impact sounds are more difficult to measure adequately (refer to paragraphs 6.3.6 and 6.7.2), and less information regarding hearing damage from impact sounds is available.

One suggested preliminary test is based on the reading of a Sound-Survey Meter or Sound-Level Meter with the B weighting network. A reading above 100 db indicates that the noise is probably unsafe for everyday exposures, at least for some people, and noise reduction or ear protection is necessary. Readings below 80 db indicate that there is probably no danger from the noise even if it is a simple tone.

When the reading with the B weighting network is above 80 db, analysis is necessary, and an investigation should be made with the octave-band analyzer. When this analysis is made, the following tentative criteria may be applied: If the octave-band pressure level in any of the bands from 300 to 4800 cycles per second exceeds 85 db, hearing-conservation procedures are recommended. The more these band levels exceed 85 db, the more urgent is the need for noise reduction and ear protection. This criterion is limited to years of everyday exposure; evidence reported by the American Standards Association Subcommittee Z24-X-2 indicates that intermittent exposure causes less hearing loss than does continuous exposure to the same type of noise. This information is inadequate for formulation in terms of noise rating; however, an estimate has been made that if the daily exposure is only five minutes, for instance, a level of 105 db can be used as the criterion level. More evidence is needed before a widely accepted standard is available.

Some industrial and governmental organizations have set up a program that includes periodic hearing tests⁷ and records

⁷ A Guide for Conservation of Hearing in Industry, Subcommittee on Noise of the Committee on Conservation of Hearing, American Academy of Ophthalmology and Otolaryngology.

of noise exposure of their employees. The noise-exposure records give the octave-band analysis of the noise to which the particular employee is exposed, the duration of the exposure, and the protective devices — such as ear protection — used. Such a systematic approach is recommended for organizations having employees exposed to high-level noise.

For those concerned with the problem of noise-induced hearing loss, we recommend that they request the latest information on this subject from the Research Center, Subcommittee on Noise of the Committee on Conservation of Hearing of the American Academy of Ophthalmology and Otolaryngology, 327 S. Alvarado St., Los Angeles 57, California.

NOISE CONTROL

9.1 INTRODUCTION.

When we want to reduce noise, we usually begin by measuring the noise spectrum to obtain the quantitative information that is helpful in doing something about the problem. We compare the measured noise levels with the acceptable levels, which are often estimated by use of one of the criteria given in Chapter 8. The difference between these two levels is then the noise reduction necessary.

The next step is to find out how this noise reduction can be achieved most satisfactorily. A complete discussion of this problem is not possible in this handbook. But since many of those using this book are just beginning to work on noise problems, a few introductory statements on the subject will be made. Useful information on this subject will be found in Sound (formerly Noise Control), published by the Acoustical Society of America, in books on noise control and architectural acoustics, in books on mechanical vibrations, in some books on acoustics in general, in some articles in the Journal of the Acoustical Society of America, and in some articles in various trade journals.

The general approach to noise reduction can be divided into two major parts as follows:

- (1) Reduction of noise at its source.
- (2) Reduction of noise level at the ear of the listener by changes in the path from the source.

9.2 CONTROL AT THE SOURCE.

It is usually wise to see first if the noise can be reduced at the source. A different type of source might be selected. For example, a process might be changed so that parts are welded instead of riveted together. A source of different basic construction but of a similar type might be used. For example, a slower fan of many blades can sometimes be substituted for a high-speed two-bladed fan. Or, the construction of the particular source at hand might be modified, and this procedure will be discussed briefly.

When modification of a source is attempted, a decrease in the radiated power is usually the most important change that can be made. This usually means a reduction of vibration amplitudes and of the radiation of sound produced by the vibration. We can separate this problem into three sections:

(1) Decrease the energy available for driving the vibrating system.

(2) Change the coupling between this energy and the acoustical radiating system.

(3) Change the structure that radiates the sound so that less is radiated.

In each of these sections it is usually helpful to track down the important sources of noise and the path of transmission by using frequency analysis of the sound and vibration. The effects of changes in the source (for example, speed, structure, and mounting) on the spectrum should also help in finding the important elements.

The sound energy can be reduced in a number of ways. If friction is the force producing the vibration, better lubrication may help to reduce it. But in some situations, adding friction or damping may absorb some of the energy in the vibration and thereby reduce it. Driven parts that fit poorly or that are badly worn may need correction or tightening. Usually, the speed of all parts should be kept as low as possible to achieve a low noise level. Air streams should be of low velocity to keep noise energy down. The use of structural materials, such as some plastics, with inherent vibration-damping qualities may be possible as another means of absorbing the energy.

Change in the coupling system frequently means the use of vibration isolation mounts. It may also mean decreased or even increased stiffness in some members transmitting the vibration. Or it may mean better fastening of some parts to massive, rigid members. Resonant structures are often troublesome coupling members. The resonance may be in the mechanical structure or in an air chamber. In either situation it is usually possible to shift the resonance by changes in the structure or to damp the resonance by adding absorbing material. Mufflers may be needed on exhaust or intake systems.

Changing the radiating structure often means nothing more than reducing the external surface areas of the vibrating parts as much as possible. It may be possible to put holes in the radiating member to reduce the efficiency of radiation. Less stiffness of the part may help to reduce radiated sound by permitting sections to vibrate in different time patterns. Large surfaces near the vibrating parts should also be avoided, since these surfaces may increase the radiating efficiency of the vibrating parts.

Another possible way of modifying the source to improve the noise situation is to change the directivity pattern of the radiated sound. When streams of air or other gases come out of an opening, they radiate sound that may be highly directional at high frequencies. Changing the direction of flow can shift this pattern. It may be possible to direct it in such a way that noise in certain directions is considerably reduced.

9.3 CONTROL OF THE PATH OF SOUND.

The control of the noise by changes in the path of the sound can be analyzed into three sections:

- (1) Change in relative position of source and listener.
- (2) Change in acoustic environment.
- (3) Introduction of attenuating structures between source and listener.

9.3.1 CHANGES IN POSITION. Increasing the distance between the noise source and the listener is often a practical method of noise control. Furthermore, merely rotating the source of noise may permit one to decrease the level if a change to a direction of low directivity factor is achieved. Both these procedures are effective only in the region where approximately free-field conditions exist. (See Section 7.4.)

9.3.2 CHANGE IN ENVIRONMENT. The most obvious change that can be made in a room to reduce the noise level is to add acoustical absorbing material. A wide variety of commercial acoustical materials is available. These materials are often of great value in a noise reduction program, but the limitations of this treatment should be realized. These materials are mainly useful in the room where the noise originates, and there they help mainly to reduce the noise level at some distance from the source. But at the same time not much reduction is obtained at a distance of 2 feet, say, which is a common distance between a machine and the operator's ear.

9.3.3 ATTENUATING STRUCTURES. A number of different types of attenuating structures are used for reducing the noise level for the listener. One of these is an ear defender, which may be an ear plug, waxed cotton, or earmuffs. Others are walls, barriers, and total enclosures. Almost any degree of reduction of air-borne sound can be achieved by a total enclosure or a combination of several enclosures. But as the required attenuation increases so does the complexity, weight, and cost. In addition, great care must be taken that the attenuation gained by the enclosure is not lost by sound transmission through a ventilating duct or by solid-borne vibration. Because of this possible flanking transmission in ventilating systems, total enclosures frequently require carefully designed ventilating systems with ducts lined with absorbing material. These lined ducts are essentially mufflers for the air stream.

When a door is required in a total enclosure, it should be built with air-tight seals at all joints. A refrigerator-type door is usually satisfactory when it can be used. A total enclosure should also be lined at least on part of the inside walls with absorbing material. This lining helps to keep the noise at the walls of the enclosure at the lowest practical level.

A barrier is not as effective as a total enclosure, but it

does help to shield high-frequency sound. Little attenuation of low-frequency sound is obtained unless the barriers are very large, and the attenuation of high-frequency sound is usually only a few decibels unless the opening that remains is relatively small. Here, too, absorbing material should cover the barrier to avoid exaggerating the level by reflections from the barrier.

9.3.4 ILLUSTRATIVE EXAMPLE. In order to illustrate the possible noise reduction achieved by use of vibration isolation, barriers, enclosures, and acoustic treatment, an example made up for the purpose is shown in a series of figures, Figures 9-1 to 9-8. We intend to show here only the general nature of the noise reduction obtainable as given by changes in the octave-band spectrum and the speech-interference level (Section 8.3). Actual results will vary in detail, and situations do occur where the results differ materially from those shown because of factors not considered here. But, in general, the noise reduction shown in the figures can be considered typical.

Figure 9-1 shows the octave-band analysis of the noise from the assumed machine. The speech-interference level is also shown. This machine is a noisy one with a spectrum that shows appreciable noise energy all over the audible range. All the noise measurements are assumed to be made in the relative position shown for the microphone designated M on the figures.

The use of vibration isolation mounts may be an important step in noise control. As shown in Figure 9-2, the initial result, however, is often only a moderate reduction of the low-frequency noise. The machine itself usually radiates most of the high-frequency noise directly to the air, and the amount radiated by the floor is small. A reduction in the vibration level at the floor only is then not important at high frequencies. At low frequencies, however, the machine may be too small to be effective in radiating sound, and then the floor may act as a sounding board to contribute materially to low-frequency sound radiation.

It is even possible to increase the noise as a result of the use of vibration mounts. This result is usually found when the stiffness of the mounting is of such a value that some vibration mode is exaggerated by resonance, but resonance can be avoided by proper design of the mounting. In the illustrative example it is assumed that the mounting is sufficiently soft that the basic vibration resonance of the machine on the mounting system is below 20 cps. In this particular example no significant change in the speech-interference level is shown as a result of the use of vibration isolation mounts alone.

The results shown in Figure 9-3 illustrate that a barrier is mainly effective at high frequencies, and there it produces only a moderate reduction in noise level.

The novice in this field sometimes assumes that the materials used for sound absorption can also be used alone for

OCTAVE-BAND ANALYSIS OF NOISE

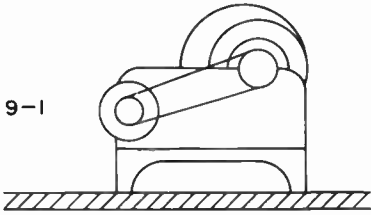

(M)

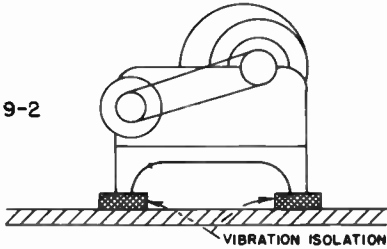
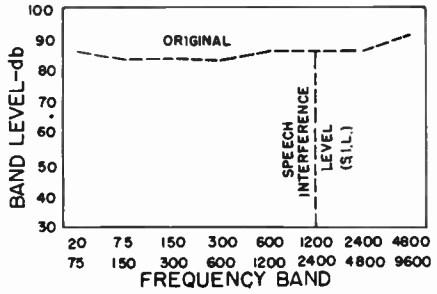

(M)

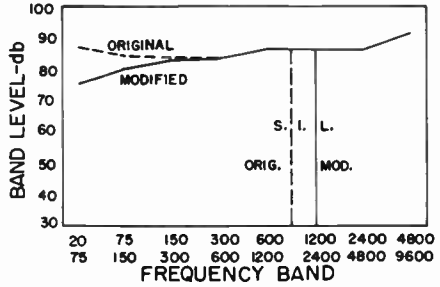

ACOUSTICAL ABSORBING MATERIAL

BAFFLE

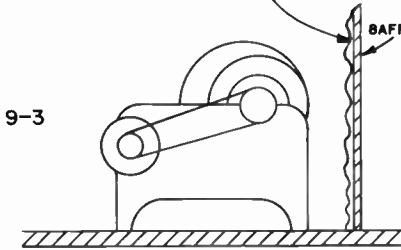

(M)

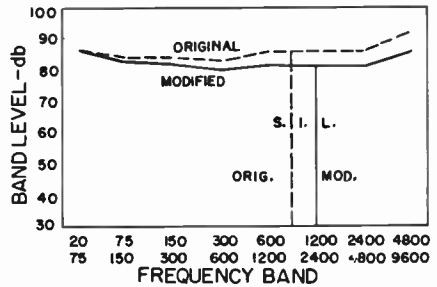

ENCLOSURE OF ABSORBING MATERIAL

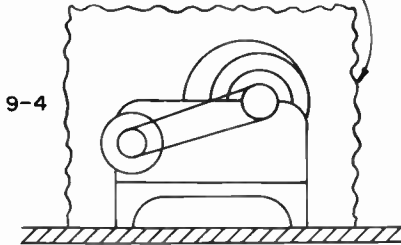

(M)

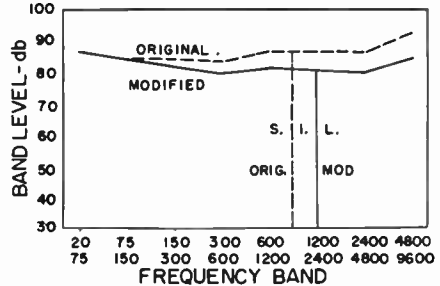

Figures 9-1 through 9-4. Examples to illustrate the possible noise reduction effects of some noise control measures.

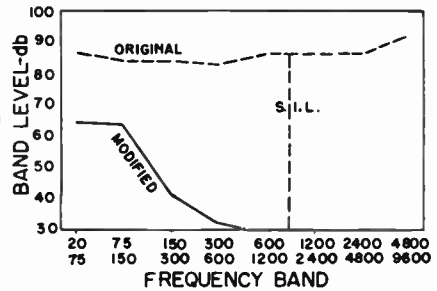
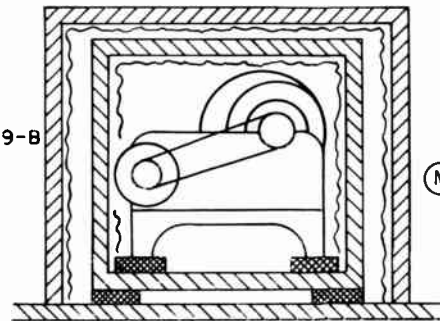
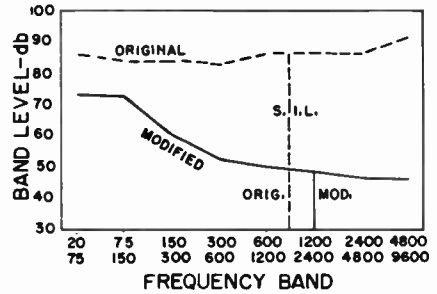
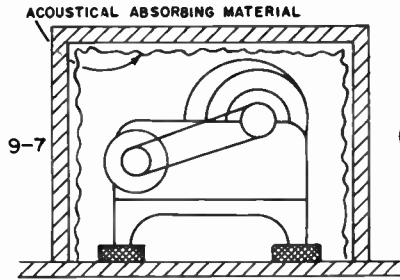
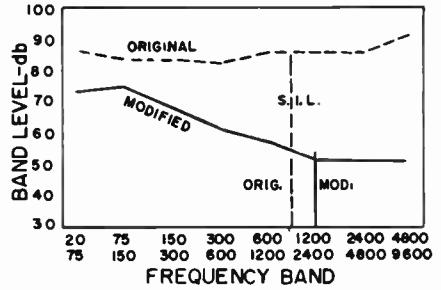
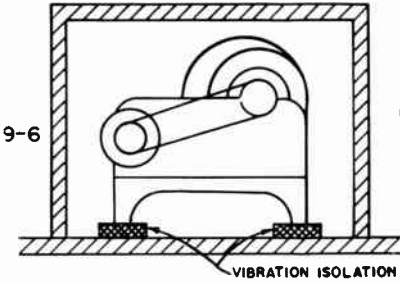
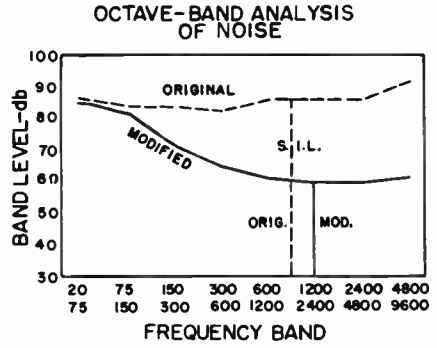
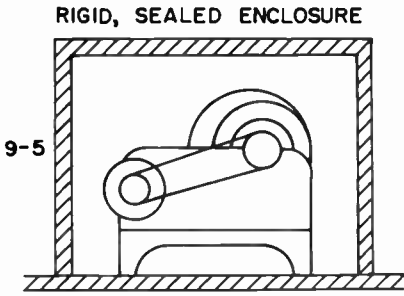

Figures 9-5 through 9-8. Examples to illustrate the noise reduction possible by the use of enclosures.

sound isolation. If we build an enclosure solely of these materials mounted on a light framework, we would typically find the result shown in Figure 9-4. Only at high frequencies do we have a noticeable reduction in level, and even there it is a small reduction.

A more satisfactory enclosure is built of more massive and rigid constructional materials. Assume that we enclose the machine by a well-sealed, heavy, plasterboard structure. Then we might observe the result shown in Figure 9-5. Here an appreciable reduction is obtained over the middle- and high-frequency range. The enclosure is not as effective as it might be, however, because two important factors limit the reduction obtained. First, the vibration of the machine is carried by the supports to the floor and then to the whole enclosure. This vibration then may result in appreciable noise radiation. Second, the side walls of the enclosure absorb only a small percentage of the sound energy.

The addition of a suitable vibration isolation mounting will reduce the noise transmitted by solid-borne vibration. This effect is illustrated in Figure 9-6. Here we see a noticeable improvement over most of the audio spectrum.

When the sound absorption within an enclosure is small, the noise energy from the machine produces a high level within the enclosure. Then the attenuation of the enclosure operates from this initial high level. The level within the enclosure can usually be reduced by the addition of some sound-absorbing material within the enclosure, with the result that the level outside the enclosure is also reduced. This effect is shown in Figure 9-7, which should be compared with Figure 9-6.

If even more noise reduction is required than that obtained by the one enclosure, a second, lined, well-sealed enclosure can be built around the first. The first enclosure is supported within the second on soft vibration mounts. Then a noise reduction of the magnitude shown in Figure 9-8 can be obtained.

9.4 SUMMARY.

The approach to a noise reduction problem can be summed up as follows:

- (1) Consider the source.
 - Can a quieter machine be substituted?
 - Can the noise energy be reduced?
 - Can a useful change be made in the directivity pattern?
 - Are resilient mounts of any use here?
 - Can a muffler be used?
- (2) Consider the path from the source to the listener.
 - Can the source or the listener be readily moved to reduce the level?
 - Is acoustic treatment a useful solution?
 - Should barriers be erected?
 - Is a total enclosure required?

INTRODUCTION TO VIBRATION MEASUREMENTS

10.1 GENERAL.

Vibration is the term used to describe continuing or steady-state periodic motion. The motion may be simple harmonic motion like that of a pendulum, or it may be very complex like a ride in the "whip" at an amusement park. The motion may involve tiny air particles that produce sound when the rate of vibration is in the audible frequency range (20 to 20,000 cps), or it may involve, wholly or in part, structures found in vacuum tubes, bridges, or battleships. Usually the word vibration is used to describe motions of the latter types, and is classed as solid-borne, or mechanical, vibration.

Many important mechanical vibrations lie in the frequency range of one or two cps to 2,000 cps (corresponding to rotational speeds of 60 to 120,000 rpm). In some specialized fields, however, both lower and higher frequencies are important. For example, in seismological work, vibration studies may extend down to a small fraction of a cycle per second, while in loudspeaker cone design and studies of subminiature vacuum-tube elements, vibrations up to 20,000 cps must be studied. Electrical, electronic, and mechanical components of guidance systems of space probes, missiles, and supersonic airplanes must withstand severe vibrations at frequencies extending from below 10 cps to above 20 kc. Vibrations of electrical and mechanical auxiliaries aboard ships must be kept to a minimum to ensure service-free and silent operation. Several important effects of unwanted vibration in mechanical systems make it desirable to study vibration and, if possible, to reduce it.

(1) Noise is created by the transmission of solid-borne audio-frequency vibrations to air. Hence, the process of quieting a machine or device includes a study of the mechanical vibrations involved.

(2) High-energy acoustical noise, generated by very powerful jet or rocket engines, produces vibrations that may weaken structural members of a vehicle or cause failure of an electrical or electronic component.

(3) Human discomfort and fatigue result when a vehicle subjects the passenger and operator to excessive vibration. Hence, vibration studies are an essential part of the development program for trains, buses, boats, airplanes, and automobiles.

Vibration then, is not only a source of noise, annoyance,

and discomfort, but often a source of danger. The present refinement of high-speed planes, ships, and automobiles could never have been achieved without thorough measurement and study of mechanical vibration.

There are, on the other hand, many important applications of controlled vibration. Tiny vibrators attached to instrument panels are used to overcome pivot friction of indicating meters. Electrical and pneumatic vibrators of numerous shapes and sizes are used as hopper shakers in material-handling applications. Electrodynamic shakers or vibration exciters are made in sizes ranging from small units to calibrate small vibration pickups and to excite lightweight specimens such as subminiature vacuum tubes, to giant six-ton units used to test large assembled mechanisms and heavy components. In addition, small piezoelectric shakers are used to test small components and to calibrate vibration pickups. Also, electro-mechanical shakers using electric-motor-driven off-balance weights generate vibrations of components weighing up to 200 or 300 pounds, and hydraulic shakers are used to test very large machines.

In the design and adjustment of these vibrating systems it is necessary to make the same types of measurements as are made in the study of unwanted vibrations.

10.2 VIBRATION TERMS.

10.2.1 DISPLACEMENT, VELOCITY, ACCELERATION, AND JERK. Vibration can be measured in terms of displacement, velocity, and acceleration. The easiest measurement to understand is that of displacement, or the magnitude of motion of the body being studied. When the rate of motion (frequency of vibration) is low enough, the displacement can be measured directly with the dial gauge micrometer. When the motion of the body is great enough, its displacement can be measured with the common scale.

In its simplest case, displacement may be considered as simple harmonic motion, that is, a sinusoidal function having the form

$$x = A \sin \omega t \quad (1)$$

where A is a constant, ω is 2π times the frequency, and t is the time as shown in Figure 10-1. The maximum peak-to-peak displacement (a quantity indicated by a dial gauge) is $2A$, and the rms¹ displacement is $A/\sqrt{2}$ ($=0.707A$). The average (full-wave rectified average) value of the displacement is $2A/\pi$ ($=0.636A$), while the "average double amplitude" (a term occa-

¹root-mean-square

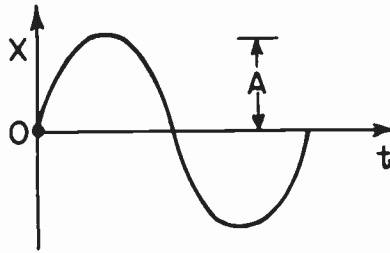

Figure 10-1. A simple sinusoidal function.

sionally encountered) would be $4A/\pi (=1.272A)$. Displacement measurements are significant in the study of deformation and bending of structures.

In many practical problems, however, displacement is not the important property of the vibration. A vibrating mechanical part will radiate sound in much the same way as does a loudspeaker. In general, velocities of the radiating part (which corresponds to the cone of the loudspeaker) and the air next to it will be the same, and if the distance from the front of the part to the back is large compared with one-half of the wavelength of the sound in air, the actual sound pressure in air will be proportional to the velocity of the vibration. The sound energy radiated by the vibrating surface is the product of the velocity squared and the resistive component of the air load. Under these conditions it is the velocity of the vibrating part and not its displacement that is of greatest importance.

Velocity is the time rate of change of displacement, so that for the sinusoidal vibration in equation (1) the velocity is:

$$v = \omega A \cos \omega t \quad (2)$$

Thus velocity is proportional to displacement and to frequency of vibration.

The analogy cited above covers the case where a loudspeaker cone or baffle is large compared with the wavelength of the sound involved. In most machines this relation does not hold, since relatively small parts are vibrating at relatively low frequencies. This situation may be compared to a small loudspeaker without a baffle. At low frequencies the air may be pumped back and forth from one side of the cone to the other with a very high velocity, but without building up much of a pressure or radiating much sound energy because of the very low air load, which has a reactive mechanical impedance. Under these conditions an acceleration measurement provides a better measure of the amount of noise radiated than does a velocity measurement.

In many cases of mechanical vibration, and especially where mechanical failure is a consideration, the actual forces set up in the vibrating parts are important factors. The acceleration of a given mass is proportional to the applied force, and a reacting force equal but opposite in direction results. Members of a vibrating structure, therefore, exert forces on the total structure that are a function of the masses and the accelerations of the vibrating parts. For this reason, acceleration measurements are important when vibrations are severe enough to cause actual mechanical failure.

Acceleration is the time rate of change of velocity, so that for a sinusoidal vibration.

$$a = -\omega^2 A \sin \omega t \quad (3)$$

It is proportional to the displacement and to the square of the frequency or to the velocity and the frequency.

Jerk is the time rate of change of acceleration. At low frequencies this change is related to riding comfort of autos and elevators. It is also important for determining load tie-down in planes, trains, and trucks.

10.2.2 ACCELERATION AND VELOCITY LEVEL. Some use is now being made of "acceleration level" and "velocity level," which, as the names imply, express the acceleration and velocity in decibels (see Chapter 2) with respect to a reference acceleration and velocity. The reference value of 10^{-6} cm/sec for velocity and 10^{-3} cm/sec/sec for acceleration are now being used, although other references, notably 10^{-9} meters/sec and 10^{-6} meters/sec/sec, have been proposed. The selection of suitable standard reference values for acceleration, velocity, and displacement is now being studied.

10.2.3 NONSINUSOIDAL VIBRATIONS. Equations (1), (2), and (3) represent only sinusoidal vibrations, but as with other complex waves, complex periodic vibrations can also be represented as a Fourier series of sinusoidal vibrations. These simple equations may therefore be expanded to include as many terms as desirable in order to express any particular type of vibration. For a given sinusoidal displacement, velocity is proportional to frequency and acceleration is proportional to the square of the frequency, so that the higher-frequency components in a vibration are progressively more important in velocity and acceleration measurements than in displacement readings.

10.2.4 SUMMARY. Displacement measurements are used only in instances where the actual amplitude of motion of the parts is important. This would include those instances where the dynamic loading due to the operating machinery in a factory

may cause unsafe deflections in flooring and walls, or where the large amplitude of motion might actually cause parts to strike together causing damage or serious rattle. The deflections observed at the center of a wall panel or a beam, for example, can give useful information about the stresses acting in these members. The displacement is not directly a measure of surface strain of the member but is rather an integrated indication of the strain. The strain measured by the usual strain gauge is a minute elongation or compression of material between points an inch or so apart. In contrast, the displacement measurement referred to above is the bending of material over a distance of several feet.

Velocity measurements are generally used in noise problems where the radiating surfaces are large compared with the wavelength of the sound.

Acceleration measurements are applied to problems where actual mechanical failure of the parts involved is important, and they are also applied to many noise problems, especially those involving small machinery.

Jerk measurements are used for checking riding comfort or load tiedown requirements. A general-purpose vibration meter, therefore, must be able to measure all four vibration characteristics.

DESCRIPTION OF VIBRATION-MEASURING INSTRUMENTS

11.1 INTRODUCTION.

A remarkably wide variety of systems is used to measure vibration.¹ When the vibratory motion is slow and large, the measurement can sometimes be made with a scale. If the motion is slow but small, a measuring microscope may be used. For rapid motion, a stroboscope can be used to produce an apparent slow-motion replica of the rapid motion for optical measurement. This technique is discussed in more detail later in this handbook.

The measuring system may be entirely mechanical or a mixture of mechanical, electrical, and optical elements. Many of these systems have been described in the literature.¹ Of the many possible systems, the one particularly adaptable to a broad range of applications uses a vibration pickup (more generally called a transducer) to transform the mechanical motion into a corresponding electrical signal. This signal is amplified, measured, and analyzed by electronic instruments. We will devote most of our attention to this system.

The most commonly used vibration pickup is a piezoelectric accelerometer, in which a piezoelectric element is deflected by its own inertia when the pickup is subjected to vibration. The voltage generated is proportional to the acceleration. This type of pickup has the advantages of small size, light weight, and wide frequency range, and it does not require a fixed frame of reference for the measurement.

11.2 THE VIBRATION METER.

The vibration meter shown in Figure 11-1 takes advantage of the wide frequency range of the piezoelectric type of pickup. The response for the measurement of acceleration extends smoothly from 2 to 20,000 cycles per second, as shown in

¹Cyril Harris and Charles Crede, Shock and Vibration Handbook, McGraw-Hill Book Co., New York, 1961, Chapters 12 through 17.

J. Ormondroyd, R. B. Allnut, F. Mintz, and R. D. Specht, "Motion Measurements," Handbook of Experimental Stress Analysis, Edited by M. Hetenyi, John Wiley: New York, 1950, Chapter 8, pp. 301-389.



Figure 11-1. Type 1553-A Vibration Meter.

Figure 11-2. The meter is calibrated directly in terms of peak, peak-to-peak, and average displacement, velocity, acceleration, and jerk; these are indicated in mils, inches/second, inches/second², and inches/second³, respectively. Another model of this instrument indicates the same quantities in metric units, i.e., mm, meters/sec, meters/second², and meters/second³, respectively.

Since the vibration pickup used with this meter is of the acceleration type, two stages of electrical integration and one differentiation are necessary to provide the various types of response. The integrating and differentiating circuits are built in as part of the amplifier. This allows more freedom in the design, and better performance is possible than with the control-box attachment used with the sound-level meter (see paragraph 11.3).

Figure 11-3 shows the over-all characteristics in terms of response for a constant-acceleration vibration as a function of frequency. The peak above 2000 cycles is caused by the natural resonance of the pickup. The instrument is direct-reading for acceleration, velocity, and displacement from 2 to 2000 cps, and direct-reading for jerk over the frequency range of 1 to 20 cps, when used with the Type 1560-P52 pickup normally supplied. When used with an auxiliary high-frequency accelerometer such as the Endevco Type 2217, the direct-reading range starts at about 25 cps and extends to 20 kc for

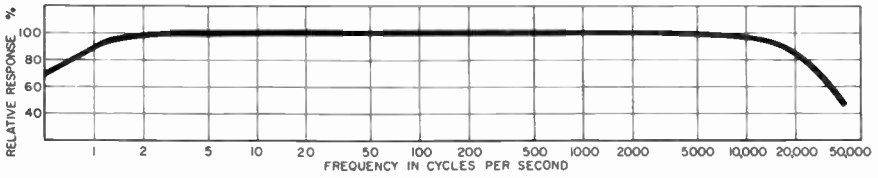
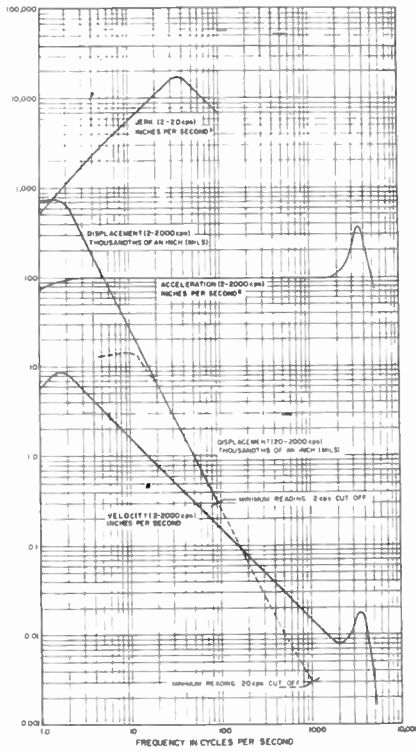
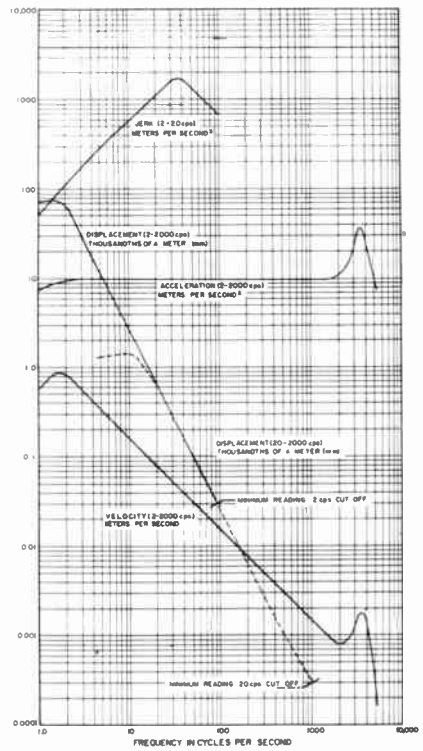

Figure 11-2. Frequency response of Type 1553-A Vibration Meter, FUNCTION switch at ACCEL, power switch at 2-20,000 cps.



(A)



(B)

Figure 11-3. (A) Readings of the Type 1553-A Vibration Meter for a constant acceleration of 100 inches per second² as a function of frequency. (B) Readings of the Type 1553-AK Vibration Meter for a constant acceleration of 10 meters per second² as a function of frequency.

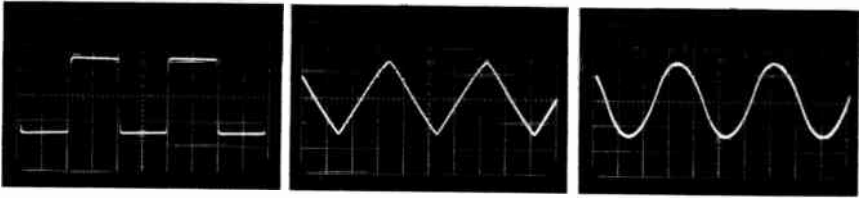

Figure 11-4. Oscillograms showing the operation of the integrating circuits in the vibration meter. In (A) a square wave is shown as transmitted by the amplifier when set for acceleration measurements. (B) shows the wave after one stage of electrical integration for velocity measurements, and (C) shows the result of two stages of integration as used for displacement measurements.

acceleration measurements. For velocity and displacement measurements, the high-frequency range is limited to about 2000 cps by the internal noise level in the instrument. The curves of Figure 11-3 show how the integration process attenuates the higher frequencies with respect to lower frequencies. Figure 11-4 shows the effect of the electrical integration on a square wave. The square waveform of Figure 11-4A, after two steps of integration, approaches a sinusoidal waveform (Figure 11-4C).

11.3 VIBRATION PICKUP SYSTEM.

Vibration measurements can be made with a sound-level meter when a vibration pickup is substituted for the microphone. With the sound-level meter, the Type 1560-P52 Vibration Pickup and the Type 1560-P21B Control Box are used. The pickup itself is of the piezoelectric accelerometer type. The control box, which is connected between the meter and the pickup, converts the response so that the meter indicates velocity and displacement as well as acceleration. The combination of pickup and control box, called the Type 1560-P11B Vibration Pickup System, provides a convenient and inexpensive way for owners of sound-level meters to make vibration measurements within the audio-frequency range. However, the sound-level meter circuits respond down to only 20 cycles, and consequently the combination is not suitable for measuring lower-frequency vibrations. The vibration meter must be used where low frequencies are important.

The sound-level meter is calibrated in decibels, which must be converted to vibration amplitude, velocity, or acceleration. The calibration chart supplied with each vibration pickup system gives the proper conversion factors for that system when it is used with a particular sound-level meter. By means of these data, plus the decibel table in the Appendix (also supplied in the instruction book for the vibration pickup system), the read-

Figure 11-5. The Type 1560-P11B Vibration Pickup System. (See also Figure 6-11.)

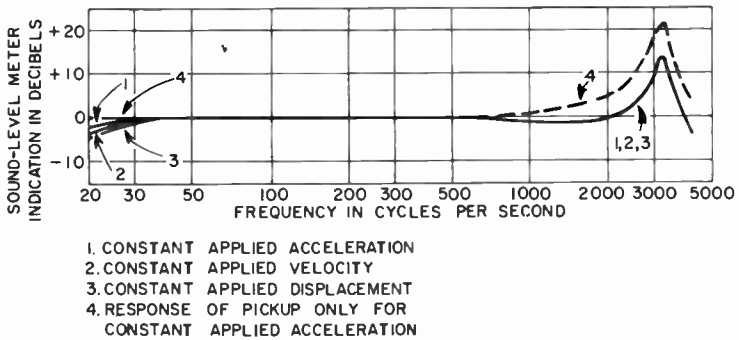

Figure 11-6. Over-all frequency response of Type 1560-P11B Vibration Pickup System and sound-level meter for constant applied acceleration, displacement, and velocity.

ings may be readily converted to inches (displacement), inches per second (velocity), or inches per second per second (acceleration).

11.4 ANALYZERS.

11.4.1 GENERAL. The vibration meter measures the displacement, velocity, acceleration, or jerk of a vibration. Unless the waveform is substantially sinusoidal, however, the vibration meter by itself gives little information about the frequencies

of the individual vibration components.² An analyzer, therefore, is desirable and often is a necessity. As with noise, the analysis of vibration provides clues to the sources of the vibration components and information necessary in the suppression of the vibration.

Vibration, like noise, may be classified into two types--pitched, which consists of individual components that vary in frequency by the same percentage that the machine speed varies; and unpitched, which is caused by shock excitation, turbulence, friction, and the like, and which occurs over bands of frequencies.

A number of analyzers can be used with the vibration meter or with the sound-level meter--vibration pickup system combination to extend the range of usefulness of these instruments. These analyzers vary in complexity and ease of operation. The relative usefulness of each analyzer depends on the vibration problem to be solved.

11.4.2 SOUND AND VIBRATION ANALYZER. The sound and vibration analyzer shown in Figure 4-5 is a portable, battery-operated, continuous-spectrum instrument. Operation is simple, and the entire frequency range of the instrument can be quickly scanned. Any one of four decade frequency ranges can be selected, and the frequency is indicated on a single dial. Circuit elements consist of only resistors and capacitors, and the case is electrostatically shielded so that the instrument is unaffected by ordinary electromagnetic and electrostatic fields.

The sound and vibration analyzer covers the frequency range from 2.5 to 25,000 cycles per second. The meter scale is calibrated in decibels for use with the sound-level meter--vibration pickup system combination, and in linear units for use with the vibration meter. In combination with the vibration meter, this analyzer provides a convenient means for measuring not only the over-all vibration level but also the amplitudes of the components of the complex waveform.

The selectivity characteristics are shown in Figure 11-7. The shape of the selectivity curve is constant in terms of percentage of the resonant frequency over the entire range.

Either of two bandwidths is selected by means of a panel switch. The ONE-THIRD OCTAVE position is helpful in locating components quickly in a fast sweep over the spectrum and in checking amplitudes of random vibrations. It is also used to measure frequency and amplitude of components when

²For sinusoidal vibrations, the frequency can be calculated from readings of displacement and velocity. As shown in equations (1) and (2), the frequency will be: $f = v/2\pi x$, where the displacement (x) is in inches, and the velocity (v) is in inches per second.

Figure 11-7. Selectivity characteristics of the Type 1564-A Sound and Vibration Analyzer.

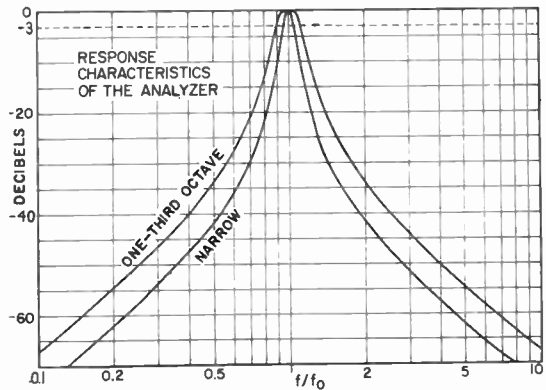

the frequency is drifting rapidly or is fluctuating about a mean frequency. Otherwise, the final determination of frequency and amplitude is made with the bandwidth switch in the narrow 1/10 OCTAVE position.

11.4.3 WAVE ANALYZER. A wave analyzer uses a fixed-frequency filter in a tunable heterodyne system similar in principle to the common superheterodyne radio receiver. It is continuously tunable from 20 cycles per second throughout the audio band in a single sweep of the tuning dial. The resulting filter response is constant with respect to the number of cycles per second deviation from the center frequency over the entire tuning range.

This analyzer has an output for recording and a linear frequency scale. An analysis that is linear in frequency scale is useful for tracking down harmonic relations, since successive integral harmonics are spaced uniformly. Modulation of one frequency component by another, such as occurs in gear trains, is also more readily observed in terms of the frequency spacing of components about a main component. A wave analyzer is often preferred to other types of analyzers for analysis of the vibration of gear trains and rotating or reciprocating machinery.

11.4.4 OCTAVE-BAND ANALYZER. The octave-band analyzer shown in Figure 4-4 can be used for the rapid analysis of noise or vibration. It operates directly from the output of a vibration meter or sound-level meter. Except for very low-level vibrations, it also operates satisfactorily from the output of the vibration pickup - control box system. The analyzer is sensitive enough to indicate over-all and octave-band acceleration levels operating simply with a vibration pickup. Although the octave-band analyzer does not operate at the low frequencies desired in many vibration measurements, it is useful in those vibration measurements made in connection with noise reduction problems. It is much easier to use than is a narrow-band analyzer, although this added convenience is gained at a

sacrifice in detail of analysis.

The Type 1558-A Octave-Band Noise Analyzer consists of a set of 10 band-pass filters selected by means of a rotary switch. These bands are: 18.75 to 37.5 cps; 37.5 to 75 cps; 75 to 150 cps; 150 to 300 cps; 300 to 600 cps; 600 to 1200 cps; 1200 to 2400 cps; 2400 to 4800 cps; 4800 to 9600 cps; 9600 to 19,200 cps.

The Type 1558-AP Octave-Band Noise Analyzer is similar to the Type 1558-A, except that its 10 octave bands are centered on a different set of preferred frequencies. Its octave bands are centered at 31.5, 63, 125, 250, 500, 1000, 2000, 4000, 8000, and 16,000 cps.

The instrument is powered by a rechargeable nickel-cadmium battery and is housed in a convenient portable carrying case that serves as an easel-type stand during operation.

11.4.5 IMPACT-NOISE ANALYZER. Impact-type waveforms, such as those produced by punch presses or drop hammers, cannot be properly evaluated by a vibration meter or vibration meter--spectrum analyzer combination. A cathode-ray oscilloscope can be used to study such waveforms, but measurement is complicated and often cannot be carried out at the site of the vibratory disturbance. The instrument recommended for studying impact or impulse-type waveforms is the impact-noise analyzer. This analyzer operates directly from the output of a vibration meter to measure the peak level and duration of the impact waveform. The sound and vibration analyzer or a magnetic tape recorder can be used as auxiliary equipment.

Through the use of electrical storage systems, three characteristics are measured by the analyzer for each impact; a peak instantaneous level, an average level, and a continuous indication of peak vibration level. (The duration of the impact can be estimated from the difference between peak instantaneous level and average level.) Any one of the three characteristics can be switch-selected for presentation on the meter.

11.5 VIBRATION CALIBRATOR.

The vibration calibrator shown in Figure 11-8 is a small, single-frequency calibrator useful for checking the over-all operation of a vibration-measuring system. The calibrator consists of a resiliently supported cylindrical mass, driven by a small, transistorized, electromechanical oscillator mounted within the cylinder. Small accelerometers may be mounted on either of two disk-shaped platforms attached to the shaker. Large accelerometers may be mounted in place of the disk-shaped platforms. To calibrate an accelerometer, the LEVEL control is adjusted for a meter reading corresponding to the mass added to the moving system of the calibrator. The accelerometer is then being driven at an acceleration of 1 g at 100 cps. The excursion of the calibrator can be adjusted for 1 g acceleration with any pickup weighing up to 300 grams.

*Figure 11-8. Type 1557-A
Vibration Calibrator.*



11.6 STROBOSCOPES.

11.6.1 GENERAL. The stroboscope is valuable in many vibration studies because it permits rotating or reciprocating objects to be viewed intermittently and produces the optical effect of slowing down or stopping motion. For instance, an electric fan revolving at 1800 rpm will apparently stand still if viewed under a light that flashes uniformly 1800 times per minute. At 1799 flashes per minute the fan will appear to revolve at 1 rpm, and at 1801 flashes per minute it will appear to rotate backwards at 1 rpm. Because the eye retains images for an appreciable fraction of a second, no flicker is seen except at very low speeds. The apparent slow motion is an exact replica of the higher-speed motion, so that the motion of the high-speed machine can be analyzed with the stroboscope under normal operating conditions. This type of instrument can be used to measure the speeds where vibrations occur in most rotating or reciprocating machines. Displacements in vibrating parts can often be measured accurately with the aid of a microscope if a fine reference line is scribed on the part. This technique has been used to confirm the calibration of vibration calibrators, and automotive engineers have used it to measure crankshaft whip and vibration.

11.6.2 STROBOTAC[®] ELECTRONIC STROBOSCOPE. The Strobotac[®], shown in Figure 11-9, is a small, portable strob-



Figure 11-9. Type 1531-A Strobotac[®] electronic stroboscope (left), Type 1531-P2 Flash Delay (attached to stroboscope), and Type 1536-A Photoelectric Pickoff.

oscope calibrated to read speed directly in revolutions per minute. The light source is a strobotron tube, mounted in a parabolic reflector. The frequency of an internal electronic pulse generator determines the flashing speed, which can be adjusted by means of a direct-reading dial. Normal flashing range is from 110 to 25,000 rpm. Speeds above and below this range can be measured by use of flashing rates that are simple multiples or submultiples of the speed to be measured. As the flashing rate of the Strobotac[®] is decreased below 600 per minute, the flicker becomes pronounced due to the inability of the human eye to retain successive images long enough to give the illusion of continuous motion.

Of especial use in vibration measurements is the provision for connecting an external synchronizing signal to the Strobotac[®]. Thus the light flashes can be triggered directly by any of several devices. These include two stroboscope accessories, the Type 1535-B Contactor, a mechanical coupling which permits synchronization of the stroboscope with a rotating shaft, and the Type 1536-A Photoelectric Pickoff, which uses a photocell to synchronize the stroboscope with repetitive mechanical motion. A major advantage of the latter is that it requires no attachment to the device being observed, and thus can be used effectively with low-torque devices. The output of the photoelectric pickoff requires amplification to trigger the stroboscope; this is provided by the Type 1531-P2 Flash Delay Unit,

which also permits observation of the vibration at any point in its cycle.

The stroboscope can also be flashed by the output from one of the vibration pickup systems described earlier. For instance, a vibration pickup can be used with a sound-level meter or vibration meter to send triggering impulses to the stroboscope. Filtering is necessary between the measuring instrument and the stroboscope. An octave-band or a narrow-band analyzer can be used to provide such filtering.

11.6.3 STROBOLUME (TYPE 1532-D). The Strobolume is a source of very bright light that is triggered by an external device, such as the Type 1531-A Strobotac® electronic stroboscope or the Type 1535-B Contactor. It is useful where the ambient light level is high or where large areas must be illuminated. The Strobolume produces brilliant white flashes continuously at rates up to 60 per minute or for short periods at rates up to 1200 per minute. It also produces flashes of shorter duration (and of about the same intensity as those produced by the Strobotac) up to 3000 per minute.

11.7 GRAPHIC LEVEL RECORDER.

The graphic level recorder shown in Figure 4-10 produces a permanent chart record of the level of an applied ac signal. For vibration measurements, this signal is usually obtained from the output of a vibration meter, vibration pickup system--sound-level meter combination, or an analyzer.

The graphic level recorder can be used to record the vibration levels of building floors or walls, bridges, airframes,

*Figure 11-10.
Type 1532-D Strobolume.*

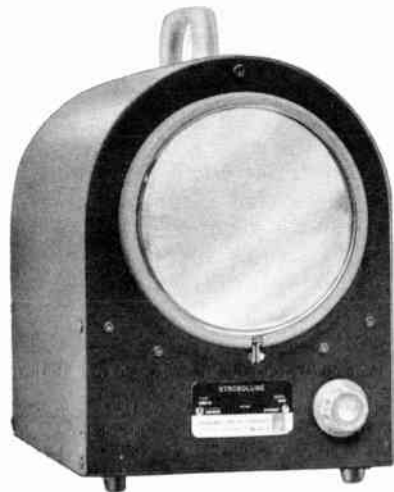

or other structures over periods of time. Levels can also be recorded as a function of frequency, and such recordings are used to show frequency response curves of transducers and other instruments.

Used with a narrow-band analyzer, the recorder can plot the frequency spectrum of a vibrating object (i.e., its displacement, velocity, or acceleration vs frequency). The analyzer-recorder combination can also be used in response measurements of shaker-driven components excited by sine waves or random noise, or of networks excited by white noise. Mechanical linkages and special chart papers reproduce the frequency scale of the analyzer at the recorder.

The recorder can be used with an oscillator to plot frequency characteristics of analyzers, recording systems, networks, filters, equalizers, vibration pickups, and other transducers.

11.8 RANDOM-NOISE GENERATOR.

The random-noise generator shown in Figure 4-11 is a source of high-level, broad-band, electrical noise. This noise can be converted to a random mechanical motion produced by an electromechanical shaker. Random motion is widely used in mechanical reliability testing of components and structures of all types^{3,4} For example, randomly driven vibration shakers are used for structural tests of components and assemblies in rocket- and jet-engine-driven devices and for microphonic tests of vacuum tubes.

11.9 CATHODE-RAY OSCILLOSCOPE

A cathode-ray oscilloscope is a useful means of observing the waveform of a vibration signal from the vibration meter. It can be used to measure the peak amplitude of a wave, and after some experience the observer can, by adjusting the sweep frequency, tell something about frequency components by looking at the waveform. In addition, the oscilloscope makes possible the study of the instantaneous values of a vibratory motion. In contrast with the vibration analyzer and other wave analyzers that present information in terms of frequency, the oscilloscope presents information as a function of time. This time representation is often of great assistance in the solution of vibration problems. Because the oscilloscope presents information instantly and continuously and because its frequency response

³J. Robbins, "Standardized White-Noise Tests," Electronic Industries and Tele-Tech, Vol 16, No. 2, Feb. 1957, pp 68-69.

⁴A. N. Crandall, Editor, Random Vibration, Cambridge, Massachusetts, The Technology Press of MIT, 1958.

is not a limiting factor it is useful in the study of any vibration waveform.

For vibration measurements an oscilloscope with slow sweep rates, long-persistence screen, and dc amplifier is recommended. Many oscilloscopes have provision for the addition of a camera, which makes possible the permanent record of the vibration wave shape being studied.

11.10 MAGNETIC TAPE RECORDER.

The magnetic tape recorder is used in vibration measurements to perform the following functions:

(1) To preserve vibration signals for later analysis and display or for comparison with vibration measurements after adjustments or changes have been made in the equipment or machine being measured.

(2) To store a sample low-frequency vibration signal, which can be played back at higher tape speeds for analysis with conventional audio-frequency analyzers.

(3) To store shock- or impact-type vibration signals for reverse playback to determine peak amplitudes. Conventional meters can then be used to follow the decay slope in reverse even though the response time is much too slow to indicate peak values when the signal is played back in a forward or correct direction.

(4) To record low-frequency vibrations with flat response from dc to 3000 cps by special fm carrier techniques for seismic explorations⁵.

For accurate analyses the recorder selected should have a flat frequency characteristic, low hum and noise levels, low non-linear distortion, wide dynamic range, and constant speed.

11.11 RECORDING GALVANOMETER.

The recording galvanometer is very useful in applications where the vibration to be measured is transient in nature. Also, for steady-state vibrations, the recording galvanometer produces a permanent record of a vibration waveform for future study and analysis. Most of the many models of recording galvanometers can be used at the output of a vibration meter. The fidelity of recording is limited by the characteristics of the galvanometer.

Direct-writing galvanometers may write with ink on paper, with special styli on heat-sensitive or voltage-sensitive paper, or with a pointed stylus on waxed paper. The pen motors usually have relatively low resonant frequencies and require dc amplifiers when used with the vibration meter. Most manu-

⁵Kenneth P. Booth, "Tape Recording for Telemetry and Data Analysis", Tele-Tech, May and June, 1952.

facturers of pen motors also make the corresponding dc amplifiers. Compensation is sometimes added to extend the flat response range of the pen motor. Pen motors with compensating amplifiers are useful from dc up to about 100 cps.

Another type of galvanometer moves a tiny mirror which reflects a light beam onto a photographic paper or film. Here sensitivity and resonant frequency can be increased because the mirror can be tiny with little mass, and the light path from the mirror to the recording surface can easily be made relatively long. Flexibility is increased because galvanometers varying widely in sensitivity and frequency range can be readily interchanged. Many of these galvanometers can be operated from the output of the vibration meter with the use of a resistive pad and no extra amplification. Units with resonant frequency as high as 3000 cps are available. Since the record is produced on a photographic film or paper, and is not always immediately available, this type of recording galvanometer is not as convenient as the direct-writing type. To reduce the time lag between tests and viewing or interpretation of data, several companies manufacture compact photo record processors for paper oscillograms and other rolled-paper photo records. The units require no darkroom for operation and can be used at the testing site without connection to an external source of water. In addition, at least two companies have introduced light-beam-type recorders using a high-intensity light source and specially sensitized paper to produce a trace that becomes visible almost immediately.

11.12 VIBRATION SHAKERS.

As noted in Section 10.1, several types of vibration shakers are widely used. One of the most versatile is the electrodynamic shaker. These shakers, produced in a wide range of sizes, are used by vibration engineers in many ways to help evaluate performance of instruments, components, and structures. Typical uses are: endurance or fatigue testing of electrical and mechanical structures, testing of resilient or shock mounts, shake testing of electrical components such as switches, relays, or amplifiers, determination of damping characteristics of materials, and calibration of vibration pickups.

Some tests use sine-wave motion, with the frequency either set at a resonance of the device under test or swept over a specified band. Random motion is becoming widely accepted in vibration testing, with a random-noise generator (see Section 11.8) used as the signal source, and an adjustable band-pass filter used to shape the noise spectrum.

APPLICATIONS FOR VIBRATION-MEASURING EQUIPMENT

12.1 GENERAL.

All designers of airplanes, ships, and other expensive or elaborate structures, particularly where vibration may be dangerous, carefully calculate the vibratory conditions as a part of the design work. Such calculations generally involve assumptions that cannot always be rigidly justified, and measurements are usually necessary on the completed structure to check the calculations and to make minor readjustments.

With small machinery it is sometimes more economical to build a sample and measure the vibration than to spend too much time on laborious calculations. The vibration meter, therefore, is not a substitute for thorough theoretical analyses, but should be used to supplement and check such analyses. Its use will often simplify the calculations and reduce the number that is necessary.

The vibration meter is also an invaluable tool in checking finished equipment for vibration and, indirectly, for noise. The relation between the vibration pattern and vibration amplitude of a device and the output noise level is exceedingly complicated except in some idealized cases. A few structures approximate some of these idealized cases sufficiently well that the relation between the vibration and the sound level can be predicted with good accuracy. A loudspeaker vibrating at low frequencies is an example. The vibrating elements of machinery often are so complicated in structure and the patterns of vibration are so complex, however, that the relations are generally obscure. Nevertheless, it is sometimes possible to establish experimentally a sufficiently good correlation between the noise output and the vibration at some points on a machine so that the vibration level can be used as a guide in noise-rating the individual units on a production run of the machine. These tests can then be carried on under unfavorable conditions of ambient noise level.

Engineers have often approached vibration problems, sometimes satisfactorily, by "cut and try" or intuitive experiments. This procedure is not necessary or generally recommended and is often completely unsuccessful. Suitable vibration measuring equipment and techniques should be used to analyze and evaluate vibration problems. The analysis usually will provide the information necessary to solve the problem.

The vibration meter has been a very useful tool for many

research and development engineers faced with vibration problems.¹ Noise levels from fans and large room air circulators have been reduced to acceptable levels by use of information gained by vibration measurements on fan blades and circulator housings. Similar techniques have been used in the development of room air-conditioners. Ball-bearing manufacturers use the vibration meter to test assembled ball bearings as they come off the production line. If a unit is defective, analysis of waveforms will indicate corrective measures to be taken at the high-speed automatic machines shaping or forming the part.

The vibration meter is widely used in the testing and evaluation of resilient vibration mountings. A manufacturer of rubber products uses a vibration meter and a vibration analyzer to measure shock-absorbing qualities of its products. For example, the equipment is used to measure the amount of vibration absorbed by their automobile tire¹ and to measure the shock-absorbing qualities of special power transmission belts or power take-off wheels.

The engineering department of a company manufacturing Diesel engines uses a vibration meter and a vibration analyzer to measure, in the field, the torsional vibration characteristics of marine and stationary engine installations.² In these installations it is essential that no criticals (excessive torsional vibrations) occur within the operating range.

Stroboscopic techniques are widely used for visual observation of vibration. The high-speed performance of fans, propellers, and other rotating devices can be studied by means of the slow-motion effect of the stroboscope, and sources of vibration and noise due to misadjustments, misalignment, and wear can be readily detected. The vibratory modes of turbine blades are checked as they are driven electromagnetically, and the mode shapes are observed with the aid of an optical magnifier under stroboscopic illumination. Similarly, the flapping of the blades of a model helicopter rotor has been observed in slow motion by stroboscopic illumination.

The stroboscope can also be used to observe the motion of apparatus being tested on a shaker. If the flashing rate is just slightly offset from the frequency of the shaker, a slow-motion replica of the high-speed vibration will result, so that the displacement can readily be observed. The form of the motion can be seen, and one can often tell what section needs

¹"Bumps Take a Beating," Research in Action section of Gates Employees Progress News, August, 1953, p. 9, The Gates Rubber Company Denver, Colorado.

²White, Trescott S., "Taking the Mystery Out of Torsional Vibration", Bulletin No. Em-B7, Enterprise Engine and Machine Company, 18th and Florida Streets, San Francisco 10, California.

to be strengthened and how damping material and damping devices can best be applied.

When a rotating or reciprocating machine is brought up to speed or is a variable speed device, there may be resonant vibration modes of various parts at certain speeds, known as critical speeds. If these parts are visible and can be illuminated by a stroboscope, it is often possible to use the slow-motion feature to check on the actual behavior of the part at resonance. One can see if it is a fundamental resonance or a multiple resonance with various sections going in phase and others in phase opposition. This type of observation can be of great assistance in the determination of the proper treatment to reduce the resonant vibration.

The examples listed above illustrate the wide range of activities in which vibration measuring equipment has proved useful. Although the list is by no means complete, these examples indicate the versatility of the measuring instruments.

12.2 EXAMPLES OF TYPICAL VIBRATION MEASUREMENTS.

12.2.1 VIBRATION MEASUREMENTS ON A MAGNETIC TAPE RECORDER. Measurements of the flutter (variations in tape speed) of a tape recorder showed strong components at 15, 30, and 75 cps and other minor components. Although it was expected that eccentricities in the drive produced some of this flutter, a check on the effects of vibration was made.

A vibration pickup was mounted on the tape deck and connected to a vibration meter and third-octave analyzer. The analyzed vibration showed strong components at 30 and 75 cps, but very little at 15 cps. The 30-cycle component corresponded to the motor speed. Although the motor and attached flywheel had been balanced before being mounted, the vibration was easily reduced by rebalancing of these in place. After balancing, the flutter component at 30 cps was negligible, and the 75-cps component was markedly reduced also.

The 15-cycle component corresponded to the capstan speed, and it was the largest remaining component. The fact that there was no appreciable vibration at this frequency seemed surprising at first. The flutter could be reduced significantly by the placing of eccentric weights on the capstan flywheel; but then the vibration of the tape deck increased markedly at 15 cps. Obviously, this flutter component was caused by eccentricity in the capstan, and the vibration introduced was canceling the effects of eccentricity.

Measurements at the capstan bearing showed that the vibration at 75 cps was a maximum there. What was happening here, apparently, was that the capstan flywheel and shaft structure had a vibration resonance at 75 cps that was excited either by the fifth harmonic of the capstan rotation frequency or, more

likely, by a combination of a multiple of the motor rotation frequency and the capstan rotation frequency. Because of the resonance, very little energy was required to produce a significant vibration. This mode could be reduced significantly by a change in the resonant frequency, but the balancing of the motor and flywheel had already reduced it so that the 15-cycle component was the only significant one remaining.

12.2.2 DIRECT-WRITING RECORDER USED WITH VIBRATION METER IN VIBRATION ANALYSIS. As mentioned in Section 11.10, the recording galvanometer is widely used in vibration measurement and analysis. Photographs of four records taken with a popular recording galvanometer are shown in Figures 12-1 through 12-3. These records are only a few of many taken during the course of a vibration study made in a large industrial plant. The instrumentation used for this vibration study was General Radio vibration meter, a Brush³ Model BL-201 single-channel oscilloscope, and a Brush Model BL-905 amplifier.

For all measurements the vibration meter was set to read displacement and the attenuator was set for a full-scale reading of .003 inch rms. The Brush Amplifier settings were: voltage calibration control, 5; attenuator, 1; and gain adjusted to give 1mm/volt deflection on the recorder at 60 cps. With the amplifier connected to the output of the vibration meter and the vibration pickup placed on a shaker, the following over-all calibration was obtained:

<u>Reading of Vibration Meter - rms inch</u>	<u>Deflection of Recorder mm either side of center</u>
0.001	3
0.002	6
0.003	9

The four records reproduced here were taken in one location. The vibration pickup was placed on the floor of a room housing a number of high-speed metal-forming presses. Figures 12-1 and 12-2 are records made with all presses running while Figures 12-3a and 12-3b are records made with all the presses stopped.

The two records shown in Figures 12-1 and 12-2 are for the same vibration, but different information can be derived from each. We can see quite clearly that it was a distinct advantage to have the different chart speeds, 5 and 125 mm/sec, available. From the two records we can make a reasonably complete analysis of the complex vibration waveform, while

³Brush Electronics Company, Cleveland, Ohio.

$$16\text{ mm} \\ = 3.2 \text{ sec} \quad f = \frac{1}{3.2} = 0.313 \text{ cps or } 18.8 \text{ rpm}$$

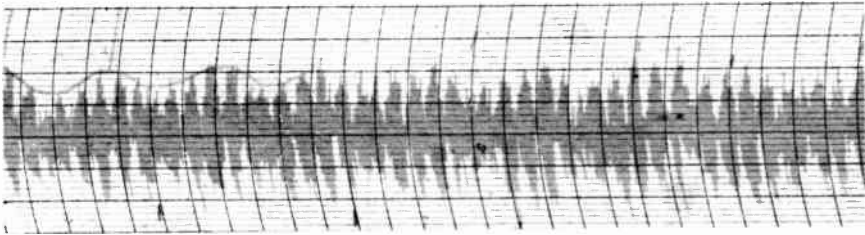

Figure 12-1. Record of vibration displacement on pressroom floor (all presses running) made with a direct-writing recorder. Chart speed was 5mm/sec (see text).

$$\begin{aligned} & \leftarrow 125 \text{ mm} = 1 \text{ sec} \quad f = 14 \text{ cps or } 840 \text{ rpm} \longrightarrow \\ & \leftarrow 0.64 \text{ sec} \quad f = 1.57 \text{ cps or } 94 \text{ rpm} \leftarrow \end{aligned}$$

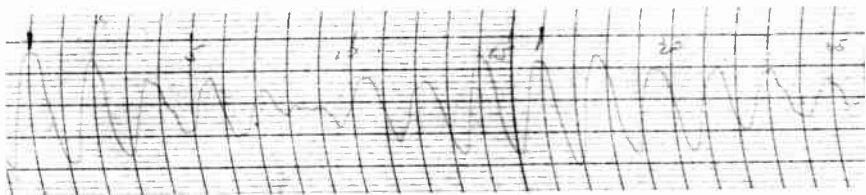

Figure 12-2. Record taken under same conditions as Figure 12-1 except with chart speed of 125 mm/sec.

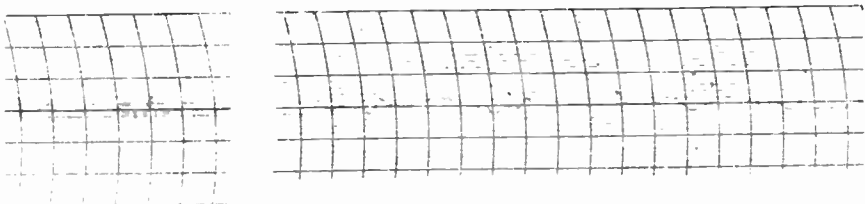

Figure 12-3a (Left) and 12-3b (Right). Residual vibration recorded on pressroom floor with all presses stopped - chart speeds 5 and 125 millimeters per second, respectively.

Records reproduced by courtesy of United Carr Fastener.

neither record by itself can tell us the whole story. From Figure 12-1 we can determine that the vibration waveform looks like a carrier frequency modulated by two lower frequencies. The lower frequency is readily computed as 0.313 cps or 18.8 rpm. The other modulating frequency is five times the lower frequency, making 1.57 cps or 94 rpm. The frequency of the carrier cannot be determined from Figure 12-1. Figure 12-2, which is stretched out by a factor of 25, yields the carrier frequency at 14 cps or 840 rpm and verifies the higher modulating frequency as being 1.51 cps. The lower modulating frequency is not recognized in Figure 12-2.

Figures 12-3a and 12-3b show the residual vibration of the factory floor after all of the presses had been shut down. Figures 12-3a and 12-3b should be compared respectively with Figures 12-1 and 12-2. The vibration amplitude is now well below .001 inch and no periodic modulating frequency is easily recognized. The record in Figure 12-3b indicates that the residual vibration is not sinusoidal and is 60 cps (3600 rpm) or higher.

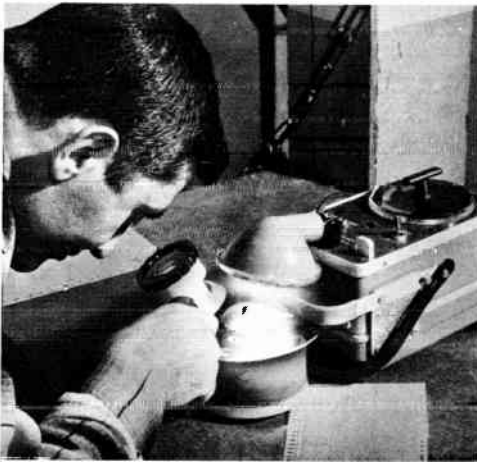
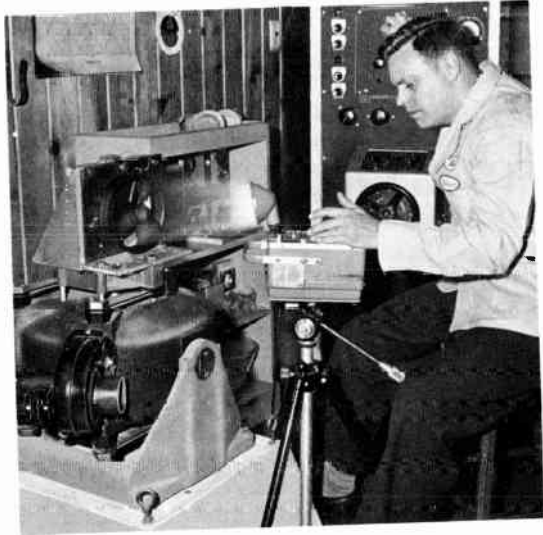

Figure 12-4. Acoustic Research, Inc. studies acoustic-radiator diaphragms with the Type 1531-A Strobotac® electronic stroboscope. A band of fine flock fiber is applied to the radiator's surface. Under stroboscopic light, nodal points and radiator break-up zones are pinpointed by the degree of fiber vibration along the band of flock. Former methods limited measurements to 1 kc. The high intensity, short-duration flash of this new stroboscope extends these measurements to 20 kc.

Figure 12-5. At Rotron Manufacturing Company, the Strobotac[®] electronic stroboscope serves as the principal instrument for analyzing structural weaknesses of air-moving devices. Fan-blade resonances of developmental models are observed under stroboscopic light while the units are subjected to shake-table vibration. Clearance between fan and housing is also noted to ensure that no interference is present.



VIBRATION MEASUREMENT TECHNIQUES

13.1 INTRODUCTION.

The reason for measuring vibration usually determines both the quantity to be measured and the point or points at which the vibration pickup should be placed. Sometimes, however, the correct pickup location is not obvious, and some exploration of the vibration pattern of the device being studied is necessary. Furthermore, the pickup must be correctly oriented, and this too sometimes requires exploration.

Fastening a pickup to a device is usually simple if the device is much larger than the pickup and if the important vibration frequencies are below 1000 cps. Otherwise, difficulties may arise because of the mechanical problem of fastening the pickup at the desired point, because the pickup seriously affects the motion to be measured, or because the method of attachment affects the performance of the pickup.

13.2 ORIENTATION OF PICKUP.

The piezoelectric accelerometers used in General Radio vibration-measuring instruments are most sensitive to vibrations in the direction perpendicular to the largest flat surface on the pickup. This direction is the one for which the rated sensitivity applies. The sensitivity in other directions varies approximately as the cosine of the angle with respect to this rated direction, with a minimum of about 5 percent or less of rated sensitivity when vibrated in a direction perpendicular to the rated one.

For accurate results, the pickup must be properly oriented with respect to the direction of motion. In practice, this orientation is usually not critical, however, because sensitivity changes slowly with direction, there being a drop of only about 2 percent for a 10-degree change in orientation.

The direction of maximum vibration at a point is often obvious from the structure that is vibrating. That is, it is usually in the direction of least stiffness. But this rule is sometimes misleading, because of the many possible resonant modes of vibration, some of which are perpendicular to the obvious direction of least stiffness. Such a mode can be strongly excited if close to the frequency of a component of the driving force. Furthermore, the nature of the motion may favor one mode of vibration rather than another.

When it is important to be certain of the direction of motion, one can measure the motion along three mutually perpendicular axes. Often one can select these so that only one of these components of motion is significant, and that will determine the choice of direction. Otherwise, they must be combined vectorially to yield a resultant total; then one needs to know the relative phase of the components. To determine phase, sums and differences can be measured with two pickups, as explained later, or another set of three measurements can be made along mutually perpendicular axes that are rotated from the first set. With two sets of measurements, one can sort out the possible combinations and calculate the direction of the total motion. Often it is simple to obtain the direction of the maximum motion by experiment.

Except for simple harmonic motions, this resultant direction is of significance only as a function of frequency. Then an analyzer is essential so that one can determine the motion for the individual components.

When one attempts to measure vibration in a direction that is not the direction of the total vibration at the point of measurement, the orientation is more critical, because the vibration in the other directions will provide some signal in the output. It is often impractical to measure a directional component that is less than 5 percent of the total vibration at a point.

The above procedure does not lead to a measurement of the rotational vibration about a point. This type of measurement can be made with a torsional vibration pickup or by the technique discussed in paragraph 13.7.

13.3 HAND-HELD PICKUP.

When one must explore a vibration pattern or make a quick check of the vibration amplitude, one is tempted to hold the pickup to the device being measured by hand. If the device is massive and is vibrating with a significant amplitude, this technique can be useful for frequencies below about 1000 cps. There are enough serious limitations to this technique, however, so that it should not generally be expected to yield accurate or highly reproducible results.

When the pickup is held by hand, a test probe, a pointed metal rod, is fastened to the pickup to facilitate applying the probe to the desired point. The motion is transmitted along the rod to the pickup, and the motion in the direction of the rod actuates the pickup.

Because the test probe adds another element to the pickup, the response is different from that of the pickup alone. Typical relative frequency response characteristics are shown for two types of probe in Figures 13-1 and 13-2. More than one response run is shown to indicate the variability that can occur. Note resonance in the range from 1400 to 2000 cps introduced by the long (6 3/8-inch) probe and the one above 2000 cps for

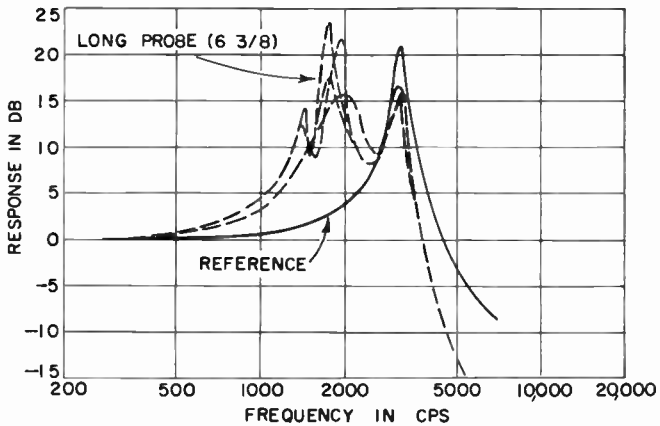

Figure 13-1. Frequency response of vibration pickup mounted on hand-held long (6 3/8-inch) probe. Several sample responses are shown.

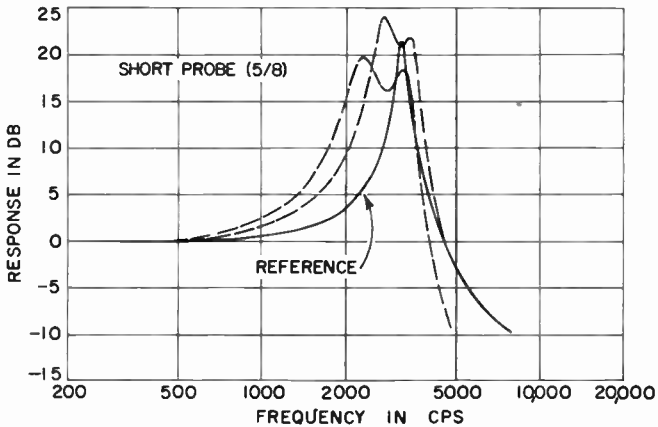

Figure 13-2. Frequency response of vibration pickup mounted on hand-held short (5/8-inch) probe. Several sample responses are shown.

the probe with the short conical tip.

Unless the device being tested is massive, the force, mass, resilience, and damping introduced by the hand may seriously alter the motion, and another method of applying the pickup should be tried.

Some vibration is applied to the pickup by tremor of the hand. This vibration is made up chiefly of components below 20 cps, and the peak-to-peak order of magnitude is 5 in./sec² acceleration, 0.2 in./sec velocity, and 10 mils displacement,

when the pickup is held against a relatively stationary surface. These values will be appreciably attenuated by a low-frequency cutoff at 20 cps, such as is obtained on the "DISP-20 CUTOFF" position of the vibration meter. Then the observed peak-to-peak displacement is of the order of 0.2 mil.

This tremor sets a lower limit to the vibration that can be observed when the pickup is hand-held against the vibrating device. One should not attempt to use a hand-held pickup down to the levels quoted above unless some filtering is introduced to reduce the low-frequency response.

13.4 PICKUP FASTENING METHODS.

Pickups are fastened to a vibrating surface by many different methods. For greatest accuracy the fastening should be as direct and as rigid as possible. But if the acceleration is less than gravity, if only a temporary fastening is desired, and if only low frequencies are present, simple fastenings are adequate. These may be plasticene or double-sided adhesive tape placed between the base of the pickup and a flat surface at the point desired. If the surface is horizontal, flat, and smooth, the pickup may be wrung to the surface with a thin film of petroleum jelly. Another simple technique, useful on magnetic materials, is to fasten a magnet to the pickup and then attach the magnet to the surface to be measured.

At high accelerations, these simple fastenings are not satisfactory, and a stud or bolt must be used to hold the pickup directly against the surface being measured.

The performance of some pickups is affected by any attachment to the pickup body other than to the reference surface, so that a pickup should not be attached by clamps to the body of the pickup.

When the pickup is to be permanently installed, the use of an adhesive, such as a dental cement, Eastman 910, or an epoxy cement, is often advisable. For best results, one should be careful to use only a thin layer, so that the elastic characteristics of the bonding cement will not affect the behavior of the pickup.

The fastening should be rigid, so that the pickup does not move significantly with respect to the surface to which it is fastened. Any rocking motion or looseness that might lead to chattering should be prevented. If the fastening alone is not adequate to prevent this looseness, the use of some plasticene in addition may be helpful. When fastening, even by bolts, the use of a lubricant or petroleum jelly is advisable to ensure close contact between the pickup and the fastening surface without putting undue strain on the pickup.

When the surface is not smooth or flat, the pickup is sometimes mounted on a bracket. For low vibration frequencies (below a few hundred cps), the bracket can readily be made

stiff enough so that it does not seriously affect the behavior of the pickup.

The pickup is calibrated in terms of the motion of the flat contacting surface of the pickup. Because of the resilience of the fastener and the mass of the pickup, this surface of the pickup will not move exactly as the surface being measured moves. At low frequencies this difference is easily made insignificant by the relatively simple techniques discussed. But at high frequencies care must be used in fastening to keep this effect small.

The mass of the Type 1560-P52 Vibration Pickup is sufficiently small that simple temporary fastenings are adequate even to frequencies beyond the normal resonance at about 3200 cps. This fact is illustrated by the response-vs-frequency characteristics shown in Figures 13-3 and 13-4. In each instance the pickup was driven at a constant acceleration. The reference condition is the response for the vibration pickup wrung to the smooth, flat surface of the driver with petroleum-jelly lubricant. The acceleration was 0.002 g.

The effect of fastening by means of double-sided tape was generally less than 10-percent deviation from the reference condition at all frequencies up to the resonance at 3200 cps. In some instances the deviation over the range to 3200 cps was only about 2 percent. The variability was probably a result of changes in contact adhesion obtained with different samples of the tape.

Plasticene as a fastening means, even as thick as 1/16 inch, showed very good reproduction of the reference performance, being within 2 to 5 percent up to 4000 cps. In one instance a marked departure from the reference performance was found even at 500 cps, and this was quickly traced to the fact that the

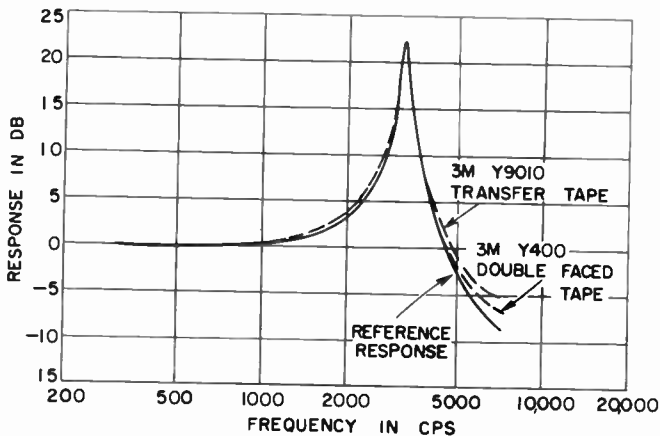

Figure 13-3. Frequency response of vibration pickup attached by means of Minnesota Mining Types Y9010 and Y400 tapes.

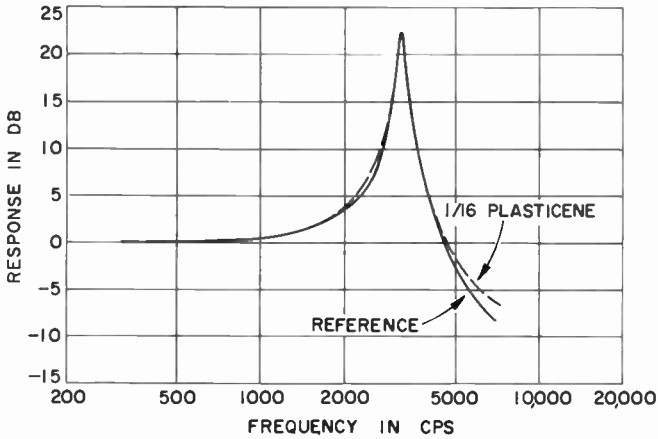

Figure 13-4. Frequency response of vibration pickup attached by means of 1/16-inch-thick layer of plasticene.

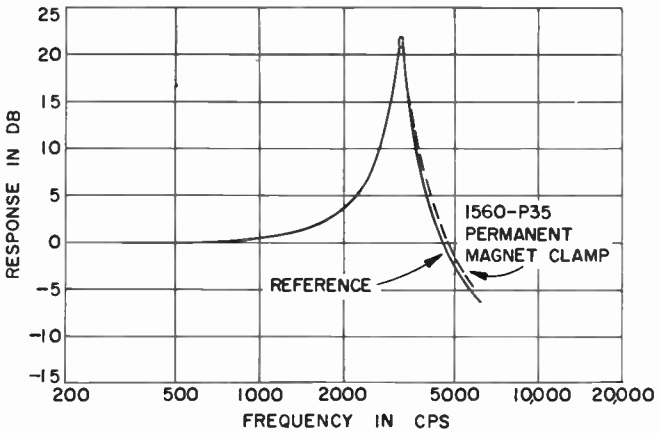

Figure 13-5. Frequency response of vibration pickup attached by Type 1560-P35 Permanent-Magnet Clamp.

pickup had come loose from the plasticene. This example illustrates the importance of careful inspection of the fastening during a test, particularly when one cannot check the performance independently.

The response of the pickup when held to a smooth, flat, steel plate by means of the Type 1560-P35 Permanent Magnet Clamp is shown in Figure 13-5. Up to 5 kc, the response is very similar to the reference response. One should fasten the pickup carefully to the magnet so that no rocking motion is possible, and the magnet itself should be placed on a smooth surface so that it, too, will not rock.

13.5 EFFECT OF THE PICKUP ON THE VIBRATION.

The mass added by the pickup to the vibrating surface being measured changes the motion of that surface. If the added mass is much smaller than that of the vibrating surface or is closely coupled to it, the effect is small except near resonant modes. Thus, it is important to have a lightweight pickup.

One can often judge the effect of adding the mass of a pickup by noting the difference in behavior with the pickup fastened and with another mass equal to that of the pickup in addition to the pickup. If the difference is negligible for these two conditions, the effect of the pickup is usually unimportant. Under certain conditions near the resonant vibration frequency of the device under test, even a small mass can shift the resonance enough to affect the motion at the original resonant frequency by a large amount.

When it is possible to change the excitation rate or frequency so that resonance with the pickup in place is re-established, the behavior at the new resonant point will often be sufficiently similar to the resonance behavior without the pickup that the resonant condition can be satisfactorily measured.

When stroboscopic observation of the motion is possible, the effect of the mass of a pickup on the motion can often be judged by direct observation of the behavior with and without the pickup present.

13.6 CALIBRATION.

In order to ensure that one can make satisfactory vibration measurements, the instruments used must be kept in proper operating condition. The vibration meter itself can be checked electrically very simply by the built-in calibration system, and the instrument should be checked at the start of a test, after the instrument has been on and allowed to stabilize for a few minutes.

The vibration calibrator should also be used regularly to check the complete measurement system. If the acceleration produced by the calibrator reads between 340 and 430 rms (or 950 to 1220, peak-to-peak) inches/sec² on an electrically calibrated vibration meter, there is reasonable assurance that the pickup and the meter are operating correctly. If the agreement is not satisfactory, one should first check that the correct pickup for the vibration meter is being used, and that the internal reference dial in the meter is set to the correct pickup sensitivity. If these are all checked and agreement is still unsatisfactory, another pickup should be tried (with the internal reference dial set to its nominal sensitivity). The next step would be to have the pickup and the calibrator checked at the General Radio Company.

Vibration pickups are rugged and stable, but they can be damaged. Although a damaged pickup will ordinarily be de-

tected by the check at 100 cps provided by the vibration calibrator, it is possible, but most unusual, for the sensitivity at other frequencies far from 100 cps to be affected when that at 100 cps is not. Therefore, the frequency response of pickups should be verified periodically by calibration at the National Bureau of Standards or at the General Radio Company.

13.7 A SIMPLE TWO-PICKUP METHOD FOR DETERMINING THE ROTATIONAL VIBRATION OF ROTATING MACHINERY.¹

When analysis of rotational vibration must be made on an existing installation and a torsional pickup cannot readily be used, the following technique may be useful. Two vibration pickups and a summing network are required in addition to the vibration meter. One must assume that the engine behaves like a rigid mass and that its center of gravity is equidistant from all four mounting posts.

A simple summing circuit is shown in Figure 13-6. The voltages e_1 and e_2 represent the output signals of two vibration pickups, and the voltage e_o represents the signal fed into the input of the vibration meter. If the three resistors R are equal, e_o will be $1/3 (e_1 + e_2)$. A practical arrangement of this circuit is shown in Figure 13-7. Only two resistors are shown, since the third resistor is in the input circuit of the vibration meter. One pickup is connected to input No. 1 and the other pickup is connected to input No. 2. The output of the summing circuit is connected to the input of the vibration meter. When switch S-1 is at position 1, one third of the output of pickup No. 1 is applied to the input of the vibration meter. When S-1 is set at position 2, one third of the output of pickup No. 2 is applied to the input of the vibration meter. When S-1 is at position 3, one third of the sum of the outputs from the two pickups is applied to the input of the vibration meter.

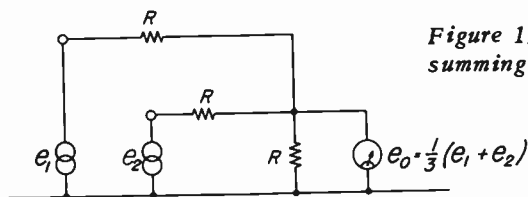

Figure 13-6. A simple resistive summing circuit.

¹This method was suggested by Mr. George Kamperman of Bolt, Beranek and Newman, Inc., Cambridge, Mass. He has used this technique on numerous occasions with gratifying results.

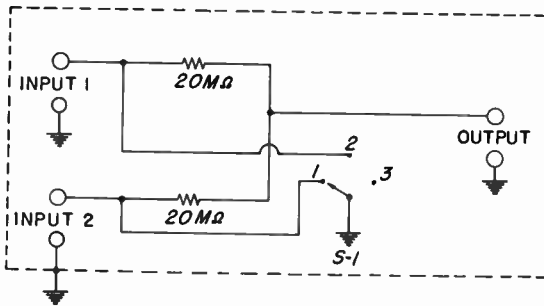

Figure 13-7. A convenient arrangement of the summing circuits of Figure 13-6.

Example:

The top view of a typical engine and its mounting is outlined in Figure 13-8. A and B represent the forward engine mounts while C and D represent the rear engine mounts. With the two pickups (oriented for vertical-displacement measurement) mounted on the two forward engine mounting brackets, the translational or vertical amplitude is indicated on the vibration meter when the output signals of the two pickups are summed. The rotational mode of vibration is canceled out. When the outputs of the two pickups are summed 180° out of phase or subtracted, the rotational amplitude of vibration is indicated on the vibration meter and the translational mode of vibration is canceled out. The pickup can be mounted upside down to shift the output 180° to perform the subtraction of outputs, or, the pickup can be left in its normal mounting position and the 180° shift in the phase of its output can be achieved with an electronic phase inverter. By making the set of measurements outlined above on all pairs of mounting brackets (A,B-C,D-B,C) the amplitude of any rotational or rocking motion about the axes a-a' or b-b' can easily be sorted out from the direct vertical or translational motion of the engine.

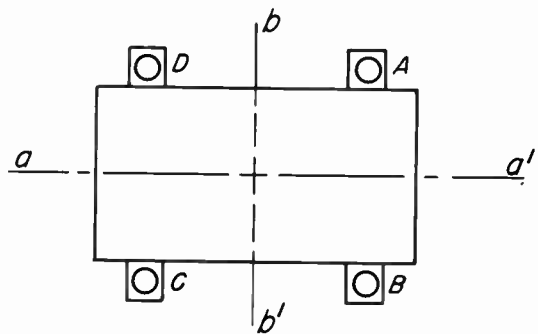

Figure 13-8. Outline of engine and mounting (top view).

EFFECTS OF MECHANICAL VIBRATION

14.1 GENERAL.

Vibration, like sound, may be used to man's advantage or disadvantage. Without vibration there could be no speech or music. Vibration is used as a tool in chemical and biological processes and in ultrasonic cleaning and machinery. Vibration, on the other hand, can produce fatigue and structural damage in both people and materials and can shorten machine life, spoil machine operations, limit the accuracy of some measurements, and produce noise.

Dealing effectively with vibration requires thorough knowledge of vibration characteristics, effects, criteria, and measurement. The characteristics and effects of vibration have been studied extensively, and some preliminary criteria have been established, but much more remains to be done.

14.2 EFFECTS OF VIBRATION ON MAN.

The published work on the effects of vibration on man has recently been reviewed comprehensively by D. E. Goldman and H. E. von Gierke.¹ This excellent review, which covers the injurious levels of vibration as well as subjective aspects, is recommended to those concerned with these problems. The subjective response is important to those concerned with passenger or operator comfort in automobiles, planes, boats, trains, and other vehicles. Vibration levels that are structurally safe for a vehicle are often uncomfortable, annoying, or even dangerous for the occupant. In military vehicles it may not be very important that the occupant be comfortable, but it is certainly important that excessive vibration does not cause fatigue and reduce sharply the efficiency of personnel. The U. S. Naval Medical Center at Bethesda, Maryland, has built a large displacement-amplitude vibration machine, designed for a maximum load of 200 lb at any combination of displacement (0 to 4 inches) and frequencies (2 to 50 cps) not exceeding 15 g peak acceleration. (In the words of one reporter, "the engineering principle involved likens this project to a number

¹D. E. Goldman and H. E. von Gierke, "Effects of Shock and Vibration on Man," Chapter 44, Shock and Vibration Handbook, edited by C. M. Harris and C. E. Crede, McGraw-Hill, New York, 1961.

of units currently being operated in New York City. In New York they call them subways.")

There are no curves that present the human responses to vibration as completely as do the Robinson-Dadson curves for human responses to simple tones of sound. Goldman² has surveyed and correlated the data of a large number of investigators. From these data he derived the three solid curves I, II, and III shown in Figure 14-1, which represent the threshold of perception, the threshold of discomfort, and the threshold of tolerance or the level of intensity at which the subject for any reason was unwilling to tolerate the stimulus further. All workers did not make their measurements over the same frequency range or over the same intensity range. Also, each worker used his own apparatus and his own method of exposing his subjects. In many cases duration of exposure was not clear. The data were grouped without reference to the direction of the vibration, since examination of the data showed that differences due to the direction of application of the vibration were smaller than differences due to statistical variations. Each point on the curves is the average of from four to nine values based on measurements reported by the various workers. The subject was standing, sitting, or lying on a support that was vibrated vertically or horizontally.

In addition to the Goldman curves McFarland³ shows curves prepared by Lippert⁴ covering the frequency range of 1 to 200 cps and curves prepared by McFarland⁵ covering the frequency range of 10 to 70 cps. The three sets of curves are shown in the same chart and agree within reasonable tolerances.

Using only data collected by Meister⁶ and Reiher and

²Goldman, D. E., A Review of Subjective Responses to Vibratory Motion of the Human Body in the Frequency Range 1 to 70 Cycles per Second, Report No. 1, Project NM 004001, Naval Medical Research Institute, March 16, 1948. (See also footnote¹)

³McFarland, Ross A., "Human Body Size and Capabilities in the Design and Operation of Vehicular Equipment," Harvard School of Public Health.

⁴Lippert, S., "Human Response to Vertical Vibration," read at S. A. E. National Aeronautical Meeting, October, 1946.

⁵McFarland, Ross A., "Human Factors in Air Transportation," Occupational Health and Safety, New York, McGraw-Hill Book Co.

⁶Meister, F. J., "Sensitivity of Human Beings to Vibration," Forschung (V.D.I. Berlin), May-June, 1935.

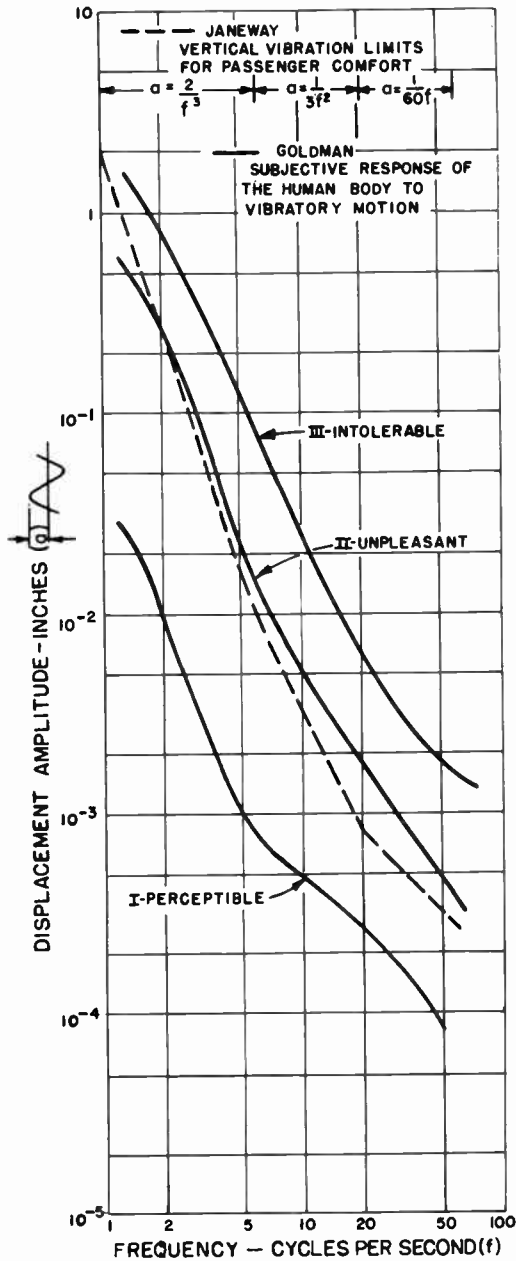

Figure 14-1. Subjective response of the human body to vibratory motion as a function of frequency.

Meister⁷, Janeway⁸ has prepared a chart giving recommended limits of vertical vibration for passenger comfort in automobiles. The data he used also made up a good part of the data used by Goldman, but Janeway limited his analysis to data obtained for vertical sinusoidal vibration at a single frequency, with subjects standing or sitting on a hard seat. As shown in the dotted curve of Figure 14-1, the recommended characteristic consists of three simple relations, each of which covers a portion of the frequency range. In the low-frequency range from 1 to 6 cps the recommended limit is a function of jerk. Mathematically the rule is written $af^3=2$; that is, the maximum comfortable displacement (a) at any frequency between 1 and 6 cps is 2 divided by the frequency cubed (f^3). Over the frequency range from 6 to 20 cps the recommended limit is a function of the acceleration to which the passenger is subjected. This rule is written $af^2=1/3$. From 20 to 60 cps the recommended limit is a function of velocity, and the rule is written $af=1/60$.

Little work has been done on the effects of nonsinusoidal vibration, except for sudden acceleration and deceleration, such as occur in accidents and space travel. Apparently no technique has been evolved for predicting the effects of broad-band or multicomponent vibration (such as has been developed for loudness). In short, this remains an important area of research for further investigation.

14.3 OTHER EFFECTS.

Many of the useful effects of vibration in chemical, biological, and physical processes are discussed by Hueter and Bolt⁹, Crawford¹⁰, and Bergman¹¹. The effects of machine-tool vibration have been reviewed by S. A. Tobias¹², and metallic fatigue has been covered by Harris¹³. Many of the effects of vibration are discussed briefly in books and trade journals for the particular specialty in which the effect occurs. The recent handbook edited by Harris and Crede¹² is, however, remarkably comprehensive in its coverage of the many problems areas of shock and vibration.

⁷Reiher, H. and Meister, F. J., "Sensitivity of Human Beings to Vibration," Forschung (V.D.I. Berlin), February, 1931.

⁸Janeway, R. N., "Vertical Vibration Limits for Passenger Comfort" in Ride and Vibration Data, a set of reference charts. Society of Automotive Engineers, Inc., Special Publications Department (SP-6).

⁹T. F. Hueter and R. H. Bolt, Sonics, John Wiley; New York, 1955.

- ¹⁰A. E. Crawford, Ultrasonic Engineering, Academic Press, New York, 1955.
- ¹¹L. Bergman, Der Ultraschall, S. Hirzel Verlag, Stuttgart, 1954 (Sixth Edition).
- ¹²C. M. Harris and C. E. Crede, Op Cit, Chapter 40.
- ¹³W. J. Harris, Metallic Fatigue, Pergamon Press, New York, 1961.

APPENDIXES

	<u>Page</u>
I Decibel Conversion Tables	175
II Chart for Combining or Subtracting Decibels. .	184,5
III Table for Converting Loudness to Loudness Level.	186
IV Vibration Conversion Charts	187-196
V Effects of Atmospheric Pressure	197,8
VI Interpretation of the Behavior of the Pointer of a Noise-Measuring Instrument	199-204
VII Definitions	205-216
VIII Words Commonly Used to Describe Sounds . . .	217
IX References	218-224
X Catalog Section	225-242

DECIBEL CONVERSION TABLES

It is convenient in measurements and calculations to express the ratio between any two amounts of electric or acoustic power in units on a logarithmic scale. The decibel (1/10th of the bel) on the briggsian or base-10 scale is in almost universal use for this purpose.

Table I and Table II on the following pages have been prepared to facilitate making conversions in either direction between the number of decibels and the corresponding power and pressure ratios. Decibel — The number of decibels N_{db} corresponding to the ratio between two amounts of power W_1 and W_2 is

$$N_{db} = 10 \log_{10} \frac{W_1}{W_2} \quad (1)$$

When two pressures P_1 and P_2 operate in the same or equal impedances,

$$N_{db} = 20 \log_{10} \frac{P_1}{P_2} \quad (2)$$

TO FIND VALUES OUTSIDE THE RANGE OF CONVERSION TABLES

Values outside the range of either Table I or Table II on the following pages can be readily found with the help of the following simple rules:

TABLE I: DECIBELS TO PRESSURE AND POWER RATIOS

Number of decibels positive (+): Subtract +20 decibels successively from the given number of decibels until the remainder falls within range of Table I. To find the pressure ratio, multiply the corresponding value from the right-hand voltage-ratio column by 10 for each time you subtracted 20 db. To find the power ratio, multiply the corresponding value from the right-hand power-ratio column by 100 for each time you subtracted 20 db.

Example — Given: 49.2 db
 $49.2 \text{ db} - 20 \text{ db} - 20 \text{ db} = 9.2 \text{ db}$
 Pressure ratio: 9.2 db →
 $2.884 \times 10 \times 10 = 288.4$
 Power ratio: 9.2 db →
 $8.318 \times 100 \times 100 = 83180$

Number of decibels negative (-): Add +20 decibels successively to the given number of decibels until the sum falls within the range of Table I. For the pressure ratio, divide the value from the left-hand pressure-ratio column by 10 for each time you added 20 db. For the power ratio, divide the value from the left-hand power-ratio column by 100 for each time you added 20 db.

Example — Given: -49.2 db
 $-49.2 \text{ db} + 20 \text{ db} + 20 \text{ db} = -9.2 \text{ db}$
 Pressure ratio: -9.2 db →
 $.3467 \times 1/10 \times 1/10 = .003467$
 Power ratio: -9.2 db →
 $.1202 \times 1/100 \times 1/100 = .00001202$

TABLE II: PRESSURE RATIOS TO DECIBELS

For ratios smaller than those in table — Multiply the given ratio by 10 successively until the product can be found in the table. From the number of decibels thus found, subtract +20 decibels for each time you multiplied by 10.

Example — Given: Pressure ratio = .0131
 $.0131 \times 10 \times 10 = 1.31$
 From Table II, 1.31 →
 $2.34 \text{ db} - 20 \text{ db} - 20 \text{ db} = -37.66 \text{ db}$

For ratios greater than those in table -- Divide the given ratio by 10 successively until the remainder can be found in the table. To the number of decibels thus found, add +20 db for each time you divided by 10.

Example — Given: Pressure ratio = 712
 $712 \times 1/10 \times 1/10 = 7.12$
 From Table II, 7.12 →
 $17.05 \text{ db} + 20 \text{ db} + 20 \text{ db} = 57.05 \text{ db}$

USE OF DECIBEL TABLES TO CONVERT VIBRATION READINGS

These decibel tables offer a convenient means of converting decibel vibration readings obtained with the sound-level meter and vibration pickup into displacement in inches, velocity in

inches per second, and acceleration in inches per second per second.

Each control box nameplate is inscribed with a conversion table, which applies when that control box is used with the pickup and sound-level meter indicated on the nameplate. The conversion figures appearing on the nameplate of the Type 1560-P21B Control Box are:

Displacement	120 db = 1 in. rms
Velocity	90 db = 1 in. per second
Acceleration	50 db = 1 in. per second per second rms

N.B. For Types 759-P36 and 1560-P21 Control Boxes, the conversion figures are different from the above. When these control boxes are used, substitute values given on the nameplate for those used below to obtain correct conversion.

NOTE: In Tables I and II, the term "pressure ratio" is equivalent to the term "voltage ratio" as used in the following instructions.

TO CONVERT DB SOUND-LEVEL METER READINGS INTO RMS AMPLITUDE IN INCHES

1. Note decibel readings of sound-level meter when vibration pickup is in contact with vibrating surface and control box switch is set at DISplacement.

2. If reading for Step 1 is below 120 db: Subtract +20 db successively from 120 minus db reading until the remainder falls within the range of Table I of decibel tables. To determine rms amplitude in inches, multiply the voltage ratio (left-hand column) corresponding to the db remainder by 0.1 for each time you subtracted 20 db. Figures obtained are expressed directly in inches rms amplitude.

If reading for Step 1 is above 120 db: Subtract +20 db successively from db reading minus 120 db until the remainder falls within the range of Table I. To determine amplitude in inches, multiply the voltage ratio (right-hand voltage ratio column) corresponding to the db remainder by 10 for each time you subtracted 20 db. Figures obtained are expressed directly in inches rms amplitude.

TO CONVERT DB SOUND-LEVEL METER READINGS INTO RMS VELOCITY IN INCHES PER SECOND

1. Note db reading of sound-level meter with vibration pickup in contact with vibrating surface and control box switch set at VELOCITY.

2. If reading for Step 1 is below 90 db: Subtract +20 db suc-

cessively from 90 minus db reading until the remainder falls within the range of Table I of decibel tables. To determine rms velocity in inches per second, multiply the voltage ratio (left-hand voltage ratio column) corresponding to the db remainder by 0.1 for each time you subtracted 20 db. The value obtained is velocity expressed directly in inches per second rms.

If reading for Step 1 is above 90 db: Subtract +20 db successively from db reading minus 90 until the remainder falls within the range of Table I. To determine rms velocity in inches per second, multiply the voltage ratio (right-hand voltage ratio column) corresponding to the db remainder by 10 for each time you subtracted 20 db. The value obtained is velocity expressed in inches per second rms.

TO CONVERT DB SOUND-LEVEL METER READINGS INTO RMS ACCELERATION IN INCHES PER SECOND PER SECOND

1. Note db reading of sound-level meter with vibration pickup in contact with vibrating surface and control box switch set at ACCELERATION.

2. If reading of Step 1 is below 50 db: The value obtained from the left-hand ratio column corresponding to 50 minus db reading is acceleration expressed directly in inches per second per second rms.

If reading for Step 1 is above 50 db (maximum 132 db): Subtract +20 db successively from db reading minus 50 until the remainder falls within the range of Table I. To determine rms acceleration in inches per second per second, multiply the voltage ratio (right-hand voltage ratio column) corresponding to the db remainder by 10 for each time you subtracted 20 db. The value obtained is acceleration expressed directly in inches per second per second rms.

Example:

With the vibration pickup placed in contact with some vibrating surface and the control box switch, let us say, on DISPLACEMENT, a reading of 54 db is obtained. Then, following outlined procedure:

1. db reading = 54 db.
2. $120 - 54 = 66$ db.
 $66 - (+20) - (+20) - (+20) = 6$ db remainder.

Voltage ratios corresponding to 6 db (left-hand column) equal 0.5012; 20 db was subtracted from 66 db three times; therefore 0.5012 should be multiplied by 0.1 three times.

Result = 0.0005012 or (to 2 significant figures) 0.00050 inch rms amplitude.

Like procedure should be followed for the calculation of velocity or acceleration.

Acceleration and Velocity Level

In order to convert the readings obtained with the sound-level meter and vibration pickup system into acceleration level in adb (that is, db re 10^{-3} cm/sec²) or velocity level in vdb (that is, db re 10^{-6} cm/sec), proceed as follows:

When the conversion figures on the nameplate are:

Velocity	90 db = 1 in./sec
Acceleration	50 db = 1 in./sec ²

add 38.1 db to sound-level meter reading to get vdb when the control box is set to velocity, and add 18.1 db to sound-level meter reading to get adb when the control box is set to acceleration.

TABLE I

GIVEN: Decibels

TO FIND: Power and Pressure Ratios

TO ACCOUNT FOR THE SIGN OF THE DECIBEL

For positive (+) values of the decibel—Both pressure and power ratios are greater than unity. Use the two right-hand columns.

For negative (−) values of the decibel—Both pressure and power ratios are less than unity. Use the two left-hand columns.

Example—Given: ± 9.1 db. Find:

	Power Ratio	Pressure Ratio
+9.1 db	8.128	2.851
−9.1 db	0.1230	0.3508

← -db+ →					← -db+ →				
Pressure Ratio	Power Ratio	db	Pressure Ratio	Power Ratio	Pressure Ratio	Power Ratio	db	Pressure Ratio	Power Ratio
1.0000	1.0000	0	1.000	1.000	.5623	.3162	5.0	1.778	3.162
.9886	.9772	.1	1.012	1.023	.5559	.3090	5.1	1.799	3.236
.9772	.9550	.2	1.023	1.047	.5495	.3020	5.2	1.820	3.311
.9661	.9333	.3	1.035	1.072	.5433	.2951	5.3	1.841	3.388
.9550	.9120	.4	1.047	1.096	.5370	.2884	5.4	1.862	3.467
.9441	.8913	.5	1.059	1.122	.5309	.2818	5.5	1.884	3.548
.9333	.8710	.6	1.072	1.148	.5248	.2754	5.6	1.905	3.631
.9226	.8511	.7	1.084	1.175	.5188	.2692	5.7	1.926	3.715
.9120	.8318	.8	1.096	1.202	.5129	.2630	5.8	1.950	3.802
.9016	.8128	.9	1.109	1.230	.5070	.2570	5.9	1.972	3.890
.8913	.7943	1.0	1.122	1.259	.5012	.2512	6.0	1.995	3.981
.8810	.7762	1.1	1.135	1.288	.4955	.2455	6.1	2.018	4.074
.8710	.7586	1.2	1.148	1.318	.4898	.2399	6.2	2.042	4.169
.8610	.7413	1.3	1.161	1.349	.4842	.2344	6.3	2.065	4.266
.8511	.7244	1.4	1.175	1.380	.4786	.2291	6.4	2.089	4.365
.8414	.7079	1.5	1.189	1.413	.4732	.2239	6.5	2.113	4.467
.8318	.6918	1.6	1.202	1.445	.4677	.2188	6.6	2.138	4.571
.8222	.6761	1.7	1.216	1.479	.4624	.2138	6.7	2.163	4.677
.8128	.6607	1.8	1.230	1.514	.4571	.2089	6.8	2.188	4.786
.8035	.6457	1.9	1.245	1.549	.4519	.2042	6.9	2.213	4.898
.7943	.6310	2.0	1.259	1.585	.4467	.1995	7.0	2.239	5.012
.7852	.6166	2.1	1.274	1.622	.4416	.1950	7.1	2.265	5.129
.7762	.6026	2.2	1.288	1.660	.4365	.1905	7.2	2.291	5.248
.7674	.5888	2.3	1.303	1.698	.4315	.1862	7.3	2.317	5.370
.7586	.5754	2.4	1.318	1.738	.4266	.1820	7.4	2.344	5.495
.7499	.5623	2.5	1.334	1.778	.4217	.1778	7.5	2.371	5.623
.7413	.5495	2.6	1.349	1.820	.4169	.1738	7.6	2.399	5.754
.7328	.5370	2.7	1.365	1.862	.4121	.1698	7.7	2.427	5.888
.7244	.5248	2.8	1.380	1.905	.4074	.1660	7.8	2.455	6.026
.7161	.5129	2.9	1.396	1.950	.4027	.1622	7.9	2.483	6.166
.7079	.5012	3.0	1.413	1.995	.3981	.1585	8.0	2.512	6.310
.6998	.4898	3.1	1.429	2.042	.3936	.1549	8.1	2.541	6.457
.6918	.4786	3.2	1.445	2.089	.3890	.1514	8.2	2.570	6.607
.6839	.4677	3.3	1.462	2.138	.3846	.1479	8.3	2.600	6.761
.6761	.4571	3.4	1.479	2.188	.3802	.1445	8.4	2.630	6.918
.6683	.4467	3.5	1.496	2.239	.3758	.1413	8.5	2.661	7.079
.6607	.4365	3.6	1.514	2.291	.3715	.1380	8.6	2.692	7.244
.6531	.4266	3.7	1.531	2.344	.3673	.1348	8.7	2.723	7.413
.6457	.4169	3.8	1.549	2.399	.3631	.1318	8.8	2.754	7.586
.6383	.4074	3.9	1.567	2.455	.3589	.1288	8.9	2.786	7.762
.6310	.3981	4.0	1.585	2.512	.3548	.1259	9.0	2.818	7.943
.6237	.3890	4.1	1.603	2.570	.3508	.1230	9.1	2.851	8.128
.6166	.3802	4.2	1.622	2.630	.3467	.1202	9.2	2.884	8.318
.6095	.3715	4.3	1.641	2.692	.3428	.1175	9.3	2.917	8.511
.6026	.3631	4.4	1.660	2.754	.3388	.1148	9.4	2.951	8.710
.5957	.3548	4.5	1.679	2.818	.3350	.1122	9.5	2.985	8.913
.5888	.3467	4.6	1.698	2.884	.3311	.1096	9.6	3.020	9.120
.5821	.3388	4.7	1.718	2.951	.3273	.1072	9.7	3.055	9.333
.5754	.3311	4.8	1.738	3.020	.3236	.1047	9.8	3.090	9.550
.5689	.3236	4.9	1.758	3.090	.3199	.1023	9.9	3.126	9.772

TABLE I (continued)

←-db+→					←-db+→				
Pressure Ratio	Power Ratio	db	Pressure Ratio	Power Ratio	Pressure Ratio	Power Ratio	db	Pressure Ratio	Power Ratio
.3162	.1000	10.0	3.162	10.000	.1585	.02512	16.0	6.310	39.81
.3126	.09772	10.1	3.199	10.23	.1567	.02455	16.1	6.383	40.74
.3090	.09550	10.2	3.236	10.47	.1549	.02399	16.2	6.457	41.69
.3055	.09333	10.3	3.273	10.72	.1531	.02344	16.3	6.531	42.66
.3020	.09120	10.4	3.311	10.96	.1514	.02291	16.4	6.607	43.65
.2985	.08913	10.5	3.350	11.22	.1496	.02239	16.5	6.683	44.67
.2951	.08710	10.6	3.388	11.48	.1479	.02188	16.6	6.761	45.71
.2917	.08511	10.7	3.428	11.75	.1462	.02138	16.7	6.839	46.77
.2884	.08318	10.8	3.467	12.02	.1445	.02089	16.8	6.918	47.86
.2851	.08128	10.9	3.508	12.30	.1429	.02042	16.9	6.998	48.98
.2818	.07943	11.0	3.548	12.59	.1413	.01995	17.0	7.079	50.12
.2786	.07762	11.1	3.589	12.88	.1396	.01950	17.1	7.161	51.29
.2754	.07586	11.2	3.631	13.18	.1380	.01905	17.2	7.244	52.48
.2723	.07413	11.3	3.673	13.49	.1365	.01862	17.3	7.328	53.70
.2692	.07244	11.4	3.715	13.80	.1349	.01820	17.4	7.413	54.95
.2661	.07079	11.5	3.758	14.13	.1334	.01778	17.5	7.499	56.23
.2630	.06918	11.6	3.802	14.45	.1318	.01738	17.6	7.586	57.54
.2600	.06761	11.7	3.846	14.79	.1303	.01698	17.7	7.674	58.88
.2570	.06607	11.8	3.890	15.14	.1288	.01660	17.8	7.762	60.26
.2541	.06457	11.9	3.936	15.49	.1274	.01622	17.9	7.852	61.66
.2512	.06310	12.0	3.981	15.85	.1259	.01585	18.0	7.943	63.10
.2483	.06166	12.1	4.027	16.22	.1245	.01549	18.1	8.035	64.57
.2455	.06026	12.2	4.074	16.60	.1230	.01514	18.2	8.128	66.07
.2427	.05888	12.3	4.121	16.98	.1216	.01479	18.3	8.222	67.61
.2399	.05754	12.4	4.169	17.38	.1202	.01445	18.4	8.318	69.18
.2371	.05623	12.5	4.217	17.78	.1189	.01413	18.5	8.414	70.79
.2344	.05495	12.6	4.266	18.20	.1175	.01380	18.6	8.511	72.44
.2317	.05370	12.7	4.315	18.62	.1161	.01349	18.7	8.610	74.13
.2291	.05248	12.8	4.365	19.05	.1148	.01318	18.8	8.710	75.86
.2265	.05129	12.9	4.416	19.50	.1135	.01288	18.9	8.811	77.62
.2239	.05012	13.0	4.467	19.95	.1122	.01259	19.0	8.913	79.43
.2213	.04898	13.1	4.519	20.42	.1109	.01230	19.1	9.016	81.28
.2188	.04786	13.2	4.571	20.89	.1096	.01202	19.2	9.120	83.18
.2163	.04677	13.3	4.624	21.38	.1084	.01175	19.3	9.226	85.11
.2138	.04571	13.4	4.677	21.88	.1072	.01148	19.4	9.333	87.10
.2113	.04467	13.5	4.732	22.39	.1059	.01122	19.5	9.441	89.13
.2089	.04365	13.6	4.786	22.91	.1047	.01096	19.6	9.550	91.20
.2065	.04266	13.7	4.842	23.44	.1035	.01072	19.7	9.661	93.33
.2042	.04169	13.8	4.898	23.99	.1023	.01047	19.8	9.772	95.50
.2018	.04074	13.9	4.955	24.55	.1012	.01023	19.9	9.886	97.72
.1995	.03981	14.0	5.012	25.12	.1000	.01000	20.0	10.000	100.00
.1972	.03890	14.1	5.070	25.70					
.1950	.03802	14.2	5.129	26.30					
.1928	.03715	14.3	5.188	26.92					
.1905	.03631	14.4	5.248	27.54					
.1884	.03548	14.5	5.309	28.18					
.1862	.03467	14.6	5.370	28.84					
.1841	.03388	14.7	5.433	29.51					
.1820	.03311	14.8	5.495	30.20					
.1799	.03236	14.9	5.559	30.90					
.1778	.03162	15.0	5.623	31.62					
.1758	.03090	15.1	5.689	32.36					
.1738	.03020	15.2	5.754	33.11					
.1718	.02951	15.3	5.821	33.88					
.1698	.02884	15.4	5.888	34.67					
.1679	.02818	15.5	5.957	35.48					
.1660	.02754	15.6	6.026	36.31					
.1641	.02692	15.7	6.095	37.15					
.1622	.02630	15.8	6.166	38.02					
.1603	.02570	15.9	6.237	38.90					

←-db+→				
Pressure Ratio	Power Ratio	db	Pressure Ratio	Power Ratio
3.162×10^{-1}	10^{-1}	10	3.162	10
	10^{-2}	20		10^2
	10^{-3}	30		10^3
3.162×10^{-2}	10^{-4}	40	3.162×10^2	10^4
	10^{-5}	50		10^5
3.162×10^{-3}	10^{-6}	60	3.162×10^3	10^6
	10^{-7}	70		10^7
3.162×10^{-4}	10^{-8}	80	3.162×10^4	10^8
	10^{-9}	90		10^9
3.162×10^{-5}	10^{-10}	100	3.162×10^5	10^{10}

TABLE II

GIVEN: { Pressure } Ratio TO FIND: Decibels

POWER RATIOS

To find the number of decibels corresponding to a given power ratio—Assume the given power ratio to be a pressure ratio and find the corresponding number of decibels from the table. The desired result is exactly

one-half of the number of decibels thus found.

Example—Given: a power ratio of 3.41.
Find: 3.41 in the table:

$$3.41 \rightarrow 10.655 \text{ db} \times \frac{1}{2} = 5.328 \text{ db}$$

Pressure Ratio	.00	.01	.02	.03	.04	.05	.06	.07	.08	.09
1.0	.000	.086	.172	.257	.341	.424	.506	.588	.668	.749
1.1	.828	.906	.984	1.062	1.138	1.214	1.289	1.364	1.438	1.511
1.2	1.584	1.656	1.727	1.798	1.868	1.938	2.007	2.076	2.144	2.212
1.3	2.279	2.345	2.411	2.477	2.542	2.607	2.671	2.734	2.798	2.860
1.4	2.923	2.984	3.046	3.107	3.167	3.227	3.287	3.346	3.405	3.464
1.5	3.522	3.580	3.637	3.694	3.750	3.807	3.862	3.918	3.973	4.028
1.6	4.082	4.137	4.190	4.244	4.297	4.350	4.402	4.454	4.506	4.558
1.7	4.609	4.660	4.711	4.761	4.811	4.861	4.910	4.959	5.008	5.057
1.8	5.105	5.154	5.201	5.249	5.296	5.343	5.390	5.437	5.483	5.529
1.9	5.575	5.621	5.666	5.711	5.756	5.801	5.845	5.889	5.933	5.977
2.0	6.021	6.064	6.107	6.150	6.193	6.235	6.277	6.319	6.361	6.403
2.1	6.444	6.486	6.527	6.568	6.608	6.649	6.689	6.729	6.769	6.809
2.2	6.848	6.888	6.927	6.966	7.008	7.044	7.082	7.121	7.159	7.197
2.3	7.235	7.272	7.310	7.347	7.384	7.421	7.458	7.495	7.532	7.568
2.4	7.604	7.640	7.676	7.712	7.748	7.783	7.819	7.854	7.889	7.924
2.5	7.959	7.993	8.028	8.062	8.097	8.131	8.165	8.199	8.232	8.266
2.6	8.299	8.333	8.366	8.399	8.432	8.465	8.498	8.530	8.563	8.595
2.7	8.627	8.659	8.691	8.723	8.755	8.787	8.818	8.850	8.881	8.912
2.8	8.943	8.974	9.005	9.036	9.066	9.097	9.127	9.158	9.188	9.218
2.9	9.248	9.278	9.308	9.337	9.367	9.396	9.426	9.455	9.484	9.513
3.0	9.542	9.571	9.600	9.629	9.657	9.686	9.714	9.743	9.771	9.799
3.1	9.827	9.855	9.883	9.911	9.939	9.966	9.994	10.021	10.049	10.076
3.2	10.103	10.130	10.157	10.184	10.211	10.238	10.264	10.291	10.317	10.344
3.3	10.370	10.397	10.423	10.449	10.475	10.501	10.527	10.553	10.578	10.604
3.4	10.630	10.655	10.681	10.706	10.731	10.756	10.782	10.807	10.832	10.857
3.5	10.881	10.906	10.931	10.955	10.980	11.005	11.029	11.053	11.078	11.102
3.6	11.126	11.150	11.174	11.198	11.222	11.246	11.270	11.293	11.317	11.341
3.7	11.364	11.387	11.411	11.434	11.457	11.481	11.504	11.527	11.550	11.573
3.8	11.596	11.618	11.641	11.664	11.687	11.709	11.732	11.754	11.777	11.799
3.9	11.821	11.844	11.866	11.888	11.910	11.932	11.954	11.976	11.998	12.019
4.0	12.041	12.063	12.085	12.106	12.128	12.149	12.171	12.192	12.213	12.234
4.1	12.256	12.277	12.298	12.319	12.340	12.361	12.382	12.403	12.424	12.444
4.2	12.465	12.486	12.506	12.527	12.547	12.568	12.588	12.609	12.629	12.649
4.3	12.669	12.690	12.710	12.730	12.750	12.770	12.790	12.810	12.829	12.849
4.4	12.869	12.889	12.908	12.928	12.948	12.967	12.987	13.006	13.026	13.045
4.5	13.064	13.084	13.103	13.122	13.141	13.160	13.179	13.198	13.217	13.236
4.6	13.255	13.274	13.293	13.312	13.330	13.349	13.368	13.386	13.405	13.423
4.7	13.442	13.460	13.479	13.497	13.516	13.534	13.552	13.570	13.589	13.607
4.8	13.625	13.643	13.661	13.679	13.697	13.715	13.733	13.751	13.768	13.786
4.9	13.804	13.822	13.839	13.857	13.875	13.892	13.910	13.927	13.945	13.962
5.0	13.979	13.997	14.014	14.031	14.049	14.066	14.083	14.100	14.117	14.134
5.1	14.151	14.168	14.185	14.202	14.219	14.236	14.253	14.270	14.287	14.303
5.2	14.320	14.337	14.353	14.370	14.387	14.403	14.420	14.436	14.453	14.469
5.3	14.486	14.502	14.518	14.535	14.551	14.567	14.583	14.599	14.616	14.632
5.4	14.648	14.664	14.680	14.696	14.712	14.728	14.744	14.760	14.776	14.791
5.5	14.807	14.823	14.839	14.855	14.870	14.886	14.902	14.917	14.933	14.948
5.6	14.964	14.979	14.995	15.010	15.026	15.041	15.056	15.072	15.087	15.102
5.7	15.117	15.133	15.148	15.163	15.178	15.193	15.208	15.224	15.239	15.254
5.8	15.269	15.284	15.299	15.313	15.328	15.343	15.358	15.373	15.388	15.402
5.9	15.417	15.432	15.446	15.461	15.476	15.490	15.505	15.519	15.534	15.549

TABLE II (continued)

Pressure Ratio	.00	.01	.02	.03	.04	.05	.06	.07	.08	.09
6.0	15.563	15.577	15.592	15.606	15.621	15.635	15.649	15.664	15.678	15.692
6.1	15.707	15.721	15.735	15.749	15.763	15.778	15.792	15.806	15.820	15.834
6.2	15.848	15.862	15.876	15.890	15.904	15.918	15.931	15.945	15.959	15.973
6.3	15.987	16.001	16.014	16.028	16.042	16.055	16.069	16.083	16.096	16.110
6.4	16.124	16.137	16.151	16.164	16.178	16.191	16.205	16.218	16.232	16.245
6.5	16.258	16.272	16.285	16.298	16.312	16.325	16.338	16.351	16.365	16.378
6.6	16.391	16.404	16.417	16.430	16.443	16.456	16.469	16.483	16.496	16.509
6.7	16.521	16.534	16.547	16.560	16.573	16.586	16.599	16.612	16.625	16.637
6.8	16.650	16.663	16.676	16.688	16.701	16.714	16.726	16.739	16.752	16.764
6.9	16.777	16.790	16.802	16.815	16.827	16.840	16.852	16.865	16.877	16.890
7.0	16.902	16.914	16.927	16.939	16.951	16.964	16.976	16.988	17.001	17.013
7.1	17.025	17.037	17.050	17.062	17.074	17.086	17.098	17.110	17.122	17.135
7.2	17.147	17.159	17.171	17.183	17.195	17.207	17.219	17.231	17.243	17.255
7.3	17.266	17.278	17.290	17.302	17.314	17.326	17.338	17.349	17.361	17.373
7.4	17.385	17.396	17.408	17.420	17.431	17.443	17.455	17.466	17.478	17.490
7.5	17.501	17.513	17.524	17.536	17.547	17.559	17.570	17.582	17.593	17.605
7.6	17.616	17.628	17.639	17.650	17.662	17.673	17.685	17.696	17.707	17.719
7.7	17.730	17.741	17.752	17.764	17.775	17.786	17.797	17.808	17.820	17.831
7.8	17.842	17.853	17.864	17.875	17.886	17.897	17.908	17.919	17.931	17.942
7.9	17.953	17.964	17.975	17.985	17.996	18.007	18.018	18.029	18.040	18.051
8.0	18.062	18.073	18.083	18.094	18.105	18.116	18.127	18.137	18.148	18.159
8.1	18.170	18.180	18.191	18.202	18.212	18.223	18.234	18.244	18.255	18.266
8.2	18.276	18.287	18.297	18.308	18.319	18.329	18.340	18.350	18.361	18.371
8.3	18.382	18.392	18.402	18.413	18.423	18.434	18.444	18.455	18.465	18.475
8.4	18.486	18.496	18.506	18.517	18.527	18.537	18.547	18.558	18.568	18.578
8.5	18.588	18.599	18.609	18.619	18.629	18.639	18.649	18.660	18.670	18.680
8.6	18.690	18.700	18.710	18.720	18.730	18.740	18.750	18.760	18.770	18.780
8.7	18.790	18.800	18.810	18.820	18.830	18.840	18.850	18.860	18.870	18.880
8.8	18.890	18.900	18.909	18.919	18.929	18.939	18.949	18.958	18.968	18.978
8.9	18.988	18.998	19.007	19.017	19.027	19.036	19.046	19.056	19.066	19.075
9.0	19.085	19.094	19.104	19.114	19.123	19.133	19.143	19.152	19.162	19.171
9.1	19.181	19.190	19.200	19.209	19.219	19.228	19.238	19.247	19.257	19.266
9.2	19.276	19.285	19.295	19.304	19.313	19.323	19.332	19.342	19.351	19.360
9.3	19.370	19.379	19.388	19.398	19.407	19.416	19.426	19.435	19.444	19.453
9.4	19.463	19.472	19.481	19.490	19.499	19.509	19.518	19.527	19.536	19.545
9.5	19.554	19.564	19.573	19.582	19.591	19.600	19.609	19.618	19.627	19.636
9.6	19.645	19.654	19.664	19.673	19.682	19.691	19.700	19.709	19.718	19.726
9.7	19.735	19.744	19.753	19.762	19.771	19.780	19.789	19.798	19.807	19.816
9.8	19.825	19.833	19.842	19.851	19.860	19.869	19.878	19.886	19.895	19.904
9.9	19.913	19.921	19.930	19.939	19.948	19.956	19.965	19.974	19.983	19.991

Pressure Ratio	0	1	2	3	4	5	6	7	8	9
10	20.000	20.828	21.584	22.279	22.923	23.522	24.082	24.609	25.105	25.575
20	26.021	26.444	26.848	27.235	27.604	27.959	28.299	28.627	28.943	29.248
30	29.542	29.827	30.103	30.370	30.630	30.881	31.126	31.364	31.596	31.821
40	32.041	32.256	32.465	32.669	32.869	33.064	33.255	33.442	33.625	33.804
50	33.979	34.151	34.320	34.486	34.648	34.807	34.964	35.117	35.269	35.417
60	35.563	35.707	35.848	35.987	36.124	36.258	36.391	36.521	36.650	36.777
70	36.902	37.025	37.147	37.266	37.385	37.501	37.616	37.730	37.842	37.953
80	38.062	38.170	38.276	38.382	38.486	38.588	38.690	38.790	38.890	38.988
90	39.085	39.181	39.276	39.370	39.463	39.554	39.645	39.735	39.825	39.913
100	40.000	—	—	—	—	—	—	—	—	—

CHART FOR COMBINING OR SUBTRACTING DECIBELS*

TO COMBINE DECIBELS:

Enter the chart with the NUMERICAL DIFFERENCE BETWEEN TWO LEVELS BEING ADDED. Follow the line corresponding to this value to its intersection with the curved line, then left to read the NUMERICAL DIFFERENCE BETWEEN TOTAL AND LARGER LEVEL. Add this value to the larger level to determine the total.

Example: Combine 75 db and 80 db. The difference is 5 db. The 5-db line intersects the curved line at 1.2 db on the vertical scale. Thus the total value is $80 + 1.2$ or 81.2 db.

TO SUBTRACT DECIBELS:

Enter the chart with the NUMERICAL DIFFERENCE BETWEEN TOTAL AND LARGER LEVELS if this value is less than 3 db. Enter the chart with the NUMERICAL DIFFERENCE BETWEEN TOTAL AND SMALLER LEVELS if this value is between 3 and 14 db. Follow the line corresponding to this value to its intersection with the curved line, then either left or down to read the NUMERICAL DIFFERENCE BETWEEN TOTAL AND LARGER (SMALLER) LEVELS. Subtract this value from the total level to determine the unknown level.

Example: Subtract 81 db from 90 db. The difference is 9 db. The 9-db vertical line intersects the curved line at 0.6 db on the vertical scale. Thus the unknown level is $90 - 0.6$ or 89.4 db.

*This chart is based on one developed by R. Musa.

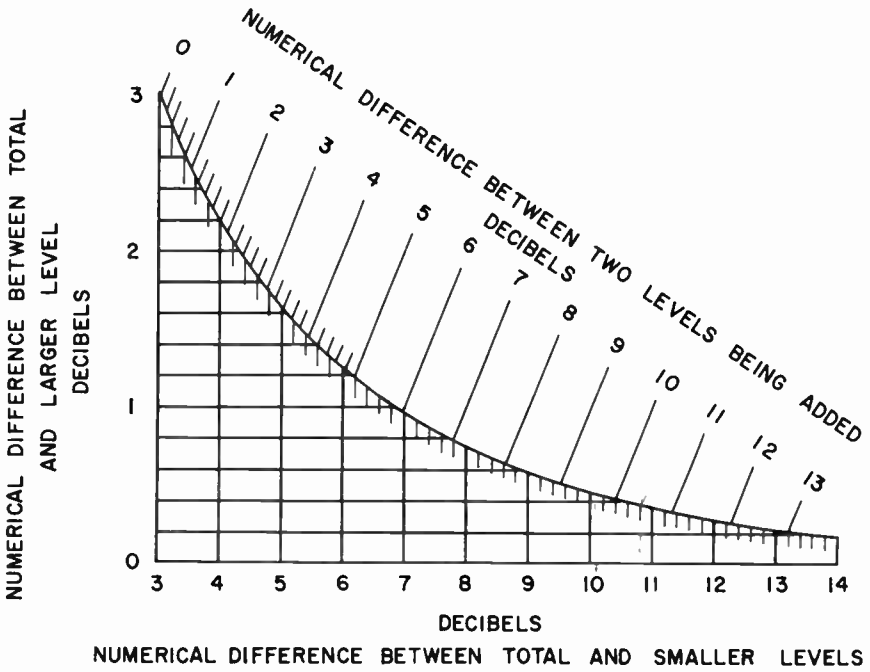

TABLE FOR CONVERTING LOUDNESS TO LOUDNESS LEVEL

A simplified relation between the loudness in sones and the loudness level in phons has been standardized internationally (ISO/R131-1959). This relation is a good approximation to the psychoacoustical data and is useful for engineering purposes, but it should not be expected to be accurate enough for research on the subjective aspects of hearing.

The relation is

$$S = 2^{(P-40)/10}$$

where S is the loudness in sones and P is the loudness level in phons.

A table of values of sones for loudness levels ranging from 20 to 130 phons in increments of 1 phon, calculated from the above relation, is given below.

Examples:

Given - loudness level of 72 phons.

Find - in table under "+2" in the "70" row - 9.2 sones.

		SONES TABLE									
Phons	0	+1	+2	+3	+4	+5	+6	+7	+8	+9	
20	.25	.27	.29	.31	.33	.35	.38	.41	.44	.47	
30	.50	.54	.57	.62	.66	.71	.76	.81	.87	.93	
40	1	1.07	1.15	1.23	1.32	1.41	1.52	1.62	1.74	1.87	
50	2	2.14	2.30	2.46	2.64	2.83	3.03	3.25	3.48	3.73	
60	4	4.29	4.59	4.92	5.28	5.66	6.06	6.50	6.96	7.46	
70	8	8.6	9.2	9.8	10.6	11.3	12.1	13.0	13.9	14.9	
80	16	17.1	18.4	19.7	21.1	22.6	24.3	26.0	27.9	29.9	
90	32	34.3	36.8	39.4	42.2	45.3	48.5	52.0	55.7	59.7	
100	64	68.6	73.5	78.8	84.4	90.5	97	104	111	119	
110	128	137	147	158	169	181	194	208	223	239	
120	256	274	294	315	338	362	388	416	446	478	

VIBRATION CONVERSION CHARTS

The charts on the following pages illustrate the relationship between frequency, velocity, acceleration, displacement, and jerk (refer to Chapter 10).

Figures IV-1 and IV-2 are general conversion charts for frequency, displacement, velocity, and acceleration. Enter the chart with any two of these parameters to solve for the other two. In Figure IV-1, displacement, velocity, and acceleration are given in inches, inches/second, and inches/second², respectively, while Figure IV-2 uses metric units.

Figures IV-3 through IV-9 show the direct-reading ranges of the Type 1553-A (inch) and Type 1553-AK (metric) Vibration Meters. Each of these figures is merely a portion of Figure IV-1 or IV-2, expanded and configured to show the range of displacement, velocity, acceleration, or jerk over the frequency range of the instrument.

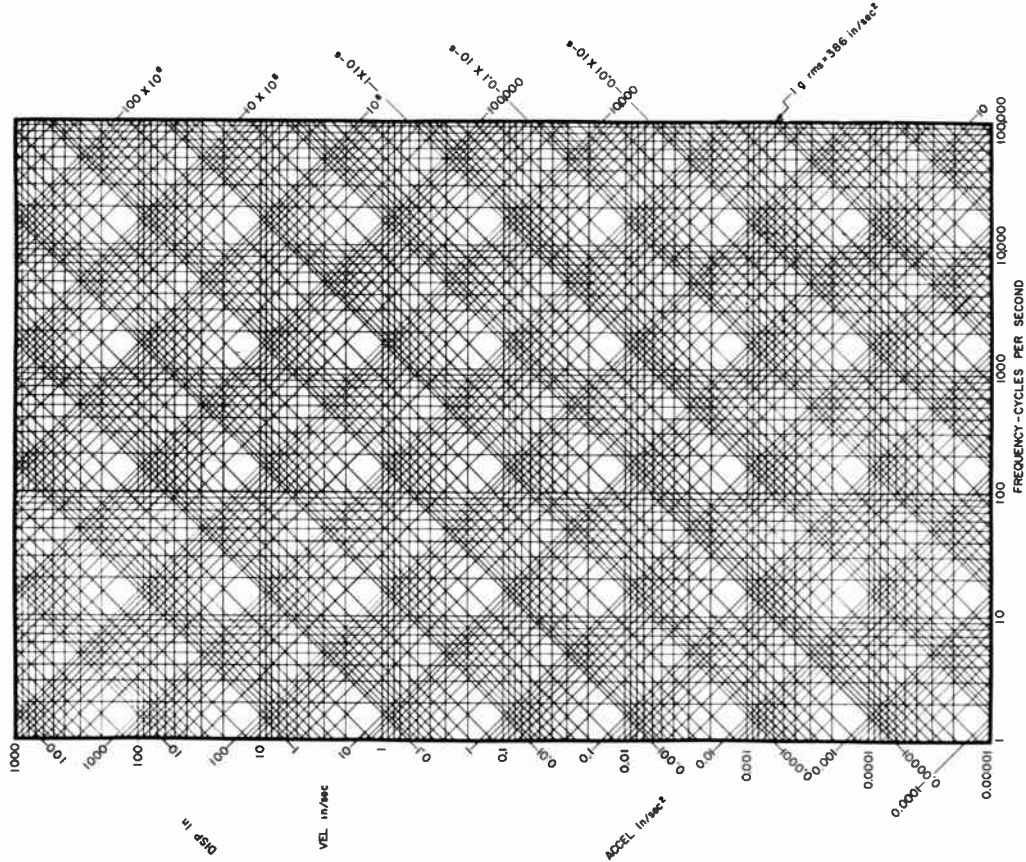

Figure IV-1. Conversion chart for vibration parameters, for use with Type 1553-A Vibration Meter.

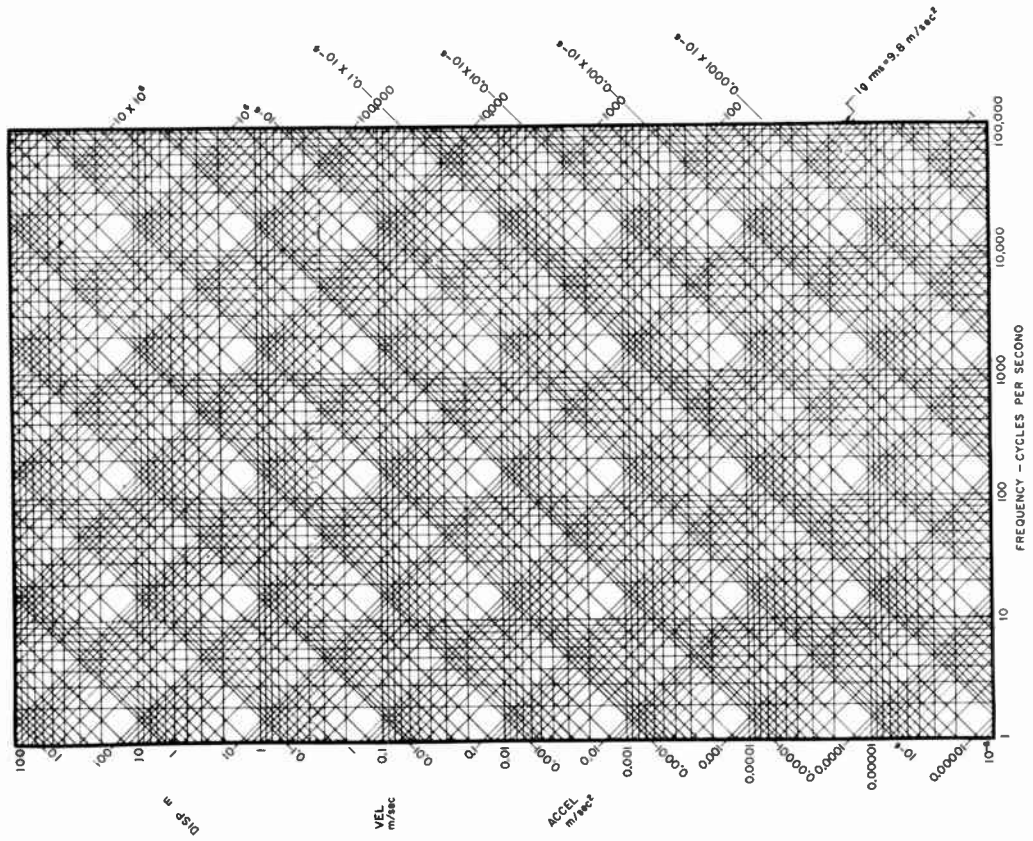

Figure IV-2. Conversion chart for vibration parameters, for use with Type 1553-AK Vibration Meter.

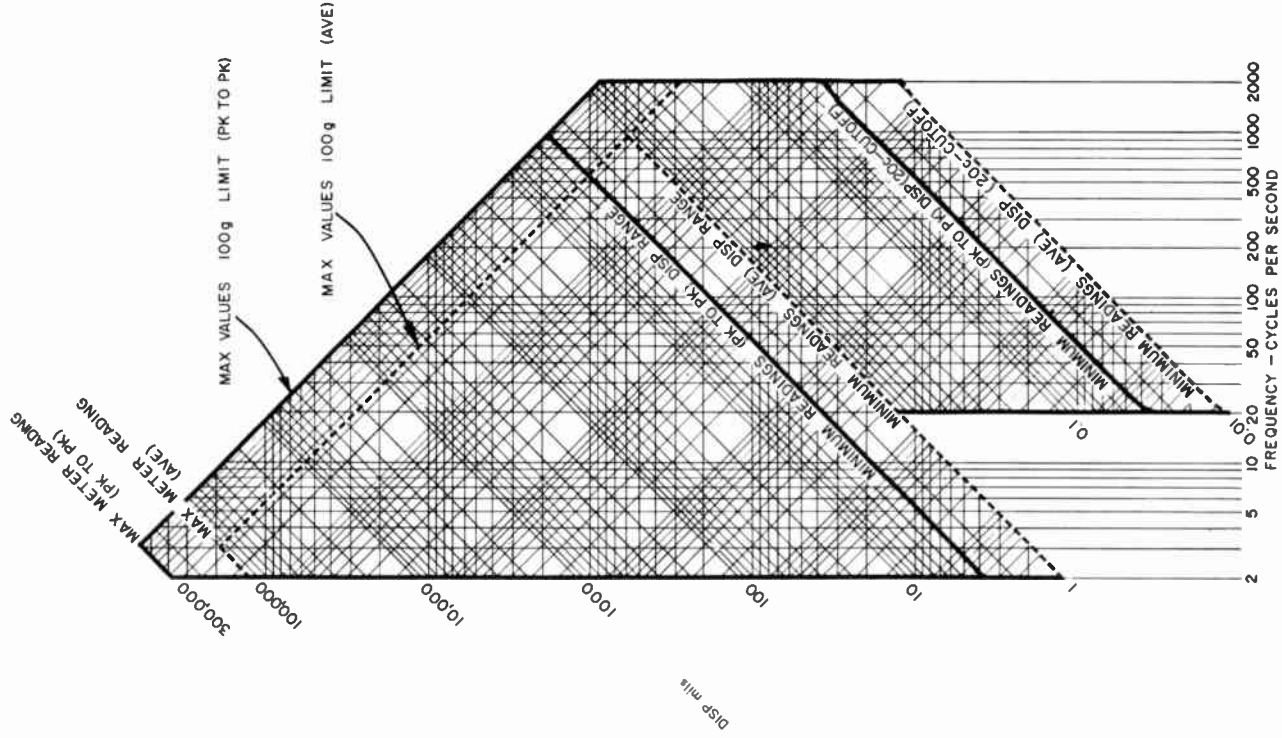

Figure IV-3. Direct-reading displacement ranges of the Type 1553-A Vibration Meter.

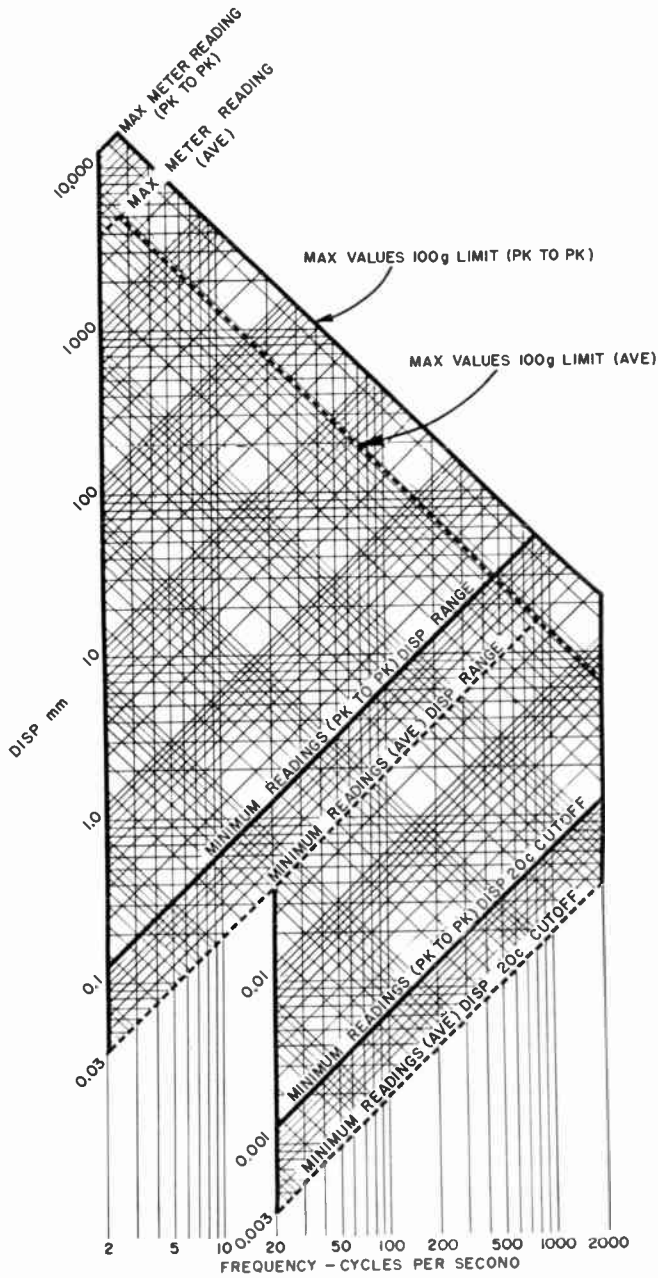

Figure IV-4. Direct-reading displacement ranges of the Type 1553-AK Vibration Meter.

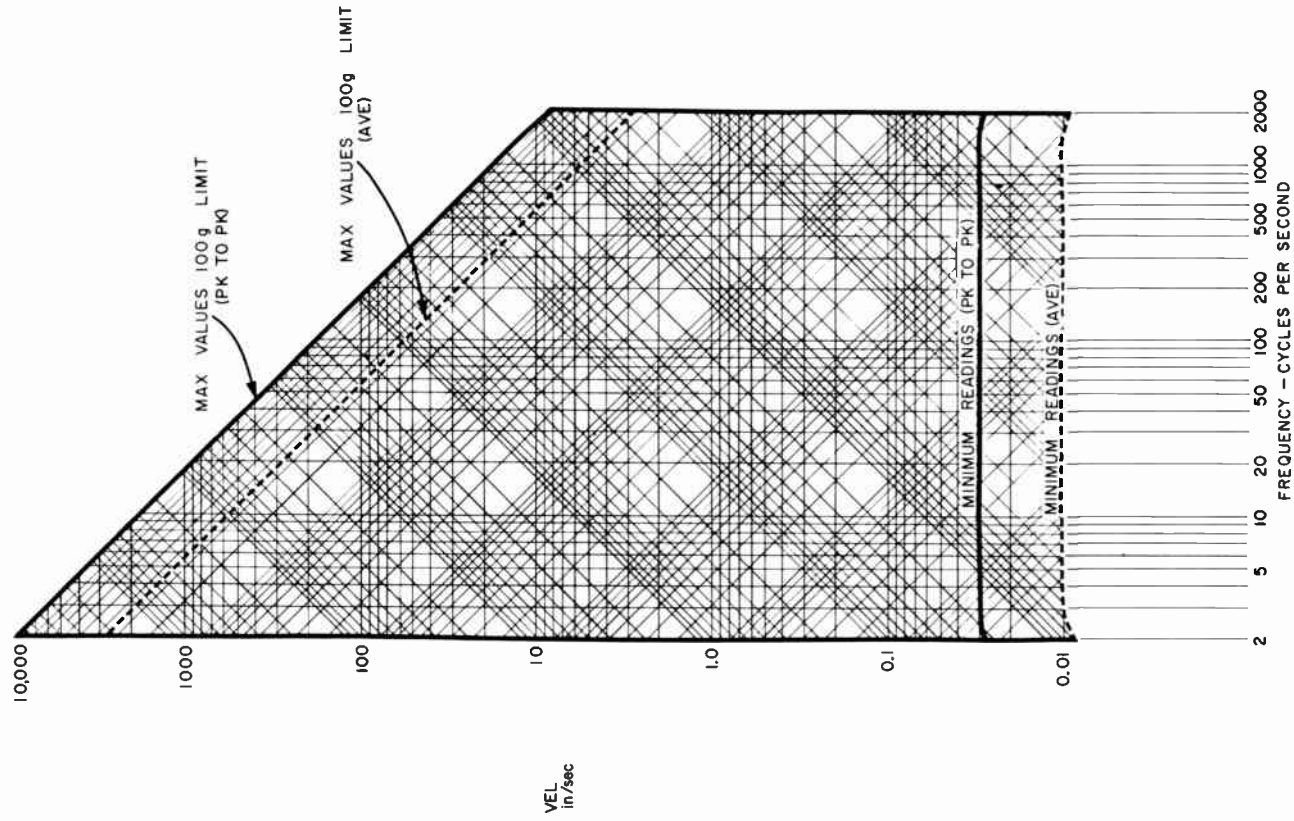

Figure IV-5. Direct-reading velocity ranges of the Type 1553-A Vibration Meter.

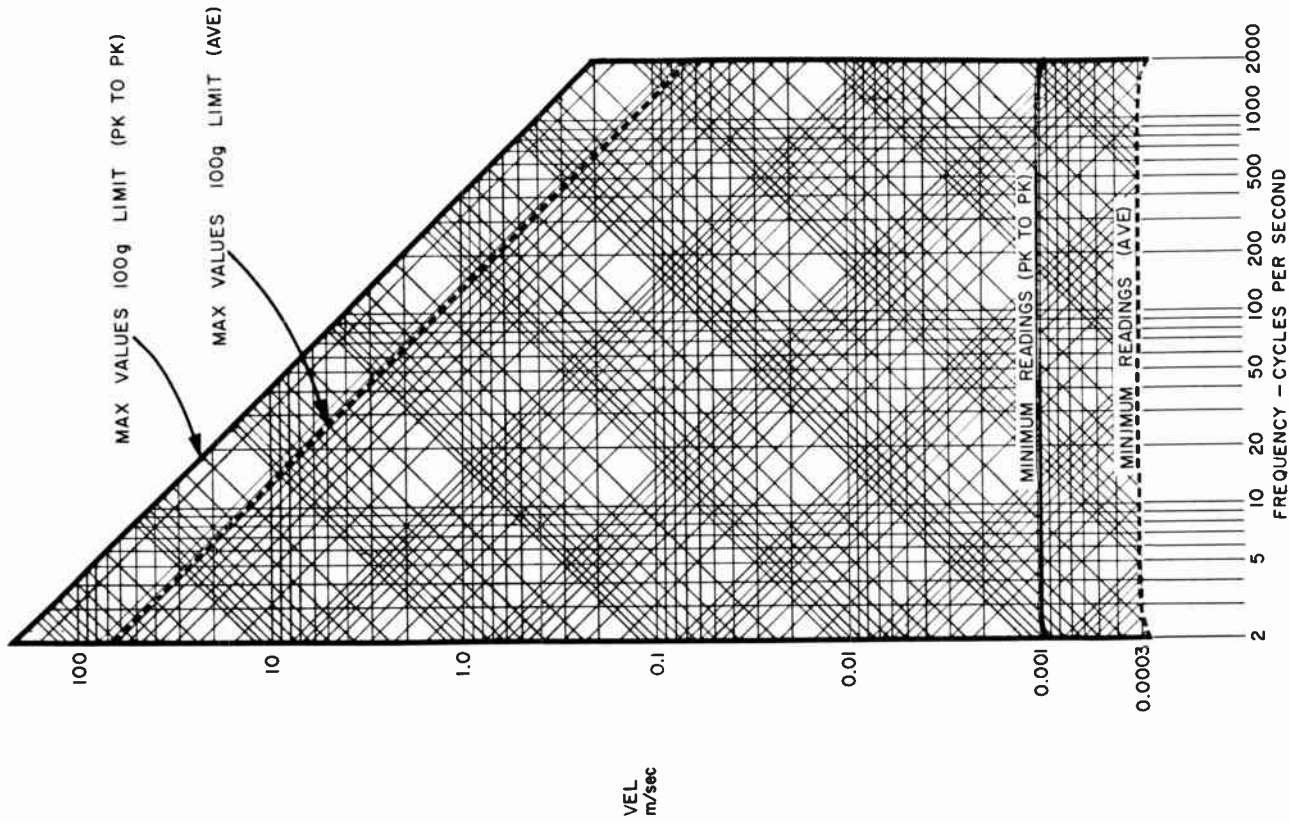

Figure IV-6. Direct-reading velocity ranges of the Type 1553-AK Vibration Meter.

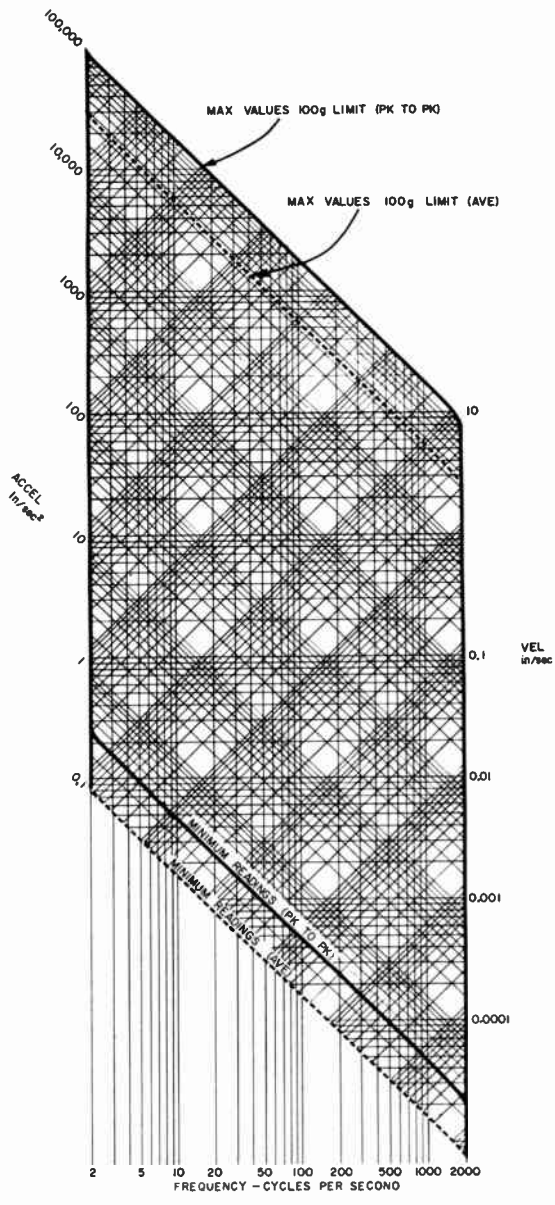

Figure IV-7. Direct-reading acceleration ranges of the Type 1553-A Vibration Meter.

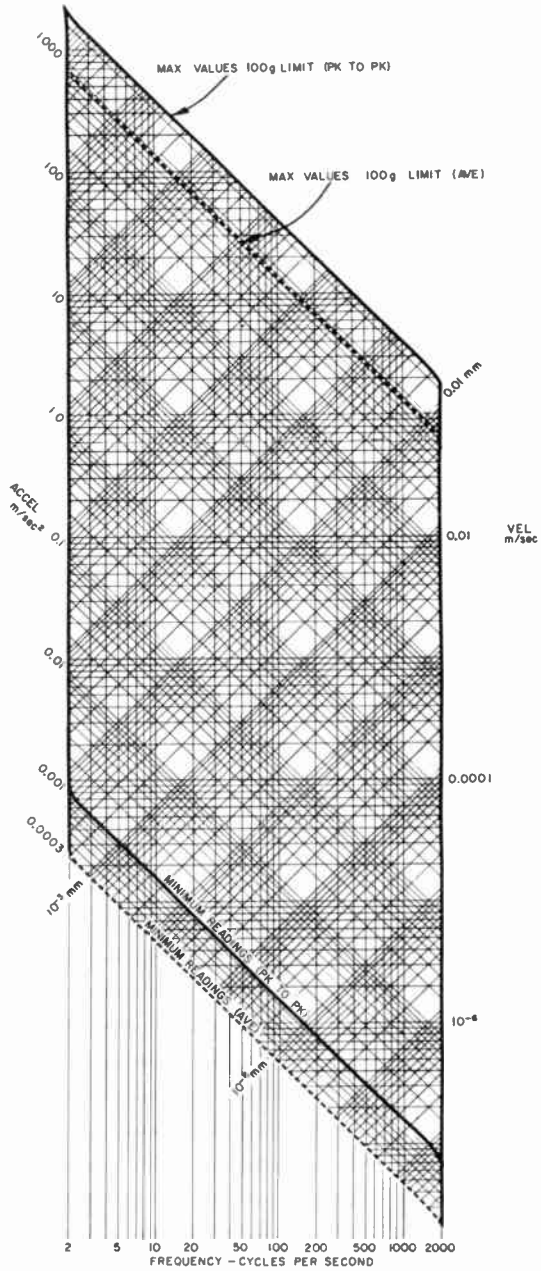

Figure IV-8. Direct-reading acceleration ranges of the Type 1553-AK Vibration Meter.

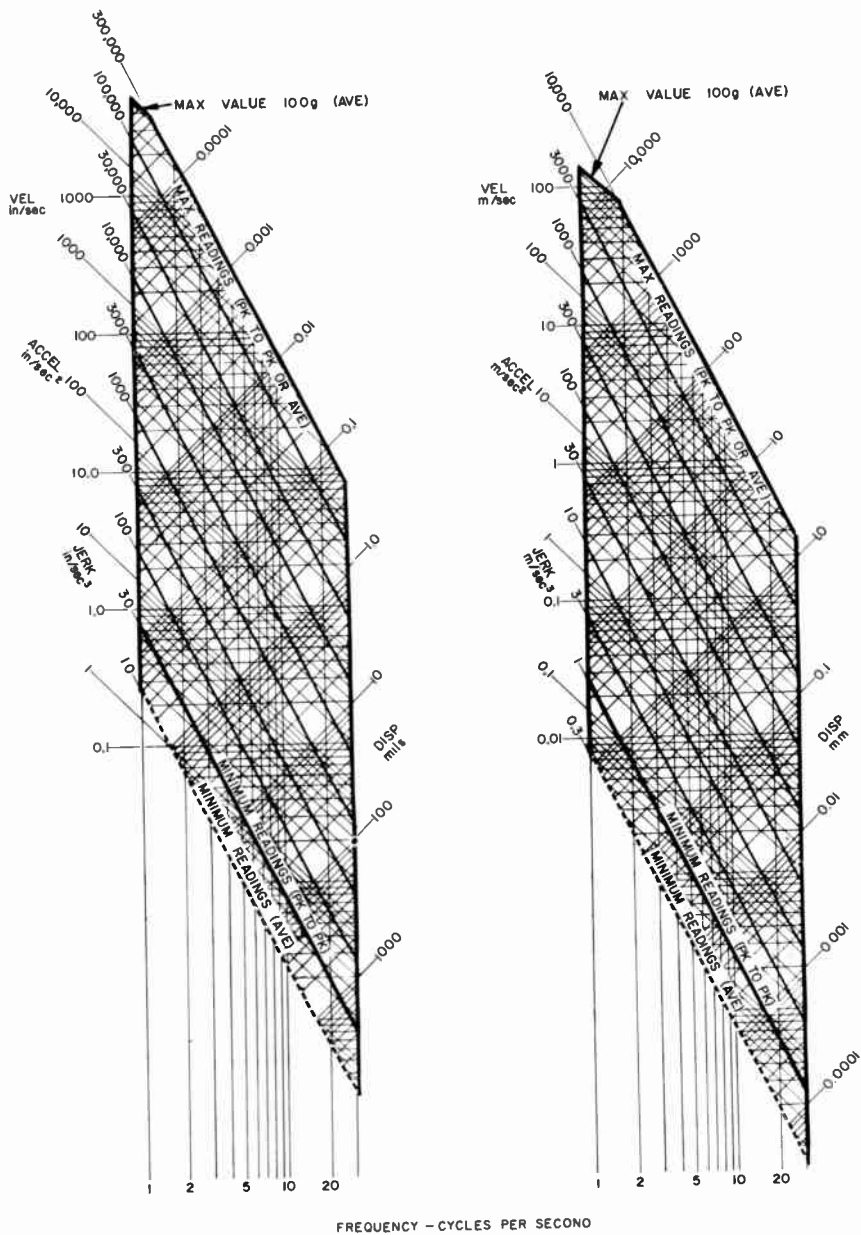
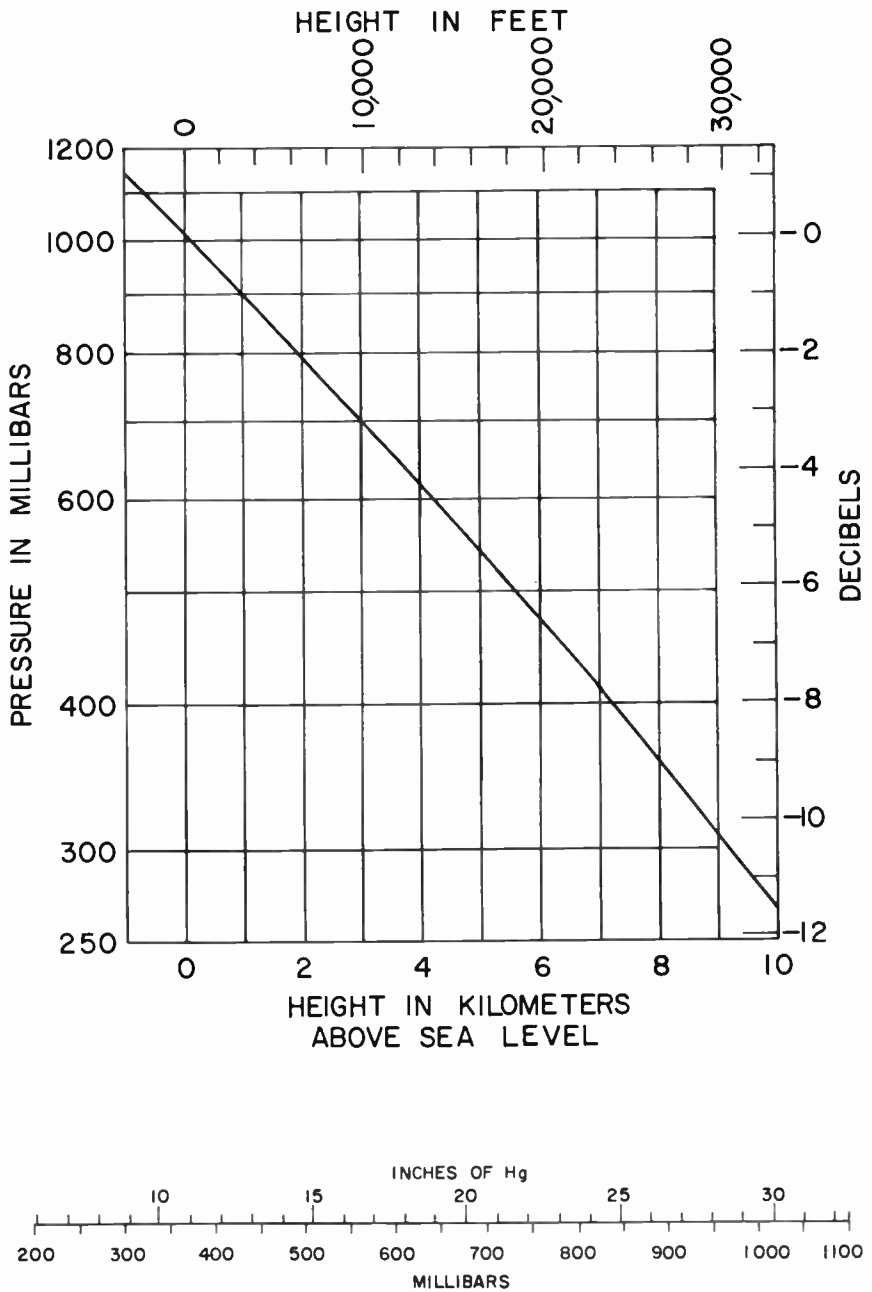

Figure IV-9. Direct-reading jerk ranges of the Types 1553-A (left) and 1553-AK (right) Vibration Meters.

EFFECTS OF ATMOSPHERIC PRESSURE

Some acoustical measurements are affected by atmospheric pressure and temperature. The output of the Type 1552-B Calibrator, for instance, is directly proportional to the pressure, and the rated reference level occurs at a standard atmospheric pressure of 1013 millibars. If the pressure when the calibrator is used is significantly different from 1013 millibars, a correction should be made. The altitude where the calibrator is used is usually the most significant factor in determining the average atmospheric pressure, and a chart for correcting for this effect is included in the instruction book. Since the output of most other sound sources is affected by the pressure, a chart relating height to average pressure is included here. The actual variation in output with pressure for practical sources is usually between that shown by the corresponding decibel scale on the right and one-half that value. Thus, for altitudes up to 2 kilometers (6560 feet), the change in output with altitude is generally less than 2 db.

The variation of atmospheric pressure at a given location from day to day is usually less important, but for careful measurements where fractions of a decibel are being considered, the actual atmospheric pressure should be noted. The pressure can be obtained from the local weather bureau, and a correction for the difference in altitude between the point where the acoustical measurements are made and the weather bureau may be necessary. This correction is readily estimated from the chart.



INTERPRETATION OF THE BEHAVIOR OF THE POINTER OF A NOISE-MEASURING INSTRUMENT

VI.1 TONES AND BEATS.

The indicated sound level of a constant-amplitude pure tone is steady, and so is that of a mixture of tones, unless at least two components are close together in frequency. Examples of sounds that have a constant indicated sound level are transformer hum and noise from some rotating electrical machinery. When the combined noise of several machines is measured, the indicated level is also constant, unless the speed of the machines is such that some of the major noise components are only a few cycles apart in frequency. In this situation an audible beat, a periodic rise and fall in amplitude, occurs, and the indicated level also rises and falls.

VI.2 VARYING-SPEED SOURCES.

Machinery that operates at a varying speed usually produces a noise that fluctuates in level. If the speed varies periodically, the level will also vary periodically. This variation results because the noise produced by the machine varies with speed, because the response of the room in which the measurement is made varies with frequency, and, if an analyzer is used, because the response of the measurement system varies with frequency.

If the machine speed varies erratically, the noise level will also vary erratically, and the behavior may be similar to that of random noise.

VI.3 RANDOM NOISE

The indicated sound level of a random noise, such as that produced by jets, blowers, combustion chambers, ventilating systems, etc, is not steady. In fact, all sounds contain some random noise energy, and most have enough so that the indicated level fluctuates noticeably. The extent of this fluctuation is a clue to the nature of the sound.

The fluctuations in level are ordinarily not a result of erratic behavior of the measuring equipment, but rather reflect the irregularities in the process of noise production. This process can often be considered as a combination of many

sources that produce sound at random time intervals. The measurement of such noises can be treated on a simplified statistical basis that is satisfactory for almost all sounds.

VI.3.1 AVERAGE ENERGY LEVEL OF A RANDOM NOISE. When a random noise is measured, the first important result that is desired is the long-time average energy level. This concept leads to taking the average of the fluctuating pointer reading. If the fluctuations are less than about 2 db, this average can be easily and confidently estimated to a fraction of a decibel. If the fluctuations cover a range of 10 or more decibels, the average is much less certain.

The extent of the meter fluctuation depends on the meter characteristic. The slower the movement, the smaller are the fluctuations. Thus, if the fluctuations exceed 3 or 4 db for the "FAST" meter position, the "SLOW" meter position should be used.

VI.3.2 EFFECT OF BANDWIDTH. If an analyzer is used, the extent of the fluctuations also depends on the bandwidth. The narrower the band, the greater are the fluctuations, and the longer is the meter averaging time required for a satisfactory estimate of the level.

A relatively simple principle is involved here. The narrow band is used to get fineness of detail. The finer the detail that is desired, the more time is needed to obtain the result to a certain degree of confidence. This idea can be expressed in quantitative terms by the use of statistical theory.^{1,2}

VI.3.3 EXAMPLE OF RANDOM-NOISE MEASUREMENT. To illustrate by an actual numerical example the type of behavior that occurs, some measurements were made of an arbitrary level of a random-noise generator in the octave band from 150 to 300 cps. With the FAST meter speed, the average of the fluctuating levels indicated on the meter was estimated to be about +5 db, where in a period of 30 seconds the level fluctuated from a minimum of +3.3 db to a maximum of +6.5 db, a range of 3.2 db. In the SLOW position the estimated level was +4.7 db, and the level fluctuated over a three-minute period from a minimum of +3.8, to a maximum of +5.7, a range of 1.9 db. Some sample readings were as follows: FAST position: 4.8, 4.1, 5.3, 3.7, 5.8, 4.9, 5.3, 5.2, 6.2, 4.6; SLOW position: 4.4, 5.1, 3.9, 4.9, 4.2, 5.0, 4.7, 4.1, 4.3, 4.9. (These sample

¹R. B. Blackman and J. W. Tukey, The Measurement of Power Spectra, Dover, New York, 1958.

²T. P. Rona, "Instrumentation for Random Vibration Analysis," pp 7-27 to 7-30 in Random Vibration, edited by S. H. Crandall, Technology Press, Cambridge, Massachusetts, 1958.

readings were taken with the help of a stroboscope, to avoid observer bias in selecting readings and to make it possible to take definite readings on the rapidly moving pointer in the FAST position.) One hundred samples were taken for each position. The average value for SLOW was +4.72, with the lowest reading +3.8 and the highest +5.8. The average for FAST was +4.74, with a low reading of +3.1 and a high reading of +6.2.

Taking such a set of readings is not the usual way to obtain the indicated level; rather, one estimates a value by observing the pointer fluctuations. But these discrete samples permit one to describe statistically the behavior that can be expected.

For the FAST position one would expect only 1 in 1000 readings to differ from the average by more than about -3 db or +2.4 db, a range of 5.4 db. The corresponding extremes for one chance in 100 is about -2.3 db or +1.9 db, a range of 4.2 db; for 1 in 10, about -1.4 to +1.2, a range of 2.6 db. Note that the range is not symmetrical.

These statements about variability can be expressed in another way, which is the converse of that above. If any reading is taken in the FAST position, the chances are only 1 in 100 that the long-time average value of the noise is below the observed value by more than 1.9 db or above the observed value by more than 2.3 db. These limits are called the 99% confidence limits.

VI.3.4 CONFIDENCE LIMITS FOR OCTAVE BANDS. A chart of the 99% confidence limits for octave bands for random noise measurement is given below:

Octave Band cps	99% Confidence Limits in db	
	Meter Speed	
	FAST	SLOW
18.75 - 37.5	-4.5, +8.0	-2.6, +3.5
37.5 - 75	-3.4, +5.0	-1.9, +2.4
75 - 150	-2.5, +3.4	-1.4, +1.7
150 - 300	-1.9, +2.3	-1.0, +1.1
300 - 600	-1.4, +1.6	-0.7, +0.8
600 - 1200	-1.0, +1.1	-0.5, +0.5
1200 - 2400	-0.7, +0.8	-0.4, +0.4
2400 - 4800	-0.5, +0.5	-0.3, +0.3
4800 - 9600	-0.3, +0.3	-0.2, +0.2

Center Freq cps	99% Confidence Limits in db	
	Meter Speed	
	FAST	SLOW
31.5	-4.2, +7.0	-2.5, +3.3
63	-3.2, +4.7	-1.8, +2.2
125	-2.4, +3.1	-1.3, +1.5
250	-1.7, +2.1	-1.0, +1.1
500	-1.2, +1.4	-0.7, +0.7
1000	-0.9, +1.0	-0.5, +0.5
2000	-0.6, +0.7	-0.3, +0.3
4000	-0.5, +0.5	-0.2, +0.2
8000	-0.3, +0.3	-0.2, +0.2
16000	-0.2, +0.2	-0.1, +0.1

These ranges of uncertainty can be reduced by the use of the average of a number of independent readings. The reduction in the range is approximately inversely proportional to the square root of the number of independent observations. Thus, the average of four observations would reduce the uncertainty to about one-half that shown.

The range of uncertainty is sometimes called the statistical error.

VI.3.5 AVERAGING BY OBSERVATION. When one observes the fluctuations for a time and estimates an average, the extent of the reduction of the uncertainty is limited by the fact that all the observations are not independent, and one can remember and use only a small portion of the total observed behavior. The observations are not independent because of the finite time required for the pointer to assume a new value. In the FAST position of the meter one should allow about a half second between observations; in the SLOW position, an interval of one to two seconds is desirable.

VI.3.6 DURATION OF A SAMPLE. The uncertainty that results from the limited observation time in comparison with the detail desired in the frequency domain occurs for other time limitations as well. Moreover, some of these may not be under the control of the operator. Thus, the sound source may not perform uniformly over an extended period of time; for example, a rocket may run for only a fraction of a minute. During launch, the time available for observing a rocket may be only a few seconds or less.

When a noise signal, recorded on a magnetic tape recorder, is to be studied, it is customary to take short samples for analysis. These samples are cut from the full recording and formed into loops that can be run continuously in the recorder.

This procedure directly limits the fineness of detail possible in the analysis and also limits the accuracy with which one can determine the actual level in a band.

This limitation of accuracy results from the fact that the maximum time during which independent information can be obtained is the sample duration. If the noise is sufficiently uniform with time, a longer sample can be used to obtain increased accuracy, or measurements on a number of samples can be averaged.

Because of the inherent variability of random noise, analyses of distinct samples of the same noise will not yield identical results. The expected spread in values predicted by statistical theory can be used as a guide in judging whether the results of such analyses agree well enough to be useful. Unless this inherent variability is appreciated, one can be led into rejecting useful data, rejecting a useful analysis system, or placing too much reliance on a particular measurement.

VI.4 FLUCTUATIONS PRODUCED IN PRACTICE.

The table of values shown for the octave bands is based on the analysis of noise that is uniform in energy per cycle per second throughout the band. In the wider bands the values shown are misleading for acoustical signals, because the energy is not uniformly distributed. One should expect from such values that when the full range of a sound-level meter is used, the fluctuations would be a small fraction of a decibel. As a matter of fact, one can find many examples of an over-all sound level that fluctuates over many decibels.

One example is the background noise of private offices. Here, for C weighting in the SLOW meter position, one can commonly find fluctuations of three or more decibels. The fluctuation corresponds to a band that is only tens of cycles wide rather than 8000 to 10,000 cps wide, such as that of the response of the sound-level meter. This is because the energy in the sound is concentrated in the low frequencies over a relatively narrow band. The fluctuations reflect only the relation between the equivalent frequency band of the signal applied to the metering circuit and the averaging time of the circuit. Whether the energy is concentrated in a narrow band by means of an electrical analyzer or by the source and path to the microphone is immaterial.

VI.4.1 INTERPRETATION OF THE FLUCTUATIONS. One can conclude, then, that if the observed fluctuations are significantly greater than would be expected, an important part of the random-noise energy is concentrated in a band or bands that are narrower than the pass band of the measuring system. (Another possibility is that the type of noise is sufficiently dif-

ferent from normal that the fluctuations for a given bandwidth are inherently excessive. This behavior is possible for a tone whose frequency varies in a region where the response of the measuring system varies markedly with frequency.)

It is also clear that if the fluctuations are significantly smaller than would be expected, the noise very likely includes some discrete tones that have significant amounts of energy.

DEFINITIONS

This section on definitions includes most of the technical terms used in this handbook. Most of the definitions are selected from the American Standard Acoustical Terminology (S1.1-1960), and those definitions are marked with an asterisk. The others have been adapted especially for this handbook.

A number of these definitions are very technical in order to be precise. Some readers may then find it easier to refer to the discussion in the main text of this handbook for obtaining a general understanding of some of these terms.

ACCELERATION*

Acceleration is a vector that specifies the time rate of change of velocity.

Note 1: Various self-explanatory modifiers such as peak, average, rms are often used. The time interval must be indicated over which the average (for example) was taken.

Note 2: Acceleration may be (1) oscillatory, in which case it may be defined by the acceleration amplitude (if simple harmonic) or the rms acceleration (if random), or (2) non-oscillatory, in which case it is designated "sustained" or "transient" acceleration.

ANALYZER

An analyzer is a combination of a filter system and a system for indicating the relative energy that is passed through the filter system. The filter is usually adjustable so that the signal applied to the filter can be measured in terms of the relative energy passed through the filter as a function of the adjustment of the filter response-vs-frequency characteristic. This measurement is usually interpreted as giving the distribution of energy of the applied signal as a function of frequency.

ANECHOIC ROOM (FREE-FIELD ROOM)*

An anechoic room is one whose boundaries absorb effectively all the sound incident thereon, thereby affording essentially free-field conditions.

AUDIOGRAM (THRESHOLD AUDIOGRAM)*

An audiogram is a graph showing hearing loss as a function of frequency.

AUDIOMETER*

An audiometer is an instrument for measuring hearing sensitivity.

BAFFLE*

A baffle is a shielding structure or partition used to increase the effective length of the external transmission path be-

tween two points in an acoustic system as, for example, between the front and back of an electroacoustic transducer.

CONFIDENCE LIMITS

Confidence limits are the upper and lower values of the range over which a given percent probability applies. For instance, if the chances are 99 out of 100 that a sample lies between 10 and 12, the 99% confidence limits are said to be 10 and 12.

CRITICAL SPEED*

Critical speed is a speed of a rotating system that corresponds to a resonance frequency of the system.

DEAD ROOM* (See also ANECHOIC ROOM)

A dead room is a room that is characterized by an unusually large amount of sound absorption.

DECAY RATE (See RATE OF DECAY)

DECIBEL*

The decibel is one-tenth of a bel. Thus, the decibel is a unit of level when the base of the logarithm is the tenth root of ten, and the quantities concerned are proportional to power. Note 1: Examples of quantities that qualify are power (any form), sound pressure squared, particle velocity squared, sound intensity, sound energy density, voltage squared. Thus the decibel is a unit of sound-pressure-squared level; it is common practice, however, to shorten this to sound pressure level because ordinarily no ambiguity results from so doing.

Note 2: The logarithm to the base the tenth root of 10 is the same as ten times the logarithm to the base 10: e.g., for a number x^2 , $\log_{10^{0.1}} x^2 = 10 \log_{10} x^2 = 20 \log_{10} x$. This last relationship is the one ordinarily used to simplify the language in definitions of sound pressure level, etc.

DIRECTIVITY FACTOR*

(1) The directivity factor of a transducer used for sound emission is the ratio of the sound pressure squared, at some fixed distance and specified direction, to the mean-square sound pressure at the same distance averaged over all directions from the transducer. The distance must be great enough so that the sound appears to diverge spherically from the effective acoustic center of the sources. Unless otherwise specified, the reference direction is understood to be that of maximum response.

(2) The directivity factor of a transducer used for sound reception is the ratio of the square of the open-circuit voltage produced in response to sound waves arriving in a specified direction to the mean-square voltage that would be produced in a perfectly diffused sound field of the same frequency and mean-square sound pressure.

Note 1: This definition may be extended to cover the case of finite frequency bands whose spectrum may be specified.

Note 2: The average free-field response may be obtained, for example,

- (1) By the use of a spherical integrator
- (2) By numerical integration of a sufficient number of directivity patterns corresponding to different planes, or
- (3) By integration of one or two directional patterns whenever the pattern of the transducer is known to possess adequate symmetry.

DIRECTIONAL GAIN (DIRECTIVITY INDEX)*

The directional gain of a transducer, in decibels, is 10 times the logarithm to the base 10 of the directivity factor.

DISPLACEMENT*

Displacement is a vector quantity that specifies the change of position of a body or particle and is usually measured from the mean position or position of rest. In general, it can be represented by a rotation vector or translation vector or both.

EARPHONE (RECEIVER)*

An earphone is an electroacoustic transducer intended to be closely coupled acoustically to the ear.

Note: The term "receiver" should be avoided when there is risk of ambiguity.

**EFFECTIVE SOUND PRESSURE
(ROOT-MEAN-SQUARE SOUND PRESSURE)***

The effective sound pressure at a point is the root-mean-square value of the instantaneous sound pressures, over a time interval at the point under consideration. In the case of periodic sound pressures, the interval must be an integral number of periods or an interval long compared to a period. In the case of non-periodic sound pressures, the interval should be long enough to make the value obtained essentially independent of small changes in the length of the interval. Note: The term "effective sound pressure" is frequently shortened to "sound pressure."

FILTER

A filter is a device for separating components of a signal on the basis of their frequency. It allows components in one or more frequency bands to pass relatively unattenuated, and it attenuates components in other frequency bands.

FREE SOUND FIELD (FREE FIELD)*

A free sound field is a field in a homogeneous, isotropic medium free from boundaries. In practice it is a field in which the effects of the boundaries are negligible over the region of interest.

Note: The actual pressure impinging on an object (e.g., electro-acoustic transducer) placed in an otherwise free sound field will differ from the pressure which would exist at that point with the object removed, unless the acoustic impedance of the object matches the acoustic impedance of the medium.

FREQUENCY (IN CYCLES PER SECOND OR HERTZ)

Frequency is the time rate of repetition of a periodic phenomenon. The frequency is the reciprocal of the period.

g*

The quantity "g" is the acceleration produced by the force of gravity, which varies with the latitude and elevation of the point of observation. By international agreement, the value $980.665 \text{ cm/sec}^2 = 386.087 \text{ in./sec}^2 = 32.1739 \text{ ft/sec}^2$ has been chosen as the standard acceleration of gravity.

HEARING LOSS (HEARING LEVEL)

(HEARING-THRESHOLD LEVEL)*

The hearing loss of an ear at a specified frequency is the amount, in decibels, by which the threshold of audibility for that ear exceeds a standard audiometric threshold.

Note 1: See American Standard Specification for Audiometers for General Diagnostic Purposes, Z24.5-1951, or the latest approved revision.

Note 2: This concept was at one time called Deafness; such usage is now deprecated.

Note 3: Hearing Loss and Deafness are both legitimate qualitative terms for the medical condition of a moderate or a severe impairment of hearing respectively. Hearing Level, however, should only be used to designate a quantitative measure of the deviation of the hearing threshold from a prescribed standard.

IMPACT*

An impact is a single collision of one mass in motion with a second mass which may be either in motion or at rest.

ISOLATION*

Isolation is a reduction in the capacity of a system to respond to an excitation attained by the use of a resilient support. In steady-state forced vibration, isolation is expressed quantitatively as the complement of transmissibility.

JERK*

Jerk is a vector that specifies the time rate of change of the acceleration; jerk is the third derivative of the displacement with respect to time.

LEVEL*

In acoustics, the level of a quantity is the logarithm of the ratio of that quantity to a reference quantity of the same kind. The base of the logarithm, the reference quantity, and the kind of level must be specified.

Note 1: Examples of kinds of levels in common use are electric power level, sound-pressure-squared level, voltage-squared level.

Note 2: The level as here defined is measured in units of the logarithm of a reference ratio that is equal to the base of logarithms.

Note 3: In symbols

$$L = \log_r (q/q_0)$$

where L = level of kind determined by the kind of quantity under consideration, measured in units of $\log_{r,r}$
r = base of logarithms and the reference ratio

q = the quantity under consideration

q_0 = reference quantity of the same kind.

Note 4: Differences in the levels of two quantities q_1 and q_2 are described by the same formula because, by the rules of logarithms, the reference quantity is automatically divided out:

$$\log_r(q_1/q_0) - \log_r(q_2/q_0) = \log_r(q_1/q_2)$$

LIVE ROOM*

A live room is a room that is characterized by an unusually small amount of sound absorption.

LOUDNESS*

Loudness is the intensive attribute of an auditory sensation, in terms of which sounds may be ordered on a scale extending from soft to loud.

Note: Loudness depends primarily upon the sound pressure of the stimulus, but it also depends upon the frequency and wave form of the stimulus.

LOUDNESS CONTOUR*

A loudness contour is a curve that shows the related values of sound pressure levels and frequency required to produce a given loudness sensation for the typical listener.

LOUDNESS LEVEL*

The loudness level of a sound, in phons, is numerically equal to the median sound pressure level, in decibels, relative to 0.0002 microbar, of a free progressive wave of frequency 1000 cycles per second presented to listeners facing the source, which in a number of trials is judged by the listeners to be equally loud.

Note: The manner of listening to the unknown sound, which must be stated, may be considered one of the characteristics of that sound.

LOUDSPEAKER (SPEAKER)*

A loudspeaker is an electroacoustic transducer intended to radiate acoustic power into the air, the acoustic waveform being essentially equivalent to that of the electrical input.

MASKING*

(1) Masking is the process by which the threshold of audibility for one sound is raised by the presence of another (masking) sound.

(2) Masking is the amount by which the threshold of audibility of a sound is raised by the presence of another (masking) sound. The unit customarily used is the decibel.

MECHANICAL SHOCK*

Mechanical shock occurs when the position of a system is significantly changed in a relatively short time in a non-periodic manner. It is characterized by suddenness and large displacement, and develops significant inertial forces in the system.

MEL*

The mel is a unit of pitch. By definition, a simple tone of

frequency 1000 cycles per second, 40 decibels above a listener's threshold, produces a pitch of 1000 mels. The pitch of any sound that is judged by the listener to be n times that of a 1-mel tone is n mels.

MICROBAR, DYNE PER SQUARE CENTIMETER*

A microbar is a unit of pressure commonly used in acoustics. One microbar is equal to 1 dyne per square centimeter.

Note: The term "bar" properly denotes a pressure of 10^6 dynes per square centimeter. Unfortunately, the bar was once used to mean dyne per square centimeter, but this is no longer correct.

MICROPHONE*

A microphone is an electroacoustic transducer that responds to sound waves and delivers essentially equivalent electric waves.

NOISE*

(1) Noise is any undesired sound. By extension, noise is any unwanted disturbance within a useful frequency band, such as undesired electric waves in any transmission channel or device.

(2) Noise is an erratic, intermittent, or statistically random oscillation.

Note 1: If ambiguity exists as to the nature of the noise, a phrase such as "acoustic noise" or "electric noise" should be used.

Note 2: Since the above definitions are not mutually exclusive, it is usually necessary to depend upon context for the distinction.

NOISE LEVEL*

(1) Noise level is the level of noise, the type of which must be indicated by further modifier or context.

Note: The physical quantity measured (e.g. voltage), the reference quantity, the instrument used, and the bandwidth or other weighting characteristic must be indicated.

(2) For airborne sound unless specified to the contrary, noise level is the weighted sound pressure level called sound level; the weighting must be indicated.

OCTAVE*

(1) An octave is the interval between two sounds having a basic frequency ratio of two.

(2) An octave is the pitch interval between two tones such that one tone may be regarded as duplicating the basic musical import of the other tone at the nearest possible higher pitch.

Note 1: The interval, in octaves, between any two frequencies is the logarithm to the base 2 (or 3.322 times the logarithm to the base 10) of the frequency ratio.

Note 2: The frequency ratio corresponding to an octave pitch interval is approximately, but not always exactly, 2:1.

OSCILLATION*

Oscillation is the variation, usually with time, of the magnitude of a quantity with respect to a specified reference when the magnitude is alternately greater and smaller than the reference.

PEAK-TO-PEAK VALUE*

The peak-to-peak value of an oscillating quantity is the algebraic difference between the extremes of the quantity.

PHON*

The phon is the unit of loudness level. (See "Loudness Level.")

PITCH*

Pitch is that attribute of auditory sensation in terms of which sounds may be ordered on a scale extending from low to high. Pitch depends primarily upon the frequency of the sound stimulus, but it also depends upon the sound pressure and wave form of the stimulus.

Note 1: The pitch of a sound may be described by the frequency or frequency level of that simple tone, having a specified sound pressure level, which is judged by listeners to produce the same pitch.

POINT SOURCE

See "Simple Sound Source."

POWER LEVEL*

Power level, in decibels, is 10 times the logarithm to the base 10 of the ratio of a given power to a reference power. The reference power must be indicated. [The reference power is taken as 1.0×10^{-12} watt in this handbook.]

PRESBYCUSIS

Presbycusis is the condition of hearing loss specifically ascribed to aging effects.

PRESSURE SPECTRUM LEVEL*

The pressure spectrum level of a sound at a particular frequency is the effective sound pressure level of that part of the signal contained within a band 1 cycle per second wide, centered at the particular frequency. Ordinarily this has significance only for sound having a continuous distribution of energy within the frequency range under consideration. The reference pressure should be explicitly stated.

PRIMITIVE PERIOD (PERIOD)*

The primitive period of a periodic quantity is the smallest increment of the independent variable for which the function repeats itself.

Note: If no ambiguity is likely, the primitive period is simply called the period of the function.

PURE TONE

See "Simple Tone."

RANDOM NOISE*

Random noise is an oscillation whose instantaneous magnitude is not specified for any given instant of time. The instantaneous magnitudes of a random noise are specified

only by probability distribution functions giving the fraction of the total time that the magnitude, or some sequence of magnitudes, lies within a specified range.

Note: A random noise whose instantaneous magnitudes occur according to Gaussian distribution is called Gaussian random noise.

RATE OF DECAY*

The rate of decay is the time rate at which the sound pressure level (or other stated characteristic) decreases at a given point and at a given time. A commonly used unit is the decibel per second.

RESONANCE*

Resonance of a system in forced oscillation exists when any change however small in the frequency of excitation causes a decrease in the response of the system.

Note: Velocity resonance, for example, may occur at a frequency different from that of displacement resonance.

RESONANCE FREQUENCY

(RESONANT FREQUENCY)*

A resonance frequency is a frequency at which resonance exists.

Note: In case of possible confusion the type of resonance must be indicated: e.g., velocity resonance frequency.

RESPONSE*

The response of a device or system is the motion (or other output) resulting from an excitation (stimulus) under specified conditions.

Note 1: Modifying phrases must be prefixed to the term response to indicate kinds of input and output that are being utilized.

Note 2: The response characteristic, often presented graphically, gives the response as a function of some independent variable such as frequency or direction. For such purposes it is customary to assume that other characteristics of the input (for example, voltage) are held constant.

REVERBERATION*

1. Reverberation is the persistence of sound in an enclosed space, as a result of multiple reflections after the sound source has stopped.

2. Reverberation is the sound that persists in an enclosed space, as a result of repeated reflection or scattering, after the source of sound has stopped.

Note: The repeated reflections of residual sound in an enclosure can alternatively be described in terms of the transient behavior of the modes of vibration of the medium bounded by the enclosure.

REVERBERATION TIME*

The reverberation time of a room is the time that would be required for the mean squared sound pressure level therein, originally in a steady state, to decrease 60 db after the source is stopped.

SIMPLE SOUND SOURCE*

A simple sound source is a source that radiates sound uniformly in all directions under free-field conditions.

SIMPLE TONE (PURE TONE)*

1. A simple tone is a sound wave, the instantaneous sound pressure of which is a simple sinusoidal function of the time.
2. A simple tone is a sound sensation characterized by its singleness of pitch.

Note: Whether or not a listener hears a tone as simple or complex is dependent upon ability, experience, and listening attitude.

SONE*

The sone is a unit of loudness. By definition, a simple tone of frequency 1000 cycles per second, 40 decibels above a listener's threshold, produces a loudness of 1 sone. The loudness of any sound that is judged by the listener to be n times that of the 1-sone tone is n sones.

Note 1: A millison is equal to 0.001 sone.

Note 2: The loudness scale is a relation between loudness and level above threshold for a particular listener. In presenting data relating loudness in sones to sound pressure level, or in averaging the loudness scales of several listeners, the thresholds (measured or assumed) should be specified.

SONICS*

Sonics is the technology of sound in processing and analysis. Sonics includes the use of sound in any noncommunication process.

SOUND*

1. Sound is an oscillation in pressure, stress, particle displacement, particle velocity, etc., in a medium with internal forces (e.g. elastic, viscous), or the superposition of such propagated alterations.
2. Sound is an auditory sensation evoked by the oscillation described above.

Note 1: In case of possible confusion the term "sound wave" or "elastic wave" may be used for concept (1), and the term "sound sensation" for concept (2). Not all sound waves can evoke an auditory sensation: e.g. ultrasound.

Note 2: The medium in which the source exists is often indicated by an appropriate adjective: e.g. airborne, waterborne, structureborne.

SOUND INTENSITY (SOUND POWER DENSITY) (SOUND-ENERGY FLUX DENSITY)*

The sound intensity in a specified direction at a point is the average rate of sound energy transmitted in the specified direction through a unit area normal to this direction at the point considered.

SOUND LEVEL*

Sound level is a weighted sound pressure level obtained by

the use of metering characteristics and the weighting specified in the American Standard Sound Level Meters for Measurement of Noise and Other Sounds, Z24.3-1944, or the latest approved revision thereof. The weighting employed must always be stated. The reference pressure is 0.0002 microbar.

Note: A suitable method of stating the weighting is, for example, "The A sound level was 43 db."

SOUND LEVEL METER*

A sound level meter is an instrument including a microphone, an amplifier, an output meter, and frequency weighting networks for the measurement of noise and sound levels in a specified manner.

Note: Specifications for sound level meters for measurement of noise and other sounds are given in American Standard Sound Level Meters for Measurement of Noise and Other Sounds, Z24.3-1944, or the latest approved revision thereof.

SOUND PRESSURE LEVEL*

The sound pressure level, in decibels, of a sound is 20 times the logarithm to the base 10 of the ratio of the pressure of this sound to the reference pressure. The reference pressure shall be explicitly stated.

Note 1: The following reference pressures are in common use;

(a) 2×10^{-4} microbar

(b) 1 microbar

Reference pressure (a) is in general use for measurements concerned with hearing and with sound in air and liquids, while (b) has gained widespread acceptance for calibrations of transducers and various kinds of sound measurements in liquids.

[The reference pressure used in this handbook is 2×10^{-4} microbar.]

Note 2: Unless otherwise explicitly stated, it is to be understood that the sound pressure is the effective (rms) sound pressure.

Note 3: It is to be noted that in many sound fields the sound pressure ratios are not the square roots of the corresponding power ratios.

SPECTRUM*

1. The spectrum of a function of time is a description of its resolution into components, each of different frequency and (usually) different amplitude and phase.

2. "Spectrum" is also used to signify a continuous range of components, usually wide in extent, within which waves have some specified common characteristic; e.g., "audio-frequency spectrum."

Note 1. The term spectrum is also applied to functions of variables other than time, such as distance.

The speech interference level of a noise is the average, in decibels, of the sound pressure levels of the noise in the three octave bands of frequency 600-1200, 1200-2400, and 2400-4800 cps.

STANDING WAVE*

A standing wave is a periodic wave having a fixed distribution in space which is the result of interference of progressive waves of the same frequency and kind. Such waves are characterized by the existence of nodes or partial nodes and antinodes that are fixed in space.

THRESHOLD OF AUDIBILITY

(THRESHOLD OF DETECTABILITY)*

The threshold of audibility for a specified signal is the minimum effective sound pressure level of the signal that is capable of evoking an auditory sensation in a specified fraction of the trials. The characteristics of the signal, the manner in which it is presented to the listener, and the point at which the sound pressure is measured must be specified. Note 1: Unless otherwise indicated, the ambient noise reaching the ears is assumed to be negligible.

Note 2: The threshold is usually given as a sound pressure level in decibels, relative to 0.0002 microbar.

Note 3: Instead of the method of constant stimuli, which is implied by the phrase "a specified fraction of the trials," another psychophysical method (which should be specified) may be employed.

THRESHOLD OF FEELING (OR TICKLE)*

The threshold of feeling (or tickle) for a specified signal is the minimum sound pressure level at the entrance to the external auditory canal which, in a specified fraction of the trials, will stimulate the ear to a point at which there is a sensation of feeling that is different from the sensation of hearing.

TONE*

(a) A tone is a sound wave capable of exciting an auditory sensation having pitch.

(b) A tone is a sound sensation having pitch.

TRANSDUCER*

A transducer is a device capable of being actuated by waves from one or more transmission systems or media and of supplying related waves to one or more other transmission systems or media.

Note: The waves in either input or output may be of the same or different types (e.g., mechanical, or acoustic).

TRANSIENT VIBRATION*

Transient vibration is temporarily sustained vibration of a mechanical system. It may consist of forced or free vibration or both.

ULTRASONICS*

Ultrasonics is the technology of sound at frequencies above the audio range.

Note: Supersonics is the general subject covering phenomena associated with speed higher than the speed of sound (as in the case of aircraft and projectiles traveling faster than sound). This term was once used in acoustics synonymously with "ultrasonics"; such usage is now deprecated.

VELOCITY*

Velocity is a vector that specifies the time rate of change of displacement with respect to a reference frame.

Note: If the reference frame is not inertial, the velocity is often designated relative velocity.

VIBRATION*

Vibration is an oscillation wherein the quantity is a parameter that defines the motion of a mechanical system.

VIBRATION ISOLATOR*

A vibration isolator is a resilient support that tends to isolate a system from steady-state excitation.

VIBRATION METER (VIBROMETER)*

A vibration meter is an apparatus for the measurement of displacement, velocity, or acceleration of a vibrating body.

WHITE NOISE*

White noise is a noise whose spectrum density (or spectrum level) is substantially independent of frequency over a specified range.

Note: White noise need not be random.

*This material is reproduced from the American Standard Acoustical Terminology, S1.1-1960, copyrighted by ASA, copies of which may be purchased from the American Standards Association at 10 East 40th Street, New York 16, N. Y.

WORDS COMMONLY USED TO DESCRIBE SOUNDS

The words listed below are commonly used to describe sounds of various types. Such words are often helpful in conveying information on the general nature of a sound.

BANG	CLINK	JANGLE	RUSTLE	THUMP
BARK	CLUCK	KNOCK	SCREAM	THUNDER
BELLOW	CLUNK	MEW	SCREECH	TICK
BLARE	CRACK	MOAN	SHRIEK	TINKLE
BLAST	CRACKLE	MOO	SIZZLE	TOOT
BLEAT	CREAK	MURMUR	SLAM	TRILL
BONG	DINGDONG	NEIGH	SNAP	TWANG
BOOM	DRUMMING	PATTER	SNARL	TWITTER
BRAY	FIZZ	PEAL	SNORT	WAIL
BUZZ	GOBBLE	PEEP	SPLASH	WHEEZE
CACKLE	GROAN	PING	SQUAWK	WHINE
CHEEP	GROWL	POP	SQUEAK	WHIR
CHIME	GRUMBLE	POUNDING	SQUEAL	WHISPER
CHIRP	GRUNT	PULSING	SQUISH	WHISTLE
CLACK	GURGLE	PURR	STAMP	YAP
CLANG	HISS	RAP	SWISH	YELP
CLANK	HOOT	RATTLE	TAP	
CLAP	HOWL	RING	TATTOO	
CLATTER	HUM	ROAR	THROB	
CLICK	JINGLE	RUMBLE	THUD	

REFERENCES

STANDARDS

The following standards in acoustics and mechanical shock and vibration can be purchased from the American Standards Association, 10 East 40th Street, New York 17, New York:

S1.1-1960	Acoustical Terminology
S1.2-1962	Physical Measurement of Sound
S1.4-1961	General-Purpose Sound Level Meters
S1.6-1960	Preferred Frequencies for Acoustical Measurements
S2.1-1961	Shock Testing Machine
S2.2-1959	Calibration of Shock and Vibration Pickups
S2.4-1960	Specifying the Characteristics of Auxiliary Equipment
S2.5-1962	Specifying the Performance of Vibration Machines
S3.1-1960	Criteria for Background Noise in Audiometer Rooms
S3.2-1960	Measurement of Monosyllabic Word Intelligibility
S3.3-1960	Electroacoustical Characteristics of Hearing Aids
S3.4	Computation of the Loudness of Noise
Z24.4-1949	Pressure Calibration of Laboratory Standard Pressure Microphones
Z24.5-1951	Audiometers for General Diagnostic Purposes
Z24.8-1949	Specification for Laboratory Standard Pressure Microphones
Z24.9-1949	Coupler Calibration of Earphones
Z24.10-1953	Octave Band Filter Set
Z24.11-1954	Free-Field Secondary Calibration of Microphones
Z24.12-1952	Pure-Tone Audiometers for Screening Purposes
Z24.13-1953	Speech Audiometers
Z24.15-1955	Specifying the Characteristics of Analyzers
Z24.17-1955	Class H I (High-Impact) Shock-Testing Machine
Z24.19-1957	Laboratory Measurement of Air-Borne Sound Transmission Loss of Building Floors and Walls

- Z24.21-1957 Specifying the Characteristics of Pickups for Shock and Vibration Measurements
- Z24.22-1957 Measurement of the Real-Ear Attenuation of Ear Protectors at Threshold
- Z24.24-1957 Calibration of Electroacoustic Transducers (Particularly Those for Use in Water)

as well as the following recommendations of the International Organization for Standardization:

- ISO/R131-1959 Expression of the physical and subjective magnitudes of sound or noise
- ISO/R140-1960 Field and laboratory measurements of airborne and impact sound transmission
- ISO/R226-1961 Normal equal-loudness contours for pure tones
- ISO/R266-1962 Preferred frequencies for acoustical measurements
- IEC/123-1961 Sound level meters

GENERAL REFERENCES

- L. L. Beranek, editor, Noise Reduction, McGraw-Hill: New York, 1960.
- L. L. Beranek, Acoustic Measurements, John Wiley: New York, 1949.
- L. L. Beranek, Acoustics, McGraw-Hill: New York, 1954.
- L. C. Cremer, editor, Proceedings of the Third International Congress on Acoustics, Stuttgart, 1959, Elsevier: Amsterdam, 1961.
- C. M. Harris, editor, Handbook of Noise Control, McGraw-Hill: New York, 1957.
- T. F. Hueter and R. H. Bolt, Sonics, John Wiley: New York, 1955.
- L. E. Kinsler and A. R. Frey, Fundamentals of Acoustics, John Wiley: New York, 1962.
- H. F. Olson, Acoustical Engineering, D. Van Nostrand: New York, 1957, 3rd Edit.
- R. H. Randall, An Introduction to Acoustics, Addison-Wesley Press: Cambridge, Mass., 1951.
- E. G. Richardson, editor, Technical Aspects of Sound, Elsevier: Amsterdam; Vol 1, 1953; Vol 2, 1957.
- G. W. Swenson, Jr., Principles of Modern Acoustics, D. Van Nostrand: New York, 1953.
- School of Public Health, University of Michigan, Noise, University of Michigan Press: Ann Arbor, 1952.
- American Industrial Hygiene Association, Industrial Noise Manual, AIHA: Detroit 27, Michigan, 1958.
- American Industrial Hygiene Association Journal, AIHA: Detroit 27, Michigan.

- Acoustical Society of America, 335 East 45th Street, New York 17, New York. (The Acoustical Society has published in its Journal numerous papers on the subjects discussed in the handbook. Cumulative indexes to the Journal and to other acoustical literature for the years 1928-1958 are available from the Society.)
- Acustica, S. Hirzel, Zurich 4, Switzerland (an international journal on acoustics published since 1951).
- The Journal of the Acoustical Society of Japan (in Japanese), c/o Aeronautical Research Institute, University of Tokyo, Komaba, Meguro-ku, Tokyo.
- Lärbekämpfung, Verlag für angewandte Wissenschaften GmbH, Baden-Baden, Germany.
- National Noise Abatement Council, New York, and Armour Research Foundation, Chicago, Proceedings, National Noise Abatement Symposium, 1950-1953 (subsequent proceedings have been superseded by particular issues of Noise Control).
- Sound, American Institute of Physics, 335 East 45th Street, New York 17, New York. (The subjects covered in this journal include control of noise, shock, and vibration, and this journal is the one most useful for those interested in the latest information on such subjects. This journal replaces Noise Control.)
- Soviet Physics - Acoustics (a translation of "Akusticheskii Zhurnal" of the Academy of Sciences of the USSR, published by American Institute of Physics, 335 East 45th Street, New York 17, N. Y.).

HEARING

- D. E. Broadbent, Perception and Communication, Pergamon Press: New York, 1958.
- H. Davis, Editor, Hearing and Deafness - A Guide for Laymen, Murray Hill Books: New York, 1947.
- H. Fletcher, Speech and Hearing in Communication, D. Van Nostrand: New York, 1953.
- A. Glorig, Noise and Your Ear, Grune & Stratton: New York, 1958.
- I. J. Hirsh, The Measurement of Hearing, McGraw-Hill: New York, 1952.
- K. D. Kryter, "The Effects of Noise on Man," Journal of Speech and Hearing Disorders, American Speech and Hearing Association, Monograph Supplement 1, 1950.
- W. A. Rosenblith and K. N. Stevens, Handbook of Acoustic Noise Control, Vol II Noise and Man, WADC Technical Report 52-204, PB111274, Office of Technical Services, Department of Commerce, Washington 25, DC, June 1953.
- J. Sataloff, Industrial Deafness, Blakiston Division, McGraw-Hill: New York, 1957.

- S. S. Stevens, editor, Handbook of Experimental Psychology, John Wiley: New York, 1951.
- S. S. Stevens and H. Davis, Hearing, John Wiley: New York, 1938.
- American Standards Association Subcommittee Z24-X-2, "The Relations of Hearing Loss to Noise Exposure." ASA: New York, January, 1954.
- N. L. Carter and K. T. Kryter, "Masking of Pure Tones and Speech," The Journal of Auditory Research, Vol 2, No. 1, January, 1962, pp 66-98.
- J. P. Egan and A. W. Hake, "On the Masking Pattern of a Simple Auditory Stimulus," Journal of the Acoustical Society of America, Vol 22, September, 1950, pp 622-630.
- I. Pollack, "The Loudness of Bands of Noise," Journal of the Acoustical Society of America, Vol 24, September, 1952, pp 533-538.
- D. W. Robinson and R. S. Dadson, "A Re-determination of the Equal Loudness Relations for Pure Tones," British Journal of Applied Physics, Vol 7, May, 1956, pp 166-181.
- D. W. Robinson, "A New Determination of the Equal-Loudness Contours," IRE Transactions on Audio, Vol AU-6, January-February 1958, pp 6-13.
- S. S. Stevens, "Procedure for Calculating Loudness," Journal of the Acoustical Society of America, Vol 33, No. 11, November, 1961, pp 1577-1585.
- W. D. Ward, A. Glorig, and D. L. Sklar, "Temporary Threshold Shift from Octave-Band Noise: Applications to Damage-Risk Criteria," Journal of the Acoustical Society of America, Vol 31, April, 1959, pp 522-528.
- C. D. Yaffe and H. H. Jones, Noise and Hearing, Public Health Service Publication No. 850, U. S. Government Printing Office: Washington, D. C., 1961.
- International Audiology; Secrétariat de la Société Internationale d'Audiologie, 4, Rue Montvert, Lyon 8^e, France.
- The Journal of Auditory Research, The C. W. Shilling Auditory Research Center, 348 Long Hill Road, Groton, Connecticut.

MEASUREMENT OF NOISE

- National Physical Laboratory, "Noise Measurement Techniques," Notes on Applied Science, No. 10, Her Majesty's Stationery Office: London, 1955.
- H. C. Hardy, "Standard Mechanical Noise Sources," Noise Control, Vol 5, May, 1959, pp 22-25.
- R. T. Jenkins, "A New Sound Integrator," Bell Laboratories Record, Vol 32, September, 1954, pp 331-335.
- W. B. Snow, "Significance of Readings of Acoustical Instrumentation," Noise Control, September, 1959, pp 304-307, 329.

- R. V. Waterhouse, "Output of a Sound Source in a Reverberation Chamber and Other Reflecting Environments", Journal of the Acoustical Society of America, Vol 30, April, 1958, pp 4-13.
- R. W. Young, A Brief Guide to Noise Measurement and Analysis, Research and Development Report 609, US Navy Electronics Laboratory, San Diego, California, PB118036.
- R. W. Young, "Sabine Reverberation Equation and Sound Power Calculations," Journal of the Acoustical Society of America, Vol 31, July, 1959, pp 912-921.

NOISE CONTROL

- L. L. Beranek, editor, Noise Reduction, McGraw-Hill: New York, 1960.
- R. H. Bolt et al, editors, Handbook of Acoustic Noise Control, Vol I, Physical Acoustics, WADC Technical Report 52-204, PB111200, Office of Technical Services, Department of Commerce, Washington 25, DC, December, 1952, S. J. Lukasik and A. W. Nolle, editors, Supplement 1, April 1955, PB111200S.
- P. V. Brüel, Sound Insulation and Room Acoustics, Chapman and Hall: London, 1951.
- P. H. Geiger, Noise Reduction Manual, PB110828, OTS, Department of Commerce, Washington 25, DC, 1952.
- C. M. Harris (See General References).
- P. H. Parkin and H. R. Humphreys, Acoustics, Noise, and Buildings, F. A. Praeger: New York, 1958.
- V. O. Knudsen and C. M. Harris, Acoustical Designing in Architecture, John Wiley: New York, 1950.
- H. J. Sabine, Less Noise - Better Hearing, Celotex Corporation: Chicago, 1950.
- Lärmbekämpfung (See General References).

NOISE CRITERIA

- L. L. Beranek, "Revised Criteria for Noise in Buildings," Noise Control, Vol 3, January, 1957, pp 19-27.
- L. L. Beranek, K. D. Kryter, and L. N. Miller, "Reaction of People to Exterior Aircraft Noise," Noise Control, Vol 5, September, 1959, pp 23-31.
- L. L. Beranek (See General References).
- D. E. Broadbent, op cit.
- T. F. W. Embleton, I. R. Dagg, and G. J. Thiessen, "Effect of Environment on Noise Criteria," Noise Control, Vol 5, November, 1959, pp 37-40.
- A. Glorig, op cit.
- C. M. Harris (See General References).
- K. D. Kryter, "Noise Control Criteria for Buildings," Noise Control, Vol 3, November, 1957, pp 14-20.

- D. P. Loye, "Much Needed Motor Vehicle Noise Control," Noise Control, Vol 5, July, 1959, pp 30-35.
- W. A. Rosenblith, op cit.
- R. W. Young, "Comments on 'Effect of Environment on Noise Criteria,'" Noise Control, Vol 5, November, 1959, p 44.
- R. W. Young, "Don't Forget the Simple Sound-Level Meter," Noise Control, Vol 4, May, 1958, pp 42-43.

ACOUSTICAL MATERIALS

- Acoustical Materials Association (59 East 55th Street, New York 22, New York), Sound Absorption Coefficients of Architectural Acoustical Materials.
- National Bureau of Standards, US Department of Commerce, "Sound Absorption Coefficients of the More Common Acoustic Materials," Letter Circular, LC 870.
- National Bureau of Standards, US Department of Commerce, "Sound Insulation of Wall and Floor Constructions," Building Materials and Structures Report BMS144, February 25, 1955. Supplement, February 27, 1956.
- C. Zwicker and C. W. Kosten, Sound Absorbing Materials, Elsevier: New York, 1949.

AUXILIARY EQUIPMENT

- D. C. Apps, "Use of Binaural Tape Recording in Automotive Noise Problems," Journal of the Acoustical Society of America, Vol 24, November, 1952, pp 660-662.
- J. F. Rider and S. D. Uslan, Encyclopedia on Cathode-Ray Oscilloscopes and their Uses, John F. Rider Publisher: New York, 1950.
- D. A. Snel, Magnetic Sound Recording, Philips' Technical Library: Netherlands, 1959.
- H. G. M. Spratt, Magnetic Tape Recording, Heywood: London, 1958.
- W. E. Stewart, Magnetic Recording Techniques, McGraw-Hill: New York, 1958.
- J. Tall, Techniques of Magnetic Recording, MacMillan: New York, 1958.

VIBRATION

- J. N. Brennan, editor, Bibliography on Shock and Shock Excited Vibrations, Pennsylvania State University: University Park, September, 1957.
- British Internal Combustion Engine Research Association, A Handbook on Torsional Vibration, University Press: Cambridge, 1958.
- S. H. Crandall, editor, Random Vibration, Technology Press of the MIT: Cambridge, Massachusetts, 1958.

- C. E. Crede, Vibration and Shock Isolation, John Wiley: New York, 1951.
- J. P. Den Hartog, Mechanical Vibrations, McGraw-Hill: New York, 1956.
- C. M. Harris and C. E. Crede, editors, Shock and Vibration Handbook, McGraw-Hill: New York, 1961.
- C. T. Morrow, Shock and Vibration Engineering, John Wiley: New York, 1963.
- J. Ormondroyd, R. B. Allnut, F. Mintz, and R. D. Specht, "Motion Measurements," Handbook of Experimental Stress Analysis, Edited by M. Hetenyi, John Wiley: New York, 1950, Chapter 8, pp 301-389.
- J. N. MacDuff and J. R. Curreri, Vibration Control, McGraw-Hill: New York, 1958.
- R. T. McGoldrick, A Vibration Manual for Engineers, 2nd Ed., US Navy, PB131785, December, 1957.
- R. T. McGoldrick, Ship Vibration, David Taylor Model Basin, Report 1451, December, 1960.
- G. W. Van Santen, Mechanical Vibration, Philips Technical Library, Elsevier: Houston, 1953.
- W. Ker Wilson, Vibration Engineering, Charles Griffin: London, 1959.
- American Society of Mechanical Engineers, Shock and Vibration Instrumentation, ASME: New York, 1952.
- A. E. W. Austen and T. Priede, "Origins of Diesel Engine Noise," Proceedings of the Symposium on Engine Noise and Noise Suppression, London, 24 Oct 1958, Institution of Mechanical Engineers.
- VDI 205-210, Messung mechanischer Schwingungen, Verein Deutsches Ingenieure, Dusseldorf, October, 1956.
- Environmental Quarterly, 252-46 Leeds Road, Little Neck 62, N. Y.
- Experimental Mechanics, Society for Experimental Stress Analysis, 21 Bridge Square, Westport, Connecticut.
- The Journal of Environmental Sciences, Institute of Environmental Sciences, 34 S. Main St., Mt. Prospect, Illinois.
- Sound (See General References).
- Test Engineering, 61 Monmouth Road, Oakhurst, N. J.

CATALOG SECTION

The following pages include detailed specifications for General Radio sound- and vibration-measuring instruments and accessories. Further information may be obtained from General Radio, which maintains sales engineering offices in West Concord, Mass., and in the following metropolitan areas: New York, Philadelphia, Washington, Orlando, Dallas, Chicago, Los Angeles, San Francisco, Syracuse, and Toronto. Overseas, General Radio is represented by its wholly owned subsidiary, General Radio Company (Overseas), Zurich, Switzerland, and by representatives in many countries.

Prices and specifications given are subject to change without notice.



Type 1555-A SOUND-SURVEY METER

FEATURES:

- ♦ Small enough to fit in pocket.
- ♦ Can be used set on a table, mounted on a tripod, or held in the hand.
- ♦ Miniature in size, yet uses standard and well-tested components.

The TYPE 1555-A Sound-Survey Meter is an inexpensive, pocket-sized instrument for use in general survey measurements. Some of the many uses of this versatile meter are:

Measurement of noise levels in homes, offices, factories, and outdoor locations.

Measurements of noise levels produced by appliances, office equipment, and machinery.

Measurement of sirens and other warning systems.

Measurement of level and dispersion pattern of reproduced sound from public address systems, theaters, and home sound systems.

Field surveys for acoustic material companies.

Acoustical experiments in physics classes.

Measurements of cross-over characteristics and dynamic range of high-fidelity music-reproducing systems.

Frequency-response measurements on loudspeakers and rooms.

Loudness checks on speakers and singers, at rehearsals and in classes.

DESCRIPTION: The TYPE 1555-A Sound-Survey Meter consists of a nondirectional microphone, a continuously adjustable, calibrated attenuator, a stable amplifier with three weighting networks, and an easily read indicating meter. The entire assembly, including microphone and batteries, is housed in a rugged, two-piece aluminum case. The attenuator and weighting-network selector are fingertip-operated, permitting operation of the instrument with one hand. No provision is made for connection of an analyzer, but, by comparing measurements in different weighting positions, one can estimate the relative importance of low-frequency components in the sound being measured.

SPECIFICATIONS

Range: 40 to 136 db (re 0.0002 μ bar).

Frequency Characteristics: Any one of three different frequency characteristics can be selected by the FUNCTION switch. For c weighting, the frequency response is substantially flat from 40 to 8000 cps. The A- and B-weighting positions follow, respectively, the 40- and 70-db contours used as the weighting for sound-level meters.

Accuracy: The gain of the amplifier is so set that the sensitivity of the instrument is correct at 400 cps within ± 1 db.

Stability: The amplifier is stabilized by feedback to minimize the effect of changes in battery voltage. Temperature and humidity changes over the normal range of room conditions have no noticeable effect. The temperature coefficient of the sound-level indication is low, in the order of 0.03 db/°F.

Operating Limits: The maximum safe operating temperature of the instrument is 115°F. Temperatures above 130°F will permanently damage the Rochelle-salt crystal in the microphone.

Microphone: A crystal-diaphragm-type microphone is mounted at the top of the instrument.

Batteries: One 1½-volt size C flashlight battery (Rayovac 1LP or equivalent) and one 30-volt hearing-aid battery (Eveready 413E or equivalent) are supplied.

Case: Aluminum, finished in crackle, with a standard ¼-20 threaded tripod mount. A leather "ever-ready" carrying case (not supplied with the sound-survey meter, but available separately) permits operation of the instrument without removal from the case.

Dimensions: Width 3½, height 6, depth 2½ inches (80 by 155 by 65 mm), over-all.

Net Weight: 2 pounds (0.9 kg) with batteries.

Shipping Weight: 2½ pounds (1.3 kg); case, ¾ pound (0.3 kg).

The Primer of Noise Measurement, free on request, discusses sound and noise measurements possible with this instrument.

Type		Code Number	Price
1555-A	Sound-Survey Meter	1555-9701	\$185.00
	Set of Replacement Batteries		1.95
1555-P2	Leather Carrying Case	1555-9602	10.00



Type 1551-C SOUND-LEVEL METER

USES:

The TYPE 1551-C Sound-Level Meter is an accurate, portable instrument designed to meet American Standards Association specifications. In its primary function as a noise meter, this is the accepted instrument for the measurement of both product noise and environmental noise by industry, laboratories, regulatory bodies, and noise-abatement groups.

Typical users include:

MACHINE AND APPLIANCE MANUFACTURERS, in industrial and development laboratories as well as on the production line. The sound-level meter provides a means of establishing noise standards and of accepting or rejecting products on the basis of noise tests.

ACOUSTICAL ENGINEERS AND PHYSICISTS, for the measurement of machinery noise and for determining the acoustical properties of buildings, vehicles, and materials.

INDUSTRIAL HYGIENISTS AND PSYCHOLOGISTS, in surveys of the psychological and physiological effects of noise and for the determination of satisfactory noise environments in factories and offices.

In addition to its primary use as a self-contained sound-level meter, the TYPE 1551-C is the heart of a complete sound-measuring system, which includes spectrum analyzers, special-purpose microphones, calibrators, and vibration pickups. Many other accessories, such as graphic level recorders and tape recorders, can also be operated from the sound-level-meter output.

This sound-level meter can also be used as a portable amplifier, attenuator, and voltmeter for laboratory measurements in the audio-frequency range.

DESCRIPTION: The TYPE 1551-C Sound-Level Meter consists of a nondirectional microphone, a calibrated attenuator, an amplifier, standard weighting networks, and an indicating meter. The complete instrument, including batteries, is mounted in an aluminum case. The microphone can be used in either a vertical or a horizontal position and, when not in use, folds down into a storage position, automatically disconnecting batteries. An ac power-supply unit is available.

FEATURES:

- ◆ Small, compact, and portable — weighs less than 8 pounds with batteries.
- ◆ Simple to operate.
- ◆ Meets requirements of ASA S1.4-1961 and IEC Publication 123, 1961.
- ◆ Wide dynamic range.
- ◆ Two-speed meter movement permits measurement of either steady or fluctuating sound.
- ◆ Wide sound-level range — from 24 to 150 db.
- ◆ Uses readily available batteries.
- ◆ Wide frequency response of amplifiers and panel meter — from 20 cps to 20 kc.
- ◆ Low internal noise level.
- ◆ Internal calibration system for standardizing gain.
- ◆ Quasi-rms meter; indication is essentially rms for all waveforms except short impact pulses.

SPECIFICATIONS

Sound-Level Range: From 24 to 150 db ($\approx 0.0002 \mu\text{bar}$).

Frequency Characteristics: Any one of four response characteristics, A, B, C, or 20 kc, can be selected by a panel switch.

The A-, B-, and C-weighting positions are in accordance with ASA S1.4-1961.

Frequency response for the 20-kc position is flat from 20 cps to 20 kc, so that complete use can be made of wide-range microphones such as the TYPE 1551-P1 Condenser Microphone System.

Microphone: The microphone is a highly stable PZT ceramic type. A condenser microphone is available as an accessory.

Sound-Level Indication: Sound level is indicated by the sum of the meter and attenuator readings. The clearly marked, open-scale meter covers a span of 16 db with calibration from -6 to 10 db. The attenuator is calibrated in 10-db steps from 30 to 140 db above 0.002 μbar .

Output: An output of 1 volt across 20,000 ohms (when the panel meter is at full scale) is available at an output jack. The output can be used to drive frequency analyzers, recorders, and oscilloscopes.

Input Impedance: 25 megohms in parallel with 50 pf.

Output Impedance: 7000 ohms.

Meter Damping: The panel meter has two different damping characteristics; either FAST or SLOW response can be selected by a panel switch. The meter ballistics comply with current ASA standards.

Calibration: Built-in calibration circuit standardizes the sensitivity of the electrical circuits in the sound-level meter within ± 1 db at 400 cps, as specified in ASA standards. The TYPE 1552-B Sound-Level





The Type 1551-C Sound-Level Meter with the microphone in the storage position and batteries automatically disconnected.



The sound-level meter is here operated while in its leather carrying case, with the microphones in the horizontal operating position.



The Type 1551-C Sound-Level Meter can be ac-operated by means of the Type 1262-B Power Supply, which plugs directly into the base of the sound-level meter.

Calibrator is available for making periodic acoustical checks on the over-all calibration, including microphone. The PZT microphone can be accurately calibrated with the TYPE 1559-A Microphone Reciprocity Calibrator, which can also be used for over-all acoustical checks of the sound-level meter.

Environmental Effects: Readings are independent (within 1 db) of temperature and humidity over normal ranges of room conditions.

Power Supply: Two 1½-volt size D flashlight cells (Rayovac 2L1⁰ or equivalent) and one 67½-volt battery (Burgess XX45 or equivalent) are supplied. An ac power supply, the Type 1262-B, is available.

Accessories Supplied: Telephone plug.

Accessories Available: Type 1551-P2 Leather Case, which permits

operation of the instrument without removal from the case. Type 1560-P95 Adaptor Cable Assembly, for connecting output to Type 1521-A Graphic Level Recorder.

Cabinet: Shielded aluminum, finished in gray crinkle. **Dimensions:** Width 7¼, height 9¼, depth 6¼ inches (185 by 235 by 160 mm), over-all.

Net Weight: 7¾ pounds (3.5 kg) with batteries; 9¾ pounds (4.4 kg), including leather case.

Shipping Weight: 9 pounds (4.1 kg) with batteries; 11½ pounds (5.3 kg), including leather case.

See also *General Radio Experimenter*, 35, 8, August, 1961.

Type		Code Number	Price
1551-C	Sound-Level Meter	1551-9703	\$450.00
1262-B	Power Supply	1262-9702	95.00
	Set of Replacement Batteries		3.90
1551-P2	Leather Carrying Case	1551-9602	25.00
1560-P95	Connecting Cable	1560-9695	3.00

MILITARY SPECIFICATIONS: We can supply TYPE 1551-C Sound-Level Meters to meet the specifications of MIL-STD-740. Price and details on request.



Type 1560-P3 PZT MICROPHONE

This microphone, which is used in the TYPE 1551-C Sound-Level Meter, is a PZT piezoelectric ceramic type, whose characteristics approach those of condenser microphones used as laboratory standards. It requires no polarizing voltage, however, and its impedance is lower by an order of magnitude. Thus, leakage due to high humidity is less of a problem than with the condenser type, and the microphone can be more readily used at the end of a cable.

SPECIFICATIONS

Frequency Response: Typical response is shown in the accompanying plot. Deviations of individual units are approximately ±0.3 db from 20 to 1000 cps and ±1 db up to about 8000 cps.

Sensitivity: -60 db re 1 volt/μbar.

Temperature Coefficient of Sensitivity: Approximately 0.01 db/°C. **Internal Impedance:** Capacitive; 475 pf at 25 C, varying from 445 to 475 over a temperature range of 0 to 50 C.

Directivity: See frequency characteristic plot.

Environmental Effects: The microphone is not damaged by temperatures from -30 C to +95 C and relative humidities of 0 to 100%.

Terminal: Microphone fits Cannon XLR-3-11C cable connector.

Dimensions: Length 2¾ inches (70 mm), maximum diameter 1¼ inches (29 mm). **Net Weight:** ¼ pound (115 grams).

Type		Code Number	Price
1560-P3	PZT Microphone	1560-9603	\$80.00

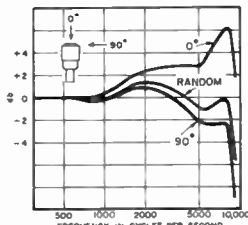



Type 1551-P1 CONDENSER MICROPHONE SYSTEM

USES:

The TYPES 1551-P1L (for normal-level measurement) and 1551-P1H (for high-level measurement) Condenser Microphone Systems are designed for use with the TYPE 1551-C Sound-Level Meter for measuring sound levels over wide frequency ranges. These microphones are not damaged by high sound levels or by high temperatures.

Applications include:

Measurement of high-frequency and high-level noises produced by such noise sources as air streams, wood-working and metalworking machinery, turbines, and jet engines.

General-purpose sound-level measurements where ambient temperature and sound level are high.

Measurements on high-fidelity sound systems over the full audio spectrum.

SPECIFICATIONS

Frequency Response: 20 cps to 18 kc with either microphone. Typical response curves are shown at right.

Calibration: The output level as a function of frequency is measured in our laboratory by comparison with a standard microphone. The measured level at 400 cps is supplied, and a calibration curve is included with each instrument.

Output Impedance: 6500 ohms (typical).

Direct Use with Analyzers: These assemblies can supply a signal directly to either the TYPE 1558 Octave-Band Noise Analyzer or the TYPE 1564-A Sound and Vibration Analyzer, provided that the levels of the measured components are above the following indicated values:

	1551-P1H	1551-P1L
TYPE 1558-A, -AK	85 db	70 db
TYPE 1564-A	65 db	50 db

A TYPE 1552-B Sound-Level Calibrator is necessary for absolute level calibration.

Maximum Sound-Pressure Level:

For the TYPE 1551-P1L Condenser Microphone Assembly, non-linear distortion is below 1% at levels up to 135 db, and below 10% at 155 db.

For the TYPE 1551-P1H Condenser Microphone Assembly, non-linear distortion is below 1% up to 150 db and below 10% up to 170 db.

Minimum Measurable Sound-Pressure Level:

TYPE 1551-P1L — 50 db (re 0.0002 μ bar)
TYPE 1551-P1H — 65 db (re 0.0002 μ bar)

DESCRIPTION: The TYPE 1551-P1L Condenser Microphone System uses an Altec 21-BR-150 microphone and measure a sound-pressure levels up to 155 db; the TYPE 1551-P1H, which uses a 21-BR-180 microphone, measures levels up to 170 db.

The microphone base houses a subminiature pre-amplifier tube. A battery-operated power supply provides preamplifier filament and plate power and a polarizing voltage for the microphone. An extension cable, a tripod, and a leather carrying case are supplied.

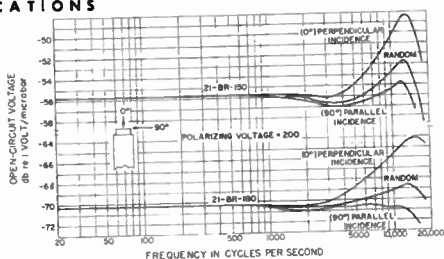

Temperature and Humidity: Maximum recommended operating temperature of the microphone in its probe is 100 C°. The microphone is not damaged by exposure to high humidity, but prolonged exposure may cause electrical leakage and render it temporarily inoperative.

Batteries: One 1½-volt size D flashlight cell (Rayovac 2LP or equivalent) and one 300-volt B battery (Eveready 493, Burgess V-200 or equivalent) are supplied. Batteries should last at least 150 hours under normal use.

Mounting: The microphone on its base plugs into one end of a 10-foot cable and will slip into a receptacle on the tripod. The other end of the cable is connected to the power-supply unit, which fastens to one end of the sound-level meter.

Components and Accessories Supplied: Microphone base assembly, cable assembly, power supply, microphone, microphone cap, carrying case, and tripod.
Dimensions: Leather carrying case is approximately 7 by 5½ by 8½ inches (180 by 140 by 220 mm).

Net Weight: Complete in carrying case, 7¼ lb (3.3 kg).

Shipping Weight: 10¼ pounds (4.9 kg).

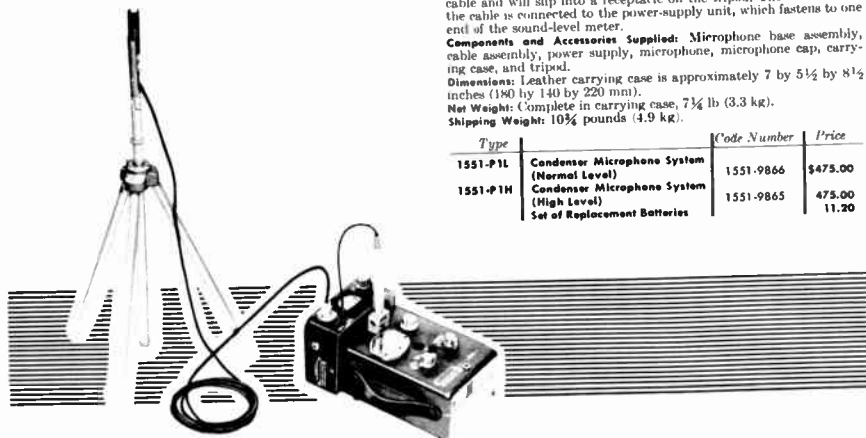

Type	Code Number	Price
1551-P1L Condenser Microphone System (Normal Level)	1551-9866	\$475.00
1551-P1H Condenser Microphone System (High Level) Set of Replacement Batteries	1551-9865	475.00

STANDARD ACCESSORIES FOR THE SOUND-LEVEL METER

The following accessories are available for use with the TYPE 1551-C Sound-Level Meter to increase its field of application and to adapt it for specialized types of measurement. These accessories can also be used with our older Sound-Level Meters, the TYPES 1551-B and 1551-A. An adaptor is required for the TYPE 1551-A.

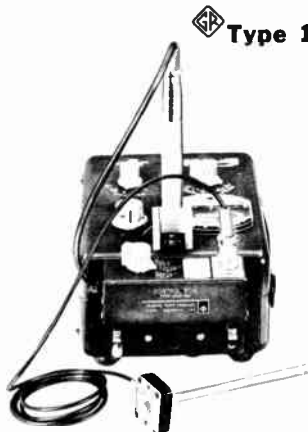

Type 1560-P11B VIBRATION PICKUP SYSTEM

The TYPE 1560-P11B Vibration Pickup System consists of a TYPE 1560-P52 Vibration Pickup (with removable probe and probe tips), a TYPE 1560-P21B Control Box, and a 5-foot cable. The vibration pickup is an inertia-operated, lead-zirconate-titanate ceramic device which generates a voltage proportional to the acceleration of the vibrating body. By means of integrating networks in the control box, voltages proportional to velocity and displacement can also be delivered to the sound-level meter. The desired response is selected by means of a three-position switch on the control box. This pickup is also used on the TYPE 1553 Vibration Meter.

The TYPE 1560-P11S2 Vibration Pickup System, consisting of Endeveco Model 2217 Vibration Pickup with TYPE 1560-P21S1 Control Box, meets the requirements of MIL-STD-740 (Ships) and is available on special order. Write for details.

SPECIFICATIONS

SYSTEM

Calibration: The db readings on the sound-level meter can be converted into absolute values of displacement, velocity, or acceleration by means of calibration data supplied.

Range: The range of measurement of the pickup and control box when used with the TYPE 1551-C or 1551-B Sound-Level Meter is approximately as follows:

Rms Displacement, 100 microinches, minimum.
Rms Velocity, 3000 microinches per second, minimum. The upper limit of velocity and displacement measurements depends on frequency, and is determined by the maximum acceleration permissible before nonlinearity occurs (100 g).

Rms Acceleration, 0.3 to 39,000 in./sec/sec (100 g).

PICKUP

Sensitivity 75 mv/g
Resonant Frequency 3200 cps
Capacitance 0.01 μ F
Temperature Coefficient of Sensitivity <0.01 db/°F
Temperature Range -30 to +200 F
Relative Humidity Range 0 to 100%
Cable Length 5 feet (1.55 m)
Dimensions 1 5/8 × 1 7/16 × 9/16 in.
 (42 × 37 × 15 mm)

Net Weight 1 3/4 pounds (0.8 kg).
Shipping Weight: 3 pounds (1.4 kg).

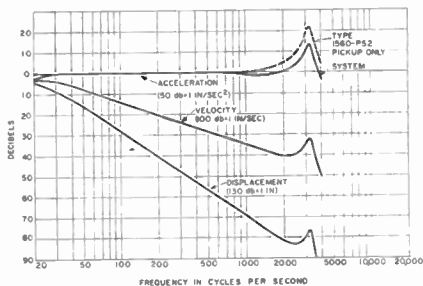

Frequency-response characteristics of the Type 1560-P11B Vibration Pickup System for constant applied acceleration.

Type	Vibration Pickup System	Code Number	Price
1560-P11B	Vibration Pickup System	1560-9922	\$160.00
1560-P52	Vibration Pickup only	1560-9652	100.00

TRIPOD AND EXTENSION CABLE

A 25-foot extension cable (TYPE 1560-P73) and tripod (TYPE 1560-P32) for mounting the TYPE 1560-P3 PZT Microphone (supplied with the TYPE 1551-C Sound-Level Meter) are available as the TYPE 1560-P34 Tripod and Extension Cable. A 100-foot cable is also available.

Net Weight: 5 1/2 pounds (2.5 kg).
Shipping Weight: 8 pounds (3.7 kg).

Type	Code Number	Price
1560-P34	1560-9634	\$45.00
1560-P73B	1560-9982	29.00



Type 1552-B SOUND-LEVEL CALIBRATOR

USES:

The TYPE 1552-B Sound-Level Calibrator supplies an acoustic signal of known sound-pressure level for checking the over-all performance of a sound-level meter, including its microphone.



Calibrator fits over microphone of the Type 1551-C Sound-Level Meter. At the right is the Type 1307-A Transistor Oscillator.

It can be used to calibrate not only the TYPE 1551-C Sound-Level Meter and the TYPE 1555-A Sound-Survey Meter but also the TYPE 1558 Octave-Band Noise Analyzers and TYPE 1564-A Sound and Vibration Analyzer when they are used directly with the microphones listed in the specifications, below. The calibrator can also be used to supply an acoustic reference level for audio systems.

The TYPE 1307-A Transistor Oscillator serves as both power source and level indicator when used with the sound-level calibrator.

DESCRIPTION: A small, stable loudspeaker is mounted in one end of a cylindrical enclosure. The other end of the enclosure fits over the microphone. Acoustic coupling between the speaker and microphone is fixed by chamber and microphone dimensions. The calibrator provides acoustic shielding and a high test level to reduce effects of ambient noise during calibration. Calibration checks under these conditions are accurate and readily repeatable.

FEATURES:

- ◆ Good accuracy — ± 1 db at 400 cps. Very stable, low temperature coefficient and long-term stability.
- ◆ Easily portable — calibrator and battery-powered Type 1307-A Oscillator together weigh under 3 pounds.
- ◆ Fits many microphones.

SPECIFICATIONS

Accuracy of Calibration: ± 1 db at 400 cps.

Microphones: The calibrator can be used on the following microphones without the need of special adaptors:

Current types

Shure Brothers 98108 (General Radio Types 1560-P3, -P4)
General Radio Type 1551-PIH, -PIL Condenser Microphone Systems
General Radio Type 1555-A Sound-Survey Meter
Western Electric 640-AA
Kellogg Microphone

Discontinued types

Shure Brothers 98B99 (General Radio Type 1551-B Sound-Level Meter)

Shure Brothers 9898 (General Radio Type 759-Band Type 1551-A Sound-Level Meters)

Terminals: Input terminals are Type 938 Binding Posts, spaced $\frac{3}{4}$ inch to fit Type 274-MB Double Plug.

Accessory Required: A 400-cycle source, with output control and voltmeter. The Type 1307-A Transistor Oscillator, a battery-operated instrument with self-contained voltmeter, is recommended (see below).

Accessory Available: Type 1560-P31 Leather Carrying Case, for both calibrator and Type 1307-A Oscillator.

Dimensions: Length $4\frac{1}{2}$, diameter $2\frac{1}{2}$ inches (115 by 64 mm), over-all.

Net Weight: 14 ounces (0.4 kg).

Shipping Weight: $1\frac{1}{4}$ pounds (0.6 kg).



Type 1307-A TRANSISTOR OSCILLATOR

Recommended as a power source for the sound-level calibrator, this oscillator is a convenient 400- and 1000-cycle source for general testing at audio frequencies. (Output voltage is indicated by a voltmeter, and a finger-tip output control facilitates setting the output level.)

SPECIFICATIONS

Frequency: 400 and 1000 cps.

Frequency Accuracy: $\pm 3\%$ at 2 volts output into 600-ohm resistive load.

Output: Adjustable to a maximum of at least 2 volts into a 600-ohm load.

Distortion: Less than 5% at 400 cps and less than 6% at 1000 cps with 2 volts across a resistive 600-ohm load.

Voltmeter: Calibrated in volts, with 3 volts full scale.

Output Circuit: Output cable (20 inches) terminated in Type 274-MB Double Plug.

Batteries: Three mercury A batteries (Mallory RM-1 or equivalent) are supplied. Battery life is about 100 hours for 8 hours use per day. Cabinet: Aluminum, with aluminum panel.

Carrying Case: Leather case with a strap is available for holding both oscillator and sound-level calibrator.

Dimensions: Width $3\frac{3}{8}$, height 6, depth $2\frac{1}{2}$ inches (79 by 153 by 64 mm), over-all.

Net Weight: $1\frac{3}{4}$ pounds (0.8 kg) with batteries.

Shipping Weight: $2\frac{1}{2}$ pounds (1.2 kg).

Type		Code Number	Price
1552-B	Sound-Level Calibrator Transistor Oscillator Leather Carrying Case, for both calibrator and oscillator	1552-9702	\$52.50
1307-A		1307-9701	97.00
1560-P31		1560-9631	15.00



Type 1559-A MICROPHONE RECIPROCALITY CALIBRATOR

USES:

- ◆ Primary calibrator for pzt microphones (Type 1560-P3 and Type 1560-P4).
- ◆ Precision acoustical source.
- ◆ Sound-level calibrator.

This instrument employs the closed-coupler (cylindrical cavity), reciprocity calibration procedure, the recognized method of performing the absolute calibration of laboratory standard microphones. Without calculations, one can rapidly determine the sensitivity of a microphone in db re 1 volt/ μ bar.

As a sound-level calibrator of constant acoustic output, it covers a wide frequency range, for rapid check on microphones and sound-level meters or for setting the reference levels in analyzing systems.

DESCRIPTION: This instrument provides the circuit and the structure required for closed-coupler reciprocity calibrations of General Radio Type 1560-P3 and 1560-P4 PZT Microphones. An audio oscillator and a detector are also needed. All calculations are automatically performed by an analog computer, and microphone sensitivity is read from a dial.

The necessary reversible transducer is the cartridge of a Type 1560-P3 PZT Microphone, which is built into the coupler; and the auxiliary transducer is a pzt cylinder that forms the cylindrical wall of the coupler. The symmetry

that results from the use of a reversible transducer identical with the microphone being measured and an auxiliary transducer in the form of an encompassing cylinder makes the coupler usable over a wide frequency range without the necessity of removal and replacement of transducers during the course of the measurement.

A single switch controls simultaneously the calibration operations and the analog computer. The detector characteristics and the magnitude of the applied voltage do not influence the result.

The pzt cylinder used in the reciprocity calibration also serves as a stable acoustical source for the sound-level-calibrator applications of the instrument. The sound-pressure level produced is indicated on a meter, which is actuated by the signal applied to the pzt cylinder.

FEATURES:

- ◆ Rapid and simple operation.
- ◆ High accuracy.
- ◆ Direct readout — answers available with no calculations.
- ◆ Useful for daily verification of calibrations.
- ◆ Portable or relay-rack mounting.

SPECIFICATIONS

MICROPHONE CALIBRATOR

Range: Direct reading for microphone sensitivities between -55 db and -65 db re 1 volt/ μ bar.

Frequency Range: 20 to 8000 cps.

Accuracy: ± 0.2 db $\pm (0.1 \text{ db} \times \text{frequency in kc})$ up to 2.5 kc, ± 0.7 db above 2.5 kc to 7 kc, when reference is set to actual barometric pressure.

PRECISION ACOUSTICAL SOURCE

Frequency Range: 20 to 8000 cps.

Output: 92 db re 0.0002 μ bar for excitation of 50 volts.

Accuracy: At 92 db, ± 0.1 db + error in determining microphone sensitivity.

SOUND-LEVEL CALIBRATOR

Frequency Range: 20 to 2000 cps.

Output: 92 db re 0.0002 μ bar for excitation of 50 volts.

Accuracy: ± 0.7 db at standard atmospheric pressure.

GENERAL

Maximum Safe Input Voltage: 50 volts behind 600 ohms.

Accessories Required: Generator and detector. Generator to supply 5 volts or more into a 2000-pf load, and 2.5 volts or more into a 600-ohm load. Lower voltage can be used, with a resultant lowering of signal-to-ambient-noise ratio. The Type 1304-B Beat-Frequency Audio Generator, the Type 1210-C Unit Res-C Oscillator, and the Type 1311-A Audio Oscillator are recommended. The Type 1551-B or -C Sound-Level Meter is recommended for the detector.

Accessories Supplied: Type 274-NP Patch Cord and an extension cable, for connection to generator and detector.

Cabinet: Flip-Fit; relay-rack model also is available.

Dimensions: Portable model, case closed — width 10, height 8, depth 7½ inches (255 by 205 by 190 mm), over-all; rack model — panel 19 by 10½ inches (485 by 270 mm), depth behind panel 5 inches (130 mm).

Net Weight: Portable model, 13 pounds (6 kg); rack model, 14 pounds (6.5 kg).

Shipping Weight: Portable model, 22 pounds (10 kg); rack model, 29 pounds (13.5 kg).

Type		Code Number	Price
1559-A	Microphone Reciprocity Calibrator, Portable Model	1559-9701	\$475.00
1559-9820	Microphone Reciprocity Calibrator, Rack Model	1559-9820	475.00



◆ Type 1553 VIBRATION METER

USES: Vibrations in machines and structures can be measured quickly and easily with this instrument. For the manufacturer of machinery and equipment, the TYPE 1553 Vibration Meter is extremely useful in research, design, and production testing.

Maintenance engineers will find it useful for checking the operating condition of bearings, gear trains, and other mechanisms. Excessive vibrations due to improper adjustment or to structural resonances can be located and measured.

Its excellent low-frequency response permits the study of the operation of belt drives and of the effectiveness of mountings designed to reduce vibrations in adjacent structures.

A frequency analysis of the measured vibration can be made with the TYPE 1564-A Sound and Vibration Analyzer or the TYPE 1900-A Wave Analyzer.

DESCRIPTION: The TYPE 1553 Vibration Meter consists of an inertia-operated, lead-zirconate-titanate ceramic pickup, which delivers a voltage proportional to the acceleration of the vibratory motion; an adjustable attenuator; an amplifier; and an indicating meter. Integrating networks can be switched to convert the output of the vibration pickup to a voltage proportional to either displacement or velocity.

A differentiating network can be switched in to convert the output of the vibration pickup to a voltage proportional to time rate of change of acceleration, or jerk.

The TYPE 1553-A Vibration Meter indicates directly in peak-to-peak, peak, or average inches, inches per second; inches per second², or inches per second³. The TYPE 1553-AK indication is in metric units: millimeters, meters/sec, meters/sec², and meters/sec³.

Filter jacks on the panel allow the use of external high-pass filters where it is desired to eliminate the frequency components below 30 or 70 cps.

The vibration meter is portable and is mounted in a Flip-Tilt cabinet, which serves as protective cover and case in transit, and as a base on which the instrument can be operated in almost any position from vertical to horizontal. The instrument is powered by readily available batteries and is equipped with a built-in calibrating circuit. A relay-rack model is also available.

Accessories include various tips and a metal probe for the pickup to facilitate measurements in normally inaccessible places. Available at additional cost is the TYPE 1560-P35 Permanent-Magnet Clamp, which replaces the probe or tip when measurements are made under conditions where hand-held operation would not be satisfactory.

FEATURES:

- ◆ Portable and self-contained.
- ◆ Easy to operate.
- ◆ Direct read-out includes units being measured.
- ◆ Low-frequency response down to 2 cycles per second.
- ◆ Meter indication independent of load connected to output jack.
- ◆ Meter is true peak, peak-to-peak, or average indicator.
- ◆ 20-cycle cutoff position on function switch increases displacement sensitivity by a factor of 100 over that obtainable with a 2-cycle cutoff.
- ◆ Measures jerk as well as conventional vibration parameters.
- ◆ Can be used to measure acceleration with a suitable pickup over the full range (2-20,000 cps) of the amplifier.
- ◆ Panel jacks provided for addition of external filters.



The Type 1553 Vibration Meter can be furnished with calibration in either English or metric units. The portable model in the convenient Flip-Tilt case is shown here. A rack-mount model is also available, as listed on the opposite page.

SPECIFICATIONS

Ranges of Measurement:

Type No.	Quantity	Peak to Peak		Average		Units	Frequency Range (cps)
		Min	Max	Min	Max		
1553-A	Acceleration	0.3	300,000	0.1	100,000	in/sec ²	2-2000
1553-AK	Acceleration	0.01	10,000	0.003	3,000	m/sec ²	2-2000
1553-A	Velocity	0.03	30,000	0.01	10,000	in/sec	2-2000
1553-AK	Velocity	0.001	1,000	0.0003	300	m/sec	2-2000
1553-A	Displacement	3	300,000	1	300,000	mils	2-2000
1553-AK	Displacement	0.1	10,000	0.03	10,000	mm	2-2000
1553-A	Displacement	0.03	30,000	0.01	10,000	mils	20-2000
1553-AK	Displacement	0.001	1,000	0.0003	300	mm	20-2000
1553-A	Jerk	30	300,000	10	300,000	in/sec ³	2-20
1553-AK	Jerk	1	10,000	0.3	10,000	m/sec ³	2-20

Accuracy: $\pm 10\%$ of full scale.

Input Impedance: 25 megohms.

Voltage at Output Jack: 5 volts rms behind 75 kilohms for full-scale deflection.

Attenuators: A 10-step attenuator changes the meter scale range by a factor of 100,000 to 1. Window readout indicates full-scale values and units.

Calibration: Internal.

Altogether Pickup Sensitivity for Direct Reading: 30 to 150 mv/g.

Terminals: A panel jack is provided for plugging in earphones. TYPE 1564-A Sound and Vibration Analyzer, TYPE 1556-B Impact-Noise Analyzer, TYPE 1531-A STROBOLAC electronic stroboscope, TYPE 1900-A Wave Analyzer, or an oscilloscope.

Batteries: 3 size D cells and one 67½-volt battery (Hurgess Type XX45 or equivalent) supplied. Typical battery life, 7 days at 8 hours per day.

Accessory Supplied: TYPE 1560-P52 Vibration Pickup.

Other Accessories Available: TYPE 1560-P35 Permanent-Magnet Clamp; TYPE 1557-A Vibration Calibrator.

Cabinet: Flip-Tilt; relay-rack models also are available.

Dimensions: Portable model, case closed — width 8, height 9¼, depth 7½ inches (205 by 235 by 190 mm), over-all; rack model — panel 19 by 10½ inches (485 by 270 mm), depth behind panel 5 inches (130 mm).

Net Weight: Portable model, 10½ pounds (4.8 kg); rack model, 11 pounds (5 kg).

Shipping Weight: Portable model, 14½ pounds (7 kg); rack model, 21½ pounds (10 kg).



(Left) Vibration pickup with permanent-magnet clamp. (Right) Vibration pickup with probe and tips.

The TYPE 1553 Vibration Meters can be supplied on special order with a wide-range accelerometer, 20 - 20,000 cps (Endevco model 2217). Write for details.

Type		Code Number	Price
1553-A	Vibration Meter (English Units), Portable Model	1553-9701	\$775.00
1553-9820	Vibration Meter (English Units), Rack Model	1553-9820	775.00
1553-AK	Vibration Meter (Metric Units), Portable Model	1553-9819	775.00
1553-9840	Vibration Meter (Metric Units), Rack Model	1553-9840	775.00
1560-P52	Replacement Pickup	1560-9652	100.00
	Set of Replacement Batteries		4.10
1560-P35	Permanent-Magnet Clamp	1560-9635	6.50



Type 1557-A VIBRATION CALIBRATOR

USES:

This vibration calibrator is a convenient device for calibrating vibration pickups, accelerometers, vibration meters, and other vibration-measuring systems that use small, piezo-electric accelerometers as the sensing elements.



The calibrator provides a single-frequency (100 cps), single-level (1 g) check on the TYPE 1560-P52 Vibration Pickup (part of the TYPE 1560-P11B Vibration Pickup System), the TYPE 1553 Vibration Meter, or any pickup whose total mass is 300 grams or less. It can provide

SPECIFICATIONS

OUTPUT

Acceleration: 1 g rms \pm 10%.

Velocity: 0.614 in/sec (15.6 mm/sec), rms.

Displacement: 0.000978 inch (0.0248 mm), rms; 0.00277 inch (0.0704 mm), peak-to-peak.

Frequency: 100 cps \pm 1% for 50-gram load; 100 cps \pm 0, -2% for 300-gram load.

GENERAL

Batteries: Four RM-4 (or equivalent) mercury cells. Battery life is 100 hours of continuous operation. (Dry cells optional; please specify.)

Accessory Supplied: Leather carrying case.

Dimensions: Width 4, height 8, depth 4 inches (105 by 205 by 105 mm), over-all.

Net Weight: 3¼ pounds (1.5 kg), including case.

Shipping Weight: 5¼ pounds (2.4 kg).

on-the-spot calibration of vibration-measuring systems immediately before and after important measurements and can also be used to compare transducers or to calibrate working transducers against a standard transducer.

DESCRIPTION: The TYPE 1557-A Vibration Calibrator is a small, battery-operated unit consisting of a transistorized electromechanical oscillator and a cylindrical shaker. The acceleration output of the calibrator appears at two pillbox-shaped, 50-gram disks mounted on an internal cylinder that projects through the sides of the instrument.

Operation of the calibrator is simple. A pickup of known mass is attached to the shaker, either in place of one of the removable 50-gram disks or to one of the disks by double-faced, pressure-sensitive tape. The user adjusts the LEVEL control until the panel meter, calibrated in grams, indicates the mass of the pickup. The pickup will then be automatically subjected to an acceleration of 1 g at 100 cps. The only other control on the instrument is a combination of on-off switch and battery checker.

Life tests on the calibrator indicate that it will operate continuously for over 1000 hours. Since normal operation will usually be below the maximum and will not be continuous, the calibrator should give trouble-free service for many years.

FEATURES:

- Completely portable, with long-life mercury batteries.
- Accommodates most of the accelerometers and vibration pickups in use today.
- Weighs less than four pounds, with leather carrying case.

Functional diagram of the calibrator.

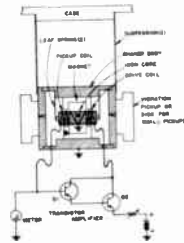

Type	Code Number	Price
1557-A	1557-9701	\$225.00

Vibration Calibrator



Type 1900-A WAVE ANALYZER

FEATURES:

- Wide frequency range — 20 to 50,000 cps. ♦ Three bandwidths — 3, 10, and 50 cps.
- Outputs for dc recorder and graphic level recorder.
- Tunable filter — output at selected frequency is provided.
- Tracking analyzer — analyzer can be used as both source and detector.
- Self-contained voltage-calibrating system.
- 30 microvolts to 300 volts, full scale. ♦ Input impedance of one megohm.
- Three meter speeds for easier noise analysis.
- Linear frequency scale for optimum tuning characteristics over full range.
- Arc holds analyzer in tune despite small drifts in input frequency.

USES: The wave analyzer is used for measuring the components of or analyzing the spectrum of complex electrical signals, including those which are replicas of acoustic noise or mechanical vibrations.

Individual components of periodic complex waveforms such as harmonic or intermodulation distortion are readily separated and measured, owing to the excellent selectivity available.

This analyzer is particularly suited for analyzing noise, because its bandwidth in cycles per second is independent of the center frequency. The required averaging time is, therefore, constant, and the calculation of spectrum level is simple. Furthermore, when the 50-cycle bandwidth is used, the averaging time required is reasonably short.

The analyzer can also be used as a tunable filter, so that the individual components of a complex input signal can be used to drive other instruments, such as frequency counters, when a highly accurate measure of the component frequencies is desired, or to drive earphones. When a wide-band noise generator drives the analyzer, the output is a tunable narrow band of noise. Such a signal is useful in a number of psychological and architectural-acoustics tests.

In the "tracking analyzer" mode of operation the output is a sine-wave signal tunable over the 50-ke range and

always in tune with the analyzer. When this signal is used to drive a bridge or other network, the output can be measured by the analyzer, whose selectivity reduces the interference from extraneous noise, hum, and distortion.

For automatic waveform analysis, outputs are provided for driving the TYPE 1521-A Graphic Level Recorder as well as dc recorders.

DESCRIPTION: The TYPE 1900-A Wave Analyzer is a heterodyne type of voltmeter. The intermediate-frequency amplifier at 100 kc includes a highly selective quartz-crystal filter whose bandwidth can be switched to 3, 10, and 50 cps. The use of a heterodyne system makes it possible to vary the response frequency although the filter frequency is fixed. The 100-ke output of the filter is indicated on a meter and is also available at the panel. In one mode of operation the output is also heterodyned back to the original frequency. In another mode the local oscillator beats with a 100-ke quartz-crystal oscillator to function as a beat-frequency oscillator. These two outputs are also available at panel terminals as FILTERED INPUT COMPONENT and INDICATED FREQUENCY, respectively. The block diagram shows how the elements of the analyzer operate to produce the several outputs.

SPECIFICATIONS

FREQUENCY

Range: 20 to 50,000 cps. The frequency is indicated on a counter and a dial with a linear graduation, 1 division/10 cps.

Accuracy of Calibration: $\pm 1\frac{1}{2}\%$ + 5 cps.

Incremental-Frequency Dial (ΔF): ± 100 cps. Accuracy is ± 2 cps below 2 kc, ± 5 cps up to 50 kc.

Automatic Frequency Control: Range of frequency lock is ± 200 cps for 50-cycle band, ± 50 cps for 10-cycle band.

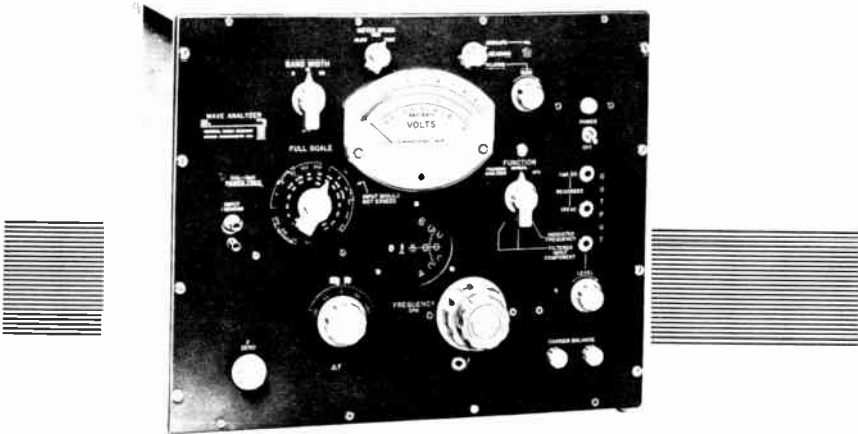

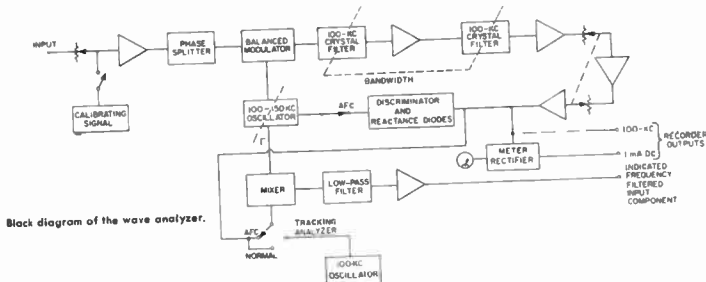

SELECTIVITY: Three bandwidths (3, 10, and 50 cps) selected by switch.

3-Cycle Band: At least 30 db down at ± 6 cps from center frequency, at least 60 db down at ± 15 cps, at least 80 db down at ± 25 cps and beyond.

10-Cycle Band: At least 30 db down at ± 20 cps, at least 60 db down at ± 45 cps, at least 80 db down at ± 80 cps and beyond.

50-Cycle Band: At least 30 db down at ± 100 cps, at least 60 db down at ± 250 cps, at least 80 db down at ± 500 cps and beyond.

Effective bandwidth for noise equal to nominal bandwidth within $\pm 10\%$ for 10- and 50-cycle bands and $\pm 20\%$ for 3-cycle band.

INPUT

Impedance: One megohm on all ranges.

Voltage Range: 30 microvolts to 300 volts full scale in 3, 10 series. A decibel scale is also provided.

Voltage Accuracy: $\pm 3\%$ of indicated value $\pm 2\%$ of full scale ± 3 microvolts. On the most sensitive range, a small residual error, due to internal noise, occurs.

OUTPUT

100-kc Output: Amplitude is proportional to amplitude of selected component in analyzer input signal. With the TYPE 1521-A Graphic Level Recorder connected through the adaptor cable supplied, at full-scale meter deflection output is at least 3 volts. Dynamic range is approximately 80 db.

Recording Analyzer: The analyzer in combination with the TYPE 1521-A Graphic Level Recorder produces continuous, convenient

records of frequency spectra over the complete range of the analyzer. The end frames of the bench models can be bolted together to form a rigid assembly. The recorder is described on page 144. Use chart paper 1521-9464 or 1521-9465.

DC Output: One milliamperer in 1500 ohms for full-scale meter deflection.

Filtered Input Component: Output at least 1 volt across 600-ohm load for full-scale meter deflection with output control at maximum.

Tracking Analyzer (Indicated Frequency): 20 cps to 50 kc; output is at least 2 volts across 600-ohm load with output control at maximum.

GENERAL

Residual Modulation Products and Hum: At least 75 db down.

Terminals: Input, TYPE 938 Binding Posts; output, telephone jacks.

Power Requirements: 105 to 125 (or 210 to 250) volts, 50 to 60 cps, approximately 40 watts.

Accessories Supplied: TYPE 1560-195 Adaptor Cable Assembly, phone plug, TYPE CAP-22 Power Cord, spare fuses.

Other Accessories Available: TYPE 1900-P1 Link Unit for coupling to TYPE 1521-A Graphic Level Recorder.

Cabinet: Rack-bench.

Dimensions: Bench model—width 19, height 16 $\frac{1}{4}$, depth 15 $\frac{1}{4}$ inches (485 by 415 by 390 mm), over-all; rack model—panel 19 by 15 $\frac{3}{4}$ inches (485 by 400 mm), depth behind panel 13 $\frac{1}{4}$ inches (340 mm).

Net Weight: 56 pounds (26 kg).

Shipping Weight: 84 pounds (39 kg).

Type	Code Number	Price
1900-AM	1900-9801	\$2150.00
1900-AR	1900-9811	2150.00

A recording-analyzer assembly can be made up of the wave analyzer and the Type 1521-A Graphic Level Recorder for the automatic recording of complete spectra. A Type 1521-P10 Drive Unit and a Type 1900-P1 Link Unit are also required.

Either rack-mount or bench-mount models can be used for this combination. Bench-mount units are furnished with end frames, which can be bolted together to form a rigid assembly without the use of a rack.

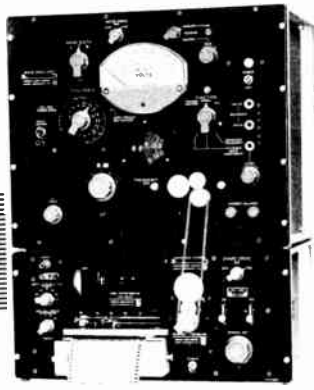



Type 1564-A SOUND AND VIBRATION ANALYZER

FEATURES:

- ◆ Wide frequency range — 2.5 cps — 25 kc.
- ◆ True logarithmic frequency scale.
- ◆ High input impedance — 25 megohms in parallel with 80 pf.
- ◆ High sensitivity — 0.3 millivolt full scale.
- ◆ Direct reading in either volts or, when used with microphone, in db re 0.0002 μ bar.
- ◆ Operates from either power line or rechargeable battery.
- ◆ Internal amplitude calibration system.
- ◆ Quasi-rms detector with three averaging times.
- ◆ Completely transistorized.
- ◆ Detent at ASA preferred frequencies can be engaged with panel control.

USES: The TYPE 1564-A Sound and Vibration Analyzer is designed primarily for measuring the amplitude and frequency of the components of complex sound and vibration spectra. Its 1/3-octave (23%) and 1/10-octave (7.1%) noise bandwidths provide the flexibility needed for analysis of both line (single frequency) and continuous spectra. The high input impedance of the analyzer permits direct connection of piezoelectric transducers for measuring sound pressures from 44 to 150 db re 0.0002 μ bar and acceleration from 0.0005 g to 100 g.

Automatic range switching is provided so that the TYPE 1521-A Graphic Level Recorder can record automatically the spectrum of the signal under analysis.

The analyzer can be used in conjunction with the TYPE 1390-B Random-Noise Generator for transfer and

reverberation measurements using 1/3- or 1/10-octave bands of random noise.

High sensitivity, wide amplitude and frequency ranges, and high input impedance make the TYPE 1564-A a very useful tuned voltmeter or general-purpose wave analyzer at audio and subaudio frequencies.

The TYPE 1560-P41 Audio-Frequency Voltage Probe is available for convenient connection to an electrical circuit.

DESCRIPTION: The TYPE 1564-A Sound and Vibration Analyzer consists of a high impedance preamplifier, a continuously tunable filter having a noise bandwidth of either 1/3 or 1/10 octave, an output amplifier, and an indicator. The center frequency of the filter is continuously adjustable. An all-pass, or flat, characteristic permits measurement of the over-all signal amplitude.

SPECIFICATIONS

FREQUENCY

Range: From 2.5 cps to 25 kc in four decade ranges.

Dial Calibration: Logarithmic.

Accuracy of Calibration: $\pm 2\%$ of frequency-dial setting.

Filter Characteristics: Noise bandwidth is either 1/3 octave or 1/10 octave.

One-third-octave characteristic has at least 30-db attenuation at one-half and twice the selected frequency (see plot). One-tenth-octave characteristic has at least 40-db attenuation at one-half and twice the selected frequency.

For both characteristics peak response is flat ± 1 db over the entire tuning range.

All-pass response is flat ± 1 db from 2.5 cps to 25 kc

INPUT

Impedance: 25 megohms in parallel with 80 pf (independent of attenuator setting).

Voltage Range: 0.3 millivolt to 30 volts full scale in 10-db steps.

Microphone: TYPE 1560-P4 PZT Microphone Assembly is recommended.



1/3- and 1/10-OCTAVE BANDWIDTHS
2.5 cps to 25 kc

OPERATES FROM SOUND-LEVEL METER
OR DIRECTLY FROM MICROPHONE

This combination of the Type 1564-9820 Sound and Vibration Analyzer and the Type 1521-AR Graphic Level Recorder forms a rack-mount recording analyzer, for the automatic plotting of complete spectra

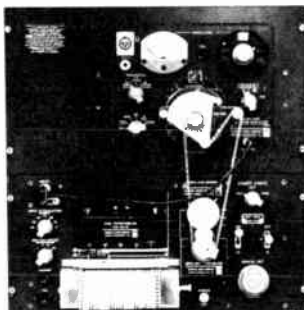

OUTPUT

Voltage: 1.2 volts open circuit when meter reads full scale.
Impedance: 6000 ohms. Any load can be connected.
Meter: Three scales, 0 - 3 volts; 0 - 10 volts; -6 to +10 db.

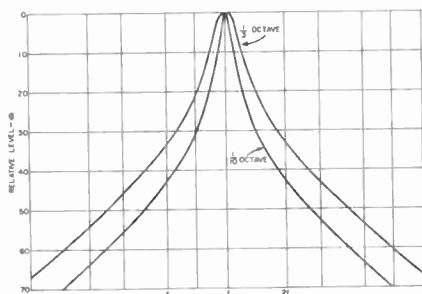

Band-pass characteristics of the analyzer.

Recording Analyzer: Automatic range switching at the end of each frequency decade allows convenient continuous recording of spectra with the TYPE 1521-A Graphic Level Recorder.

GENERAL

Amplitude Calibration: Built-in, feedback-type calibration system permits amplitude calibration at any frequency.

Detectors: Quasi-rms with three averaging times. Fastest speed conforms with ASA standard for sound-level meters.

Power Requirements: Operates from 115 (or 230) volts, 50-60 cps, or from nickel-cadmium battery supplied. Battery provides 25 hours of operation when fully charged and requires 14 hours for charging.

Accessories Supplied: TYPE CAP-22 Power Cord, shielded cable, and TYPE 1564-2020 Detented Knob and Dial Assembly.

Accessories Available: TYPE 1560-P4 PZT Microphone Assembly for direct acoustic pickup ; TYPE 1560-P02 Vibration Pickup for solid-borne vibrations ; TYPE 1560-P41 Audio-Frequency Voltage Probe for voltage measurements (see below).

Cabinet: Flip-Tilt; relay-rack model also is available. (See page 210.)

Dimensions: Portable model, case closed — width 10¹/₄, height 8¹/₂, depth 8 inches (260 by 210 by 205 mm), over-all; rack model — panel 19 by 10¹/₂ inches (485 by 270 mm), depth behind panel 6 inches (155 mm).

Net Weight: Portable model, 14¹/₂ pounds (7 kg); rack model, 15¹/₂ pounds (7.5 kg).

Shipping Weight: Portable model, 23 pounds (10.5 kg); rack model, 30 pounds (14 kg).

Type		Code Number	Price
1564-A	Sound and Vibration Analyzer, Portable Model	1564-9701	\$1150.00
1564-9820	Sound and Vibration Analyzer, Rack Model	1564-9820	1150.00

TEST PROBE FOR VOLTAGE MEASUREMENT WITH THE ANALYZER

The TYPE 1560-P41 Audio-Frequency Voltage Probe consists of a 10:1 rc divider. It presents a high impedance to the circuit under test and connects to the analyzer with a 4-foot cable. It is supplied with a variety of probe tips, including plugs, to fit jack-top binding posts on 3/4-inch centers.

Input Impedance: 25 megohms in parallel with 20 pf.
Net Weight: 1/4 pound (115 grams).

Type		Code Number	Price
1560-P41	Audio-Frequency Voltage Probe	1560-9641	\$45.00



Type 1558 OCTAVE-BAND NOISE ANALYZER

USES: The TYPE 1558 Octave-Band Noise Analyzer is used for the rapid analysis of broadband noises, where a knowledge of individual frequency components is not required. For the measurement of octave-band sound-pressure levels above 44 db re 0.0002 μ bar, the analyzer can be used directly with a piezoelectric microphone. For lower levels, it can be operated from the output of the TYPE 1551-C Sound-Level Meter.

It is particularly useful for:
 Measurement of aircraft, vehicle, and machinery noise.
 Measurement of environmental noise, as in offices and factories, where speech-interference level is important.
 Studies of environmental noise as related to hearing damage.
 Production testing and noise-level acceptance tests.
 Loudness determinations.
 Acoustical studies of rooms and materials.

DESCRIPTION: Two models of the octave-band noise analyzer are available. The TYPE 1558-A has bands as specified by the ASA Standard for Octave-Band Filters, Z 24.10-1953. In the TYPE 1558-AP, the bands are centered at the ASA Preferred Frequencies for Acoustical Measurements, ASA S 1.6-1960. In addition, the -A model has band-pass filters that extend the range at both ends beyond the range specified in the standard.

Essentially, the analyzer consists of a high-impedance preamplifier, a filter, an output amplifier, and a meter. The preamplifier frequency response can be set to be either flat or c-weighted. A built-in reference allows calibration for microphones ranging in sensitivity from -52 to -62 db re 1 volt/ μ bar. No active filters are used, resulting in small size, light weight, and lack of interference from stray magnetic fields. The high input impedance and pre-amplification permit the use of piezoelectric microphones and vibration pickups. The analyzer is portable and powered by rechargeable nickel-cadmium batteries.

FEATURES:

- ◆ Small, compact, and portable — weighs less than 9 pounds.
- ◆ Measures level in 10 octave bands.
- ◆ Direct use with piezoelectric microphones for levels in the range from 44 to 150 db.
- ◆ Uses rechargeable nickel-cadmium battery.
- ◆ Fully transistorized.
- ◆ Internal calibration system.
- ◆ Quasi-rms meter; indication is essentially rms for all waveforms except short impact pulses.
- ◆ Load impedance has no effect on meter indication.
- ◆ c or 20-ke preamplifier weighting can be selected by means of an internal switch.

ACCESSORY MICROPHONE

The TYPE 1560-P4 PZT Microphone Assembly consists of a TYPE 1560-P3 ceramic microphone unit attached to a short length of flexible conduit, which in turn mounts on a swivel base. The assembly plugs into the MIKE input connector on the panel of the octave-band analyzer.

It has a flat response to sounds of random incidence from 20 cps to 8 kc. It will withstand temperatures from -30 to 200 F and relative humidity from 0 to 100%. It shows little change in sensitivity and internal impedance with temperature.

SPECIFICATIONS

Filter Characteristics: Level at center frequency in bands from 37.5 to 9600 cps is uniform within 1 db. Maximum deviation from ALL-PASS level at center frequency in any band is 1 db. For bands from 37.5 to 9600 response at nominal cutoff frequency is (3.5 ± 1) db below response at center frequency. Attenuation is at least 30 db at

one-half the lower nominal cutoff frequency and twice the upper nominal cutoff frequency for all octave bands. Attenuation is at least 50 db at one-fourth the lower nominal cutoff frequency and four times the upper nominal cutoff frequency for all octave bands. The 75-cycle low-pass filter has at least 30-db attenuation at 200 cps and at least 50-db attenuation at 400 cps.

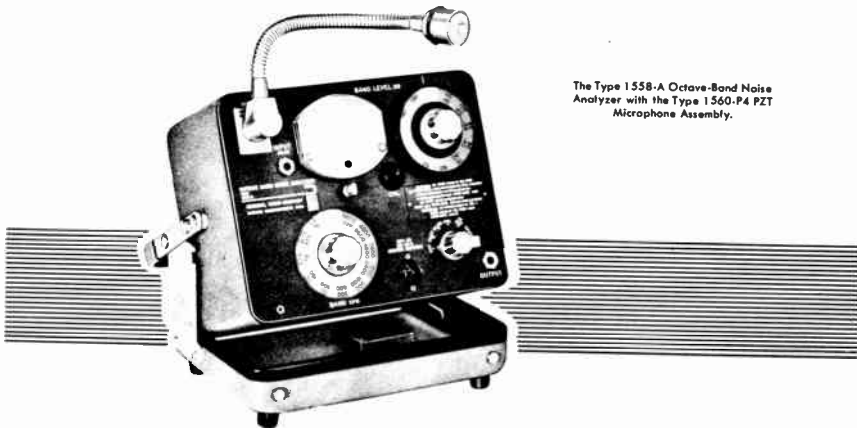

The Type 1558-A Octave-Band Noise Analyzer with the Type 1560-P4 PZT Microphone Assembly.

Type 1558-A		
Lower Cutoff Frequency — cps	Upper Cutoff Frequency — cps	Center Frequency cps
18.75	37.5	26.5
37.5	75.0	53.0
75.0	150	106
150	300	212
300	600	424
600	1200	840
1200	2400	1700
2400	4800	3390
4800	9600	6780
9600	19,200	13,590
LP	75	

ALL PASS

For TYPE 1558-AP, center frequencies are 31.5, 63, 125, 250, 500, 1000, 2000, 4000, 8000, 16,000.

Sound-Pressure Level Range: 44 to 150 db above 0.0002 μ bar in any band when TYPE 1560-P4 PZT Microphone Assembly is used.

Input: Impedance at MIKE terminals is approximately 50 pf in parallel with 50 megohms. It is intended for use with high-impedance transducers such as the TYPE 1560-P4 PZT Microphone Assembly.

Impedance at INPUT (S.M.) terminals is approximately 100 kilohms. Maximum input is 3 volts. Low-input terminal is connected to case. This input is intended for connection to the output of a sound-level meter.

Preamplifier Frequency Characteristic: Can be set to be either c weighting, which is specified by the American Standards Association (ASA S1.4-1961 SLM), or 20 kc, an essentially flat response.

Output: Open-circuit output is at least 1 volt for full-scale meter indication. Output impedance is 6000 ohms. Any load can be connected across the output terminals.

Meter Response: PART of slow meter response is selected by panel control. These characteristics are as specified in the American Standard Specifications for General Purpose Sound Level Meters, ASA S1.4-1961. Meter indication is closely rms for most waveforms.

Internal Calibration: A built-in reference allows the gain of the analyzer to be calibrated for use with piezoelectric microphones having sensi-



Relay-rack model, Type 1558-9820 (for Type 1558-9822), is adapted from portable model, see page 210.

tivities from -52 to -62 db re 1 volt/ μ bar. The absolute accuracy for ALL-PASS is then within 1 db over a wide range of atmospheric conditions.

Batteries: Two 9.6-volt rechargeable nickel-cadmium batteries (Gould Type 9.6V/450B) give 30 hours operation. They are recharged by connection to a 115-volt (or 230-volt), 25- to 60-cycle power line. Full charge takes about 14 hours.

Accessories Supplied: Carrying strap, power cord for charging battery, shielded cable assembly for connection to sound-level meter.

Accessories Available: TYPE 1560-P4 PZT Microphone Assembly.

Cabinets: Flip-Tilt; relay-rack models also are available.

Dimensions: Portable model — width 10 $\frac{1}{4}$, height 9 $\frac{1}{4}$, depth 7 $\frac{1}{4}$ inches (260 by 235 by 185 mm), over-all, including handle; rack model — panel 19 by 8 $\frac{3}{4}$ inches (485 by 225 mm); depth behind panel 5 inches (130 mm).

Net Weight: Portable models, 8 $\frac{3}{4}$ pounds (4 kg); rack models, 9 pounds (4.1 kg).

Shipping Weight: Portable models, 17 $\frac{3}{4}$ pounds (8.1 kg); rack models, 24 pounds (11 kg).

Type		Code Number	Price
1558-A	Octave-Band Noise Analyzer (ASA Standard), Portable Model	1558-9701	\$770.00
1558-9820	Octave-Band Noise Analyzer (ASA Standard), Rack Model	1558-9820	770.00
1558-AP	Octave-Band Noise Analyzer (ASA Preferred Frequencies), Portable Model	1558-9829	770.00
1558-9822	Octave-Band Noise Analyzer (ASA Preferred Frequencies), Rack Model	1558-9822	770.00
1560-P4	PZT Microphone Assembly	1560-9604	80.00



Type 1556-B IMPACT-NOISE ANALYZER

This device measures the characteristics of impact-type sounds and electrical noise impulses, which cannot be satisfactorily measured with conventional noise-measuring equipment.

IMPACT NOISES

include those produced by punch presses, forging hammers, fire alarms, pile drivers, office machinery, and similar equipment. From the standpoint of hearing damage, some of these sounds constitute a serious problem for industry. They have hitherto been measurable only by complicated methods employing oscilloscopes.

The two characteristics of impact sounds that seem most significant are the peak amplitude and the duration, or decay time. This analyzer measures both of these quantities and also a quasi-peak value that is useful in determining the variation among repetitive peak values.

Peak value is the maximum sound-pressure level reached by the noise; quasi-peak is a continuously indicating measure of the high sound-pressure levels reached just before the time of indication; time-average is a measure of the average level over a predetermined period of time, which, when subtracted from peak level, is a measure of the time duration of the sound.

For these applications, the TYPE 1556-B Impact-Noise Analyzer operates from the output of a TYPE 1551 Sound-Level Meter and, when a vibration pickup is used in place of the microphone on the sound-level meter, will measure

vibration impacts. It will also operate from octave-band analyzers, tape recorders, and vibration meters.

ELECTRICAL NOISE PEAKS

in a wire communication circuit can be measured with this instrument as one of the tests to determine the adequacy of the circuit for transmitting data pulses to and from computers and other business machines. In such measurements, many peaks may be measured in a short time, and, after each peak, the stored signal must be erased before the next pulse occurs. To facilitate this, to reduce operator fatigue, and to minimize acoustic noise from the switching process, a RESET pushbutton is provided, which can also be operated by an ordinary camera cable release.

CIRCUIT

A battery-operated, degenerative, transistor amplifier simultaneously drives three ac voltmeter circuits, which comprise rectifiers, storage capacitors, and a dc electronic voltmeter. The electrical storage system (a capacitor charged by a rectifier) makes it possible to measure three characteristics—peak, quasi-peak, and time-average—of an impulse with a single indicating meter.

SPECIFICATIONS

Input: Any voltage from 1 to 10 volts for normal range. Inputs below 1 volt reduce the range of reading.

Input Impedance: Between 25,000 and 100,000 ohms, depending on the setting of the LEVEL control.

Frequency Range: 5 cps to 20 kc.

Level Indication: Meter calibrated in db from -10 to +10. Attenuator switch increases range by 10 db.

Peak Reading: Rise time is less than 50 microseconds for a value within 1 db of peak value (for rectangular pulses). Storage time at normal room temperature is greater than 10 seconds for a 1-db change in value.

Quasi-Peak Reading: Rise time of less than 1/4 millisecond and decay time of 600 ± 120 milliseconds for rectifier circuit.

Time-Average Reading: Charge time of rectifier circuit selected by seven-position switch, having times of 0.002, 0.005, 0.01, 0.02, 0.05, 0.1, and 0.2 second for the resistance-capacitance time constant. Storage time at normal room temperature is greater than 1 minute for a 1-db change in value.

Accessories Required: A sound-level meter or frequency analyzer to supply the analyzer input if it is to be used for acoustical measurements.

Input Terminals: Cord with phone plug at one end.

Batteries: One 1 1/2-volt size D flashlight cell (Rayovac 2LP or equivalent) and one 45-volt B battery (Burgess XX30 or equivalent) are supplied. Typical battery life is 100 hours.

Cabinet: Aluminum; carrying case supplied. Cabinet can be fastened directly to one end of a TYPE 1551 Sound-Level Meter.



The Type 1556-B Impact-Noise Analyzer with the Type 1551-C Sound-Level Meter.

Dimensions: Width 7 1/2, height 6 1/2, depth 4 1/4 inches (190 by 170 by 110 mm), over-all.

Net Weight: 4 1/2 pounds (2.1 kg); carrying case, 1 pound (0.5 kg).

Shipping Weight: 7 1/4 pounds (3.3 kg), in case.

Type		Code Number	Price
1556-B	Impact-Noise Analyzer	1556-9702	\$240.00



MEASURES BOTH ELECTRICAL AND
ACOUSTICAL NOISE PEAKS



Type 1521-A GRAPHIC LEVEL RECORDER

FEATURES:

- ◆ Plots rms level of ac voltage, 20 cps to 200 kc. ◆ Completely transistorized.
- ◆ Fast writing speed with optimum ballistics.
- ◆ Calibrated in absolute level. ◆ Interchangeable logarithmic potentiometers.
- ◆ Mechanical coupling available for driving oscillator or analyzer.
- ◆ Simple to operate — three basic controls. ◆ Easily converted to dc linear recorder.

USES: The TYPE 1521-A Graphic Level Recorder has a wide variety of uses in electronics, acoustics, and other branches of physical science and engineering. It records linearly in decibels the rms magnitude of ac voltage from 20 cps to 200 kc. It produces permanent ink records of the response of electrical or electroacoustical devices and systems as a function of time or frequency. Owing to the high stability of its reference voltage and amplifier gain, it can be used as a recorder of absolute level.

Amplitude-Frequency Plotting. For frequency-characteristic measurements, the paper drive can be coupled by means of drive and link units to the frequency-control shaft of an oscillator or analyzer for completely automatic recording. The combination of the recorder and the TYPE 1304-B Beat-Frequency Audio Generator produces records having a true logarithmic frequency scale and is ideal for plotting frequency characteristics of analyzers, recording systems, networks, filters, and equalizers, as well as of loudspeakers, microphones, vibration pickups, and other transducers.

Acoustical Measurements. The combination of the recorder and either the TYPE 1564-A Sound and Vibration Analyzer or the TYPE 1900-A Wave Analyzer makes possible automatic analysis of sound spectra, and response measurements on devices excited by white noise.

Used with the TYPE 1551 Sound-Level Meter, the recorder can plot sound levels over a wide dynamic range. For measurements of level as a function of time, the writing speed is sufficiently high for the measurement of reverberation time and other transient phenomena.

The wide range of paper speed facilitates long-period studies of the noise produced by traffic, office machinery, industrial processes, and potential hearing-damage conditions, as well as of short-duration transients.

DESCRIPTION: The TYPE 1521-A Graphic Level Recorder is a completely transistorized, single-channel, servo-type recorder. It produces a strip-chart record with ink on white paper, suitable for reproduction. The pen is attached to a coil, which moves linearly over a 4-inch distance in a uniform magnetic field. A contact attached to the coil rides on a straight potentiometer, which is the balancing element for the servo. The position of the contact is determined by the input signal, and the exponential potentiometer characteristic produces a linear db scale.

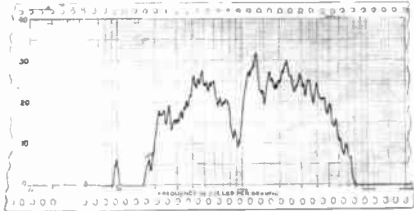

Plot of frequency response of a public-address system made on the graphic level recorder driving the frequency dial of the beat-frequency audio generator.

The detector circuit response is, for all commonly encountered waveforms, very close to true rms.

The difference between the detector output and a one-volt reference is amplified and used to position the coil, which carries the potentiometer contact and pen. A velocity-feedback coil mounted on the drive-coil frame provides appropriate damping.

Careful design has made it possible to maintain both a high writing speed and the largest servo bandwidth consistent with a frequency response extending downward to 20 cps, without exceeding a 1-db overshoot. Writing speeds are selected by a single switch without auxiliary adjustment of low-frequency cutoff or damping.

Changes of range are easily accomplished by use of a 20-db or an 80-db potentiometer in place of the standard 40-db unit. With the 80-db unit, the maximum writing speed becomes 300 db/second, permitting measurement of reverberation times as short as 0.3 second. The slow writing speeds filter out abrupt level variations, yielding a smoothed plot without loss of accuracy.

For dc recording, a linear potentiometer provides a balancing voltage in series with the input voltage, and the combined voltage is balanced against the 1-volt reference. A single 0.8-volt range at a 1000-ohm input-impedance level makes the instrument interchangeable with the usual direct-writing strip-chart recorders.



SPECIFICATIONS

Dynamic Range: With potentiometer furnished, 0 to 40 db for level recording (20-db and 80-db potentiometers are also available); 0 to 0.8 volt (at 1000 ohms) full scale, for dc recording with zero input position adjustable over full scale.

Frequency Response

Level Recorder: 20 cps to 200 kc (within 3 db).
DC Recorder: 0 to 10 cps (peak-to-peak amplitude less than 25% of full scale).

Potentiometer Linearity

Level Recorder: $\pm 1\%$ of full-scale db value plus a frequency error of 0.5 db at 100 kc and 1.5 db at 200 kc.
DC Recorder: $\pm 1\%$ of full scale.

Resolution: $\pm 0.25\%$ of full scale.
Maximum Input Voltage: 100 volts, ac.
Input Attenuator: 60 db in 10-db steps.
Input Impedance: 10,000 ohms for ac level recorder; 1000 ohms for dc recorder.
Maximum Sensitivity: 1 millivolt at 0 db for level recording; 0.8 volt full scale for dc recording.

General

Paper Speeds: 2.5 inches per minute to 75 inches per minute. A slow-speed motor to provide speeds of 2.5 to 75 inches per hour is available as an alternate. See below.

Writing Speed: 1, 3, 10, or 20 inches per second (approximately), with overshoot less than 1 db.
Oscillator or Analyzer Drive: Order TYPE 1521-P10B Drive Unit and appropriate link unit.

External DC Reference: Internal terminals are provided for an external dc voltage, which can be substituted for the 1-volt internal dc reference. The recorder will operate properly over a 3:1 reference-voltage range (0.5 to 1.5 volts). If this reference voltage is derived from the source of energy in the system under test, variations of up to 3:1 in the source output can be eliminated from the recording.

Detector: Quasi-rms; within 0.25 db of rms for multiple sine waves, square waves, or noise. Detector operating level is 1 volt.

Chart Paper: 4-inch recording width on 5-inch paper. Charts have 8 major divisions, 40 total divisions on vertical scale, except 1521-9427, which has 80 total divisions, and 1521-9466, which has 50.

Accessories Supplied: 40-db potentiometer, 2 pens, 2-ounce bottle of red ink, 2-ounce bottle of green ink, bottle of potentiometer cleaner, 1 roll of 1521-9428 paper, droppers for filling pens, CAP-22 Power Cord, spare fuses, adaptor cable for connection to sound-measuring equipment and other devices having telephone jacks.

Accessories Available: Potentiometers, charts, ink, slow-speed motors, drive and link units, as listed in price table.

Power Requirements: 105 to 125 (or 210 to 250) volts, 60 cps, 35 watts. 50-cycle models are available; see price list below.

Cabinet: Rack-bench (see page 210).

Dimensions: Bench model — width 19, height 9, depth 13 1/2 inches (485 by 230 by 350 mm), over-all; rack model — panel 19 by 8 3/4 inches (485 by 225 mm), depth behind panel 11 1/4 inches (280 mm).
Net Weight: 50 pounds (23 kg).
Shipping Weight: 64 pounds (29 kg).

POTENTIOMETERS

Type		Code Number	Price
1521-P1	20 db	1521-9601	\$ 55.00
1521-P2*	40 db	1521-9602	70.00
1521-P3	80 db	1521-9603	155.00
1521-P4	Linear (for dc)	1521-9604	55.00

* Supplied with recorder.

MOTORS FOR LOWER CHART SPEED††

1521-P20	(60 cps) for paper speeds of 2.5-75 inches/hour	1521-9620	\$ 52.50
1521-P22	(50 cps) for paper speeds of 2.5-75 inches/hour	1521-9622	65.00

†† Recorder can be supplied with low-speed motor installed, at same price as with standard motor.

Type	Mounting	Supply Frequency	Paper Speed	Code Number	Price
1521-AR	Rack	60 cps	2.5-75 in./min	1521-9811	\$995.00
1521-AM	Bench	60 cps	2.5-75 in./min	1521-9801	995.00
1521-ARQ1	Rack	50 cps	2.5-75 in./min	1521-9496	995.00
1521-AMQ1	Bench	50 cps	2.5-75 in./min	1521-9495	995.00

CHART PAPER† — 100-FOOT ROLLS

Type		Code Number	Price
1521-9427	Calibrated 20 cps to 20 kc, logarithmic, 9 inches, repeating every 13 1/2 inches; for use with Type 1304-B Beat-Frequency Audio Generator.	1521-9427	\$ 2.75
1521-9464	Calibrated 0 to 10 kc, linear, repeating every 20 inches; for use with Type 1900-A Wave Analyzer.	1521-9464	2.75
1521-9465	Calibrated 0 to 50 kc, linear, 10 inches, repeating every 16 inches; for use with Type 1900-A Wave Analyzer.	1521-9465	2.75
1521-9493	Calibrated 2.5 to 25 (normalized decades) for use with Type 1554-A Sound and Vibration Analyzer.	1521-9493	2.75
1521-9463	Calibrated 25 to 25,000 cps, repeating every 21 inches; for use with Type 1554-A Sound and Vibration Analyzer.	1521-9463	2.75
1521-9429	Calibrated 25 to 7500 cps in 1/2-decade segments 2 1/2 inches long; for use with Type 760-B Sound Analyzer.	1521-9429	2.75
1521-9428	Linear time base, 1 division = 1/4 inch; for ac or dc records as a function of time.	1521-9428	2.75
1521-9466	Linear time base, 1 division = 1/4 inch; 10 major divisions, 50 total divisions. For use with Types 1134-A and 1136-A Digital-to-Analog Converters.	1521-9466	2.75

† Subject to quantity discounts.

INK

1521-4092	16-ounce bottle of red ink	1521-4092	\$ 5.50
1521-4093	16-ounce bottle of green ink (for oszoid copies)	1521-4093	5.50

DRIVE AND LINK UNITS FOR COUPLING TO OSCILLATOR AND ANALYZERS

1521-P10	Drive Unit to operate any link unit.	1521-9610	\$ 72.00
1521-P14	Link Unit for coupling to Type 1304-B Beat-Frequency Audio Generator above or below recorder, or to Type 1554-A or Type 1564-A Sound and Vibration Analyzer above recorder.	1521-9614	23.00
1900-P1	Link Unit for coupling to Type 1900-A Wave Analyzer.	1900-9601	35.00

INDEX

Acceleration	133,205
Acceleration level	135
Accelerometer	137
Acoustical calibration	34,77,79
Acoustic calibrator	34
Acoustic power levels	5,98,105
Acoustic materials	47,127
Acoustical properties of rooms	47,68,110
Age, hearing variation with	14
Analysis of noise	45,55
Analysis of recorded noise	83
Analyzers	30,205
Impact-noise	32,144,242
Octave-band	30,56,143,240
Sound and vibration	31,57,142,238
Vibration	141
Wave	33,58,143,236
Anechoic room	102,205
Annoyance	21
Apparatus test codes	43,72,76
Applications	
Sound-measuring instruments	40
Vibration-measuring instruments	151
Architectural acoustics	42,99,127
Articulation index	21
Atmospheric pressure, effects	197
Attenuating structures	127
Audiogram	205
Audiometer	14,205
Averaging procedure	108
Background noise effects	72
Baffle	127,205
Cables, microphone	67
Calibration	
Acoustical	34,77,79
Electric circuit	77
Microphone	77
Vibration pickup	164
Calibration at high frequencies	80
Catalog section	225
Cathode-ray oscilloscope	39,84,148
Chart recorder	35,61
Circuit noise	73
Comparison method of measuring radiated power	109

Comparison tests on sound-level meters	80
Condenser microphone	29,64,84,229
Confidence limits	201,206
Contours, sound-pressure	101
Control of noise	125
Correction for frequency-response characteristic	80
Criteria for indoor noise levels	116
Criteria for noise control	118
Critical speed	206
Dead room	102,206
Decay rate	107,110,206,212
Decibel	
Combining	9,184
Conversion tables	175
Definition	3,206
Definitions	205
Differential sensitivity	23
Diffuse field	111
Directional effects, microphone	67
Directional gain	106,207
Directional source in free field	99
Directivity factor	101,106,206
Discomfort threshold	13
Displacement	133,207
Earphones	86,207
Effects of vibration	167
Effective sound pressure	207
Electrical circuit calibration	77
Environmental noise	49
Equal-loudness contours	16
Far field	100
Filter	207
Flash delay unit	146
Fluctuating sounds	61,199
Flutter	82
Free sound field	97,207
Directional source in	99
Simulated	102
Frequency	3,207
Frequency analysis by sound-survey meter	54
Frequency response (See also Response Curves)	
Analyzers	56,143
Sound and vibration analyzer	143
Vibration meter	139
Vibration pickup	141,160,162,163
Frequency spectrum	55
g	208
Galvanometer, recording	149,154
Graphic level recorder	35,61,147
Graphic presentation of noise levels	47

Harmonic index	55
Hearing loss	24,48,122,208
Hemispherical measurements	105
High-frequency noise	64
High sound levels	64
Hum pickup	74
Microphone	67
Humidity effects	66,75
Hydrophone	30
Impact	208
Impact-noise analyzer	32,63,144,242
Impact sounds	63
Indoor noise levels	116
Isolation	127,208
Jerk	133,208
Level	5,208
Loudness	17,111,186
Power	5,98,105,211
Reference	3,9
Sound	7,213
Sound-pressure	7,214
Spectrum	60
Speech interference	21,48,115,215
Live room	107,209
Loudness	17,48,111,186,209
Loudness contour	16,209
Loudness level	17,48,186,209
Loudness rating	15
Loudspeaker	209
Low-frequency noise	64
Low sound levels	64,73
Machine noise	46
Magnetic tape recorder	38,81,149
Masking	20,209
Materials, acoustic	47,127
Measurement points	51,102
Mechanical shock	209
Mel	23,209
Meter pointer behavior	199
Microbar	3,210
Microphones	29,63,210
Microphone, choice of	63
Microphone position	51,76,102
Microphonics	74
Mounting of device under test	75,108
Narrow-band analyzer	31,57,153
Near-field behavior	100
Noise	
Analysis	45,55
Control	125

Criteria	118
Definition	210
Test codes	43,72,76
Noise level	210
Noise levels, residential	119
Noise source characteristics	96
Nonsinusoidal vibrations	135,159
Observer effect on measured data	70
Octave	210
Octave-band analyzer	30,56,143,240
Office noise, rating chart	117
Operation of vibration pickup	158
Oscillation	211
Oscilloscope	39,84,148
Pain, threshold of	11
Peak-to-peak value.	133,211
Phon	17,111,186,211
Photoelectric pickoff.	146
Pitch	23,211
Point source	97,211
Position of microphone	51,76,102
Power, acoustic	6,98,105
Power level.	5,211
Calculation of	105
In free field.	98
Power, radiated, calculation of	103
Predicting noise levels	110
Presbycusis	14,211
Pressure spectrum level.	60,211
Primitive period	211
Psychoacoustical aspects.	21
Psychoacoustical experiments	11
Pure tone	211
Q	101,106
Radiated power, calculation of	103
Random noise	16,199,211
Random-noise generator	37,148
Rate of decay.	107,110,206,212
Reciprocity calibrator.	34,79,232
Recorder	
Graphic level.	35,61,147
Tape	38,81,149
Record of measurements	87
Reference levels, pressure and power	3,9
Reference signal	82
References	218
Residential noise levels.	119
Resonance.	212
Resonant frequency.	212
Response	212

Response curves (See also Frequency Response)	
For sound-level meter, sound-survey meter	52
Of various microphones	65
Reverberant room, measurements in.	107
Reverberation	110,212
Reverberation time.	110,212
Room effects on measurement	68,106
Sampling procedure	108
Schools, applications for sound-survey meter	42
Shakers, vibration	148,150
Simple sound-source.	213
Simple tone	213
Simulated free field	102
Sone.	18,111,213
Sonics	213
Sound.	3,213
Sound intensity.	213
Sound level	7,213
Sound-level calibrator.	35,77,231
Sound-level measurement	51
Sound-level meter	7,28,51,214,227
Applications	43
Sound levels, typical.	4
Sound path, control of	127
Sound pressure	3
Sound-pressure contours in free field	99
Sound-pressure level	7,55,214
Sound-pressure level for a directional source	101
Sound-pressure level measurement.	55
Sound source in reverberant room.	107
Sound-survey meter	27,226
Applications	41
Source characteristics, noise	96
Spectrum	214
Spectrum level.	60
Speech-interference level	21,48,115,215
Standards	218
Standing wave	69,215
Stethoscope	86
Stroboscope.	145,152
Strobolume	147
Strobotac® electronic stroboscope	145
Subjective comparisons of noise	15,83
Tape recorder	38,81,149
Telephone usability.	116
Temperature effects on microphones	66
Test codes, noise.	43,72,76
Theaters, applications for sound-survey meter	42
Third-octave-band analyzer	31,57,142,238
Thresholds of audibility, detectability, feeling	11,13,215

Thresholds of hearing, pain, discomfort	11,13
Tickle	215
Tone	215
Transducer	215
Transient vibration	215
Ultrasonics	216
Uniformly distributed measuring points (for calculating radiated power)	103
Velocity	133,216
Velocity level	135
Vibration	132,216
Analyzers	141,238
Calibrator	144,164,235
Conversion charts	187
Human response to	167
Instruments	85,137
Isolator	216
Measurement	132,153,158
Meter	137,216,233
Pickup	29,140,158,230
Hand-held	159
Fastening methods	161
Orientation	158
Shaker	148,150
Vibrometer	216
Wave analyzer	33,58,143,236
Wave-form observations	85
Weighting networks	7,51,115
White noise	16,37,143,216
Words commonly used to describe sounds	217
Work output, effects of noise on	24

GENERAL RADIO COMPANY

WEST CONCORD, MASSACHUSETTS

NEW YORK • PHILADELPHIA • SYRACUSE • WASHINGTON
CHICAGO • DALLAS • ORLANDO
LOS ANGELES • SAN FRANCISCO • TORONTO

GENERAL RADIO COMPANY (OVERSEAS)

ZURICH, SWITZERLAND

REPRESENTATIVES IN PRINCIPAL COUNTRIES

