

**CATHODE - RAY
OSCILLOGRAPHS**

REYNER

ALSO BY J. H. REYNER

MODERN RADIO COMMUNICATION

A Manual of Modern Theory and Practice,
Covering the Syllabus of the City and Guilds
Examinations and Suitable for Candidates for
the P.M.G. Certificate.

In two vols. Each crown 8vo, cloth gilt,
illustrated.

VOL. I. 330 pp. 7s. 6d. net.

VOL. II. 255 pp. 7s. 6d. net.

"The treatment is concise and clear. . . .
We have no hesitation in recommending the
books."—*Wireless World*.

"The two volumes together form one of the
most concise and authoritative textbooks avail-
able."—*English Mechanics*.

SHORT-WAVE RADIO

"The student will find a wealth of authorita-
tive information to help him in this fascinating
study."—*Popular Wireless*.

"A reliable and readable summary of the
latest developments in short-wave radio com-
munication."—*Electrical Review*.

"Confidently recommended."—*Electrical En-
gineer*.

In crown 8vo, cloth gilt, 172 pp., illustrated.
10s. 6d. net.

Sir Isaac Pitman & Sons, Ltd., Parker Street, Kingsway, W.C.2

CATHODE-RAY OSCILLOGRAPHS

BY

J. H. REYNER

B.SC., A.C.G.I., D.I.C., A.M.I.E.E., M.INST.R.E.

(SECOND EDITION)



LONDON
SIR ISAAC PITMAN & SONS, LTD.

1943

SIR ISAAC PITMAN & SONS, LTD.
PITMAN HOUSE, PARKER STREET, KINGSWAY, LONDON, W.C.2
THE PITMAN PRESS, BATH
PITMAN HOUSE, LITTLE COLLINS STREET, MELBOURNE
UNITEERS BUILDING, RIVER VALLEY ROAD, SINGAPORE
27 BECKETTS BUILDINGS, PRESIDENT STREET, JOHANNESBURG

ASSOCIATED COMPANIES

PITMAN PUBLISHING CORPORATION
2 WEST 45TH STREET, NEW YORK
205 WEST MONROE STREET, CHICAGO

SIR ISAAC PITMAN & SONS (CANADA), LTD.
(INCORPORATING THE COMMERCIAL TEXT BOOK COMPANY)
PITMAN HOUSE, 381-383 CHURCH STREET, TORONTO



THE PAPER AND BINDING OF
THIS BOOK CONFORM TO THE
AUTHORIZED ECONOMY STANDARDS

MADE IN GREAT BRITAIN AT THE PITMAN PRESS, BATH
D3-(T.125)

PREFACE TO SECOND EDITION

IN revising this book the opportunity has been taken to include some additional matter dealing with recent developments in the circuits associated with deflection amplifiers, time bases, and frequency modulators, and also to include some reference to applications in the industrial field.

The construction of the cathode ray tube has advanced considerably since this book was first published, with the result that it is becoming an even more valuable tool, both to the laboratory worker and the equipment engineer.

J. H. REYNER

PREFACE

THE cathode-ray tube has ceased to be an expensive luxury primarily of academic interest. Improvements in construction and reductions in price have brought it into the realm of practical measuring equipment. It has the advantage that in many cases it will provide definite information, where previously inferential methods had to be adopted. Even a simple a.c. meter is calibrated with a sinusoidal current and calculations based on this assumption can be appreciably in error.

For instructional purposes the modern inexpensive oscillograph has no equal, while practical experience has amply demonstrated the robustness and reliability of this form of equipment in industrial fields.

It was felt that a simple book dealing with the practical application of cathode-ray tubes would prove of value. Matters of tube design have not been discussed, nor has it been possible to include data on all possible variants of the fundamental methods. An attempt has been made, however,

to provide a detailed groundwork of the theory underlying the circuits involved.

The treatment is based on practical experience extending over many years. The opportunity has been taken in this revised reprint to include some small additional matter, but in the main the treatment remains unchanged and it is hoped that the book will continue to prove of value to all who have occasion to use cathode-ray equipment.

J. H. REYNER

BOREHAM WOOD

CONTENTS

PREFACE	PAGE V
-------------------	-----------

CHAPTER I

TYPES OF OSCILLOGRAPH TUBE	1
--------------------------------------	---

Construction of low-voltage tube—Brilliance—Shield—Focusing—Gas-focus tube—Merits and defects of soft tubes—Electrostatic focusing—Merits of hard tubes—Magnetic focusing—Colour of image—Afterglow—Effect of size of screen

CHAPTER II

THE OSCILLOGRAPH IN USE	15
-----------------------------------	----

Sensitivity—Visual persistence—Direction of deflection—Alignment of tube—Time bases—Synchronism—Magnetic deflection—Estimation of magnetic field—Shifts—Tube networks—Tube distortions—Origin distortion—Trapezium distortion—Loss of focus—Magnetic distortion—Location of deflecting coils—Stray fields—Mumetal shield—Faults in setting up—Bulb charge—Excessive deflection—Incorrect speed of time base—Self-centring—Inverted deflection—Softness

CHAPTER III

WAVEFORM EXAMINATION	49
--------------------------------	----

Phase difference—Harmonics—Amplitude distortion—Time bases—Non-linearity—Charging time—Synchronism—Too much synchronism—Phase of synchronizing voltage—Push-pull time bases—High-frequency time bases—Fly-back—Faults in time bases—Non-linearity—Limited scan—Time-base hum—Magnetic hum—Vertical hum deflection—Intermodulation

CHAPTER IV

DEFLECTION AMPLIFIERS	87
---------------------------------	----

Design of amplifier—Linearity—Gain control—Cathode follower—R.M.S. and peak values—Transients—Faults in amplifiers—Frequency response—Phase angle—Negative feed-back—Ripple voltage—Intermodulation—Compensation

	PAGE
CHAPTER V	
FREQUENCY-RESPONSE CURVES	107
Motor-driven modulators—Electronic modulators—Application of control voltage—Use of reactor valve—Magnetic methods of frequency modulation—Double-image working—Resonance curves—Adjustment of frequency—Frequency sweep—Modulated envelope—Faults in frequency modulators—Effect of A.V.C.—Inverted images—Hum—Audio-frequency curves	
CHAPTER VI	
CHARACTERISTIC MEASUREMENTS	131
Valve curves—Sweep voltage—Magnetic deflection—Direction of characteristic—Looped characteristics—Phase ellipses—Harmonic analysis—B-H curves	
CHAPTER VII	
FREQUENCY COMPARISON	143
Lissajous figures—Time-base methods—Crystal control—Frequency standards	
CHAPTER VIII	
RADIO-FREQUENCY EXAMINATIONS	150
Band pattern—R.f. distortion—Modulation—Effect of phase—Measurement of modulation depth	
CHAPTER IX	
SPECIAL APPLICATIONS	157
D.C. circuits—D.C. amplifiers—Compensated amplifiers—Repeating transients—Elliptical time base—Phasing circuits—Integration and differentiation—Production of pulses—Zigzag time bases—Single-sweep circuits—Velocity modulation—Cathode follower—Double-wave recording—Double beam tubes—Pressure recording—Capacity micrometers—Photographic recording—Other applications	
INDEX	185

CATHODE-RAY OSCILLOGRAPHS

CHAPTER I

TYPES OF OSCILLOGRAPH TUBE

AN oscillograph or oscilloscope is a device for writing or tracing an oscillation. Such devices have been known for many years. They first took the form of electromagnetic vibrators which were, in effect, moving coil meters with a small mirror attached. A spot of light focused on the mirror was reflected on to a scale and as the vibrator moved under the influence of current so the spot moved over the scale.

Any ordinary mechanism, however, is obviously only capable of following quite slow variations of current, and if the current is varying many hundreds or even thousands of times per second, it is clear that very special construction is necessary.

Up to a point this was successfully achieved by these mechanical methods, but it was not long before attempts were made to produce the desired result by purely electrical means. Clearly, if this can be done there is a tremendous advantage at the outset because the absence of moving parts renders the operation of the device practically instantaneous.

The cathode-ray tube provides the necessary electrical mechanism. It produces, in fact, a spot of light which can be caused to move in strict accordance with the current or voltage in a circuit, even when the current or voltage is changing at an extremely rapid rate—some hundreds of thousands or even millions of times per second. What is more, the cathode-ray tube provides facilities for moving the spot in two directions

at once, as we shall see later, and this not only makes it possible to examine oscillations or waveforms but supplies the means for a whole host of other applications quite beyond the scope of the mechanical oscillograph.

In consequence, the cathode-ray oscillograph has come into use to a surprising extent, not only in the electrical but in the industrial field, since it enables an actual picture of events to be obtained speedily and accurately, and while the mechanical oscillograph with its somewhat bulky construction and limited scope was formerly used principally in schools and colleges, cathode-ray equipment is found to-day in the test and research departments of a large number of enlightened industrial concerns.

Cathode-ray tubes are of two main types—the high- and low-voltage variety. In the former, the anode potentials employed are such that the electrons can be emitted from a cold cathode, whereas, in the low-voltage type, a hot cathode is employed which emits electrons much more readily, so that voltages of a much lower order are required, and the whole equipment can be made reasonably portable. This book deals exclusively with the second type.

Construction of Low-voltage Tube.

The fundamental features of a low-voltage tube are—

- (a) A heated cathode or filament.
- (b) An anode or gun maintained at positive potential.
- (c) A control electrode or shield for controlling the emission.
- (d) A deflecting system.
- (e) A fluorescent screen on which the image appears.

Fig. 1 shows a simple type of tube. It is similar in principle to a thermionic valve. The electrode system is enclosed in an evacuated glass bulb. When the cathode or filament is heated (by passing current through it) small particles of electricity called *electrons* are emitted. Close at hand is an anode on which is placed a positive voltage which attracts the electrons

across the space so that a current flows. This is the normal action of the thermionic valve.

In the cathode-ray tube, the anode is in the form of a disc with a hole in the centre and the electrons in this region, finding nothing to impede their progress, shoot through the anode and continue to travel in a straight line. The tube is made elongated and the end is coated on the inside of the glass with a fine crystalline powder made of chemical salts which

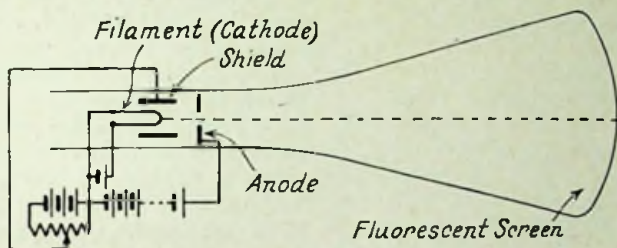

FIG. 1. DIAGRAM OF SIMPLE CATHODE-RAY TUBE

glow or fluoresce under the impact of electrons. Where the electrons strike this *fluorescent screen*, therefore, a patch or spot of light appears.

Brilliance.

The brilliance of the light spot depends on the energy contained in the electron beam. The fluorescent screen, in fact, converts the electron energy into light. To obtain sufficient energy the voltage applied to the anode has to be greater than is usually adopted for valves, a value between 500 and 2 000 being customary in oscillograph practice.

We do not make the voltage higher than necessary to provide adequate brilliance, because with high voltages the electrons are moving faster and are not as easily deflected from their course. In practice we require the beam to deflect under the influence of externally applied voltages, as we shall see in the

next chapter, so that we have to compromise between reasonable "sensitivity" and satisfactory brilliance.

Recent improvements in fluorescent materials have resulted in very satisfactory brilliance at voltages between 500 and 1 000, and this is the general order of anode potential used to-day.

Shield.

Around the cathode is a small cylinder or shield which is usually maintained at a small negative potential (though in some tubes a small positive potential is used). The actual potential depends upon the geometrical proportions of the electrode assembly, but the effect is that the electrostatic field near the cathode is such as to repel any electrons which leave the cathode in a diverging direction, and thereby to concentrate the stream towards the centre. By this means a larger part of the total emission is enabled to go through the hole in the centre of the anode.

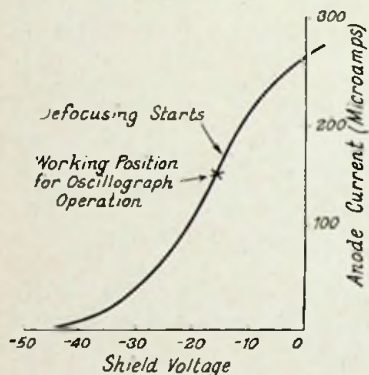

FIG. 2. CHARACTERISTIC OF CATHODE-RAY TUBE

An increase in the negative bias first of all produces an optimum concentration of the electrons as just explained, but thereafter the shield begins to influence even the central electrons. It then reduces the emission in the same way as the grid of a valve restricts the anode current, and if the process is continued far enough the emission is completely cut off and the tube ceases to operate. A typical tube characteristic is shown in Fig. 2.

In oscillograph working the tube is usually employed at some such point as X, but the possibility of controlling the emission, and thereby the intensity of the light spot on the

screen, is sometimes utilized, and it is, of course, the basis of television reception.

Use has been made of tubes in which the control electrode is maintained at a small positive potential. The action is similar, although the electrode assembly is naturally different. It is, however, impossible to extinguish the beam (i.e. cut off the current completely) with this type of tube.

Focusing.

The effect of the concentration of electrons just explained is twofold. In the first place the number of electrons in the beam increases so that the spot on the screen becomes brighter. It also resolves itself into a spot instead of an irregular patch, owing to the concentration of the electrons into a bundle.

For oscillographic work we require this spot to be small, brilliant and sharply defined, and therefore we require to carry this concentrating process to the maximum. A certain amount of focusing can be obtained by suitable adjustment of the shield, and also of the filament current if the cathode is of the directly heated type, but this will not by itself produce a really sharp spot. It is necessary to adopt some additional focusing device, and there are two principal methods by which this may be done.

In the first system, a small quantity of inert gas is introduced into the tube, and this considerably assists the focusing action, as explained in the next section. In the second method, the electrons which shoot through the hole in the anode are subjected to additional external influences which tend to make them converge. These external influences may be either electrostatic or electromagnetic, though for oscillograph tubes the electrostatic type is nearly always employed.

Gas-focus Tube.

In the gas-focus type, the tube is first exhausted in the normal way to remove the air and occluded gas, as in the case of a valve, after which a small quantity of inert gas such as argon, helium, or the like is introduced. Gases at a low pressure

such as this are very easily *ionized*. This means that the electrons in the atoms can be displaced from their normal position, so that the atom splits up into a positively charged *ion* and a free electron. The passage of the electron beam through the gas has this effect. As the electrons in the beam encounter molecules of gas they ionize them.

The electrons which are removed from the atoms add themselves to the stream. The positively charged particles or ions left behind as a result of the encounter begin to drift back towards the cathode, for, being positively charged, they will move in the opposite direction to the negatively charged electrons. Such encounters continue to happen from time to time, with the result that the electron stream contains within itself a sort of core or nucleus of positively charged ions. The ions are continually endeavouring to recover the electrons which they have lost, and they therefore exert a considerable attraction for the electrons which consequently cluster round this central core in a very compact pencil.

This concentrating action is entirely automatic and is very effective in practice. Experiments show that there are certain pressures of gas which are better than others, and also the focusing action depends upon the beam current, i.e. the number of electrons in the beam.* In practice, we control the beam current by alteration of the shield potential (and perhaps the filament current), so that under actual conditions of use all we do is to adjust these two controls until the spot becomes sharp and clearly defined. In a well-designed tube operating under correct conditions the spot can be as fine as 0.25 mm. in diameter. More usually the spot is between 0.5 and 1 mm. in diameter.

Merits and Defects of Soft Tubes.

The soft or gas-filled tube has several advantages which render it readily applicable to many problems. It has also

* See "The Theoretical and Practical Sensitivities of Gas-focused Cathode-ray Oscillographs," by J. T. MacGregor Morris and J. A. Henley. *Journal I.E.E.*, Vol. 75, p. 487.

certain defects which must be taken into account when making a choice as to type of tube.

Its principal advantages are—

(1) Satisfactory operation at low voltages (300 to 500 volts being adequate for most purposes).

(2) High sensitivity. This is a term related to the ease with which the beam may be deflected, causing a movement of the spot as discussed in the next chapter. A high sensitivity is convenient, though if the tube is too sensitive it is unduly prone to external interference.

(3) Excellent focus and good brilliance of the spot.

(4) Low first cost.

The defects of the soft tube are—

(1) Failure of focus at high deflecting speeds. As the beam is moved from side to side under the influence of a deflecting force, the ions constituting the core must move with it. These ions, however, are relatively heavy, and cannot follow the movement of the beam above a certain limiting speed which depends upon the nature of the gas used and the operating conditions. As a general rule it may be taken that a gas-focused tube is perfectly satisfactory for all audio frequencies, but begins to show loss of focus at radio frequencies.

(2) Limited life, owing to the presence of the heavy ions within the bulb. These ions move slowly in the opposite direction to the electrons, and ultimately arrive at the cathode. Being heavy, such ions as actually strike the cathode do appreciable damage, and in time the sensitive electron-emitting surface of the cathode is destroyed by this means.* This limits the life of a soft tube to a few hundred hours, whereas with hard tubes several thousand hours are possible.

(3) Origin distortion. There is a form of distortion prevalent with soft tubes known as origin distortion, which is discussed in more detail on page 31. It is not a very serious fault, and

* The design of the shield has an important bearing on this question. Not only does it serve to concentrate the electrons leaving the cathode, but it attracts a large proportion of the positive ions, preventing them from reaching the cathode.

may be entirely avoided by the use of a special tube construction as described later.

(4) Dependence of focus on beam current. The concentrating action of the ionic core only holds good at one particular value of beam current, so that if the intensity of the beam is altered by adjustment of the shield bias, the focus is lost. This is not greatly important for oscillographic work but it renders a soft tube quite impracticable for normal television.

Electrostatic Focusing.

An alternative type of focusing uses a composite gun or anode system instead of the simple disc previously discussed.

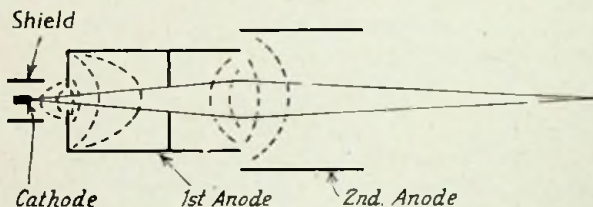

FIG. 3. DIAGRAM OF TWO-ANODE ELECTRON GUN

The dotted lines are lines of equipotential. The electrons are directed along the path of the electrostatic flux, which is at right angles to the dotted lines.

With this arrangement a succession of anodes is used at increasing potentials, and the various electrodes are so arranged that the electrostatic fields produced tend to re-direct any electrons which have left the centre of the tube. An idea of the concentrating action is shown in Fig. 3.

Using this form of focusing it is possible to evacuate the tube completely, so that the bombardment of the cathode by positive ions is practically obviated and the life of the tube is considerably increased.

For oscillograph tubes it is customary to use a two-anode arrangement, the first anode being maintained at a positive potential of something like one-quarter that of the second

or final anode. A typical practical tube uses 1 000 volts on the main anode and 250 on the first anode with about 50 volts negative on the shield.

It is found that, with a simple arrangement of this type, the focus and intensity controls are not independent. The voltage on the first anode affects the beam current and hence the intensity, while the adjustment of the shield also affects the focus, though to a smaller degree. Fig. 4 shows three typical horizontal lines traced out by a cathode-ray spot, the top two being incorrect and the third correct.

With a given setting of the focus control, however, variation of the voltage on the shield causes a change in brilliance only. There is usually some increase in spot diameter with increasing brilliance, so that the focus deteriorates, but the effect is not serious over the normal range of intensity.

In addition, the application of sufficient negative voltage to the shield will cause the spot to "black out" completely, which is often useful. For this reason the shield is often termed the *modulator*, or sometimes the *grid*, by analogy with the ordinary valve.

For purposes where a really sharp spot with a practically independent focus control is required, a three-anode tube is employed. Here, the first and second anode voltages are both made variable, although in practice the first anode potential is fixed at a convenient figure and the focus is adjusted by

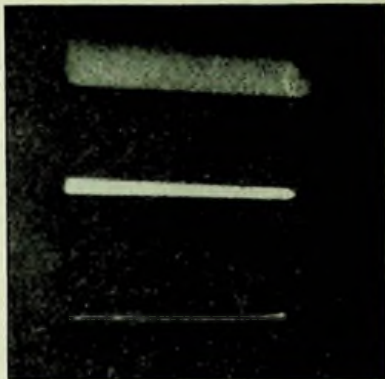

FIG. 4. ILLUSTRATING FOCUSING OF SPOT

In the top line the focus control is too far advanced. In the second, intensity is too great, while in the third both controls are correct.

altering the voltage on the second anode. Owing to the presence of the first anode at a fixed potential, it is found that the interaction of the focus and intensity controls is much less. It is possible to adjust the focus without serious alteration to the intensity, and, conversely, variations of the intensity control may be made over quite a wide range without seriously disturbing the focus. These desirable features, of course, are used in television technique to a large extent, but there are occasions in oscillograph work where similar facilities are required, in which case a three-anode tube is used.

Merits of Hard Tubes.

The hard or vacuum tube has its own particular advantages which may be summarized briefly as follows—

(1) The life of the tube is considerably increased owing to the absence of heavy ions bombarding the cathode.

(2) The focus remains good up to quite high radio frequencies.

(3) It is possible to control the brilliance of the beam independently of the focus.

(4) The image may be "blacked out" momentarily or for any desired period by applying negative voltage to the modulator. Owing to the absence of gas in the tube this action is instantaneous.

(5) It is possible to make the tube shorter than would be practicable with a gas-focused tube and this is sometimes important.

The disadvantages of the hard tube are—

(1) It is necessary to use higher anode voltages since the focusing action cannot usually be obtained satisfactorily at low anode potentials. The anode voltage ranges from 750 to 2 000 in the ordinary hard oscillograph tube.

(2) In consequence of the higher anode voltage the sensitivity is reduced, but special constructions recently evolved have produced sensitivities equal to the gas-focused tube.

(3) Although origin distortion is not present an equally objectionable form of distortion known as *trapezium distortion*

is liable to be present. This, however, may be obviated by the use of special deflecting systems, and the subject is discussed in detail in the next chapter.

(4) The spot does not remain sharply focused over the whole screen. This defect can be overcome by the use of symmetrical deflecting systems as is discussed in the next chapter.

Magnetic Focusing.

It is also possible to focus the electron stream by placing a coil round the neck of the tube as illustrated in Fig. 5. Any electrons which are diverging from the axis of the tube will be affected by this axial magnetic field, and if the field is sufficient they will be bent round and caused to converge on the axis again. The actual movement of the electrons in the field is slightly complex because in addition to being bent round they are given a twisting motion, but the net result is that they leave the area of magnetic field moving inwards towards the axis again, and the angle at which each electron converges is proportional to the angle at which it was originally diverging. Consequently, all the electrons tend to come together at one spot on the axis.

If the intensity and position of the field are correctly adjusted this focal point occurs at the screen, giving a very sharp point of light, and the method has some advantages in that the defocusing at the edges of the screen is not present.

For this reason magnetic focusing has become popular for television tubes where a sharp focus all over the screen is highly desirable. The position of the coil is important. If it is located immediately in front of the anode the focus in the

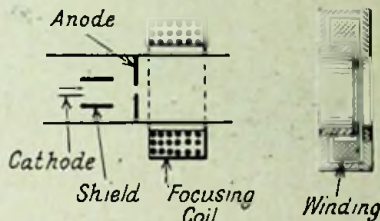

FIG. 5. ILLUSTRATING POSITION OF COIL FOR MAGNETIC FOCUSING AND (right) CONSTRUCTION OF TYPICAL FOCUSING MAGNET

centre of the screen will be very sharp, but it will be found to fall off at the edges. As the coil is moved farther forward the focus will be found to get slightly worse, the spot size becoming a little larger, but the focus will be more uniform over the

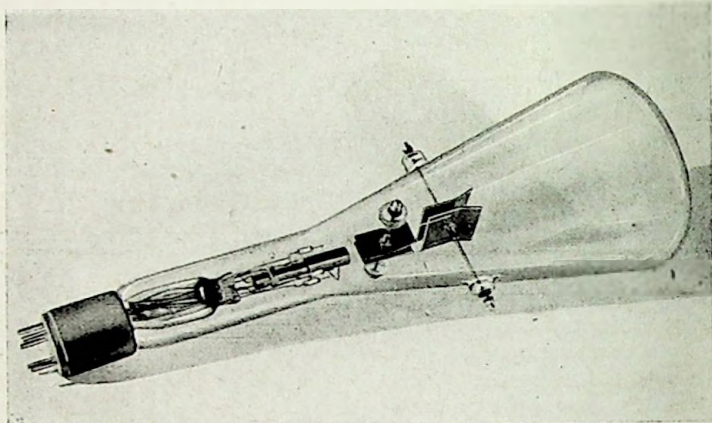

FIG. 6. ILLUSTRATION OF TYPICAL CATHODE-RAY TUBE

The electron gun can be seen on the left and the two pairs of deflector plates immediately following. This particular tube is of a special type wherein the leads to the deflectors are brought straight out through the sides of the tube to minimize the capacitance. With the more usual type of tube the connections to the deflectors are brought out to pins in the base.

(Mullard Wireless Service Co.)

whole of the screen and an optimum position can readily be obtained.

As mentioned, however, the magnetically focused tube is principally employed for television, and for oscillograph purposes a two-anode electrostatically-focused tube or a gas-focus tube is usually adopted.

Colour of Image.

The colour of the spot on the screen is determined by the

material of the screen. Willemite (zinc silicate) is commonly used and gives a bright green spot easily visible since it corresponds roughly with the maximum sensitivity of the human eye. For photographic work a blue screen is often employed using a tungstate of cadmium or calcium. The calcium salt in particular gives a very actinic fluorescence (i.e. it has a strong action on photographic emulsions) so that it may be used for recording phenomena of very short duration.

It is perhaps worth noting that the actual colour of the screen as viewed by ordinary light gives no indication of its fluorescent colour. All the fluorescent materials take the form of a fine white crystalline powder which is deposited on the inside of the screen and the actual colour under the impact of electrons can usually only be determined by actual trial.

Afterglow.

An alternative method of examining phenomena which occur very rapidly (transients) is to use a screen with an afterglow. Ordinarily the spot on the screen vanishes almost immediately after the electron beam is removed, so that if the beam is moved across the screen the spot moves with it instantaneously. Certain screens, however, continue to glow for a while after the electron beam has passed. Thus if the spot moves across the screen the path traced out will remain visible (though at greatly reduced intensity) for several seconds. Hence if the spot moves too rapidly for the eye to follow, the afterglow will show a faint but quite clear trace of the path which it has followed.

Zinc phosphate has a red fluorescence with an afterglow of $\frac{1}{4}$ second while some more recent compounds give a green afterglow lasting 10 seconds or more (in the dark). The afterglow, of course, is very much fainter than the spot itself.

In certain circumstances afterglow is deleterious and it is necessary to use screens specially chosen to have negligible afterglow. Willemite has a duration of about 8 milliseconds. The blue (tungstate) screens are faster still, having durations of

about 8 microseconds, while zinc sulphide with a small quantity of nickel "killer" added has a completely negligible afterglow.*

Effect of Size.

Cathode-ray tubes are made in various sizes ranging from 1 inch to 6 inches screen diameter for oscillographic work, while for television purposes still larger screens are employed. The size of screen chosen depends very largely on the circumstances and is governed by the following considerations.

As the size of screen increases, the length of path traced out by the spot also increases. As we shall see in the next chapter, the spot of light is caused to trace out a certain pattern repeatedly, and if this is done in a satisfactory manner the effect on the eye is that of a stationary trace. Actually, however, the trace on the screen is not there the whole time but is an illusion produced on the eye by the movement of the *single spot of light* which is covering the trace and recommencing the operation in sufficient time to allow the visual persistence of the eye to bridge the gap.

This being the case, the longer the trace made by the spot the less will be the apparent brilliance of the pattern unless the intrinsic brilliance of the spot is increased. Consequently the larger the screen diameter, the higher must be the anode voltage applied to the tube. On the other hand, with any particular electrode assembly there is a certain limiting minimum spot size, and clearly if we can retain the same spot size with a pattern twice as large we can improve the focus fourfold.

Screen size, therefore, is a matter of compromise. The higher operating voltage demanded by the larger screen, though not in itself a disadvantage, involves a reduced sensitivity as is explained in the next chapter, and after a certain point this begins to introduce difficulties. The lower limit of screen size is reached when the focus of the spot cannot be made fine enough. A satisfactory compromise for general work is a screen of 3 to 4 inches in diameter.

* For further details, see "Fluorescent Screens for Cathode Ray Tubes," by L. Levy and D. W. West. *Journal I.E.E.*, Vol. 79, p. 11.

CHAPTER II

THE OSCILLOGRAPH IN USE

HAVING discussed the general construction of the cathode-ray oscillograph tube, we can proceed to a broad examination of the manner in which the tube is put to work. It has already been mentioned that the spot of light on the screen can be caused to move across the screen under the influence of externally applied forces.

Let us consider electrostatic deflection first, since this is the

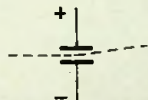

FIG. 7
ILLUSTRATING
DEFLECTION
OF BEAM

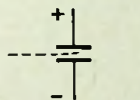

FIG. 8. IF
THE PLATES
ARE TOO CLOSE
TOGETHER THE
BEAM WILL
HIT THE PLATES

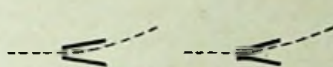

FIG. 9. ILLUSTRATING
METHODS OF INCREASING
SENSITIVITY WITHOUT
CAUSING OBSTRUCTION

more usual method for oscillographic purposes. Two plates are arranged one on each side of the beam as shown diagrammatically in Fig. 7. If we apply a voltage across these plates the beam is attracted towards the more positive plate and repelled from the negative one, so that it changes its course, and the spot of light on the screen will change its position.

The more voltage we apply across the deflector plates, the greater will be the deflection of the beam, and in fact the movement of the spot is directly proportional to the applied voltage. Hence, if we double the voltage on the deflecting plates, the movement of the spot will be doubled and if we apply a voltage which is continually varying, the spot will follow the variations in voltage exactly and instantaneously.

Sensitivity.

The actual movement of the spot depends upon various factors in the tube construction and operation. The closer we can locate the deflector plates to the beam, the greater will be their influence, which is the reason for inserting the plates inside the tube instead of mounting them externally. They cannot be placed too close, however, or the beam, having once been deflected, may hit the plate as shown in Fig. 8, in which case it will never reach the screen, and the spot will vanish altogether. To avoid this and still enable the plates to be as close as possible to the beam, they are often arranged in diverging fashion as shown in Fig. 9.

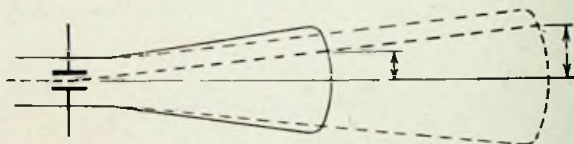

FIG. 10. A LONG TUBE HAS A GREATER SENSITIVITY THAN A SHORT TUBE

With a given arrangement of deflecting plates, a certain angular movement of the beam is provided. Consequently, the longer the tube is made the greater is the movement of the spot. It is clear from Fig. 10 that if we make the length of the tube, from the deflector plates to the screen, twice as long we obtain twice the movement of the spot, and for this reason a long slender tube is always more sensitive than a short stubby one. Practical usage, of course, has to compromise, as always, between considerations of space and sensitivity.

The final factor which affects the sensitivity is the velocity of the electrons in the beam which is directly proportional to the voltage on the anode of the tube. Consequently, if we double the anode voltage, the sensitivity (the movement produced on the screen by a given voltage on the deflector plates) will be halved. We shall, of course, gain in brilliance (and possibly focus) by virtue of a higher anode voltage, and

here again compromise between two conflicting requirements is adopted by the tube designer.

With the tube as purchased by the user, either individually or as part of a complete equipment, the tube construction is a fixed factor. The length of the bulb, the disposition and distance between the deflector plates are all fixed. The only factor which is under his control is the anode voltage and this is usually not capable of wide variation since the tube is designed to operate within certain specified limits.

The sensitivity of the tube is expressed in the form—

$$\text{Sensitivity} = k/V \text{ mm. per volt.}$$

Where k is a constant V volts is the anode voltage.

A typical electrostatic tube would have a sensitivity of $250/V$, which means that with 500 volts on the anode a voltage of one volt applied across the deflector plates would cause a deflection of the spot of $\frac{1}{2}$ mm. From this we can easily determine the voltage required to "fill" the tube, i.e. to produce a deflection spreading right across the screen. If the screen is 3 inches in diameter, then we shall require 150 volts across the deflector plates to fill the screen.

It should be noted that this 150 volts is the extreme or peak-to-peak value of the applied voltage. It would correspond to an r.m.s. value of 53 volts if the waveform were sinusoidal. The relation between peak and r.m.s. or average values is discussed in more detail in the next chapter.

Visual Persistence.

A suitable oscillating voltage applied to the deflector plates will therefore produce movement of the spot. If the oscillation is slow, the spot will actually be seen to move up and down, but as the oscillation frequency is increased so the movement of the spot becomes faster and faster until it becomes too swift to be followed, and the visual persistence of the eye causes the spot to be seen in all its various positions at once, providing the illusion of a straight line of light.

This question of visual persistence is important because in practically all the applications of the cathode-ray tube we

carry out the operation at a very rapid rate, and consequently the whole pattern is seen at once. The eye continues to see things for a fraction of a second after they have been removed. Therefore, a spot on the screen moving rapidly in a horizontal direction will first be seen at the beginning of its movement. A fraction of a second later it will have moved to a position slightly to one side and will be observed in its new position, but the eye will continue to see it in its original position as well, so that it will see two spots close together. Following the same argument it will be clear that the spot is seen in every position throughout its movement, so that the eye will obtain the impression of a continuous line of light irrespective of the fact that the spot is really only in one position at any one instant.

If the spot is also subjected to vertical deflection as well as horizontal movement, we shall obtain some form of pattern as explained later, and we shall see that by arranging for the spot to continue to sweep over the same pattern continuously at a sufficiently rapid rate, we obtain the impression of a stationary pattern, and this is the condition in which the tube is customarily used.

Direction of Deflection.

This line of light may be either horizontal or vertical, depending upon which pair of deflector plates has been used. It is customary to refer to the deflector plates in terms of the deflection they produce, so that the plates which cause a vertical movement of the spot are termed the vertical deflector plates or sometimes the *Y* or "work" plates. It is worth noting in passing that the plates themselves are actually horizontal, as is obvious from Fig. 7.

Similarly, the other pair of plates, actually disposed in a vertical plane, will produce a horizontal deflection of the spot, and would be called the horizontal or *X* plates.

Alignment of Tube.

It should be noted also that the actual direction of movement of the spot depends entirely on the position of the tube.

The *Y* plates will only produce a vertical deflection when the tube is so located that these plates are absolutely horizontal. The tube, therefore, must always be mounted in such a manner that it can be rotated slightly so that the deflection may be properly aligned. With an electrostatic tube the two deflections on the *X* and *Y* plates will be accurately at right angles to one another but not necessarily horizontal and vertical. The instructions provided with the tube indicate the approximate position of the tube for this to be obtained, but in production there is a deviation of perhaps 10 or 15 degrees on either side of the normal position, and the tube must be capable of rotation to this extent.

Time Bases.

A simple deflection, produced by the application of a voltage across the *X* or *Y* plates, is of little value except that it gives an indication of the peak value of the applied voltage which is sometimes useful. More often, however, we are concerned with an actual inspection of the waveform of the voltage applied to the tube. Just what is meant by waveform is explained in more detail in Chapter III, but the essential point is that the voltage applied to the plates is not steady but is changing its amplitude at some regular rate. The simplest form of variation is the *sine wave* in which the voltage rises to a maximum, falls to zero, rises to a maximum in the opposite direction and falls to zero again, repeating this *cycle* indefinitely.

If we wish to examine the exact manner in which this variation takes place, we arrange to move the spot on the oscillograph sideways, by the application of some voltage to the *X* plates, at the same time as it is being moved up and down by the voltage under examination. The process is explained diagrammatically in Fig. 11, where it will be seen that by the time the spot has reached the upper limit of its travel, it has also moved a little to one side. When it falls to zero again, it has moved still farther to the right. The sideways movement continues as the spot travels down to its negative maximum and so on until it returns to zero again.

Thus the spot actually traces out a waveform on the screen, and if the movement of the spot horizontally is strictly proportional to the time, then the waveform traced out by the spot will be a faithful record of the variation of the voltage with time, which is usually what we require to know.

The arrangement which causes the spot to move sideways at a steady rate is called a *time base*.

Unfortunately, the time taken for one oscillation is usually some very small fraction of a second. Even with the mains

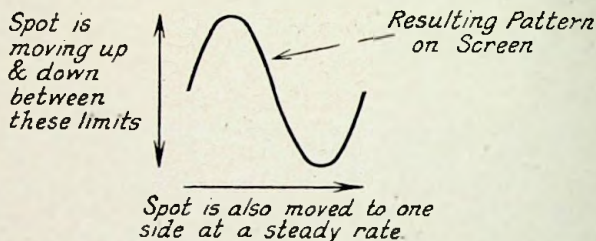

FIG. 11. ILLUSTRATING HOW WAVEFORMS ARE TRACED

supply used for lighting and power supplies the time of one oscillation is only $1/50$ th of a second, while the oscillations encountered in audio-frequency technique may occur as rapidly as ten thousand times per second or even more. Radio-frequency oscillations recur millions of times per second.

Synchronism.

How then are we to look at such extremely rapid waves? Where the phenomenon only occurs once, being what we call a *transient*, the only available method is to photograph it (or to use a delay screen as explained on p. 13), but as it happens, most of the waves with which we are concerned are recurrent or repeating. In such circumstances we can cause the spot of light on the oscillograph screen to fly back after it has completed one wave and commence to trace out the wave again. If we arrange that the second and subsequent traces lie

exactly on top of the first, then if the process is continued indefinitely we shall obtain the impression of a stationary trace on the screen. We should say we were looking at exactly one wave of the voltage or current under examination, though actually we should be examining the combined effect of a large number of waves superimposed.

This can be arranged by *synchronizing* the time base with the work under examination. As explained above, the time base is the arrangement which causes the spot to move horizontally across the screen. It is discussed in more detail in the next chapter, where it is shown that it is possible to make the time of transit across the screen an exact multiple of the time of one wave. Such being the case, the various traces all coincide, and we obtain the illusion of stationary waves. Fig. 12 is a photograph of a typical sine wave, while the effect of insufficient or faulty synchronizing is shown in Figs. 31 and 50.

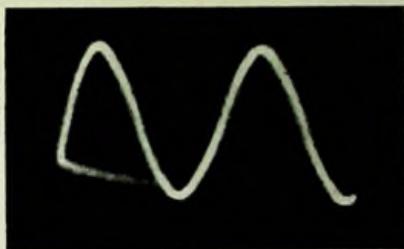

FIG. 12. PHOTOGRAPH OF TYPICAL SINE WAVE TRACE SHOWING TWO COMPLETE WAVES

This is the general technique involved in the examination of waveforms which is an important part of oscillographic technique. In fact, in the early days of mechanical oscillographs it was the only use to which the device was put.

The cathode-ray tube, however, has numerous other applications in which a time base is not required. It can be used for comparing input and output voltages of an amplifier or network to see whether there is any phase shift or distortion (for distortion can be observed by other means than actually looking at the wave-form). It can be used for plotting response curves of either high- or low-frequency circuits. It can be used for the examination of transformer magnetization, for

frequency comparison and a host of applications. The more important of these uses are described in detail in the succeeding chapters.

Magnetic Deflection.

In some instances it is convenient to produce the deflection by magnetic means, for which purpose a coil is located beside

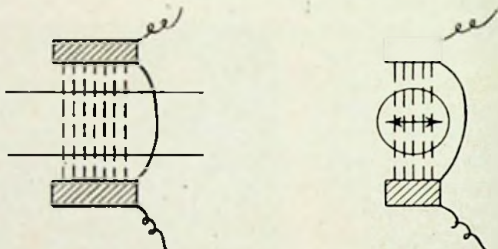

FIG. 13. A MAGNETIC FIELD WILL PRODUCE DEFLECTION AT RIGHT ANGLES TO THE FIELD

the tube in such a manner as to pass a magnetic field *across* the neck of the tube, as shown in Fig. 13. This produces a deflection of the spot *at right angles to the direction of the field*, as shown.

It is important that the magnetic field shall be uniform, for the deflection produced is dependent upon the actual strength of the magnetic field. If, for a given current through the deflecting coil, the field produced is different at two sides of the tube, the sensitivities will differ.

Consequently, the movement of the spot produced by a given current at one side of the screen will be different from that of the other. If we are using a time base in a horizontal direction to spread out the wave, the pattern produced will not be of uniform height but will either increase or decrease in depth, giving an effect similar to that of trapezium distortion (Fig. 23, p. 34).

The actual deflection produced by the coils depends again

on the length of the tube from the deflecting point to the screen. It also depends upon the speed of the electrons, but in this case the result is only inversely proportional to the square root of the anode voltage. Consequently if the anode voltage is doubled we shall require approximately 40 per cent more current for the same deflection.*

We also have a little more under our control in the case of magnetic deflection because we can make the shape of the coil what we wish. As long as the electron beam is in the magnetic field it is continually being deflected, so that if we make the axial length of the magnetic field twice as great we shall produce twice the deflection, always assuming that we do not appreciably shorten the distance between the deflecting coil and the end of the tube.

* This difference arises because the deflection of the beam due to magnetic forces is dependent on the velocity of the electrons in the beam, whereas with electrostatic deflection this is not the case, except in respect of the time taken by the electrons to pass through the deflecting field which applies to both forms of deflection.

With magnetic deflection the force on the beam is Hev where H is the deflecting field strength, and e and v are the charge and velocity of the electrons. The acceleration α is therefore $\alpha = Hev/m$ where m is the mass of the electrons. The beam is acted upon for a time $t = l/v$, l being the length of the field (Fig. 14) and the deflection is thus

$$\frac{1}{2}\alpha t^2 = \frac{1}{2}(Hev/m) (l/v)^2$$

At the screen this deflection is multiplied by the ratio $\frac{L}{l/2}$, so that the deflection is $(Hev/m) (Ll/v^2)$. But by ordinary dynamics the energy of an electron = $Ec = \frac{1}{2}mv^2$, E being the accelerating (h.t.) voltage, so that $v^2 = 2Ec/m$, whence by substitution

$$\text{Deflection} = \frac{HLl}{\sqrt{(2E)}} \cdot \sqrt{\frac{e}{m}}$$

The expression quoted in the text is derived from this by inserting the actual values of e and m , the charge and mass of an electron.

With electrostatic deflection the force on the beam is Ve/d , V being the voltage across the deflector plates and d the distance between them. By similar reasoning to the above we obtain a deflection at the deflector plates of $\frac{1}{2}(Ve/dm) (l/v)^2$ and at the screen $(Ve/dm) (lL/v^2)$, which by substitution for v^2 simplifies to $VLl/2dE$.

The magnetic sensitivity of a tube is usually expressed in the form

$$\text{Deflection} = kl/\sqrt{V} \text{ mm. per gauss}$$

where l is the length of the magnetic field in cm. (see Fig. 14) and V is the anode voltage, as before.

In instances where the magnetic deflection is not quoted, it is possible to estimate the deflection produced from the

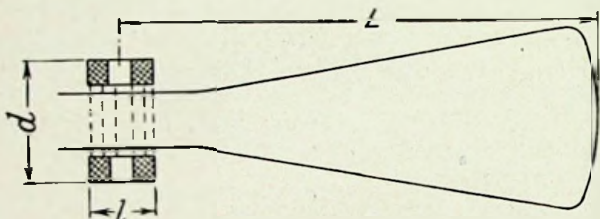

FIG. 14. RELEVANT DIMENSIONS FOR ESTIMATING MAGNETIC DEFLECTION

dimensions of the tube and the gun voltage by using the formula—

$$\text{Deflection} = 0.3 Ll/\sqrt{V} \text{ cm.}$$

where l and L are as shown on Fig. 14, measured in cm.

Estimation of Magnetic Field.

Magnetic sensitivities are quoted in terms of H , the magnetic field. This is determined as follows—

For an air-cored coil the magnetic field produced is given by

$$H = 1.25 Is/d \text{ gauss, where } I = \text{current in amperes}$$

$$s = \text{number of turns on coil}$$

$$d = \text{length of coil in cm. (see Fig. 14).}$$

In actual practice, as already explained, it is desirable to employ two coils one on each side of the tube so that the field

may be uniform. In this case the two coils help one another, and the effective length is a compromise. It is obviously greater than the sum of the two coils themselves since the arrangement tends to be something equivalent to one long coil with the tube stuck through the middle. It is not strictly equivalent to this, however, and in practice the length may be taken as about 0.7 times the actual overall length d .

Iron cores are sometimes used for assisting the magnetic field, since the arrangement is obviously more efficient if the return path of the field is completed through an iron core which may be either a simple U shape arrangement or an annular ring with projecting poles as shown in Fig. 15.

Actually the projecting pole pieces are not essential, except that they simplify the location of the coils themselves, but in many instances a plain ring of iron suffices. This form of construction is often used for television scanning arrangements, the ring being made up of laminations of high-permeability low-loss steel.

For oscillographs special precautions such as this are not usually necessary, and if an iron core is required at all, the simple U-shaped core is adequate, particularly as magnetic deflection is usually only required in one direction.

When an iron core is used the same formula for the magnetic field is employed, but in this case the length d is taken as the actual air gap between the pole pieces of the magnet (across the tube). The length and width of the coils themselves does not matter within reason, though the width of the pole piece (along the axis of the tube) is of course important, since this determines the sensitivity, as already explained.

It is most important with magnetic deflection that the direction of the magnetic field shall be correctly disposed

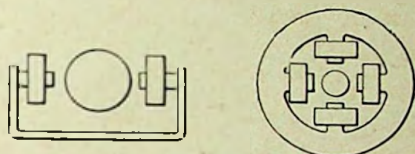

FIG. 15. TYPES OF YOKE FOR MAGNETIC DEFLECTION

relative to any electrostatic deflection in the tube, as otherwise the two deflections (one electrostatic and the other magnetic) will not be correctly at right angles. This point is illustrated in Fig. 24, p. 36.

Shifts.

In addition to the variable movement of the spot, due either to the work under examination or the time base, it is often convenient to be able to produce a permanent deflection of the

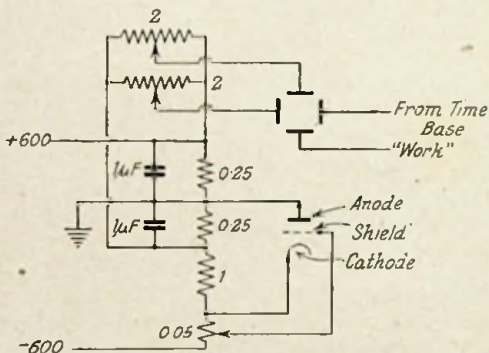

FIG. 16. CIRCUIT FOR PRODUCING LATERAL AND VERTICAL SHIFTS

spot from one edge of the screen or even off the screen altogether, so that it is only moved on to the screen by the application of the work voltage. For this purpose we apply what are known as *shift potentials*.

Most electrostatic tubes are arranged so that all four deflecting plates are brought out separately. One plate of each pair may be used for the application of the work and time base voltages respectively, while the other plate of each pair is connected to a potentiometer across a source of supply running a little above and a little below the potential of the anode or gun. It should be noted that all deflector voltages

spot. Normally the spot, without any deflecting voltages on any of the plates or coils, will be located approximately in the centre of the screen. Due to inevitable variations in production it will not be dead central, though the displacement will probably be small. Occasions arise, however, where one requires to start the

are arranged relative to the gun or final anode of the tube, and a typical arrangement is shown in Fig. 16. Here the shift potentiometers can easily be seen, and by moving the slider across the potentiometer the voltage can be varied between 100 volts positive to the gun and 100 volts negative to the gun, and the spot will take a permanent deflection to one side or the other according to where the potentiometer is set. This permanent voltage makes no difference to the deflection produced by the work, so that if we have an oscillogram on the screen, the effect of the shift potentiometer will simply be to move the pattern up and down or from side to side.

In some instances tubes are made with one of each pair of deflector plates permanently connected internally to the gun. In this case the shift must be arranged by isolating the live deflector plate of each pair with a condenser and a leak. This is usually done in any case, but the leak is taken to the shift potentiometer instead of direct to the gun.

Shifts with magnetic deflection are not so easily arranged. It is necessary to pass a permanent current through the deflecting coil. This may be done by including a suitable d.c. voltage in series with the "work" or by a parallel arrangement such as that in Fig. 17. A high inductance choke is placed in series with the d.c. source, which may be obtained from some part of the oscillograph power supply. The choke must present a high impedance to the frequency under examination. At the same time the d.c. is prevented from passing through the work by the condenser *C*.

Usually, however, magnetic deflection is used as an accessory with an electrostatic tube, in which case it is possible to use the electrostatic deflector plates for providing the shift and the magnetic coils for the deflection.

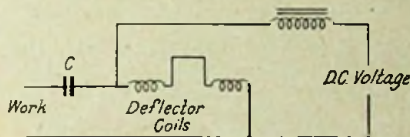

FIG. 17. SHIFT CIRCUIT FOR USE WITH MAGNETIC DEFLECTION

Tube Networks.

We may conveniently consider here a few representative circuits of the tube network, i.e. the arrangement for feeding the voltage to the various electrodes on the tube and the deflector, but not including the time base or work circuit which are discussed in the next chapter.

Fig. 18 shows a simple arrangement suitable for a soft or gas-focus tube. The current taken by the tube itself is very

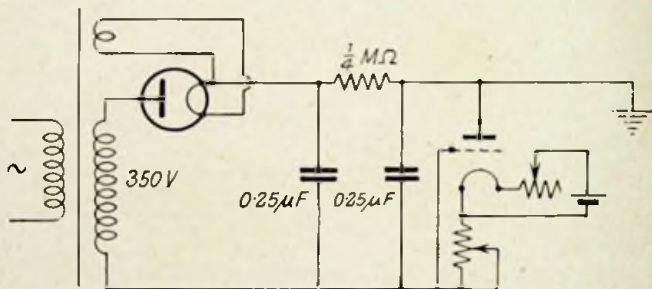

FIG. 18. SIMPLE POWER SUPPLY CIRCUIT FOR SOFT TUBE

small—usually something like 50 microamperes (0.05 mA.) and as there is only one control involved it is quite satisfactory to use a “self-bias” arrangement for supplying the voltage to the shield. This arrangement, of course, cannot be used if the shield has to run positive as is the case with the Standard 4050 type of tube, but with a negative-shield tube such as the Cossor, the arrangement shown is quite satisfactory. Alternatively, a potentiometer may be taken across the h.t. supply as in the case of the arrangement shown in Fig. 16.

The current drain being so small, the h.t. supply (Fig. 18) is of a very simple character and consists of a half-wave rectifier feeding quite a small reservoir condenser. Smoothing is obtained by a resistance followed by another condenser. A choke is unnecessary because of the very small current drain. Even a resistance as high as 0.25 megohm will only drop $12\frac{1}{2}$ volts at 50 microamperes.

Ripple Volts.

The smoothing required depends on circumstances. With a single condenser the peak ripple is i/fC , where f is the rectification frequency ($= 50$ for a single-wave circuit), C is the capacity, and i is the current drain. The influence of ripple on the gun voltage is negligible by comparison with the effect on the shield. The proportion of the full ripple appearing between shield and cathode is easily calculated, and this should not exceed about 10 per cent of the voltage required to black out the spot.

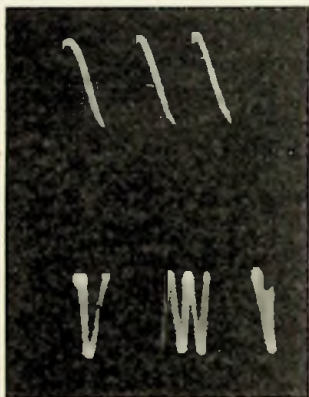

FIG. 20. MODULATION OF IMAGE CAUSED BY A.C. RIPPLE ON SHIELD

The current drain is mainly that of the potentiometer network which is usually made of the order of 1mA, so that the small current taken by the first anode shall be negligible. Otherwise, alteration of the intensity control, causing changes in tube current, would appreciably affect the voltage distribution on the potentiometer and increase the interaction be-

tween focus and intensity controls.

If the ripple on the shield is too large a double filter may be used, with resistance or choke smoothing. This reduces the ripple n times, where $n = RC_1\omega$, very nearly, for the circuit of Fig. 17, C_1 being the capacity of the second condenser and ω being $2\pi f$. If R is replaced by an inductance L , the improvement factor $n = LC_1\omega^2$.

Alternatively, the shield itself may be smoothed by connecting a condenser between shield and cathode, preferably with a resistance of 0.1 to 0.5 megohms between the shield and the slider of the potentiometer. This will give an improvement of n times on the shield alone, where $n = Rc\omega$ as before.

The tube in Fig. 19 is indirectly heated, with one side of the heater connected to cathode. This is often done internally, and care must be taken to ensure that the cathode connection is correctly made; otherwise, if the cathode lead is taken to the other side of the heater, the tube will still work, but it will have an a.c. voltage equal to the heater volts injected in the grid circuit, which will cause the intensity to vary over the pattern as shown in Fig. 20.

Some *mains modulation* of this type may still be present if any a.c. voltage is picked up on the shield. With the circuit shown a capacitance current will flow from the bottom end of the h.t. winding on the transformer through the tube network in the reverse half-cycle (when the rectifier is non-conducting), and this often causes modulation hum. It may be avoided by interposing an earth screen between the h.t. and heater windings as shown.

Tube Distortions.

It has been stated that the deflection produced is directly proportional to the voltage on the deflector plates, from which one may infer that the picture or pattern presented on the screen is an accurate record of the voltage applied. With suitable precautions this is true, but there are certain instances in which distortion may occur, and it is convenient to examine these specific instances at the present point.

Origin Distortion.

One form of distortion obtained with soft or gas-focused tubes is known as origin distortion, and is due to the fact that the sensitivity of the plates is subject to a small change just around the centre portion of the tube. On a simple horizontal or vertical "scan" no visible effect occurs, but if we apply a voltage to both plates at once, we shall obtain a diagonal line which should be absolutely straight over the whole of its length. Actually with a soft tube it will be found to kink slightly in the centre as illustrated in Fig. 21.

On a waveform this distortion will produce a little kink in

the wave as shown on the right of Fig. 21. This, however, may easily be detected as due to the tube, since, if the wave is shifted laterally, or is allowed to run slowly through the screen by adjusting the time-base frequency to be not quite a true sub-multiple of the work frequency, the origin distortion will appear to move up and down the waveform, remaining always at the centre of the tube. If the distortion were actually due to a deformation of the wave itself, it would,

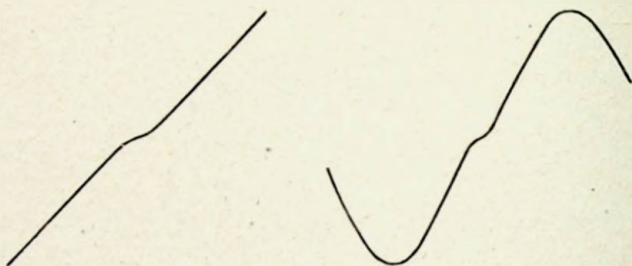

FIG. 21. ILLUSTRATING ORIGIN DISTORTION

of course, always remain in the same relative position on the waveform irrespective of the actual position of the wave on the screen.

Origin distortion arises from the presence of the gas in the tube which produces a sort of "space charge" in between the deflector plates in consequence of which the sensitivity is slightly less at low values of deflecting voltage. It can be overcome by adopting special forms of tube construction. One method which has been proposed and adopted is to locate the electrode system such that it normally projects the spot down into one corner of the screen. It can then be brought into the centre of the screen by the application of shift voltages on each plate, and the tube may then be used in the usual manner and will be free from origin distortion, which would only occur when the spot is in the corner of the screen, where it does not matter.

An alternative arrangement used in the Cossor tube is to employ a split plate as illustrated in Fig. 22. One plate of each pair is made in two portions, and these two portions are connected to voltages V volts above and below the gun potential. The other plate of the system can then swing over the same excursion $\pm V$ volts without reversing the electrostatic field between the plates, which avoids the origin distortion very neatly. If V is the voltage which just deflects the

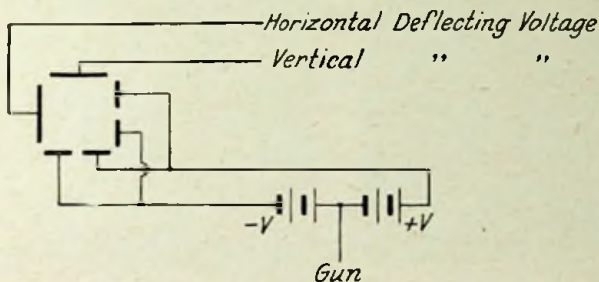

FIG. 22. COSSOR SPLIT PLATE DEFLECTING SYSTEM FOR ELIMINATING ORIGIN DISTORTION

spot off the screen full deflection may be used without danger of distortion.

In the diagram, batteries are shown supplying the voltage V , for simplicity. In practice, of course, the requisite voltage would be picked off the tube network as is done with shift voltages.

Trapezium Distortion.

Another form of distortion, encountered principally with hard tubes, is known as trapezium distortion. It arises from the influence of one pair of deflecting plates on the sensitivity of the other pair. The deflecting system, being connected to the final anode or gun, affects the velocity of the electrons in the beam. Thus, if we have a positive potential on the

deflecting plates, the effective h.t. voltage on the tube is increased slightly, and the electrons will move faster.

When the beam passes between the next pair of deflector plates the deflection sensitivity, being inversely proportional to the electron velocity, will vary with the position of the beam so that a given deflecting voltage will produce more movement of the spot at one side of the scan than at the other.

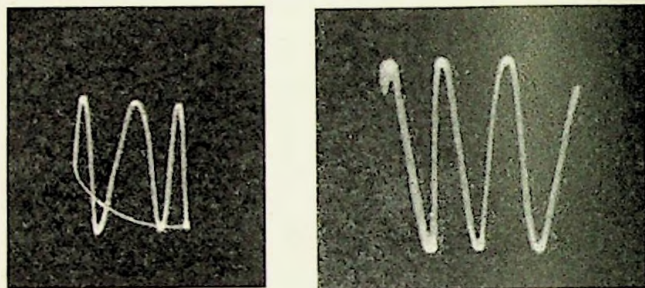

FIG. 23. TWO FORMS OF TRAPEZIUM DISTORTION

With soft tubes the deflecting voltages are small in comparison with the h.t. voltage and consequently this varying sensitivity is of negligible account, but with hard tubes, which are in general several times less sensitive than soft tubes, the effect is appreciable, and towards the positive side of each pair of deflector plates the sensitivity drops noticeably.

The effect is familiar to television workers as one which causes the edges of the scan to be trapezium shaped instead of at right angles. Its effect in waveform examination is not always so obvious. Fig. 23 shows the effect on a waveform with trapezium distortion on the horizontal and vertical plates respectively.

One solution of the difficulty is to use a symmetrical deflection in which one deflector plate of each pair is caused to rise in voltage while the other falls in voltage by a similar amount. The mean potential is thus maintained unaltered so that the

sensitivity of the tube is not affected. This symmetrical deflection is obtained by using a push-pull scanning or amplifying arrangement as is shown in the next chapter.

An alternative method which is finding favour in oscillographic practice is to use a tube which has a specially shaped deflector system. If the deflector plates are not parallel the electric field strength v/d will vary. Hence if the plates are deliberately tapered so as to produce greater sensitivity at one side than at the other, this can be made to offset the distortion produced by the electrical effect just described. The result will be a satisfactorily uniform sensitivity, and this arrangement is adopted in some of the Mullard oscillograph tubes such as the A41/B4.

Another method, used in the RCA and Hivac tubes, is to introduce a plate (connected to the gun) between the first and second pairs of deflector plates. This plate has a slit to permit the beam to pass, but it reintroduces a uniform electric field and hence causes the electrons to enter the second pair of deflecting plates at uniform velocity so that the sensitivity is uniform.

Modern development is tending to increase the sensitivity of tubes by special forms of gun construction, and this may be utilized to reduce trapezium distortion. The matter, however, is one of tube design, and it is necessary for the user to ascertain for himself how serious the distortion is under the particular conditions of use.

Loss of Focus.

Since the focus of a hard tube (electrostatically focused) depends upon the relative potentials of the first and second anodes it follows that the variation of the effective voltage of the second anode due to the voltage on the deflector plates will have a defocusing effect. This shows as a thickening of the trace at the top or bottom of the waveform, or at one side of the image.

The loss of focus can be quite marked, particularly with a short tube which requires large deflecting voltages. It can

only be satisfactorily overcome by the use of a balanced (push-pull) scan, though it is not serious with a long tube. A partial remedy is to feed some of the deflecting voltage on to the first anode so that this also rises or falls in potential and the ratio of voltage on the two anodes is preserved, but since trapezium distortion is usually troublesome before defocusing becomes serious this method is not used to any extent.

The use of the accelerating plate between the two sets of deflectors also restricts the defocusing.

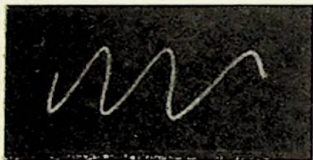

FIG. 24. DISTORTION CAUSED BY VERTICAL DEFLECTION NOT AT RIGHT ANGLES TO HORIZONTAL DEFLECTION

Magnetic Distortion.

It has already been mentioned that, where magnetic deflection is being used, the location of the coils must be chosen very carefully. If both scans are magnetic then it is only necessary to arrange that the two sets of coils are correctly at right angles. If, as is more usual, the magnetic deflection is being used for the work and an electrostatic deflection is employed for the time base, it is important to ensure that the coils are absolutely co-axial with the horizontal deflector plates.

The deflection produced by the deflector plates will then be horizontal while the magnetic deflection will be at right angles to the magnetic field, i.e. vertical. If the two are not accurately aligned then the vertical deflection will not be strictly at right angles, and the effect shown in Fig. 24 will arise. This is very easily recognizable and is cured quite simply by rotating the coils relative to the tube until the deflection comes strictly vertical.

Most oscillographs incorporate a cover scale which is ruled in squares at right angles to one another, and correct adjustment can easily be obtained by first applying a current through the deflector coils with no voltage on the time base, when a simple vertical line will appear on the screen. The position of the

coils must be altered until this line is truly vertical. The next step is to cut off the current through the coils and apply voltage to the time base which should produce a horizontal line on the screen, and to rotate *the tube itself* until this line is horizontal. The arrangement is now correctly aligned.

Another form of magnetic distortion arises when the magnetic field is not uniform. This produces an effect somewhat similar to trapezium distortion in that the deflection is different

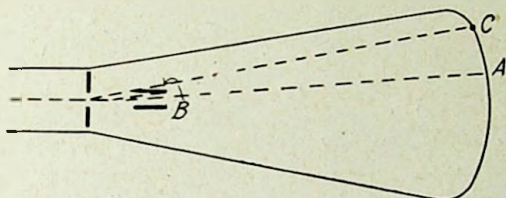

FIG. 25. ILLUSTRATING DEFLECTOR PLATE CUT-OFF

at the different sides of the tube. The remedy is to dispose the deflecting coils symmetrically as already explained.

Location of Deflecting Coils.

The position of the deflecting coils is important. They should be just in front of the final anode, but should be clear of any deflector systems which may be incorporated in the tube. This is not because of any trouble due to eddy currents or the like, for the deflector plates have little effect on the magnetic field and may be ignored. If the coil is large, however, and is located in the same position as the deflector plates; it is possible for the deflection of the beam to start before it reaches the deflector plates as indicated at *B* in Fig. 25. If this happens the beam will hit the deflector plates before it has been fully deflected, so that the spot will never reach the top of the screen but will be obscured by deflector plate cut-off half-way up.

It is even possible for the spot to reappear again as at *C* in Fig. 25 when the deflection is such that the beam now passes completely outside the deflector plate. A similar cut-off will

appear due to the bottom deflector plate and Fig. 26 illustrates an actual photograph of a scan in which this defect was present. The cut-off and reappearance of the beam at the top of the screen can clearly be seen. At the bottom of the screen the beam did not reappear owing to the fact that the bottom deflector plate was a little larger than the top plate.

The remedy for this trouble is to locate the deflecting coil a little farther forward, and possibly to use smaller deflecting coils, so that the magnetic field is more concentrated. Then the deflection of the beam can be limited to the region where there are no obstructions, and satisfactory results can be obtained.

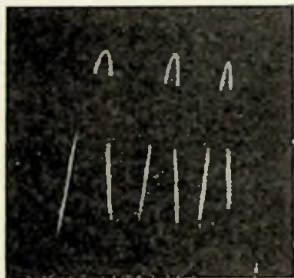

FIG. 26. PHOTOGRAPH OF WAVEFORM SHOWING DEFLECTOR PLATE CUT-OFF

Stray Fields.

The possibility of magnetic deflection must always be remembered, for it is quite feasible for deflection to be obtained due to stray magnetic fields. The leakage field from mains transformers is particularly troublesome in this respect, and any transformers or smoothing chokes should be kept well away from the tube. It is not possible to give any hard and fast rule, since the influence of the field naturally depends upon its magnitude which in turn depends upon the design of the transformer.

A point which is often overlooked is that the heater wiring of any valves, or even the tube itself, may produce appreciable magnetic field. All heater wiring, therefore, should be twisted.

In general, the stray magnetic fields from a transformer will produce a 50-cycle field across the electron stream, which will cause a deflection just as if magnetic deflecting coils had been used. The direction of this deflection is determined by the positions of the components, and it does not follow that it will be either horizontal or vertical.

Mumetal Shield.

The best methods of locating and curing hum deflection are discussed on p. 82. In many oscillographs, however, the tube itself is housed in a cylinder of *mumetal*, which is a high permeability nickel-iron alloy.

The effect of the mumetal is to "soak up" the magnetic field which prefers to flow within the mumetal owing to its very

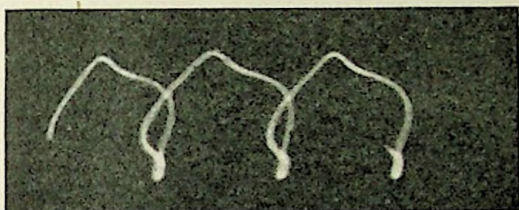

FIG. 27. DISTORTION OF WAVE CAUSED BY MAGNETIC INDUCTION

much higher permeability than that of air. Consequently, the field never penetrates the shield to any appreciable extent, and is therefore unable to affect the tube, and this obviates the influence of any stray magnetic fields, whether from the instrument itself or neighbouring apparatus.

The fact that the magnetic deflection may be at any angle relative to the normal horizontal and vertical deflection sometimes introduces the most queer deformations. As a matter of interest, Fig. 27 shows a bad case. The waveform is a normal 50-cycle sine wave, but, in addition to the horizontal and vertical deflections produced by the time base and the work respectively, there is a magnetic deflection at an angle which, operating with the other two, has caused the spot to trace out the extremely unorthodox path shown.

Stray magnetic fields may affect the tube in other ways. In one case in the writer's experience the earth's magnetic field was sufficient to alter the intensity of the spot as the

tube was rotated, a rotation of 90° being sufficient to black out the spot completely.

In other cases an alternating field from a transformer may run axially along the tube. This will not produce any deflection but will give rise to modulation hum similar to that illustrated in Fig. 20. In both instances a mumetal shield overcomes the difficulty.

Faults in Setting Up.

We can conveniently conclude this chapter with a reference to some of the simpler types of fault which can be obtained due to mistakes in setting up or operating the tube. Some of the faults will be more completely understood when later chapters have been perused; while in addition more complex types of incorrect indication will be discussed from time to time as the occasion arises.

If, on setting up the tube, nothing happens a good plan is to connect all the deflector plates to the gun (i.e. the final anode). This may usually be done directly without disconnecting the circuit. The voltages to the deflector plates are usually fed through isolating condensers with leaks from the deflector plates either to the gun or to shift potentiometers. No damage will be done by short circuiting the plates direct to the gun with clip leads, or by actual direct connection, but if there is any doubt the deflecting terminals should be disconnected completely from the rest of the set-up. Then, on switching on and allowing for the tube to warm up, a single spot should be obtained in the centre of the tube.

The intensity of this spot should be run down with the intensity control or it should be considerably defocused, because if the spot is allowed to remain stationary on the screen, the electron bombardment of the fluorescent material will produce deterioration and cause the material to lose its sensitiveness at that particular point. This is known as *burning the screen*, and although visible discoloration may not occur, the screen will be less sensitive at that point than elsewhere, so that a reduction in brilliance will occur showing

as a black mark in the trace if it happens to pass over the burnt portion.

The spot, therefore, should never be left stationary at full brilliance for any length of time. It is, indeed, possible to produce burns even with a trace, particularly if this is just a horizontal or vertical line, if the tube is left running in this condition for any length of time at full brilliance, and a burn of this type can be more troublesome than a simple spot burn. As far as possible the tube should always be run at as low a brilliance as is practicable to produce the required result. Certain screens are more prone to damage than others, the photographic (calcium tungstate) type of screen being particularly vulnerable.

If the connection of the deflector plates to the gun does not produce the spot as required then the circuit should be examined to make sure that all the connections are correct. Some types of tube, for example, have the second anode brought out to a terminal at the side, and it is possible for this terminal not to be connected. In such circumstances a partial effect may be obtained. The spot may appear but will not focus properly and will tend to move about the screen when the focus or intensity controls are operated. It is indeed possible to obtain waveforms and other traces with the second anode disconnected, but in such cases the focus is poor and the various controls cause the pattern to move about as just described, so that the location of the defect should not take long.

Bulb Charge.

Another form of defect which will result in no pattern on the screen is that of bulb charge. The electrons striking the screen cause the crystals to acquire a charge, and unless this can leak away rapidly a cloud of electrons forms over the surface of the screen preventing any further electrons from reaching it, so that no visible trace appears. Often this defect is accompanied by a diffused brilliance at the sides of the screen, particularly if a deflection is applied to one pair of deflector plates by the

time base or some other source. The effect may gradually wear off, though it often proves very obstinate.

Certain tubes exhibit the effect more than others, depending on the thickness of screen coating and the conductivity of the glass, but it is nearly always due to the use of too low gun voltage and may be cured by increasing the h.t. on the tube anode either momentarily or permanently.

In general, it may be noted that touching the screen will often

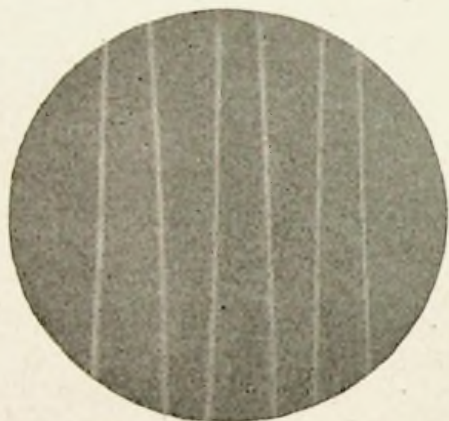

FIG. 28. RESULT OF APPLYING TOO MUCH VOLTAGE TO DEFLECTOR PLATES

The tops of the waves are deflected off the screen and the brilliance of the trace is reduced

cause the pattern to change its position or even distort the wave, due again to bulb-charge. If this effect is marked the gun voltage is too low and if any measurements are to be made the h.t. voltage should be increased until the effect is negligible.

Excessive Deflection.

Fig. 28 illustrates the result of applying to the tube a vertical deflection which is too great. In the case shown a time base was used to produce a horizontal sweep, and an ordinary a.c.

waveform was applied to the vertical plates, but the value of this latter voltage was too great, causing the tops of the peaks to disappear beyond the top and bottom of the screen. All that can be seen, therefore, is a series of nearly parallel vertical lines, being the middle portions of the waves where they cross the zero line.

It will also be noted that the lines are much fainter than normal for the reason, explained earlier in the chapter, that

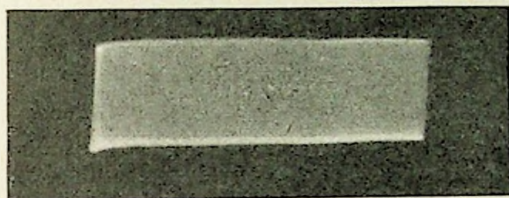

FIG. 29. EFFECT OF RUNNING TIME BASE TOO SLOWLY
The individual waves are indistinguishable

the more rapidly the spot moves the less is the apparent brilliance, and since at the point where the wave crosses the zero line it is moving very rapidly the brilliance is very considerably below normal. The remedy, of course, is to reduce the applied voltage to a value which does not deflect the spot right off the screen. It may be noted, in passing, that within reason, the application of an excess voltage to the deflector plates does no damage to the tube. If a very high voltage is applied, of course, the insulation somewhere in the tube itself will break down and spark over will occur which may or may not damage the tube.

Incorrect Speed of Time Base.

Fig. 29 illustrates the effect of operating the time base at much too slow a speed. In this case a series of waves is obtained, but they are so close together that they cannot be distinguished individually, and the result is that the trace

resolves itself merely into a broad patch of light spreading across the screen. The remedy here is to increase the speed of the time base until it becomes a small sub-multiple of the

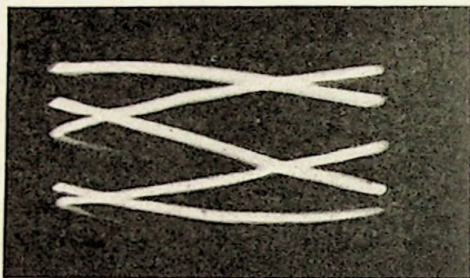

FIG. 30. EFFECT OF RUNNING TIME BASE TOO FAST

Only part of the wave is traced at each stroke

frequency under examination when the wave structure will be more clearly defined. Sometimes, however, the use of a band pattern of this form is deliberately employed, as is explained further in Chapter VIII.

Fig. 30 shows the effect of running a time base at too rapid a speed. Here, the spot moves completely across the screen in an interval of time corresponding to only a portion of the complete waveform. The spot then flies back and on its second trace continues to draw another part of the wave, completing the delineation of the complete waveform in perhaps five or six sweeps. The result is the basket network shown.

It may be remarked, in passing, that it is not possible to synchronize the time base at a speed higher than the work voltage (unless a separate synchronizing

source is used) and therefore in practice a pattern such as that of Fig. 30 would never appear stationary but would be moving through the screen fairly rapidly, giving a confused criss-cross pattern. The remedy, of course, is to run the time base slower.

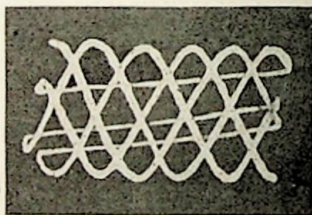

FIG. 31. PATTERN PRODUCED WITH UNSYNCHRONIZED TIME BASE

Fig. 31 illustrates the effect of no synchronism on the time base. The movement of the spot horizontally across the screen bears no definite relationship to the time of one waveform, and therefore each trace shows some odd fraction of a waveform (actually a little over one complete wave in the photograph). The successive traces therefore do not lie on top of one another, and a confused pattern of waves is obtained.

When the time base is nearly correct the successive traces are only slightly displaced from one another, giving the effect of a steady waveform which is slowly drifting through the screen from one side to the other. As the frequency of the time base becomes more removed from the correct speed, this drift increases in rapidity and finally becomes so rapid that a confused succession of waves appears.

Self-centring.

A factor which sometimes puzzles the beginner is the self-centring action of the normal tube. If a voltage is applied directly to the deflector plates, then the spot takes up a position dependent upon the voltage applied, and if this is steady the spot will remain in this displaced position. Such methods of connection are used where d.c. potentials have to be recorded, but more usually the deflectors are isolated with condensers, and high-resistance leaks are connected from the deflector plates themselves down to the gun.

In such circumstances the spot will not retain its displaced position indefinitely. The application of a steady voltage to the deflecting system will cause the spot to take up its displaced position, and at the same time the isolating condenser will acquire a charge. This charge, however, will gradually leak away through the high resistance leak so that the spot will gradually drift back again to its original position. The time it takes to do this will depend upon the time constant of the isolating system, for a condenser discharging through a resistance does not do so immediately but in a gradual manner, the actual time depending upon the product of the capacitance and resistance. The discharge, in fact, is exponential in

character, and is exactly the inverse of the charging of the condenser discussed on page 60.

In practice, the time constant of the isolating condenser and its leak should be such that the condenser will not lose more than a small fraction of its charge in a time equal to the longest time likely to be encountered in practice. If, for example, we are not likely to be examining waves of a frequency lower than 50 cycles per second, we should make the time constant of the condenser such that it did not lose more than about 1 per cent of its charge in one-tenth of a second. Even such a time constant, however, would be quite inadequate to keep the spot permanently deflected indefinitely, and in the matter of a second or two it would restore itself to its original position, as we have already described.

When a phenomenon is being examined which is known to be entirely in one direction—for example, a series of impulses produced by making and breaking a battery circuit—the tube would not show these as all above the horizontal (as represented by a line across the centre of the tube). It would tend to settle down to a condition where the pulses would show above and below the centre line.

The subject is discussed in more detail in Chapter IX for there are occasions where we require to make the tube behave in a d.c. fashion, at any rate for a fairly long period, but with normal operation this self-centring action must always be borne in mind.

Direction of Deflection.

Another point which must be remembered with a cathode-ray tube is that it has no knowledge as to which is positive and negative. We may, for example, be examining the waveform in the anode circuit of a valve amplifier, and obtain a figure of the type shown in Fig. 38 (b), p. 55. Such a wave would result from bottom-bend distortion due to the fact that the valve has too much grid bias, so that on the negative peak of the applied grid voltage the anode current is reduced to zero and the bottom portion of the waveform is incorrectly reproduced.

An exactly similar curve, however, might be produced by grid current distortion, in which the valve had too little bias so that on the positive peak of the cycle the grid became positive, grid current flowed and the amplification was limited in consequence. One would, of course, expect such a curve to be the other way up, but it will only be so if the voltage is applied to the deflector plates in the correct sense.

In fact, according to the way in which the voltage is connected to the deflector plates, so the curve may appear either way up. Therefore, we cannot say merely by inspection whether the waveform of the type mentioned represents bottom-bend or grid-current distortion. The fact that it is the right way up for bottom-bend distortion does not necessarily mean that this is the type of distortion present, since we could, by changing over the connections to the deflector plates, turn the curve upside down!

It is, of course, quite possible with any particular oscillograph to determine at once the effect of any voltage. By applying a positive voltage to the input terminal we can see in which direction the spot moves, and once this has been done for a particular instrument, the user can distinguish positive from negative.

If an amplifier is introduced between the input and the deflector plates of the tube, as described in the next chapter, this in itself will automatically reverse the phase. A positive grid voltage applied to an amplifying valve causes an increase in anode current which causes an increased voltage drop in the anode circuit so that the anode voltage falls, producing a deflection in the opposite direction from that which would be obtained if the voltage were applied direct to the tube.

Many oscillographs contain two input terminals, one of which goes direct to the deflector plates (through an isolating condenser) and the other goes to the input of an amplifier which then feeds the deflector plates. The same waveform applied to these two input terminals would appear reversed, due to the change of phase in the amplifier.

This point again should always be remembered when

examining any form of circuit in which the top and bottom of the image are different. A similar ambiguity arises on the horizontal plates, though this is often of minor importance. It requires attention, however, in certain cases, particularly with stationary patterns such as valve curves.

These are the general points which are likely to give rise to bewilderment at the outset. Once they have been appreciated they give no further trouble. Other little difficulties like this will be encountered, and will be mentioned from time to time in the appropriate place.

Softness. Effect of Beam Current.

In a good tube arrangements are made to collect the beam electrons and return them to cathode. Otherwise the space between the deflector plates will be conducting and this will cause deformation of the image, since the deflectors will draw current when subjected to a positive potential.

This effect is always present with an asymmetrical scan, but with a good tube it is only serious with high impedance input circuits. With a bad tube (particularly of the gas-focused type) the effect may be so bad as to require very low input impedances which defeats one of the primary advantages of the cathode-ray tube.

This "softness" is characterized by an instability of the position of the image and the fact that with no signal applied the spot is not central on the screen. The remedy is to reduce the impedance between deflector plate and gun.

CHAPTER III

WAVEFORM EXAMINATION

WE can now consider in detail some of the applications of the cathode-ray tube, commencing with the important one of waveform examination. It is helpful in doing so to have a clear understanding of the structure of the ordinary oscillation or wave.

We find in electrical engineering that the fundamental waveform encountered in a very large number of phenomena is what is known as a *sine wave*. A typical example of such a wave is the voltage generated by a coil rotating in a uniform magnetic field. The voltage induced in the coil depends upon the rate at which the wires of the coil "cut" the magnetic field. This is obviously a maximum when the wires are moving exactly across the field, and it is zero when the wires are moving parallel with the field (see Fig. 32). When the wire is in any other position the voltage induced is proportional to that component of its motion which is at right angles to the field, which can easily be shown to be $E \sin \theta$.

This, then, is a fundamental example of a sine wave, and it is clear that such a voltage will rise to a maximum in each direction alternately in a smooth and regular manner. We can, in fact, plot the exact form of the variation by a graphical method using what we call a rotating vector, as shown in Fig. 33.

If the line OA is assumed to be rotating in an anti-clockwise direction at a uniform speed, then if we plot the height of the

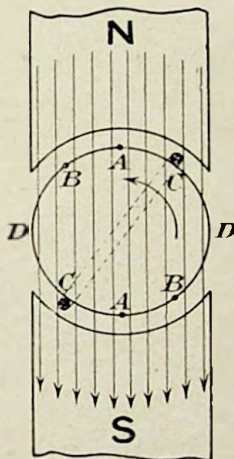

FIG. 32. SIMPLE ALTERNATOR

point A at successive instants we shall obtain the waveform shown on the right. The voltage at any moment is proportional to $OA \sin \theta$, where θ is the angle through which the vector OA has rotated.

Uniformly varying currents such as these are encountered throughout electrical engineering from the a.c. supply brought in on the electric light mains, where we have fifty complete *cycles* every second, up to radio-frequency oscillations generated by wireless transmitters at *frequencies* of several million

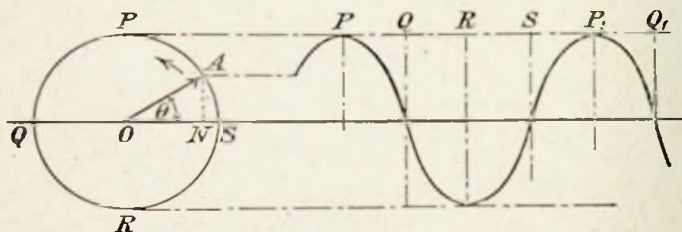

FIG. 33. ILLUSTRATING FUNDAMENTAL GENERATION OF SINE WAVE

cycles per second. Speech and music involve oscillations within a range from 50 to 16 000 cycles per second. The higher the pitch of the note the more rapid is the oscillation.

Phase Difference.

When a voltage of this type is applied to a circuit, the current which flows must obviously vary in the same manner, but except in special cases we find that the current and voltage do not go through their periods together. The exception is the purely resistive circuit having no inductance or capacitance, but as most circuits exhibit one or other of these properties we find as a rule that the current and voltage are not *in phase*.

In Fig. 34, for example, we have two vectors OA and OB , the latter being 90° in advance of OA . If these two vectors rotate together there will be 90° between them at every

instant. Hence the wave generated by OA will go through its cycle a quarter wave behind that of OB , so that when the first is at a maximum the second is zero, and so on. The

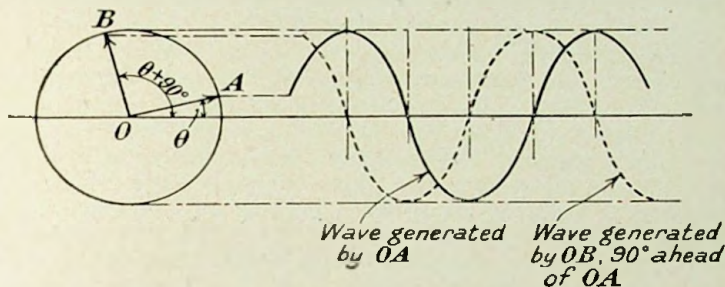

FIG. 34. ILLUSTRATING PHASE DIFFERENCE

wave OA is said to lag by 90° behind OB , while conversely OB is said to be leading on OA by the same amount.

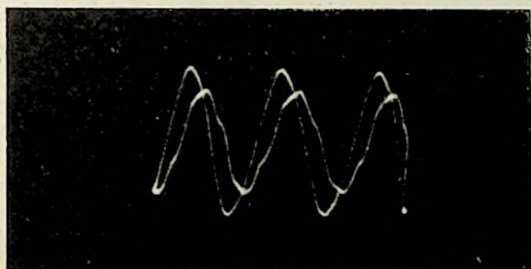

FIG. 35. PHOTOGRAPH OF VOLTAGE AND CURRENT WAVES IN AN ACTUAL PRACTICAL CIRCUIT SHOWING THE DIFFERENCE IN PHASE

Fig. 35 shows an actual photograph of voltage and current in an inductive circuit. This was taken with a double-wave switch of the type described in Chapter IX, and it will be seen

that the current wave is not only distorted but out of phase with the voltage, going through its maxima and minima a little after the voltage. Any ordinary measurement will fail to disclose either the distortion or the phase lag, which is one of the reasons for using an oscillograph.

Varying degrees of phase angle can be encountered. In any single circuit the maximum angle is 90° . A pure inductance carries a current which lags exactly 90° , while a pure condenser current leads by 90° . Resistance in the circuit causes the phase angle to be less than this amount, but in any single circuit it can never be more. However, we are not only concerned with phase angle between voltage and current. The voltages at two different points in an amplifier or network may be different in phase, and where we have a chain of circuits each contributing its own phase angle, it is quite possible for the total angle to add up to quite a considerable amount. If the total phase angle adds up to 180° it means that the two waves are exactly in opposition. It is even possible for the phase angle to amount to 360° so that the input and output voltage once more become in phase, although at intermediate points in the chain they will be seriously out of phase. Incidentally, this is not a practical condition because the phase angle changes with frequency, and so the correct condition would only be obtained at one particular frequency.*

Harmonics.

The current wave in Fig. 35 is distorted due to the presence of *harmonics*. These are smaller waves having an amplitude only a fraction of the *fundamental* wave but of a frequency which is some simple multiple thereof.

In practice these distorted waves are not produced by mixing waves of different frequencies but arise from the passage of the current through some non-linear circuit which does not transmit all amplitudes uniformly, such as a valve operating under incorrect conditions. The resulting current,

* The reader who wishes to study this matter more closely should refer to *Modern Radio Communication*, by the author.

however, behaves as if it were made up of fundamental and harmonic components, and may be treated as such.

If a distorted wave is passed through a circuit which transmits higher frequencies better than low ones, the distortion will be accentuated, and vice versa—a useful fact to remember.

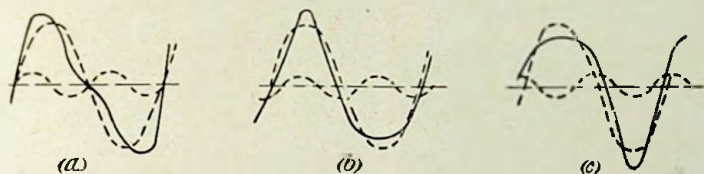

FIG. 36. THE PHASE OF THE HARMONIC WILL INFLUENCE THE SHAPE OF THE WAVEFORM

It is, indeed, possible to imitate any type of wave by suitable choice of fundamental and harmonics.

The actual form of wave produced depends upon the phase of the harmonic relative to the fundamental. In Fig. 36 (a), for example, we have shown dotted a fundamental and a second harmonic (a wave of twice the frequency) with an amplitude of about 20 per cent. The combined wave is obtained by adding the instantaneous values of the two waves together (subtracting if they are in opposite directions) and a distorted wave is the result.

In (b) the harmonic is displaced by 45° (relative to the fundamental). The amplitude is the same but the resulting wave is quite different in appearance, while in (c) the harmonic is displaced by 135° and gives a similar wave but inverted.

Second harmonics are not common in power practice though when they are experienced they are usually of type (a). Types (b) and (c) are often found in radio practice, being produced by bottom-bend or grid-current distortion.

Fig. 37 shows two actual oscillograms of waveforms similar to Fig. 36 (a) and (b) respectively produced artificially by mixing a fundamental and a wave of twice the frequency. The harmonic content is rather more than in Fig. 36, giving a more

pronounced deformation of the wave shape. There is also evidence of a small ripple due to a harmonic of much higher frequency.

Fig. 38 shows two practical wave forms resembling these artificial examples. That on the left is the secondary waveform of a badly overloaded intervalve transformer, showing the effect of saturation in the iron. That on the right was produced by overloading a valve and causing severe bottom-bend distortion.

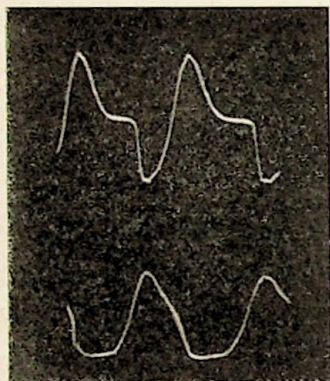

FIG. 37. PHOTOGRAPH OF WAVE-FORMS CONTAINING SECOND HARMONIC DISTORTION

Fig. 39 shows the effect of a third harmonic. It should be noted that the positive and negative halves of the wave are similar, which is a characteristic of odd harmonics, whereas with even harmonics this is not the case.

If the harmonic is very high in frequency compared with the fundamental it ceases to distort the wave shape and merely superposes itself on the fundamental as shown in Fig. 40. The same form of wave is obtained even if the high frequency is not an exact multiple of the fundamental, though in such a case the ripple waveform would not be stationary but would travel along the fundamental at a speed depending on the relative frequencies.

In audio-frequency practice the phase of the harmonic does not appreciably affect results. In other words, a waveform of any of the three types shown in Fig. 36 passed through a loud speaker would produce the same noise, all three of them being noticeably different from that produced by a pure sine wave.

It should also be noted that harmonics are not necessarily

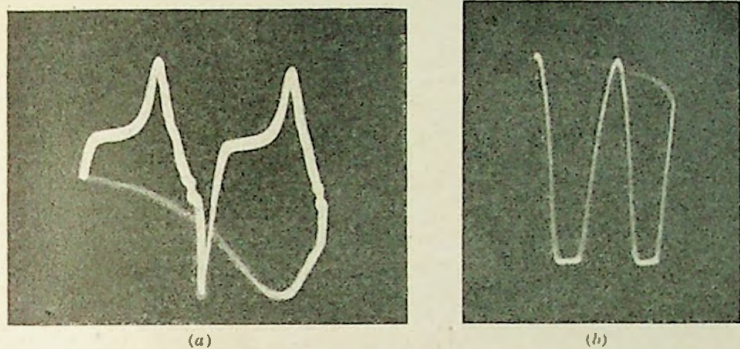

FIG. 38. PRACTICAL EXAMPLES OF DISTORTED WAVES, DUE TO IRON DISTORTION AND OVERLOADING

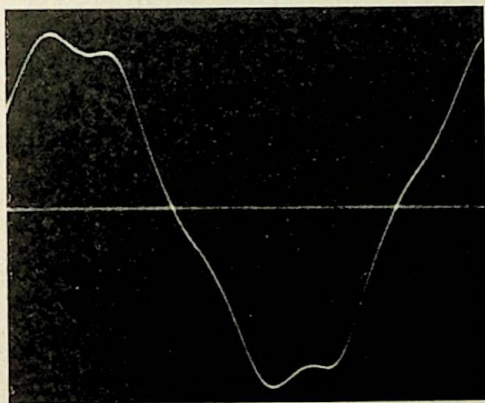

FIG. 39. OSCILLOGRAM OF MAGNETIZING CURRENT OF THREE-PHASE TRANSFORMER SHOWING THIRD HARMONIC DISTORTION

undesirable. Speech and music are made up of very complex waveforms of which the distinctive quality depends essentially on the harmonics present. The same note played on a violin and a flute, though of the same pitch, would be quite different in timbre or tonal quality because the flute note is practically pure while the violin note is very rich in harmonics.



FIG. 40. WHEN THE HARMONIC FREQUENCY IS VERY HIGH THE WAVES DO NOT INTERACT

In such a case, our concern is to see that any harmonics in the input are faithfully reproduced in the output, but this is very difficult to do and it is more convenient to supply a pure wave to the input *at various frequencies* and to ensure that—

(a) no extra harmonics are introduced by the amplifier:

(b) the amplification is just as effective at high frequencies as at low.

If these conditions are fulfilled the amplifier will probably reproduce a complex wave reasonably well, though this does not necessarily follow, as is explained on page 95.

Amplitude Distortion.

In order to comply with the first condition above, it is necessary that the characteristics of the valves and circuits used should be such that the output voltage is directly proportional to the input. If, however, this "linearity" only holds over part of the characteristic we may obtain a condition where, say, the bottom portion of the wave is not amplified to the same extent as the middle portion. This will produce a wave having a flattened bottom and, as we have just seen, this form of wave corresponds to a fundamental with a small percentage of second harmonic added. Consequently, we have automatically generated a frequency of twice the fundamental by virtue of the non-linear amplification.

In practice harmonics of this type are introduced in varying degrees. It is usually only the early harmonics, i.e. second,

third, and fifth, which are of serious importance, though transients, saw-tooth waves and the like contain harmonics of much higher order.

Time Bases.

It will be clear, therefore, that an inspection of the waveform will often provide useful information about a circuit, and for

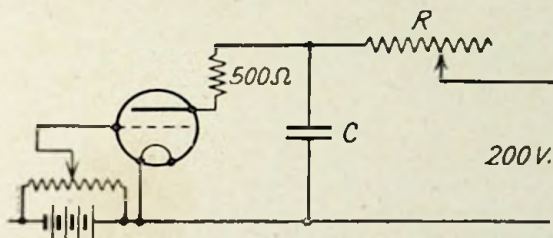

FIG. 41. SIMPLE TIME-BASE CIRCUIT

this purpose we select the voltage or current at some suitable point and apply it to the work or *Y* plates of an oscilloscope. It is then necessary to spread out the movement of the spot in a horizontal direction as explained in the last chapter, which is done by supplying the *X* plates with a voltage which is slowly increasing at a uniform rate until the spot has moved across the screen, when it flies back and recommences its journey.

The mechanism usually employed for producing this movement is the charging of a condenser through a high resistance, in a circuit such as that shown in Fig. 41. On connecting the 200v. supply to this circuit the condenser does not immediately acquire the full charge, but builds up relatively slowly at a rate determined by the value of the resistance and the capacitance of the condenser. Increasing either of these factors makes the charging take longer. Consequently, the voltage on the condenser slowly builds up to its peak value, and if we apply this voltage to the *X* plates of the oscillograph we shall

produce the gradual sideways movement of the spot which we require.

It is necessary to make the process repeating in some way, and to do this we connect across the condenser some device which discharges it periodically. The charging process then recommences until once again the condenser discharges, and so on.

The form of discharge device most commonly employed is what is known as a gas relay or thyatron.* Gas relays are also colloquially known in some quarters as *poppers*, a convenient and expressive name. Such a device consists essentially of a triode valve into which a small quantity of gas is introduced. The gas is usually neon, helium, or argon, though in some cases mercury vapour is used. Suppose we consider a valve with its grid biased sufficiently negative to prevent any anode current from flowing. If we raise the anode volts the relative effect of the grid will be reduced, and a point will be obtained at which current commences to flow. With a normal valve the current would remain small, becoming gradually larger as we continue to increase the anode voltage, but with a gas tube the electrons flowing from the cathode to the anode encounter molecules of the gas which, being at a low pressure, is readily ionized. At each collision more electrons are released and these in their turn collide with further molecules of gas releasing further electrons, so that a cumulative and very rapid build up of current is obtained, and the tube becomes practically a short circuit.

Moreover, once the ionization has commenced and current has started to flow, it will continue to do so until the anode voltage is removed or at any rate reduced to a value below the ionization potential of the gas which is between 10 and 20 volts in most cases. The grid has no effect whatever in stopping the discharge once it has started.

Fig. 41 shows a gas relay of this type connected across the condenser. Normally the relay is biased negatively such that it passes no current, and the bias would be adjusted so that,

* Thyatron is the registered trade name of the Mazda organization.

say, 150 volts was required on the anode before current would commence to flow. As the condenser charges slowly through the resistance, the voltage rises and the spot on the cathode-ray tube will move horizontally in unison until the condenser voltage reaches 150. At this point the tube "fires," short-circuits the condenser, discharging it practically completely, and then "goes out," for the discharging of the condenser has caused this voltage to fall practically to zero and the tube has again become non-conducting. The charging process now recommences and the same cycle is gone through and continues to take place regularly.

Non-linearity.

Obviously, such a device is ideal for our purpose. It causes the spot to move across the screen and fly back to the starting point as often as we like. We can vary the speed with which it moves across the screen by changing the values of either the resistance or the condenser, whichever we prefer, and the most usual arrangement of a time base is to have a variable resistance in series with a number of fixed condensers selected by switch to give the appropriate range.

The charging of a condenser through a plain resistance, however, suffers from one defect, in that the charging rate is not constant. At first the rush of current in the condenser is fairly rapid, while as it charges up it becomes less eager to absorb any more current and consequently the charging rate falls off. The voltage on the condenser therefore does not build up steadily but in an exponential form such as is illustrated in Fig. 42. Theoretically, indeed, the condenser never becomes fully charged. It acquires 63 per cent of its full voltage in a time equal to $1/CR$, where C is the capacitance in microfarads and R is the resistance in megohms. From this point onwards the charge is progressively slower and the condenser does not acquire 95 per cent of its full charge until after a time equal to $3/CR$.

The point to note is that the rise in voltage is not uniform, and therefore the spot will not move steadily across the screen,

causing the waves to be spaced unevenly on the cathode-ray tube. Fig. 43 shows a 50-cycle wave scanned by a non-linear time base. The uneven spacing of the waves is clearly evident, causing them to be crowded at one side of the image. The effect can be observed on one wave but is easier to detect with two or three. Too many waves should not be used,

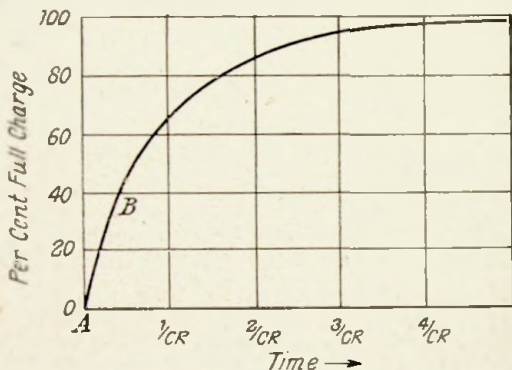

FIG. 42. ILLUSTRATING EXPONENTIAL CHARGE OF A CONDENSER

however, at low frequencies, since this involves a very low speed of time base when linearity is difficult to maintain owing to the time constant of the circuit as explained on page 77.

Correction of the non-linearity just discussed can be obtained in various ways. One is to arrange that the condenser only charges to about 20 per cent of its full voltage before it discharges. This uses the portion *AB* of the curve shown in Fig. 42 which approximates to a straight line, and under these conditions satisfactory operation is possible. This is quite easy to arrange, it being merely necessary to use a charging source having a voltage four or five times as high as the scan required. If, for example, we need 100 volts to fill the tube, i.e. to scan

completely from one side to the other, then we must have an h.t. supply of at least 500 volts. We then arrange the bias on the gas relay such that it discharges at 100 volts.

The "firing" point of the relay is practically directly proportional to the grid bias, in much the same way as the anode current of an ordinary valve is controlled by grid bias. The

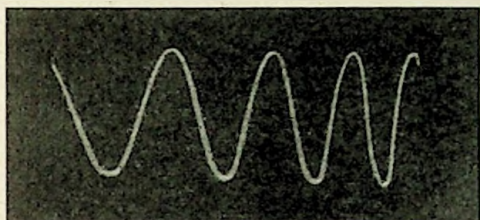

FIG. 43. NON-LINEARITY IN THE TIME BASE CAUSES THE WAVES TO BE UNEVENLY SPACED

ratio between the firing voltage and the grid bias on the anode is termed the *control ratio* of the relay and it ranges from 15 to 30 according to the construction of the relay and gas filling. A value of about 20 is customary, so that if we wish the relay to fire at 100 volts we should have to apply 5 volts bias.

An alternative method of obtaining a linear scan is to charge the condenser through some constant-current device. For example, a saturated diode may be used as shown in Fig. 44. Here, the diode is run at a reduced filament temperature such that the emission from the filament saturates at quite a low voltage of 10 or 20 volts. Any voltage higher than this will cause no increase in the current. Consequently, if we place such a device in series with the condenser, instead of the customary resistance we shall obtain an absolutely constant current in the condenser, which must therefore charge up at a uniform rate until it is within 10 or 20 volts of its full charge. By this arrangement we can obtain a linear scan over nearly

the full voltage of the condenser, so that the high tension voltage required is less.

The charging rate is determined by the actual emission from the diode which is controlled by altering the filament temperature. This, therefore, requires a directly heated valve and one which has a thoriated filament. The arrangement is convenient in certain instances, notably where a really high charging resistance is required but needs battery operation which is not always acceptable. There is also a small time lag in its operation.

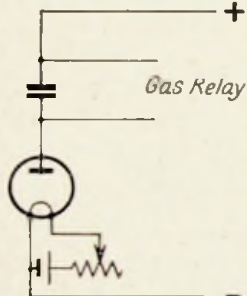

FIG. 44. A SATURATED DIODE MAY BE USED FOR CHARGING THE CONDENSER

An alternative method is to use a pentode valve. A pentode with a constant voltage on its grid and screen exhibits a similar form of characteristic inasmuch as the anode current remains practically constant irrespective of the anode voltage above about 50 or 60 volts. This arrangement therefore may be used in exactly the same manner, as shown in the circuits of Figs. 45 and 46, and in this instance the actual charging current is easily controlled by altering the

voltage on the screen or grid of the pentode.

Two alternative arrangements are shown. In the first (Fig. 45) the actual charging current is varied by altering the negative voltage applied to the grid of the valve by adjusting the slider of the potentiometer *P*. Since the cathode of the valve is tapped a little way up the potentiometer across the h.t. supply, the grid will always be negative with respect to the cathode.

The bias on the gas relay is obtained by connecting the grid to the slider of the potentiometer between the cathode of the gas relay and the anode of the pentode. During the charging cycle current flows into the condenser *C*, and as this current is constant the voltage drop on the potentiometer *Q* will also be constant, and therefore any portion of this voltage may be tapped off and used as grid bias for the gas relay. When the

relay fires this state of affairs is no longer obtained but the process of discharge has already been set in motion, and, as we have seen, it will not cease until the voltage on the anode is reduced practically to zero, i.e., until the condenser is discharged. The resistance in the anode circuit of the gas relay is to limit the current as explained on p. 76.

The second circuit (Fig. 46) is similar except that the charg-

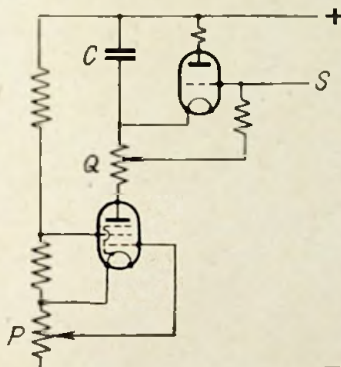

FIG. 45. CIRCUIT OF PENTODE CHARGING ARRANGEMENT

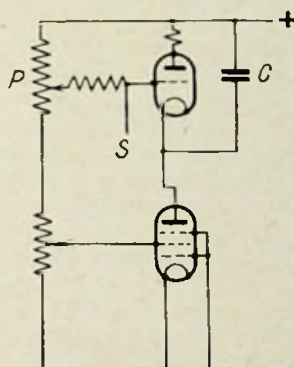

FIG. 46. ALTERNATIVE PENTODE-CHARGED TIME-BASE CIRCUIT

ing current is varied by altering the potential of the screen of the pentode. The bias on the gas relay is also obtained in a different manner. When the condenser *C* is discharged the cathode of the gas relay is very nearly at the same potential as the h.t. line. The grid of the relay is tapped down the potentiometer *P*, so that it is considerably negative relative to the cathode.

As the condenser charges up, the cathode becomes negative and therefore begins to approach the grid bias potential, and ultimately a point is reached where the difference in the grid voltage and the cathode voltage reaches the critical value at which the relay will fire.

This form of arrangement is actually particularly definite, since while the cathode is running down to meet the grid and therefore reducing the grid bias, the anode-cathode voltage is increasing due to the charge building up on the condenser. Both effects would ultimately cause the relay to fire and the combined action causes a rapid and definite "triggering."

Charging Time.

In the design of a time base we have to choose the values of condenser and resistance such that the condenser charges to the required voltage in the specified time. As already explained, it is customary to use a variable resistance so that a range of frequencies can be covered with a given condenser. With plain resistance charging a ratio of between 5 and 8 to 1 can be obtained, depending on the gas relay.

In order to limit the energy to be dissipated on the discharge the condenser is kept small. This also reduces the charging current and hence the load on the power supply unit. A typical arrangement would be a variable resistance of 1 megohm in series with a fixed resistance of 0.25 megohm, giving a frequency range, with a given condenser, of 5 to 1.

With pentode charging the ratio may be larger but this is not desirable in ordinary circumstances as the setting of the frequency control becomes too critical.

If we assume that the charging is linear the constants may be easily determined. If R is the charging resistance and E is the h.t. voltage, the charging current is $i = E/R$. The charge on the condenser $Q = it$, where t is the charging time and the voltage on the condenser $V = Q/C$.

Whence $t = CRV/E$ sec. and $f = E/CRV$ cycles per second. With resistance charging V/E must not exceed 0.2 if linearity is to be preserved. The charging current is simply E/R .

With pentode charging it may be simpler to express the frequency in terms of charging current. In these terms—

$$t = CV/i, \text{ and } f = i/CV$$

Synchronism.

There remains one important point which has yet to be covered. We saw in the last chapter that it was necessary to arrange that the horizontal sweep of the spot occupies an exact multiple of the oscillation period of the waveform under examination, so that after a complete number of waves the spot flies back and recommences to trace the second and succeeding patterns immediately on top of the first. It is impracticable to hold the time base sufficiently stable to do this by itself, even assuming that the frequency under observation remains absolutely fixed, which is not likely. It is therefore necessary to use some artificial aid to ensure this strict co-ordination between time base and work.

Fortunately this can very easily be done by introducing a small portion of the voltage under examination on to the grid of the gas discharge relay. This causes the grid voltage on the relay to vary a little above and below its normal value, and consequently the firing voltage of the tube will also vary slightly. Thus, if we applied a signal of 0.5 volt (peak) to the grid of the relay which was normally set with a bias of 5 volts, the grid voltage would vary rhythmically between 4.5 and 5.5, and (with a control ratio of 20) the firing voltage of the relay would vary between 90 and 110 volts.

Let us suppose that we have set the charging rate of the time-base condenser to reach 100 volts just at the end of one complete wave. Then the condenser should be just approaching 100 volts at this period. Let us suppose that it happens to be running a little slow so that it has not quite reached the 100 at the correct firing point.

The firing voltage, however, is not fixed but is varying, and if we can arrange that at this point it is decreasing, it will, in effect, be coming down to meet the condenser voltage, and even though the condenser may not be quite at its right voltage at the exact instant, a fraction of a second later the discharge will take place as required.

This action is entirely automatic. It is not even necessary to worry about which way the voltage is connected, for the

tube will fire initially at a point where the voltage is going in the right direction and will continue to do so afterwards, so that the pattern remains stationary.

This synchronising voltage is injected on to the grid of the gas relay as indicated at *S* in Figs. 45 and 46. The resistance in the grid lead transfers the d.c. potential necessary to

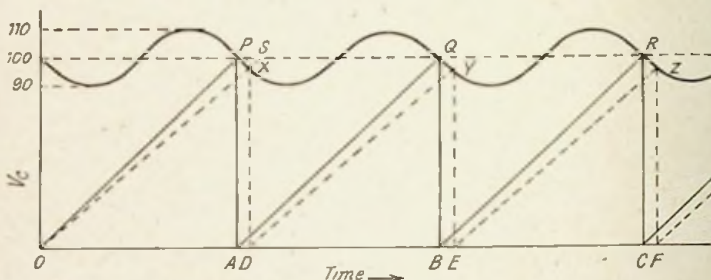

FIG. 47. ILLUSTRATING PRINCIPLE OF SYNCHRONISM

determine the operating conditions while still leaving the grid free to vary in potential when the synchronizing pulse arrives. The amount of resistance necessary depends on the value of *P* (or *Q*), and in any case the total resistance between grid and cathode of a discharge valve should not exceed about 50,000 ohms, as otherwise the operation may become erratic. A high resistance in this position also renders the grid sensitive to pick up of hum.

The amount of voltage introduced into the time base in this way must be small, otherwise the travel of the spot across the screen will no longer be uniform and distortion of the waveform will result. The speed of the time base should therefore be adjusted reasonably accurately and just enough synchronizing voltage applied to "lock" the image.

The action can be understood even more clearly if a diagram is drawn. In Fig. 47 the firing voltage of the relay is shown varying between 110 and 90 as explained, while the voltage on the condenser is represented by the diagonal line which

starts at O and gradually climbs up towards the 100 level in a time which corresponds with one complete oscillation of the waveform under examination. The relay then fires, causing the voltage to fall practically instantaneously to zero, and to start to climb up again, and so the process repeats indefinitely.

The full line $OPAQBR$ represents the condition when the speed of the time base is correct. The time base operates regularly and the times OA , AB , BC , etc., are all the same and equal to the period of the wave under examination. The dotted line OX represents the growth of voltage with a charging resistance a little too great, so that it would normally not fire until the point S . Actually, however, the firing voltage has been reduced by the synchronism so that the relay fires at X , and the sequence is $OXDYEZF$, etc. The time OD is a little longer than OA , but thereafter the time of the sweep is DE , EF , etc., which is the same as before. In other words, the time is still exactly equal to the period of the wave, but the actual point on the wave at which firing occurs is a little later.

Too Much Synchronism.

It will also be noted that when the wave is running slow the effect of the synchronism is to cause the condenser to discharge a little before its normal voltage. Now the *sweep*, or distance moved horizontally across the screen, depends upon the actual voltage to which the condenser builds up, and if we reduce this voltage we shall shorten the sweep.

It is possible, by applying a very strong synchronizing impulse, to make the condenser discharge long before it has reached its proper value, as illustrated in Fig. 48, which shows the firing part of the cycle enlarged. It is assumed here that the time base is set to a frequency two or three times less than the frequency of the wave, so that several waves will appear on the screen. With the full line, representing normal weak synchronism, the relay fires at A , and the sweep voltage is V_1 . The dotted line represents a stronger "sync." which causes the relay to fire at B . The sweep voltage is reduced to V_2 , slightly less than before, but otherwise conditions are the same.

The chain dotted line represents too strong a sync. which causes the relay to fire on the preceding wave with greatly reduced amplitude of sweep V_3 . Hence we see that increasing the amount of synchronism applied to the time base will first cause a small and progressive decrease in the amplitude of the sweep, and then a sudden jump to a much smaller amplitude

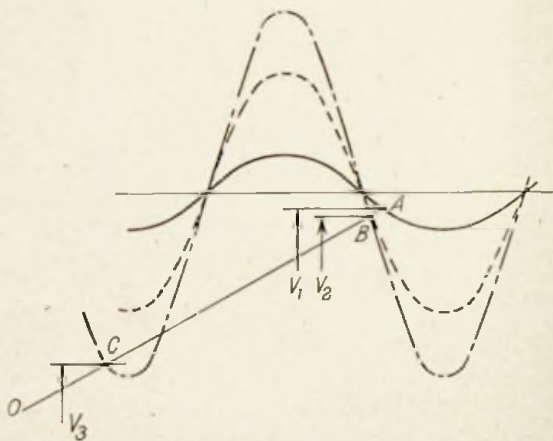

FIG. 48. ILLUSTRATING EFFECT OF INCREASING THE SYNCHRONIZING VOLTAGE

which shows one wave less than before. If the time base is set originally to show a number of waves the increase in the synchronism will cause the waves to be cut off one after the other until finally we are left with one wave or perhaps even a fraction of a wave.

Fig. 49 shows the effect of altering the speed of the time base with a fixed synchronism. OA represents conditions with the correct speed. At OB this speed is a little too slow. The amplitude of the sweep will be reduced but synchronism will still be maintained. If the time base is made still slower the reduction in the firing voltage of the relay will be insufficient

to meet the condenser charge at the end of the second wave and the time base will therefore continue to charge up till it reaches *C*, so that three waves will appear on the tube. The amplitude of the sweep is much the same as before, actually slightly more than with condition *B* but less than with condition *A*.

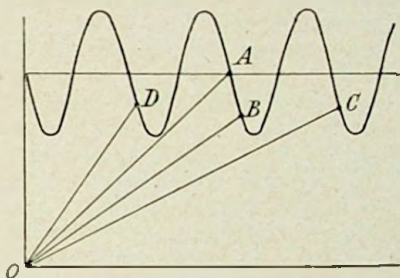

FIG. 49. SHOWING HOW THE SPEED OF THE TIME BASE AFFECTS THE NUMBER OF WAVES WHICH APPEAR ON THE SCREEN

Similar synchronism applies if the time base is running too fast, but *OD* represents the condition where it is appreciably faster than it should be, when it will be seen that the firing has taken place on the preceding wave, so that only one wave will appear on the screen. As before, the amplitude remains substantially the same.

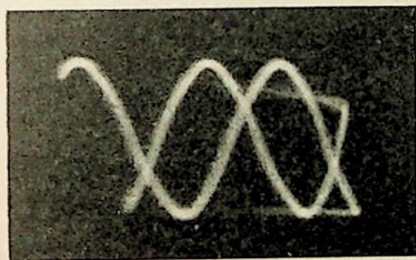

FIG. 50. PHOTOGRAPH SHOWING EFFECT OF TOO STRONG SYNCHRONISM

The distinction between these two possible operations should be quite clear. With a given value of synchronism, preferably not too strong, alteration of the speed of the time base will have the effect of altering the number of waves appearing on the screen. There will be a slight alteration in the length of the sweep

and correspondingly of the actual portion of the wave shown, but this will only be small and the pattern will suddenly jump from one setting to another showing one wave more or less.

Increasing the strength of the synchronism, on the other hand, will cause a small reduction in the amplitude of the sweep followed by a sudden jump to a much smaller amplitude showing one wave less.

Reference to Fig. 48 will also show that the point at which synchronism has occurred is considerably different on the two waves. This may often result in two alternative modes of operation, the first corresponding to the position somewhat like OA , and the second corresponding to OC , and these two will follow one another so that two waveforms will appear on the screen displaced from one another as illustrated in Fig. 50. This is particularly liable to happen when looking at only one wave, and is a symptom of too strong synchronism.

Phase of Synchronizing Voltage.

It should also be noted that the point at which the time base will synchronize depends upon the phase of the voltage relative to that under examination. From Fig. 47 it will be clear that the firing of the gas relay occurs around the point where the wave is crossing the zero line, this being the point of maximum slope. Therefore, provided the synchronizing voltage is in phase with the input, the pattern on the screen will normally show a series of complete waves starting and finishing around the zero point. The first and last waves will not be complete because a little time is occupied by the fly-back so that, particularly when only one waveform is being examined, an appreciable portion of the wave is lost.

It is desirable, for this reason, that the fly-back shall be kept as rapid as possible. With a gas relay the discharge is usually quite rapid enough except at high frequencies. With a hard-vaive time-base the discharge of the condenser is usually not as rapid, and the fly-back is appreciably slower. As a general rule, it should be taken that the fly-back should not be visible, since the spot ought to be moving with too great a speed to leave a visible trace by comparison with the rest of the wave-

form, although if the intensity control of the tube is turned up the fly-back will be seen.*

If, for any reason, it is desired to alter the point at which the fly-back occurs, the phase of the synchronizing voltage should be altered by passing it through a suitable phase-shifting network of the type discussed in Chapter IX. Suitable circuits are indicated on page 165, and Fig. 51 shows two single



FIG. 51. EFFECT OF PHASE OF SYNCHRONIZING VOLTAGE ON SHAPE OF WAVE

waves synchronized at different points of the cycle. At first sight the second oscillogram does not appear to be a single wave at all, but it is actually one complete wave triggered at the maximum instead of the zero point.

Pulse Synchronizing.

It has been shown (Fig. 49) that small changes in the speed of the time base are accompanied by corresponding changes in the length of the sweep. The time-base circuits may, and often do, pick up small voltages from the mains, from the work under examination or other causes, and this may cause unsteadiness of the image. Some of the effects produced are discussed in the section on faults (p. 77).

Such difficulties may be overcome by the use of a special

* It appears in many of the photographs in this book as a result of a relatively long exposure.

synchronizing pulse having a very steep wavefront. This would make the portion *AB* in Fig. 49 vertical, so that the time base is always triggered at the same instant. Such pulses may be derived from the "work," or from some other source. The subject is discussed further in Chapter IX.

Push-pull Time Bases.

It has been mentioned previously that with hard tubes it is

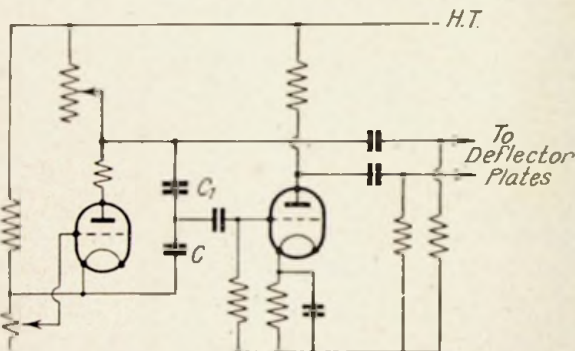

FIG. 52. PUSH-PULL TIME BASE

usually necessary to adopt a symmetrical scan if trapezium distortion is to be avoided. Strictly speaking, this symmetrical deflection should be arranged on both pairs of deflector plates, but fortunately it is possible to obtain quite tolerable results if the time base only is arranged to be operated in a symmetrical fashion.

Fig. 52 shows an amplified time base in which the time base itself provides one-half of the scan and an amplifier valve driven from it provides the other half. The amplifier valve is a straightforward resistance-coupled triode which is fed with a small portion of the voltage developed by the time base itself. The time-base voltage, however, will be 100 volts or more, which is far greater than is required on the grid of the

amplifier valve, so that it has to be stepped down by some suitable arrangement. In the circuit shown a capacitance potentiometer is used, the condenser C being roughly ten

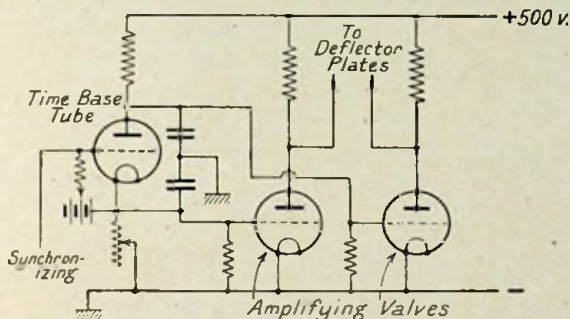

FIG. 53. AMPLIFIED TIME BASE

times greater than C_1 , whereby the voltage is stepped down about ten times, so that if the gain of the valve is ten, we have the right order of volts in the anode circuit.

Due to the phase reversing action of the valve, however, when the anode potential of the first valve is rising, that on the second valve is falling, so that the two deflector plates receive impulses in opposite directions. The deflection produced is proportional to the total voltage difference across them, but

as the deflector plates are above and below earth by an equal amount the defocusing and trapezium effects do not occur.

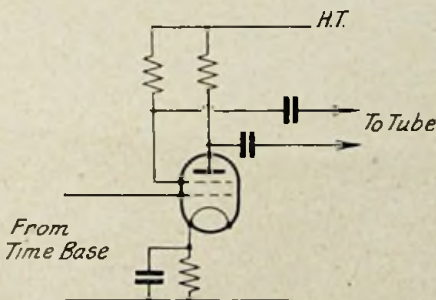

FIG. 54. SINGLE-VALVE PUSH-PULL TIME BASE

For the same reason, the tube does not defocus, since the effective gun potential is now not affected by the scan.

It has already been pointed out that the use of a push-pull time base can be obviated by the use of special construction of deflector plates, but where such is not available the use of some form of balanced arrangement such as that illustrated should be resorted to.

Another form of balanced amplifier is that shown in Fig. 53

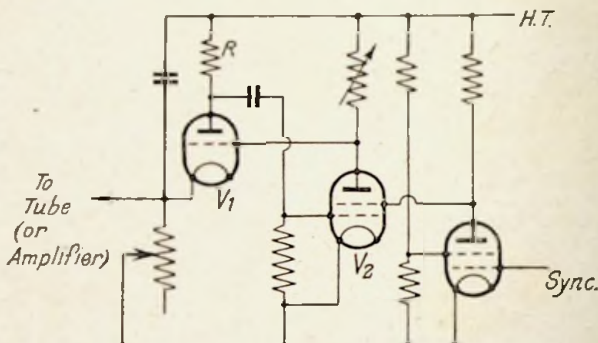

FIG. 55. HARD-VALVE TIME BASE DUE TO O.S. PUCKLE

where the time-base voltage is not applied to the tube but feeds two amplifiers, the second being fed from the first by the paraphase arrangement just discussed. In this instance the reduction of the voltage applied to the grid of the second valve is obtained by tapping down the anode resistance of the first valve.

The circuit of Fig. 54 is yet another arrangement, worthy of note since it only uses one valve. It is based on the fact that the anode and screen currents of a tetrode or pentode are complementary, so that an increase of anode current is accompanied by a decrease in screen current. Hence if the anode voltage increases the screen voltage decreases, giving the push-pull action required.

High-frequency Time Bases.

A gas triode is satisfactory up to frequencies of 10 to 50 kilocycles per second, the upper limit depending upon the type of gas filling. A neon- or argon-filled tube will function satisfactorily at 50 kilocycles per second provided the sweep required is not too great. The limiting factor is the time taken for the gas to de-ionize after the discharge. Until this happens the condenser will not re-charge, so that the charging time and sweep are reduced until finally the circuit ceases to function. It is also necessary to ensure that the stray capacitance in the circuit is reduced to a minimum because the condenser required will be of the order of $100 \mu\mu$ F. only, and it is easy for stray capacitance to exceed this value.

For really high frequencies it is necessary to use some form of hard-valve time-base. That shown in Fig. 55 is due to Puckle and is a modification of the well-known multi-vibrator circuit. In place of the ordinary gas relay a triode valve is connected. When this commences to discharge, the anode current flowing in the resistor R causes the grid of V_2 to become more negative which causes the anode of V_2 to become more positive. As this is tied directly to the grid of V_1 this becomes more positive causing an increase in the anode current which produces a further increase in grid voltage, and so by a cumulative action the current builds up to a large value which rapidly discharges the condenser. When the condenser has discharged and the anode current decreases, the reverse action takes place, which causes a rapid cut-off. This circuit can be used very successfully up to frequencies of one megacycle or even more.

Fig. 56 shows a single-valve time-base operating on an oscillating principle. The valve commences to oscillate and the pulses of grid current charge the condenser C to a high negative potential, in accordance with the well-known cumulative grid action, until the oscillation ceases. The negative charge is then neutralized relatively slowly by the positive voltage fed from the h.t. line through the resistance R , which is of a high value, until a point is reached where the valve

recommences oscillation, runs itself back negative again and so recommences the process. This arrangement operates in an inverted condition in that it is the discharge which is slow

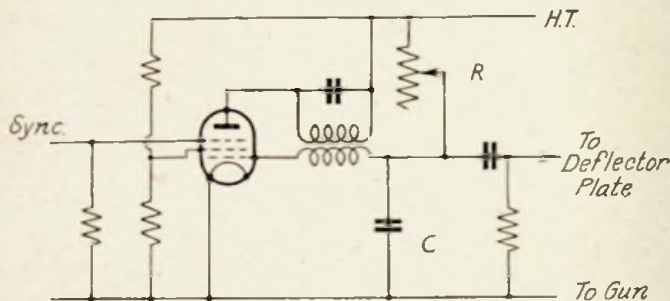

FIG. 56. ALTERNATIVE FORM OF HARD-VALVE TIME BASE (MARCONI)

while the charge is rapid, but the net result is the same as far as we are concerned, since we still obtain slow movement of the spot and the rapid fly-back.

Fly-back.

In all these time bases the spot must fly back from the end of the sweep to the beginning, and takes a finite time to do this. It is obviously desirable that this time shall be as short as possible. On the other hand, as a protective device to prevent the gas relay from passing too much current, it is customary to insert a small safety resistance of a few hundred ohms in the anode circuit. This is shown in the various diagrams and serves to limit the current to a safe value, as otherwise the excessive ionic bombardment of the cathode by the large number of ions liberated would very quickly cause the tube to lose effectiveness. This safety resistance, however, must not be too great or the fly-back is appreciably slowed down. In this case the waveform is not completed but an appreciable

portion of it is traced out by the spot on its return journey. As mentioned in the last chapter the fly-back speed is usually troublesome only at high frequencies.

Slow fly-backs may also arise in amplifying circuits due to top loss. The fly-back is a transient wave having a steep wave-front which requires a very good h.f. response, as explained in Chapter IX. Top loss in the amplifier will therefore cause the steep front to be cut off, with consequent slowing down of the effective fly-back.

FAULTS IN TIME BASES

Some of the difficulties which may be encountered with time bases have already been mentioned, but it is convenient to summarize the principal types of fault which may occur.

Non-Linearity.

Of these the first is non-linearity, which may arise from various sources. These may be enumerated as—

(1) *Failure to Maintain Constant Current Charging.* If resistance charging is used, the portion of the charging cycle employed must be strictly limited, or the charging current will begin to fall off and the speed of travel of the spot will fall accordingly.

If a constant current device, such as a pentode, is used, it does not follow that the current is necessarily constant. For example, if the condenser is allowed to charge up too near to the h.t. value, the voltage across the valve may become so low as to run into the curved portion of the characteristic, and in this case the current will not remain substantially constant but will begin to fall, and non-linearity will result. Care must be taken, therefore, that the valve is only operated under conditions where the constant current charging really applies.

(2) *Leakage.* If there is any leakage across either the charging valve or the condenser, non-linearity will be introduced to an extent dependent upon the severity of the leak. Obviously, leakage in parallel with the charging valve will pass a current into the condenser which is not constant but which

falls off as the condenser charges just in the same way as a normal resistance charged arrangement, and the actual current will therefore be the sum of the leakage current and the valve current. If the leakage is an appreciable proportion of the total current then there will be a noticeable departure from linearity on the scan.

A leakage across the condenser produces non-linearity in a similar manner, for the current supplied by the charging valve will not all serve to charge the condenser but will be partly wasted in flowing through the leakage, and this effect will increase as the condenser charges up, so that again the effect is not constant and non-linearity results.

Apart from direct leakage across the condenser one often finds that an equivalent effect has been inadvertently introduced. In most time-base circuits the voltage across the charging condenser is fed to the deflector plates of the tube through an isolating condenser with a leak (as in Fig. 56). It is necessary that the condenser shall present a negligible impedance at the frequency of the time-base, so that, in effect, the leak is connected across the charging condenser and will therefore introduce non-linearity from the cause just considered. It is essential, therefore, that the leak shall be high—3 to 5 megohms being the customary value. The capacitance of the condenser must be increased accordingly, for the voltage actually transferred to the deflector plates of the tube depends upon the reactance of the condenser relative to the resistance of the leak. The same conditions apply as in the case of deflection amplifiers discussed in the next chapter.

(3) *Defective Gas Relay.* Some forms of gas relay exhibit non-linearity. In fact, most relays are prone to this defect to some extent. The difficulty arises from an internal leakage in the valve under operating conditions. It is not measurable by actual insulation tests when the valve is cold, but it is found to be present when the valve is running, and with all possible precautions a non-linear scan is still obtained. There is no remedy for this defect but to change the relay and possibly to use a different type.

(4) *Amplifier Overloading.* If an amplified time-base is being used it is obvious that the amplifier must be operating in a strictly linear condition. This is a matter principally of the choice of components and operating conditions. In general, a high voltage should be used for the h.t. supply, feeding the valve through a high resistance. The subject is discussed further in the next chapter.

(5) *Amplifier Time Constant Incorrect.* The amplifier will be fed from the gas relay through a condenser leak combination. This must have a high resistance for the reasons described in (3).

Limited Scan.

In some cases difficulty is experienced in obtaining the full length of the scan over the range of control. The effect may be manifested in various ways. Sometimes the length of the scan obtained falls off progressively as one increases the frequency. This is due to the gas relay being unable to de-ionize sufficiently rapidly. In this case the condenser remains discharged for an appreciable time, giving an effect as illustrated in Fig. 57.

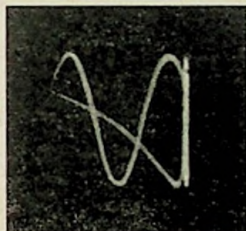

FIG. 57. PARTIAL SCAN
DUE TO DEFECTIVE GAS
RELAY

Another form of difficulty is met when the scan operates satisfactorily over the middle of the charging control but ceases at one or both ends. This again is due to the gas relay, and it will usually be found that there is a certain minimum charging resistance below which the relay will not generate the relaxation oscillations required. This minimum resistance is usually independent of the capacitance of the charging condenser, and when the resistance approaches this value all that happens is a continuous discharge through the relay. The effect is bound up to some extent with the ionic leakage mentioned in (3), and exhibited to a greater degree with some forms of relay than others. It is necessary to find what this minimum resistance is, and to design the capacitance

of the condensers accordingly in order to obtain the required frequency.

It is also often found that there is a maximum resistance beyond which the gas relay will not function. This, however, is not so common and is usually only found with defective design of the gas relay. As the charging resistance is increased, of course, the effect of any leakage in the circuit becomes more and more pronounced, so that troubles due to non-linearity are more likely to occur.

Time-base Hum.

A form of fault which is particularly vicious and which requires to be guarded against is the introduction of 50-cycle voltage from the mains on to the time base. This would cause audible mains hum in a receiver and is usually referred to as hum voltage. The grid of the discharge valve is particularly vulnerable in this respect, and if hum voltage is present the amplitude of the scan will not remain fixed but will vary about a mean value, 50 or 100 times per second, depending upon the frequency of the ripple introduced. This means that successive traces will not lie exactly over one another and the pattern will therefore alternately elongate and compress itself.

Normally this effect will not be noticeable except in producing a progressive thickening of the line towards one side of the image—an effect which may sometimes be confused with bad focusing. If the effect is serious, however, the variation in length may be so severe as to render the production of a steady trace practically impossible.

Usually induced mains voltages are small. The trouble, however, becomes very objectionable when the time base is operated at a frequency which is very nearly a multiple of the main frequency, for in this case the beats between the time-base frequency and the mains frequency cause a slow variation in the amplitude which can quite distinctly be seen, and the expansion and contraction of the wave become very marked.

The remedy is to take care to avoid pick-up of mains voltage

in the time-base circuit. The h.t. supply, of course, must be adequately smoothed, and it is quite instructive to remove the smoothing of the time base so that some h.t. hum is deliberately introduced, when the effects described will clearly become visible.

As already mentioned, however, the grid or cathode of the discharge valve are the most vulnerable points, since any voltage induced here has an amplified effect in the anode circuit. In circuits such as that of Figs. 45 and 55, for example, the cathode of the valve is floating in potential. The heater (not shown) must be supplied from a suitable winding on the mains transformer. If this winding is adjacent to a secondary developing large a.c. voltages, capacity currents will flow through the heater-cathode capacitance which will cause the cathode potential to fluctuate. It is therefore a good plan to have an entirely separate heater winding, and to interpose an earth screen on the transformer between this winding and the remainder. This, of course, must be done when designing or ordering the transformer since this screen is an integral part of the transformer.

Another form of hum in the time base is that due to induction of voltage on the deflector plates of the tube. There is a distinction between the two types of interference. In the case of pure time-base hum, one end of the scan will remain fixed and it is only the other end which will move, causing an expansion and contraction of the waveform, as already explained. In the case of voltage pick-up on the deflector plates there will be an alternating voltage superposed on the sawtooth scanning voltage which will cause the whole pattern to shift from side to side.

The effect of this will be the same as before. At random frequencies the various traces will all be slightly displaced from one another causing a thickening of the line or, more often, a split image because the trace is at its two extreme positions for a relatively long time and only occupies the intervening positions for a short while. At frequencies which are nearly multiples of the main frequency, however, beats

will occur causing the line to move from side to side relatively slowly. Both effects are equally unpleasant, and can only be remedied by tracing and removing the source of interference.

Since the deflector system will normally be provided with high leaks, it is particularly vulnerable to the pick-up of hum in this manner. The leaks should be introduced actually at the deflector plates themselves, i.e. as close to the tube terminals as possible, and should go direct to the gun.

Where shifts are being used, particularly with a circuit such as that in Fig. 16, hum may be easily introduced due to imperfect smoothing of the h.t. network. It is usually found that comparatively simple smoothing is sufficient from the point of view of the operation of the tube proper, whereas quite small ripple voltages introduced on to the deflector plates may be troublesome. To avoid this difficulty, smoothing condensers are placed across the shift portions of the network in Fig. 16. The capacitance of these condensers must be calculated so that they present a really low impedance, relative to the shift resistance, at the mains frequency.

Even this is only partially effective because the long leads to the shift potentiometers can still pick up hum voltages, and it is usually better to decouple the leaks to the deflector plates through a circuit such as that illustrated in Fig. 19, mounting the leaks and decoupling condensers as close to the tube as possible.

Magnetic Hum.

It is essential, when locating small hum voltages, to make sure that there is no direct radiation on to the tube itself from nearby transformers or heater wiring. If such voltages are present any tests which are made can be most misleading, and considerable time can be wasted. A mumetal shield should be placed around the tube even if it is proposed later to dispense with this. This shield should be completely adequate for the purpose so that there can be no question of any magnetic effect.

The best form of magnetic shield is one which fits around the tube itself, being small in diameter at one end and having

the same taper as the tube. This form of shield is expensive and the next best is a large cylinder of sufficient diameter to enclose the tube. This shield should extend from the front of the tube to a point a little beyond the gun.

In some cases it is possible to reduce the hum to negligible proportions by a small cylinder fitting merely round the neck of the tube where the gun and deflector plates are located, but this is by no means so effective, since the beam is still unprotected in the front portion of the tube near the screen and it is quite sensitive to fields in these positions. Therefore, to make certain, it is preferable to use a large cylinder completely surrounding the tube.

It is also usually impracticable to endeavour to locate hum by examining the spot unless the hum is bad. Where only a trace of hum is left, it will be found that when the deflecting voltages are removed the brilliance of the spot is so great that it is necessary to run down the intensity control. This, however, may quite easily cause the hum deflection itself to be blacked out, particularly if the waveform produced by the stray fields is of a peaky character, as it often is. In such circumstances the movement of the spot away from its central position is rapid and only occupies a small portion of the total cycle, so that if the intensity control is run down, the excursion of the spot will not appear, leaving what seems to be a sharp and unimpaired spot.

It is sometimes possible to alter the position of the tube by unfixing the tube holder and swivelling the whole tube with the leads in position. This may give a clue to the trouble, but the practice of connecting long leads to the circuit and locating the tube in a separate holder 18 or 20 inches away from the remainder of the apparatus is almost useless because it is quite likely that the long leads themselves will pick up sufficient hum to mask the results.

The subject of hum is in fact a very important one, and nothing but systematic investigation will locate the residual ripple which is causing the trouble. One good plan is to replace all the voltage sources by batteries, preferably doing

this a step at a time so that the improvement, if any, can be noted.

It is also worth noting, in passing, that the customary gas relay usually exhibits a critical amplitude above which it is very susceptible to pick-up of hum, either on the grid or by direct magnetic radiation on to the valve itself. The same valve and circuit will often operate quite successfully at the small amplitude but will be seriously interfered with by mains hum at a larger amplitude.

Vertical Hum Deflection.

Pick-up of stray hum voltages may occur in the vertical as well as the horizontal direction, and the same methods have to be adopted to locate the trouble. The difficulty is usually not so marked because the amplifier circuits are usually tied to earth in conventional manner. The hum voltages introduced are therefore usually due either to direct pick-up on the deflector plates, or to inadequate smoothing either of the h.t. supply or the feed to the screen or cathode of the valves employed in the amplifier feeding the vertical deflecting plates, if any.

Hum voltages are often masked if they are small in character, when the time base is running at a high speed, particularly if a strong synchronism is being used. For simple equipment this is an advantage and it means that a small amount of hum can be tolerated, but for first-grade equipment the time base should be run at a slow speed of about $12\frac{1}{2}$ cycles per second without any synchronism applied. Any vertical deflection will then cause a small ripple to appear while horizontal deflection will cause the edges of the scan to wander as already explained. Sometimes the two effects are difficult to distinguish and it is helpful to connect the vertical deflector plates direct to gun, in which case the vertical ripple should disappear. Any movement of the ends of the scan then indicates the presence of hum in the horizontal direction. Care should be taken to make the test at various frequencies, for if the time base is running at an exact sub-multiple of the mains frequency the defect will not appear.

A further useful trick is to apply a very slow sweep, either single stroke or recurring, to one pair of deflectors, the other pair being connected direct to the gun. Any deflection at right angles to the sweep may then immediately be observed. A sweep covering the screen in 0.5 to 1 second will suffice.

Intermodulation.

There is one further form of time-base fault which may conveniently be discussed here and that is the modification of the time-base voltage by the work voltage. If the oscillations being examined are allowed to introduce voltage into the horizontal sweep, it is clear that the waveform will be distorted. Fig. 58 illustrates a typical example of the distortion. In effect the horizontal movement of the spot is not constant in speed

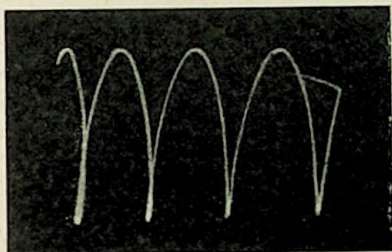

FIG. 58. DISTORTION PRODUCED BY MODULATION OF TIME BASE BY THE WORK FREQUENCY

but is continually increasing and decreasing in speed due to the superposition of a small percentage of work voltage, so that instead of a regular waveform we obtain a distortion.

There are various possible channels through which such distortion can be introduced. One is due to interaction in the power supply of an oscillograph in which a high gain deflection amplifier is used to amplify the work voltage. This amplifier will have anode currents, varying at the work frequency, which pass through the power supply unit. The internal resistance of this is not negligible, so that a small voltage will be developed across the terminals of the power unit, and if the time base is being fed from the same source the time-base circuit will be modulated in the undesirable manner just explained.

The remedy, of course, is to decouple the circuit with a

resistance-condenser network in exactly the same way as is done with ordinary radio technique.

The trouble is generally only serious at high frequencies and with high gain, but the possibility is always present, and with a poor design the distortion may easily be very bad.

Another source of intermodulation is through actual capacitive coupling between the deflector plates on the tube. This is a defect of the tube itself and therefore is more serious in certain types than in others. It is more troublesome at high frequencies than at low, and if a tube is required for use at high audio or radio frequencies, particular attention should be paid to the capacitance between the deflectors (i.e., between one pair and the other, not the internal capacitance between the two plates of any one pair. This is of importance in certain instances but it is not the cause of the trouble which we are considering here).

It is possible to overcome this trouble if the tube has both pairs of deflector plates brought out, by introducing on to the appropriate plates a voltage in the reverse direction, as is explained on page 105 under the heading of Compensation.

A push-pull or balanced scan also greatly reduces the intermodulation due to this capacitance, but the fact remains that for radio-frequency work the tube should have as little capacitance as possible between the deflector plates.

CHAPTER IV

DEFLECTION AMPLIFIERS

SINCE the normal oscillograph requires anything from 50 to 100 volts r.m.s. in order to produce a full-size pattern on the screen, it is customary to include a deflection amplifier. These are simple amplifiers having a strictly linear law and giving a gain dependent upon the requirements, such that the voltage to be examined is amplified to an extent which provides a deflection occupying about two-thirds of the screen. For normal purposes the amplifiers are resistance-coupled, and may be either triodes or pentodes. Triodes are used where the frequency band is limited to power or low audio frequencies, and where a low gain only is required.

There are two considerations, one that of the frequency response, and the other that of the linearity of the amplification. Frequency response follows normal laws as applied to radio technique. The amplification of a resistance-coupled stage is constant with frequency until such time as the capacitances in the circuit begin to exert limitation. At the low-frequency end of the scale the reactance of the coupling condenser becomes large compared with the following grid leak, and therefore the amplification falls. At the upper frequencies the stray capacitances in the circuit (including the valve anode-cathode capacitance) shunts the resistance and reduces its effective impedance, so that the amplification again falls.

It is quite easy to determine where these two limiting actions begin to be serious. Fig. 59 shows the skeleton circuit of a deflection amplifier. At low frequencies the shunting effect of any stray capacitances is negligible, and the voltage developed at the anode of the valve is transferred through the condenser C on to the tube. Across the deflector plates of the tube is the customary grid leak R , and again we may neglect the shunt effect of the grid-cathode capacitance of the

tube. We are left therefore with a simple capacitance-resistance filter, and the voltage actually applied to the tube is that developed across R which depends upon the relative value of grid resistance and the reactance of the condenser.

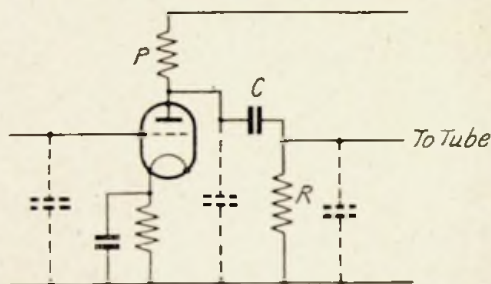

FIG. 59. SIMPLE DEFLECTION AMPLIFIER

Actually, the ratio of the voltage across R to that developed by the preceding valve is

$$RC\omega / \sqrt{1 + (RC\omega)^2}$$

Where R is the resistance in ohms

C is the capacitance in farads

and $\omega = 2\pi \times$ frequency.

This may be worked out for any given condition, but it is convenient to remember that if the voltage across R is to be 90 per cent of the applied voltage, so that we only lose 10 per cent of our gain, the product $RC\omega = 2$. As we shall see later, this is the minimum value tolerable, and if negligible phase shift is required the value is appreciably larger.

At upper frequencies the reactance of C is negligibly small in comparison with R , and we can assume that the whole of the voltage developed is transferred to the second valve. All the stray capacitances in the circuit, however, now begin to exercise their effect, and we can, in fact, consider them all as

connected across the anode resistance P . The capacitance includes the anode-cathode capacitance of the valve, the capacitance between the deflector plate and earth and the stray capacitances due to circuit wiring, etc., all of which add up to 20 to 30 $\mu\mu\text{F.}$, even with quite careful precautions.

The amplification obtained from a resistance and condenser in parallel is less than that of the resistance by itself in the ratio

$$P/\sqrt{1 + (PC_o\omega)^2}$$

where C_o is the stray capacitance in farads

P is the anode resistance in ohms

and $\omega = 2\pi \times$ frequency, as before.

This expression again can be worked out for the given conditions and we find that for a loss of approximately 10 per cent the product $PC_o\omega = 1/2$, another convenient figure to memorize.

Linearity.

Obtaining purely proportional amplification is a matter of choice of valves and components. In general, as the anode resistance is increased the dynamic or effective characteristic tends to become flatter. On the other hand, since we are using resistance in the anode circuit we cannot avoid the voltage drop which will be caused by the anode current flowing through it, so that in order to maintain an adequate voltage on the anode itself the h.t. supply must be increased considerably.

The suitability of a given valve can be judged from its characteristics. Through the operating point a line is drawn having a slope such that the voltage intercept OV (Fig. 60 (a)) divided by the current intercept OI is equal to the resistance which is to be used in this anode circuit. The total voltage swing on the valve when fully loaded is then as shown on the diagram, and the distances PQ and PR should be equal if the amplification is to be distortionless. It is often

not convenient to produce the actual load line to cut the current axis, in which case a parallel line may be drawn as shown dotted in Fig. 60 (b) to determine the resistance represented.

The working point chosen will probably be appreciably less than the maximum permissible for the particular valve, for one often finds that the required output voltage swing can be

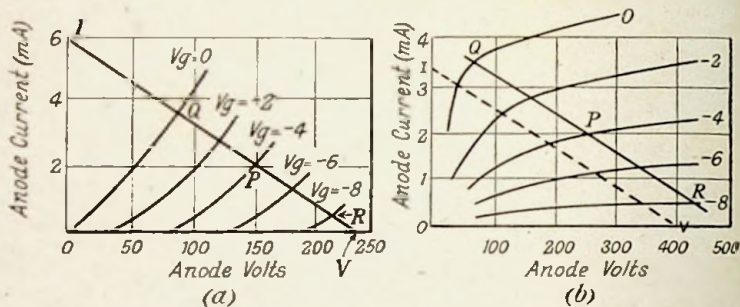

FIG. 60. ILLUSTRATING CHOICE OF OPERATING POINT ON VALVE CHARACTERISTIC

obtained by working around some lower voltage than normal. This means that a lower overall h.t. will be required. Having chosen the actual resistance which will fulfil the conditions, the h.t. on the circuit must equal the working voltage chosen plus the voltage drop in the resistance, which is equal to the anode current at the working voltage multiplied by the resistance. Thus in Fig. 60 (a) we have assumed a working voltage of 150 with a load line corresponding to 40 000 ohms and an anode current at the working voltage of 2 milliamps. The voltage drop on the resistance will thus be 80 volts which added to the working voltage of 150 requires an h.t. supply of 230 volts.

This amplifier would give a gain of 17.5 since it will be seen that an anode swing of ± 70 volts is obtained for a grid excursion of ± 4 volts.

Higher gains than this would be possible by using higher anode resistances, particularly with pentode valves, and in this case the h.t. required may easily rise to something of the order of 1 000. The conditions of Fig. 60 (b) are for a pentode with 120 000 ohms load. The gain is 47.5 and the h.t. required is

$$250 + (120\,000 \times .002) = 490.$$

It must be remembered that the optimum value obtained from the characteristic in this way may not be suitable from the point of view of frequency response. In practice it is necessary to fulfil both requirements simultaneously, which often involves considerable trial and error.

Gain Control.

It is customary to provide a variable control on the gain of the amplifier, and this should be applied on the input so that if a large voltage is impressed the proportion applied to the valve may be suitably reduced to avoid overloading. In other words, when the valve is giving its full output it will always have a safe input and therefore will not introduce distortion.

The input potentiometer, however, is liable to introduce frequency distortion because of the input capacitance of the amplifier valve which is shunted across the bottom half of the potentiometer. This trouble is greatest in the middle, i.e. at half maximum gain, therefore the resistance of the potentiometer should be so chosen that the shunting effect of the capacitance does not reduce the effective impedance of the bottom half of the potentiometer more than about 10 per cent. The conditions for this are easily calculable and it can be shown that the attenuation of the potentiometer is

$$1/[1 + P(1 + j\omega CR)/R]$$

where P and R are the resistances of the top and bottom of the potentiometer and C is the input capacitance of the valve (as shown in Fig. 61).

This criterion unfortunately usually requires a somewhat

low potentiometer resistance, particularly with triode valves, for the input capacitance which has to be considered in these calculations is not the static capacitance of the valve which can be kept to something under $5 \mu\mu\text{F}$. by using a valve with a grid top cap, but the effective capacitance allowing for the Miller effect.* This is the effect due to the anode-grid capacitance of the valve which passes current from the anode back

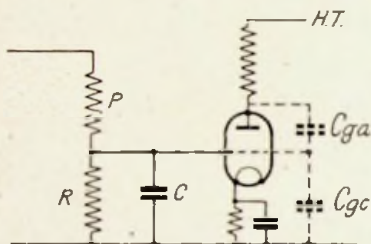

FIG. 61. THE INPUT CAPACITANCE OF A VALVE CAUSES LOSS OF THE UPPER FREQUENCIES

to the grid in such a direction and in such a phase as to have the effect of increased input capacitance.

The additional capacitance introduced by this means is proportional to the gain of the amplifier and to the anode-grid capacitance and may quite easily amount to as much as $100 \mu\mu\text{F}$. One method of overcoming the difficulty is to use pentode

valves for amplifiers even though a low gain is required, because the anode-grid capacitance here is of the order of $0.01 \mu\mu\text{F}$. or less, so that the additional capacitance introduced is quite small. If, in addition, valves having a grid top cap are used the value of the input potentiometer may be increased to something like 0.25 to 0.5 megohm without serious attenuation of the upper frequencies.

This question of input resistance is important because one of the virtues of the cathode-ray oscillograph is that it has normally a high input impedance and therefore has little effect on the circuit under examination. In many cases, of course, the presence of quite a low input resistance does

* The effective input capacitance $C_o = C_{gc} + C_{ga} (1 + A \cos \theta)$ where A is the stage gain and θ is the angle by which the voltage in the anode leads the valve voltage μe_p . With a resistance load at frequencies where top loss is negligible this is simply $C_{gc} + C_{ga} (1 + A)$. See *Modern Radio Communication*, Vol. II, Chapter VI (Pitman).

not matter, as for example in the investigation of problems dealing with mains supply and the like where an adequate power is available.

It is worth noting that if instead of a variable potentiometer a series of fixed tapings is adopted, it is possible to compensate for the effect of capacitance across the lower half of the potentiometer by connecting an equivalent capacitance across the top half. This gives an absolute compensation and input resistances as high as several megohms may be used without difficulty.

The capacitance to be connected across the top portion of the potentiometer may be calculated from the expression

$$C_1 = RC/P$$

where C_1 is the capacitance across the top portion and R , C and P are as before.

This form of correction can only strictly be applied for a fixed tapping on the potentiometer. With a variable tapping, however, it is possible to obtain a partial correction by connecting a small condenser between the slider and the top of the potentiometer. This will give a correct compensation at one particular setting of the potentiometer but will be incorrect everywhere else, although possibly the final results may be better than those obtained by using no such correction.

Cathode Follower.

When conditions permit the use of an extra stage this problem of input impedance can be entirely surmounted by the use of a cathode follower. This is a valve which gives a gain of unity but acts as an impedance changer. Suitable circuits are given in Chapter IX. (See page 173.)

R.M.S. and Peak Values.

In dealing with cathode-ray tubes and the amplifiers associated with them, we nearly always deal with peak values of voltage or current. The sensitivity of the tube, for example,

must be arranged such that the extreme values of the deflector voltage cause the spot to move to within a short distance of the top and bottom of the screen. Suppose we find that in order to move the spot over this distance we require 150 volts. If we apply an alternating voltage which just occupies this space between the top and bottom peaks of the wave and then measure the voltage applied with an a.c. voltmeter, we shall find that the reading is nothing like 150. Actually, it will be 53 volts. The reason for this discrepancy should be clearly understood.

Unless we are to have two sets of units, one for d.c. and the other for a.c., we must find some method of specifying the value of alternating current (or voltage) such that its effects are equivalent to d.c. The maximum value does not comply with this requirement since the current is only at its maximum for a brief instant. Either a.c. or d.c. current will heat up a wire, for example, but clearly the average heating effect of an a.c. current having a maximum value of, say, one ampere would be considerably less than that of a steady current which remained at one ampere all the time.

It is thus necessary to arrive at a mean value which would produce an equivalent heating effect and since the heating is proportional to the square of the current we first determine the mean or average of the squares of the current at successive instants. The actual equivalent current is then the square root of this mean value.

This somewhat complex average value is known as the *root-mean-square* or r.m.s. value, and with a sine wave it is found to be $1/\sqrt{2} = 0.71$ time the peak value of the wave, in either direction. With an oscillograph we are concerned with peaks in both directions, so that the peak-to-peak value is twice the peak value in one direction only, and therefore the peak-to-peak value is $2\sqrt{2}$ times the r.m.s. value.

Therefore, when making any calculations, or any measurements involving instruments of the normal type used for current or voltage measurement at audio or radio frequencies, this distinction should always be borne in mind.

Transients.

We have assumed so far that the waves being examined are regularly recurring, so that we may set the time base running at some sub-multiple of the frequency of the work and thereby obtain a series of coincident traces which will result in an apparently steady pattern. In many instances one requires to examine waveforms which are only transient, i.e. only occurring once or at regular but relatively lengthy intervals.

In such circumstances special technique has to be adopted. If the transient is a recurring phenomenon we can use an ordinary time base and arrange that it shall be started on its travel every time the transient starts, and hence, if the repetition is sufficiently rapid, we still can get a stationary pattern. Otherwise photographic or long-delay screens have to be used, together with special types of time base.

It is in the response to transient effects, such as the clash of cymbals and even certain speech sounds, that the ordinary amplifier or loud-speaker is liable to fail. The methods of analysis previously considered are of little avail here, though they may be used, if intelligently applied, to provide some data, and for many purposes they prove adequate. True transient response, however, can only be analysed by the methods discussed in Chapter IX.

In general it may be stated that an amplifier called upon to deal with transients must be capable of a much higher frequency response than a normal amplifier, and as a rough guide the amplifier should have not only a satisfactory response but negligible phase shift at frequencies at least ten times as high as the maximum fundamental frequency to be handled.

A typical example of a transient amplifier is a time-base amplifier which is called upon to amplify the saw-toothed wave generated by a time base. This has a slow rise followed by a very rapid fall and the time of the fly-back or discharge period will in general be of the order of 10 per cent of the scan time. Hence, if we are scanning at a frequency of 10 000 cycles per second, the fly-back will occupy 10 microseconds only. The amplifier therefore must have a satisfactory

response as high as 100 kilocycles per second, otherwise the fly-back will be unduly prolonged.

Strictly speaking, even this frequency response is not good enough, for the fly-back is not a regular sine wave but itself is saw-toothed in form. Now a triangular wave can be built up of a fundamental sine wave together with a number of high order harmonics of fairly large amplitude, so that in order to maintain true amplification even on the fly-back, we require a still higher frequency response. In practice, this very high frequency response is not normally required, for a little slowing down of the fly-back can usually be tolerated. The saw-toothed waveform itself, of course, is a transient type of wave, and requires amplification at frequencies several times greater than its fundamental charging time would indicate, but if the amplifier has been satisfactorily designed to accommodate the fly-back it will more than suffice for the main wave.

Faults in Amplifiers.

The deflection amplifier has to be virtually a perfect amplifier for we are using it to examine distortion in waveforms or other phenomena, and it is essential that the amplifier used in the measuring instrument should be above reproach. Very careful design is required if this condition is to be fulfilled.

The faults experienced are of two main types, according to the type of distortion they introduce. The first is straight-forward amplitude distortion, to avoid which we must ensure that the output voltage is always strictly proportional to the input. This is another way of saying that the characteristic of the valve must be straight over the working portion. It is usually assumed that the use of a high resistance load will automatically accomplish this condition, but too hasty acceptance of this dictum will quickly lead to difficulties.

It is, of course, necessary to make sure that the amplifier will deliver the output voltage required, and this is best determined by drawing a load line on the characteristics of the valve in the manner already indicated in Fig. 60, p. 90.

Fig. 60 (a), of course, does not by any means represent the optimum condition for operation of the particular valve represented. The voltage swing is only 140 volts peak-to-peak, whereas, by increasing the load two or three times, we could obtain an output approaching 180 volts peak-to-peak. Moreover, since we are using high loads it is possible to operate with small anode current, in which case the anode voltage at the working point can be increased considerably. The average mains valve is rated to withstand 250 volts on the anode under normal load conditions, and if we are prepared to operate it with a lower anode current than necessary, the anode voltage may safely be increased up to (or actually slightly below) the limit where the steady wattage dissipation, as given by the product of the anode voltage and the anode current, is the same as before. Under these conditions and with a suitable choice of load, the valve quoted in Fig. 60 (a) would be capable of delivering an output voltage of over 300 volts.

When choosing the load line it is important to make sure not only that the peak swings from the working point to the extreme are equal on both sides, but also that similar equality is obtained at intermediate points. The anode voltage change for equal increments of grid voltage in both directions, up to and including the peaks, is read off from the load line. These anode voltage increases should be equal over the whole scale. It does not by any means follow that the load line which gives the maximum output necessarily complies with this condition. Pentode valves, in particular, require more careful examination because there is a tendency for third-harmonic distortion to be introduced. With this form of distortion the anode voltage increments show a tendency to increase as the grid swing is increased and then to decrease again, so that although the peak values may be equal, distortion may nevertheless be present.

A convenient method of checking the operation of a deflection amplifier is to use the static characteristic method discussed in Chapter VI. A voltage is applied to the horizontal deflector plates, and a small portion of this voltage is tapped

off and applied to the amplifier which in turn feeds the vertical plates. This will give a diagonal trace on the screen, and if the amplification is distortionless this line will be truly straight over its whole length.

Frequency Response.

The other form of distortion is that arising from varying response at different frequencies. This is a comparatively simple matter to check by applying a known voltage to the input of the amplifier and noting the output voltage obtained by measuring the height of the line on the tube. In making this test the time base can be switched out of action so that a simple vertical line is produced. It is desirable, if this is done, to reduce the intensity to avoid burning the screen, since, owing to the reduced travel of the spot, when it is not tracing out the waveform, the brilliance will increase considerably, and there is a risk of damaging the screen if the same intensity setting is used.

Alternatively, the time base may be run at a much lower frequency than that under examination, so that a number of waves is introduced, degenerating into a band pattern of the type of Fig. 29, p. 43. The overall height of this pattern is an indication of the amplifier response.

Phase Angle.

The criteria governing low and high frequency-response have already been discussed fully, but a factor of considerable importance is that of phase angle at the low and high frequencies. When we feed voltage through a condenser and resistance in series, as in Fig. 59, p. 88, the current leads on the voltage by a small amount. The voltage across the resistance R , which is the voltage applied to the tube, is in phase with the current, so that there is a small phase shift in transferring the voltage.

This phase shift is easily calculable and is given by the expression

$$\tan \theta = 1/RC\omega$$

Where θ is the angle by which the output voltage leads the input voltage

R is the resistance in megohms,

C is the capacitance in μF .,

and $\omega = 2\pi \times \text{frequency}$.

It will be seen that the larger the condenser relative to the resistance, the less is this phase shift. It will also be noted that for given values of condenser and resistance the phase shift increases as the frequency is reduced. This form of phase error, therefore, only occurs at low frequencies and the amplifier must be designed to give a negligible phase shift at the lowest frequency to be handled.

For 5° phase shift $RC\omega = 11.4$, while for 1° shift $RC\omega = 57$. It will be noted that the product $RC\omega$ has to be much higher than is given by the expression for tolerable cut-off.

Similar expressions may be deduced for the high-frequency phase shift which is caused by the shunt capacitance of the circuit and when this is done we obtain the expression

$$\tan \theta = \omega C_o P / (1 + r/P)$$

where r is the a.c. resistance of the valve, in ohms,

P is the anode resistance in ohms,

C is the shunt capacitance in farads,

and $\omega = 2\pi \times \text{frequency}$.

If P is large compared with r , this reduces to $\tan \theta = \omega C_o P$, and for 5° phase shift $\omega C_o P$ must not exceed 0.0875.

It is useful to note that high-frequency loss and phase shift may both be delayed by the introduction of a choke in series with the resistance. This choke resonates with the shunt capacitance and maintains the response when it would normally begin to fall off. It is, indeed, possible to make the response rise slightly before the cut-off occurs. Fig. 62 indicates the type of response obtained, and gives particulars relevant to the calculation of the appropriate choke.

Negative Feed-back.

A form of amplifier which is useful in oscillograph work where extreme linearity of characteristic is required, both as regards amplitude and frequency, is the negative feed-back amplifier. This is an arrangement in which a small portion of the output from the amplifier is fed back to the input in such a direction as to oppose the voltage already introduced on the

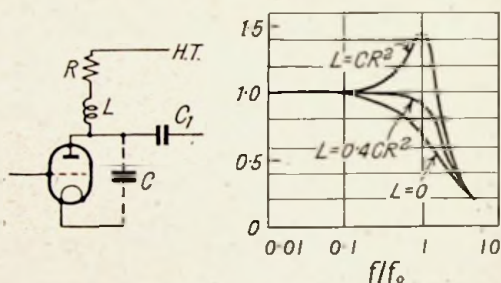

FIG. 62. COMPENSATING CIRCUIT FOR MAINTAINING UPPER FREQUENCY RESPONSE

f_0 is the frequency at which $RC\omega = 1$

input terminals. It can be shown that if the proportion of the output voltage fed back is β , and if the total normal gain of the amplifier is A , then if βA is large compared with unity, the effective gain of the amplifier with feed-back in operation is simply $1/\beta$.*

This is very significant since it indicates the amplification is entirely independent of the valves and circuit constants of the amplifier, and is solely determined by the feed-back arrangement.

There are, as one might expect, some limitations to this statement. The first is that if a high gain is required β must be small, but since βA is to be large compared with unity, A must be large. The arrangement is in fact an inefficient one

* See the author's *Modern Radio Communication*, Vol. II (Pitman).

and it is necessary to use at least two valves to obtain the gain which could normally be obtained from one.

The second reservation is that the amplifier and feed-back circuit should have no phase shift, and this condition is not by any means so easy to comply with. If the overall phase shift exceeds 90° the feed-back will have a positive component and, provided that the gain of the amplifier is more than

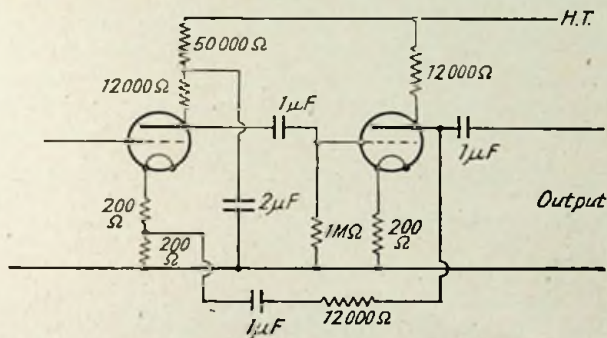

FIG. 63. SIMPLE NEGATIVE FEED-BACK CIRCUIT

unity at this point, it will produce continuous self-oscillation. Clearly, also, long before this point is reached any serious change in phase means that the effective voltage on the input is not the simple arithmetical difference between the normal input voltage and the feed-back voltage, so that the simple expression for the effective gain is no longer valid.

The difficulty only occurs at low or high frequencies outside the normal range of the amplifier, so that if the amplifier can be designed so that the gain falls off very rapidly as soon as phase shift commences the trouble may be avoided.

Fig. 63 illustrates a typical circuit suitable for low and medium audio frequencies. At high frequencies this circuit is not so useful owing to the limitation of phase shift already mentioned.

Here $\beta = 200/12,200 = .0164$, and as A with normal triodes would be about 500, $\beta A = 8.2$, which is sufficiently large compared with unity to fulfil the requirements. Hence the gain would be $1/\beta = 61$ and tests with an actual amplifier to this circuit proved that whereas without feed-back (and a correspondingly reduced input) amplitude distortion was present, the application of feed-back removed this practically completely (at the expense of overall gain).

Most deflection amplifiers are single stages and a common device is to obtain some measure of feed-back thereon by omitting the customary cathode by-pass condenser. The a.c. voltage developed across the cathode resistor is then in opposition to the signal input, and the gain is reduced approximately in the ratio $1/\left(1 + \frac{\mu R_c}{R_a + r}\right)$ where R_c and R_a are the cathode and anode resistors, r is the a.c. resistance and μ the amplification factor of the valve.

It may be remarked that while such feed-back does assist in removing amplitude distortion, $\beta A = \mu R_c/(R_a + r)$ which is not large compared with unity, so that the full benefits of negative feed-back are not obtained.

Ripple Voltage.

A very common defect in deflection amplifiers is ripple voltage picked up either from the power supply or from some other source, such as the time base or another amplifier. Any mains frequency picked up on the deflection amplifier will cause a movement of the spot in addition to the deflection provided by the amplifier. The waveform produced, therefore, will be the sum of these two waves. If we are looking at frequencies below the mains frequency, the presence of this ripple will introduce harmonics which may or may not be an exact multiple of the waveform under examination. At mains frequency this ripple will add to the waveform under examination and may or may not introduce distortion depending upon its base. If the waveform under examination is not at mains frequency, but is still low, then the amplitude of the wave will be continually

changing at a slow rate depending on the beats between the mains frequency and the frequency under test.

As the frequency rises this variation in amplitude will result in a blurred image. Fig. 65 shows a 1 000 cycle wave with a small amount of 50 cycle mains voltage superposed, and it will be seen that two entirely distinct waves are present. In practice, a stationary pattern of this type would not be encountered and one would have two or more waves permanently showing on the screen, each bobbing up and down slightly and giving a thoroughly confused pattern.

Similar effects are experienced if the ripple voltage picked up is of other frequency, and the only remedy, of course, is to remove the source of the ripple. It is assumed that the trouble is not due to magnetic deflection, which has already been discussed in Chapters II and III. In certain cases trouble has been experienced due to the use of directly heated tubes (and sometimes indirectly heated types) in which a small magnetic deflection is produced by the passage of current through the tube heater.

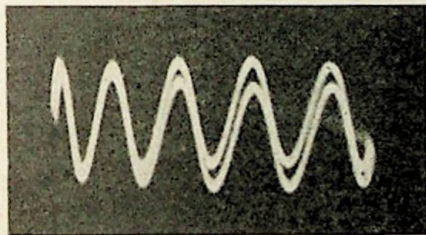

FIG. 65. ANOTHER EFFECT DUE TO
MAINS RIPPLE

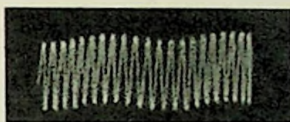

FIG. 64. ILLUSTRATING
EFFECT OF MAINS RIPPLE
SUPERPOSED ON AUDIO-
FREQUENCY WAVEFORM

Any difficulties on this score may be eliminated by removing the connections to the tube heater and feeding it from a battery, through a resistance and filament ammeter if necessary. Care should be taken in conducting any test of this type, since the cathode and heater of a normal oscillograph tube are not at earth potential but are negative to earth by the full tube h.t.

Therefore, the filament circuit should not be touched when the apparatus is switched on.

If, however, the short-circuiting of all the plates to the gun removes the deflection, then the interference is coming in on the deflection amplifier and will probably be found to be due either to pick-up direct on the grid or to imperfect smoothing, either in the h.t. or screen feed. Pick-up on the grid may

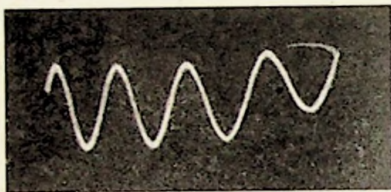

FIG. 66. EFFECT PRODUCED BY INTRODUCTION OF TIME-BASE VOLTAGE INTO THE VERTICAL SCAN

be verified by short-circuiting the grid to earth as close to the valve as possible, when the interference should disappear if it is due to this form of pick-up. Inadequate smoothing may be checked by increasing the smoothing at suitable points. Screens of pentodes are vulnerable points for this form of interference.

Shifts are another fruitful source of mains ripple. This form of interference was discussed on page 82. The remarks there which were concerned mainly with horizontal ripple deflection apply equally well to vertical deflection, and the same remedies may be used.

Intermodulation.

Interaction between the deflection amplifier and the time base may have two effects. The first is the modulation of the time-base voltage by the work which has already been discussed in Chapter III (Fig. 58). The other is the converse effect whereby a small deflection is introduced in the vertical direction as a result of the time base. This causes the pattern to lift slowly as it travels across the screen, as illustrated in Fig. 66. The remedy is to find where the interaction is coming from, and to remove the particular part of the circuit which is causing the trouble. For example, if both time base and amplifier are being fed from a common h.t. supply, it is

possible that the voltage of the power supply is fluctuating slightly at time-base frequency due to the internal resistance of the power unit, as explained on page 85, and the remedy is to decouple the circuit suitably.

Compensation.

The fact that many oscillograph tubes have both pairs of deflector plates brought out enables one to compensate in

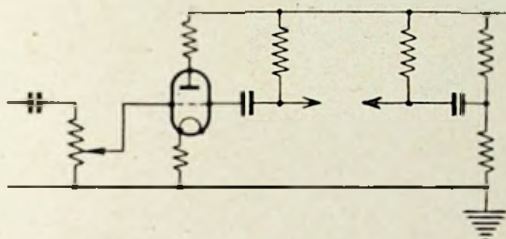

FIG. 67. CIRCUIT FOR COMPENSATING MAINS RIPPLE

many instances for voltages which are difficult to eliminate. For instance, a voltage may be introduced by capacitance coupling which may be extremely difficult to avoid. It could be neutralized by feeding an equivalent voltage through a negative capacitance, but we have no such component at our disposal, for an inductance can only be used in this manner at one particular frequency.

A similar voltage fed on to the other deflector plate of the pair, however, would produce a deflection in the opposite direction, and this fact may often be utilized to provide a means of removing an unauthorized deflection.

Fig. 67 illustrates a typical example of a simple oscilloscope in which a ripple voltage was introduced on one of the deflector plates by virtue of inadequate smoothing in the h.t. supply to the deflector amplifier. In this particular instance it was not desired to increase the smoothing from considerations of cost, and a far simpler remedy was to connect the other deflector

plate of the same pair to a suitable point on a (fixed) potentiometer across the supply (through a suitable isolating condenser) so that it picked up sufficient voltage to offset the ripple introduced by the deflection amplifier.

Tactics of this sort are often expedient and more helpful than the complete removal of the offending ripple which may either be an expensive matter or may of itself introduce difficulties or limitations as bad as, if not worse than, the trouble which is to be overcome.

CHAPTER V

FREQUENCY-RESPONSE CURVES

AN application of the oscilloscope which is increasingly used to-day is the plotting of the variations in output voltage or *response* of a circuit in terms of frequency. This is a matter which interests the communications engineer to a large extent, both in radio- and audio-frequency work.

The general principle of operation is to apply to the circuit under test a varying frequency, and to develop a voltage which is proportional to the output of the circuit, which is then applied to the vertical deflecting plates of an oscilloscope. The horizontal movement of the spot is controlled by a circuit which operates in a manner proportional to the frequency supplied to the circuit, so that as the frequency varies, the spot moves horizontally across the screen in unison, and the vertical movement of the spot then traces out the actual response.

The method of application of this principle varies according to the requirements. It is most easily applied at radio frequencies, for here it is possible to cause the frequency to vary at a sufficiently rapid rate to permit repetition at a speed above the flicker limit, as in the case of the ordinary delineation of waveform. If the oscillator, for example, is caused to vary in frequency between predetermined limits fifty times a second, then an ordinary time base can be arranged to scan the tube in the usual manner, also fifty times a second. At each operation the required response curve would be traced out and the net result would be an apparently stationary pattern on the tube.

The repetition rate must not be too high or, with a sharply tuned circuit, the response obtained will not be the same as that which would be obtained under static conditions. It is, indeed, argued in some quarters that the method is invalid

for serious work on this account, but for experimental investigation of the behaviour of circuits, particularly those involving band-pass tuning, there is no question that the method is one of considerable utility.

Motor-driven Modulators.

The combination of variable-frequency oscillator and time base is known as a *frequency modulator*. One of the earliest forms used consisted of a motor driving a small condenser which was connected in parallel with the normal tuning condenser of an oscillator. If this auxiliary condenser is suitably designed, the change in frequency with rotation can be made linear. The time base, therefore, can consist of a simple condenser, charged through a high resistance or a constant current arrangement such as a pentode, and then discharged by a contact on the motor shaft at the appropriate point. As the motor rotates and therefore varies the frequency of the circuit, the time-base condenser charges up and causes the spot to move horizontally across the screen, and when the motor has completed half a revolution and thereby provided the maximum frequency change, the contact discharges the condenser and the operation is ready to recommence.

A feature of this method is that during the second half-revolution of the motor, the frequency changes in the reverse direction, so that if it increased during the first half-revolution it now decreases and therefore a second response curve is plotted which will be different from the first unless the circuit is strictly symmetrical, which is not likely. Fig. 68 (a) shows the type of double image obtained.

With simple receivers the presence of asymmetry is accepted as inevitable so that this double image is a source of embarrassment. With higher grade receivers, on the other hand, efforts are made to achieve a truly symmetrical resonance curve and this double image is of considerable value. We shall discuss the matter further later in the chapter, but for the present we shall consider methods which only produce a single image.

One obvious solution is to discharge the time base once

every revolution of the motor in which case two images are obtained side by side, one being the mirror image of the other, as illustrated in Fig. 68 (b). This may be less confusing since it is possible to displace the second image off the screen altogether so that only one image appears. This procedure loses half the brilliance in the trace, and the intensity itself

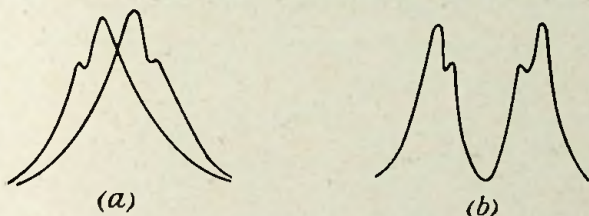

FIG. 68. AN A.C. SWEEP PRODUCES DOUBLE IMAGES OF THIS KIND

The displacement of the images in the left-hand diagram is exaggerated

must be correspondingly increased, which may possibly involve some loss of focus.

It is also possible to arrange to black-out the spot on the return stroke, which may be done by an auxiliary contact on the motor shaft which is closed during the forward sweep and opened during the second half-revolution. This contact would be connected across part of the potentiometer feeding the shield of the tube, which would be adjusted to give normal brilliance with the contact closed. When the contact is open the shield bias is increased and therefore the spot blacks out. A similar black-out arrangement could be produced electrically, as is discussed later.

Electronic Modulators.

More recent forms of the device utilize electrical methods of varying the frequency. One simple arrangement is to employ the Miller effect of a valve. It was explained in the previous

chapter that the input capacitance of a valve is not simply the grid-cathode capacitance, but contains in addition an effective parallel capacitance equal to $C_{ga}(1 + A \cos \theta)$. If θ is 0 (resistive anode load) and A is large compared with unity this becomes simply AC_{ga} , which is many times as great as the static capacitance C_{gf} .

Normally, the amplification is fixed, but if we can arrange

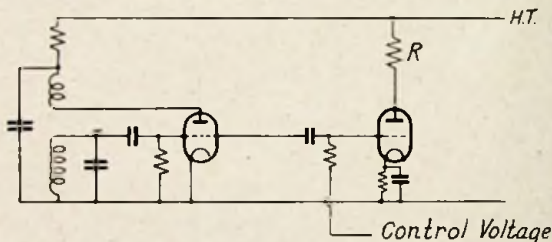

FIG. 69. SIMPLE ELECTRONIC SWEEP CIRCUIT

to vary the gain of the stage, then this reflected capacitance will change. Fig. 69 illustrates a circuit in which a vari-mu valve is connected across the tuned circuit of an ordinary oscillator. The anode circuit of the control valve contains a resistance sufficient for the valve to develop a reasonable gain at the oscillator frequency. We do not use this amplified voltage, but it is necessary that the valve shall be in a condition of amplification so that the reflected capacitance shall be large. In addition to the steady bias on the valve we superpose a control voltage which causes the bias to change and therefore varies the amplification, and as it does so the effective capacitance in parallel with the oscillator changes and consequently alters the frequency.

As before, it is necessary that the change in frequency should be proportional to the control voltage, and if the percentage change in frequency is small the variation of capacitance (or other quantity employed to vary the frequency) must be linear. Hence the gain of the control valve needs to

be directly proportional to the control voltage, which condition can be obtained with a vari-mu valve over a limited range.

Normally the actual frequency change produced will vary as the frequency is altered. Certain circuits (detailed later) will give a constant ratio of $\delta f/f$, but no circuit will give a constant actual change of frequency, whereas for many investigations this is desirable.

One solution of the problem is to use two oscillators, one

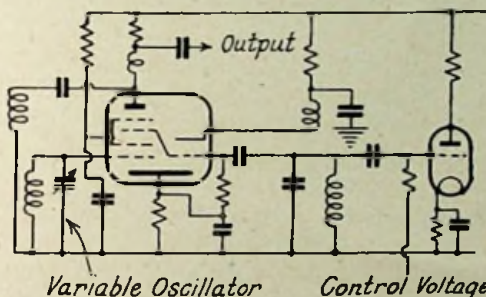

FIG. 70. FREQUENCY MODULATING CIRCUIT GIVING CONSTANT SWEEP

fixed but frequency-modulated and the other variable. The two are mixed in a frequency changer, and the beats will then be frequency-modulated by a fixed amount, while the actual frequency can be altered at will by adjustment of the variable oscillator. Such a circuit is shown in Fig. 70.

Application of Control Voltage.

The control voltage can be supplied in various ways. One could, for example, apply the ordinary a.c. supply to the control grid, and a similar a.c. voltage to the horizontal deflector plates of the tube. Then although the movement of the spot itself would not by any means be uniform, the change in frequency would follow the same law and the position of

the spot would at every instant be proportional to the frequency, so that a true resonance curve would result.

The forward and return traces should coincide, for when the spot is returning the frequency varies in the reverse direction. In practice, however, the traces are usually slightly displaced, particularly at high sweep speeds, which may cause confusion

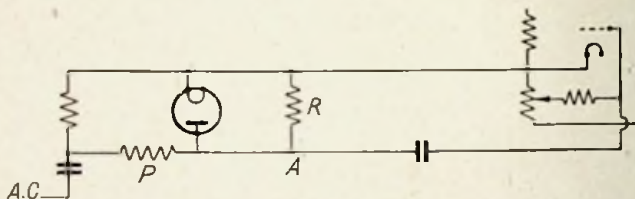

FIG. 71. ARRANGEMENT FOR BLACKING-OUT RETURN TRACE

unless arrangements are made to black-out the spot during one-half of the cycle. This could be done by using the circuit as shown in Fig. 71. During the negative half-cycle, the diode is non-conducting and current will flow through the resistances P and R which will develop at the point A a negative voltage relative to cathode. This is applied to the shield of the tube and causes it to black-out. During the positive half-cycle the diode short-circuits the resistance R so that the bottom portion of the potentiometer $P + R$ is short-circuited. Hence practically none of the positive half-cycle is actually applied to the tube, which thus behaves in a more or less normal manner during this part of the wave.

It is necessary for the black-out voltage to be correctly phased. The effective part of the control voltage is the steep portion where the curve crosses the zero line, so that we want to use the portion from negative peak to positive peak of the a.c. wave and suppress the next half-wave from positive peak back to negative peak again.

We must therefore apply the a.c. to the black-out circuit through a phasing network which advances or retards the

voltage by 90° . Such a circuit is shown in Fig. 71. The design of such networks is discussed in Chapter IX.

An alternative frequency-modulator circuit may be provided by using a time base for the control voltage, this being the same time base as is used to scan the tube. Then as the spot moves horizontally in conformity with the varying time-base

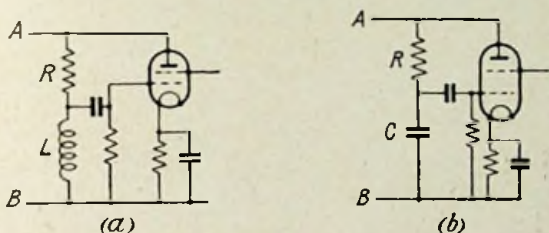

FIG. 72. ALTERNATIVE FREQUENCY MODULATING CIRCUITS

voltage, the frequency of the oscillator changes in the same manner, uniformly and linearly, until the spot reaches the end of its sweep when it flies back and recommences the operation. Since the fly-back will normally be very rapid the wave traced out on the return stroke is barely visible, although in some of the photographs in this chapter a faint trace can be seen.

Use of Reactor Valve.

There are various other methods of altering the frequency electrically. In some instances the damping effect of a valve is used, for if a resistance is connected across a tuned circuit the frequency changes, and since the effective resistance between anode and cathode of the valve is controlled by grid bias this provides another method of frequency variation.

A more common method to-day is to use a reactor valve, which is a valve so connected as to "look like" a reactance. Consider the circuit of Fig. 72 (a). If a voltage is applied across the terminals *AB*, then a voltage will be applied across grid and cathode which will lead on the input voltage. If *R*

is made large compared with $L\omega$, the current through this network will be practically in phase with the voltage and therefore the voltage on the grid will lead by almost exactly 90° .

If this network is connected in a circuit the point A (connected to the anode) will be capable of varying in potential, and because of the normal action of the valve, these anode

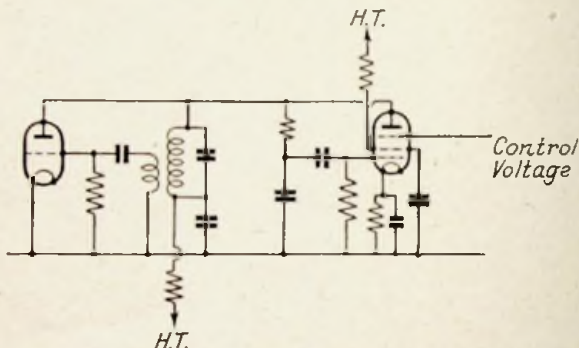

FIG. 73. FREQUENCY MODULATED OSCILLATOR USING INDUCTANCE CHANGE

voltage variations will be in the opposite direction to the grid voltage variations. Therefore, the voltage on the anode will vary as if the valve were a (negative) capacitance. The value of this effective capacitance will depend upon the gain of the valve, which we can control either by varying the grid bias or by varying the voltage on some other electrode such as the suppressor grid. The effective capacitance across $AB = -gL/R$, g being the slope of the valve.

An even more convenient circuit is that shown in Fig. 72 (b), where the network contains a resistance and condenser in series, in which case the valve between the points A and B looks like a negative inductance. This is often convenient, for if we are able to change the inductance in a circuit, the percentage change of frequency will remain the same irrespective

of the value of the tuning condenser that it employs. The effective inductance is $-RC/g$, and Fig. 73 shows a circuit using this form of control.

It is often useful to know what frequency variation is

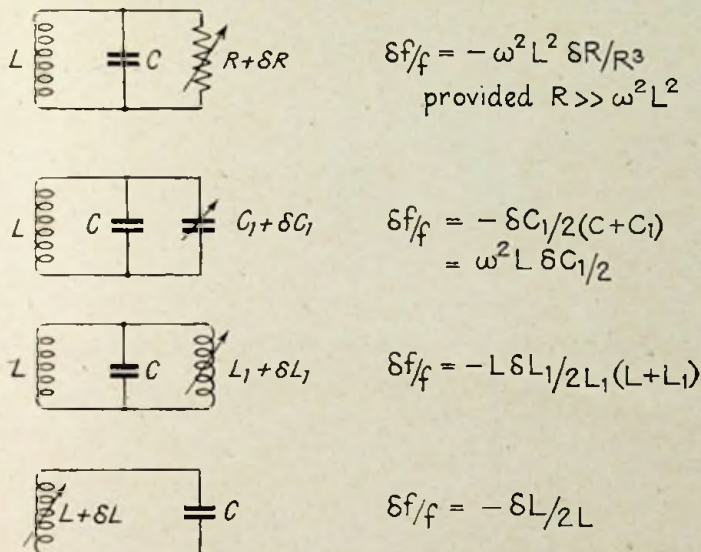

FIG. 74. FUNDAMENTAL FREQUENCY-MODULATING CIRCUITS

obtainable with given conditions. Fig. 74 shows a number of possible arrangements with expressions for $\delta f/f$ in each case. f is the mean frequency and δf is the change produced.

Magnetic Methods of Frequency Modulation.

Reference may be made to certain other types of circuit which are used. One of the limitations of the reactor valve is the relatively small change of frequency which can be produced. If, for example, we require a 20 per cent change in

frequency, the reactance must be varied by 40 per cent, which is difficult of accomplishment within linear conditions.

The use of beat-frequency technique simplifies the problem, for the change in primary frequency is then a much smaller proportion. Thus a 100 kilocycles sweep in 500 would be hard to achieve directly, but if an oscillator operating between

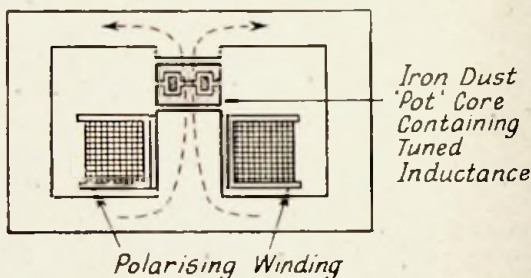

FIG. 75. MAGNETIC ARRANGEMENT FOR FREQUENCY MODULATION

5000 and 5100 were caused to beat with a frequency of 4500 we should obtain the required result easily enough.

The beat-frequency technique, however, has its own difficulties. Accurate calibration of the beat is awkward, while the possible drift of the beat frequency due to drift of the primary oscillators is an ever present trouble since stable high-frequency oscillators are difficult to construct. Finally, there is the need for adequate filtering of the unwanted r.f. components without adversely affecting the beat output.

One method of direct modulation which is very successful is illustrated in Fig. 75. Here the inductance of the oscillator circuit (or part of it) is wound on a dust iron core and located in the path of a d.c. magnetic circuit. The inductance of the coil is then dependent on the value of steady flux in the circuit (in the same way as the inductance of an iron-cored choke depends on the d.c. polarization). By varying the current in the main magnet coil the flux, and hence the inductance, can be varied over wide limits. With due precautions the change

is linear and a frequency change of 25 or 30 per cent is quite feasible. The method can only be used at frequencies for which the customary iron dust core is effective since the change in inductance depends on the alteration in permeability of the core, but frequencies of several megacycles per second can be handled satisfactorily.

Double Image Working

The possibility of showing two traces, one with rising frequency and the other with falling frequency, has already been referred to. In general, the mechanical frequency modulator has been displaced by the electronic type, but this does not lend itself so readily to double-image operation.

One method which has been used employs an a.c. sweep for the frequency modulator but a normal time base, synchronised from the a.c. supply, for the X scan on the tube. This provides the desired result, with the disadvantage that the frequency scale is non-linear, since the time base is linear while the frequency sweep is sinusoidal. The effect is to open out the central portion and compress the edges, and while a calibrated cover scale may be used to allow for the non-linearity, one is often particularly interested in the "skirts" of the resonance curve, which with this system will be located in the compressed portion.

A solution of this difficulty, which has been used by the author with success, is to convert the mains a.c. waveform to a square top and then to integrate this wave. The result will be a triangular wave rising and falling at a uniform rate. The modulator is then fed with a normal time base, synchronised from the mains, so that while the oscillator frequency always changes in the same direction (with a rapid fly back), the X scan on the tube is a linear to-and-fro motion.

The integrating circuit used is of the type discussed in Chapter IX. The method is capable of application to other frequencies, and one can, in fact, generate a square wave by any convenient means at any desired frequency and use this as the primary source.

Resonance Curves.

The application of this technique to resonance curves is straightforward. It is necessary to develop a voltage which is proportional to the response of the circuit under examination. The actual voltage applied to the circuit, of course, is a radio frequency, and we are not interested in the actual variation of radio-frequency current but only in the amplitude of the

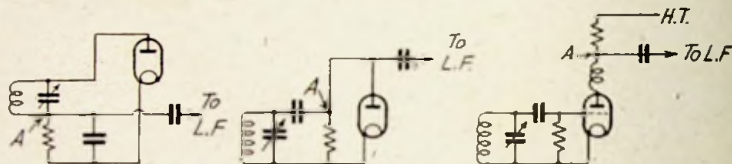

FIG. 76. ILLUSTRATING POINT AT WHICH VOLTAGE SHOULD BE MEASURED

current or voltage developed at different frequencies. We must, therefore, connect some form of valve voltmeter across the circuit which will give a maximum indication when the circuit is in tune and some smaller indication on either side, depending upon the actual value of the voltage.

A simple type of valve voltmeter is a diode, and it is convenient in many instances to use the actual diode detector in the receiver. Fig. 76 illustrates three detector circuits, the first two being diode circuits and the third being a triode grid detector. The input to the oscilloscope must be connected directly to the point *A* in each case, so that it picks up its voltage directly from the diode load, or from the anode circuit of the detector, *without going through any coupling condensers*. This is important because the time constant of the coupling condensers used in the average radio receiver is quite inadequate to sustain the resonance curve for the required length of time.

Let us consider this point in detail. When the time base commences to move the spot across the screen, the frequency of the oscillator begins to change. Conditions would be

adjusted so that the frequency of the oscillator at this point was just outside the normal tuning band of the receiver. As the frequency changes, the voltage developed across the detector rises. This rise in voltage will charge up the coupling condenser and the voltage will be transferred to the tube. As the frequency continues to increase, the voltage continues to rise until the resonance point is reached at which maximum

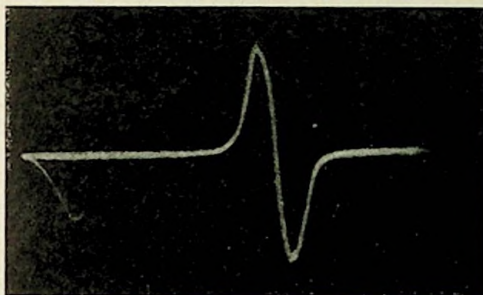

FIG. 77. TYPE OF IMAGE OBTAINED WITH TOO SHORT A TIME CONSTANT

response is obtained. Beyond this point the voltage will begin to fall and we shall finish up at the end of the sweep with zero voltage again (assuming that our frequency variation has been sufficient to sweep over the complete resonance curve).

Suppose, however; that the time constant of the coupling condenser and leak is too short, which means that it is unable to sustain a charge for more than a small fraction of a second. The whole of the time that the voltage is rising the charge on the condenser is leaking away so that the rise in voltage will not be as great as it should be. As soon as the voltage begins to fall this discharge will be helped and a very rapid falling off in voltage will result, actually carrying itself beyond the zero line and finishing up at some point below the correct zero level, after which it will restore itself to zero in its own time giving us a waveform of the type illustrated in Fig. 77,

whereas what we should obtain, and what we do obtain if the time constant of the coupling condenser and leak is sufficient, is a curve of the type shown in Fig. 78.

Actually, the curve of Fig. 77 is a "differential" curve proportional to the slope of the curve of Fig. 78, as is explained in Chapter IX.

The time constants of the coupling condensers in the average set are generally too small to be satisfactory, whereas most

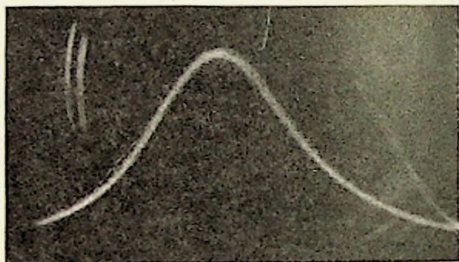

FIG. 78. RESONANCE CURVE WITH CORRECTLY ADJUSTED TIME CONSTANT

oscilloscopes, being intended for use at frequencies of 25 cycles or less, have an adequate time constant. If the curve shows any signs of being like Fig. 77, however, this is the probable cause.

Adjustment of Frequency.

The adjustment of the oscillator feeding the receiver, or conversely the adjustment of the tune of the circuit, must be arranged until the resonance curve appears in the centre of the screen. If the oscillator is not correctly tuned then the varying frequency will not produce any response from the receiver, and the pattern on the tube will simply be a horizontal line. As the tuning is varied, one side of the line will tilt and gradually a resonance curve will appear passing

through the picture and disappearing again the other side. As a rule the adjustment is fairly critical, and the tune must be set so that the curve appears in the middle.

Frequency Sweep.

The actual range of frequency variation has an effect on the shape of the curve. If the frequency band is large then the resonance curve will appear steep and narrow, for obviously if

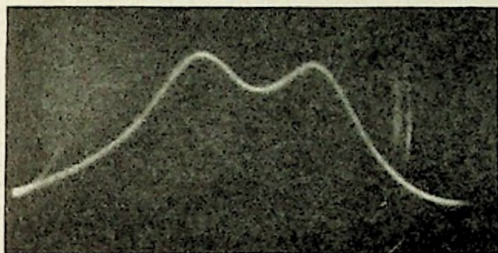

FIG. 79. DOUBLE-HUMP RESONANCE CURVE OBTAINED WITH BAND-PASS FILTER

we have a resonance curve in which the voltage falls nearly to zero, say 10 kilocycles per second each side of resonance (20 kilocycles per second in all), and we apply a frequency sweep of 100 kilocycles per second, the resonance curve itself will only occupy one-fifth of the total width of the tube. As we reduce the sweep (i.e. the frequency sweep, *not* the actual length of travel of the spot across the screen) the resonance curve will occupy a larger proportion of the picture, and, in general, one should arrange the frequency variation to be such as to give an image which just occupies the full width of the screen, as illustrated in Fig. 78.

Fig. 79 illustrates the double-humped curve obtained with a correctly tuned band-pass filter. Both the humps are of the same height and the curve is symmetrical in shape. Fig. 80 shows the effect of mistuning one of the circuits. It will be

seen that one of the humps has slipped right down and is in fact barely visible.

The use of the cathode-ray tube in this way is very convenient in examining experimental circuits and in certain instances the circuit may be merely a hook-up without any detector incorporated. In such circumstances it is necessary to provide a detector connected across the circuit and if, as is usually the case, it is not desired to affect the response

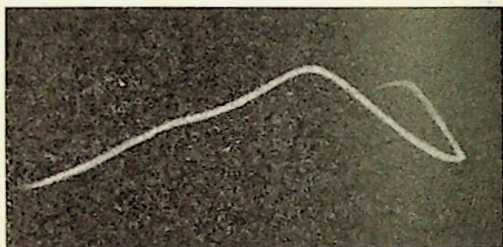

FIG. 80. EFFECT ON FIG. 79 OF MISTUNING ONE OF THE CIRCUITS

seriously, an anode-bend detector may be employed. This would be constructed on the same lines as a simple deflection amplifier, but would be considerably over-biased. In fact, in some oscilloscopes provision is incorporated for inserting an extra cathode-bias resistance of something like 20 000 ohms which over-biases the valve into such a condition that it acts as an anode-bend detector.

Modulated Envelope.

In some cases it is convenient not to use a detector at all, but merely to examine the modulated radio frequency. As explained in Chapter VIII, a radio-frequency oscillation applied to the vertical deflector plates of a tube with a normal audio-frequency time base will just produce a band of light made up of a large number of radio-frequency oscillations very close

together. If we are using a frequency modulator then the height of this band will vary according to the response of the circuit. As we sweep through resonance, in fact, the band will

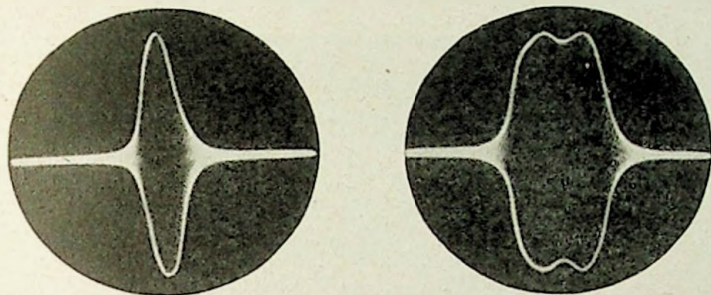

FIG. 81. MODULATED ENVELOPES OBTAINED BY OMITTING DETECTOR

The inside of the envelope is normally bright. In this instance the intensity control has been reduced so that only the edges of the envelope show, these being brighter than the rest of the image

(Mullard Wireless Service Co.)

expand and then contract again, giving what is in effect two resonance curves, one upside down, with the space in between them filled in with light.

For many purposes, a simple arrangement of this character tells us all we want to know and avoids any difficulties due to the introduction of detectors or amplifiers. Since we are dealing with radio frequency the question of time constant hardly arises, for any circuit which is suitable for audio frequency will have a time constant quite adequate for radio frequencies. Moreover, the voltage developed in the circuit, particularly in an actual receiver, is often sufficient to apply direct to

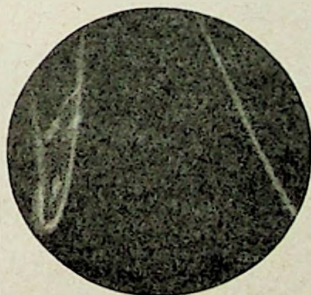

FIG. 82. IF THE AMPLITUDE IS TOO GREAT THE TOP OF THE RESONANCE CURVE WILL BE OFF THE SCREEN

the tube without any amplification. Fig. 81 illustrates two typical examples of a modulated envelope of this type, one for a single circuit and the other for a band-pass circuit.

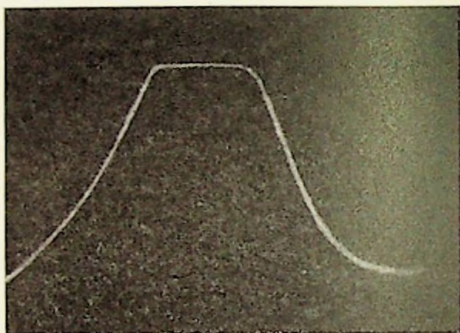

FIG. 83. TOP OF RESONANCE CURVE CUT OFF DUE TO OVERLOADING OF THE DEFLECTION AMPLIFIER IN THE OSCILLOGRAPH

Faults in Frequency Modulators.

There are various defects which can occur with frequency



FIG. 84. PARTIAL RESONANCE CURVE OBTAINED BY USING TOO SMALL A FREQUENCY SWEEP

modulating equipment, some of them arising mainly from unfamiliarity with the effects and some from definite faults. Fig. 82, for example, represents a resonance curve in which

too large an amplitude has been applied to the vertical deflector plates, so that the image has disappeared off the top of the tube. Fig. 83 represents the condition where the amplifier in the oscilloscope is being overloaded. This is a condition which should not occur, of course, but it may do in practice, and the result has been that the top of the resonance curve has been cut off sharply, giving what might at first appear a very desirable resonance curve, whereas actually it is not a correct record of the behaviour of the circuit.

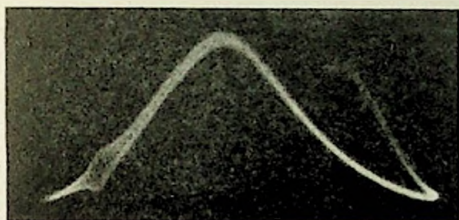

FIG. 85. PARASITIC OSCILLATION ON RESONANCE CURVE

Fig. 84 shows the effect of using too small a sweep. It is actually the resonance curve of Fig. 79 with the frequency sweep reduced to one-third of the value shown in that figure. Therefore the response shown is merely that of the tops of the curve, and while this may be useful for some special examination it is normally valueless.

Fig. 85 shows a parasitic oscillation. This form of disturbance is due to a beating between a harmonic of the oscillator and either the fundamental or a harmonic of the local oscillator in the receiver (which was a superheterodyne). If the frequency modulator is being used to line up a receiver, a parasitic oscillation of this type may be disregarded, and the adjustment of the circuit carried on in the normal way. If one is particularly examining the resonance curve then the simplest remedy is to change the frequency very slightly, when the parasitic oscillation will appear at some other portion of

the frequency spectrum and will not come within the actual resonance curve.

Effect of A.V.C.

When lining up receivers the effect of a.v.c. must be borne in mind. This will limit the amplitude of the voltage developed across the detector circuit, so that all the images obtained will appear to be much the same height, but as more and more

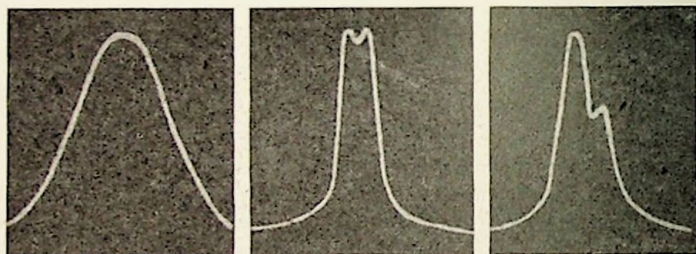

FIG. 86. IMAGES OBTAINED DURING THE PROGRESSIVE LINING UP OF RECEIVER

circuits are introduced they will tend to get narrower. Fig. 86, for example, represents successive images obtained in lining up a receiver. In the left-hand diagram the frequency-modulated input was applied to the grid of the i.f. valve so that only two tuned circuits were in operation prior to the detector, and a fairly broad-topped resonance curve was obtained. The second diagram shows the result when the input was transferred to the grid of the frequency-changer valve which now brings into play the full i.f. amplifier. The height of the curve remains the same due to the action of the a.v.c., but the curve has become very much narrower and more steeply sided, and also the double hump due to the band-pass tuning is now clearly evident. The right-hand curve shows the effect of a misalignment of one of the tuned circuits causing the second hump to slip. It will be noted that this has produced a distinct

broadening of the whole curve, so that not only will the quality suffer but the selectivity will also be impaired. Yet, if this receiver were lined up with a voltmeter or output meter, both these two adjustments would give practically the same reading.

Inverted Images.

It should be noted that the resonance curve may appear upside down. It has already been explained that the cathode-ray tube cannot say which way up a curve is, and it is quite feasible therefore for a curve to appear inverted. The voltage developed across the diode load is negative relative to earth, and if this is passed through an amplifier positive voltages would be developed, which may or may not produce an upward deflection on the tube. If they produce a reversed deflection one remedy is to leave out the amplifier which will automatically invert the image, although this will not give such a large curve.

Reversing the input leads, i.e. the leads connected across diode and earth in the receiver, may be adopted, although this will sometimes introduce hum. If any difficulty is experienced in turning the image the right way up, it is simplest to work with it inverted as the information obtained is just as valid.

Hum.

Mains ripple (hum) is, of course, a source of trouble, as in most oscillograph investigations. If hum is present on the deflection amplifier the image will wobble up and down as explained in the previous chapter, giving either a blurred image if the frequency is well removed from the mains frequency, or a slow and disconcerting up-and-down movement if the sweep frequency happens to be close to that of the mains. This form of hum can be picked up on the input leads, and the deflection amplifier itself may be quite above reproach in this respect. One simple solution of the difficulty is to operate the sweep at mains frequency, when any troubles of this sort will disappear, and in many instances this is the simplest solution,

for the location and removal of ripple can be quite a troublesome business.

The same remarks apply to any hum actually introduced on the frequency-modulator circuit. This can cause very disconcerting effects producing quite unauthorized bulges and depressions on the resonance curve which will all disappear in

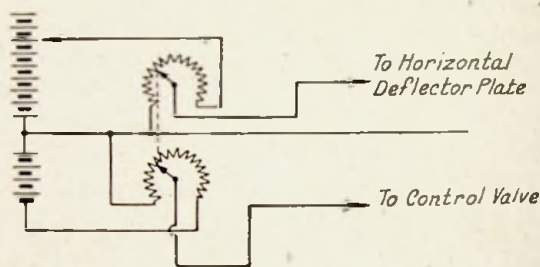

FIG. 87. CIRCUIT FOR LOW-FREQUENCY RESPONSE CURVES

a most satisfactory manner if the sweep is run at 50 cycles per second.

Audio-frequency Curves.

We may conclude the chapter with a brief reference to other forms of frequency response curve. Audio-frequency curves are not so easy to trace, principally because it is impossible to sweep through the frequency range required in a sufficiently rapid time to permit continuous repetition of the sweep as is possible with radio frequencies. It is practicable, however, to use delay screens or alternatively to use a photographic tube and obtain a camera record. The horizontal movement of the spot is linked up with the frequency in the same way as before. For example, a beat-frequency oscillator could be used in which one of the oscillators is capable of frequency modulation.

In this case the modulation would not be a rapid affair, but would be produced by actually varying the bias on the valve with a hand-rotated potentiometer or by using a variable

condenser in parallel with the frequency control condenser of the oscillator. A second potentiometer ganged with the first and drawing supply from a battery would apply voltage to the horizontal deflector plates, so that the spot would take up a position proportional to the frequency.

A suitable detector connected across the output of the amplifier or other device would then record the response at each frequency, and quite satisfactory results can be obtained.

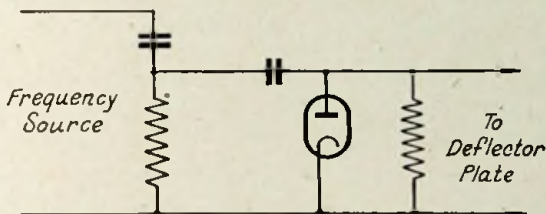

FIG. 88. ELECTRONIC SWEEP CIRCUIT FOR LOW-FREQUENCY RESPONSE CURVE

Using a delay screen one could sweep over the audio-frequency spectrum in perhaps one second, and the afterglow on the screen would then permit the response curve to be examined for a matter of five or six seconds afterwards. If a photograph of the trace is taken then a permanent record of the response will be obtained. Fig. 87 illustrates a typical circuit for a low-frequency response of this type.

A slightly different method of obtaining the horizontal movement of the spot is illustrated in Fig. 88. Here, a frequency modulator in the ordinary sense of the word is not used at all, but merely an ordinary variable oscillator, such as a beat-frequency oscillator or other source of variable frequency. A gliding tone frequency record could, in fact, be used for the purpose. This frequency is applied to the amplifier under examination in the normal way, and it is also applied (through another amplifier if necessary) to a resistance condenser network. The voltage across the condenser will be large

at low frequencies, so that only a small percentage of the total voltage will be developed across the resistance. As the frequency rises the reactance of the condenser falls, and more and more voltage is developed across the resistance.

The voltage across the resistance, therefore, is fed into a diode and develops a d.c. potential which is proportional to the frequency. This potential is applied to the deflector plates of the tube and causes the horizontal deflection. By suitable choice of values of condenser and resistance it is possible to obtain a substantially linear variation of voltage with frequency.

The only requirement is that the reactance of the condenser at the highest frequency involved shall be large compared with the resistance. The voltage across the resistance is

$\frac{R}{(R + 1/j\omega C)}$. If $1/j\omega C$ is large compared with R , this becomes simply $j\omega CR$. Hence the voltage across R is directly proportional to the frequency.

The advantage of this method is that the law of the frequency sources does not matter. Nor is it important how quickly or slowly the frequency is varied, for the movement of the spot is at all instants proportional to the frequency, and therefore a faithful response curve is plotted.

CHAPTER VI

CHARACTERISTIC MEASUREMENTS

THE cathode-ray tube may be used for the tracing of characteristics and diagrams of various types. Any ordinary characteristic is a representation of the manner in which some quantity varies in terms of some other quantity. The primary variable is plotted along the horizontal axis and the unknown

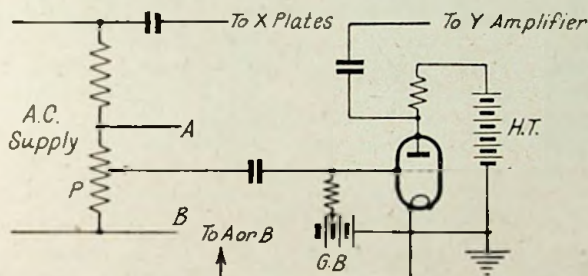

FIG. 89. CIRCUIT FOR TAKING VALVE CHARACTERISTICS

quantity along the vertical axis. Since a cathode-ray tube provides means for moving the spot both horizontally and vertically, it follows that practically any phenomenon which can be represented by a graph or chart can be drawn for us on the cathode-ray tube. The horizontal plates must be supplied with a voltage proportional to the primary variable and the vertical plates supplied from the secondary or unknown quantity.

Valve Curves.

A typical example of this is in the plotting of valve characteristics. The valve is set up in the normal way with suitable d.c. anode and grid voltages. An a.c. voltage is then

introduced in series with the steady supply to whichever electrode is under investigation. The same voltage is applied suitably (amplified or reduced) to the horizontal deflector plates of the tube.

The valve current is conveniently measured by inserting a small resistance in the anode circuit. The voltage developed across this is proportional to the current, and may be fed through a deflection amplifier to the vertical deflector plates. Fig. 89 shows one suitable circuit for plotting the I_a/E_g and I_a/E_a curves of a valve respectively, while Fig. 89 (a) shows an actual characteristic.

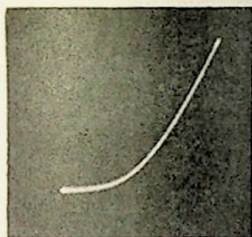

FIG. 89 (a). I_a/E_g CHARACTERISTIC

The method of varying the voltage on the grid or the anode depends on the requirements. Where one is only concerned with grid voltage variations which do

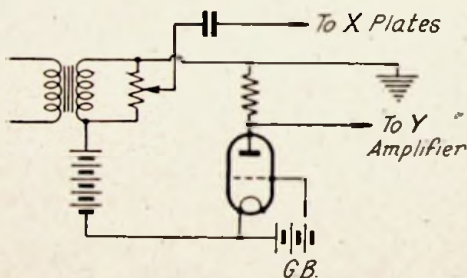

FIG. 90. CIRCUIT FOR I_a/E_a CHARACTERISTICS

not involve any power, a simple time base can be used which will trace out the characteristic on its forward stroke and fly-back very rapidly. The same time base, of course, would be used to feed the tube and this method has the advantage that it obviates the stray loops discussed later.

On the other hand, no power can be taken by this method and a more usual arrangement is to apply the a.c. from the mains and a similar voltage to the horizontal deflector plates. The curve of Fig. 89 (a) was taken by this means.

For I_a/E_a curves power has to be supplied and the circuit

of Fig. 90 may be used. The alternating voltage is fed from the a.c. supply as before, but the voltage to the X plates is fed off a potentiometer across the secondary winding. If it is fed off the primary, the leakage reactance introduces a small phase difference between the voltage applied to the tube and that on the valve, and a looped characteristic will result as explained later. Note also that h.t. + is earthed.

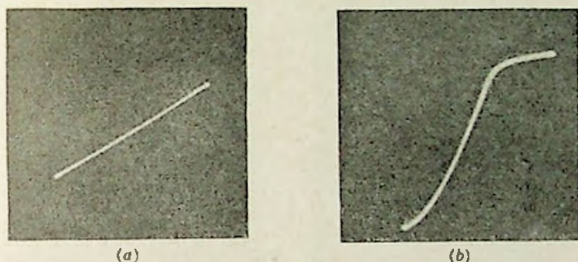

FIG. 91. EFFECTS OF INCORRECT SWEEP

Sweep Voltage.

The a.c. sweep applied to the valve should be variable so that it may be adjusted to the required conditions. For example, when taking an I_a/E_g characteristic, the peak value of the a.c. voltage should equal the grid bias, and at the same time the grid bias should be the normal working value half-way between zero grid bias and the cut-off. Fig. 91 illustrates the effect of incorrect adjustment. In the first example the a.c. sweep is much less than the peak value of the grid bias, so that we are only operating over a small portion of the characteristic giving us merely a diagonal line. In Fig. 91 (b) the sweep is the same as in Fig. 89 but the grid bias is too small, so that we are sweeping well into the grid-current region in one direction, while at the bottom we only just reach the curved portion of the characteristic.

Similar remarks apply to the I_a/E_a characteristic, for the

a.c. sweep should be equal to the h.t. or preferably a little more, since this shows the zero line as indicated in Fig. 92 which represents the characteristic of a tetrode showing the negative resistance or dynatron portion. In Fig. 92 (b) this dynatron section has been expanded by reducing the steady h.t. value and also reducing the a.c. sweep applied to the valve (while leaving the sweep on the tube the same). Hence

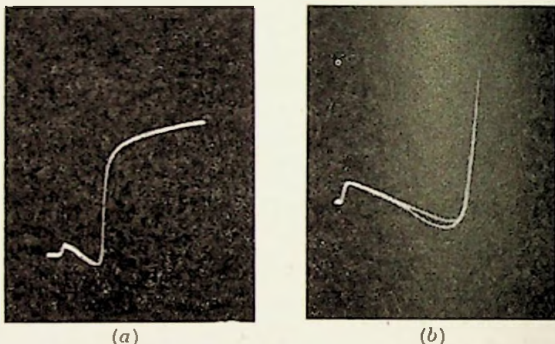

FIG. 92. I_a/E_a CHARACTERISTICS OF TETRODE

the full width of the tube is now occupied by an excursion over a much smaller range of anode voltage, which just includes the dynatron portion but leaves out entirely the normal flat top portion of the characteristic.

In both cases the zero line is indicated by the small horizontal portion at the extreme left of the curve, obtained by making the a.c. peak a little greater than the h.t. voltage so that the valve runs for a small fraction of a cycle with a negative anode voltage. This is very useful as indicating the base line: it shows, for example, that in the case of Fig. 92 the anode current definitely reverses during part of the dynatron characteristic.

The customary self-centring action of the tube must again be remembered, for if the sensitivity of the valve is altered in

any way (as for example by alteration of the screen current) the characteristic on the screen will alter suitably, and it will immediately re-centre itself so that the base line is now farther up or farther down.

Magnetic Deflection.

If this is a serious drawback, an alternative method is to include a pair of magnetic deflecting coils in the anode circuit of the valve and use these to produce the required magnetic deflection. With magnetic deflection, as long as the current in the coil is maintained, the deflection on the screen remains the same, so that the problem of time constant does not affect the result in the same way. It cannot be ignored because the inductance of the deflecting coils causes the current to be slowed up, and therefore if any rapid changes have to be handled the design of the deflecting coil becomes a matter of some difficulty. For operation at 50 cycles, however, or even at audio frequencies, the problem is not very troublesome.

On the other hand, it is important to make sure that the magnetic deflection coils are absolutely correctly located, as any small deviation in the position of the coils will cause distortion of the characteristic. For this reason, the simpler method outlined in Fig. 89 is to be preferred for many purposes.

Direction of Characteristic.

As always, it is necessary to make sure that the voltages are applied to the tube in the correct direction. If the voltage applied to the *X* plates is incorrect then the characteristic will appear as a mirror image, sloping to the left instead of sloping to the right, while if the vertical deflection is reversed, the characteristic will appear upside down. With the circuit of Fig. 89, reversal of the characteristic from side to side may be obtained by connecting the cathode of the valve under test either to *A* or to *B*, as required. If the vertical deflection is upside down, the connections to the *Y* plates should be reversed.

It is, of course, possible to have the characteristic upside down and left to right, in which case it may be slightly puzzling for it will slope the right way, and if there is only a small distortion at each end, it may be difficult to decide what is happening. For example, the curve of Fig. 91 (b) if turned upside down might be a valve "bottom bending" and also running slightly into grid current. The best plan is to operate

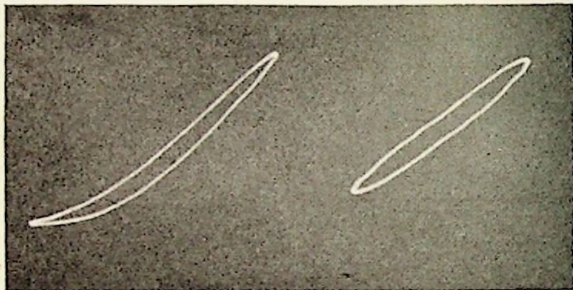

FIG. 93. LOOPED CHARACTERISTICS CAUSED BY PHASE SHIFT

a valve under known conditions, such as deliberate over-bias giving a bottom-bend condition, when the characteristic of the form shown in Fig. 89 (a) should be obtained.

Looped Characteristics.

A more serious source of difficulty with valve characteristics is that of phase loops. The production of phase ellipses is discussed in the next section, from which it will be clear that if there is any phase displacement between the voltage applied to the deflector plates of the tube and the voltage actually developed in the anode circuit of the valve, the go and return paths will not coincide and a looped characteristic such as that of Fig. 93 will be obtained.

This is difficult to avoid, and the only satisfactory remedy is to reduce any possibility of phase shift to the minimum. A

particular form of phase shift is obtained if the valve is driven from a power unit instead of a battery, for the voltage delivered by such a power unit will vary with the current and will actually lag behind the current change slightly, owing to the reservoir action of the condensers in the smoothing system. It can be taken as an axiom that satisfactory characteristics without any loops cannot be shown unless the valve is operated off batteries.

Sometimes it is possible to black-out the return half-wave with a circuit such as that illustrated in Fig. 71 (p. 112), but this is not to be recommended except in special circumstances where appreciable inaccuracy can be tolerated.

Phase Ellipses.

The possibility of making the spot follow different paths on the go and return stroke is often deliberately utilized for measuring the phase angle. If two voltages from the same source are connected to the horizontal and vertical plates of a tube, a diagonal line will appear. When both voltages are zero the spot is central, and as the horizontal voltage increases a corresponding increase in the vertical direction is also obtained, so that the spot will take a diagonal path. With no phase shift between the voltages the pattern is a single line.

If there is any phase difference, however, the spot may reach the end of its horizontal travel before it has finished moving vertically upwards and will therefore start to come back while it is still subject to vertical deflection. When the vertical deflection begins to decrease again the spot will retrace its steps on a slightly different path from that by which it went up, and the result will be an ellipse. A similar ellipse results if the spot begins to move downwards before it has reached the maximum horizontal travel.

The slope of the line or ellipse depends upon the relative values of the voltages. If they are equal the pattern is inclined at an angle of 45° . If the vertical voltage is more than the horizontal, then the pattern is inclined at a steeper angle, while if the vertical voltage is less the pattern becomes flatter.

In any case, the actual phase difference between the voltages can be determined by measuring the distances shown on Fig. 94.

The phase angle is obtained from the relationship $OP/OQ = \sin \phi$. This may be proved as follows. Let the vertical deflecting voltage be $V_1 \sin \omega t$ and the horizontal voltage be $V_2 \sin(\omega t + \phi)$. At the point P the vertical voltage is zero

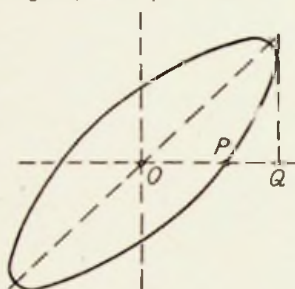

FIG. 94. METHOD OF DETERMINING PHASE ANGLE FROM PHASE ELLIPSE

so that $\sin \omega t = 0$. Hence the horizontal voltage at that instant = $V_2 \sin \phi$, which is represented by OP . The maximum value of the horizontal voltage = V_2 , represented by the maximum horizontal travel OQ . Hence $OP/OQ = \sin \phi$, from which ϕ can at once be determined.

This method may be used to determine the phase angle in various forms of circuit. The phase between current and voltage in a circuit, for example, can be measured by applying the voltage to one pair of plates, and a second voltage proportional to the current (obtained by using the voltage drop on a resistor, amplified if necessary) applied to the other pair of plates. A phase ellipse can also be obtained with magnetic deflection by applying the voltage to the deflector plates and the current to the deflecting coils.

In communications work one often requires to know the phase shift over an amplifier. To do this, a source of voltage of the required frequency is applied to the horizontal deflector plates, the actual voltage being such as to provide a reasonable sweep. A small portion of this voltage is then applied to the input of the amplifier, and the output voltage is applied to the vertical plates. The proportion of voltage applied to the input should be so adjusted that the phase ellipse is approximately at 45° . The phase angle can then be calculated from the ellipse as already explained, and it will usually be found that

at medium frequencies there is no phase shift, while at low and high frequencies an ellipse forms due to phase shift arising from series or shunt capacitances in the amplifier.

The principal source of error in this method is the introduction of phase shift in the potentiometer network employed to apply the voltage to the amplifier in the first place. The resistances used should be such that the input capacitance of the

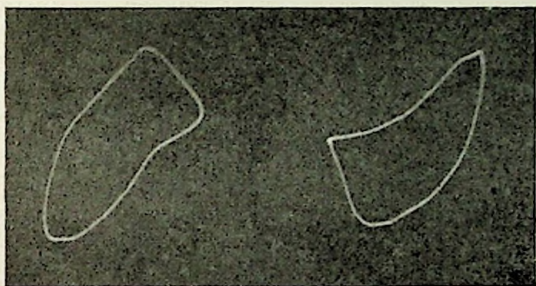

FIG. 95. DISTORTED PHASE ELLIPSES DUE TO VALVE OVERLOADING

amplifier introduces a negligible amount of phase shift (see p. 98). Otherwise, the amplifier may be blamed for something which has actually taken place externally.

It is often helpful to examine a single valve in this manner. A portion of the voltage applied to the X plates would be connected to the input of the valve while the amplified voltage would be connected to the vertical plates. In this way a dynamic valve characteristic would result and this, of course, should be a straight line. Any phase shift present will produce an ellipse, while if there is any amplitude distortion in the valve, one or both ends of the line or ellipse will be curved. A valve which was running into bottom-bend distortion, for example, would produce an ellipse of the type shown in Fig. 93, while Fig. 95 illustrates two cases of distorted phase ellipses obtained with an inductive anode load. That on the left

starts off as a tolerable ellipse though of fairly large eccentricity indicating considerable phase shift. On the right-hand side of the oscillogram, however, it will be seen that serious distortion results, actually due to the valve running into grid current. The second oscillogram of Fig. 95 was obtained with the same inductive load but with the valve running into bottom-bend distortion.

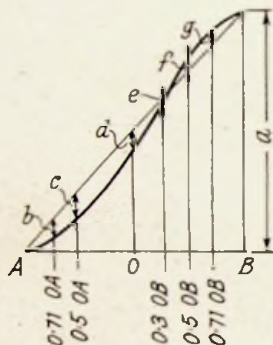

FIG. 96. METHOD OF HARMONIC ANALYSIS USING PHASE LINE

Harmonic Analysis.

It is interesting to note that if there is no phase shift, the waveform applied to the valve need not be pure. If the valve is operating without distortion the pattern on the screen will still be a straight line. Moreover, if distortion is present, the harmonics may be analysed by an ingenious method due to Hutcheson (*Electronics*, January, 1936). The curve on the screen is either carefully traced, or better still photographed, and then a line is drawn from end to end of the curve as shown in Fig. 96. Along the horizontal axis distances are measured off as shown (OA and OB being equal), and the vertical ordinates noted at each of these points when the harmonic content is obtained from the expressions below. Intercepts above the diagonal line are considered positive while those below it are negative.

$$V_1 \text{ (fundamental)} = \frac{a}{2} + V_3 - V_5 + V_7$$

$$V_2 \text{ (second harmonic)} = \frac{f+c}{3} + \frac{d-b-g}{4}$$

$$V_3 \text{ (third harmonic)} = \frac{f-c}{3}$$

$$V_4 \text{ (fourth harmonic)} = \frac{d - b - g}{4}$$

$$V_5 \text{ (fifth harmonic)} = \frac{f - c}{3} + \frac{b - g}{2\sqrt{2}}$$

$$V_6 \text{ (sixth harmonic)} = \frac{d}{2} - V_2$$

The percentage of any harmonic = $100 V_n/V_1$ while the total harmonic content = $\frac{100}{V_1} \sqrt{(V_2^2 + V_3^2 + \dots)}$.

This method, of course, is mainly applied to ordinary valve amplifiers, but it may be used to analyse any form of wave if

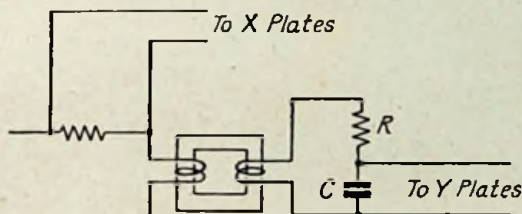

FIG. 97. CIRCUIT FOR TAKING B-H CURVE

a pure wave of the same frequency and phase is applied to the X plates. A simple arrangement is to feed the horizontal plates from the waveform under examination through a low-pass filter tuned to a frequency a little above the fundamental. This will remove any harmonics, and if the filter is correctly designed will not distort the phase of the wave so that a single trace is still obtained.

B-H Curves.

The customary magnetization curves of iron can be reproduced on a cathode-ray screen quite easily. Fig. 97 shows a circuit whereby this can be done. The magnetizing force on

the iron is proportional to the magnetizing current, and therefore the horizontal deflection is made proportional to this. In Fig. 97 this is done by including a resistance in series with the magnetizing coils. The voltage drop across this resistance, amplified if necessary, is applied to the horizontal deflector plates. It is best to insert a $1 \mu\text{F}$. condenser in each lead, since one pole of the mains will be earthed, and if the oscillograph is also earthed a short circuit may result.

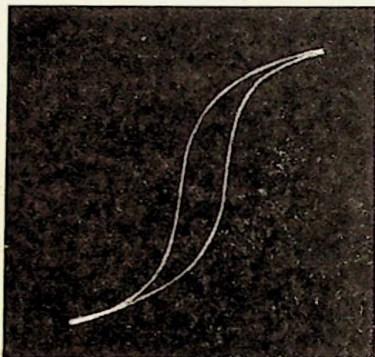

FIG. 98. PHOTOGRAPH OF TYPICAL
B-H CURVE

The flux density is determined by measuring the voltage induced in a secondary winding on the same core. For accuracy this secondary winding should be small and located outside the flux of the magnetizing coil, so that it only responds to the flux actually in the iron circuit. The voltage is, of course, proportional to the rate of change of flux and it is therefore necessary to integrate the voltage in order to obtain

a deflection proportional to B . This can be done by arranging a resistance-condenser network as shown in Fig. 97, the values of this network being determined as explained in Chapter IX.

For demonstration purposes it is often quite satisfactory to use an ordinary transformer, with a resistance in series with the primary, and using the voltage from a suitable secondary winding through a phasing network for the vertical deflection. Fig. 98 represents an actual $B-H$ curve showing the customary hysteresis effect. It should be noted that if the magnetizing force (current) is insufficient to saturate the iron, the curve obtained will simply be a slightly distorted phase ellipse.

CHAPTER VII

FREQUENCY COMPARISON

ANOTHER useful application of the cathode-ray tube in the laboratory is in frequency comparison. We have already seen that if two voltages of the same frequency are applied to the *X* and *Y* plates, the result is either a straight line or an ellipse. The ellipse is produced when there is a phase difference between the voltages, and it will be appreciated, therefore, that if one of the voltages is not quite of the same frequency as the other, it will gradually differ in phase by an increasing amount until it becomes first of all out of phase and finally in phase again, and it will continue to fall in and out of phase like this.

When there is a 90° phase angle between the two voltages, the width of the ellipse is a maximum. Thereafter it decreases in width until, when the waves are exactly out of phase, the diagonal line merely takes up the opposite slope. Therefore as the frequency drifts, the image on the tube will change from a straight line through an ellipse into a straight line at right angles to the original direction, and back again, so that we shall have a continually wobbling ellipse.

As the frequency of one wave is increased relative to the other, this wobble becomes more and more rapid until the pattern becomes confused, but we find that at certain stated points another definite pattern appears. The fundamental ones occur at exact multiples, and there are in fact a series of standard patterns, known as Lissajous figures, with which the cathode-ray worker soon becomes familiar.

Fig. 99 shows a number of these possible patterns, and in each case the pattern has been shown in various forms in which it may appear. Just as in the case when the frequencies are nearly equal and the pattern changes from a diagonal line to a circle or ellipse and back again, so we find that with each

of the other figures the pattern is rarely stationary but is continually changing through the various possible forms. In practice, when one is adjusting the frequency it is necessary to recognize the sort of pattern which is being obtained while

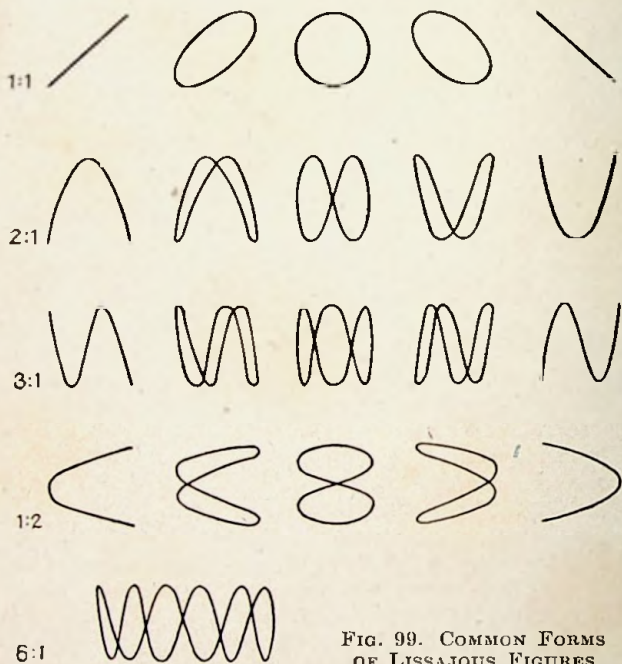

FIG. 99. COMMON FORMS
OF LISSAJOUS FIGURES

it is still moving and then, if necessary, gradually to adjust the frequency until the pattern becomes absolutely stationary. It should be noted, however, that when the pattern is reasonably steady the frequencies are an exact multiple within a few cycles *per minute*, so that the method forms a really accurate basis of comparison.

For anything except small multiples, however, the Lissajous figures tend to become confused. It should be noted that the arrangement can be used for either multiples or sub-multiples, the only effect of a sub-multiple being that the pattern turns on its side. As far as possible the vertical and horizontal amplitudes should be made approximately equal, in which case there will be no difficulty in recognizing either form of pattern. For the sake of clearness the fourth line of Fig. 99 shows a sub-multiple pattern of 1 : 2 which will be seen to be exactly the same as the 2 : 1 pattern turned on its side.

The relative frequencies may be determined by counting the waves, for which purpose the pattern should preferably not be one of the end patterns of Fig. 99, but should show a clear go and return trace. The frequency ratio is then one-half the *total* number of peaks: e.g. in the 6 : 1 pattern at the bottom of Fig. 99 there are 12 peaks.

Time-base Methods.

For the comparison of frequencies where the multiple is large, the use of a time-base method is to be preferred. A normal time base should be used, and it should be synchronized from a source of known frequency such as the 50-cycle mains. Then if, for example, one arranges to have just one waveform on the sweep, the time base can be left running at exactly 50 cycles and held in synchronism by the mains. The wave to be examined is then applied to the vertical plates, and it will show a succession of waves chasing through the screen in a confused jumble. As the frequency is varied, however, the wave pattern will become stationary at a number of points corresponding to exact multiples of the mains frequency, and by counting the number of waves the multiple in question can easily be determined. If there are eight waves, for example, we have the eighth multiple so that the frequency is 400 cycles.

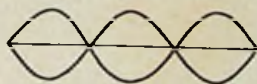

FIG. 100. PATTERN OBTAINED WITH TIME BASE RUNNING AT TWO-THIRDS OF THE WORK FREQUENCY

It should also be noted that it is possible to obtain half-way points where the frequency is midway between two exact multiples, in which case the pattern of the type shown in Fig. 100 results. As a general rule, however, it is desirable to avoid this form of pattern as it is not always possible to say what the frequency ratio is, particularly with the higher multiples.

With this form of frequency measurement the use of some form of double-wave recording is very helpful. It enables the

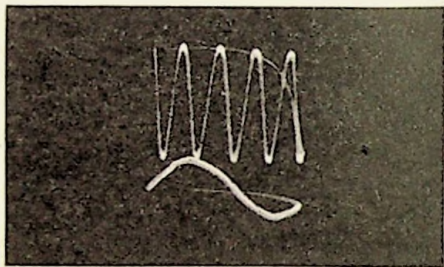

FIG. 101. DOUBLE IMAGE PATTERN SHOWING A WAVE OF FIVE TIMES THE STANDARD FREQUENCY

standard wave always to appear on the screen at the same time as the wave being measured, so that it is always possible to make sure that the time base is synchronized at the correct frequency. It is, however, always possible to run a small monitor tube in parallel with the main tube operating from the same time base but having on its vertical plates the standard wave which can then be kept under permanent observation in the same way. The inexpensive one-inch monitor tubes available to-day are very convenient for such a purpose.

Fig. 101 shows a photograph of a typical frequency comparison trace using the double-wave device mentioned in Chapter IX. The bottom half of the tube depicts the standard frequency, actually showing one complete wave, while at the top we have five waves indicating a ratio of 5 to 1.

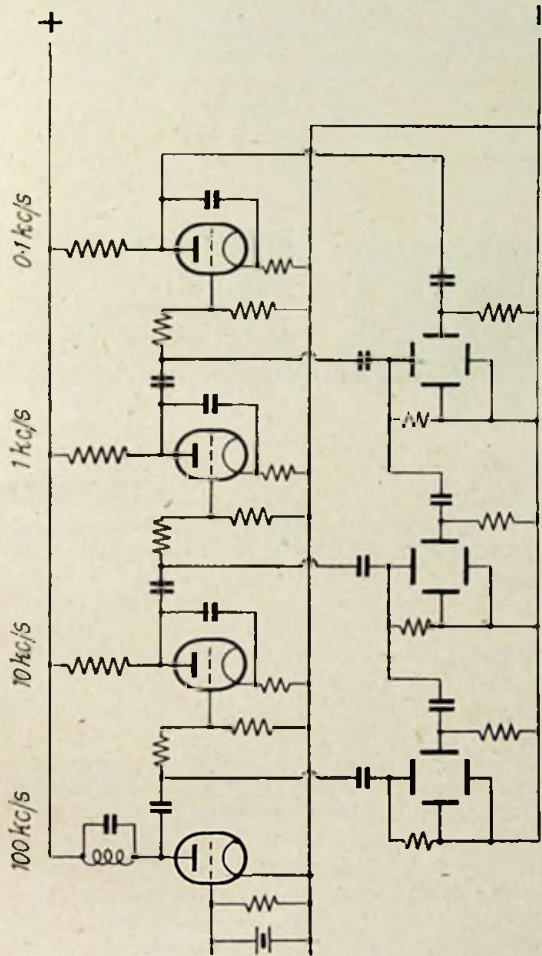

FIG. 102. FREQUENCY STANDARDIZING SET-UP

The standard wave, of course, need not be 50 cycles, nor need it be an audio frequency. It could be obtained from a 1 000 cycle tuning fork, or from a 100 kilocycle crystal. It is not even necessary for the standard wave to be pure, since its only function is to synchronize the time base.

A typical example of the use of a series of cathode-ray tubes in a frequency testing equipment is shown in Fig. 102. Here,

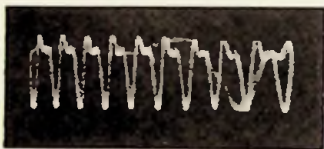

FIG. 103. WAVEFORM OF
100 KC./S. CRYSTAL OSCILLATOR

Note that the fly-back occupies an appreciable time

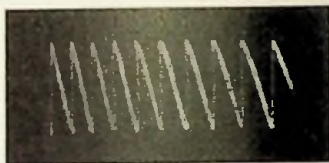

FIG. 104. LINE SCREEN
OBTAINED FROM SUB-MULTIPLE
TIME BASE

a quartz crystal operating at 100 kilocycles per second is used as the primary standard of frequency. This crystal is employed to synchronize a 10-kilocycle time base. The waveform generated by this time base is saw-toothed in form, and is synchronized by impulses from the 100-kilocycle crystal by ordinary technique. This voltage is used for the X sweep of a monitor cathode-ray tube, while the vertical plates are fed with voltage from the crystal, giving us ten complete waves. It should particularly be noted that, at this high frequency, the fly-back is not negligible and that part, if not the whole, of the last wave will probably be occupied in the fly-back. Fig. 103 shows an actual photograph which will make this point clear.

A further time base operating at 1 kilocycle is then set up and synchronized from the 10-kilocycle time base. The 1-kilocycle oscillation is used to feed the horizontal plates of a second monitor tube, while the 10-kilocycle time base feeds the vertical plates. This gives us therefore a saw-tooth

waveform containing ten complete waves. During the vertical portion of the wave the spot is moving very rapidly so that the trace will normally be invisible, giving the impression of ten diagonal lines, as indicated in Fig. 104. The last line (on the right) is cut off in the middle since the fly-back starts at this point.

This process can be continued indefinitely till we reach the time base running at perhaps 50 cycles. This can be compared with the mains frequency, and if necessary used to drive an ordinary synchronous clock, and the time of this clock driven ultimately from the 100-kilocycle crystal can then be compared with Greenwich time.

Although the use of monitor oscillographs is not strictly necessary in this chain, it is possible by their use to see at a glance that each stage is exactly one-tenth the frequency of the preceding stage, by ensuring that there are ten waves on each tube.

CHAPTER VIII

RADIO-FREQUENCY EXAMINATIONS

THE examination of radio-frequency phenomena is less common than audio-frequency investigations. This is partly because the fact that the modern tube will actually look at waveforms at frequencies of a megacycle or more is not always realized, but it is partly because audio-frequency technique covers the greater part of one's requirements.

If it is desired to examine the actual waveform of a radio-frequency oscillation, the technique adopted is exactly the same as that already outlined in Chapter III. It is necessary to use a hard tube and a hard-valve time-base, and the construction of such a time base may require a little thought owing to the fact that the capacitances and resistances will have to be small in order to obtain a sufficiently rapid sweep. The time-base valve should be mounted as close as possible to the tube itself so that short leads are possible, and the self-capacitances of the circuit are thereby reduced to the minimum.

Band Pattern.

It is often possible, however, to obtain some idea as to the behaviour of a radio-frequency wave by using an audio-frequency time base. This will give a band of light rather similar to that illustrated in Fig. 29, p. 43. While the waves are too close together to be distinguished individually it is possible by examination of the band itself to discover whether conditions are satisfactory or not. The waveform of Fig. 29 is, indeed, not a satisfactory one because it shows evidence of bottom-bend distortion. Because of this the individual waves spend a little longer than normal at the bottom of the travel, with the result that the band of light appears slightly brighter at the bottom.

Fig. 105 illustrates this point even more clearly. On the left is a band pattern which is far from uniform in brilliance. With any sine wave of course, the top and bottom of the band must be slightly brighter than the middle section because the spot of light is moving more slowly at these points, but difference in brilliance will be of the same order as that seen in the top of the left-hand oscillogram in Fig. 105. In this

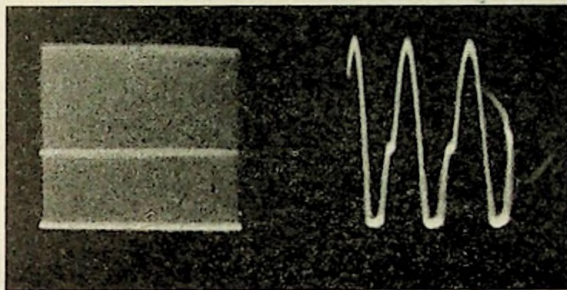

FIG. 105. BAND PATTERN PRODUCED BY RADIO-FREQUENCY WAVE AND OSCILLOGRAM OF WAVEFORM ITSELF

example, however, we have two quite marked horizontal lines across the band, one a little below the middle and the other at the bottom. These indicate distortion, and the trace on the right of Fig. 105 is an actual oscillogram of the radio-frequency waveform which produced this band pattern.

The reason for the bands will now be quite clear. The very bright line at the bottom of the band is due to bottom-bend distortion which is causing the spot to remain in the same position for an appreciable portion of the total time of one wave. The other band across the middle of the picture is produced by a small second harmonic distortion of the type shown in Fig. 37 (top), p. 54, and is again causing the spot to remain at or about the same position for an appreciable period of time.

The presence of distortion in a radio-frequency wave may

therefore be determined by just looking at the band pattern. If it appears of uniform density, except for a slight increase in brilliance at the top and bottom, then the waveform is reasonably pure. The presence of any sharp lines of light indicates distortion, and remedies may be applied accordingly.

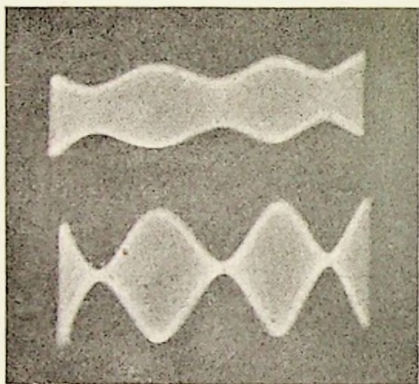

FIG. 106. MODULATION PATTERNS

Modulation.

A good deal of the radio frequency encountered in communications practice is modulated, that is, its amplitude is changing at a low frequency. We are often concerned to find out how this amplitude variation is taking place and whether it is behaving according to theoretical requirements. A simple way of examining it is to apply the radio frequency direct to the deflector plates of the tube, and to set the time base in operation at a suitable sub-multiple of the *modulation* frequency. If this is done a pattern such as Fig. 106 appears, and it is at once possible to determine whether the modulation is satisfactory or not.

In the top oscillogram of Fig. 106 we have a partial modulation, in which the amplitude of the carrier is never reduced to

zero. In the lower oscillogram, however, we have practically complete modulation, the amplitude of the carrier being reduced nearly to zero at each modulation period. This oscillogram indicates a distortion which is often found, namely, that the height of the modulated wave from the centre line to the

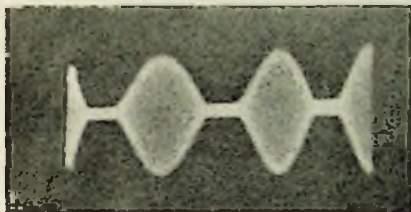

FIG. 107. OVER-MODULATION

top of the wave is not the same as from the centre line to the bottom. This is because the modulator valve is not operating linearly, and is therefore introducing distortion.

The waveform shown in Fig. 106 is, of course, reasonably sinusoidal, but if there is any distortion in the wave this will be shown up accordingly. Fig. 108 shows a typical distorted modulation actually taken from the output of a "service" signal generator.

Fig. 107 illustrates the effect of over-modulation. In this instance the amplitude of the wave is reduced to zero for an appreciable fraction of each period. Comparison of this wave with the bottom wave of Fig. 106 also shows a form of fault which is often obtained in modulated circuits. It will be noted that although the wave of Fig. 107 is over-modulated, indicating that the modulation has been increased beyond its correct value, the amplitude of the high-frequency oscillation is no greater than with the normally modulated wave. Now, the application of modulation to the transmitter should cause the amplitude of the carrier to increase and decrease alternately, whereas what has happened in this case is that the carrier

amplitude has *only been decreased*. This often happens in a badly adjusted transmitter and obviously the power radiated is considerably reduced if the carrier cannot expand as it

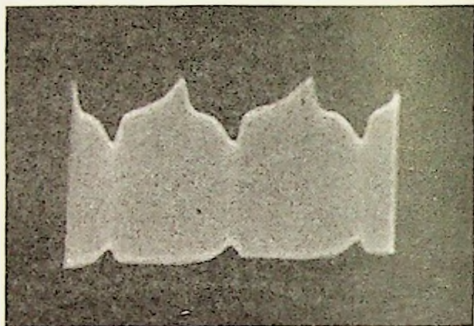
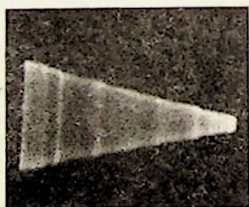
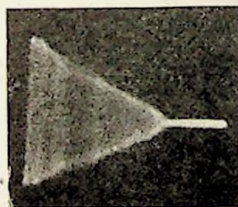

FIG. 108. DISTORTED AND ASYMMETRICAL MODULATION

should do. If the carrier amplitude expands to twice its normal value on the peaks (as it should do on 100 per cent modulation) the peak power radiated is increased four times.



(a)



(b) $\frac{1}{2}$

FIG. 109. ALTERNATIVE FORMS OF MODULATION PATTERN

An alternative form of modulation pattern is that shown in Fig. 109. To obtain this, modulation is applied to the X plates and the modulated radio frequency to the Y plates. Then a

trapezium shaped figure is obtained as shown. With partial modulation the end of the trapezium never reaches the zero line, whereas with over-modulation it falls to zero too soon and finishes off in a straight line as in Fig. 109 (b). The presence of any distortion in the modulated wave is shown by vertical

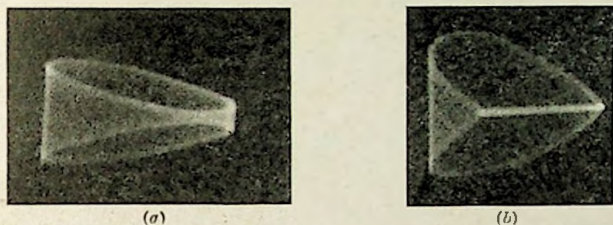

FIG. 110. EFFECT OF PHASE DISTORTION ON MODULATION PATTERN

bands across the pattern, some of which can be seen in the illustration.

A serious form of distortion can occur when taking this type of modulation pattern which is illustrated in Fig. 110. The effect is as if the modulation trapezium were wrapped round a cylinder, and this is due to a phase displacement between the modulation voltage applied to the X plates of the tube and the actual effective modulation of the carrier wave. It usually indicates that some phase shift has occurred during the modulation of the transmitter, and this point may easily be verified.

This form of pattern is inconvenient, particularly if any measurements are to be made. It can, however, be converted to the normal form by correcting the phase either in the transmitter itself or by introducing a phase shifting network on the voltage applied to the X plates.

The percentage modulation can be calculated from any of the patterns shown, by measuring the maximum and minimum vertical height, as illustrated in Fig. 111. The percentage modulation is then $100(a - b)/(a + b)$.

The use of modulation patterns is often convenient in examining the distortion which is produced in the mixing stages of a superheterodyne receiver. Obviously, the mixing

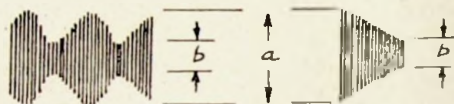

FIG. 111. METHOD OF ESTIMATING MODULATION DEPTH

should be free from distortion, or undesirable harmonics may be introduced. By applying an unmodulated carrier of steady amplitude to the signal grid of the mixer, beats will be obtained between this and the local oscillation, and if these are adjusted to a suitable frequency the modulation pattern can be examined by any of the methods just discussed. The frequency may be a radio frequency if desired, provided the time base on the oscilloscope can be made to operate at a radio frequency and synchronized accordingly.

CHAPTER IX

SPECIAL APPLICATIONS

It is proposed to conclude this brief review of the subject with a reference to some of the more specialized applications of cathode-ray tubes. It will be appreciated that the treatment cannot be in any way exhaustive, but this introduction should serve to indicate the lines of approach to particular problems.

D.C. Circuits.

Quite a common form of usage which has not been discussed in detail is that of circuits in which a d.c. component is present.

Often the current is not continuously in the same direction but maintains a steady amplitude for long periods. The term long is, of course, a relative one, for in the ordinary way we are dealing with oscillations which take place with comparative rapidity—fifty times per second even at mains frequencies and many thousands or millions of times per second at audio or radio frequencies. A second or so is quite a long time judged by such standards.

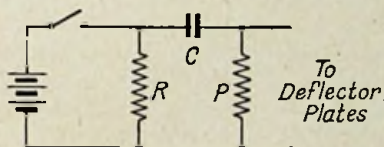

FIG. 112. ILLUSTRATING EFFECT OF TIME CONSTANT

Consider a make-and-break of a battery circuit as shown in Fig. 112. If we can apply the voltage across the resistance R direct to the tube, then the tube will record the make and break without any question, irrespective of how long the current remains steady, for the passage of current will put a permanent d.c. voltage on the deflector plate of the tube, and the spot will be moved from its normal position and will remain in its displaced condition indefinitely.

Quite often, however, it is inconvenient to make a direct

connection to the tube in this manner, and it is necessary to isolate the deflector plates from the voltage under examination with a condenser and a leak, as shown. As soon as this is done the circuit ceases to be a d.c. circuit, and it can only represent d.c. conditions for a limited time.

The application of the d.c. voltage across R to the condenser of Fig. 112 will charge the condenser through the resistance P . This charge will be exponential in character, as already explained in Chapter III. The voltage actually applied to this tube will be the voltage drop caused by the passage of the charging current through the resistance P . At the instant of switching on, the condenser C is a short circuit having no charge and hence presenting no back e.m.f. Hence the voltage across P is the same as that across R .

As the condenser charges up, however, the effective voltage across P is the applied voltage minus the condenser voltage, so that the current falls off, and with it the voltage across P . We could avoid this by using an infinitely large condenser, but in practice, of course, we cannot do this, and we therefore have to arrange that the time constant of the condenser-leak combination is long enough to approximate to the d.c. conditions. In other words, the reduction of the charging current must be negligible over the length of time with which we are concerned, so that the voltage across P remains substantially the same (and equal to the applied voltage).

Fig. 113 shows the waveform of the voltage applied. On the closing of the switch, the voltage on the condenser rises to V . Due to the leak P it then discharges until, after an interval t , the voltage is kV , where k is some fraction—about 0.8 in the diagram. We then open the switch which removes the applied voltage. But removing a voltage of V from the condenser will cause it to charge slightly negative, as shown, by an amount $(1 - k)V$.

This charge will now leak away through P and after time t the percentage loss of voltage will be the same. The actual loss, however, will be much less than before because we started with a smaller voltage.

We then close the key, add V to the voltage, and so on indefinitely, and it will be seen that after a few oscillations a steady state is reached where the charges above and below the zero line are equal. This will always happen with a condenser-leak coupling subjected to asymmetrical oscillations. The d.c. component, in fact, is removed by the coupling.

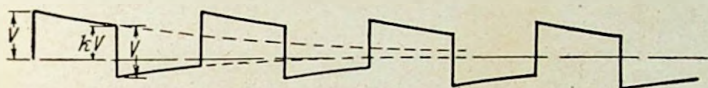

FIG. 113. ILLUSTRATING SELF-CENTRING ACTION OF CONDENSER-RESISTANCE COUPLING

It can be restored, if necessary, by a trick often used in television. A diode is connected across the circuit as shown in Fig. 114 (a). This is so connected as to cause a rapid leakage

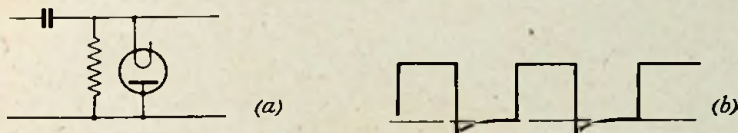

FIG. 114. D.C. RESTORING CIRCUIT AND EFFECT ON WAVEFORM

when the condenser charges negatively so that the positive impulses always start from the zero line as shown in Fig. 114 (b). This device can be very successfully employed in certain cases of pulsating e.m.f.'s, but it will be observed that it introduces a small distortion at the foot of each wave.

It is preferable, therefore, to arrange that the time constant is long enough to avoid any appreciable falling off, which can always be done, provided the voltage does drop to zero or reverse after a period. The factor k , above, is $e^{-t/CR}$, which we can therefore make what we like by suitable choice of C and R .

If k is to be 0.99, $e^{-t/CR} = 0.99$ so that $e^{t/CR} = 1.01$

$$\therefore t/CR = \log_e 1.01 = 0.01$$

Hence $CR = 100 t$, a convenient figure to remember.

For a 10 per cent drop in voltage CR is very nearly $10 t$ (actually $9.5 t$).

Fig. 115 illustrates an actual square-topped wave reproduced on an oscillograph screen with an adequate time constant in the coupling circuit, and it will be seen that the falling off is not noticeable.

Where a steady d.c. is to be handled, and it is not desired to

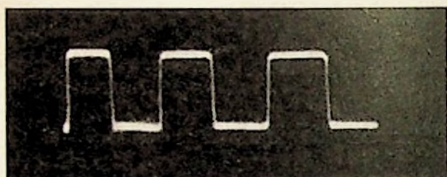

FIG. 115. OSCILLOGRAM OF SQUARE-TOPPED WAVE WITH ADEQUATE TIME CONSTANT

The greater intensity of the horizontal traces is due to the slower movement of the spot over these portions.

use direct connections or magnetic deflection, the voltage may be interrupted with a relay or suitable device at intervals. The interruption need only be momentary—enough to discharge the condenser and reset the operation, as it were.

D.C. Amplifiers.

There are occasions when a true d.c. amplifier is essential. Such an amplifier employs a direct coupling between the anode of one valve and the grid of the next (and a similar direct connection to the deflector plate of the tube). Since this would normally place a high positive potential on the grid of the following valve, it is necessary to raise the cathode to a similar potential, arranging matters so that the cathode is higher in potential than the preceding anode by an amount equal to the grid bias required.

Such a circuit is illustrated in Fig. 116. It will be seen to involve a high value of overall h.t. supply to allow for the progressive stepping-up of the circuits. The arrangement is

very sensitive to small changes of h.t. voltage and valve emission because it depends on an accurate balance of the voltage at various points on the h.t. potentiometer against the voltage drop in the various valves, and in practice the d.c. output voltage is subject to uncontrollable wandering which may be serious.

A form of circuit developed by F. R. Milsom in the author's

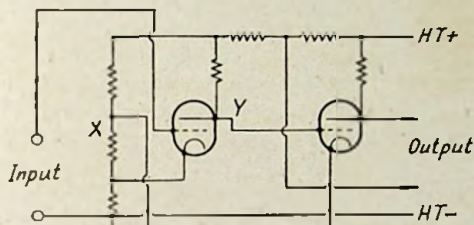

FIG. 116. CONVENTIONAL D.C. AMPLIFIER

laboratories is shown in Fig. 117. Here the voltage at the anode of V_1 is applied to a potentiometer, of which the bottom end is connected to a stabilized source of voltage negative to the earth line. At some point on this potentiometer, therefore,

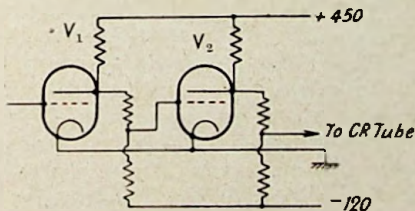

FIG. 117. IMPROVED FORM OF D.C. AMPLIFIER

the voltage will be zero, and if the grid of V_2 is connected to a point just below this (to allow the requisite grid bias), the valve V_2 will operate normally. Only a portion of the voltage developed by V_1 is handed on to V_2 , but the stability of the arrangement more than compensates for this disadvantage.

Compensated Amplifiers.

An alternative method devised by Edwards and Cherry is shown in Fig. 118. As the frequency falls, the shunting action of C_2 across R_2 becomes less and the gain falls off (c.f. the "feedback" type of amplifier in which C_2 is omitted). At the same time the by-passing effect of C_1 falls away so that the effective anode resistance begins to change from R towards $R + R_1$ (the value which will result when $1/C_1\omega$ is infinite), and this tends to restore the gain.

If conditions are correctly chosen the gain can be made to remain the same down to zero frequency. The requirements are that the gain of the stage with C_1 and C_2 omitted shall be equal to that at medium frequencies when R_1 and R_2 are completely by-passed, so that the stage is a normal triode amplifier with anode resistance R .

It remains to arrange a smooth transition between the two states, which is done by making $Z_1/Z_2 = R(g + 1/r_a)$, where g and r_a are the mutual conductance and a.c. resistance of the valve. The compensation thus depends on the valve constants which are liable to vary,

and this constitutes a somewhat serious disadvantage.

With triodes the values of the components to fulfil the required conditions are apt to prove awkward, but better results are obtainable with tetrodes or pentodes, provided the screen potential is held really constant by the use of a neon stabilizer or other device.

If the circuit is applied to more than one stage the adjustment of the valves must be done with extreme care, and the valve constants must be measured (not taken from makers' figures). Otherwise sharp changes of amplification will be obtained at certain frequencies.

For further information the reader should refer to "Amplifier

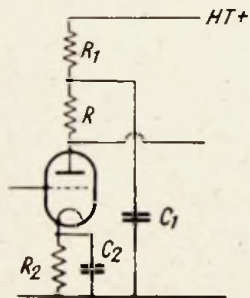

FIG. 118. COMPENSATED AMPLIFIER

Characteristics at Low Frequencies," by G. W. Edwards and E. C. Cherry, *Journal I.E.E.*, 1940, vol. 87, p. 178.

Repeating Transients.

Mention was made in Chapter III of transient phenomena, i.e. phenomena which are not continuously recurring but either take place at regular intervals or only occur once. An example of the repeating transient is to be found in Fig. 119 which shows a parasitic oscillation in a valve amplifying circuit. The valve was being driven positively so that it ran into grid current. As the valve approached zero bias on the grid, the increased efficiency permitted a self-oscillation to be developed in the circuit which, however, was rapidly quenched by the grid current which began to flow at the same time. Therefore we have a burst of high-frequency oscillations at a definite point in the low-frequency cycle of the main oscillation.



FIG. 119. TYPICAL REPEATING TRANSIENT DUE TO PARASITIC OSCILLATION IN VALVE CIRCUITS

This form of transient is quite frequently encountered, and it is best examined by an expanded time base.

Elliptical Time Base.

A normal time base could be used running at the frequency of the low-frequency oscillation and synchronized to it in the normal way. The sweep of this time base, however, must be expanded so that instead of showing one complete wave on the tube it only showed something like one-tenth of the wave which would have the effect of expanding the high-frequency transient oscillation to occupy the full width of the screen.

This method appears a wasteful one, because the spot is off the screen for nine-tenths of the time, but actually this is not the case. The small portion of the wave we wish to examine can only occupy a certain time in its traverse, and we can therefore only obtain a certain amount of brilliance. The fact that we are repeating the trace with every oscillation of

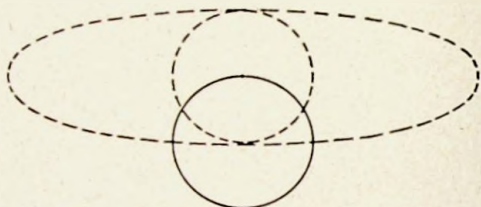

FIG. 120. PRINCIPLE OF ELLIPTICAL TIME BASE

the main wave renders it possible to inspect the transient visually, though it would be necessary to increase the intensity control of the oscillograph over and above the normal setting.

Another form of time base which can be used for this type of investigation is the elliptical time base. For this an ordinary a.c. wave is applied to the horizontal deflector plates, and at the same time a small proportion of this waveform is applied out of phase to the vertical deflector plates. This, therefore, will produce the customary phase ellipse, but we now increase the amplitudes such that the tube screen only occupies a small portion of the total ellipse, as illustrated in Fig. 120.

If the total horizontal scan applied is three to five times as great as that which will just fill the tube, the movement of the spot as it passes over the screen is substantially linear and the arrangement can be used as a time base with success. It is, of course, necessary to have shifts on the vertical deflection because otherwise the trace may miss the tube altogether. The dotted circle of Fig. 120 shows the position of the tube relative to the trace if no shift is provided.

This form of time base cannot be synchronized with the work under examination, but it has its advantages. For

example, if a waveform of the type of Fig. 119 is being investigated, alternating current of the required frequency would be supplied to an elliptical time base and also to the amplifier or other device developing the transient.

The particular part of the wave in which we are interested may, of course, occur anywhere on the phase ellipse and therefore may not appear on the tube itself. We overcome

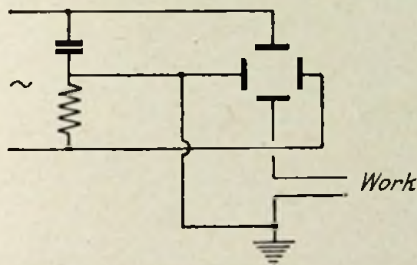

FIG. 121. SIMPLE PHASING CIRCUIT

this difficulty by interposing a phasing arrangement between the source of supply and the input to the amplifier, so that the phase of the work voltage can be varied relative to the voltage applied to the tube, and in this way we can cause the transient to work round the ellipse until it comes on to the screen of the tube.

Fig. 126 shows the method of applying both work and a.c. to the deflecting plate.

Phasing Circuits.

The design of the phasing circuit is simple. If we have a resistance and condenser in series (as in Fig. 121) the phase of the current depends upon the relative value of resistance and reactance. If, at the frequency in question, the reactances are equal we have a 45° phase shift. If the resistance is very much larger than the reactance of the condenser the phase shift is very small while, conversely, if the reactance is large the phase shift approximates to 90° .

Phase shifts of 90° are used in some of the special circuits mentioned for blacking out the return sweep of the spot or for ensuring the correct phase voltage in a $B-H$ curve and so on. Such circuits, embodying a reactance much larger than the resistance also, of course, cause considerable attenuation so that the voltage applied across the phasing circuit has to be at least ten times the voltage actually required.

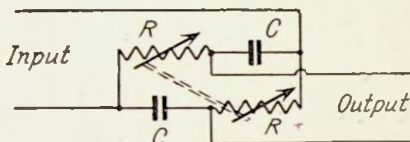

FIG. 122. CIRCUIT GIVING CONTROL OF PHASE INDEPENDENT OF AMPLITUDE

Similarly any change in the circuit alters both phase and amplitude, which is often inconvenient. The phasing bridge of Fig. 122 overcomes both these defects, the output voltage being the same as the input and substantially constant.

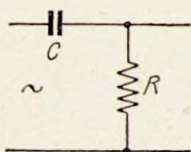

FIG. 123 (a). DIFFERENTIATING CIRCUIT

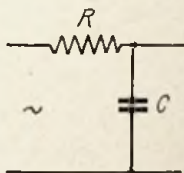

FIG. 123 (b). INTEGRATING CIRCUIT

The two resistances are ganged so that they increase and decrease together and if $R_{max} = 1/C\omega$ the maximum phase shift is 90° . If $R_{max} = 10/C\omega$ a shift of nearly 180° is possible.

These conditions can obviously only hold good over a limited range of frequency. Hence if the frequency is varying provision must be made for changing the capacitances.

Integration and Differentiation.

It should be noted that by the use of circuits of this type it is possible to produce a response which is equal to the integral or differential of the applied waveform. Fig. 123 (a) shows a differentiating circuit in which the voltage across R is proportional to the *rate of change* of the voltage applied. For this to be strictly true the resistance R must be negligible in comparison with the reactance of C at the frequency of the highest (important) harmonic of the input wave.

This may be proved as follows. The charge on the condenser is $q = Cv_c$. The current through the circuit is the rate of change of charge and is Cdv_c/dt , so that the voltage across R is $CRdv_c/dt$. But if R is small, the voltage on the condenser is practically equal to that across the whole circuit, so that the output voltage = $CRdv/dt$ very nearly.

Clearly this stipulation that R is small compared with the reactance of C means that the circuit will attenuate considerably, but this is often offset by the fact that the rate of change is large. Nevertheless an amplifier is usually required following the resistance to provide a satisfactory deflection.

With a pure sine wave R must be small (less than about 10 per cent) compared with $1/C\omega$. The rate of change (differential) wave is then a second sine wave lagging 90° behind the input wave. With a wave having a steep front (such as a synchronizing impulse or a transient) R must be still smaller, for a steep-fronted wave can be analysed into a fundamental and a series of high order harmonics, and the reactance of C to these high harmonics is much less than it is to the fundamental. Generally, R will need to be about one-tenth of the value which would suffice for a sine wave.

Fig. 123 (b) shows an integrating circuit. Here the voltage on the condenser = $q/C = \frac{1}{C} \int idt$. But if the reactance of C is small compared with R (the reverse of the previous condition), $i = v/R$ nearly, so that the voltage across the condenser = $\frac{1}{CR} \int vdt$.

With a sine wave input, making $1/C\omega = 0.1R$, or less, the output voltage is a sine wave leading by nearly 90° . Such a circuit is employed in Fig. 97, p. 141.

Production of Pulses.

These circuits are often used to produce pulses of steep wave-front for triggering time bases or similar devices. If a square-

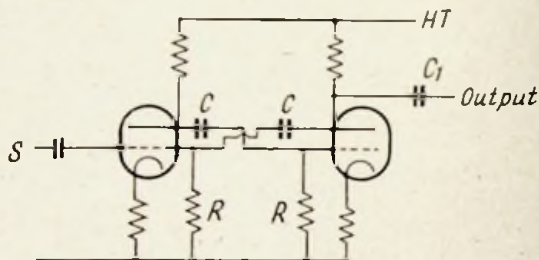

FIG. 124. MULTIVIBRATOR CIRCUIT

topped wave, for example, is applied to a differentiating circuit a very sharp pulse is obtained, because there is a large practically instantaneous rate of change at the beginning and end of each section of the wave, as will be clear from an examination of Fig. 115.

The square-topped wave may be obtained in the first place by applying a normal sine wave to a limiter valve. A tetrode operating with an anode voltage well below the screen volts will act in such a manner. If the grid is run positive the anode current rapidly limits producing a sharp saturation effect, while if the grid is made negative the anode current falls to zero, so that a similar limiting action takes place. By making the peak applied a.c. at least ten times the maximum amplitude of the square wave required, a rapid transition will be obtained. The wave of Fig. 115 was produced in this way.

Another form of pulse generator is the well-known multivibrator shown in Fig. 124. This produces a poor form of

square-topped wave, the frequency being given approximately by $f = \frac{1}{2CR}$. The top is not flat, but is of the form of Fig. 113.

but the use of a small amount of cathode resistance improves the waveform appreciably. If such a wave is differentiated it provides very sharp isolated pulses, and this may be done quite simply by feeding off the anode through a condenser of a few $\mu\mu\text{F}$. only. Similar pulses fed into the grid, as at *S*, will synchronize the circuit over a wide range.

Zigzag Time Bases.

In addition to the elliptical time base

already mentioned a zigzag time base is sometimes employed where one requires to examine the behaviour of a wave over

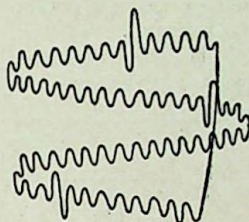

FIG. 125. ZIGZAG TRACE

a long period. If one suspects, for example,

that some effect is occurring at every 200 or 300 waves, the ordinary time base would fail to show it, except perhaps as a momentary blurr occasionally. If we apply an alternating voltage to the horizontal sweep and at the same time a vertical voltage from a slow time base, then

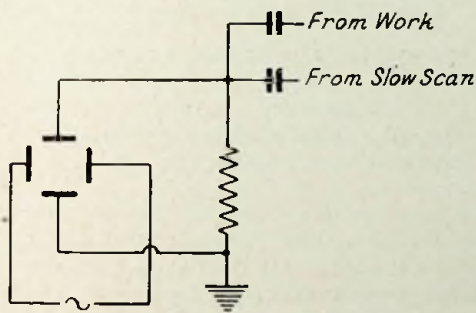

FIG. 126. METHOD OF APPLYING TWO VOLTAGES TO THE SAME DEFLECTOR PLATE

the successive traces across the screen will be displaced from one another and the spot will, in fact, wander backwards and forwards up the screen as illustrated in Fig. 125. We can then superpose in the vertical direction the waveform we wish to

examine; if the speed of the horizontal traverse is slow in comparison with the frequency under test we shall then have a series of waves represented on the zigzag trace, and we can easily cover a prolonged period and so obtain the information we require.

The superposition of the two voltages on the vertical scan may be obtained by using a parallel circuit such as that

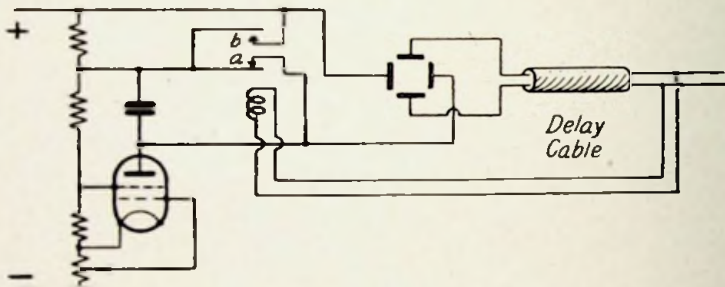

FIG. 127. SINGLE-SWEEP CIRCUIT WITH DELAY CABLE

shown in Fig. 126. An alternative arrangement is to use a magnetic deflection for the slow speed displacement and then to apply the work voltage to the vertical deflector plates in the ordinary manner.

A sinusoidal deflection can be applied by just passing alternating current of the required frequency through the deflecting coils. If a saw-tooth deflection is required, a time base must be used which feeds a deflection amplifier. In the anode circuit of this amplifier we include the deflecting coils. The design of this amplifier is similar to that of an ordinary deflection amplifier except that we are concerned with obtaining a satisfactory current change. The current change will be linear so long as the voltage is linear, and it is customary to use a high voltage and feed through a high resistance in series with the deflecting coils, since with this arrangement it is much easier to obtain the linearity required.

Single-sweep Circuits.

Where a transient is non-repeating it is necessary to use a single-sweep circuit. This is usually set up as a normal time base without the gas relay. The circuit is then started by the act of switching on the circuit in which the transient is developed. Fig. 127 shows a typical arrangement. When voltage is applied to the bus bars on the right the relay operates, removes the short circuit on the time-base condenser,

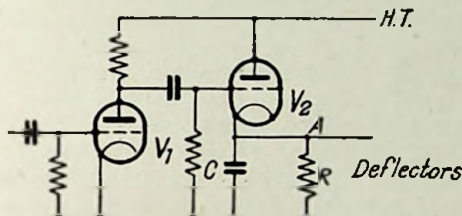

FIG. 128. LANSIL TRANSIENT-OPERATED CIRCUIT

and so starts the scan. The speed of sweep would be adjusted so as to cover the screen in the approximate time which the transient is expected to occupy.

Fig. 127 also incorporates an arrangement to keep the spot off the screen until it is actually required. This is particularly important with photographic operation because the spot brilliance has to be considerably higher than normal in order that there shall be sufficient effect on the plate during the limited travel time. If the spot is stationary during the period when it is waiting for the transient to start, there is considerable risk of burning the screen. In Fig. 127 one of the deflectors is over-biased accordingly. The closing of the relay by the transient opens contact *a*, causing the condenser to start charging, and closes contact *b* which short-circuits the extra bias. The spot thus leaps into position and then moves across the screen at the predetermined rate. Resetting the relay discharges the condenser and restores the bias.

To make sure that the time base is properly in operation

before the transient arrives, the voltage on the vertical deflectors may be applied through several yards of cable which will delay its arrival for a small fraction of a second.

A photographic or delay screen would be used. In the latter case the camera would be set up and focused on the tube face and left with the shutter open. All stray light, of course, must be excluded. Then, when the transient operates the time base, the movement of the spot will be recorded on the plate.

In some instances a mechanical relay is not fast enough, and an equivalent electrical circuit has to be arranged. Fig. 128 shows the basis of a circuit (due to Lansil) for this purpose. The condenser C is normally charged through the valve V_2 at a rate faster than the charge can leak away through R . The condenser C therefore becomes practically fully charged. On the arrival of a transient, which must be in such a direction as to make the grid of V_1 positive, the grid of V_2 is driven negative with the sudden impulse which renders the valve non-conducting. The condenser C then discharges in normal fashion through the resistance R . In place of this resistance, of-course, we may (and customarily do) use a pentode to obtain a linear discharge, while it is also desirable to incorporate some arrangement which holds the discharge in operation once it has started. This may be done by feeding the voltage across the condenser through another valve (not shown) such that, as the voltage at the point A falls, an increasing voltage is applied to the grid of V_1 which maintains the grid of V_2 negative throughout the whole of the discharge. In many instances, however, this can be avoided by using a sufficiently long time-constant on the input network to V_1 .

Velocity Modulation.

When dealing with transient circuits the spot has to move over certain parts of the wave at a very rapid rate and the brilliance of the resulting trace is reduced. Bedford has suggested that this can be overcome by including a differentiating circuit and applying the resulting voltage, suitably amplified if necessary, to the shield of the cathode-ray tube. In this

way the brilliance of the spot can be made inversely proportional to the speed of movement, so that when it is moving fast it is automatically increased in brilliance and reduced again on the slower portions of the trace.

This system may also be used instead of the permanent bias adopted in Fig. 127 for preventing the spot from damaging the screen. It is possible for the brilliance to be practically zero until the transient arrives, and then to increase in value to any desired extent during the actual recording of the phenomenon.

Cathode Follower.

The use of negative feed-back has been referred to in the chapter on deflection amplifiers. A form of feed-back circuit which has considerable application in cathode-ray

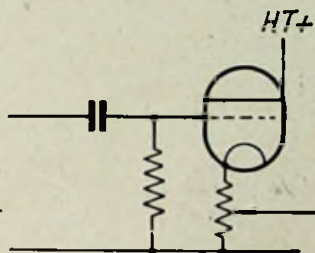

FIG. 129. CATHODE FOLLOWER

work is the cathode follower circuit shown in Fig. 129. This circuit is a development of the arrangement in which the cathode resistance is not by-passed. It has already been explained that with such a circuit negative feed-back is produced, and it will be clear that the amount of feed-back depends upon the relative values of anode and cathode resistance, the larger the cathode resistance the greater being the feed-back.

If this increase in cathode resistance is carried to its limit, we obtain all the resistance in the cathode circuit and none in the anode. Under such conditions the whole of the output volts is fed back so that the feed-back factor becomes 1 and gain of the stage is also 1.

The important feature of the circuit is its impedance-changing property, for the cathode resistor may be made of quite low value, say 1 000 ohms, while the input impedance remains high and can easily be several megohms. Such a circuit is of considerable value in many instances. For example, it is well known that a high resistance potentiometer

is subject to top loss. If the amplifier is made with a cathode follower stage first, its input impedance can be made several megohms, while the control of the gain can be achieved by tapping down the cathode resistance, which, as we have seen, is of quite low value, such that the normal circuit capacitances will have negligible effect.

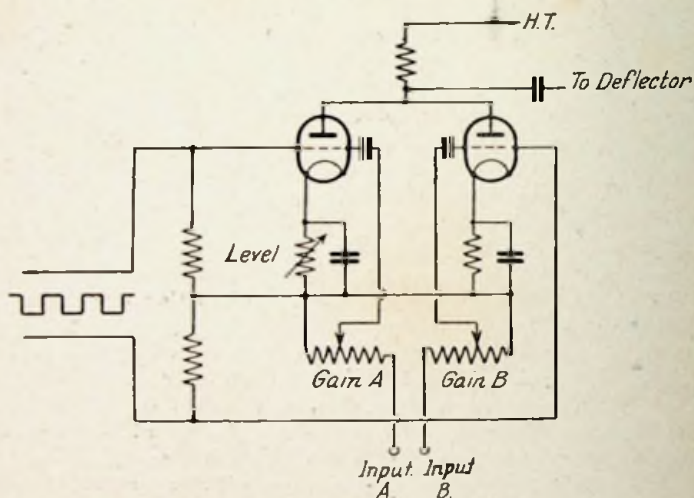

FIG. 130. ELECTRONIC SWITCHING DEVICE

Double-wave Recording.

A useful accessory to the normal oscillograph is a device for showing two waveforms on the screen simultaneously. An early method was to incorporate a relay operated from the time base. This relay changed over the connections of the vertical deflector plates to two amplifiers in turn, so that on the first sweep of the time base the first amplifier was connected, and on the second the other amplifier came into operation. The two amplifiers, therefore, operate in turn, and

if the time base is operating at a sufficiently rapid speed, the visual persistence of the eye enables two traces to be seen on the tube at once.

Fig. 130 illustrates an electrical method. Two amplifiers are employed feeding a common anode resistance, the voltage across which is applied to the deflector plates. The grids of the amplifier valves are supplied with the voltage to be examined from the two different channels, but in addition a square-topped pulse is applied in push-pull fashion, so that as one amplifier receives a positive impulse the other receives a negative impulse. The normal working conditions of the amplifiers are so adjusted that each is normally over-biased. The arrival of a positive impulse puts one of the amplifiers into a normal working condition whereas the other, which receives a negative impulse, is over-biased to such an extent that it ceases to amplify. A fraction of a second later conditions are reversed and a continuous change-over is automatically arranged.

The position of the spot on the screen is therefore determined alternately by each amplifier, and it will therefore trace out two waveforms in a series of small dots. By making the change-over sufficiently rapid relative to the sweep of the time base, a practically continuous curve can be obtained, and the method has the advantage that it is independent of the speed of the time base (subject to the limitation just mentioned) and may actually be used to record transient phenomena.

By altering the steady bias on one of the amplifiers, two waveforms may be displaced vertically so that they may either be superposed as in Fig. 35 (p. 51), or separated as in Fig. 101 (p. 146). Lateral displacement of the waves, however, is not possible and in fact they will retain strict phase relationship, which is a very valuable property. In practice, the arrangement is very flexible, it being possible to vary the amplitude of each trace quite independently by using the gain controls shown.

This simple circuit has several defects and a more practical arrangement, due to F. R. Milsom, is shown in Fig. 131. Here

the switching impulse is applied to a different electrode. A hexode valve is used (actually a triode hexode with the triode section not used). The switching voltage is applied to the triode grid, which is connected internally to the modulator grid. The application of sufficient negative voltage to this grid will render the valve inoperative.

The switching voltage is applied from the split transformer

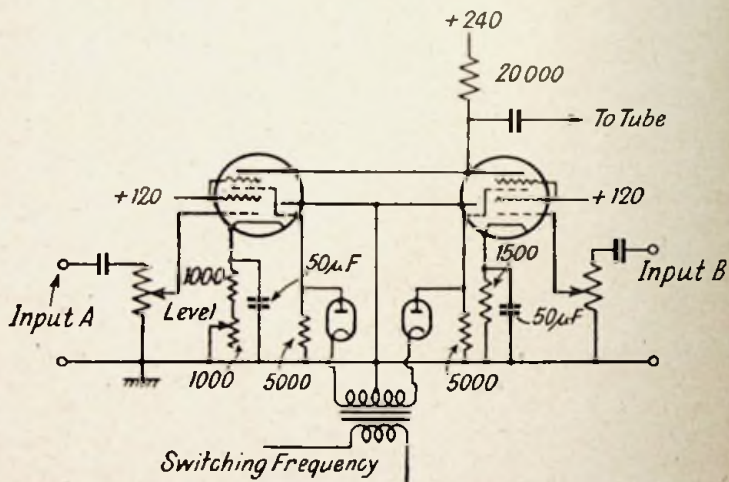

FIG. 131. IMPROVED TYPE OF ELECTRONIC SWITCH

shown through a diode to a 5 000-ohm resistance, and the arrangement is such that current will only flow in such a direction as to make the triode grid negative. At any instant, therefore, one valve will receive negative bias, causing cut off. The other valve will not be affected, because the diode will not pass any current when its cathode is positive, and normal operation will be obtained. The positions are reversed every half-cycle of switching frequency.

The signal input is applied to the signal grid so that the

amplifier exhibits a tetrode characteristic to the signal which is an advantage, and the separation of signal and switching voltages avoids interaction and gives better flexibility. As before, the relative levels are controlled by altering the steady bias on one of the valves.

The waveforms are surrounded by a slight haze due to the rapid movement of the spot during its change-over, but if the circuit is correctly designed this haze is of negligible importance. Satisfactory operation involves making the change-over extremely rapid, which means that the amplifiers have to be capable of handling frequencies greatly in excess of the fundamental change-over frequency, so that a steep-fronted waveform can be satisfactorily amplified. For normal work a change-over speed of 10 to 30 kilocycles is adopted with amplifiers having a response up to 1 megacycle.

Because of this necessity for rapid change-over, the amplifiers should be used immediately prior to the deflector plates, i.e. the output from the switch should not be taken to any further amplifier. Any gain which may be required should be incorporated in the individual channels prior to the switching.

Double Beam Tubes.

Messrs. A. C. Cossor market a double beam tube which has proved useful for many purposes. It is of normal construction, but has in between the *Y* plates a "splitter" plate connected to the anode. The electron beam splits into two at this point and the two beams then pass between the central splitter plate and one or other of the *Y* plates.

These two beams behave independently and voltages applied to the appropriate *Y* plate deflect the beam in the normal manner so that two independent traces appear on the screen. Since the beam had passed between the *X* plates before splitting, both beams are subjected to the same *X* deflection.

The focus is slightly worse than with a single beam tube, and at high frequencies there is some interaction between the

beams, but in general the arrangement works well and has the merit of simplicity. The tube is available separately or in a complete oscilloscope with double amplifier.

Pressure Recording.

An application of the cathode-ray tube which has come to

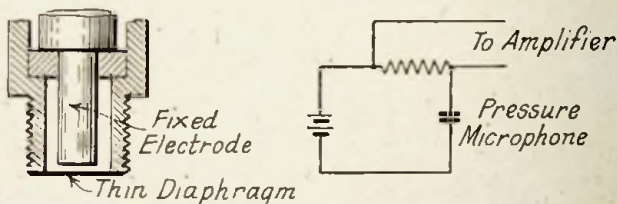

FIG. 132. TYPICAL PRESSURE INDICATOR

the fore in recent years is that of recording explosion pressures in internal combustion engines, or other equipment. It is often of great value to be able to determine the manner in which the pressure in the cylinder changes during the travel of the piston. For this purpose a small head is inserted in the cylinder containing a device which develops an electrical voltage in proportion to the pressure. Quartz crystals have been used for this purpose, as also have carbon rods which change resistance with pressure, or small condenser microphones of the type shown in Fig. 132. The pressure inside the cylinder causes the thin diaphragm to flex, and the change in capacitance causes a corresponding change in the current in the circuit which can be suitably amplified.

Fig. 133 shows two indicator diagrams of this type. That on the left is for an internal combustion engine while that on the right shows the diagram for a steam engine. The horizontal movement of the spot is obtained by a time base of the normal type, synchronized with the rotation of the engine in such a way that it moves once across the screen for one complete travel of the piston.

The engine expert can tell a great deal from these diagrams. With internal combustion engines in particular, the phenomenon known as *pinking* is indicated by a sudden increase in the slope of the curve towards the top. By providing a differentiating circuit, the rate of change of slope can be examined and any sudden increase in the rate of change is at once

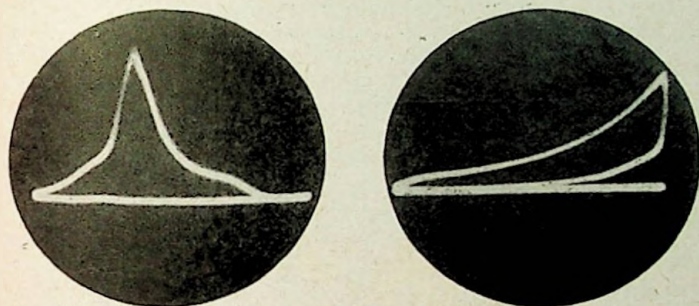

FIG. 133. INDICATOR DIAGRAM FOR INTERNAL COMBUSTION ENGINE (LEFT) AND STEAM ENGINE (RIGHT)
(Mullard Wireless Service Co.)

detected. So definite is this, indeed, that it has been incorporated in the form of a small indicator which gives immediate indication to the pilot of an aircraft if *pinking* is occurring, and he alters his mixture accordingly.

Similar arrangements are used for recording stresses on various parts of machinery, as, for instance, the pressure developed in the punch of a power press, the vibrations in bearings, the strains in propeller blades, etc. Indeed, the field here is extremely wide, but as almost every case is different, detailed discussion is impracticable.

The primary device for picking up the pressure, or responding to the vibration or other movement, varies with the circumstances and is usually determined by mechanical considerations. The amplifier is then designed in accordance with the principles laid down in Chapter IV, with due regard

for the time constant of the phenomenon under investigation. If a high gain is required, the input circuits must be carefully screened to avoid the pick up of interference.

Capacity Micrometers.

Instead of amplifying the voltage direct, the capacity change can be made to mistune a radio-frequency circuit. A form of circuit using this technique is shown in Fig. 134. The circuit

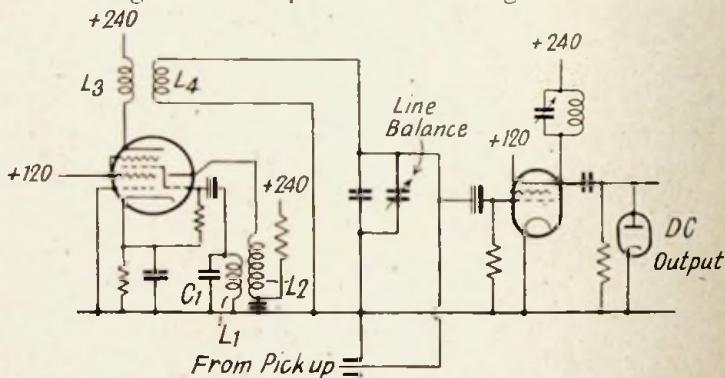

FIG. 134. CAPACITY MICROMETER USING R.F. TECHNIQUE

L_1C_1 is a primary oscillator connected to the grid of a triode hexode, the triode anode being coupled via L_2 in order to maintain continuous oscillation. Amplified voltages appear in the anode circuit and are accepted by the transformer L_3L_4 , of which the secondary is tuned.

The tuning condenser is made up of a fixed capacitance, a variable section and the capacity micrometer (of the type of Fig. 132), connected to the apparatus through a length of cable. The variable condenser serves to tune the whole circuit (including the line capacitance) to a point just off resonance. Any further changes of capacitance (due to the micrometer) will then produce a relatively large change in the voltage across the grid of V_2 , and still greater changes in the anode circuit.

The anode voltage is rectified by a diode giving a steady d.c. potential, the value of which varies in direct proportion (over a limited range) to the small changes in capacitance of the micrometer. Backing-off arrangements (not shown) can be employed to offset the steady d.c. potential leaving only the change to be examined as required.

Photographic Recording.

We may conveniently conclude with a brief reference to the photographing of cathode-ray images. Most of the photographs appearing in this book were taken on steady pattern with an ordinary green willemite screen operating at normal intensity, and using an exposure of about five seconds with an f 4.5 lens. Where conditions permit, this is the most satisfactory arrangement since it enables the focus of the tube to be sharply adjusted and does not involve a high brilliance. External light, of course, must be excluded as far as possible, the camera being set up in front of the oscillograph screen and suitable light shields being erected around it.

The material used was normal high-speed orthochromatic stock nominally of 400 H & D. The exposure time may be considerably shortened by using faster film, and a fast orthochromatic stock is very suitable. The use of panchromatic film does not materially improve the results, and it is of course more difficult to handle in the development.

Where short exposures are essential a blue (photographic) screen should be used. The screen materials here vary with different manufacturers, some being markedly better than others, so that hard and fast rules cannot be given; but a blue screen is very considerably more actinic than a green screen, although to the eye its brilliance may not appear so great.

The actual spot brilliance depends on the anode voltage and the beam current. This is usually higher with a gas focused tube, which is sometimes preferable on this account. Using such a tube with a blue screen and an anode voltage of about 1 000 a particularly intense spot is obtained, enabling satisfactory records to be obtained with exposures of a few milliseconds.

If this does not prove satisfactory then a lens of a wider aperture must be used—with modern technique an aperture of $f\ 4.5$ is no longer considered very large. It is quite easy to obtain lenses having apertures of $f2$ or better without great expense, and with such lenses very short-time transients can be satisfactorily recorded.

Again, owing to the intensely actinic properties of the blue screen normally used for this purpose, there is little advantage in using panchromatic stock. Most manufacturers supply film which is specially sensitive to this blue region of the spectrum, and therefore particularly suitable for cathode-ray recording.

For single-sweep operation it is necessary, of course, to open the shutter of the camera a fraction of a second before the impulse is due to pass and to leave it open until the impulse has passed by. It is therefore particularly important to ensure that no other light is allowed to reach the lens. The illumination from the heaters of any valves must be guarded against in particular, as this is quite sufficient to fog a sensitive film or plate left exposed with a wide aperture lens for several seconds.

Difficulties sometimes arise due to general fluorescence of the cathode-ray tube, even when the spot is deflected off the screen. This is due to stray emission which is not concentrated within the beam, but which may nevertheless cause sufficient intensity on the face of the tube to produce fogging. One remedy for this is to incorporate some circuit for reducing the intensity of the emission (e.g. apply an increased negative bias to the shield) until just prior to the arrival of the transient.

Optical Reduction.

When dealing with high-speed transients appreciable improvement can be obtained by using a small optical reduction, so that the size of the photographic image is less than that on the screen of the tube. If I_1 and I_0 are the intensities of the image and object respectively

$$I_1/I_0 = 1/16f^2(1 + 1/R)^2$$

where f is the aperture and R is the linear reduction ratio. For a given aperture, this ratio obviously increases as R increases, though little improvement results if R is greater than 4, at which point there is an improvement of some $2\frac{1}{2}$ times, as is shown by the following table—

R	1	2	3	4	5	6
$1/(1 + 1/R)^2$	0.25	0.44	0.56	0.64	0.69	0.73

The use of an optical reduction also permits the lens to be mounted closer to the film, which allows the use of smaller physical dimensions, under which conditions apertures of 1.6 or less are not prohibitively expensive.

The ultimate criterion is the actual speed of movement of the spot, and Messrs. A. C. Cossor quote the following figures for the *maximum* writing speed in km./sec. on the tube screen with a 2 : 1 reduction, aperture $f1$ and 1300 volts on the anode. Normal operating speeds would be about one-tenth of these figures

	Selochrome	Ilford FP1	Ilford hyper-pau
D screen (green)	0.02	0.07	0.1
J screen (blue)	4.3	4.3	6.5

Knowing the anticipated size and wave form of the image to be recorded the maximum writing speed may be calculated by simple geometry and appropriate optical arrangements may be made to suit.

Other Applications.

There are numerous other applications which cannot be discussed in detail. Heart beats and nerve impulses have been satisfactorily recorded on the cathode-ray screen; direction finders are in use in which the relative phase of the signals received on two directional aerials at right angles are caused to produce a diagonal line indicating the angle of arrival of the signal; vibrations in machinery due to out-of-balance forces may be observed; echo tones due to reverberation of

buildings can be determined—a principle which can be extended to depth sounding and similar investigations; commutators of generators and motors may be examined for defects during actual running. In fact the use of cathode-ray technique is increasing almost daily.

All these applications utilize the basic principles which have been laid down in the preceding pages, and it is hoped that the information provided will serve as a groundwork which will enable the user to apply this versatile instrument to the solution of any problems which he may encounter.

INDEX

ACTINIC screen, 13
 Afterglow, 13, 127, 177
 Alignment, 18, 25, 35, 43, 126
 Alternator, 49
 Amplified time base, 73
 Amplifier, 87
 — compensation, 162
 —, faults in, 96
 —, overloading of, 78
 Amplitude distortion, 56
 Attenuator, 91
 A.v.c., 126

BALANCED scan, 33
 Band pattern, 43, 98, 151
 Beam, 3, 10
 — current, 6, 8
 — obstruction of, 15
 Brilliance, 3, 16
 B-H curves, 141
 Bulb charge, 41
 Burning of screen, 40

CAPACITY micrometer, 180
 Cathode follower, 93, 173
 Characteristics of c.r. tube, 4
 — of valves, 131
 Charging time, 59, 64
 Colour of image, 12
 Compensation, 86, 100, 105, 162
 Condenser, charging of, 60, 64, 76
 Constant sweep circuit, 111
 Construction of c.r. tube, 2
 Control ratio, 61
 — valve, 109
 Cut off, 4, 36, 43
 Cylinder, 4

D.C. circuits, 157
 — restorer, 159

Deflecting coil, location of, 36
 Deflection, 15, 23
 — amplifiers, 87
 —, direction of, 18, 22, 46, 127,
 136
 —, electrostatic, 17
 —, excessive, 42
 —, magnetic, 22, 38, 136
 Defocusing, 72
 Delay cable, 170
 — screen, 95, 127, 172
 Differentiation, 119, 167
 Distortion, amplitude, 56
 —, bottom bend, 53, 154
 —, grid current, 53
 —, magnetic, 22, 35, 39
 —, origin, 7, 31
 —, trapezium, 10, 33, 72
 Double beam tube, 177
 — image, 117

EARTH screen, 30, 80
 Electron gun, 8
 Electronic modulator, 108
 — sweep, 111, 128
 — switch, 51, 146, 174
 Electrostatic focus, 8
 Elliptical time base, 163

FAULTS in amplifiers, 76
 — in frequency modulators, 124
 — in setting up tube, 40
 — in time base, 76
 Feedback, 100, 173
 Filter, 30
 Firing point, 61
 Fluorescence, 13, 182
 Fluorescent screen, 3, 95, 129, 180
 Flyback, 20, 70, 75, 95
 —, elimination of, 112, 137

- Focusing**, 5, 9, 34
 —, electrostatic, 8
 —, magnetic, 11
Frequency comparison, 143
 — modulation, 107, 114
 — response, 87, 97
 — — — curve, 107, 128
GAIN control, 91
Gas focus, 5
 — relay, 58, 77
HARD tubes, 10
Harmonics, 52, 167
 —, analysis of, 140
Hum, deflection, 84, 103
 —, in frequency modulators, 127
 —, magnetic, 82
 —, time base, 80
INDUCTOR diagram, 179
Image, colour of, 12
 —, inverted, 47, 127, 135
 —, split, 28
Integration, 117, 167
Intensity, 3, 40
Intermodulation, 85, 104
Ionization, 6, 58
Isolation of plates, 27, 40, 45
KILLER, 13
LEAKAGE, 76
Lens, electron, 8
Life of tube, 7, 10
Linearity, 56, 76, 89
Lining up. of receiver, 126
Lissajous figures, 144
Load line, 90, 96
Looped characteristics, 136
MAGNETIC deflection, 22, 38, 135
 — field, estimation of, 24
 — — —, strength of, 37
 — focus, 11
Magnetizing current, 55
Miller effect, 92, 109
Modulated envelope, 122
Modulation, depth of, 156
 — hum, 30
 — pattern, 154
Modulators, 108
Multivibrator, 168
Mumetal, 38
NEGATIVE capacitance, 114
 — feedback, 100, 173
 — inductance, 114
Non-linearity, 58, 76
OBSTRUCTION, 15, 37
Operating point, choice of, 90
Optical reduction, 182
Origin distortion, 7, 31
Oscillation, 17
 —, parasitic, 122, 158
Overloading, 78, 121
PARASITIC oscillation, 125, 163
Pattern, 17, 43, 98, 151
Peak value, 17, 93
Pentode charging, 63
Phase, 50, 53
 — angle, 98
 — ellipse, 137
 — of synchronism, 70
 — shift, 21, 88, 95, 100, 112, 136, 163
Phasing circuits, 165
Photography, 95, 181
Popper, 58
Potentiometer, 30
Power supply, 28
Pressure recording, 178
Pulse synchronism, 71, 168
Push-pull amplifiers, 35, 71
R.M.S. values, 17, 94
Reactor valve, 113
Recording, 181
Reservoir condenser, 28

- Resonance curve, 106, 118
 Response curves, low-frequency, 128
 Ripple, 102

 SATURATED diode, 62
 Saturation, 142
 Scan, 31, 78
 —, balanced, 35, 71
 —, partial, 79
 Screen, burning of, 40
 —, delay, 95, 129
 —, photographic, 95
 Self-centring, 45, 134, 159
 Sensitivity, 4, 7, 10, 16, 33
 —, magnetic, 23
 Shield, 4, 6
 Shifts, 26, 81, 108
 Sine wave, 19, 49
 Single sweep, 171
 Smoothing, 28
 Soft tubes, 6
 Space charge, 32
 Split image, 28
 — plate system, 32
 Spot size, 6, 14, 38
 Square-top wave, 159, 168
 Stray fields, 37
 Sweep, 67, 117, 129, 133
 —, speed of, 64
 Symmetrical deflection, 33
 Synchronism, 20, 65, 145, 168
 —, absence of, 44

 THYRATRON, 58
 Time base, 19, 57
 —, amplified, 71
 —, elliptical, 163
 —, faults in, 76
 —, h.f., 74
 —, incorrect speed of, 43
 —, push-pull, 35, 71
 —, zig-zag, 169
 — constant, 78, 119, 158
 Top loss, 92, 100
 Transients, 13, 20, 57, 94, 163, 171
 Trapezium distortion, 10, 33, 72
 Triggering, 64, 71, 171
 Tube, characteristics of, 4
 —, construction of, 2
 —, power supply to, 28
 —, size of, 14

 VALVE characteristics, 131
 Vector, 49
 Velocity modulation, 172
 Visual persistence, 16

 WAVEFORM, 20
 Willemite, 12
 Work plates, 18
 Writing speed, 7, 183

 YOKE, 25

 ZIG-ZAG time base, 169

EXPERIMENTAL RADIO ENGINEERING

By E. T. A. Rapson. Assisted by E. G. Ackermann.

This book is the outcome of instructional courses for students engaged in the radio industry. Every test described has been performed for the special purpose of the book.

Crown 8vo, cloth. 8s. 6d. net.

DICTIONARY OF ELECTRICAL TERMS

Including Electrical Communication

By S. R. Roget, M.A., A.M.Inst.C.E.

A comprehensive and up-to-date dictionary, covering electric light, power and traction, telegraphy and telephony, radio, and the general science of electricity and magnetism.

Crown 8vo, cloth gilt, 432 pp. 12s. 6d. net.

ELECTRIC CIRCUITS AND WAVE FILTERS

By A. T. Starr, M.A., Ph.D., A.M.I.E.E., A.M.I.R.E.

A text-book for telegraph engineers, wireless engineers, and advanced students who wish to obtain a clear and comprehensive grasp of the fundamental principles of wave filters.

476 pp. 25s. net.

THERMIONIC VALVES IN MODERN RADIO RECEIVERS

A Handbook on Theory and Practice

By Alfred T. Witts, A.M.I.E.E.

An up-to-date book for service engineers, students and keen amateurs, and for all who are engaged in commercial wireless work.

218 pp. 10s. 6d. net.

PUBLISHED BY PITMAN

