

AMPLIFIERS

**THE WHY AND HOW OF
GOOD AMPLIFICATION**

AMPLIFIERS

THE WHY AND HOW OF
GOOD AMPLIFICATION

By

G. A. BRIGGS

Author of "LOUDSPEAKERS; THE WHY AND HOW OF GOOD REPRODUCTION"

"SOUND REPRODUCTION"

"PIANOS, PIANISTS AND SONICS"

and

H. H. GARNER

UNTIL RECENTLY TECHNICAL OFFICER TO THE ESSEX EDUCATION COMMITTEE

..... *but hearing oftentimes*
The still, sad music of humanity,
Nor harsh nor grating, though of ample power
To chasten and subdue.

Wordsworth.



Published by WHARFEDALE WIRELESS WORKS
BRADFORD ROAD · IDLE · BRADFORD, YORKS

FIRST EDITION. MARCH 1952



Copyright
Registered at Stationers' Hall

Made and Printed in England by Tapp & Toothill Ltd. Leeds, London and Johannesburg

CONTENTS

	<i>Page</i>
Acknowledgments, Abbreviations and Symbols	6
Introduction	7
Foreword	8
Chapter 1 Amplifier Quality	9
„ 2 Valve Theory	18
„ 3 Valves, Voltage and Amplification	26
„ 4 The Valve as a Power Amplifier	41
„ 5 Decoupling and Instability	48
„ 6 Push-pull Amplification	57
„ 7 Negative Feedback	63
„ 8 The Cathode Follower	85
„ 9 Phase Splitters	91
„ 10 Tone Compensation	106
„ 11 Pick-up Input Circuits	123
„ 12 Whistle and Scratch Filters	134
„ 13 Microphones and Mixing Circuits	138
„ 14 Power Supplies	152
„ 15 Hum and Noise in Amplifiers	171
„ 16 Measurement of Distortion	178
„ 17 Garner Amplifier	180
„ 18 A Few Questions Answered	193
Conclusion	197
Supplement: Useful Formulæ, Db tables, Reactance tables, Transformer ratios, Loudspeaker Watts	198
Index	203
Garner Amplifier Circuits	207

ACKNOWLEDGMENTS

Our thanks are due to the *Wireless World* and other publications for permission to reproduce diagrams as acknowledged under various Figures. If as a result of two-fold authorship an acknowledgment has been inadvertently overlooked, we offer our apologies here and now to the authors and publishers concerned.

ABBREVIATIONS AND SYMBOLS

C	= Capacitance or Capacity in <i>Farads</i> (Units).
c/s	= Cycles per second.
δ	= Delta = Small change.
EMF	= Electro-motive force—Units <i>Volts</i> .
E or V	= Voltage—Units <i>Volts</i> .
I or i	= Current—Units <i>Amperes</i> .
K or K Ω	= Kilohms, <i>i.e.</i> ohms \times 1,000, or ohms \times 10 ³ .
Kc/s	= Kilocycles per second, <i>i.e.</i> cycles \times 1,000.
L	= Inductance—Units <i>Henries</i> .
m	= Milli (one-thousandth).
mu or μ	= Micro (one-millionth).
mA	= Milliamps, <i>i.e.</i> $\frac{1}{1,000}$ of an ampere or 1 amp \times 10 ⁻³ .
mH	= Millihenries (Henries \times 10 ⁻³).
mV	= Millivolts, <i>i.e.</i> $\frac{1}{1,000}$ of a volt or 1 volt \times 10 ⁻³ .
M or M Ω	= Megohms, <i>i.e.</i> ohms \times 1,000,000 or ohms \times 10 ⁶ .
Mc/s	= Megacycles per second, <i>i.e.</i> cycles \times 1,000,000.
μ A	= Microamps, <i>i.e.</i> $\frac{1}{1,000,000}$ of an amp or 1 amp \times 10 ⁻⁶ .
μ F or Mfd	= Microfarads (Farads \times 10 ⁻⁶).
μ H	= Microhenries (Henries \times 10 ⁻⁶).
μ V	= Microvolts, <i>i.e.</i> $\frac{1}{1,000,000}$ of a volt or 1 volt \times 10 ⁻⁶ .
Ω	= Ohm.
pF	= Picofarads (Farads \times 10 ⁻¹²).
R or r	= Resistance (Units <i>Ohms</i>).
RMS	= Root mean square.
Z	= Impedance.
ω	= $2\pi f$.

ABBREVIATIONS applied to VALVE CIRCUITS

μ	= Amplification factor of a valve.
a	= anode, <i>e.g.</i> r_a = Internal resistance, R_a = Anode resistance.
k	= cathode, <i>e.g.</i> R_k = Cathode resistance.
f	= filament, <i>e.g.</i> V_f = Filament volts.
g	= grid, <i>e.g.</i> V_g = Grid voltage.
	g_1 Control Grid.
	g_2 Screen Grid.
	g_3 Suppressor Grid.
h	= heater, <i>e.g.</i> V_h = Heater volts.
R_L	= Load resistance.
g_m	= Mutual conductance of a valve.

INTRODUCTION

When the second edition of *Sound Reproduction* was published, I sent a copy to Major Garner with the usual gesture of generosity, but in reality fishing for the odd word of praise. He replied in appropriate vein, but added a word of regret that the field of Amplification had not been covered and suggested that there was a gap which might with advantage be filled. I replied that in my opinion he was just the man for the job, and we finally came to the conclusion that we should have to put our heads together and produce a joint effort. The result of our work now makes its appearance.

I naturally do not mind admitting that my colleague has done all the donkey work, but I have also had to work very hard in order to preserve some continuity of style—whether good or bad—throughout the book.

As usual, the main problem has been what to leave out. I have been appalled at the vastness of the subject; an enormous amount of the original copy and scores of diagrams have been jettisoned, much to the chagrin of their hard-worked producers, in order to keep the volume down to a reasonable size and price.

I must acknowledge help from many directions. This is the fourth time that Mr. F. Beaumont, Chief Engineer of Ambassador Radio, Brighthouse, has acted as my technical sub-editor; as he has succeeded in keeping me out of serious trouble, he *must* be good. Major Garner joins me in acknowledging the immense value of the corrections and suggestions which he has contributed to the present work. It is also the fourth occasion on which my old friend F. Keir Dawson has designed the cover and done the drawings. In this case, some of the diagrams have involved the burning of much midnight oil. I think all readers will agree on their general excellence—particularly for an amateur.

Mr. E. M. Price, M.Sc.Tech., has again helped in technical and oscillographic tests, and for final commendation there is my Secretary, Miss E. Isles, who not only transcribes illegible manuscripts but corrects mistakes in grammar at the same time.

G. A. BRIGGS

FOREWORD

This book is intended to supply the missing link between the previous volumes, *Loudspeakers* and *Sound Reproduction*, which described in considerable detail the equipment used before and after the process of amplification. It should furnish ideas for the experimenter so that he may obtain the best result from the amplifier and associated circuits, with his available resources. For those who are blessed with the necessary cash, there are several well-known designs for home construction of amplifiers which give superb results, and commercial amplifiers are now available which are a delight to use and hear. Such readers may well be able to assess and appreciate their equipment all the better after a perusal of this book. Many of us (the writer included) have to think twice before we buy what we want, and if we achieve good results by judicious and economic buying, we are all the more pleased, and value our masterpiece so much more highly. It is hoped, therefore, that the man who "makes one of his own", who is not content to put in 40K and 0.5 mfd just because it says so in the book but wants to know why he does it, will find most of the answers in the following pages.

No doubt this book will be considered by some to insult their intelligence by explaining a circuit in too great detail in words with too few syllables, whereas others may complain that there are too many technicalities; yet it is felt that a good foundation and appreciation of basic principles is necessary to build the finished article. Professional engineers may boggle at some of our short cuts to arrive at a general conclusion, but we plead that the means justify the end—that of giving some guidance and pleasure to the many amateurs striving to build or buy that elusive thing, the perfect reproducer, and to obtain therefrom the maximum performance.

H. H. GARNER

CHAPTER 1

AMPLIFIER QUALITY

The ideal audio amplifying system is, by definition, a device which will give an increased output relative to the input supplied to its terminals, without any additions to or subtractions from the nature of that input.

The first consideration is the avoidance of distortion. Distortion can be classified under a number of headings, and these will be discussed separately as follows :

1. HARMONIC DISTORTION. (The production of harmonics not present in the original.)
2. FREQUENCY DISTORTION. (Unequal amplification of a frequency or band of frequencies.)
3. PHASE DISTORTION. (Phase angle changes with frequency.)
4. SCALE DISTORTION. (Acoustic unbalance due to reproduction at a sound intensity differing from that of the original.)
5. DISTORTION OF TRANSIENTS. (Sudden, sharp sounds becoming muddy and blurred.)
6. INTERMODULATION. (One frequency interacting with another.)
7. SPURIOUS combination tones.
8. MAINS HUM, CIRCUIT and VALVE NOISE.
9. INSTABILITY. (The production of spurious oscillations, continuously or intermittently.)

1. HARMONIC DISTORTION

A harmonic, sometimes called an overtone, is a tone at a frequency which is twice, three times, four or more times that of the original frequency or fundamental. Whilst all musical instruments produce harmonics, an amplifier is capable of introducing harmonics on its own account, and these naturally modify the original tone quality, and may make a Strad violin sound like a one-string fiddle. The critical faculty of the human ear to distinguish harmonic distortion varies, and the only test of high fidelity reproduction is to compare the reproduced with the original sound at the same time, as the "memory" of the ear is most capricious. This is rarely possible, but if a reproducer is to please it must not cause the listener to flinch when a violin is bowed in the

AMPLIFIER QUALITY

upper register. The "wiry" type of reproduction in the so-called wide range reproducer can be attributed to :

- (a) Undue amplification of the high tones.
- (b) The presence of spurious harmonics.

Harmonic distortion is generally worse when a reproducer is working at a level approaching its full output, and whilst the average output power required for ordinary domestic listening is not more than 0.5 watt, this usually sounds better from a so-called 10 watt amplifier than from a 3 watt version of the same standard.

Triodes show a preference for producing even harmonics, pentodes, odd harmonics, but *any* non-linearity in operation, using any valve, can produce combination tones.

As commercial amplifiers are now produced with a total harmonic content of not more than 0.1 per cent., the bogey of distortion from this cause may be said to have been frightened off, and I think we should pay tribute to H. J. Leak for his pioneer work in this particular form of ghost-laying. Pre-war figures accepting limits of 5 per cent. 2nd harmonic and $2\frac{1}{2}$ per cent. 3rd harmonic in high quality amplifiers now appear to be absurd.

The idea that spurious even harmonics are more acceptable than odd ones seems to have arisen because the 7th produces a strong discord with the fundamental, and the 9th is even harsher. This can easily be tested on the nearest piano by playing the overtones of the second C from the bass end, as follows :

Harmonic	1	2	3	4	5	6	7	8
Note	C	C	G	C	E	G	B \flat	C
True Harmonic (c/s)	65.4	130.8	196	261	327	392	458	523
Tempered Scale (c/s)	65.4	130.8	196	261	330	392	466	523
Harmonic	9	10	11	12	13	14	15	16
Note	D	E	F \sharp	G	A	B \flat	B	C
True Harmonic (c/s)	588	654	719	785	850	916	981	1,046
Tempered Scale (c/s)	587	659	740	784	880	932	987	1,046

It will be observed that the first really discordant even harmonic is the 14th, but above the 16th the harmonics crowd more and more closely together, and there is little to choose between them. We can conclude, therefore, that all spurious harmonics are poisonous and affect the timbre of sound, but the even harmonics are a rather slower poison than the odd ones, and the higher they go the worse are the results.

While on the subject, it is interesting to note that the oscillogram of bottom C of a good piano shows traces of 30th harmonic, as in Fig. 1/1.

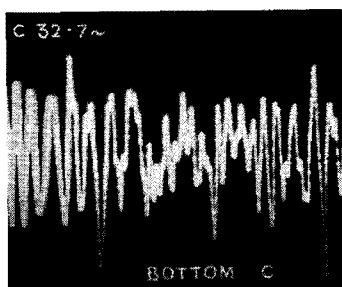

FIG. 1/1.—Oscillogram of piano tone at C 32.7 c/s, showing traces of 30th harmonic.

It is obvious that any harmonic distortion in valves would affect the tone colour of such a note, even if actual harshness were not produced.

2. FREQUENCY DISTORTION

This needs little explanation beyond saying that all frequencies should be amplified so that their relative intensities are as near the original as possible. The production of a continuous boom of bass, so beloved of receiver manufacturers in the days of early moving-coil loudspeakers, is not to be tolerated, whilst undue exaggeration of the sibilants of speech due to high frequency over-emphasis is equally distressing.

3. PHASE DISTORTION

Figure 1/2 shows two voltages in phase, the same two voltages displaced through a phase angle of 180° and also out of phase by 90° . Phase displacement can of course be of any angle, but over 180° the phase displacement is becoming less, until at 360° you are back exactly where you started.

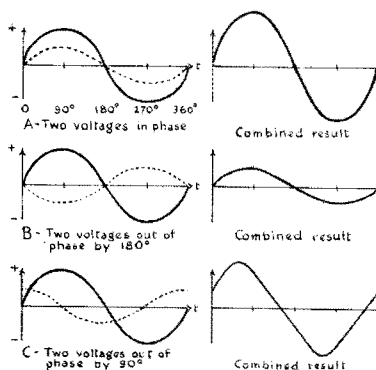

FIG. 1/2.—Diagrams to show voltages in and out of phase, with combined result in each case.

The audible effect of phase shift does not appear to be objectionable, but, contrary to general belief, it is of great importance up to the speaker diaphragm, from a transient point of view. It is now well known that

AMPLIFIER QUALITY

the tone quality of sounds is determined by attack and decay times, as well as by harmonic content. To illustrate this point, we cannot do better than examine the wave envelope of a typical piano note played staccato, if the reader will forgive another reference to this instrument in the first chapter.

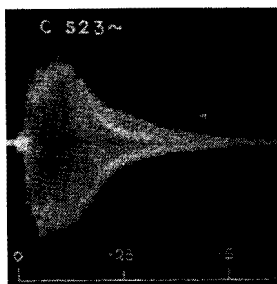

FIG. 1/3.—Wave envelope of piano tone, C 523 c/s as produced under normal domestic room conditions.

From "Pianos, Pianists and Sonics", G. A. Briggs

The steep wavefronts at the start of the note are clearly shown; the fairly exponential decay pattern lasting more than half a second is partly due to the reverberation characteristics of the room. It is an axiom that the steeper the pulse wavefront, the less the phase shift must be. This gives great point to securing good transients, which in turn demands both wide frequency response *and* a small and linear phase shift over the given frequency bandwidth.

Incidentally, there is an explanation here of why conventional bass and treble boost circuits often sound so muddy; it may also explain to some extent why excessive pre-emphasis of high frequencies in recording has such an unfortunate effect on the final tone quality.

In order to remove any impression that the amplifier is the only black sheep in the phase family, let us admit here that a form of phase distortion may be discerned when two loudspeakers in phase are used without a crossover network, and the listener is not positioned equidistant from the speakers. Sound waves having to travel different distances may arrive out of phase and cause varying degrees of cancellation of certain frequencies. The analogy could of course be applied with equal force to many concert halls, where the acoustics are so bad that cancellations from phase effects in certain positions result in the unfortunate concert-goer hearing only about half of the performance. (Such seats should be sold at half-price.)

4. SCALE DISTORTION

The ear is a most deceptive organ, and if the volume level as heard from the loudspeaker is greater or less than the original (as normally heard), then the ear "hears" certain frequencies predominating. For example, at low level the double bass in an orchestra may be practically inaudible, yet at high level it could appear to be over-emphasised

due to no fault of the reproducing system. This is readily overcome by the use of suitable compensation, and for domestic listening at the low level which is nearly always necessary, it is desirable to incorporate bass lift, and possibly some increase in the extreme "top" above 5,000 c/s.

5. DISTORTION OF TRANSIENTS

Sudden, sharp noises of a percussion type may suffer a hangover effect that reduces their clarity and realism. Figure 1/4 shows the idealised waveform of a transient.



FIG. 1/4.—Square Wave.
Note that the changes are extremely rapid, as shown by the vertical edges of the pulse.

A square wave is actually a combination of a large number of sine waves of different frequencies, including the highest.

The next diagram, Fig. 1/5, shows an analysis of a square wave up to the 15th harmonic; but actually the odd and even harmonics extend up to infinite frequency. A first-class amplifier should deal with a square wave without distortion; restriction of the HF response will

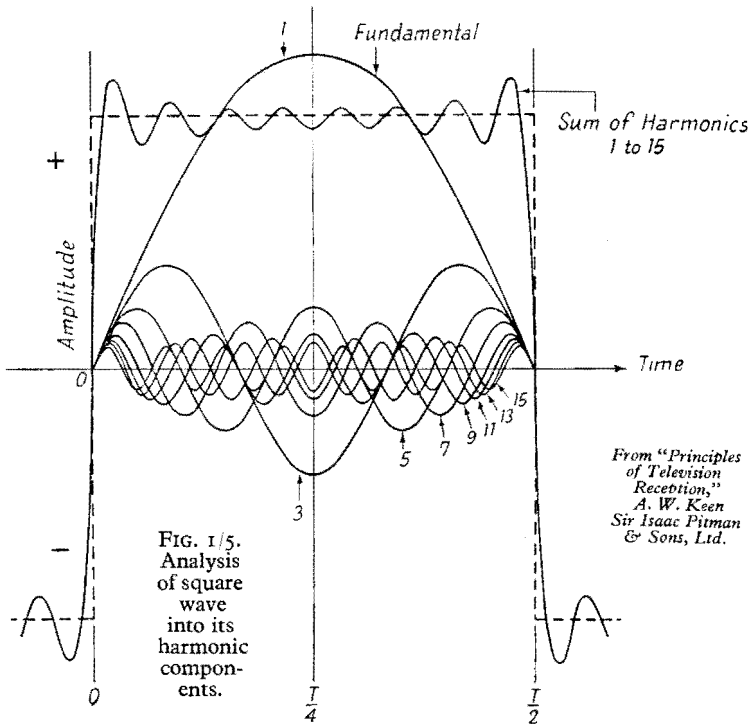

FIG. 1/5. Analysis of square wave into its harmonic components.

AMPLIFIER QUALITY

show up, but this would hardly be classed as distortion where it operates above 20 Kc/s.

As a perfect square wave consists of an infinite number of pure sine waves in the harmonic series, it will be clear that any distortion of these pure sine waves will affect the shape of the square wave. Figure 1/6 shows two forms of distortion which may be produced.



FIG. 1/6.—Distorted Transient Waveforms. The rounding of corners denotes poor HF response.

It is interesting to note at this point that loudspeakers are usually classed as the weakest link in the chain of distortionless reproduction (especially by amplifier makers!). It must be admitted that the strange effects which many loudspeakers produce on square wave input lend some support to this sad criticism. The following diagram, Fig. 1/7,

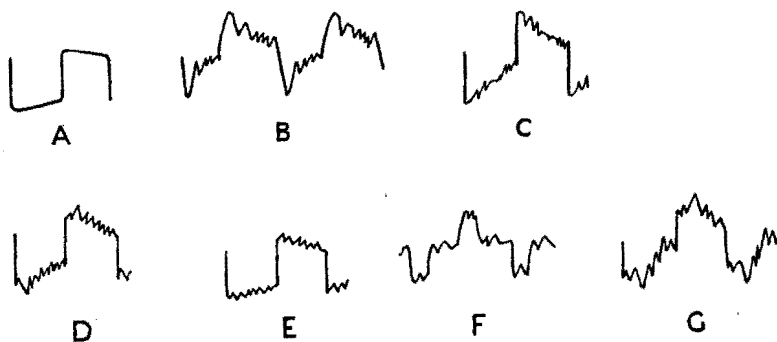

FIG. 1/7.—Transient effects produced on square waves by various types of loudspeaker.

- A. Output from amplifier.
- B. Output from 8-in. speaker 8,000 lines magnet, corrugated cone.
- C. Improved result from 8-in. speaker with 13,000 lines magnet and cloth suspension.
- D. 10-in. speaker, 13,000 lines magnet and heavy one-piece corrugated cone.
- E. Improved result from 10-in. speaker 14,000 lines, heavy one-piece cone with cloth suspension.
- F. 10-in. speaker with rubber compliance in speech coil.
- G. 10-in. speaker with jointed two-piece cone.

shows the effect of stiff suspension, cone resonances, inadequate air-loading, etc., as seen via microphone and oscilloscope.

It is probably very fortunate that the loudspeaker is at the end of the chain, and its output is projected into the air, where its performance is camouflaged by a multitude of room effects and then accepted by the wide tolerance of the average ear.

To return to the amplifier, satisfactory transient reproduction obviously calls for a very wide frequency range. The subject is further dealt with under the discussion of loudspeaker damping.

6. INTERMODULATION

This effect may be observed whilst listening to a violin with an organ accompaniment, the amplitude of the higher frequency sound varying in accordance with the powerful low frequencies of the organ. The effect may be overcome by separating these frequencies in a dual or even treble loudspeaker system, if the intermodulation arises in the speaker.

It is, however, important to remember that in the case in question the distortion would only arise—even in a single speaker—when the powerful low notes were actually producing non-linearity. This is illustrated in Fig. 1/7A, where we have oscillograms of the output of loudspeakers fed from two separate tone sources, as follows:

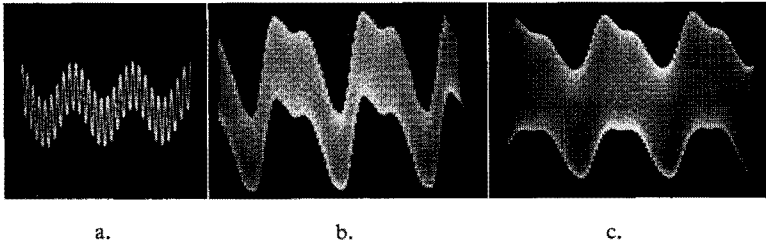

FIG. 1/7A.—Oscillograms to illustrate intermodulation effects produced in loudspeakers.

- (a) Frequencies 82 and 900 c/s produced in one 15-in. speaker without intermodulation.
- (b) Non-linear 62 c/s note from 10-in. unit, with pure tone at 2,500 c/s from 8-in. unit. Reasonably free from intermodulation.
- (c) Treble note of (b) transferred to 10-in. speaker now suffers severe intermodulation from the non-linear 62 c/s note. This is indicated by the difference in outline between top and bottom of trace, and also by general shading effects.

The important point is that the intermodulation in a single speaker is *caused* by non-linearity or overloading.

The same sort of thing can happen in pick-ups and amplifiers. It is quite common practice, especially in America, to measure the intermodulation product of amplifiers, divide by 4, and take the answer as the distortion factor. The following tests with the EMI Intermodulation Test record JH.138, with 60 c/s, and 2,000 c/s at 12 db lower level, and the Garner amplifier described at the end of this book, may throw some light on the problem. Fig. 1/7B shows

AMPLIFIER QUALITY

output from pre-amp and main amplifier with 15 ohms resistive load, and the effect of deliberately overloading the output and increasing distortion by removing NFB.

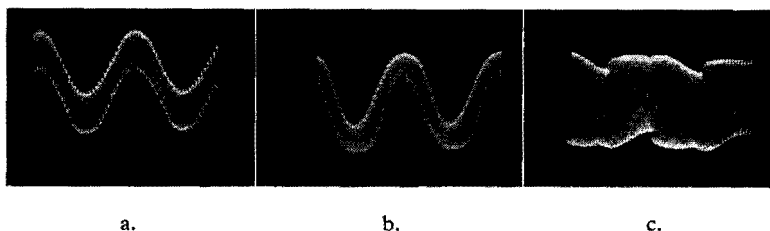

FIG. 1/7B.—Intermodulation test using EMI Record JH.138.

- (a) Output from Garner amplifier at 5 watts with full NFB, linearity is quite good.
- (b) Output increased to 15 watts by reducing NFB. Note onset of non-linearity.
- (c) Output increased to 20 watts with excessive top lift. Severe intermodulation.

The performance at (a) is quite good. Overloading at (c) produces distortion and intermodulation with a shape that looks like the work of one of our modern sculptors, but testing for distortion by intermodulation always strikes the writer as equivalent to testing a man's strength by seeing how much force is required to knock him down.

As intermodulation is a product of distortion or non-linearity, surface noise from a record is intensified by intermodulation products which may be produced by non-linearity in a pick-up, amplifier or loudspeaker. It is claimed that surface noise is lower when a crystal pick-up with absolutely linear movement is used, compared with a type of pick-up which has some degree of non-linear output. The reason is, of course, that the sound waves of music are linear with overtones in the harmonic series, whereas surface noise from a record is absolutely non-linear, which in the musical sense would be severe distortion.

7. SPURIOUS COMBINATION TONES

This effect may be observed when two frequencies are fed into a non-linear system, with the result that in the output there appear, besides the original frequencies, various sum and difference combinations of the originals, their harmonics and their combinations. The number and strength of these combination tones increase as the harmonic distortion percentage increases, and also increase as the *order* of the harmonic increases. It is largely for this reason that insistence

is made on the necessity of avoiding any harmonic distortion like the plague, particularly the higher order odd harmonics, 3rd, 5th and 7th, the 4th and 6th usually being negligibly small.

8. HUM, CIRCUIT AND VALVE NOISE

No amplifier can be considered as high fidelity if there is a constant buzz or hiss present in quiet intervals. In the designs discussed in this volume every hint will be given that may assist in a reduction of self-generated noise.

9. INSTABILITY

This may take the familiar form of "motor-boating", when a plopping noise is heard in the loudspeaker. The more insidious types are of:

- (a) Oscillations that are continuous, but above audibility or even of radio frequency; and
- (b) Oscillations that only take place when triggered off by a sudden transient.

Figure 1/8 illustrates the effect of this type of oscillation on a square wave.



FIG. 1/8.—Effect of oscillations set-up in amplifier by a transient.

These insidious faults are to be suspected in many home-built amplifiers, particularly in those using negative feedback, and as such will be discussed later. It is very necessary to check for condition (a) with an oscilloscope, and for condition (b) with the oscilloscope and a square wave generator.

* * * *

It is not suggested that there is anything new in the foregoing summary of the qualities affecting the design and construction of good amplifiers. The list outlines most of the problems which confront the home constructor; but it is comforting to know that it is now possible to buy first-class amplifiers from reputable makers, which have been competently designed, built and tested.

CHAPTER 2

VALVE THEORY

As this chapter is inserted simply for the benefit of the amateur who is new to the subject, or for the older hand who may have forgotten all the theory he ever knew, let us begin by including a list of the symbols which will be encountered in its perusal.

E or V	=	Volts.	I	=	Current, in amps.	R	=	Resistance.
mA	=	Milli-amps.						
E_a or V_a	=	Anode voltage.						
E_g or V_g	=	Grid voltage.						
I_a	=	Anode current.						
I_g	=	Grid current.						
r_a	=	Anode resistance.						
δ	=	Small change (not necessarily in copper !) (Pronounced delta).						
V_g	=	Grid/Cathode voltage.						
g_m	=	Mutual conductance.						
μ	=	mu, meaning amplification factor.						

The inclusion of this list makes it quite clear that the chapter is not intended for the expert, unless of course he wishes to read it in order to exercise his critical faculties.

* * * *

An artist can make a good picture without studying the chemistry of his paints ; in the same way, a knowledge of the physics of the Thermionic valve is not altogether essential to the investigator primarily concerned with the uses to which it may be put. He can examine, mathematically as well as electrically, the behaviour of a host of circuits, knowing not *why* the valve works, but only *how* it works. In this book our more practical concern is with the outward applications of valves rather than their inward design ; nevertheless, as an appropriate introduction to the study of electronic circuitry, a brief survey of the theory of valve action is thought to be desirable.

1. THERMIONIC EMISSION

It is generally accepted that, if matter is pulverised, broken up and sub-divided into tiny pieces, a point will be reached at which any

further sub-division will destroy the very nature and properties of the substance itself. When this point is reached, we are left with a *molecule* of the substance. Further investigation of a molecule would reveal that it is comprised of atoms, a water molecule being made up of two atoms of hydrogen and one atom of oxygen, or common salt comprising one atom of sodium (a metal) and one atom of chlorine (a gas). The molecules or atoms in a body are not tightly packed together, even in the hardest and most dense substances, and it is perfectly true to say that "iron has pores"—it has, in its inter-atomic spaces. The atom is the smallest part of an element capable of taking part in a chemical reaction. Investigation into the nature of an atom would reveal that it comprises a solar system in miniature. A central core of a fixed quantity of negative and positive charges, together with neutrons and probably other particles, is surrounded by orbital electrons revolving around the nucleus. In certain substances which are known as conductors, some of the electrons in the outer orbits are but loosely attached to their particular solar system, and there is a more or less constant flitting of these electrons across the wide inter-atomic spaces at normal temperatures.

In the absence of an external electric field the velocities of the free electrons have random distribution. No electric displacement occurs in any fixed direction; but if a difference of potential is maintained between two points in a conductor or a semi-conductor, a steady drift of electrons results, flowing from the region of lower towards the region of higher potential. It should be noted here that a battery, in spite of having a plus sign on its positive terminal, is actually deficient in electrons at the positive pole or plate. Therefore, in the *electron sense*, the flow is from the negative to the positive pole. This is very confusing when studying the old and classical text-books on electricity and magnetism which insist that current flows from plus to minus. One could note at this point that an insulator is a substance that has no free electrons which can be readily displaced.

From the foregoing summary it will be seen that the flow of electric current is but the movement or scurrying of electrons within the conductor. If the rate of flow is greatly accelerated, there is such intense activity within the body of the conductor and so many collisions occur between electrons, that heat is generated to the point of incandescence and ultimately volatilisation. At the point of incandescence electrons actually leave the surface of the conductor. If a thin filament of a refractory metal like tungsten is enclosed in an evacuated glass envelope, together with a plate or anode, as in Fig. 2/1, and the plate is given a positive charge relative to the filament, this plate will collect some of the electrons escaping from the surface of the filament and the current will flow in the external circuit back to the filament as indicated by the current measuring instrument.

VALVE THEORY

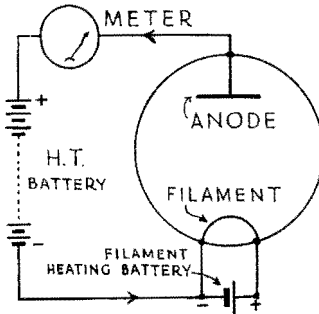

FIG. 2/1.—Simple Diode Valve Circuit.
← Direction of Electron flow.

This emission of electrons is known as Thermionic Emission, and is the basic principle underlying the construction of practically all modern valves, the invention being due to an Englishman by the name of Fleming. The word "valve" is a mechanical term which implies that gases or liquids can only flow through it in one direction, just as the valve of a cycle tyre will allow air to pass into the tube but not out again. The simple circuit just described can be justly termed "valve" because it is only when the anode is positively charged by the external battery that electrons will be attracted to it. If the anode is charged negatively with respect to the filament, electrons will be repelled and thus no current will flow in the external circuit. The device outlined is termed a "diode". The filament, or more accurately the cathode, could well be, and was in early types of valves, a thin tungsten wire, but tungsten is quite a poor emitter, and the fact that it will only emit when its temperature is brought up to white heat is a disadvantage in two ways. It is wasteful of battery power, and the heat rapidly causes the metal to become crystalline and so extremely fragile.

FILAMENT COATING

Methods were sought to overcome these disadvantages and it was found that the addition of a very small quantity of the metal thorium greatly improved the thermionic emission efficiency and such filaments only required to be heated to yellow heat. These valves were then styled dull emitters as distinct from those with filaments operating at incandescence and styled bright emitters.

Further investigation to improve the efficiency revealed that coating a filament with a mixture of strontium and barium oxides produced higher emission at an even lower temperature, and these are the types commonly used in the modern valve.

MAINS VALVES

The demand for "all mains" sets rapidly called for a valve whose cathode could be heated by using a low voltage AC source readily

obtained from a step-down transformer. However, the 50 cycle current caused the emission to be varied at 100 times a second when the AC current was at its minimum, due to the low thermal capacity of the filament. This defect was overcome by making the cathode a nickel cylinder coated with emitting material. The whole system was heated by a reasonably high wattage heater wire, the economy of current not being so important as when storage batteries were used. This type of cathode is known as the indirectly heated cathode and serves exactly the same function as the thin filament. Fig. 2/2 shows the schematic for an indirectly heated valve.

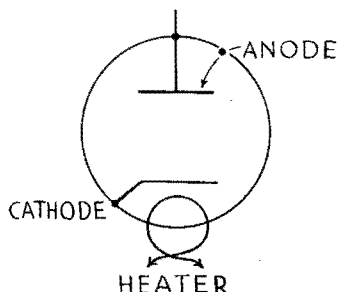

FIG. 2/2.—Schematic of indirectly heated Diode Valve.

Typical directly heated valves consume 50 mA at 1.4 volts, 50 mA at 2 volts and a few legacies 1 amp at 4 volts. Typical indirectly heated types operate with 4 volts .65 to 1 amp, 6.3 volts .3 to .9 amps, 12 volts .15 amps, etc.

THE DIODE

Referring again to Fig. 2/1, if the voltage applied between anode and cathode is steadily increased and the current readings are plotted on a graph, a curve will be produced as shown in Fig. 2/3. It will

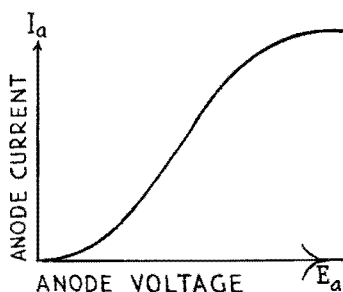

FIG. 2/3.—Typical voltage/current curve of Diode Valve.

be seen that at low anode voltages the current increases but slowly. Then, as the anode is made more positive, the electron current grows rapidly, then less rapidly, and finally remains constant. Any further

VALVE THEORY

increase in anode voltage produces practically no corresponding increase in current. At this point the electron current is said to be saturated. The actual value of current at which saturation takes place depends on the temperature of the cathode (for a given emitting material) and the electron capacity of the cathode surface. Any attempt at increasing the value of anode current beyond saturation by applying an excessively high anode voltage will most likely result in the destruction of the cathode. The initial knee on the curve is due to the electric field which surrounds the cathode, and contains a large quantity of negative electrons called a "space charge". Sufficient force must be applied to overcome this tendency to form a traffic jam at and near the cathode surface.

The resistance offered to the flow of the anode current is commonly known as the anode impedance, or internal resistance of the valve, and this depends upon the anode voltage and the relative geometrical dispositions of the anode and cathode. From the curve in Fig. 2/3, it will be seen that the relationship is never quite linear, although for the higher anode voltages it becomes very nearly so. We cannot, therefore, apply Ohm's law to arrive at the internal resistance of a valve; this can only be determined by taking the ratio of a very small change in anode voltage to the resulting very small change in anode current. This is expressed mathematically as $\frac{\delta E_a}{\delta I_a}$, δ (pronounced delta) being the mathematical term for a very small change. E_a of course means anode voltage and I_a = anode current.

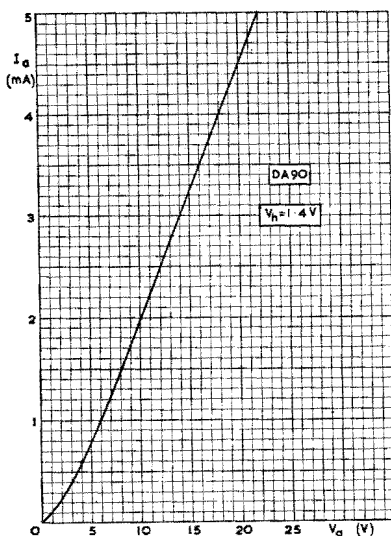

FIG. 2/4.—Anode Characteristic of Mullard DA90 Diode Valve.

Reference to Fig. 2/4 for a Mullard DA90 valve having a 1.4 volt heater consuming 0.15 ampere will show that for a change from 10 to 15 volts on the anode a current change from 2 to 3.2 mA takes place.

Therefore, the anode impedance of this valve would be $\frac{5}{3.2 - 2 \text{ mA}} = \frac{5 \times 1,000}{1.2}$ ohms (expressed in basic units of volts and amperes) = 4,166 ohms.

3. THE TRIODE

If a wire mesh grid is interposed between cathode and anode as shown schematically in Fig. 2/5, we have what is called a triode valve.

FIG. 2/5.—Schematic of Triode Valve.

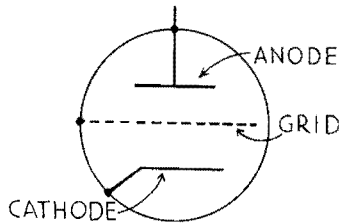

This fine mesh grid is in the electron path between cathode and anode, and if it is given an increasingly negative charge the electrons will be progressively repelled until no more electrons can reach the anode, this point being known as cut-off. Fig. 2/6 shows the action

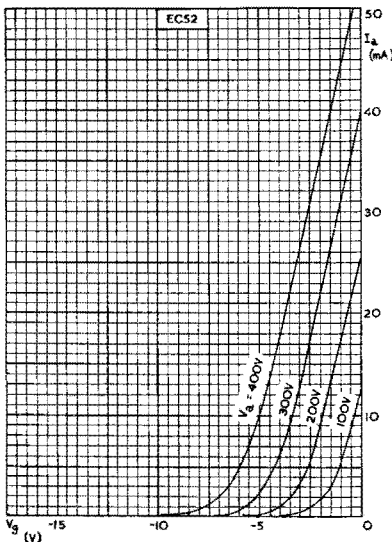

FIG. 2/6.—Grid Characteristic of Mullard EC52 Triode.

graphically in the characteristic curve of a Mullard type EC52 valve. It will be seen that with a constant anode voltage of 300 volts, the application of 7 volts negative to the grid will completely cut off the flow of anode current. Even with the anode voltage increased to 400 volts, the grid is capable of cutting off anode current when made 10 volts negative. Fig. 2/7 shows a family of anode characteristics for various values of grid volts, with a shape very similar to that of the diode, except that these curves are not taken up to the point of saturation, otherwise the valve would be damaged.

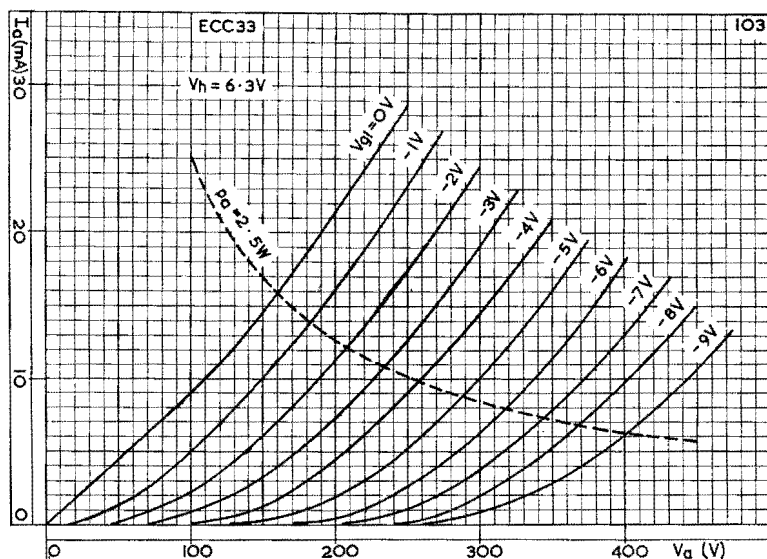

FIG. 2/7.—Anode Characteristic of Mullard ECC33.

A dotted line indicates where the wattage dissipated at the anode as heat imposes a limit to the anode current.

The anode resistance of this triode valve with zero grid volts ($V_g = 0$), calculated exactly as in the case of the diode, is as follows :

$$\frac{\delta E_a}{\delta I_a} = \frac{150 - 100}{14.5 - 9} = \frac{50 \times 1,000 \text{ (ohms)}}{5.5} = 9,000 \text{ ohms.}$$

From Fig. 2/7, which is known as the anode characteristic of the valve, it can be seen that with the anode voltage at 200 volts and the grid at minus 2 volts, 11 mA of anode current will flow. Increasing the grid voltage to -3 volts reduces the anode current to 7.25 mA. This relationship shows that for 1 volt change on the grid there would be 3.75 mA change in anode current. This is known as the mutual

conductance and is expressed in mA/V. In this case the valve has a mutual conductance of 3.75 mA/V.

One further relationship can be established from the family of curves shown in Fig. 2/7. With the grid at -2 volts and anode volts at 190, the anode current is 10 mA. Increasing the grid voltage (E_g) to -3 volts with the anode still 190, the anode current falls to 6.3 mA. To restore the anode current to 10 mA the anode volts would have to be increased to 225 volts. Thus a 1 volt change on the grid is equal to changing the anode volts by 35. This measure of the effectiveness of the grid compared with the anode in controlling anode current is the amplification factor of the valve, in this case $\frac{\delta E_a}{\delta E_g} = \frac{35}{1}$ giving an amplification factor of 35.

SUMMARY

$$\text{Amplification} = \mu = \frac{\delta E_a}{\delta E_g}$$

$$\text{Anode Resistance} = r_a = \frac{\delta E_a}{\delta I_a}$$

$$\text{Mutual Conductance} = g_m = \frac{\delta I_a}{\delta E_g}$$

There is a fixed relationship expressed as

$$\mu = g_m \times r_a \text{ i.e. } \frac{\delta E_a}{\delta E_g} = \frac{\delta I_a}{\delta E_g} \times \frac{\delta E_a}{\delta I_a}$$

In the valve quoted (Fig. 2/7), $\mu = 35$, g_m 3.75 mA/V and $r_a = 9,000$ ohms. Checking, 35 should equal $\frac{3.75}{1,000} \times 9,000$, but actually equals 33.75 which is within reasonable limits of error in reading the graphs.

CHAPTER 3

VALVES, VOLTAGE AND AMPLIFICATION

In the following chapter, an attempt is made to give an outline of the various methods of coupling and biasing different types of valve, without introducing technicalities which would be beyond the scope of the average amateur. Such chapters are always extremely difficult to write, as protecting readers from mental strain is liable to give the writers a few headaches. The subject is a dry one and covers a wide field ; to make it entertaining would be almost as difficult as producing music from a slide rule. It is hoped that the result will enable the amateur to improve his general conception of valve practice, with consequent better understanding of amplifier " why and how ".

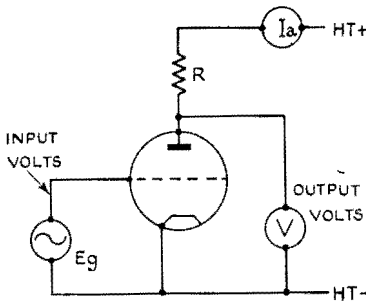

FIG. 3/1.—The Triode as an amplifier.

THE TRIODE AS AN AMPLIFIER

Fig. 3/1 shows a triode with a resistance interposed between anode and the anode battery (usually referred to as the high tension battery). Between grid and cathode is shown an AC generator E_g . From the grid characteristic in the previous chapter, it will be realised that, as the grid is made increasingly negative, anode current will fall. However, when the grid is made increasingly positive anode current will increase because the positive grid, instead of limiting the flow of electrons from cathode to anode, will now assist and accelerate the process. These variations in anode current have to flow through the resistance R , and by Ohm's law a voltage will be developed across this resistance in sympathy with the grid fluctuations. If a voltmeter is placed between anode and cathode it will show a rise in voltage when the grid is going increasingly negative (less anode current flowing, less volts dropped across R), but when the grid is going increasingly positive, the volt-

meter reading will fall due to the increase of anode current causing a bigger drop along resistance R. From this emerges the fact that when the grid is going increasingly negative the anode is going increasingly positive, thus showing that the grid and anode are in effect 180° out of phase. Given a suitable value of R, the voltage fluctuations as read between anode and cathode will be greater than the voltage fluctuations between grid and cathode. Thus our valve is acting as an amplifier.

DISTORTION

If the grid is made positive with respect to cathode, it will actually behave like a second anode and will collect electrons unto itself; not all of them, of course, due to the wide spacing of the grid mesh. The source of AC voltage applied to the grid has internal resistance. The

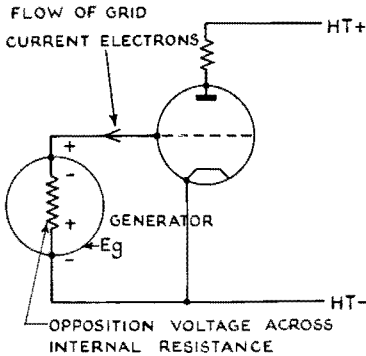

FIG. 3/2.—Effect of Grid Current. Opposition voltage developed across internal resistance of input voltage source.

electrons collected by the grid will flow through this resistance back to the cathode, but by Ohm's law this will produce a voltage across the internal resistance of the generator and this voltage will be in opposition to that of the generator itself. The net result will be that, on the positive

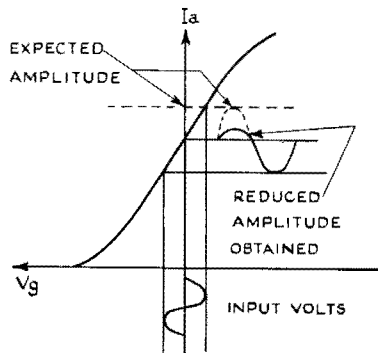

FIG. 3/3.—Distortion due to Grid Current.

half cycle of input the actual input waveform will be distorted and therefore the output at the anode will not be a faithful replica of the input. This state of affairs arises from the grid being allowed to go positive. If, however, a small battery is introduced as in Fig. 3/4, and this battery has such a voltage that the positive swing of the generator can never drive the grid positive, then grid current cannot flow and distortionless amplification should result.

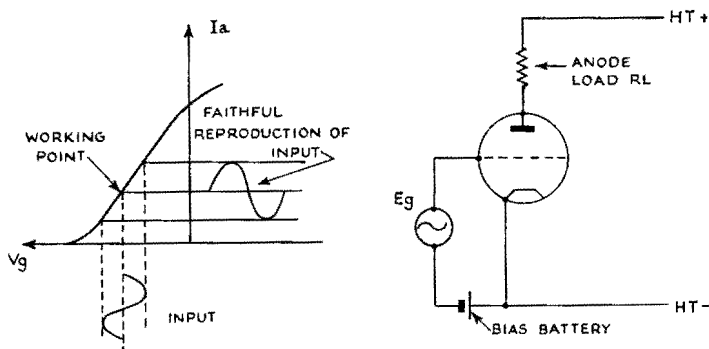

FIG. 3/4.—Grid Bias, to avoid grid current.

Another factor that must be considered is that to obtain distortionless output, the grid voltages must only be swung over the straight or sensibly straight part of the grid characteristic. This means that the battery voltage should be so chosen that the valve works either side of the mid point of the straight part of the grid characteristic. This battery is known as the bias battery, to give grid bias. The resistance R is called the anode load, and is referred to as “ R_L ”.

CHOICE OF VALUE FOR ANODE LOAD

From the foregoing description of the valve as an amplifier, it would seem that the bigger the value of load resistance employed, the better, so that very large voltage changes occur across it. However, even when the valve is not amplifying, a certain standing value of anode current is flowing and this will cause a voltage drop across the load. It follows that, with a large resistance, a very high value of high tension is required if the valve is to be worked at a high tension voltage which will give a sensible length of grid characteristic. It can be shown that the gain obtained from a valve equals the amplification factor :

$$\times \frac{\text{load resistance}}{\text{load resistance} + \text{anode resistance.}}$$

$$\text{Formula A} = \mu \frac{R_L}{R_L + r_a}$$

It will be seen that the stage gain can never quite equal the amplification factor of the valve, although it can approach it for high values of load resistance. This circuit arrangement is not as perfect as it would appear because a hidden factor creeps in which is the shunt capacitance across the load resistance. This shunt capacitance will have an increasing "admittance" with increase of frequency. Therefore the total load will be less as frequency rises. This change of "admittance" in ohms in a capacitor, in relation to frequency, will often be met with; for example, it is the basis of conventional crossover networks in loudspeakers.

LIMITATION OF ANODE LOAD

The serious reduction of high tension voltage due to the voltage drop across the load resistance suggests the use of a load with a high impedance to alternating current and a low DC resistance. A choke may be used at both audio and radio frequencies providing it has a suitable inductance for the frequency or band of frequencies it is desired to amplify. But as the inductive reactance of a choke varies with frequency, the load will be less effective as frequency goes down. This means that the lower the frequency we want to amplify, the larger must be the inductance of the choke. Again, shunt capacitances are fairly high in this type of load so that a response tailing off at the higher frequencies would result.

RC INTERSTAGE COUPLING

Having developed an ample voltage, it is necessary to apply this voltage to a succeeding valve for further amplification. Referring to Fig. 3/4, the output voltage appears across the load resistor, and we wish to apply this voltage between grid and cathode of the succeeding

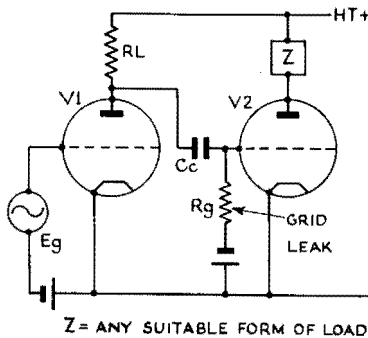

FIG. 3/5.—INTERSTAGE Resistance Capacity Coupling.

valve. If direct connection were made between the load resistor and the second valve, the grid of this valve would have the high tension voltage applied to it. As we have already seen, a positive grid is to be

abhorred, quite apart from the fact that the valve would probably be destroyed by the excessive space current which would flow. So the use of a coupling capacitor is suggested, this capacitor having infinite impedance to DC and, if a suitably large value is chosen, a negligible reactance to even the lowest audio frequency voltages likely to be encountered. Reference to Fig. 3/5 shows the actual arrangement employed.

The bottom or anode end of the load resistor R_L is connected to the grid of V_2 via the coupling condenser C_c . The top end of the load resistor is connected to the cathode of V_2 via the high tension battery which is assumed to have negligible internal resistance. The presence of the resistance R_g is necessary in order that the valve V_2 may be supplied with the necessary grid bias voltage. The load resistance is actually shunted by the coupling condenser and grid resistance in series. It is important to appreciate this point because the effective load of the valve is influenced by the presence of the coupling condenser and the grid resistance. If the coupling condenser is of too small a value, its reactance will increase with decrease of frequency, giving a decrease of voltage across the resistance R_g and the input to the valve V_2 will not be a faithful replica of the input voltage as applied to the first stage V_1 . It will also be seen that the value of R_g should be kept as high as possible to avoid giving a reduced total value of load for the valve V_1 . The same method of interstage couplings could well be adopted when a choke or a tuned circuit is used as the anode load for V_1 .

TRANSFORMER COUPLING

Another method of interstage coupling is shown in Fig. 3/6. This is the inter-valve transformer.

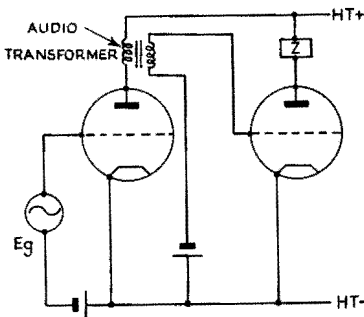
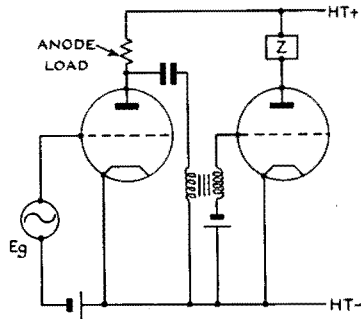

FIG. 3/6.—Transformer Coupled Amplifier.

The primary of the transformer constitutes the anode load for V_1 , the secondary applies the voltage between the grid and cathode of V_2 and also supplies the DC path for the application of the bias voltage. This transformer can be of a step-up ratio primary to secondary, giving a

step-up of voltage, and would appear at first sight to be an ideal method of interstage coupling. However, this is not altogether the case, because to obtain a sensibly constant value of anode load at all frequencies the primary must have a high value of inductance. This demands many turns of wire with considerable self capacity giving a shunting effect at the higher frequencies. The step up ratio in practice cannot exceed 1 to 7 and in most cases 1 to 3 or 4 is employed. The loss of inductance due to the flow of DC in the primary, in addition to the alternating component of anode current, can be avoided if the circuit of Fig. 3/7 is employed.

FIG. 3/7.—Parallel-fed transformer. Removes DC from primary and improves bass response.



This is known as shunt or parallel feeding and enables a smaller transformer with lower self capacity but the same inductance to be used, but either method of using an interstage LF transformer is not regarded with much favour where the highest fidelity of reproduction is demanded. The transformer method of interstage coupling is frequently employed in radio circuits where the HF transformer will have an air core or dust iron core to avoid eddy current losses.

DIRECT COUPLING

In order to avoid the use of a condenser in the interstage coupling with troubles due to increasing reactance at low frequency and phase

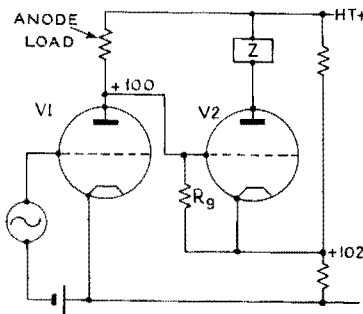

FIG. 3/8.—DIRECT-COUPLED AMPLIFIER. By eliminating coupling condenser bass response is maintained, and phase shift avoided.

shift, the direct coupling as shown in Fig. 3/8 may well be employed.

It will be appreciated that the cathode of V_2 must be raised to a positive potential slightly higher than that at the anode of V_1 in order to avoid grid current. This method is employed in the well-known Williamson amplifier.

DETERMINATION OF THE BIAS POINT

The value of grid bias must be chosen with a view to avoiding two sources of trouble :

- (a) Too low a bias may permit of the grid being driven positive with grid current flowing.
- (b) If bias is excessive then large excursions on the grid in the negative direction may produce cut-off of anode current and distortion of the negative half cycle of input after amplification.

THE TRIODE AS AN OSCILLATOR

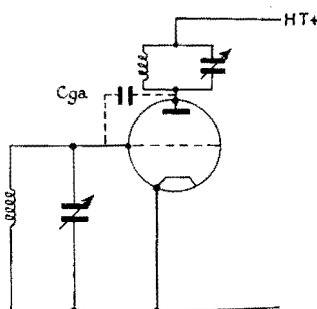

FIG. 3/9.—The valve as an oscillator, with tuned grid circuit and tuned anode load. C_{ga} is internal capacity grid/anode of the valve.

Fig. 3/9 shows a triode valve with a tuned circuit in the grid and another tuned circuit as the anode load. Assuming that inductive coupling cannot take place between the two tuned circuits, it would most probably be found that the amplifier was unstable and tended to behave as an oscillator. Now a valve can only behave as an oscillator when sufficient energy is fed back from the anode into the grid circuit to overcome the losses in the grid circuit due to resistance. Such feedback takes place through the internal capacity in the valve between the anode and the grid C_{ga} , the two electrodes behaving as the two plates of a condenser. The capacity may amount to several pico-farads and is quite sufficient to cause instability. This feedback is referred to as positive feedback and is sometimes deliberately introduced into a tuned circuit to reduce the resistive losses, as in a set with reaction. This increases the gain and improves the Q of the circuit, thereby narrowing the band of frequencies which it will accept. Reference is made to

this phenomenon because when the construction of a radio feeder unit is considered, it is important to realise that every step must be taken to avoid feedback in the radio frequency amplifier; otherwise the tuned circuits will not accept the full bandwidth of the station, with consequent loss of high notes contained in the outer fringes of the side bands. Whilst the capacity anode to grid is normally the one with which we are most concerned, it should be appreciated that capacity also exists between anode and cathode and grid and cathode.

MILLER EFFECT

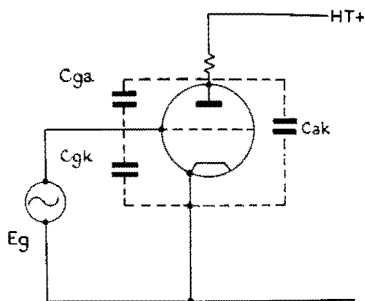

FIG. 3/10.—Inter-electrode capacities in a valve.

When an alternating voltage is applied between grid and cathode of the triode amplifier shown in Fig. 3/10, an alternating current flows in the small condenser formed by the grid and cathode electrodes, C_{gk} , just as in any other condenser. This means that the grid input impedance is by no means infinity, and as frequency increases the input damping will become more marked.

In a similar way an alternating current flows in the condenser formed by the grid and anode, C_{ga} , but since the instantaneous voltage between these electrodes is considerably larger than the signal voltage on the grid, the current in the grid/anode capacity C_{ga} is larger than it would be were no amplification taking place. Looked at from the grid circuit the increased current is equivalent to an increase in input capacity of the valve and the effective input capacity is $(1 + A)$ times (where A is the amplification of the stage) the capacity which would be expected from an examination of the actual inter-electrode capacity C_{ga} alone.

Readers desiring to study the Miller effect more fully are recommended to an article by "Cathode Ray" in the August 1949 issue of *Wireless World*, which gives a well reasoned and lucid survey. The third hidden capacity is capacity anode/cathode, C_{ak} , which will shunt the load of the valve.

THE SHIELDED OR SCREENED GRID VALVE

In early days of radio communication, the feedback due to inter-electrode capacitance already described, made it exceedingly difficult to obtain stable radio frequency amplification. Attempts were made to balance out the positive feedback by applying an equal amount of feedback in the opposite sense, *i.e.* negative feedback. This system was known as neutralisation, but was never a particularly practical solution. At the same period, the idea of putting an electro-static shield between the grid and anode was evolved. A positive voltage was applied to the screen to draw the electrons through to the anode.

FIG. 3/11.—The tetrode valve.

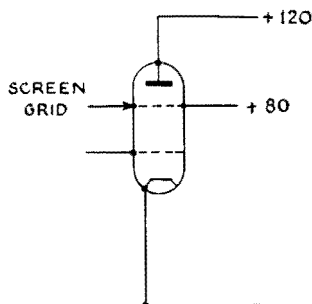

This greatly reduced the anode to grid capacity but did not completely eliminate it. Examination of the grid characteristics of typical screen grid or tetrode valves shows them to be not dissimilar to those of an ordinary triode.

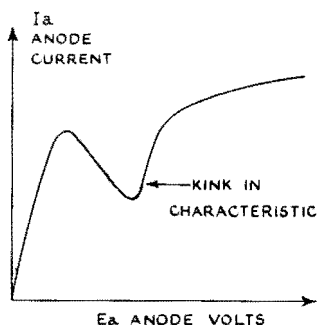

FIG. 3/12.—Anode characteristic of a Tetrode Valve.

Examination of the anode characteristic shows that it is a very different shape from that of the triode. At low anode voltages, the anode current rises linearly, but after a certain critical value of anode voltage, the current actually falls and continues to do so until it again

takes on its normal upward trend. This kink in the characteristic is due to the fact that when electrons impinge on the anode sufficient energy is released to produce new electrons from the anode material, called secondary emission electrons. These are then attracted by the positively charged screen until the anode voltage is raised sufficiently to pull them back to itself. This kink in the anode characteristic is a serious drawback to this type of tetrode valve in that the voltage swings at the anode must be limited so that the valve works over the straight part of the characteristic.

THE PENTODE

This valve is a development of the tetrode and a further wide mesh grid is interposed between the anode and the screen. This grid is normally connected to cathode and its presence repels the electrons produced by secondary emission from the anode and these return to the anode. The anode characteristic of a typical pentode shows that the tetrode kink has been removed but that the characteristic is still very unlike that of a triode. The grid characteristic of a pentode is, however, very similar to that of a triode. This means that g_m is similar to that of the triode. Referring to Fig. 3/12, and remembering that the anode resistance of a valve is obtained from the relationship $\frac{E_a}{I_a}$ it will be seen that on the flat part of the characteristic, the anode resistance will be very high and in practice a value of one megohm is by no means unusual. From the relationship μ equals $g_m \times r_a$, it will be seen that r_a being very large μ will become very large. In other words, the valve will have a high amplification factor, and this implies that a high stage gain can be obtained from one of these valves used as a resistance capacity coupled amplifier. The screen is maintained at a potential of from half to two-thirds that of the anode and is coupled to the cathode by means of a bypass condenser, thus ensuring that AC fluctuations on the screen, remembering that the screen takes some little part of the space current, will be obviated.

OPTIMUM VALUES FOR RC COUPLED AMPLIFIERS

By now the reader should have a fair appreciation of the basic principles underlying the choice of coupling values, but it is quite outside the scope of this book to tell him how to determine them for each and every valve. (Valve makers publish data for all their valves.)

As the value of grid leak in the succeeding stage affects the stage gain and maximum voltage output, the obvious inference is to use as large a value of R_g as possible. There is usually a maximum value of grid/cathode resistance that a valve can tolerate, particularly in the case of a power valve.

METHODS OF BIASING

It is necessary to bias a valve in order to prevent grid current, and up to the present a battery has been used for the sake of simplicity. However, the separate bias battery is a thing of the past as much simpler ways of biasing can be employed. If it is borne in mind that grid bias is fundamentally a matter of making the grid some few volts more negative than the cathode, then biasing problems do not exist.

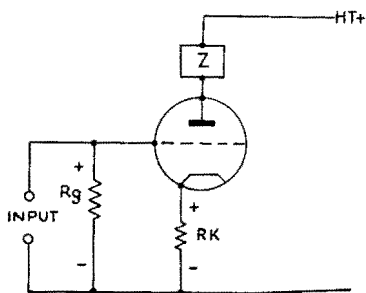

FIG. 3/13.—Cathode Biasing. Method of obtaining grid bias by resistance in cathode.

Fig. 3/13 shows an arrangement that is commonly adopted to produce so-called "Cathode Bias", "Self Bias" or "Automatic Bias". (The last two terms are not liked as they can so easily be confused with another method used largely in RF technique.)

It will be seen that a resistance R_K has been introduced between cathode and HT- of an amplifying system. The space current of the valve will flow through R_K and in accordance with Ohm's law, $IR = E$, a voltage will be produced across it, so that the cathode is more positive than the HT- line. The grid is connected to the HT- line through its grid leak, R_g , and therefore the cathode is more positive than the grid, which is another way of saying that the grid is more negative than the cathode—the condition we seek for grid biasing.

The current flowing through R_K will be the direct current component of anode current plus the alternating current component, therefore both a steady mean potential and an alternating voltage will appear across R_K . This condition is undesirable for the following reason—when the grid of the valve is going less negative the anode current will increase and the cathode will go more positive with respect to the HT- line. Now the grid input of a valve is applied between grid and cathode, and therefore the potential across R_K is in effect in series with the input, and a study of Fig. 3/13 shows that the two potentials are in anti-phase, or out of step, and the net input voltage is the difference between the two.

The effect may be overcome by shunting R_K with a condenser of such a capacity that its reactance at any frequency within the range it

is desired to amplify is negligibly small relative to R_K . It is usual to employ a low voltage electrolytic condenser for this purpose, having a capacity of from 25 to 100 microfarads. This ensures that the voltage across R_K is a steady DC potential.

It might suggest itself that if it is desired to attenuate the bass frequencies, this could be accomplished by deliberately using a shunting condenser of a small value, thus achieving a form of "tone control". In practice, however, it is more difficult to produce the bass notes than lose them!

The partial cancellation of the input voltage by the voltage fed back to the input across the cathode resistor is often referred to as degeneration, the opposite of reaction or regeneration. As reaction is referred to as positive, in phase, feedback, it is logical to refer to degeneration, out of phase feedback as "Negative Feedback" and as it is due to the current through the valve the example outlined above is termed "Current Negative Feedback". The subject of Negative Feedback is treated in some detail in a later chapter.

DIRECTLY HEATED VALVE BIAS ARRANGEMENT

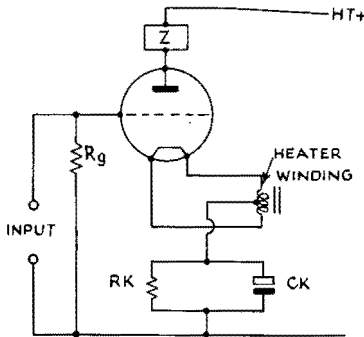

FIG. 3/14.—Cathode biasing applied to a directly heated valve.

Cathode biasing may be applied to a directly heated valve in the manner shown in Fig. 3/14. It is necessary to use a centre tap on the heater winding to establish a mean cathode potential, otherwise there will be superimposed on the bias voltage a 50-cycle ripple voltage equal to the heater voltage.

BACK BIASING

An examination of Fig. 3/15 shows that a resistance R_b has been inserted in the HT- lead, and the total space current of the valve or valves flowing through this resistance will produce a voltage across it. If the grid of the valve is connected to HT- via its grid leak then the grid will be more negative than the cathode, which is the result desired.

A bypass condenser must be in shunt with the resistance R_b to avoid the production of alternating voltages across it, just as was used in Cathode biasing. This method of obtaining bias is well adapted for

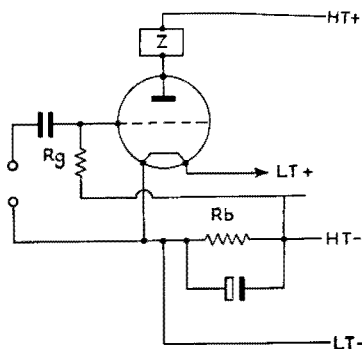

FIG. 3/15.—Back biasing, or HT-lead biasing.

use with directly heated battery valves where the cathode biasing system is not convenient to use, as the resistance R_b may be tapped to obtain other values of bias.

CALCULATION OF THE BIAS RESISTANCE

The calculation of the bias resistance is a simple application of Ohm's law, $R = \frac{E}{I}$, where E is the desired bias voltage and I is the current flowing through the bias resistance.

To take a practical example of cathode biasing, a Mullard output pentode type EL37 with 250 volts on both anode and screen requires a bias voltage of 13.5. The current flowing through the bias resistor will be the sum of the anode and screen currents, 100 and 13.5 mA respectively; therefore

$$R_K = \frac{13.5}{100 + 13.5} \times 1,000 \quad (\text{Remember the 1,000 because Ohm's law is in the basic units of amps})$$

$$= \frac{13.5}{113.5} = 120 \text{ ohms approx.}$$

Take another example, this time HT-lead biasing; a small battery set has as its output pentode a Mullard DL93, preceded by three other valves taking a total HT current of 5.5 mA. The output valve takes a total of 17.5 mA and the bias voltage required is -7.5. The total HT current is 17.5 + 5.5 mA; therefore the HT-lead resistance

$$= \frac{7.5}{17.5 + 5.5} \times 1,000 \text{ ohms}$$

$$= 326 \text{ ohms approx.}$$

Note carefully that in this system the *total* HT current of the *whole set or amplifier* must be ascertained to make the calculation.

When using any particular valve as an RC coupled amplifier, a direct calculation of the bias resistance is not feasible because, due to the high value of load resistance, the actual HT voltage at the anode bears no relation to the figures of "Operating Conditions" as shown in a valve manufacturer's catalogue. In consequence the space current will be reduced, and for the correct bias to be obtained a higher value of bias resistor will be needed.

The calculations involved are complex, and the reader is recommended to refer to tables produced by the valve maker for each valve suitable for use as an RC coupled amplifier, in which the values of R_L and R_K and R_g of following valve are listed, together with stage gain and maximum output voltage for a given distortion figure.

For American type valves a comprehensive table is given in the (American) Amateur Radio Relay League's Handbook, easily obtained in this country.

LEAKY GRID BIAS

A system sometimes used for early stage audio amplifiers is leaky grid or condenser bias. This method depends on the flow of grid current and for that reason is not to be recommended.

GENERAL

A point to note is that in both Cathode biasing and Back biasing, the bias voltage is obtained at the expense of the actual value of HT voltage applied between anode and cathode of the valve, but this is rarely a serious problem, especially in mains operated sets.

VARIABLE μ

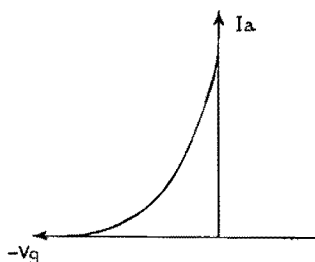

FIG. 3/16.—Grid characteristic of variable- μ valve. The slope or g_m decreases with increase of bias.

Reference to Fig. 3/16 shows the grid characteristic of a variable- μ valve. Comparison with the grid characteristics shown in Fig. 2/6 shows that the essential differences are that the point of cut-off is much more remote and that the characteristic is not truly straight over

any portion. This is achieved by incorporating a grid varied with a non-constant pitch, *i.e.* the wires are close together, say, at the ends, and wide apart in the centre. The net effect is that very considerable negative voltage must be applied to the grid before it can completely prevent the flow of electrons to the anode through the widely spaced parts of the mesh, resulting in the long gradual curve as shown in the diagram. Mutual conductance is defined as $\frac{\delta I_a}{\delta E_g}$. It will be appreci-

ated that this value will be greater when the grid is slightly negative and the slope steeper, than at a higher value of grid volts when the slope is less steep; hence the name variable- μ . The gain afforded by an amplifier incorporating such a valve will depend on the working bias point selected, and the arrangements of Fig. 3/17 would enable the stage gain to be varied by adjustment of the value of VR_K , where VR_K forms part of a potentiometer across the HT supply.

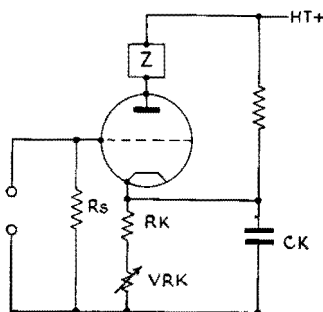

FIG. 3/17.—Circuit for control of gain by variable bias.

The inclusion of R_K is desirable, so that when the value of VR_K is turned to zero the valve cannot be worked with zero bias but will have a minimum bias value dependent on the value of R_K .

It will be appreciated that, due to the constant curvature of the characteristic, distortion is inevitable, but this will not be serious if the input is kept to a very low value. The chief application of these valves being in RF circuits, the latter condition will normally be satisfied; the type is mentioned here because it has a restricted application in giving an automatic gain control effect in audio amplifiers.

CHAPTER 4

THE VALVE AS A POWER AMPLIFIER

The problem so far has been to produce an exact facsimile of the input voltage, but amplified to give greater voltage excursions at the output. The problem in the final stage is to make a valve produce a distortionless power output to do work: the work of actuating a headphone diaphragm or causing the mass of a loudspeaker cone and coil assembly to move and displace a column of air. Electrical work or energy is measured in watts, the product of volts and amperes. Thus, besides large voltage changes, we require comparatively large current changes. The factors that govern the current that can pass through the valve are:

- (a) the extent of the emissive surface on the cathode linked with heater wattage which together govern the number of electrons available, and
- (b) the permissible heat dissipation at the anode without causing overheating and the possibility of softening the vacuum due to driving out occluded gases from the electrode structure. Study of these points shows that a power valve will generally speaking have a larger cathode and larger electrodes than a valve used only for voltage amplification.

CHOICE OF OUTPUT VALVE

TRIODE v. PENTODE

For the triode there is a low inherent distortion due to straightness and parallelism of grid characteristics coupled with a low anode resistance. Against the triode is the low stage gain due to its low mutual conductance; a large voltage input is needed to drive it fully and it is greedy of high tension current for the output obtained. The triode also produces a fair measure of 2nd harmonic distortion although steps can be taken to eliminate this fault as will be seen in later chapters.

For the pentode is its high gain for a comparatively small input voltage and its good return for the expenditure of anode current. Against it is its higher inherent distortion due to lack of straightness and parallelism of grid characteristic, although these defects can very largely be overcome, as will be seen in Chapter 15. The pentode has a very much higher anode resistance; this question of internal resistance of the output valve and its effect on the quality of reproduction is discussed later in this chapter and also in Chapter 8.

THE TRIODE OUTPUT STAGE

The valve can be considered as an alternator and as such there will be a value of load into which it can deliver its energy to the best effect. It is helpful to consider the case of a simple battery possessing a certain internal resistance. When current is taken from the battery it has to flow through this internal resistance, made up of the resistance of the elements of the battery. A battery may be said to have an EMF of 1.5 volts, but on load it would not show a potential difference of 1.5 volts across its terminals. When current is drawn, a certain voltage drop will occur across the internal resistance and the potential difference at the terminals is the difference between the EMF and the voltage across the internal resistance.

Fig. 4/1.—Battery EMF=1.5 volts. Internal resistance 0.5 ohm.

External Resistance	Current in Circuit	PD across external R	Power in external R
7.0 ohms	0.2 amp	1.4 volts	0.28 watt
2.5 "	0.5 "	1.25 "	0.625 "
1.0 "	1.0 "	1.0 "	1.000 "
0.5 "	1.5 "	0.75 "	1.125 "
0.25 "	2.0 "	0.5 "	1.000 "
0.1 "	2.5 "	0.25 "	0.625 "
0.05 "	2.73 "	0.136 "	0.372 "

Columns 1, 2 and 3 in the table shown in Fig. 4/1 should make this clear. Reference to column 4 of the table shows that the watts dissipated in the external load steadily increase until a maximum is reached when the external load resistance equals the internal resistance of the battery.

After this, reduction of the load causes more current to flow, but only produces a lower dissipation of energy external to the battery, where, after all, it is of most use.

From the foregoing example it can be seen that the greatest *voltage* appears across the external load when this load is so very large that practically no current flows, and in consequence there is little voltage drop across the internal resistance of the battery. This agrees with our conclusion that when the greatest voltage output is wanted from a valve connected as a voltage amplifier, the load should be as high as possible: many times the anode resistance of the valve.

Let us take the case of a valve as a generator of an alternating potential as shown in Fig. 4/2 (a). This represents a valve of anode resistance r_a feeding into a load R_L . The alternating input to the grid is E_g volts. Fig. 4/2 (b) shows the electrical equivalent of the circuit, in which the

valve is shown as a generator of internal resistance r_a delivering μE_g volts into the load R_L when μ is the amplification factor of the triode. Our argument shows that for maximum power in the load, R_L must equal r_a , and the practical significance is that when a triode valve is

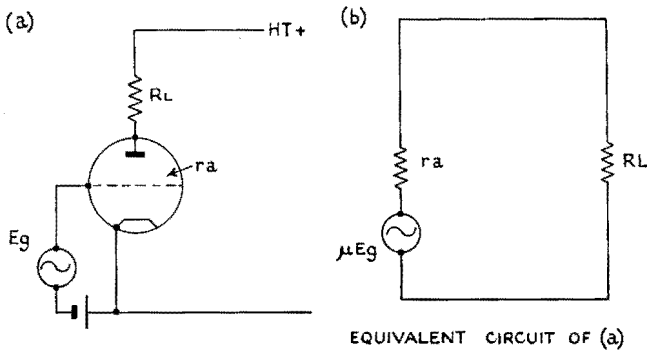

FIG. 4/2.—The valve as a generator.

working into a loudspeaker approximating to a pure resistance, we get maximum power into the speaker when its resistance is equal to the anode resistance of the valve.

Most readers already know that for various mechanical and electrical considerations, it is usually undesirable to produce a moving coil loudspeaker having a coil resistance much in excess of 15 ohms, which is nowhere approaching the anode resistance of a valve and cannot be placed directly in the anode circuit for an efficient development of power across it.

To overcome this difficulty, it is necessary to introduce a step-down transformer into the circuit, the primary being placed in the anode circuit of the valve and the secondary connected to the coil of the loudspeaker. The turns ratio of this transformer can be determined approximately from the following formula :

$$\sqrt{\frac{\text{Load required by valve}}{\text{Resistance of speech coil}}} : 1$$

The load usually required by a triode valve is approximately twice its anode resistance because the load offered by a loudspeaker is not resistive. When the load R_L is twice r_a the most efficient condition is obtained at the expense of an increased driving voltage on the grid.

THE BEAM TETRODE

A beam tetrode employs the principle of focusing the stream of electrons flowing from the cathode to the anode. Furthermore, the control grid and screen grid have the same winding pitch and are

assembled in the valve so that they are in optical alignment. The effect of the latter is to reduce the value of screen current as compared with a pentode of similar power. This is due to the screen wires being in the "shadow" of the grid wires which, being negatively charged, cause the electrons to diverge. This reduction in screen current represents a saving of power, giving a higher overall power efficiency.

Beam forming or confining plates, connected to cathode, are employed to shield the anode from receiving any electrons coming towards it from the direction of the grid support wires, where the focusing of the electrons is imperfect. The presence of these plates, bent round as they are, prevents the slow velocity secondary emission from the anode reaching the screen, and the anode characteristic exhibits no kink as in the normal tetrode. This means that greater swings of anode current over the approximately linear part of the characteristic can produce greater power output. Furthermore, due to their general shape, the harmonic distortion produced is principally 2nd, with but little 3rd, which is the opposite to a pentode and more like a triode. In push-pull the 2nd harmonic is cancelled and a pair of such valves gives a better return in terms of undistorted power output than a pair of equivalent pentodes for the same HT requirements.

Well known examples of this type of valve are the Osram KT66 and American types 6V6, 6L6 and 807.

PENTODE OR TETRODE LOAD

When using pentode or tetrode output valves the method of determining the value of the load previously outlined is not applicable, as such valves have very high values of anode resistance, 50-70,000 ohms, and work most satisfactorily into loads generally between one-third and one-sixth of their anode resistance. These output valves can give an intolerable degree of distortion (without NFB) unless matched most carefully to the loudspeaker.

A pentode or tetrode will give more inherent distortion than a triode in any case, due to lack of parallelism in its characteristics. It is apparent that a value of load should be chosen that will give the least possible total harmonic distortion, but this is pretty certain not to be the value of load that will give greatest power output.

ACTUAL VALUE OF LOAD FOR A POWER VALVE

The calculations needed to determine the actual value of load required for any particular type of power valve are quite complex. The requirements of maximum power output and minimum harmonic distortion are conflicting as already indicated, and it is quite beyond the scope of this book to treat fully the methods adopted. The interested reader might well refer to *Radio Designers' Handbook*, edited by F. Langford Smith and published by Iliffe & Sons Ltd.

The experimenter would do well to obtain the recommended values of load resistance for any particular valve from the makers and abide closely to their data.

THE LOAD LINE AND POWER AMPLIFIERS

A power amplifier is certain to be working into an inductive load and it is assumed that the inductance of the transformer primary is sufficiently high to offer a sensibly constant load with no appreciable shunting of the AC load at all frequencies it is called upon to handle. However, if it does not fulfil these conditions, or even if a capacitance is placed across the primary to reduce top response, then the load will be reactive and not a constant value.

The general effect is either to increase distortion for the power output the valve is capable of giving, or to produce less output for the quoted distortion figure.

LOUDSPEAKER DAMPING

This is a term used indiscriminatively to describe two separate and yet inter-related phenomena.

First the ability of a loudspeaker moving system to come to rest immediately the input applied to its terminals ceases, and secondly the damping out of resonances, particularly the bass resonance of the moving system, by the action of the output stage. Treating the second one first, it will be seen from the impedance curve of a typical loudspeaker shown in Fig. 4/3 that the impedance of the speaker rises to a high value at 52 c/s.

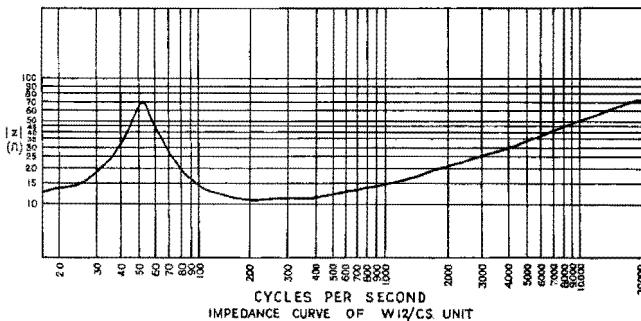

FIG. 4/3.—Typical loudspeaker impedance curve.

The effective resistance shunted across the primary of the output transformer is the resultant of the anode resistance and the load resistance in parallel. If the load resistance were a *fixed* resistance load say of 2,500 ohms for an Osram PX₄ of anode resistance 860 ohms

then the resultant would be 2,500 and 860 in parallel = 606 ohms. However, with a speaker load, if the impedance of the speech coil rises six times at the bass resonant frequency, the shunt impedance on the primary will be 15,000 and 860 ohms in parallel = 814 ohms.

Taking the case of a pentode output valve, Mullard EL32, working into a load of 8,000 ohms with an anode resistance of 20,000 ohms, a rise of speech coil impedance by a factor of 6 will give a shunt impedance of 20,000 and 48,000 ohms in parallel = 29,000 ohms approximately as compared with a normal value of about 7,180 ohms.

By comparing the figures quoted, it can be seen that the voltage output will rise very considerably in the case of the pentode, and a pronounced audible effect will take place when a note is fed to the loudspeaker in the region of its bass resonant frequency. The triode however, by virtue of its low anode resistance, tends to swamp the rise in load resistance and gives a much less pronounced effect.

This must not be taken as a condemnation of the pentode or tetrode, as methods can be employed to give them in effect a very low anode resistance and these are described in the chapter on Negative Feedback.

The foregoing arguments have assumed that a good output transformer has been used, *i.e.* one with adequate primary inductance to reproduce down to the lowest audible frequencies. It should, however, be realised that a transformer having a low primary inductance will be helpful in reducing bass resonance with a pentode output stage, due to low value of inductance acting as an appreciable shunt across the load. The power output will, in this case, be reduced to a value very much less than the rated output of the valve.

Reverting to the question of damping of a loudspeaker for the reproduction of transients, the moving system should come to rest immediately the transient ceases and should not come to rest like a pendulum. Loudspeakers vary enormously in this quality of transient response.

Results are improved by high flux density, free suspension and efficient systems of mounting, all of which help to reduce "ringing".

The coil of a loudspeaker moving in a powerful magnetic field will behave as a dynamo and when falling back to rest will generate an EMF in opposition to the one originally causing it to move. This EMF will cause a current to flow in the coil and the field produced will interact with the flux of the field and tend to cause a movement in the opposite direction to the original one, taking the system past its dead centre position instead of coming to rest immediately. Now the anode resistance of the output valve as reflected into the loudspeaker via the output transformer acts as a shunt damping resistance across the speech coil, and it can be seen that the lower the anode resistance of the valve the better the damping on the speech coil. It would appear that the triode valve would score here over the pentode or tetrode,

but the same measures can be applied to these as for improving the resonance damping. The "damping factor" of an output system can be expressed in general terms as the ratio of the load resistance to the anode resistance (R_L to r_a).

As this is the case, the damping at frequencies at which the impedance of the loudspeaker rises will improve, since R_L is greater and a greater effective damping factor is obtained. It will be seen therefore that whilst the increase of load resistance, at bass resonance of the loudspeaker in particular, tends to increase the output fed to the loudspeaker, the improved damping factor tends to improve the reproduction as regards transients.

In the case of the PX4, the damping factor would be :

2,500 : 860, 3 : 1. The EL32.....8,000 : 70,000, 1 : 8.5.

CHAPTER 5

DECOUPLING AND INSTABILITY

In view of the fact that the popularity of negative feedback has resulted in more and more cases of instability in amplifiers, often unsuspected in home-built equipment, it is considered worth while to devote an entire chapter to the study of the problem.

For the benefit of readers who are not accustomed to inspecting the antics of amplifiers with the aid of an oscilloscope, we will begin by the study of a few oscillograms of typical effects of instability, before proceeding to a technical, albeit less picturesque, diagnosis.

EXAMPLES

For the purpose of the first test (and others described elsewhere in the book) an amplifier with uncorrected push-pull tetrode output was used and was known to be unstable with any more than 20 db NFB. A variable resistance provided a means of adjusting feedback to any value between 26 db and zero, giving an effect equivalent to source impedances varying between 1 ohm and about 100 ohms. A rough-and-ready test for ascertaining this important impedance value in an amplifier (which incidentally may vary with frequency) is to feed in a steady tone between 500 and 1,000 c/s from AF oscillator or constant frequency record, and measure the voltage across the secondary of the output transformer without loudspeaker load: then to connect a calibrated variable resistance across the secondary and adjust the value until there is a voltage drop of 50 per cent. The resistance reading then approximates the amplifier impedance in question. With the tetrode amplifier, variation of feedback produced the following impedance readings, with corresponding effect on the voltage rise due to bass resonance of a loudspeaker. The transformer ratio was for load matching to a 15 ohms speaker.

TABLE 1
Tetrodes and Voltage NFB. No load.

Feedback	Volts Input	Volts Output	Impedance measured
0 db	1	7	100 ohms
6 "	10	7	13 "
8 "	12	7	10 "
14 "	32	7	4 "
20 "	75	7	2 "
26 "	*	*	*

* Serious instability intensified by absence of speech coil load.

Table 1 shows the impedances achieved by varying the feedback up to 20 db. The gain control of amplifier was set very low and was not moved during the test. At 26 db the oscillations made readings impossible. (They blew the fuse of the voltmeter.)

Fig. 5/1 illustrates the presence of oscillation at a frequency as high as 150,000 c/s in the tetrode amplifier. It was found that reducing feedback (in this case) from 26 db to 20 db completely cleared the oscillation, and improved the quality of reproduction—despite the very high frequency of the disturbance.

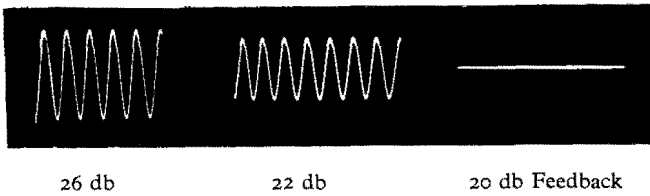

FIG. 5/1.—Oscillation at 150 Kc/s in tetrode amplifier. Time base 50 micro-secs.

It is fairly easy to check the frequency. The oscillograph was set with the time base at 50 micro-sec., $\cdot 000050$, which is $\frac{1}{20,000}$ sec. There are 7.5 waves in the complete trace, so the frequency is $7.5 \times 20,000 = 150,000$. It is hardly necessary to say that an ordinary AC voltmeter will not give a reading at such frequencies, but it is necessary to add that a dummy speech coil, fed by this input, started to go up in smoke. (The output transformer is still standing up to grave abuse, and is a credit to its makers, Excel Radio, of Shipley, Yorkshire, who threw together the "guinea pig" amplifier for the purpose of these tests.)

An amplifier which gives poor results, with excessive "top" and possibly excessive heat in the output valve (or valves) should be suspect. An AC voltmeter connected across the speech coil of the loudspeaker should obviously give no reading with the absence of input to amplifier. An oscilloscope similarly connected should show no amplitude on the "Y" axis. The discovery of unwanted voltage by either of these simple tests would clearly indicate that the "patient" required medical attention. Unfortunately, the oscillation might only occur at a particular part/amplitude of a low frequency cycle. This would not show statically, *i.e.* with zero input, so diagnosis of the fault would require the use of an oscilloscope and a signal source. The writer recently tested an amplifier in which this fault produced a picture rather like a string of sausages, as shown in Fig. 5/2, which has been drawn from memory.

DECOUPLING AND INSTABILITY

The amplifier received some attention, with slight improvement, and the sausages disappeared from the menu, but there is still a tendency

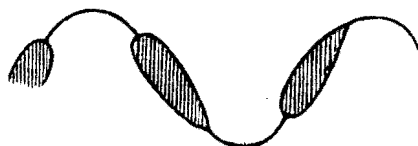

FIG. 5/2.—Oscillogram of shock-excited parasitic oscillation of extremely high frequency, carried on 50 cycle mains hum.

towards motor-boating, which is easily provoked by switching on without a reasonable load on the output stage. This is coupled with instability which is provoked by turning the treble control fully on. These combined operations produce some rather fascinating pictures on the oscilloscope, and incidentally burnt out quite a robust variable resistance which was tried as a dummy load. (See Figs. 5/3, 5/4 and 5/5.) In the first of these oscillograms, Fig. 5/3, a steady tone at 1,500 c/s was fed into the amplifier, to be mixed with the motor-boating and HF oscillation.

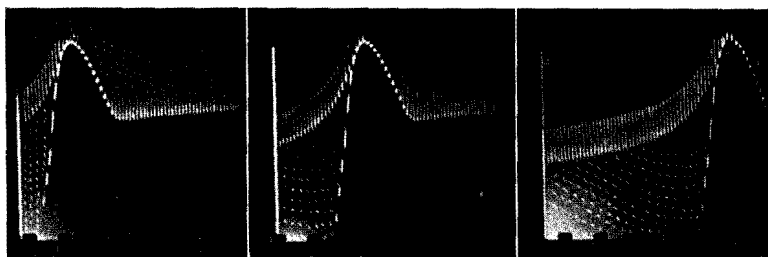

FIG. 5/3.—Picture of combined effect of motor-boating and parasitic oscillation, with steady tone at 1,500 c/s, showing severe intermodulation.

Three traces are included in Fig. 5/3 because the period of the motor-boating was too slow for the complete cycle to be reproduced in one shot. It is interesting to observe how the 1,500 cycle note is pushed around by the low frequency of the motor-boating; also (in the third picture) how the high frequency oscillations beat in sympathy with the 1,500 c/s "carrier".

The next oscillogram, Fig. 5/4, shows at A the combination of motor-boating and two bursts of HF oscillation, taken with motor-speed of 1.2 ins. second (which establishes the frequency of the LF disturbance at about 5 c/s), and at B a single trace to show the effect of connecting a loudspeaker to the output of the amplifier.

When comparing these oscillograms, it is necessary to bear in mind

that A is a continuous trace with a moving film, whereas B is a snapshot.

The final oscillogram in this set, Fig. 5/5, shows the effect of the HF oscillation on a pure tone of 800 c/s.

The audible effect of condition B-C was to introduce a hissing effect

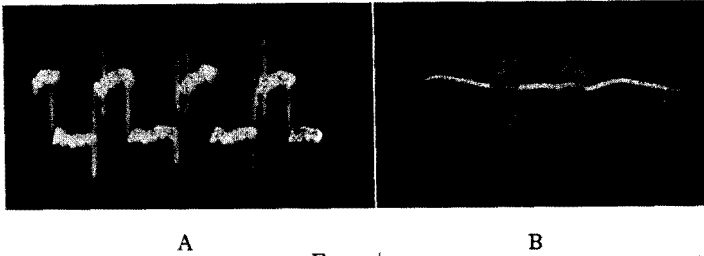

FIG. 5/4.

- A. Motor-boating and HF oscillation. No loudspeaker. Film speed 1.2 ins. sec.
- B. Motor-boating stopped by connection of speaker. Two shock-excited bursts of oscillation remain. Time base 50 m/s.

to the pure tone of A which was easily heard and could not be overlooked by the normal ear. Unfortunately, a listening test on music resulted in condition B-C being mistaken by experienced loudspeaker-

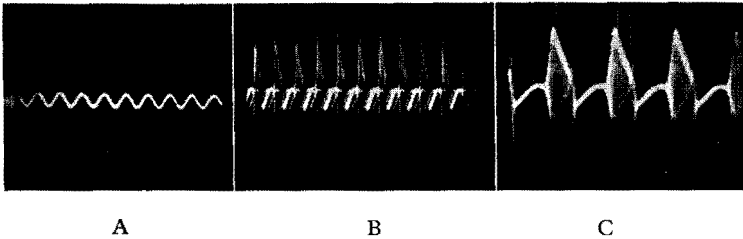

FIG. 5/5.—Effect of oscillation on a pure tone (Loudspeaker in circuit).

- A. 800 cycle note, with treble control at normal position. Time base 15 m/s.
- B. Oscillation caused by turning treble control to maximum. Time base 15 m/s.
- C. Same as B, but time base on oscilloscope altered to 5 milli-secs.

builders as an increase in HF response, instead of being classified as distortion, which it undoubtedly is. This only goes to prove how difficult it is to trace this type of trouble—which may be dangerous to valves and coils—by simple listening tests. In fact, an oscilloscope

is an invaluable aid in checking any amplifier for a wide range of suspected and unsuspected faults.

TREATMENT

The cure for oscillation produced by in-phase feedback due to coupling through the common HT power supply is to reduce the internal resistance of this supply at the frequencies involved. The connection of a large condenser across the HT supply will do this, and a value of 16–100 mfd is suggested, the larger the better.

A 16 mfd condenser has a reactance of 332 ohms at 30 c/s whilst 100 mfd has a reactance of but 53 ohms, thus too small a value will not effect a cure at low frequencies. It should be noted that this feedback effect can only take place over three or more stages of amplification, but serious difficulties can arise in an amplifier of high gain, and a more elaborate system of decoupling becomes necessary.

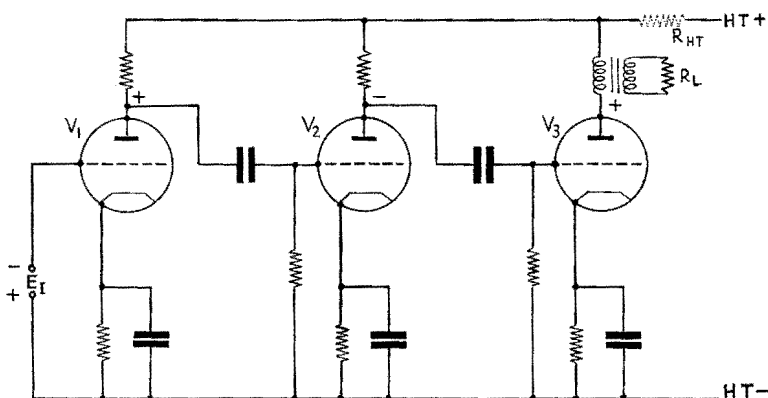

FIG. 5/6.—Three stage amplifier. The resistance of the HT supply forms a common coupling resistance to all stages.

In Fig. 5/6 is shown the outline of a typical amplifier. V_1 is RC coupled into V_2 , and V_2 into V_3 the output stage, which being a power valve will make large excursions of anode current. Ideally there will be no internal resistance in the HT battery or other source of HT supply but some will exist in practice (R_{HT} Fig. 5/6), and the large current variations in the anode circuit of V_3 will produce alternating voltages across R_{HT} . The valves V_1 and V_2 also deriving anode volts from the same source, will receive a DC potential with an AC potential superimposed. Taking the instant when the grid of V_1 is becoming more negative, its anode volts will be increasing due to reduced voltage drop across its anode load. The grid of V_2 will therefore be going positive and its anode negative, and the grid V_3 will be going negative and its anode positive. It will be seen that the variations at the anodes

of V_3 and V_1 are in step, and it is quite possible for the variation in HT voltage at the anode of V_1 to be quite as large as that caused by the input voltage on the grid. If this is the case the input could be removed and the system would continue to operate as an oscillator, supplying its own input at some frequency determined by the circuit values, and the value of the common coupling resistance. If in the audio range, this would give rise to the familiar noise of "motor-boating". The exact frequency of oscillation is difficult to forecast and may quite easily be above audibility, at 20 Kc/s or more, and its presence is difficult to detect, as already shown in Fig. 5/1.

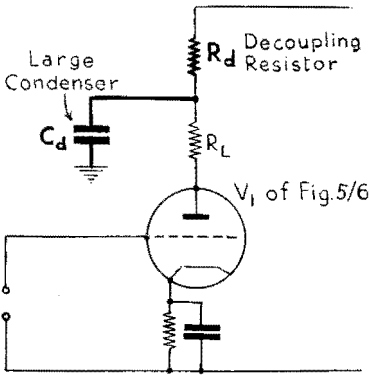

FIG. 5/7.—Decoupling the HT Supply.

Figure 5/7 shows the modification that can be applied to V_1 of Fig. 5/6. An additional resistance R_d is inserted between the HT supply and the load resistance R_L with a condenser C_d to the ground line from the junction of R_d and R_L .

The time constant in seconds of the system R_d and C_d is obtained by multiplying $R_d \times C_d$ where R_d is expressed in ohms and C_d in farads. To be completely effective the time constant should be such that it is longer than the time interval of any frequency to which the amplifier will respond. For example, 25 c/s takes $1/25$ th of a second for one complete cycle ($\cdot 04$ second). Suitable decoupling values would be 40,000 and $2 \pi f$, having a time

$$\text{constant of } 40,000 \times \frac{2}{1,000,000} \text{ sec.} = \frac{8}{100} \text{ sec.} = \cdot 08 \text{ sec. which gives}$$

an ample margin. If an increase of R_d is possible, bearing in mind the reduction of available HT (not usually serious in an early voltage amplifying stage where the grid voltage swing is limited), then C_d could be decreased in proportion; 80,000 and 1 mfd would give the same result as 40,000 and 2 mfd. A rule of thumb is to make $R_d = \frac{1}{5}$ of R_L with an appropriate value for C_d . The addition of the decoupl-

ing R_d and C_d will also assist in the reduction of hum when a mains HT supply unit is used, but this aspect is treated in the chapter devoted to Hum.

2. INSTABILITY

Whilst motor-boating is one particular form of instability, it has been indicated that supersonic oscillations may be taking place and these are unlikely to be caused by coupling due to the common supply, but to hidden factors such as valve inter-electrode capacitance. Fig. 5/8 shows an output stage with valve inter-electrode capacitances indicated.

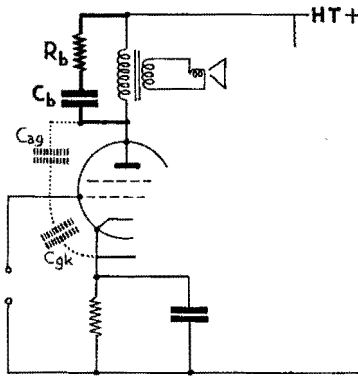

FIG. 5/8.—Feedback through inter-electrode capacitances causing oscillation in output stage. R_b and C_b act as tone control by reducing higher frequencies, thus preventing oscillation.

Typical values :

$$R_b = 10K \Omega$$

$$C_b = 0.01 \text{ mfd}$$

Due to phase shift in the transformer at high audio frequencies the capacity C_{ag} , small but nevertheless present even in a pentode (greater in an output pentode due to larger electrodes), will feed back enough energy into the grid, thus further shifting the phase, so that oscillation will take place. Pentodes and tetrodes are particularly prone to this trouble because they tend to produce more high order harmonics, and with increase of frequency the reactance of C_{ag} will decrease and so help to produce oscillation. An output pentode will normally have a resistance (R_b) and capacitance (C_b) in shunt with the transformer primary as Fig. 5/8, to reduce the high frequency response which is harsh and objectionable due to the presence of harmonics, and is intensified by the normal increase of loudspeaker coil reactance at high frequencies. The component R_b and C_b will normally remove the possibility of feedback and oscillation.

Further steps to reduce the possibility of oscillation are the inclusion of "Stoppers" in the grid, screen and anode circuits.

The presence of resistance in an oscillatory circuit damps the oscillations and may even preclude oscillation from starting. The grid stopper will not reduce the input voltage to the grid as normally no current flows in the grid circuit, and may be of a large value up to

0.1 megohm for example, bearing in mind limitations of resistance between grid and cathode. The presence of the capacity between grid and cathode also limits the size of grid stopper that one may introduce,

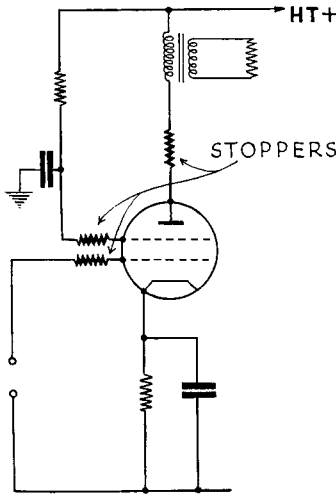

FIG. 5/9.—“Stoppers”. Resistances in anode, screen and grid leads reduce tendency to spurious oscillation.

as the grid stopper and the capacity (R and C_{gk} , Fig. 5/10) form a low pass filter and attenuate the higher frequencies. R_1 and C_{gk} behave as a potentiometer in which the reactance of C_{gk} becomes less with increase of frequency.

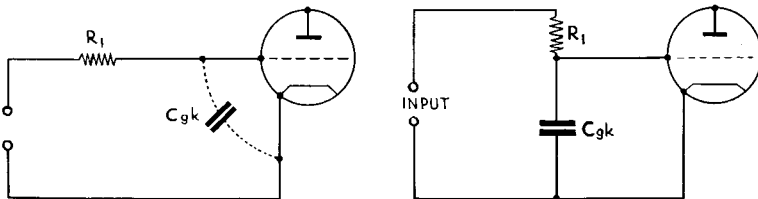

FIG. 5/10.—Diagram to illustrate formation of low-pass filter by grid stopper and capacity grid/cathode; higher frequencies are attenuated.

However, as considerable current flows in the anode circuit, both DC and AC, a large resistance cannot be tolerated due to the power lost therein, and a value from 5–50 ohms is suitable. When using a pentode or tetrode 47–470 ohms would be suitable values in the screen; anything greater would unduly reduce the screen potential.

To be completely effective, stopper resistors should be wired in circuit directly on to the pin of the valve base concerned.

Whilst continuous parasitic oscillation is fairly easy to detect, the triggered variety previously mentioned may require a Sherlock Holmes

DECOUPLING AND INSTABILITY

technique. The trouble may only arise during operation with a signal input, usually started off by a transient and rapidly dying away. It will cause muddiness of reproduction. A transient is a rapid build-up and dying away of signal and for checking purposes may be produced by a square wave generator. Comparison of the input and the output waveform on oscilloscope will reveal any differences. Distortion of the shape of the waveform will reveal amplifier deficiencies usually of the OP stage as a whole, whereas the addition of a "tail" of oscillations of high decrement will reveal parasitic oscillation.

The reason why a transient will produce oscillations is that the shock excites the resonant circuit of stray capacity and inductance, usually leakage, the resonance dying away rapidly due to the resistive losses of the circuit.

A square wave obviously starts with vertical transients, and contains harmonics up to and above audio frequency limits ; it is therefore the ideal "yardstick" for the characteristics in question.

CHAPTER 6

PUSH-PULL AMPLIFICATION

When the need arises for obtaining a great power output there are several ways of approaching the problem. First one thinks of using a larger valve with a greater anode dissipation. This is perfectly feasible as single output valves are capable of producing 20 watts of audio; the same result could be achieved by using two valves in parallel as shown in Fig. 6/1, where double the power output range of one valve would be obtained for the same grid swing.

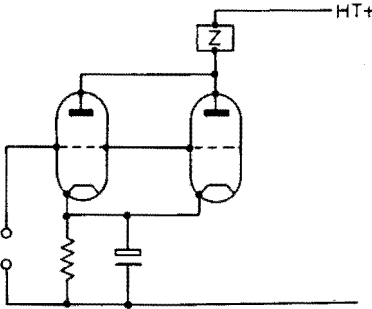

FIG. 6/1.—Valves connected in parallel to increase power output capacity.

Both systems would demand an output transformer capable of carrying the large anode current without saturation of the core. This requires a generous core which is expensive. Push-pull output probably has its greatest merits in that saturation of the core by the DC component is obviated. There are other important advantages; in fact, the writer considers the expense and complication of push-pull to be worth while even for an output of 4 watts because of the low distortion obtainable. Figure 6/2 shows two valves arranged in a push-pull circuit.

In the absence of signal input to the grid of V_1 , the quiescent anode current of the valves V_2 V_3 will be equal, or very nearly so, depending on how closely they are matched. Therefore the anode current in the two halves of the output transformer primary T_2 , flowing in opposite directions, will tend to cancel out the magnetising effect on the core of the transformer. This means that the transformer core will only need to provide sufficient primary inductance to give adequate loading at the lowest frequencies.

At any instant, the ends of the secondary winding of the input transformer T_1 will be at opposite potentials with respect to the mid-point which is connected to the common cathode, so that the grid of

PUSH-PULL AMPLIFICATION

one valve is swung positive at the same instant that the grid of the other is swung negative, hence the anode current of one valve is out of phase with that of the other. The net effect is that of two valves both delivering power to the load. A common analogy is that of two men sawing a

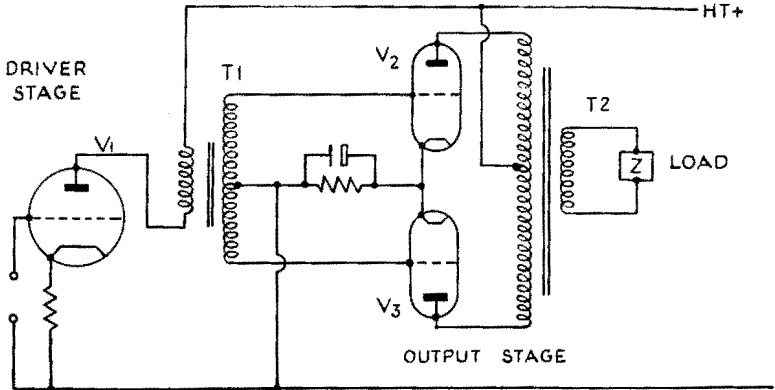

FIG. 6/2. Push-pull output stage.

tree trunk with a double-handed saw—one man pushes as the other pulls, and vice versa, with equal force (provided they are both working equally hard!).

In push-pull operation the even harmonics, 2nd, 4th, etc., are cancelled in the symmetrical anode circuit so that for the same output the distortion will be less than with parallel operation of the same pair of valves. This feature is of special importance when triodes are used as the distortion produced by a triode is very largely 2nd harmonic. Fig. 6/3 illustrates the grid characteristics of valves V_2 and V_3 showing

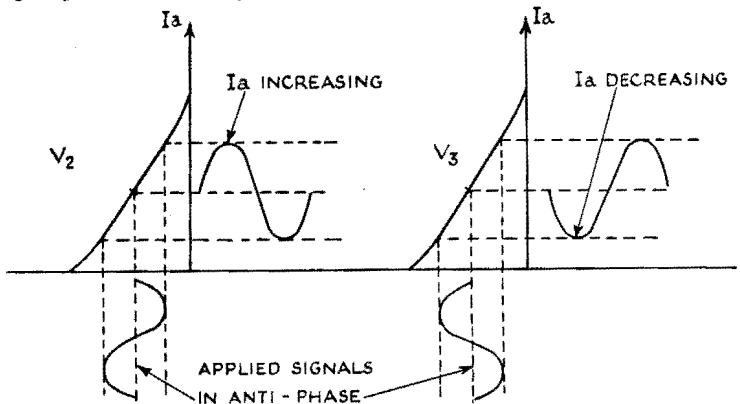

FIG. 6/3.—Grid characteristics of Valves in Push-pull.

that the grids are operated in anti-phase on the straight part of their characteristic, with mid-point biasing known as the class A condition. The exciting voltage measured between the two grids will be twice that required for one valve, or parallel valves, but this presents little difficulty in practice, and the transformer T1 in Fig. 6/2 readily enables the grids to be fed in anti-phase. Other methods of obtaining the "phase split" are described in Chapter 9.

The value of anode load for each valve is not the same as that required for single output working. The precise value is always quoted in the maker's published characteristics and is a figure arrived at by a careful computation of conditions that will give the minimum odd harmonic distortion.

The dominant harmonic with Power Pentodes is the 3rd, and there is very little reduction of distortion with push-pull operation. If, however, the load resistance per valve is decreased the effect is to increase the 2nd harmonic distortion which is cancelled out, and to decrease the 3rd harmonic, thus improving the overall performance. Beam Power Tetrodes have considerable 2nd harmonic, but less 3rd and higher order harmonics than pentodes and are thus very suitable for push-pull operation.

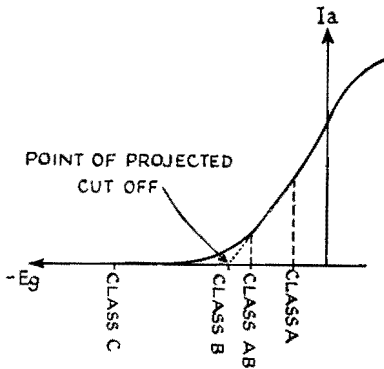

FIG. 6/4.—Classes of Bias.

So far the description of a push-pull amplifier has been taken to mean a pair of valves biased to the mid-point of their grid characteristic. This is referred to as Class A amplification. However, the valves may be biased slightly in excess of the Class A condition, normally to the point where the bottom curve is commencing (Fig. 6/4). This is referred to as Class AB biasing and the general effect is to step up considerably the power output available from a pair of valves as compared with the Class A condition, because each valve is contributing much greater anode current swings in the primary of the output transformer. Reference to Fig. 6/5 shows that each valve is driven

PUSH-PULL AMPLIFICATION

well beyond cut-off on the negative half cycle input, but that the current-swings to the positive half cycle of input "marry" in the primary of the output transformer to give a result which approximates the waveform of the input. The same pair of valves biased to the Class AB position may be driven even harder on their grids so that grid current is produced. This is referred to as the Class AB₂ condition. When no grid current flows it is referred to as the Class AB₁ condition. In both the Class AB₁ and AB₂ conditions greater output is obtained than in the Class A condition, but at the expense of fidelity. A pair of valves may be worked still harder by biasing them to the point of projected cut-off shown in Fig. 6/4. This is in effect biasing the valves almost to the point of cut-off and is known as Class B amplification.

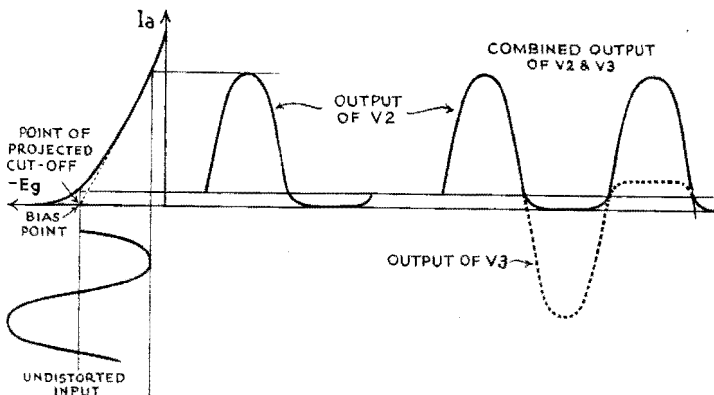

FIG. 6/5.—Operating condition for Valves in Class B Push-pull.

Class B operation would never be considered for high fidelity results ; its use is limited to public address work where high power at low cost is required. This statement is not intended to imply that PA equipment is usually designed on these lines. Very high standards of quality are nowadays provided and, indeed, expected.

CLASS C

A further method of biasing known as Class C involves biasing the valve to $\frac{1}{2}$ \times cut-off voltage and exciting the grids with a high input voltage. The " pips " of anode current of high value that will flow can be used to excite a tuned circuit which will " fill in " due to the fly-wheel action of such a circuit, but this is of course only applicable to radio frequency technique.

BALANCE

A problem that often worries the experimenter when dealing with push-pull circuits is the question of "balance". We have assumed

in this chapter that the pair of push-pull valves were identical in every way, that the grids were fed with exactly equal voltages, exactly 180° out of phase, that the loads for the anodes had exactly the same inductance and DC resistance—now let us come down to the hard facts of reality.

It is desirable that the pair of valves shall be reasonably alike and it is always possible to purchase a pair "matched" by the manufacturer. Matched is put in quotes because it is pretty certain that the valves even then will not have identical anode currents. It is impossible to do better than 1 mA in 50 mA, but 2 per cent. is nothing to worry about. The need for matched pairs arises to avoid possible differences of 20 per cent. which may occur when valves are selected at random.

The question of equal input voltages and opposite phase is dealt with in the chapter on Phase Splitters.

The value of load for the two halves of the transformer should be fairly closely matched. This is attained by having the same turns/ratio in the two halves of the transformer. In other words, the number of turns in the two halves of the primary winding must be identical, regardless of the effect on the DC resistance of each half. As a coil is wound, the size increases and the length of wire per layer increases at a proportionate rate. This may result in a difference of 10 to 25 per cent. between the resistance of the inner and outer sections. Many amateurs are unduly worried by such differences.

In a large, expensive transformer, wound with 4, 6 or even more primary sections (and 3, 5 or more secondaries neatly sandwiched to reduce leakage inductance) the different resistances are balanced by suitably "marrying" long and short primary sections. It should nevertheless be remembered that the main object of section-winding is to improve the coupling between primary and secondary; the equalising of resistance is of secondary importance (in spite of being in the primary).

In a small or medium size transformer, considerations of space and cost usually make section-winding an impracticable proposition. It so happens that the need is less because the leakage inductance is *ipso facto* lower in a small winding.

The actual effect of a difference of 10 per cent. in resistance values works out as follows :

The load is actually made up of two parts—the DC resistance and the inductance. The reactance of the inductance X_L is equal to $\omega L = 2\pi fL$. Therefore the impedance $Z = \sqrt{R^2 + X_L^2}$ where R is the DC resistance. It will be instructive to take a likely value for L and see what part of the total load R actually is. A triode valve of $r_a = 1,000$ ohms requires a load of about 3,000 ohms, 16H would be a very generous primary inductance, and say 100 ohms of DC resistance. X_L at 30 cycles would equal 3,014 ohms approx. Thus the DC

PUSH-PULL AMPLIFICATION

resistance is approx. $3\frac{1}{2}$ per cent. of the load at 30 cycles, and but 0.33 per cent. at 300 cycles. This should show that small differences in resistance will have but little effect on the effective load. Due to the direct component of anode current there will be a voltage drop across the primary. Taking likely figures, 50 mA for a certain Tetrode's anode current and 10 per cent. difference in primary resistances, 100 ohms one half and 110 ohms the other, we arrive at the following result :

$$\begin{aligned} \text{The voltage drop across one} &= \frac{50 \times 100}{1,000} \text{ Volts} = 5\text{V.} \\ \text{,, ,, ,, ,, other} &= \frac{50 \times 110}{1,000} \text{ Volts} = 5.5\text{V.} \end{aligned}$$

The difference of 0.5 volt in the anode voltage of one valve will not affect its anode characteristics and load line in any way and will not upset the push-pull working.

In all mass produced output transformers as used in the average radio set, the primary winding is continuous, with tappings brought out as required. The secondary winding is put on either before or after the primary. In rather more expensive types, one half of the primary is wound on, the coil is removed to another machine to receive the secondary winding, and then returned to the first machine for completion. These antics have the effect of reducing the leakage inductance, increasing the cost of production, and intensifying the difference in resistance between the two primary windings—which may now amount to 25 per cent. The voltage drop in a typical case with 50 mA, 200 ohms one half and 250 ohms the other, would be 10V and 12.5V respectively. The difference in anode volts is still only 2.5V.

From a quality point of view, the reduction of leakage inductance is more important than the increase of disparity in the resistance readings.

CHAPTER 7

NEGATIVE FEEDBACK

There are two types of negative feedback—current and voltage—both of which are investigated and explained in this chapter.

Voltage feedback is the form usually employed for the improvement of amplifier performance, at the expense of available gain. It would remove ambiguity if the use of the initials “NFB” could be discontinued in favour of “CFB” for current feedback and “VFB” for voltage feedback.

For the benefit of those readers who are new to the subject, or possess only a vague idea of its function, a few illustrations of the effect of NFB (voltage type) on amplifiers and loudspeakers now follow. So far as the loudspeaker is concerned, it will be observed that 14 db feedback with uncorrected tetrode output was adequate in levelling the response of the amplifier reasonably well, and also in removing the bass resonance of the speaker. This 14 db application of feedback

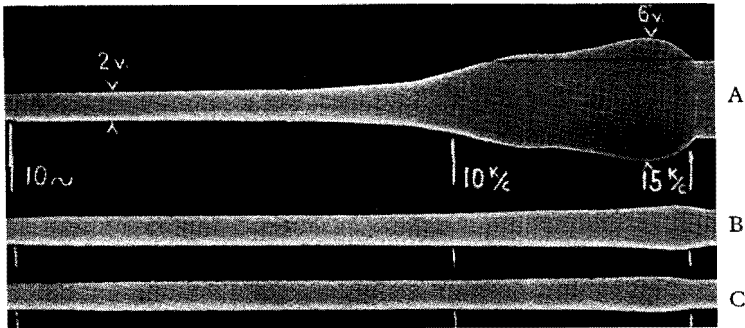

(A) NFB Zero (B) 14 db (C) 26 db

FIG. 7/1.—Oscillograms showing effect of NFB on tetrode response.

reduces the source impedance from 100 to 4 ohms, where the optimum load is matched to 15 ohms. Increasing NFB to 20 db lowers the source impedance to 2 ohms, and 26 db to 1 ohm. It is evident that the reduction of source impedance is becoming more and more difficult. It is therefore absurd, *so far as the loudspeaker is specifically concerned*, to increase the NFB beyond a reasonable point of safety and stability.

The use of a variable resistance for the control of feedback in home-built amplifiers is an attractive proposition, which would in some cases

NEGATIVE FEEDBACK

lead to the elimination of HF squirting and to prevention of cruelty to loudspeakers, transformers and valves.

FREQUENCY RESPONSE

Figure 7/1 shows the effect of NFB on the response of uncorrected tetrodes, as seen by oscilloscope. The glandular swelling is neatly removed by 14 db feedback.

The 26 db curve is identical with the response of the AF oscillator as fed into amplifier.

SPEAKER RESONANCE

No apology need be made for including details of loudspeaker performance in a book on amplifiers. After all, the improvements which are achieved in amplifier quality must culminate in improved speaker performance, otherwise they become abortive; research should be co-ordinated as much as possible.

A very simple test for the effect of NFB on speaker resonance is to measure the volts developed in the voice coil. The following Table 2 gives results with the tetrode amplifier of Fig. 7/1, already used in Chapter 5, and a typical 8-in. speaker mounted on a small baffle, with voice coil resistance of 10 ohms.

TABLE 2
Effect of voltage NFB on cone resonance.
8-in. unit on baffle.

Approx. Source Impedance	Feedback Tetrodes	Voice coil Volts at 500 c/s into speaker	Voice coil Volts at cone resonance	Frequency of cone resonance
100 ohms	0 db	3.5	10.0	85 c/s
13 "	6 "	3.5	6.8	82 "
10 "	8 "	3.5	6.2	80 "
4 "	14 "	3.5	4.5	77 "
2 "	20 "	3.5	4.0	74 "
1 ohm	26 "	3.5	3.75	71 "
9.5 ohms	Oscillator direct to speaker	3.5	6.0	80 "

The addition of the voice coil load to the amplifier reduced the instability at 26 db mentioned in Chapter 5, Table 1, but the 150 Kc/s oscillation pictured in Fig. 5/1 must have been present as an invisible guest.

For the tests of Table 2 the power was in every case set at 3.5 volts at 500 c/s into the loudspeaker. The source impedance of the AF

N.B. The oscillator output stage was triodes in push-pull without NFB.

oscillator at this frequency was about 10 ohms. It is interesting to note that the voltage rise at cone resonance was in this case about the same as the rise with tetrodes with 8 db feedback, where the internal impedance is also 10 ohms.

Another interesting disclosure, which the writer had not previously observed, is the fact that the frequency of the cone resonance goes down as the intensity of the resonance is reduced by feedback. This is an obvious advantage; but whether it is always desirable to absorb all the bass resonance of a loudspeaker by feedback is another question. It is conceivable that where the frequency of the resonance is very low it may be an advantage to retain some of it in order to make up for losses in other parts of the reproducing system, and for the inefficiency of small listening rooms at very low frequencies.

Not infrequently, keen listeners complain of lack of bass after installing an amplifier with a high damping factor, which tends to make the cone move with constant velocity at low frequencies. A similar effect may be produced by using a magnet with very high flux density, but results are always affected by the mass of the cone and coil. For example, flux density of 13,000 lines with a 1-in. centre pole—total flux 54,000 lines—completely damps the cone resonance of an average 8-in. speaker; but the same flux density with a 1 $\frac{3}{4}$ -in. centre pole—total flux 145,000 lines—does not succeed in damping the cone resonance of the average 12-in. speaker. A really expensive 17,000 line magnet does the trick here, but some users then complain of lack of bass and write the makers insinuating they have been swindled! It should always be remembered that "perfection" in a single link in a reproducing chain is still impossible, and usually undesirable.

The following oscillograms show the effect of NFB on resonance, linearity and response in a more interesting and vivid way. The oscilloscope is far more sensitive in recording loudspeaker performance than the mechanical stylus used in conventional pressure response curves. The free-field readings were taken with the loudspeaker mounted in the wall of the research room, facing into a large field at a height of some 16 ft. above ground level; they are, therefore, free from any special characteristics which may be associated with anechoic rooms.

Figure 7/2 illustrates the response of a typical 12-in. speaker used with the tetrode amplifier, with snapshots of the waveform produced by the speaker at 60 and 50 cycles per second, under different conditions of feedback.

The cone resonance at 60–65 c/s with zero NFB is very pronounced. Frequency doubling and trebling are shown as shadows in the trace, and disappear at about 75 c/s. With 14 db of feedback the bass resonance disappears, but there is still some distortion at 60 and 50 c/s. The LF waveform is again improved by increasing the NFB to 26 db, but the shape is still non-sinusoidal at 50 c/s.

It is very important to note here that any steps which are taken to

NEGATIVE FEEDBACK

reduce the amplitude of cone movement at resonance (*e.g.* reflex loading) automatically improve the waveform by reducing frequency doubling. It follows therefore that the difference between the wave-

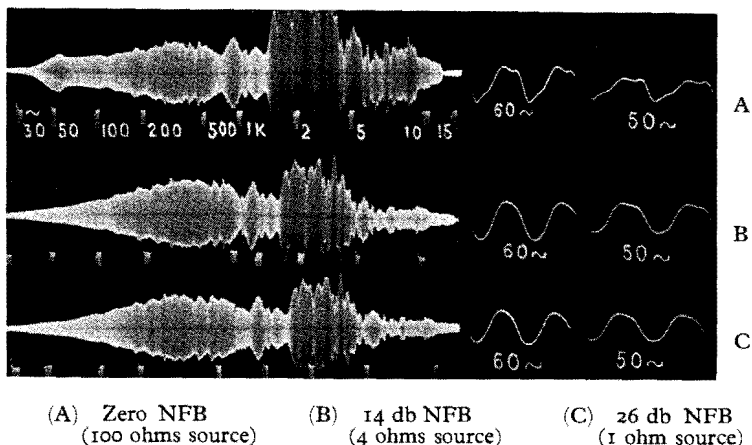

(A) Zero NFB (100 ohms source) (B) 14 db NFB (4 ohms source) (C) 26 db NFB (1 ohm source)
 FIG. 7/2.—Free-field response of 12-in. unit with corrugated cone suspension, plus waveform at 60 and 50 c/s. Input 3.5 volts at 500 c/s. Mic. 12 ins. on axis.

form at A and B is due to reduced cone movement as well as to improved quality from NFB, whereas the difference between B and C is due entirely to the improved amplifier quality from the extra feedback. (The possibility of distortion from HF instability is being ignored here.)

Before leaving Fig. 7/2, a word must be said about the response in the region of 1,000 c/s upwards. The HF output is reduced with increase of feedback—as one would expect after seeing Fig. 7/1—but the rise in the region of 1,500 to 3,000 c/s cannot be blamed entirely on tetrodes, nor can it be entirely removed by NFB. Unfortunately, it is in the nature of loudspeaker cones to display a range of maximum efficiency usually covering between one and two octaves in extent: the smaller the cone, the higher the frequency range of this rise in output. With a small cone and very light voice coil, it is possible to cover the range of 5 to 15 Kc/s with remarkable efficiency. Incidentally, these oscillograms, by reproducing the full positive and negative half-cycle of the sound waves, make the rise in output appear twice as bad as it really is, compared with the normal sound pressure curves, so there is no need for readers to consign their 12-in. speakers to the lumber-room as a result of shock from seeing these illustrations.

The next illustration, Fig. 7/3, shows results with the same speaker as the previous one, but fitted with cloth suspension. It will be observed that the cone resonance has gone down from 65 to 45 c/s. There is

still frequency doubling at 50 c/s with zero NFB, but it has largely disappeared at 60 c/s.

As regards the HF performance, the tendency for soft surrounds

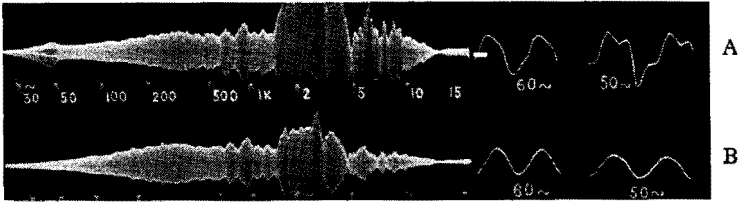

(A) Zero NFB (B) 26 db NFB

FIG. 7/3.—Free-field response of 12-in. unit with cloth suspension. Conditions as in Fig. 7/2.

to smooth out the sharper peaks of resonance is discernible by comparison with Fig. 7/2.

REFLEX LOADING

The third picture in this series, Fig. 7/4, is intended to show the effect of NFB in reducing resonances associated with reflex loading. A typical 12-in. speaker with corrugated cone suspension was mounted

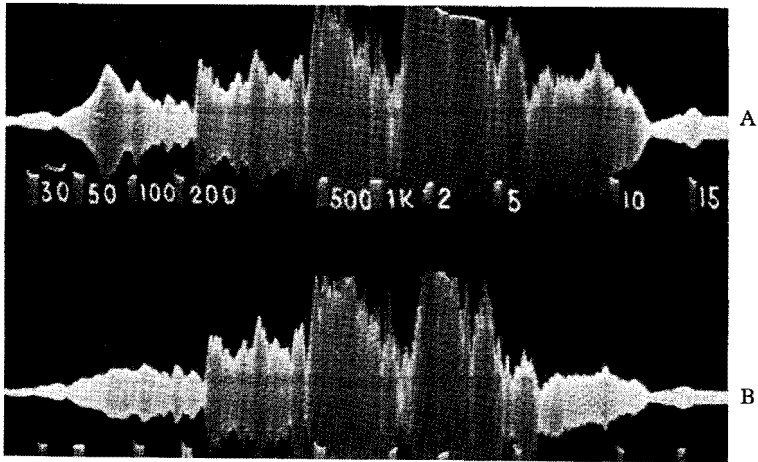

(A) Feedback Zero (B) 14 db

FIG. 7/4.—Live-room response of 12-in. unit in reflex cabinet, showing effect of NFB on resonances at 40, 75 and 120 c/s. Tetrode source. Input 3.5 volts into 12 ohms at 500 c/s. Mic. 12 ins. on axis.

NEGATIVE FEEDBACK

in a reflex cabinet with inside dimensions of 32 ins. \times 15 ins. \times 16 ins. and a port area of 9 ins. \times 3 ins. The readings were taken in a room 16 ft. \times 15 ft., with the cabinet standing in a corner. The start of room reflections is clearly shown. (In fact, the use of oscillograms may greatly enhance the value of live-room readings in assessing speaker performance.)

There is a fundamental cone resonance at 40 c/s which is (fortunately?) hardly affected by NFB, but the main resonance at 75 c/s is virtually removed, and the next one at 120 c/s is rounded off.

Although outside the purpose of the present investigations, it is interesting to note that the first outbreak of room reflections begins at about 220 c/s, with still stronger effects at 500 c/s. These are related to the corner position. Moving the cabinet away from the corner produces strong reflection effects as low as 120 c/s.

PRACTICAL APPLICATION

Two references have already been made to actual examples of negative feedback; one when describing cathode biasing where it was seen that the omission of the bypass condenser from across the cathode resistor reduced the effective input voltage to the amplifier, and the other when describing the split load type of phase splitter which was seen to be an exaggerated version of case one. Sundry hints have been made that NFB would prove to be a panacea for all ills, but whilst this is not strictly true, it will be seen from this chapter that its discriminating application can be most beneficial in the reduction of harmonic distortion and in generally improving amplifier performance. NFB is a vast subject; it is hoped that the survey given will enable readers to acquire a fair appreciation of its commoner uses.

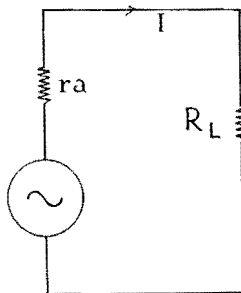

FIG. 7/5.—Equivalent circuit of an amplifier with an output of μ times the input

voltage. $I = \frac{\mu E_g}{r_a + R_L}$ (Ohm's law).

CURRENT FEEDBACK

Reference to Fig. 7/5 shows the now familiar equivalent circuit of an amplifier. Consideration of this circuit will show that the current in the circuit will depend on the application of Ohm's law, and that it will be equal to $\frac{\mu E_g}{r_a + R_L}$ amps.

Referring now to Fig. 7/6 with the cathode resistance R_K un-bypassed, if the value of the anode load is decreased, say by connection of another loudspeaker, then the signal current through the circuit

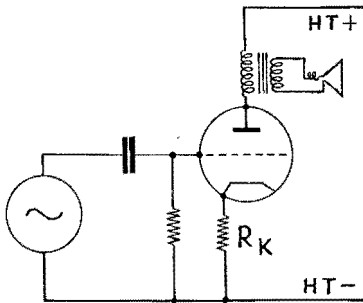

FIG. 7/6.—Bias resistance R_K un-bypassed giving CURRENT NFB in an output stage.

will increase and therefore the voltage developed across R_K will be greater. This will reduce the effective input volts still further, causing a decrease in anode current which tends to offset the original rise due to the reduced value of load R_L , *i.e.* the feedback is tending to make the valve into a *constant current generator*.

Now if the current has been maintained constant it would appear that the total value of resistance in the circuit of Fig. 7/5 has remained constant. But the load has been reduced by parallel connection of an additional speaker, therefore the anode resistance (r_a) must have been increased. This is undesirable in an output stage. The advantages of low anode resistance giving a high value of damping factor have already been explained.

We can conclude that current NFB is not desirable in the output stage, and the omission of the cathode bypass condenser is to be deprecated, although this is often done in the mistaken belief that some NFB is better than none—regardless of type.

On the other hand, current feedback can often be usefully employed to raise the input impedance of a valve. An analysis of the arrangement is made later in this chapter.

VOLTAGE FEEDBACK

An output circuit of this type is shown in Fig. 7/7.

A proportion of the output voltage has been fed back into the grid/cathode circuit by means of the potentiometer chain C, R_1 and R_2 . The anode being in anti-phase with the grid, will develop a voltage across R_2 opposing the grid voltage E_g , and effectively reducing the voltage input between grid and cathode. Assuming that r_a (the anode resistance) is high compared with R_L (the load resistance), and R_L is increased, say due to a speaker resonance in the case of an output stage, then the voltage across the load will tend to rise. This, however, will

NEGATIVE FEEDBACK

increase the feedback volts and so tend to reduce the input volts and cancel the original rise in output volts. This means that voltage NFB tends to make the valve into a constant *voltage* generator. If the voltage

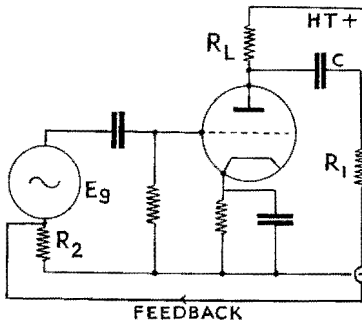

FIG. 7/7.—Amplifier with a fraction of the output *voltage* fed back in anti-phase to the input.

across the circuit of Fig. 7/5 tends to remain steady, it is as if the total resistance load on the generator is constant. As R_L the load resistance is known to have increased, the effect of voltage NFB is an apparent reduction of the anode resistance, and so is a desirable state of affairs in the output stage, as seen in Chapter 4 on the output stage.

Figure 7/7 is not a practical circuit as it is nearly always necessary to have one side of the input to an amplifier earthed, and this arrangement would make earthing impracticable. The presence of C is necessary to act as a blocker to the HT voltage, and its value in the feedback network would have to be chosen with due care to ensure that feedback did not take place at different values for different frequencies (unless so desired). If C is small, then more feedback will take place at high frequencies than at low, allowing bass notes to receive less attenuation, thus giving a form of tone control which has decidedly useful applications.

PHASE SHIFT EFFECTS

When thinking of phase relationships in connection with NFB it should be remembered that by definition NFB is feedback which has a component out of phase with the input voltages. Ideally the feedback should be 180° out of phase at all frequencies but the presence of a reactive component will mean that the phase shift can be something other than 180° .

Figure 7/8 shows a vectorial diagram. If e is the input voltage, the output voltage E and thus the feedback voltage BE (where B is the fraction fed back) will ideally be 180° out of phase. If there is a change of phase due to a reactive component the output voltage may be as shown at E_1 , and the feedback voltage BE will be at the angle θ with OE . The effective feedback voltage is therefore reduced to OA ,

($BE_1 \cos \theta$). When the angle θ is 90° , there is no feedback voltage, and if θ exceeds 90° there will be an *in phase* feedback voltage giving positive feedback and instability.

A single RCC stage can never cause an undesirable phase angle

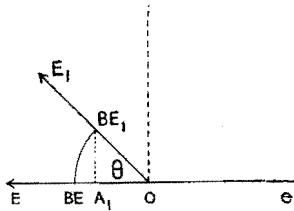

FIG. 7/8.—Vectorial diagram of feedback voltage less than 180° out of phase, showing how magnitude of effective feedback is reduced from OBE to OA. Method of arriving at actual feedback voltage where a phase shift other than 180° is involved.

rotation of more than 90° , even at the extreme limits of frequency where there is the greatest possibility of phase shift. Therefore feedback over a single stage is safe from the risk of instability.

If feedback is applied over two or more RCC stages it is possible for regeneration to occur at the extreme ends of the frequency scale, although by careful design stability can be achieved up to three or even four stages if the degree of feedback is not too high.

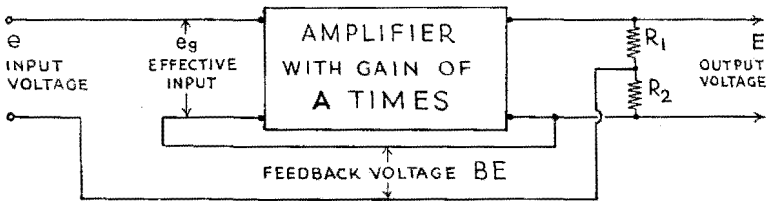

FIG. 7/9.—Block schematic of voltage feedback circuit.

Figure 7/9 shows a block schematic for NFB of the voltage type. A potential divider, R_1 and R_2 , across the output of the amplifier feeds back a proportion of the output voltage in opposition to the input voltage e , leaving a net input of e_g to the grid of the first valve.

The *fraction* of voltage fed back, called B , is equal to $\frac{R_1}{R_1 + R_2}$. If no voltage is fed back, that is $e = e_g$, then the basic gain of the amplifier, called A , will be the ratio of the input and output voltages, that is $A = \frac{E}{e_g}$. If feedback is now applied, the input volts e will have to be raised to obtain the same output voltage E , and the new gain of the amplifier, A_1 , will equal $\frac{E}{e}$; this value for A_1 will be less than A .

NEGATIVE FEEDBACK

Now e is equal to the sum of the input volts to the grid circuit, e_g , and the feedback volts, BE , but as the feedback factor B is negative for negative feedback, $e = e_g - BE$. Thus A_1 may also be expressed

$$\text{as } \frac{E}{e_g - BE}.$$

The *Gain Reduction Factor* due to feedback can be expressed as the ratio of the old gain without feedback to the new gain with feedback, that is: $\frac{A}{A_1}$, but $A = \frac{E}{e_g}$ and $A_1 = \frac{E}{e_g - BE}$. $\therefore \frac{A}{A_1} = \frac{E/e_g}{E/e_g - BE} = 1 - \frac{BE}{e_g} = 1 - BA$.

The block schematic of Fig. 7/9 forms the basis for a practical circuit shown in Fig. 7/10. This leaves room for experiment on an existing amplifier.

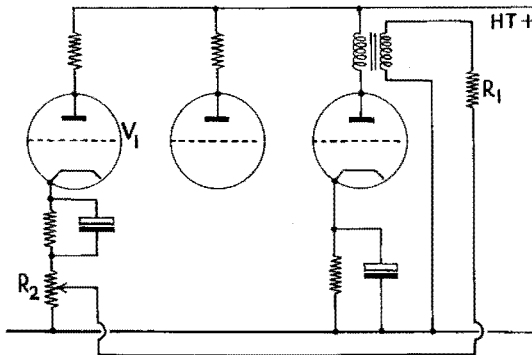

FIG. 7/10.—Typical NFB circuit (with potentiometer control) over three stages.

The feedback is taken from the secondary of the output transformer. One side of this is earthed and the feedback network comprises R_1 and R_2 . R_2 is a potentiometer of, say, 200 ohms, and R_1 is 800 ohms. With the slider of R_2 at the end nearest the cathode of V_1 , 20 per cent. feedback would be obtainable, variable down to zero at will.

If, on switching on, the amplifier gives a violent moan, one can conclude that positive feedback has been inadvertently applied. It should be switched off hurriedly, and the connections to the secondary of the output transformer reversed.

It is always advisable to apply a minimum of feedback when first checking for sense of feedback.

One should not be surprised if an amplifier of three stages as shown, or even two stages, to which the experiment can equally well be applied, oscillates when a large measure of feedback is applied. To check if

the feedback circuit is working, the connection to the slider of R_2 can be broken and a rise in gain should be observed.

EXAMPLE: Taking a practical example, if 20 per cent. feedback is employed, the fractional feedback voltage B will be $\frac{E \times 20}{100}$ or 0.2 E . Assuming the amplifier without feedback had a gain A of 20 times, then the new gain A_1 will be $\frac{A}{1 - BA} = \frac{20}{1 - (-0.2 \times 20)}$
 $= \frac{20}{1 + 4} = 4.$

Another way of expressing the same thing, which is often employed, is to say that the gain with feedback is equal to the gain without feedback divided by $1 + AB$. Using the figures above: $A_1 = \frac{20}{1 + (20 \times 0.2)}$
 $= \frac{20}{5} = 4.$ This latter expression is more convenient if not strictly accurate, as the fact that B is negative in the first expression can, and often does, lead to errors in calculation!

CONCLUSIONS TO DATE

- (1) Voltage feedback lowers the output impedance of a valve.
- (2) As a result of (1), better damping of the loudspeaker resonances is obtained.
- (3) Voltage feedback reduces the gain of an amplifier.
- (4) As the gain is reduced, so is the available output; this can be counterbalanced to some extent by providing a bigger signal input to the amplifier, but this may necessitate a further stage of amplification, with more distortion.
- (5) Voltage feedback can cause instability in an amplifier due to phase shifts at extremes of frequency producing positive feedback. These phase shifts can arise from two main sources:
 - (a) An insufficiently sectionalised output transformer with a high leakage inductance producing phase shift at high frequencies. This applies most particularly when the feedback is taken from the secondary winding, which is usually desirable to correct for distortion arising in the transformer.
 - (b) Inadequate size of interstage coupling condenser causing phase angle rotation at the lower frequencies.

NEGATIVE FEEDBACK

OTHER EFFECTS OF NFB

The next sections deal with other effects of NFB, and may well be skipped on a first reading, as they are summarised at the end of the chapter.

THE EFFECT OF VOLTAGE FEEDBACK ON FREQUENCY RESPONSE

If an amplifier has different gains at various frequencies due to deficiencies of one kind or another, the application of feedback will tend to make the gains at these frequencies more nearly equal.

Let A = gain of amplifier at one frequency.

Let X = gain of amplifier at another frequency.

The ratio of gains without feedback will be $\frac{A}{X}$.

With feedback the new gains will be : $A_1 = \frac{A}{1+BA}$

$$X_1 = \frac{X}{1+BX}$$

and the ratio of gains with feedback will be :

$$\begin{aligned} \frac{A_1}{X_1} &= \frac{A}{1+BA} \bigg/ \frac{X}{1+BX} \\ &= \frac{A}{1+BA} \times \frac{1+BX}{A} = \frac{A}{X} \times \frac{1+BX}{1+BA} \end{aligned}$$

This equals the ratio of gains without feedback multiplied by the factor $\frac{1+BX}{1+BA}$.

Assuming the gain A was 20 and the gain X was 25, the new ratio of gains will be with 20 per cent. feedback :

$$\begin{aligned} &\frac{20}{25} \times \frac{1 + (.2 \times 25)}{1 + (.2 \times 20)} \\ &= \frac{20}{25} \times \frac{1 + 5}{1 + 4} = \frac{20}{25} \times \frac{6}{5} = \frac{120}{125} \end{aligned}$$

The ratio of 120 : 125 = 96 per cent. is considerably better than 120 : 150 = 80 per cent., thus demonstrating that voltage NFB tends to even out the gain of an amplifier at all frequencies.

THE EFFECT OF VOLTAGE FEEDBACK ON HARMONIC DISTORTION

The application of voltage NFB will assist in reducing harmonic distortion generated within the amplifying stage itself, and a proof, not entirely rigorous, but giving a close approximation for practical purposes is appended.

Let D = distortion voltage in the output without feedback.

Let Y = distortion voltage in the output with feedback.

Now the distortion voltage fed back to the input will be BY , but at the input there is no component at this frequency, so no cancellation can take place, and the fed back voltage is amplified, giving an output of ABY . This amplified distortion is out of phase with the original distortion voltage and the resultant voltage will be :

$$Y = D - ABY$$

$$\therefore Y + ABY = D$$

$$\therefore Y(1 + BA) = D \therefore Y = \frac{D}{1 + BA}$$

From this it can be seen that the harmonic distortion is reduced by a factor approximating to the gain reduction factor.

THE EFFECT OF VOLTAGE FEEDBACK ON AMPLIFIER NOISE

The inevitable circuit noise generated in an amplifier will tend to be reduced in the same way that harmonic and frequency distortion is "ironed" out by feedback, but what one gains on this particular swing one may lose on the roundabout of an extra stage to make up for the gain lost by feedback. There is little advantage in using feedback on the early stages of amplifiers handling very small voltages where distortion is not likely to creep in.

THE EFFECT OF CURRENT FEEDBACK ON INPUT IMPEDANCE

Figure 7/11 shows a valve amplifier in which a resistance R_1 has been inserted in the cathode circuit. The alternating anode current will have to flow through R_1 and a voltage will be developed across it in opposition to the input voltage, *i.e.* current NFB.

Now the input impedance, Z , will equal $\frac{E}{I}$ and in the absence of R_1 would equal R_g , the grid leak, neglecting inter-electrode capacitances and Miller effect for the moment. When feedback is applied the effec-

NEGATIVE FEEDBACK

tive voltage appearing across R_g will be lessened and I will fall. If I is reduced then the value of Z in the expression $Z = \frac{E}{I}$ will increase.

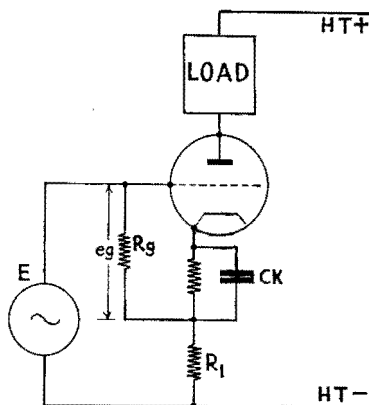

FIG. 7/11.—Useful current feedback circuit; the presence of R_1 will give rise to current feedback and one effect is to increase the input impedance.

Practical figures may serve to clinch the argument.

Assume E , the input = 1 volt, R_g , the grid leak = 0.25 megohm, then without feedback $I = \frac{1 \times 10^6}{0.25 \times 10^6}$ micro-amps = 4 μ A. With feedback the effective input voltage across R_g (eg), might well be reduced to 0.25 volt, then $I = \frac{0.25 \times 10^6}{0.25 \times 10^6} = 1 \mu$ A, and now the input impedance = $\frac{1}{1 \times 10^6} = 1$ megohm.

It will be seen that with an increase of feedback, the voltage across the grid leak will be made smaller, and the input impedance will rise in proportion, with, of course, increasingly reduced stage gain.

When the Miller Effect was discussed, it was seen that the input capacitance to a valve was much greater than might be expected, thereby reducing the input impedance so that the effect of current feedback will largely wipe out Miller effect to great advantage, particularly on the input circuits for crystal pick-ups and microphones.

In the circuit of Fig. 7/11, the omission of the cathode resistor bypass condenser will give the same effect as the inclusion of R_1 , but if the value of resistance needed to get adequate feedback is greater than is required for biasing purposes, then R_1 can be included and C_K omitted in addition.

FINAL SUMMARY OF EFFECTS OF NFB

- (1) A reduction of harmonic distortion.
- (2) Improved linearity of frequency response.

- (3) A reduction of noise.
- (4) A reduction of gain.
- (5) A modification of internal resistance of an amplifier.
- (6) Greater stability with changing supply voltages, ageing valves, and difference between individual valves.
- (7) A modification of input resistance to an amplifier.

Some not so obvious practical implications of these effects are to be noted as being of considerable importance.

Possibly one of the biggest problems in the mind of the constructor is concerned with speaker matching; how far can one mis-match before trouble starts?

Referring back to the section on voltage feedback it was found that the feedback tended to offset any change in the load resistance of the valve. The load resistance in the case of an output valve is the loudspeaker, and changes on the secondary of the transformer are reflected back to the valve's anode circuit. It is not suggested that the reader would be so casual as to connect a 3 ohms speaker to a transformer wound to match a 15 ohms speaker*, but if this experiment is carried out, using an amplifier with a heavy degree of feedback, it is very surprising how tolerant the amplifier has become. The main effect will be a restriction of power output available, and a loss of bass, due to the valve being underloaded. If a 15 ohms speaker is connected to a 3 ohms secondary, there will be loss of power, without the attenuation of bass. Another aspect of the same problem would be the use of a transformer ratio of, say, 26 : 1 with valves and loudspeaker calling for a ratio of 20 : 1. With NFB, such liberties may be taken with impunity.

Heavy NFB is used in commercial amplifiers, say in a school, where the load may vary from one speaker, demanding 3 watts, to eight demanding 24 watts, and almost perfect regulation is achieved. Listening at the first speaker to be switched on, no change in level is perceptible when the other seven are switched in circuit, and the quality remains remarkably uniform.

METHODS TO COUNTERACT INSTABILITY

In-phase feedback may occur in audio amplifiers over which a large amount of NFB has been applied. Phase shifts at extremes of frequency in various parts of the circuit, mainly the output transformer, produce instability either continuously or on peaks and transients only, but always disagreeably.

Instability usually occurs in a feedback amplifier at a high audio or supersonic frequency. The response of a quite usual amplifier is

*I often do this.—G.A.B.

fairly flat up to some high frequency and then drops off sharply. This rapid fall off means that the phase shift runs rapidly up to 180° before the amplitude has dropped appreciably, and instability results. The old dodge of applying condensers across anode loads of RC coupled stages may work by reducing the amplification rapidly but is not necessarily a cure. What is really required is a stabilising device that will provide attenuation without phase shift. The arrangement in Fig. 7/12 will practically meet the requirement because the "tailing off" of the high frequency response is gradual and once the phase

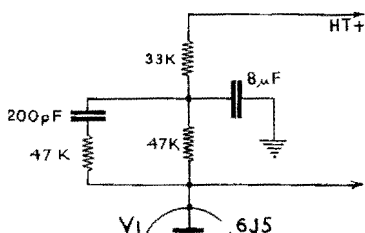
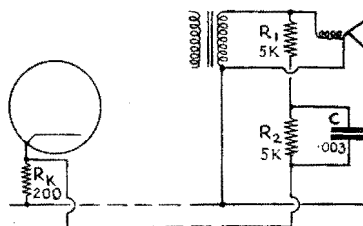

FIG. 7/12.—Modification of anode load giving a gradual fall of amplification with rise of frequency, thus avoiding large phase shift. Values are those of Williamson amplifier.

shift peak is passed the phase displacement remains small up to several hundred Kc/s and so the danger of high frequency parasitics is lessened. This circuit is used in the Williamson amplifier.

FIG. 7/13.—NFB circuit in which feedback increases with rise of frequency due to shunting of R_2 by C.



The arrangement of Fig. 7/13 is particularly valuable for obtaining a high stability margin under conditions of wide changes in load, and for applying to awkward cases. The resistor R_K , the cathode resistor of an early valve, has feedback applied across it from the secondary of the output transformer by means of the network R_1 , R_2 and C. At low frequencies the reactance of C is made great and the feedback is proportional to $R_K/R_K + R_1 + R_2$. At the higher frequencies the presence of C corrects for the phase shift introduced by the leakage inductance and self capacity of the output transformer.

Yet another method of cancelling phase shift effects consists of shunting the two halves of the primary of the output transformer by condensers as in Fig. 7/14.

The capacity tends to reduce gain with increase of frequency so that as the critical frequency is approached where leakage reactance of the output transformer is liable to cause instability, the gain has fallen to such a degree that there is not enough positive feedback to

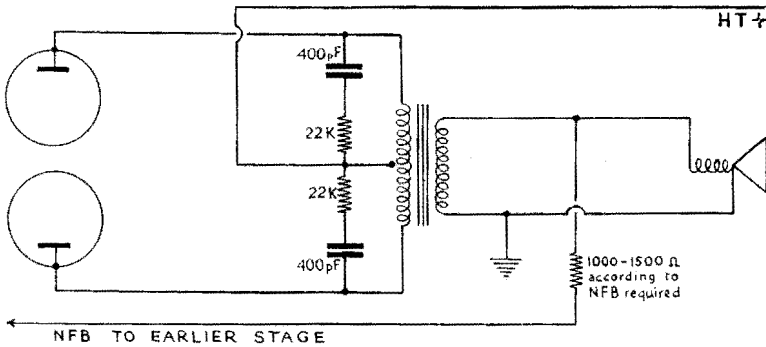

FIG. 7/14.—Method of stabilising amplifier with heavy NFB, as employed in Garner amplifier described at end of book.

cause trouble anyway. The inclusion of resistors is to damp out possibility of forced oscillations in the primary circuit. To translate into the sordid terms of £ s. d. this “economy” operation of extracting bad teeth enables the user to work with an 8-section OP transformer; the RC network used on the primary costs but a fraction of the higher price involved in winding a transformer with 16 sections.

SELECTIVE NEGATIVE FEEDBACK FOR LOW LEVEL LISTENING

It is sometimes considered advisable for the degree of negative feedback to vary the gain of an amplifier differentially (a) at different volume control settings; (b) according to the frequencies being reproduced by the amplifier.

It is quite possible to arrange for either bass boost or cut and/or treble boost or cut by including frequency discriminating networks as part of the negative feedback loop. These may consist of either inductances or capacitors, or sometimes a combination of the two. Similarly it is easy enough to arrange for the volume control to act additionally as a potentiometer across the injection points for negative feedback and thereby to vary the amount of applied feedback.

We will consider both these conditions when applied to the simple amplifier shown in Fig. 7/15.

The amplifier is designed to provide 3.3 watts maximum into the 15 ohms load of the speaker. Therefore, approximately 7 volts RMS will be developed across this load. The output valve requires 5 volts

NEGATIVE FEEDBACK

RMS at its grid, and since V_1 has a gain of 10 times it is obvious that a signal of .5 volt RMS is required between grid and cathode at the

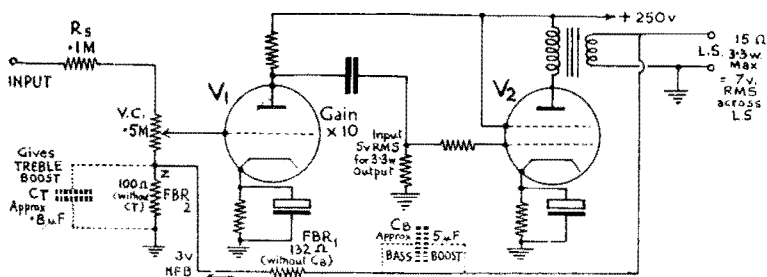

Circuit by F. H. Beaumont

Fig. 7/15.—NFB circuit giving higher proportion of extreme bass and treble as the volume level is reduced. Independent control of treble and bass can be included. (See text.)

input. Taking the case of the volume control being adjusted for maximum input and with the feedback disconnected, .6 volt input will be needed however, since .1 volt is dropped across the series resistance R_s . Introducing feedback so that the gain of the amplifier is halved with the volume control at maximum, it will be seen from the values given on the circuit that six times this amount of feedback must be applied at the earthy end of the volume control. In other words, if the output were fully maintained at such a control setting 3 volts RMS must appear as a result of feedback at the point Z. Since we have 7 volts across the speaker, a divider consisting of FBR_1 and FBR_2 of the values given on the diagram would meet the requirements. At minimum volume control setting, a signal of 3.5 volts RMS would now be needed at the grid of V_1 so that negative feedback has reduced the gain 7 times or 17 db. At the maximum volume setting, however, gain reduction is only 2 times or 5 db, and intermediate settings of the volume control will vary the amplifier gain proportionately.

Now it is permissible to introduce counter distortion at lower volume settings to correct for the non-linearity of sound perception of the human ear when plotted against frequency. This means that we want more bass and more treble and less middle at low volume settings. Dealing with the bass boost required if we insert a capacitor in series with FBR_1 of such a value that the impedance in this branch of the feedback network totals 6 times FBR_1 alone at, say, 50 c/s we shall obtain a bass boost at that frequency of 11 db. Similarly, if we connect a capacitor across FBR_2 of such a value that the impedance between Z and earth is only one-sixth of the value of FBR_2 at, say, 10,000 c/s we shall have a treble boost of 11 db. Thus, with both capacitors

connected, bass and treble boost result. The amount of boost becomes relatively larger the nearer the volume control is set towards minimum. A ready means of correcting for aural characteristics is therefore to hand. The amount of boost permitted by this method is restricted by considerations of stability, since the two capacitors naturally introduce a phase shift. Care must be taken with the output transformer design, and in general such selective feedback is only permissible over one or two stages.

If it is desired to vary the amount of boost introduced, a variable resistance of say 1,000 ohms connected across the bass boost capacitor C_B and another variable resistor of about 2,000 ohms in series with the treble boost capacitor C_T would allow adjustment of either.

On the other hand, bass cut could be accomplished by inserting a capacitor in series with FBR_2 and treble cut by connecting a capacitor across FBR_1 .

NOVICE'S CORNER

Our imaginary correspondent writes: "Can you elucidate the following points? Please reply in simple language as I have forgotten all my algebra and I can only multiply up to 10 times."

No. 1.—I have an amplifier with pentode output and a medium-price output transformer with leakage inductance in excess of $\cdot 1H$. I should like to apply negative feedback to improve quality. I am prepared to accept a reduction to 1 watt output. 15 ohms speaker. How do I proceed?

Answer.—As the output valve is a pentode, the distortion is probably largely odd harmonic. The best method would be to apply feedback from the secondary of the output transformer and feed it into the cathode circuit of the previous valve. A 200 ohms potentiometer would be inserted between cathode resistor and earth, the slider being connected to a 1,000 ohms resistor—thence to transformer secondary. If excessive feedback is attempted, the high leakage inductance of the OP transformer will result in instability, either audible or supersonic. If the loss of gain is too severe for available input, the feedback loop could be taken to the bottom end of the grid leak of the output valve, thus limiting its operation to one stage, and incidentally reversing the sense of the required connection to the output secondary winding.

No. 2.—I have an amplifier similar to No. 1 but fitted with power valve instead of pentode. What must I do for the same results?

Answer.—The triode valve, providing it is reasonably well matched to its load, will not produce much distortion inherently, and the application of NFB will give little advantage. The low anode resistance of the triode is already giving a measure of loud-speaker damping, and whilst NFB will provide increased damping

NEGATIVE FEEDBACK

it is a moot point whether any real advantage will accrue. If distortion is present it is probably in the driving stage, a triode needing a large drive voltage. (The pentode and tetrode output valves score here, as they need less driving, and with NFB can be arranged to give plenty of damping to the loudspeaker.) To deal with distortion, check that the penultimate stage is supplied with adequate HT voltage and is correctly biased.

No. 3.—I have an amplifier with push-pull output of about 10 watts, which I am prepared to drop to 2 watts by NFB if there is any benefit. What do you advise?

Answer.—If the push-pull amplifier is giving satisfactory results, leave it alone. If distortion is present, find out where it comes in. Suspect:

- Gross mis-match between valves and load.
- Unmatched pair of output valves.
- Poor quality output transformer.
- Phase splitter grossly out of balance.
- Ageing valves or low HT voltage.
- Wrong bias conditions.
- Short on bias resistor due to electrolytic bypass failure.
- Load resistor or screen feed resistor to early valves changed in value.

NFB is not a patent purge to eliminate distortion; it is asking for trouble to apply it to a basically unsatisfactory amplifier. It will however improve frequency response and LS damping, and could be applied over penultimate stage as shown in Fig. 7/16, or to previous valve as described in Answer No. 1.

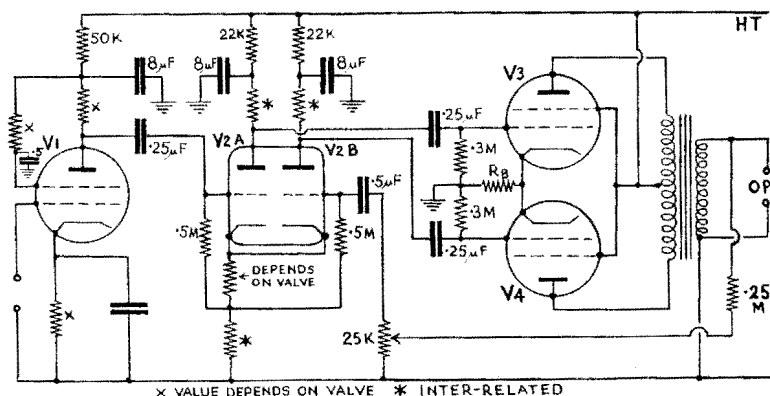

FIG. 7/16.—PP Amplifier with NFB applied over penultimate stage, with less reduction of gain than if fed into cathode of V1.

No. 4.—If my output conditions are matched to a 3 ohms speaker instead of 15 ohms, how would this affect the NFB arrangements?

Answer.—The voltage appearing across the secondary of the output transformer will be less with the 3 ohms unit. For 3 watts the voltage is 3V across a 3 ohms voice coil, but 6.7 volts appear across a 15 ohms coil. Therefore, the ratio of the feedback potentiometer arms will be lower for the 3 ohms secondary to obtain an equivalent feedback voltage.

No. 5.—I have an amplifier with NFB which is used with a 15 ohms speaker. If I connect another speaker in parallel and reduce the load to $7\frac{1}{2}$ ohms what effect does this have on the NFB voltage? Does it increase the NFB or reduce it?

Answer.—When the second loudspeaker is connected, the voltage across the two will be reduced, but this will reduce the feedback, so the gain of the amplifier will rise and a compensating effect will take place. The output therefore tends to remain level and voltage feedback tends to produce a constant voltage generator. This accounts for the fact that NFB helps to overcome a mismatch in the output transformer or speaker load.

No. 6.—I should like to know a simple way of estimating the amount of NFB which is being applied in one or two typical cases.

Answer.—As the premise is that $10 \times$ table is the highest one we know, it is rather difficult to answer this question. An approach in terms of input sensitivity for equal outputs seems to present the fewest mathematical obstacles. If an input of 0.25 volt will give an output X without feedback, and 1.5 volts are needed to give the same output X, then we have divided the gain by 6. This is clearly a voltage ratio of 6 : 1, which is approximately 15.5 db. (The db/ratio can be checked by reference to the table in the supplement.) Also, in the case in question, we must have fed back 1.25 volts.

Looked at from the other end, let us assume we produce 15 volts across a 15 ohms load. The power is now 15 watts. Feedback is applied and the output volts fall to one-sixth of the former value, *i.e.* $2\frac{1}{2}$ volts, which is equivalent to 0.416 watt. This is a power ratio of 15 : 0.416, say 36 : 1 which is again 15.5 db approx.

If it is desired to restore the output to 15 watts without reducing NFB, this can be done by increasing the input volts by 6 times, and the grid/cathode circuit of the first valve still only receives its original net input and all the valves in the amplifier proper are only called upon to handle the same voltage excursions as without feedback. Also, the power-handling capacity of the output stage is not destroyed in any way. This is one advantage of overall feedback to an early stage, which more than offsets phase shift difficulties that may creep in. When feedback is

NEGATIVE FEEDBACK

applied to fewer stages or only one stage, there is always the danger of overloading if the input level is increased to counter-balance the feedback losses.

For reading voltages as outlined in this answer, a valve voltmeter on the input and ordinary AC meter across a dummy resistive load on the output are quite satisfactory.

CHAPTER 8

THE CATHODE FOLLOWER

Although the use of a valve in a cathode follower circuit actually converts it into a de-amplifier, it has so many useful and interesting aspects that the system cannot be ignored in a book about Amplifiers.

BASIC CIRCUIT

Inspection of the basic circuit shows that the load is connected in the cathode circuit instead of the usual anode circuit, and the output is taken from cathode and earth. The effect is to reduce the stage gain

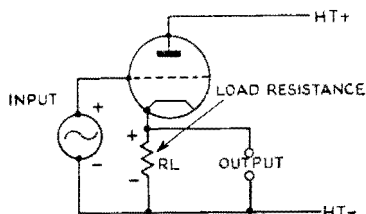

FIG. 8/1.—Basic Cathode Follower circuit in which the output is in opposition to the input, giving a “gain” of less than unity.

to a value slightly less than unity, for the total output voltage appears across the cathode resistor and opposes the input voltage, thus giving 100 per cent. feedback.

The salient features of such an arrangement are to give a high input impedance and a low output impedance.

STAGE GAIN

The stage gain can be calculated from the usual formula $A_1 = \frac{A}{1 + BA}$ where A = gain of amplifier without feedback, and B = the fractional voltage feedback. Since B in this case is unity, the expression becomes $A_1 = \frac{A}{1 + A}$, but as A is always larger than unity,

the gain is slightly less than unity: e.g. $A = 20$ $A_1 = \frac{20}{1 + 20} = \frac{20}{21} = 0.95$. This means that the input voltage must always be slightly higher than the output voltage required; in fact, obtaining sufficient grid drive for the stage often constitutes a difficulty.

THEORY OF OPERATION

This particular circuit arrangement has caused more obscure

THE CATHODE FOLLOWER

“ explanations ” of how it works than any other circuit the writer has ever encountered, but he considers that the best approach to the problem is to observe the facts and then explain them.

The amplifier at first glance appears to be very similar to that in which the current feedback was obtained by omitting the cathode bypass condenser and this can quite well be the case as the stage has a high input impedance.

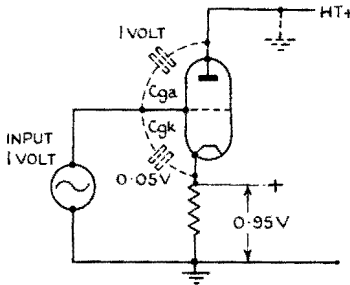
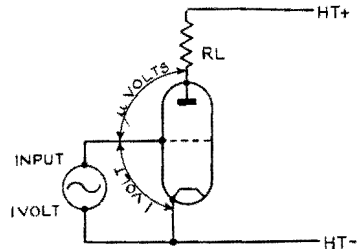

FIG. 8/2.—Voltages appearing across inter-electrode capacitances in a cathode follower.

This can also be argued by reference to Fig. 8/2 in which the actual voltages applied across the inter-electrode capacitances are shown. If the grid is made 1 volt less negative, *i.e.* 1 volt positive, the cathode follows it to nearly 1 volt positive (hence the name cathode follower). The voltage across C_{gc} (capacity grid-cathode) will now be 0.05V. This will certainly cause less current to flow than the 1 volt that would appear across it in an ordinary amplifier as shown in Fig. 8/3.

FIG. 8/3.—High value of voltage appears across C_{ga} in normal amplifier, cf. Fig. 8/2.



Now the voltage appearing across C_{ga} (capacity grid-anode) is only 1 volt in the cathode follower, but in Fig. 8/3 it would be $\mu \times (1 + A)$ volts. In an amplifier with a stage gain of 20 times, this would amount to 21 volts for 1 volt input. Furthermore, much more current would flow. The cathode follower behaves like a Miller effect in reverse, and has the highest input impedance obtainable in any circuit with a particular valve.

Taking the cathode follower's second characteristic, that of a low

output impedance, this is not a characteristic of a current NFB arrangement, but rather that of a voltage feedback arrangement. It is argued that the feedback is the voltage across the load, the whole of it, but it cannot be both kinds of feedback at once, yet it certainly appears to be so.

CATHODE FOLLOWER OUTPUT STAGE

Take a case as shown in Fig. 8/4 in which the cathode follower is used as an output stage. The load in the cathode as presented by the

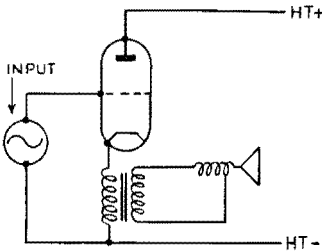

FIG. 8/4.—Cathode Follower as an output stage driving a loudspeaker.

loudspeaker via the transformer is the optimum load quoted for the particular valve employed.

If the load rises, as it will do at the frequency of the bass resonance of the loudspeaker, then the voltage across the load will increase, giving rise to greater feedback, thus tending to cancel the increase in output. Conversely, connect another loudspeaker in parallel with the original one and the load impedance will fall; this gives less feedback and the gain rises. These are all the characteristics of a low impedance generator and are admirable for an output stage.

The argument of the output stage still goes on: whether to use the cathode follower, a low impedance triode, or a pentode or tetrode with NFB, but the general tendency seems to be to use the pentode or tetrode with NFB giving adequate loudspeaker damping. The extra damping factor conferred by cathode follower output is considered to give no appreciable improvement in speaker performance. It is possible to have too much of a good thing and give a loudspeaker excessive damping.

It is certainly much easier to provide the drive for an output stage of a more normal type. For instance, a PX25 triode would require a *grid* drive of approximately 230 volts to give 6 watts output as a cathode follower, but with an output resistance of 120 ohms. The normal grid drive is 33 volts. It is a big problem to provide seven times as much, demanding a voltage amplifier with a very large value of anode load and HT supply to match. An inter-valve transformer might be used to give a voltage step-up, but the shunt capacities would take their toll.

PRACTICAL DESIGN

If the reader desires to experiment, the circuit of Fig. 8/5 could be used. This has given very satisfactory results, such as one only expects from a more ambitious output stage.

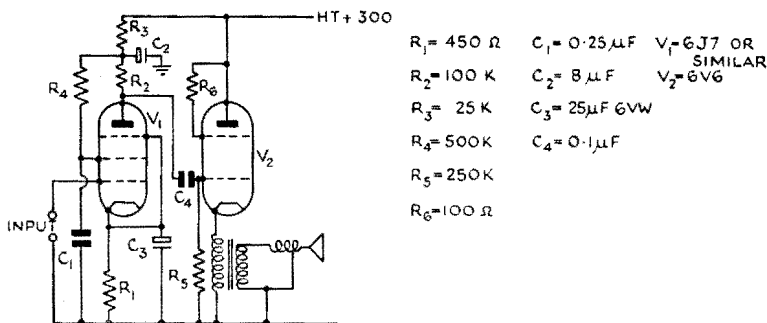

FIG. 8/5.—Practical amplifier circuit for a cathode follower output stage.

A 6V6 Tetrode is used in the output stage, but will of necessity become a triode with an expected output of 0.8 watt. This valve works into a load of approximately 3,000 ohms, through a suitable matching transformer, ratio 14 : 1 with 15 ohms speaker, or 32 : 1 with 3 ohms LS. The matching is by no means critical due to the low internal resistance of output. To develop 0.8 watt across 3,000 ohms requires about 49 volts ; this means that an input of $\frac{49}{0.9}$ volts = 54 volts is needed.

A 6J7 pentode as an RCC amplifier is capable of giving 81 volts peak across a following grid leak of 0.25 megohm, the recommended value for a 6V6, using a 300 volts HT supply. The anode load of the 6J7 should be 100K, screen resistor 0.5 megohm, cathode resistor 450 ohms, screen bypass conveniently 0.25 mfd, cathode bypass 25 mfd. The coupling condenser due to the high input impedance of the output stage need not be large, 0.1 mfd is adequate. The 6J7 will give a stage gain of 82 times, thus a 1 volt input will fully load the output. 1 volt is easily obtained from a radio feeder, but if a pick-up is used a low gain triode might be employed ahead of V_1 . The bias voltage for the 6V6 is in the order of 15 volts, thus with a space current of 50 mA the DC resistance in the cathode should be $\frac{15}{0.05} \times 1,000$ ohms = 300 ohms. If the primary of the output transformer is less than 300 ohms then it should be made up to 300 ohms as shown in Fig. 8/6A.

If the primary of the output transformer has a resistance greater than 300 ohms, then the grid is returned to a potential divider across the

HT supply as shown in Fig. 8/6B, thus raising the grid to a positive potential equal to the excessive bias produced in the cathode circuit.

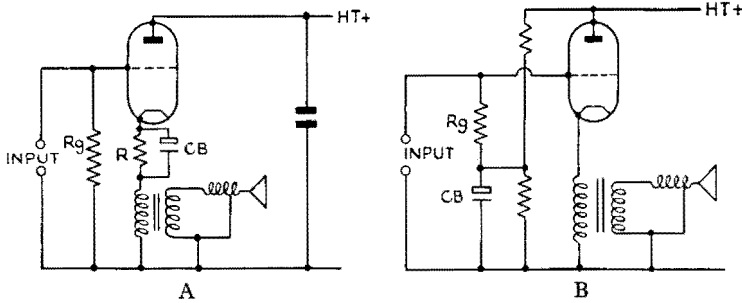

FIG. 8/6.

- A. Method of obtaining more bias for a cathode follower output stage.
- B. Method of cancelling excessive bias voltage developed across transformer primary.

For example, transformer primary 400 ohms, therefore excess bias $(400 - 300) \times \frac{50}{1,000} = 5$ volts. A suitable divider across the HT would be one in which the elements are in the ratio of 295 : 5 e.g. 295,000 ohms : 5,000 ohms. A low 300K would be suitable.

The bypass condenser of Fig. 8/6A makes no audible difference if R is quite small, say less than 100 ohms, which it normally would be, but the omission of a bypass condenser in Fig. 8/6B produces mains hum.

COMPARABLE TETRODE OUTPUT

It is very instructive to compare the cathode follower amplifier with the one shown in Fig. 8/7, where the 6V6 is used as a tetrode with NFB. The loading is 5,000 ohms, bias $-15V$, input say 12 volts. The 6J7 stage gain is 82, therefore the input required is $\frac{12V}{82} = 0.15V$ without feedback.

Assuming 3 watts output across 15 ohms voice coil, we have 6.7 volts. With VR1 at 150 ohms in feedback loop, the voltage feedback will be $\frac{6.7}{4} = 1.675$ volts. Therefore the input voltage for full output becomes 1.825 volts ($1.675 + 0.15V$). This degree of feedback may cause instability due to phase shift in output transformer, but very pleasant results can be achieved with only 20-30 ohms of VR1 in the feedback loop.

THE CATHODE FOLLOWER

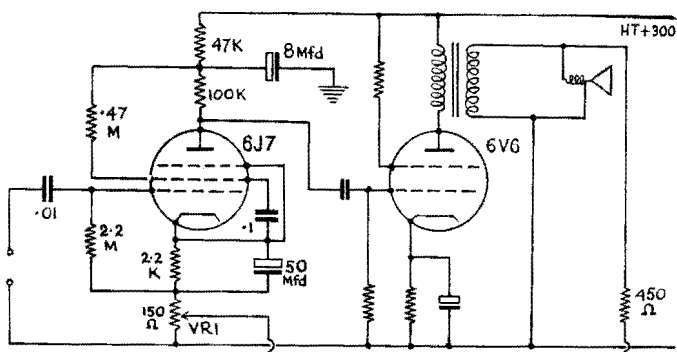

FIG. 8/7.—Comparable amplifier to that of Fig. 8/5, but arranged for triode output with variable voltage NFB overall.

CONCLUSIONS—OUTPUT STAGE

The use of the cathode follower in the output stage is judged to be hardly worth while, but a trial of the system may interest the experimenter. The loudspeaker can be over damped, and the NFB is limited to the output stage, leaving preceding stages to produce distortion unless they have NFB overall.

INPUT STAGES

1. Using crystal microphones or pick-ups, the cathode follower with its high input impedance is excellent as the first stage, in spite of contributing less than no gain.
2. If a microphone or pick-up of high impedance is operated remotely from the main amplifier, a long length of screened cable will introduce excessive top cut due to its self capacity. A cathode follower between pick-up and line will avoid this attenuation, and provide a form of line matching which obviates the use of a step-down transformer with its inherent distortion and unerring instinct for finding any stray induction fields and producing hum.
3. As a device for mixing two or more inputs into an amplifier, a cathode follower in each input channel provides ideal isolation and great ease of mixing, using low resistance wire-wound potentiometers as cathode loads.

CHAPTER 9

PHASE SPLITTERS

When discussing push-pull output stages in Chapter 6, it was seen that the two grids of the output valves must be fed in anti-phase; therefore a voltage is required balanced to earth. This was obtained in Fig. 6/2 by the use of a transformer, but a transformer as phase splitter is not regarded with much favour in modern high fidelity apparatus, due to its tendency to attenuate the upper frequencies by shunt capacities. There is also the difficulty of maintaining adequate primary inductance, although this problem is eased by shunt feeding the primary, as shown in Fig. 3/7.

Other drawbacks are the high cost of a good component, and the possibility of hum pick-up due to interaction with mains transformers and smoothing chokes. A single valve may be employed as a phase splitter, and, whilst it contributes little to amplification in some cases, it is an elegant way of obtaining a phase split and is favoured both on the basis of cost and efficiency.

When the output stages are driven into grid current, as in the AB_2 and B_2 modes of high power operation, it is essential to have a low value of resistance in the grid circuit, otherwise the flow of grid current will develop a voltage across the resistance and completely upset the biasing condition. This requirement can only be satisfied by using a transformer with a suitable low-resistance secondary. To assist in this direction, a step-down transformer is usually employed. The use of a nickel/iron alloy core is precluded in this application due to the high level of operation. Quite a large transformer will be required presenting no small design problem. As we are more interested in good quality than maximum noise, the RCC types of phase splitters have the strongest appeal.

The desirable attributes of a phase splitter device may well be summarised as follows :

- (1) The two outputs should be of equal amplitudes, *i.e.* in balance at all instants of time.
- (2) The high frequency response should be well sustained.
- (3) The two outputs should be in exactly 180° phase relationship over the frequency range involved.
- (4) If possible some useful amplification should be obtainable, with a sufficiently high voltage output to fully drive the succeeding push-pull pair of valves.
- (5) No hum should be introduced into the circuit.

PHASE SPLITTERS

- (6) Initial adjustments for balance, if any, should not demand complex apparatus.
- (7) It should not be extravagant of valves or components. Six possible types of phase splitters are described in this chapter and a summary of their merits or demerits is made in the light of the above requirements, before an explanation of their mode of operation is attempted. It might be thought a waste of time and space to include three types of phase splitters which are later condemned out of hand, but these arrangements are so frequently met with in published designs that an analysis of their working and defects should prove of value in assessing the merits of a particular circuit.

ANALYSIS OF SIX TYPES

The following list is not exhaustive, as other systems exist, and some possible modifications in detail in those described are not discussed.

1. THE CONCERTINA OR SPLIT LOAD PHASE SPLITTER

- (1) Good balance of outputs at all times, say 0·125 per cent. error.
- (2) Some unbalance of outputs at the highest frequencies (0·02 per cent.) but amplitude well maintained.
- (3) Some phase shift at the highest frequencies.
- (4) Stage gain less than unity, for each output ; subject to limitation imposed by permissible anode swings of the valve, equal to 0·9 of input to stage.
- (5) Tends to introduce heater hum into the circuit, but this can be counteracted.
- (6) No initial setting up for balance apart from fairly close match of load resistors.
- (7) Economical of components and only one valve needed.

REMARKS

In order to obtain sufficient drive for succeeding stages, the temptation exists to increase input to stage to get greater output with risk of introducing harmonic distortion due to operation over curved part of valve's characteristic. NFB reduces distortion.

Whilst not quite perfect, can be recommended for use at low output levels as giving excellent results with minimum trouble.

2. THE PARAPHASE SPLITTER

- (1) Balance of amplitude of outputs usually poor at low frequencies.
- (2) High frequency response falls off.

- (3) Severe phase shift at extremes of frequency.
- (4) Useful gain of a voltage amplification stage available.
- (5) No tendency to introduce heater hum.
- (6) Initial adjustment for balance not too easy.
- (7) Economical of components but two valves required giving discount in gain obtainable.

REMARKS

Gives mediocre results, and two valves can be used to much better effect.

3. FLOATING PARAPHASE SPLITTER

- (1) Never exactly in balance under dynamic conditions, and not essentially stable.
- (2) No initial balance adjustment required—in theory.
Other remarks as for Type 2.

REMARKS

To be avoided, although often used in cheaper apparatus for ease of initial testing.

4. CATHODE COUPLED PHASE SPLITTER

- (1) Completely self-balancing in effect.
- (2) High frequency response well sustained.
- (3) Only very small phase shift effects.
- (4) Gives gain of approximately one-half a stage of amplification.
- (5) Some tendency to introduce heater hum which can be counter-acted.
- (6) No setting up for balance.
- (7) Economical of components but two valves required.

REMARKS

Probably the best types to be employed where medium drive voltages are required. Reduction of effective anode voltages make maximum signal output somewhat reduced as compared to Type 5.

5. THE ANODE FOLLOWER PHASE SPLITTER

- (1) To a very large degree self-balancing due to NFB employed.
- (2) High frequency response well maintained.
- (3) Phase unbalance can be held to 1 per cent.

PHASE SPLITTERS

- (4) Gives gain of one stage of amplification.
- (5) No tendency to introduce hum.
- (6) No initial balance adjustment.
- (7) Two valves required and somewhat extravagant of components.

REMARKS

The best all-round type, especially when the maximum drive voltage is required.

6. THE HIGH GAIN CONCERTINA PHASE SPLITTER

This type has all the characteristics of the Concertina Type 1, but has the advantage that the full gain of the preceding amplifier, a pentode, can be realised, which offsets the disadvantage of no gain from the normal circuit arrangement.

CIRCUIT DIAGRAMS

THE CONCERTINA PHASE SPLITTER

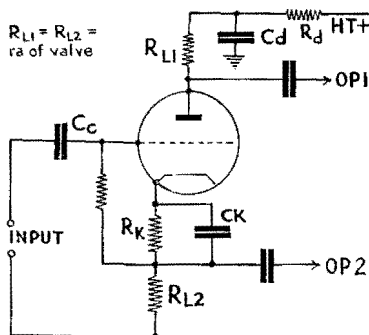

FIG. 9/1.—The single valve Concertina Phase Splitter.

In the arrangement of Fig. 9/1 the valve is given two equal loads, one in the anode R_{L1} which is completely normal, and one in the cathode R_{L2} , which resembles the cathode follower output stage. The outputs taken from anode and cathode will be equal and opposite in phase. The circuit is interesting because of the NFB principles involved. R_{L2} will provide current feedback for output 1 making it of high impedance, whilst output 2 will appear to have a very low impedance due to the effect encountered in the cathode follower. However, the apparent internal resistance of the output will not influence the grid circuits to which the outputs are fed; the only thing that matters is that the voltages shall be equal. This specification is well met at low frequencies providing the decoupling condenser C_d , if present, is of adequate value with negligible reactance at the lowest frequencies; otherwise the anode load will rise and there will be inequality of output. C_d should be at least 8 microfarads.

The output at high frequencies is slightly out of balance due to the presence of C_{gK} and C_{g2} . The currents through these capacitances (of unequal size) are not in phase with the space current, and they have the effect of making the anode and cathode voltages unequal in amplitude at the highest audio frequencies, and of giving them a small phase difference not equal to the ideal 180° .

Reference to Fig. 9/1 shows the arrangement for obtaining bias. The value of C_K must be made adequate or output 2 will become larger than output 1 at low frequencies, although the degree of unbalance will not be very serious as R_K is small compared with R_{L2} , say 1,000 ohms, compared with 50,000 ohms. In practice the two load resistors are made roughly equal to the anode resistance of the valve. R_{g2} , the grid leak, should be as large as possible, otherwise the current flow through R_g and R_K tends to increase the cathode output, but with $R_g = 2$ megohms, the degree of unbalance for a valve of mutual conductance 2 mA/V, is only 0.125 per cent., and the degree of unbalance is not of practical importance unless R_g is below about 100K ohms.

The output expected at *each* output can be reckoned as about 0.9 of the input for average stages.

The input resistance can usually be taken as about ten times the value of the grid leak, thus the size of C_c , the coupling condenser, can be reduced accordingly, effecting a saving. This high input resistance is very valuable when the preceding amplifier is a pentode, enabling more gain to be obtained, and less attenuation of the higher frequencies.

A disadvantage of this circuit is that the cathode of the valve is considerably positive with respect to its heater which is usually earthed. This may give rise to a breakdown of insulation between heater and cathode. Valve manufacturers usually give the maximum permitted voltage that may be applied across heater and cathode, and care has to be taken that this voltage is not exceeded. The difficulty might be overcome by using a separate heater winding for this valve and raising potential of the winding to some point above earth, as shown in Fig. 9/2, although this is an unwanted complication and expense.

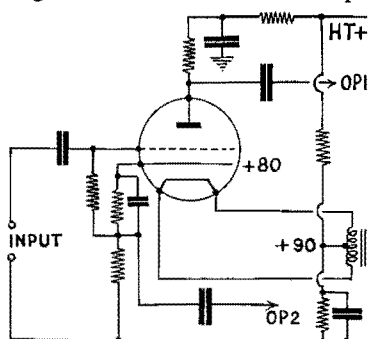

FIG. 9/2.—Modifications to Concertina Circuit. Arrangement to make heater of valve more positive than the cathode to avoid the effects of heater emission, and to avoid excessive voltage between heater and cathode. Separate heater winding is sometimes required.

PHASE SPLITTERS

Another way of tackling the problem is to raise the whole heater circuits throughout the amplifier to a suitable positive potential. This can be done quite successfully.

This circuit sometimes gives rise to mains hum, as the heater of the valve may be producing thermionic emission, and the electron stream, modulated with hundred cycle ripple, will be collected by the positively charged cathode. Either of the artifices previously described may be adopted to eliminate this trouble. Although with some valves heater hum may be troublesome, the 6J5 and 6C5 seem to work well in every respect, also the Mullard EF37A strapped as a triode. The use of a pentode is inconvenient in this circuit, as with the cathode follower, because a screen supply must be decoupled to the cathode if the valve is not to become in effect a triode. The currents through the decoupling condenser to cathode would materially affect the balance of output.

THE PARAPHASE CIRCUITS

Figs. 9/3 and 9/4 show two circuits in which V_1 is a standard amplifier and a fraction of the output of V_1 is fed into V_2 so that the output of V_2 is equal to that of V_1 and of course in anti-phase. Fig. 9/3 shows

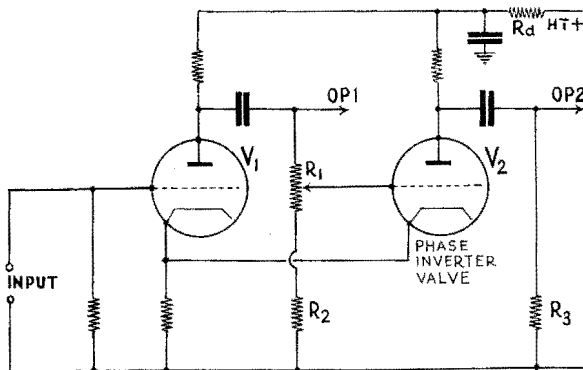

FIG. 9/3.—Paraphase Splitter.

a form of phase splitter in which V_2 is fed with a fraction of the output of V_1 from the potentiometer $R_1 R_2$ so that the output of V_2 equals that of V_1 . $R_1 + R_2 = R_3$ serving as grid leaks for succeeding valves.

Fig. 9/4 is a similar circuit to Fig. 9/3 giving a somewhat improved HF response as R_g can be made much larger than R_2 in Fig. 9/3.

These circuits cannot be recommended as the phase unbalance at extremes of frequency is too great (up to 12 per cent.). Their advantages are that the system gives amplification and is capable of higher

output than the concertina type ; also the large difference in potential between cathode and heater is avoided.

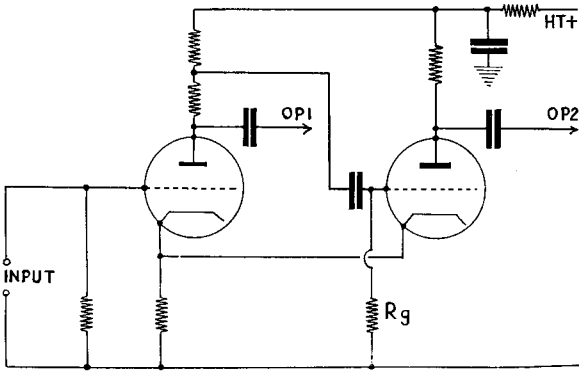

FIG. 9/4.—Alternative feed to phase inverter valve in paraphase splitter.

FLOATING PARAPHASE

The resemblance here to Fig. 9/3 is marked, but the circuit has its weakness, that of poor HF response. $R_1 = R_3$, therefore $R_1 + R_2$ and $R_3 - R_2$ may be used as grid resistors for the succeeding valve. This limits the upper values of R_1 , R_2 and R_3 in practice, and is one reason for the weakness of the circuit.

The circuit of Fig. 9/5 shows the general form of the arrangement. Resistors R_1 and R_2 form a load across the output of V_1 . A portion of

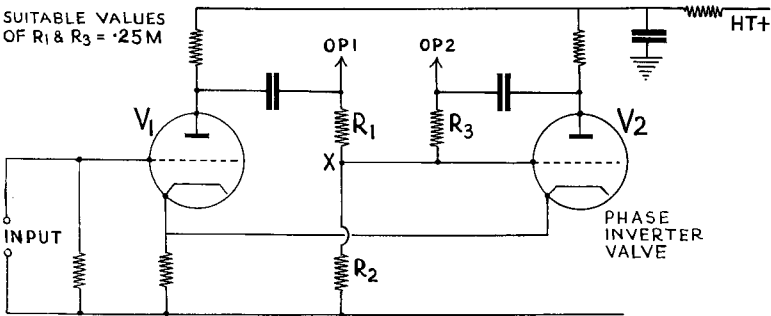

FIG. 9/5.—Floating paraphase.

the output of V_1 is fed to the grid of V_2 whose output will cause a voltage to appear across R_3 and R_2 . The voltage developed by V_2 across R_2 will, of course, be in opposition to the voltage developed across R_2 by V_1 . If the outputs of V_1 and V_2 are of the same order,

PHASE SPLITTERS

then the point X will be virtually at earth potential. If the output of V_1 rises, then the input to V_2 rises and so V_2 gives increased output and the net result is that point X is balanced at earth potential and the voltages across R_1 and R_3 , the input voltages to the output valves, are equal. The circuit has the advantages of the previous type, but in practice the point X is never quite at earth potential, but floating, hence the name. Equality of output is rarely attained.

THE CATHODE-COUPLED TYPE

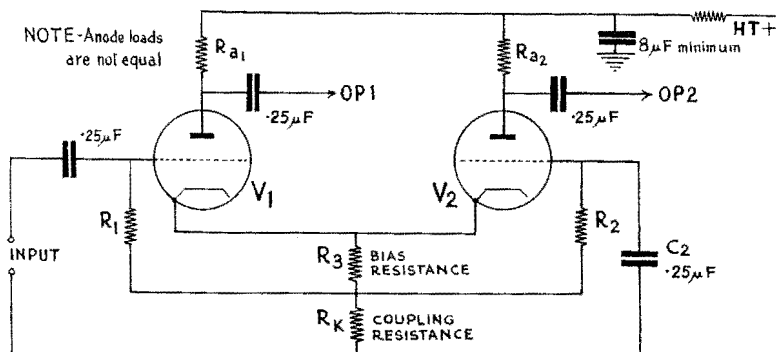

FIG. 9/6.—Cathode-coupled phase splitter.

The name of the circuit can readily be understood because the cathodes of V_1 and V_2 (Fig. 9/6) are coupled due to the common resistor R_K . The mode of operation can easily be followed. If the grid of V_1 is made more positive, the anode current increases, and so a larger voltage appears across R_K . The anode of V_1 will, of course, be negative going. The increased voltage across R_K makes the cathode of V_2 more positive relative to the grid, which is another way of saying that the grid of V_2 becomes more negative than its cathode; consequently the anode current of V_2 falls, and the anode of V_2 is positive going. We thus have two outputs in anti-phase.

A common bias resistor R_3 is employed with suitable grid leaks R_1 and R_2 returned to the junction of R_3 and R_K . The size of C_2 is important; if it is not large enough it will introduce phase unbalance at low frequencies, because then in effect the grid of V_2 would not be returned to earth but to a tapping on a potential divider formed by R_2 and C_2 across R_K .

There is a slight unbalance at all frequencies brought about by the presence of R_1 causing extra current in R_K due to the input current flowing through R_1 and R_K . This was also a defect of the Concertina type, but if R_1 is large, up to $2M$ being common, the unbalance due to this cause is almost negligible. At high frequencies stray capacitances

greatly complicate the action of the circuit, but providing R_K is not large any unbalance is virtually cancelled out.

A further advantage of keeping R_K small is that a large voltage is not developed across it thereby seriously reducing the effective HT voltage between anode and cathode, and of course not giving an excessive cathode/heater voltage.

To preserve a good high frequency response the value of anode load should not be too high or shunt capacities take their toll. As the anode load should not be less than twice the anode resistance of the valve, to secure good linearity, a valve of fairly low anode resistance will be chosen.

The value of R_K is usually chosen to equal the anode resistance of the valve, but as a low anode resistance valve is needed for the reason above, R_K will be low which satisfies on all counts.

With the preceding conditions met there will be an unbalance if equal values of anode loads are employed, but adjustment of these values can put this right. The anode load of V_1 should be smaller than that of V_2 .

To obtain exact balance the equation below must be satisfied :

$$R_{a1} = \frac{R_{a2}}{1 + \frac{r_{a2} + R_{a2}}{R_K (1 + R_{a2})}}$$

Let us take two common examples of valves suitable for this application : 6SN7 or Mullard ECC32 or 6J5's.

$$r_a = 14,000 \text{ ohms, } R_{a2} \text{ say } 47K, R_K = 15K, \mu = 32.$$

By substitution in formula :

$$R_{a1} = \frac{47K}{1 + \frac{14K + 47K}{15K (1 + 32)}} = \frac{47K}{1 + \frac{61K}{495K}} = \frac{47K}{1.123} = 41K.$$

6SL7 or Mullard ECC35.

$$r_a = 34K, R_{a2} \text{ say } 68K, R_K = 33K, \mu = 68.$$

By substitution :

$$\begin{aligned} R_{a1} &= \frac{68K}{1 + \frac{34K + 68K}{33K (1 + 68)}} = \frac{68K}{1 + \frac{102K}{33K \times 69}} \\ &= \frac{68K}{1 + \frac{102K}{2,277K}} = \frac{68K}{1.044} = 65K. \end{aligned}$$

It can be seen that as R_K and μ become larger, and with a small value for R_{a2} the difference between R_{a1} and R_{a2} becomes less. Quite satisfactory results have been achieved using an ECC35 with $R_{a2} =$

PHASE SPLITTERS

180K and $R_K = 47K$ with $R_{a1} = 180K$ as the difference in outputs is negligible if the above formula is applied, the denominator being but 1.056. The ideal value for R_{a1} being approximately 170K, the error is only 0.5 per cent.

This circuit arrangement is by no means new, as it was used in the Science Museum Receiver described in *Wireless World* in 1930. New importance was given to the circuit during World War II by its suitability for radar work, when it received its present name.

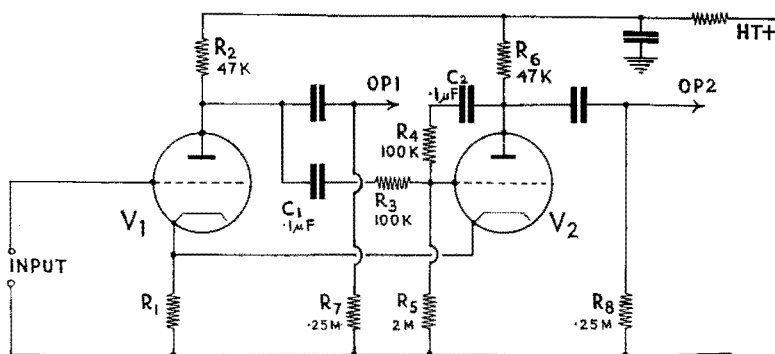

FIG. 9/7.—The Anode Follower, which is the modified version of the "Floating Paraphase" of Fig. 9/5.

Fig. 9/7 shows one form of the circuit which will give phase unbalance of less than 1 per cent. The cathodes of both valves are not at a high potential relative to the heater, which is often an advantage. Also the undistorted output given by each valve is greater than the arrangement of Fig. 9/6 in which the effective HT voltage is reduced by the drop across the common cathode resistor. Where high output voltages are required to drive big output valves this circuit is undoubtedly the best so far discussed, although for low level work it is somewhat costly and cumbersome as compared with the Concertina type.

The valve V_2 is fed from a potential divider comprising C_1 , R_3 , R_5 across the output of V_1 so that the overall amplification of V_2 is unity. V_2 is provided with negative feedback from anode to grid via C_2 and R_4 thus giving it a low input impedance which is effectively one arm of the input potential divider. As the input impedance depends on the amplification and the potential divider ratio depends on the input impedance, the circuit is largely self-compensating for changes of amplification.

The greatest drawback in practice is obtaining values for R_3 and R_4 to ensure that near balance is achieved, but in Fig. 9/7 100K and 2M would be suitable.

A HIGH GAIN PHASE SPLITTER CIRCUIT

The Concertina phase splitter, whilst an attractive circuit for its simplicity, has the serious disadvantage that its gain is less than unity. However, a circuit that overcomes the difficulty in a neat way appeared in American literature some years ago and appears to be little known.

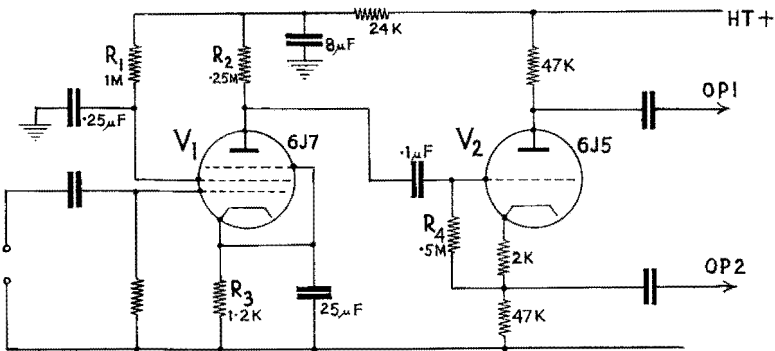

Fig. 9/8.—A typical pre-amplifier and Concertina phase splitter stage.

Fig. 9/8 shows a typical pre-amplifier and phase splitter stage in which a gain of 94 might be expected as a maximum, using normal values for a 6J7, $R_1 = 0.5M$, $R_2 = 0.25M$, $R_4 = 0.5M$ with a peak output of 94 volts. The outputs from the phase splitter would then be about 84 volts peak for an input of 1 volt. The 6J7 pentode actually has an amplification factor of 1,500 with $r_a = 1.5$ megohms, but full use cannot be made of the valve because the anode load cannot be made large compared with anode resistance, due to the excessive HT voltage required. Now the input impedance of V_2 is high, roughly $R_4 \times 10$, and if this high input impedance is utilised as the actual load for V_1 , say 0.5×10 megohms, a value bearing a sensible relationship to the anode resistance of V_1 is produced and the stage gain in theory at least could be :

$$\begin{aligned} \text{Stage gain} &= \mu \frac{R_L}{R_L + r_a} = \frac{(1,500 \times (5 \times 10^6))}{(5 \times 10^6) + (1.5 \times 10^6)} = \\ &= \frac{1,500 \times (5 \times 10^6)}{6.5 \times 10^6} = \frac{7,500}{6.5} = 1,154 \text{ times.} \end{aligned}$$

This is a handsome value which would raise the input sensitivity of the system from 1 volt to 0.08 volts for equal outputs (not that 84 volts of drive for output valves is ever likely to be needed in domestic apparatus).

PHASE SPLITTERS

The circuit shown in Fig. 9/9 will give this result, but in order to follow the exact working of the circuit it is necessary to analyse the changes to the phase splitter.

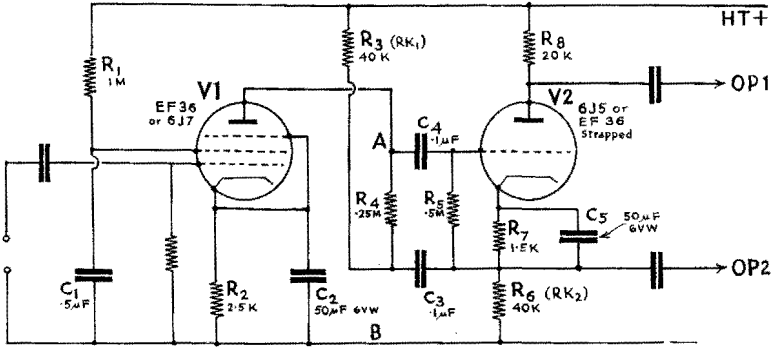

FIG. 9/9.—High gain phase splitter.

Fig. 9/10 shows the interim stage. The load in the cathode has been split into two parts R_{K1} and R_{K2} , but as each of these resistors is twice the value of the normal cathode resistor the AC loading remains the same. The presence of C_3 in series with R_{K1} across R_{K2} will have some adverse effect on phase shift at the lowest frequencies unless it is reasonably large. The bottom end of R_{K1} connected to earth in Fig.

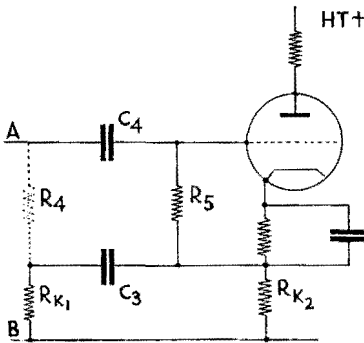

FIG. 9/10.—Interim stage in development of High Gain Phase Splitter Circuit.

Points A and B refer to the same points in Fig. 9/9.

9/10 can be connected to HT+ as in Fig. 9/9 with exactly the same result in the AC sense, HT+ being at earthy potential. R_4 shown dotted in Fig. 9/10 is a necessary addition to the circuit to provide HT feed for V_1 and whilst the DC resistance is about 0.25M the impedance is, say, 1.6 megohms (0.2M + .5M in parallel \times 10) because of the NFB (neglecting negligible reactances of C_3 and C_5).

The grid circuit now has an effective "grid leak" of R_4 and R_5

in parallel, but the impedance is ten times this value, also because of the NFB. In this impedance calculation the multiplier of ten assumes the values of anode and cathode loads to equal the anode resistance of the valve. It also assumes that the amplification factor is around 27. The actual multiplier for the 6J5 with $r_a = 7.7K$, $\mu = 20$ and $R_L = 20K$ works out at 9.8 so this guess of ten times is fairly close.

The anticipated stage gain for V_1 is now :

$$A = \mu \frac{R \text{ in}}{r_a + R_4} \quad (6J7 \ r_a = 1.5M \text{ and } \mu \ 1,500)$$

$$= \frac{1,500 \times (1.6 \times 10^6)}{(1.5 \times 10^6) + (0.25 \times 10^6)}$$

$$= \frac{24 \times 10^8}{1.75 \times 10^6} = \frac{24 \times 10^2}{1.75} = 1,371 \text{ times approximately.}$$

It would be a reasonably safe assumption that a stage gain of approaching 1,000 times can be obtained. This has, in fact, been confirmed by bench tests. The 6J7 is not a very high μ valve and a Mullard EF37A with $\mu = 4,500$ and $r_a = 2.5$ megohms would give higher gain. The Mazda SP61 has also given good service. The Mullard EF50 could also be expected to perform well in spite of being a semi-variable- μ valve, as the grid swing would be very small, and the curvature of the grid characteristic would not introduce much distortion.

A short list of suitable and tested valves for the position of V_1 is appended. In every case it will be seen that μ , the amplification factor, is high.

Valve type	Anode Resistance	Amplification Factor	Remarks
Mullard EF50 (ARP35, VR91)	$r_a = 1M$	$\mu = 6,500$	Very satisfactory.
Mazda SP61 (VR65)	$r_a = 0.7M$	$\mu = 5,950$	
Mullard EF54 (VR136 or CV1136)	$r_a = 0.5M$	$\mu = 3,800$	Low noise valve. Apt to be micro- phonic.
Mullard EF37A	$r_a = 2.5M$	$\mu = 4,500$	
Mullard EF36 (CV1056, VR56)	$r_a = 2.5M$	$\mu = 5,000$	
Mullard EF42	$r_a = 0.44M$	$\mu = 4,180$	Miniature.
Mullard EF40	$r_a = 2.5M$	$\mu = 4,625$	Miniature—low noise. Very good.

The above table of valves must not be taken as exhaustive, but in general a high μ is first choice with freedom from microphony and heater hum.

PHASE SPLITTERS

The value of cathode resistor must not be too high or the cathode/heater voltage may be exceeded, but there is little point in going above 20K for anode load. A reduction to 10K reduces the gain from 0.892 to 0.881 per output, so that the values of $R_L = R_K = r_a$ will always be safe.

CHECKING FOR BALANCE

If unbalance exists an audio voltage will be developed across R and so fed to the phones. N.B.—The isolating condensers or transformer, or

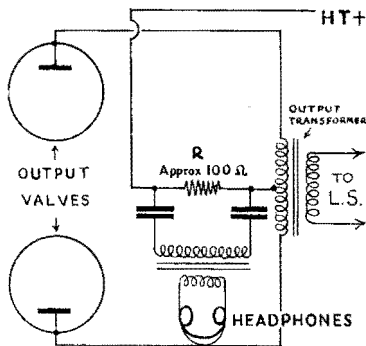

FIG. 9/11.—Checking push-pull output stage for dynamic balance.

both, are a very necessary safety precaution when wearing headphones connected to the HT+ supply.

DYNAMIC BALANCE

If a state of unbalance is suspected, the first step is to check the input voltages to the grids of the PP output stage, it being assumed of course that the valves and transformer are known to be in order. A steady tone fed into the amplifier should produce equal voltages between the grids of the output valves and earth as read by a valve voltmeter, this being the only suitable instrument. In the absence of a valve voltmeter it is virtually impossible to make the check; and reliance must be placed in the method of checking shown in Fig. 9/11. If the AC components of anode current are not exactly equal and opposite then a signal will be heard in the phones. Should this be the case the constructor can do little about it unless the phase splitter device has an adjustable element, as in Fig. 9/3. Suggested lines of investigation are:

- Check the output transformer for lack of equality of inductance in the two halves of the primary. This may be done by substitution in the absence of available test gear.
- Check the two output valves for equal amplification factor (equal anode currents do not eliminate the possibility of unbalance).

A visit to a friendly dealer equipped with valve tester for checking mutual conductance is indicated.

- (c) Checking load values in the phase splitter, if not already done, is about the last hope, barring the unfortunately not infrequent chance of a leaky coupling condenser.

If muzy quality still persists, it is almost certain that a parasitic oscillation is present, usually only to be checked by valve voltmeter or oscilloscope. It is interesting to note that one amplifier constructed by the writer did not sound too bad, but a heterodyne on the Light programme was traced to the 4th harmonic of the oscillations present in the amplifier.

One last point that often escapes notice is that, in theory at least, the anodes of a pair of push-pull valves may be fed with comparatively unsmoothed HT from the rectifier and that no hum will result due to the equal and opposite ripple currents in the two halves of the transformer primary cancelling out. Often no hum results, but severe modulation of the speech frequencies by 100 cycle hum *does* occur. The saving of cost by using a smaller smoothing choke may therefore prove dear in the end.

STATIC BALANCE

Notes were made on this problem in Chapter 6, and the only point to add is that a final adjustment of the bias value of valves is helpful. A small extra resistance added to one valve to give it extra bias of only $\frac{1}{2}$ volt may serve to equalise anode currents.

GENERAL NOTE

Where two valves are used in a phase splitter circuit it is quite common to employ a duo-triode for the sake of convenience, but it is by no means essential to do so, as two separate triodes can be used equally well. In fact, where a close match of valves is called for it is probably a better solution to use separate valves as they are likely to be better matched than the two sections of a duo-triode.

TONE COMPENSATION

The use of the familiar term "Tone control" has been deliberately avoided here, because it has popularly become associated with the mellow tone so often preferred by users of commercial radio sets. Such mis-use of tone control was undoubtedly brought about originally by a natural desire to eliminate HF distortion and spurious harmonics. In many cases, improvements in quality have not been followed by a more judicious use of the tone control by the average listener. It is a well-known fact that as quality of reproduction is improved, the frequency range can be extended and enjoyed, but extended "top" should always be accompanied by improved LF performance, otherwise in many musical items there is a distressing lack of balance.

In Chapter 1, mention was made of scale distortion, and it must be appreciated that scale distortion is not only associated with listening to reproduced music or sounds, but with listening to the real thing. A military band in a procession is first heard as the thin reedy noise of the clarinet and the "edge" of the trombone and it is only when it is quite near that the beat of the bass drum is heard. This is due to the ear itself not having a straight line response, but tailing off in the bass and the extreme top as the sound intensity is reduced.

For quiet domestic listening, it would seem that a considerable measure of bass boost is desirable, together with some treble lift. In fact, maximum flexibility in control of response is necessary to compensate for deficiencies and variations which occur in radio, record, pick-up, speaker, listening room and the human ear.

It should nevertheless be remembered that amplifier boost cannot get to work on frequencies which are not present in the sound source—radio or records—nor can it help the loudspeaker system if this cannot reproduce them. Excessive top lift applied to a loudspeaker with poor HF response may result in an unpleasant noise due to resonances and increase of harmonic distortion, which becomes more and more objectionable as frequency is raised. It is therefore most important that the quality should be true and clean before top lift is indulged in, so that high fidelity does not become unduly associated with high futility.

GENERAL METHODS OF TONE COMPENSATION

The arrangement may include one or more of the following:

- (1) Resonant circuits, employing inductances.

- (2) Resistance and Capacity networks.
- (3) Selective Negative Feedback, *i.e.* feedback of differing amounts at different frequencies.

Let us examine these in turn.

1. RESONANT CIRCUITS

This type of compensation includes values of inductance and capacitance which resonate within the audio range. The circuit is "selective", giving a tuning effect in the same way that a desired radio transmission is selected out of the many signal voltages induced in the aerial. The values of inductance required will be high to resonate at audio frequencies. This generally means the use of iron cores and many turns of wire with comparatively high hysteresis and resistance losses, which affect the "Q" of the circuit, as at radio frequencies. The low "Q" means that the shape of the response curve is quite flat and broad. This is undesirable when it is required to eliminate one particular frequency such as a heterodyne whistle between two stations. It is difficult to cut this one slice out of the frequency spectrum without attenuating adjacent wanted frequencies at the same time.

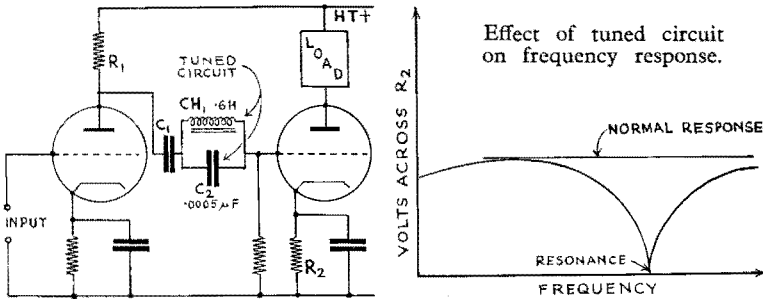

FIG. 10/1.—Circuit tuned to one frequency. Typical values for resonance at 9 Kc/s would be: $CH = 0.6H$.
 $C = 0.0005 \mu F$.

Fig. 10/1 shows a circuit which could be employed to eliminate—or greatly reduce—the undesirable 9 Kc/s whistle already mentioned. This circuit will present the greatest impedance at resonance, and the signal voltage appearing across R_2 will be reduced as indicated.

A similar result might be achieved by employing the same choke and condenser in series across R_2 , forming a series tuned circuit which at resonance will have such a low impedance (*i.e.* act as an absorption filter) that there will be a big reduction in the unwanted frequency appearing across R_2 .

The inclusion of resistance in the tuned circuit will "spoil" the

sharpness of the response curve and this effect can be utilised to give a form of bass and treble boost at the expense of the middle frequencies. If the broadly tuned circuit "resonates" and covers a wide band of middle frequencies then top and bass pass to the next valve with little attenuation.

The use of any resonant type of tone compensation circuit is to be deprecated when other steps can be taken to achieve a similar result, for the following reasons:

(a) A resonant circuit is an oscillatory system and any sudden change in the circuit, *i.e.* a transient, can shock excite the circuit into self oscillation at its natural resonant frequency. The lower the damping the greater the likelihood of oscillation and the longer it will persist. The likelihood can be reduced if the resonant circuit is incorporated early in the circuit where signal levels are very low but this gives prominence to the next objection.

(b) The inductance tends to interact with any stray electro-magnetic fields in the vicinity, usually due to mains transformer and chokes, giving rise to hum, or if interacting with the output transformer instability can easily result. The cure lies in heavy iron shrouds, or Mu-metal cases which become expensive items.

(c) The inductance of iron-cored chokes varies with change of direct current, although usually the flow of direct current can be avoided, but more serious still the inductance varies with change of AC flux which cannot be dodged, except by once again incorporating the device at the low level end of the amplifier. The use of air cored coils is suggested, but they become very bulky to obtain adequate inductance, much more wire being required in the absence of an iron core.

(d) For general tone compensation purposes, the tendency to produce a peakiness, rather than a gradual curve, is undesirable.

(e) The production of considerable phase shift which may give rise to instability especially when NFB is applied over a later part of the circuit is a serious disadvantage.

2. RESISTANCE AND CAPACITY CIRCUITS

The reactance of the condenser C_s will decrease as the frequency goes up, resulting in HF attenuation. To take a practical example:

Amplification factor of valve = 20.

Anode resistance, 10,000 ohms.

Anode load, 50,000 ohms.

Stage gain without shunt capacitance 16.6 times.

With 0.001 μ F connected in parallel the gain at 400 c/s falls to 1.4 times, and at 4,000 c/s to 5.4 times. It will be seen that the gain is

considerably reduced with increase of frequency, but it is also reduced at all frequencies, even the lowest. This type of control has been used in the past to boost the bass, although in reality it only cuts the response more and more as frequency rises.

A variable resistance of say 100,000 ohms could be included in

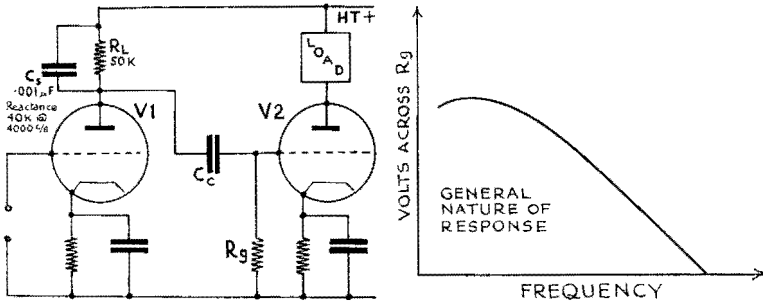

FIG. 10/1A.—RC Compensation.

Shunt capacity C_s across anode load R_L reduces effective value of load as frequency of input increases, giving reduced amplification.

series with C^s of Fig. 10/1A to control the degree of top cut. The greater the value of the resistance, the more gradual would be the attenuation. The shunting condenser C_s could equally well be incorporated across R_g ; the same effect would be produced.

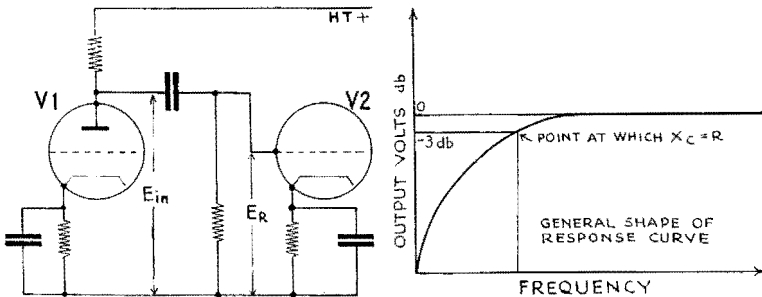

FIG. 10/2.—Bass-cut circuit.

Fig. 10/2 is the familiar circuit of an RC interstage coupling. The coupling condenser C must be of adequate capacity, otherwise attenuation of low frequencies will result, quite apart from undesirable phase shift effects which would promote LF instability in an amplifier when considerable NFB was applied. C and R are in series across the output of V_1 and it is the voltage developed across R which provides the input

to V_2 at any particular frequency. Now when the reactance of C equals the resistance R , the loss of output volts is equal to 3 db. This is arrived at in the following manner:

Assume that $R=1$ megohm and the reactance of C at a certain frequency $x_C = \frac{1}{2\pi fC}$ also equals 1 megohm. The fraction of the input voltage appearing across R will be equal to the ratio of R to the total impedance (Z) of C and R in series, that is $\frac{ER}{E_{in}} = \frac{R}{Z}$.

$$Z \text{ in this case} = \sqrt{R^2 + x_C^2} \text{ megohms}$$

$$= \sqrt{1^2 + 1^2} \quad ,,$$

$$= \sqrt{2} \quad ,,$$

$$= 1.412 \text{ megohms}$$

$$\therefore \frac{ER}{E_{in}} = \frac{1}{1.412}$$

This ratio is equivalent to 3 db loss of volts. To spare the reader any further painful calculations of this nature, the following table is given. This shows that where the reactance of the coupling condenser at a given frequency is equal to the resistance of the grid leak, the loss increases at about 6 db per octave as the frequency goes down.

Table showing the loss occasioned by a value of coupling condenser in which the reactance x_C at frequency f is equal to the resistance of the grid leak.

Frequency	Reactance of Condenser	Loss
f	$x_C = R$	- 3 db
$2f$	$x_C = \frac{R}{2}$	- 1 db
$4f$	$x_C = \frac{R}{4}$	Negligible
$\frac{1}{2}f$	$x_C = 2R$	- 7 db
$\frac{1}{4}f$	$x_C = 4R$	- 12.5 db
$\frac{1}{8}f$	$x_C = 8R$	- 18 db

Below $\frac{1}{8}f$ the loss will be at a constant rate of approximately 6 db per octave.

The foregoing argument has brought to light two important points:

(1) In an RC coupled stage the size of the coupling condenser must be large if the following grid leak is small and *vice versa*, if full bass response is to be obtained.

(2) By suitable choice of coupling condenser bass attenuation can be obtained if desired, although in domestic listening the only useful application is to avoid boom on speech reproduction.

CHOICE OF COUPLING CONDENSER

Bearing in mind the cost of condensers *and* the lower insulation resistance which is probable as the capacity increases, the associated grid leak should be large, although this is governed by the maximum permissible grid/cathode resistance for the succeeding valve as quoted by the makers.

The following table, calculated on the basis of approximately 1 db loss at 12.5 c/s gives a useful combination.

Following grid leak	Coupling condenser
10,000 ohms	2.5 μ F
50,000 „	0.5 „
100,000 „	0.25 „
250,000 „	0.1 „
500,000 „	0.05 „
1 megohm	0.025 „

Table showing values of coupling condenser and grid leak for 1 db loss at 12.5 c/s.

CONTROLLED BASS CUT

C_B is a large condenser with negligible reactance at the lowest frequencies, say 0.1 μ F. C is a small condenser, 0.003, with considerable reactance at the lowest frequencies. $x C = 0.25 M$ at 200 c/s, thus

FIG. 10/3.—A method of controlling bass cut. R_c is bass cut control say of 1M. $C = 0.003$. $R = 0.25 M$.

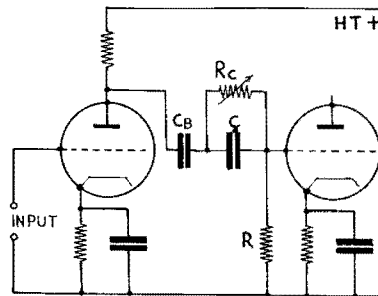

there is a cut of 3 db at 200 c/s or 1 db 400 c/s. However, as the value of R_c is reduced C is progressively shorted out, reducing the bass cut to zero at $R_c = \text{zero}$.

In Fig. 10/4 is shown the basic form of a circuit giving top cut.

TONE COMPENSATION

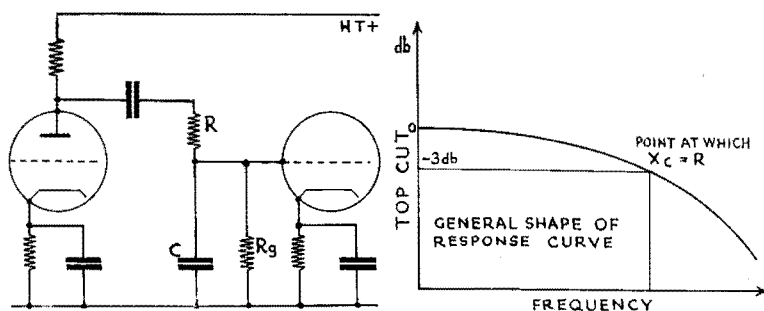

FIG. 10/4.—Basic treble cut circuit.

Again there is 3 db loss at the frequency for which the reactance of $C=R$, 1 db when $xC=2R$, 7 db when $xC=\frac{R}{2}$ and so on.

“LIFT” CIRCUITS

The use of this sub-heading really calls for an apology, because no actual lifting of output level takes place in the circuits to be described. All that can be done is to reduce the power over a range of frequencies and so permit the excluded frequencies to proceed unmolested. This has in point of fact already been done in the treble and bass cuts just examined. A bass lift circuit could be more aptly described as a low pass filter, but it is no part of the writer's function to rationalise the terminological ambiguities currently used in radio circles, so we will continue with the uplift.

TREBLE LIFT CIRCUIT

The circuit of Fig. 10/2 could be arranged so that the bass drooped from 1,000 c/s downward. Referring to our table we could arrange for the reactance of C at 500 c/s to equal the value of the grid leak R. Thus at 1,000 c/s we should be 1 db down, with a loss of 24 db at approximately 30 c/s. This would give a thin bass response. Even the middle frequencies would be rather weak because at middle C we should be about 7 db down. If the bass droop could be arranged so that the tailing off could be slowed down, the circuit would be more acceptable, giving a measure of top lift with a reasonably strong bass response.

If the circuit of Fig. 10/2 is modified to that of Fig. 10/5, the action of C is changed due to the presence of R_1 in parallel with it. At very low frequencies, xC is arranged to be so great that the loss in the circuit is almost entirely a function of the ratio of R_1 to R_1+R , but at the highest frequencies xC has become very small, practically shorting out R_1 and so almost the whole gain is realised.

If R_1 is made to equal $3R$, the attenuation at very low frequencies is in the ratio of 4 : 1, thus the lift available at high frequencies is practically 12 db.

The value of C decides at what frequency the bulk of the lift begins.

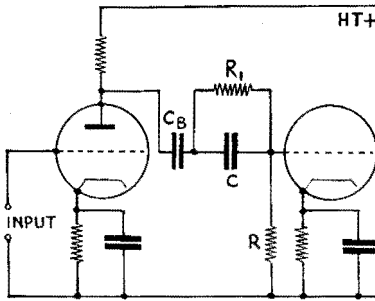

FIG. 10/5.—Basic treble lift circuit. See text for values.

For example, with $x C$ at 1,000 c/s equalling R_1 these two in parallel equal $1.5R$ and the attenuation will be 8 db, a ratio of 1 : 2.5. This is equivalent to a lift of 8 db at 10,000 c/s where $x C$ has fallen to $\frac{R}{10}$ and gives very little attenuation. Remembering the attenuation at low frequencies is 12 db, it will be seen that the bulk of the lift takes place above 1,000 c/s.

If $x C$ is made to equal R_1 at 500 cycles then the bulk of the lift would be above 500 cycles. In this way the lift can be started at any desired frequency, *i.e.* by choice of condenser. A list of reactance values will be found at the end of the book.

BASS LIFT CIRCUIT

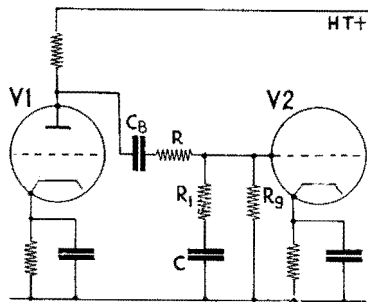

FIG. 10/6.—Typical bass lift circuit.

The circuit of Fig. 10/4, a treble cut circuit, can be modified to that of Fig. 10/6 to give a bass lift effect.

The additional resistor R_1 is connected in series with C , thus smooth-

TONE COMPENSATION

ing out the rapidity with which the top is attenuated by the condenser C.

The method of deducing the action is similar to that employed in the treble lift circuit. At the highest frequencies the reactance of C is negligible and the network will again show a range of control proportionate to the ratio of R_1 to $R_1 + R_2$. At the low frequencies the reactance of C will be very large and the impedance of $R_1 + xC$ will be great compared with R, so that a large proportion of the input voltage from V_1 is fed to V_2 .

The frequency below which the bulk of the rise takes place is again determined by the reactance of C. If C is large its reactance is not appreciable until a low frequency is reached; thus bass lift starts in late. The rough approximation may be made that the rise begins at the frequency where the reactance of C equals R_1 . The circuit is particularly important because it is frequently used to correct for the deficiencies of gramophone records when dynamic pick-ups are used. Suitable circuits are given in the next chapter, so it will suffice to say here that for 78 rpm, turnover frequency around 300 c/s, R might be 100,000 ohms and R_1 20,000 ohms, so the condenser would be 0.025 μ F.

For an exhaustive treatment of the subject the reader is referred to an article which appeared in *Wireless World* in June 1946, from which Fig. 10/7 is reproduced.

$V_1, r_a = 15,000 \Omega.$ $\mu = 40.$ Stage gain 6.33 times.

30 c/s	..	11 db lift	100 c/s	..	5 db lift
40 "	..	10 " "	200 "	..	2 " "
50 "	..	9 " "	300 "	..	1 " "

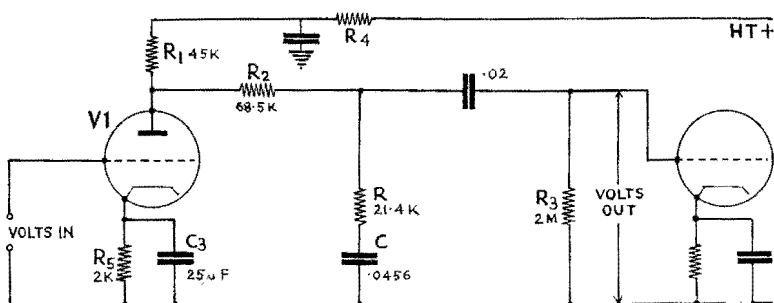

From "*Wireless World*", June 1946

FIG. 10/7.—Practical bass lift circuit with performance figures.

SIMULTANEOUS FIXED BASS AND TREBLE LIFT

This is considered desirable to offset scale distortion in low level listening. Fig. 10/8 shows an interstage coupling with a circuit for giving simultaneous bass and treble lift. R_1 and R_2 and C will be seen to constitute the bass lift circuit of Fig. 10/6, and C_1 will provide a path for top depending on its reactance. The presence of C_1 across R_1 would reduce the effective anode load for V_1 particularly at high frequencies, but the inclusion of R_3 overcomes this difficulty. The higher the anode impedance of V_1 , the greater is the risk of reducing the effective anode load to a value less than twice the anode resistance with the possibility of amplitude distortion. The circuit has been used most successfully with a 6C5 as V_1 .

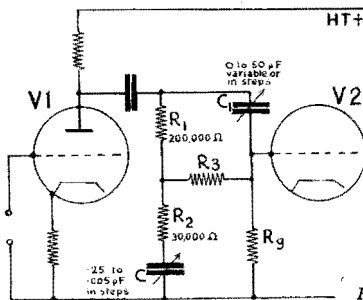

FIG. 10/8.—Arrangement for simultaneous bass and treble lift. (Max. value max. top. Min. value max. bass.)

E. O. Powell

From "Wireless World", Dec. 1940

DUAL TONE COMPENSATION

It is sometimes desirable to include means of achieving both bass and treble cut or lift at will, particularly in a general purpose amplifier that may at one time be providing domestic listening and at other times be doing duty as a small PA or home cinema amplifier. For the latter application it is by no means difficult to improve on the average 16 mm home cinema quality of reproduction, and a trimming of the bass response removes some of the plums from the mouths of the speakers. There are two circuit arrangements both of which have been used with considerable success. Fig. 10/9 shows the first. This is the arrangement of Fig. 10/8 with the addition of "cut" circuits.

The top cut condensers may be reduced in value if their effect is found to be too severe. For click suppression, 10M resistors may be connected between toggles of all switches and associated condensers; otherwise shunting contacts between switch positions should be employed. This circuit is taken from G.E.C. TP.1 publication. Overall gain of stages is approximately 20 db.

It should be noted that the circuit is so arranged that there is little variation in general output level whatever combination of switch

STONE COMPENSATION

positions is used. The turnover frequency where lift or cut starts is about 800 c/s.

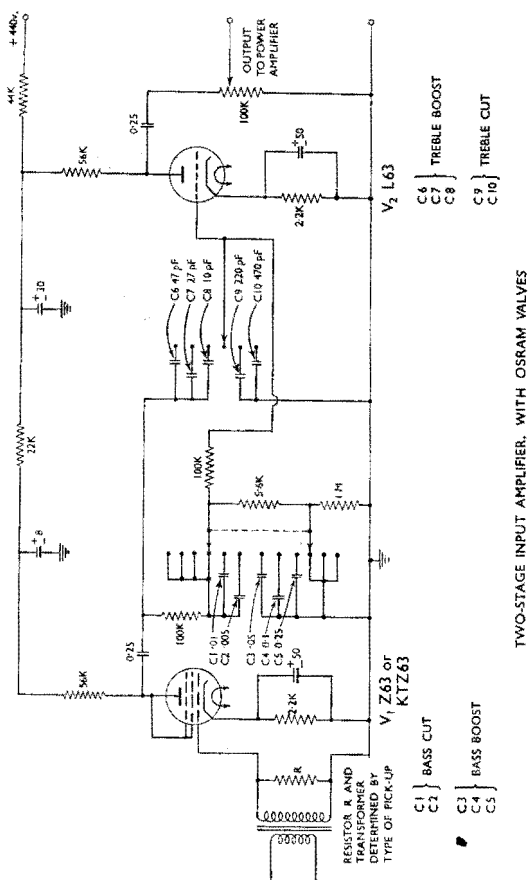
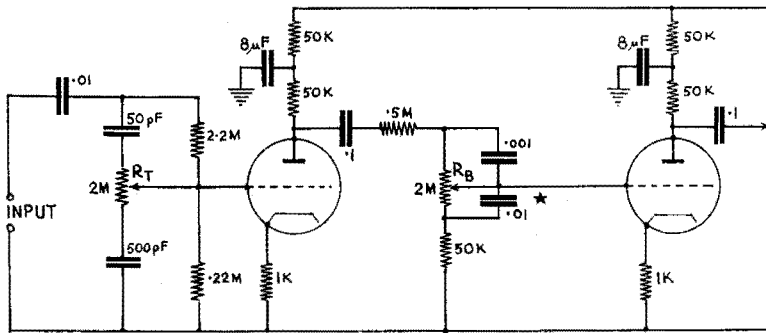

FIG. 10/9—Bass and treble lift/cut circuits with switch controls, from G.E.C. Pamphlet T.P.1 on Quality Amplifiers.

The use of switched circuits is sometimes criticised because the "ideal" tonal effect may lie between two positions, but they have the advantage that the "level response" position is readily available when required. Furthermore, the risk of noise from the more flexible control given by variable resistors of the carbon type is avoided. Clearly, both systems have their pros and cons, so a typical example of the continuous control method now follows.

The circuit of Fig. 10/10 may be built around the two halves of a 6SN7 or two 6J5 or similar valves, and affords a range of nearly

40 db of bass control at 20 cycles, and 30 db of treble control at 10,000 cycles, the turnover point being at 800 c/s. R_T is the treble control and R_B is the bass control. This circuit is useful for record reproduction



Howard T. Sterling

From "Audio Engineering", U.S.A., February, 1949

FIG. 10/10.—Bass and treble lift/cut circuit employing variable resistances.

* Reduction of this condenser from .01 to .005 will increase degree of bass lift.

as the treble cut starts in at an octave higher than the top lift enabling record surface noise to be reduced without reducing the medium high notes and destroying the brilliance of reproduction.

3. TONE CONTROL BY NFB

Selective negative feedback may be used to give tone compensation. The simplest case is that in which the cathode resistor bypass condenser is made smaller than usual, thus with increase of frequency the reactance of the condenser becomes less, and has a bigger bypassing effect,

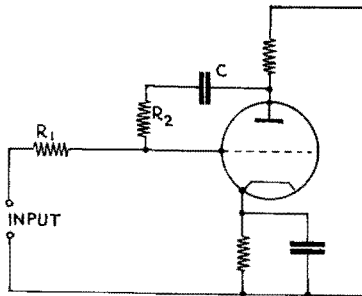

FIG. 10/11.—Out of phase feedback, anode to grid. The value of C determines the amount of LF component fed back.

reducing the current feedback and affording a greater stage gain. This will give a form of bass cut and the exact amount will depend on the relative values of R_K and C_K .

Fig. 10/11 shows a slightly more elaborate system in which negative

TONE COMPENSATION

feedback is introduced into the grid circuit from the anode. The choice of value for C will determine the amount of feedback at a given frequency. If C is small the feedback will be less at low frequencies so modifying the stage gain as to give a form of bass boost.

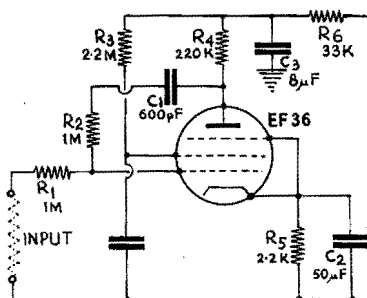

FIG. 10/12.—Feedback circuit for bass lift suitable for correction of bass in record reproduction.

For the mathematics of the circuit the reader is referred to an article by J. Ellis, B.Sc., appearing in *Wireless World* for September 1947, but suggested values for the circuit of Fig. 10/12 are appended, these giving the requisite degree of bass compensation for record reproduction, with approximately a 6 db rise per octave below 300 cycles.

LOW LEVEL LISTENING

The tone compensation circuits so far described enable settings to be made for the desired results from any media, at *one particular volume level*. However, if the volume is turned down the reproduction tends to become uninteresting, so much so that to the uninitiated it appears that the volume control adversely affects the frequency response of the amplifier, cutting both bass and treble.

This effect is due to the sensitivity of hearing, which is not so acute at low volume levels at the extremes of the audio range. The Fletcher-Munson curves of hearing are already well known.

If the gain control of an amplifier is arranged to give increasing bass boost as the gain is turned down much more satisfying results

FIG. 10/13.—Arrangement of auxiliary gain control VR_2 giving increasing bass boost below 1,000 ~ as volume is reduced.

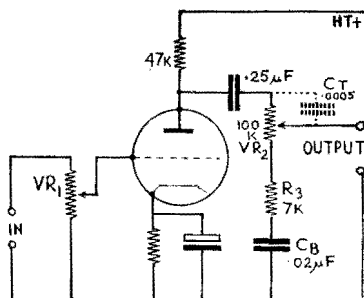

can be obtained. In general one rather neglects the treble boost as the falling off of the ear is not so rapid as in the bass. The simple circuit of Fig. 10/13 will afford a degree of bass compensation.

Juggling with the value of C_B will give more or less bass boost, and the value of R_3 relative to C_B will determine the frequency at which boost starts, roughly when $R_3 = xC_B$. The inclusion of the dotted condenser C_T will afford some treble lift if desired. In operation VR_1 is adjusted with VR_2 about halfway, so that comfortable room volume is obtained. Other tone control circuits set the balance, and then as volume is turned down by means of VR_2 extra bass boost is provided.

Compensated attenuators for low level listening are quite difficult to construct. A very useful LF Compensator, made by C. T. Chapman Reproducers Ltd., of Chelsea, S.W.10, is available at a reasonable price. As the general volume level is reduced, the LF attenuation becomes less severe, as indicated in Fig. 10/14.

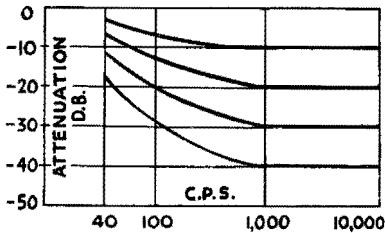

FIG. 10/14.—Response characteristic of Chapman Compensator.

This unit may be installed between the existing volume control of an amplifier and the grid of the next valve, or it could replace the existing control.

NFB LOW LEVEL CONTROL

It is evident from section 3 that NFB circuits could be arranged to provide high and low pass filters to improve realism at low volume levels. Purists will object that the full benefits of NFB are not being obtained at the extremes of the audio range, but as distortion is normally increased by increase of power, the low level case is to some extent self protected. As NFB automatically reduces output from a given voltage input, it is certainly sound economics to use the device for subduing a range of frequencies where necessary. A typical circuit was therefore included at the end of Chapter 7 on NFB.

EXLEY CIRCUIT LOW LEVEL LISTENING

Reference to the design of Dr. Exley will not be out of place here. The basic idea is to increase the impression of bass by deliberate production of harmonics, so that difference tones help to bolster the funda-

TONE COMPENSATION

mental frequency. The result, at very low volume levels, gives remarkably good LF response. The writer's impression was that any attempt to obtain more than about half a watt from the 4.5 watt output pentode produced unpleasant effects; but as the system is expressly designed for quiet listening this criticism is rather beside the point.

The reason for this apparent overloading effect is that, whilst the *general* level appears to be about half a watt, there is very considerable power used to drive the loudspeaker at the low frequency harmonics which are deliberately produced. The result is that the output valve may be overloaded at low frequencies before the power level at medium or high frequencies has been increased very much.

It should always be remembered that any attempt to produce heavy bass from, say, an 8-in. speaker on a very small baffle will distress the loudspeaker and generate non-linearity in the cone. Bearing these fundamental principles in mind, the Exley Circuit gives very satisfying results.

In view of the widespread interest which was shown in this rather unorthodox system, we are reproducing Dr. Exley's latest circuit in Fig. 10/15 along with his comments.

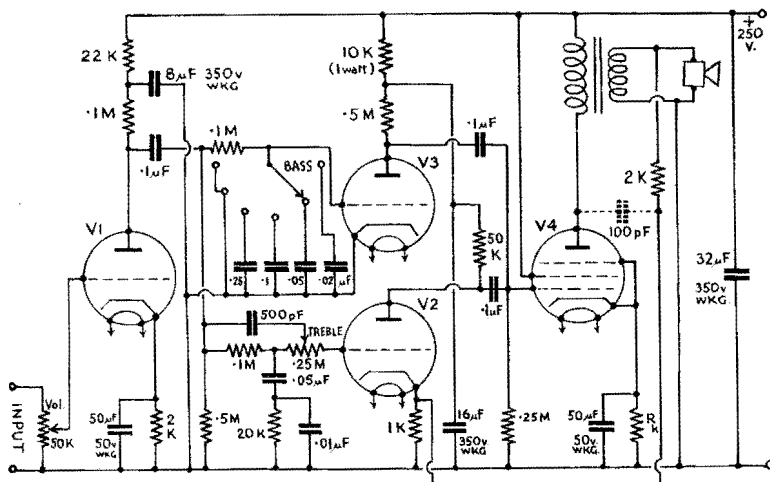

Reproduced by permission of "Wireless World"

Fig. 10/15.—Exley circuit.

COMPONENTS

V_1 and V_3 , 6F5 or H63.

V_2 , 6J5 or L63.

V_4 , 6V6 ($R_K=240$ ohms, 3 watts).

or EL33 ($R_K=180$ ohms, 3 watts).

Output transformer; Wharfedale W12 (22:1 ratio for 15 ohms speech coil).

Power supply; 250V, 60 mA, heaters, 6.3V.

The condenser shown in dotted lines is optional, but may often help to remove instability (capacity, 0.0001 mfd).

DESIGNER'S REMARKS

The 4-watt negative feedback amplifier shown above (with minor modifications suggested by the designer) was fully described in *Wireless World*, April 1951 issue. It was developed as an approach to the problem of achieving effective bass reproduction in the home without the use of either a large loudspeaker baffle or a high power output.

The lower bass frequencies are converted electrically into their respective harmonics by passage through a variable low-pass filter followed by a non-linear (grid-distorting) stage V_3 . The output from this is then mixed with middle and high frequencies which have passed through the linear stage V_2 . Since each harmonic is of shorter wavelength than the fundamental, the resultant sound can be radiated more efficiently from a small baffle. The human ear, presented with a combination of harmonics such as these, tends to add the "missing fundamental" subjectively, thus giving a sensation closely simulating the fundamental.

The amplifier is provided with volume, treble and "harmonic bass" controls. The latter should not be turned up too high, otherwise *unpleasant* distortion products may become audible in the final output.

Dr. Exley has very kindly agreed to help experimenters who may have difficulty in obtaining the desired results. His address is 146 Otley Road, Leeds 6. Letters should be brief and to the point and should certainly contain a stamped, addressed envelope for reply!

GENERAL NOTES

It must be admitted that although the use of complex RC networks can produce desired modifications of response, they should be used as little as possible, particularly in feedback circuits, for the following reasons:

- (1) Angular phase displacements adversely affect transient response.
- (2) Treble boost aggravates harmonic distortion.
- (3) Bass boost by reduced feedback, if carried to the point of distortion, loses the cleaning-up effect of the feedback circuit.
- (4) Bass boost systems often lead to instability due to phase shift.

It will be generally acknowledged that the best results are obtained when level response can be adhered to throughout the entire system,

TONE COMPENSATION

from microphone to loudspeaker. This has been demonstrated on several occasions by Mr. C. E. Watts, of Sunbury-on-Thames, at meetings of the British Sound Recording Association. Mr. Watts records flat up to 20 Kc/s, or as near thereto as he can get. His realistic results are due in no small degree to the absence of phase shift, helped of course by the absence of surface noise when direct recordings are played. It is a pity that such recordings cannot be bought, as many people who are interested in sheer quality of reproduction would be willing to pay quite a good price for lacquer discs which would give up to fifty playings with suitable lightweight pick-ups.

CHAPTER 11

PICK-UP INPUT CIRCUITS

The gramophone pick-up is an electro-mechanical device for converting the mechanical vibrations imparted to the needle by the groove on the record into alternating EMF's of the same frequency and relative intensity.

As explained later in the chapter, the problem so far as the amplifier is concerned is to obtain sufficient voltage at the grid of the input valve to produce the required volume level at the other end. Impedance matching does not enter into the picture at this stage. If a transformer is used, its sole purpose is to step-up the voltage. The question of impedance does however assume importance when it is required to control the response of the pick-up or match recording characteristics.

PICK-UPS

The principal types in use today are:

- | | |
|------------------|------------------|
| (1) Moving iron. | (2) Moving coil. |
| (3) Ribbon. | (4) Crystal. |

As a chapter in *Sound Reproduction* was devoted to this subject, it is only necessary here to remind readers that types 1, 2 and 3 belong to the magnetic or dynamic systems, where the voltage output is proportional to the velocity, and therefore require bass lift to balance the reduced output of records below the turnover frequency, whereas the crystal response is proportional to the displacement of the stylus and bass lift is not required, but the response of the crystal is not necessarily the inverse of the recording characteristic.

RECORDING CHARACTERISTICS

The turnover point is about 250 c/s on 78 rpm, and around 900 c/s on LP records. There is often pre-emphasis at high frequencies to improve the signal to noise ratio. Typical characteristics are shown in Fig. 11/1.

The EMI curve is similar to A without the rise above 4,000 c/s.

It is clear that a good deal of flexibility of control is required in reproducing equipment to do justice to such varying conditions; a switch is usually incorporated in high quality amplifiers to change the turnover point to suit LP records.

PICK-UP INPUT CIRCUITS

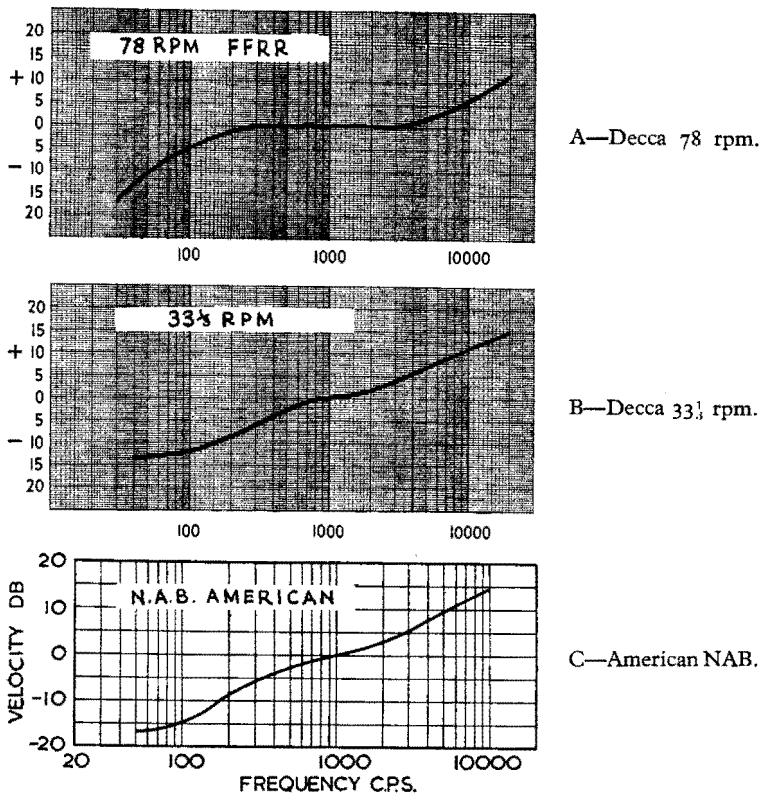

FIG. 11/1.—Recording characteristics.

OUTPUT LEVEL

The levels of output vary widely with the different types of pick-ups and different makes of the same type. Full information is obtainable from the makers but some details are given later. It must be remembered that the output obtainable from a pick-up will be reduced to a seventh or tenth if compensation is effected immediately after the pick-up. It is usually preferable to compensate after some amplification to keep a good ratio between signal and circuit noise, although compensation is best effected at quite a low level as most correction circuits seriously reduce the load on the preceding valve and can give rise to amplitude distortion if the signal voltages handled by this valve are high.

The highest voltage output is given by the crystal type, followed in descending order by the high impedance magnetic, low impedance magnetic, moving coil and ribbon.

CHOICE OF PICK-UP

There are other factors besides sheer performance to be taken into account when making a choice. The obvious one of how much gain will be required to obtain adequate output is the first, and is tied up with the question of amplifier noise and hum. If it is necessary to use a transformer with a very low output type, this transformer will couple with any 50 cycle field in the parish. Therefore, the lower the output level the greater the design troubles here. Astatically wound transformers and Mu-metal boxes are of great help in reducing induced hum.

Various methods of attacking hum in the early stages of a high gain amplifier are treated in the next chapter dealing with microphones, where the problem is still a low input to the amplifier.

Another consideration is the robustness of the design, particularly if other people, probably completely non-technical, have occasion to handle the apparatus. Compromise between performance, output and robustness is very often necessary.

PICK-UP LOADING

The difference between a magnetic pick-up and a crystal is mainly due to the fact that the former is partly inductive, whereas the latter is capacitive. The reactance of an inductance increases with frequency at the rate of two to one per octave, whereas the reactance of a capacitance is reduced at the rate of two to one per octave. Therefore a resistance in parallel with a magnetic pick-up cuts the top response, but a resistance in parallel with a crystal pick-up cuts the bass.

It is always of supreme importance to ensure that a pick-up is correctly loaded, and to ascertain what has been done to the input circuit of an amplifier, before blaming the pick-up or loudspeaker for peculiar results. Correct loading must be arranged before any form of tone control circuit is considered.

Broadly speaking, a magnetic type works very well when loaded with a resistance about twice the ohmic value of its own coil impedance. As the value of the resistive load is reduced, the HF response of the pick-up is cut down. The makers will always indicate the most suitable value for maintaining a level response. For example, the 400 ohms lightweight Connoisseur is happy when loaded with a 1,000 ohms resistor. If a step-up transformer is used, say ratio 1 : 5, the load required across the secondary will then be 1,000 ohms \times the square of the turns ratio, $1,000 \times 25 = 25,000$ ohms.

It is interesting to observe the effect of this loading on the production of surface noise. Fig. 11/2 shows the difference produced with the Connoisseur pick-up (without transformer) by using a resistance of 10K instead of the prescribed 1K.

Difference in sound level approximately 6 db.

PICK-UP INPUT CIRCUITS

Condition B is recommended by the makers, for level response. It is quite evident that Condition A would contain an undue proportion of surface noise in relation to music. The photographs serve to illus-

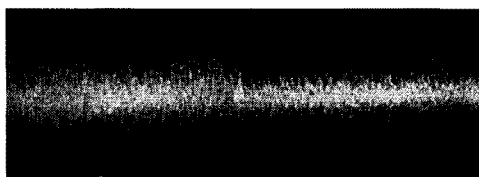

A

B

FIG. 11/2.—Oscillogram of needle scratch produced in wide range two-speaker system. Shellac record, groove diameter 10 ins. 78 rpm, 400 ohms magnetic pick-up, without transformer.

A. Loaded by 10K resistor.

B. „ „ 1K „

trate the importance of adopting correct working conditions with any pick-up.

The voltage output of the Connoisseur model is approximately as follows:

400 ohms coil	Direct	With transformer ratio 1 : 6
78 rpm	35 mV	175 mV
LP	25 mV	125 mV

Interchangeable heads are of course supplied.

The Decca pick-up is available in four types with different impedances, three of them with interchangeable heads for LP. The following table gives essential data, along with recommended value of load resistance.

	Impedance at 1,000 c/s	Voltage direct	Load	Voltage with 1 : 40 transformer	Load
Decca A 78	30 ohms	13 mV	—	0.7V	47K
„ B 78	170 „	36 „	—	1.2V	47K
„ B LP	170 „	18 „	—	0.75V	47K
„ C 78	850 „	70 „	10K	—	—
„ C LP	850 „	30 „	10K	—	—
„ D 78	4,200 „	180 „	10K	—	—
„ D LP	4,200 „	80 „	10K	—	—

Another illustration of variation in load requirements is the EMI Type 14 with an impedance of only 2 ohms at 800 c/s and an output of 6 mV direct. The matching transformer is normally ratio 1 : 110,

stepping up the output to 1.5 volts and calling for a load resistance of about 100K.

These examples will serve to emphasise the importance of loading a pick-up correctly to reduce subsequent tone controls to a minimum, and to avoid distortion.

With a crystal pick-up, the situation is quite different as we have already seen: the resistive treatment just outlined would result in severe loss of bass. Broadly speaking, the crystal type is reasonably loaded by the grid leak of the input valve provided this is not less than 250,000 ohms. The response would be well maintained up to the resonant frequency of the crystal, above which there would be severe attenuation. Fig. 11/3 shows a simple input circuit which could easily be adopted with a GP20, and would provide correction for both 78 and LP records.

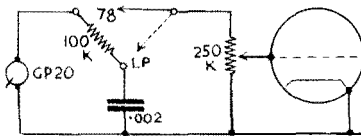

FIG. 11/3.—Input circuit for a crystal pick-up (lightweight) with switch for LP.

PICK-UP MATCHING

The term "matching" as applied to a pick-up is not strictly accurate, as matching is a problem of power transference, *e.g.* matching the output valve to the loudspeaker, or matching the output of a telephone repeater (amplifier) to a line, whereas with a pick-up one is largely concerned with obtaining a reasonably high voltage between grid and cathode of the first valve of the amplifier. Nevertheless, matching is generally understood to apply to balancing the response of a pick-up with the recording characteristic, and to damping possible resonances to ensure a smooth response.

After making sure that a pick-up is being loaded correctly, we can proceed to the general problem of matching by means of tone control circuits. There are four main tonal varieties: dynamic and crystal pick-ups, each to be adapted to 78 and 33½ characteristics, further complicated by the fact that the correction may be applied in the pick-up circuit or—preferably—in a following valve circuit. Furthermore, as the recording level on microgroove discs is 6–10 db lower than on 78 rpm, and as the correction network may reduce the output level by 90 per cent., the pick-up circuit is hardly the ideal stage in which to apply compensation. In fact, if you put the correction there with some types, you will find yourself in the position most of us are in when we have paid our income tax—with little or nothing left! However, it is in many cases easier to fiddle with control circuits which are located externally than hidden away under the pre-amp or main amplifier. Yet another difficulty is that the HF resonance of a pick-up may be lower with LP head and stylus than with the normal 78 rpm type.

PICK-UP INPUT CIRCUITS

Complete matching circuits are readily available from all pick-up makers, but acknowledgment should be made here of the information and diagrams received from Connoisseur, Cosmocord, Decca and EMI from which the following representative circuits have been compiled. The intention is to furnish a range of tone control arrangements which, in combination with those described in Chapter 10, will enable the reader to achieve anything but the impossible. To simplify matters, let us concentrate on the maximum circuitry with the minimum of verbosity.

CONTROLS IN PICK-UP CIRCUIT

Figure 11/4 shows a bass lift circuit with LP switch suitable for the Connoisseur lightweight 400 ohms model, which could also be used

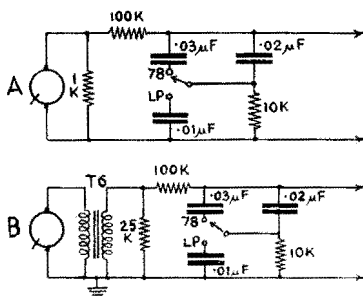

FIG. 11/4.—Bass lift circuit, with switch for 78 and LP matching, suitable for 400 ohms Connoisseur pick-up or other low impedance magnetic types. Increase value of R_1 for higher impedance coils or transformer input.

with magnetic pick-ups of higher impedance by increasing the value of the load resistance R_1 .

If used with step-up transformer with a ratio of 1 : 5 R_1 would be 25K, across secondary.

NFB CONTROL

An interesting feedback circuit from EMI is given in Fig. 11/5.

As will be appreciated from an examination of the diagram, all frequencies are fed back to the grid circuit from the anode, so that an

FIG. 11/5.—NFB type bass compensation circuit, with separate brilliance control, matching EMI pick-up types 13 and 14, at 78 rpm.

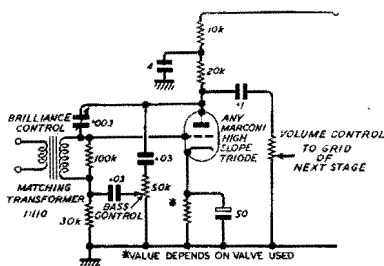

overall reduction in the stage gain is brought about, due to the out of phase inputs to the grid. By adjusting the bass control however, feedback of the out of phase lower frequencies may be reduced, thus resulting in the greater amplification of these frequencies.

CRYSTAL TYPES

As the voltage output here is comparatively generous, correction in the pick-up circuit leaves a useful margin to be passed on to the grid of the first valve. The GP20—quite a lightweight—has a direct output of about .5 volt with 78 rpm head, or .25 volt with LP head. A simple but effective 78/LP corrective circuit has already been given in Fig. 11/3.

MOVING COIL AND RIBBON

No mention of these types has yet been made in this section, but no disrespect to their elegant qualities is thereby implied. To ignore them would be like preparing a Who's Who in audio and omitting Voigt and Klipsch, or a What's What in motoring and omitting names like Rolls-Royce and Bentley, although the latter are famous for high-powered efficiency whereas the finest pick-ups and microphones are conspicuous by their low output. It is for this reason that moving coil and ribbon pick-ups would not have compensation applied until some amplification had been brought in. The makers always supply the required step-up transformer with instructions for use, but once such a pick-up has been correctly matched to the first valve there is no reason why the "fluence" should not be applied—as outlined in the next section.

VARIABLE CONTROLS

We now come to variable bass and treble controls. Figs. 11/6 and 7, which can be combined as shown in Fig. 11/8, give complete control and LP switching in a form which can be applied to a pick-up circuit or to an intervalve circuit, provided the requirements of input and output impedance are reasonably met. These are followed by a pre-amp circuit which employs NFB and conforms to the specified conditions. The writer has to thank Mr. B. Marsden, chief radio engineer to A. R. Sugden & Co. of Brighthouse for valuable data and circuit diagrams.

The preferred arrangement for maximum results is as follows:

1. Pick-up correctly loaded.
2. Pre-amplifier to boost the level at least 40 or 46 db.
3. Filter as outlined in Fig. 11/8.
4. Flat response amplifier with NFB applied to cathode of first valve to increase input impedance of first stage.

PICK-UP INPUT CIRCUITS

Fig. 11/6 gives the Connoisseur circuit for variable bass compensation.

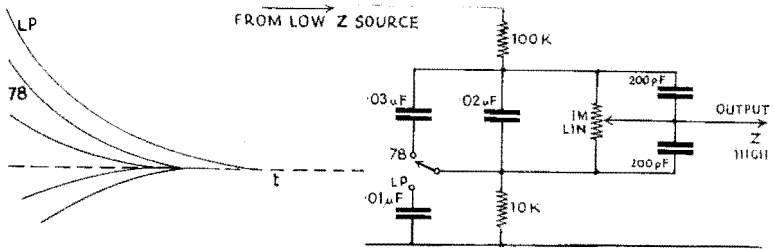

FIG. 11/6.—Variable bass control with 78/LP switching.

The condensers (200 pF each) are necessary to maintain constant response at HF, as the wiring and grid capacity of following stage can give top cut when potentiometer is in mid position.

Fig. 11/7 shows a treble variation circuit which would have its uses in coping with worn discs and LP characteristics.

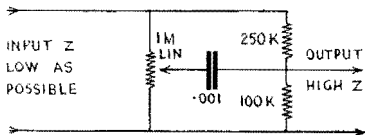

FIG. 11/7.—Variable treble control.

The value of C in Fig. 11/7 determines the hinge point. Values between .0002 and .002 mfd can be used to give compensation for all discs, but .001 is a good compromise for LP and 78 variations.

As the input impedance of the bass control circuit is 100K and output load of the treble control is also 100K, they can be joined together as shown in Fig. 11/8, complete with 78 and LP switch. The addition of a 1M volume control should enable the user to make his pick-up sit up and beg or lie down quietly, at will.

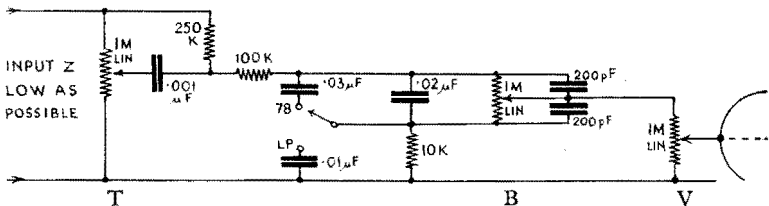

FIG. 11/8.—Pick-up circuit providing wide range of control, including 78/LP switch.

T—treble control. B—bass control. V—volume control.

For a useful circuit with switched controls refer to Fig. 10/9 on page 116.

Since the valve following the control is usually the first valve of "flat" amplifier and has NFB applied to cathode, its input Z is very high and one need not worry about C_o existing from wiper of volume control to ground. NFB applied to cathode does not of course remove effect of any C_o due to screened leads, wiring, etc., but reduces C_o due to C_{gk} and C_{ga} .

PRE-AMPLIFIER

The following circuit employs a twin triode 6SL7 or 12AX7 in cascade, and will give a stage gain according to the book of 50 or 60 per section: *i.e.* input G_1 to output A2 about 3,000. The excess gain is thrown away on feedback, giving a reduction in pre-amplifier noise and distortion, with a reduction in output impedance which is useful if the pre-amplifier is separated from the subsequent tone control.

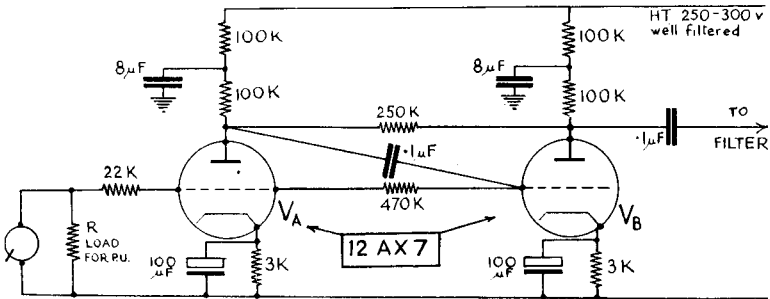

FIG. 11/9.—Pre-amplifier with low output impedance designed to feed into filter circuit of Fig. 11/8. Input circuit for magnetic pick-up.

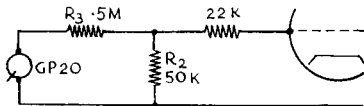

FIG. 11/9A.—Modification of input circuit to pre-amp to suit lightweight crystal pick-up. R_3 is made 10 times the value of R_2 , thus giving an input of 50 mV to pre-amp.

Feedback is applied for each section as follows:

VAG_1 is connected to pick-up via a 22K resistor. Feedback from anode to grid is via $\cdot 1$ and 470K. Amount of feedback is determined by ratio of 470K to 22K (increasing 22K reduces gain).

In the second portion feedback anode to grid is via 250K and $\cdot 1$.

Due to the high gain, care must be taken that coupling does not exist between anode 2 and grid 1, as this would be positive feedback and would produce high frequency oscillation. To cancel the capacity between the valve electrodes and wiring, a small condenser can be connected between G_1 and ground, say 50 pF or so. The loss of treble introduced is negligible. (*Connoisseur circuit.*)

PICK-UP INPUT CIRCUITS

Other valves can of course be used. The 6SN7 gives less gain per stage. Alternatively, two separate triodes could be employed.

The type of feedback used—anode to grid—reduces the input impedance of the stage. A voltage in anti-phase to the incoming signal is supplied by the anode. This is in series with the incoming voltage and gives a larger circulating current, the exact effect that would be present if the valve VA were replaced by a resistor between G_1 and ground. The lower input impedance will of course act as a load on the pick-up feeding the first grid, and explains the presence of the 22K resistor. This tends to isolate the low impedance pick-up from the grid to allow the feedback to manifest itself, and also to reduce the loading applied to the pick-up. With a crystal pick-up it is essential to modify the input circuit, as indicated in Fig. 11/9A.

To conclude this section, it should again be stressed that tone control circuits are a necessary evil; they cannot improve quality, but they are necessary on account of the recording characteristics shown in Fig. 11/1. The Garner Amplifier includes a versatile and useful system. It is hoped that this chapter will serve to throw additional light on a complicated problem.

In any case there are wide differences in frequency characteristics in commercial records, and the idea that they can be corrected by a fixed network would appear to be a form of wishful thinking. It seems inevitable that recording engineers must adjust their controls to suit ambient conditions and the "tone" of the voice or instrument which is being recorded. It is therefore necessary to have flexible controls in the reproducing equipment, as depriving the user thereof would be almost as bad as asking him to drive a motor-car with a fixed steering wheel.

It is unfortunate that the big recording companies do not give us more information on these points. One looks in vain for a really interesting book on the subject of recording, written by a man of vast experience.

MOTOR RUMBLE

Magnetic pick-ups are not seriously troubled by motor rumble, which originates from vibration components, usually between 5 and

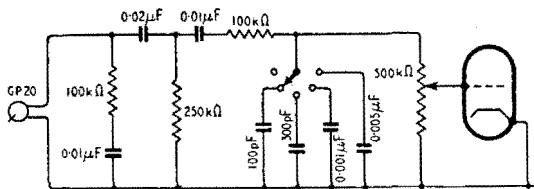

From "Wireless World", Nov. 1950 (Kelly & West)

FIG. 11/10.—Complete compensating circuit for crystal pick-up, including rumble filter, and switched top control for FFRR recordings.

50 c/s. Their output is proportional to velocity, which falls with frequency for a given amplitude, and consequently little output occurs at these low frequencies. Crystal pick-ups, on the other hand, are particularly susceptible to the large amplitude at low frequencies and show up the deficiencies of a motor in no uncertain way. With the Acos GP20 a *velocity* type characteristic has been introduced below about 30 c/s and the trouble is considerably reduced. Where necessary, however, a high pass filter may be employed, as shown in Fig. 11/10, consisting of the two condensers .02 and .01, and two resistors. A switched circuit to give top control for FFRR characteristics is also included in the diagram, for good measure.

ADAPTABILITY

For general use the ideal input circuit for pick-ups and microphones is of course the Cathode Follower. Its input impedance is so high that it accepts all that comes its way with equal impartiality. It catches the ball, whether thrown high or low, and passes it on to the next stage at a convenient height. As its stage gain in technical terms is less than unity (which means that it has no gain and so we are referring to something which does not exist), it is unlikely that the Cathode Follower will have a big following in domestic circles; but it would be an advantage if all amplifiers could be sold with high impedance input and all pick-ups supplied complete with requisite loading. The fiasco of connecting a crystal pick-up to an amplifier with low resistance input originally designed for use with a magnetic type, or of playing a 400 ohms magnetic type into a load of 250,000 ohms instead of 1,000 would thereby be avoided.

Amplifiers and loudspeakers are now turned out ready for use and are expected to be interchangeable within limits of 3 to 15 ohms. It is about time that the input problem was tackled along similar lines, so that a pick-up could be changed as easily as a loudspeaker.

It is the custom to stamp the output impedances on an amplifier so that the user always knows where he stands when he connects different loudspeakers. But how often do we find the same brand of information stamped on the input terminals? The input impedance should be clearly marked, or if the input circuit has been arranged to match a certain pick-up the chassis should be labelled accordingly.

It is not suggested that all pick-ups should be made of similar impedance, as this would clearly be impossible. They could, however, be supplied complete with the necessary loading circuit so that they could be plugged in to any amplifier, which in turn should have a versatile high impedance input.

CHAPTER 12

WHISTLE AND SCRATCH FILTERS

WHISTLE FILTERS

The use of whistle filters in association with radio feeders with a wide frequency response is not uncommon, due to lack of elbow room in the medium wave band and the production of objectionable whistles in the 8-10 Kc/s region. When the interference is limited to a signal of a definite frequency it is possible to incorporate a sharply tuned resonant circuit to eliminate it, or at least to greatly reduce its nuisance value; but it must be emphasised once again that the elimination of the one frequency will necessarily cut out any musical frequencies of the same order. Suitable circuits and a discussion of their properties were given in Chapter 10.

It is, of course, always a debatable point whether a more sharply tuned radio feeder cutting off around 7-8 Kc/s is not a better proposition than a whistle filter. In many districts, the use of a filter only removes part of the "dirt", and a tuner of the super-het type with variable bandwidth comes as a boon and a blessing. It should always be remembered that a filter removes some adjacent frequencies. If the transmission cuts off at about 10 Kc/s and the filter is tuned to 9 Kc/s there will be precious little left in the programme above 7-8 Kc/s. The operation of such filters always strikes the writer as equivalent to cutting out a thin slice of bread about $\frac{1}{4}$ in. from the end of a loaf and expecting the $\frac{1}{4}$ in. crust to stand up on its own.

SCRATCH FILTERS

If examined under powerful magnification, shellac records will be found to have a surface rather like fine glasspaper, due to the filler

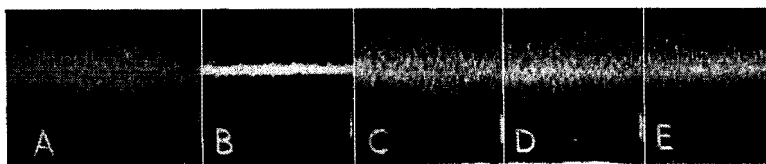

- A. Combined output from 15-in. and 8-in. units. 85 db.
- B. 15-in. unit, crossover 1,000 c/s. 68 db.
- C. 15-in. unit, crossover 3,000 c/s. 79 db.
- D. 8-in. treble crossover 1,000 c/s. 82 db.
- E. 8-in. treble crossover 3,000 c/s. 76 db.

FIG. 12/1.—Oscillograms of needle scratch. The approximate sound levels above threshold are indicated. Note the increased level when the 8-in. treble unit is extended from 3,000 cycles down to 1,000, and the still greater difference when the bass unit is taken up from 1,000 to 3,000 c/s.

which is mixed with the shellac. The irregularities in the surface cause output across the pick-up terminals over a very wide range of frequencies, almost equivalent to "white noise". The oscillograms of Fig. 12/1 will illustrate to some extent the energy distribution of the surface noise in relation to the frequency range.

It will be observed that there is very little power at frequencies below

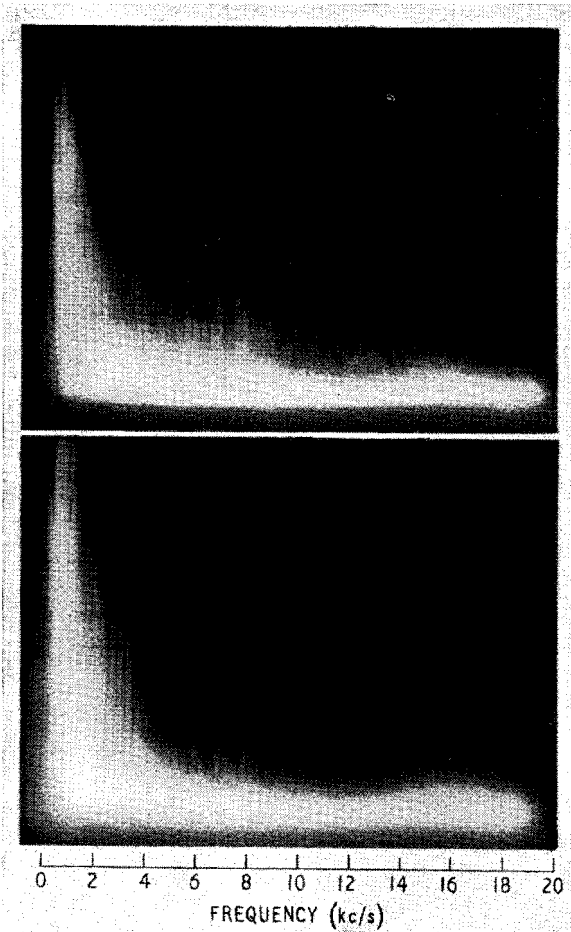

TOP:
Second side of
Danse Macabre.

BOTTOM:
First side of
Beethoven's
Fifth Symphony.
Standard shellac
records.

Courtesy Decca Record Co. Ltd.

FIG. 12/2.—Panoramic display of the audio spectrum from 0–20 Kc/s showing energy levels with time exposures of $1\frac{1}{2}$ and 2 minutes respectively, 250 c/s upwards.

1,000 c/s. By comparison, it is interesting to note the energy distribution in music as shown in Fig. 12/2, which is the result of investigations made by Decca.

The main peak would appear to be located around 1,000 c/s and with

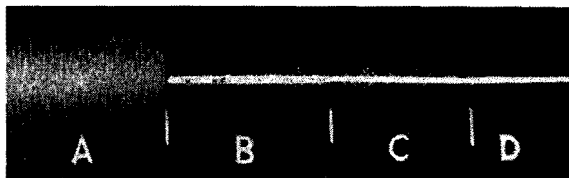

FIG. 12/3.—Oscillograms of surface noise.

- A. Shellac.
- B. Vinylite 78 rpm.
- C. Vinylite 33½ rpm.
- D. Trace on 'scope without input.

a very much higher output below 3,000 c/s than above this frequency. These illustrations serve to show why surface noise is most obtrusive in the upper register, where it easily equals or exceeds the sound level of the overtones of music.

Vinylite records, being without filler, are comparatively free from surface noise. It is unfortunate that high cost precludes the general adoption of this material for 78 rpm discs. Fig. 12/3 shows oscillo-

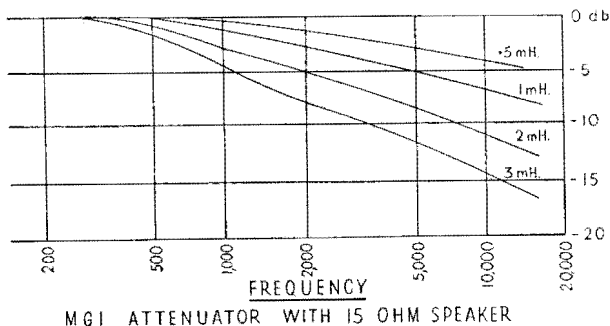

FIG. 12/4.—Attenuation in response of 15 ohms speaker with tapped inductance in series with voice coil. Values 0.5–3 mH.

grams of surface noise from shellac and Vinylite discs respectively, taken under identical pick-up, amplifier and oscilloscope conditions, with wide range two-speaker system.

The long-playing disc shows rather more vertical lines from dust, etc.,

than the 78 rpm equivalent. This is no doubt due to the finer stylus point.

The elimination of scratch by means of a resonant circuit peaked at any particular audio frequency is quite impossible. Such a "cure" might appear to be successful if it eliminated a pick-up resonance which was emphasising random noise.

As a general rule, the treble control on the amplifier will be effective in reducing the output of surface noise by cutting HF response. If an additional control is required, the simplest method is to use a tapped inductance in series with the LS speech coil.

Figure 12/4 shows the extent of HF attenuation introduced by inductance values up to 3 mH with 15 ohms speaker, and Fig. 12/5 shows the corresponding reduction in surface noise up to 2 mH.

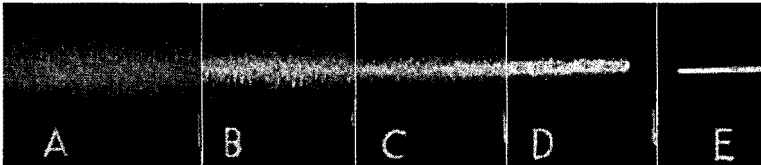

FIG. 12/5.—Oscillograms to show reduction of surface noise from 15 ohms speaker by series inductance, as used in Fig. 12/4.

- A. Flat response.
- B. 0.5 mH.
- C. 1 mH.
- D. 2 mH.
- E. Oscilloscope line only.

The 2 mH condition obviously includes a good deal of treble cut and would only be required with extremely worn and noisy discs.

The problem of surface noise may seem to be rather outside the scope of a book on amplifiers, but it is so much wrapped up with the question of frequency response and tone compensation that it cannot reasonably be ignored.

MICROPHONES AND MIXING CIRCUITS

The microphone is an electro-mechanical device for converting the vibration of the air particles caused by a sound, into alternating electrical currents of EMF's of the same frequency and relative intensities as the exciting sound waves.

It is akin to the loudspeaker because its performance is vitally affected by the conditions under which it is used ; in both cases the design must take into account acoustical as well as electrical principles.

The sensitivity of a microphone is its electrical output for a given intensity of input. Sensitivity varies greatly with microphones of different basic types, and between different models of the same type. The output is also greatly dependent on the distance of the sound source from the microphone, both as to character of sound and intensity. In free air, the intensity of sound from a point source is inversely proportional to the square of the distance from the source. In an enclosed space, reverberation plays an important part and ambient conditions vary enormously. As the microphone is moved away from the source of sound the balance between pick-up of direct and reflected sound waves is varied, depending to some extent on the directional properties of the microphone and the angle of incidence, which refers to the direction in which the microphone is faced in relation to the sound source.

The actual size of a microphone also affects its sensitivity in relation to frequency, as diffraction effects become serious where the outside dimensions are greater than the wavelength. It is stated in *Microphones*, written by BBC engineers and recently published by *Wireless World*, that for diffraction effects to be moderate at 15 Kc/s the dimensions of the outer casing (preferably spherical) should be less than 2 ins.

FREQUENCY RESPONSE

The frequency response of a microphone is its relative ability to convert sounds of different frequencies into alternating currents or potentials. With a fixed input of sound intensity the electrical output may vary considerably as the sound frequency is varied ; thus, quite a good microphone may be rated as having variations not exceeding ± 6 db between 50 and 8,000 c/s. To claim that a given type has a frequency response which extends from 50 to 8,000 c/s means nothing, as the output at 8,000 c/s may be only a fraction of the level at 50 or 500 c/s.

MICROPHONE TYPES

Microphones fall naturally into two groups:

1. *Low Impedance*—Carbon and carbon granule, velocity or ribbon types and dynamic or moving coil types.
2. *High Impedance*—Condenser and crystal types.

On the other hand, the ribbon is a *velocity* microphone in which the electrical output follows the instantaneous particle velocity of the impressed sound waves. The carbon, crystal, moving coil and condenser microphones—shall we say the “c” types?—all belong to the *pressure* class, in which the electrical output substantially corresponds to the instantaneous sound pressure of the impressed sound waves. Microphones differ from pick-ups in that they are referred to the acoustic property of the driving medium.

A brief description of the various types now follows, as a prelude to the input circuits with which they could be used.

CARBON MICROPHONES

(a) SINGLE BUTTON TYPE

This consists of a case with a metal front plate or diaphragm placed against the face of a cup containing loosely packed carbon granules. One connection is made to the front diaphragm and the other to the back of the container. A battery is placed in series with the button and the primary of a suitable step-up transformer of about 1 : 100, Fig. 13/1. As the diaphragm vibrates in sympathy with the sound waves its pressure on the carbon granules alternately increases and decreases, causing a corresponding variation of current flow through the circuit, since the change of pressure on the mass of granules varies the resistance of the path.

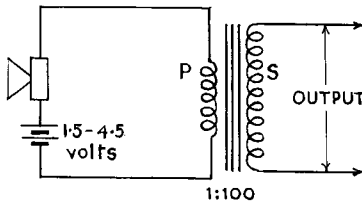

FIG. 13/1. — Carbon Microphone.

The chief characteristic of this type is a high output level, 0.1–0.3 volt across the primary giving up to 10 volts on the secondary. This is the normal post-office telephone type which without any amplification will actuate a telephone headpiece. The frequency range is restricted, but is enough to give intelligible speech. There is an inherently high noise level, and variable behaviour with a tendency for the granules to “pack” if the current through the microphone is too high. This current is usually 50–100 mA.

This microphone is quite unsuited to any serious work.

(b) DOUBLE BUTTON TYPE

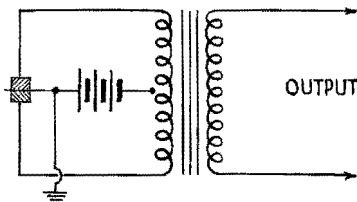

FIG. 13/2.—Double Button Microphone.

This operates in a similar way to the single button, but in push-pull, Fig. 13/2. The sensitivity is less, about 0.5 volt on the secondary being an average value. The quality of speech is better, but not at all useful for serious work.

(c) THE TRANSVERSE CURRENT TYPE

FIG. 13/3.—Diagram of transverse current microphone. The current passes from one electrode to the other across the granules.

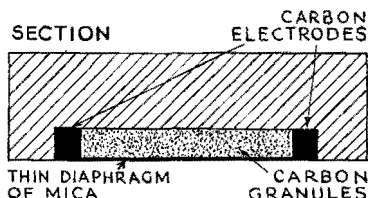

Figure 13/3 shows diagrammatically the principle of the transverse current type. Carefully constructed, these can give quite good quality of speech, but again are not to be taken very seriously for quality work.

RIBBON MICROPHONE

The book *Microphones* (already referred to) contains a full description of the *BBC-Marconi Ribbon*, from which the following interesting details are taken :

Ribbon—beaten aluminium foil, $2\frac{1}{2}$ ins. long, about .0003 in. thick, with corrugations to facilitate smooth adjustment of tension.

Response—flat to 5 Kc/s, -6 db at 10 Kc/s, -16 db from 15 to 20 Kc/s.

Resonance—flexible suspension gives a fundamental resonance at approximately 2 c/s.

Impedance—0.6 ohm—virtually a pure resistance.

Designed for high-quality broadcasting from a studio.

It is pointed out that ribbon microphones are being made in America, in which the corrugations are confined to the end portions of the ribbon, the centre portion being stiffened to ensure a more

piston-like motion, free from harmonic modes. The "boom" experienced when a velocity type microphone is used too close to the sound source is due to the fact that the particle velocity follows a different law for spherical waves compared with that for plane waves in free space. This results in considerable accentuation of the low frequencies.

This type of microphone is free from cavity resonance.

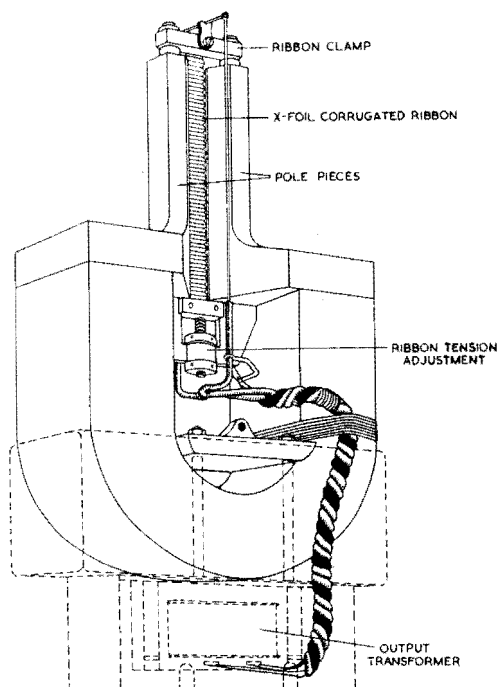

From "Microphones," courtesy BBC and "Wireless World"

FIG. 13/4.—BBC-Marconi Ribbon Microphone.

The output from Ribbon types is very low, and hum pick-up can be troublesome if long leads to the input of a high-gain amplifier are required. In some cases, one stage of amplification is built into the microphone head to raise the signal-to-noise ratio in the leads.

MOVING COIL MICROPHONE

This is a form of moving coil loudspeaker in reverse. Sound waves impinging on the diaphragm cause the coil to move in the magnetic field and thus an EMF is induced across the ends of the coil. The

MICROPHONES AND MIXING CIRCUITS

weight of the diaphragm and the stiffness of the suspension govern the location of resonances in the musical scale, but with careful design they need not be objectionable. The impedance of the coil may be anything between 0.5 and 70 ohms, and a step-up transformer will be employed. An average output might be 100 mV across secondary for close speaking, or with reference level $1\text{V}/\text{Dyne}/\text{cm}^2 - 83\text{ db}$ across 20 ohms speech coil or -43 db across transformer secondary at 200,000 ohms.

This is probably the most widely used type, as it combines reasonable sensitivity with good frequency response and is not inordinately expensive. Freedom from blasting and fluffing are other advantages.

S. T. & C. moving coil microphones, type 4017 (now superseded by 4035-A) and type 4021A, are largely used by the BBC, especially on outside broadcasts. The response is flat from 35 to 10,000 c/s. Model 4021A has a domed diaphragm only $\frac{3}{4}$ in. diameter, with a piston-like motion at all frequencies below 15 Kc/s. The microphone is used with the diaphragm facing upwards so that the angle of incidence is the same for all sound in the horizontal plane. The complicated structure of the instrument is well illustrated in Fig. 13/5. This model today costs £17 10s. od.

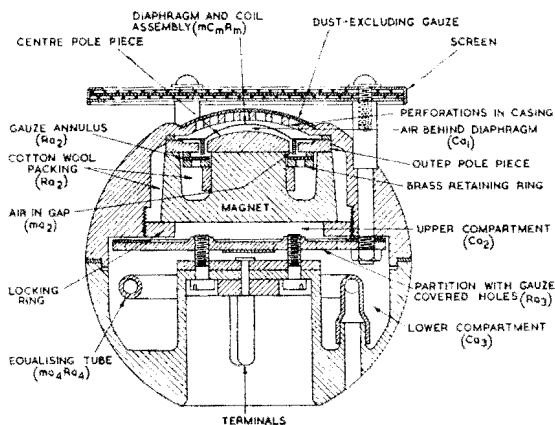

From "Microphones," courtesy BBC and "Wireless World"
FIG. 13/5.—S. T. & C. Microphone 4021A. Moving coil.

CONDENSER MICROPHONE

The condenser microphone consists of two plates, one a rigid back plate and the other, separated from the first by about a thousandth of an inch, a thin perforated metal membrane serving as a diaphragm. This condenser is connected in series with a DC voltage source and a

resistance which is useful to limit current in the not unlikely event of a short, but is actually the load across which the output voltage is developed, Fig. 13/6. When the membrane vibrates the change in spacing causes a change in capacitance and a back and forth flow of current. $Q=CV$ with V constant, but C changing, Q will also change.

The first stage amplifier must be built adjacent to the unit or the capacitance of the connecting lead will seriously impair both output and frequency range.

FIG. 13/6.—Circuit of Condenser Microphone.

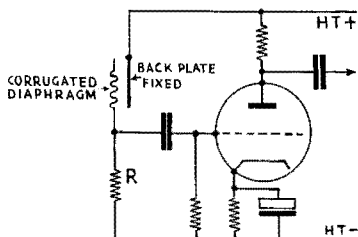

This type of microphone has been developed in America to a much greater extent than in Great Britain. Very wide frequency response is achieved, but at the present rate of exchange the best instruments cost about £75 each. Even at this price there is a good deal of interest in obtaining specimens in this country, when dollar exchange is available.

More recently, reports are to hand on the performance of the *Neumann* condenser microphone which is of German origin, costing about £60 in England after payment of duty. The frequency response is substantially flat at all audio frequencies; the physical dimensions are small enough to avoid diffraction effects. The microphone can be arranged to be omni-directional, or to have a cardioid characteristic which reduces the sound acceptance at the back virtually to zero. It is free from cavity resonance, and its behaviour is reported on good authority to be more in keeping with the human ear in that it is not so seriously affected by distance from sound source as most types of microphone.

CARDIOID MICROPHONE

A combination of two types, such as moving coil and ribbon in one instrument, enables a cardioid characteristic to be obtained, so that the microphone is directional. This is extremely useful for recording purposes in "live" rooms, as it helps in obtaining the desired balance between direct and reflected sound, without placing the microphone too near to the sound source. In other words, a more distant technique is possible without recourse to acoustic treatment of walls, ceiling, etc.

The two units of the microphone work in series and are arranged so that voltages are out of phase for sound reaching the back, resulting in cancellation.

Switches and/or attenuators are usually fitted to enable the user to

MICROPHONES AND MIXING CIRCUITS

vary the characteristics as required, and to use the velocity or dynamic microphone on its own.

The output impedance is usually about 50 ohms, so quite long leads

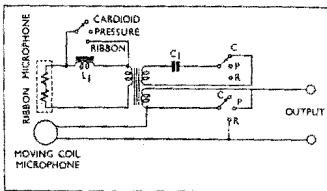

FIG. 13/6A.—Circuit of Stantel Cardioid Microphone. Output impedance 50 ohms.

may be run to amplifier without fear of hum pick-up, loss of power or attenuation of frequency response. These microphones today cost between £35 and £42 each.

Fig. 13/6A illustrates the switching arrangements adopted in the Stantel 4033 Cardioid.

CRYSTAL MICROPHONE

The sound cell type has a very flat response/frequency characteristic up to the frequency of mechanical resonance, which can be arranged

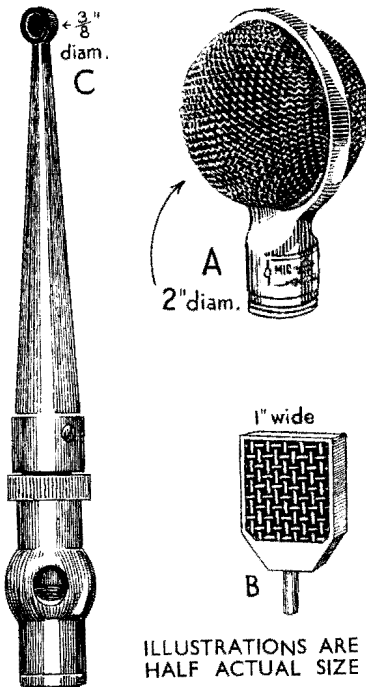

FIG. 13/7.—Crystal Microphones drawn to scale.

- A. Cosmocord.
Range 30 c/s to 8 Kc/s.
- B. Tannoy.
Range 30 c/s to 16 Kc/s.
- C. Cosmocord.
Range 5 Kc/s to 30 Kc/s.

ILLUSTRATIONS ARE
HALF ACTUAL SIZE

to occur at high frequencies by reduction of size. The small size of the cells eliminates diffraction and phase-difference effects, and the response at all useful frequencies is virtually independent of the angle of incidence. With these omni-directional qualities, the sound cell crystal is eminently suitable for use in response measurements of loudspeakers. The above (Fig. 13/7) sketches illustrate the proportionate size of three types used by the writer in taking sound level readings, response curves, and oscillograms of various sounds.

Type A is used with Noise Meter which is effective up to 7,500 c/s. Type B is used for response curves. The miniature Type C was specially made for observing frequencies up to 30 Kc/s (not in loudspeakers). These instruments cost about £12, £25 and £50 respectively. As usual, size and sensitivity go down as price and performance go up, and cavity resonance disappears.

Types A and B are of bimorph construction, which is adapted to reduce the mechanical impedance of the crystal so that it more nearly matches that of the medium in which it is working and thus increases the efficiency—and hence the sensitivity—of the unit; this limits the upper frequency range of the microphone. Type C, with response reaching up to supersonic regions, is an expander unit with sensitivity some 20 or 30 db lower than the bimorph.

MICROPHONE INPUT CIRCUITS

When microphones are used for close speech, the output (with associated transformer where required) is of a reasonable level which could probably be connected to the input of an amplifier normally working from a high quality pick-up; but when distant sounds are involved considerable extra amplification will be required. It is then that the difficulty of obtaining low hum level, little microphony and low valve hiss becomes apparent. The choice of the first valve is limited, but certain types are recommended by the makers as being less prone to microphony and hum than others: for example, the Mullard EF37A and EF42.

Careful wiring of the first stage is essential, and attention to the heater circuit as outlined in Chapter 15 will help to keep hum at a low level. The use of DC for the heaters of early valves is often recommended; either accumulator or rectified AC may be used as a source and often effects an improvement compared with AC.

If post-office jacks are used for mic-input circuits the outer casing must be metal to afford screening. The bakelite cover types invariably allow electro-static hum pick-up. All connections should of course be screened: the Belling-Lee range of "Screenectors" and conventional co-axial plugs and sockets are suitable. Any long length of connecting cable must be screened, co-axial cable being superior to ordinary screened leads for low capacitance.

MICROPHONE LEADS

The technique of connecting microphone to the first valve of the amplifier varies according to the type involved. The following methods combine simplicity and efficiency :

Moving coil types.

The impedance here will probably be between 20 and 60 ohms. The best plan is to place a balanced input transformer in the amplifier and run low impedance lines direct from the microphone. Any type of twin cable may be used, as there is no fear of hum pick-up or loss of power, and the capacitance of the leads will have no effect on frequency response.

Ribbon and low impedance MC types with transformer.

Owing to the very low impedance and the small output of a ribbon, the transformer will be mounted in the microphone head. The same course would be adopted with a moving coil type of very low impedance as distinct from the 20-60 ohms models. The output impedance from the transformer will probably be between 20 and 250 ohms. A further step-up transformer will be placed in the amplifier. Twin leads should be run (in screened cover if 250 ohms) which should be connected to the case of the microphone, but should only be earthed at the amplifier end, as shown in Fig. 13/8.

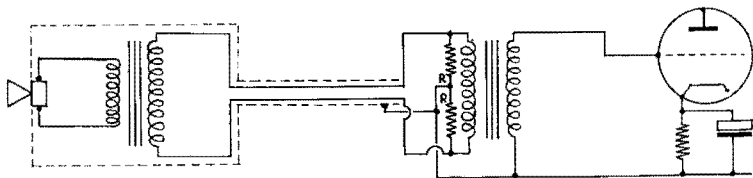

FIG. 13/8.—Diagram showing transformer input circuit balanced to earth.

The primary of the input transformer should be balanced to earth. This could be done by using a centre tap on the winding, but it is easier to find the electrical centre by using an external load which is variable. A potentiometer with a resistance of at least ten times the input impedance would answer the purpose, or two resistors of similar value could be used.

As regards the microphone transformer, it is better not to balance the centre of the secondary to earth, as this would create another loop which could be a source of hum troubles.

Studio Technique.

Where long microphone lines are used under exacting conditions, with high quality microphones of low sensitivity, the precautions against hum pick-up must obviously be thorough and complete. One system is outlined here, as it may prove useful to the amateur

in overcoming problems of hum with a ribbon pick-up—a type which often presents difficulties.

The circuit is outlined in Fig. 13/8A.

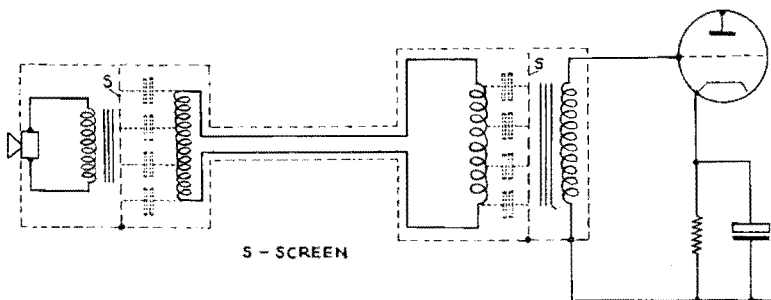

FIG. 13/8A.—Input circuit with stray capacities balanced to avoid hum.
Suitable line impedance would be 600 ohms.

Both transformers would be fitted with Mu-metal cases and would have a screen between windings. The secondary of the microphone transformer and the primary of the input transformer (to amplifier) would be section wound so that the capacitance between ends of winding and screen is uniform. Screened leads would, of course, be used. Coaxial cable with two conductors would be very satisfactory. By comparison with this system, with its balanced capacitances, a centre tapped transformer would be looked upon as a palliative.

Crystal Microphones.

These are of high impedance and are also capacitive. There will be loss of power in long leads to the first valve, but the capacitance of the wires will not affect the response characteristic. The best arrangement is to run a pair of wires above earth potential and enclose them in a screened casing connected to the metal case of the microphone. The screen should then be earthed only at the amplifier end, as shown in Fig. 13/9.

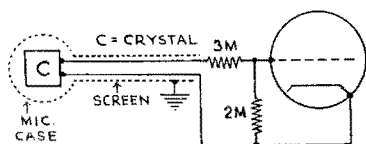

FIG. 13/9.—Input arrangement for Crystal Microphone.

Ratio of voltage drop with 3M resistor is 5 : 2.

The writer uses a crystal microphone quite successfully with 18 feet of ordinary co-axial TV cable feeding into a pre-amp

operated by dry batteries. Apparently this arrangement breaks all the copy-book rules, but no difficulty is encountered in observing very slight acoustic changes at frequencies over a range of nine octaves, say 30 to 16,000 c/s.

Crystal microphones are usually supplied with a three-pin plug and socket, the third pin being connected to the case.

Owing to the high impedance of the small sound cell type, the input impedance to the valve could be of the order of 5 megohms, say 2 megohms grid leak and 3 megohms resistor in series with the grid, for ordinary use. For use with measuring type crystal microphones, the circuit of Fig. 13/9A would be advised. This employs double-shielded coaxial cable (Telcon K16-MYM) and a cathode follower with an input impedance of 100 megohms.

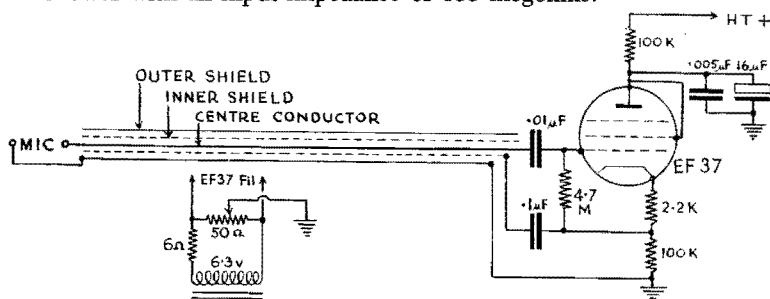

Courtesy S. Kelly, Cosmocord

FIG. 13/9A.—Cathode follower input circuit. Input impedance 100M Ω . Reduced heater volts are applied to the valve to reduce the effects of grid (gas) current flowing in the high value of grid leak.

Cardioid Microphone.

The output impedance will be around 50 ohms, and the unit will include the transformer for the ribbon. The procedure should be the same as outlined above for ribbon types.

Condenser Microphones would probably have a small amplifier incorporated in the head with 600 ohms output.

MIXING CIRCUITS

When the use of two or more microphones is contemplated, the necessity of combining their outputs to feed into the main amplifier arises. The most obvious way is to connect them in parallel, and this system is often used successfully in spite of the fact that one microphone is feeding into the other and may produce phase cancellation effects, especially if the two microphones are not equidistant from the sound source.

Another possibility is the series arrangement of Fig. 13/10, which gives fairly satisfactory results, but the chief drawback is that both

sides of channel A are above earth and the risk of hum pick-up is great.

Also stray capacities of channel A appear across the output of channel B and tend to attenuate the high frequencies of the latter. It

FIG. 13/10.—Series arrangement of two inputs to one valve.

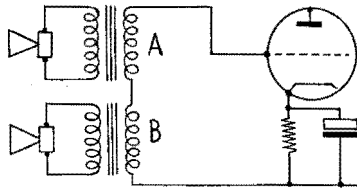

is often desirable to control the individual levels of the two channels. This can be done as shown in Fig. 13/11, in which the inputs are really in parallel and one side of each channel is earthed.

The series resistors R_1 and R_2 prevent either control short-circuiting

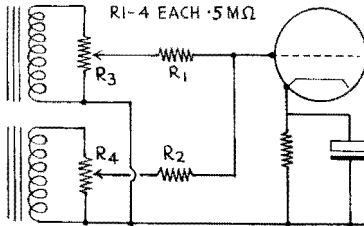
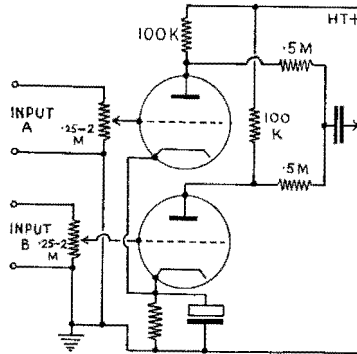

FIG. 13/11.—Practical arrangement of inputs in parallel with isolating resistors and volume controls.

the other if of sufficient value, say 0.5 megohm, although there is still some inter-action between controls.

In order to overcome interdependence of controls, the two inputs may be fed into separate valves as shown in Fig. 13/12.

FIG. 13/12.—Improved circuit for mixing two channels, using separate anode loads and isolating resistors.



The two valves might well be a duo-triode such as ECC35 or 6SN7 but with greater risk of mismatch. In order to avoid limited output due to low value of effective anode load, isolating resistors are inserted so that the effective anode load for each valve is almost that of the anode load resistor.

Figure 13/13 shows how pentodes can be incorporated in the same

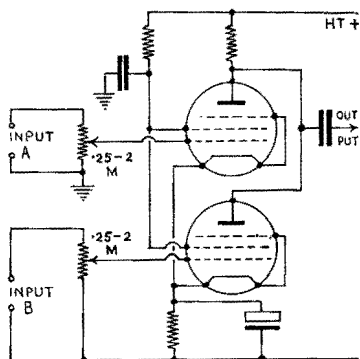

FIG. 13/13.—Mixer circuit employing two pentodes giving high efficiency due to low input capacitance and avoidance of unused valve loading.

mixer circuit and a high stage gain achieved, due to the high anode resistance of the pentodes.

Crystal Mic. Mixer.

A circuit schematic of double microphone mixer suitable for crystal input is given in Fig. 13/14.

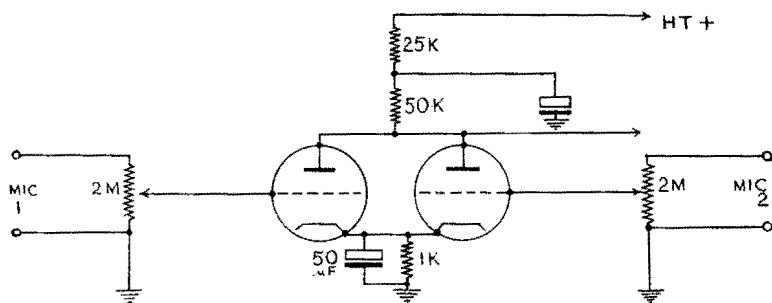

FIG. 13/14.—Mixer circuit for crystal mics.
Cosmocord

There are several types of non-electronic mixers employed in studio technique, normally with low impedance lines which give constant input and output impedances; thus they may be connected in parallel with little ill effects. One type, the "T" attenuator, is shown in Fig. 13/15. As R_1 becomes less, R_2 becomes greater, giving constant

input impedance. As R_2 becomes greater R_3 also becomes less, giving constant output impedance.

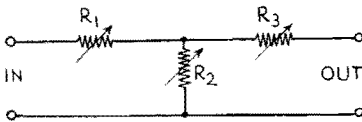

FIG. 13/15.—“T” Attenuator for constant impedance.

The inclusion of carbon-track volume controls in the grid circuit of an early valve is very questionable technique, due to the liability of noise. When low-level microphones are used, with little possibility of the input overloading the valve, the control could well be placed later in the circuit where mixing takes place.

RECAPITULATION

In the present chapter the performance of the best types of microphone in each class has been examined, although it is realised that for many uses a cheaper instrument may answer the purpose to better effect.

The problem with microphones is an exact miniature of the loudspeaker problem—to cover the audio range without resonance. It is significant that moving coil microphones can be produced with a piston-like action up to 15 Kc/s. If this could be done in a loudspeaker (with reasonable acoustic output) there would be no necessity in future to refer to the loudspeaker as the weakest link in the chain.

In the case of the crystal, the type fitted with a small diaphragm has not been mentioned. This gives much greater voltage output but not with the freedom from resonances associated with the sound cell type.

Some indication of the cost of high quality microphones has been given, to which must be added the cost of the extra amplification that follows from their low output, and the cost of the precautions which must be taken against hum. There would be no point in buying a microphone which is too good for the job.

It is interesting to note that BBC engineers are seriously concerned with response up to 10 Kc/s only. One can but agree that flat response and good transients with little phase shift up to that frequency sound very well.

Very few people can hear above 15–17 Kc/s. We understand that there is no truth in the assumption that people with bats in the belfry can hear ultrasonic frequencies.*

* Not scientifically proven as yet!—H.H.G.

CHAPTER 14

POWER SUPPLIES

Supplies for powering receivers and amplifiers fall under three main categories: (a) Battery, both primary and secondary ; (b) Mains, both AC and DC ; (c) Rotary generators, motor or hand driven.

BATTERY SUPPLIES

Unless the experimenter with no mains supply is an Atlas or a Croesus, he will have to content himself with a modest power output, as many watts mean either frequent carrying of dead weight secondary cells or buying and running a petrol electric set. If a modest output of 500 milliwatts will satisfy, consideration of ways and means can be undertaken. The technical service of Mullard Limited has recently issued a design for a push-pull amplifier giving 450 mV output with HT voltage of 90 and current at 7 mA, with LT at 1.5 volts 250 mA, which is a reasonable load for the modern dry battery. This amplifier employs DL94 pentodes. If a pair of DL92 pentodes are used the output is 780 mW with 6 per cent. distortion for 17 mA of HT at 90 volts.

The lead/acid accumulator is the best answer for filament heating and also provides a good solution for a stable HT supply, although the initial expense is heavy and its life somewhat uncertain. The pre-war scheme of hiring HT accumulators had much to commend it.

The use of vibrator HT supplies from 2-volt LT batteries is quite a workable solution. The conversion efficiency is reasonably high, but a large 2-volt accumulator is needed to cope with the current demands.

MAINS SUPPLIES

(1) HT SUPPLY

Figure 14/1 shows the elements of a rectifying circuit, a single diode

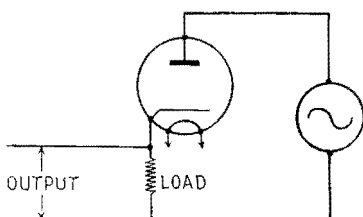

FIG. 14/1.—Single phase Half Wave Rectifier. The "load" is the HT current drain of the amplifier.

connected across an alternating voltage in series with a load. When the polarity of input makes the anode positive with respect to cathode, the

diode will conduct and current will flow through the load, producing a voltage across it as shown graphically in Fig. 14/2b.

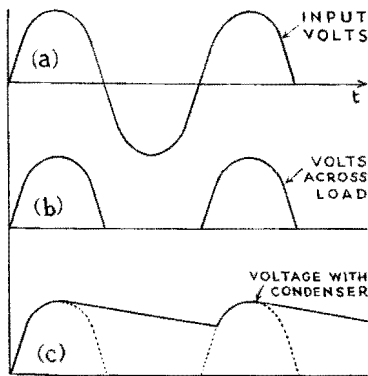
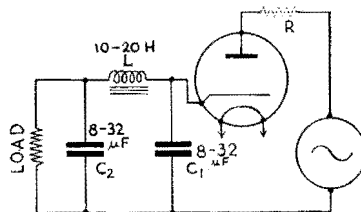

FIG. 14/2.—Voltage from Half Wave Rectifier.

The voltage due to the pulses of unidirectional current will be quite unusable as a source of HT for an amplifier. The addition of a large capacity reservoir condenser across the load will help towards producing a steady voltage, the condenser charging during the conducting regime in the diode and discharging during the non-conducting period, Fig. 14/2c. If this voltage is used to supply HT to valves, a steady hum will be heard in the output, at the frequency of the input voltage, usually 50 cycles. The addition of a filter circuit comprising L and C_2 as shown in Fig. 14/3 will reduce ripple. The choke due to its self-inductance will oppose any rise or fall of the current through it, and the second condenser will further eliminate ripple by storing a charge during the troughs.

The circuit of Fig. 14/3 is referred to as a “condenser input” filter and is by far the most common form of filter for general use. The

FIG. 14/3.—Condenser Input Filter.



condenser C_1 will influence the peak emission delivered by the valve during the charging period. If C_1 is large, say 16 or 32 μF , a very heavy current will flow into the condenser, limited only by the internal resistance of the diode and input voltage, both low. When using a half wave rectifier as described, valve makers usually recommend that a small limiting resistance of say 50 ohms be included in the anode

circuit to act as a surge current limiter. This resistance has been known to save a valve from complete destruction when C_1 , usually an electrolytic type, has developed a short-circuit or when the output has been accidentally shorted. The omission of the resistance may lead to premature ageing of the rectifier valves due to destruction of their emission. The temptation to omit the resistor is strong when the filtered output voltage is usually a bare 200 volts at full load for a 230 volts input, but a gain of 5 volts in this way is unwise.

If the circuit of Fig. 14/3 is modified by the omission of C_1 , it becomes a "choke input" type. The absence of C_1 relieves the onerous position of the rectifier having to supply high values of instantaneous current, as the inductance limits the peak values. Thus this circuit is of value when higher mean currents are required to be drawn from the rectifier, but it has the disadvantage of being less efficient, as the presence of the choke does not allow the voltage across C_2 to build up to so high a value. In short, it gives a smaller output voltage than the condenser input filter.

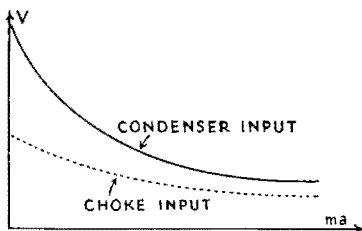

FIG. 14/4.—Regulation Curves of choke input and condenser input circuits.

Figure 14/4, showing the comparative behaviour of choke input and condenser input circuits, reveals that the regulation of the former is better, *i.e.* the output voltage does not vary so much for changes in current drawn. This suggests that when an amplifier is using class AB, AB₂ or B output with large anode current swings, the choke input circuit is preferable, but where the accent is on quality of reproduction, the use of such output stages is not envisaged.

AC/DC TECHNIQUE

If the input voltage of Fig. 14/3 was DC instead of AC, and provided the input terminal connected to the anode of the rectifier valve was the positive leg of the mains, the valve would be permanently conducting and would behave as a low value of series resistance. Should the mains connection be the other way round, the valve would not conduct and the apparatus it was expected to supply with HT would obviously fail to work. However, the condensers C_1 , C_2 , usually electrolytic, would be guarded from destruction by being connected to a high voltage source in reverse. On purely DC apparatus the inclusion of the

valve is not usually considered foolish as its cost can well be saved and elbow room easily provided by using electrolytic condensers instead of bulky paper condensers of large capacity.

The type of half wave rectifier developed for AC/DC use will have a fairly high wattage heater. This is due to the fact that a copious emission from the cathode is required. The heaters of valves used in AC/DC sets obtain the requisite heater wattage by high heater voltage and low current, thus when they are connected in series across the mains together with a suitable device to absorb surplus voltage, the power consumption is not large and the power lost as heat in the voltage dropping device is not very wasteful or embarrassing.

When heaters are series connected, all being of the same current consumption, the voltage across each heater should automatically adjust itself to the correct value, but a check should always be made. Particular regard should be paid to the rectifier as it is most important that the cathode of any rectifier should be maintained at its correct working temperature to avoid damage to the emissive surface.

It will be appreciated that the use of directly heated cathodes would not be practical due to the excessive length of fine and fragile filament that would be required.

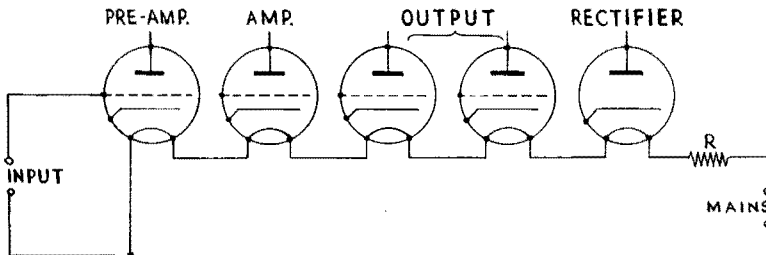

FIG. 14/5.—Arrangement of Valve Heaters in AC/DC Amplifier. Early valves at low potential end of chain.

Figure 14/5 shows the arrangement of heaters in series. The earliest valve in the amplifier is connected to chassis or "earthy" end of the chain to ensure the smallest possible chance of hum pick-up. R of Fig. 14/5 may be of several types.

VOLTAGE DROPPING DEVICES

1. *Wire wound resistor* on ceramic or other heat resisting former, with tapplings for different mains voltages and adjustable band for adjusting resistance to value required. Known brands are made with a low temperature co-efficient alloy and their "hot" resistance is not much greater than their "cold", but the "bargain" type wound with any old wire can give wide resistance variations usually resulting in serious under-running of the rectifier heater.

2. "*Line Cords*". These comprise a length of resistance wire spirally wound on an asbestos core, overlaid with asbestos and run in the same sheath as the mains lead. Chief characteristics are that they are completely unreliable, dangerous and a trap for the uninitiated. *Unreliable* in that the internal wire soon breaks. It is often twisted up again with lots of black tape, zinc oxide tape, corn plaster or boot lace to complete the repair. *Dangerous*; A short in the set will cause them to overheat. They are hated by fire insurance actuaries, but beloved of morticians. Several cases of "shortening the flex" by tidy-minded people have given joy to local radio valve stockists. Verdict: Generally nasty and should be illegal.

3. *Barretters*. Usual form is of iron or iron alloy filament in atmosphere of hydrogen reminiscent of early drawn wire vacuum lamps. Give excellent compensation for voltage changes over wide limits, as much as 90 volts, but are fragile.

4. *Household Lighting Lamps*. In spite of the fact that there is a momentary current surge on switching on (because the resistance of the filament increases as it gets hot) a lamp gives excellent barretter action for reasonable mains fluctuations, provided it is chosen to run at approximately $\cdot 6$ of its rated supply of volts. Many thousands of such lamps were used by Ambassador Radio in a particular wartime AC/DC receiver, without a single recorded failure of filaments over a period of years.

Incidentally, a carbon filament lamp has a negative temperature coefficient; its resistance goes down as the filament becomes hot.

GENERAL NOTES ON AC/DC WORKING

The danger of such sets without a transformer to isolate them from the mains, is that a serious shock may be received on touching HT minus. This is usually thought to be safe in conventional sets, as it is connected to chassis and earth. The danger arises in this way. One leg of the mains, AC or DC, is earthed and there is no guarantee that the "earthed" leg is connected to chassis; thus, in the absence of a transformer, the chassis can easily be 230 volts "hotter" than the floor, and a considerable shock can be experienced even through a high resistance earth return made through your feet, or worse still through the hot-water radiator that is likely to be too conveniently to hand.

When constructing AC/DC sets, any metal part that can be touched, such as a metal gramophone tone-arm, must be connected to a good earth and *isolated* from the chassis. It should be noted that even if the earthy side of the mains is connected to the chassis it is forbidden by supply authorities to earth the mains at the consumer's end, so a direct earth connection cannot be made to the chassis.

On some DC distribution systems the positive leg of the mains may

be earthy on one side of a street, and whilst it is possible to treat HT+ as the low potential "earthy" part of an amplifier, the usual practice of making HT- the "earthy" side precludes the earthing of a chassis under these conditions, even if it were permitted.

If there is a *guarantee* that the exposed metal parts will be earthed, these parts should *not* be connected to the chassis even by the smallest of condensers, because on AC mains, should the earth connection come adrift quite an unpleasant shock can result through a condenser.

Bakelite tone-arms often have metal back bearings with a grub-screw or pin appearing on the surface. These should be free from chassis. The pick-up head may have a metal case connected to a common earth connection on the output; check this and isolate if necessary. The screening braid of modern pick-ups is usually isolated from the head with a view to AC/DC applications.

Cover all grub-screws on control knobs with a thick rubber band, bind with tape, or fill the grub-screw hole with sealing wax. Any space between knob and face of cabinet exposing a short length of metal shaft should be filled in with felt washers, or better still the metal spindle should be sleeved with rubber tubing.

This may seem grandmotherly advice, but the author has seen many cases which amounted to a threat of sudden death waiting for an unfortunate child or unwary person, and a great deal of thought must go into the final version of any AC/DC apparatus.

A final word in this strain—is the third pin of *your* power point a reliable and safe earth?

2. LIMITATIONS IMPOSED BY LACK OF HT VOLTS

In AC/DC sets one can usually budget on having 200 volts of ripple-free HT available. Can a quality amplifier be produced to work at this voltage? The answer is yes, as two Mullard UL41 output pentodes with 200 volts HT will provide 12.5 watts with 4 per cent. distortion. The distortion is, of course, less at lower output levels.

VOLTAGE DOUBLER

The use of voltage doubler circuits to obtain higher HT voltages will probably occur to the reader, but it must be pointed out that the regulation is generally not good and will only give an output voltage twice that of the input voltage at moderate current drains.

The development of the Mullard PZ30 special voltage doubler has produced a valve that is stated to give 480V at 200 mA from 240V input, but earlier types have been prone to fail through overheating. The application here is not AC/DC; it is transformerless AC.

The circuit is undeniably useful for providing final anode voltages

for Cathode Ray Tubes and Television Tubes where only low current is called for.

AC MAINS TECHNIQUE

When designing apparatus for use on AC mains only, one has a very much freer hand than when DC mains have to be taken into consideration. First of all the use of double wound transformers to give complete isolation from the mains supply reduces the problem of ensuring complete safety. Secondly, one is not tied down to any maximum HT voltage, as any voltage can be obtained by the use of transformers. Thirdly, the range of available valves is vastly greater.

The use of single phase half wave rectifying circuits is not contemplated, and the half wave bi-phase rectifier, or full wave rectifier as it is more commonly called, is used.

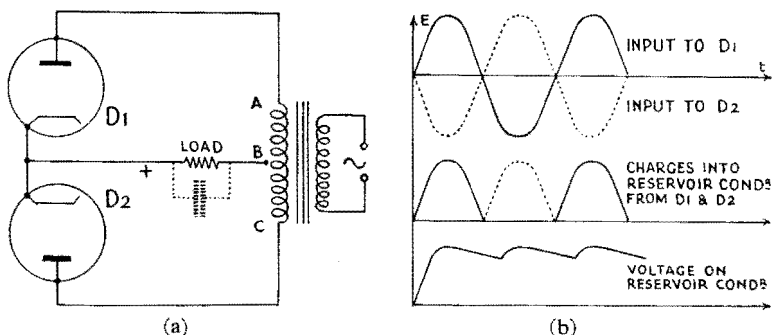

FIG. 14/6.—Basic bi-phase half wave Rectifier Circuit.

Figure 14/6a shows the basic circuit of a full wave rectifier. A centre tapped secondary is used on the transformer. The voltage appearing across AB will be equal to but in anti-phase to the voltage appearing across BC. When point A is positive with respect to B then diode D₁ conducts and current flows through the load in the direction DB. At the same time the point C is negative with respect to B therefore the diode D₂ is non-conducting, however half a cycle later the situation is reversed and diode D₂ conducts allowing current to flow through the load in the direction DB which is the same as before. If a reservoir condenser is connected across the load DB, it will receive a charge every half cycle as shown in Fig. 14/6b. Comparing this with the half wave arrangement it will be seen that the condenser has only half the time in which to lose its charge, and the amount of ripple superimposed on the DC will be correspondingly less. Furthermore, being at double the frequency (100 cycles), it will be correspondingly easier to filter out.

The two diodes of Fig. 14/6a are more usually combined in one envelope with a common cathode as shown in Fig. 14/7.

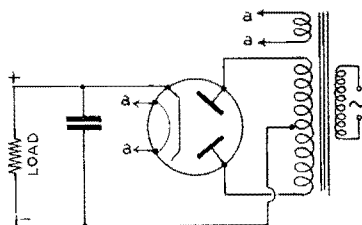

FIG. 14/7.—Usual form of full wave Rectifier Circuit.

The inclusion of a series resistance in the anode circuit as in the half wave system is no longer necessary as the inevitable resistance of the transformer secondary provides the necessary limiting in practice.

There are two main types of valve rectifiers, the hard vacuum and the gaseous. Generalising, the hard vacuum types are used for currents up to 250 mA, beyond which it is usual to employ the gaseous types, which are principally mercury vapour.

The vacuum types may be sub-divided into:

- (a) Half Wave—indirectly heated as already explained.
- (b) Full Wave—directly heated—verging on obsolete.
- (c) Full Wave—indirectly heated, usually to be preferred and practically universal now, because they heat up at the same rate as the other valves in the set and avoid high voltages being applied to the condensers which occurs with directly heated valves. (The voltage applied to the condensers will be 1.4 times the RMS value of the transformer voltage, until current is drawn *e.g.* a 350 volts transformer will give 490 volts on no load.)
- (d) Full Wave—indirectly heated “Car Radio” types. When a valve is used for car radio applications it is desirable to run the heater from the car battery, yet the cathode is connected to HT+ so that heater to cathode insulation must be capable of withstanding the full HT voltage. American 6X5 and Mullard EZ35 are examples, both having 6.3-volt heaters. This is a useful type of valve when one is short of a rectifier heater winding.

THE GASEOUS TYPES

OPERATION

With the cathode heated, a gradually increasing positive voltage is applied to the anode. At first a small anode current passes (Fig. 14/8),

limited by the internal resistance of the valve, exactly comparable to a high vacuum type.

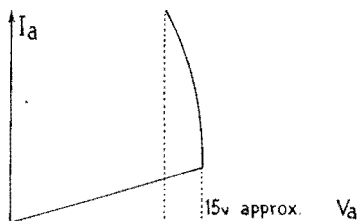

FIG. 14/8.—Anode Characteristic of a gaseous Rectifier.

When about 15 volts is applied to the anode the whole behaviour of the valve changes; the space current suddenly becomes great, as great as the emission of the cathode will allow. The inside of the valve begins to glow at this instant due to the ionisation of the gas molecules by electron bombardment, the positive ions released neutralising the space charge around the cathode and making the internal resistance of the valve of negligible proportions. The commonest gas employed is mercury vapour, and the valve exhibits the well-known ghostly glow. The Osram GU50 is probably one of the best known valves of its type, being capable of passing 250 mA at 1,000 volts.

The chief characteristic of this type of valve is its low internal resistance, lower than that of the high vacuum type. This reduces the voltage drop across the valve, with of course better regulation, which is also assisted by the fact that the voltage drop (15 volts) is practically independent of the current.

Certain precautions have to be observed in the use of these valves :

- (1) The anode voltage must not be applied until the cathode has attained working temperature, usually done by using a thermal delay switch. The reason for this is two-fold—the emission may be destroyed by taking current before it is actively emitting, and metallic mercury must be volatilised or an internal short may occur.
- (2) The temperature of the cathode must not fall below the specified minimum value.
- (3) Choke input filters must be used as the peak charging current into a condenser input filter would be very high due to low internal resistance and might result in cathode disintegration.
- (4) The ambient temperature must be within specified limits, 10°C to 40°C is a usual range, or internal flashover may occur.
- (5) Radio interference is produced, as with fluorescent lighting strip, but this can be suppressed by the judicious application of small condensers between anode and cathode of the valve.

METAL RECTIFIERS

The so-called "metal" rectifiers are divided into two classes, the copper-oxide and the selenium types, and comprise a series of coated discs assembled to form a stick of units.

These rectifiers can take the place of a rectifying valve in practically all applications with an immediate saving in that there is no valve heater to supply with current. Further advantages are that they are very robust, and virtually everlasting providing they are suitably protected against overload by the adequate fitting of fuses.

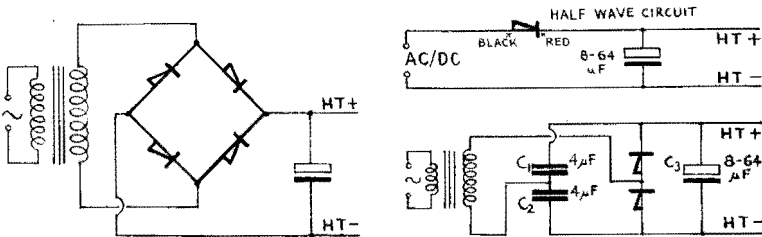

FIG. 14/9.—Typical Metal Rectifier Circuits.

The Selenium type is growing in popularity because of its relatively small size, low cost and high efficiency. The growing shortage of rectifier valves with the present nickel limitation is likely to accentuate the position. As an example, a Selenium (STC) RM4 will provide 250 mA at 250V in a half wave circuit with less voltage drop than a valve, with no limitation on size of reservoir condenser and no need for limiting resistors.

Probably the most useful application of the metal rectifier is in the low voltage, high current field for battery charging, etc., where a simple arrangement will give 10A at 12 volts, which is a grossly un-economic proposition using valves. Their use for supplying DC volts for the heating of valves in early stages is admirable. Other useful applications in audio work are for rectifiers in contrast and compression units, peak limiters (crash limiters), and grid current protection devices. They also have advantages to offer when used in conjunction with vibrator packs in battery work, and will receive mention in this connection. Their use in circuits for supplying fixed grid bias will also be discussed.

THE ASSESSMENT OF VALUES FOR L & C IN FILTERS

In a book of this character, it is only possible to give rule-of-thumb guidance, because the calculation of residual ripple present after a

filter is by no means easy. The professional engineer uses graphical methods and the interested reader is referred to the *Radio Designer's Handbook* edited by F. Langford Smith and published by Iliffe & Sons Ltd., for exact information.

The valve manufacturer will specify the value of condenser for the reservoir, and after that a little intelligent guesswork, or trial and error, will give the answer. With push-pull output, the HT supply to the anodes need not be well filtered due to automatic cancellation in the output transformer primary. Economy at no sacrifice of quality can be effected by using 5H to smooth the anode supply, say 5H at 150 mA (110 mA for the output stages and 40 mA for the rest of the set). The 40 mA supplying screens of output valves and all earlier stages can be well smoothed by a 20H choke of modest size. The total cost of a 5H 150 mA choke and 20H 40 mA choke will be lighter than for 20H at 150 mA, and space will probably be saved. The value of capacity for the condensers cannot be too large. It should be noted that the screens of the output valves are supplied with well smoothed HT as they are susceptible to hum.

The reservoir condenser can be a paper type with advantage, having a better power factor and being generally more reliable and lasting. The cause of electrolytics failing is often that they are used in positions where too high a ripple current flows. The maximum value of this ripple current is shown in makers' catalogues, and should not be exceeded, or even approached in the writer's opinion. The lack of information on permissible ripple current, which could at least be coded on the condenser, is regrettable. The etched foil type of condenser permits of only a reduced ripple current flow. A point not often made regarding ripple on a power supply is that the ripple voltage is by no means sinusoidal, and the harmonic components may be calculated by Fourier analysis. Observation of the ripple voltage by means of an oscilloscope is illuminating. High order harmonics are best eliminated by a mica condenser of up to 0.01 μ F across the filter condenser, particularly when the latter is an electrolytic.

OBTAINING EXTRA HT CURRENT

Whilst the gaseous rectifier is a good solution for high voltage at high current, its use is not always necessary. A single valve, the Mullard GZ32 is rated to give 500 volts at 250 mA, but should more than the 250 mA be required, the circuit of Fig. 14/10 can be employed.

A normal bi-phase rectifier is capable of passing 250 mA per anode, therefore two of these valves in parallel can be used to produce 500 mA in a bi-phase half wave circuit. It is considered good practice to inter-connect the anode by a small resistance, then individual differences in the two halves of the valve do not lead to one diode doing more than its share of the work.

In transformerless circuits the same technique may be employed

as shown in Fig. 14/11. This device is often needed because the average AC/DC rectifier is limited to 120 mA except in the case of

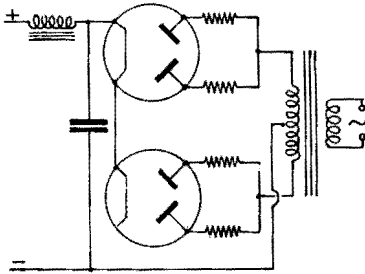
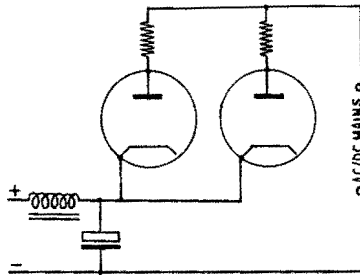

FIG. 14/10.—Circuit for increased current output.

Mullard PZ30 and Mazda U801 which are rated to supply 200 mA and 300 mA respectively, these having separate diodes in the one envelope.

FIG. 14/11.—Circuit for increased current output on transformerless circuits.



METHODS OF OBTAINING FIXED GRID BIAS

Sundry methods of obtaining grid bias at the expense of the full HT voltage have been described. The use of "self Bias," that is bias which is dependent on the anode current of the valve, is normally the one recommended by valve makers for the Class A condition of operation when swings of anode current in a push-pull pair are equal in either direction, producing a steady mean anode current, and in consequence a steady value of bias across the common bias resistor. To take two examples, a pair of Mullard EL37's, 25 watt pentodes, with 325 volts on the anodes, a 130 ohms bias resistor giving approximately 29 volts of bias will produce 35 watts of audio with 4.4 per cent. total distortion. The same valves with 350 volts on the anode and -31 volts of *fixed* bias, give 46 watts of output with 2.8 per cent. of distortion, this for comparable HT supplies (325 + 29V), against 350V. Two Osram output Tetrodes, type KT66 in push-pull, anode voltage 390, self bias -22.5V, produce 30 watts of output for 6 per cent. total

distortion. The same valves with fixed bias of -40 produce 50 watts with 5 per cent. distortion.

From the foregoing, it can be deduced that if the maximum power is required from a pair of valves, they may be driven harder in the Class AB₁ condition, but fixed bias must be employed. The variations in self bias would produce increased distortion. The fixed bias may be produced from a dry battery, which is perfectly satisfactory providing its voltage is checked regularly, but human nature being what it is, it is safer to use a separate supply from the mains. This can be readily achieved by using a separate small mains transformer and rectifier. The additional cost of such a transformer is not strictly necessary. Fig. 14/12 shows a possible circuit quite frequently employed in American commercial apparatus, in which a tapping on one half of the HT secondary is employed in conjunction with a half wave rectifier.

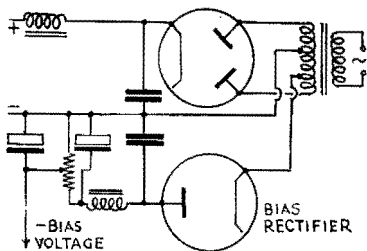

FIG. 14/12.—Power Circuit including a fixed GB supply.

Type 6X5 rectifier (or similar) is very convenient because its heater supply can be the normal 6.3V line to the heaters of the other valves, or a small metal rectifier can be employed. The latter is probably preferable, since any failure of a valve would leave the output valves without bias, and they would quickly come to grief. It is usual to stabilise the output by means of a bleeder resistance. Really good filtering of the circuit is essential, particularly as the rectifier is a half wave type. This is easily done by the use of large capacity low voltage electrolytics, with a word of warning: the negative of the condenser is *not* connected to the chassis, so that it must be isolated or a cardboard type used. A choke is by no means essential and may be replaced by a resistance.

The use of a special transformer is a decided disadvantage of this arrangement, but even this can be overcome by using the circuit of Fig. 14/13, given in an article by G. R. Woodville (M.O. Valve Company), in *Wireless World* of December, 1948.

Independent bias controls for each valve provide a bias variable from 30–60 volts for balancing purposes. The rectifier is fed from one side of the HT secondary via a $0.02 \mu\text{F}$ condenser of high working voltage. The maximum bias voltage obtainable is determined by the value of this capacity, and the value of the resistance network.

It should be borne in mind that in either of the two bias circuits described the source of voltage is of high impedance and will not be suitable for use with stages in which grid current flows during part of the cycle.

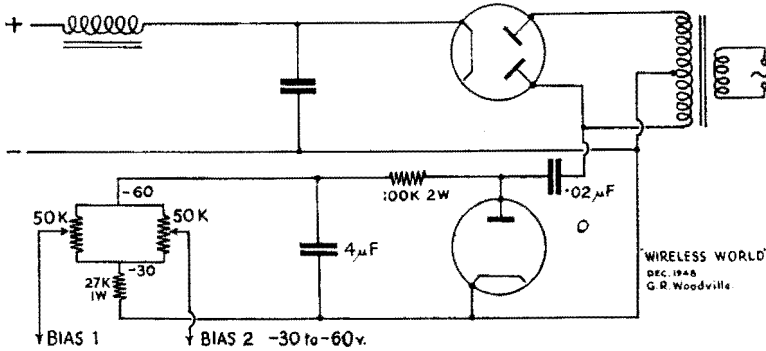

FIG. 14/13.—Alternative fixed bias circuit needing no special transformer.

POWER SUPPLIES EMPLOYING VIBRATOR UNITS

Vibrators consist essentially of a reed caused to vibrate on the trembler bell principle. The speed of vibration can be adjusted to 50 cycles with quite good accuracy, or a higher frequency, say 100 cycles, may be employed with consequent economy of iron in transformers and smoothing chokes.

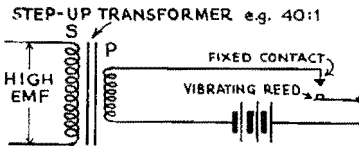

FIG. 14/14.—Vibrator Principles.

Readers familiar with the operation of the ignition coil of a car will recognise in Fig. 14/14 the same principle. As the reed vibrates against the fixed contact a pulse of current will flow through the primary of the transformer, creating a magnetic field which will cut the secondary winding of the transformer, comprising many turns of wire, and a high EMF will be produced across the winding. On the break of the contacts the field will collapse rapidly and a higher back EMF will be induced in the secondary. A back EMF will also be produced in the primary and will attempt to jump the gap between the contacts, causing burring and pitting of the surfaces. The fitting of a condenser of suitable capacity across the contacts will absorb this

POWER SUPPLIES

back EMF and so prolong the life of the contacts. As car users will know, the failure of this condenser reduces the spark almost to extinction. This is because the presence of the condenser increases the rapidity with which the field can collapse and the greater rate of cutting of the conductors by the lines of magnetic force increases the EMF produced.

The choice of value of the condenser on a car ignition system, usually about $0.2 \mu\text{F}$, is quite critical, and this is the case in vibrator power packs. A balance must be struck because on the *closing* of the contacts the charge on the condenser will be discharged again in opposition

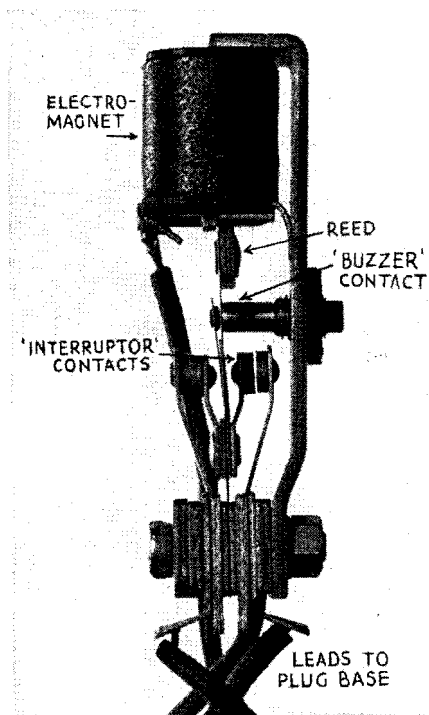

FIG. 14/14A. — Photograph showing working parts of vibrator.

to the battery. Too large a value of condenser would produce excessive sparking on discharge and would also hinder the build-up of the field again. It is usual to fit a buffer resistance across the primary to supply some damping of this oscillatory circuit due to the presence of both inductance and capacity.

The system so far described will produce a form of AC across the secondary and after rectification this could be smoothed and used as an HT supply.

Figure 14/15 shows another arrangement sometimes employed in which the vibrating reed causes pulses to flow through the two halves

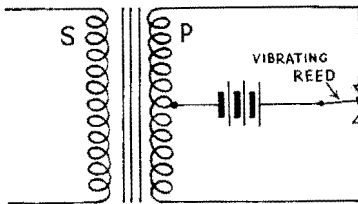

FIG. 14/15.—Vibrator system employing centre tapped primary.

of the primary in opposite directions, giving an increased efficiency and better waveform of AC in the secondary. In the two arrangements so far described, the rectification system on the secondary would have

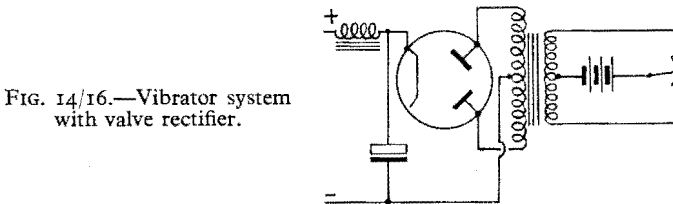

FIG. 14/16.—Vibrator system with valve rectifier.

to be single phase half wave, but the addition of a centre tapped secondary as in Fig. 14/16 would enable bi-phase half wave, "Full Wave" to be employed. A normal rectifier valve could be employed. The types 6X5 or EZ35 already mentioned would be admirable, having 6-volt heaters which could be connected across the battery actuating the vibrator, and being rated to withstand the full HT between cathode and heater. The heater current 0.5A imposes an additional drain on an already severely tried battery and the use of a metal rectifier is indicated. In some arrangements the rectifier valve is heated from a winding on the vibrator transformer. This imposes extra loading on the transformer and vibrator, but is convenient when the apparatus is intended for battery or AC mains operation. The addition of a mains primary to the transformer makes the change-over to mains easy, but again the use of a metal rectifier is the best solution.

Another type of vibrator is self rectifying or synchronous. An additional pair of contacts is added to the reed together with another pair of fixed contacts.

The extra pair of contacts will give greater heating of the vibrator and will limit the total wattage it can handle. The enemy of the vibrator reed, which is made of spring steel, is heating with loss of temper. When it ceases to function, much generation of heat takes place unless adequate fusing is fitted. The trend of design is against the self-rectifying type as it proved fickle under Service conditions. Manu-

230 or 110 volts output machine as a battery charger. The output side can be connected to the mains, the low voltage side to the battery which will supply the excitation of the shunt field, and receive a charge. A limiting resistance is necessary on the mains side.

On the care of commutators the best rule is no oil and no abrasives. Keep clean with carbon tetrachloride and in extreme cases a piece of the very finest grade of glasspaper, 00, may be applied—never emery. Do not scratch out between the sections or a lip will be raised that will act like a rotary planing machine against the brushes. Oil bearings regularly.

2. MAINS CONVERTORS

Rotary convertors to produce AC are available for those on DC mains of any voltage, and are completely satisfactory except that if loaded too lightly the nominal 50 cps output is very nominal, and induction type gramophone motors behave accordingly. The initial cost is high, but their life with care is very great.

For those on 24-volt supplies a useful ex-Government convertor giving 230V 50 cycles 100 VA is available. Samples have been given a frequency check against the normal grid supply with every satisfaction—especially in cold weather!

THE PROTECTION OF POWER SUPPLIES

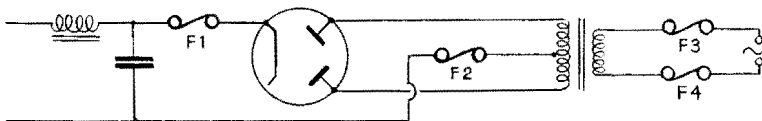

FIG. 14/18.—A rectifier circuit showing fitting of fuses.

In Fig. 14/18 a power pack is shown with suggested positions for the insertion of fuses to afford protection to the rectifier valve and mains transformer. F_1 , included between the rectifier and the reservoir condenser, is an insurance on the valve in case of a breakdown in the reservoir condenser, particularly if an electrolytic type is used. F_2 is an alternative position affording equal protection and with the probable advantage that it protects the transformer should an internal short develop in the valve. The fuses F_3 and F_4 are a fire insurance should an internal short develop in the transformer. The use of a flashlamp bulb in positions F_1 and F_2 is deprecated due to danger of shock when searching for trouble. The type of fuse-holder recommended is either the screw-in type common on Service apparatus, or the type where the fuse is contained in the lid of the fuse-box. Open type fuse-holders are dangerous in moments of stress.

The value of HT fuse can usually be rated to blow at two to three

POWER SUPPLIES

times normal current. The lower value will sometimes blow if the apparatus is switched off and on again immediately, due to charging surge whilst the valve is still warm.

Circuits employing metal rectifiers should receive exactly the same attention as those for valves.

Circuits employing vibrators should receive the same attention on the HT side, and the primary side must also be carefully fitted with fuses to afford protection when a vibrator sticks. Due to the comparatively high current in these circuits, the fuse fitting must be capable of affording really sound contact to avoid serious voltage drop (0.6 volt on one 6-volt circuit examined). The gauge of wire for the battery lead should always err on the generous side; a little investigation with a voltmeter across the ends of the lead will sometimes yield surprises.

A very neat little device containing two fuses and two neon indicators is being brought out by Belling & Lee, Ltd., and is illustrated in Fig. 14/19.

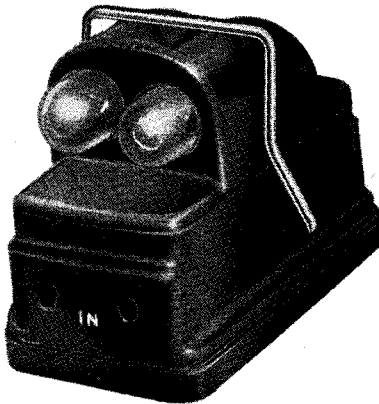

FIG. 14/19—Twin neon indicator fuse-box.

The fuse-box takes standard cartridge fuses $1\frac{1}{4}$ ins. x $\frac{1}{4}$ in. The photograph is approximately actual size.

CHAPTER 15

HUM AND NOISE IN AMPLIFIERS

As this book has progressed, mention has been made of precautions that should be taken to avoid hum and noise when the circuit described was known to be prone thereto, but a thorough recapitulation would not be out of place here, particularly as it may serve as a useful guide should trouble-shooting be in progress.

The main sources of hum are dealt with under the following eight headings, in the order of probable likelihood.

1. Lack of sufficient filtering of the power supply, due to inadequate inductance or capacity, or both. The remedy is obvious, starting with the addition of further capacity across the filter condenser, but *not* across the reservoir as the rectifier may be damaged. If the addition of this capacity reduces hum but does not cure it, the next step is to find out where the hum is getting into the amplifier. Remove the penultimate valve, or valves if a push-pull driver is in use, and if there is a large reduction of hum or almost complete silence, the trouble does not lie in the output valve or valves or the HT filtering. If the trouble proves to be in the output stage and the valves are pentodes or tetrodes, add extra capacity between screens and ground. If the valves are directly heated, such as PX4's, the centre tap on the heater winding may not be accurately made, and should be artificially located by the use of a potentiometer or "humdinger" as shown in Fig. 15/1. Adjustment of slider will find a point where hum is at a minimum.

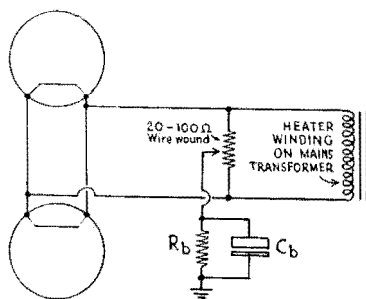

FIG. 15/1.—Artificial location of centre tap on heater winding.

If the output stage is push-pull, unbalance of current in output transformer windings due to bad mis-match between the valves may be the cause of hum. Check anode currents with both grids earthed. If removal of earths on grids causes change in anode currents suspect grid-earth return paths. If removal of earth on grids increases hum

and an inter-valve transformer is used, pass on to section 2. If no cure is found now, pass on to sections 3 and 4.

If the output stage is blameless, replace penultimate valve and earth its grid. If hum reappears, add filtering to anode circuit say 20K and 8 μ F, or increase capacity of condenser or value of resistance if filtering is present. If no cure, change valve as fault may be one described in section 3. If penultimate stage is concertina or cathode coupled type of phase splitter, suspect heater hum as described in section 5. Troubles of sections 3 and 4 may be present.

If penultimate stage with earthed grid is blameless, remove earth; if hum reappears suspect HT filtering of previous stage, or leaky coupling condenser. Increase or add filtering, replace coupling condenser.

Replace pre-amplifier and earth grid if hum now appears, check HT filtering to this stage, add C or R. If pentode, increase screen bypass condenser up to 8 μ F. If removal of earth on grid produces hum, suspect input wiring. See Fig. 15/2, for schematic of wiring to an early stage.

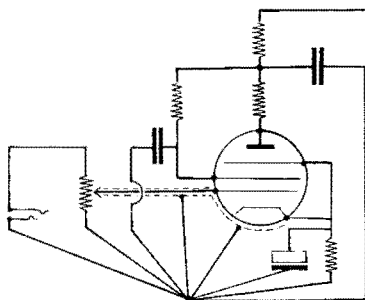

FIG. 15/2.—All “earthy” points returned to single point on chassis.

It is imperative that all “earthy” points should be bonded to chassis at one point only, otherwise small ripple voltages will be introduced into the amplifier, due to eddy currents in the chassis producing slight differences in potential between two points on the chassis surface.

The chassis material can influence the spread of electro-magnetic hum. Magnetic materials are commonly employed and strong eddy currents exist throughout such substances. These can be virtually eliminated by using a dia-magnetic material such as aluminium, duralumin, or best of all copper which is even silver-plated in the highest grades of professional apparatus.

The use of an earth bus bar to replace the common technique of soldering down to the chassis at various points has much to recommend it. It is common practice to earth one side of the heater pins on the valve base, Fig. 15/3a. This latter earth connection should not be the same earth point as the one described in the preceding paragraph.

Modification of the valve heater circuit to the arrangement shown in Fig. 15/3b sometimes reduces the residual hum in an amplifier, but in the writer's experience is rarely necessary with modern valves. The device shown in Fig. 15/3c is sometimes helpful in removing high order harmonics of hum in an early amplifying stage.

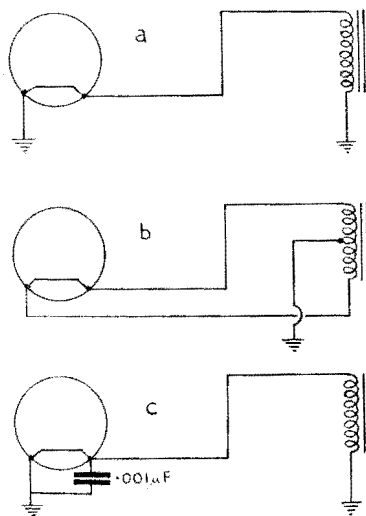

FIG. 15/3.

(a) One side of heater winding earthed.

(b) Centre tap on heater winding to reduce heater hum.

(c) Bypass condenser at each valve holder to avoid hum due to high order harmonics on mains supply. Also avoids inter-stage coupling.

It has been assumed that the wiring of the valve heater circuits has been properly carried out by careful disposition of the heater wiring close to the chassis, avoiding close proximity to grid and anode pins on valve bases. The use of a twisted pair of wires for heater wiring reduces stray external fields.

If attention to all these points fails to reduce hum, sections 3, 4 and 5 should be referred to.

2. Hum may be introduced by electro-magnetic coupling from the mains transformer to other iron cored apparatus such as choke, output transformer, inter-valve or input transformer for pick-up or microphone, iron cored scratch filter inductances or even the air cored variety. This is a problem of design layout. The filter choke and mains transformer are usually not far apart. They should be arranged in such a way that their external fields are mutually at right angles, and also the output transformer, as in Fig. 15/4.

In one piece of commercial apparatus tested by the writer, the hum level was only 28 db below the full audio output. Removal of the rectifier valve reduced the hum level to -34 db, but re-positioning of the output transformer reduced the hum to -42 db, which was tolerable. This is a bad case and should never have happened.

An inter-valve transformer should be placed well away from the mains transformer and smoothing choke ; it usually pays to attach flexible leads and orientate this component for the position of minimum hum.

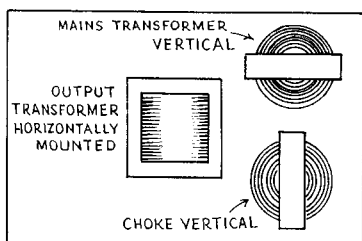

FIG. 15/4.—Cores of components arranged mutually at right angles to avoid interaction of fields.

Transformers used with microphones or pick-ups and a high gain amplifier are particularly liable to pick up stray fields and must be located well away from any other apparatus. It is usually necessary to employ a Mu-metal screening box to afford electro-magnetic screening.

Mu-metal is a specially treated nickel alloy which has a particularly high value of permeability. The permeability of a vacuum is taken to be unity but that of any other "non-magnetic" material such as air, wood, copper, etc., is so nearly the same that $\mu = 1$ is accepted for practical purposes. As indicated in an earlier chapter, magnetic permeability is analogous to electrical conductivity and, just as the perfect insulator does not exist, there is no such thing as a "flux insulator". But flux will always tend to flow within or through a high permeability material, *i.e.* take the path of lowest "magnetic resistance" (Reluctance). Thus if a transformer is enclosed in a Mu-metal box it is well protected against external fields. The thicker the protective cover the

greater will be the shielding effect as reluctance $S = \frac{\text{length}}{\text{area}} \times \frac{1}{\mu}$.

It should be noted that Mu-metal is a proprietary name of Telegraph Construction & Maintenance Co. Ltd. Another brand is Permalloy C and both are 76-79 per cent. nickel with small percentages of copper and molybdenum or chromium or manganese.

BBC amplifiers introduce a negligible amount of hum, yet the gain employed between a ribbon microphone producing but a few microvolts and the final modulators producing kilowatts of audio output is a fantastic figure, possibly one billion times or 240 db. But all BBC pre-amplifiers use transformers due to the necessity of standardising outputs and inputs to 600 ohms for connection to telephone lines. This proves that hum pick-up in transformers can be avoided by adequate precautions.

3. Hum may be introduced into a circuit by leakage between the heater and cathode of a valve. Most valve testers have facilities for checking this insulation, which should be at least 1 megohm. The

leakage may not be and often is not apparent unless the valve is warm so any tests must be made bearing this in mind, and also the leads of an ohmmeter should be so connected that the cathode is negative with respect to heater or the issue may be clouded by heater emission, see section 5.

Internal leakage in valves is not very common, but a baffling fault that has convinced the writer that it is unwise to assume any piece of apparatus is perfection, is that of leaky valveholders. Certain moulded valveholders show leaks between adjacent pins which reduce the insulation to a figure as low as 2 megohms. Thus a cathode pin, often close to the heater, may inject 50 cycles AC into the circuit. This can and does cause bad hum in a stage at the beginning of a high gain amplifier.

4. If a valve, particularly an early one in an amplifier, is placed in the magnetic field of a mains transformer, choke or energised loudspeaker, it is possible for hum to be induced in the amplifier due to the velocity modulation of the electron stream.

5. Thermionic emission can take place from a valve heater, and if the adjacent cathode is positively charged with respect to the heater, it will behave as an anode and collect electrons modulated with a 50-cycle ripple. As mentioned earlier, this effect can be noticed particularly when using concertina and cathode coupled phase splitters, but the likelihood is always present when cathode biasing is employed, raising the cathode positive with respect to heater. Cures have been discussed when dealing with the circuits in Chapter 9.

6. Induction can readily take place between a high impedance circuit and a neighbouring conductor. If the mains lead is taken near to the grid of an early valve, the effect will be readily observed. This gives point to the strictures on careful disposition of valve heater wiring. The general line of approach is the screening of "hot" leads, such as early grid leads, and the employment of electrostatic screening cans around valves not already metallised, screened top cap connectors, etc. This type of hum is easily recognised since it usually contains a large proportion of higher order harmonics to which the ear is more sensitive than to the low fundamental frequency of 50 or 100 cycles.

7. Capacity must necessarily exist between the heater and cathode of a valve, usually kept to a low value, but it is one way in which a trace of hum can be introduced into a stage.

The idea of "neutralising" hum injected in this way, or any other way, is worth mentioning, although it is a "brute force and ignorance" method. A small capacity, usually consisting of a pair of wires twisted together for a few turns, is used to inject into cathode, grid or screen circuit a trace of 50-cycle ripple from one side and then the other of the heater circuit.

8. It is not common practice to use electro-magnetic speaker fields,

now that permanent magnets have reached such a high degree of perfection, but the introduction of hum from this source should be mentioned. The speaker field may be energised in one of three ways. Firstly, by having its own rectifier, when hum would be heard without connecting the speaker to the amplifier. Secondly, the field coil may be connected across the rectifier output of the amplifier. To check if hum is due to the field, the speech coil is disconnected from the secondary of the output transformer which should be loaded temporarily with a resistance about equal to the nominal speech coil resistance. Any hum now present is due to the field. Thirdly, the speaker field may be used in place of or supplementing the choke in the filter circuit of the HT rectifier. To check for field hum the speech coil should be disconnected and a PM speaker connected to the secondary of the output transformer.

A hum-bucking coil of a few turns is frequently wound adjacent to the field winding and connected in series with the speech coil in such a way as to introduce a hum voltage in opposition to the hum induced by the field. This is only a partially successful device as phase differences and the presence of harmonics rarely allow of complete cancellation.

NOISE IN HIGH GAIN AMPLIFIERS

Random noise quite apart from normal hum due to mains apparatus, various "frying", "breathing" and sizzling noises, can be present in a high gain amplifier. This is due to a variety of causes, some of them quite outside the control of physicists. Thermionic emission is not a gentle spraying of electrons from the surface of the cathode like the spray from a rose-spray hose, but rather like the spray of fat from the frying-pan when father is cooking the breakfast; a fine haze with random spurts. This irregular emission accounts for the background of "breathing" even in the best of amplifiers. In any body that is warm, *i.e.* at any temperature above that of absolute zero, electrons in the atom are in a state of continual agitation and this gives rise to thermal noises in any component. The use of a refrigerator is not a complete solution to the problem; however, neither random emission nor thermal agitation is a really serious problem.

One of the biggest offenders is the common moulded carbon resistor and its variants, and many an elusive sizzle is removed when resistors are changed, particularly in the grid circuit of the first amplifying stage. Carbon track variable resistances will also add to the noise, quite apart from noisy operation when operated.

Leaky decoupling and interstage coupling condensers will add their quota of noise, and the writer never takes a condenser into service until the megger has given it a clean bill. Screen decoupling condensers of $2M$ "insulation" resistance used in conjunction with a $2.2M$ screen

resistor will completely upset the working conditions of an amplifier, and will introduce noise if the leakage is not constant.

Another source of frying can arise in a bad connection to the metalising of a valve. The only cure is to scrape off the metal and use a shielding can, or change to metal valves. Government surplus valves, stored under damp conditions, are bad offenders in this respect.

One bitter lesson is that the top cap connection to a valve can give rise to scratching noises, as the formation of oxide on the cap and connector, aggravated by heating, produces a partly intermittent contact. The soldering iron provides the best cure by soldering on direct.

The use of electrolytic condensers to decouple early stages can introduce random "noise", or even instability, due to high power factor. A new condenser may well have a power factor of 10 per cent. Naturally this rises with age and may lead to trouble, particularly in amplifiers incorporating heavy NFB, where a phase shift in the system at low frequency may introduce a rise in the responsive curve to the point of low frequency instability.

NOISY VOLUME CONTROLS

Carbon track volume controls are disliked as, besides becoming noisy in use, the contact is normally so uncertain and the track itself so unstable that noise is inevitable. Good quality carbon track potentiometers fitted to the input of an amplifier with 100 mV input for 25 watts output have proved to be a great source of trouble after only a few months' use. The practice of using carbon track controls when DC exists in the circuit is worse, as they become noisy in operation even more quickly. In certain sets the detector diode load resistor is the potentiometer controlling audio gain, and noisy operation always results. When this type of volume control is used it is better to use it fairly late in the amplifier, certainly after the pre-amplifier.

Audio gain controls cannot reasonably be much lower than 100,000 ohms in a grid circuit and whilst this value has been produced in wire-wound controls, the wire is so fine that the slider rapidly destroys it. Switch type attenuators are very much more reliable and quiet in operation.

The professional type of attenuator, as made by Painton & Co., comprises a stud switch making certain, noiseless contact, and wire-wound resistances, controlling gain in steps of 3 db. This type constitutes a virtually perfect control.

A simplified version can easily be constructed, using a good type of "make before break" wafer switch and good quality carbon resistances. Such a device was described in *Wireless World* of February 1950. Preferred-value carbon resistors are used which are readily obtainable. With 5 per cent. tolerance, the error at any step of the attenuator is not likely to exceed about 0.1 db.

THE MEASUREMENT OF HARMONIC DISTORTION IN LF AMPLIFIERS

Although no amateur is likely to have at his disposal the laboratory equipment necessary for tracing and measuring small amounts of harmonic distortion, the question cannot be entirely ignored, and a brief description of some of the methods used is included here.

Perhaps the simplest method whereby the introduced harmonic distortion of an amplifier may be observed, is to display the input and output waveforms on a double beam oscilloscope. The time base of the oscilloscope is adjusted so as to exhibit two or three complete waves when injecting a steady input frequency signal to the amplifier. The output display is then moved so as to nearly coincide with the input display, and the difference in wave shape will be discernible. A variation of this method involves the use of a simple single beam oscilloscope without a time-base generator. The input and output of the amplifier under test are connected to the respective X and Y plates of the oscilloscope and the resultant diagonal line (at say 400 c/s) is observed. The introduction of harmonic distortion by the amplifier will produce a departure from a straight line in the display. The position of the kinks in the line can be used to determine the order of the harmonic content.

Both the above methods are only satisfactory where a total distortion of approximately 8 per cent. is permissible, since at lower figures than this the kinks do not show up well enough on most commercial oscillographs.

The standard laboratory method used for measuring harmonic distortion calls for the use of two pieces of precision apparatus. The first is a low frequency signal source of sufficient output to load up the amplifier under test. Naturally the signal from such a source must be beyond suspicion in so far as harmonic content is concerned. A beat frequency oscillator is commonly selected for this purpose and the greatest care is taken to ensure purity of waveform—a figure of 0.1 per cent. being about the maximum permissible distortion.

A Distortion Factor Meter measures the total harmonics content at the output of the amplifier. This consists of a frequency discriminating bridge network to enable the fundamental test frequency to be balanced out. Following the bridge comes an amplifier and a valve voltmeter, the whole being housed in a single container. At the commencement of measurement the bridge network is switched out of circuit and the amplifier gain adjusted to give a reading of 100 per cent.

on the valve voltmeter scale. This then is a measure of the total output of the amplifier fundamental and harmonic content combined. Now the bridge is switched into circuit and adjusted until the fundamental frequency is completely balanced out, the harmonic content alone carrying on to the amplifier and valve voltmeter. Consequently the reading on the scale of the valve voltmeter will now be considerably reduced (we hope). It will be seen that careful adjustment of the bridge results in a minimum reading. This is the point at which the fundamental frequency is virtually removed, and the percentage indicated by the valve voltmeter represents the total harmonic content of the amplifier output.

Sometimes, where it is desirable to know the magnitude of individual harmonics, a device known as a Wave Analyser replaces the Distortion Factor Meter. In this instrument the bridge network is replaced by a frequency selective amplifier having an extremely narrow bandwidth (of the order of a few cycles per second). A superheterodyne type of tuner and mixer is used to select the individual harmonics, and the magnitude of each is read on a valve voltmeter scale, as before.

Another method is to measure the intermodulation product. Two pure tones at widely separated frequencies are fed into the amplifier, the output being set at the required power. One of the AF components is then filtered out and the extent of modulation which remains is a measure of the distortion produced in the amplifier. As the intermodulation product may be four times the percentage of distortion, it is possible to trace very small amounts of non-linearity. Oscillograms showing the visual effect of intermodulation were reproduced in Chapter 1.

F.H.B.

CHAPTER 17

GARNER AMPLIFIER

By G.A.B.

The rather ambiguous heading to the penultimate chapter in the book does not imply that the Garner Amplifier was made by G. A. B. ; it simply means that I am writing about the equipment designed by my colleague, to ensure as far as possible an impartial line.

I suppose I am both well and badly equipped for the task. In my favour is the fact that I am not commercially interested in amplifiers, but have nevertheless at my disposal quite an array of test equipment, ranging from enough AF oscillators to produce a travesty of a string quartette, to almost perfect free-field acoustic conditions. On the debit side is the fact that I do not really know anything about amplifiers, * and I am actually the mysterious correspondent who admitted, in Chapter 7, his inability to multiply by more than ten.

About half-way through the chapter I pass the ball to H. H. G., so that he can score a few goals in outlining the technical merits of his designs, or kick into touch if necessary.

My opinion is that the best way to obtain a first-class amplifier is to buy one of the reputable makes. I do not think it is possible to improve the standard of performance by home construction. But I also realise that many amateurs like to experiment and build at home, and it is necessary to round off the book by giving circuits which employ some of the principles which have been investigated. Our object is neither more nor less than this, and the designs should be viewed in the light of this declaration.

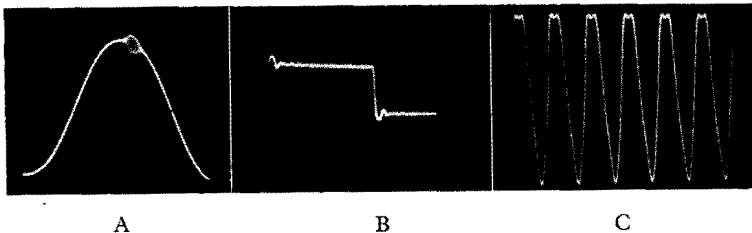

FIG. 17/1.—A. 100 cycle note showing burst of oscillation.

B. Square wave at 1,000 c/s.

C. Distortion at 15 Kc/s at 5 watts output.

* Was it A. E. Housman who said that a dog can recognise a rat although it cannot define one?

The amplifier and pre-amp were assembled in Chelmsford and were sent to Bradford for test. A first inspection by oscilloscope, AF oscillator and square wave generator revealed a slight triggered oscillation, a transient over-shoot, and some distortion at 5 watts at high frequencies, which were photographed and are reproduced in Fig. 17/1.

Having recently devised a method of taking loudspeaker response curves by oscilloscope fitted with camera and moving film (which also shows up frequency doubling and non-linearity), the system was applied to the amplifier, and the result appears in Fig. 17/2.

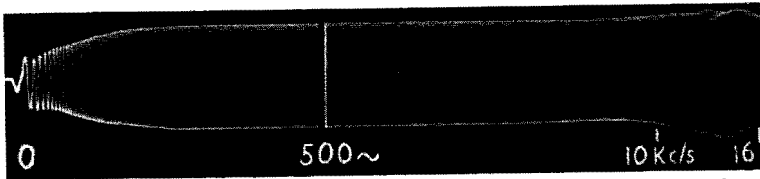

FIG. 17/2.—Oscillogram of response of amplifier, exposing distortion at 10–15 Kc/s.

It was interesting to find that the distortion snapped at 15 Kc/s in Fig. 17/1C was exposed in the response curve.

The value of this type of response record in exposing instability and distortion was further tested by running off a curve of the strange amplifier (not the Garner or any renowned make!) which had furnished the pictures reproduced in Figs. 5/2, 5/3 and 5/5 in the chapter on Instability.



FIG. 17/3.—Response oscillogram of nameless faulty amplifier. Effects of motor-boating, HF oscillations and harmonic distortion are included. Amplifier as used in Figs. 5/2, 5/3 and 5/5.

The February 1952 issue of *Wireless World* contained a brief technical description of this oscillographic response-recording technique. A print of Fig. 17/3 was sent to the Editor as being of likely interest, but it was returned with the alacrity one might expect if a seditious article were submitted to *The Times*. They pointed out that a full interpretation of this complex curve would provide someone with several months' work.

Even so, it was possible to use this amplifier—once the motor-boating was stopped—without any concrete evidence of trouble beyond an impression of peculiar tone quality. Removing the treble speaker from

a crossover network always re-started the motor-boating. (A really stable amplifier should stand up to any such activities in the speaker circuit.)

Revenons à nos moutons. The Garner Amplifier received some post-natal treatment, including the loading shown on the primary of the output transformer, and the following actual photographic records of response, square wave results, LF and HF waveform, all taken by the writer, should give a reasonable indication of performance to be expected from the circuits employed. Very good stability is achieved with 25 db of NFB, but personally I liked the "tone" of the reproduction with about 15 db feedback; the bass was warmer as a result of the lower damping factor. The margin of stability is of course much greater with the reduced NFB. (Bass lift was later increased.)

It will be observed that the areas of trouble pictured in Fig. 17/1 have been cleaned up.

All the oscillograms of Figs. 17/4, 5, 6, 7 and 8 were taken with 15 ohms resistance across the secondary of the output transformer.



FIG. 17/4.—Response characteristic of final version of Garner Amplifier (without pre-amp). Note absence of peculiarities exposed in Fig. 17/3 which was taken under similar conditions, which proves that the Garner Amplifier is not as bad as it could be. The response is flat up to 35 Kc/s (see Fig. 17/11 for 20–40 Kc/s).

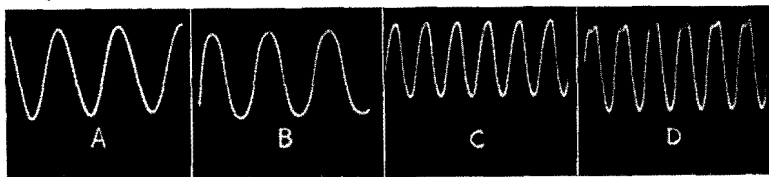

FIG. 17/5.—Actual photographs to show waveform at 30 c/s and 20 Kc/s.

- A. Reasonable linearity at 30 c/s, 10 watts, with 22 db negative feedback.
- B. 10 watts output without NFB. Note rounding of waveform indicating harmonic distortion.
- C. First signs of rounding-over at 20,000 c/s occurred at $7\frac{1}{2}$ watts.
- D. Serious distortion at 10 watts at 20,000 c/s.

When considering $7\frac{1}{2}$ watts at 20 Kc/s, it should be remembered that the power produced at very high frequencies is not likely to exceed a fraction of a watt in the loudest musical item.

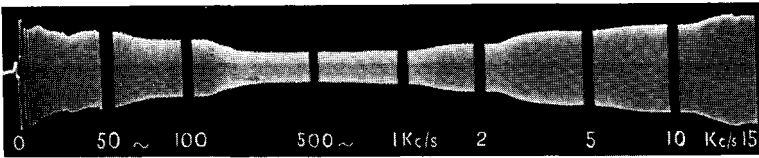

FIG. 17/6.—Response of original version of Garner Amplifier with pre-amp. Controls set for maximum bass and full top lift. There are indications of phase shift usually associated with tone control circuits.



FIG. 17/7.—Controls set for minimum bass and minimum top. Otherwise same as Fig. 17/6.

The width of trace in the previous three figures is proportional to voltage output.

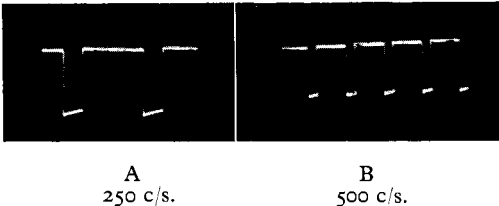

FIG. 17/8.—Square wave photographs of final amplifier. The slope of lower line of the wave should be ignored as it arose in the original wave as generated.

My impression was that the bass lift shown in Fig. 17/6 was not quite adequate for equalising recording characteristics with a magnetic pick-up. The ratio of lift from 250 to 60 c/s is about 2.5 to 1 or 8 db, whereas a lift of 12 db is required. The pre-amp was then modified by the designer and the final circuit as shown at the end of the book gives a lift of 14 db at 50 c/s in relation to the level at 250 c/s.

Major Garner informs me that he uses the Chapman compensated tone/volume control in his own equipment, with very satisfactory results. This made up for any lack of bass in the original design.

The performance of the tuning units struck me as being very good. Where I live, I should plump for the superhet.

OUTPUT TRANSFORMER AND MAIN AMPLIFIER

Analysis of the circuit of the Williamson amplifier reveals that it is literally designed around its output transformer. The circuit originally appeared in the *Wireless World*, and some of the faults to be guarded against were summarised as follows:

- (1) Low winding inductance, giving rise to frequency distortion and intermodulation and harmonic distortion at low frequencies.
- (2) High leakage reactance which, resonating with self-capacity, produces sufficient phase shift to cause parasitic oscillation when NFB is applied over all.
- (3) Excessive flux density, which will greatly aggravate harmonic and intermodulation distortion normally present due to the non-linearity between flux produced in the core material and the magnetising force.
- (4) Harmonic distortion introduced by excessive resistance in the primary winding.

The design of a practical transformer must be a compromise between these conflicting requirements; but the Williamson transformer, built on a generously proportioned core of superior laminations with two coils, each containing five primary sections interleaved with four secondaries—*i.e.* eighteen sections in all—gives the following result:

Primary inductance 100H measured at 50 c/s with 5 volts RMS on primary = 2.5 mW.

Leakage inductance 0.22H measured at 1,000 c/s. Primary resistance 250 ohms each half.

As there is a booklet on this amplifier, published by Iliffe & Sons Ltd., no useful purpose would be served by offering a similar design in these pages. It was therefore decided to produce a less ambitious unit with tetrodes for economical 10 watts output, and a good margin of stability with fairly generous NFB. The 6L6 valves are well within the drive capabilities of the concertina phase splitter employed, in which balance is readily achieved by no more than a careful selection of top and bottom load resistors.

Due to the high input impedance of the phase splitter the preceding stage can be a pentode, giving a high stage gain and yet retaining an excellent top response. The pentode employed in the original model is a Mazda SP61 (Service type VR65), but a Mullard EF37A gives good results with anode load of 0.22M, screen resistor 0.68M and bias resistor 2.2K. A 6J7 has been used with $R_L = 0.25M$, $R_{sc} = 1.45M$, $R_K = 1.3K$, with entirely satisfactory results.

The output transformer is a Wharfedale W15 with the following specification :

Primary inductance 70H.

Primary resistance 375 ohms (the two sections reading 185 and 190 ohms respectively).

Leakage inductance 0.083H.

The primary is wound with 34 gauge Conysil ; the secondary with 23g enamelled copper, and this can be adapted for 15 ohms or 3 ohms speaker without affecting the leakage inductance.

When using the 3 ohms output, it will be necessary to modify the values of resistance in the feedback loop for the same fractional feedback. Maximum feedback with the 15 ohms output is $\frac{250}{1,500} = \frac{1}{6}$ of out-

put volts. At 10 watts this is roughly $\frac{12V}{6} = 2$ volts. With 10 watts at 3 ohms we have approximately 6 volts, so the fraction fed back should be about one-third. This means reducing the series resistor from 1,250 to approximately 500 ohms $\left(\frac{250}{750} = \frac{1}{3}\right)$.

There are seven sections as shown in Fig. 17/9.

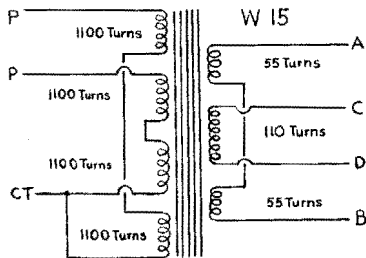

FIG. 17/9.—Winding data of W15 transformer as used in Garner Amplifier. Ratios 20:1 and 40:1.

15 ohms Speaker : Connect B to C. Use A and D.
3 ohms Speaker : Join A and C, also B and D. Use A and D.

The core is $1\frac{7}{8}$ ins. stack of size 4A laminations .014 in. thick in Stantranis No. 1. Any output transformer of equivalent or superior specification may be used. An inferior type should not be entertained. (The W15 transformer is inferior to, and cheaper than, the Williamson model, and is not suitable for use in the Williamson Amplifier.)

NFB is applied from the secondary of the OP transformer into the grid/cathode circuit of the pentode amplifier and is adjustable between zero and 22 db. Whatever the amount of NFB up to 22 db, no valve is called upon to handle more voltage swing than with zero feedback—a most important point. Of course, a larger input to the main amplifier is required as NFB is increased.

MAIN AMPLIFIER

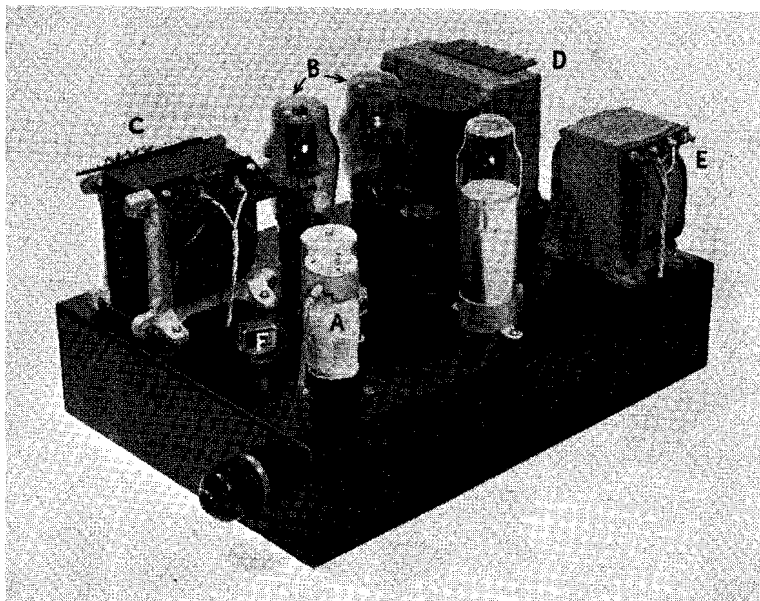

FIG. 17/10.—Main amplifier. Chassis 14 ins. by 10 ins. by 3 ins.

- A. First stage (Phase splitter 6J5 to right).
- B. Output valves.
- C. „ transformer.
- D. Mains transformer.
- E. Choke.
- F. Feedback control.

Power take-off plug on end of chassis.

Circuit diagram and list of components will be found on pages 214/5.

HF RESPONSE

There is no loss of top response in the pentode first stage.

Fig. 17/11 shows the overall response of the main amplifier between 20 and 40 Kc/s, with a similar curve of the output from the tone source for comparison. There is a drop in the amplifier of about 2 db at 36 Kc/s, and the outline is not so clean and smooth as the oscillator, but apart from these minor differences the curves are identical. In short, the HF response is good enough to avoid undue phase shifts. The square wave results indicate that transient response is also good.

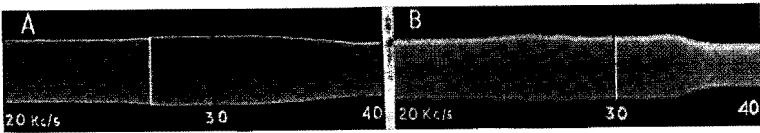

A
Oscillator Output.

B
Amplifier Output.

FIG. 17/11.—Oscillogram of response at 20–40 Kc/s.

N.B.—The white line at about 27 Kc/s in curve A should be ignored, as it was due to a slip in the clutch driving the film.

DELIBERATE DISTORTION

A few tests were made on this amplifier with one of the output valves not working. Naturally, some peculiar results were observed.

Fig. 17/11A shows the waveform at 30 c/s with 5 watts and 10 watts output, and also the nature of the response between 20 and 40 Kc/s. It will be observed that the output falls off suddenly at about 28 Kc/s with signs of distortion. This sudden drop of HF response would cause severe phase shift effects in the feedback circuit.

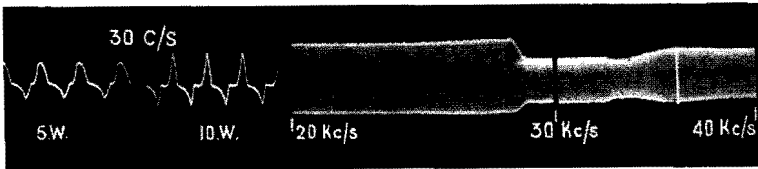

FIG. 17/11A.—Oscillograms to show effect of failure of one output valve on LF quality and HF response. Primary of output transformer loaded 20K and 400 pF on each half.

The curve gives a further illustration of the effectiveness of these oscillograms in providing a clear picture of amplifier response at high frequencies, together with evidence of distortion that may be taking place.

STABILITY

Precautions have been taken so far as possible to ensure that stability will be achieved by anybody desiring to build the amplifier. The anode load of the first stage is modified, the two halves of the primary of the OP transformer are shunted, and the feedback circuit is selective at high frequencies. As a check, a second amplifier was assembled exactly to the circuit diagram and proved to be completely stable, and gave expected results with *unmatched* output valves (one Brimar and one Ferranti).

TEST FIGURES

The second Garner amplifier to be built—as mentioned in the previous paragraph—was tested at different NFB settings for output resistance, hum level, input sensitivity and harmonic distortion. A Wave Analyser was used for the distortion measurements. The results appear in the following table :

TEST OF MAIN AMPLIFIER

	Maximum Feedback	Control half way	Control set for 10 db	Minimum Feedback
Output resistance ohms ..	1.3	2.0	4.3	110
Hum level db below 10W	57	52	47	37
„ „ Volts r.m.s. ..	0.018	0.032	0.057	0.182
Input voltage for 10W output	2.2V	1.3V	.7V	.2V
Harmonic distortion at 10W output ..	1.5%	2.5%	4.2%	9.1%
Harmonic distortion at 5W output8%	1.3%	2.5%	6.9%

Mains supply voltage was 230V, 50 c/s.

Hum, sensitivity and distortion tests were carried out using a 15 ohms resistive load.

For the distortion test, the input waveform was purified by means of a filter. The harmonic content of the input was below 0.1 per cent. The test frequency was 1,000 c/s.

These figures are very satisfactory for an amplifier which does not claim to compete with the Williamson or the highest grade of commercial equipment.

The hum level could be reduced by using a larger smoothing choke. A mains transformer with an electrostatic screen between primary and secondaries reduces the highest order harmonics which are all included in the hum and noise figures quoted.

Tests with a large number of unmatched pairs of 6L6 valves in the output stage revealed that—at the comparatively low level of output demanded from them—there is no need to worry about a close match.

The other positions do not call for carefully selected valves. Useful equivalents should be easily obtainable in any part of the free world, the whole of the equipment having been designed with this end in view. The amplifier is stable with or without loudspeaker load ; with any type of crossover network ; and with any number of loudspeakers attached thereto.

PRE-AMPLIFIER

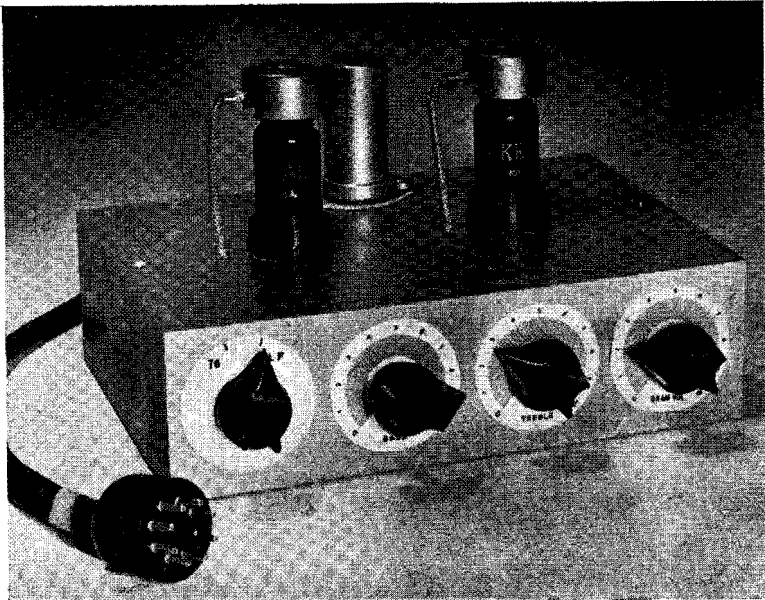

FIG. 17/12.—Pre-amplifier. Chassis $8\frac{1}{2}$ ins. by $5\frac{3}{4}$ ins. by $2\frac{1}{2}$ ins. 8 by $8\ \mu\text{F}$ condenser at rear. V_1 left, V_2 right. Note plug to main amplifier.

The pre-amplifier is a general purpose device and in this respect has considerable limitations. The author (H. H. G.) was rather reluctant to produce a finalised design because he feels that every pre-amp is an individual problem intimately connected with the frequency characteristic of the particular pick-up to be used. For this reason, he was even reluctant to include 78/LP compensation. However, the circuit published has performed well with a lightweight magnetic and also with a lightweight crystal pick-up. With the crystal, it is recommended that the correction be applied directly in the pick-up circuit, as indicated in the diagram, the output being applied to the input of V_2 . Good domestic volume will then be obtained with about 12 db of feedback on the main amplifier. If more NFB is preferred, or more gain, the corrected output from the crystal may be fed into V_1 , but the 78/LP correction circuit which follows V_1 must then be cut out.

When a magnetic pick-up is used, the input is applied to V_1 , and a suitable load resistor for the pick-up must be included, as outlined in Chapter 11. The gain is adequate for a moving coil pick-up with its associated transformer.

If the range of bass boost seems to be less than expected, this is due to the fact that treble boost begins at a frequency lower than the start of bass lift. This is thought to be desirable as it avoids reproduction that is all top and bottom with no middle. Some juggling with the value of the capacitor $0.02 \mu\text{F}$ can always be tried—a reduction in value affording more bass lift, starting at a higher frequency. Or, the capacitors in the treble network may be adjusted to give more or less boost or cut as desired. In all cases the controls will be found to be interdependent.

The 6J7's in the pre-amp were given a clean bill of health on the score of hum, but certain specimens in the first position were somewhat prone to microphony.

CIRCUITS AND COMPONENTS

Pages 208–215 show full circuit diagrams of the main amplifier, pre-amp, TRF and superhet feeders, with details of components required for construction.

THE TRF FEEDER

This simple feeder is capable of good results within about thirty miles of a main BBC station, and will give reasonable selectivity. It comprises a high gain RF amplifier and a so-called “infinite impedance” detector—actually a cathode follower. This detector imposes very little loading indeed on the associated tuned circuit, and accounts for the good degree of selectivity achieved. Great care must be taken with the layout and screening of the unit, as with the high gain available instability can easily result due to coupling between the aerial coil and HF transformer. The neutralising device of Fig. 17/14 will help in balancing out the effects of feedback due to C_{ag} , and two turns of fine wire wound over the transformer, with a coupling condenser of 3–5 pF, are usually adequate. The sense of the winding must be determined by trial and error.

This feeder, with pre-amp, is illustrated in Fig. 17/13.

ANODE CURRENT

The radio feeder and pre-amp draw their HT and LT current from the main amplifier. The total anode current for the three circuits *under the actual working conditions* is 142 mA. The mains transformer and choke are rated at 150 mA.

Attention is drawn to this point because a calculation of anode current—on paper—would indicate a higher value. Any alteration to the working conditions of the valves which resulted in higher anode current—particularly with the 6L6 output valves—would obviously call for a more generous source of supply.

THE TRF FEEDER

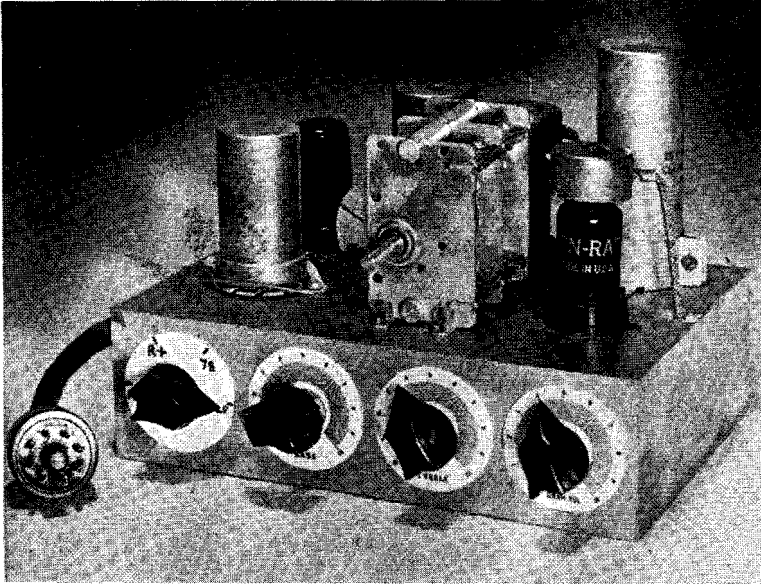

FIG. 17/13.—TRF Feeder and Pre-amp. Chassis $8\frac{1}{2}$ ins. by $5\frac{1}{4}$ ins. by $2\frac{1}{2}$ ins.

- EF50 front left, RF amp.
- 6J5 rear left, Det.
- 6J7 back centre, 1st stage pre-amp.
- 6J7 front right, 2nd stage pre-amp.
- 8 by 8 μ F back right.
- 8 μ F rear.

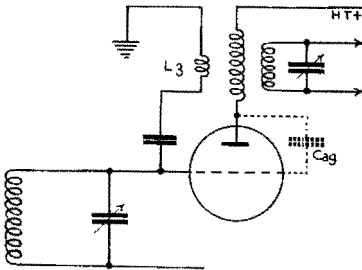

FIG. 17/14.—Stabilising RF amplifier by introducing out of phase feedback to cancel effects of inter-electrode capacity and stray couplings.

THE SUPERHET FEEDER

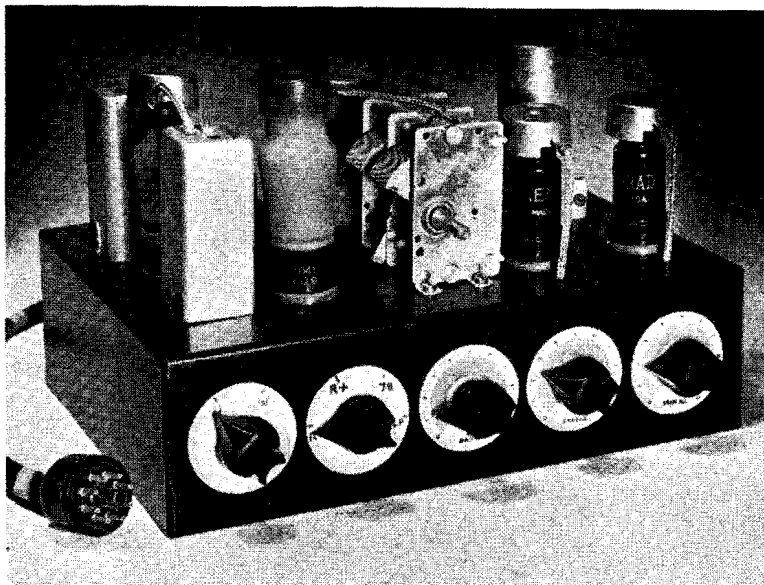

FIG. 17/15.—Superhet Feeder and Pre-amp. Chassis 11 ins. by 8 ins. by 3 ins.

- Frequency changer, front left.
- IF amp, centre left.
- Det. AVC, at rear.
- 8 μ F behind gang condenser.
- Pre-amp on right.
- Note variable selectivity knob, front left.

This consists of a triode-hexode frequency changer, a variable-mu pentode IF amplifier, and a double diode for signal detection and delayed automatic volume control. It should be noted that reduced AVC is applied to the IF amplifier as distortion results if full AVC is applied to this valve when a very strong signal is received.

Variable selectivity is applied to the first IF transformer by changing the trimming values on the wide position, thus giving a "staggering" of the resonant frequencies of primary and secondary windings and increasing the pass-band. The second IF transformer is not treated in this way as the loading imposed by the diodes ensures a wide pass-band.

This unit, complete with pre-amp, is illustrated in Fig. 17/15.

CHAPTER 18

A FEW QUESTIONS ANSWERED

The following questions have been drawn up with a view to helping the large number of quality enthusiasts who live out in the country or in remote corners of the world, where facilities for radio service and repairs are a long way off or non-existent.

Questions by G.A.B.

Answers by H.H.G.

- Q. 1.—In the chapter on Valves, internal resistance, amplification factor, mutual conductance, etc., are discussed. When a valve is growing old and is due for replacement, are all these qualities affected? In other words, does it suffer from lameness, shortness of breath, indigestion, etc., or only from one illness at a time?*
- A. 1.—The formula is $\mu = g_m \times r_a$. As the cathode emission falls off with advancing years, less anode current will flow for a given anode voltage, thus δE_a will not cause such a big change in I_a , and anode resistance will rise. Similarly, δE_g will not cause such a big change in I_a , and g_m is less. The effect in the case of a power output valve is a reduction in available output; in a voltage amplifier the output voltage will be restricted.*
- Q. 2.—In the absence of valve-testing equipment, can you outline a method of checking the state of a valve with the aid of an instrument like the Avo Meter?*
- A. 2.—A valve with lowered emission will pass less anode current, therefore the voltage across the bias resistor will be less. Providing HT voltage is correct and the resistance of the anode load has not changed, the voltage developed across the bias resistor is a sure guide to the state of the valve's emission. It is always a good plan to record these voltages when the set is new. With battery valves it is necessary to break the anode circuit and check the anode current—of course making sure that the value of load resistance has not changed, and that the bias voltage is normal.*
- Q. 3.—With push-pull output, let us assume that we have two valves which are grossly mismatched and are therefore causing trouble. What sort of distortion would result?*

A. 3.—The general effect of gross mismatch is to restrict the power output available. At low and moderate levels, distortion would not be noticeable, but if full output is attempted harmonic distortion will be produced due to the inequality of contribution from each valve into the two halves of the output transformer primary.

Q. 4.—*Could the quality in the case of No. 3 be improved by equalising the anode current to the two valves by introducing extra resistance in one anode circuit?*

A. 4.—The quality would most certainly be made worse by such treatment. But extra resistance can be introduced into the cathode of the valve taking the higher anode current, thus biasing it back until equality of anode currents is obtained.

Equality of mutual conductance is a very desirable feature in a pair of output valves, so that equal grid swings produce equal anode current swings.

Q. 5.—*In the case of No. 3, would you say that the effects were a step in the direction of removing one valve entirely, as illustrated in Fig. 17/12A.*

A. 5.—Yes; the removal of one valve is but the ultimate case of a mismatch.

Q. 6.—*Phase Splitters. It is clear from Chapter 9 that good balance is essential. Can you give a brief outline of the steps which are normally taken to obtain this, or would they depend on the type of splitter in use?*

A. 6.—The question of adjusting for equality of output from a phase splitter is entirely governed by the type of splitter used. The most reliable check is made with a valve voltmeter, which can be easily strung together as it does not need to be calibrated for a comparative test. *Radio Laboratory Handbook* by Scroggie and *Radio Designer's Handbook* by Langford-Smith (both published by Iliffe & Sons Ltd.) give several simple designs. An oscilloscope can also be used—again of the simplest type.

Q. 7.—*Pre-Amp. Assuming that a particular valve proved to be noisy or microphonous in position 1, is it likely that it could be used in position 2 with success?*

A. 7.—Yes. It is always worth while changing over V₁ and V₂ to check which is the less subject to microphony.

Q. 8.—*When dealing with hum pick-up we are always told to encase*

the transformer at the input end in Mu-metal. If the mains transformer is the source, would emission of hum be avoided by encasing the offending unit in Mu-metal?

A. 8.—Yes, but the cost would be absolutely prohibitive. A microphone transformer case only costs about 10/-. The Admiralty use heavy cast-iron cases—but what a weight! (They probably save ballast.)

Q. 9.—*In some cases an amplifier begins to motor-boat and show signs of distress when crossover networks or tapped inductances are used in the voice coil circuit. Would you agree that a really stable amplifier should stand up to any variation of load conditions? Could you explain briefly why motor-boating is induced in some cases?*

A. 9.—A truly stable amplifier remains stable whatever the type of load placed across the output. If motor-boating or instability results when a crossover network is used it is due to phase shifts introduced by the L and C of the crossover system reflecting back into the NFB circuit and producing in-phase feedback by an addition to existing phase displacement.

In one case, a capacity of 2 mfd placed across the output terminals of an amplifier produced a display of fireworks in the output pentode which did not fail to draw admiration from the onlookers, particularly as the amplifier had only been received on approval.

Q. 10.—*Taking the Garner Pre-amp and Amplifier as a typical case, which valve or valves would be the most likely to deteriorate first, and how would such deterioration affect the performance?*

A. 10.—The order of deterioration would be rectifier first, output tetrodes next, and the remaining valves a long way behind.

During three years' actual experience with more than 100 amplifiers of a similar type, the replacements for failure have been as follows:

15 per cent.	HT rectifiers
4 „ „	Output tetrodes
2 „ „	Pentode amplifiers
	No phase splitters.

A failing rectifier will give reduced HT with lower available power output. Failing tetrodes will give reduced power, but not necessarily distortion at low levels.

Q. 11.—*HF oscillation in an unstable amplifier often burns out spots of wire in an OP transformer, resulting in shorted turns, without producing an open circuit. The drop in inductance leads to loss of*

bass and thin, reedy tone. In the absence of an Inductance Bridge for checking the condition of the transformer, is there an alternative test which could be carried out with simple equipment?

It is interesting to note here that a single turn of 38's copper wire shorted round a typical output transformer will reduce the inductance from 40H to about 36H. Three turns of the same wire will drop the inductance by 25 per cent.

- A. 11.—The thin reedy tone is not wholly caused by the loss of inductance. The effect of shorted primary turns is analogous to a secondary winding with a dead short on it; thus a very low value of load is presented to the valve which will naturally cut bass. An inductance bridge will, of course, show a reduced inductance as it measures the impedance. A transformer with a loaded secondary takes more primary current; *i.e.*, its primary impedance has gone down. One can make a rough check of the impedance by connecting to a source of AC voltage and reading

$$\text{current passed } Z = \frac{E}{I}.$$

A rough check of the inductance of the primary can be made by connecting this in series with the 6.3 volt heater winding of the mains transformer. The current which then flows, as indicated on an AC milliammeter, will be proportional to the inductance; thus an inductance of 10H would pass practically 2 mA on a 50 cycle supply, ignoring the DC resistance which will be less than 5 per cent. of the impedance in normal cases.

20H would pass 1 mA.

40H „ „ .5 mA.

Proportionately it is an easy matter to estimate the inductance by this means.

It is clear from this simple test that the value of current for any transformer will be doubled if the applied voltage is doubled.

CONCLUSION

According to C. E. Montague, a wizard in the use of words, the common adversary of good writing is formlessness—a kind of lumpish and sluggish recalcitrance, a hugger-mugger fecklessness—an inveterate halfness. . . .

If this is true of the cult of writing, how much more does it apply to semi-technical work, where it is necessary to elucidate countless problems with the minimum of recourse to the mathematics and electronic symbols on which the problems are based! To a large extent, words have to be used to replace figures. Clarity of meaning is therefore a first essential, or in the modern idiom, a “must”.

It is, unfortunately, impossible to avoid running into some degree of error in a book of this description, but it is important that such mistakes, whether of fact or deduction, should stand out clearly and should not be hidden or confused by equivocation.

The modern amplifier is of necessity a highly technical and elaborate piece of equipment. The purpose of this book has been to clarify some of the problems for the benefit of those who like to experiment and construct at home; and also to clear the air for the ever-growing army of “hi-fi” listeners who use professionally made equipment but still like to know “how the wheels go round”.

Should a reader experience trouble in building the Garner Amplifier, the designer is willing to give reasonable technical help by post. His address is :

Major H. H. Garner,
393 Baddow Road,
Chelmsford,
Essex.

Letters should be as short as possible and *must* contain a stamped addressed envelope for reply. It is always a great help when queries are listed and numbered instead of being hidden in a maze of verbosity. Arguments about the relative merits of alternative designs cannot be entertained.

I think this is a very noble gesture on the part of H. H. G. I have already received well over 2,000 letters from readers of my L.S. and S.R. books, and letters are still rolling in at the rate of about twenty a week from all English-speaking countries. I have office and secretarial facilities for dealing with this friendly correspondence, but H. H. G. will be working at home in his spare time, so will correspondents kindly temper the wind accordingly.

G. A. B.

SUPPLEMENT

USEFUL FORMULAE

OHM'S LAW $I = \frac{E}{R}$ or $R = \frac{E}{I}$ or $IR = E$

POWER IN A CIRCUIT $\text{Watts} = I^2R$ or $\frac{E^2}{R}$

RESISTANCES IN SERIES $R_T = R_1 + R_2$ ———— etc.

RESISTANCES IN PARALLEL $R_T = \frac{R_1 \times R_2}{R_1 + R_2}$

CONDENSERS IN SERIES $C_T = \frac{C_1 \times C_2}{C_1 + C_2}$

CONDENSERS IN PARALLEL $C_T = C_1 + C_2$ ———— etc.

INDUCTANCES IN SERIES $L_T = L_1 + L_2$ ———— etc.

INDUCTANCES IN PARALLEL $L_T = \frac{L_1 \times L_2}{L_1 + L_2}$

RESONANT FREQUENCY OF A TUNED CIRCUIT $f = \frac{I}{2\pi\sqrt{LC - \frac{r^2}{4L^2}}}$

Where f = resonant frequency in c/s
 L = Inductance in Henrys
 C = Capacity in farads
 r = Series resistance in Ohms

The term at the right $\frac{r^2}{4L^2}$ is usually so small with radio frequency coils as to be negligible. Only .005 per cent. error results in neglecting it with average coils. At audio frequencies, the term may be included, although the degree of accuracy required seldom warrants it.

RESISTOR COLOUR CODE

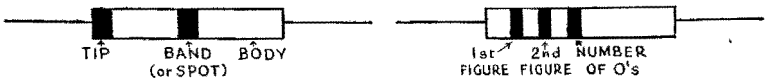

The body colour determines the first figure of value, the tip the second, and the band or spot the number of noughts. Tolerance = 20%

0 Black	1 Brown	2 Red
3 Orange	4 Yellow	5 Green
6 Blue	7 Violet	8 Grey
	9 White	

SELECTED RESISTORS

Silver Band = 10% Tolerance Gold Band = 5% Tolerance
 Red Band = 2% „ Brown Band = 1% „

REACTANCE OF A CAPACITOR
AT AUDIO FREQUENCIES

$$X_c = \frac{10^6}{\omega C}, \quad \omega = 2\pi f = 2 \times 3.14f, \text{ and } C = \text{capacity in microfarads.}$$

CAPACITY IN MICROFARADS	REACTANCE IN OHMS					
	30 c/s	50 c/s	100 c/s	400 c/s	1000 c/s	10,000c/s
·00005	106M	63·7M	31·8M	7·96M	3·18M	318,450
·0001	53M	31·8M	15·9M	3·98M	1·59M	159,200
·0005	10·6M	6·37M	3·18M	796,000	318,500	31,850
·001	5·3M	3·18M	1·59M	398,000	159,200	15,900
·005	1·0M	637,000	318,500	79,600	31,800	3,180
·01	531,000	318,500	159,200	39,800	15,920	1,590
·05 Coupling	106,100	63,700	31,850	7,960	3,180	318
·1 Condensers	53,100	31,850	15,920	3,980	1,590	159
·25 R C C	21,200	12,700	6,370	1,590	637	63·7
·5 Stages	10,600	6,370	3,180	796	318	31·8
1	5,310	3,180	1,590	398	159	15·9
8 H T	663	398	199	49·7	19·9	1·99
16 Smoothing Cathode	332	199	99·5	24·9	9·95	·99
25 Bypass H T	212	127	63·7	15·9	6·37	·64
32 Smoothing Cathode	166	99·5	49·8	12·4	4·98	·498
50 Bypass	106	63·7	31·8	7·95	3·18	·318

These reactance values follow a simple rule. As the capacity is doubled the reactance is halved ; as the frequency is doubled the reactance is again halved.

REACTANCE OF INDUCTANCES

	REACTANCE IN OHMS				
	50 c/s	500 c/s	1,000 c/s	5,000 c/s	10,000 c/s
0·5 mH ..	·157	1·57	3·14	15·7	31·4
1 „ ..	·314	3·14	6·28	31·4	62
2 „ ..	·628	6·28	12·56	62	125
3 „ ..	·942	9·42	18·84	94	188
4 „ ..	1·25	12·56	25·12	125	251
5 „ ..	1·57	15·7	31·4	157	314
0·1 H ..	31·4	314	628	3,140	6,280
0·5 „ ..	157·0	1,570	3,140	15,700	31,400
1·0 „ ..	314·0	3,140	6,280	31,400	62,800

DECIBEL RELATIONSHIPS

(2) POWER AND VOLTAGE RATIOS EXPRESSED IN DECIBELS		
Ratio : 1	db (Power Ratio)	db (Voltage Ratio)
1.0	0	0
1.1	0.414	0.828
1.2	0.792	1.584
1.3	1.139	2.279
1.4	1.461	2.923
1.5	1.761	3.522
1.6	2.041	4.082
2.0	3.010	6.021
2.5	3.979	7.959
3.0	4.771	9.542
3.5	5.441	10.881
4.0	6.021	12.041
4.5	6.532	13.064
5.0	6.990	13.979
5.5	7.404	14.807
6.0	7.782	15.563
6.5	8.129	16.258
7.0	8.451	16.902
7.5	8.751	17.501
8.0	9.031	18.062
8.5	9.294	18.588
9.0	9.542	19.085
9.5	9.777	19.554
10.0	10.000	20.000

DECIBELS EXPRESSED AS VOLTAGE RATIOS		
Voltage Ratio	db	Voltage Ratio
1.0000	0	1.000
.8913	1	1.122
.7943	2	1.259
.7079	3	1.413
.6310	4	1.585
.5623	5	1.778
.5012	6	1.995
.4467	7	2.239
.3981	8	2.512
.3548	9	2.818
.3162	10	3.162
.2818	11	3.548
.2512	12	3.981
.2239	13	4.467
.1995	14	5.012
.1778	15	5.623
.1585	16	6.310
.1413	17	7.079
.1259	18	7.943
.1122	19	8.913
.1000	20	10.000
.056	25	17.78
.03162	30	31.62
.01778	35	56.23
.010	40	100.0
.0056	45	177.8
.003162	50	316.2
.001	60	1,000
.0003162	70	3,162
.0001	80	10,000
.00003162	90	31,620
.00001	100	100,000

MEMORY AID

3 db power ratio nearly 2 : 1
6 db voltage ratio nearly 2 : 1

For power ratios, the db figure is half the above.

It is required to find a ratio corresponding to 23 db, or any other value not included in Table. Take the next lowest multiple, in this case 20 db and note the corresponding voltage ratio, in this case 10. Take the difference between the specified levels and the next lowest multiple, in this case 3 db, and note the corresponding voltage ratio, in this case 1.413. Multiply the two ratios so determined and the answer gives the voltage ratio, in this case $10 \times 1.413 = 14.13$.

Cross checking, 14.13 lies between 20 and 25 db.
20 times the common log of voltage ratio = db.
10 times the common log of power ratio = db.

TRANSFORMER RATIOS FOR LOUDSPEAKER MATCHING

LOAD REQUIRED IN OHMS	VOICE COIL—OHMS				
	2	3	6	10	15
1,000	24/1	19/1	13/1	10/1	8/1
1,500	28/1	22/1	16/1	12/1	10/1
2,000	32/1	26/1	18/1	14/1	12/1
3,000	38/1	32/1	22/1	17/1	14/1
5,000	50/1	41/1	29/1	22/1	18/1
7,500	62/1	50/1	35/1	28/1	22/1
10,000	70/1	58/1	41/1	32/1	26/1
15,000	85/1	70/1	50/1	38/1	32/1
20,000	100/1	80/1	58/1	45/1	36/1

FORMULA

$$\text{Ratio squared} = \frac{\text{Load required}}{\text{LS impedance}} \quad \text{or} \quad \text{Ratio} = \sqrt{\frac{\text{Load required}}{\text{LS impedance}}}$$

The impedance of a moving coil loudspeaker may be assumed to be 50 per cent. higher than the DC resistance of the voice coil.

The impedance tends to rise with frequency above about 1,000 c/s, and reflex loading often results in a rise in impedance at frequencies below 100 c/s. Perfect matching of load by careful choice of transformer ratio is, therefore, rather outside the realms of possibility. One of the main benefits of the use of NFB is the provision of a low impedance source which greatly reduces the problem of load matching and so removes the necessity of trying to achieve the impossible.

FREQUENCY AND WAVELENGTH

F.	(c/s)	27.5	40	50	60	70	80	90	100
Wavelength	(ft.)	40'	28'	22.4'	18'	16'	14'	12.5'	11.2'
F.	(c/s)	120	150	200	300	400	500	1,120	
Wavelength	(ft.)	9'	6.8'	5.6'	3.4'	2.8'	2.2'	1'	
F.	(c/s)	2K	3K	4K	5K	10K	15K	20K	
Wavelength	(ins.)	5.6"	3.7"	2.8"	2.2"	1.1"	.78"	.56"	

Formula for Wavelength in feet : 1,120 divided by frequency.

SUPPLEMENT

LOUDSPEAKER WATTS EXTENDED TO NEAREST USEFUL DECIMAL POINT

VOICE COIL IMPEDANCE IN OHMS						VOLTS ACROSS COIL	
2	3	6	10	12	15		
WATTS	0.125	0.083	0.041	0.025	0.02	—	0.5
	0.5	0.333	0.166	0.1	0.083	0.066	1.0
IN	1.125	0.75	0.375	0.225	0.187	0.15	1.5
	2.0	1.333	0.666	0.4	0.333	0.266	2.0
VOICE	3.125	2.083	1.041	0.625	0.52	0.41	2.5
	4.5	3.0	1.5	0.9	0.75	0.6	3.0
COIL	6.12	4.08	2.0	1.23	1.02	0.81	3.5
	8.0	5.3	2.6	1.6	1.3	1.0	4.0
	10.1	6.7	3.4	2.0	1.7	1.3	4.5
	12.5	8.3	4.2	2.5	2.0	1.6	5.0
	15.0	10.0	5.0	3.0	2.5	2.0	5.5
	18.0	13.0	6.0	3.6	3.0	2.4	6.0
		14.0	7.0	4.2	3.5	2.8	6.5
		16.3	8.2	4.9	4.0	3.3	7.0
			9.4	5.6	4.7	3.75	7.5
			10.6	6.4	5.3	4.3	8.0
			13.5	8.1	6.75	5.4	9.0
			16.6	10.0	8.3	6.6	10
				12.1	10.1	8.0	11
				14.4	12.0	9.6	12
				16.9	14.1	11.25	13
				19.6	16.3	13.0	14
				22.5	18.8	15	15

INDEX

A

Abbreviations	6, 18
AC Component	31
AC/DC Technique	154
AC Valves	20
Amplification Factor	25
Amplifier, Garner	180, 207
" Quality	9 <i>et seq.</i>
" Response	63, 181
" Test	188
Anode	20
" Characteristics	21, 22, 24, 34, 35
" Circuit	19, 20, 26
" Current	19
" Follower Phase Splitter	93, 100
" Impedance	22-5, 35
" Load	28, 29
" Stopper	54
Atom	19
Attenuator	177
Attenuators "T" Type	151
Audio Engineering	117
Audio Spectrum	135
Automatic Gain Control	40, 192

B

Background Noise	176
Balance, Push-Pull	60-2, 104-5
Ballast Resistance	155
Barretters	156
Bass Cut and Lift	80, 109-16, 118-21, 128, 130, 212
Bass Synthesis	119
Battery Supplies	152
Beam Tetrode	43
Beaumont, F. H.	80, 178
Bias, Various Types	27, 28, 36, 37, 103
" Point	32
" Resistance Calculation	38
" Variable	40
BBC	138-42

C

Capacity, Bypass	36
" Coupling	29, 111
" Inter-electrode	33, 54, 86
Carbon Microphone	139
Cardioid	143
Cathode Bias	36
" Coupled Phase Splitter	93, 98, 99
" Follower	85, 87, 90
" Indirectly Heated	21
Chapman, C. T.	119
Choke as Load	30
" Smoothing	153
Circuit Noise	9, 17
Class A Amplification	59
" B	59
" C	59, 60
Combination Tones	16
Concertina Phase Splitter	92, 94, 95, 184
Condenser Coupling	111
" Input Filter	154
Condenser Microphone	142
Connoisseur	126, 130
Cosmocord	128, 144
Crossover Network	12
Crystal Microphone	144
" Pick-up	129
Current Feedback	37, 68-9
Cut-off Grid	23

D

Damping Factor	47
Decca	124, 128, 135
Decoupling	48, 52, 53
DB Tables	200
Diode	20, 21, 23
Direct Coupling	31
Directly Heated Valve	19, 20, 37
" " Bias	37
Distortion	27, 182, 187
" Frequency	11
" Harmonic	9
" Intermodulation	15

INDEX

D

Distortion Phase 11
 „ Scale 12
 „ Transient 13

E

Earth Connection .. 157, 172
 „ Point 172
 Eddy Currents 172
 Electrons 19
 Emission 18, 19
 E.M.I. Ltd. 128
 Equivalent Valve Circuit .. 43
 Excel Sound Service 49
 Exley Circuit 119
 External Fields .. 173, 175

F

Field Winding, LS 175
 Filament 19, 20
 „ Battery 20
 „ Coating 20
 Filter, HT 153
 „ Scratch and Whistle .. 134
 Formulae 198
 Fractional Feedback 71
 Frequency Distortion 11
 „ and Wavelength .. 201
 Full Wave Rectification .. 158
 Fuses 169

G

Gain Reduction Factor .. 72
 Garner Amplifier 15, 180, 207-15
 Gaseous Rectifier 159
 GEC 116
 Grid 23
 „ Bias 28
 „ Characteristic 23
 „ Current 27
 „ Leak 30, 111
 „ Stopper 54

H

Half Wave Rectification .. 152
 Harmonics 10
 Harmonic Distortion .. 9, 178-9
 Heater Winding .. 171, 173
 Heterodyne Receiver .. 210
 „ Whistle Filter .. 134
 HF Oscillation .. 50, 180
 HF Response .. 13, 14, 186
 High Gain Phase Splitter 101-2
 High Tension Battery .. 152
 „ „ Supplies 152 *et seq.*
 Hum 17, 171 *et seq.*
 Hum-bucking Coil 176

I

Impedance 45, 48, 90
 Indirectly Heated Cathode .. 21
 Inductance, Tapped 136
 Input Impedance .. 75, 90
 Instability 17, 48 *et seq.*, 54, 77
 Insulator 19
 Intermodulation 15

K

Keen, A. W. 13
 Kelly, S. 148

L

Leak, H. J. 10
 Leakage Current Electrolytic
 Condenser 177
 Leaky Grid Bias 39
 Lift Circuits 112
 Load Line 45
 Load Matching .. 43, 44
 Loudspeaker Characteristic
 Curve 45
 Loudspeaker Damping 45, 46
 „ Resonance 46, 64, 65-8
 „ Transients .. 14
 Low Level Listening .. 79, 118
 Low Pass Filter 55

M

Mains Valves 20
 Metal Rectifiers 161
 Microphone Response 138-44
 Microphones 138 *et seq.*
 " Circuits 145-6
 Microphony 103
 Miller Effect 33, 76
 Mixing Methods 148
 Molecule 19
 Motor Boating 50, 51
 " Rumble 132
 Moving Coil Microphone .. 142
 " " Pick-up 129
 Mullard DA90, EC52, ECC33 22-4
 Mutual Conductance 24, 25

N

Needle Scratch 16, 126, 134
 Negative Feedback
 16, 37, 48, 63 *et seq.*, 185
 Negative Feedback Current 68, 69
 " " Selective 79, 107
 " " Summary 73, 76
 " " Voltage .. 69
 Neumann Microphone .. 143
 Neutralisation of Hum .. 175
 Novice's Corner 81

O

Oscillation, Continuous 9, 32
 " Intermittent 9, 17, 50
 " Parasitic 49, 50, 180
 Oscillator 32
 Output, Power 41 *et seq.*
 " Transformer 43

P

Parallel Feed 31
 " Output 57
 Paraphase Phase Splitter 92, 96, 97
 Parasitic Oscillation 49, 50
 Pentode 35

P

Pentode Distortion 11
 " Output Stage 41
 Phase Shift 11, 70, 108
 " Split 58, 59, 91 *et seq.*
 Pick-up Circuits 123 *et seq.*
 " Crystal 127
 " Equalization 128
 " Loading 125
 " Magnetic 125-7
 " Matching 126
 " NFB Control 128
 " Output Level 124, 126
 " Transformer 126
 Plate 19
 Potential 19
 Power Supplies 152
 Pre-amplifier for Pick-up
 116, 131, 189, 212
 Pre-emphasis 12
 Push-Pull 57 *et seq.*

Q

Quality 9
 Questions Answered 81-4, 193-6

R

Radio Designers' Handbook 44, 194
 " Frequency Interference 160
 Reactance, Condenser .. 108
 " Tables 110, 199
 Recording Characteristics 123-4
 Rectifiers, Gaseous 159
 " Metal 161
 " Valve 152 *et seq.*
 Reflex Loading 67
 Resistance, Anode Load 26, 29
 " Capacity Coupling
 29, 35
 " Damping 54
 " Grid 30
 Resonance of Loudspeaker
 46, 64-8
 Resonant Circuits 106-8

INDEX

R

Ribbon Microphone .. 140-1
 „ Pick-up 129
 Rotary Converter 168

S

Saturation 22
 Scale Distortion .. 9, 12
 Scratch Filter 134
 Screen Grid Valve 34
 Screening 108
 „ Transformer .. 147
 Screen Stopper 54
 Secondary Emission 35
 Shielded Microphone Leads .. 146
 „ Valves 175
 Sine Wave 13
 Smoothing Circuits 153
 „ Choke 153
 Smith, F. Langford .. 44, 194
 Source Impedance .. 48, 188
 Space Charge 22
 Square Wave .. 13, 14, 56, 183
 Stage Gain .. 28, 102, 103
 „ „ Cathode Follower 85
 Standard Telephones & Cables
 Ltd. 142-4
 Step-up Transformers .. 30
 Stoppers, Anode, Grid, Screen
 54, 55
 Superhet Feeder .. 192, 210
 Suppressor Grid 35
 Surface Noise 16
 Suspension Loudspeaker
 Diaphragm 14

T

“T” Attenuator 151
 Tannoy Microphone 144
 Tetrode 34, 89
 „ Beam Type .. 43, 44
 Thermionic Emission .. 18, 19
 Tone Compensation 106 *et seq.*
 „ „ Dual
 115, 116, 117

T

Tone Control 37
 „ „ by NFB .. 117
 Transformer Coupling .. 30
 „ Load 61
 „ Output 43, 61, 62, 184
 „ Ratios 201
 „ Step-down .. 43
 Transient Definition 13
 „ Distortion .. 13, 17
 Treble Cut and Lift
 80, 109, 111, 112, 116, 130, 212
 Triode 23, 26
 „ Characteristic .. 23, 24
 „ Output Stage 42
 „ Oscillator 32
 TRF (Garner) 190

V

Valve as Amplifier .. 26, 41
 „ Inter-electrode Capacity
 33, 54
 „ Noise 9, 17
 „ Diode 20, 21
 „ Tetrode 34, 43
 „ Theory 18
 „ Triode 23, 24
 „ Pentode 35, 41, 54
 Variable Mu Valve 39
 „ Resistance 177
 Vibrators 165
 Voltage Feedback 69
 „ Dropping 155
 „ Doubler 157
 Volume Controls 177

W

Watts, C. E. 122
 Watts 42, 202
 Wavefront and Wave Envelope 12
 Wavelengths (c/s) 201
 Whistle Filter 134
Wireless World
 114, 115, 120, 138, 164, 181, 184, 194
 Waveform 182
 Williamson Amplifier 184

**GARNER
CIRCUITS**

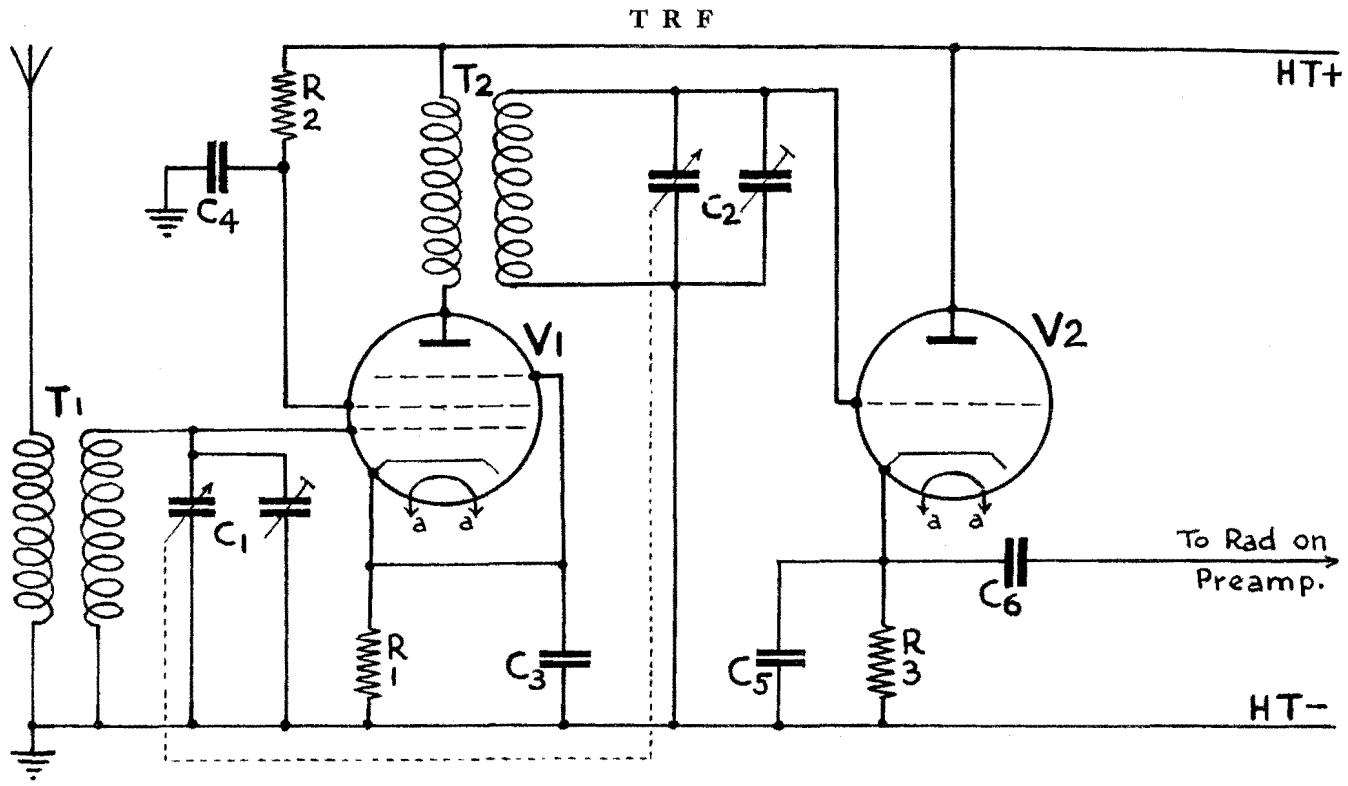

TRF COMPONENTS

C1 & C2	2-gang condenser 0.0005 μ F each section
C3 . . .	0.1 μ F
C4 . . .	0.1 μ F
C5 . . .	100 pF
C6 . . .	0.25 μ F
R1 . . .	100 Ω
R2 . . .	5K
R3 . . .	100K $\frac{1}{2}$ W
T1 . . .	Wearite PA2 for medium waves
T2 . . .	„ PHF2 „ „ „
V1 . . .	EF50 or 6AC7
V2 . . .	6J5, Mullard EBC33 or Osram L63

Note: (1) With an EBC33, the top cap grid is used for triode connection.

(2) It is sometimes desirable to decouple V2 with 47K and 8 μ F to earth, to avoid motor-boating.

Chassis $8\frac{1}{2}$ ins. \times $5\frac{3}{4}$ ins. \times $2\frac{1}{2}$ ins. Eddystone die-cast or similar.

SUPERHET

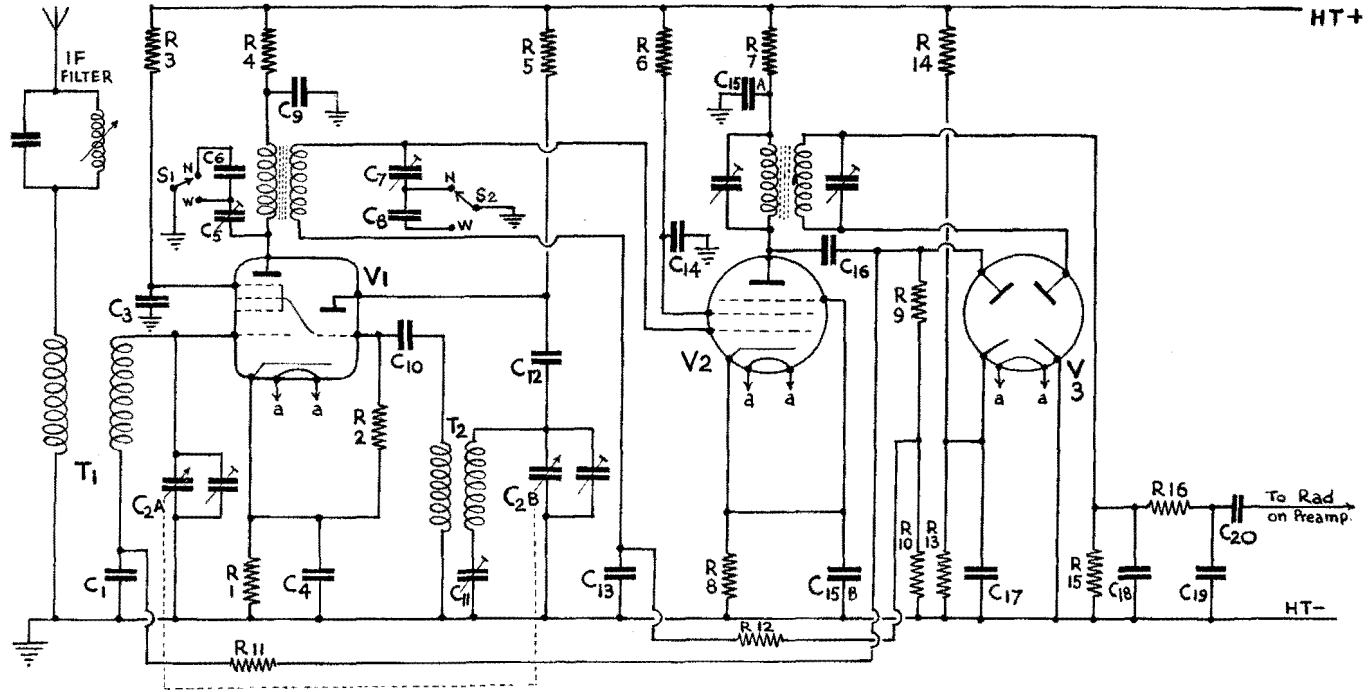

SUPERHET PARTS

C1 0.1 μ F paper	R1 200 Ω
C2A & C2B 0.0005 μ F 2-gang	R2 50K
C3 0.1 μ F paper	R3 50K
C4 0.1 μ F paper	R4 5K
C5 & C7 IF trimmer, say 200 pF	R5 50K
C6 & C8 3,300 pF	R6 90K
C9 0.1 μ F paper	R7 5K
C10 50 pF mica	R8 300 Ω
C11 450 pF padder	R9 & R10 470K
C12 50 pF mica	R11 0.5M
C13 0.05 μ F paper	R12 1M
C14, C15A & C15B 0.1 μ F paper	R13 5K (variable)
C16 50 pF mica	R14 100K
C17 0.1 μ F paper	R15 270K
C18 100 pF mica	R16 47K
C19 100 pF mica	
C20 0.25 μ F paper	

T1 Wearite PA2

T2 „ PO2

V1 ECH35

V2 EF39

V3 6H6

Chassis 11 ins. \times 8 ins. \times 3 ins.
or slightly smaller.

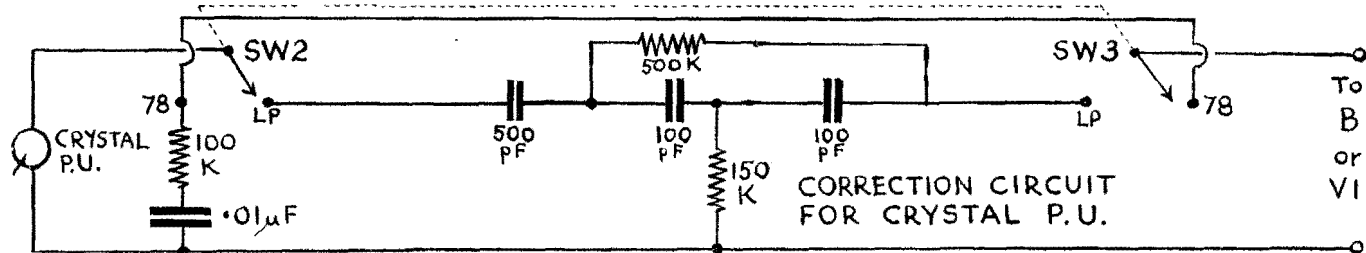
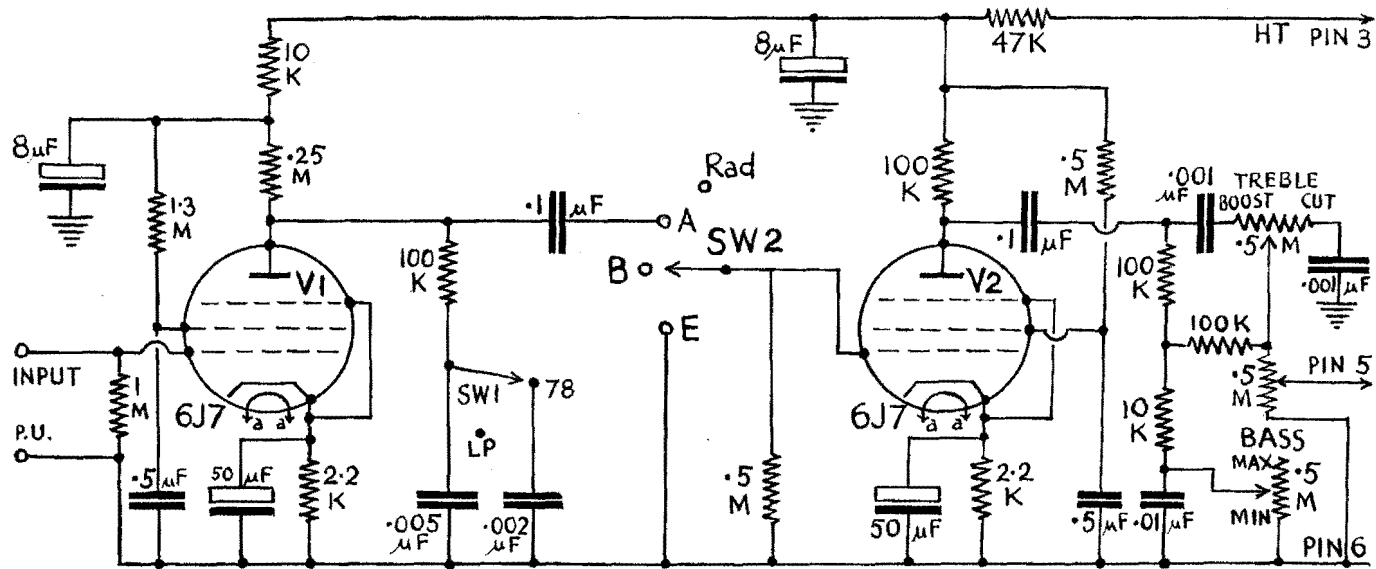

PRE-AMPLIFIER

Component values are given in circuit diagram.

The two electrolytic condensers, $50 \mu F$, should be 12V working.

SW₂ is a 3-position switch. The tuner would be connected to terminals Rad. and E.

A crystal pick-up with its associated correction circuits (as shown) would be connected to B and E if there is adequate gain ; otherwise to input of V_1 with the following 78/LP correction cut out.

A magnetic pick-up—with or without transformer—must be fitted with its appropriate resistive load before it is connected to input of V_1 .

A moving coil pick-up with transformer may be connected to input of V_1 without further ado.

VALVES—GENERAL NOTE

It should be pointed out that it has not been considered necessary to outline all the possible alternative makes of valve throughout this book, as it is not intended to serve as a valve guide. No brief is held for any particular make, and readers should not hesitate to use equivalents to those mentioned, provided the specification is the same in essentials.

OSCILLOGRAMS

It will no doubt have been appreciated by readers that the original oscillograms reproduced in the book are untouched photographs. Although the interpretation of the various phenomena may in some cases be at fault, the accuracy and authenticity of the records as shown are beyond question. In this respect the camera is more convincing than a free-hand drawing.

MAIN AMPLIFIER

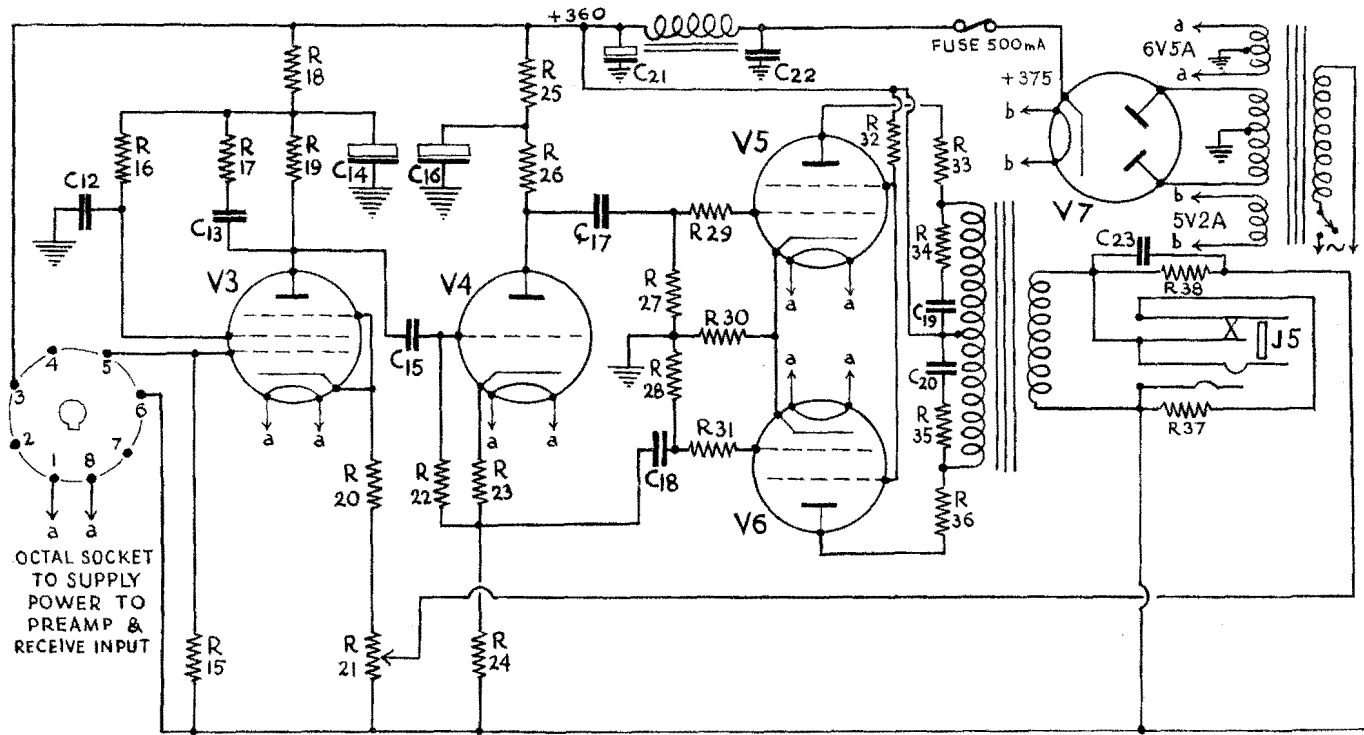

OCTAL SOCKET
TO SUPPLY
POWER TO
PREAMP &
RECEIVE INPUT

MAIN AMPLIFIER PARTS

R15 2M
R16 0.91M
R17 20K
R18 47K
R19 220K
R20 1K
R21 250 ohms Potr.
R22 0.91M
R23 2K
*R24 47K
R25 20K
*R26 47K
R27 0.33M
R28 0.33M
R29 15K
R30 250 ohms 3W
R31 15K
R32 1K
R33 47 ohms
R34 20K
R35 20K
R36 47 ohms
R37 15 ohms 15W
R38 1,250 ohms

*Close match essential.

All resistors are $\frac{1}{2}$ watt unless otherwise stated, and close tolerance is not required except for R24 and R26.

N.B.—R37 (dummy load) and Jack (J5) may be omitted according to discretion of user.

C12 0.25 mfd 350V
C13 200 pf mica
C14 4 mfd 350VW electrolytic
C15 0.25 mfd 350V
C16 4 mfd 350VW electrolytic
C17 .25 mfd 350V
C18 .25 mfd 350V
C19 400 pf mica
C20 400 pf mica
C21 8 mfd 500VW electrolytic
C22 4 mfd 500VDC paper
C23 .002 mfd

VALVES

V3 SP61 Mazda (Alternatives : EF37A, 6J7) See page 184 for circuit values if EF37A or 6J7 is used.
V4 6J5
V5 & V6 6L6
V7 GZ32 (must be indirectly heated type)

Note: The SP61 requires a Mazda Octal base. All other valves are International Octal.

MAINS TRANSFORMER

350-0-350 150 mA, 6V 5A and 5V 2A

CHOKE

10H at 150 mA

OUTPUT TRANSFORMER

Wharfedale W15

