

PRICE 25 CENTS

HOW TO MAKE A WIRELESS SET



POPULAR MECHANICS HANDBOOKS

A
0
0
0
0
3
6
4
3
1
5



DC SOUTHERN REGIONAL LIBRARY FACILITY

Unive
Sou
Li!

HOW TO MAKE A
WIRELESS SET

BY

ARTHUR MOORE

POPULAR MECHANICS HANDBOOKS

CHICAGO
POPULAR MECHANICS CO

Copyright, 1911,
by H. H. WINDSOR

THIS book is one of the series of handbooks on industrial subjects being published by the Popular Mechanics Company. Like the Magazine, these books are "written so you can understand it," and are intended to furnish information on mechanical subjects at a price within the reach of all.

The text and illustrations have been prepared expressly for this Handbook Series, by experts; are up-to-date, and have been revised by the editor of Popular Mechanics.

CONTENTS

	PAGE
Chapter I—The Necessary Parts.....	9
Chapter II—The Spark Coil.....	15
Chapter III—The Condenser.....	22
Chapter IV—The Spark Gap and Vibrator.....	29
Chapter V—Construction of Telegraph Key and Aerial Wires	37
Chapter VI—Construction of a Coherer and a Decoherer	43
Chapter VII—Construction of a Potentiometer ...	51
Chapter VIII—Secondary Windings.....	59
Chapter IX—Another Secondary Winding.....	67
Chapter X—Connections for Sets.....	77

HOW TO MAKE A WIRELESS SET

CHAPTER I

THE NECESSARY PARTS

THERE is no field of electrical experimentation that has received more attention from the amateur in the last few years than that of wireless telegraphy. A great many persons have the impression that one must be an electrical engineer in order to construct and operate successfully a wireless telegraph set. Such an impression is not well grounded. The following description of a small wireless set will not only be useful to those who wish to experiment along this particular line, but it will be a great aid in making clear the elementary principles upon which wireless telegraphy is based. A set suitable for transmitting for distances of four or five miles in the open country can be easily constructed by a boy of ordinary ability at a small cost. The information gained by constructing a small set would be a great help to those who intend building larger outfits later.

Before explaining the construction of the various parts in detail, it might be well to give a general description of them and explain their functions and operation. You will need the following parts to complete the equipment for a single station that can both send and receive a message: A spark coil that is capable of producing a spark from 1 to 1½ in. long, telegraph

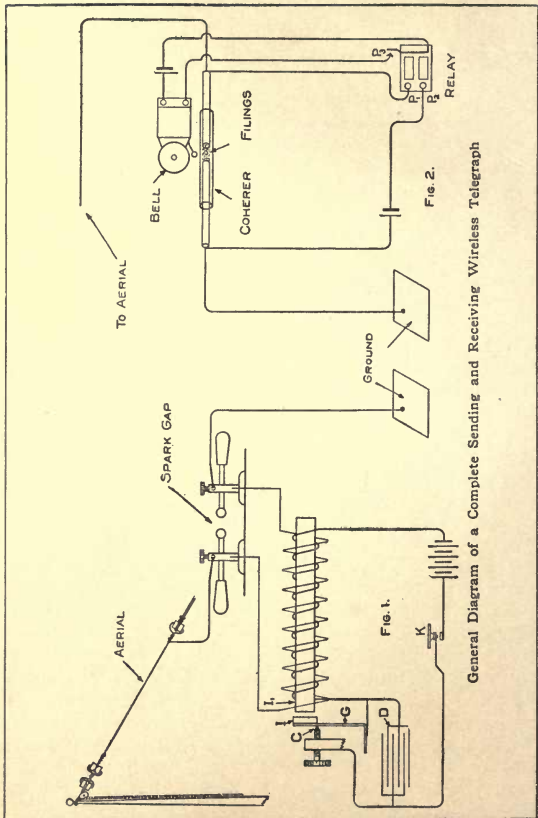

General Diagram of a Complete Sending and Receiving Wireless Telegraph

key, 150 or 200-ohm relay, common vibrating electric bell, aerial conductors, coherer and spark gap.

The spark coil is used to produce a very high voltage current from a source of electrical energy of low voltage, such as dry cells, and consists of two windings about an iron core.

The source of electrical energy is connected in series with one of these windings, which is called the "primary." The terminals of the other winding are connected to the spark gap, as shown in Fig. 1. This second winding is called the "secondary." There will be produced in the secondary winding an electromotive force when there is a change of current in the primary. If the primary circuit is then made and broken by placing the telegraph key in circuit with it, there will be an electromotive force set up in the secondary for each make and break in the primary due to the operation of the key. The value of the induced electromotive force in the secondary will depend upon the ratio of primary and secondary turns and the rapidity of the "making and breaking" of the primary circuit which can be greatly increased by placing in the circuit a current "breaker," or interrupter, as it is more usually termed. The construction of the interrupter is indicated in Fig. 1. When the key K is closed, the iron core I_1 becomes magnetized, due to the current in the primary, and as a result attracts the iron armature I, which is normally held away from the core by the spring G. The movement of the armature I toward the core I_1 , results in the contact at C being broken and the current in the primary winding dropping to zero. The iron core loses its magnetism and the armature again returns to its normal position, completing the circuit at C and again going through the same operation. With this interrupter in

circuit, as shown in Fig. 1, there will be a number of makes and breaks in the primary when the key is closed only for a short time and hence a much greater electromotive force set up in the secondary.

There is quite an arc formed at the contact C when the circuit is broken, due to the inductance of the primary winding. The condenser D is connected directly across the gap and reduces to a great extent the tendency for the arc to form, and as a result, the decay of the primary current is a great deal more rapid, hence a greater electromotive force is set up in the secondary, and it will be continuous as long as the key is closed.

One terminal of the spark gap is well grounded and the other terminal is connected to the aerial as indicated in Fig. 1. The aerial may be made from a piece of No. 14 gauge copper wire that has one end fastened to the top of a 60 or 70-ft. pole by means of two knob insulators. One of these knobs can be tied to a rope that runs in a small pulley on the top of the pole; one end of the aerial is fastened to the other insulator or knob, and the two knobs are then connected by a link of wire. The aerial should be run off at an angle to the pole to prevent them touching, and it should be well insulated where it is led into the building. If it is possible, the pole carrying the aerial should be placed on the top of a building. This will give much better results. A good ground connection can be made by soldering a No. 14 gauge wire to a metal plate and burying it at a depth of 5 or 6 ft. in moist earth. The sending end is now complete. The details in construction and adjustment will be taken up later.

The coherer is the most important part of the receiving set. Branly was the first to discover that a

quantity of iron filings when brought within the influence of a high-frequency discharge, such as that from an induction coil or Leyden jar, will cling together, or cohere as it is termed, thus lowering the resistance of the quantity of iron filings as a whole, and a current from a battery will more easily flow through them when they are in coherence than when they are not. These filings are usually placed in a glass tube between two metal terminals. One of these terminals is connected to the aerial and the other is grounded, when the station is used in receiving, as in Fig. 2.

A battery of low voltage and the relay are connected across the terminals of the coherer, as shown in Fig. 2. The adjustment of the coherer and the relay is such that there is not sufficient current through the relay to operate it when the filings are not cohered. When, however, the coherer is acted upon by a high-frequency discharge, the filings will cohere, thus reducing the resistance of the relay circuit and increasing the current through the relay, which will operate it, if the proper adjustment has been made.

This relay in Fig. 2 can be made to close a second local circuit consisting of a battery of a few dry cells and an ordinary vibrating bell, which serves to give an audible signal. The relay consists of two magnet coils connected in series and their outside terminals connected to the posts P_1 and P_2 , Fig. 2. There is a soft iron armature that is delicately balanced on two pivots near the ends of the cores of these two coils. These two iron cores become sufficiently magnetized, due to a very small current in the coils, to attract the armature, which is normally held away from them a very small distance by a weak coil spring. The armature closes the second circuit by coming in contact with the point P_3 .

When the iron filings are once cohered they will not return to their original condition if they are removed from the influence of the high-frequency discharge, and as a result the bell would continue to ring even though the coherer was not being acted upon by any discharge. To overcome this objectionable feature the filings must be decohered, which can be done by allowing the tapper of the electric bell to strike lightly against the glass tube of the coherer. The receiving station is now complete and the operation of such a set can be traced as follows: The telegraph key at the sending end is pressed, allowing a current to flow through the primary winding and start the vibrator in operation. At each make and break of the primary circuit due to the vibrator, there will be a high voltage induced in the secondary which is sufficient to break down the air gap between the terminals of the spark gap, and as a result, a high-frequency current will flow in the secondary circuit. This high-frequency current oscillates up and down the aerial and is supposed to set up a similar motion in the ether existing in the air and the ground. This wave motion is sent out in all directions and any receiving station that is within its influence receives a small portion of the total energy sent out. As a result a very high frequency current flows through the coherer, thus reducing its resistance and operating the relay and closing the local circuit which starts the bell in operation. The bell will continue to ring as long as the wave continues to come in, which is determined by the time the telegraph key at the sending end is closed, and as a result the dots and dashes of the code can be easily distinguished.

CHAPTER II

THE SPARK COIL

THE spark coil is the principal piece of apparatus used in the transmitter of a wireless telegraph set and its detailed construction is given herewith. The coil described here can be used for ordinary laboratory work, lighting Geissler tubes, etc., in addition to its use in the wireless set. All spark coils might be thought of as composed of the following parts: iron wire core, primary winding, secondary winding, vibrator, condenser and containing case. These various parts will be taken up in turn.

The core of a spark coil is one of the most important parts and it should be constructed of a large number of small soft iron wires. If a solid iron core is used, the reversal of magnetism in the core does not take place as rapidly as the current is interrupted by the vibrator. That is, the solid iron core would not take on and lose its magnetic effect as rapidly as the vibrator worked, which would result in a weak current in the secondary. A core composed of a number of small iron wires is said to be laminated.

To build the core, procure a sufficient quantity of No. 22 gauge soft iron wire to form a bundle 1 in. in diameter and 10 in. long. All of these pieces should be cut to the same length and straightened before they are placed in the bundle. One easy way to form this core is to wind on a stick 1 in. in diameter at least six turns of good quality paper, and glue the various turns as they are rolled on, forming a tube. Fill this

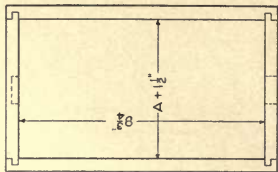
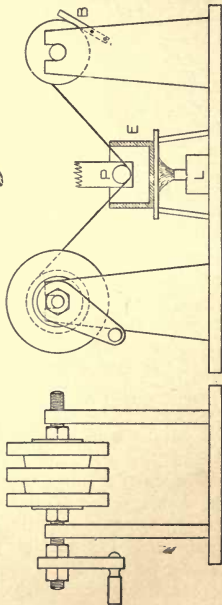
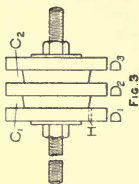
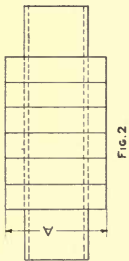
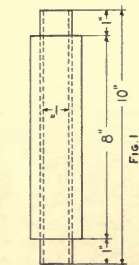

FIG. 4

FIG. 5

FIG. 6

Method of Winding Coils

tube with the pieces of iron wire, then roll it between two boards which will cause the wires to imbed themselves better, and you can add more pieces, making your core much more compact. Wrap this core with a good quality twine, such as is used by shoemakers, the various turns to be placed neatly together.

Outside of the twine, wrap 15 or 20 layers of very porous tissue paper and boil the whole core in a hot bath of beeswax and paraffin for at least one hour. This completes the core and you can now wind upon it the primary winding. The primary winding is to consist of three layers of No. 16 gauge double cotton-covered magnet wire wound on the core to within 1 in. of each end. It might be well to place two or three turns of good quality paper between the various layers. A terminal at least 10 in. long should be left at each end for making connections to the coil. It might be well for you to place a piece of small rubber tubing over the terminals where they are led from the winding. The completed core and winding, as shown in Fig. 1, should be thoroughly boiled in beeswax and paraffin before starting on the secondary winding.

The secondary winding is to be placed outside of this primary winding, but must be insulated from it by an insulating tube placed over the primary winding. You can construct such a tube by winding on a piece of wood, whose outside diameter is a little greater than the outside diameter of the primary winding, several layers of paper and afterwards boiling it in paraffin. This tube should be about 1 in. longer than the primary winding and the inside diameter should be a neat fit over it. The wall should be about $\frac{3}{16}$ in. in thickness. All the additional space between the primary winding and the tube should be filled with paraffin.

Too much care cannot be used in properly constructing and insulating the secondary winding. For very small coils, it is customary to wind all of the secondary wire in one section, while in larger coils, the secondary winding is composed of a number of sections, if it is desired to reduce the possibility of breakdowns. When all of the wire is wound in one section, the difference in electrical pressure between the various layers becomes enormous and the insulation must be greatly increased. If the secondary is made of a number of sections, as shown in Fig. 2, and they are so connected that their electromotive forces all act in the same direction, the same total electromotive force can be obtained from the coil, but the voltage between the various parts of the winding is not nearly so great as in the previous case.

The secondary of the coil described here is to consist of six double sections, and these six sections when placed side by side should take up a length of 6 in., that is, each section should be 1 in. in thickness. You will find the winding of these various sections of the secondary a very tedious job if attempted by hand, and time will be gained by constructing a simple form of winding machine.

The core of the form upon which these coils are to be wound should have a diameter a little greater than the outside diameter of the insulating tube. The cross section of such a form is shown in Fig. 3. The disks D_1 , D_2 and D_3 can be made of $\frac{1}{2}$ -in. wood, and should be about 4 in. outside diameter. The two cores C_1 and C_2 should have a length of about $\frac{1}{2}$ in., and the diameter of the two ends should differ by $\frac{1}{16}$ to $\frac{1}{8}$ in. This form can be fastened in a lathe and the wire wound on in a very short time, but usually the amateur has no lathe that can be used and must devise

some type of machine that will serve the same purpose. The form just described can be supported by two uprights as shown in Fig. 4 and it can be rotated by means of a small handle attached to one end of the shaft.

In winding the secondary, the wire should pass through a hot bath of beeswax and paraffin as it is being placed on the coil, instead of depending upon the boiling-out process, as in the case of the primary winding. This can be accomplished by the arrangement shown in Fig. 5. A small can, E, is supported above a gas or oil flame, L, and contains the beeswax and paraffin. The wire is made to pass through this mixture because it must pass over the small pulley P, which is below the surface of the mixture. The tension in the wire can be adjusted by placing a small brake, B, on the spool from which the wire is being unwound. There will be needed for each double section about $5\frac{1}{2}$ oz. of No. 34 gauge single silk-covered magnet wire. Make sure in winding that the operation is slow enough to allow the wire to become thoroughly saturated, but it must reach the coil before the wax has had time to cool. You can remove the coils from the form very easily if you line the form with sheets of paper before you start the winding. To wind one of the double sections, proceed as follows: Pass 3 or 4 in. of the wire through the opening H in disk D_1 , Fig. 3, and wind $2\frac{3}{4}$ oz. in the regular way upon the core C_1 , terminating the winding on the righthand side of the coil or next to the disk D_2 . When this first coil is complete remove the form from the shaft and turn the coil around and place it back on the shaft. The disk D_2 will now be on the left-hand side of the coil and the inside end of the coil winding will project through the disk D_1 on the right-

hand side. Carefully remove the disk D_1 and place four or five paper washers that have been saturated in paraffin against the side of the coil. Put the core C_2 in place with its small end to the left and the disk D_3 on the outside. Do not replace disk D_1 . Solder the end of the wire to the inside end of the first coil. Tape this point thoroughly and do not use a flux that will destroy the wire. Two and three-fourths ounces of wire should now be wound on the second core and the winding terminated at the right-hand side or near the disk D_3 . It no doubt would be best to boil this double section in hot paraffin before it is removed from the form. If this is done, do not allow it to get too cool before the disks and cores are removed, as the coil may be damaged in trying to separate them. These various sections may be placed in linseed oil and allowed to soak, which will add to their insulation properties.

When all of the sections are complete they should be placed on the outside of the insulating tube and connected in series in such a way that if a current is passed through them, it will flow around the core in the same direction in all of them. Seven or eight paper washers saturated with paraffin should be placed between each double section as they are placed on the insulating tube. This completes the most difficult part of the work and the next thing in order will be the construction of a suitable case for the coil.

The customary manner of constructing such a case is to make the base in such a form that it will contain the condenser, and the primary and secondary windings can be placed in a smaller case mounted upon this base. The binding-posts, which serve as terminals for the primary, and the vibrator are also mounted upon the top of the base.

Cut from some well-seasoned cherry or other close-

grained wood two square pieces whose edge is 2 in. greater than the outside diameter of the completed secondary. Bore a 1-in. hole through the center of one of these pieces and a 1-in. hole half way through the center of the other. Figure 6 gives the dimensions of the sides and the means of fastening the ends and sides together. The bottom can be made of $\frac{3}{8}$ -in. material held in a groove $\frac{3}{8}$ in. wide and $\frac{1}{4}$ in. deep, cut around the inside of the frame just formed $\frac{1}{4}$ in. from the edge. This bottom must be put in place before the frame is fastened together. The coil will also have to be put in place before the frame is fastened together. The top can be made from $\frac{1}{2}$ -in. material and screwed to the top of the frame with round-headed brass screws. The corners can be rounded off and the box given a nice finish.

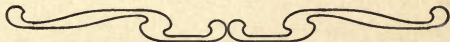

CHAPTER III

THE CONDENSER

AFTER your coil proper is completed, you can proceed with the construction of some of the other parts while you are waiting for the various coats of varnish to dry on the containing case. It would be well to construct the condenser next, as it will require some time to dry thoroughly, and your coil will be ready to assemble when the remaining parts are complete. The purpose of the condenser is to reduce the spark at the contact in the interrupter, which increases the life of the contact and at the same time causes a more rapid change of current in the primary, thus increasing the voltage induced in the secondary. A condenser consists of two electrical conductors separated by an insulating material called the dielectric. The capacity of a condenser depends upon the area of the conductors, their distance apart, and the kind of material or dielectric separating the plates. You will need at least 2,400 sq. in. of exposed plate in a condenser suitable for the coil you are constructing. Now, instead of attempting to build the condenser by using only two sheets, you can reduce its size by increasing the number of plates and arranging them as shown in Fig. 1. In determining the size to use in the condenser you should bear in mind the fact that it would be desirable to mount the condenser in the sub-base of your coil. The upper containing case was $10\frac{1}{4}$ in. long and approximately 6 in. wide, outside dimensions. This case should be mounted upon a second case about 11

in. wide, and 17 in. long. If it is made of $\frac{3}{4}$ -in. material, it will have inside dimensions of $9\frac{1}{2}$ by $15\frac{1}{2}$ in. You will want to allow at least $\frac{1}{2}$ -in. clearance at both sides and one end, and about 3 in. at the other end, where connections can be made to the condenser. This will give you the dimensions of your insulating sheets $8\frac{1}{2}$ in. wide and 12 in. long. The tinfoil that you will use as the conductors should be cut into sheets 6 by 8 in. Each of these sheets will have an area of 48 sq. in., and since there is a total of 2,400 sq. in. required you will need 50 sheets. Twenty-five of these sheets will be connected to one terminal and the remaining 25 to the other. You may think that there will be 50 positive and 50 negative plates required, but each plate will have both surfaces exposed, as shown in Fig. 1, and only half as much tinfoil will be required in a condenser of this type as in one consisting of only two large sheets.

Procure a small quantity of the very best grade of thin bond paper and cut about 60 sheets $8\frac{1}{2}$ in. wide, and 13 in. long. These sheets of paper should be boiled in paraffin for about one hour and hung up to drain. The paraffin should be real hot when the sheets are removed so that it will drain off easily, resulting in a uniform thickness throughout. When they have cooled, cut $\frac{1}{2}$ in. from each end, making the sheets $8\frac{1}{2}$ in. wide by 12 in. long. Now cut from some tinfoil 50 pieces 1 in. wide and 4 in. long, that are to be used in making connections to the various sheets or plates of the condenser.

It is impossible to predetermine the exact capacity that will give the best results, and for this reason it would be best to divide your condenser into a number of parts, so that the capacity can be varied. Such an arrangement is shown in Fig. 2, which amounts to

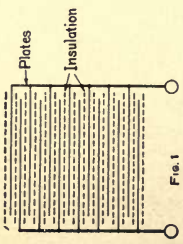

Fig. 1

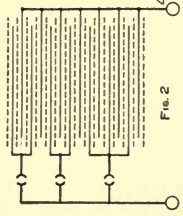

Fig. 2

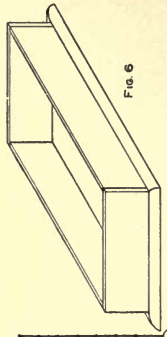

Fig. 6

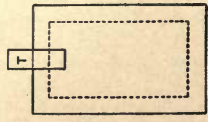

Fig. 3

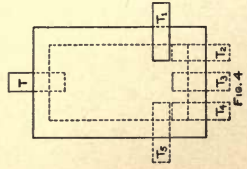

Fig. 4

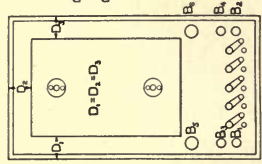

Fig. 7

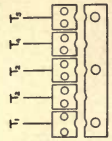

Fig. 8

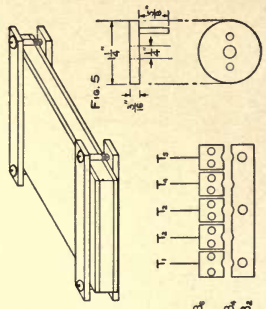

Fig. 5

Fig. 9

Details of a Condenser

connecting a number of condensers in parallel. To construct your condenser so that it will correspond to the above arrangement, you should divide the connections to one set of plates into, say, five groups, and these various groups can be connected to switches on the top of the lower base of your coil. The construction and connections of these switches will be taken up in another chapter.

To build up your condenser, you should proceed as follows: Lay a sheet of the paraffin paper on a smooth board and place a sheet of the tinfoil in the center of this piece of paper. Take one of the small tinfoil connecting strips and put it in place, as shown in Fig. 3. Now place a second sheet of paper in place and run a squeegee print roller over it, applying quite a little pressure, thus removing any air that might exist between the foil and paper. Place a second sheet of tinfoil in place and make the connection to it, as shown by full line in Fig. 4. Continue in this way until you have a total of 10 sheets in place, the odd numbered sheets being connected together at the point T and the even numbered sheets connected together at the point T₁, Fig. 4. The odd numbers of all the remaining sheets should be connected to the common terminal T, and the even numbers should be grouped, five sheets to the group, and connected to the terminals T₂, T₃, T₄ and T₅. The terminals should be arranged as shown in Fig. 4, so that there is no likelihood of them coming in contact with each other. After all the plates are in place, lay three or four sheets of paper on the outside of the condenser and clamp it between two boards, as shown in Fig. 5. The terminals formed of the tinfoil connecting strips are very weak and can be easily broken off when handling, so that they should be strengthened by folding some

pieces of very thin brass over them, the end of the brass strips being slipped between the plates when the condenser is under construction.

You should now heat the condenser until the paraffin softens, at the same time increasing the tension in the screws, and then allow it to cool. It might be well to boil the condenser in paraffin, as that will remove any air that may have collected between the plates.

You are now ready to construct the containing case for the condenser. This case should be about 1 in. deeper, inside dimension, than the depth of the condenser. The ends and sides of this box can be fastened together in the same way you made the coil case, and should be made of $\frac{3}{4}$ -in. material. The bottom should be of such a size that it will project $\frac{3}{4}$ to 1 in. beyond the sides and ends of the case. Round off the corners as shown in Fig. 6 and fasten it to the frame with screws from the under side. The top of this case should be made of $\frac{5}{8}$ -in. material with the edges rounded and fastened to the frame with brass screws. Fasten this piece to the base of the upper case with screws, countersinking their heads. The position of the upper case on its base is shown in Fig. 7. After the holes have all been drilled for mounting the upper case, the lower case should be nicely finished to match the upper one.

Mount the condenser in the end of the lower case, Fig. 7. Small blocks of wood can be fastened to the side of the case and the clamps on the condenser fastened to them, thus holding it rigidly in place. The end of the condenser with all the terminals on should be toward the open end of the box. Mount upon the end of the top of the lower case five small switches, as shown in Fig. 7. One point on all of these switches should be connected to one line, which is to form one

terminal of the condenser. The other points of the switches should be connected to the terminals T_1 , T_2 , T_3 , T_4 and T_5 of the condenser. Mount two back-connected binding-posts B_1 and B_2 , Fig. 7, and connect the terminal T of the condenser to one of them and the common connection of the switches to the other. You can now vary the capacity between B_1 and B_2 by manipulating the switches. By placing these binding-posts on the base and connecting your condenser to them you can use the condenser for other purposes than across the contacts of the vibrator. Two other binding-posts, B_3 and B_4 , should be mounted beside B_1 and B_2 and they should be connected to the two sides of the vibrator contact. Connecting B_1 and B_3 together, and B_2 and B_4 together with a piece of wire, you will have the condenser across the contact. Mount two more binding-posts, B_5 and B_6 , a little larger than the others, as shown in Fig. 7. These are to form the terminals of the primary winding.

A single switching device for the condenser is shown in Fig. 8. The various pieces of brass can be cut from some $\frac{1}{8}$ -in. sheet brass and fastened to the board with round-headed screws. After they are all in place, a tapered reamer can be used in cutting the openings between them. The connections can now be made by inserting small tapered plugs in these openings.

You can get a better variation in your capacity by using the following combination instead of the one given in the first part of the article: First section, 14 sheets; second section, 12 sheets; third section, 10 sheets; fourth section, 8 sheets and the fifth section, 6 sheets. This gives the same total capacity as in the previous case, from the same total number of plates.

Cut from some $\frac{1}{8}$ or $\frac{3}{16}$ -in. brass, two pieces whose dimensions correspond to those of Fig. 9, that are to form part of the terminals of the secondary winding. These two pieces should have $\frac{1}{4}$ -in. holes drilled in their centers and tapped. Countersink them in two openings cut in the top of the upper case about 8 in. apart and fasten them in place with two flat-headed brass screws. A piece of $\frac{1}{8}$ -in. brass about $\frac{3}{4}$ in. long should be soldered to the under side as shown in Fig. 9. These pieces will project through the under side of the case top and the terminals of the secondary winding can be soldered to them, leaving quite a little slack in the leads. It might be best to make the leads from the coil to these plates of wire insulated to stand a high voltage.

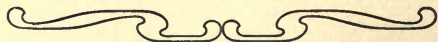

CHAPTER IV

THE SPARK GAP AND VIBRATOR

IN order to use your spark coil for experimental and wireless work, you will need some form of a spark gap. A very simple one, that can be mounted in the plates attached to the top of the containing case of the coil, can be made as follows:

Procure two pieces of $\frac{5}{16}$ -in. brass rod, each about 5 in. long, and thread both ends to a distance of about $\frac{1}{4}$ or $\frac{5}{16}$ in. Now turn, from some hard wood, two pieces similar to the one whose cross-section is shown in Fig. 1. These pieces should have a $\frac{5}{16}$ -in. hole drilled through them and the brass rods forced into the holes, the rods being held in place by a small brass pin, P, placed in a hole drilled through the brass and wood as shown in Fig. 1. Obtain two brass balls about 1 in. in diameter. Drill a $\frac{3}{16}$ -in. hole through each of them. At a right angle to this hole drill a second hole half way through $\frac{1}{4}$ in. in diameter, and the remainder of the way $\frac{1}{8}$ in. in diameter. Tap the larger end of this hole so the balls can be screwed on the ends of the brass rods. The smaller end should also be threaded or a small piece of brass rod with threaded end soldered into it, that can be used in mounting a binding-post as shown in Fig. 2. Obtain two pieces of $\frac{3}{16}$ -in. brass rod, each about 7 in. long. Turn from some hard wood two handles as shown in Fig. 3. Drill a $\frac{3}{16}$ -in. hole in the small end of these handles to a depth of at least 1 in. and force the brass rods in place. The other end of the brass rods should be threaded for a

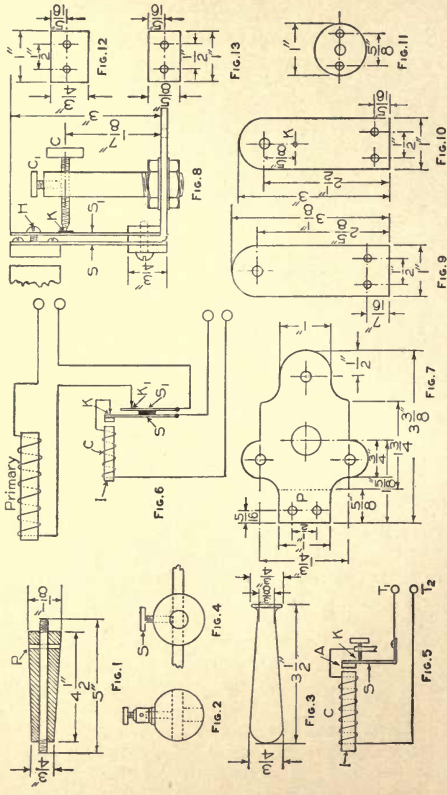

Spark Gap and Vibrator Details

short distance. These rods can be passed through the openings in the balls and held in place by means of a setscrew, S, as shown in Fig. 4. The spark gap proper can be adjusted by moving one or both of these rods. Small brass balls or pieces of zinc can be screwed on the threaded ends of the rods to form the terminals of the gap.

The spark coil is now complete with the exception of an interrupter for the primary circuit. It is impossible to use the ordinary alternating current in the primary as its frequency is too low to produce the required number of reversals in the secondary. There are three different types of interrupters that are used in wireless telegraph circuits. These are the electrolytic, the mercury and the vibrating spring types.

The electrolytic interrupter consists of a vessel containing a solution of dilute sulphuric acid with two terminals immersed in this solution. The positive terminal or anode is made of platinum and should have a surface of about $\frac{3}{16}$ in. The negative terminal or cathode is made of lead and should have an area of something like 1 sq. ft. When this interrupter is connected in series with the primary of an induction coil and a source of electromotive force of about 40 volts, the circuit will be interrupted, due to the formation and collapse of bubbles on the platinum electrode.

The mercury interrupter, which is no doubt the one most commonly used in commercial wireless stations, is capable of making interruptions as high as 10,000 per second. This interrupter consists of an iron vessel with a vertical steel shaft mounted in it, and arranged to be driven at a very high speed by a small motor. Attached to this spindle is a small worm or centrifugal pump. Above this pump, there is mounted on the shaft a small nozzle which is connected to the

outlet from the pump. When the spindle is rotated, the mercury is raised to the nozzle and thrown outward against the side of the vessel.

There is mounted in the side of the vessel a small insulated piece of metal which forms one terminal of the circuit that is to be interrupted, while the iron vessel forms the other terminal. By varying the length of the insulated segment and the speed of the shaft, the number of interruptions can be adjusted to the desired value.

The vibrating spring type of interrupter is no doubt familiar to almost every one, it being practically the same as the ordinary vibrating bell. Its operation is very satisfactory when properly constructed and adjusted.

The construction of the mercury interrupter is rather difficult, and the electrolytic interrupter requires 40 volts or more to operate it, so that you had better construct the vibrating spring type.

The principle of the spring interrupter is shown in Fig. 5. When a current is passed through the circuit by connecting a battery or some other source of electromotive force to the terminals T_1 and T_2 , the iron core I of the coil C becomes magnetized and attracts the soft iron armature A, which is mounted on the spring S. When this armature A is drawn toward the iron core I, the contact K is broken and the core of the coil C becomes demagnetized, due to the fact that no current is flowing in the circuit, thus allowing the armature A to return to its initial position and again complete the contact K, and the same operation is again gone through. The winding C may be the primary winding of the spark coil or it may be an entirely different winding, as shown in Fig. 6, the make-and-break contact for the primary circuit being an

additional one mounted on the spring S, as shown at K_1 . This second type of construction has the advantage that it can be used with any coil, while the other type is mounted rigidly to one particular coil.

The following description is that of a vibrator as shown in Fig. 5, with a little change, and will serve your purpose. All the care that you may exercise in the construction of your coil will give results far below those anticipated, if the vibrator is of poor design. The simple vibrator shown in Fig. 6 should have the following modification to make its operation the best. The make-and-break contact is not mounted upon the main spring S, but upon a second spring, S_1 , whose movement is controlled by S through the screw H, Fig. 8. This screw H passes through a hole in S_1 , a little larger in diameter than the screw itself, and screws into S. With this arrangement, the division of the time between the make and break of the circuit is better made.

First procure some $\frac{1}{8}$ -in. brass and cut a piece to correspond to the dimensions given in Fig. 7. Drill the holes in this piece as indicated. Bend the part P at the dotted line until it is at right angles to the remainder of the piece.

Procure a piece of spring brass, $3\frac{1}{8}$ in. long, 1 in. wide and $\frac{3}{32}$ in. thick, that is to form the spring S, Fig. 8. Round off the upper end of this piece and drill the holes as indicated in Fig. 9. The spring S_1 should be made from some spring brass $\frac{1}{64}$ in. thick and its other dimensions should correspond to those given in Fig. 10. Drill the holes indicated in the figure and fasten a small piece of platinum in place at the point K.

Cut from a round bar of soft iron, 1 in. in diameter, a piece $\frac{1}{4}$ in. long and drill three holes in it as shown

in Fig. 11. These holes should be threaded to take machine screws. This piece can now be mounted on the upper end of the spring S with two small screws.

Cut two pieces from some $\frac{1}{8}$ -in. brass whose dimensions correspond to those given in Fig. 12 and Fig. 13. Tap the two holes in the piece shown in Fig. 12. These two pieces are to be used in mounting the springs S and S_1 upon the base of the vibrator as shown in Fig. 8.

The support for the screw C, Fig. 8, can be made from some $\frac{1}{2}$ -in. brass rod. Take a piece $2\frac{3}{4}$ in. long and thread one end for a distance of $\frac{3}{4}$ in. Drill a hole $\frac{1}{4}$ in. from the other end and thread it to take the screw C, which should be about $\frac{3}{16}$ in. in diameter. Drill a second hole in the end of the rod and thread it to take the screw C_1 , Fig. 8, that is to hold C in place after it is once adjusted. Another hole should be drilled in the threaded end of the rod and a piece of No. 14 gauge copper wire, about 12 in. long, soldered into it to be used in making connections to the vibrator. Make two nuts, $\frac{3}{16}$ in. thick, to fit the thread cut on the rod; one rubber bushing to fit the large hole in the base of the vibrator, with an opening in it $\frac{1}{2}$ in. in diameter; and two washers of insulation material, 1 in. in diameter and $\frac{1}{16}$ in. thick, with openings in them $\frac{1}{2}$ in. in diameter. The support for C can then be fastened to the base as shown in Fig. 8. The vibrator is now complete and can be mounted on the case of the coil. A small wooden block of sufficient thickness to place the armature A on the same level as the end of the core of the coil should be provided. Place the end of a piece of No. 14 gauge copper wire under one of the screws used in mounting the base, and pass it through a hole in the top of the lower case, and solder the other end to the binding-post B_3 . (See Fig. 7,

Chapter III.) The wire that was soldered to the support for C should also be soldered to the binding-post^t B₄. The primary winding is connected to the binding-posts B₅ and B₃. The condenser can be connected across the contact of the vibrator by short pieces of wire as previously described. Connect binding-posts B₄ and B₆ with a piece of copper wire.

Assuming that all connections have been made as directed and that the construction of the various parts is complete, you can make the final adjustment as follows: Connect 12 dry cells in series to the posts B₅ and B₆. Adjust the spark gap to about $\frac{1}{2}$ in. and the condenser to maximum capacity. Turn the screw C up until it completes the circuit and the vibrator is started. You should now vary the tension in the screw H, the position of the screw C and the capacity of the condenser until you obtain the maximum spark. This adjustment is a matter of trial, becoming easier as you operate your coil.

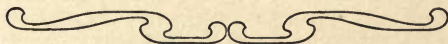

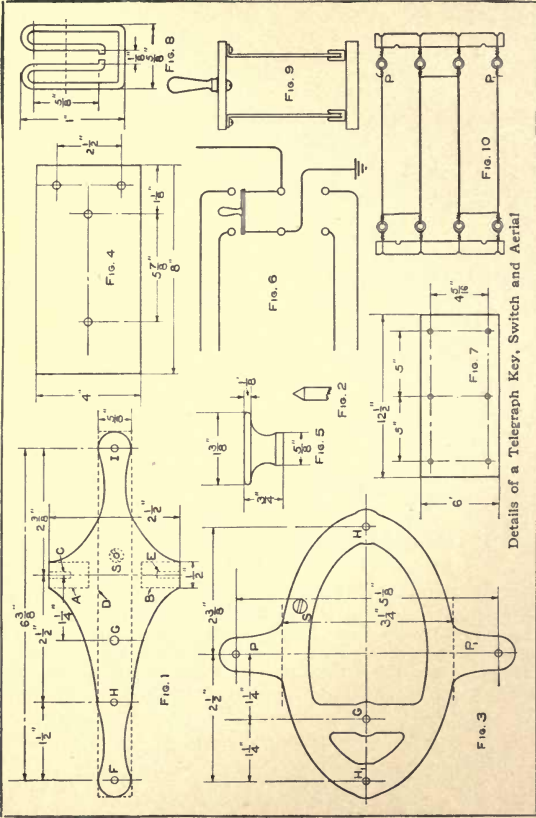

Details of a Telegraph Key, Switch and Aerial

CHAPTER V

CONSTRUCTION OF TELEGRAPH KEY AND AERIAL WIRES

IT is necessary that you have some means of making and breaking the primary circuit of your spark coil, so that there will be impulses sent out from the secondary winding corresponding to the intervals the primary circuit is closed. An ordinary telegraph key will serve the purpose very nicely when the primary current is not very large, and its mechanical operation will be the same as when it is being used on a telegraph line. The following simple construction may, however, be of interest to those who are constructing all of the various parts in preference to purchasing them, and want a key that will carry more current and have a larger and better contact than the ordinary telegraph key.

Cut from a piece of $\frac{1}{8}$ -in. sheet brass, a piece whose dimensions correspond to those given in Fig. 1. Cut a second piece, from some $\frac{1}{8}$ -in. stock, $\frac{5}{8}$ in. wide and 7 in. long, and solder it to the first piece, as shown by the dotted line D in Fig. 1. File off the edges and ends of this piece, after it is soldered in place, to conform to the outline of the main piece. Solder two other pieces, $\frac{1}{2}$ in. wide and $\frac{3}{4}$ in. long, to the first piece as shown by the dotted lines A and B, Fig. 1, and insert two pieces of $\frac{1}{8}$ -in. steel rod, of such a length that the ends project about $\frac{1}{4}$ in. These projecting ends should be pointed, as shown in Fig. 2. Drill a $\frac{1}{8}$ -in. hole at F. The holes at H, G and I should be threaded for $\frac{3}{16}$ -in. screws.

Cut another piece from some $\frac{1}{8}$ -in. sheet brass as shown in Fig. 3. The projecting arms P and P₁ should be bent up at right angles to the rest of the piece, at the points indicated by the dotted lines. Before bending these pieces, two holes should be drilled in them, as indicated in the figure, and threaded to take $\frac{3}{16}$ -in. screws. Place a $\frac{3}{16}$ -in. brass thumbscrew, with a lock nut on it, in the hole G, Fig. 1. The end of this screw should be turned down to $\frac{1}{8}$ in. in diameter for a distance of $\frac{1}{4}$ in., and a $\frac{3}{8}$ -in. washer of $\frac{1}{16}$ -in. brass made to slip on the end. Secure two $\frac{3}{16}$ -in. brass bolts, about $1\frac{1}{2}$ in. long, that are threaded their entire length and each having three or four washers and four nuts. Place one of these bolts through the hole H, Fig. 3, and fasten it in place with a nut on the under side. The other bolt should be fastened in the hole H₁, but insulated from the piece of brass. The hole H₁ should be drilled $\frac{5}{16}$ in. in diameter and a small bushing with a $\frac{1}{16}$ -in. wall placed inside of it. The opening in the bushing should be $\frac{3}{16}$ in. Place a metal washer on the bolt first, then an insulating washer and slip it through the hole and then place on a second insulating washer and metal washer and lastly the nut which will hold them all in place. This bolt should, however, have its head filed off flat and a small hole drilled in the center, into which a short piece of platinum wire is forced, and the projecting end hammered down, thus giving a platinum surface considerably larger than the area of the wire. Obtain two thumbscrews, about 1 in. long, that will fit the threaded holes in the arms P and P₁. Drill a $\frac{3}{32}$ -in. hole in the end of each of these screws and provide each with a small nut that will aid in holding them in place when their final adjustment has been made.

The piece shown in Fig. 3 can now be mounted on

a wooden base. This base can be made from a piece of close-grained wood, about 1 in. thick, and its dimensions should correspond to those given in Fig. 4. The holes in this base should be countersunk on each side with a $\frac{5}{8}$ -in. bit to a depth of $\frac{1}{4}$ in. so that the nuts on the screws used in mounting will be entirely below the surface. Mount two back-connected binding-posts in the corners of the base and connect them to the two screws with wires placed in grooves, cut in the under side of the base.

A small handle should now be turned from a piece of hard rubber or very hard wood as shown in Fig. 5. This handle can be mounted on the piece shown in Fig. 1 with a $\frac{1}{8}$ -in. brass screw passed through the hole F from the under side. Obtain two thumbscrews about 1 in. in length that will fit the holes H and I, Fig. 1. Each of these screws should be provided with a lock nut. Drill a small hole in the end of the one you intend to put in the hole H and rivet a piece of platinum wire in place. A screw, S, should be provided on both the pieces shown in Figs. 1 and 3, to be used for electrical connections.

Make a small coil spring by winding a piece of No. 20 gauge steel wire around a $\frac{3}{16}$ -in. rod. The distance between turns should approximately equal the diameter of the wire, and the total length of the spring should be $\frac{5}{8}$ in. Place the end of a piece of lamp cord about 4 in. long under the screw S, Fig. 1. Now mount the piece shown in Fig. 1 upon the piece shown in Fig. 3, making sure the coil spring is in place before the screws in the supports P and P₁ are given final adjustment. The other end of the piece of lamp cord can now be fastened under the screw S, Fig. 3. The screws in the holes H and I can now be adjusted, giving any desired movement of the handle before the

contact is closed. The screw G can be adjusted to give any pressure of the spring desired.

It might be well at this point to give the construction of a special switch to be used in connecting the transmitting and receiving equipment to the aerial and ground. Figure 6 shows the scheme of connections, the switch being in the upper position when you are transmitting and in the lower position when you are receiving. The base of this switch should be made of slate or marble with its dimensions to correspond approximately to those given in Fig. 7. Cut from some $\frac{1}{16}$ -in. sheet brass, six pieces $\frac{5}{8}$ in. wide and $4\frac{1}{4}$ in. long. Drill a $\frac{1}{8}$ -in. hole in the center of each of these pieces and bend them into the form shown in Fig. 8. Drill a $\frac{1}{8}$ -in. hole through two of these pieces, after they are bent, with the dotted line shown in Fig. 8 as a center. Mount them all on the base with $\frac{1}{8}$ -in. brass bolts about $1\frac{3}{4}$ in. long. Each bolt should be provided with two additional washers and nuts to be used in making connections to the switch. Cut from some $\frac{1}{8}$ -in. sheet brass, two pieces $\frac{5}{8}$ in. wide and 7 in. long. Drill a $\frac{1}{8}$ -in. hole in each end of these pieces, $\frac{5}{16}$ -in. from the end. Round off one end of each of the pieces to a $\frac{5}{16}$ -in. radius, with the hole as a center. Bend the other end over $\frac{5}{8}$ in. from the end, forming a right angle. Cut from some hard rubber, a piece 6 in. long, 1 in. wide and $\frac{1}{2}$ in. thick. Drill a $\frac{1}{4}$ -in. hole in the center of this piece and a $\frac{1}{8}$ -in. hole $\frac{1}{2}$ in. from each end. These various parts can now be assembled as shown in Fig. 9. A small wooden handle can be attached to the rubber cross bar by means of a $\frac{1}{4}$ -in. screw, as shown in Fig. 9.

Your sending equipment is now complete, with the exception of the aerial. There are numerous forms of aerials and each is supposed to have cer-

tain advantages and disadvantages peculiar to itself. It is impossible to give the construction of all the different types, as it would lead to considerable confusion and you would be at a loss to know just which type to use. The type described below is known as the double-ended "T" type and it is shown diagrammatically in Fig. 10. First of all, you must select the location for your aerial, bearing in mind that it should be well up in the air and, if possible, not obstructed by adjoining buildings. You can no doubt place the aerial at the greatest height with the least trouble by supporting it on masts placed on the roof of the highest building near your station. The kind of mast to use will depend upon the requirements. In your case a 12 or 15-ft. mast will no doubt be ample, and a 2-in. iron pipe will do very nicely, as it can be easily handled. First obtain a good sized block of wood and cut it to conform to the shape of the roof. Then bore a hole in it that will take the pipe or wooden mast you are going to use and fasten it in place very securely. Two or three guys should be attached to the upper end of the mast, before it is raised. They should be attached to the roof after the masts are raised in such a way that they will not interfere with the raising or lowering of the aerial wires. Place wooden pins in the upper ends of the pipes, and screw on them high-tension insulators. Fasten a small pulley to these insulators with short pieces of seagrass line, and run sufficient $\frac{1}{4}$ -in. bell cord through the pulleys to raise and lower the aerial wires. The distance between the masts will be governed by the size of roof, etc.; the greater this distance the better.

Cut from some well seasoned oak, two pieces $1\frac{1}{4}$ in. thick, 4 in. wide and 30 in. long and use them in suspending the aerial wires between the masts. Cut

notches in these pieces, as shown in Fig. 10, and tie four porcelain knobs to each of the pieces with seagrass rope. The knobs should have a play of at least 4 or 5 in. The four equally spaced notches should be used in preventing the ropes from slipping along the wooden pieces. A good sized porcelain knob should be tied in the center of a piece of seagrass rope about 4 ft. long, and the ends tied around the wooden stretchers where the remaining two notches are cut. One end of the ropes that pass through the pulleys on top of the poles should be tied to this porcelain knob.

Run some No. 14 gauge bare copper wire through the insulators fastened to the stringers, as shown in Fig. 10, and fasten the wire in place. Solder a piece of No. 14 gauge copper wire to the points P and P₁, Fig. 10. In the center of this piece, solder another piece that will lead into your instrument.

The lead-in wire should be made as clear as possible, and by that is meant to use just as few insulators as you can conveniently get along with, since each tends to dissipate a certain part of the high-tension current and thus greatly lowers the efficiency of your sending or receiving. The wire should be well taped and passed through a heavy porcelain tube where it goes through the wall, or a better way still would be to drill a hole in the window pane and pass the wire through it.

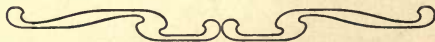

CHAPTER VI

CONSTRUCTION OF A COHERER AND A DETECTOR

EITHER the coherer or a detector may be used in the receiving circuit. When it is desired to receive with audible signals, the coherer is used in combination with a relay and battery, as shown in Fig. 2. The relay R controls a local circuit consisting of a second battery, B_2 , and a vibrating bell, B. The use of the detector in connection with a telephone receiver, as used in receiving, will be taken up later.

One of the easiest coherers to make, and one that will give excellent results when used with a sensitive relay, is one of the ordinary metal filings kind. The following coherer has been found to give excellent results, if properly constructed. A wooden base for the instrument should first be made from some $\frac{3}{4}$ -in. hard wood, about $3\frac{1}{2}$ in. wide and 6 in. long. Round off the upper corners and edges of this piece and give it two or three coats of good shellac. Obtain two good size binding-posts, as shown in Fig. 1. These binding-posts should have holes in them that will allow a $\frac{3}{32}$ -in. brass rod to pass through. Mount the binding-posts on the wooden base as shown in Fig. 1. Two other binding-posts, B_3 and B_4 , should be mounted on the ends of the base and back-connected to the first two.

These two binding-posts are to serve as terminals for the coherer. Procure two pieces of $\frac{3}{32}$ -in. brass rod, 2 in. long, and amalgamate one end of each of them by first dipping the end in acid and then in mercury. These rods can now be mounted as shown. A

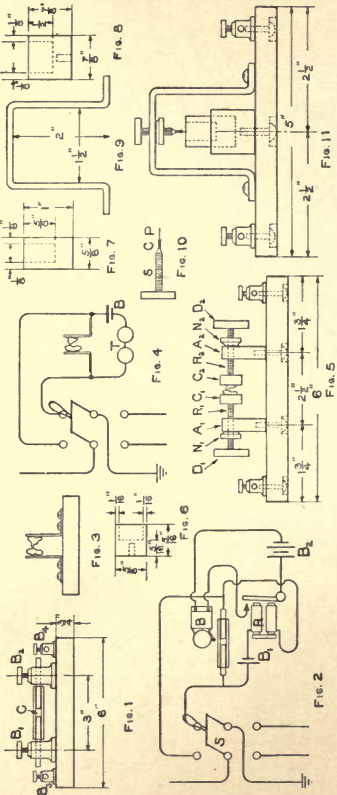

Coherer and Detector Details

glass tube, whose inside diameter corresponds to the outside diameter of the rods, should be cut to such a length that it will slip over the rods and be almost in contact with the two binding-posts B_1 and B_2 .

The ends of the brass rods inside of the glass tube should be separated $\frac{1}{16}$ to $\frac{3}{32}$ in., providing a small chamber, C, in which the filings are to be placed. These filings can be made from a piece of nickel, by sawing it with a medium-toothed hacksaw. They should then be sifted through a thin cheesecloth or a very fine sieve to separate the coarser filings from the fine dust which is not desired. A small trace of silver filings added to the nickel filings will increase the sensitiveness of the coherer.

Assuming you have constructed the aerial at the receiving end and have made the proper ground connection, you can put your set in operation. You will, of course, need a 300-ohm relay, R, Fig. 2. This relay will cost about \$7, if purchased ready made, but a description of how to build one will be given in one of the following chapters and its cost will be considerably less. The completed connections at the receiving end are shown in Fig. 2. The switch S is the same kind of a switch as you installed at the transmitting station. The brass rods of the coherer should be pushed in against the mass of iron filings until the armature of the relay R is drawn up and the bell B starts to ring. Withdraw the brass rods until the bell barely stops ringing.

The distance between the armature of the relay and the contact should not be much more than the thickness of a piece of good quality wrapping paper. The adjustment of the spring controlling the armature of the relay will be found to be rather tedious.

It no doubt would be best to place the receiving and

sending equipment only 10 or 15 ft. apart at first, using short pieces of wire hung to the ceiling for aerials, and the adjustments can be more easily made than when they are quite a distance apart. The distance can then be increased and the adjustment continued.

The vibrating bell must be mounted so that the hammer strikes the coherer a light tap when it is vibrating. You could, if desired, make the base of the coherer large enough so that the bell could be mounted on it permanently. A rubber band can be wrapped around the hammer on the bell so the striking will not break the glass rod. The operation of this coherer has been previously described, but it might be well to give it again. The wave motion sent out from the aerial at the sending station goes in all directions and a part of it is caught by the aerial at the receiving station and passes through the coherer to the ground. The passage of this current through the filings in the coherer causes them to cohere, this lowers the resistance of the relay circuit and allows sufficient current to flow from the battery to actuate the relay and close the bell circuit.

The filings are decohered, of course, when the hammer of the bell strikes the glass rod, and the bell will cease to operate, unless there is still current through the coherer which causes the filings to immediately re-cohere. Hence, the bell will only stop ringing when the current ceases to flow through the coherer. This current will flow so long as the key in the primary winding of the spark coil at the sending station is closed, and in this way the dots and dashes of the code are sent.

Two types of detectors will be described—the “crystal” and “electrolytic.” It has been found that certain metallic oxides and sulphides possess the remarkable

property of conducting current a great deal better in one direction than in the other, when two dissimilar crystals are in contact. This condition is utilized in the construction of the so-called "crystal detector." These detectors, when connected in the aerial circuit, will transform the electrical oscillations into a pulsating current which is unidirectional and a sound will be produced in a high-resistance telephone receiver connected in parallel with the detector, without the use of a local battery.

The "pericon" detector is no doubt one of the most important crystal detectors made, and its construction will be given here. You should purchase a small quantity of chalcopyrite, $\text{Cu}_2\text{SFe}_2\text{S}_3$, and zincite, ZnO , from a dealer in wireless telegraph supplies. Break up the largest pieces into small fragments and test them out by placing a piece of each kind of material in a crystal detector as shown in Fig. 3. The best combination you can obtain is selected and they can be mounted in a better form of detector as shown in Fig. 5. The first detector consists of nothing more than two spring clips fastened to a small block of wood and connected as shown in Fig. 4. The most sensitive pair can be determined by listening in the telephone receiver T to the signals.

Cut from some $\frac{5}{16}$ -in. round brass, two pieces $1\frac{1}{2}$ in. long, A_1 and A_2 , Fig. 5. Drill a small hole in one end of each of these pieces and tap them to take a $\frac{1}{8}$ -in. screw. Drill two other holes through the pieces, $\frac{3}{8}$ in. from the opposite end, and thread them to take $\frac{1}{8}$ -in. screws. Mount these pieces on a wooden base, $2\frac{1}{2}$ in. wide and 6 in. long, cut from some $\frac{5}{8}$ -in. hard wood, with small brass screws passed through the base from the under side. These screws should be countersunk and the brass pieces should be about $2\frac{1}{2}$

in. apart. The holes in the upper ends of these pieces should be on a line with each other.

Make two rods, R_1 and R_2 , $2\frac{1}{2}$ in. long and threaded their entire length, to fit the holes in the pieces A_1 and A_2 . Two disks, D_1 and D_2 , $1\frac{1}{4}$ in. in diameter, should be cut from some $\frac{1}{4}$ -in. hard wood and fastened on the ends of the rods R_1 and R_2 to serve as handles in adjusting the detector. Make from some $\frac{5}{8}$ -in. brass rod two cups, C_1 and C_2 . The dimensions are given in Fig. 6. Drill a small hole in the bottom of these cups and thread them to fit on the ends of the rods R_1 and R_2 . These holes should not be drilled all the way through the bottom of the cups.

The two crystals you selected can now be mounted in these cups by means of a composition known as Wood's metal. This metal can be purchased at a supply store or it can be made by melting together four parts of bismuth, two parts of lead, one part of tin and one part of cadmium. This composition melts at a very low temperature, something like 140 deg. F. The cups should be thoroughly cleaned and then nearly filled with this metal, and the crystals held in place until the metal cools and hardens. Two lock nuts, N_1 and N_2 , should be placed on the rods R_1 and R_2 , as shown in Fig. 5, to hold the cups in place after they have been once adjusted. Two binding-posts should be mounted on the base and connected to the screws on the under side of the base.

This detector can now be connected in circuit, as shown in Fig. 4, and the final adjustment made, which will remain for a long period, unless it be roughly handled or burned out by being placed near a strong transmitter without proper protection. A battery, B , should be connected in series with the telephone receiver to give the best results.

It might improve the sensitiveness of the detector to construct it so that the crystals are held in contact by means of a small spring. To do this, do not thread the hole in one of the supports, but drill it out so that the rod will move freely through it. A small spring can be slipped over the rod between the cup and the support and the lock nut used in adjusting the tension in the spring, it being placed on the rod between the end of the spring and the cup.

An inexpensive electrolytic detector can be made as follows: The cup that is to hold the electrolyte should be made from a piece of carbon rod, and its dimensions should correspond to those given in Fig. 7. Cut from a rod of brass a piece whose dimensions correspond to those given in Fig. 8. Drill a small hole in the bottom of this piece and thread it to take a $\frac{1}{8}$ -in. screw. Now cut from some $\frac{1}{2}$ -in. hard wood a piece 5 in. long and 2 in. wide. Drill the holes indicated in Fig. 11 and countersink them on the under side. The upper edges of the piece can be nicely rounded off, and it should then be given three or four coats of shellac. Cut from some $\frac{1}{8}$ -in. brass a piece $6\frac{1}{2}$ in. long and $\frac{1}{2}$ in. wide. Drill a hole in the center of this piece and thread it to take a $\frac{1}{8}$ -in. screw. Drill two other $\frac{1}{8}$ -in. holes, $\frac{1}{4}$ in. from the ends.

Now bend the piece into the form shown in Fig. 9 and mount it on the base so that the hole in its center is directly over the center of the carbon cup. Mount two back-connected binding-posts with screws through holes in the ends of the base. Connect one of these to the U-shaped piece of brass and the other one to the screw that holds the piece of brass, supporting the carbon cup, in place.

Obtain a low-voltage lamp that has been burnt out and remove the pieces of platinum wire in the base of

the lamp. Be careful not to break the platinum wires loose from the copper lead-in wires. Mount one of these pieces in the end of a screw, S, Fig. 10, by soldering the copper wire C in a small hole drilled in the end of the screw. This screw should now be placed in the threaded hole in the U-shaped piece and provided with a lock nut. The piece of platinum wire can be raised and lowered with respect to the carbon cup. The detector should be connected in circuit, as shown in Fig. 4, with a battery in series with the telephone receiver. Connect the positive pole of the battery to the binding-post corresponding to the platinum-pointed screw. Fill the carbon cup with a solution, made by adding one part nitric acid to four parts water (always add the acid to the water) to within $\frac{1}{8}$ in. of the top. The platinum point should just barely touch the electrolyte. Figure 11 shows the completed detector.



CHAPTER VII

CONSTRUCTION OF A POTENTIOMETER

THE successful operation of the detectors described in the previous chapter will depend upon some device for varying the current that flows through the detector from the battery. There are ways by which the current can be adjusted. First, a suitable rheostat could be connected in series with the detector and the current adjusted to the desired value by changing the total resistance of the circuit; second, a potentiometer could be used. The potentiometer differs from the rheostat in that it changes the applied voltage, which in turn results in a change in the current, the resistance remaining constant, while the rheostat changes the value of the current by changing the resistance, the voltage remaining constant. The potentiometer is widely used in connection with detectors employing a local battery, it being so sensitive that a very fine adjustment of current can be obtained. The principle of the potentiometer will be made clear by reference to Fig. 1. A battery, B, is connected in series with a resistance, AC. The direction of the current flow through this resistance is indicated by the arrow, and any point such as D will be at a higher electrical level or potential than some point such as E, which is near the end C. If a resistance, R, be connected to the points D and E, there will be a current flow through the resistance, due to the potential difference between D and E, and the value of the current in amperes will be equal to this potential difference, in volts, divided by the resistance of R, in ohms. If the position of the points D and E on the resistance AC can be changed,

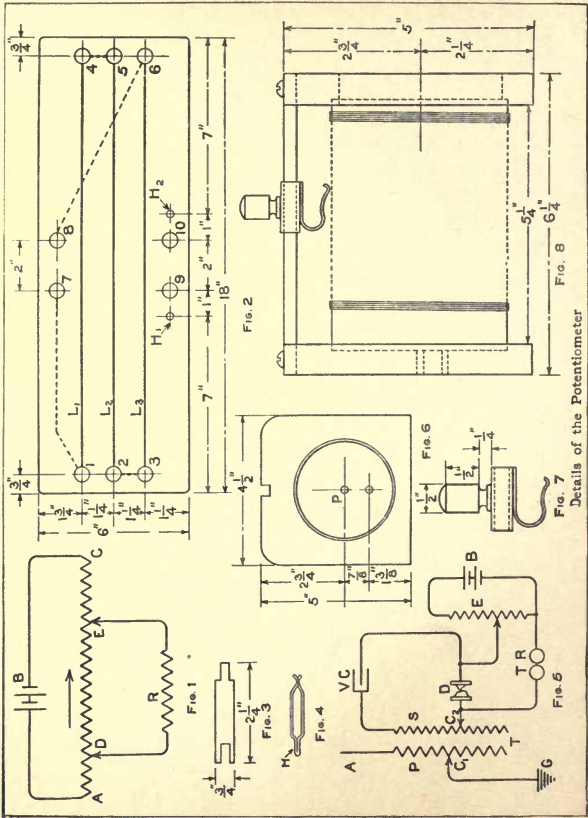

Details of the Potentiometer

the value of the current in R can be varied, since the potential difference between D and E will increase as they are moved apart and decrease when they are moved toward each other. The range of this adjustment would be from the full voltage of the battery, when the points D and E coincide with A and C respectively, to zero, when they are connected to the same point on the resistance AC. The resistance R in Fig. 1 should be replaced by the detector when the potentiometer is to be used for wireless work.

A potentiometer suitable for wireless work may be constructed as follows: For the base, obtain a piece of oak or other hard wood, $\frac{3}{4}$ in. thick, 6 in. wide and 18 in. long. Round off the corners and edges on one side, which will add greatly to the appearance, and give it two or three coats of good shellac. Ten good sized binding-posts should now be mounted on this base as shown in Fig. 2. These posts should preferably be of the back-connected type, and the screws holding them in place should be countersunk so that they do not come below the under side of the base. Stretch three pieces of 30 or 32-gauge bare german silver wire between these binding-posts on the upper side of the board as indicated, in Fig. 2, by the lines L_1 , L_2 and L_3 . These wires should not be fastened between the binding-posts and the board, but in the opening in the binding-posts, which will raise the wires at least $\frac{1}{2}$ in. from the board. Before fastening the binding-posts rigidly to the board, connect 1 and 7, 4 and 5, 2 and 3, and 8 and 6 with a piece of 18-gauge copper wire placed in grooves cut in the under side of the base. These conductors are indicated by dotted lines in Fig. 2. Obtain two pieces of lamp cord, or other flexible wire, about 18 in. long and fasten one end of these two pieces under the binding-posts 9 and 10. The wires

can be passed down through two holes, H_1 and H_2 , drilled in the base at the side of the binding-posts, and the ends connected to the binding-posts on the under side. Two clips should be made and fastened to the other ends of these wires for the purpose of making connections to the german silver wire.

These clips can be made as follows: Cut from some spring brass two pieces corresponding in dimensions and form to that given in Fig. 3. Bend these two pieces into the form shown in Fig. 4, drill a small hole, H , through the end and solder the free ends of the wires in these holes.

In using the potentiometer, the battery should be connected to the posts 7 and 8. It would be best to place a small switch in this circuit so that the battery can be readily disconnected when not in use. The variable source of potential corresponds to the terminals 9 and 10. The value of the potential between these two binding-posts can be easily adjusted by moving one or both of the clips along the German silver wire.

The various pieces of apparatus described thus far, will, when properly connected and adjusted, give satisfactory results, provided there are not too many wireless stations operating in the same neighborhood. The electrical waves sent out by any wireless station have a certain length depending, of course, upon the equipment making up the sending set. To obtain the best results in transmitting signals by wireless, the receiving and sending stations must have such equipment and it must be so adjusted that they have the same wave length. When this condition is realized, the stations are said to be in tune. Nearly everyone has at some time heard a piano string vibrate in unison with some note that was sounded on another musical

instrument. The natural period of vibration of the string corresponds to that of the note and it, as a result, vibrates more than any of the other strings, which results in its being heard. The same condition is true to a greater or less extent in wireless work. All stations in the neighborhood of a station that is sending will be affected, and the effect increased as the condition of perfect tuning is approached or reached.

There are two important pieces of apparatus, the condenser and tuning coil, that are employed in changing the wave length of a given station, and their construction will be taken up presently. Before describing the construction, however, it might be well to explain how they are connected in the receiving circuit. Figure 5 shows the connections of the various parts that compose a complete receiving set. The tuning coil T consists of two windings marked P and S; VC is a variable condenser (one whose electrostatic capacity can be changed by an adjustment of the plates composing the condenser); D is the detector; TR, the telephone receiver; E, the potentiometer, and B, the battery.

There are two sliding contacts on the tuning coil, as shown by C_1 and C_2 , Fig. 5. The purpose of these contacts is to give a means of changing the number of turns that are effective in the primary or secondary winding, which causes a change in the value of the inductance of the two circuits. In addition to this adjustment, these coils are usually so arranged that their relative position to each other can be changed, which varies the effect one winding has on the other. Such coils are very often spoken of as "loose coupling" tuning coils or transformers.

The wave length of any circuit is dependent upon its inductance and capacity, and the wave length may

be varied by changing either the inductance or the capacity of the circuit, or both. The proper adjustment of the coil and condenser to give the best results will be taken up later, after you have constructed them and are ready to operate. Two types of tuning coils will be described, the construction being quite different while the principle of operation is practically the same in both. The first coil to be described consists of a primary winding on a cylinder of fiber with the secondary winding on another cylinder of such size and so arranged, that it can be moved in and out of the primary winding. One terminal of each of these windings should be connected to a sliding or moving contact so that the number of turns actually in use can be altered and the inductance thus changed.

The details of construction are as follows: First obtain a piece of hard wood, $\frac{5}{8}$ in. thick, $5\frac{1}{2}$ in. wide and 16 in. long. This piece is to serve as a base for the completed coil. Round off the upper edges to a radius of about $\frac{1}{4}$ in. and give it two or three coats of good shellac. Next obtain a piece of good maple, $\frac{5}{8}$ in. thick, $4\frac{1}{2}$ in. wide and 2 ft. long. Cut from this board two pieces of the dimensions given in Fig. 6. Cut a notch, $\frac{1}{4}$ in. wide and $\frac{1}{4}$ in. deep, in the center of the upper edge of each of these pieces. Turn a groove $\frac{1}{16}$ in. wide and $\frac{1}{8}$ in. deep in the surface of each piece with the point P, Fig. 6, as a center. These grooves should have an outside diameter of $3\frac{1}{2}$ in. In one of the pieces, with P as a center, cut a circular opening $3\frac{1}{4}$ in. in diameter. In the other piece drill a $\frac{1}{8}$ -in. hole with P as a center and a second $\frac{1}{8}$ -in. hole $\frac{7}{8}$ in. below P. The second hole should not be drilled all the way through. Obtain a piece of insulating fiber, $\frac{1}{16}$ in. thick, $5\frac{1}{2}$ in. wide and 10 in. long. Bend this piece into a cylinder $5\frac{1}{2}$ in. long and trim off the ends until

it is of such a diameter that it will fit into the grooves cut in the two pieces shown in Fig. 6. You should use considerable care in trimming the edges so that they will fit against each other perfectly the entire length of the cylinder. This cylinder should then be glued into the grooves in the wooden pieces, making sure that these are in line with each other before the glue sets, which can be determined by resting the lower edges of the pieces on a plane surface. If the edges of the piece forming the cylinder do not stay in line with each other they can be held in place in the following manner: Wind around the outside of the cylinder several turns of wire, drawing the ends of the piece of fiber into place. Then glue a second piece of fiber over the joint inside of the cylinder. Do not remove the wire from the cylinder until the glue in the joint has set thoroughly. Another way of forming the cylinder, and one that will give good results, is as follows: Obtain a sheet of thin fiber, $5\frac{1}{2}$ in. wide, and roll it around a wooden cylinder, $3\frac{3}{8}$ in. in diameter, until the wall of the cylinder thus formed is $\frac{1}{16}$ in. thick. Glue each layer of the insulating fiber in place as it is wound on, and wind the completed cylinder with several turns of wire and allow it to dry.

When the cylinder has been fastened to the wooden blocks, it is ready for the winding, which is to consist of 20-gauge single cotton-covered copper wire. Drill two $\frac{1}{16}$ -in. holes in the under side of the cylinder, $\frac{3}{4}$ in. from the wooden end piece without the large opening in it. These two holes should be drilled about $\frac{1}{2}$ in. apart. Pass the end of the wire to be used in winding the cylinder down through one of these holes and up through the other, allowing about 5 in. of free wire to protrude. You may find it necessary to drive a small wooden peg into one of the holes along the

side of the wire to hold it firmly in place. The end of this peg can be cut off even with the surface of the cylinder and should not project more than $\frac{1}{8}$ in. inside of the cylinder. Wind on wire until you are within $\frac{1}{4}$ in. from the other end of the cylinder. This end of the winding can be terminated in the same way the other end was fastened, except that no free wire to form a terminal is needed.

Now, take a small block, cover it with a piece of fine sandpaper and cut off the insulation, to a width of $\frac{1}{2}$ in., on the upper side of the wire along the top of the cylinder and directly in line with the two grooves in the top of the end blocks. The sliding contact is to move along a support fastened in the two grooves and make contact with the various turns of wire where the insulation has just been removed.

The support for this contact can be made from a piece of brass, $\frac{1}{4}$ in. square, fastened in the grooves with a round-headed brass screw in each end. Make the slider as follows: Cut from thin sheet brass a piece 1 in. wide and $1\frac{1}{16}$ in. long. Bend this piece around a piece of iron, $\frac{1}{4}$ in. square, in such a way that the joint will come in the center of one side. Take a small flat-headed machine-screw of brass, about $\frac{1}{2}$ in. long, and solder it in the center of the side opposite the joint. A small handle can be turned from a piece of hard rubber and fastened to this screw. Then cut from thin spring brass a piece $\frac{1}{4}$ in. wide and $2\frac{1}{4}$ in. long. Bend this piece into the form shown in Fig. 7 and solder it to the square brass tube on the side where the joint was made. The complete sliding contact can now be placed on the brass support, and the primary winding of your tuning coil is complete, as shown in Fig. 8, with the exception of the connections to the binding-posts that are to serve as terminals.

CHAPTER VIII

SECONDARY WINDINGS

TO construct a secondary winding suitable to use with the primary winding described in Chapter VII you would proceed as follows: Turn from a piece of $\frac{1}{2}$ -in. hard wood two disks 3 in. in diameter. Drill two $\frac{3}{16}$ -in. holes in one of these pieces as shown in Fig. 1. Turn from the same stock another disk $3\frac{1}{2}$ in. in diameter. The edges of this disk should be rounded off as shown in Fig. 2. Now glue the small disk without the holes in it to the larger disk and then drill the holes indicated in Fig. 3. The holes 1 to 8, inclusive, should be $\frac{1}{8}$ in. in diameter, and their centers should be located on the arc of a circle whose radius is 1 in. and its center should be the center of hole No. 9. The distance between the centers of the holes located on the arc should be $\frac{3}{8}$ in. Hole No. 9 should be $\frac{5}{16}$ in. in diameter.

Take eight brass machine screws, $1\frac{1}{4}$ in. in length and $\frac{1}{8}$ in. in diameter, and file their heads down as shown in Fig. 4. Mount these screws in the openings 1 to 8, inclusive, using a small nut on the back side to hold them in place. These screws are to be connected to various points on the secondary winding, and a contact arm, which is to form one terminal of the winding, will be arranged to move over them, giving a means of changing the number of secondary turns that are effective.

Obtain a piece of brass tubing 2 in. long with a wall $\frac{1}{16}$ in. thick and an opening $\frac{3}{16}$ in. in diameter. Saw

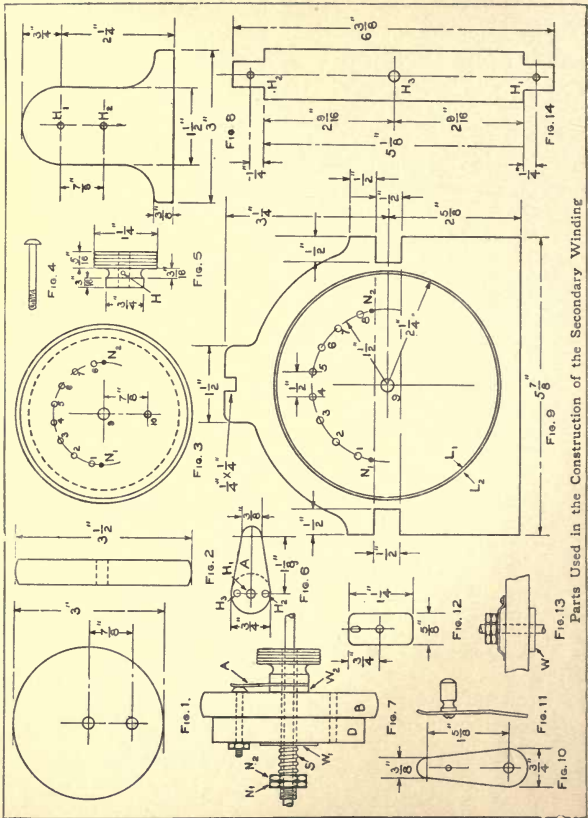

Parts Used in the Construction of the Secondary Winding

three slots $\frac{3}{4}$ in. deep in one end of this piece of tubing and bend each of the six parts thus formed in toward the center so that the tube will fit very snug over a $\frac{3}{16}$ -in. rod. Thread the other end of the tube to a distance of 1 in. and screw it into the hole numbered 10 in Fig. 3. The protruding end should be on the side corresponding to the smaller disk.

Take a second piece of the same kind of tubing, 3 in. long, and thread one end for a distance of $\frac{1}{2}$ in. and the other end about $1\frac{1}{2}$ in. Saw three slots in the end with the larger number of threads on it, to a depth of $\frac{3}{4}$ in. and bend the six pieces in toward the center of the tube, as you did in the previous case. Turn a small handle from some hard wood or rubber whose dimensions correspond approximately to those given in Fig. 5. Drill a $\frac{1}{4}$ -in. hole in this handle as indicated by the dotted lines and thread it so that the handle can be screwed on the end of the brass tube. The handle can then be held in place by means of a small setscrew countersunk in a hole at H, Fig. 5.

Make two nuts from some $\frac{1}{8}$ -in. stock that will screw on the threaded end of the tube. Cut from some thin spring brass a piece whose dimensions correspond to those given in Fig. 6. Drill a $\frac{3}{8}$ -in. hole, H_1 , in this piece. Make a washer of some $\frac{1}{8}$ -in. brass with an opening $\frac{1}{4}$ in. in diameter and an outside diameter of $\frac{3}{4}$ in. Thread this washer so that it can be screwed on the end of the brass tube and then solder it to the contact arm A, shown in Fig. 6. The large opening in the arm should correspond to the opening in the washer. The dotted circle in Fig. 6 indicates the position of the washer. After you have soldered these two pieces together, drill two $\frac{3}{32}$ -in. holes, H_2 and H_3 , through both of them. Countersink these holes in the brass washer for flat-headed screws.

The washer and arm can now be screwed on the end of the tube and then the wooden handle put in place and fastened with two small screws through the holes H_2 and H_3 . Fastening the handle to the washer and arm after they are all put in place prevents the likelihood of an improper alinement.

All the parts are shown assembled in Fig. 7. A small spiral spring, S , is placed between the two nuts N_1 and N_2 , and the washer W_1 , so that the end of the arm A will always be held against the heads of the screws. Two stops should be provided to prevent the arm A turning too far around and dropping off the heads of the screws. These can be made by driving two small brass nails in the wooden disk as shown by N_1 and N_2 , Fig. 3.

The cylinder upon which the secondary winding is to be placed can be made by winding some thin insulating fiber around a round wooden piece, 3 in. in diameter. This cylinder should be 6 in. long and its wall should be $\frac{1}{16}$ in. thick. When the cylinder is completed, one end can be put over the disk D , Fig. 7, and fastened with three or four small screws equally spaced around the end of the tube. The other small disk shown in Fig. 1 can be fastened in the other end of the cylinder in a similar manner, making sure the holes in the disks are in line before you fasten the last one.

The secondary part of your tuning coil is now complete, with the exception of the winding, which should be made as follows: Procure a small quantity of No. 22-gauge single cotton-covered copper wire. Drill a small hole $\frac{5}{8}$ in. from the end opposite the switch. Pass about 10 in. of wire down through this hole and fasten the wire with a wooden peg. Wind on wire until you have covered $\frac{1}{2}$ in. of the cylinder, then drill

a small hole as close to the winding as you can. Make a loop in the wire you are winding on the cylinder and pass this loop down through the hole just drilled in the cylinder and fasten the wire securely. This loop should be at least 9 in. long. Proceed in this way until you have completed the winding, which should consist of eight sections.

The end of the winding farthest from the switch should be connected to the brass tube fastened in the hole No. 10, Fig. 3. The loops in order, numbering them from this end of the winding, should be fastened to the screws placed in the holes 1, 2, 3, etc. The cylinder must, of course, be disconnected from the block the screws are mounted on, in order that the wires may be soldered to the screws. The secondary winding can now be mounted inside of the primary winding as follows:

Cut from your $\frac{5}{8}$ -in. stock a piece whose dimensions correspond to those given in Fig. 8. Drill two $\frac{3}{16}$ -in. holes, H_1 and H_2 , in this piece. Mount this piece on one end of the board that is to form the base of the instrument with two or three screws passed through the base from the under side and counter-sunk. This piece should be parallel to the end of the base and $\frac{3}{4}$ in. from the end. Mount the primary winding on the other end of the board forming the base, with four screws, two in each end piece. Two back-connected binding-posts may be mounted in the corners of the base to serve as terminals for the winding. One of these binding-posts should be connected to the brass rod carrying the sliding contact and the other to one end of the winding itself. These connections can be passed down through holes drilled in the end of the cylinder and base and placed in grooves on the under side of the base. The end of the frame for

the primary winding should be $1\frac{1}{2}$ in. from the end of the base.

Obtain two pieces of brass rod $\frac{3}{16}$ in. in diameter and $14\frac{1}{8}$ in. long. Thread both ends of these pieces to a distance of at least $\frac{1}{4}$ in. Place a nut on one end of each of these and solder it in place when the surface of the nut and the end of the rod are flush. The end of the rod may be filed down level with the surface of the nut after they are soldered, which will present a better appearance. Put these two rods through the holes in the end of the primary coil, then through the openings in the secondary coil and finally through the two openings through the block on the end of the base. The block must be unfastened from the base so that the secondary coil can be put inside of the primary coil. Two binding-posts can now be screwed on the projecting ends of the rods and they will form the terminals of the secondary winding.

The appearance of the coil can be greatly improved by sandpapering all the various wooden parts and giving them several coats of good shellac. The two windings can be shellacked, but care must be used not to get any on the primary where the slider comes in contact with the wire.

Another method of constructing a tuning coil that will give very good results is as follows: First make a cylinder $4\frac{1}{2}$ in. outside diameter and $5\frac{1}{2}$ in. long, with a wall $\frac{1}{8}$ in. thick, by winding some thin insulating fiber around a form and gluing the various turns in place. Now obtain two pieces of hard wood, 6 in. long, 6 in. wide and $\frac{1}{2}$ in. thick, and cut them to the dimensions given in Fig. 9. Cut a groove in each of these pieces as shown by the lines L_1 and L_2 . In one of these pieces drill $\frac{1}{8}$ -in. holes from 1 to 8 as indicated and a $\frac{3}{16}$ -in. hole at No. 9. Obtain eight $\frac{1}{8}$ -in. machine

screws, $\frac{3}{8}$ in. long; file their heads flat on top and mount them in the holes 1 to 8, with a small nut on the back. Cut from some thin spring brass a piece whose dimensions correspond to those given in Fig. 10. This piece should be bent and a small handle fastened to it, as shown in Fig. 11. It may now be mounted on the wooden block by means of a $\frac{3}{16}$ -in. machine screw that passes through the hole No. 10 and is fastened in the back with a lock nut.

This bolt should be fastened so that it will not turn when the contact arm is moved over the various contacts, which may be done in the following way: Cut from some spring brass a piece $\frac{5}{8}$ in. wide and $1\frac{1}{4}$ in. long. Drill two holes in this piece, as shown in Fig. 12. Now bend the piece and solder it to one of the nuts, as shown in Fig. 13. A small brass washer, W, should be placed between the contact arm and the surface of the board when the parts are being assembled. Two stops, N_1 and N_2 , Fig. 9, should be provided to prevent the contact arm moving off the tops of the brass bolts.

Cut from some $\frac{1}{2}$ -in. hard wood two pieces whose dimensions correspond to those given in Fig. 14. Drill a $\frac{3}{16}$ -in. hole in the center of each of these pieces. These two pieces are to be fastened to the two end pieces shown in Fig. 9 with screws that pass through the holes H_1 and H_2 . The size of these holes will depend upon the size of the screws you use.

Place the cylinder between the two end pieces and fasten the two pieces shown in Fig. 14 in place. Drill two holes through the sides of the cylinder to correspond with the hole H_3 in the side pieces. These holes in the cylinder should be at least $\frac{5}{16}$ in. in diameter. The secondary coil is to be placed inside of the cylinder and mounted on a metal shaft that rests in the

holes H_3 and provided with a small handle on one end so the secondary can be revolved. Before taking up the construction of the secondary, it would be best to wind the primary. Obtain a small quantity of No. 20-gauge single cotton-covered copper wire and wind 120 turns on the cylinder. This winding should be divided into two equal parts, there being a space of about $\frac{3}{8}$ in. between them, which will permit the shaft that is to carry the secondary coil to pass through the cylinder without coming into contact with the winding. The terminals of this winding can be secured to the cylinder as described in Chapter VII. The insulation should be removed from the wire and a sliding contact constructed similar to the one described for the first coil. This sliding contact is to form one terminal of the primary winding, while one end of the winding itself will form the other terminal. These connections can be made as previously described.

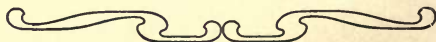

CHAPTER IX

ANOTHER SECONDARY WINDING

A SECONDARY winding that will work with the primary winding described in Chapter VIII can be constructed as follows: Turn up a piece from some hard wood, whose dimensions correspond to those given in Fig. 1. Cut eight small grooves in the outer edge of this disk as shown. Drill a $\frac{1}{4}$ -in. hole, H, through the piece, making sure you get it in the exact center, and then burn it out with a piece of square iron so that a piece $\frac{1}{4}$ -in. square will fit into it very snug. Drill nine $\frac{1}{8}$ -in. holes, numbered 1 to 9, in the cylinder, $\frac{1}{2}$ in. from the outer edge and parallel to its axis. Now drill nine more small holes through the partitions between the various grooves and connecting with the nine drilled parallel with the axis of the cylinder. The position of these holes is shown in the diagram by dotted lines.

Obtain a small quantity of No. 22-gauge single cotton-covered copper wire for use in winding the secondary coil. Pass one end of the wire down through hole H₁ and out through hole No. 1, allowing at least 8 in. of free wire, to be used in making connections. Wind 22 turns of wire in groove G₁ and at the point where the hole H₂ was drilled, and cut a groove in the partition so that the wire can pass over into the next groove, G₂. Remove the insulation from the wire directly over the hole H₂ and solder a piece of wire 6 or 7 in. long to the main wire. Pass the short piece of wire down hole H₂ and out through hole No. 2. Continue in this way until you have completed the eight sections of the secondary. All of the terminals of the

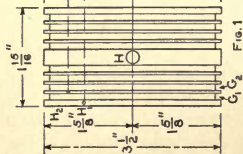

Fig. 1

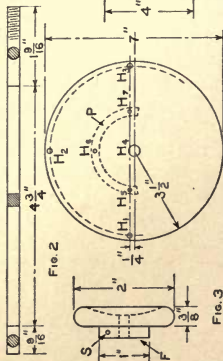

Fig. 2

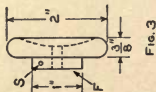

Fig. 3

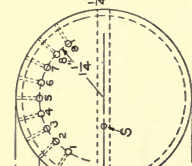

Fig. 4

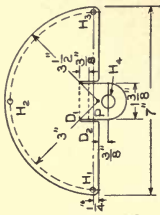

Fig. 5

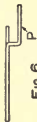

Fig. 6

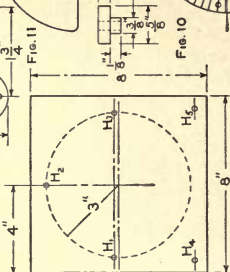

Fig. 7

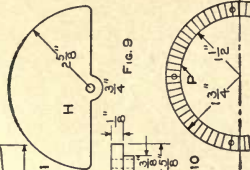

Fig. 8

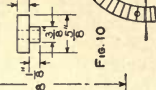

Fig. 9



Fig. 10

Fig. 12

Fig. 8

Parts Used in the Secondary Winding

various sections should be brought out at the same end of the cylinder. Give the completed coil several coats of good shellac.

The shaft upon which the secondary coil is to be mounted and the handle used in turning it can be made as follows: Obtain a piece of brass, $\frac{1}{4}$ in. square and $6\frac{7}{8}$ in. long. Turn the ends of this piece down to a diameter of $\frac{1}{4}$ in. as shown in Fig. 2. Turn from some $\frac{1}{16}$ -in. brass two washers $\frac{3}{4}$ in. in diameter and drill in each of them a $\frac{1}{4}$ -in. hole and slip one of them over each end of the shaft. The wooden side pieces will rest against these washers, which will prevent the shaft moving endwise. In turning down the end of the shaft, make a good square shoulder for the washers to rest against. Thread the right-hand end, as shown in the figure, to a distance of $\frac{5}{8}$ in. Remove the two side pieces and the end with the switch on it from the primary and slip the shaft in place, having placed the secondary coil inside of the primary with the square hole through it in line with the two holes in the side of the cylinder. The core of the secondary can be fastened to the shaft with a screw placed in the hole S, Fig. 1, which will prevent it from moving along the shaft. The core of the secondary should be turned so that the ends of the terminals project from it toward the open end of the cylinder. Now solder the terminal from hole No. 2 to the back end of contact No. 1, Fig. 3 (Chapter VIII), and the other terminals in regular order to the contacts 2 to 8 inclusive. The wire projecting from hole No. 1 is to form one terminal of the secondary and the center of the switch is to form the other terminal. A piece of wire, 7 or 8 in. long, should have one end fastened to the bolt holding the switch in place. Two small holes should be drilled in the lower part of the cylinder and as near

the end block as possible and the two wires forming the terminals passed down through them. Be sure to have sufficient slack in the wire from the secondary so that it will not interfere with the free motion of the core about its axis. The coil can now be assembled and it is ready to mount on a base with the exception of a small handle to fasten on the end of the shaft. The dimensions of a handle suitable for this purpose are given in Fig. 3. A small screw placed in the hole S will serve to hold the handle from turning on the shaft after it is once in place.

The base can be made from a piece of hard wood $\frac{5}{8}$ in. thick and should be $7\frac{1}{2}$ in. wide and $8\frac{1}{2}$ in. long. The upper edges and corners of this piece should be rounded off and it then given two or three coats of shellac. Four back-connected binding-posts should be mounted on the base, one in each corner, and the leads from the primary and secondary windings connected to them. The leads should be placed in grooves cut in the under side of the base.

A small condenser, constructed in such a way that its capacity may be varied from zero to its full value (known as a variable condenser), will be needed in order that the best results may be obtained when you are using the tuning coils previously described. Any condenser consists of two or more conducting plates separated from each other by some kind of insulating material that is called the dielectric. The capacity of such a combination of plates and dielectric is measured in terms of the quantity of electricity the condenser will store when it is subjected to a certain electrical pressure. A condenser is said to have unit capacity (one farad) when a unit quantity of electricity (one coulomb) will raise its potential one volt. The capacity will depend upon the area of the plates ex-

posed to each other, their distance apart and the kind of material separating them. In the following description of a variable condenser, use is made of the fact that the capacity varies directly as the area of the plates exposed, the distance between them and the dielectric remaining constant. The construction, in brief, consists of a stationary set of plates mounted in a pile, all separated from each other the same distance and electrically connected. This combination of plates is to form one terminal of the condenser. A second set of plates, of practically the same area, are mounted in a pile and electrically connected, the distance between them being the same as the distance between those forming the stationary pile. This second set of plates is mounted in such a way, with respect to the first set, that the plates forming the second or variable set may be moved into the intervening spaces between the stationary plates. The extent of this movement will determine the area of the plates forming one combination that is influenced by the plates of the other combination, which together with their distance apart and the kind of dielectric used determines the capacity of the condenser. The dielectric used in such a condenser is usually air and their distance apart is determined by the mechanical construction. The condenser may be constructed as follows:

You will need 18 pieces of metal cut to the dimensions given in Fig. 4, which are to form the stationary plates of the condenser. These plates may be cut from some thin sheet aluminum, about .04 in. thick. Considerable care should be exercised not to bend the sheets out of shape when you are cutting them. Drill three $\frac{1}{8}$ -in. holes, H_1 , H_2 and H_3 , in each of the 18 plates as shown. In addition to the above 18 plates, two more will be needed to complete the number re-

quired for the stationary part of the condenser. Cut from some $\frac{1}{8}$ -in. sheet aluminum two whose dimensions correspond to those given in Fig. 5. Drill in each of these plates the holes indicated. Bend the projecting part P down at right angles to the main part of the plate at the dotted line D_1 . After this bend has been made, again bend P at the dotted line D_2 so that it is parallel to the main plate. A cross-section through the plate, after these bends have been made, is shown in Fig. 6. These plates are to be mounted in a pile as follows: Obtain a piece of hard rubber 8 by 8 in. and about $\frac{1}{4}$ in. thick. Drill in this piece of rubber the holes indicated in Fig. 7. Obtain three pieces of $\frac{1}{8}$ -in. brass rod, 7 in. long, and thread them to a distance of about $1\frac{1}{2}$ in. at one end and about 1 in. at the other. Provide each of these rods with six $\frac{1}{8}$ -in. nuts. Procure about 300 small washers approximately .05 in. in thickness. The outside diameter of these washers should be about $\frac{1}{2}$ in. and there should be a $\frac{1}{8}$ -in. hole through them. Place a nut on each of the rods on the end with the larger number of threads, then put on ten of the small washers, and put the ends of the rods down through the holes H_1 , H_2 and H_3 , shown in Fig. 7. Put two nuts on the ends of the rods that protrude through the base and screw these nuts up until the last one is just flush with the end of the rod. The first nuts you placed on the rods may now be tightened, thus fastening the rods rigidly to the base. Now place one of the plates, cut to the dimensions given in Fig. 5, on the three rods with the projecting part P toward the base. Place three washers on each rod and then one of the eighteen similar plates. Continue in this way until all of the 18 plates are in place.

After all the 18 plates are in place put the remaining heavy plate on the rods with the projecting portion

above the main part of the plate. Put a washer on each of the rods and then a nut and draw all of the plates down in place. You may experience some difficulty in not having all the plates the same distance apart, owing to a variation in the thickness of the washers. This can be prevented by making your own washers and cutting them all from the same sheet of metal.

Cut from a piece of sheet rubber or fiber about $\frac{1}{8}$ in. in thickness, a circular disk 7 in. in diameter and drill three $\frac{1}{8}$ -in. holes in it, as shown in Fig. 8, so it will slip down on the three rods that support the stationary plates. A fourth hole, H_4 , $\frac{3}{8}$ in. in diameter should be drilled in the center of this plate, and three other small ones as shown. This plate cannot be put in place until the movable portion of the condenser has been completed, which may be constructed as follows:

Cut 19 plates from the same sheet metal you used for the 18 plates, to the dimensions given in Fig. 9. Drill a $\frac{3}{16}$ -in. hole, H , in each of these plates. Obtain a piece of $\frac{3}{16}$ -in. brass rod about $5\frac{1}{2}$ in. long. Thread one end of this rod to a distance of 1 in. and the other end to a distance of about 2 in. Provide four $\frac{1}{8}$ -in. nuts that will fit the threads on this rod. Cut from some hard rubber two pieces whose dimensions correspond to those given in Fig. 10. Drill a hole through these pieces and thread them so that they may be screwed on to the ends of the $\frac{3}{16}$ -in. brass rod. Place two of the nuts on the end of the rod with the fewer number of threads on it and screw on one of the pieces of rubber with the larger end toward the nuts. Allow $\frac{1}{8}$ in. of the rod to protrude through the rubber and screw one of the nuts down on top of the rubber, which will serve to hold it in place. The end of the rod

should be rounded off before the rubber piece is put in place. Slip one of the pieces on the rod shown in Fig. 9, and then three washers and then another piece, etc., until all the pieces are in place. The washers separating the pieces should be the same thickness as those separating the stationary plates and these should be about $\frac{3}{4}$ in. in diameter, which will give a larger bearing surface. Place a nut on the rod after the plates are all in place and screw it down. The position of the plates along the rod should be adjusted so that they will move into the spaces between the stationary plates when the piece of rubber on the lower end of the rod is placed in the hole in the projection on the heavy lower plate of the stationary set. This adjustment can be made by moving the two nuts holding the plates in place up or down on the rod. All of these plates should be placed directly over each other when they are finally fastened in place.

The upper piece of rubber should be placed on the rod so that it will fit in the hole in the projection in the upper heavy plate. A nut should be placed on the rod before the piece of rubber and it can be screwed up against the piece of rubber after adjustment.

The upper heavy plate must be removed so that the movable portion of the condenser may be put in place. The large rubber disk can now be fastened on the three rods by means of two nuts on each rod, one above and one below the disk. Before fastening the disk in place cut from a sheet of brass, or bend it from a strip, a piece similar to that shown in Fig. 12, and fasten it to the rubber disk as shown by the dotted lines in Fig. 8, by means of three screws that pass up through the disk from the under side. File in the upper side of this piece a number of grooves as shown by radial lines in Fig. 12.

Cut from a piece of thin spring brass a piece similar to that shown in Fig. 11 and fasten it to the surface F of a handle similar to that shown in Fig. 3. Screw this handle down on the upper end of the rod that supports the movable plates until the arm A, Fig. 11, rests upon the piece P, Fig. 8. The arm A should rest on the piece P very near its end when the movable plates are outside of the stationary plates. If the end of the rod protrudes through the handle, you can file it off until it is just flush with the surface of the handle. Any adjustment of the movable plates will be maintained by the arm engaging in the grooves on the surface of the piece P, Fig. 8.

Mount on the base a small piece of spring brass so that it will press up against the lower end of the rod, supporting the movable plates, with a slight pressure. Mount two binding-posts in the corners of the base and connect one of them to the spring and the other to one of the rods supporting the stationary plates. These binding-posts will form the terminals of your condenser.

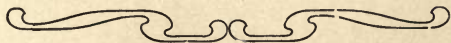

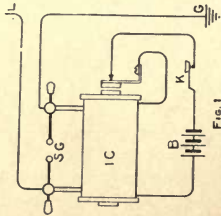

Fig. 1

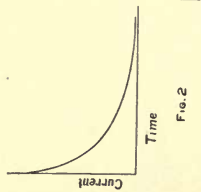

Fig. 2

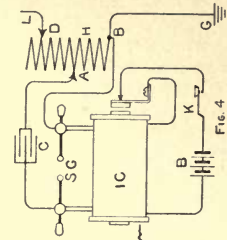

Fig. 3



Fig. 7

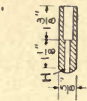

Fig. 8

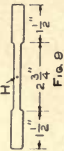

Fig. 9

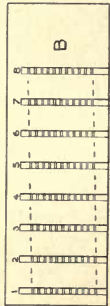

Fig. 6

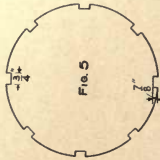

Fig. 5



Fig. 10

Sending Sets

CHAPTER X

CONNECTIONS FOR SETS

THE various tuning devices described in the previous chapters were designed to be used as a part of the equipment at the receiving station. The purpose of these devices was to enable the operator at the receiving station to adjust his equipment so that it would respond to a certain frequency wave. The frequency of these waves is determined by the construction and adjustment of the transmitting station. If the induction coil be connected to the aerial as shown in Fig. 1, the frequency of the wave such a combination would transmit would be fixed and there would be no way of changing the frequency unless some change were made in the construction of the aerial. This condition of affairs would confine the frequency at which such a station could transmit to a single value. It is often desirable, however, to have some means by which the frequency of the waves sent out by the transmitting station can be varied. With this adjustment, the station can communicate with several different stations whose receiving equipment is adjusted to respond to waves of different frequencies. The theory, in brief, upon which the construction and adjustment of the transmitting station is based, is as follows:

If a condenser be discharged through a circuit consisting of resistance alone, the current that exists in the circuit at any instant after the circuit is closed will be equal to the ordinate (the distance from the horizontal line to the curve) of the curve at that particular

instant. It will be seen from the curve shown in Fig. 2 that the current is a maximum at the instant the circuit is closed and decreases in value as the time of discharge increases. The decrease in the value of this current is very rapid, it requiring only about .0001 of a second for the current in a circuit, consisting of a 2-micro-farad condenser charged to a potential of 100 volts and connected to a resistance of 10 ohms, to decrease to about .06 ampere. The current in this circuit, just at the instant the circuit is closed, would be 10 amperes, it being equal to the voltage of the condenser divided by the resistance of the circuit, or 100 divided by 10 equals 10 amperes. If the condenser be connected to a coil of wire and allowed to discharge through it, the current will not follow a curve such as that shown in Fig. 2, where it is represented as dying away gradually, but it will oscillate back and forth in the circuit, as shown in Fig. 3. The circuit in the second case possesses a peculiar property called inductance, which is in reality a contracted form for the word "self induction" and corresponds to what might be called "electrical inertia." It is a property of the circuit which tends to prevent any change in the value of the current in the circuit. Thus, if the current in a circuit is increasing in value, there will be an increase in the magnetic field associated with the circuit, and this increase in the field strength will produce an electromotive force in such a direction as to oppose the increase in the value of the current. If the current decreases in strength, the reverse action will take place, the induced electromotive force tending to prolong the current or rather prevent a change in its value.

Oscillations will not always take place in a circuit in which there is inductance and capacity, but certain

conditions as to the relation between the value of the inductance and the capacity must be fulfilled before there will be an oscillating current produced. The "fundamental equation" of wireless telegraphy gives this relation as follows: There will be oscillations in a circuit provided the resistance, in ohms, is not greater than the square root of four times the inductance, in henries (The henry is the unit of inductance. Refer to some book on electricity for its definition.), divided by the capacity of the condenser, in micro-farads.

An instrument termed a transmitting helix is employed at the transmitting station to furnish the inductance necessary to produce the oscillations in the circuit, and a variable condenser will supply the capacity. In addition to furnishing the inductance, the helix acts as a step-up auto transformer and increases the voltage of the high-frequency currents in the aerial circuit. The helix consists of a piece of large copper conductor bent into the form of a spiral of quite a number of turns and supported on a suitable frame.

The operation of the helix can be shown by reference to Fig. 4, which shows the induction coil, condenser, helix and aerial all connected. The current from the secondary winding of the induction coil passes through the condenser C and the part of the helix that is connected between the points A and B. This results in the condenser becoming charged, and it would discharge through the secondary winding of the induction coil if it were not for the inductance of the induction coil secondary, which has a large counter electromotive force produced in it, and in order to discharge, the circuit is completed through the spark gap. When the adjustment of the capacity and inductance in the circuit composed of the condenser C, the part of the helix between the points A and B and

the spark gap is properly made, there will be electrical oscillations set up in the circuit. The high-frequency oscillations in the part of the helix from A to B produce a strong magnetic field about all the turns in the helix and, as a result, the electromotive force between the points D and B will usually be greater than that between the points A and B. The part of the helix between D and B can be thought of as a secondary winding, which in this case consists of the turns on the helix between the points D and B. The electromotive force in this secondary part causes electrical oscillations to be sent out into the aerial and ground.

The circuit composed of the condenser, spark gap and the turns in the helix between the points A and B, is called the "closed circuit," while the circuit composed of the aerial, ground and the turns in the helix between D and B constitutes what is called the "open circuit."

A helix suitable to be used with the other equipment previously described can be made as follows: Cut from a piece of maple, or other hard wood, about $\frac{7}{8}$ in. thick, two circular pieces 10 in. in diameter. Cut eight grooves in each of these pieces, as shown in Fig. 5, to a depth of $\frac{7}{8}$ in. Cut from some $\frac{7}{8}$ -in. hard wood, eight pieces $\frac{3}{4}$ in. wide and 8 in. long. These pieces, called "struts," are to form the supports for the wire and should have a number of grooves cut in them in which the wire can be placed. In order to mark the proper location of these grooves, you should proceed as follows: First obtain a board about 3 ft. long and 1 ft. wide. One edge of this board should be reasonably straight. Draw eight lines perpendicular to the straight edge of the board spacing them $3\frac{1}{8}$ in. apart. Now tack the eight struts to the board with some very small brads, placing the edge of one of them

along each of the lines and the ends even with the edge of the board. The pieces must all be on the same side of the lines. Figure 6 shows the eight pieces fastened to the board B. Number the pieces 1 to 8, starting with the left-hand one as No. 1. Measure off a distance of 1 in. from the lower end of piece No. 1 and a distance of $1\frac{1}{2}$ in. from the lower end of piece No. 8, marking the points on the pieces with a light lead-pencil mark. Make 10 other marks, $\frac{1}{2}$ in. apart, on each of these pieces above those just made. Now, with the use of a straightedge, draw a line across all of the pieces as shown in Fig. 6, by means of the broken lines. Draw another set of lines $\frac{1}{8}$ in. above each of the first set and parallel to them. Cut 11 grooves in each of the struts to a depth of $\frac{1}{8}$ in., using the lines that are $\frac{1}{8}$ in. apart on the pieces as marks for the sides of the grooves.

When all the grooves have been cut, the pieces can be fastened to the two circular pieces, or heads, shown in Fig. 5. Drill a $\frac{1}{8}$ -in. hole in each end of the eight struts, $\frac{1}{2}$ in. from the end. Obtain 16 round-headed brass screws about $\frac{1}{8}$ in. in diameter at the shank and 2 in. long. The eight struts should now be fastened in the grooves in the two heads by means of the brass screws. The struts should be placed in regular order around the circular pieces, starting with No. 1 and ending with No. 8. When the cage thus formed has been completed, give it several coats of shellac.

The frame of the helix may be raised above the surface upon which it is to rest by means of three wooden legs similar to those shown in Fig. 7. These legs can be fastened at three equally spaced places on the under side of the cage by means of two screws that pass through the holes H_1 and H_2 into the lower head of the helix.

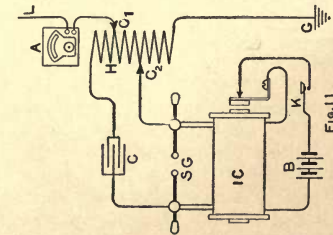

Fig. 11

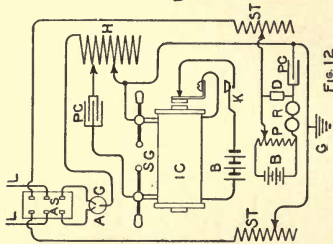

Fig. 12

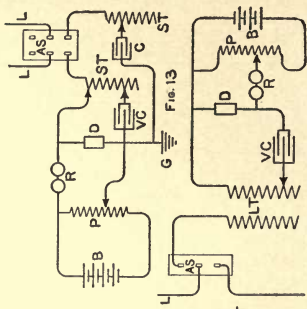

Fig. 13

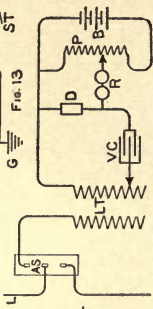

Fig. 14

Sending and Receiving Sets

About 32 ft. of No. 8-gauge bare copper wire will be needed for the winding on the helix. Drill a $\frac{1}{8}$ -in. hole through the lower end of strut No. 1 in the center of the groove. Pass about 3 in. of the wire through the hole and proceed with the winding, placing the wire in the grooves in the struts, using considerable care in not bending the wire too abruptly where it passes over the various struts. A $\frac{1}{8}$ -in. hole can be drilled in the center of the upper groove in strut No. 8 and the end of the wire passed through it, which will serve to hold the winding in place.

The two ends of the winding should be given one half turn around the struts through which they pass and two small binding-posts may be soldered to them to serve as terminals to the coil.

The connections A and D, Fig. 4, can be made by means of two small clips soldered to the ends of flexible cords. These clips can be made as follows: Turn out of some hard rubber two pieces whose dimensions correspond to those given in Fig. 8. Cut from some spring brass two pieces similar to the ones shown in Fig. 9. Drill a small hole, H, in this piece, as shown in Fig. 9, and bend it into the form shown in Fig. 10. Obtain two pieces of good rubber-covered wire, about 3 ft. long (preferably a flexible conductor), pass one end through the hole H in the rubber handle, as shown in Fig. 8, and solder it in the hole H in the piece of spring brass shown in Fig. 10. Pull the wire back through the handle and force the spring clip in place. After the clip has been forced into place, a piece of rubber should be cut and placed between the two parts P_1 and P_2 as shown in Fig. 10.

In the operation of a transmitting station such as that shown in Fig. 4, it is desirable to know the value of the current in the conductor to the aerial so that the

proper adjustment of the circuit may be made in order that the energy transmitted by the station be a maximum. The only instrument suitable for the measurement of this current is a hot-wire ammeter. Its operation depends entirely upon the heating effect of a current and its indications are not influenced on account of the direction of the current changing. If a hot-wire ammeter of suitable range is obtainable, the adjustment of the sending station can be made as follows: Connect the ammeter in circuit as shown in Fig. 11. Place the two movable clips C_1 and C_2 on the helix near its center, close the key in the primary circuit and note the ammeter reading. Move both the clips along the helix until you find the point giving a maximum indication on the ammeter. Fasten the clip C_2 at this point and then move C_1 until you get the maximum reading on the ammeter. When this adjustment is secured, the two circuits are in "tune."

Figures 1, 4 and 12 show three different types of sending sets, while figures 12, 13 and 14 show three different types of receiving sets. Figure 1 shows an "open-circuit sending set," Figure 4 a "tuned sending set" and Figure 12 a "loop aerial system" for sending. Figures 13 and 14 show two "tuned receiving sets" and Figure 12 a "loop aerial system" for receiving. The letters in the above diagrams refer to the following apparatus:

B—Battery
 C—Fixed Condenser.
 D—Detector.
 G—Ground.
 H—Helix.
 K—Key.
 L—Lead to Aerial.
 P—Potentiometer.
 R—Telephone Receiver.

AG—Anchor Gap.
 AS—Aerial Switch.
 IC—Induction Coil.
 LT—Loose Coupled Coil.
 PC—Plate Condenser.
 SG—Spark Gap.
 ST—Straight Tuning Coil.
 VC—Variable Condenser.

New Revised Enlarged Edition
of Our Popular Book for Boys

Mechanics for Young America





Gives plain directions for making scores of articles which delight the heart of the average youth. This volume has been thoroughly revised from cover to cover and improved where possible. Much entirely new matter has been added making the book unusually instructive and interesting.

Some of the things which it tells how to make are:

Boats of Many Kinds
Magic Lantern
Electric Searchlight
Small Steamboat
Electric Engine
Model Yacht
Sailing Cycle
Paper Aeroplane
Water Bicycle
Water Motors
Ice Boat
Bell Tent
Camps and How to Build Them
Small Steam Turbine
Fishing Tackle
Crossbow and Arrow
Coin Purse
Camera
Kites of Many Kinds
Overhead Trolley Coaster
Electric Furnace Regulator
Ornamental Iron Work
Devices for Winter Sports
Home-Made Roller Skates
Trailer for a Bicycle
Combination Telegraph and Telephone Line

Price 25c Postpaid

Mechanics for Young America

 Ice Boat	A Book for Boys — How to Build	 Sailing Bicycle
BOATS, WATER MOTORS, WIND MILLS, SEARCHLIGHT, ELECTRIC BURGLAR ALARM, ICE BOAT, WATER BICYCLE, CABINS, CAMPS, CLOCKS, FISHERY TACKLE, KITES, IMITATION STREET CAR LINE, ETC.		
 Water Bicycle	The Directions are Plain and Complete — COPYRIGHT POPULAR MECHANICS PUBLISHING	 Street Car
PRICE 25 CENTS		

150 Articles, 128 Pages, 221 Illustrations

Order of your newsdealer or send direct to the publisher

POPULAR MECHANICS CO.
CHICAGO

Amateur Mechanics No. 1

A Valuable Book

Of Exceeding Interest to the Practical Mind
FOR BOTH OLD AND YOUNG

Part Contents

Acetylene Gas Generator, Home-Made
Alarm, Callers' Approach
Alarm, Cheap Fire
Alarm, Combined Door-bell and Electric
Arc Light, Home-Made
Auto, Young Mechanic Builds
Batteries, Connecting to give any Voltage
Boat, Paddle, How to Make
Camera, Pictures Without
Cannon, How to Make
Door Opener, Electric
Draft Opener, Automatic
Electric Lighting, Miniature
Electric Lamps, Experiments with
Electrical Experiments, Interesting
Electro-Plating
Foundry Work at Home
Furnace, Small Brass
Hammock, Barrel Stave
Incandescent Lamp, Lighting with
Induction Coil
Jump Spark Coil, How to Make
Kite, Box, How to Make
Lathe, How to Make
Lock, Automatic
Locomotive, Neat Model
Magic, Parlor
Motor, Small, Reversing
Photographs, Freak, How to Make
Porch Chairs, How to Make
Rheostat, Battery
Steam Engine, Toy, How to Make
Telegraph Line, One-Wire
Telescope, Farmer's Boy Builds
Toboggan Sled, How to Build
Wireless Telegraph, How to Make

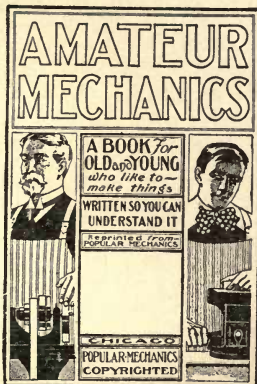

Price 25 cents postpaid

Contains 174 Articles ——— 165 Illustrations

"Amateur Mechanics" is a thorough, practical book for old and young. Tells how to make hundreds of different articles of daily use. This book should be in every American home.

"Written So You Can Understand It"

For sale by all Newsdealers or may be ordered direct from the
Publishers

Popular Mechanics Book Dept.
CHICAGO

Amateur Mechanics No. 2

Price 25 cents, postpaid

Bigger and better than No. 1; contains entirely different matter, yet along the same interesting, practical lines; tells how to make hundreds more different articles of daily use, among which are:

Air Thermometer
Ammeter
Arts and Crafts Leather Work
Balloon, Pilot
Barometer
Battery Cell, Dry
Battery, Small Storage
Bicycle Catamaran
Boomerangs
Candle Shade
Canoe, Sailing
Cart, Home-made Dog
Coil, Induction
Copper Trays
Electric Lamps, Miniature
Electric Locomotive, Miniature
Electric Post Card Projector
Flash Lamp
Flying Machine
Geissler Tube, Small
Glider, Aerial
Induction Motor
Kite Reel
Lamp Stand and Shade
Lantern Slides
Library Table, Mission
Merry-Go-Round Swing
Micrometer
Microscope
Motor, Small
Motorcycle
Pocket Lamp
Punt
Rabbit Trap, Self-Setting
Rustic Seat
Stage, Miniature
Static Machine
Volcano, Miniature

NUMBER 2

25 CENTS



Water Wings
Windmill, Stationary
Wireless Telegraph, Simple
Wireless Telephone
Workbench
X-Ray Instrument

Interesting to the Practical Mind, Both Old and Young, and "Written So You Can Understand It"

128 Pages — 193 Articles — 196 Illustrations

For sale by all newsdealers or may be ordered direct from publishers

POPULAR MECHANICS BOOK DEPT.

318 W. Washington St., Chicago

Mission Furniture

50c

How to Make It

50c

PART I

THIS is the first of a series of handbooks on industrial subjects to be issued from time to time by POPULAR MECHANICS. This book consists of a number of articles telling how to make a large assortment of pieces of mission furniture. It is fully illustrated and the directions are accompanied by dimensioned working drawings.

Like POPULAR MECHANICS, it is in *plain, simple language* and "*Written so you can understand it,*" so that anyone possessing a slight knowledge of how to use tools can easily make the various pieces described.

Among the contents are:

Forty Styles of Chairs, An Easily Made Book-Shelf, How to Make a Porch Chair, A Portable Table, A Pyrographer's Table, How to Make a Mission Library Table, How to Make a Lamp Stand and Shade, How to Make a Roman Chair, A Home-made Mission Chair, A Home-made Mission Book-Rack, How to Make a Tabouret, Another Mission Chair, How to Make a Roll Top Desk, Home-made Lawn Swing, A Mission Candlestick, How to Make a Magazine Stand, How to Make a Blacking Case, How to Make a Mission Shaving Stand, How to Make a Piano Bench, A Dresser for a Child's Play-room.

It has 96 pages; is attractively bound in cloth covers, and can be ordered of any newsdealer in the U.S. or will be sent to any address upon receipt of the price, 50 cents, by the publishers.

Popular Mechanics Book Dept.

50c

CHICAGO

50c

50c**PART TWO****50c**

Mission Furniture

How to Make It

32 New and Approved Designs

**A Large and Varied Selection
of Immensely Popular Pieces,
Among Which Are:**

Two China Closets—Two
Arm Chairs — Rocker —
Side Chair—Mantel Clock
—Lamp Stand—Two Foot
Stools—Bookcase—Maga-
zine Table — Smoking
Stand—Wall Case—Waste
Paper Basket — Music
Stand—Hall Clock—Cedar
Chest — Child's Dresser
— Couch — Oil Lamp —
Grill—Two Writing Desks
— Library Set — Buffet —
Bedstead — Dining Table
— Medicine Cabinet—
Telephone Stand — Plate
Rack — Dining Room
Shade.

Complete dimensioned
working drawings, ex-
plicit instructions how
to make, and half-tone
illustrations of the fin-
ished pieces.

Special Features Are:
Articles describing how
to produce the different
finishes and showing
methods of making
joints and bending
wood.

**“Written So You Can
Understand It”**

May be ordered of any news-
dealer in the U. S. or will be
sent to any address postpaid
upon receipt of the price,
50 cents, by the publishers.

128 Pages, Cloth Cover

POPULAR MECHANICS COMPANY
CHICAGO

Art-Crafts Lamps

How to Make Them

By JOHN D. ADAMS

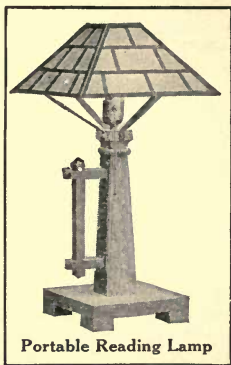

Portable Reading Lamp

16 Beautiful Designs

As Follows :

Two Light Portable—
Portable Reading—Four
Light Chandelier—Read-
ing Lamp—Dining Room
Dome—Porch or Den
Lantern—Four Light
Chain Hung Chandelier—
One Light Portable—Lan-
tern—Drop Light—One
Light Bracket—Piano
Lamp—Wall Lamp—Elec-
tric Candle Sconce—
Newel Post Lamp—Chain
Hung One Light Bracket.

PRICE 50 CENTS

Plain Instructions—Dimensioned Detail Draw-
ings and Illustrations of Each Finished Design

A handy little working manual of 96 pages, printed
on the best quality of book paper and handsomely
bound in cloth. Supplied by your newsdealer
or may be ordered direct from the publisher

Popular Mechanics Book Department
CHICAGO, ILL.

A GOOD, USEFUL BOOK

Wood-Working for Amateur Craftsmen

"WRITTEN SO YOU CAN UNDERSTAND IT"

By IRA S. GRIFFITH, A. B.

128 Pages, 125 Illustrations
Cloth Cover, Size 5x7 inches



Price
50 Cents
Postpaid

**One of the latest of Popular Mechanics Series
of Industrial Handbooks**

This book was especially designed to cover every essential step from the A B C to the X Y Z of wood-working. The chapters dealing with making special articles bring out every cut, joint and process used in this important trade, and the proper use and care of tools, working up of materials, etc., are treated thoroughly and plainly.

CONTENTS:

Making Out a Stock Bill—Laying Out Rough Stock—Hand Saws—Sawing with Hand Saws—Planes: How to Set and Adjust the Irons—Squaring Up Mill Planed Stock—Squaring Up Rough Stock—Whetting Plane Irons and Chisels—Grinding Plane Irons and Chisels—Making a Bird Box—Making a Tabouret—How to Make an Umbrella Stand—Making a Magazine Stand—Making a Table—Making a Cabinet.

**A valuable book for either self instruction or
use in manual training courses**

Order of your Newsdealer, Bookseller or direct from
Popular Mechanics Book Dept., Publishers
CHICAGO, ILLINOIS

Metal Spinning

50c

By PROF. F. D. CRAWSHAW
Assistant Dean, College of Engineering
University of Illinois

50c

METAL SPINNING is one of the *Popular Mechanics Handbook Series* and has 80 pages, 33 illustrations, is bound in attractive cloth covers and printed on a fine quality of paper.

This handbook is unique in that it is the *only book published* on this interesting art, instructions regarding which have previously been handed down by word of mouth from generation to generation of expert metal spinners.

It is "Written so you can understand it" by a man well qualified because he has made a thorough study of all obtainable information on the subject. He has tried out the different methods himself and herein he sets forth the best practice.

Concise, yet complete, this book is adapted to use as a text in manual training and industrial schools and will be found a practical working manual both by those who desire to spin metal as an art recreation and those who wish to follow this work as a trade.

Explicit instructions are accompanied by figures to illustrate the meaning. It tells not only what tools are required, but how to make each kind. Definite forms to be spun are treated, and finally the unclassified and more difficult work is dealt with.

Contents: Chapter 1, The Lathe and Its Uses; 2, Tools; 3, The Preparation of Metal for Spinning; 4, How to Spin a Shallow Dish; 5, How to Spin a Deep Dish; 6, How to Spin a Vase; 7, How to Spin Some Unclassified Forms.

Price 50 Cents, Postpaid

**Popular Mechanics Book Dept.
CHICAGO**

Metal Work and Etching

"WRITTEN SO YOU CAN UNDERSTAND IT"

By JOHN D. ADAMS

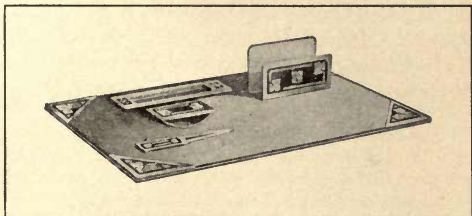

ONE of the latest of the POPULAR MECHANICS series of industrial handbooks. A complete manual for art metal workers giving every detail for making a great variety of useful and ornamental objects such as book ends, desk sets, pad corners, paper knives and letter openers, stationery racks, rocking blotter, desk calendars, match boxes, tie and pipe racks, whisk broom holders, candle sconce, arts and crafts jewelry, hinges, drawer pulls, etc.

96 Pages, Richly Illustrated, Cloth, Size 5x7 Inches

Price, 50 Cents, Postpaid

ORDER OF YOUR NEWSDEALER, BOOKSELLER, OR

Popular Mechanics Book Dept., Publishers
CHICAGO

NOW READY

Electroplating

"WRITTEN SO YOU CAN UNDERSTAND IT"

BY HENRY C. REETZ

PRICE 50 CENTS POSTPAID

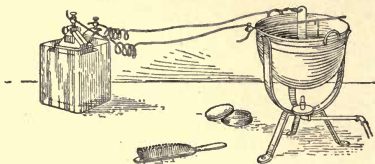

112 PAGES FULLY ILLUS., CLOTH COVER, SIZE 5X7 IN.

*One of the latest of Popular Mechanics Series of
Industrial Handbooks*

THIS handbook gives brief and practical directions calculated to be of benefit to those already engaged, as well as to those about to engage, in the electroplating business, with no more technical detail than is necessary for practical work, and yet with such explicit directions concerning the actual operations as an old hand at the business thinks may be useful to the beginner.

CONTENTS:

Introduction — Electrical Equipment — Shop Equipment —
Cleaning Goods before Plating — Copperplating — Nickelplating
— Silverplating — Goldplating — Miscellaneous — First Aid to
the Injured — Business Suggestions.

Order of your Newsdealer, Bookseller or

POPULAR MECHANICS BOOK DEPT.
PUBLISHERS CHICAGO

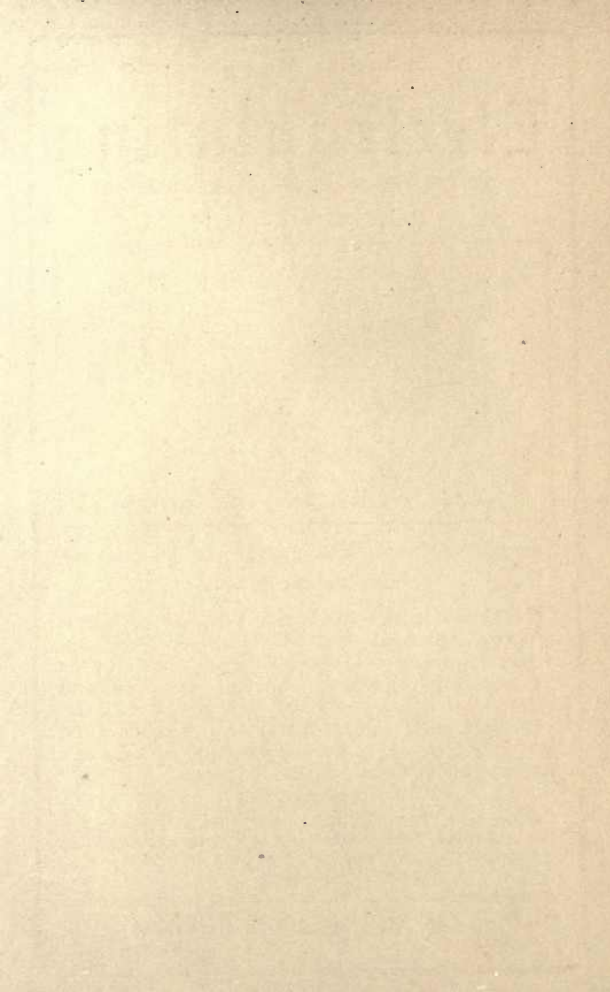



University of California
SOUTHERN REGIONAL LIBRARY FACILITY
405 Hilgard Avenue, Los Angeles, CA 90024-1388
Return this material to the library
from which it was borrowed.

AUG 18 1993

RECEIVED

DEC 20 1993

EMS LIBRARY

UC SOUTHERN REGIONAL LIBRARY FACILITY



A 000 036 431 5

California
Regional
Library