

Radio Frequency

**Treatise
on
Radio-Frequency
Reception
for the Engineer
and Layman**

10 Cents a Copy

**RADIO SERVICE LABORATORIES
RASLA SALES CORPORATION**

Radio Service Laboratories 1922

Asbury Park, N. J.



Contents

Introduction

Radio-Frequency Amplification

Radio-Frequency Transformers

Radio-Frequency Amplifiers

General Circuits

R.S.L. Radio Transformers

Copyright 1922 by
Radio Service Laboratories

RASLA SALES CORPORATION

National Distributors

10 East 43rd Street

New York, N. Y.

Radio Frequency

(Introduction)

The rise of Radio Phone broadcasting stations, and the great radio audience resulting, has created not only a demand for radio sets and parts, but has imposed requirements of design of the highest order for those companies who shall continue in favor. Radio reception in future must be conducted on engineering principles. The receiver can no longer be a careless assembly of parts that will bring in a signal. The list of requirements that successful receiving apparatus must meet is long, yet none can be overlooked. The following items must all be considered.

A good receiver must be simple and direct in operation. Many and complicated adjustments are discouraging, unnecessary, and generally defeat their purpose. Quick, accurate, reliable adjustments are a necessity. The old attraction that Radio still gives to the "amateur" of hearing a still more distant call, is not lost upon the new audience, and the pleasure of hearing a more distant concert than his neighbor is a distinct pleasure for every listener. The delight of clear programs without interference or atmospheric disturbances, and the accomplishment of these results with a minimum of apparatus —without the outdoor aerial in fact —imposes, therefore, the requirements of high sensitiveness and high selectivity.

Efficiency is generally most considered at the transmitting stations, but is as highly important in the modern receiver. A roomful of cabinets, wires and batteries relegates Radio to the position of a fad or a boy's plaything. Neat and compact sets, and parts of accurate and efficient design, both electrically and mechanically, of best quality and workmanship and of pleasing appearance must constitute the successful receiver.

Musical reproduction in perfect quality of strength and tone, and speech intelligible and recognizable, are absolutely essential factors. The receiver, which endeavoring to operate, radiates power to the interference of other listeners, will eventually be restrained.

These, and still more technical considerations, mean that Radio apparatus must be designed, not assembled; that Radio must be engineered. The Radio Service Laboratories, incorporated by a nucleus of engineers having experience in practically all phases of the art, especially that branch utilizing the vacuum tube, have anticipated the demands which must be met, and their efforts thus far have been directed to the development of receiving methods and apparatus along direct and logical lines.

Radio-Frequency Amplification

The methods of reception in radio are too numerous to be explained in detail here. The simple crystal detector alone, for converting the high frequency radio waves to supply the audible frequency current to the telephone receiver, lacks sensitivity and selectivity. A single vacuum tube detector is more sensitive, and in addition amplifies the produced audible signal to some extent. When connected regeneratively to "feedback," the received radio wave, it becomes more selective and acts as a limited radio frequency amplifier. When further aided by two audio stages of amplification it constitutes the most familiar type of receiver employed with ground and outdoor antenna. Such a receiver may be made sensitive and selective when loosely coupled to a good aerial, but to obtain such results the adjustments render simple operation impossible. When deprived of the multiple adjustments, the interference received is a source of constant annoyance. The sensitiveness of such an arrangement is conceded to be too low for effective operation on an indoor loop aerial.

The progressive trend is then for a directly operating sensitive receiver; a receiver of high sensitivity to operate on an antenna if desired, but mostly to be effective on an indoor-loop receiver and to require only a single-tuning adjustment.

*Radio-frequency amplification offers unusual advantages in receiving radio signals of all types, especially radio phone or modulated waves, over all other known methods of receiving. The use of audio amplification is familiar to operators and is known to be limited. A signal which is too weak to operate the detector tube can never be amplified by audio amplification, regardless of the number of stages used. After the signal is strong enough to operate the detector, audio amplification is effective up to two stages. Audio amplification, beyond this, is limited by distortion and inherent audio tube noises.

*By radio amplification the original weak incoming signal is raised to a value for effective operation of the detector tube. Regardless of how weak the signal is to start with, a proper radio amplification will bring it up to sufficient strength to make the detector function, after which audio amplification may be applied. Stations which are normally beyond range can, therefore, easily be brought in by using radio amplification.

Radio frequency amplification is readily accomplished by the use of additional vacuum tubes preceding the de-

*The paragraphs marked with the asterisk, as well as other material in this pamphlet were originally published in the Radio Service Laboratories bulletin No. 101, of December 1921. These paragraphs have been generally copied in descriptive bulletins, magazines and radio text.

detector tube arranged in what is termed "cascade" connection. This means that the radio wave received by a loop receiver or ordinary tuner is applied to the grid or input of the following tube through a suitable coupling device. Each vacuum tube and coupling device used preceding the detector is termed a stage of Radio amplification, and the number of stages used is dependant upon the efficiency of the vacuum tube and coupling device, the wave length or frequency amplified and the methods of connection and control.

The coupling device used is the heart of the amplifier, and in the design of it the success of amplification is determined. Long wave lengths may be readily amplified by a resistance coupling device wherein the voltage developed across a resistance in the plate circuit of one tube is passed on through condensers to the input of the following tube. Resistance coupling is not critical in that it operates for all of the longer waves (waves over 3000 meters) fairly well, but it lacks the advantages which a step-up transformer will give on long waves and loses entirely the voltage increase which obtains through a proper use of resonance or tuning, and which alone is effective for short wave amplification. At the short wave lengths, such as amateur and public broadcasting stations are using, resistance coupling is futile. The elements of the vacuum tube itself act as small capacities or condensers and these small capacities offer so low an impedance to the short waves that they effectively short circuit the resistance coupler for the short wave lengths. Reactance coupling, or coupling which uses a choke coil substitute for the resistance coupler, can be made responsive to short wave lengths, but requires in itself an adjustment of each stage used for each wave length received. Condensers and grid leaks must accompany the reactance coupler and lack of damping or resistance in the device results in poor stability of such an amplifier.

Radio-Frequency Transformers

Radio-Frequency Transformers are direct coupling devices, requiring no additional condensers or grid leaks and with proper design can be made highly responsive on both short and long waves. Broad ranges of wave length and stable operation of several stages with large gains on each stage used are demonstrated facts using Radio-Frequency Transformers. Greater stability of operation is obtained when the transformers are limited by design to a narrow band of the short wave lengths and cascade operation is more simple. With proper design of the transformer a broader range of wave lengths is readily covered, but more care must be exercised by the user in connecting his set. The ratio of primary to secondary turns is less of a determining factor in Radio-Frequency Transformers than

in those for lower frequencies. For this reason transformers that have appealed to buyers by possessing a step-up ratio of windings will generally be found to operate as well reversed to give a step-down ratio. The voltage built up by a successful transformer is determined through what can be termed "automatic resonance" on all wave lengths of its operating range. The proper use of iron to give stability through its damping (introduced losses) and magnetic permeability to the circuits, as well as to confine the magnetic flux path solely within the transformer, together with windings arranged to reduce capacity coupling effects are the basis of design for efficient Radio-Frequency Transformers.

*By using a correct radio transformer the incoming signal frequency is amplified without the accompanying tube noises and local sounds, since the transformer will not respond to low-frequency or audio sounds. Jarring the tubes, etc., will, therefore, not produce a ringing sound or disturb the receiver in any way, as with audio, nor limit the number of stages or radio amplification which the operator desires to use.

Perfect reproduction of tone and quality is an inherent property of radio-frequency amplification. The audible tones, such as speech and music, exist only as a "modulation" of the received radio wave, i. e., the audible signals appear in the form of variations in the strength of the received radio wave and only appear as the audible frequency currents after they have been developed by the detector. It is only by abuse of radio-frequency amplifying methods and parts that distortion of tones can occur. The use of highly tuned or resonant coupling devices such as air core transformers, or capacity tuned units, results generally in distortion through limiting the variations in the radio wave it seeks to amplify, i. e., through excessive resonance the radio wave with its modulation is not faithfully reproduced, resulting in distortion before the detector is reached. The lack of shielding or confining the magnetic flux to the transformer or coupling device where iron is not used as a core or flux path, results in undesirable feed-back action between the radio stages. This misapplied feed-back action may defeat amplification or raise it uncontrollably to a point within stages where further distortion or local oscillations renders reception impossible.

Radio-Frequency Transformers manufactured by the Radio Service Laboratories, Inc., are designed by engineers having a thorough knowledge of the subject, through years of experience in this country and abroad. The transformers, by actual tests, are superior to any domestic or foreign make which is known, and are probably as fine as can be designed. These statements can be made because of several unusual features incorporated in R. S. L. transformers, protected by this company and available only to

it. All type numbers of R. S. L. transformers, regardless of their range, possess these advantages.

Some features of the Radio Service Laboratories, Inc., Radio-Frequency Transformers are:

Iron Circuit—The comminuted iron core construction (patent pending) accomplishes the threefold purpose of shielding, magnetic permeability and damping. The special form of divided magnetic material completely encloses the bobbin. This core limits eddy current losses, and in addition allows the transformer to be made of the same convenient size for all wave-length ranges. One important function of this core is that of broadening the wave-length range of the transformer without decreasing the efficiency. The iron having a greater permeability at the long waves than at the short, gives a high value of inductance when receiving a long wave, and a low value of inductance when receiving a short wave, thereby amplifying over a broad range. The proper resistance or damping is introduced in the windings through correct amount of losses in the iron to give stability of operation and render cascade operation of stages successful.

Shielding—The iron completely surrounds the transformer bobbin or windings on all sides and ends, preventing stray fields of flux, which in open-core or air-core forms of transformers, are present, and limit the number of stages which can be used by giving rise to undesirable feed-back action.

Air-Gap—In some types of R. S. L. Transformers a thin air-gap is utilized in the iron circuit to bring each transformer to the same operating wave-length range. This air-gap is placed inside the bobbin where the escape of any leakage flux to the external circuit is prevented by the comminuted iron core which completely surround all sides and ends of the windings.

Capacity Effects Eliminated—Capacity effects are of two varieties within the transformer: (a) Capacity effects between turns, which limit the number of turns or inductance a winding may have for a given wave-length, are reduced by using a small diameter winding. (b) Capacity coupling between the windings is made negative by reversal of the secondary leads so that the magnetic coupling nullifies it. The transformer therefore operates only by magnetic exposure or coupling.

Mounting—Two mounting tabs are a moulded part of the base enabling the transformer to be screwed in place for temporary or permanent use in an amplifier. The binding posts are of such strength and so securely fastened that the transformer may be hung by these posts from a transformer shelf located below the tube shelf in an amplifier. When this arrangement is used the four moulded knobs are sufficient to hold the transformer to the shelf and offer a rapid method for removing the transformers of one

wave-length range and replacing transformers of another wave-length to suit the reception desired.

Insulation and Engineering Construction—R. S. L. transformers are designed with careful regard for the elimination of all leakage currents. The container is of the best grade of moulded condensite, completely protecting the delicate windings and lead wires from breakage, however roughly they are handled. The condensite insulation is a guarantee of maximum efficiency and a guarantee against a leaky, noisy transformer. The bobbin upon which the primary and secondary turns are wound is also of moulded condensite, preventing internal leakage. The four binding posts are made with square shanks which fit square holes in the transformer top. It is therefore impossible to turn these posts in anyway to injure the lead wires within the transformer case.

Testing—It is important for the buyer to realize he is purchasing thoroughly tested apparatus. A triple test is made on all transformers in connection with their production, which is the best guarantee to the purchaser. The three tests which every transformer receives are:

Test of Windings—The bobbins when wound and sealed are tested for continuity of winding and for shorts and leaks. The resistance of each winding is exactly checked.

Test of Inductance of Windings—After assembly of the bobbin within the container a careful check is made of the inductance of the primary and secondary, and of their coupling, to insure the consumer against any wrong connections or hasty, careless construction.

Test for Amplification—After the iron core is assembled and the transformer sealed, each transformer is given an actual circuit test in a radio-amplifier, the gain in signal strength being noted over that of the detector tube alone and required to meet the gain of our standard laboratory models.

Such complete testing might be doubted by the reader unless explained. Test sets utilizing mercury cup connectors make rapid production tests possible and absolute contacts to the transformer post for each test a certainty. Thus quantity testing is simple and accurate for each of the three tests and facilitates rather than handicaps production.

Connections—In a radio-frequency amplifier it is highly important to have all connecting wires as short and direct as possible. Loose wires and long connections give rise to undesirable feed-back action which, unless corrected, may defeat the operation of the transformers. The binding posts are arranged for most direct connections when the transformer is mounted in a panel type amplifier using the transformer shelf mounted below the tube shelf or when the amplifier is built upon a board. The condensite top shown

in Fig. 1 is marked with the figures P, G, 1, 2, indicating the post P1 between P and 1; P2 between P and 2, etc. For cascade amplification the connections should be as follows: P1 to the plate; P2 to the positive (+) B battery; G1 to the grid of the following tube, and G2 to the filament.

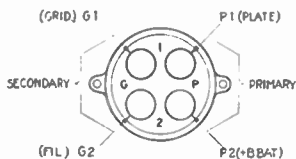

FIG. 1

The manner in which the connection of post G2 is made to the filament circuit may be varied and examples are shown in circuit diagrams elsewhere in this pamphlet. The success of amplification often depends upon the mode of connection of post G2 in a given amplifier scheme. Therefore, careful attention should be paid to such connections when use of any of the diagrams is made.

Radio-Frequency Amplifiers

Radio-Frequency Amplifiers require careful and exact work in construction and the use of the best apparatus. When properly built the operation of the amplifier is more simple and direct than any other type of receiver.

In constructing a Radio-Frequency Amplifier care should be taken to make all wiring as short and neat as possible. This means physically placing the transformers as near as possible to the tubes which they couple. Switching arrangements for changing the number of stages used should be avoided since the wiring of such switches invariably leads to long connections.

Vacuum tubes for Radio-Frequency purposes should have as small capacity between elements as possible. Since a choice of tubes cannot be made the R. S. L. transformers are designed and tested on standard market tubes and claims are made from tests with these tubes. A critical selection of tubes is unnecessary with these transformers and interchanging will give no increased results unless the operator should be using a defective tube. The transformers are not critical to filament temperature excepting in that the temperature of filaments should not be allowed to fall too low. Tubes in the radio stages in general should burn more brightly than those in the detector and audio stages. The operator's first consideration in failing to get results should be to his filament battery.

The plate voltage used should be from 40 volts up to as high as 120 volts. The gain with the higher voltage is worth its use, but results are obtainable on 40 volts plate

potential. The use of the standard soft detector tube is recommended, with a careful adjustment of its plate voltage, which is from 18 to 22 volts. Too high filament temperature of the detector tube will cause hissing noises, which means that a separate filament rheostat for the detector should be used.

The use of a tickler coil, or variometer, in the plate circuit of the detector tube to produce additional amplification through a feed-back is seldom satisfactory in Radio-Frequency Amplifiers.

The use of a filament potentiometer to bias the grids of the radio stages is shown in the various diagrams of this pamphlet. When proper use is made of this means of bias control, additional regenerative devices are of no value for improving the amplifier's sensitiveness since the selectivity in tuning is as sharp as can be had without self oscillations being generated.

By adjusting the potentiometer to bias the grids positive, grid current is drawn from the tubes which stabilizes the set, but reduces its sensitiveness. Adjusting the potentiometer to bias the grid more negatively increases the received signal strength until a point is reached on some wave lengths where oscillations are generated by the set. For broadcasting and modulated wave reception the bias should be set at a point just preceding oscillations. With transformers designed to cover a broad wave-length range the potentiometer is desirable. With transformers for the narrower bands, no such control is needed for one or two stages. Three stages are more effective with potentiometer control or some other means of introducing resistance into the receiver to stabilize it.

Stability of operation is a question generally evaded by manufacturers, and a little advice on this point is highly valuable. When receiving on a loop or a loosely coupled receiver with any amplifier of high sensitiveness, a loop or secondary of the tuner which is of high inductance, tuned by a small capacity, (for example, a coil which tunes to the broadcasting wave, at about 15 to 20 divisions on the usual .0006 variable condenser) will tend to destabilize the amplifier and cause it to oscillate. Fewer turns on the loop or secondary, with more capacity to tune it, (60 to 70 divisions on the .0006 variable condenser) will give stable operation of the amplifier and a greater signal strength in spite of the fewer turns of the loop, because the vacuum tubes are being operated more efficiently.

There are probably many enthusiasts already familiar with the operation of a detector, either regenerative or non-regenerative, and with audio amplification, who hesitate whether or not to improve their reception by the direct and logical methods of radio amplification, or by experimenting with indirect methods which are widely discussed, but as yet uncertain in operation. To these people we can with

all faith advise the direct method as cheaper in cost, more certain in operation, and more simple in control than any other method. Our own comparative tests show greater signal strength and sensitivity, using direct Radio Frequency Amplification than any other method we have tried or seen demonstrated.

The use of an indoor loop aerial is particularly recommended for use with Radio-Frequency Amplifiers. This does not mean that an outdoor antenna is not to be used; in fact, the antenna will bring in more and louder signals than the loop. When the antenna is used, however, it is desirable to use a loose-coupled receiver for tuning, in order that the antenna resistance shall not be introduced into the amplifier to render it less selective and sensitive. Also since the antenna receives from all directions, the interfering stations it receives, requires it to be sharply tuned for their reduction and loosely coupled to the amplifier through a tuned secondary. The loop receiver is directional. A maximum signal is obtained when the plane of the loop is pointed toward the desired transmitting station, and a minimum signal from that station is heard when the plane of the loop is at right angles to it. With a sensitive amplifier the loop may also act as a small antenna. The lead wires from the loop to the set will pick up noticeable energy, and if the wires from the batteries are long, their action will be like that of a ground connection. For these reasons true-loop reception, which means reception where the loop shows marked maximums and minimums when rotated, requires that the mentioned leads be short. The advantage of good directional quality in a loop receiver is in the reduction of interference and static from all directions, save that in which direction the loop is pointed. Frequently the operator may desire to add the antenna or ground to his set to pick up a new station. This may be done by connecting the antenna and ground across the loop terminals. The directional quality of the loop is then lost, and interference brought in. Once the station is heard, it is more satisfactory to use the loop alone, and locate the station free from interference.

Amplifier Circuits

The following diagrams are given as applying to all types of R. S. L. Radio-Frequency Transformers. Where a type of transformer calls for other circuit methods, additional diagrams and instructions will be found in the paragraphs relating to that transformer.

(12)

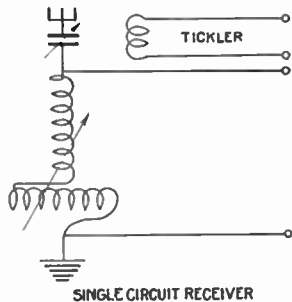
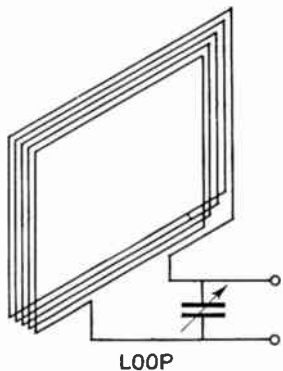

FIG. 2

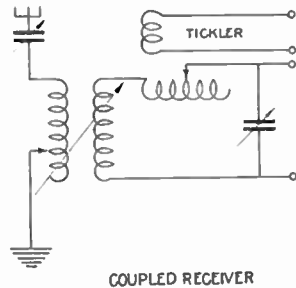

Figure 2 illustrates a loop receiver, a direct coupled receiver, and a loose coupled receiver. In view of the previous discussion of receivers, a loop is shown throughout the succeeding circuit diagrams, but it is to be understood that the other type receivers shown may replace the loop.

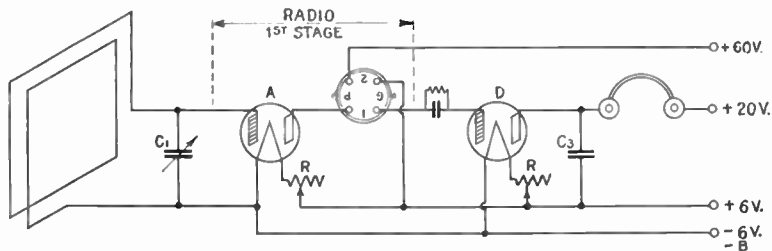

FIG. 3

Figure 3 illustrates one stage of radio amplification, and a detector without the use of any stabilizing control.

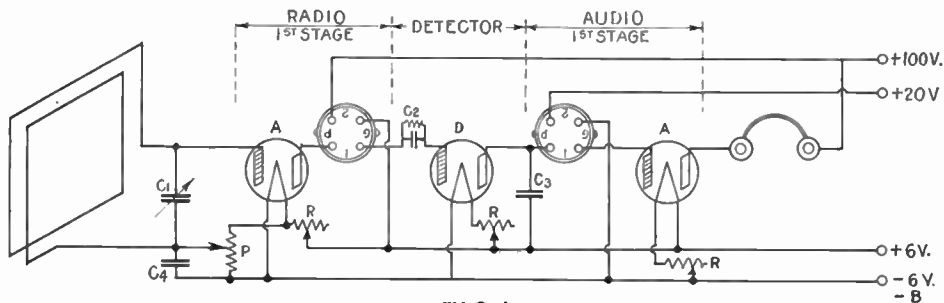

FIG. 4

Figure 4 illustrates one stage of radio, detector and one audio with grid bias control by use of a potentiometer.

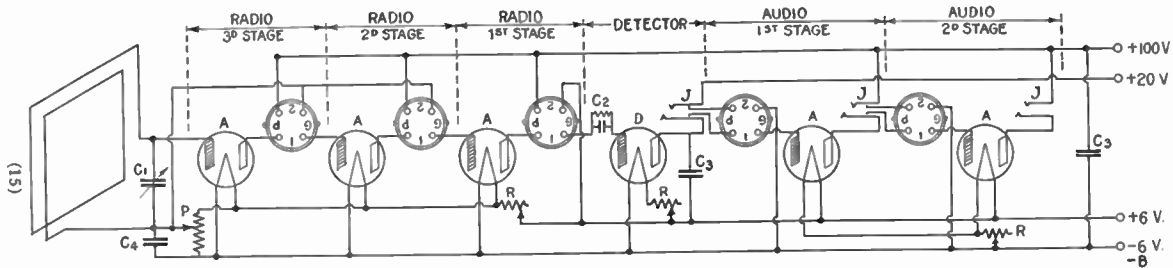

FIG. 6

Figure 6 illustrates three stages of radio, detector and two stages of audio with grid bias control.

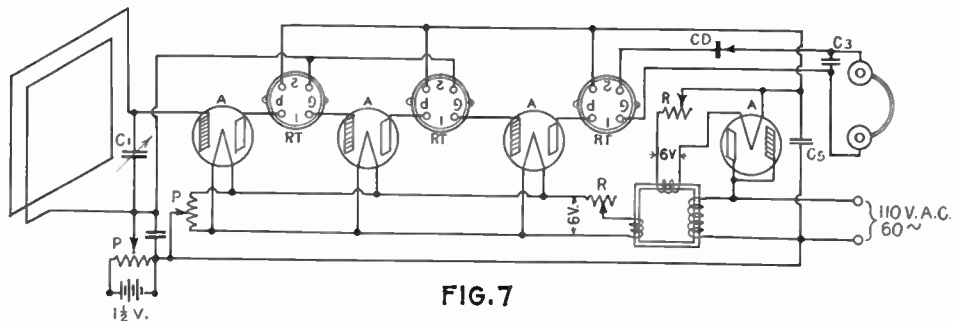

FIG. 7

Figures 7 and 8 are circuits given for the more advanced operator. Their use requires care and judgment, and are shown only to illustrate the many possibilities with Radio-Frequency Amplification.

Figure 7 shows means for utilizing 60-cycle alternating current to operate the filament and plates of the radio stages. Proper Radio-Frequency Transformers will not pass low-frequency currents, and hence will not repeat the 60 cycle currents, a fact which is not new, but which has not often been utilized. A crystal detector is illustrated with this circuit. The usual audio stage can be added.

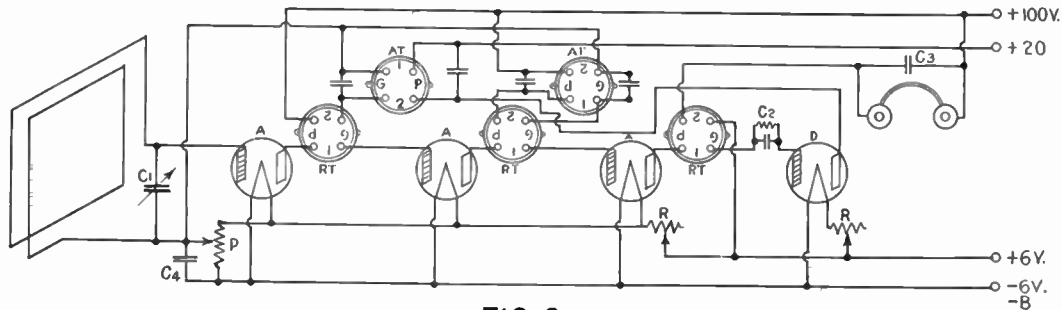

FIG. 8

REFLEX CIRCUIT

Figure 8 illustrates the combined use of the tubes to amplify, both as radio and audio stages simultaneously. Thus an arrangement of three amplifier tubes and one detector tube is shown to accomplish the results of three radio, detector, and two audio stages. This circuit requires great care in arrangement and connections, but with care, full amplification can be realized and the set made quite stable.

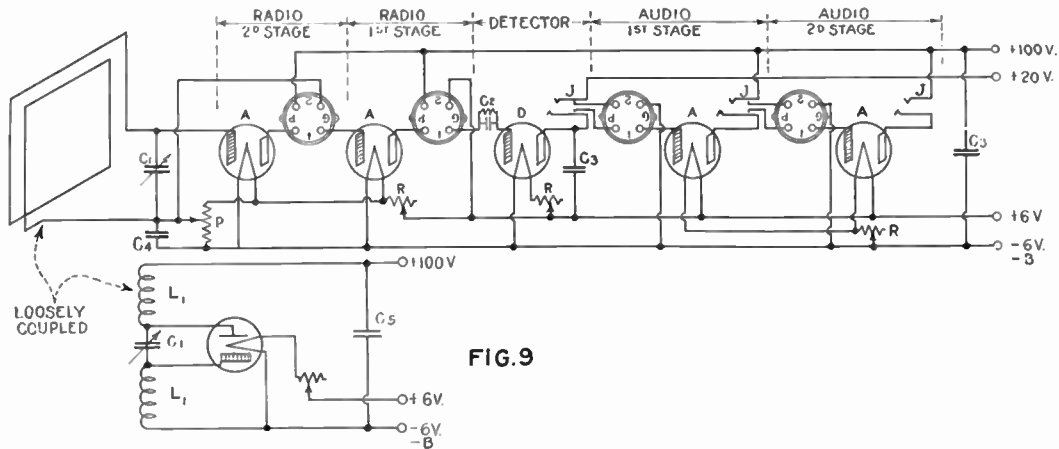

FIG. 9

Figure 9 illustrates the use of a separate heterodyne in conjunction with the R. F. Amplifier for C. W. reception.

R. S. L. Radio Transformers



Patent Pending

Types RT-5 and RT-5A—The types RT-5 and RT-5A are the first Radio-Frequency Transformers designed primarily for the amateur. The wave length range is from 150 to 300 meters. The ratio of primary to secondary turns is one to one. The usual grid bias control is recommended when using these transformers and the amplification per stage is exceptionally high.

Type RT-5 is used in the first stage (the stage nearest the detector.) Type RT-5A is used in the second and third stages. When using a single stage alone the RT-5A is used.

By adjusting the potentiometer control the amplifier may be made to generate oscillations, acting as a self heterodyne for receiving continuous wave, DX signals. It is, however, more satisfactory to use a separate heterodyne (an oscillating vacuum tube) loosely coupled to the loop or receiver used. Such an arrangement is illustrated in figure 9.

In tests conducted at the Radio Service Laboratories, using two stages of these transformers on a 16" loop, using no antenna or ground connections, stations up to a distance of one thousand miles have been readily picked up under summer receiving conditions. List Price \$6.00.

Types RT-6 and RT-6A—The types RT-6 and RT-6A are designed for positive results on broadcast reception.

The wave-length range is from 300 to 600 meters. The ratio of primary to secondary turns is one to one.

For one and for two stages no potentiometer control is necessary, unless the loop or receiver used has too high an inductance. Three stages are best operated with potentiometer control. The operation of these transformers in cascade is less critical than that of transformers covering a broader wave range, and requires less understanding of radio circuits on the part of the operator. The gain as each stage is added is closely equivalent to that of an audio transformer on a signal already audible with the detector alone. On weak signals the amplification per stage is of course much higher.

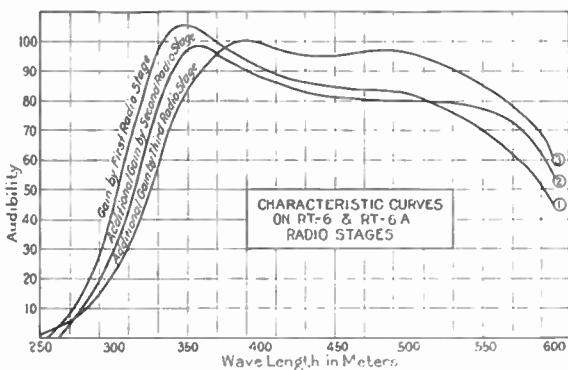

FIG. 10

Figure 10 shows the amplification curve of these transformers in their respective stages of operation. Each point on each curve shows the gain over a signal of unit audibility before the stage is added. Readings were taken using a standard General Radio Co. Audibility meter type 164.

In taking curves of operation on radio frequency transformers of high sensitivity the use of switching is impossible because of the changes in circuit operation due to introducing the wiring to the switches. The curves, therefore, were necessarily taken under actual amplifier operation conditions, inserting the audibility meter directly in the plate of the detector tube and averaging the results of a large number of audibility readings. The cumulative amplifications of two and three stages compared with the results on the detector alone was in all cases beyond the maximum range of the audibility meter and hence such values could not be plotted. The curve given showing audibility gain on adding the second stage, therefore, rep-

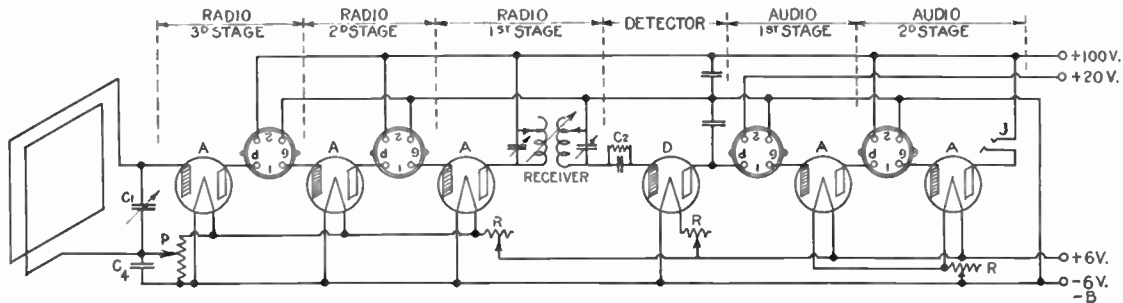

FIG. 11

Figure 11 illustrates the use of a coupled receiver used as a variable radio-transformer in the first radio stage. For broadcast reception RT- 6A transformers should be used in the second and third stages.

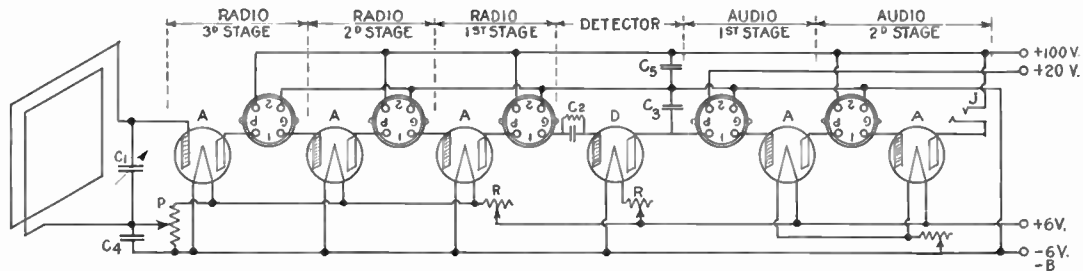

FIG. 12

Figure 12 illustrates the posts G2 of the transformers connected to the negative (-) filament. Here the potentiometer is only used to control the grid of the third stage of radio frequency for stabilizing.

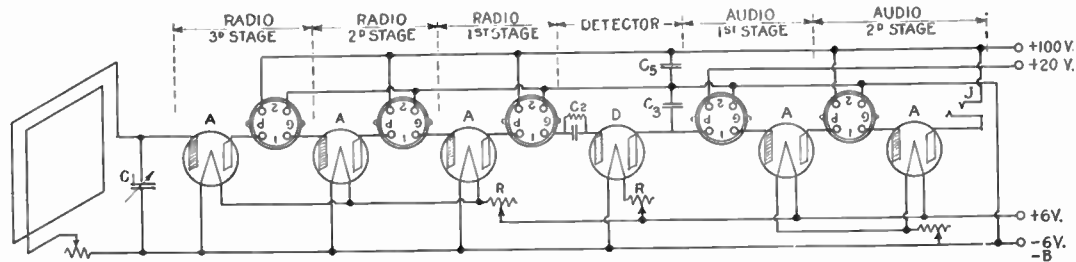

FIG.13

Figure 13 is similar to figure 12, except in manner of stabilizing control which consists of merely adding a variable resistance in series with the tuned loop circuit to introduce sufficient losses to prevent the set oscillating. This is a method frequently used in laboratory experiments and is quite satisfactory for control, provided the resistance introduced can be varied gradually and not in large steps.

resents the increase in a signal, barely audible on the detector, plus the first stage. The curve given showing audibility gain on adding the third stage likewise represents the increase in a signal barely audible on a detector plus two stages of radio amplification.

Figures 11, 12 and 13 are added at this point because users of the RT-6 and RT-6A stages generally prefer to operate with three stages of radio, detector and two audio, and desire a number of circuits from which to choose and experiment with. Figure 6, also, already shown, is a proper circuit for the RT-6 and RT-6A stages.

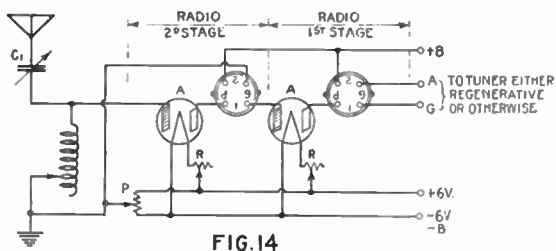

Figure 14 is a circuit which has been highly recommended by Mr. John G. Rieger, Radio Editor of the *Buffalo Evening News*. This circuit has been found to be very satisfactory for use with any standard receiver, including regenerative sets. The use of the direct coupled antenna indicated is possible with this circuit, the resistance which it introduces being compensated for by the regeneration in the receiver. This is the circuit mentioned in Mr. Rieger's letter shown on page 29.

In all the circuits type RT-6 is used in the first stage (the stage nearest the detector). Type RT-6A is used in the second and third stages. When using one stage only of Radio-Frequency amplification, better results will be obtained with the Type RT-6A, but RT-6 should always be used in the first stage when using two or three stages of radio-frequency amplification. List Price \$6.00.

Data

- A Standard amplifier hard tube.
- D Standard soft detector tube. (A standard hard amplifier tube may be used in place of the soft tube by connecting post plus 20 to post plus 100.)
- RT Radio Service Laboratories' Radio-Frequency Transformer.
- AT Radio Service Laboratories' Audio-Frequency Transformer.
- C₁ .0006 mf maximum variable air condenser. Use of a .001 mf maximum variable air condenser is fully as satisfactory and the use of one with a loop of fewer turns frequently results in greater stability.
- C₂ .00025 mf fixed mica condenser. A pencil mark for grid leak should be made shunting this condenser. Care should be taken to provide sufficient grid leak to prevent the tubes blocking, especially when three stages of Radio-Frequency Amplification is used.
- C₃ .002 mf fixed mica condenser. This condenser is a radio frequency bypass to allow the radio frequency currents to be repeated in the plate circuit of the detector for proper detection. This condenser prevents the radio entering the audio transformer or phones, and its discharge reinforces the audio frequency. Too large a value for this condenser would bypass and hence distort the audio frequency.
- C₄ .002 mf fixed mica condenser. This condenser bypasses the Radio-Frequency currents so they will not be obliged to pass through the resistance of the potentiometer. The potentiometer control is most satisfactory when this condenser is used, although satisfactory results can be obtained without it.
- C₅ .002 mf fixed mica condenser. This condenser is another Radio-Frequency bypass so that the radio-frequency currents need not pass through the A and B batteries. Operation is possible without this condenser, but its use is recommended and the larger its value the better. For circuit figure 7 it should be as large as 2 mf as in this position it is used to smooth out fluctuations in the rectified AC plate voltage supply.
- R Rheostat for filament control. 6 ohms variable.
- P Potentiometer, 200 ohms or larger.

Loop Receivers

In laboratory and practical work a large number of coil and loop receivers have been tested, ranging from small coils one inch in diameter, honey-comb coils and receiving coils of various tuners up to a single turn loop, ten feet square. Data is herein indicated on three practical receiving loops.

Square flat type loop, 23 inches square, 12 turns, $\frac{1}{2}$ inch space between turns to tune with .0006 mf maximum variable condenser.

Square spiral type loop, 12 inches square, 12 turns 3-16 inch space between turns to tune with .0006 mf maximum variable condenser.

Square spiral type loop, 16 inches square, 6 turns 3-8 inch space between turns. This loop is very stable in operation with an amplifier, when used with a .001 mf maximum variable condenser and is suitable for 200 meter amateur reception, using a .0006 mf maximum variable condenser.

Any stranded wire equal to a number 14 to 18 B. & S. gauge solid copper wire may be used in the construction of the above loops.

It has not been found advisable to use a loop with taps, since when using few turns the remaining turns act as an antenna and while they bring in additional energy in some cases they usually destroy the directional quality of the loop which is of value in avoiding interference.

All letters of inquiry as to the use of Radio Amplification in connection with a standard or home-made set should be accompanied by both an exact circuit diagram of the set with posts marked as on the set and also a sketch of the physical appearance of the set showing locations of posts with the same markings as on the circuit diagram. Without this information it will be impossible for us to give definite instructions for the adding of Radio Stages to particular sets. It is not sufficient to give the type number of a standard set; the diagram must be sent with the letter of inquiry.

Radio Service Laboratories Audio Transformers

The Radio Service Laboratories have completed the design of an Audio-Frequency Transformer which should be ready for the market by January 1st. This transformer is a mate to the Radio Transformer, being completely enclosed in the same case of condensite moulded in brown for distinguishing it. The circuit diagrams have indicated the connections using the RSL audio transformer, but any other make of audio transformer is similarly connected in the circuits shown. The new RSL audio transformer gives as high amplification per stage as the best obtainable and is absolutely without distortion.

Radio Frequency

TECHNICAL DEVELOPMENT CORPORATION
47 FIFTH AVENUE, NEW YORK

Oct. 30, 1922.

Rasla Sales Corp.,
10 East 43rd St.,
New York, N. Y.

Personally to Mr. Bills.

Dear Sir.,

While my enthusiasm is at white heat I want to pass along to you some of the remarkable results we are getting daily with our new set using your Triple Test Transformer.

You will remember our Cabinet is complete in itself not an outside connection. It is complete with loud-speaker, both batteries and we receive from a small coil that can be carried in your coat pocket. In this new hookup we use three stages of radio and two of audio.

Personally, having spent many years in the music business, my chief aim has been tone quality and not particularly long distance reception, but since using your transformer we get both. We receive from Chicago, Davenport, Iowa, Detroit and New Orleans with about the same volume as nearby stations and all distortionless.

Please call in some day; you owe it to your business to hear this revolutionary instrument.

Yours very truly,

Technical Development Corp.



Radio Frequency



Telephone ~~XXXXXXXX~~ 210 CENTRAL AVENUE
NEWARK, N. J.

November 3, 1922.

Kasla Sales Co.,
10 E. 43rd St.,
New York City

My dear Mr. Sills:

In connection with our Portabloop Receiver using your Type 6 & 6 A radio-Frequency transformers. The writer has been getting from his home in Chatham, New Jersey on a Baldwin phone and 14" Standard Horn audible enough to hear all over a good sized room the following stations:

Chicago, Ill; KJW, Minneapolis, Minn; cutting in on Washington station. All of these stations have been picked up on several different occasions; entire concerts heard without any noticeable fade out.

We are pleased with the operation of your transformers.

Yours truly,

Eagle Radio Co.,

HFT/MS

SHIP OWNERS
RADIO SERVICE
INC.



November 3, 1922.

80 Washington St.
New York, N.Y.

Raela Sales Corporation,
10 East 43d Street,
New York, N.Y.

Gentlemen:-

In accordance with my promise to give you a confirmation of my verbal report of some excellent reception which we have been able to accomplish with the aid of the Radio Service Laboratory radio frequency transformers, I wish to state that for the past two weeks I have had in New York City consistent reception on the following stations:

WGY	-	Schenectady, New York
KDEA	-	Pittsburg, Pa.
WWJ	-	Detroit, Mich.
WEE	-	Atlanta, Ga.
WOC	-	Davenport, Ia.
YCAP	-	Chicago, Ill.

This reception was accomplished with a single circuit receiver, consisting merely of one variable condenser and one variometer, one step of RF amplification using an RF 6-A transformer and radiotron UV-2C. The only other apparatus was an Andrea detector and two step audio frequency amplifier.

The building in which the tests were conducted had no antenna erected on it and an Antenella plug in the electric light socket was used as an aerial. The signal strength in every case was sufficiently high enough to operate a standard Magnavox and could be heard at least thirty-five to forty feet from the horn.

Very truly yours,
SHIP OWNERS RADIO SERVICE INC.

J. B. Ferguson
By: J. B. Ferguson.

JBF-BD



BUFFALO EVENING NEWS.
EDITORIAL DEPT.

BUFFALO, N.Y. October 31, 1922.

Mr. G. L. Sill, President,
Rasla Sales Corporation
10 East 43rd Street
New York City.

Dear Mr. Sill:

After our pleasant visit a few days ago, I am doubly pleased to write these few lines telling you of the splendid results which I have received with the new RT-6 and RT-6-A transformers.

They are the best I have as yet tried. The entire broadcasting range is covered splendidly. While there are some other transformers that give the same application as the RT-6 on 360 meters. I find that these other transformers fall off considerably in amplification on the broadcasting above that wavelength. All of the Canadian stations, broadcast from 400 to 450 meters, and make very desirable reception.

In accordance with our conversation, you will find enclosed a copy of the hook-up which I am using, with the exception that mine is a three stage. I believe that this amplifier using your transformers will make a "super-regenerative" out of an ordinary regenerative receiver. (I think that this will make a good sales argument, don't you?).

I have received several telephone calls and written requests for the best r. f. transformers. You were recommended.

At the time my tests were made, I did not have an audibility meter to determine if the radio frequency amplifier equalled the audio in intensity. With three radio, detector and one audio, a total of five tubes, signals from WOC, WMB, KSD, and WLAG were audible all over my home. You can imagine what happened when nearer stations, such as KDKA and WGY were tuned in.

I am anxious to know what you are doing to produce transformers for wavelengths other than the broadcasting range. Write when you can.

Very truly yours,

John G. Rieger

RADIO EDITOR

JGR S

P.S. Would like to have you try the enclosed circuit.

FEDDERS MANUFACTURING COMPANY

AUTOMOTIVE RADIATORS

BUFFALO, N.Y. October 30, 1922.

RADIO DIVISION

Mr. George L. Sill,
c/o Rasla Sales Company,
10 E. 43d Street,
New York City.

Dear Mr. Sill:

I am enclosing herewith a log, which I am keeping of the Broadcasting Stations I have heard with the Fedders Model JRH Receiving set.

The set is composed of three Radio Frequency Units, a Detector and two Audio Units in which we use your RT 6 and RT 6 A Transformer.

It is surprising what a difference there is in Broadcasting reception since we have had the change in transformers. We have increased our distance very materially and you will note in the list that we have heard the Manitoba Free Press at Winnipeg, the Dallas News at Dallas, Texas, and I pick up Atlanta every night without any great amount of effort.

I really believe you now have the best Frequency Transformer offered to the trade, at least that is true in our experience.

Wishing you continued success, we are

Yours very truly,

FEDDERS MANUFACTURING COMPANY,

R. E. Jones
Radio Division.

LJ/L

Radio Comment and A

Report of Tribune Institute Radio Laboratory for Week

Exceptional Results Obtained With New Type R. F. Transformers; Other Apparatus Tested and Approved Includes a Novel Condenser

During the week some interesting tests were made with a new type of radio frequency transformer, which is described in the report below, in the radio laboratory. The results obtained from these were really remarkable and call for special mention. The amplification of the high frequency currents obtained was so good that it was found possible to eliminate ground and aerial connections entirely.

Reception was then made with a simple variometer of the tuning element and the sole means of picking up the energy, despite the fact that the test was made in a building of steel construction. It was found that the variometer was extremely directional, as much so as the regulation loop aerial, with the consequence that the complete set had to be "aimed" toward the broadcasting station. The outstanding feature of the circuit using three stages of radio frequency amplification was the absence of any capacity effects.

The circuit used was the same as that which has been illustrated on these pages, using a potentiometer across the "A" battery for the purpose of stabilizing the set. A description of the transformers, together with the report of the Institute radio laboratory, follows:

Radio Frequency Transformers Bring Music Without Loop

Types RT-5 and RT-6 Radio Frequency Transformers—These two types are the latest development of the "RT" group, with which most of the long distance radio enthusiasts have at least made an interesting acquaintance.

In external appearance the "RTs" differ not at all from their elder brothers, but their internal design has been changed somewhat in accordance with the experience acquired by experiment. Their construction is neat and compact—the four insulated terminals projecting from the top of the cylindrical, hard rubber casing two inches high and one and three-quarters in diameter. Small projecting studs at either side of the base are drilled to take a match-sized screw for attachment to the set base.

The "5a" type is designed for the special purpose of preceding the detector tube of the series, while the "6" functions more efficiently on the input side of the "5a" stage. The difference in type is necessary because the tubes of the radio-frequency stages are operating under conditions quite unlike those to which the detector tube is subjected.

While under test in The Tribune laboratory music was reproduced on a loud speaker from WJZ, at Newark, without aerial or ground connection of any kind. In this case three stages of radio-frequency amplification, detector, and two stages of audio-frequency were used. The minute energy picked up by the variocoupler was amplified until loud speaking results were obtained, despite the fact that the test was made in a shielded building.

For long distance work, and for loop reception, over the range from 300 to 600 meters, these transformers will give very satisfactory results when employed in any of the standard circuits outlined in the literature describing adaptations. Manufactured by Radio Service Laboratories, Inc., Asbury Park, N. J.



These transformers are for sale by all reliable radio and electrical stores. If your dealer cannot supply you, send your order direct to

RASLA SALES CORPORATION
10 E. 43rd Street
New York City