



How to build Radio Receivers

including
**COMPLETE
INSTRUCTIONS**
on **28**
**DIFFERENT
MODELS**

by



Meissner

**18 PAGES OF
TELEVISION DATA**

**FULLY ILLUSTRATED
WITH CHARTS,
RADIO FORMULAE,
SCHEMATIC CIRCUIT
DIAGRAMS,
PICTORIAL WIRING
DIAGRAMS**

PRICE **50** CENTS

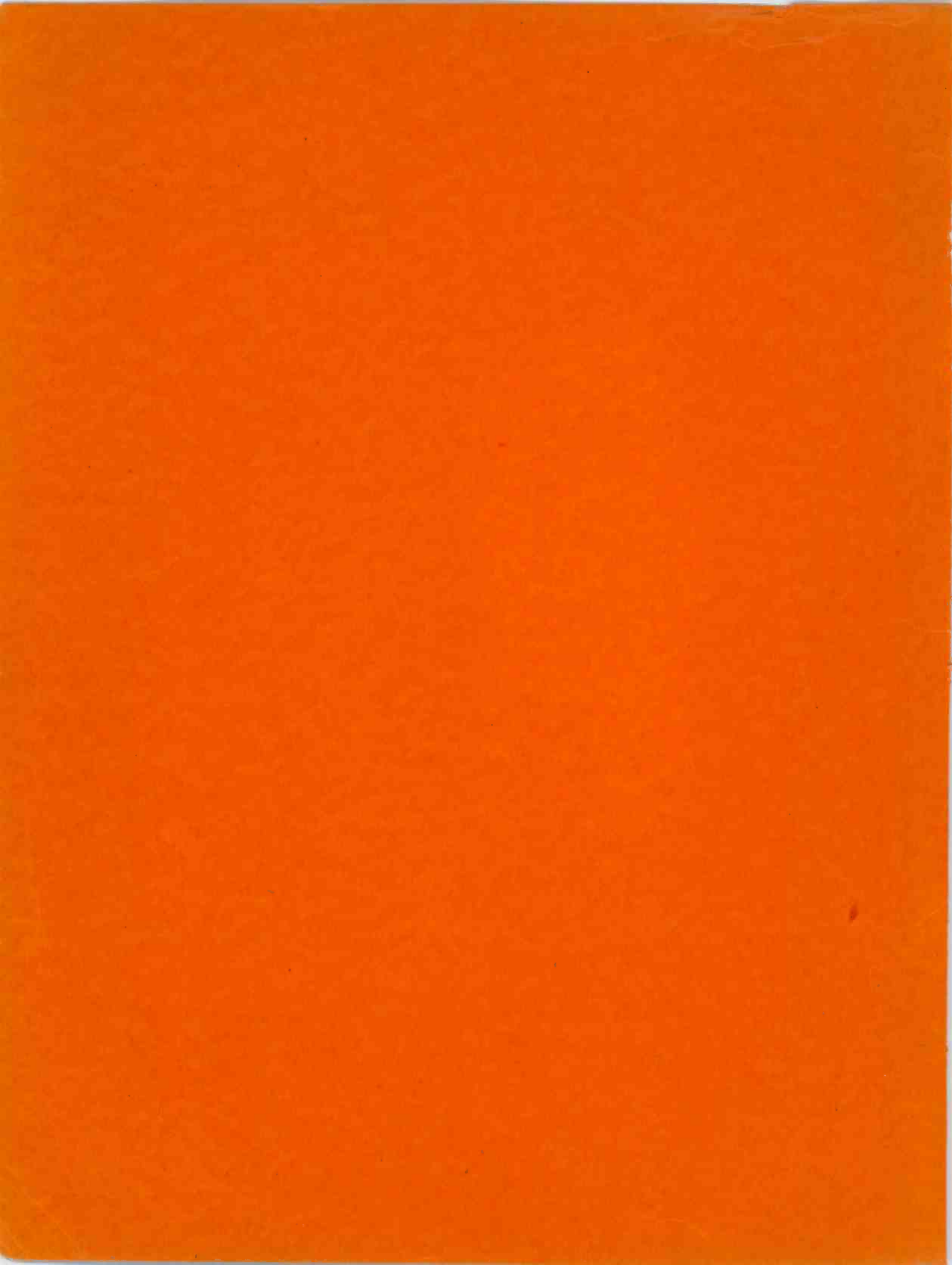



FOREWORD

This new issue of the Meissner Instruction Manual is dedicated to the Radio Amateur, Serviceman and Experimenter. The subject matter will be found to contain a wide variety of interest to anyone interested in the Radio art from whatever angle.

Complete constructional data is herewith presented on the entire 1939-1940 line of Meissner kit receivers. This information includes the detailed Pictorial Wiring Diagram, in addition to the regular Schematic Circuit Diagram, which makes Meissner kits so easy and simple to construct.

In addition to complete information on receiver kits, there is presented technical data, diagrams and operating instructions on the several ready-wired units which were introduced in the 1939-40 line. These include such items as the new DeLuxe Signal Shifter, Signal Calibrator, Signal Booster and the MC 28-56 Converter.

All of the material presented is not new. Some previously published material has been reproduced in order to make the book complete and self-sufficient. Not only, however, have new kits and wired instruments been included, but many pages of entirely new informative material and charts have been added. The treatise on "Television in Theory and Practice" will be found to provide excellent coverage of a comparatively complex subject in a simple and understandable manner. This article, in connection with the constructional information on the Meissner Television Receiver, will provide a practical education on the present stage of the art.

THE RADIO-FREQUENCY SPECTRUM

This chart will enable the radio listener to determine the frequency channels to which he must tune when looking for reception in any of the classified services listed at the bottom of the page.

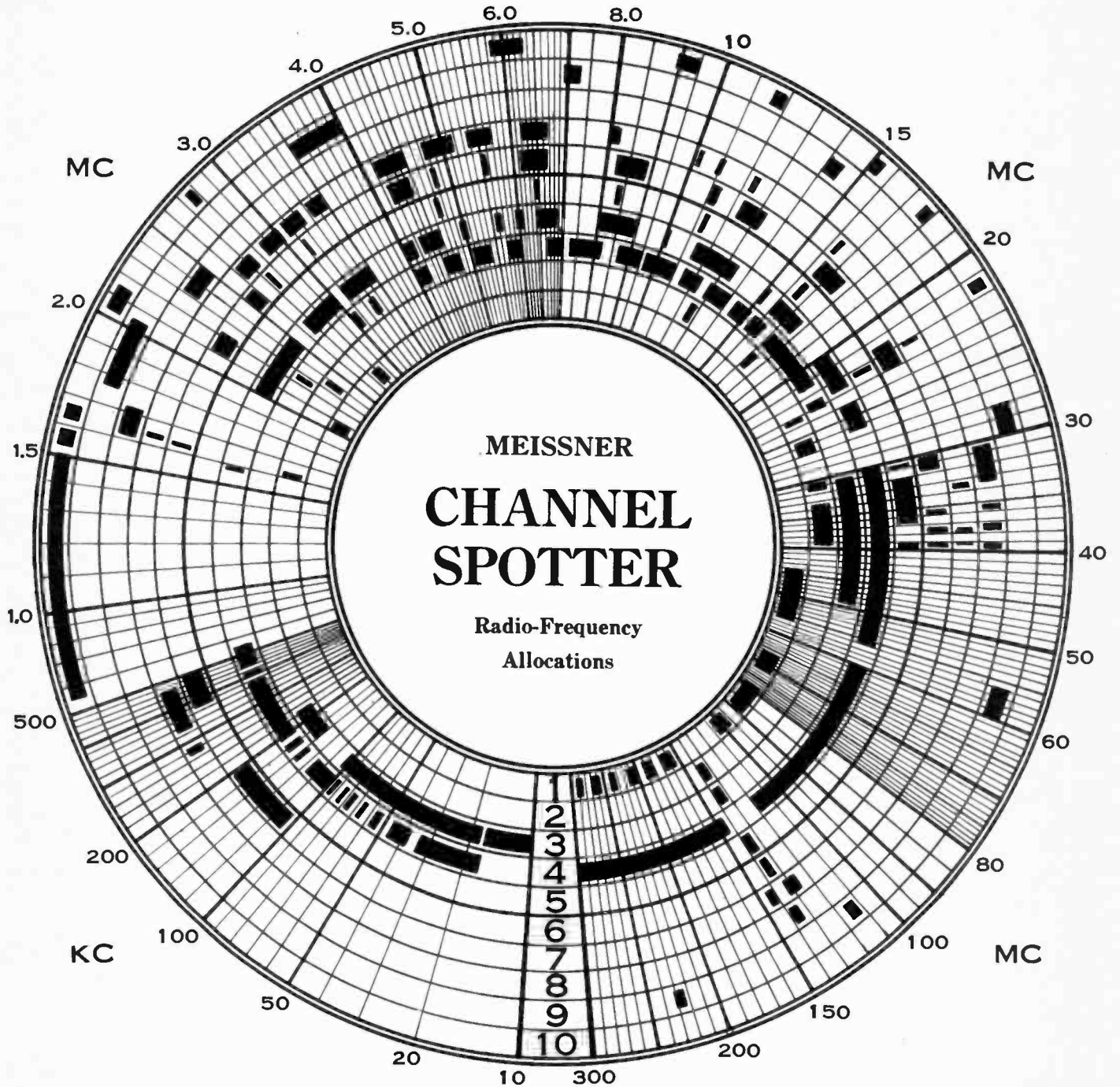

- 1 TELEVISION
- 2 EXPERIMENTAL
- 3 POINT-TO-POINT
- 4 GOVERNMENT
- 5 NEWS & PRESS

- 6 SHIP AND COASTAL
- 7 AIRPORT AND AVIATION
- 8 STATE & LOCAL POLICE
- 9 AMATEUR COMMUNICATION
- 10 U. S. & FOREIGN BROADCAST

HOW TO TELL WHAT RESISTOR TO USE

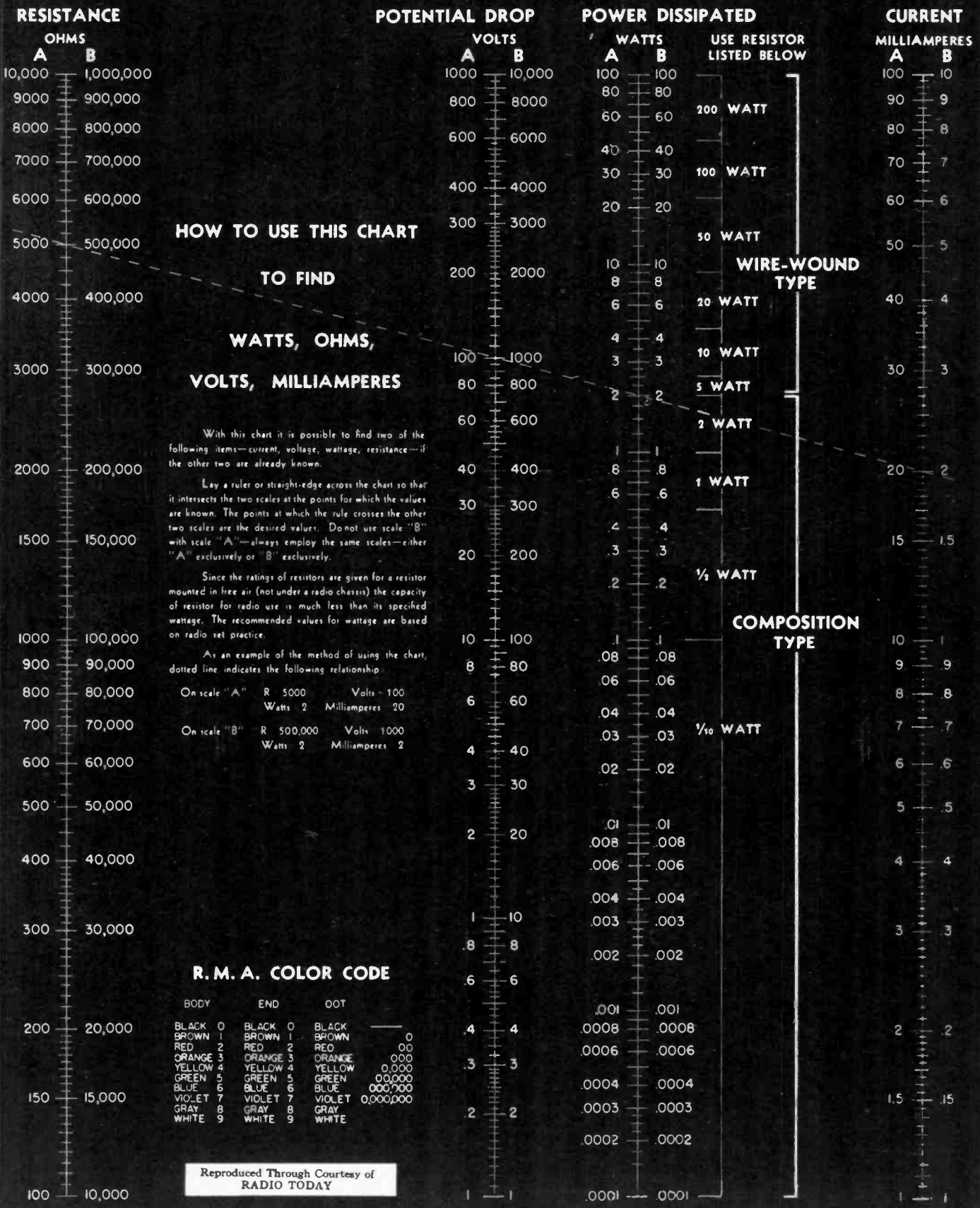

HANDY RADIO FORMULAE

Direct Current Relations

VOLTS = I R $\frac{W}{I}$ \sqrt{RW}
 AMPERES = $\frac{E}{R}$ $\frac{W}{E}$ $\sqrt{\frac{W}{R}}$
 OHMS = $\frac{E}{I}$ $\frac{W}{I^2}$ $\frac{E^2}{W}$
 WATTS = E I I²R $\frac{E^2}{R}$

Resistance Relations

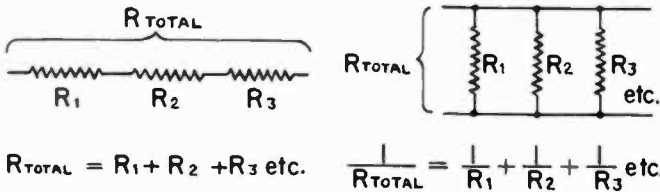

Two Resistances Only

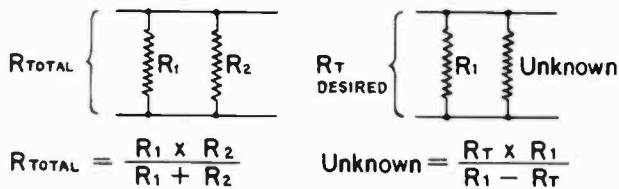

Capacity Relations

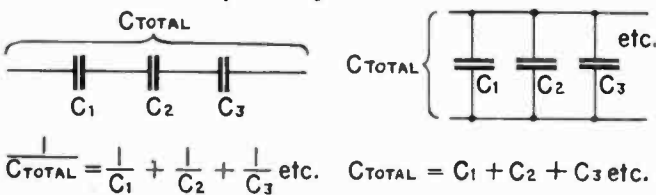

Two Capacities Only

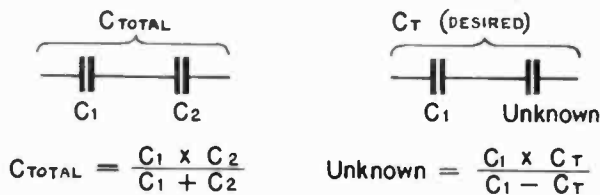

Simple Reactance

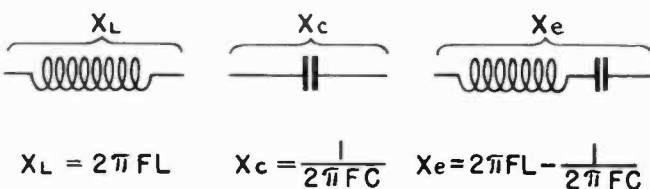

Complex Impedance

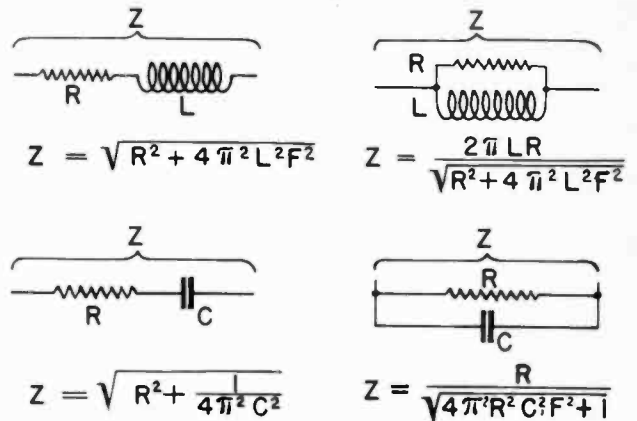

Resonance Formulae

$F = \frac{1}{2\pi\sqrt{LC}}$ $L = \frac{1}{4\pi^2 F^2 C}$ $C = \frac{1}{4\pi^2 F^2 L}$
 Where F is in cycles, L is in henries, and C in Farads

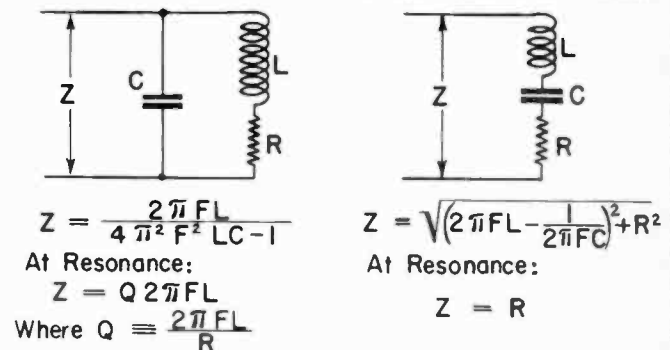

Coupling Coefficient

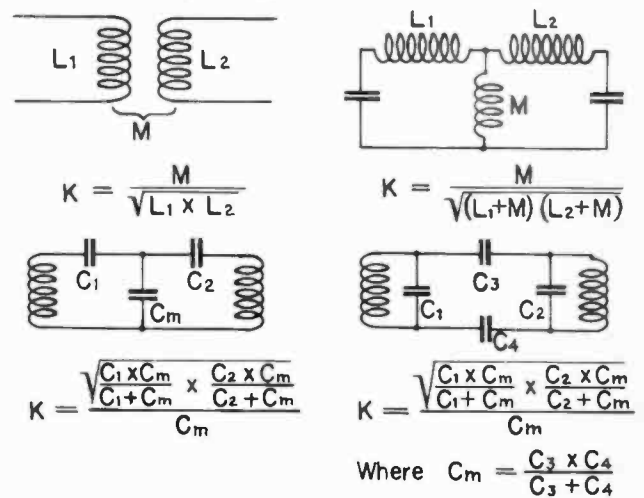

Over-Coupled Circuit Frequencies

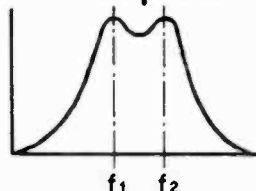
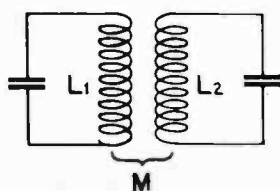

$f_1 = \frac{F}{\sqrt{1+K}}$
 $f_2 = \frac{F}{\sqrt{1-K}}$

Where F is the resonant frequency of each circuit independent of the other and K is the coupling-coefficient

CAPACITY
A, B
MICRO-MICROFARADS

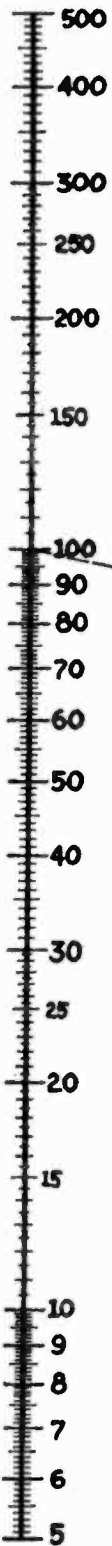

FREQUENCY
A B
KC MC

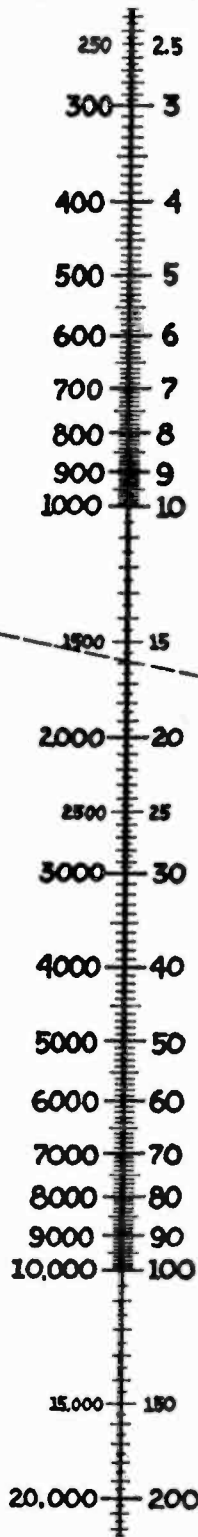

INDUCTANCE
A B
MICROHENRIES

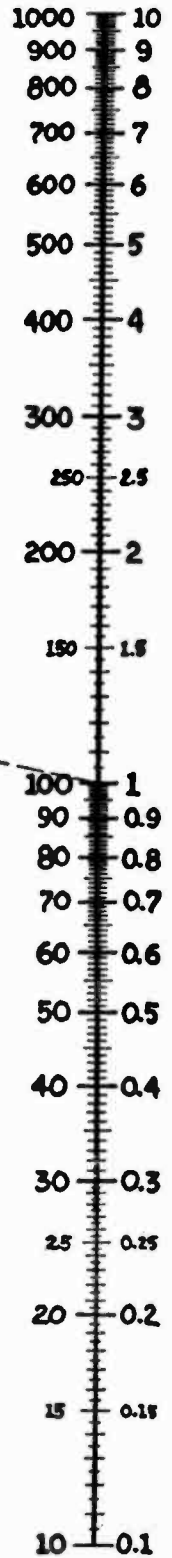

$$f_{kc} = \frac{159000}{\sqrt{C_{\mu\text{fd}} \times L_{\mu\text{h}}}}$$

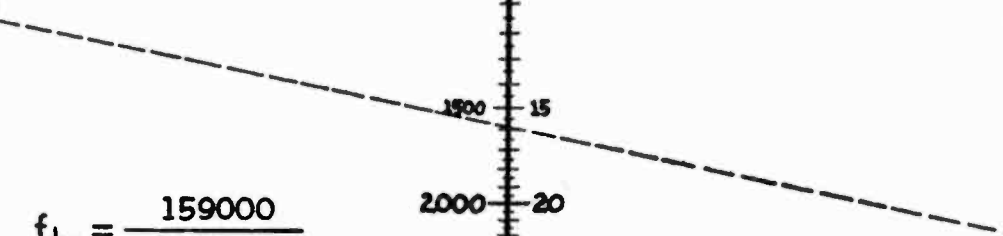

When any two of the quantities F, L, or C are known the third can be found by drawing a straight line.
Example: 100 mmfd. and 100 microhenries tune to 1590 kc. (reading all A scales) or 100 mmfd. and 1 microhenry resonates at 15.9 mc. (reading all B scales).

General Construction Hints

The following hints on the construction of receivers from Meissner Kits are offered to the experimenter to call his attention to a few of the practices that the engineer or professional radio man uses. Their observation will, perhaps, eliminate easily-made errors and will assure proper operation of the completed receiver.

PICTORIAL DIAGRAM

A pictorial wiring diagram of each kit has been prepared with great care to show what no circuit diagram can show—the physical arrangement of parts and leads, which, in many cases, is more important than some of the values of circuit elements shown in the schematic diagram.

If the arrangement of parts shown therein is followed closely, your kit will work with the same freedom from trouble that characterizes the finished original Master Models leaving the engineering department of the Meissner Manufacturing Company. Very close adherence to the arrangement shown will bring results which cannot be improved even if re-assembled and rewired by Meissner Engineers.

For the sake of clarity, all pictorial diagrams are drawn with components somewhat smaller in proportion to the chassis than a true scale drawing would show them, but they are shown in the proper place with respect to all other parts.

All components have been placed in positions that facilitate wiring as much as possible and which give minimum coupling or regeneration.

Each wire in the pictorial diagram has its color shown to facilitate wiring and checking. The corresponding colors of wire are furnished in the kit, each in sufficient quantity to make the required connections. It is recommended that you follow these colors.

AVOIDING MISTAKES IN WIRING

It has been found a good plan to go over each wire on the Pictorial Diagram with a colored pencil as that wire is placed in the chassis. If this plan is followed without exception, the progress of wiring is obvious from a single glance at the marked diagram, the unfinished portion is quickly identified, and errors in wiring will automatically be non-existent.

WIRE LENGTH AND POSITION

All wiring should be kept as short as convenient and should be placed close to the chassis. Wiring, particularly a plate lead, that stands several inches from the chassis provides much greater coupling or regeneration than wiring placed close to grounded metal objects such as the chassis, and consequently should be avoided.

INSULATING SLEEVING

Braided insulating sleeving or "Spaghetti Tubing" is recommended on a few leads in most kits where there is considerable chance for a short-circuit to occur between that lead and some other object. Most leads, however, will not require sleeving if arranged as shown in the Pictorial Diagram.

LOCKWASHERS

Lockwashers are provided with all nuts so that each nut may be adequately fastened in such a manner that vibration will not loosen it. Put a lockwasher of appropriate size on each screw before putting on the nut, then tighten the nut until it is quite firmly seated, compressing the lockwasher. If this is done the assembled kit will have the same freedom from loose parts as good commercial receivers.

SOCKETS

When mounting sockets into a chassis pay special attention to the position of the Keyway in octal sockets or to the large prongs in the older types of tube sockets. This precaution will eliminate the distasteful and exasperating task of removing all of the connections from the

socket to permit reversing it if it was originally installed incorrectly.

PAPER CONDENSERS

Most paper by-pass condensers have one connection marked "ground" to designate the outside foil in the condenser. If this end is grounded this outside foil shields the inside foil which is the "hot" or high-potential part of the condenser. Wherever a condenser by-passes any point to chassis it is recommended that the "ground" side of the condenser be connected to chassis.

DRY ELECTROLYTIC CONDENSERS

Dry electrolytic condensers have their positive end marked "positive" or "plus." When connected into a circuit the marked polarity must be observed.

WET ELECTROLYTIC CONDENSERS

Wet electrolytic condensers usually do not have their polarity marked since the can is always negative. They should never be operated in a horizontal position for more than a few minutes. They all have some means of "breathing" when in operation. If tuned upside down or horizontally the fluid may leak out during operation.

CARBON RESISTORS

Carbon resistors are made in several sizes according to the wattage or power they dissipate. The sizes for a given rating differ slightly between the different manufacturers but not enough so that the rating can be easily mistaken. The approximate sizes are as shown in Fig. 1.

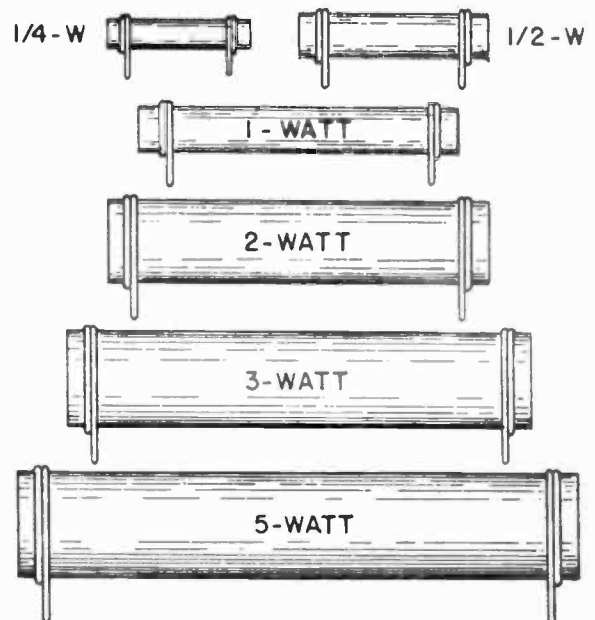

FIGURE 1.

When operating at their rated power the resistors are warm. The wattage dissipated may be easily calculated from $\text{Watts} = \text{Volts} \times \text{amperes}$, or $\text{Watts} = \text{Resistance} \times \text{amperes-squared}$.

The body color indicates the first digit of the resistance value, the end color indicates the second figure and the dot at the center indicates the number of zeros following. The table below gives the color code:

0—Black.	5—Green.
1—Brown.	6—Blue.
2—Red.	7—Violet.
3—Orange.	8—Gray.
4—Yellow.	9—White.

RESISTANCE CORDS

Equipment for AC-DC operation cannot have a power transformer since the transformer will not work on D-C. Where it is necessary to obtain low voltages for filaments from a 110 volt line, the filaments are usually connected in series and a resistance connected between the filaments and one side of the line. Often, this resistance is built into the line cord. When such is the case, the cord will become quite warm in operation. It should never be cut short for to do so would change the resistance and damage the tubes. It should not be operated with the cord all bunched up but should be spread out for proper cooling.

POWER TRANSFORMERS

Unless specifically marked for other service all Meissner power-transformers are designed for 110 Volt 50-60 cycle supply. They may be used on higher frequencies if desired but cannot be used on lower frequencies. If 40 or 25 cycle transformers are necessary they must be furnished special.

If any power transformer is found to hum or buzz objectionably, the mounting screws should be tightened up. If this fails to cure the trouble, the screws should be loosened up and the edges of the laminations painted with heavy orange shellac, the transformers allowed to stand for several hours, and the bolts then tightened up.

GANG CONDENSERS

Gang condensers are instruments of precision that should be looked upon with respect. They are made and adjusted by experts to very close limits of uniformity so that your kit may have the best possible "tracking" and accuracy of calibration. To give them the best protection when handling them or working on any chassis on which they are mounted, keep the condenser closed, that is, plates fully meshed. Never bend a condenser plate unless you are very sure that you know what will happen.

ADJUSTABLE CONDENSERS

Adjustable mica condensers are used to align many circuits. They are usually built with fine-pitch threads (many threads per inch) to facilitate adjustment. Because of the small size of the threads the strength thereof is limited. Accordingly, do not force a trimmer screw adjustment.

RANGE SWITCHES

Range switches are so designed that their self-wiping contacts keep themselves clean if the switch is placed in a protected place such as inside a closed cabinet or under a chassis. The greatest threat to satisfactory operation is rosin on the contacting surfaces. Therefore, when soldering connections to the switch lugs, heat the lug and wire quite hot by means of the iron before applying the rosin-cored solder so that as soon as the solder is applied it will quickly flow around the wire forming a perfect joint with as little solder as possible. By keeping the quantity of solder small, the chances for the rosin to spatter or flow onto the contacts are minimized.

SHIELDED WIRE

Shielded wire is not the panacea for all regeneration troubles. It must be used with discretion, remembering that it has a relatively high capacity of not too good power factor. When used on the grid or plate leads of radio-frequency or intermediate-frequency circuits, the capacity added may prevent proper tuning or trimming. Its use, in Meissner Kits has been specified only where it can be used to advantage safely. If it is desired to cut the shielding back from the end of the wire to a given point, it will be found advantageous to solder the shielding all around the wire for a length of 3-16 to 1-4 inch at the point to which the shield is to be stripped. This gives the wire a neat appearance, holds the shielding in place, and prevents fraying.

BIAS CELLS

Bias cells are used in many receivers and Kits to furnish grid bias, instead of using a cathode bias resistor and by-pass condenser. They are held in clips some-times singly, some-times in multiples. Fig. 2 shows these units assembled in their holder as used in Meissner Kits.

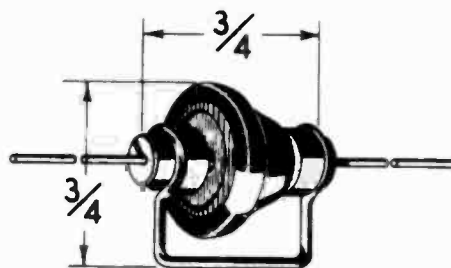

FIGURE 2.

They are actually batteries of essentially constant voltage but very high resistance. As a consequence if a voltmeter is connected across the cell, the meter will read a voltage far lower than the open-circuit or no-load voltage of the cell. It is not a good idea to measure the voltage of a bias cell or to permit it to become short-circuited. If, through accident, the bias cell is short-circuited for some period of time it will probably resume its normal operating characteristics shortly after the short-circuit is removed. If it is desired to determine whether the bias cell is operating properly, a single flash-light dry cell may be substituted for the bias cell to check for similarity of action. The outside containers of both the flash-light battery and the bias cell are the negative terminals.

DIAL LIGHTING

When dials are illuminated from the rear, uniformity of illumination over the dial scale can sometimes be improved by placing a piece of glossy white cardboard or white painted metal behind the dial lights to act as a reflector.

When dials are illuminated from the front, sometimes improvements in uniformity can be made by equivalent treatment in appropriate places.

SOLDERED CONNECTIONS

All joints must be well soldered to insure good electrical connections. When the solder on each joint has cooled, test the joint to be sure that it is perfect. Attempt to pull the joint loose or wiggle it. If the joint breaks or the wire wiggles in the "soldered" connection, insufficient heat or solder (probably the former) was used in the first attempt and the joint should be reheated. Use only rosin-cored solder and plenty of heat. All surfaces must be clean. Never use soldering-paste, acid, or other fluid flux.

SOLDERING IRONS

Satisfactory work can be done with any kind of a soldering iron whether heated by gas, electricity or other source of heat, provided that the iron is kept properly tinned and that it has enough thermal capacity to do the job. For most connections of wires to lugs, even a very small iron will be satisfactory, but where connections are soldered to the chassis or to any other large objects, a large iron is required in order to get the chassis hot enough to solder properly.

The first time a soldering iron is used it is necessary to "Tin" it properly. Get the temperature high enough to melt solder freely, file the desired surfaces until smooth and clean, then quickly apply rosin-cored solder before the cleaned surface has an opportunity to oxidize or discolor badly. If rosin in the solder is the only flux used when tinning the iron, it may be necessary to make several attempts before the iron is tinned properly. A small amount of soldering-paste applied to the cleaned surface of the iron just before the solder is applied will facilitate tinning, but the paste should never be used in soldering any of the wiring in the Kit.

If a soldering iron is used that is heated by gas or other flame, the tinning on the point of the iron will be best preserved if the flame does not strike the tinned surface, and if the temperature of the iron is never permitted to get too high. If the iron gets red-hot, it will be necessary to re-tin the working surface before good work can again be done with it. It is far more satisfactory to use a small flame heating the iron almost continuously rather than to use a large flame heating the iron for short periods only. In the latter case invariably the iron will be permitted to overheat.

RADIO COILS AND CIRCUIT APPLICATIONS

RADIO COILS

Radio coils are frequently thought of in the light of being essentially radio components, and as a part of the more general classification "Inductance." In order to understand the performance of coils in radio receivers, it is first necessary to understand the fundamental ideas about inductance and about resonant circuits.

Inductance is of two general types, "Self-Inductance" and "Mutual-Inductance," both of which are important in a radio receiver and both of which are described below.

SELF INDUCTANCE

Self inductance is, by definition, that magnetic property of a circuit that opposes any change in current. When a current flows in a wire, a magnetic flux is set up around that wire. If the current increases, the flux increases and, as it increases, the flux generates a voltage that tends to oppose the increase in current.

If the conductor is wound into a coil, the flux from many turns is concentrated so that each turn in the coil encloses not only its own flux, but also that from many other turns, thereby greatly increasing the effectiveness of each turn. Where the turns are large in diameter but bunched very closely together, the inductance increases practically in proportion to the square of the number of turns in the coil.

The practical unit of inductance is the "Henry" which is that value of inductance in which one volt is generated when the current is changing at the rate of one ampere per second. This unit of inductance is of quite convenient size when dealing with problems in power filter design, but is much too large for convenience when dealing with problems in intermediate frequencies or in high frequencies. For intermediate frequency work a one-thousandth part of a Henry, called a millihenry, is the most convenient unit of inductance, and for higher frequencies the microhenry, a one-millionth part of a Henry, is more convenient.

When an inductance is connected in an alternating current circuit, the current that flows is a function of the voltage across the inductance, the frequency of the current, and the magnitude of the inductance. The impedance to the flow of current is expressed:

$$X_L = 2\pi FL \quad \text{or} \quad X_L = \omega L \quad \text{where}$$

$$\omega = 2\pi \text{ times Frequency (cycles per second),}$$

$$F = \text{frequency (cycles per second),}$$

$$L = \text{inductance in Henrys.}$$

Impedance in an alternating current circuit is very similar to resistance in a direct current circuit except that the magnitude of the impedance changes with frequency. If it were not for this fortunate effect, radio receivers and any other devices employing resonant circuits would be unknown.

MUTUAL INDUCTANCE

In the section on Self-Inductance, above, the definition of "Self-Inductance," and the properties thereof were briefly explained. If, in the example of the bunched winding, half of the turns formed one circuit and the remaining half formed another circuit, a change in magnetic flux occasioned by a change in current in one winding, would induce two voltages, one in its own winding opposing the change in current, and the other in the second coil. This phenomenon of a voltage induced in the turns of one coil by a change in current in another coil is known as "Mutual Inductance."

The unit of Mutual Inductance is the "henry" defined as that value of mutual inductance in which one volt is generated across the terminals of one coil when the current in the other coil is changing at the rate of one ampere per second.

The practical units for Mutual Inductance are the same as those for self inductance, namely the Henry, Millihenry and Microhenry.

A very convenient property of mutual inductance is that the mutual inductance existing between two dissimilar coils is the same, whether the current change is in the large coil and the voltage is measured in the small one or vice versa, regardless of how dissimilar the coils may be.

This phenomenon called mutual inductance makes the formulae for inductances in series or in parallel much different from the formulae for resistances. In the latter case, the equivalent resistance of two resistances in series is the sum of the individual resistances; but in the case of two inductances in series, there may be a mutual

inductance between the coils that may seriously disturb that simple relationship. If the two coils are placed so that the wires of one coil and those of the other coil occupy practically the same space, as in the case of winding the second coil as a single layer directly over the first single layer coil, or between the turns of the first coil, the overall inductance of two equal coils wound as above, will be twice the sum of the inductances of the two individual coils, if the coils are connected "Aiding" and will be practically zero if connected "Opposing." This is a special case which seldom occurs, but shows one of the extremes of mutual inductance which can influence the equivalent inductance of two coils connected in series.

The general expression for any case involving only two coils in series is: overall inductance equals the sum of the individual inductances plus or minus twice the mutual inductance. The reason for this relationship is given in the following explanation.

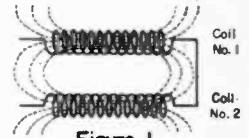

Figure 1

A current change in coil No. 1 induces in itself a voltage proportional to its inductance, and similarly in coil No. 2 a voltage proportional to the inductance of coil No. 2. The current change in coil No. 1 induces a voltage in coil No. 2 proportional to the mutual inductance between the two coils, and similarly the current change in coil No. 2 induces a voltage in coil No. 1 of the same magnitude because the mutual inductance is the same whether measured from the first to the second coil, or in the reverse direction. The overall inductance is proportional to the total voltage induced, and is consequently equal to the sum of the individual inductances plus or minus twice the mutual inductance. The "plus or minus" provision is made because the voltage induced in one coil by a current change in the other does not necessarily aid the self-induced voltage in the coil. Inductances themselves are positive, there being no negative inductances; nor, strictly speaking, are there any negative mutual inductances; but a mutual inductance may be connected into a circuit so that its effect may oppose some other effect and can be considered as a negative mutual inductance *when so connected*.

The maximum value of mutual inductance that can exist between two coils is equal to the square-root of the product of the two individual inductances. In practice it is very difficult to obtain sufficiently close coupling to produce this limiting value unless the two coils are wound together, the wires from both circuits being wound on the coil simultaneously.

COUPLING COEFFICIENT

When two coils are arranged so that some definite mutual inductance exists, the coils are said to be magnetically coupled.

In many calculations, it is frequently convenient to express the amount of coupling as a percentage of the maximum that could possibly exist, rather than a numerical value of mutual inductance. In such a case, the term applied to this percentage is "coupling coefficient" which, for inductance, is defined as the quotient resulting from dividing the existing mutual inductance by the maximum possible mutual inductance (square-root of the product of the two separate inductances).

DESIGN OF RADIO COILS

Since almost all radio-frequency coils operate in resonant circuits, the coils must be designed for three important characteristics — inductance, distributed capacity, and losses.

For simple geometric forms such as the solenoids, formulae are available in many text books for calculating the above mentioned characteristics, but for universal wound coils no satisfactory formulae exist for any one of the three quantities. Within limits, the inductance and distributed capacity are practically constant with frequency, but the losses change with frequency, requiring different designs for minimum losses in coils of the same inductance but operating at different frequencies. This is the reason for the great amount of design work required on radio-frequency coils.

The losses in a coil may be divided into the following classes:

- 1 — Ohmic or D.C. losses in the wire.
- 2 — Eddy-current losses in the conductor
- 3 — Eddy-current losses in the shield

- 4 — Eddy-current losses in the core material
- 5 — Skin effect
- 6 — Dielectric loss in the wire insulation
- 7 — Dielectric loss in the terminal strip

None of these items is independent of the others, and a change to improve one usually changes one or more of the remaining factors.

Considering the sources of loss in the order named above, the D.C. or ohmic resistance of a coil can be reduced by increasing wire size, in which case the coil becomes larger, and, in the case of shielded coils, brings the coil closer to the shield, which consequently increases the shield losses. In addition, because the copper cross section increases, permitting higher eddy-voltages to be generated, the eddy-current losses in the conductor increase.

The eddy-current losses in the conductor are minimized by subdividing the conductor as finely as is economical, insulating each of the subdivided parts from all other parts. Commercially, this is done by the use of so-called Litz (Litzendraht) wire, which consists of many strands of fine wire, each strand individually insulated with enamel, and the group of wires covered with some insulation, usually fabric, although sometimes enamel, paper, or other covering is used over the group.

Eddy-current losses in the shield are minimized by using a shield as large as possible, or large enough so that further increase in diameter produces no improvement, and by the choice of shield material of the lowest economical specific resistance. The shield materials in common use are copper, aluminum and zinc, named in the order of their merit. Magnetic alloys, such as sheet iron or silicon steel, are very high in R F losses.

A peculiar phenomenon with regard to composite shields is that whenever a shield is made of two closely bonded materials, the characteristics of the shield approach the characteristics of the poorer material. For example, a copper plated steel shield is almost as bad as an all steel shield of equal dimensions even though the plating is commercially heavy.

Iron cores are frequently used in coils to increase the effectiveness of the turns of wire, thereby permitting a given inductance to be obtained with fewer turns, and consequently with lower D.C. resistance. The core itself introduces some eddy-current losses which partially offset the improvement made by reducing the number of turns. In some cases (usually above 6 megacycles) the introduction of even the highest grade of powdered iron cores results in an increase in losses rather than a decrease.

Eddy-current losses in the conductor have dictated the use of Litz wire wherever economically possible, but "Skin Effect" goes a step farther and requires that the conductor not only be subdivided into a multiplicity of individually insulated strands but that these strands be arranged in a special manner. In an attempt to have each individual strand occupy a place on the surface of the conductor an equal percent of the time, so that the current would divide equally among the many strands and thereby give the lowest effective R.F. resistance, the original braided Litzendraht wire was developed. Because of price, however, modern "Litz" wire as used in radio receivers, is merely twisted, which brings different strands to the surface at different points giving a result approaching that of braided Litz, but at far less expense. Where Litz wire is made without twisting, that is, with parallel strands, the results are inferior to twisted Litz on two counts: (1) the losses are consistently higher than for twisted Litz, (2) coils made with it exhibit greater variations in resistance than coils made from twisted Litz. (All Meissner Litz wire is twisted.)

A very important and frequently unsuspected contributor to coil losses is the insulation of the wire. Analyzing a coil, it will readily be apparent that the fabric insulation on the wire is the dielectric of the distributed capacity of the coil. The losses in the insulation influence the coil just as surely as would an external condenser of the same capacity connected across the coil, having the same fabric for a dielectric. With this in mind, many coil designs have been improved by increasing the thickness of fabric insulation, thereby reducing the distributed capacity and consequently its detrimental effect. In many cases, this effect was so important that increasing the insulation thickness resulted in improvement in the coil even though smaller wire was used to give space for the insulation!

In considering the distributed capacity of a coil it must be remembered that, in many instances, the terminals on the coil contribute an important part to the distributed capacity, and that the losses in the terminal strip should not be neglected. On some coils of high quality, hard rubber terminal strips are used to minimize the losses occasioned by the terminal strip.

Since all of the losses in a coil taken together make up the radio frequency resistance of the coil, a single number can be used to express this quantity, but the resistance alone does not give sufficient information to judge the electrical excellence of the coil. Resistance is usually the undesired quantity in a coil, and practically all coil designs attempt to make it as low as possible. Reactance is the desired characteristic of the coil and is the product of frequency, inductance and the usual multiplier, 2π . A special term has been given to the ratio of the desired to the undesired characteristic of

the coil. This term is "Q" which is defined as the reactance divided by the resistance.

From the foregoing discussion of the factors influencing the performance of radio coils it is obvious that when Meissner lists high "Q" coils the products offered are the results of many hours of work on each individual design backed by the experience of years on the same type of problem.

SHIELDING

Having considered, in the paragraphs last preceding this section, the effect of high insulation loss in a radio coil or its associated terminal strip, it immediately follows that the losses in any associated wiring should also have an effect on the efficiency of the circuit. Probably the most serious offender in this category is a shield on any high potential R F hookup wire.

The common type of shielded wire, consisting of two wax impregnated cotton braids over the conductor, covered with a woven copper shield is particularly bad when used on high- "Q" resonant circuits. Such shielding frequently has a capacity of 50-to 100-mmfd. per foot which means that if more than a few inches are used, so much capacity may be added to the circuits that they may not be tunable with the trimmer condenser provided. In addition, the capacity added has high losses even when dry. It is characteristic of this type of wire that as it becomes damp its losses increase tremendously, thereby greatly reducing the efficiency of high-"Q" circuits, and, in addition, the capacity increases, detuning the circuits. This loss in efficiency is bad enough, but when detuning is added, the cumulative results may prevent operation of a receiver having an appreciable amount of shielding on grid or plate leads. Because of these humidity effects, the safe rule to follow is never to use a close fitting shield on any R.F. or I.F. circuit. If, however, it is necessary to use shielding, some form of large diameter shielding should be used. A piece of spiral spring, whose inside diameter is considerably larger than the outside diameter of the insulation on the wire passing through it, makes a good flexible shield. In this case, a great deal of the dielectric between the conductor and the shield is air. This partially reduces the dielectric loss, but even this should be avoided if possible.

The electrically ideal type of shielding is the partition type which separates one tube and its associated wiring from another tube and its wiring. Since it is not always possible to employ partition shielding, the next best thing to use is either rigid bare wire in a rigid shield tube, or a small wire in a large diameter shield such as is frequently employed on automobile antenna lead-ins.

If a close-fitting shield must be used, the best economical commercial insulation obtainable at present is Celanese insulated wire such as is marketed by several firms under the name "R.F. Hookup Wire."

RESONANT CIRCUITS

The fundamentals of resonant circuits are covered so thoroughly and completely in many standard text books on radio, that no attempt will be made here, in limited space, to cover the same territory. Only a very few important ideas and relationships will be brought to your attention.

Inductance and capacity, when measured in an alternating current circuit are found to possess "Reactance" measurable in ohms. The reactances, although both measured in ohms, have the peculiar property of adding to resistive ohms as if the resistance were the base of a right angle triangle, the reactance were the altitude of the triangle, and the overall impedance the hypotenuse of the triangle. This relationship is expressed as the square of the hypotenuse being equal to the sum of the squares on the other two sides.

The reactances of a condenser and of an inductance are of opposite sign, however, so that if an inductance and a capacity are connected in series, the overall reactance will be the algebraic sum, or in this case, the numerical difference between the two reactances.

From the above statement it follows that for any given value of inductive reactance, a value of capacity can be chosen whose reactance will exactly equal the inductive reactance. A special name, "Resonance" has been given to this condition. The circuit is referred to as being "In Resonance." Under this condition the current is limited only by the resistance in the circuit.

When circuits are resonant, some very astonishing things can happen. Consider the circuit shown in Fig. 2.

This is a theoretical case because it is impossible to obtain both inductance and capacitance without resistance, although, of the two, a perfect condenser can be approached closer than a perfect inductance. If all of the resistance is considered to reside in the inductance, E_1 ceases to exist as a separate voltage that can be measured with a meter, but it still limits the current flow at resonance. The voltages that then could be measured are $E_2 = 100$ and $E_3 = 100.005$ volts.

If an inductive and a capacitive reactance are connected in parallel the total reactance is higher than the highest reactance instead

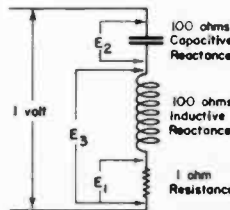

Figure 2

of being lower than the lowest, which is the case existing when reactances of the same type are connected in parallel.

The reason why the effective impedance of two similar impedances connected in parallel is lower than the impedance of either separate circuit branch is immediately obvious. The second circuit offers a second path for current, raising the total current, and, since it is known that with constant voltage supplied, increased currents indicate lower impedances. The reason why the impedance rises when dissimilar reactances are connected in parallel is explained as follows:

When an inductive reactance is connected across a supply of alternating voltage a current flows 90 electrical degrees or $\frac{1}{4}$ of a cycle behind the voltage. When a capacitive reactance is connected across a similar supply, a current flows 90 electrical degrees or $\frac{1}{4}$ cycle ahead of the voltage. From this it is obvious that when both types of reactance are connected to the same voltage source, the currents will be exactly $\frac{1}{2}$ cycle apart, meaning that the moment the current is at its positive peak on the alternating current wave in the condenser, the current in the inductance is at its negative peak, or that the total current in the two circuits will be the arithmetic difference between the two individual currents. It is obvious then that since connecting two dissimilar reactances (one capacitive and one inductive) in parallel reduces the total current drawn from the line, the impedance must increase. If the condenser and inductance both have zero losses, the same current would flow in the inductance as if the condenser were absent, and the same current would flow in the condenser as if the inductance were absent, but no current would be drawn from the line. The impedance of the combination must therefore be infinite.

Since radio coils do not come within 10% of being as good as high grade condensers, and since condensers themselves are not perfectly loss free, it follows that the infinite impedance circuit discussed is theoretical and that it is highly desirable to have a convenient method of calculating the impedance of actual circuits.

Starting with the formula for the impedance of an inductance of practical design in parallel with a condenser simple algebraic manipulation produces the very workable formula

Resonant Impedance = $Q \omega L$
 where Q is the "Q" of the coil (by definition, its reactance divided by its resistance) $\omega = 2 \pi$ times frequency in cycles per second, and L is the inductance in henrys.

ANTENNA COILS

The basic types of antenna coils have high-impedance inductive, high-impedance capacitive, low-impedance inductive and low-impedance capacitive couplings. Typical values of capacity, self inductance and mutual inductance for these four types of broadcast coils are shown in Fig. 3.

HIGH-IMPEDANCE PRIMARY

High-impedance magnetic coupling, usually spoken of as "High-Impedance Primary" is the most universal type of coupling on the broadcast range of household receivers. It has good image ratio, reasonable gain, and, when properly designed, almost negligible misaligning of the first tuned circuit as the size of antennas is changed. With the usual design of coil, this type of coupling results in higher gain at the low-frequency than at the high-frequency end of the tuning range. Sometimes, to compensate for this deficiency at the high frequency end, a small amount of high-impedance capacity coupling is used. This capacity is connected from the antenna to the grid terminals of the coil. Its size is from 3 to 10 MMF.

It is to be noted that capacity coupling can reduce as well as raise the gain of a high-impedance magnetically coupled transformer, depending upon the polarity of the windings. If capacity coupling is to aid the magnetic coupling, a current entering the antenna terminal of the primary and the grid terminal of the secondary must go around the coil form in opposite directions, and the coupling capacity must be connected between these two points.

LOW-IMPEDANCE PRIMARY

Antenna coils with low-impedance primaries, although cheaper to manufacture than high-impedance primaries, are rare on the broadcast band of modern home radio receivers.

This type of coupling, when used with any of the conventional household antennas, gives a great deal more gain at the high-frequency end than at the low-frequency end of the tuning range. This gives rise to very poor image-ratio when used in a super-heterodyne receiver.

The closely coupled low-impedance primary reflects the antenna capacity across the tuned circuit in an amount depending upon its inductance and coupling coefficient. Without attempting to derive an expression for the actual magnitude of this effect, suffice it to say that if the primary is large enough to give reasonable gain at the low-frequency end of the frequency range, the reflected antenna capacity will be so high that the secondary tuning condenser will not be able to tune to the high-frequency end of the band, and

every different antenna capacity would change the amount of mis-tracking. Because of this sensitivity to changes in antenna capacity, and because of poor image ratio, the low-impedance primary is seldom used on broadcast-band antenna coils.

On short-wave coils, the low-impedance primary is used almost exclusively because the antenna gain is usually higher than with a high-impedance primary, and the antenna is usually resonant in or below the broadcast band. For this reason, the image-ratio does not suffer nearly as much as in the case of using low-impedance broadcast coils in place of coils with high-impedance primaries.

HIGH-IMPEDANCE CAPACITY COUPLING

The high-impedance capacity coupling scheme consists essentially of connecting the antenna directly to the grid end of the first tuned circuit through a capacity, usually from 1 to 10 mmf. This method of coupling has been popularly used on amateur receivers of simple design, where simplicity of coil construction was imperative, but is not used in broadcast receivers by recognized manufacturers because of the very poor image-ratio that results.

Practically speaking, the only use for high-impedance capacity coupling in a broadcast receiver is as reinforcement to a high-impedance primary, as discussed in the paragraph on "High-Impedance Primaries."

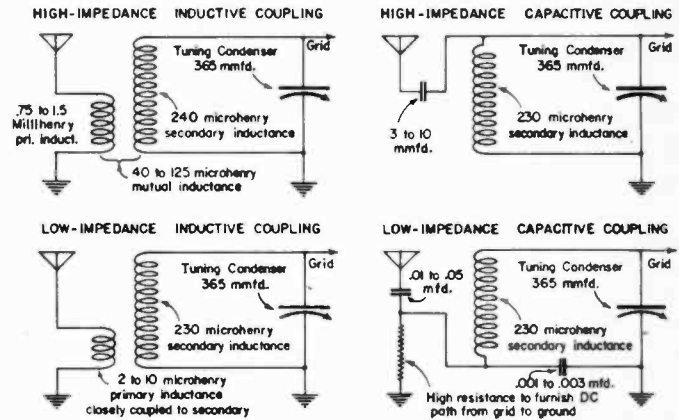

Figure 3 Typical Antenna Coils

LOW-IMPEDANCE CAPACITY COUPLING

Low-impedance capacity coupling, familiarly known among radio engineers as the Hazeltine coupling system, consists of coupling the antenna directly to the junction of the low side of the tuning inductance with the high side of a high-capacity coupling condenser which is connected to ground. (See Fig. 3.) The voltage across this coupling condenser is multiplied by the resonance phenomena of the tuned circuit to give appreciable voltage at the grid.

This circuit is particularly adapted to receivers that must use a high-capacity shielded lead-in such as an automobile radio receiver. In such a circuit, the shielded lead-in is made part of the coupling capacity because of the circuit arrangement and, practically speaking, causes no loss in voltage as would be occasioned if this capacity would be connected across a high-impedance primary. For this statement to be strictly true, it is necessary that the shielded lead-in have a good power factor or else the losses in the lead will slightly reduce the effective circuit "Q," thereby bringing down the gain in the antenna coil by a corresponding amount.

This type of coil has high gain and excellent image-ratio. The drawbacks to its use are that the R.F. amplifier circuit, if used, must have a value of capacity included in its tuned circuit equal to the antenna coupling capacity in order that proper tracking may result.

An alternative is to use a tuning condenser whose antenna section is different than its R.F. section, but this can only be done where a heavy production schedule justifies the additional tool cost.

When this coupling scheme is used in household radio receivers, precautions must be taken to prevent 60-cycle hum modulation from being introduced into the first tuned circuit by low-frequency voltages picked up on the antenna circuit. In the best of receivers employing this circuit, an R.F. choke is connected from antenna to ground to provide a low impedance path for power frequencies in order to keep hum modulation off of the grid of the first tube.

R. F. COILS

R.F. coils may be divided essentially into four types: high-impedance magnetic, low-impedance magnetic, high-impedance magnetic with high-impedance capacity coupling, and choke-coupled circuits.

The high-impedance magnetically coupled R.F. coil has characteristics very similar to the high-impedance antenna coil and therefore needs little discussion.

The low-impedance magnetically coupled R.F. coil has the same deficiency as the similar antenna coil and is consequently seldom used in the broadcast range of a superheterodyne receiver. Like the antenna coil, it has possibilities for higher gain than the high-impedance type, but usually the selectivity is enough worse to rule out this type of coupling on modern receivers.

In the shortwave range, this is the most popular type of circuit, because it is the one giving the highest gain and since, with a fixed capacity of gang condenser, it becomes increasingly more difficult to obtain high gain as the frequency is increased, this circuit with its high gain is the almost universal choice in spite of its deficiencies in image-ratio.

The R.F. coil employing a high-impedance primary in combination with high-impedance capacity coupling is the most flexible design, and is popularly used for that reason. By shifting the primary resonant frequency and by changing the amount of capacity coupling together with changes in "Q" of the secondary circuit, the overall gain of an amplifier stage can be made to have almost any desired shape with respect to frequency; that is, it may give high gain in the middle, at the high-frequency end, at the low-frequency end, or almost any shape desired, to compensate for the frequency characteristics of the other stages employed in the receiver.

The choke-coupled R.F. circuit is very similar to the high-impedance primary with high-impedance capacity coupling, except that, in choke coupling, the magnetic coupling has been made zero, but design still requires that the choke have as much inductance as a primary would have, in order that the resonance of the primary circuit may fall outside of the tuning range of the secondary.

OSCILLATOR COILS

Oscillator coils in modern receivers exhibit less variation in types than any other R.F. component. They either do or do not have a "tickler."

Those oscillators that do not have a tickler coil, oscillate by virtue of the feedback across the padding condenser. A typical circuit of such an oscillator is shown in Fig. 4. Using a 456 KC IF system requiring relatively small padding condensers makes this type of operation possible. The only bands that have padding condensers small enough to sustain oscillation are the long wave and broadcast bands. In some instances the range 1500 to 4000 KC can be made to oscillate if a very high Q coil is used with a tube of high mutual-conductance, but much more reliable results will be obtained on this band with the conventional tickler feedback, shown in Fig. 5.

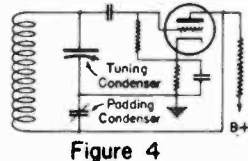

Figure 4

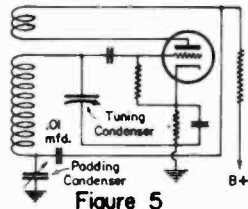

Figure 5

IF TRANSFORMERS

Intermediate-frequency transformers used in radio receivers have taken a variety of forms and have operated at many different frequencies. They may be divided into several classes according to the number of selective circuits: untuned or self-tuned, single-tuned, double-tuned, and triple-tuned. Receivers have employed IF transformers with more than three tuned circuits per transformer but such cases are very rare.

The untuned IF transformer usually added practically no selectivity to a receiver. Its principal purpose was to give a high amplification at very little cost. It was always used in conjunction with one or more tuned IF transformers which supplied the required selectivity.

SINGLE-TUNED IF TRANSFORMERS

The single-tuned IF transformer has taken two important forms, the bi-filar coil and the double coil types.

In the former case, the two wires constituting primary and secondary are wound simultaneously, forming a coil that is a single physical unit yet having two independent circuits. The start of the primary was usually the plus "B" connection and the start of the secondary was ground. The outside of the primary was the plate connection and the outside of the secondary was the grid connection. These transformers were characterized by very high gain and comparatively little selectivity. They were used on receivers that had no A.V.C. and the secondary low-potential end usually connected directly to chassis. Such a transformer could not be used satisfactorily in a receiver employing the conventional diode type A.V.C. circuit for the reason that on damp days there is enough leakage between primary and secondary to produce a decidedly positive bias on the grids of the automatically controlled tubes.

In addition, such a structure possesses such a high capacity between windings that the ripple in the "B" supply would be transferred to the diode load resistance which would produce a bad audio hum in the output of the receiver. A third reason why this type of transformer would not now be acceptable, even if there were no diode load resistance to pick up hum or to be incorrectly biased, is the frequent failure of windings due to electrolytic corrosion. Where two conductors are run so intimately parallel for so

many turns, with opposite D.C. potentials applied to the two wires, ideal conditions are set up for rapid failure due to electrolytic corrosion in the presence of moisture.

With this transformer redesigned to have two physically separate coils wound side by side, the objectionable features of leakage, corrosion and hum transfer are reduced to a very small per cent of their original importance, and transformers acceptable in today's critical market can be produced. The largest remaining objection to the single-tuned transformer is selectivity. In a low-frequency amplifier operating at 125 KC or 175 KC, the transformers are too sharp for good audio fidelity, and at the higher intermediate frequencies such as 456 KC, the transformers do not add sufficient adjacent-channel selectivity.

Single-tuned transformers may be divided into two classes according to the circuit tuned; some have their primaries tuned while the remainder have their secondaries tuned. As far as secondary voltage is concerned, there is not a great deal of difference regardless of which winding is tuned, but if there is a question of single-stage oscillation in the tube driving the single-tuned transformer, greater stability is had by tuning the secondary than by tuning the primary.

DOUBLE-TUNED IF TRANSFORMERS

The double-tuned IF transformer is, by far, the most popular type. It is simple in construction, has negligible leakage, no measurable hum transfer into diode circuits and can have its selectivity curve made as sharp as two single-tuned transformers in cascade, or can be considerably broader at the "Nose" of the selectivity curve than two cascaded single-tuned transformers, yet on the broader part of the selectivity curves maintain practically the same width as the cascaded single-tuned transformers.

If the coupling on a double-tuned transformer is made sufficiently loose, the transformer is quite selective and has a resonance curve of the same general shape as a single circuit, except sharper. As the coupling is increased, the gain will go up until the point of "critical coupling" is approached where the gain of the transformer is practically constant but the selectivity curve is changing, particularly at the "nose" of the curve. As the coupling continues to increase, first there is a decided flattening on the nose of the selectivity curve, after which continued increase in coupling produces an actual hollow in the nose of the curve. Still greater increase in coupling can spread the two "humps" and deepen the "hollow" in the nose of the response curve until a station can be tuned in at two places on the dial very close together.

Variations in magnetic coupling cause variations in the gain and selectivity of IF transformers as described above, but this is not the only source of variation. Variations in capacity coupling can be equally important in transformers operating above 400 KC. This variation is so important that it is discussed separately in the section "Capacity Coupling in IF Transformers."

The complete selectivity characteristics of any circuit can be shown only by a curve from which it is possible to determine the performance at any point, but nearly as much useful information can be given in a few figures where the selectivity of IF transformers is concerned.

The Meissner catalog lists the "Band Width" of each transformer at three points on the selectivity curve. These three points are labeled 2X, 10X, and 20X meaning respectively, two times, ten times and twenty times. These terms designate the place on the selectivity curve at which the gain at resonance is two, ten, or twenty times the gain at the point specified. The width of the response curve has been measured at these points and has been tabulated so that the comparative selectivity of transformers may be judged.

TRIPLE-TUNED IF TRANSFORMERS

Triple-tuned IF transformers have been used for two general purposes: greater adjacent-channel selectivity without increasing the number of tubes and transformers, or a better shape on the nose of the selectivity curve to produce better audio fidelity than is produced by double-tuned transformers. Capacity coupling on such transformers is of even greater importance than in double-tuned transformers, especially where both plate and diode hook-up wires come out at one end of the transformer shield, as is the usual case with output IF transformers.

CAPACITY-COUPLING IN IF TRANSFORMERS

The ordinary circuit diagram of a double-tuned IF transformer is as shown in Fig. 6, but actually the circuit in Fig. 7 is more representative of true conditions.

The capacity coupling, shown in dotted lines, is a very important part of the coupling in practically all transformers operating at frequencies above 400 KC. This statement applies with even greater emphasis as the frequency, or the "Q," of the coils is raised.

The capacity that is effective in the above mentioned "capacity coupling" is that which exists between any part of the plate end of the primary circuit and any part of the grid end of the secondary circuit; to be more specific, the capacity between the plate and grid sides of the trimmer condensers, the plate and grid ends of the coils, the plate and grid leads, the grid lead and the plate end of

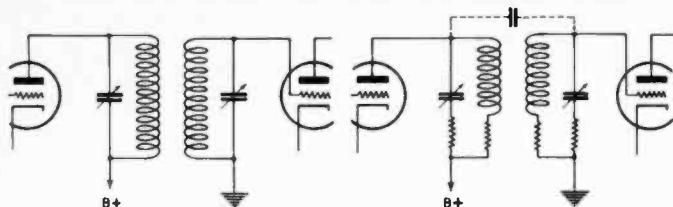

Figure 6

Figure 7

the primary coil, and between the plate lead and the grid end of the secondary coil.

The capacity between the two high-potential plates of a trimmer condenser such as the Meissner unit shown in Fig. 8 is 0.35 mmfd. if both trimmers have an even number of plates and the bottom plate of each trimmer (on the same base) is a high-potential (either grid or plate) electrode. If an odd number of plates is used on both trimmers, the capacity drops to 0.07 MMF. The difference between these two coupling capacities, amounting to only 0.28 MMF. is sufficient to make quite a difference in the gain of transformers operating above 400 KC.



Figure 8

Double-tuned IF transformers may be built with the magnetic coupling either aiding or opposing the capacity coupling. For reasons of production economy, both coils on one dowel are usually wound simultaneously, which means they must be wound in the same direction. For reasons of production uniformity, the insides of both windings are usually chosen as the high-potential ends of the coil so that the outside (low-potential) ends of the coils will automatically act as spacers to keep the high-potential hook-up wires from approaching the high-potential ends of the coils.

If transformers are designed so that the circuits are considerably under "Critical Coupling," variations in capacity coupling are equally important whether the magnetic coupling aids or opposes the capacity coupling. In the former case, an increase in capacity coupling will raise the gain of the transformer while in the latter case an increase in capacity coupling will reduce the gain of the transformer (except in the very rare cases where capacity coupling predominates).

If the transformer is at "critical coupling" and the magnetic and capacity couplings are "aiding," an increase in capacity coupling will merely decrease the selectivity, while if the couplings are "opposing," an increase in capacity coupling will increase the selectivity and reduce the gain.

In all of the above cases, the effect of increasing capacity coupling is described because transformers are ordinarily built with a certain irreducible minimum capacity and any changes must necessarily be additions.

Whether capacity coupling aids or opposes the magnetic coupling in a given transformer may be determined by inspection. If the coils are wound in the same direction, which is the usual case, the magnetic coupling opposes the capacity coupling if both grid and plate are connected to the same ends of their respective coils. Ordinarily both grid and plate are connected to the inside ends of the coils in order to keep the high-potential ends of the coils away from the hook-up leads passing the coil.

Special precautions and constructions are employed in building Meissner IF transformers in order to keep the capacity coupling uniform, so that transformers of uniform gain and selectivity characteristics may be provided. Fig. 9 shows fiber spacers used to hold flexible hook-up wires in a pre-determined place with respect to the coils, and Fig. 10 shows the "Perm-a-strut" construction employing rigid leads for maximum uniformity of capacity coupling.



Figure 9

In order to take advantage of the uniformity built into IF transformers by means of rigid leads,



Figure 10

or leads held in place by means of spacers, it is essential that the grid and plate leads remain everywhere well spaced from each other. Where the grid lead is brought out through the top of the shield, this is no problem, but where the high-potential end of the secondary is connected to a diode it is customary for both plate and diode leads to be brought out through the open bottom of the shield. In such cases, either two separate small holes in the chassis, well spaced, or one large (preferably 1" or larger) hole should be provided so that the leads may be well spaced from each other. In no case should both grid and plate leads be run through one small hole together.

Triple-tuned IF transformers, particularly output transformers where diode and plate leads both pass through the open end of the shield can, are particularly subject to gain and selectivity variations as a function of variation in capacity coupling.

As an example, in a particular triple-tuned output transformer where the plate and diode leads ran close together, it was found that in attempting to align the transformer, the middle circuit was effective as long as either the input circuit or the output circuit was out of tune, but as soon as both input and output circuits were aligned, the center circuit had a very peculiar action. If the gain of the transformer is plotted against the middle capacity of the middle circuit, a curve similar to Fig. 11 was obtained. From this it is seen that there is one adjustment (A) that produces an increase in the overall amplification of the transformer. At this point the center circuit is contributing to the selectivity of the transformer. At another point (B) the amplification through the center circuit opposes the capacity coupling from the input to the output winding and results in a considerable decrease in amplification. At all other settings of its tuning condenser, the center circuit is so far out of resonance that it has no effect upon the gain of the transformer, which for all practical considerations, may be assumed to be a double-tuned capacity-coupled transformer. When the capacity between the high-potential input and output leads was reduced to a very low value by keeping the leads in opposite corners of the shield can, the transformer behaved as a triple-tuned transformer should, with all three circuits effective.

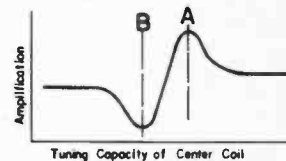

Figure 11

TRACKING

Early models of radio receivers usually used only one tuned circuit per receiver, but as the number of circuits was increased to provide better selectivity, tuning a radio set became a problem beyond the grasp of the average citizen, and confined the sale of receivers to the "DX" hunter who spent innumerable midnight hours listening for new stations.

To make the receivers commercially more acceptable, simplifications in tuning were imperative. To this end, designs were produced that had a nominal single-dial control with an "antenna compensator" to produce maximum results. Such receivers were essentially single-dial control over a limited frequency range, but required an adjustment of the antenna compensator when passing from one end of the tuning range to the other. This simplification in tuning permitted general merchandising of radio receivers to the average citizen.

In order to make such receivers possible, it was necessary for the condenser manufacturer to produce tuning condensers with several individual condenser-sections on one shaft, in which, at any point in its rotation, the several sections of the condenser were practically identical in capacity, and the radio manufacturer was required to produce coils that had practically identical characteristics.

Given identical condenser sections and identical coils, it is obvious that the resonant frequencies of the several identical combinations of coils and condensers would be the same. In other words, such circuits would be self-adjusted to the same station and it would no longer be necessary to tune each circuit separately. In the language of the radio man, the circuits are said to "Track." These conditions made the single-dial control receivers possible.

As long as low-impedance magnetically coupled antenna circuits were employed, it was not possible to eliminate the "Antenna Compensator" since the size of antenna had considerable effect upon the tracking of the first circuit, but when high-impedance primaries were adopted on the antenna coil, true single-dial control with all circuits tracking became possible.

It is not to be understood from this that a high-impedance primary on the antenna coil automatically makes the coils track properly, for there are designs of high-impedance antenna coils that mis-track seriously. Neither is it to be inferred that a properly designed high-impedance antenna coil gave perfect tracking independent of antenna constants. A properly designed high-impedance antenna coil gives reasonable gain and tracks well enough that when trimmed to accurate tracking, the increase in sensitivity in the receiver is not greater than 30%.

In setting up the conditions for perfect tracking, the first requirement is identical circuits, the second is simplicity of circuit, the third is identical circuit inductance and capacity.

It is much simpler to track two RF stages of similar circuits and constants than it is to track an antenna and RF stage, and it is simpler to track two high-impedance circuits than it is one high-impedance and one low-impedance circuit.

The circuits which track most easily are those having the smallest number of circuit elements. The simplest possible circuit of an RF amplifier is shown in Fig. 12-A, which, for purposes of track-

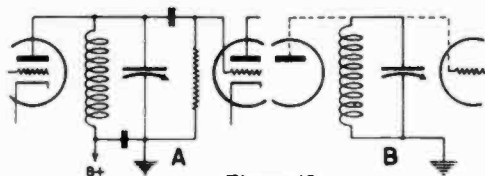

Figure 12

ing, is equivalent to Fig. 12-B. In this circuit there is one inductance tuned by one variable condenser, which condenser is assumed to include the grid and plate capacities. This circuit, in the broadcast band with the conventional capacity gang condenser, has entirely too much amplification, too much gain variation from one end of the tuning range to the other, and too little selectivity. Where the lack of selectivity and lack of uniform gain is not a serious problem, the gain of the amplifier can be reduced by tapping the coil to connect the plate somewhere near the middle of the

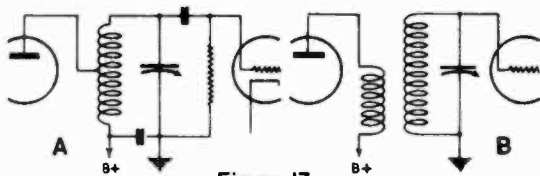

Figure 13

coil as in Fig. 13-A. In order not to have the plate voltage on the tuned circuit, a primary is usually wound on the coil, spaced between or exactly over the secondary turns, so that for all RF purposes, the plate is a tap on the secondary, but for DC is isolated. The RF coil now has a secondary tuned by the tuning condenser and is tightly coupled to the primary which has a very small capacity (plate and wiring capacity) across it. This arrangement permits the simple circuit of 13-B to be used. Such a circuit has two resonant frequencies, but for practical purposes the second resonant frequency is so high that it seldom causes any trouble, except in the case of certain high-frequency coils where the inductance of leads is comparable to the coil inductance.

The high-impedance primary type of RF coil has an inductance in the plate circuit many times higher than the inductance of the tuning coil. Such a circuit has two resonant frequencies, both of which are important. One is the frequency determined almost entirely by the secondary inductance and tuning capacity, and the other by the plate inductance and the plate capacity.

In Superheterodyne receivers, which almost universally employ an intermediate frequency lower than the broadcast frequencies, it is important to see that the primary-circuit resonance does not occur at the intermediate frequency, or the RF amplifier circuits will pass unwanted signals of intermediate frequency directly into the intermediate amplifier, even though the grid circuit of the RF amplifier is tuned to a frequency far removed from the intermediate frequency. This is particularly true of receivers employing an intermediate frequency just below the broadcast band, such as the 456 KC now so popular. On such receivers, the primary resonance should be placed either midway between the IF and the low end of the broadcast band, which gives high gain but leads to considerable production difficulties, or the primary resonance should be placed well below the intermediate frequency. The latter arrangement is highly recommended over the former because it is more uniform, causes less trouble from oscillation, and produces better tracking.

The presence of the primary circuit resonant below the low end of the tuning band has the effect of lowering the secondary inductance as the low end of the tuning range is approached. Fig. 14 shows the tuning curve for a high-impedance and a low-impedance RF circuit adjusted to have the same low-frequency inductance and the same maximum frequency. The low-impedance circuit is seen to follow the frequency curve calculated from the secondary inductance and total tuning capacity, but the high-impedance circuit does not follow this curve, departing from the calculated values at the low-frequency end. This point is brought out to show that two circuits may track perfectly over part of their tuning range and yet badly mis-track over another part due to resonances from some circuit not a part of the tuned circuit. From this it is easy to see that similarity of circuit is an aid in tracking.

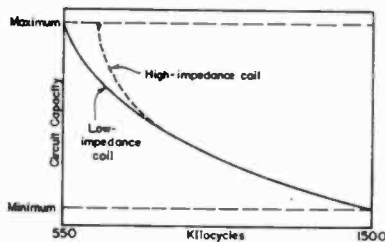

Figure 14

The amount the actual tuning curve of a high-impedance stage departs from the ideal curve depends upon two factors: the proximity of the primary resonance to the low end of the secondary tuning range, and the degree of coupling between primary and secondary. In the design of high-impedance coils, a reasonable limit on both of these factors may be assumed as follows: first, primary resonant frequency less than 80% of the lowest tuning frequency, but must not occur at the frequency of the IF amplifier in a superheterodyne receiver; second, magnetic coupling between primary and secondary should not exceed 15% coupling coefficient.

If the two circuits whose tuning curves are shown in Fig. 14 are to be tracked together, a series of compromises must be made. The tuning curves shown may be accepted as satisfactory, or a compromise may be made in the gain of the stage by moving the primary resonance

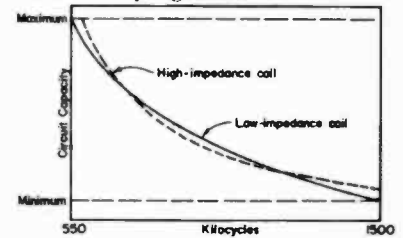

Figure 15

farther away, with consequent reduction in gain, but resulting in a straighter tuning curve, or the inductance may be changed to make the low end mis-track less and the previously perfect tracking of the remainder of the tuning curve be less perfect. Such tuning curves are shown in Fig. 15.

With the advent of superheterodyne reception, the problem of tracking became more complicated. The problem then became one of tracking one or more circuits to cover a given frequency range while another circuit (the oscillator) of different arrangement must maintain not the same frequency but a constant frequency difference in Kilocycles. Since the oscillator frequency is almost always above the signal frequency, and since the oscillator must cover the same number of Kilocycles from maximum to minimum, but cover them at a higher frequency than the antenna circuit, it is obvious that the oscillator covers a smaller frequency ratio than the antenna circuit.

In order to accomplish a restricted oscillator frequency-range compared to antenna frequency-range if no other restrictions were imposed, two methods are available; (1) Connect a fixed condenser across the oscillator. This reduces the capacity ratio by adding to the minimum capacity a much greater percentage than it adds to the maximum; (2) Connect a fixed condenser in series with the tuning condenser to reduce its maximum capacity without materially changing its minimum capacity. In actual receiver design, a combination of both types of compression is used, producing better average tracking than could be accomplished by either method alone. Formulas have been developed for calculating the values of inductance, padding and aligning capacities to be used to track an oscillator coil with a given antenna or RF coil, but unless there is access to a considerable amount of complicated test equipment, oscillator tracking must be accomplished experimentally with simple equipment.

TRACKING REPLACEMENT COILS

Radio servicemen are frequently called upon to replace Antenna, RF or Oscillator coils that have failed either through corrosion, or because of the failure of some other component in the receiver, or because damaged by some outside agency such as lightning.

Usually the damage is confined to the primary of the coil, in which case very frequently a new primary can be installed in place of the old one.

If the primary is replaceable, the winding direction of the old primary should be noted before removing it so that the new one may be installed with its winding direction the same.

If the damaged coil is beyond salvaging by installing a new primary, or if the secondary has been damaged, it will be necessary to install a new coil and check its tracking with the remainder of the tuning circuits.

In order to permit replacement coils to be tracked rapidly and to eliminate the possibility of having removed too much inductance and thereby ruined the replacement coil, to say nothing of the hours of labor installing, checking, removing and altering the coil, etc., Meissner has developed "Universal Adjustable" replacement antenna, RF and oscillator coils which are provided with a screw-driver adjustment of inductance by means of a movable core of finest quality powdered iron. By means of this adjustment, it is as easy to add inductance as to remove it, and to quickly obtain the optimum value of inductance. A coil of this type is shown in Fig. 16.

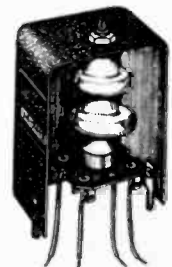

Figure 16

When a replacement antenna or RF coil is installed in a TRF receiver, the process of aligning is very simple. The dial is set to 600 KC, a dummy antenna of 200 mmfd. connected between the

high side of the service oscillator and the antenna connection of the receiver, an output indicator of some type is connected to the output of the receiver, the service oscillator tuned to the receiver and the screw adjuster in the top of the can rotated until maximum sensitivity is obtained. The receiver and signal generator are next tuned to 1400 KC and the circuits aligned in the usual manner by adjusting the trimmers on the gang condenser. The process should then be repeated in order to obtain the best possible alignment at both checking points. It is best to seal the inductance adjustment on the coil by the application of a satisfactory cement, such as Duco Household Cement or equivalent.

When replacing an antenna or RF coil on a superheterodyne, essentially the same practice is followed as above with the exception that, since the oscillator determines the dial calibration, if the adjustments thereon have been disturbed, it is necessary to readjust the oscillator circuit to agree with the dial calibration at the checking points before adjusting the inductance of the new coil or aligning it.

If a new oscillator coil is being installed, the greatest aid to rapid adjustment of the new coil to proper inductance is an *undisturbed padding condenser adjustment*. There are innumerable combinations of oscillator inductance, padding capacity, and trimmer capacity that will track an oscillator circuit at two places in the broadcast band, but these various combinations give varying degrees of mis-tracking throughout the remainder of the band. If the padding condenser has not been disturbed, one of these variables is eliminated, and, with only inductance to adjust for proper alignment at the low-frequency end of the band, and capacity to adjust at the high-frequency end of the band, the adjustment is practically as easy and rapid as installing and adjusting an antenna or RF coil.

If the oscillator padding condenser has been disturbed, it will be necessary to track the oscillator with the remainder of the receiver in the same experimental manner as used in the determination of the original design values. To arrive at a satisfactory alignment, the following experiment should be conducted systematically, *writing down* the answers obtained, so that the data does not become confused in your mind.

1. Align the IF amplifier at the frequency specified by the manufacturer.
2. Adjust the padding condenser to some value known to be much *lower* in capacity than its normal adjustment.
3. Set the dial and signal generator (of known accuracy) to 600 KC and adjust the oscillator inductance by means of the screw in the top of the can until a signal is heard. If no signal is heard within the range of the oscillator inductance adjustment, screw the adjustment as far in as possible and increase the padding capacity until a signal is heard.
4. Attempt to align the oscillator trimmer condenser to agree with the dial at 1400 KC. If the adjustment cannot be made, again increase the capacity of the padding condenser and reduce the inductance (by turning the screw out) of the oscillator coil to obtain a new setting at 600 KC. This process should continue until both 600 and 1400 KC are correctly indicated.
5. When both 600 and 1400 KC are correctly indicated, tune the receiver to the generator set at 1000 KC and make a *sensitivity measurement* which should be recorded.
6. Now increase the padding condenser capacity *slightly*, decrease the inductance to give a 600 KC signal, align at 1400 KC and again measure sensitivity at 1000 KC. If the sensitivity at that point is better than it was before, repeat this operation until the sensitivity measurements show greatest sensitivity and then start falling off again. If the steps in the process have been written down, recording the number of revolutions and fractions thereof on the adjusting screw of the inductance, it should be easy to return to the adjustment giving maximum 1000 KC sensitivity. When this adjustment is set, seal it with some satisfactory cement such as Duco Household Cement or equivalent and then give the receiver a complete alignment.

ALIGNMENT OF RECEIVERS

Modern radio receivers employ from two up to eight, ten or even more circuits to achieve the selectivity desired. These circuits, however, are of little benefit unless all of them are working at their proper frequencies simultaneously. Only someone acquainted with the alignment of receivers in a radio production department, or someone engaged in radio service work who has adjusted a receiver on which someone has tightened all of the adjusting screws, can realize how dead a receiver can sound when all of its tuned circuits are out of adjustment any considerable amount.

The purpose of "Aligning" a radio receiver is two-fold — to adjust it for maximum performance, and to make the dial indicate within two or three percent the frequency of the station being received.

Since a trimmer adjustment is more sensitive when the circuit capacity is low, the trimmer adjustment is usually made near the high-frequency end of the tuning range. If the adjustment is made at the very end of the range, the maximum mis-tracking over the

adjacent portion of the band will be greater than if an alignment point is chosen some small distance from the extreme high-frequency end of the tuning range. In the broadcast band, 1400 KC is the usual choice and is the frequency recommended as standard by the Institute of Radio Engineers. On shortwave bands on the same receiver, it is a good practice to align them at the same position of the gang condenser.

On a TRF receiver, all tuned circuits operate simultaneously at one frequency. When aligning a factory-built receiver, or a kit receiver having a dial calibrated to match the coils and condenser used, the dial is set to indicate the frequency of some signal of known frequency and the individual circuits adjusted to maximum performance on that signal at that setting of the condenser.

On a Superheterodyne receiver, circuits must operate at three different frequencies, properly related if satisfactory performance is to be obtained. Beginning with the circuits closest to the output tubes, the intermediate-frequency circuits must all operate at the same frequency in order to give satisfactory amplification. Actually they will work over a wide frequency range, but if they are operated very far from the intermediate frequency specified for the given dial, coils and tuning condenser, the dial indications will be in error more than the customary few percent and, in the case of receivers employing specially cut tracking plates in the oscillator condenser, serious mistracking of the oscillator with other tuned circuits will result, producing a loss in sensitivity and reduction in image-ratio.

The first adjustment on a superheterodyne receiver is therefore to align the intermediate-frequency amplifier at the correct frequency. Fortunately for satisfactory receiver operation, but unfortunately for the home set builder, there are no steady signals on the air at intermediate frequencies to be used for aligning IF transformers. The IF transformers furnished by Meissner are aligned in the factory to the frequency specified in the catalog. If no equipment is available to furnish the proper aligning frequency, the transformers will be closely enough in alignment to pass a signal from a local broadcasting station when the complete receiver is operating. The transformers should be adjusted to give the strongest signal by adjusting, in turn, each of the adjustments on all of the IF transformers. As the adjusting screw is turned continuously in one direction, the output of the receiver will continue to increase up to a certain point beyond which the signal begins to fall again. By reversing the direction of rotation of the adjusting screws, each can be set for maximum signal output. As alignment proceeds, and the receiver becomes progressively more sensitive, the input should be reduced by retarding the setting of the sensitivity control, if the receiver has one, or by using progressively shorter antennas or merely short lengths of wire, or by tuning in weaker stations. The last expedient is not recommended unless all others fail, because in tuning in a new station the receiver may not be accurately tuned and it may be necessary to slightly retune all IF circuits.

When the alignment of the IF amplifier is completed, alignment of the RF and oscillator circuits should be made. If there is a signal generator or service oscillator available, it should be used as the frequency standard for alignment only if it is known to have an accurate frequency calibration. A manufacturer's statement of accuracy should not be assumed to hold for long periods of time especially if tubes have been changed in the oscillator. The accuracy can be quickly checked by beating the signal from the service oscillator against stations of known frequency using an ordinary radio set to receive both signals.

If the generator has an accurate frequency calibration, set the frequency to an appropriate frequency for the band to be aligned (all aligning frequencies are specified in Meissner Kit instruction sheets) which is usually about 80% of the maximum frequency tunable on that band, set the receiver dial to the corresponding frequency, connect an appropriate "Dummy Antenna" (see following section, "Dummy Antenna") between the high side of the signal generator output and the antenna connection of the receiver, turn the volume and sensitivity controls of the receiver full on, turn the generator up to high output and adjust the *Oscillator* trimmer until a signal is heard. Reduce the signal from the service oscillator as alignment proceeds always using as little signal input as possible because weak signals permit a more accurate alignment than strong signals.

Next align the RF amplifier circuit. On the bands below 6 MC the frequency of the RF amplifier circuit has very little effect upon the oscillator frequency, but at higher frequencies the adjustment of the RF circuit has a slight effect upon the frequency of the oscillator, and consequently it is necessary, when aligning a high-frequency RF amplifier, to rock the gang condenser very slightly as the alignment proceeds to be sure that a shift in oscillator frequency has not shifted the heterodyned signal out of the range of the IF amplifier. The antenna circuit is then aligned in the conventional manner.

Shifting the tuning dial to a point about 10% up from its low-frequency end, the oscillator circuit should be "padded" for best tracking with the antenna and RF circuits. If the radio set is sufficiently sensitive to produce a readily discernible hiss in the

speaker, probably the easiest way to pad the oscillator circuit is to adjust the padding condenser for maximum hiss or maximum noise. If the receiver is not sufficiently sensitive to align by the noise method, a signal of constant amplitude should be tuned in, and then as the padding condenser is turned continuously but very slowly in one direction, the gang condenser should be rocked back and forth to keep the signal tuned in. If the sound output is plotted against time, Fig. 17 shows the result of the above described operation. The padding condenser should be set as it was at point A, giving best sensitivity.

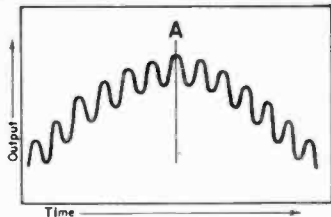

Figure 17

When this point is padded, it is well to return to the high-frequency end and realign that part of the band.

On coils operating in the frequency range 150 to 400 KC with an IF amplifier of 456 KC, the padding capacity is so important in the oscillator tuning scheme that the oscillator should be padded before the high-frequency alignment, and then the circuit aligned and padded at least twice.

Simple receivers can be aligned without instruments by tuning in stations of relatively constant volume, but it is a difficult problem to obtain optimum alignment on any kind of a signal except a constant tone. If the receiver to be aligned is complicated and no equipment is at hand for alignment, it would be well to take the receiver to a serviceman possessing adequate equipment and have him align the receiver.

DUMMY ANTENNA

Receivers are aligned on signals furnished by a "Service Oscillator" or "Signal Generator" because that is the only method of obtaining truly satisfactory signals of constant tone, of adjustable strength, and of the desired frequencies.

In order to make allowance for the effect that the outside antenna will have on the alignment of the receiver, a substitute for the antenna called a "Dummy Antenna" representing the average antenna is used to connect the service oscillator to the antenna connection of the receiver.

On frequency ranges up to 1700 KC the average antenna is essentially a capacity of 200 MMF if used on a high-impedance primary. It has an inductance of a few microhenrys but this small inductance can be neglected except in the case of aligning receivers having a low-impedance primary or a Hazeltine low-impedance capacity coupling.

On frequencies above 1700 KC, the average antenna can be represented by a 400-ohm carbon resistor.

SPURIOUS RESPONSES IN RECEIVERS

In the dawn of Radio Broadcasting, stations were few in number and limited in power. Receiving sets were likewise extremely simple, employing, as a rule, only one tuned circuit. As the power of transmitters was raised, receivers were no longer able to separate the undesired signal from those desired. Consequently, receivers of progressively greater selectivity were developed, adding tuned circuits for greater selectivity until high quality TRF receivers used as many as six tuned circuits, all ganged together and operating from one knob. The superheterodyne method of reception was then popularized, making possible a degree of selectivity never approached in the best of TRF receivers. Throughout the entire development, spurious responses were, and still are, an important design and service problem.

In TRF receivers, these unwanted responses might be divided into the following classes: cross modulation, adjacent-channel interference, and intercarrier 10 KC whistle.

With the advent of the Superheterodyne method of reception the following additional classes of spurious responses became evident: "tweets" at IF harmonic frequencies, simultaneous reception of two stations separated by a frequency difference equal to the IF frequency, reception of a station located above the dial-indicated frequency by a frequency equal to twice the IF frequency; reception of stations on or close to the intermediate frequency.

With the exception of "tweets" on stations which operate on a frequency corresponding to harmonics of the intermediate frequency, all of the remainder will respond to simple treatment to reduce or eliminate the trouble.

SPURIOUS RESPONSES — CROSS MODULATION

"Cross modulation" in a TRF receiver is, by accepted definition, the modulation of any desired program by some undesired program several or more channels away. This can occur in spite of extreme overall selectivity because it is a function of the selectivity preceding the first tube.

In superheterodyne receivers, the term "Cross Modulation" is confined to those modulations which occur at some frequency not related to the desired signal by some simple frequency relation

involving the intermediate frequency, such as, frequency of interfering signal being above the desired signal by a frequency equal to the intermediate frequency or twice the intermediate frequency. These special frequencies are classed as "Image frequencies," and are treated under a separate heading.

"Cross Modulation" is accentuated by the following design features in receivers: (1) A sharp cut-off tube such as a type 24 tube as the first tube in the receiver, (2) lack of selectivity ahead of the first tube, (3) an antenna circuit with a primary resonant near the frequency of a local station when connected to an antenna of proper constants, (4) antenna circuits with extremely close coupling, (5) antenna circuits of very high gain. All of these troubles are caused by having too large a signal of undesired frequency present on the first grid simultaneously with the desired signal. The actual modulation occurs in the first tube after which no amount of selectivity can remove the interfering modulation.

The cure for such trouble is either to use a first tube which has less tendency to cross modulate, such as a variable Mu remote cutoff tube, or to reduce the amount of interfering signal by any one of the following means: (1) Install an appropriate wave trap such as shown in Fig. 18 over A, tuned to the frequency of the interfering station.

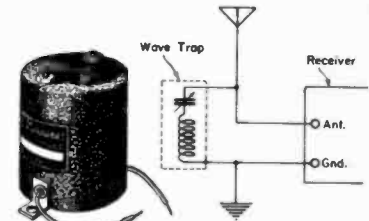

Figure 18

- (2) If the primary circuit is resonant near the frequency of the interfering stations, change the resonant frequency by a 100- to 200-mmfd. condenser connected either in series with the antenna or connected between the antenna and ground posts of the receiver.
- (3) Shorten the antenna, if long.
- (4) If a low-impedance antenna coil is used and the interfering station is at the high-frequency end of the dial, install a new antenna coil with high-impedance primary.
- (5) Connect a resistance across the antenna and ground terminals of the receiver using a value satisfactory for reducing the effect, usually 1000 to 3000 ohms.

SPURIOUS RESPONSES — ADJACENT-CHANNEL INTERFERENCE

"Adjacent-Channel Interference" is closely related to the adjacent-channel selectivity of a receiver. If insufficient for certain locations and selections of stations, selectivity may be improved by the use of better coils, but in TRF receivers the effort probably does not justify the expense of obtaining new coils of higher "Q" that track properly. In superheterodyne receivers, the adjacent-channel selectivity can easily be improved by installing new IF transformers having greater selectivity than those previously in use. Here no tracking problem is present and standard stock IF transformers may be used. If the original transformers had only fair selectivity, it is recommended that iron-core transformers similar to that shown in Fig. 9 be installed. If the original transformers have good selectivity but still higher selectivity is desired, install triple-tuned IF transformers similar to that shown in Fig. 19. In the latter case, the additional tuned circuits will add selectivity faster, and with better audio quality, than will iron-core IF transformers.



Figure 19

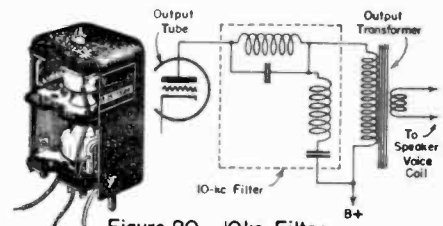

Figure 20 10kc Filter

SPURIOUS RESPONSES — INTER-CARRIER 10 KC WHISTLE

Inter-carrier 10 KC whistles can be suppressed either by increasing the selectivity of the receiver or by filtering out the objectionable 10 KC note. By far the most convenient and economical method is to install a 10 KC filter such as shown in Fig. 20. It will be immediately apparent upon inspection of the circuit diagram, that this filter consists of two tuned circuits, one resonant and one anti-resonant, giving unusual attenuation of the 10 KC interfering note. The constants of the filter have been chosen to permit the audio response to carry out flat very close to 10 KC before the filter begins

to attenuate seriously. When the filter does begin to attenuate, however, the output drops very rapidly as 10 KC is approached.

SPURIOUS RESPONSES — IMAGE AND HARMONIC INTERFERENCE

A few superheterodyne receivers have complaints on Cross Modulation, but usually complaints of interference on such receivers are closely tied up to the heterodyne operation and the interferences occur between stations separated by a frequency equal to the intermediate frequency, twice the intermediate frequency or some fractional multiple of that frequency.

Where two local stations, separated by a frequency equal to the intermediate frequency, are observed to ride in on almost any weak program, or to come through simultaneously when the oscillator is blocked, one is acting as the heterodyne for the other to produce the intermediate frequency. The remedy for such trouble is to install a wave trap tuned to the stronger of the two stations; a second method, but one which disturbs tracking and dial calibration, is to re-peak the IF transformers on a new frequency, far enough from the frequency difference between the two local stations to avoid the trouble. Depending upon conditions, the shift may vary from 10 to 25 KC either above or below the original frequency. Receivers having oscillator padding condensers should be repadded and re-aligned. This treatment is not recommended where receivers have specially cut oscillator plates on the gang condenser for purposes of tracking.

"Image interference," which is by far the most important type of superheterodyne interference, is that interference which is produced by a station located above the desired station by a frequency difference equal to twice the intermediate frequency.

The cause of image interference is that the heterodyne principle works on a frequency difference, irrespective of whether the desired signal is below or above the oscillator frequency. The first detector tube cannot recognize and differentiate between signals above and below oscillator frequency. If the frequency difference is correct, the first detector produces an IF signal. The selection of the signal frequency (usually below the oscillator frequency) and the rejection of the image frequency (usually above the oscillator frequency) is the function of the tuned circuits ahead of the first detector. The ordinary types of receivers have only one tuned circuit ahead of the detector with consequently poor image ratio. Commercially good receivers have two tuned circuits, producing much higher image ratios. A few very high class receivers have three tuned circuits producing a *measured* image ratio far better than most such receivers are capable of producing when operating on a broadcast signal rather than operating from a signal generator because of inadequate shielding.

In general, the image rejection is a direct function of the "Q" of the antenna and RF circuits and of the number thereof, but there are a few receivers employing special schemes to improve image response at certain points in the band.

Generally, image ratio is a built-in function of the receiver that it is not economical to change by the addition of tuned circuits or improvement in coil design.

Where "Image" interference is experienced from only one local station, a wave trap can be connected to remove that interference. If, as is sometimes the case, the desired station is an important out-of-town station and the interfering image station is a powerful local transmitter, it may be necessary to employ a double wave trap such as shown in Fig. 21 which gives extreme attenuation to a narrow band of frequencies.

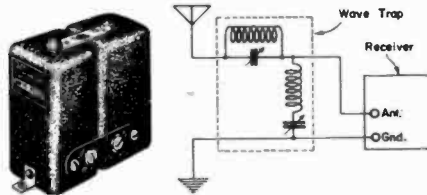

Figure 21 Dual Wave Trap

In some cases, where it is permissible to alter the calibration of the receiver slightly, image trouble between a definite pair of stations can be eliminated by shifting the intermediate frequency, but such treatment merely shifts the image interference to another station.

SPURIOUS RESPONSES — IF HARMONIC "TWEETS"

"Tweets" on harmonics of the intermediate frequency can best be eliminated by shifting the intermediate frequency. Admittedly, this treatment merely moves the interference from one to another station but, in general, the problem of attenuating IF tweets is so complex that the work of eliminating them is not justified unless

the results can be applied to a large number of similar receivers. Usually, moving the intermediate frequency to shift the tweets to another station is the only economical correction to apply.

SPURIOUS RESPONSES — IF INTERFERENCE

Reception of undesired stations on or near the intermediate frequency is caused by inadequate attenuation to IF ahead of the first detector. Usually, two-gang superheterodynes only are troubled with this type of interference, but occasionally even three-gang receivers will exhibit this type of trouble when close to such interfering stations. The usual remedy is the use of a wave trap of the type shown in Fig. 18 which may be adjusted to the intermediate frequency of the receiver if the interference is weak, or the use of a two section trap similar to the two section image trap illustrated in Fig. 21 if the interference is bad.

REGENERATION AND OSCILLATION

In the design and construction of radio receivers, employing either a limited number of amplifier stages with very high gain per stage, in an attempt to obtain the greatest possible sensitivity and selectivity from a given investment in parts, or in the design of a super-sensitive receiver having a multiplicity of conservatively designed stages, one of the limiting factors in the direction of extreme sensitivity is regeneration, which, when extreme, results in oscillation.

Regeneration is the process of building up a voltage by re-amplifying a voltage that has already passed through an amplifier. It is caused by feeding back a voltage from one point in an amplifier to some preceding point **working at the same frequency**.

Regeneration is usually present in some degree in all receivers, sometimes by design and sometimes by accident. When limited to a relatively small amount, it is useful and can be handled in quantity production of receivers with a fair degree of uniformity, but when employed in large amounts, the production variations between receivers is apt to be quite large, because regeneration tends to exaggerate relatively small differences in individual set components. In addition, receivers employing large amounts of regeneration will usually exhibit far greater changes in sensitivity, as a function of humidity variations, than will sets with little regeneration.

Normally, in domestic broadcast receivers, whatever regeneration there is has been limited by design constants to a value that will not cause trouble, and therefore no control is provided to be set by the user. In amateur receivers, controlled regeneration is employed to accomplish amazing results in the hands of an experienced operator attempting to obtain the maximum possible performance from the minimum of equipment. Usually in such cases the regeneration control is second in importance to the tuning control, requiring re-adjustment as soon as the receiver dial is moved an appreciable amount.

From the above it is not to be concluded that regeneration, of itself, is undesirable, because it can, if judiciously used, add a great deal to the performance of a receiver. What is to be concluded, however, is that in the design of a receiver, the amount of regeneration present under the best and worst operating conditions should be determined, and the regeneration limited to an amount that is safe for the type of service for which the receiver is intended.

In receivers which have not been properly checked for regeneration, conditions sometimes exist that permit the receiver to regenerate until sustained oscillations result under certain weather, tuning, or antenna conditions, or when receiving signals below certain strengths.

Regeneration may be broken down into two general classifications even though fundamentally the cause is the same. These two classes are single-stage regeneration and over-all regeneration.

SINGLE-STAGE REGENERATION

Single-stage regeneration in amplifiers is usually the least understood type of regeneration trouble and frequently has baffled many service men and radio experimenters. It is peculiar in that no amount of isolation and filtering applied to screen, cathode, plus "B" or grid return seems to make any improvement.

The feedback actually occurs inside of the tube in the stage that is giving trouble. The coupling exists between grid and plate through the inter-electrode capacity of the tube or any additional stray capacity between the two points. To some, this may seem unreasonable when the inter-electrode capacity is as low as .01 mmfd. or less, but it is an actual fact that is easily proven.

When single-stage oscillation is suspected, raising the grid bias will stop the regeneration, but so will this change stop over-all regeneration. The true test for this phenomena is to connect a milliammeter (properly bypassed) in the plate circuit of the suspected tube as shown in Fig. 22. Remove the preceding and following tubes, and then place an intermittent short-circuit on either the grid or plate circuit of the suspected stage while watching for changes in the plate current in that tube as an indication of the starting and stopping of oscillation. The tube and associated tuned

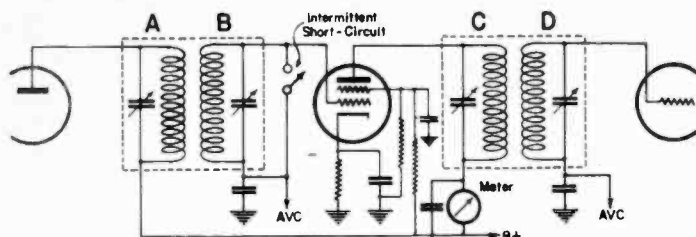

Figure 22 Test for Single-stage Oscillation

circuits form a tuned-grid-tuned-plate oscillator similar to a transmitting circuit that was very popular in the early days of vacuum tube transmitters.

The standard cures for this trouble are:

- (1) Use a tube with lower inter-electrode capacity.
- (2) Neutralize the inter-electrode capacity.
- (3) Reduce the gain of the circuit by raising the tube bias.
- (4) Reduce the value of the resonant impedance in either grid or plate circuits, or possibly both. This may be done by using coils of lower Q, or coils of the same Q but lower inductance, or by tapping one or both of the tuned circuits so that only a portion of the resonant impedance is introduced into the grid or plate circuit.

This type of oscillation is not confined to intermediate-frequency amplifiers but is encountered in RF amplifiers as well, if the primary is closely coupled to the secondary (as most shortwave RF primaries are) and has too many turns in an attempt to obtain high RF stage gain. In such cases it is necessary to reduce the number of primary turns until single-stage oscillation stops.

A peculiar effect may have been observed by some experimenters that they have never been able to explain, which can be understood when considered in the light of single-stage regeneration. This phenomenon is that a given amplifier stage may be stable when lined up properly, but will be unstable and oscillate when one or two of the associated circuits are misaligned. This phenomenon may have been observed accidentally and has not been reproducible because the reasons were not understood. Referring to Fig. 22 it will be seen that the resonant circuits are lettered for easy identification. Consider that the middle tube is the offender, but with all circuits aligned it refuses to oscillate or give any other evidence of misbehavior. If circuit A is progressively misaligned in one direction and circuit D progressively misaligned in the opposite direction, single-stage oscillation will soon result. The same results can be accomplished on variable coupling IF circuits, that are mechanically variable, if the coupling is progressively reduced. The explanation is the same in both cases, but is accomplished by a different agency. In both cases the impedance of circuits C and D rises until single-stage oscillation occurs through the inter-electrode capacity of the tube. The explanation for this statement is given here below.

When a single circuit is resonant it presents a definite resonant impedance that is a direct function of its "Q" and its reactance. If another similar circuit, similarly resonant to the same frequency, is coupled to the first circuit, and set near "Critical Coupling" the resonant impedance of the combination approaches half the impedance of either circuit separately. It is this loading effect that keeps the impedance down when all circuits are aligned, and the absence of which, when circuits A and D are detuned, that permits the impedance of circuits B and C to climb high enough to cause single-stage oscillation.

OVER-ALL REGENERATION

Over-all oscillation is a familiar complaint on multi-stage TRF receivers even of good design, and on IF amplifiers of high gain. On experimental receivers in the process of development it may be produced by any one of a number of causes. Only by experiment can the offending source of coupling be discovered and removed. It may be of two general types, high-impedance or low-impedance, or might be considered voltage feedback and current feedback although all feedback phenomena in radio receivers are, strictly speaking, voltage feedback phenomena.

Coupling between antenna and grid or plate leads, and couplings between grid leads or plate leads, etc., all of which are relatively high voltages impressed, on the very small capacities existing between the points just mentioned are classed as high-impedance feedbacks. Appropriate partition type shielding quickly stops this type of feedback.

Under the heading of low-impedance feedbacks are placed all oscillation troubles resulting from the use of common cathode, screen or plate bypass condensers, common leads in high-frequency circuits, couplings resulting from the common shaft of a gang condenser, etc. Eliminating oscillation from these sources requires a study of

the receiver and many experiments, isolating the various circuits that are suspected of causing the feedback, until finally the real offender is discovered.

Sometimes feedbacks are degenerative instead of regenerative and the disconcerting fact may be discovered in some cases that isolation of certain circuits increases rather than decreases oscillation troubles.

On manufactured receivers made by a reputable company which attempts to keep uniform quality, over-all oscillation after some time in service can usually be quickly traced to some circuit element that changes characteristics with age. For example, if no paper condenser is used across the electrolytic filter condenser to insure a permanent low-impedance RF path to ground, over-all IF oscillation can occur when the RF resistance of the electrolytic filter condenser increases with age.

In TRF receivers, frequently high-resistance contacts between the gang condenser shaft and the wipers causes over-all oscillation which can be eliminated by a thorough cleaning of the contacting surfaces. Common bypass condensers also should be suspected as the cause of feedback. When they are, they are usually found very easily by connecting a known good condenser across each bypass condenser successively until the defective unit is found.

INTER-ELECTRODE CAPACITY

It has been pointed out, in the section on Single-Stage Oscillation, that the coupling medium for such oscillation is the inter-electrode capacity of the tube.

The method of measuring such small capacities in the presence of much larger capacities in a network that cannot be opened to measure the desired capacity directly may be of interest.

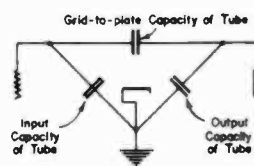

Figure 23

Fig. 23 represents the capacity network that exists in the tube as far as feedback capacities are concerned.

The method of measurement is to have a similar network, Fig. 24, in operation, supplying a voltage to some measuring device and fed by a source with the proper characteristics. The output capacity

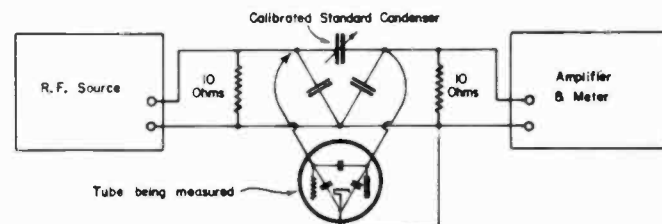

Figure 24 Measurement of Inter-electrode Capacity

of the tube is connected across the measuring circuit and a reading obtained on the output meter; then, when the grid of the tube is connected to the source of voltage, there will be an increased reading on the meter. The calibrated condenser is then reduced in capacity until the meter reads as before. The inter-electrode capacity of the tube is the difference in the capacity of the calibrated condenser at its two settings.

The calibrated condenser for the above measurement is an elaborate device not available to the experimenter or service man, therefore the above method of checking inter-electrode capacity cannot be attempted, but a very similar method can be used to check the uniformity of inter-electrode capacity in the manner shown in Fig. 25. Here a signal generator or service oscillator is used to

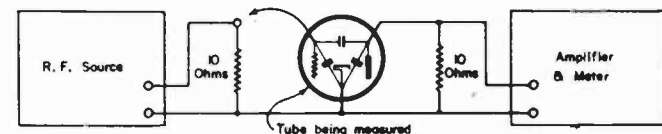

Figure 25 Comparison of Inter-electrode Capacity

furnish a signal to a low-impedance load so that the input-impedance of a tube may be connected across it with negligible change in voltage. The inter-electrode capacity feeds the signal into the radio receiver across whose input a low-impedance load has been connected so that variations in the output capacity of the tube will be swamped out. An output meter on the receiver will serve to indicate the relation between tubes of differing inter-electrode capacity.

The above system for comparing inter-electrode capacities has been successfully used in a number of laboratories desiring checks on inter-electrode capacity but which were unable to purchase complete equipment for making these measurements. It probably is not a measurement that any service man will have occasion to use, but some advanced experimenters, attempting to obtain the maximum possible performance from circuits, may desire to check their tubes for this parameter.

FIDELITY vs. SELECTIVITY

One of the most frequent requests from experimenters working on high-fidelity receivers is for IF components that will permit high-fidelity reception, yet have good adjacent-channel selectivity.

The following considerations will show that it is impossible to meet both specifications simultaneously. In order to transmit a single audio frequency by the double sideband transmission method which is standard on all types of broadcast and shortwave entertainment transmissions, a carrier and two additional frequencies are required. These additional frequencies are located one above and one below the carrier frequency by an amount exactly equal to the audio frequency. For example, if it is desired to transmit a 10 KC note on a 1000 KC carrier, the upper sideband will be 1010 KC and the lower sideband will be 990 KC. It can be shown mathematically and it can actually be demonstrated that in the above case three separate signals exist, if a sufficiently selective receiver is used for the demonstration. Since it is the American practice to assign broadcasting frequencies at 10 KC intervals, it is obvious that the 10 KC transmission of the 1000 KC station above mentioned will fall exactly on the carriers of the two adjacent channels and will produce heterodynes that will give rise to spurious audio responses in any receiver having a selectivity curve wide enough to pass both sidebands on a 10 KC modulation.

Since it is reasonable to assume that there will be modulation on both adjacent channels it will be obvious that the transmissions of the two adjacent channels will encroach upon the territory that the 1000 KC station is using if it modulates up to 10 KC. Now if all three stations are producing a signal of equal intensity and are all modulating up to 10 KC the receiver will not be able to separate these three programs. If, however, the pass-band of the receiver is narrowed down until it accepts a band of frequencies only 4 KC above and below its mid-frequency, it will accept from the adjacent channels only those frequencies above 6000 cycles which frequencies carry a comparatively small part of the energy of speech or music and consequently will not interfere with the desired program to as great an extent.

If the ratio of desired signal strength to adjacent-channel strength is now changed so that the desired signal is many times stronger than the adjacent channel signal strength, the pass-band of the receiver can be increased considerably without introducing appreciable interference.

From the above it can be seen that "High-Fidelity" reception can be used only where the ratio of desired signal to adjacent-channel signal is very great, say 1000 times or more, and that, unless the receiver is confined to the reception of local stations, it must be able to sharpen its selectivity curve when it is desired to select one station whose signal strength is near or below the signal strength of the adjacent channels. In order to accomplish this economically, IF transformers, whose physical and electrical features are shown in Fig. 26, are available. In these transformers, the pass-band is varied

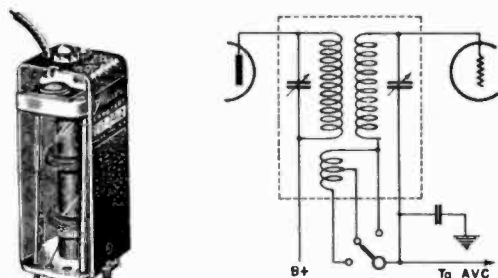

Figure 26

by changing the coupling between primary and secondary, by means of a tapped coil in series with one winding closely coupled to the other. By this arrangement a very high percentage change in coupling can be accomplished with practically no change in the self-resonant frequency of the tuned circuit which has been switched. This arrangement permits one receiver to be adjusted for either wide or narrow pass-band instead of requiring two independent receivers of the desired characteristics.

DISTORTION IN DIODE DRIVER STAGES

When a diode detector must work at reasonably high levels, as in the case of feeding a low-gain audio system such as a type-55, -85 or -6R7 tube working a push-pull stage through a transformer, considerable energy is required by the diode and its load resistance.

If the gain of the diode driver tube is varied by means of the conventional AVC circuit wherein full AVC voltage is applied to all controlled tubes, it may be found that very serious distortion is produced at high signal levels. If such distortion occurs, it is probable that the last IF tube is not able to furnish the power output required to properly drive the diode circuit when this IF tube has a relatively high bias. The quick test for this trouble is to remove the AVC voltage from the last IF tube and hold its bias constant at its nominal minimum value while the receiver is again checked for distortion. If the above test eliminates the distortion, that tube may be left without AVC or may have applied to it only a fraction, usually $\frac{1}{4}$ to $\frac{1}{2}$ of the voltage that is applied to the remaining tubes.

MICROPHONICS

In the original design of receivers one of the most exasperating and illusive problems confronting the radio engineer is that of preventing "Microphonic Howls." First-class radio manufacturers usually do everything economically practical to minimize this trouble but, even in spite of these efforts, this trouble still produces many service calls.

The cause of the trouble is easily understood, but finding the offending item is usually a difficult job with many apparently correct answers proven wrong before the real offender is found. Often when one source of trouble is eliminated another shows up.

The most powerful tool for the solution of such a problem is the combination of audio oscillator, audio amplifier, output meter and unmodulated signal generator. Fig. 27 shows the arrangement of parts for the test.

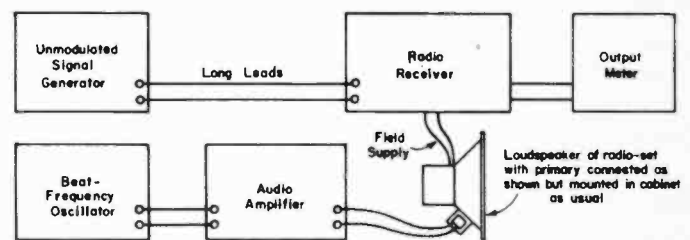

Figure 27 Mechanical Vibration Test

The receiver is tuned to the signal generator using modulation on the generator, if necessary, to properly tune the receiver. The modulation is removed without disturbing the tuning of either generator or receiver and the beat frequency oscillator is started, putting into the speaker an output approximately equal to the full output of the receiver. As the beat frequency oscillator is run over the audio range from 60 to 5000 cycles slowly, various sharp peaks will be noticed on the output meter. This audio output from the receiver is caused by the mechanical vibration of some part of the receiver modulating the CW carrier supplied by the generator. The actual means of modulation may be the vibration of a condenser changing capacity in time with the vibration to produce capacity modulation of a tuned circuit, or vibration of a coil or coil lead may give inductive modulation of the tuned circuit, or vibration of the elements in the tube itself may give direct modulation of the electron stream. Whatever may be the modulating element, the best chance of locating it quickly is provided by the above setup. The beat frequency oscillator is set to the frequency giving the greatest reading on the output meter and a search is made for the element producing this modulation. If the source is found, some means usually can be found to eliminate or reduce the trouble.

As the frequency to which the receiver is tuned increases, the percentage change in frequency necessary to produce howling becomes increasingly smaller. In the shortwave range the stability required to eliminate howling is so great that it is practically impossible to eliminate all howling on high volume. In many cases, shortwave receivers with the speaker in the same cabinet with the receiver cannot be operated at full volume. Receivers have even had their oscillator coil and oscillator tuning condenser poured full of wax to prevent vibration and still could not be kept from howling at high volume on shortwaves! Service problems of eliminating microphonic howls should be undertaken with due consideration of the difficulties involved and of the impossibility of producing a 100% permanent cure if the receiver has a shortwave range and has its speaker in the same cabinet with the receiver.

DESIGN AND CONSTRUCTION OF RECEIVING ANTENNAS

This brief article will point out the features of the several types of receiving antennas recommended for use with the receivers described in this manual. Every set owner will have his individual problem of antenna installation but it is hoped that the information provided here may enable him to select the type that will best fit his needs and provide the best possible service for the particular location and space available.

Receiving antennas for the radio amateur may be any of the types described herein. As a rule, however, the amateur will make some arrangement to use his transmitting antenna for reception purposes, especially if he has an efficient directive array. Television antennas are also a special type that will not be discussed here. Some information on antennas for television reception will be found on page 31.

Three general types of receiving antennas are in common use today. These may be classified as: single-wire, doublet and loop. Numerous modifications of these three types will be found in practice, many of them empirically dictated by the particular space for installation available.

SINGLE-WIRE

The single-wire, or inverted L antenna is most commonly used, probably because it is the simplest to install and gives generally good results on any frequency. This type of antenna is illustrated in Figure 1. Since an antenna is a "collector" of radio-frequency energy it should be as high as possible and sufficiently long to provide good signal "pick-up." A total length, including lead-in, of from 80 to 100 feet is sufficient when sensitive Meissner receivers are used. The antenna must also be provided with high-grade insulation including the lead-in, all the way to the receiver itself.

The single-wire type may be used with any of the receivers described in this manual. The larger sets, having three-terminal connection strips marked "A-D-G", will have the lead-in connected to the "A" terminal while the "D" and "G" terminals will be connected together and to ground. The smaller sets, having two terminals marked "A" and "G" will have the lead-in connected to the "A" terminal only, while "G" is connected to ground.

Many persons will believe that a small receiver will require only a small antenna and often try to get by with a wire strung about the room or in the attic. Such expedients sometimes provide entirely satisfactory results for local and strong stations but the practice is not recommended for good performance. In actual fact, since the smaller sets are usually less sensitive, they will require more antenna than a larger set for the same signal output. It should also be remembered that the lead-in wire of a single-wire antenna is a part of the antenna itself, just as much as the outside collector. Consequently, if this lead-in has to be run down to the receiver in the vicinity of power lines, as through a house or apartment, considerable electrical interference may be picked by this portion of the antenna and result in very objectionable noise in the receiver output. Where trouble of this kind is experienced, a noise-reducing doublet should be used.

DOUBLET

The doublet antenna is provided with a lead-in consisting of two wires twisted together. Such a lead-in may be run directly through an area affected by severe electrical interference without picking up any of this energy. In this way, the antenna proper may be located well away from interference sources and thus provide a comparatively clean

signal to the input of the receiver. The general arrangement of such an antenna system is shown in Figure 2. The two horizontal sections of the antenna are usually made equal in length and should be one-fourth of a wave-length long for the band most generally in use. Since this length would be impractical for wave-lengths in the broadcast band (about 160 feet for each half) all-wave receivers designed for use with doublet antennas, such as the larger Meissner sets, are provided with means for cutting out the doublet action on this band and the antenna then becomes essentially a single-wire arrangement. This switching action is incorporated in the band-switch and is entirely automatic. Antenna systems of this type may be purchased in kit form from any radio dealer with complete directions for installation.

LOOP

Loop antennas are receiving considerable attention at the present time because of their portability. Their principal application, of course, will be found in connection with small battery-operated portable receivers such as the one described on page 142. Many small AC or AC-DC sets on the market today are also designed with built-in loops. Certain large receivers are now provided with electro-statically shielded loop antennas incorporated in the console type cabinet. These are claimed to provide excellent service and require no outside antenna connections whatsoever.

DIRECTIONAL EFFECTS

The loop antenna takes the place of the antenna coil secondary in the receiver circuit and is tuned to resonance in the same manner. In addition to its portability, its directional effect is sometimes highly useful. General reception will be good from either direction in the plane of the winding and for a wide angle on either side. There is a comparatively narrow angle, however, perpendicular to the winding plane in which practically no signal pick-up will be obtained. This phenomena is especially useful in helping to eliminate noise and interfering signals as the loop may be turned at right angles to the direction of the interference and still provide good reception over a wide area.

The other types of antennas are also "directional" to a certain extent. Best short-wave reception will be obtained with a long single-wire antenna from the general direction that the wire is pointing, both ways. A long single-wire is not critical as to direction on the regular broadcast band. In the case of the double antenna, the best direction for reception is at right angles to the direction of the wire. Many local factors influence this directional tendency, however, and it can generally be disregarded when locating a new receiving antenna system.

GROUNDS

A good ground connection should be used with any receiver provided with suitable connections for same. This is many times neglected or considered not essential because apparently good results are obtained without it. It will be found, however, that the addition of a ground to a good single-wire or doublet antenna will usually well repay the extra effort in quieter and more consistent reception. A ground is, of course, unnecessary with a loop antenna. It is also advisable to use care in connecting a ground to an AC-DC receiver. If the set is not provided with a ground connection, do not try to use one. In connecting an AC-DC receiver, quickly touch the ground wire to the ground terminal (or wire) on the set. If a noticeable spark occurs, leave the ground connection off.

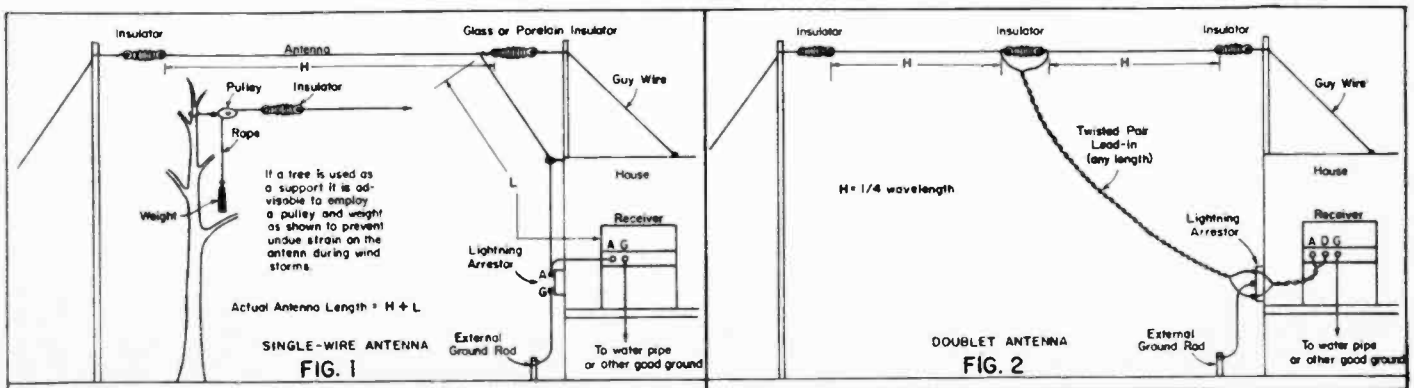

Television in Theory and Practice

INTRODUCTION

This discussion of television will include a brief explanation of how the synchronizing and blanking signals of the composite television signal are generated at the transmitter. It is believed that a practical understanding of just how the characteristic wave-shapes of a standard R.M.A. signal are generated will lend reality to the readers notion of a television signal. Then, when the same wave-shapes are encountered in the consideration of the receiver a familiarity will have been achieved which is most helpful in following the signal through the various amplifying, separating and synchronizing circuits.

Before a detailed explanation of the synchronizing signal is undertaken, however, it may be well to give a very brief description of the entire system from the transmitter to the receiver.

At the transmitter, light reflected from the scene to be telecast, is collected by a lens system and focused on the plate of the television camera tube. This plate is covered by a "mosaic" of photoelectric cells. The camera tube also includes an electron gun similar to that used in a standard cathode ray tube. Scanning at the camera tube is accomplished by electromagnetic deflection of the electron beam using external coils. These coils are energized by currents which cause the "spot" (at which the beam strikes the mosaic) to move horizontally across the mosaic, then snap back and scan another line in much the same manner in which the eyes follow the lines of a printed page. At the end of $1/30$ of a second the complete mosaic (and hence the scene) has been entirely scanned by a succession of 441 lines in a desired order. When the electron beam strikes a bright portion of the mosaic a maximum current will flow through the output of circuit of the camera tube, and this current will vary in proportion to the amount of illumination on the portion of the mosaic being scanned. These current pulses, corresponding in time sequence to the light and dark areas of the picture, are called video signals. After being amplified, they are combined with synchronizing and blanking signals separately generated. At the transmitter, the synchronizing and blanking signals are used to "time" the deflection of the electron beam and to extinguish the beam during retrace time.

The method of combining the video signal with the synchronizing and blanking signals is accomplished in such a way that it causes no interference with the portion of the signal conveying information about the picture. These pulses can be separated from the picture and finally used for blanking and synchronizing corresponding to those functions at the transmitter. The composite video signal, of course, is used to modulate a high frequency transmitter.

At the receiver the received signal is amplified and separated into sound, picture and synchronizing signals. The picture signal, with the blanking signal, is applied to the cathode ray picture tube in such a way that the intensity of the electron beam varies in proportion to the light and dark areas of the scene being scanned at the transmitter. The synchronizing signals with the video portion removed take control of the sweep circuits at the receiver and keep the electron beam in the cathode ray tube in step with the electron beam in the camera tube. Thus the receiver places on the screen of the picture tube, the right amount of light at the right place at the right time and thus produces a pattern of light and dark areas which is a reproduction of the transmitted picture.

SCANNING FREQUENCY

This over-all description necessarily gives little attention to many very interesting details of the television system. For instance, the scanning method demands additional explanation before we may logically consider the generation of synchronizing signals. The 441 scanning lines into which the picture is horizontally divided are not successively scanned but are "interlaced" to reduce flicker. That is, the top line of the picture, if called No. 1, is followed by line No. 3, No. 5, No. 7, etc., until No. 441 at the bottom is scanned. This scanning (one field) is completed in $1/60$ of a second after which the spot goes back and "gets" the even numbered lines, finishing the complete picture in $1/30$ of a second. Hence the frame frequency becomes 30 per second. In motion picture projection the frame frequency is 24 per second. In motion pictures, however, the "frame" is the picture element, while in television thousands of picture elements are required for one frame.

Some simple arithmetic involving the foregoing figures on scanning lines and picture frequency will serve to introduce

the frequencies with which the synchronizing and blanking generator at the transmitter are most concerned.

PICTURE SIGNAL GENERATOR CONSIDERATIONS

Since 441 lines are scanned in $1/30$ of a second it is evident that the time required to scan one line is the product of $1/30$ by $1/441$ or $1/13,230$. This 13,230 cycle frequency (which for purposes of discussion is often referred to as 13 KC) thus becomes the first of the frequencies with which the synchronizing generator will have to deal.

A second frequency inherently important in the picture generator is the 60-cycle frequency since the time required to scan one field is $1/60$ of a second. An equalizing pulse at a frequency of 26 KC must be available for injection during a short interval to secure proper interlacing.

The frequencies involved, therefore, in the composite picture signal used to modulate the carrier are as follows:

1. Picture information, 60 cycles to 4 MC.
2. Horizontal synchronizing and blanking, 13 KC.
3. Frame frequency, 60 cycles.
4. Equalizing pulses, 26 KC.

With these three fixed frequencies in mind we may now consider the wave shapes of the pulses at these frequencies and see how they are generated and used.

In a synchronizing and blanking signal generator some method must be used to "tie in" the 60 cycle frame frequency, the 60 cycle supply frequency and the 13 KC frequency. This may be accomplished by starting with a 13 KC oscillator, doubling to 26 KC and then with a series of multivibrators dividing by ratios of 7, 7, 3, and 3 to arrive at a 60 cycle pulse.

This chain of events may be pictured with a block diagram and wave forms showing the starting 13 KC sine wave and the 60 cycle pulse which is shaped to last exactly 7% of $1/60$ of a second. See Fig. 1.

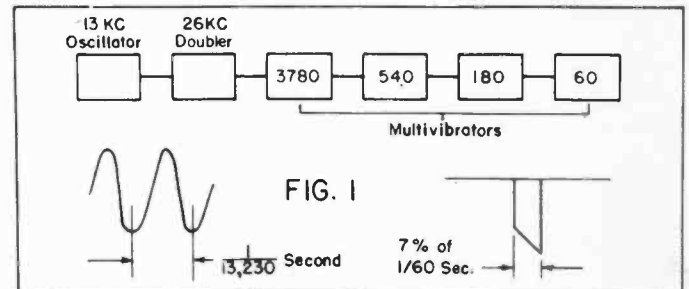

To tie the 60 cycle pulse to the 60 cycle supply and the 13 KC oscillator it is necessary to combine some low voltage 60 cycle supply frequency with the 7% pulse in a 6H6 phase detector. Through a 6K7 control tube the resultant d.c. voltage is used to control the frequency of the 13 KC oscillator, increasing its frequency if the 7% pulse lags the 60 cycle sine wave and decreasing its frequency when it leads. Fig. 2 shows this arrangement, and will be called the timing unit.

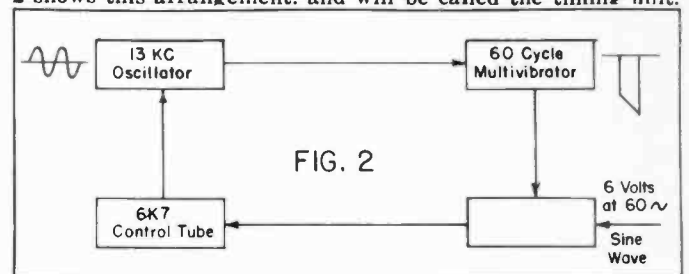

The chain of multivibrators has been omitted in Fig. 2 to simplify the control arrangement and to call attention to the fact that only two wave shapes are taken from this part of the generator, one a 13 KC sine wave and one a 60 cycle pulse of a duration of 7% of $1/60$ of a second. The 26 KC frequency is obtained in circuits following the timer, the 26 KC oscillator in the timer being used only for purposes of correct frequency division.

It has been stated that but three frequencies are used in the synchronizing and blanking generator. However, in the clipping, delayed, and narrowing circuits following the timing units the pulses at these three frequencies are altered as to shape and duration to produce the standard R.M.A. tele-

vision synchronizing and blanking signals. The duration of the pulses are measured in per cent of horizontal or vertical sweep frequency such as a .07V in the case of the vertical blanking signal or .04 H as in the case of the equalizing pulse.

The following table (Fig. 3) shows the separate characteristic synchronizing and blanking pulses:

NAME	FREQUENCY	WAVE SHAPE	DURATION
Vertical Blanking	60 cycles		.07 V
Horizontal Blanking (Pedestal)	13,230 cycles		.15 H
Vertical Sync. Pulse	26,460 cycles		X = .43 H Y = 3 H
Horizontal Sync. Pulse	13,230 cycles		.08 H
Equalizing Pulse	26,460 cycles		.04 H

All of these pulses are formed from the 60 P.P.S. signal and the 13,230 cycle sine wave taken from the timing unit. Because of the great difference in duration of the five pulses shown in the table the wave shapes are not drawn to scale, and slight slopes are disregarded.

An inspection of the complete R.M.A. television signal shown in Fig. 4 will now indicate how these five pulses (all originating from the 13,230 cycle oscillator in the timing unit) are combined. Referring to the pulses in the order in which they appear in the table it will be seen, that:

First, the vertical blanking signal occupies the largest part of the portion of the signal shown, that is, from a minimum of .07V to a maximum allowed of .10V. This signal has an amplitude extending only up to "black level" and serves to bias the grid cathode ray tube in the receiver to cut-off during the retrace time. This retrace time in the receiver must be complete at the end of .07H.

Second, the horizontal blanking signals may be seen extending to the same (black) level as the vertical blanking signal but lasting only 15% of 1/13,230 sec.

Third, the vertical synchronizing signal may be seen riding above the blanking signal and consisting of a series of 6 pulses each lasting more than twice as long as a horizontal synchronizing pulse.

Fourth, the horizontal synchronizing pulse may be seen riding above the blanking signal. The duration of this pulse is slightly more than half the duration of the blanking pulse.

Fifth, the equalizing pulses replace the horizontal synchronizing pulses for an interval which begins before the start

of the vertical synchronizing pulse interval and lasts until after this pulse is completed. The substitution of one kind of pulse for another is accomplished by keying circuits which apply or remove screen voltage from keying tubes upon the grids of which are continuously applied the pulses involved.

So far we have not considered the varying picture signal which lies between the horizontal blanking pulses. The only reference to this portion which need be made is to point out that bright portions of the picture are indicated by zero modulation amplitude while black parts of the picture are indicated by 80% modulation amplitude, which is approximately the amplitude of the blanking signals. The proper amplitude of the various parts of the composite video signal are adjusted in a mixing amplifier where the amplitude of pedestals, synchronizing pulses and picture signal may be independently controlled. When this has been done, the composite video signal may be used to modulate a high frequency carrier.

MODULATION AND CARRIER FREQUENCY RELATIONS

With the foregoing discussion of synchronizing and blanking signal generation to refer to, we may now point out a few comparisons between the television system and sound broadcasting and make a few general observations about the necessity for widely different modulation and carrier frequencies.

In sound broadcasting a band width of 10 k.c. is required. In television a band width of about 4 MC is required for the picture modulation. The reasons for this great range of frequencies becomes apparent if we consider more closely the scanning method already described.

Vertical detail is determined by the number of lines in the picture. To obtain as good horizontal detail as we have vertical, we must be able to handle picture elements along a line that are as closely spaced horizontally as are the lines spaced vertically. If the picture size transmitted were square the number would then be 441 but since the picture is longer in the ratio of 4 to 3 there must be 588 elements in each line.

Since a pair of such adjacent elements would be required to represent a signal voltage cycle, it must be possible while only a single line is being scanned to transmit $\frac{588}{2}$ or 294

cycles. Since 441 lines are traced during 1/30 of a second, it is obvious that the output from the camera tube will cover a great range of frequencies. A formula for this calculation might be set up as follows:

Band width equals $\frac{\text{Horizontal picture elements} \times \text{Number of lines} \times \text{Number of pictures per second}}{2}$

OR
Band width equals $294 \times 441 \times 30$ equals 3,889,620

Thus a band width of approximately 4 MC is required if we are to have high definition television pictures.

Having seen the necessity for a tremendous range of

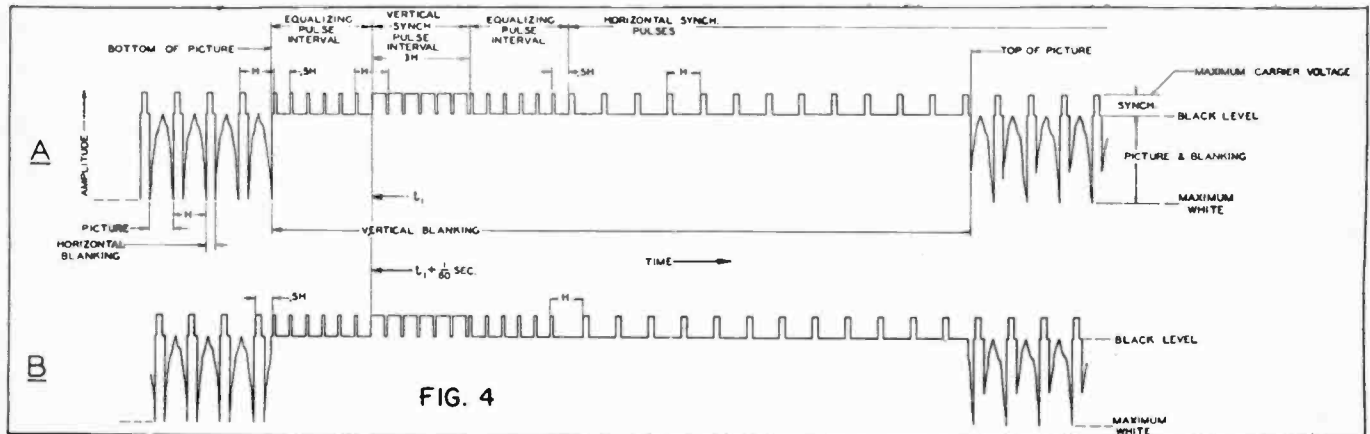

FIG. 4

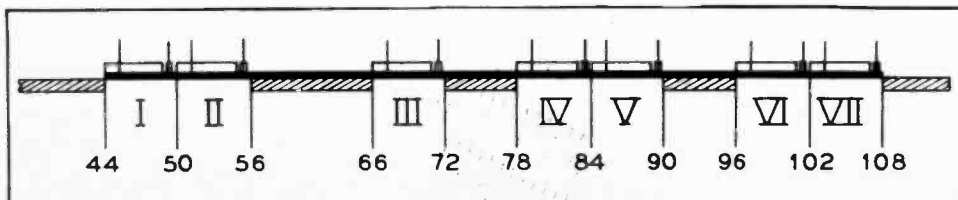

FIG. 5 TELEVISION BROADCAST CHANNEL ALLOCATIONS

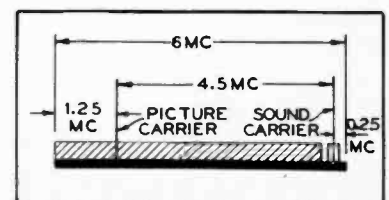
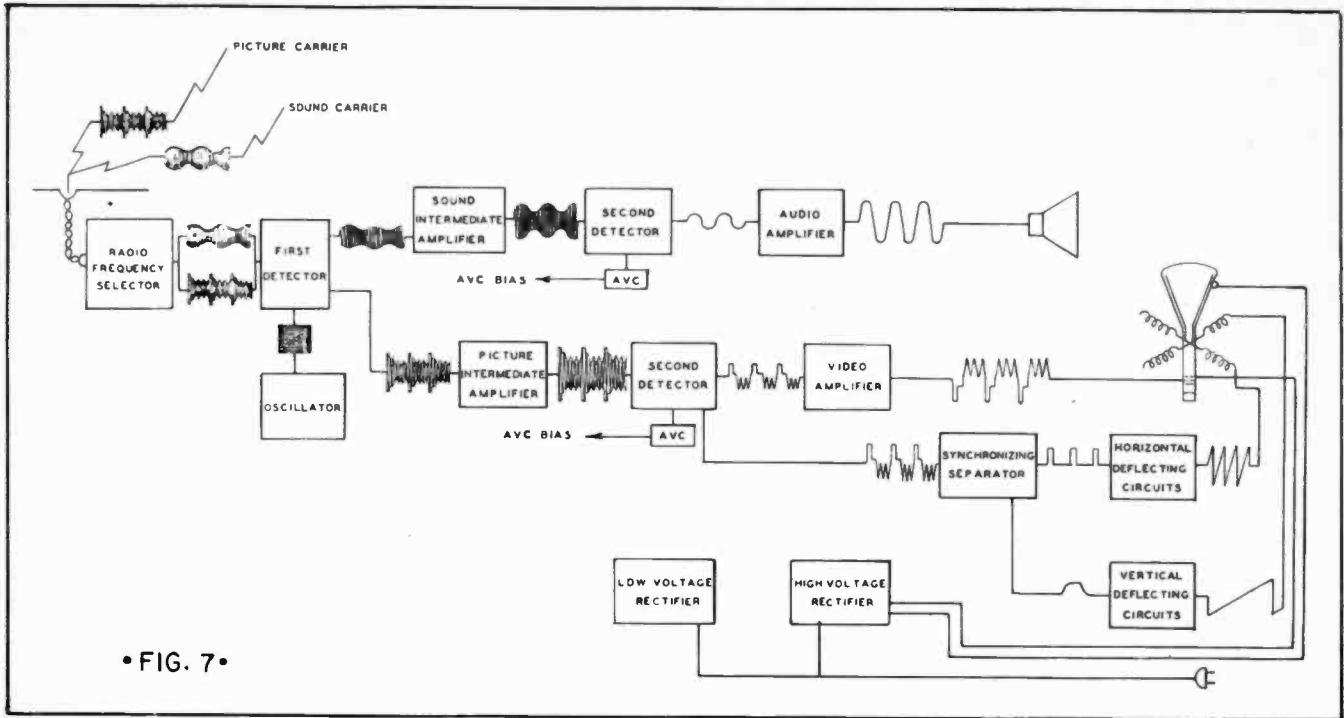

FIG. 6 CHANNEL MAKE-UP



• FIG. 7 •

modulation frequencies, we now recognize the first reason for using a high carrier frequency. Modulation considerations require that the transmitter frequency it must handle. Of course other practical considerations such as lack of available space in other portions of the radio spectrum also made it necessary to go to the ultra high frequency region. At any rate, the Federal Communications Commission has assigned seven television bands between 44 MC and 108 MC. These are shown in Fig. 5. In Fig. 6 is shown in greater detail the relation between the sound and picture carrier of any one channel.

The necessary choice of ultra high frequency carrier introduce another series of problems for these frequencies exhibit "line of sight" transmission, and to obtain respectable coverage, the transmitting antennae must be placed at a great height. The NBC transmitter, for instance, has its antennae on top of the Empire State Building. A service area in this instance, with a radius averaging 40 miles is thus obtained. Other difficulties encountered are reflections of the signals from buildings, hills and other objects, which produce multiple images at the receiver. Still another problem is interference from automobile ignition and diathermy machinery.

As more experience and knowledge is gained, we may expect that most of the problems accompanying the use of ultra high frequencies will be solved to a satisfactory degree. Reflections can be minimized by directive antennae systems and interference can be prevented by installation of suitable filters and suppressors.

In order to have a complete television signal, the sounds accompanying the scene must be broadcast. These are picked up by a regular studio technique, amplified, and used to modulate another ultra-high frequency transmitter operating 4.5 MC above the picture carrier frequency.

DISCUSSION OF BLOCK DIAGRAM OF RECEIVER

Having discussed the generation and transmission of the standard television signal in more detail we may now turn to a more thorough consideration of the receiver and follow the conversion of this rather complicated sequence of signals into a pattern of light and shade which reproduces the scene at the transmitter.

To facilitate consideration of the television receiver, a block diagram will first be employed to show, principally, where the characteristic parts of the signal are separated, amplified and used to perform their particular function.

In Fig. 7 is shown such a diagram.

The r.f. circuits are broad enough to pass both carriers and their side bands. At the first detector they are both heterodyned with a local oscillator placed 12.75 MC above the picture carrier. Because of the 4.5 MC spacing between sound and picture carriers, the oscillator frequency thus becomes 8.25 MC above the sound carrier. Thus two I.F. "beats" are produced.

Using the 44 to 50 MC channel as an example, these frequency relations are shown in Fig. 8.

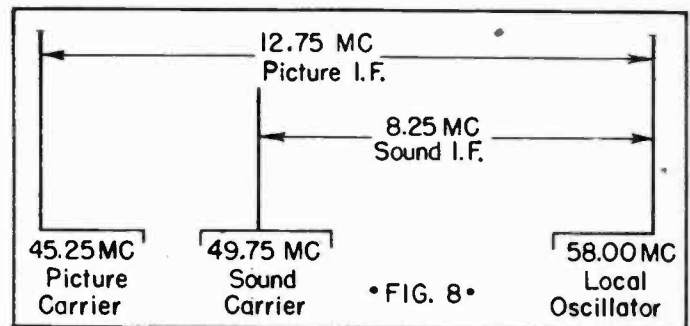

• FIG. 8 •

The sound I.F. signals are amplified by an I.F. system tuned to 8.25 MC, impressed on the sound second detector, detected and amplified in the conventional manner and reproduced as sound at the speaker.

The picture I.F. signals are amplified by an I.F. system tuned to 12.75 MC and which passes a band up to 4MC wide, depending on the detail desired at the picture tube. (A 12" tube can reproduce the detail permitted by 4 MC modulation while in the case of a 5" tube a band width of 2½ MC will allow all the detail observable with this tube).

At the picture second detector the amplified picture I.F. signal is demodulated to recover the television signal represented in Fig. 4, already discussed. Without alteration except for further amplification in the video amplifier, this signal is applied to the grid of the cathode ray picture tube, to control the instantaneous intensity of the electron beam and thus the relative illumination of the elemental picture areas. The blanking pulses which are present in this signal serve to extinguish the beam during retrace time since their amplitude brings them to the "black level." The synchronizing pulses need not be removed from the signal applied to the grid of the picture tube since the pedestals (of longer duration) have already biased the grid to "black level." Finally, the video signal must in some manner adjust the background illumination of the received picture. This action is usually called automatic brightness control and will be explained in the section under circuit descriptions.

Returning now to the second picture detector, the synchronizing chain may be considered. It has been stated that synchronizing pulses need not be removed from the video signal controlling the electron beam intensity. It is necessary, however, to remove the picture signal from the synchronizing signals if the latter are to take proper control of the deflection of the electron beam. Unless this is done the synchronizing control circuit would have a tendency to respond to signals representing black picture areas and loss of synchronism would result.

Fortunately, this separation can be readily secured because of the increased amplitude of these pulses over that of the picture signal. By means of amplitude separation the vertical and horizontal synchronizing signals may be "clipped" from the video or picture information part of the composite video signal. After amplification the vertical and horizontal synchronizing signals must be separated from each other to control the separate deflection circuits. This final separation is accomplished with filters responsive to wave shape since the horizontal synchronizing pulses (refer now to Fig. 3) are of much shorter duration than are the vertical synchronizing pulses.

The polarity of the separated vertical and horizontal synchronizing pulses must be chosen for the type of deflection to be employed. Blocking oscillators require a positive pulse while multivibrators require the opposite polarity, for proper control of the picture tube deflection system. The horizontal and vertical synchronizing pulses, then, which were originally shaped from the 13 k.c. oscillator at the transmitter, are enabled to keep the electron beam "in step" with the scanning beam at the transmitter, since the deflection system of the camera tube is controlled by pulses from the same timing unit previously referred to. (in Fig. 2). The picture information part of the signal meanwhile, controls the brightness of each elementary area of the picture and thus the original scene is reproduced as long as this precise synchronism is maintained.

CIRCUIT CONSIDERATIONS

Having considered briefly the functions of a television receiver with the aid of a block diagram, we may now study an actual circuit, emphasizing the operational details more readily portrayed by a typical example. To facilitate this study, various sections of the schematic circuit of a television receiver of the superheterodyne type will be separately considered; only those parts of the circuit necessary for an understanding of its operation will be shown and a general knowledge of radio circuits will be assumed.

The first section considered is the radio frequency circuit of Fig. 9.

In this r.f. system each band (of which but one is shown) consists of an antennae primary, a preselector, r.f. input and oscillator coil. The oscillator voltage is magnetically coupled to the mixer tube and the oscillator is provided with a small condenser for receiver tuning. The coupling, in the case of the 44 to 50 MC channel is adjusted to give approximately

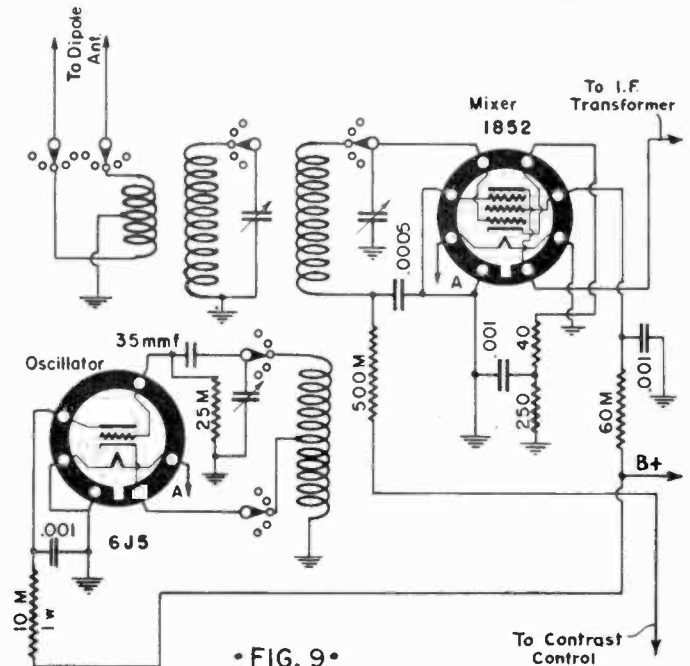

• FIG. 9 •

flat transmission characteristic from 45.5 to 47.5 MC dropping to about 40% response at 49.75 MC. The coupling between the oscillator and secondary is adjusted to give 5 volts peak of induced oscillator voltage. With an 1852 as the mixer tube with an unbypassed cathode resistor of 40 ohms, 5 volt bias and 5 volt oscillator voltage gives maximum conversion conductance.

At the plate of the 1852 mixer, the sound I.F. is taken off thru a capacity of about 2 mmfd. to the grid of the 1853 sound I.F. amplifier, the grid circuit of which is tuned to 8.25 MC by an adjustable iron-core coil. A portion of the cathode resistor is left unbypassed so that changes in A.V.C. voltages will not seriously affect the input capacity with bias change. The 1853 is followed by an iron-core tuned 8.25 MC trans-

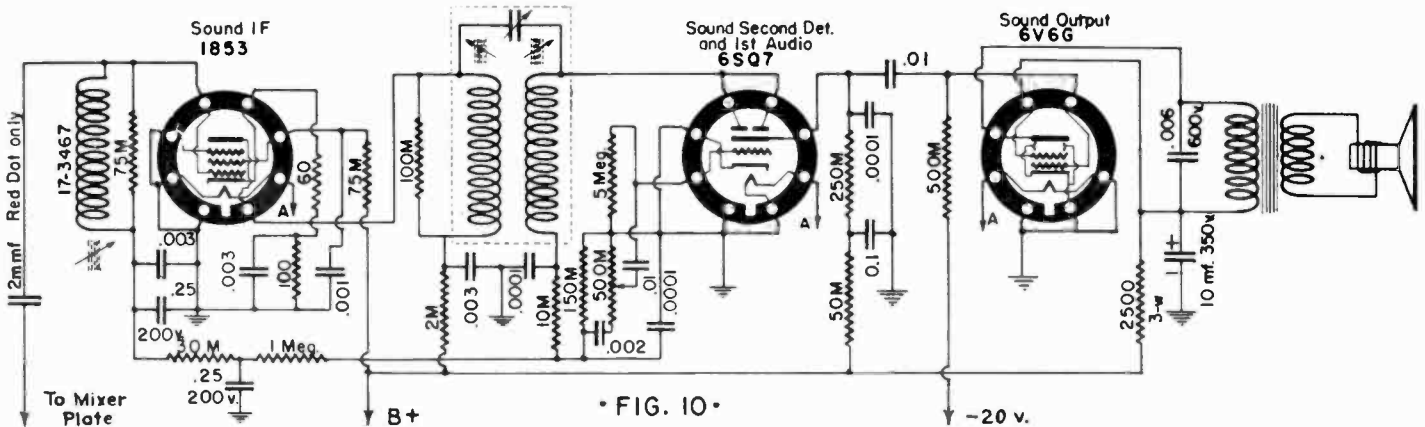

• FIG. 10 •

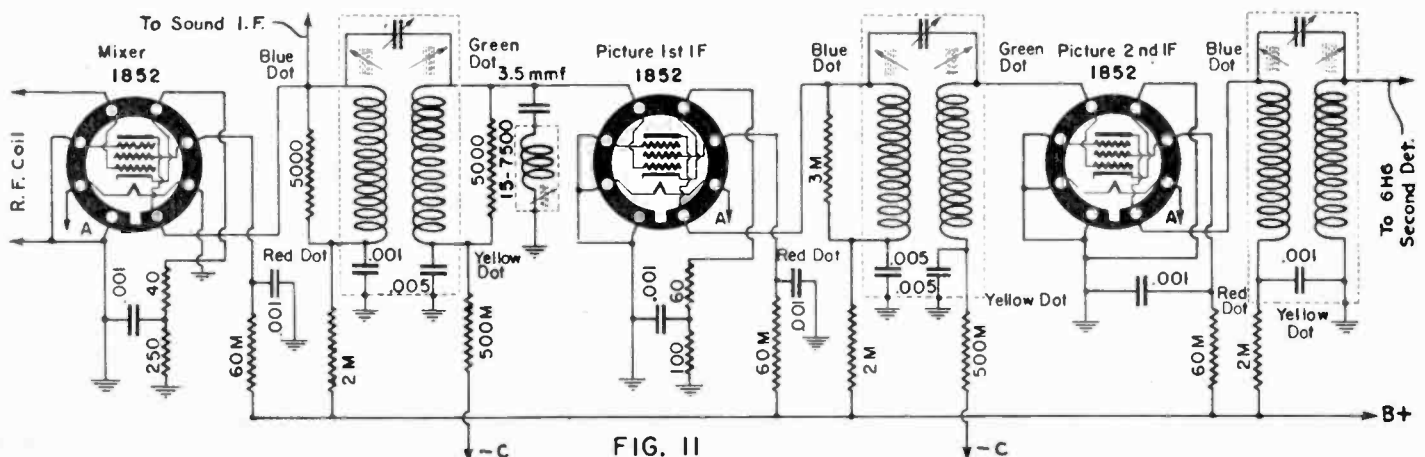

FIG. 11

former, a 6SQ7 and a 6V6G. The selectivity is 200 KC at 70% response. This portion of the receiver is shown in Fig. 10.

In Fig. 11 is shown the picture I.F. system. The three picture I.F. coils are similar, differing only in loading capacity, coupling and presence of small coupling condensers. There is included also a 14.25 MC trap which is needed to prevent the sound I.F. carrier of the next lower adjacent channel from getting into the picture I.F. signal.

Since practically all of the gain and selectivity of a super-heterodyne type television receiver lies in the I.F. stages, it seems desirable to study each stage in detail and to note how the overall frequency characteristic is obtained.

Two general methods may be used to get the desired frequency characteristic. Either each stage may be made substantially flat over the desired pass band, or two stages may be overcoupled, with the third stage "filling in" the valley between the two response peaks.

The I.F. system in question was designed to make it possible for the experimenter to align the three coils in an acceptable manner without the use of an expensive frequency modulated generator and cathode ray oscilloscope. While the use of this equipment is unquestionably the most satisfactory and most rapid means of picture I.F. alignment, nevertheless excellent pictures have been consistently received after alignment with more modest facilities.

To further clarify the effect of each adjustment on the picture I.F. coil, it may be useful to show by means of selectivity curves for one, two and three coils, just exactly how the picture I.F. may be aligned with a signal generator and output meter.

Starting with the output I.F. coils, the signal generator is connected through a coupling condenser to the grid of the preceding 1852. An output meter having a 0-1.5 volt range makes a suitable indicator and may be connected through a blocking condenser to the plate of the 1852 video amplifier.

The small condenser across the grid and plate leads of the coil is first set at minimum capacity while both iron core coils are tuned to 12.75 MC. At this stage the selectivity curve appears as shown in Fig. 11a.

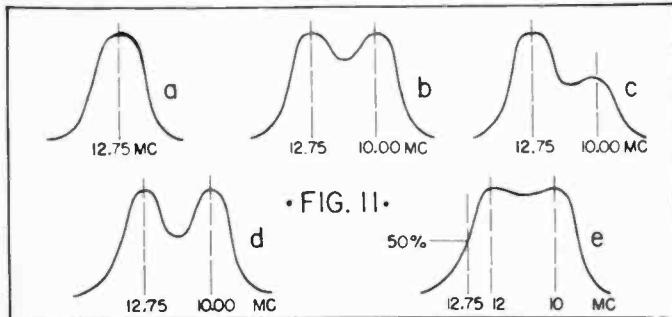

Now, by slowly increasing the overcoupling capacity which had been set at minimum, a second peak will "move out" and can be made to appear at some lower frequency say at 10 MC, without appreciably disturbing the resonant frequency of the original 12.75 peak. The signal generator, in fact, may be set to 10 MC, and the overcoupling capacity slowly increased until resonance is reached. By slowly shifting the generator frequency through the two frequencies of 10 MC and 12.75 MC the relative response at these two points may be checked and equalized by a slight change in one or the other of the coil tuning adjustments. The selectivity curve for the output now appears as shown in Fig. 11b.

The preceding stage is aligned in the same fashion, but since there is now considerable gain at 12.75 MC the first step will give the selectivity curve shown in Fig. 11c.

The increase of the coupling condenser on this stage, however, will bring up the 10 MC peak and the curve for two stages then appears as shown in Fig. 11d.

The adjustment of the input stage is more critical since this stage must "fill in" the valley shown in Fig. 11d.

The presence of the peaks on each side of this valley make it more difficult to align the input coil. However, by heavily loading the coils already aligned, their response peaks can be temporarily erased without disturbing the correctness of the adjustment of these stages. Specifically if the coils not already loaded, are temporarily loaded with a 1000 ohm resistor, the selectivity curve of this portion will not interfere with the input stage adjustment. With minimum over-coupling capacity, and no loading (on the input stage) both primary and secondary are tuned to 11.9 MC. The over-coupling capacity is then slightly increased to obtain a second peak at 10.9 MC. Finally the proper loading resistors are returned to the input coil, the temporary loads removed from the other coils, and slight adjustments of the input coil made to ob-

tain as flat a frequency response as possible. In Fig. 11e is shown the overall curve which can be obtained by this system. It is seen now that the 12.75 MC frequency is now at the 50% response point on the overall selectivity curve.

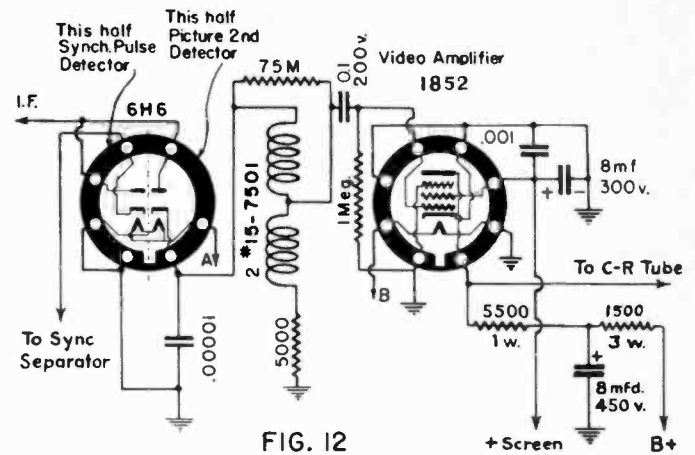
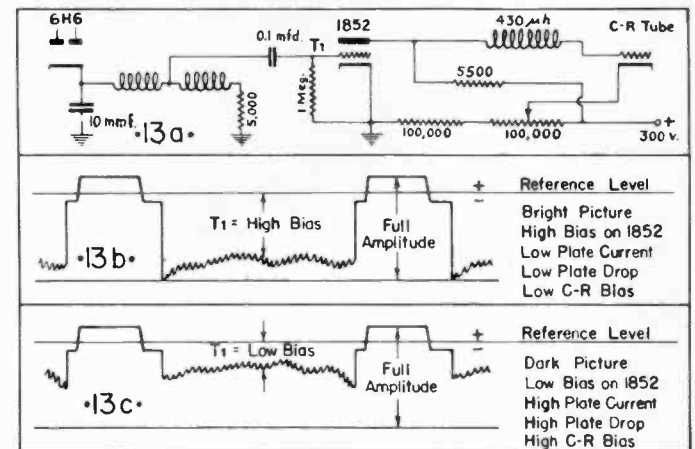

FIG. 12

Following the third picture I.F. transformer is the 6H6 picture second detector shown in Fig. 12. Only one diode of this tube is used for picture detection. This diode is followed by a low pass filter designed to pass frequencies up to 3 MC and to cut off below the picture I.F. frequencies. If harmonics of the picture I.F. are not attenuated, some of them couple back into the input and produce beats which show up as interference patterns just as harmonics of the I.F. produce a whistle interference in sound receiver if allowed to couple back into the input.

Following the second detector load is the video amplifier operating at zero fixed bias to obtain automatic background control. Some method (often another diode called the D.C. restorer is used) must be employed to enable the received picture to follow the slow variations in background illumination of the scene being transmitted. The D.C. component is restored in the present case as follows:



In Fig. 13a is shown the 1852 video amplifier T_1 in which the plate is connected to the grid of the cathode ray tube and the grid to the output of the picture second detector. Fig. 13b and 13c show how changes in the average amplitude of the picture changes the bias on T_1 and hence on the cathode ray grid. In the absence of signal, the T_1 bias is low, T_1 plate current high and cathode ray bias is high. With application of a picture signal a reference level is established which is adjusted to be slightly above the pedestal height. In Fig. 13b, the representation of a bright picture, T_1 bias is high, plate current is low and cathode ray bias is low giving bright background illumination. When the transmitted picture has a dark background, the video signal appears as in Fig. 13c, where T_1 bias is low and the cathode ray tube bias is high.

As a video amplifier, T_1 must of course, have excellent frequency response up to 4 MC for high definition pictures. The inductance in the plate circuit is commonly called a "peaking coil", and with the tube and wiring capacity it forms a band pass network designed to obtain the necessary response. With the video amplifier connected to the grid of the picture tube, variations of the video voltage control the intensity of the electron beam thus determining the relative illumination of the many elements of the scene.

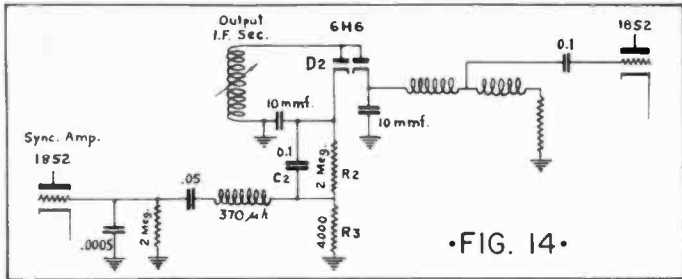

•FIG. 14•

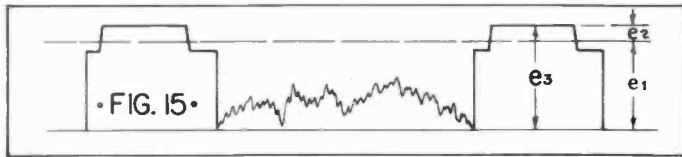

•FIG. 15•

It has been stated that synchronizing signals are obtained from the composite video signal by amplitude separation. Fig. 14 shows the portion of the circuit which "clips" these pulses and applies them to the grid of an 1852 sync amplifier. Fig. 15 shows the amplitude relation between the horizontal blanking signal and the portion removed for amplification and synchronization. This pulse will be recognized as the .08H pulse of Fig. 3. Since vertical sync pulses have the same amplitude they will be similarly treated. Following the output I.F. of Fig. 14. We see that,

The diode D₂, with its load R₂C₂ and R₃ separates the sync from the picture signals. The R₂C₂, that is, the 2 Meg., .1 mfd. combination has a time constant that is long in comparison with the video modulation frequencies. If that was the entire diode load, the diode voltage would be the peak value of the modulation envelope, that is, E₃.

Now, the part of diode voltage due to R₂C₂ when R₃ is added is E₁, and is uniform through the time of one frame, consequently providing bias for the diode which is adjusted to be slightly above the pedestal voltage. The voltage across R₃ thus consists of the sync signals with the picture portion eliminated. The 370 M inductance and the 500 mfd. filter serve to keep I.F. components out of the 1852 sync amplifier. Increasing the 4000 ohm will take more of the sync pulse; decreasing it will take less.

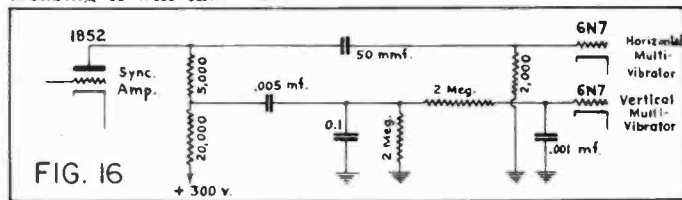

FIG. 16

The 1852 sync amplifier inverts and amplifies both vertical and horizontal pulses. They must then be separated from each other and applied to the deflection system to control its frequency and maintain synchronism. In Fig. 16 it is seen that the horizontal sync pulse can be taken directly from the sync amplifier plate through a 50 mmfd. condenser. The vertical sync pulse is taken through a filter network in which a charge is allowed to accumulate on the condensers proportional to the time the voltage is applied. As the horizontal pulses also present are of shorter duration their effect is minimized.

The equalizing pulses (the .04H pulses of Fig. 3) are of still shorter duration but their presence serves to make the vertical pulses an odd and even field sufficiently alike so that interlacing will result.

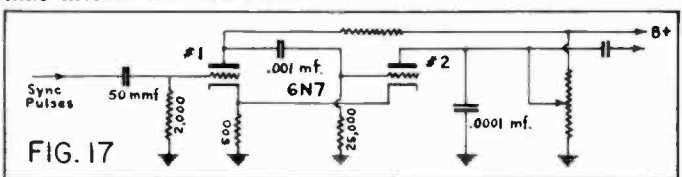

FIG. 17

Since horizontal and vertical deflection circuits are quite similar, only one (the horizontal) will be described here. Fig. 17 shows a sweep oscillator using a 6N7 in a multivibrator circuit. The output of the 6N7 is applied to a 6F86 push-pull amplifier.

To explain the action of this multivibrator it may be worthwhile to list in order the series of actions which takes place in each triode. Accordingly, the triodes are numbered 1 and 2 and one cycle may be analyzed as follows:

1. Assume a disturbance which makes grid No. 1 negative.
2. Plate current in No. 1 triode decreases.
3. Plate voltage in No. 1 triode rises and a positive pulse arrives at grid No. 2.
4. Plate current in No. 2 triode increases and plate voltage drops.
5. Cathode current increases, driving grids to cut-off.
6. The .001 condenser discharges during retrace time.
7. The .001 condenser charges during line time and oscillations are maintained by common cathode coupling.

When the amplifier sawtooth voltage is applied to the deflection plates of the cathode ray tube and the multivibrators are controlled by a discreet negative synchronizing pulse, the electron beam scans the picture area at the proper frequency thus establishing synchronization with the deflection system at the transmitter.

Electromagnetic deflection is usually used with the large cathode ray tubes and in that case a sawtooth current must be passed through the deflection coils. This requires special wave-forms best generated by blocking oscillators and discharge tube circuits. In the blocking oscillator, the grid is transformer coupled to the plate and is adjusted to have a free running speed slightly slower than the frequency of the synchronizing pulses. These being positive will trigger the blocking oscillator associated with the deflector circuits. One advantage of this synchronizing system is that pulses caused by noise, and arriving ahead of the synchronizing pulse must have sufficient amplitude to overcome the negative self-bias on the blocking oscillator before it can upset the synchronizing control.

POWER SUPPLY

In order to supply the high voltage at low current needed for the cathode ray tube and the lower voltage at high current for the amplifying tubes, two rectifiers are used in the typical television receiver. Since the current consumption to the cathode ray tube is very small, a resistor capacity filter is sufficient. The voltage to the first anode must be adjustable so that the electron beam may be properly focused. Figure (18) shows the circuit of the high voltage power supply.

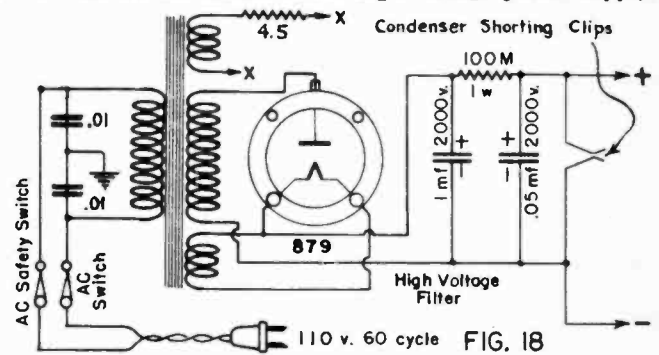

FIG. 18

The low voltage power supply is conventional. However, unusually good filtering is of prime importance.

SAFETY POINTERS

Of still greater importance, where power supplies are concerned, is the necessity on the part of the experimenter to develop a safety technique in the use of high voltages and large cathode ray tubes. All cathode ray tubes should be protected from scratches such as might be caused by sliding tubes across a hard surface. Extreme and sudden changes in temperature should be avoided. Especially in handling large tubes, goggles should be worn to guard against the possibility of collapse of the tube and the attendant danger of flying glass.

When working on a portion of the receiver not requiring high voltage, the high voltage transformer should be disconnected and taped up. When making high voltage measurements or any measurements where high voltages are present anywhere in the receiver, the supply line plug should be removed from the outlet (rather than trusting memory or an AC switch) while the test leads are attached. Power may then be supplied by replacing the line plug and measurements made without touching any part of the receiver. The line plug should then be removed and the high voltage filter condensers shorted with an insulated screwdriver before the test leads are removed. Above all, a good ground must always be connected to any chassis or apparatus normally grounded since breakdown of the primary or secondary of a high voltage transformer can expose high voltage under the most dangerous conditions, namely; at a time when the user feels perfectly safe.

Television Definitions

Aspect Ratio: The Aspect Ratio of a frame is the numerical ratio of the frame width to frame height.

Audio (Latin, "I hear"): Pertaining to the transmission of sound.

Automatic Brightness Control: Automatic Brightness Control is a device for automatically controlling the average illumination of the reproduced image.

Automatic Volume Control: A self-acting device which maintains the output constant within relatively narrow limits while the input voltage varies over a wide range.

Band-Pass Filter: A filter designed to pass currents of frequencies within a continuous band limited by an upper and a lower critical or cut-off frequency and substantially reduce the amplitude of currents of all frequencies outside of that band.

Blanking Pulse: Pulses produced during the return time of the cathode-ray beam to "blank out" the undesirable signals produced by the return lines in both the Iconoscope and Kinescope. Sometimes referred to as the "pedestal."

Brightness Control: Brightness Control is the receiver control which varies the average illumination of the reproduced image.

Carrier: A term broadly used to designate carrier wave, carrier current, or carrier voltage.

Carrier Frequency: The frequency of a carrier wave.

Coaxial Cable: Special telephone cable suitable for conveying television signals.

Contrast Control: A knob on the receiver for adjusting the range of brightness between highlights and shadows in a picture.

Cycle: One complete set of the recurrent values of a periodic phenomenon.

D.C. Transmission: D.C. Transmission means the transmission of a television signal with the direct current component represented in the picture signal.

Distortion: A change in wave form occurring in a transducer or transmission medium when the output wave form is not a faithful reproduction of the input wave form.

Electron Emission: The liberation of electrons from an electrode into the surrounding space. In a vacuum tube it is the rate at which the electrons are emitted from a cathode. This is ordinarily measured as the current carried by the electrons under the influence of a voltage sufficient to draw away all the electrons.

Fidelity: The degree to which a system, or a portion of a system, accurately reproduces at its output the signal which is impressed upon it.

Field Frequency: Field Frequency is the number of times per second the frame area is fractionally scanned in interlaced scanning.

Focus: Adjustment of spot definition.

Frame: One complete picture. Thirty of these are shown in one second on a television screen.

Framing Control: A knob or knobs on the receiver for centering and adjusting the height and width of pictures.

Frame Frequency: Frame Frequency is the number of times per second the picture area is completely scanned.

Fundamental Frequency: The lowest component frequency of a periodic wave or quantity.

Ghost: An unwanted image appearing in a television picture as a result of signal reflection.

Harmonic: A component of a periodic quantity having a frequency which is an integral multiple of the fundamental frequency. For example, a component the frequency of which is twice the fundamental frequency is called the second harmonic.

Horizontal Centering: Adjustment of the picture position in the horizontal direction.

Horizontal Hold: Adjustment of the free-running period of the horizontal oscillator.

Height: Adjustment of the picture size in the vertical direction.

Iconoscope: A type of electronic cathode-ray pickup tube which has been developed by RCA.

It serves the dual purpose of analyzing the visible picture projected on its mosaic into elements and produces electrical impulses for each of these picture elements.

Interference: Disturbance of reception due to strays, undesired signals, or other causes; also, that which produces the disturbance.

Interlacing: A technique of dividing each picture into two sets of lines to eliminate flicker.

Kinescope: A type of electronic cathode-ray receiver tube which has been developed by RCA.

It converts electrical impulses into picture elements which are visible to the eye.

Line: A single line across a picture, containing highlights, shadow, and half-tones; 441 lines make a complete picture.

Linearity Control: Adjustment of scanning wave shapes. May be qualified by the adjectives "Top," "Bottom," "Right," "Left."

Megacycle: When used as a unit of frequency, is a million cycles per second.

Modulation: Modulation is the process in which the amplitude, frequency, or phase of a wave is varied in accordance with a signal, or the result of the process.

Mosaic: Photo-sensitive plate mounted in the Iconoscope. The picture is imaged upon it and scanned by electron gun.

Negative Transmission (Modulation): Negative Transmission (Modulation) occurs when a decrease in initial light intensity causes an increase in the radiated power.

Panning: A horizontal sweep of the camera. (From "panorama.")

Polarization: The particular property of an antenna system which determines its radiation characteristics.
i.e.—Vertical or horizontal polarization.

Positive Transmission (Modulation): Positive Transmission (Modulation) occurs when an increase in initial light intensity causes an increase in the radiated power.

Progressive Scanning: Progressive Scanning is that in which the scanning lines trace one dimension substantially parallel to a side of the frame in which successively traced lines are adjacent.

Radio Channel: A band of frequencies or wave lengths of a width sufficient to permit of its use for radio communication. The width of a channel depends upon the type of transmission.

Return Line: Trace of the cathode-ray beam in returning from bottom to top of the picture. (Return trace from right to left between lines usually not visible.)

Sawtooth: A wave of electric current or voltage employed in scanning.

Scanning: Scanning is the process of analyzing successively, according to a predetermined method, the light values of picture elements constituting the total picture area.

Scanning Line: A Scanning Line is a single continuous narrow strip which is determined by the process of scanning.

Side-Bands: The bands of frequencies, one on either side of the carrier frequency produced by the process of modulation.

Signal: The intelligence, message or effect conveyed in communication.

Spot: The visible spot of light formed by the impact of the electron beam on the screen as it scans the picture.

Spottiness: Spottiness is the effect of a television picture resulting from the variation of the instantaneous light value of the reproduced image due to electrical disturbances between the scanning and reproducing devices.

Television: Television is the electrical transmission and reception of transient visual images.

Tilting: A vertical sweep of the camera.

Vertical Centering: Adjustment of the picture position in the vertical direction.

Vertical Hold: Adjustment of the free-running period of the vertical oscillator.

Vestigial-Side-Band Transmitter: A Vestigial-Side-Band Transmitter is one in which one side band and a portion of the other are intentionally transmitted.

Video Frequency: The Video (Latin, "I see") Frequency is the frequency of the voltage resulting from television scanning.

Width: Adjustment of the picture size in the horizontal direction.

Yoke: Produces magnetic deflection of an Iconoscope or Kinescope when supplied with sawtooth currents of proper voltage and phase.

**COMPLETE INSTRUCTIONS
FOR CONSTRUCTION AND OPERATION OF THE**



Television Receiver

Model 10-1153

The Meissner No. 10-1153 receiver kit was designed to answer the requirements for an easily built, safe receiver for television sight and sound. It covers only the two lowest frequency American television channels 44-50 MC and 50-56 MC, but provisions have been made for two additional channels when the need for them arises.

The sound channel operates simultaneously with the picture—one control serves to tune both channels. The sound channel has a wide acceptance band giving a much higher degree of fidelity than can be obtained in the normal broadcast band.

The receiver employs 17 tubes in all, divided as follows:

1 Oscillator	6J5
1 Mixer	1852
2 Picture I. F. Amplifiers	1852
1 Picture Detector	6H6
1 Picture Video Amplifier	1852
1 Picture Tube (Kinescope)	1802-P4
1 Sound I. F. Amplifier	1853
1 Sound Detector	6SQ7
1 Sound AF Amplifier	6V6G
2 Sweep Oscillators	6N7
2 Sweep Amplifiers	6F8G
1 Synchronizing Pulse Amplifier	1852
1 Rectifier, high voltage	879
1 Rectifier, low voltage	5V4G

A single mixer and a single oscillator serve as the input to both sight and sound channels. The video (sight) channel utilizes two I.F. stages, a second detector, a video frequency amplifier and a Cathode Ray tube. The sound channel utilizes one I.F. stage, a conventional combined diode detector, AVC and 1st Audio amplifier, and a power amplifier.

The sweep circuit oscillators are multivibrators of simple design. Sweep voltage amplifiers are provided so that the picture will occupy the desired area on the screen without the use of excessive voltage on the multivibrators. Controls on the input circuits of the sweep amplifiers permit easy adjustment of the picture size.

Synchronization is accomplished through the aid of synchronizing pulses transmitted between successive lines and frames of the picture. These synchronizing signals are selected by a synchronizing pulse separator circuit, amplified by the synchronizing pulse amplifier and applied to the sweep oscillators to control their frequency.

The sound channel is provided with conventional AVC. The picture channel has only manual control because of the complications introduced by the use of satisfactory AVC on the sight channel.

The high voltage supply for the Kinescope has been care-

fully housed in a completely closed compartment so that accidental contact with dangerously high voltage is impossible unless the safety devices provided are purposely made inoperative. Two safety switches are provided which cut off the high voltage whenever the cover is removed from the compartment housing this high voltage. One is in series with the primary of the high voltage power supply so that the high voltage transformer is inoperative whenever the cover is removed from the safety compartment, and the other switch short circuits the high voltage filter condensers so that there can be no residual charge to produce an unpleasant or dangerous shock. The voltages that are of the same magnitude as in ordinary radio sets are given no special protection.

The high frequency tuning unit is furnished pre-aligned and tested. The I. F. transformers are easily adjusted to the desired band width or sensitivity by following the simple instructions given, using as an aid, the common service oscillator possessed by every radio shop.

The receiver is furnished with a black crackled metal front panel which serves to carry the main control knobs and furnishes adequate support for the viewing end of the Kinescope. The receiver may be used without cabinet, may be mounted in a cabinet that the constructor may have on hand, or may be enclosed in the handsome wood cabinet of modern design built especially for this receiver and available through the same dealers handling this kit.

The kit is sold complete with speaker and all necessary tubes. No extra parts need to be purchased in order to make the set operative. The wood cabinet is not included in the price of the kit.

MAKE HASTE SLOWLY

This television receiver has a great many parts but each part is simple. The proper performance of the receiver depends upon the complete cooperation of all of the circuit elements. "Make haste slowly" by being perfectly sure that each part is installed in the proper place, that is, has the correct value, that it is installed in the correct direction and that it is connected to the proper lugs. See that each coil has the proper **part number** since there are several coils that look alike but are electrically different. See that each resistor has the proper resistance by checking the color code carefully. See also that its size is correct for the wattage rating specified. Mica condensers should have their capacity checked by the same color code as resistances. The values read indicate micro-microfarads. Volume controls should be checked for part number.

The best aid toward accuracy is to use a colored pencil to mark over each component or wire in the Pictorial Diagram as the corresponding part or wire is installed in the receiver. When the receiver is completed, it is wise to have someone who has not worked on the receiver check

over all values of components, and all wiring. **Care in doing each small operation perfectly cannot be overemphasized.** Take care of each detail and the aggregate will take care of itself.

ASSEMBLY

There are three principal sheet-metal pieces which carry most of the parts: the chassis, the front panel and the front wall of the safety compartment. The assembly and wiring of the first and second items are clearly shown in the Pictorial Wiring diagram Fig. 1, while the assembly and wiring of the Safety Compartment is shown in figures 2, 3, 4, 5 and 7.

The simplest method of construction is to assemble onto any one of the metal parts as many small items as possible, and to wire up as much as possible before fastening the three major metal parts together.

Starting with the front wall of the safety compartment, first assemble the Cathode Ray tube socket. (This socket is the only one with eleven pins.) A special fastener that appears to have too small an inside diameter is furnished for mounting this socket. The bakelite part is inserted into the mounting hole from the front of the panel, the panel placed on a table (with the front side down) and the mounting ring forced down around the socket. A screw-driver is a convenient tool to use for this purpose, pressing down on the clip in a number of places successively, going around the clip until the mounting ring touches the back of the metal panel. Do not force the ring down too far, however, as it probably will be necessary to turn the socket slightly to line up the vertical and horizontal edges of the picture with the true vertical and horizontal direction. The remainder of the parts on the wall of the safety compartment may be assembled in any convenient sequence. If a ground connection is made to a socket saddle or to a mounting lug on a terminal strip, it is necessary to clean the mounting surface so that a good metal contact is made and so that the mounted part can be soldered to the sheet metal to form a permanent good ground connection. **These soldered ground connections are very important.**

Having completed the assembly outlined above, prepare the large chassis for assembly. Practically every major item has at least one connection to chassis. These connections should all be well soldered. To help the soldering operation a spot on the chassis should be lightly cleaned with sandpaper or a knife. Every socket saddle, every metal electrolytic condenser mounting plate, and every terminal strip supporting lug (to which a wire is connected), should be soldered to chassis. "Make Haste Slowly."

Having bonded all grounding lugs to chassis the filament circuits should be wired complete. Note that there are two independent 6.3 volt circuits for the purpose of preventing the scanning circuits from interfering with either sound or picture reproduction. These circuits must be wired according to the diagram. "Make Haste Slowly."

Many sockets contacts are connected to the chassis. It will probably be found convenient at this point to make all of the necessary ground connections on all of the sockets. "Make Haste Slowly."

The next items most conveniently wired are the electrolytic condensers which should now be assembled. Take great care to see that the condenser with the proper capacity and voltage rating is installed in the proper position. The ratings are stamped on the sides of the cans so

that the parts are easily identified. Note that some condensers are grounded to the chassis, in which case metal mounting plates are to be used, while in other cases the condensers must be insulated from the chassis, in which case bakelite mounting plates must be used. In the former case, the metal mounting plates should have one spot on each plate soldered to the chassis.

The condensers are mounted by pushing the mounting lugs through the slots in the mounting plates and then giving each mounting lug a slight twist with a pair of pliers. The amount of twist is only enough to hold the unit tightly, usually one-eighth turn is adequate. At least one mounting lug of each condenser should be soldered to the mounting plate if the plate is metallic. "Make Haste Slowly."

Because of the electrolytic condensers projecting above the chassis, making it impossible to lay the chassis down flat on a table, it will be found quite convenient to mount the front wall of the safety compartment and the front panel of the receiver, which are of essentially the same height, permitting the chassis to stand level on these parts with the bottom side up for convenient work. "Make Haste Slowly."

Next assemble all coils except the high frequency coil assembly on the chassis, paying special attention to the location of terminals on coils that have no color code, and watching carefully to see that the position of the colors on color-coded terminal strips agrees with the position shown in the diagram. Check also to see that the coils of correct part numbers are installed in their designated places. "Make Haste Slowly."

The assembly of the two power transformers and the filter choke may well be delayed until late in the program since these items are heavy and are not actually required until the wiring is almost complete.

Pick out on the Pictorial Wiring Diagram the long leads that connect items located considerable distances apart. These wires should be installed first, followed by the shorter wires. "Make Haste Slowly."

The by-pass condensers may well be installed next, paying particular attention to the capacity and voltage ratings. Wherever one side of a by-pass condenser is connected to the chassis, it is recommended that the end so connected be the "Outside Foil" or the "Ground" end of the condenser. "Make Haste Slowly."

After the by-pass condensers have been installed, the mica condensers and carbon resistors may be installed in any convenient sequence. The resistance or capacitance of these items, as the case may be, should be very carefully checked against the color code which is explained in the sheet "General Construction Hints" packed with the kit. It is very easy to misinterpret the color code, therefore utmost caution is urged.

When all of the above work has been completed, the filter choke, low voltage and high voltage transformers should be installed. The high voltage transformer, which is mounted under the chassis, is connected to a rectifier tube mounted inside of the safety compartment. Leads from this transformer are heavily insulated to prevent accidental shock. **Great care should be exercised to see that the sleeving on these leads extends up through the rubber grommets and that the sleeving is adequately anchored above the grommet by wrapping tape around the sleeving to prevent it from slipping back. Do not connect the primary leads of the high voltage transformers until the vol-**

tage test is completed on the receiver. As an added precaution against accidental operation of the high voltage transformer, the primary leads should be wrapped together and taped until such time as it is necessary to use the high voltage. The only remaining item, the high Frequency Coil Assembly, should now be installed and connected.

SAFETY SWITCHES

There are two safety switches furnished with the kit of parts. One is of conventional design, and is the primary interlock switch which opens the circuit from the A.C. line to the primary of the power transformers. The second switch short circuits the output of the high voltage power supply. Both of these switches operate whenever the cover is off of the safety compartment.

The line safety switch is mounted on a pair of brackets so that it is recessed below the chassis an appropriate distance. Fig. 3 shows the assembly of this switch and its brackets. In order to insure permanent alignment of the parts it is recommended that the brackets be soldered to the switch as shown. The actuator for the switch is attached to the Safety Cover in accordance with Fig. 4.

The high voltage shorting switch is of special design to arrive at an efficient unit that will satisfactorily withstand the high voltage employed in the Cathode Ray tube. The switch itself consists of two contact arms or springs which are in contact with each other whenever the cover is removed from the safety compartment. These springs mount on the terminals of the output filter condenser in accordance with the details shown in Fig. 5. The actuator for the switch is mounted on the inside of the safety cover and is shown diagrammatically in Fig. 4.

SAFETY SWITCH TESTS

Having installed two safety switches in a receiver, the constructor naturally has a feeling of complete protection which may lead to his undoing unless he proves that the safety devices are functioning correctly.

With the line cord disconnected from the line, the cover to the safety compartment should be slid down as far as possible. By the time the cover is in its proper position, the line switch should have snapped on. When the cover is removed very slowly the line switch should snap off by the time the cover has been lifted about one inch. Try the switch with the fingers slowly to see that it always snaps regardless of how slowly the switch arm is moved.

The high voltage shorting switch should be tested for adequate pressure by attempting to push a thin piece of stiff paper or a playing card down between the springs. They should offer considerable resistance to the movement of the card. If the springs are not stiff enough they can be bent with a pair of pliers to give adequate stiffness to be perfectly sure that the springs will make good contact when the safety cover is removed.

A special recheck should be made of the connections between the line, the power transformers and the safety switch to avoid the possibility of the safety switch being inactive because of improper connections.

VOLTAGE TEST

If all connections are found to be correct, the most logical next step is to check the voltage that exists on each of the tube elements. Since one of the tubes to be checked has its socket inside of the safety compartment, the first checks should be made without the high voltage operating. In

that manner, voltage tests on that tube can be made with safety.

With the primary of the high voltage transformer disconnected (and for safety's sake taped up) and with all tubes except the Cathode Ray Picture tube in place, turn the receiver upside down so that it will be convenient to work on and plug the line cord into a receptacle supplying 105 volts to 125 volts at 50 to 60 cycles. Turn the "Contrast Control" to its clockwise extreme of rotation. This turns the current on and adjusts the Picture I. F. amplifier for maximum gain. Turn the range switch to the counterclockwise extreme position (lowest band). The voltages between the various tubes elements and the chassis are listed in the table shown in Fig. 10. These measurements were made on the lowest possible range of a 0-705-75 300-600 voltmeter with a resistance of 1000 ohms per volt. All readings, unless marked negative, indicate that the tube elements are positive with respect to chassis by the amount shown.

A few important voltages that do not appear directly on any tube elements are shown on the Pictorial Wiring Diagram.

In order to measure the voltages on the 6F6 Video amplifier it is necessary to remove the safety cover. Removing this cover opens the line switch so that it will be necessary to have someone hold the line switch closed while the measurements are made. **Before having someone hold down the safety switch be sure the high voltage transformer primary is disconnected. Note: Some of the electrolytic condensers in the Safety Compartment are several hundred volts from chassis potential. Do not touch their containers at the same time the chassis is touched if the voltage is on. As soon as the voltages are measured, restore the safety cover.**

If the values measured are materially different from those shown on the Pictorial Diagram or in the table of voltages, turn off the receiver, disconnect the power cord from the line, and recheck the wiring.

Having completed the voltage check satisfactorily it is time to connect the primary of the high voltage power transformer and to insert the Cathode Ray tube. The front end of this tube is supported by the heavy rubber bands supplied with the kit.

PRELIMINARY ADJUSTMENT

Fig. 6 shows two views of the completed receiver giving the name and location of each control. To start the receiver turn on the current by rotating the "Contrast Control" clockwise, but turn it only far enough to snap the line switch. After a brief warm-up period, the picture tube should show some kind of a rectangular pattern of light, even if there is no television signal on the air. If no light is visible on the picture tube, turn the "Brilliance Control" clockwise until the picture tube shows some illumination. The "Framing Control" on the front surface of the Safety box should be adjusted to center the rectangle of light on the screen of the picture tube. The "Picture Size Controls" should be adjusted until the rectangle of light occupies the desired area on the screen of the picture tube. Note: The speed controls have some effect on the size of the picture and the "Horizontal Size Control" will have some effect upon the Horizontal speed. When adjusting the synchronizing on a signal it may require several adjustments of the horizontal controls to obtain both proper speed and proper size. The vertical dimension should be adjusted to be approximately three-fourths of the horizontal dimension. If the bottom and sides of the rectangle

of light are not exactly horizontal and vertical respectively, proper position may be obtained by rotating the picture tube. Note: The receiver should be turned off while the picture tube is being rotated. Sufficient allowance has been provided in the wiring and mounting of the picture tube to permit this limited rotation. The "Brilliance Control" should be set at the lowest value that will give satisfactory illumination. The "Focusing Control" should be adjusted until the lines in the rectangle of light are as clear and sharp as possible. The above preliminary adjustments are all that can be made until the I. F. and R. F. circuits are adjusted and until a signal is on the air. Once adjusted, the picture size and centering controls seldom need readjustment.

Should the picture tube fail to behave as described above, disconnect the power cord, open the Safety box and carefully examine the wiring for possible short circuits, open circuits, or incorrect connections. Note that the screen may not show a solid rectangle of light until the speed controls are adjusted. If the speed controls are set too far from their proper position there may be wide spaces between lines. These gaps can be eliminated by rotating the speed controls and are automatically eliminated when the sweep circuits are synchronized with the transmitter. The rectangle of light will also show diagonal bright lines but these are suppressed entirely by the blanking impulse in the picture signal which completely darkens the tube momentarily as the beam retraces to start a new line or a new frame.

ALIGNMENT

The alignment of this television receiver is similar in many respects to the alignment of a conventional Superheterodyne, with the exception that the peaks on the circuits are not sharp since the receiver must pass a very wide band of frequencies in order to give satisfactory detail. The instruments required are possessed by practically every reasonably well-equipped Service Man. An oscillator covering at least the range 8 MC to 15 MC with an output voltage of .15 to .2 volts (150,000 to 200,000 microvolts) and an output meter having a low scale of 1.5 volts form a good combination.

The first step in aligning the receiver is to **disconnect the primary of the high voltage power transformer.**

The second step is to attach an output indicator to the Picture channel. Since the picture channel has very little amplification following its detector, it is a convenient aid in alignment to add to the picture channel the amplification available in the Sound Audio System. This temporary change in the circuit can be made by running a wire from the junction of the two 15-7501 chokes through a coupling condenser of any convenient capacity between .01 and .25 MFD to the high end of the audio volume control which is the terminal nearest the speaker. The lead already connected to this lug is permitted to remain. The output meter should be connected between plate (No. 3 pin) and screen (No. 4 pin) on the 6V6G tube socket, with a blocking condenser of any convenient capacity between 0.1 and 1.0 MFD in series. (No leads are removed from the socket when making these connections.)

The third step is to loosen the adjusting screws on all of the adjustable trimmer condensers mounted on the bottom of the Picture I. F. transformers. These trimmers should be set approximately 5 turns from the tight position.

The fourth step is to remove the 6J5 high frequency oscillator tube.

The fifth step is to connect the signal generator and begin the actual adjustment. The low potential or ground side of the generator output should be connected to chassis and the high side connected through a blocking condenser of .01 MFD capacity (or greater) to the grid (pin No. 4) of the second Picture I. F. amplifier tube. No connections need be removed when making this temporary connection. The generator should be set to 12.75 MC, the audio and contrast controls advanced to their clockwise extreme of rotation, the output of the signal generator turned up until a signal is audible, and the adjusting screws on top of the 17-3463 transformer rotated for maximum output. The signal generator frequency should be shifting successively to both sides of 12.75 MC to see that the transformer shows only one hump in the selectivity curve. If more than one hump is evident, the adjustable trimmer should be opened several turns more and the transformer again realigned for maximum output. Having obtained a single hump at 12.75 MC, the adjustable condenser should be screwed in slowly, meanwhile shifting the generator frequency until a second hump appears in the selectivity curve. Still further increase the adjustable capacity until one hump moves down to 10 MC. The other hump will not have shifted noticeably.

The signal generator high potential lead should now be shifted to the grid (No. 4 terminal) of the first Picture I. F. amplifier tube and the second Picture I. F. transformer aligned in the following manner: Set the signal generator to 12.75 MC and adjust both adjusting screws in transformer No. 17-3462 for maximum output. Slowly increase the capacity of the ceramic base coupling condenser on the bottom of the I. F. transformer until again two humps are obtained in the response curve, one at 10 MC and the other at 12.75 MC exactly in the same manner as the output picture I. F. transformer was adjusted. Note that if one peak is materially higher than the other a slight readjustment of the four adjusting screws will permit the high peak to be reduced somewhat and the low peak to be increased a little. When the adjustment is completed so far, remove the leads connecting the signal generator to the grid of the first Picture I. F. tube and prepare to align the input picture I. F. transformer.

First turn the adjusting screw in the 14 MC trap (part No. 15-7500) until it is as far out as possible, and the adjusting screws of the second I. F. transformer No. 17-3464 and the sound input grid coil No. 17-3467 are as far in as possible.

At the grid of the mixer tube disconnect the lead that runs from the grid (No. 4 pin) to the high frequency coil assembly. Temporarily connect any convenient resistor of 10,000 or more ohms from the grid to the wire just removed, and connect the signal generator between chassis and the grid of the mixer tube through a blocking condenser of any convenient capacity above .001 MFD. The leads used for connecting the generator to the receiver should be shielded when aligning the mixer stage to avoid regeneration.

Temporarily connect across the secondary terminals (green and yellow dots) of the interstage picture I. F. transformer No. 17-3462, and across the primary terminals (blue and red dots) of the output picture I. F. transformer No. 17-3463, resistors of approximately 2000 ohms each.

Set the generator at 12 MC, not 12.75 MC, and turn the adjusting screws of the input picture I. F. transformer No. 17-3461 for maximum output. Now slightly increase the capacity of the coupling condenser, but in this case

the capacity should be increased only enough to cause the selectivity curve to lose its sharpness and begin to show evidence of flattening out as the generator is shifted above and below the 12 MC setting. If the amplifier starts to oscillate as the input picture I. F. transformer is brought into alignment, the contrast control can be rotated slightly to reduce the gain of the amplifier, but the gain should not be reduced if shielding on the leads to the receiver will stop the oscillation. Finally, the two 2000-ohm resistors temporarily installed should be removed. A check of the selectivity of the entire amplifier should now show a peak at 10 MC and at 12 MC and the response should be fairly uniform between peaks, with the amplification about one-half as much at 12.75 MC as it is at 12 MC. If these results are not obtained, the curve shape can be altered by slight readjustment of any or all of the six adjustments concerned.

If the output of the signal generator cannot be reduced sufficiently to give a convenient indication on the output meter, the audio gain being used may be reduced by moving one end of the temporary lead (between the 15-7501 choke and the audio volume control) from the volume control to the grid (pin No. 5) of the 6V6G sound output tube, thus removing the gain of the 6SQ7 first audio tube.

The generator should next be set at 14.25 MC and the trap No. 15-7500 adjusted for minimum response. This trap really need not be adjusted unless there are two stations on adjacent television channels receivable at the location of the receiver. If any difficulty is encountered in getting enough signal to properly adjust this wave trap, and only one station is receivable, the coil may be left with its adjusting screw all the way out.

The generator should next be set for 8.25 MC and the sound I. F. transformer No. 17-3464 and the sound grid input circuit No. 17-3467 adjusted for maximum response. The two heavy wires extending away from the terminal strip of transformer No. 17-3464 constitute a small coupling condenser of a capacity too small to be obtained in a condenser of more conventional construction. They may be moved closer together to expand the sound I. F. channel if desired.

The over-all picture selectivity curve should again be checked to see that adjusting the sound trap and sound I. F. system has not changed the picture selectivity curve shape, or if it has changed, the adjustments may be touched up again to obtain the best picture selectivity curve shape.

The leads from the signal generator to the grid of the mixer should be removed and the connection from the mixer grid to the coil assembly restored to its original condition. The temporary connection from the junction of the two No. 15-7501 chokes to the sound volume control should be removed.

Plug in the 6J5 oscillator tube and the receiver is ready for operation. The antenna coil trimmer and the mixer grid trimmer shown in Fig. 8 may best be adjusted on an actual television signal since few generators will reach the television frequencies and still fewer have a frequency calibration that can be relied upon at such frequencies. An antenna of the general characteristics discussed in the section "Antenna" should be connected to the two end terminals on the antenna terminal strip and a ground connection attached to the middle terminal. A television signal should be tuned in as described in "Operation" and the antenna and mixer grid circuit alignments touched

up. This adjustment is best made with an insulated screwdriver since the capacity of the screwdriver is appreciable compared to the tuning capacities employed.

ANTENNA

The most satisfactory, and the only recommended antenna for this receiver is a short wave doublet antenna. There are several commercial antenna kits available that are very convenient to assemble and install, and which give excellent results. The dealer from whom this receiver was purchased probably has complete information on them. If you desire to make your own antenna, directions are given herewith. Excellent results can be obtained from either type of antenna if the following considerations are followed.

With television antennas, the important points to consider are:

1. To place the antenna as far as possible away from automobile traffic, elevator control panels, diathermy machines, and any other type of electrical equipment that may produce interference.
2. To place the antenna in a position that is, if possible, above all surrounding objects. It should not be in the radio shadow of any large building, bridge, trestle or similar structure; in other words, there should be no tall metallic structure between the antenna and the transmitter, especially if the obstruction is close to the antenna, in which case it will cast a deep shadow, that is, give very low signal level.
3. To make the antenna length the optimum for the signal frequency to be received.
4. To point the antenna in the direction giving the best results. If the antenna is well up in a clear space the best position will usually be with the antenna wire at right angles to a line connecting the receiver and the telecasting station. If the antenna is between some tall buildings and the telecasting station, there may be both direct and reflected signals reaching the antenna. When this occurs there may be double images on the picture tube. The antenna usually can be then rotated until one of the images is very clear and the "echo" images disappear.
5. The directive property of the antenna can sometimes be used to advantage to cut out a strong source of interference, because the antenna receives poorly through a small angle on either side of the direction in which the antenna conductors point, but receives reasonably well for a large angle on either side of the line perpendicular to the direction of the antenna conductors. The region of poor reception frequently may be aimed at the interference (unless it is directly in line with the transmitting station) thereby greatly reducing the interference, yet receiving the desired signal with reasonable strength.

The following table gives the length of the antenna, over-all, for best reception of the different channels.

	44-50 MC	119 inches
#1	50-56 MC	105 inches
#3	66-72 MC	81 inches
#4	78-84 MC	69 inches
#5	84-90 MC	64 inches
#2	60-66 MC	

Where one antenna must work on several bands, the antenna length should be the average of the best working length for each of the desired bands or it should be adjusted to give greatest improvement to the station delivering the poorest signal.

The antenna itself can be made either self-supporting, in which case thin-wall metal tubes form the antenna conductors which extend out from a central insulating support, as in the case of several commercially available designs, or the antenna may be of ordinary wire supported on a simple wooden framework. Fig. 9 shows a suggested antenna construction.

Probably the most convenient plan is to make the antenna and lead-in in one piece without any splices or soldered joints. The lead-in can well be the conventional two conductor twisted lamp cord available at almost every hardware or electrical supply store. The antenna can most conveniently be made by untwisting the required length of lamp cord and then winding the cord with strong string or tape to prevent further untwisting. The ends of the antenna wires should be fastened to porcelain insulators or equivalent.

The lead-in should run to the set in as short and direct a path as possible unless such a path passes through a zone of high interference, in which case a detour of reasonable length to avoid the interference is desirable.

Where the lead-in enters the house, a porcelain insulating tube is recommended. This tube should run uphill as it enters the house so that there will be no tendency for rain to run into the house after running down the lead-in. If the lead-in makes a small loop below the level of the outside end of the porcelain tube the rain should drip off this loop with practically no tendency to run into the porcelain tube.

RECEIVER LOCATION

The receiver should be located in a place where the screen of the picture tube can readily be seen by a group of people, and where the light is subdued. In direct sunlight the picture on the tube will hardly be discernible, in subdued light the picture will be clearly visible, but the optimum results will be obtained when the lighting corresponds closely to that very subdued light present in the average movie theater.

ADJUSTMENT OF PICTURE

When it is known that a picture signal is on the air, and the receiver has been aligned and the adjustments described under "Preliminary Adjustments" have been made, the "Television Station Selector" should be set for

the channel on which the station is telecasting, the "Contrast Control" advanced, and the "Vernier Control" tuned to produce a strongly mottled pattern on the picture tube. One speed control should then be slowly rotated until the mottled appearance of the screen begins to assume some semblance of stationary spots on it, then rotate the other speed control until the pattern stands still and a picture is visible. If there are two pictures, one above the other, the Vertical speed control should be rotated until there is only one picture. If the picture seems to be torn apart or to be slipping sideways, or if there are two pictures side by side, the Horizontal speed control should be turned to obtain proper operation. Detail in the picture may sometimes be improved by rotating the "Vernier Control." Audio volume is controlled in the conventional manner by means of the "Sound Volume Control."

PICTURE DEFECTS

If the picture appears right side up but reversed right for left so that all printed matter is reversed, the leads from the Cathode Ray tube deflecting plates to the plates of the Horizontal amplifier have been interchanged. Reversing these leads at the plates of the horizontal amplifier will give correct scanning. If the picture is inverted, the leads to the Vertical amplifier have been reversed. Interchanging them at the plates of the vertical amplifier will turn the picture over.

The connections shown in the Pictorial Diagram are arranged for the picture to be in the proper position when viewed from the front of the receiver when the receiver is placed in the conventional position. If it is desired to view the tube by means of a mirror, the necessary reversal of picture can be accomplished as described above.

Numerous wavy lines in an essentially vertical direction are the result of interference. If the wavy lines appear and disappear in a reasonably rapid rate the interference may be from code transmissions. When code is suspected, it may readily be recognized by the pulsating appearance.

Picture distortion in the form of wavy lines that do not have the sharp definite pulses characteristic of code interference is sometimes present. It is probable that this interference is from some sound service such as speech or music. The simple circuit change employed to add the amplification and speaker of the sound system to the sight channel may be used to listen to the interference with the probability that it can be easily identified.

Distortion in the picture is sometimes the result of setting both the "Brilliance Control" and the "Contrast" too far clockwise. Readjusting both of these controls sometimes improves picture quality. The best position for the "Brilliance Control" will usually be found most quickly by revolving the "Contrast Control" counterclockwise as far as possible without snapping the line switch off, and then adjust the "Brilliance Control" until the rectangle of light is just barely visible. Then advance the "Contrast Control" to obtain satisfactory picture reproduction. Before turning off the receiver, the "Brilliance Control" should be rotated to the extreme counterclockwise position.

No. 10-1153
SCHEMATIC CIRCUIT
DIAGRAM

17-TUBE TELEVISION RECEIVER

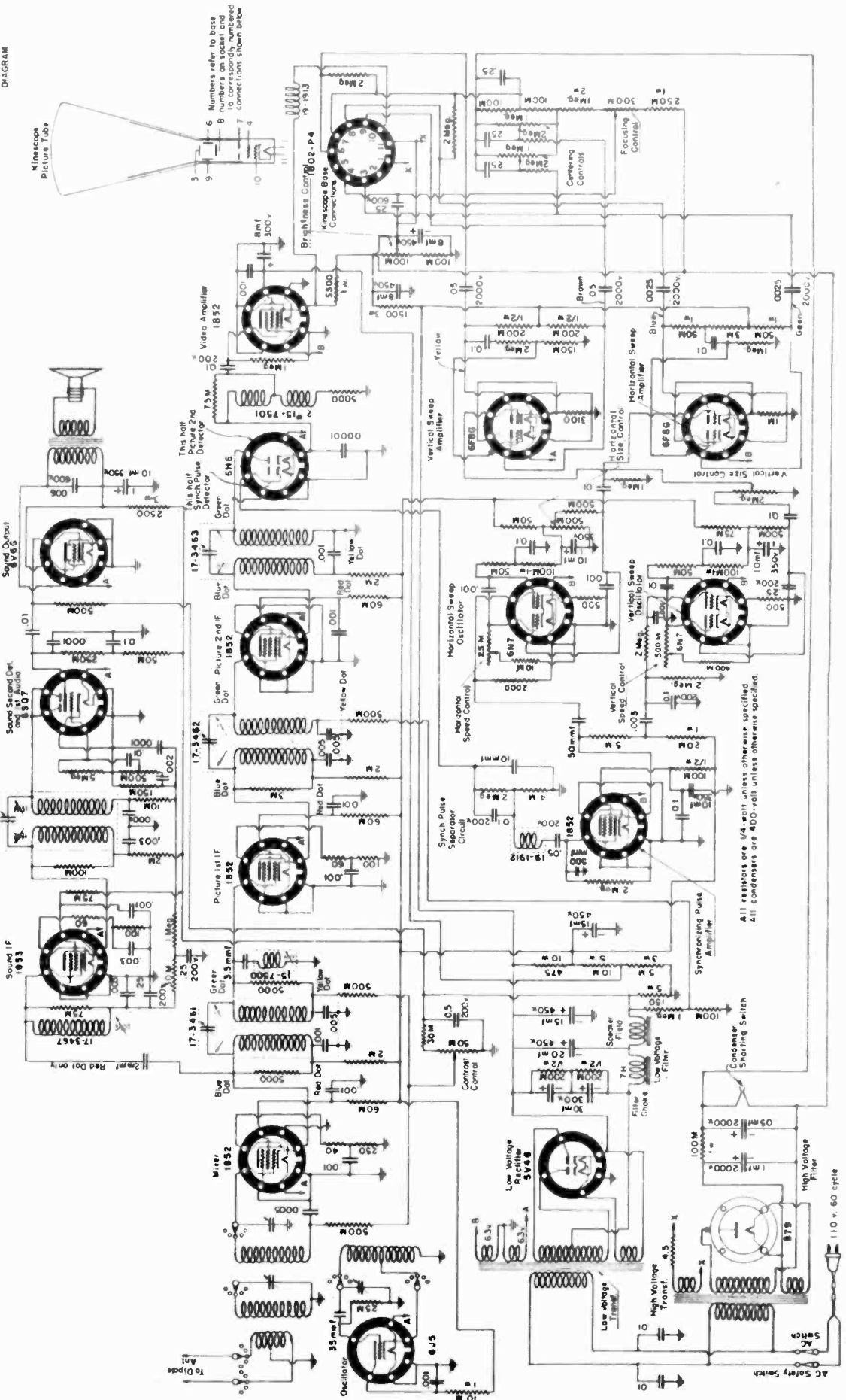

Kinescope Picture Tube

6 Numbers refer to base
B numbers on socket and
to correspondingly numbered
connections shown below

PICTORIAL WIRING

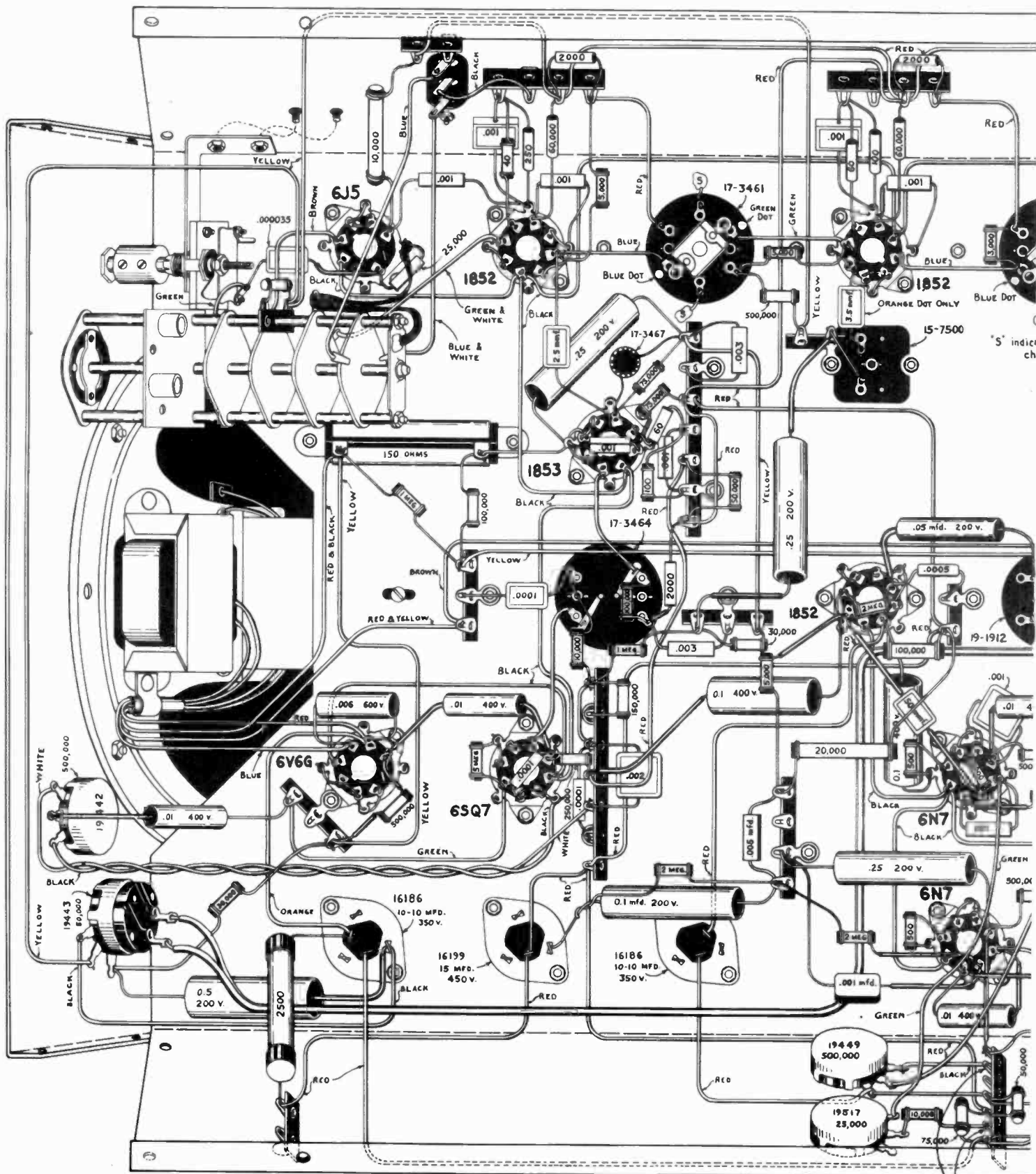

MOUNTING LUG

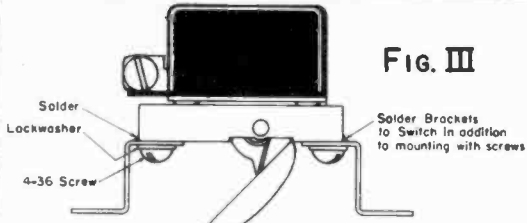

FIG. III

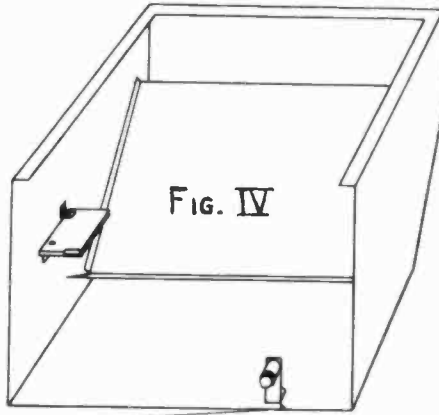

FIG. IV

External tooth lockwasher to be placed between bracket and safety cover.

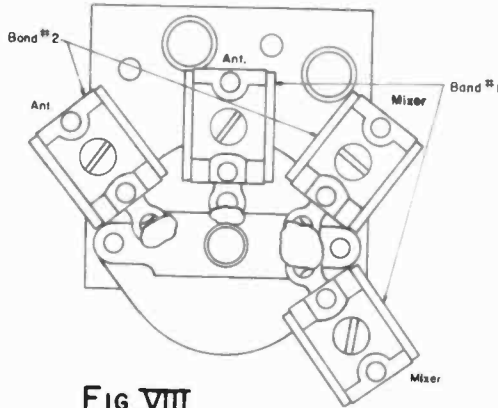

FIG. VIII

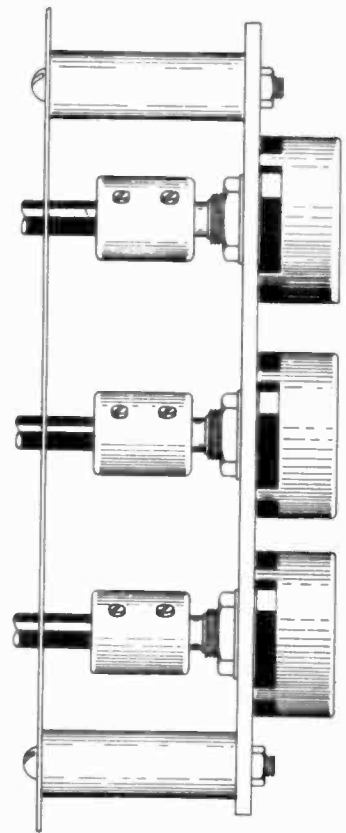

FIG. VII

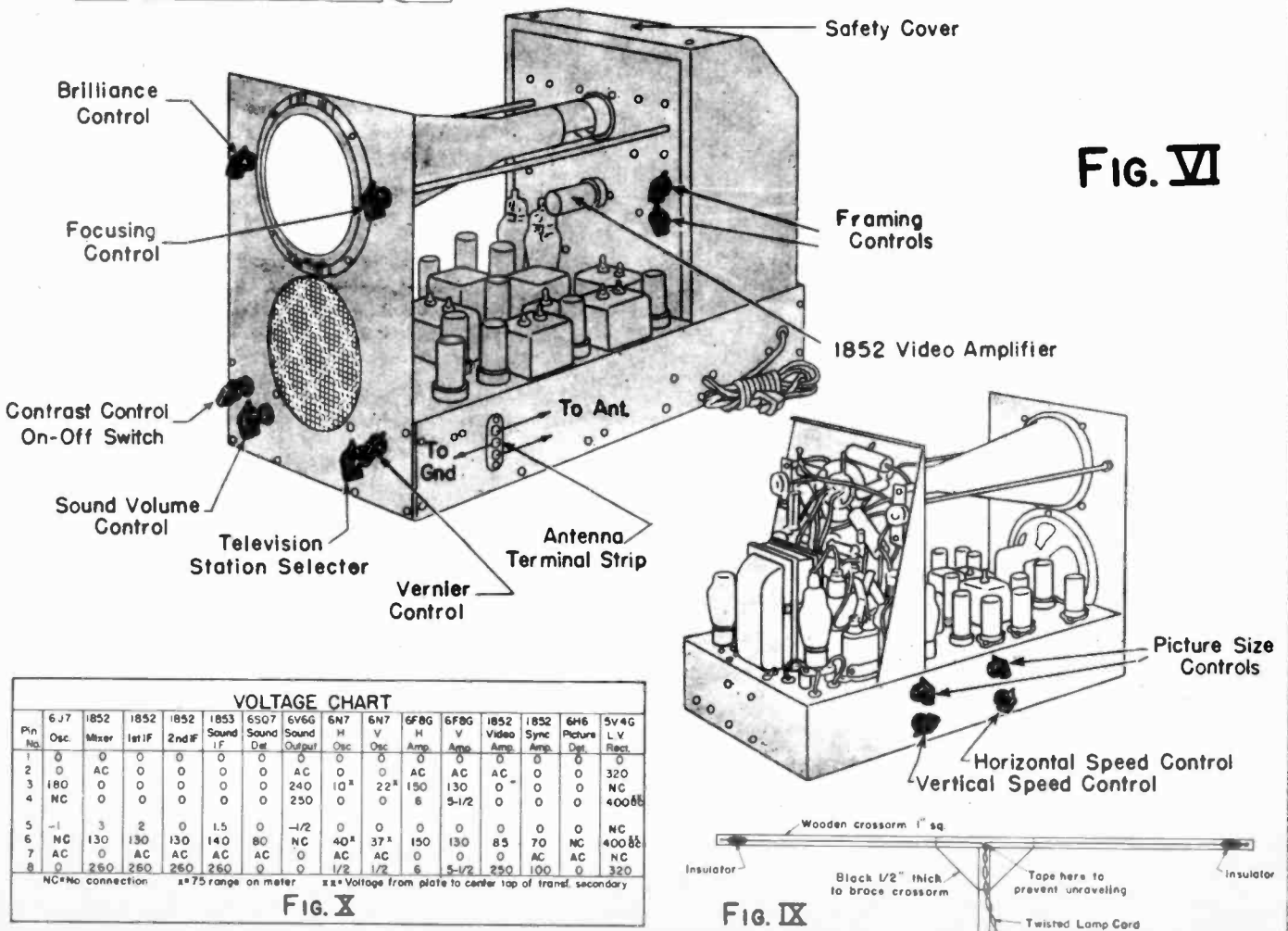

FIG. VI

VOLTAGE CHART

Pin No.	6J7 Osc.	1852 Mixer	1852 1st IF	1852 2nd IF	1853 Sound IF	6507 Sound Det.	6V6G Sound Output	6N7 H Osc.	6N7 V Osc.	6F8G H Amp.	6F8G V Amp.	1852 Video Amp.	1852 Sync Amp.	6H6 Picture Det.	5V4G L.V. Rect.
1	0	0	0	0	0	0	0	0	0	0	0	0	0	0	0
2	0	AC	0	0	0	0	AC	0	0	AC	AC	AC	0	0	320
3	180	0	0	0	0	0	240	10 ²	22 ²	150	130	0	0	0	NC
4	NC	0	0	0	0	0	250	0	0	6	5-1/2	0	0	0	400 ⁸
5	-1	3	2	0	1.5	0	-1/2	0	0	0	0	0	0	0	NC
6	NC	130	130	130	140	80	NC	40 ²	37 ²	150	130	85	70	NC	400 ⁸
7	AC	0	AC	AC	AC	AC	AC	AC	0	0	0	AC	AC	AC	NC
8	0	260	260	260	260	0	0	1/2	1/2	6	5-1/2	250	100	0	320

NC=No connection *75 range on meter ** Voltage from plate to center tap of transf. secondary

FIG. X

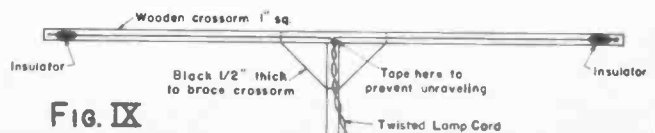

FIG. IX

**COMPLETE INSTRUCTIONS
FOR CONSTRUCTION AND OPERATION OF THE**



"Traffic Master"

14-tube, 5-Band Communication Receiver

Model 10-1174

The Meissner "Traffic-Master" is a 14-tube superheterodyne receiver, supplied in kit form, designed for the advanced radio amateur who requires a high-grade receiver of superior performance for consistent radio communication under any conditions.

A brief survey of the circuit features will reveal first the improved Meissner Band-Spread Tuning Unit incorporating the RF, Mixer and Oscillator stages with a frequency coverage of 530 kc to 31 mc in five overlapping ranges. The 456-kc output of this unit is fed into a two-stage Intermediate Frequency channel incorporating a Crystal Filter and Lamb type Noise Silencer. A variable-pitch Beat Frequency Oscillator is coupled to one side of the full-wave diode detector which feeds directly into the grid of the audio-amplifier phase-inverter tube. The push-pull output of this tube provides full excitation for the grids of the 6V6's in push-pull class AB, providing an undistorted output of 8.5 watts. A VR150 voltage regulator is used to provide stable operating voltages for the oscillator circuits while a 5V4G rectifier supplies the high-voltage DC for the set.

The Tuning Unit used with this receiver incorporates all of the circuit components up to the input of the I.F. amplifier. These include individual Antenna, Mixer and Oscillator coils, range switch, band-spread tuning condenser, dial, tube sockets and all associated resistors, by-pass condensers, padders, etc. compactly assembled and wired on a small sub-chassis to be mounted in the receiver as a unit. The entire unit is factory tested, aligned and calibrated and requires little or no adjustment.

The tuning condenser is a specially designed unit having three 280-mmfd. sections with ceramic insulation and is provided with auxiliary band-spread sections controlled by a separate shaft. The 9" linear-scale dial is also specially designed for this receiver and has separate control knobs for the main and band-spreading tuning. Fly-wheels are provided on each shaft for rapid coverage of the scale when required. Coils incorporated in the tuning unit are wound on separate forms and each is provided with its own air-dielectric trimming condenser. Ceramic tube sockets are used for the RF, Mixer and Oscillator tubes for improved high-frequency performance.

The "Mono-Unit" Crystal Filter unit is easily mounted and wired into the receiver in the same manner as an I.F. transformer. It includes the crystal input and output I.F. transformers, combined crystal-phasing condenser and crystal short-circuiting switch, air-dielectric trimmers and mounted 456-kc crystal, all factory wire and tested.

Ferrocort, iron-core, I.F. transformers with air-dielectric trimmers are used in the input and output positions of the I.F. channel. The Beat Frequency Oscillator unit and Noise Silencer transformer are also air-tuned for maximum stability.

Much attention has been given in the design of this receiver to provide the utmost in consistent performance and unusual frequency stability. To this end, the plate and screen supply circuits of the oscillator stage and the plate supply of the beat-frequency oscillator are controlled by a voltage regulator system which minimizes voltage variations and consequent frequency drifts.

An "R" indicating meter is provided whose scale is directly calibrated to indicate the strength of the received signal. This meter also operates as a tuning indicator to enable the receiver to be set in exact resonance with the received signal.

The receiver incorporates its own power supply and operates directly from 110 volts, 60 cycles. A sturdy and attractive steel cabinet and professional-appearing front panel are

separately available to complete this receiver. In addition to the parts supplied in the kit, a set of tubes is required, as listed below the Parts List, and also a P-M dynamic speaker with suitable output transformer to match the push-pull 6V6's in class AB.

ASSEMBLY

The entire kit should be carefully unpacked and all parts laid out for examination and identification. Check all parts against the parts list and report any discrepancies at once to your supplier. After making sure that all parts are in order, set aside the tuning unit and dial and begin the assembly of the smaller parts on the main chassis. Follow the Pictorial Wiring Diagram carefully at all times in assembly and wiring of the receiver as this accurately shows the placement of all parts and wiring to provide the best possible performance.

Determine the front surface of the panel to be used with the receiver and mark all control shafts to be cut so that they will extend $\frac{1}{2}$ " in front of this surface. This is best done by temporarily placing the controls in position to determine the proper length of shaft. Remove controls and saw off the shafts while the free end is held in a small vise. Do not attempt to saw shafts while the control is mounted on the chassis as the strain may cause damage to the control.

Mount all tube sockets on the chassis, using the 6-32 x $\frac{1}{4}$ " steel screws supplied for all assembly work. Be sure to use a lockwasher under each nut to insure a tight fit and freedom from later trouble. Note that in some cases there are tie-lugs to be mounted on the same screw that is used to mount the socket. These should be put in place and held by the same nut, while the sockets are being mounted. It is also very necessary to observe the position of the "key-way" in the central hole of each socket. This should be turned so that it occupies the position indicated on the Pictorial Diagram.

Next install the Power Transformer, Filter Condensers, I.F. Transformers, Crystal Filter Unit and Beat Frequency Oscillator. The Filter Chokes should be left until after the wiring to the 5V4G socket has been completed. Other small parts are then installed, such as the RF Choke, speaker socket, rubber grommets and tie-lugs not previously mounted. The four variable resistor controls are then mounted on the front of the chassis and the two small adjustors (Gain and Meter) on the chassis surface as shown in the Pictorial Diagram.

In mounting the Phone Jack, some variation will be necessary according to whether a front panel is to be used or not. If no panel is used, the Jack Mounting Plate is fastened over the large hole in the chassis at this point and the Jack mounted as shown on the diagram. The three toggle switches are also placed in positions shown on the front surface of the chassis. If a panel is used, however, these parts will all be fastened to the front panel, the Jack extending back into the chassis through the large opening. The toggle switches have long bushings which will permit the body of the switch to remain behind the front surface of the chassis and still extend through the panel on which the switch will actually be fastened. Before the panel is mounted, however, these parts may be temporarily placed on the chassis as indicated and the change made at any later time.

WIRING

Before starting the wiring, all points covered in the "General Construction Hints" should be well in mind. High-grade rubber-covered hook-up wire is supplied in ample quantity of each color to conform to the color markings on the Pictorial Diagram. A good pair of side-cutting long nose pliers or plain long-nose and diagonal cutters should be available. The

rubber-covered wire is easily stripped at the end by mashing the insulation about $\frac{1}{4}$ inch from the end and removing the rubber. Be sure that all connections are well soldered.

A small spot of solder should be applied to each socket saddle at one side near a mounting nut in order to insure good electrical connection to the chassis. Have the soldering iron good and hot for this operation as the chassis will conduct the heat away rapidly and a good joint can not be secured.

Begin wiring by connecting the colored wires from the power transformer to their proper points in the set. Then wire all heater circuits (terminals 2 and 7 on each socket), using a pair of black wires twisted together. Mark over each wire on the diagram as it is connected in the receiver, using a colored pencil or crayon. This will make it easy to see just what has been done and whether anything has been overlooked when the wiring is completed.

Connect the wires from the Crystal Filter and Beat Frequency Oscillator units to the proper points and install the heavy shielded wire shown at the back of the tuning unit opening. The Line Cord should then be installed, using the braided wire shielding to cover a portion of it as shown. Note that one wire is cut near the 5V4G socket and the two ends connected to the insulated terminals on the adjacent tie-lug.

The remainder of the wiring may be completed in any convenient order although it will be found to simplify the procedure somewhat if all wire-lengths are picked out and connected first before attempting to place and connect the resistors and paper condensers. All wiring may thus be neatly arranged close to the chassis in exactly the positions shown while the resistors and condensers, installed later, will be arranged on their self-supporting leads so they clear all other parts and wiring. The black braided insulating sleeving is supplied for use on bare wires wherever there is any likelihood that such wire may touch the chassis or some other wire and cause a short.

Check the wiring as it progresses, making sure that each connection is made to the proper terminal and that it is properly soldered, and it will be hardly necessary to make a final check. Such a check should be made, however, as a matter of safety and to provide additional assurance that everything is correct.

TUNING UNIT

After all other wiring has been completed, the Tuning Unit may be installed and connected into the circuit. Set the unit in the chassis opening and mark the area covered by the side flanges. This space on the chassis should be cleaned of paint in order to provide a solid "ground" connection when the unit is mounted. Next assemble the tuning dial to the tuning unit by inserting the two condenser shafts into the central hubs of the two large drums on the back of the dial. Loosen the set screws if necessary. Then set the entire assembly on the chassis and insert the four brass 8-32 screws through the front of the chassis into the dial frame but do not tighten them. Use six screws to mount the Tuning Unit to the chassis and tighten down firmly. Then turn the condenser shafts so that the plates are completely meshed and set the main tuning control on the dial directly on the end mark at the low-frequency end of the scale. Tighten the set screws on the main condenser shaft while in this position. Then set the band-spread control to exactly "0" and tighten the set screws on the band-spread condenser shaft. The four brass screws may then be tightened to firmly mount the dial to the front of the chassis making sure that no binding results and that the mechanical action is free and clear.

The nine colored wires shown entering the space occupied by the tuning unit (on the Pictorial Diagram) represent wires which are already on the tuning unit and which are now to be wired to their respective points as indicated. This will complete the wiring of the receiver with the exception of the dial lights and "R" meter which may be mounted and connected as shown. The dial lights are inserted in the two bayonet-type sockets provided which, in turn, are inserted into the large rubber grommets. These grommets are supplied with the dial and are to be placed in the two holes provided in the dial frame just back of the scale on either side of the center.

FRONT PANEL MOUNTING

If the Meissner steel front panel is used with this receiver it should be mounted next. Four small wooden spacers are used between the front surface of the chassis and the back of the panel, two at each end of the chassis. The 6-32 x $\frac{3}{8}$ " black screws are used for mounting the panel. The dial escutcheon and etched aluminum indicator plates should be fastened on the front of the panel before mounting. Small black 2-56 screws are provided for this purpose.

VOLTAGE TEST

Insert all tubes in their respective sockets as indicated on the top view of the receiver. Make sure that the four top grid connections are properly made, using the grid-clips provided. Have the speaker properly connected to a five-prong plug as shown on the circuit diagram and insert this plug in the speaker socket. Turn the Stand-by switch to the "Receive" position and the Tone control all the way to the left so that the line switch is turned off. Plug the line-cord into a 110-volt receptacle and turn on the receiver by turning the Tone control to the right. After a brief "warm-up" measure voltages at the points indicated, using a high-resistance DC voltmeter. The voltages shown are positive with respect to chassis which will be used as the negative connection for the meter. If these voltages are not reasonably close to the values shown, disconnect the receiver at once and re-check the wiring to determine the cause. If the receiver appears to be operating normally, permit it to run for at least a half-hour before proceeding with the alignment.

ALIGNMENT

The Band-Spread Tuning Unit has been aligned and tested in the factory before shipment; if tubes of the proper type are used the circuits should be very close to maximum efficiency. Do not disturb any of the adjustments on this unit until all other instructions given below have been followed.

With the receiver on and the Stand-by switch set to "Receive", set the remaining controls as follows: Noise Level, fully to the right (clock-wise); BFO, off; AVC, on; RF Gain (sensitivity), full on; Audio Gain (volume), full on. Adjust the I. F. amplifier channel in the usual manner except for location of the crystal frequency.

Connect the high side of the output of a service oscillator to the grid of the 6K8 mixer tube through a fixed condenser having a capacity of .0005 to .25 mfd. Do not remove the grid clip from the tube. Set the range switch to the Broadcast band and the main tuning dial indicator to about 600 kc. Turn the Crystal Phase control all the way to the right which shorts out the crystal and proceed with a general alignment of the input, output and crystal I.F. transformers at 456 kc. Keep the output of the service oscillator as low as possible at all times as the best adjustments may be made with a weak signal. Turn the Phase control to the left which places the crystal in the circuit and search for the crystal frequency in the following manner: cut off the modulation in the service oscillator and swing its frequency rapidly across the range between 450 and 460 kc until a peculiar "chirp" is heard. This point will be very sharp and it may be difficult to set the oscillator exactly on this frequency.

It should be set as accurately as possible, however, and then the six I. F. trimmers re-adjusted for maximum response on this frequency as indicated by the "R" meter reading.

To adjust the Noise Silencer Transformer, using the same 456-kc signal, increase the output of the service oscillator until a reading between 5 and 8 appears on the "R" meter. Turn the Noise Level control until there is a just-perceptible decrease in the meter reading and leave it there. Then align the Noise Silencer Transformer for maximum decrease in the meter reading. As alignment proceeds, re-adjust the Noise Level control to keep the effect of the silencer circuit just visible on the meter. In this way the sharpest alignment will be obtained.

Turn on the Beat Frequency Oscillator switch, set the Pitch Control to its mid position and adjust the beat-note to zero beat by means of a screw-driver through the hole in the top of the shield on the BFO unit, No. 01010.

If a good all-wave signal generator is available, final adjustments may be made on the antenna and mixer circuits to bring them to peak performance. However, if no such instrument is at hand, it will be much better to leave these adjustments strictly alone. The generator is to be connected to the antenna post of the receiver, through a suitable dummy antenna. This should be a 200-mmfd. condenser for the broadcast band and a 400-ohm resistor on all other bands. Connect the "D" and "G" posts together and to the low side of the generator. Adjust the antenna and mixer trimmers only for each band, the dial being set in each case to the alignment frequencies given in the table included in the instruction sheet packed with the tuning unit. No adjustment should require more than two turns of the adjusting screw. If greater adjustment is necessary it is highly probable that the wrong type of tubes or of dummy antenna has been used.

If a complete alignment of the Tuning Unit is thought desirable, consult the instruction sheet packed with the unit.

ANTENNA

A conventional single-wire antenna is connected to the "A" post on the rear of the tuning unit while the "D" and "G" posts are connected together and to ground. A doublet antenna has its two-wire lead-in connected to the "A" and "D" posts while the "G" post is again grounded.

OPERATION

The operation of all controls except, perhaps the Noise Silencer, is readily apparent from the names of the controls and the markings on the front panel. Experiments with them will soon familiarize the operator with their performance.

The Noise Silencer is a device of great assistance in the reception of signals through certain types of interference, such as ignition noise from automobiles or other types of high-intensity pulses of short duration. When properly adjusted the Noise Silencer makes it possible to actually read code signals or understand phone conversations that previously could not even be distinguished beneath the blanket of noise. Against a steady, grinding, low-amplitude interference, however, the Noise Silencer is much less effective. A little experimenting with this part of the receiver will soon demonstrate the sphere of its effectiveness.

"R" METER

A meter, calibrated in the "R" series of signal-strength designations is provided for measuring the relative strength of

the received carriers. It is not affected by the percentage modulation on the received signal. An electrical zero adjuster is provided to compensate for differences between tubes and a mechanical zero adjuster on the meter case to set the pointer with respect to the "no-current" position on the meter scale.

With the receiver turned off, the zero adjuster on the case of the meter should be set, if necessary, to cause the pointer to coincide with the extreme right-hand line on the scale. Then, with the receiver turned on and warmed up, short the antenna and ground input of the receiver by connecting a wire across the "A" and "G" posts. Have the AVC turned "On" and the RF Gain control set at maximum. Then adjust the meter adjuster on the surface of the chassis just back of the meter to make the pointer coincide exactly with the last line at the left end of the scale.

AUXILLIARY GAIN ADJUSTOR

The small 5,000-ohm control mounted on the surface of the chassis at the left end is designed to provide for differences in amplification characteristics of tubes made by various manufacturers. With certain makes of tubes, this control will have to be re-set so that the set will not oscillate. In any case, adjust this control so that the set is in a stable operating condition with the main RF and Audio Gain controls full on.

PARTS SUPPLIED FOR CONSTRUCTION OF MEISSNER "TRAFFIC-MASTER"

- | | |
|----------------------------------------------------|-------------------------------------------------|
| 1 Pre-aligned Band-spread Tuning Unit, 13-7613 | 1 10,000-ohm, ¼-watt Fixed Resistor |
| 1 Calibrated Dial and Escutcheon, 23-8229 | 4 20,000-ohm, 1-watt Fixed Resistors |
| 1 Punched Chassis, 11-8223 A | 1 20,000-ohm, ¼ watt Fixed Resistor |
| 1 "R" Meter with mounting screws, 19345 | 1 30,000-ohm, ½-watt Fixed Resistor |
| 1 "R" Meter Light Assembly, 9119 | 1 50,000-ohm, ½-watt Fixed Resistor |
| 1 Crystal Filter Unit Complete, 01008 | 1 50,000-ohm, 1-watt Fixed Resistor |
| 1 Beat Frequency Osc. Unit Complete, 01010 | 3 50,000-ohm, ¼-watt Fixed Resistors |
| 1 Input Align-Aire I.F. Transformer, 16-6643 | 2 100,000-ohm, ½-watt Fixed Resistors |
| 1 Output Align-Aire I.F. Transformer, 16-6139 | 5 200,000-ohm, ¼-watt Fixed Resistors |
| 1 Noise Silencer I.F. Transformer, 17-6869 | 1 500,000-ohm, ¼-watt Fixed Resistor |
| 1 Power Transformer, 110-v, 60-cycle, 19282 | 1 Tie-lug, 3 insulated terminals |
| 1 Filter Choke, 19251 | 5 Tie-lugs, 2 insulated terminals |
| 1 Filter Choke, 19466 | 7 Tie-lugs, 1 insulated terminal |
| 1 30-mfd., 450-v. Electrolytic, Condenser, 16111 | 1 Stand-by Terminal Strip |
| 1 15-15 mfd., 450-v. Electrolytic Condenser, 16124 | 1 Mounting plate for Phone Jack |
| 1 R.F. Choke, 19-5590 | 1 Mounting plate for Filter Condenser |
| 10 Molded Bakelite Octal Tube Sockets | 1 AC Line Cord and Plug |
| 1 5-prong Wafer Type Speaker Socket | 4 Grid Clips |
| 1 250,000-ohm Tone Control with Switch, 19287 | 1 ¼" dia. shaft for Crystal Filter Phase |
| 1 500,000-ohm Volume Control, 19258 | 1 Insulating shaft coupler |
| 1 10,000-ohm Noise Level Control, 19338 | 1 Front bearing support bracket |
| 1 3,500-ohm Sensitivity Control, 19338 | 1 Front bearing and nut for Phase Control |
| 2 5,000-ohm Midget Adjustors, 19544 | 42 6-32 x ¼" steel machine screws |
| 3 Toggle Switches, 19354 | 60 6-32 x ¼" hexagon steel nuts |
| 1 Phone Jack, #3 Yaxley, 19360 | 60 #6 steel Lockwashers |
| 1 10-mfd., 25-v. Electrolytic Condenser | 4 8-32 x ¼" brass machine screws, dial mounting |
| 2 .1-mfd., 400-v. Paper Condensers | 6 2-56 x ¼" steel screws for escutcheon |
| 1 .1-mfd., 200-v. Paper Condenser | 12 2-56 x ¼" black screws for panel plates |
| 4 .05-mfd., 400-v. Paper Condensers | 18 2-56 brass nuts |
| 6 .05-mfd., 200-v. Paper Condensers | 18 #2 steel lockwashers |
| 5 .01-mfd., 400-v. Paper Condensers | 7 Lengths #20 Colored Hook-up Wire |
| 1 .006-mfd., 600-v. Paper Condenser | 1 Length Shielded Wire |
| 1 .00025-mfd., Mica Condenser | 1 Length Tinned Braided Shielding |
| 2 .0001-mfd. Mica Condensers | 1 Length Insulating Wire Sleaving |
| 2 .00005-mfd. Mica Condensers | 1 Length Rosin-Core Solder |
| 1 .000005-mfd. Mica Condenser | 1 5-piece Tube Shield for 6C8G tube |
| 1 200-ohm, 3-watt Fixed Resistor | 4 Black wood panel spacers, ½" dia. x ¾" long |
| 2 300-ohm, ¼-watt Fixed Resistors | 4 6-32 x ¼" black screws for panel mounting |
| 2 1500-ohm, ¼-watt Fixed Resistors | 2 6.3-volt dial lights, bayonet base |
| 1 2000-ohm, ¼-watt Fixed Resistor | 3 Etched aluminum panel plates |
| 1 5000-ohm, 3-watt Fixed Resistor | 9 Black bakelite control knobs |
| 1 7500-ohm, ¼-watt Fixed Resistor | |

ADDITIONAL PARTS REQUIRED FOR OPERATION

- | | | | |
|-----------------------------------------------------------------------------------------------------------------|------------------|--------------------------------------------------------------------------|---------------------|
| 1 1853 Metal tube | 1 6L7 Metal tube | 2 6H6 Metal tubes | 1 VR150 Glass tube |
| 1 6K8 Metal tube | 1 6J7 Metal tube | 1 6SJ7 Metal tube | 1 5V4G Glass tube |
| 1 6J7G Glass tube | 1 6K7 Metal tube | 1 6C8G Glass tube | 2 6V6 or 6V6G tubes |
| 1 10" or 12" P-M Dynamic Speaker with 5-prong connection plug; output transformer primary impedance 10,000 ohms | | to match 6V6's in push-pull, class AB; power-handling capacity, 8 watts. | |

MEISSNER ACCESSORIES AVAILABLE

- | | |
|---------------------------------------------------------------------------------------|-------------------------------------------------------------------------------------------------------------|
| No. 11-8219 Steel Front Panel, completely punched, black wrinkle finish, 19"x10½"x1½" | No. 11-8224 Steel Cabinet complete with hinged lid, black wrinkle finish, 19" long x 10½" high x 13¾" deep. |
|---------------------------------------------------------------------------------------|-------------------------------------------------------------------------------------------------------------|

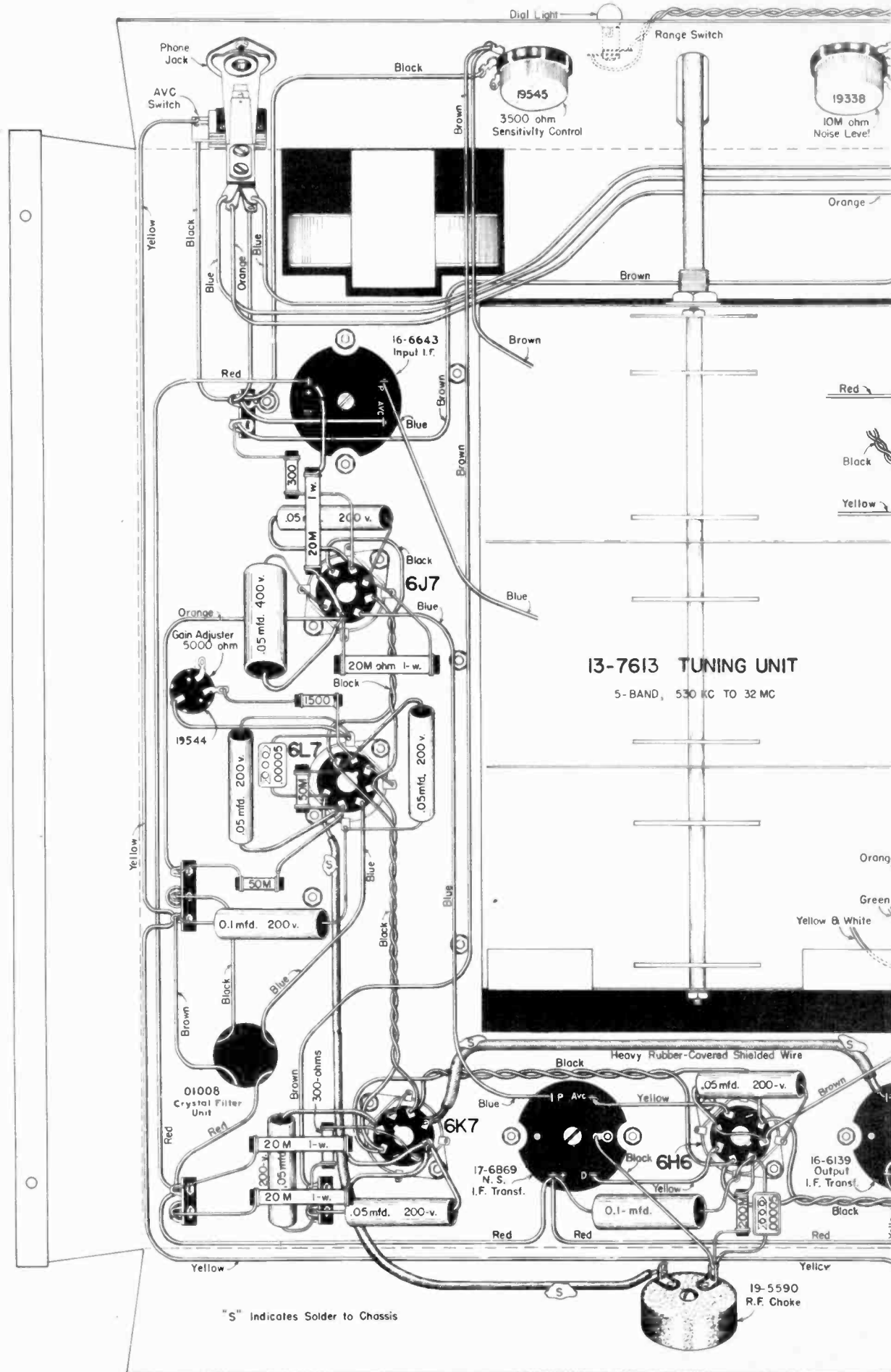

10-1174 PICTORIAL WIRING DIAGRAM

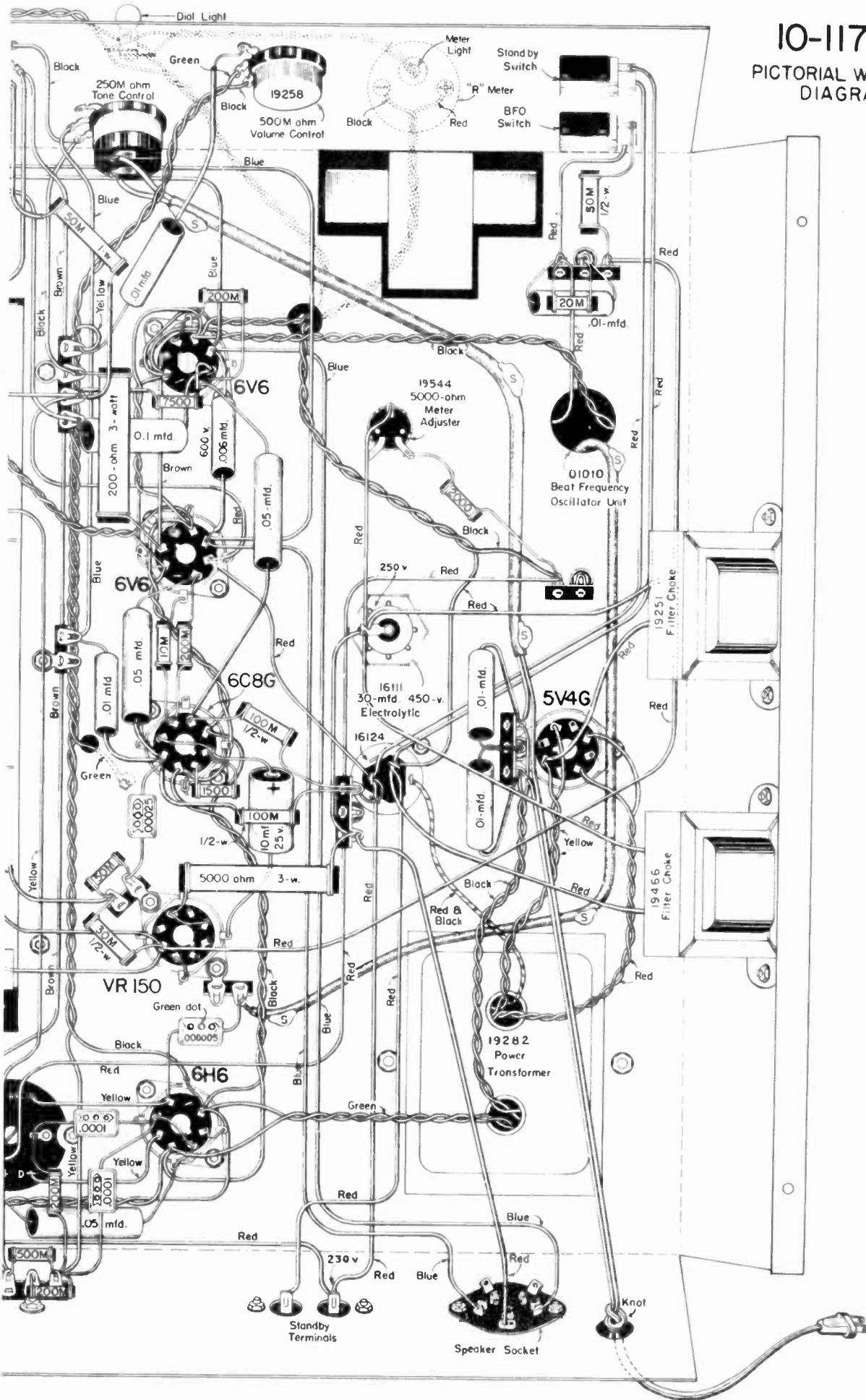

COMPLETE INSTRUCTIONS FOR



BAND SPREAD TUNING UNIT & MULTI-WAVE COIL ASSEMBLY

PART 1—TUNING UNIT

The Meissner All-Wave Band-Spread Tuning Unit, No. 13-7614 (280 MMF condenser) embraces all of the radio-frequency components of a Communications receiver ahead of the I. F. amplifier.

It consists of a special dial and Band-spreading tuning condenser, Multi-wave Antenna, R. F., and Oscillator coils, range switch and shields, padding and aligning condensers, tube sockets and all necessary resistors and condensers mounted on a sub-chassis that can be mounted through a hole cut in any chassis three or more inches deep.

The dial has five scales calibrated in frequency for the band-setting portion of the condenser and one scale calibrated linearly for the band-spreading portion. One pointer covers the five frequency-calibrated scales while a short pointer covers the single band-spreading scale. Two independent knobs located at opposite ends of the dial, drive the pointers and condenser rotors, with the drive cords so assembled that slippage of the cord on the drive shaft can have no effect on the calibration. Both drive shafts are provided with flywheels to facilitate rapidly traversing the dial scale.

One stage of R. F. amplification is used on all bands to give good signal-to-noise ratio and good image suppression.

The Tuning Unit is provided with Antenna, Doublet and Ground connections and special contacts on the range switch to automatically select doublet or conventional antenna, whichever is better for the band selected. The switch also shorts-out all unused coils that might cause objectionable absorption losses.

The circuits are all aligned with air-dielectric condensers (Meissner "align-a-res") having a very smooth action and permanence of adjustment not approached by the usual mica-dielectric trimmer condensers.

The unit is aligned, calibrated and tested for sensitivity before leaving the factory, and should not require adjustment when installed in the receiver.

The frequency ranges of the Band-Spread Tuning Unit are given in Figure 2.

If no changes are made in the setting of the Aligners and padders before placing the receiver in operation, good reception should be obtained on all bands, providing the rest of the receiver is functioning properly. Inasmuch as the coil assembly is already connected to the associated parts of the circuit, and was factory tested in this condition, it is very improbable that any improvement can be made by re-aligning or adjusting the padders on this unit. If for some reason these adjustments have been accidentally changed or it is thought desirable to re-align the unit, this may be readily accomplished by referring to the aligning instructions for the Band-Spread Coil Assembly included in this instruction sheet.

The dial, because of its size and design cannot be supported from the Tuning Unit, and consequently is provided with mounting holes in both its front and back surfaces so that it may be mounted either in front of a chassis or dropped through openings in the top of a chassis so that it can be fastened to the back of the front flange of the chassis. Proper mounting and clearance holes are provided on all Meissner kits. On sets designed by the Con-

structor, care should be taken to lay out the dial-mounting holes carefully lest they cause misalignment of the dial.

When mounting the dial, care should be exercised to see that it is placed so that there is no binding or stiffness in the bearings of the tuning condenser. The end supports should be tightened first, and then the screws holding the tuning-shaft bracket should be tightened to clamp this part firmly to the Tuning Unit sub-chassis. The condenser plates should be fully meshed (condenser closed), and the dial pointer set to the last mark at the low-frequency (small-number) end of the dial before tightening the set-screw holding the dial drum on the condenser shaft.

CIRCUIT

The complete schematic diagram of the wired Tuning Unit is shown in Fig. 3. All parts shown thereon, except tubes are furnished in the Tuning Unit which is completely wired. A regulated "B" voltage supply is recommended for use with this unit to eliminate frequency shift of the oscillator. This voltage supply circuit, using a VR-150 tube, is used to provide practically constant voltage to the oscillator tube plate and screen and to the mixer tube screen.

The full regulated voltage (150 volts) is applied to the osc. plate (white & yellow) and screen (green wire) on the tuning unit. The mixer screen is fed from the same source thru 30,000 ohms with 50,000 ohm bleeder to ground.

If a regulated supply circuit is not used, the oscillator plate is fed from a 200 to 250-volt source thru 10,000 ohms and the screen thru 40,000 ohms. The mixer screen (orange) is supplied with 80 to 100 volts. All necessary by-passes are located inside the tuning unit.

PART 2—MULTI-WAVE COIL ASSEMBLY

The Coil and Switch Assemblies used in the Meissner Band-Spreading Tuning Units are available separately for use in receivers designed without a Tuning Unit sub-chassis, such as the Meissner 9-Tube Communication Receiver, or for use in special receivers to suit the individual constructive requirements.

The frequency ranges of the Band-Spread Coil Assembly are as follows:

Band	-13-7603	13-7605
1	540-1580 K.C.	
2	1.5- 4.5 M.C.	1.5- 4.5 M.C.
3	4.1-12.2 M.C.	4.1-12.2 M.C.
4	7.3-18.8 M.C.	7.3-18.8 M.C.
5	11.2-31.6 M.C.	11.2-31.6 M.C.

The Tuning ranges of the complete band-spread Tuning Unit No. 13-7614 are the same as the ranges listed for Coil Assembly No. 13-7603.

These units may be used successfully in almost any kind of a receiver if a few important considerations are observed.

(a) The proper gang condenser must be used. This should be a high-grade, bar-type low minimum capacity electrical band-spread condenser such as Meissner No. 21-5143-B, 280 mmf condenser.

If the electrical type of band-spreading is not desired, a conventional tuning condenser of 260 mmf maximum capacity and of bar type construction for low minimum capacity, such as Meissner No. 21-5227, may be used if the trimmer condensers thereon are removed.

(b) The Tuning condenser should be mounted as nearly as possible directly over the coil assembly.

(c) The sockets for R. F., Detector and Oscillator tubes, the gang condenser and the coil assembly should be mounted with respect to each other in the relation shown in Fig. 1.

(d) On no account should the heavy braided leads

which connect to the tuning condenser be materially lengthened or shortened.

Examination of the above mentioned heavy braided leads will show that one lead from each section of the coil assembly is brought out from the front section of the band switch, while the other lead from each section connects to a ground bus connecting the two wafers in the Ant., RF, and Osc. sections of the switch. The former braided leads connect to the stators of the gang condenser while the latter braided leads connect to the rotor wipers.

Schematic Diagram, Fig. 3. shows the circuit of both the complete Tuning Unit and the Coil Assembly alone. The section enclosed within the dotted lines is the Coil Assembly, while the entire circuit shows the complete Tuning Unit.

All leads which are brought out of the coil assembly to be connected to the remainder of the circuit are color-coded and clearly indicated near the dotted lines of Figure 3. The heavy braided cables mentioned above are indicated on this diagram as "stator" and "rotor". The "stator" cables should be brought through the chassis through large insulating grommets at least $\frac{3}{8}$ " in diameter and soldered to the stator terminals of the condenser. The "rotor" cables of each coil section should be brought through similar insulating grommets and soldered directly to the corresponding section of the condenser rotor wiper.

The remainder of the circuit diagram (Figure 3) indicates the connections of a suitable R. F., Mixer and Oscillator arrangement which have been found to operate most efficiently with this coil assembly. Careful observation of these circuit components will result in utmost success and satisfaction with this coil assembly.

ALIGNMENT

The Align-aires (air-dielectric trimmers) and padders on these coil assemblies have been factory-adjusted to the correct capacities. If other parts of the receiver circuit are functioning properly, reception should be obtained on all bands without further adjustment. Due to variation in location of parts and circuit wiring it is necessary to properly align and pad the coil assembly, however, to obtain most efficient operation of the receiver. For this purpose a high-grade signal-generator or service-oscillator and output-meter must be used.

The proper Dummy Antenna must be used between the signal-generator and the receiver if the antenna circuit is to be properly aligned. On the Broadcast band a 200-mmf condenser should be used between the Antenna post of the generator and the "A" connection of the receiver. On the remaining bands a 400-ohm resistor should be used in place of the 200-mmf condenser as a "dummy" antenna. The "D" connection on the receiver should be connected to the "G" connection and to the ground side of the signal-generator.

The alignment procedure is essentially the same as usually employed in aligning any superheterodyne receiver. The intermediate-frequency channel must be accurately adjusted to 456 KC. Reference to the alignment table in Figure 2 will indicate the aligning and padding frequencies for each band as well as the low and high frequency limits of the band.

The lowest frequency band should be adjusted first by feeding into the antenna circuit a signal equivalent to the high-frequency end of that band (see column 2 in table in Fig. 2) and adjusting the corresponding oscillator Align-aire to give maximum response. The band switch must be in the proper position and both rotors of the Tuning Con-

denser at minimum capacity (open). The generator should then be set to the aligning frequency listed in the third column of the aligning table, the signal-tuned in on the receiver (using only the band-setting knob) and the Antenna and R.F. Align-aires adjusted to give maximum response. The generator frequency should now be dropped to the value given for padding and the signal tuned in by adjusting the BAND-SETTING control of the receiver. The padding condenser for the band being aligned should now be adjusted while rocking the band-setting control to obtain maximum response. It is now well to return the generator frequency to the aligning point and adjust the receiver to receive this signal and check the Antenna and R.F. Align-aires for maximum response. The Oscillator Align-aire must not be readjusted.

If these adjustments are carefully made the band should track with the dial calibrations, which has been made with the band-spreading condenser open. The same procedure should now be repeated on the remaining bands progressing toward the higher frequencies. In each case the Oscillator Align-aire should be carefully adjusted to the high-frequency end of the band with the tuning condenser at minimum capacity, the Antenna and R.F. Align-aires adjusted with the receiver tuned to the alignment frequency and the padders adjusted near the low-frequency end of the band while rocking the gang condenser.

It will be noted that on the two highest-frequency bands there are no padding adjustments to be made. The coils for these bands will be found to give sufficiently accurate tracking as they are wound within very close limits to proper inductance.

AMATEUR BANDS

It will be noted that the amateur bands are designated on the scale by heavy lines but have not been named because of congesting the dial. The calibration is made with the band-spreading portion of the condenser open. For operation on the 10, 20, and 40 meter bands it is suggested that the band setting condenser be set to the high end of the band and then the band-spreading knob be used to tune down through the band. On these bands the band-spreading condenser will tune through the entire band with some to spare.

On the 80-meter band, if the band-setting dial is set to 3900 KC. the band-spreading dial will just cover the CW portion of the band (3900KC-3500KC). For Phone reception the band-setting dial should be set to 4000 KC, in which case the band-spreading control will cover the entire phone-band and a portion of the CW band.

On 160 meters the band-spreading dial covers such a small portion of the band that it probably will be found desirable to use only the band-setting knob for tuning.

ANTENNA CONNECTIONS

The coil Assembly has been provided with leads to connect to three input terminals. On Meissner Kits a triple terminal strip marked "A", "D" and "G" is provided. The leads from the coil Assembly are color-coded so that they may be connected in accordance with the schematic wiring diagram in Figure 3.

If a conventional Antenna is used, it should be connected to binding post "A" and post "D" should be connected to post "G" which is connected to the nearest good ground.

If a noise reducing doublet Antenna is used, one side of the Doublet-Antenna is connected to "A" and the other side to "D", while "G" is connected to ground. The range switch automatically cuts out one side of the Doublet when turned to the Long-Wave or Broadcast bands.

CONNECT POINTS (A) AND (D) TO
 DOUBLE ANTENNA LEAD-IN ;
 CONNECT POINT (C) TO GROUND.
 FOR SINGLE-WIRE ANTENNA,
 CONNECT LEAD-IN TO (A), CONNECT
 (D) TO (C) AND TO GROUND.

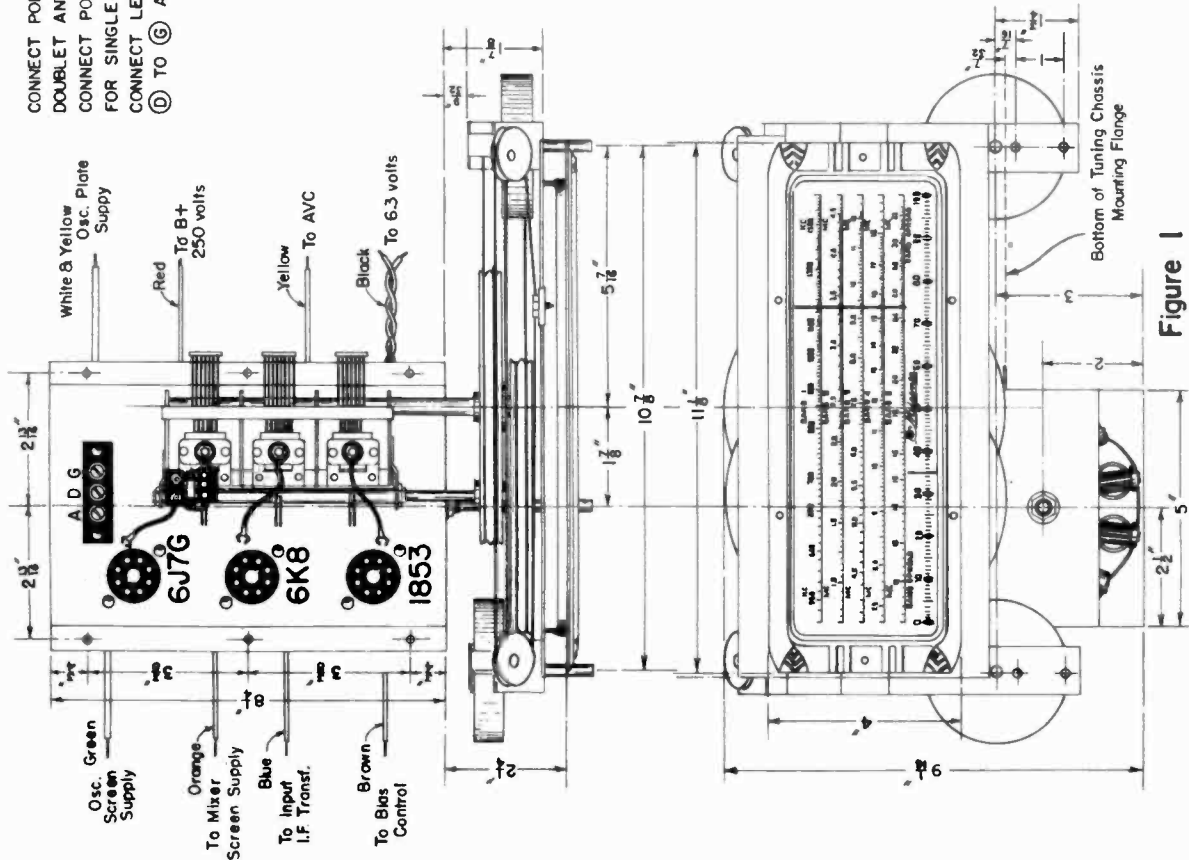
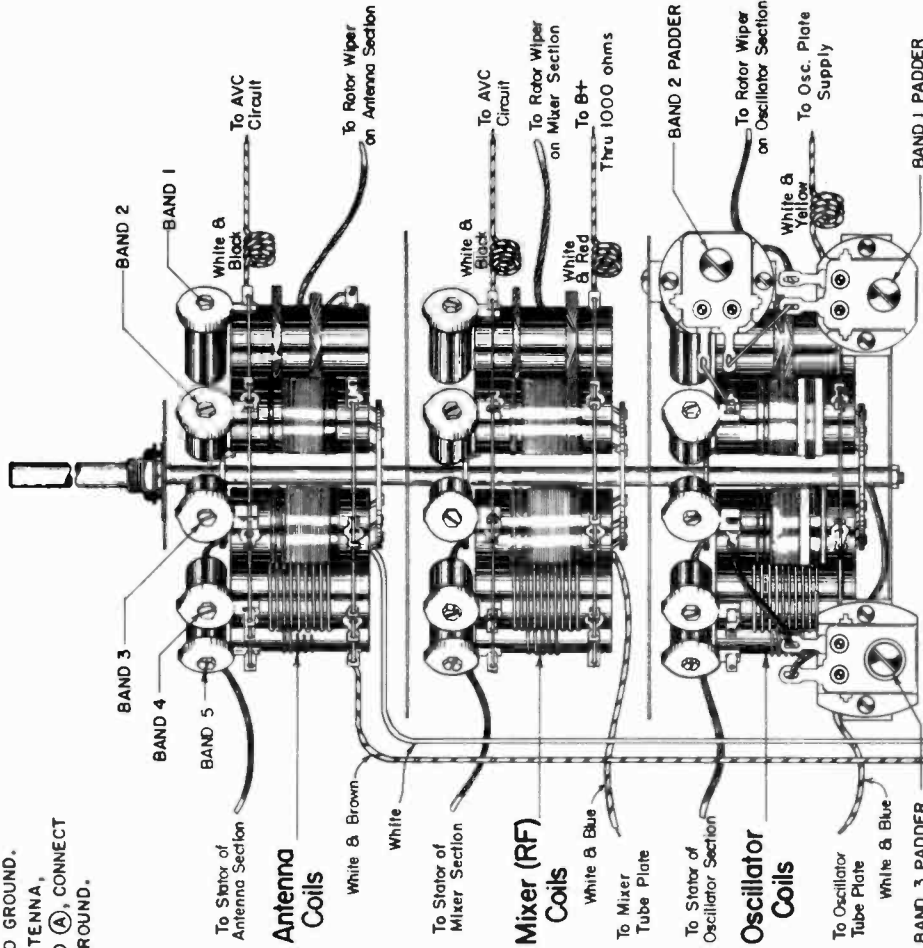

Figure 1

COMPLETELY WIRED AND ALIGNED
 TUNING UNIT



ALL-WAVE COIL ASSEMBLY
 FOR USE WITH 280-MMFD TUNING CONDENSER

ALIGNMENT TABLE

BAND	FREQ. RANGE	ALIGN AT	PAD AT
1	5.40 to 5.80 KC	1400 KC	600 KC
2	1.5 to 4.5 MC	4.0 MC	1.7 MC
3	4.1 to 12.2 MC	10 MC	4.5 MC
4	7.3 to 18.8 MC	16 MC	FIXED
5	11.2 to 31.6 MC	29 MC	FIXED

Figure 2

INSTRUCTIONS FOR USE AND OPERATION OF THE



SIGNAL BOOSTER

Model 9-1008

The Meissner "Signal Booster" is a two-stage radio-frequency amplifier to be used as a pre-amplifier ahead of an ordinary short-wave receiver to obtain improved signal-to-noise ratio, greater sensitivity and a better image ratio than is obtainable from the receiver alone.

A small variable condenser is provided on the first tuned circuit to permit adjusting the antenna coil to compensate for the effect of various antennas. This control, when once adjusted, need not be changed over a relatively-wide frequency range or unless antennas are changed. Compensation is particularly necessary when changing from a doublet antenna to a single-wire type of antenna.

Tubes of very favorable noise characteristics have been utilized to minimize the noise contribution from this source. A test of the unit will quickly show that most of the noise in the preselector is noise of thermal agitation in the antenna coil which completely masks the small noise contribution of the first tube, until the antenna coil secondary is short circuited to remove its noise voltages.

A tuned, step-down output transformer that tracks with the antenna and RF coil delivers to the receiver the maximum amount of energy so as to over-ride the tube or circuit noises generated in the receiver, particularly in the case of superheterodyne receivers having no RF stage and consequently burdened with a high tube noise from the converter tube.

A Gain control has been provided that permits adjusting the amplification of the unit over a wide range. It will be found that under some conditions, the "Signal Booster" will oscillate in spite of all precautions to shield the input from the output, but that under certain other conditions the unit will not oscillate at the same line voltage and Gain control setting. If the gain of the unit was restricted to such a value that the unit never oscillated under any normal condition, its best performance would necessarily always be inferior to the performance possible from the unit as it is now designed, which difference may be all that is necessary to make readable those signals that are barely audible. The reason for this difference in ability to oscillate is that some receiver circuits place a heavier load on the tuned output transformer than others. Some antennas also place a heavier load on the input circuit than others with the result that there is much less tendency to oscillate under these conditions than when the input and output loading is light.

INSTALLATION AND CONNECTIONS

Install the Signal Booster in a convenient location as close as possible to the receiver with which it is to be used. Refer to the rear-view diagrams in the lower right corner of the circuit for connections.

In order to realize the maximum useful amplification from the "Signal Booster", the input circuit should be as well isolated as possible from the output by properly locating the unit with respect to the receiver, and the antenna and output leads with respect to each other. If the output lead to the receiver is a piece of low-capacity concentric wire flexible cable such as is used to connect a transmitter to an antenna, greater useful amplification before oscillation can usually be obtained than if spaced wires or twisted pair are used for this purpose.

Note that if a single-wire lead-in is employed, this should be connected only to the "A" terminal on the input terminal strip, the "D" and "G" post being connected together and to ground. In a similar manner, on the output connections to the receiver, only two wires will be necessary, one connecting the two antenna terminals together and the other connecting the two ground terminals together. The "D" and "G" terminals on the output of the "Signal Booster" are strapped together also.

In case the receiver is provided with only antenna and ground terminals, a doublet antenna may still be used if desired by properly connecting it to the input of the "Signal Booster" as shown on the diagram. The "D" and "G" terminals on the output side of the unit must be connected together, however, and the two connections made to the "A" and "G" terminals of the receiver in the same manner as when a single-wire lead-in is used.

Install two 1852 metal tubes in the two ceramic sockets and a 5Y4G in the bakelite socket at the opposite side of the chassis. Turn the "Gain" control all the way to the left to the "Off" position. Connect the line plug to a 110-volt AC (50 to 60 cycle) outlet and turn the "Gain" control a quarter turn to the right to start operation of the unit.

OPERATION

The uses of the central tuning control and the Range switch are self-evident. The operation of the Compensator was discussed in the general description of the instrument.

To secure the maximum amplification, the Gain control should be set just below where the "Signal Booster" oscillates in a manner very similar to adjusting the regeneration for the reception of weak phone stations on a regenerative receiver. When the receiver and "Signal Booster" are tuned to exactly the same frequency, the amount of usable gain is greater than when they are tuned to different frequencies. This, again, is due to the heavier loading of the output circuit that results when the receiver is exactly tuned to the "Signal Booster" frequency. In consequence of this tuning action influencing the loading on the output circuit it is possible for the "Signal Booster" to be stable when tuned exactly to the receiver frequency and for it to oscillate as soon as it is detuned by a small amount.

When using the "Signal Booster" it will usually be found advantageous to retard the IF gain control on the receiver so as to make use of as much amplification as possible in the preselector and only as much as is useful in the intermediate frequency amplifier of the receiver. Such adjustment usually results in the greatest signal-to-noise ratio and the most favorable image ratio.

The "IN-OUT" switch is conveniently arranged to completely cut out the "Signal Booster" thus connecting the antenna directly to the receiver. It does not turn off the tubes, so that the unit is ready for immediate action as soon as the change-over switch is rotated to the "IN" position.

When listening to a very weak station with the "Booster" "OUT", the operator may sometimes be surprised to find the signal *absent* with the "Booster" turned "IN" instead of the stronger signal that he expected. In such cases, the signal was being receiving as an image on the receiver. Then when the "Signal Booster" is turned on, the signal disappears be-

cause the unit discriminates against images. It is important therefore, to make sure that the receiver is properly tuned to the true signal frequency in order to obtain maximum results from the combination when using the "Signal Booster." The preselector and receiver dials, in other words, should always be set to the same frequency.

When the "Signal Booster" is used in combination with a regenerative receiver having no RF stage, considerable signal-tuning effect will be had from the unit since it has actually greater non-regenerative selectivity than the receiver. In such a case the "Booster" and the receiver will probably work best if neither is shifted very far in frequency without a corresponding shift in the other. Regenerative receivers with one stage of RF amplification built-in may exhibit similar performance.

ALIGNMENT

In order to maintain the highest efficiency, the alignment of the "Signal Booster" should be checked periodically as follows:

1. Remove the instrument from the cabinet.
2. Close the gang condenser and check the position of the

dial pointer to see if it is exactly on the last line at the low-frequency end of the dial. If it is not, the dial should be re-set on the condenser shaft so that the above condition is fulfilled.

3. Connect a signal generator or service oscillator through a dummy antenna of 400 ohms to the input terminals of the "Signal Booster" and the receiver to the output terminals. Set the signal generator, of known accuracy, to the alignment frequency specified on the circuit drawing, and with the "Booster" switch "OUT", tune the receiver to resonance with the signal from the signal generator.

4. Turn the "Signal Booster" dial to the specified frequency, switch the "Booster" "IN", reduce the signal input or the sensitivity of the radio set to maintain relatively low output from the receiver and adjust the compensator condenser for maximum response.

5. Adjust the Align-Aire trimmers on the RF and output coils until maximum response is obtained. These trimmers are mounted directly on the coils in the middle and rear sections of the coil assembly and are adjusted from the bottom of the chassis.

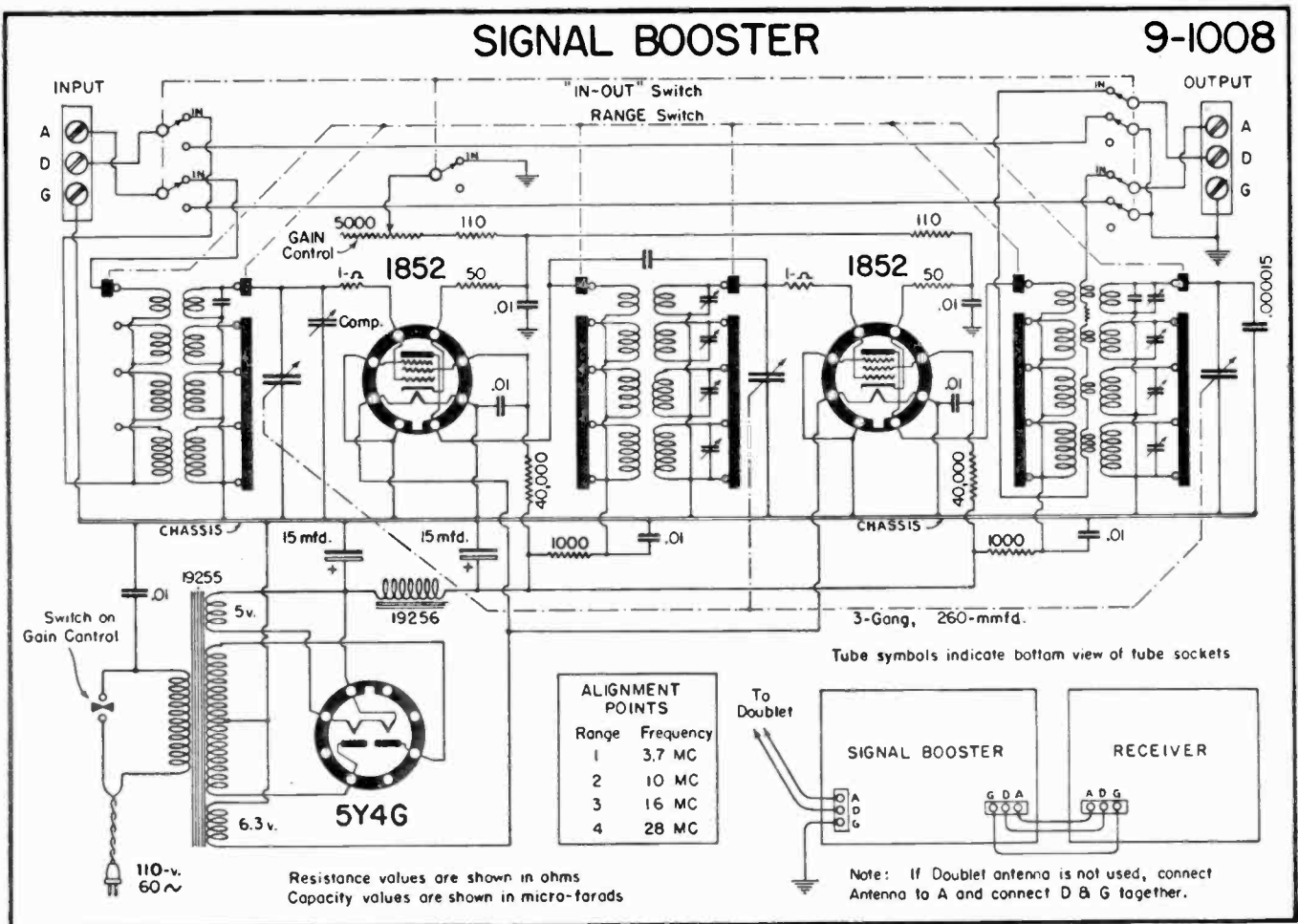

INSTRUCTIONS FOR USE AND OPERATION OF THE



MC 28-56

5 AND 10 METER CONVERTER MODEL 9-1009

The Meissner MC 28-56 is a 5 and 10 meter converter, designed to extend the frequency range of existing receivers to include the popular high frequency bands of 5 and 10 meters. The high gain and complete stability of this converter make it especially valuable, even though the existing receiver may have 5 and 10 meter coverage.

Basically the converter consists of three tuned circuits: an 1852 RF amplifier, a 6F6 high-C oscillator and an 1852 mixer. These circuits are ganged together and tuned by a precision type condenser. Tuning is accomplished by a micrometer type dial with an auxiliary fine-tuning control.

Conditions of frequency drift and signal instability due to voltage variations in the converter power supply have been eliminated by the use of a voltage regulated rectifier circuit employing a VR-150 regulator tube. The rectifier tube is a type 6X5.

Tubes of very favorable noise characteristics have been utilized to minimize the noise contribution from this source. Low noise level in addition to the high signal gain of the MC 28-56 provide effective performance: performance dependent only upon transmission conditions and antenna efficiency.

A tuned, step-down output transformer with an adjustable tuning condenser delivers to the receiver the maximum amount of energy so as to over-ride the tube or circuit noises generated in the receiver, particularly in the case of superheterodyne receivers having no RF stage and consequently burdened with a high tube noise from the mixer tube in the receiver. The use of the variable tuning condenser in the output transformer of the converter is explained in the "operation" notes which follow.

A Gain control is provided to permit the adjustment of amplification over a limited range. This control may be set to meet existing operating conditions.

INSTALLATION AND CONNECTIONS

Install the MC 28-56 converter in a convenient location as close as possible to the receiver with which it is to be used. Refer to the rear-view diagrams in the lower left corner of the circuit for connections between converter and receiver.

As shown in the rear-view diagram of the converter, the use of three antennas is recommended: one designed especially for 5-meter reception; the second for 10-meter reception; and a third for general short wave and broadcast reception. The latter may be the ordinary type commonly used with receivers of all types.

The antennas should be connected to the converter exactly as shown on the diagram. To minimize interference from strong stations, the antenna lead-ins should be as well isolated as possible from the receiver input line by properly locating the converter unit with respect to the receiver and the antenna and output leads with respect to each other. If the output lead to the receiver is a piece of low-capacity concentric wire flexible cable, such as is used to connect a transmitter to an antenna, receiver pick-up of 40-meter signals on this lead will be further minimized. This arrangement is preferable over spaced wires or twisted pair.

Note that if a single wire lead-in is employed, this should be connected only to the "A" terminal on the input terminal strip, the "D" and "G" posts being connected together and to ground. In a similar manner, on the output connections to the receiver, only two wires will be necessary, one connecting the converter output "A" post to the receiver input "A" or antenna post and the other connecting the "D" and "G" posts of the converter output strip to the ground and doublet ground posts of the receiver.

If only one antenna is available for use, it should be connected to each of the three converter antenna posts. This may be accomplished by connecting the antenna to the posts normally used by the 5 meter antenna and jumping across to

the 10 meter antenna posts and 'general' antenna posts with two wires.

In case the receiver is provided with only antenna and ground terminals, a doublet antenna or antennas may still be used if desired by properly connecting it to the input of the converter as shown on the diagram. The "D" and "G" terminals on the output side of the unit must be connected together, however, and the two connections made to the "A" and "G" terminals of the receiver in the same manner as when a single-wire lead-in is used.

Install two 1852 metal tubes in their proper sockets, together with the 6F6, VR-150 and 6X5 tubes. Turn the "Gain" control all the way to the left to the "Off" position, connect the line plug to a 110-volt AC (50 to 60 cycle) outlet and turn the "Gain" control a half turn to the right to start operation of the converter.

Tune the receiver to a frequency slightly outside the 40-meter amateur band. The frequency of 7,315 KC is a desirable spot due to the absence of interfering stations. The frequency setting is NOT critical and it may be set without exactness.

With the receiver adjusted to a frequency of approximately 7,315 KC or to a point nearby where no signal is heard, with the receiver operating in normal manner, the output transformer of the converter should be tuned for maximum converter output. This is accomplished by raising the lid of the converter and adjusting the trimmer condenser. The slotted shaft of this condenser, located near the center metal tube at the left side of the chassis, may be reached through a hole in the chassis and adjustment made with a screw driver. The point of maximum 'noise level' heard in the receiver, indicates maximum converter output, and the trimmer adjusted until this point is reached.

The uses of the central tuning control and the range switch are self-evident. The control on the front panel at the extreme left is the "Trimmer" control and may be effectively utilized as a vernier or fine-tuning control. Critical tuning adjustments are made with this control.

To secure the maximum amplification, the Gain control should be set to the extreme clockwise position. This setting may be varied to correspond with existing operating conditions. When using the MC 28-56 converter, it will usually be found advantageous to retard the IF gain control on the receiver so as to make use of as much amplification as possible in the converter. Such adjustment usually results in the greatest signal-to-noise ratio and the greatest rejection of signals on the frequency to which the receiver is tuned.

The "Range" control is conveniently arranged to connect the proper antenna to the converter and to connect the converter to the receiver. In the "Out" position, the ordinary antenna is coupled directly to the receiver and in this position it is not necessary for the converter to be turned on. The converter is turned on only when 5 and 10 meter reception is desired, with the range control adjusted accordingly.

NOTE:— The tuning control on the receiver should not be touched after it has been set to a frequency just outside the 40 meter amateur band (7,315 KC suggested). The tuning control on the converter is used to tune in 5 and 10 meter signals. However, the audio and RF gain controls on the receiver should be used in normal manner.

ALIGNMENT

Alignment of the "MC 28-56" converter is seldom necessary because of the high inherent stability of the ceramic-insulated coils and condensers. However, it may be necessary when new tubes are installed, due to the possible difference in inter-electrode capacities. Misalignment will be indicated

by the tuning dial not covering the desired frequency range of 28 to 30 MC or 56 to 60 MC. It may also be indicated by loss of sensitivity.

To align the converter, a generator with harmonics on the 5 and 10 meter bands and a monitor, crystal controlled or otherwise, calibrated accurately enough to mark the band edges, is required.

1. Connect the output of the converter to a receiver and set the receiver frequency at approximately 7,315 KC.
2. Close the converter three-gang tuning condenser and check the tuning dial. With the condenser closed, the tuning dial should read "0". If this reading is not present, the dial should be re-set on the condenser shaft.
3. Connect the generator to the 5-meter antenna terminal through a 50 or 100 ohm resistor. Connect the doublet and ground terminals together and to the ground terminal of the generator. Set the generator in operation and tune it to a point where one of its harmonics falls within the 5-meter band. This may be checked by the monitor. The generator should have a high-frequency fundamental output to produce a strong harmonic on the 5-meter band. The recommended alignment frequency is 60,000 KC. With the 60,000 KC harmonic established and checked by the monitor, the tuning dial of the converter is set at the "84" division mark and the

"Trimmer" control set at zero. Adjust the 5-meter oscillator trimmer, i.e., the five-plate air condenser on the switch assembly, until the 60,000-KC signal is tuned in. This should take place with the trimmer approximately 1/4 meshed. Adjust the ceramic-base mica trimmers on the RF and antenna sections for maximum response, operating with the generator output low enough to insure the AVC in the receiver being inoperative.

4. Turn the range switch on the converter to the 10-meter band and connect the generator to the 10-meter antenna terminals in the same manner as it was connected to the 5-meter antenna terminals.
5. With the generator set so that an accurate harmonic is emitted at 30,000 KC, adjust the 10-meter trimmer, which is the large air trimmer on the coil assembly, until the 30,000 KC generator signal is heard. This should occur with the trimmer approximately 3/4 meshed.
6. Align the 10-meter antenna and RF trimmers for maximum response. These are the mica trimmers mounted on the long insulating strip on the coil assembly.

NOTE:—"Jumpy tuning" or erratic operation is sometimes due to dirty contacts in the switch assembly. These contacts should be kept in a clean condition, free from dirt or grease.

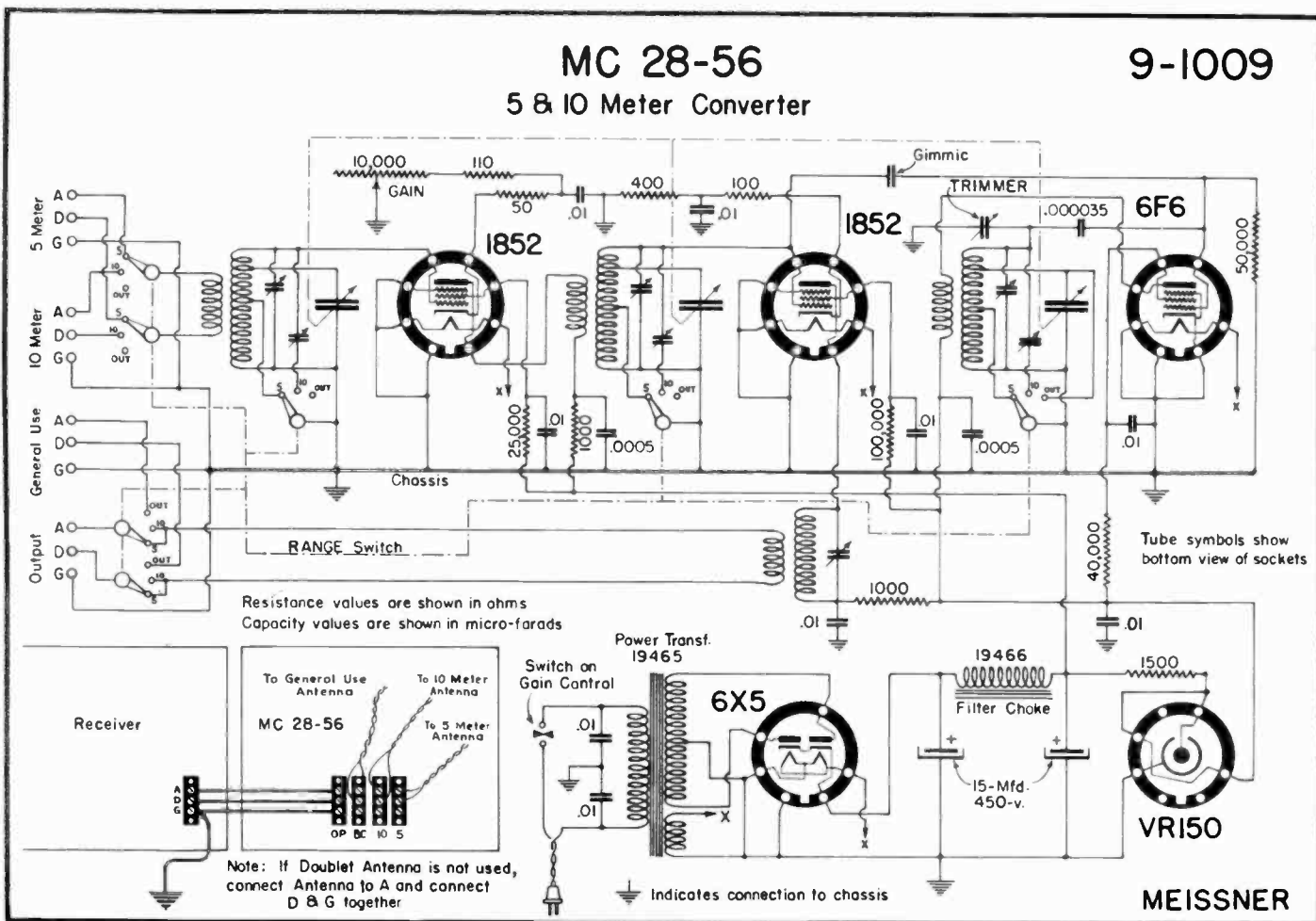

SIGNAL CALIBRATOR

MODEL 9-1006

The rules of the F. C. C. provide that the licensee of an amateur station shall provide for measurement of the transmitter frequency and establish procedure for checking it regularly. The measurement—"shall be made by means independent of the frequency control of the transmitter and shall be of sufficient accuracy to assure operation within the frequency band used."

Since it is known that most receiver calibrations cannot be relied upon with sufficient accuracy to satisfy the Commission requirements, and since most operators are not content to work well within the band, but prefer rather to work close to the edge of the band, a device of high accuracy is required to satisfy both the amateur's desire to be near the edge and the Commission's requirement that operation be confined within the frequency band used. The Meissner **Signal Calibrator** is a device that answers not only the requirement of marking the edges of the main amateur bands accurately, but marks also the edges of the phone sub-bands and provides markers every 10 kc so that interpolation may be used with confidence to find the frequency of any station within the band, since the frequency markers are spaced at sufficiently close intervals to virtually eliminate the curvature of the tuning curve as a contributing factor to errors in frequency measurement. Only one amateur band edge is not accurately marked, the low frequency edge of the 160 meter band, but markers are provided at a separation of only 5 kc above and below this edge (1715 kc) so that even this band edge can be determined with a high degree of precision.

The frequency standard is a silver-plated quartz bar clamped between knife edges. This rather expensive construction is used in preference to the more conventional pressure type or air-gap type of crystal holder in order to avoid frequency modulation of the crystal due to the vibration of the chassis as the various switch buttons are operated. An air-dielectric condenser is connected across the crystal to permit the frequency of oscillation to be shifted over a range of about 15 cycles either side of exactly 100 kilocycles.

The 50-kc series of harmonics is obtained from a multivibrator controlled by the 100-kc bar. Its frequency is exactly one-half of the crystal frequency, and therefore it has the same percentage accuracy of calibration as the crystal.

The 10-kc series of harmonics is obtained from a second multivibrator circuit, controlled by the 50-kc multi-

vibrator, which generates a series of harmonics at 10-kc intervals, all as accurate in frequency as the 100-kc crystal.

An amplifier, consisting of two stages of 1852 television amplifier tubes, is used for the purpose of providing strong harmonics of 10 kilocycles up to at least 30 megacycles and as a means of introducing modulation without disturbing the multivibrators or causing frequency modulation of the crystal.

Modulation is accomplished by placing a 60-cycle AC voltage on the suppressor grid of one of the amplifier tubes.

Controls are provided to regulate the gain of the output amplifier and the amount of modulation.

A push-button switch has been provided to conveniently change from one series of harmonics to another merely by pressing the desired button. No damage can result if two or more buttons are pressed simultaneously.

The **Signal Calibrator** is tested and sold with a proper set of tubes in place. It is recommended that at least the multivibrator (6N7G) tubes be left in their proper sockets. If the tubes are interchanged, the multivibrator may require readjusting since they are used in a manner not covered by the usual production inspection of tubes. More variation may be expected of tubes in the multivibrator circuit than in normal amplifier service. Complete instructions are given, however, for adjusting the device should it get out of adjustment accidentally or require replacement of tubes.

The tube complement is as follows: 6K8 crystal oscillator, 6SK7 buffer amplifier, 6N7G 50-kc multivibrator, 6N7G 10-kc multivibrator, 2-1852 output amplifiers, 6X5G rectifier.

ACCURACY

The Meissner **Signal Calibrator** is capable of extreme accuracy if properly adjusted and if used at the proper temperature. The oscillator circuit used with the crystal is one that is practically independent of line-voltage fluctuations; therefore, the characteristics of the crystal itself largely determine the stability of the unit.

Since the crystal has a small temperature characteristic, the equipment should be used at as near constant temperature as possible, or it should be calibrated under the temperature of use if the equipment must be used under extremes of heat and cold. Ample ventilation makes the actual shift in frequency during the warm-up period very small and the warm-up

period short. For a high degree of accuracy it is recommended that the warm-up period be at least ½ hour.

The ultimate accuracy depends upon the accuracy with which the **Signal Calibrator** is set to zero beat with a good standard of frequency. Visual methods of checking the beat note are recommended because such methods are sensitive to differences of a fraction of a cycle per second whereas audible methods of comparison are usually not sensitive to closer than 10 cycles or more, depending upon conditions and upon the hearing of the operator.

FREQUENCY STANDARDS

Since any highly precise standard of frequency must be adjusted under actual service conditions if maximum accuracy is to be obtained, the **Signal Calibrator** should be adjusted after being placed in operation.

There are numerous standards against which it may be adjusted, the most common of which is a broadcasting station. With the 10-kc series of harmonics from the **Signal Calibrator** available, it is possible to use any American broadcasting station as a frequency standard since all of them operate, at the present time, on frequencies that are integral multiples of 10 kilocycles.

With this wide choice of stations there naturally comes the question of which stations are the best to use as frequency standards. It seems a safe rule to assume that the highest-powered stations have the best equipment and consequently maintain the greatest accuracy of frequency, but this is only an assumption that should be verified before being used. Actually the best standard of frequency against which to adjust the **Signal Calibrator** is the Standard Frequency Service broadcast frequently (almost daily) by the Bureau of Standards Station WWV at Washington, D. C. This station has a schedule of transmissions on various frequencies so that the user of a **Signal Calibrator** should be able to pick up at least one, if not several of the standard frequencies broadcast regardless of his location. The schedule of transmission may be checked against the published data on WWV in QST Magazine.

THE CIRCUIT

The circuit of the **Signal Calibrator** is shown in Fig. 1. In this diagram the various parts of the circuit are segregated to facilitate understanding it.

The oscillator, shown on the left side of Fig. 1, is extremely stable against frequency variations induced by line-voltage changes or against

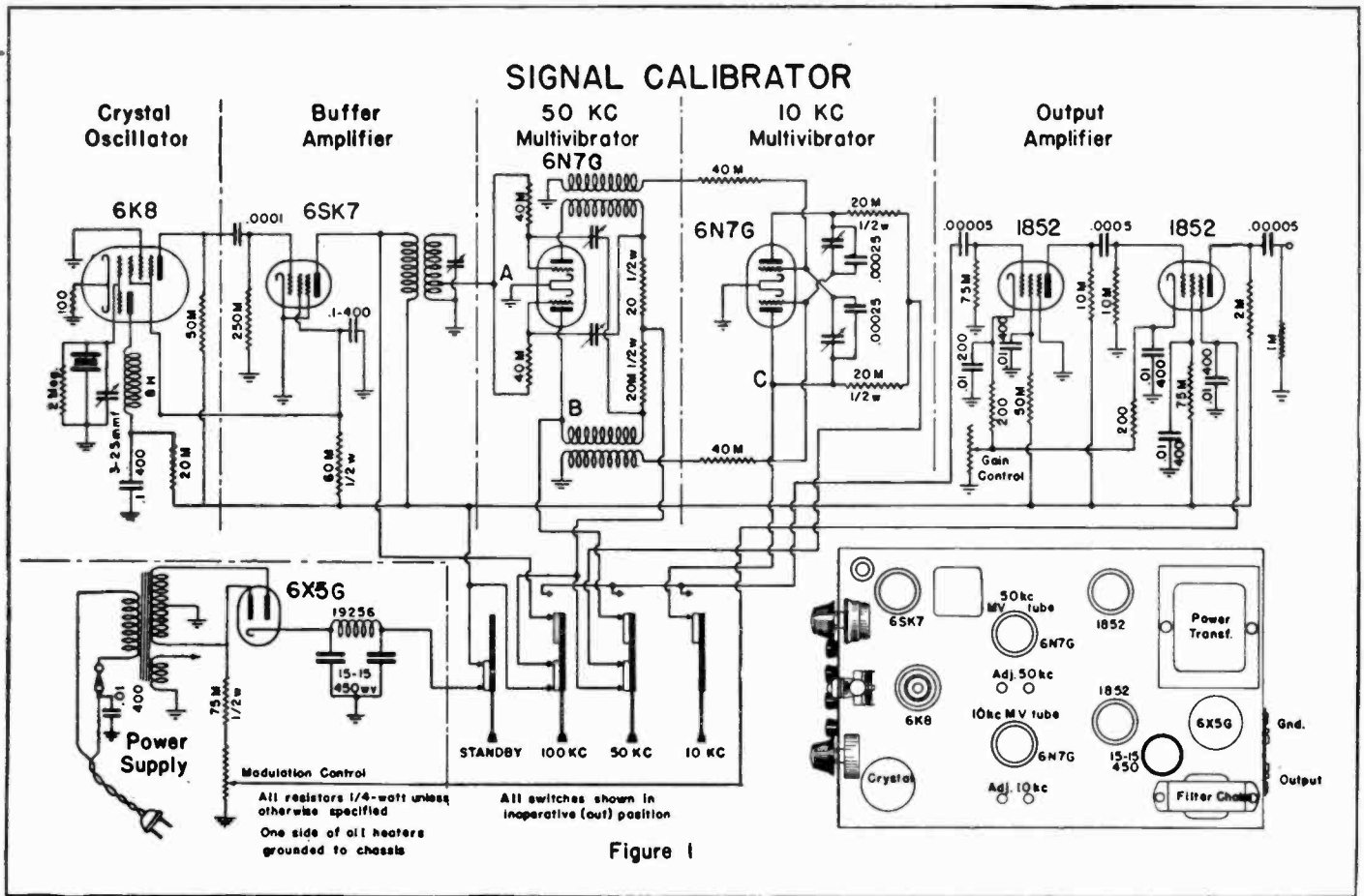

Figure 1

changes caused by the reaction of circuits following the oscillator. Its principle uncontrolled variation is caused by temperature changes influencing the crystal itself. Its only controlled change in frequency is effected by shifting the capacity of a small air-dielectric condenser that is connected in parallel with the crystal for that purpose.

The buffer amplifier, shown next to the oscillator portion of the circuit serves the purpose of providing satisfactory selection of the 100-kc fundamental and suppression of the undesired harmonics so that the following multivibrator circuit may have a wave of good shape to control its frequency. Setting the adjustments in their mid-point gives reliable stable operation.

The circuit of the 50-kc multivibrator is shown in Figure 1 next to the buffer amplifier. Examination of the circuit will show it to be of conventional type. The frequency adjustment is made by varying the capacity of the coupling condensers. The control voltage is injected in series with the low end of both grid leaks.

The fundamental circuit of the 10-kc multivibrator is similar to that of the 50-kc. The unusual feature of both multivibrators is the method of coupling them together. A mutual inductance in series with the plate circuit of the 50-kc multivibrator and the grid circuit of the 10-kc multivibrator

delivers to the grid circuit of the 10-kc multivibrator a sharp pulse at the beginning of each plate current cycle. It is these sharp pulses, applied to the grid circuits of the 10-kc multivibrator, that maintain synchronism over a wider range of adjustment of coupling condensers in the 10-kc circuit than could be obtained without such aid. 10-kc stability is therefore maintained to the extent that no normal line-voltage fluctuation will disturb the frequency of the 10-kc multivibrator and that portion of the instrument may be started and stopped at will with the assurance that it will always pull into its proper operating frequency when turned on.

The output amplifiers are high mutual-conductance television tubes in an aperiodic circuit which has been designed to suppress the low frequencies to some extent since they are naturally the strongest harmonics and do not require much amplification.

AUDIO MODULATION

Audio modulation is available on all frequencies without any trace of frequency modulation because it is introduced after the signals have passed through adequate isolation in the form of buffer amplifier stages.

The modulating frequency is 60 cycles because this frequency is available without the use of the extra tube that would be required to generate any other frequency.

Because of the fact that the modulating tube is also used as a variable-gain amplifier, the modulating characteristics of the tube are not constant but vary with the setting of the output control. As the output is increased, the modulating efficiency is reduced and the percentage modulation on the signal is lowered. As the output is reduced, therefore, the percentage of modulation increases. Under some conditions, the signals are over-modulated and sound quite ragged, but the Modulation control can always be retarded until the desired degree of modulation is obtained.

If the modulator tube is operated at fixed bias, so as to maintain constant modulating efficiency, the output variation possible with control voltage on only one tube is insufficient.

The fact that the modulating voltage is introduced into the output amplifier, together with the fact that there naturally is some radiation directly from the oscillator and from the multivibrators, means that, especially at the low frequencies, the output may be fairly large before modulation is possible. It is obvious that there must be output from the amplifier over and above the direct signal radiated from the oscillator or multivibrators before modulation is possible. This phenomenon drops off rapidly with increases in frequency and usually is not of any consequence in the Amateur Bands.

CALIBRATION

The **Signal Calibrator** is adjusted at the factory to have the appropriate harmonic at zero beat with the Standard Frequency transmission from WWV but it can be expected that this adjustment may change slightly during shipment and handling. It is desirable therefore to check the calibration when first set up and at intervals thereafter.

The **Signal Calibrator** has been built in accordance with the best engineering practice short of temperature control on the crystal which was avoided because of expense. The slight temperature coefficient should therefore be recognized when considering extremely accurate measurements. The responsibility for the accuracy of the **Signal Calibrator** rests with the user. He must adjust it and check its accuracy from time to time, the intervals between checks being governed by the accuracy demanded.

The first step in calibrating is to choose a standard of frequency. Having made the choice, tune in the signal on any receiver sufficiently sensitive. It is highly desirable to use a receiver with some kind of a tuning indicator so that a true zero-beat may be obtained. Very few receivers will reproduce as low as thirty cycles and still fewer people can hear this frequency which is still an appreciable difference from zero-beat particularly if the comparison is made at a relatively low frequency, since the error in zero-beat setting is multiplied in proportion to the ratio of the desired high-frequency point divided by the frequency on which standardization is being accomplished. In other words—if the admitted zero-beat error is thirty cycles at 700 kilocycles the error at 28 megacycles is 1200 cycles.

In the event that a tuning indicator is not available or cannot be connected to the receiver, a person with keen hearing can check zero-beat by the rise and fall in signal strength as the voltage from the **Signal Calibrator** alternately aids and opposes the voltage picked up from the station chosen as the frequency standard. It will be necessary to adjust the output of the **Signal Calibrator**, or the degree of coupling between the receiver, and the calibrator or the antenna, in order to get the best beat note effect. If at all possible, the visible method of zero-beat determination is preferred above the aural method because inherently greater accuracy is possible.

Having found the proper method of getting a satisfactory beat note, the 100-kc adjustment on the front panel is adjusted for zero-beat after an appropriate warm-up period. A minimum of $\frac{1}{2}$ hour is recommended for high accuracy. If there are drastic changes in room temperature or sudden drafts across the **Calibrator**

a few cycles shift in frequency can be expected in the amateur bands, becoming progressively less as the frequency selected is lower.

ADJUSTING MULTIVIBRATORS

A frequency-dividing multivibrator is one whose natural uncontrolled cycle is longer than the desired controlled interval, and which cycle is shortened by the application of the controlling voltage. The first step in adjusting a multivibrator is therefore to remove the controlling voltage. If the 50-kc multivibrator is to be adjusted, the crystal controlled voltage is removed which is most easily accomplished by removing the crystal. Should a receiver be available that will cover the range 50-kc to 100-kc the output frequency of the uncontrolled multivibrator can be checked directly with the receiver. If only a Broadcast and Short-Wave receiver is available, the harmonics of the uncontrolled multivibrator are picked up on the receiver on its lowest frequency range so that the greatest dial separation is obtained between harmonics. If the frequencies of a number of harmonics are determined by the calibrations on the dial, the base (uncontrolled natural) frequency of the multivibrator can be determined by the average of the differences between adjacent pairs of harmonics. Actually the base frequency is equal to the frequency difference between any two adjacent harmonics but the average is recommended to compensate as much as possible for the receiver calibration errors. The trimmers on the 50-kc multivibrator should be adjusted (approximately in equal amounts) until the base frequency is somewhere in the neighborhood of 40 kilocycles. If the crystal is now installed the multivibrator will be pulled into a 2 to 1 frequency ratio with the controlling voltage and will consequently work at 50 kc.

The 10-kc multivibrator is adjusted in a similar manner, removing the 50-kc multivibrator tube and the crystal so that there can be no voltage to influence the natural uncontrolled period. The multivibrator is adjusted to have a frequency slightly lower than 10 kilocycles and when the 50-kc multivibrator tube and the crystal are installed the 10-kc multivibrator should operate at 10-kc controlled by the pulses from the 50-kc source. Because of the fact that the 10-kc multivibrator is operating at considerably greater frequency-division ratio than the 50-kc multivibrator, 5 to 1, instead of 2 to 1, the range of adjustment giving satisfactory operation is more limited in the 10-kc circuit than in the 50-kc circuit, and accordingly the 10kc multivibrator may not pull into proper relation without slight readjustments of the low-frequency coupling condensers. The proper adjustment is obtained when there are four carriers between adjacent 50-kc harmonics. The 50-kc

markers can easily be located near the low end of the receiver being used for calibrating and checking, and the number of carriers counted between these points when the 10-kc series of harmonics is turned on.

If a cathode-ray oscillograph is available the fastest method of adjusting the multivibrator coupling condensers is to use Lissajous figures on the cathode ray tubes when one set of deflection plates is connected to the 100-kc source and the other is connected to the 50-kc circuit while adjusting the 50-kc coupling condensers, and then connecting the oscillograph to the 50- and to the 10-kc circuits while the coupling condensers of the latter circuit are adjusted. In the complete circuit diagram the suggested points for attaching the cathode-ray oscillograph are shown. The connections from the cathode-ray input amplifiers to the circuits in the **Signal Calibrator** should be made through small condensers located close to the **Calibrator**. These condensers should have a capacity between 10 and 25 mmfd. so as not to disturb the circuits unduly.

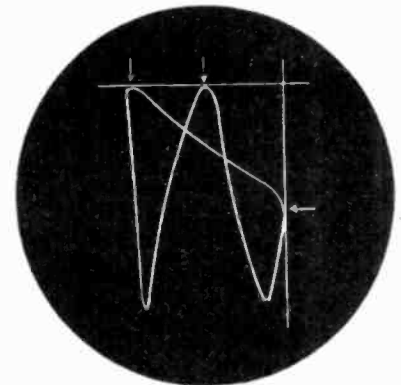

Fig. 2-A

50-kc ADJUSTMENT

Horizontal plates to "A" and chassis.
Vertical plates to "B" and chassis.

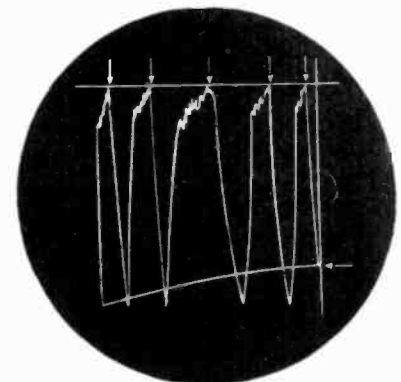

Fig. 2-B

10-kc ADJUSTMENT

Horizontal plates to "B" and chassis.
Vertical plates to "C" and chassis.

Fig. 2 shows a representative picture of the Lissajous figures for the 100- to 50-kc division and for the 50- to 10-kc division. The frequency ratio is read from the figure by counting the number of places where the figure becomes tangent or touches a pair of lines drawn at right angles to each other and acting, so to speak, as two adjacent sides of a frame for the figure. In Fig. 2-A the ratio is 2 to 1 and in Fig. 2-B, the ratio is 5 to 1. The imaginary "half frame," and the points of tangency are marked on the diagrams.

USES AND OPERATING INSTRUCTIONS

The uses for the **Signal Calibrator** are numerous and will occur in increasing number as greater use is made of the instrument. In Amateur Radio stations its principal purposes are to accurately measure the frequency of transmitters, to measure the frequency of received signals, and to mark the edges of the bands beyond which the Amateur may not go, and to pre-set receivers or transmitters to definite frequencies in order to facilitate keeping schedules with other stations. Suggested methods of accomplishing these results are given below. In addition to these functions, however, other uses for the equipment will be obvious to the user.

CHECKING TRANSMITTER FREQUENCY

To check the transmitter frequency it is necessary to have either a receiver that is well enough designed and shielded that it will not block and become inoperative when the transmitter is turned on, or a well-shielded heterodyne monitor. If the monitor has a fundamental frequency at the frequency of the transmitter, there is less chance for error and the results are easier to interpret than if a monitor harmonic beats with the transmitter signal. The method of use is to inject enough signal from the **Signal Calibrator** into the monitor to locate on the monitor the 100-kc harmonic next above and next below the transmitting frequency. The 50- or the 10-kc signals are then turned on, whichever serves the purpose better, and the transmitter frequency bracketed between two known markers 10-kc apart. The deviation of the carrier from one or the other marker is easily estimated by interpolation.

CHECKING FREQUENCY OF RECEIVED SIGNALS

The method of checking the frequency of a received signal is essentially the same as outlined above for transmitters except that a receiver is used for reception of a distant signal in place of a monitor being used to pick up a local signal.

CHECKING BAND EDGES

The **Signal Calibrator** is an excellent device to spot the edges of either CW or Phone bands. It may be coupled to the receiver and set at such a level that the markers at the band edges are just audible and operate continuously. The level of the markers may be changed instantly to make them strong enough to be picked out of the strongest interference or to be just as quickly eliminated so that a weak signal on the band edge can be read.

CHECKING E. C. O.'s

The amateur who has a good electron-coupled oscillator naturally desires to use it for operation close to the band edges if he has confidence in its calibration, or if he has any way of checking its frequency to be sure that the signal is still within the specified band. A convenient method of obtaining this assurance is to use the **Signal Calibrator** to mark the band edges in a receiver and to listen to the frequency of the E. C. O. in the receiver with the transmitter itself turned off. In this way the frequency of the E. C. O. can be checked with certainty before the signal goes on the air and the operator can therefore be sure that he is within the legal limits of frequency. Naturally the closer he chooses to work to the edge of the band, the more frequently he must check his E. C. O. but with the convenience of the **Signal Calibrator** only a moment is consumed in this checkup.

In the operation of phone transmitters it is to be remembered that the law requires **all of the sidebands** of an amateur phone to lie within the specified band. It is obvious then, that the carrier must be at least as far away from the edge of the band as the highest audio frequency transmitted. When working particularly close to the edge of a band, a low-pass filter in the audio system is recommended to cut off all frequencies above 2000 cycles in order to restrict the width of the side bands, and since most receivers are used in a highly selective condition when listening to amateur phone signals the loss of frequencies above 2000 cycles will not be noticed on long distance transmission.

LOCATING SIGNALS FOR SCHEDULES

In the crowded condition of the amateur bands it is a great convenience to be able to locate a given frequency in the band just prior to a schedule and to have both the receiver and transmitter within a few cycles of the specified frequency.

To set the receiver, the 100-kc series of harmonics is turned on and the receiver tuned to the harmonic nearest to the desired frequency. The

10-kc series is then turned on and the receiver is tuned toward the specified frequency counting the 10-kc markers that are passed until the desired frequency is bracketed between two known 10-kc harmonics. The exact frequency can then be located very closely by interpolation.

With the receiver set as specified above, an electron-coupled exciter may easily be tuned to the receiver frequency making it possible to start exactly on frequency with no time lost in looking for the operator with whom the schedule was set up.

5-KC BEAT

Many receivers pass a band wide enough that when the receiver (with beat-frequency oscillator working) is tuned midway between two 10-kc markers, there will be a 5-kc beat note with each of the 10-kc harmonics and a secondary zero-beat will be heard between the two 5-kc audio notes. When this zero-beat is obtained another calibration spot is available midway between two 10-kc harmonics, and known with just as great accuracy as the 10-kc series, or the 100-kc fundamental. The all-important thing is to be sure that no beats have been missed or spurious outside signals counted in determining an unknown frequency. As a check it is wise to count over to where the next 50- or 100-kc marker should be and then turn off the 10-kc markers to see if the receiver is still tuned to a marker from the **Signal Calibrator**. If the count has been correct a 50- or 100-kc marker should remain in tune when the 10-kc markers are shut off.

The most frequently noticed spurious responses are the images of harmonics of the **Signal Calibrator**. These images may be very close to a desired signal since a harmonic differing by approximately twice the intermediate frequency from the desired signal may be emitted by the **Signal Calibrator** simultaneously with the desired signal. To avoid apparently strong images, it is desirable to operate the **Signal Calibrator** at the lowest convenient level so that the AVC in the receiver will not tend to equalize the signal and the image.

Extreme care has been taken to make the stability of the crystal circuit enough so that there would be no audible shift in frequency at 28 megacycles when switching from one series of harmonics to another. In some receivers there will appear to be a difference due to the difference in signal strength between one series of harmonics and another changing the receiver oscillator slightly. If the output control of the **Signal Calibrator** is adjusted so that each series of harmonics gives the same reading on the "R" meter of the receiver, the beat note will be found to be practically identical.

COMPLETE INSTRUCTIONS
FOR THE CONSTRUCTION AND OPERATION OF THE



"Custom" 12

5-Band, High Fidelity Superheterodyne Receivers

Models 10-1155 and 10-1156

The Meissner "Custom" 12 is a radio receiver kit which has been designed to fill the discriminating requirements of custom set constructors. It is a high-quality, all-wave receiving set having unusual attention given to both flat frequency response, commonly known as fidelity, and wave-form purity, ordinarily described as tone quality. It is provided with phonograph terminals which makes it a superior quality record reproducer when a turntable is provided and a high-impedance pickup is attached.

It is available in two models, one with "Magic Eye" tuning indicator 10-1156, the other with "Push-Button-Tuning" for broadcast stations 10-1155. The chassis proper is identical for the two models, the only difference being the way in which the leads from the "Magic-Eye" or Push-Button unit, are connected to the chassis wiring.

The "Push-Button-Tuning" unit is the popular Meissner-Ferrocort permeability-tuned unit (Meissner No. 9-1004) with coils and core assemblies so designed that only one adjustment is required per station, and that adjustment is easily made by means of an adjusting knob projecting through the front panel directly above the corresponding station Push-Button.

For all-wave coverage the receiver utilizes the Meissner No. 13-7616 All-Wave Standard Tuning Unit, trimmed by air-dielectric condensers, which tuning unit is pretuned and thoroughly tested before leaving the factory.

Good high-frequency response is obtained by use of "Band-Expanding" I. F. transformers giving freedom from "side-band cutting" when the program being received can utilize the wide frequency band. When adjacent-channel interference is bad, the transformers can be switched to a highly selective condition to reduce or eliminate the interference.

For good low-frequency response in the audio system, the now popular Inverse Feedback scheme for flattening the audio response and reducing harmonic distortion in the output stage has been combined with a "Bass Boost" circuit that permits adjusting the low-frequency response from that flat ideal furnished by the inverse feedback, to a 12 D. B. increase in low frequencies when it is desired to boost low frequencies to compensate for stations or programs deficient in the low register.

This receiver contains its own power supply and operates directly from 110-volt, 60-cycle line. A sturdy and attractive steel panel and cabinet are available for the receiver to make it a complete ensemble worthy of the high quality parts and first-class engineering features provided.

The accessories required are a set of tubes as listed in the parts list and a dynamic speaker with a field resistance of 2000 to 3000 ohms, output transformer to match a pair of 6L6 tubes in Push-Pull Class A, and capable of handling 15 watts peak power.

ASSEMBLY

As the kit is unpacked, all parts should be carefully checked against the Parts List. Any discrepancies should be reported at once to the supplier from whom the kit was purchased.

All parts should be mounted on the chassis according to the top and bottom views shown in the Pictorial Diagram. It will be found best to mount the small parts, such as terminal-strips and sockets, first. Mount the Tuning Unit, first removing the black crackle lacquer around each mounting hole, permitting the clean metal to be exposed for a diameter of at least $\frac{1}{2}$ inch. It would be even better if the paint is removed from the chassis for practically the entire area of contact between it and the Tuning Unit sub-chassis.

This can most conveniently be done with a sharp knife and sand-paper.

Temporarily install the Tuning Unit and Dial, mount the receiver in whatever cabinet is intended for it, and determine the length of shaft desired on the tuning shaft and all other shafts. Having determined these lengths, remove the chassis from the cabinet, and the dial from the chassis. Fasten the dial shaft in a vise and saw it with a fine-tooth hacksaw. In a similar manner cut the shafts on the various controls and switches. It is advisable not to attempt to cut the shaft of any unit while mounted on the chassis because of the heavy strains imposed on the unit which may cause damage thereto.

Remove the nuts from the power transformer and install the latter unit in the chassis by means of these nuts. Be sure that the position of the transformer leads corresponds to that shown in the Pictorial Diagram.

Finish mounting the small parts including all controls and switches. Do not mount the filter choke, the push-pull input transformer, the second I. F. transformer, or the Tuning Unit until later.

Cut off the top lead of the 2nd I. F. transformer in such a manner that it will not short-circuit to the can, or, for a more finished job, carefully remove the transformer from the can, by taking off the top nut and sliding it out of the can. Remove the top connection completely, then reassemble the transformer, and mount it on the chassis.

WIRING

Having completed the assembly operations described above, the actual wiring may start, observing the hints given under "General Construction Hints." It probably will help also if all unused lugs on the socket mounting saddles are bent down against the chassis.

The filament connections should be made first, twisting the wires tightly together, seeing that the twist continues up close to the sockets. This is necessary to prevent hum from being induced in the push-pull input transformer secondary. Once induced in this manner, no amount of filtering will remove this hum. The cable attaching the "Magic Eye" or the "Push-Button" unit to the set should be put in last. The actual order of wiring the remainder of the chassis is of little consequence, since all of the wiring is accessible until the audio-transformer is installed.

The Tuning Unit does not interfere with wiring; but it is recommended that it be omitted until all other wiring is finished, in order to prevent possible accidental damage to the coils while wiring the remainder of the set.

Socket-mounting saddles should be soldered to the chassis at one point each. Paper by-pass condensers should be connected with their "ground" ends to chassis wherever the condenser has one end grounded. Electrolytic condenser polarity must be observed. Shielded wires should have both ends of the shield soldered to the chassis. Where shielded wires are long, the shielding should be soldered to the chassis every three or four inches to hold it in place and present a neat appearance.

When all of the chassis has been wired except the filter choke, Tuning unit and push-pull audio transformer, the first and second items should be mounted and connected as shown in the Pictorial Diagram.

The sub-assembly of Push-pull input audio transformer, resistors, condensers, leads and tie-lug should be made in the following manner on the transformer before it is mounted in the chassis: First, tin a spot on top of the transformer, then tin the bottom of the mounting bracket on the tie-lug. Now place the two tinned parts together in position shown in the Pictorial Diagram and solder them together. Finish the sub-assembly as shown and

then mount the finished sub-assembly of transformer resistors and condensers in the chassis, making the connections as shown in Pictorial Diagram.

Connect the cable from the "Magic Eye" or the Push Button Tuner to the proper points in the chassis. These points have been designated by letters in the Pictorial Diagram. The color code of leads corresponding to these letters is shown on the upper and lower left-hand corners of the Schematic Diagram.

In the model using the "Magic Eye" bring all wires in the cable through the large grommet in the chassis near point "C", cutting the wires to proper length for a neat job. Connect point "E" to point "H" thus grounding the oscillator cathode. In the model using the "Push Button Tuner," bring all the wires except the blue one through the large grommet mentioned above, and bring the blue wire through the small grommet near point "D". Cut all wires to appropriate lengths before attaching. Note that the brown wire connects to point "E" while point "H" is left unconnected.

VOLTAGE TEST

If all connections are found to be correct, the tubes may be inserted and the line-cord plug connected to a 110-volt 60-cycle receptacle, and the speaker (2000 to 3000 ohm field) plugged in. Be sure the speaker is connected to the plug so that the field is wired to the two filament pins, the output transformer primary center-tap to the odd pin opposite and the end connections of the primary (plate terminals) to the remaining pin on each side. A slight turn of the treble control knob to the right will turn on the receiver. After a brief warm-up period, the voltages shown on the Schematic Diagram should be checked with a high-resistance voltmeter if available. Voltages indicated are measured from the point shown, to the chassis, with the chassis as the negative terminal. If values measured are materially different than shown on the diagrams, a thorough recheck of the circuit should be made at once. **Be sure the receiver is turned off and the line-cord disconnected from the power receptacle while the wiring is being checked.**

ALIGNMENT

The All-Wave Tuning Unit has been aligned and tested at the factory before shipment; therefore, when tubes of the proper types are inserted, the circuits will be close to maximum efficiency. Do not disturb any of the adjustments until all other instructions given below have been followed.

The I. F. transformers have been aligned in the factory on a standard test-set representative of average set conditions. Since, however, each receiver has different wiring capacities, it will be necessary to adjust these circuits slightly to obtain best results.

If a service oscillator is available, connect the output of the oscillator between the grid of the 6SA7 and chassis. The service oscillator should be adjusted to 456 KC, the Band Width Switch should be thrown to the extreme counter-clock-wise position (which provides the most selective operation of the Iron-Core band expanding I. F. transformers), and the volume control should be set at maximum. Both trimmer condensers in the top of each I. F. transformer should be slowly turned with a screw-driver in whichever direction gives an increase in output signal. Each will pass through a point of maximum response and thereafter as the turning continues the volume will drop off. By reversing the direction of rotation as required, each trimmer can be adjusted to the position of maximum output. Output may be measured with an output meter or by ear. In the unit having the "Magic Eye" the shadow angle on the "Magic Eye" may be used as an output indication, adjusting for minimum shadow angle. As alignment proceeds, reduce the input signal to keep the output low, because best alignment is obtained on weak signals.

If no service oscillator is available for this adjustment, tune in a weak station, and then adjust the trimmers for maximum response in a manner similar to that described above. If the output becomes quite large as alignment proceeds, tune in a weaker station and continue the adjustments or use a smaller antenna or a short piece of wire.

Having completed the I. F. adjustment as described above the adjustment of the All-Wave Tuning Unit may be made, to bring the entire receiver to its highest peak of efficiency.

First, check the dial calibration by closing the gang condenser (plates completely meshed) and observing the pointer position. If the latter is not exactly on the last line at the low-frequency (small-number) end of the dial, loos-

en the set screws holding the dial drum on the condenser shaft and set the dial to the position required, tightening the screws again.

The Tuning Unit has been carefully calibrated and aligned in the factory and therefore, unless someone has tampered with the adjustment, very little change will be required to bring the unit to its peak of efficiency. Ordinarily the improvement to be made by realigning the All-Wave Tuning Unit is so little that it must be done with service oscillator and output meter. **If no service oscillator is available for aligning the All-Wave Tuning Unit, do not change the adjustments thereon.** If a service oscillator is available, use it with a dummy antenna to adjust only the antenna and RF circuits to give maximum sensitivity when the dial is set to the Alignment points given in column 3 of the table in Fig. 2. The proper dummy antenna (used between the high side of the service oscillator output and the antenna "A" post of the receiver) should be a 200 MMF condenser on the long wave and broadcast bands and should be a 400-ohm carbon resistor on all higher-frequency bands. During alignment, connect "D" and "G" posts together. In any case the adjusting screws should not be turned more than two turns from the factory setting. If greater adjustment is indicated it is highly probable that the wrong type of tube or the wrong type of dummy antenna has been used. If a complete alignment of the All-Wave Assembly is thought desirable consult the instruction for the Standard All-Wave Tuning Unit.

ANTENNA

The Tuning Unit has been provided with three input terminals, "A," "D," and "G". If a conventional antenna is used it should be connected to binding post "A" and post "D" should be connected to post "G" which is connected to the nearest good ground.

If a noise reducing doublet antenna is used, one side of the doublet antenna is connected to "A" and the other to "D", while "G" is connected to ground. The range switch automatically cuts out one side of the doublet when turned to the long wave or broadcast band.

OPERATION

The kit has been provided with a neat, metal name plate which gives the names of all the controls. It may be attached to the front panel of either a wood or metal cabinet, or may be left off entirely, as individual taste may dictate.

In general the names are sufficiently self-explanatory so that no further explanation is needed, except to say that the maximum effect of each control is obtained at the right-hand or clockwise position. Maximum treble, maximum bass, maximum sensitivity, maximum selectivity, and maximum volume are obtained when the controls are advanced to the clockwise extreme of rotation. The range switch obeys this same rule having its maximum frequency (shortest wave band) at the corresponding part of its rotation.

The operation of the controls can be best understood by experiment. It might be well to point out that there is a mathematical truism about selectivity that should be recognized which is that, for a given I. F. system, minimum selectivity must accompany maximum high-frequency response. As a consequence there will be occasions when interference on adjacent channels will prevent the enjoyable use of the high-fidelity position of the I. F. selectivity switch. It also might be well to point out that it is a characteristic of the human ear that, as volume is reduced, the low register seems to fall off faster than the medium register, and consequently more "Bass Boost" can be used at low volumes to give a pleasing balance of low to high tones than can be used at high volume. The overall response of this receiver is so flat that the bass response is faithful to very low frequencies. As a consequence, for high volume no "Bass Boost" is required for good tonal balance. However, the ratio of low to medium register tone is manually adjustable so that the user can set this ratio to suit his individual taste.

PHONOGRAPH

In order to utilize this radio set for phonograph reproduction a high impedance magnetic or crystal pickup should be connected to a standard phone plug. When this is inserted in the phone jack on the rear of the chassis, radio reproduction is automatically cut off, and the connections arranged for phonograph reproduction. The volume, treble, and bass controls are all effective on phonograph reproduction. Note: There are two possible ways to connect the pickup terminals to the phone plug. If wrongly connected, there will be a bad hum whenever the pickup arm is touched. The remedy is to reverse the connection to the phone plug.

Parts Supplied for Construction of "Custom" All-Wave 12

MODELS NO.
10-1155 and 10-1156

- | | |
|---------------------------------------------------|------------------------------------------------------------------------------------------------------------------|
| 1 Pre-aligned Tuning Unit, 13-7616 | 1 30,000-ohm, 1-watt resistor |
| 1 Calibrated dial and escutcheon, 23-8230 | 1 50,000-ohm, ½-watt resistor |
| 2 Dial mounting brackets | 2 50,000-ohm ¼-watt resistors |
| 10 No. 2-56x¾" R. H. Screws for escutcheon | 2 100,000-ohm, ¼-watt resistors |
| 6 No. 2 Lockwashers for escutcheon | 2 200,000-ohm, ¼-watt resistors |
| 10 No. 2-56 Hexagon brass nuts | 1 400,000-ohm, ¼-watt resistor |
| 2 6.3-volt dial lamps, bayonet base | 5 Tie-lugs, single insulated terminal |
| 1 Etched aluminum name strip, 19294. | 2 Tie-lugs, two insulated terminals |
| 1 Variable-Selectivity I. F. Transformer, 17-7400 | 2 Tie-lugs, three insulated terminals |
| 1 Variable-selectivity I. F. Transformer, 17-7412 | 1 Tie-lug, four insulated terminals |
| 1 Output I. F. transformer 16-5714 | 8 Molded bakelite octal tube sockets |
| 1 Shielded R. F. Choke, 19-7908 | 1 5-prong wafer socket for speaker |
| 1 Push-Pull audio input transformer 19283 | 1 Phono-pickup jack |
| 1 Power transformer (110-volt, 60 cycle) 19282 | 3 Rubber grommets; ¼", ⅜" and ½" |
| 1 Filter Choke, 19281 | 2 Metal-tube grid clips |
| 2 500,000-ohm volume and bass controls | 1 A C line cord and plug |
| 1 250,000-ohm treble control with switch | 7 Black bakelite knobs |
| 1 25,000-ohm sensitivity control | 5 Soldering lugs |
| 1 2-pole, 3-position selectivity switch | 48 No. 6-32 hexagon nuts |
| 2 30-mfd. 450-volt wet electrolytic condensers | 38 No. 6-32x¼" steel machine screws |
| 1 .01-mfd., 200-volt paper condenser | 43 No. 6 Steel lockwashers |
| 2 .01-mfd., 400-volt paper condensers | 4 Spacer dowels, black |
| 1 .02-mfd., 400-volt paper condenser | 4 No. 6-32x1½" black machine screws |
| 4 .05-mfd., 200-volt paper condensers | 1 No. 20 Stranded Shielded wire, 12" long |
| 4 .05-mfd., 400-volt paper condensers | 1 Braided shield, 36" long |
| 1 .1-mfd., 200-volt paper condenser | 1 Black braided sleeving, 16" long |
| 1 .1-mfd., 400-volt paper condenser | 1 Length rosin-core solder, 180" |
| 1 .25-mfd., 400-volt paper condenser | 1 No. 20 Black hook-up wire, 180" |
| 1 8-mfd., 450-volt dry electrolytic condenser | 1 No. 20 Red hook-up wire, 72" |
| 1 8-mfd., 200-volt dry electrolytic condenser | 1 No. 20 Yellow hook-up wire, 12" |
| 2 10-mfd., 25-volt dry electrolytic condensers | 1 No. 20 Blue hook-up wire, 32" |
| 2 .00025-mfd., mica condensers | 1 No. 20 Brown hook-up wire, 16" |
| 1 200-ohm, 3-watt resistor | 1 No. 20 Orange hook-up wire, 16" |
| 2 800-ohm ¼-watt resistors | 1 No. 20 Green hook-up wire, 24" |
| 1 1000-ohm, ¼-watt resistor | 1 No. 20 Stranded Green wire, 44" |
| 1 2000-ohm, ¼-watt resistor | 1 "Magic Eye" Tuning indicator assembly with cable and escutcheon, No. 19285 furnished with Kit No. 10-1156 only |
| 1 2500-ohm, ¼-watt resistor | 1 Push-button Converter unit No. 9-1004 furnished with Kit 10-1155 only |
| 1 6000-ohm, 5-watt resistor | 1 Punched steel chassis, No. 11-8207 |
| 1 5000-ohm, 3-watt resistor | Black wrinkle finish, 10"x17"x3 ⅜" |
| 1 5000-ohm, ¼-watt resistor | |
| 2 10,000-ohm, ¼-watt resistors | |

ADDITIONAL PARTS REQUIRED FOR OPERATION

- | | | |
|-----------------------------------------------|-------------------|--------------------------------------------------------------------------------------------------------------------------------------------------------------------|
| 2 6K7 Metal tubes | 1 6H6 Metal tube | 1 Dynamic speaker with 5-prong plug, 2000 to 3000-ohm field resistance; Output transformer to match 6L6's in push-pull Class A; power handling capacity, 15 watts. |
| 1 6SA7 Metal tube | 2 6C5 Metal tubes | 1 High-impedance magnetic or crystal pickup for phonograph operation |
| 2 1853 Metal tube | 1 5X4G Glass tube | 1 Phone plug for pick-up connection |
| 2 6L6 Metal tubes or 6L6G Glass tubes | | |
| 1 6G5 "Magic Eye" tube for Model 10-1156 only | | |
| 1 6A7 Glass tube for Model 10-1155 only | | |

MEISSNER ACCESSORIES AVAILABLE

FOR MODEL 10-1156

- No. 11-8210 Steel Front Panel, punched, black wrinkle finish, 9 15/16" x 19 ⅜" x 1/16".
- No. 11-8222 Steel Cabinet, black wrinkle finish, 10" x 19 ¼" x 11 ½"

FOR MODEL 10-1155

- No. 11-8209 Steel Front Panel, punched, black wrinkle finish 9 15/16 " x 21 ⅝" x 1/16"
- No. 11-8208 steel Cabinet, black wrinkle finish, 10" x21 ¼" x 11 ½"

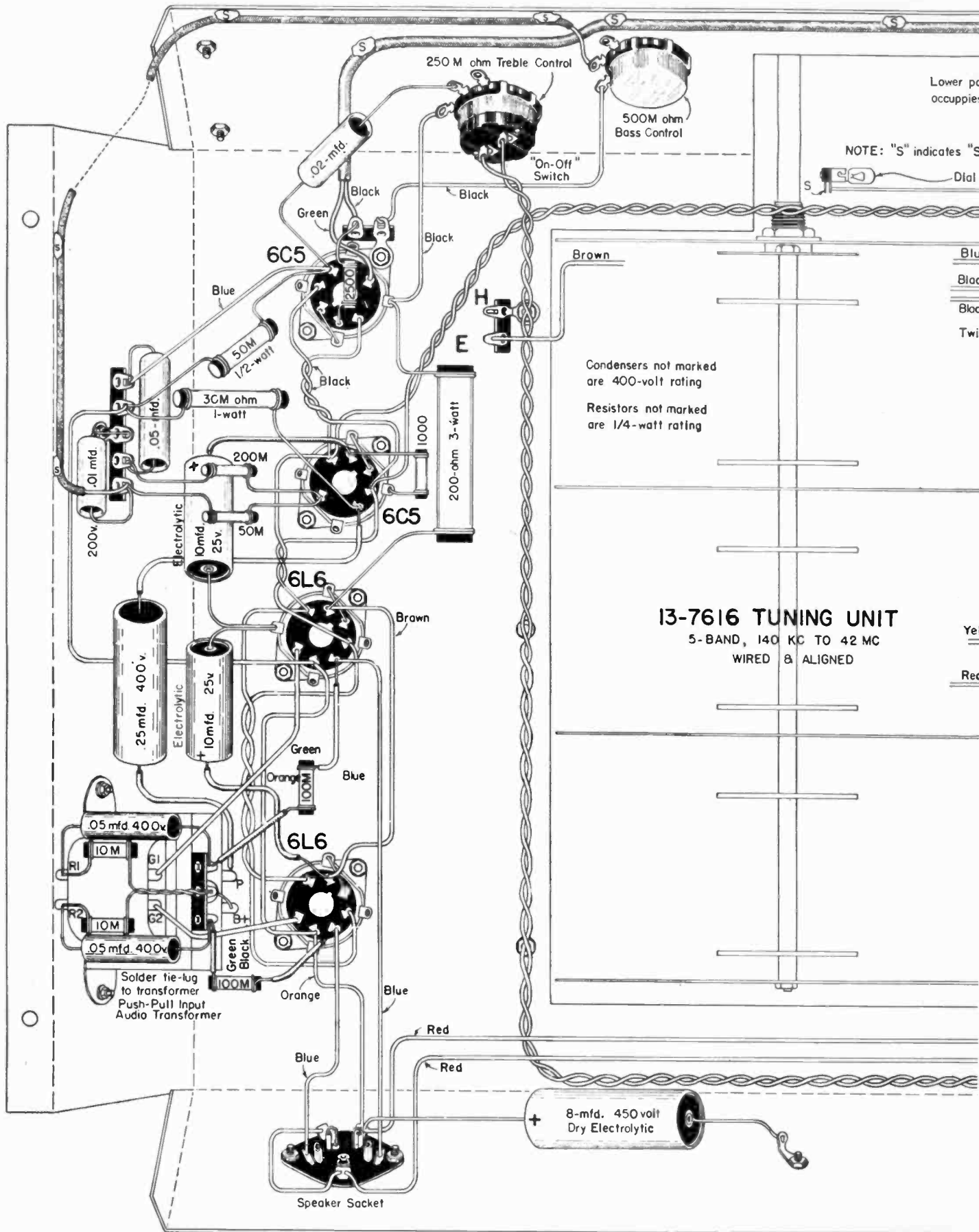

COMPLETE INSTRUCTIONS FOR



STANDARD TUNING UNIT & MULTI-WAVE COIL ASSEMBLY

PART 1—TUNING UNIT

The Meissner All-Wave Standard Tuning Unit, (410 MMF condenser) embraces all of the radio-frequency components of a radio receiver ahead of the I. F. amplifier.

It consists of a calibrated dial and tuning condenser, Multi-wave Antenna, R. F., and Oscillator coils, range switch and shields, padding and aligning condensers, tube sockets and all necessary resistors and condensers mounted on a sub-chassis that can be mounted through a hole cut in any chassis three or more inches deep.

An RF stage using a high mutual conductance Television amplifier tube, type 1853, provides excellent signal to-noise ratio, high sensitivity and superior image ratio on all bands. The oscillator, employing also an 1853 tube, has a smoothness of operation at high frequencies not approached by most other tubes.

It is provided with Antenna, Doublet and Ground connections and special contacts on the range switch to automatically select doublet or conventional antenna, whichever is better for the band selected. The switch also shorts-out all unused coils that might cause objectionable absorption losses.

The frequency ranges of the Standard Tuning Unit are given in Figure 2.

The circuits are all aligned with air-dielectric condensers (Meissner "align-aire") having a very smooth action and permanence of adjustment not approached by the usual mica-dielectric trimmer condensers.

The unit is aligned, calibrated and tested for sensitivity before leaving the factory, and should require little, if any, adjustment when installed in the receiver.

If no changes are made in the setting of the Alignaires and padders before placing the receiver in operation, good reception should be obtained on all bands, providing the rest of the receiver is functioning properly. Inasmuch as the coil assembly is already connected to the associated parts of the circuit, and was factory tested in this condition, it should be very nearly in alignment without further adjustment when new tubes are placed in the unit. Unless a Signal Generator or Service Oscillator is available for alignment purposes the adjustments on the unit should not be disturbed. If for some reason these adjustments have been accidentally changed or it is thought desirable to realign the unit, this may be readily accomplished by referring to the aligning instructions for the Multi-Wave Coil Assembly included in this Instruction Sheet.

INPUT I. F. TRANSFORMER.

When the All-Wave Tuning unit is used with a receiver not of Meissner design, an input I. F. Transformer with low primary inductance, such as the Meissner 14-7400, should be used or there may be oscillation at the high-frequency end of the Long-Wave band.

DIAL

The dial, because of its size, requires more support than can be given it by being fastened to the Tuning Unit alone.

therefore it will require additional supports at the ends to fasten it firmly to the chassis. Brackets for this purpose are furnished with all Meissner Kits using this dial. On receivers other than Meissner Kits, the constructor should provide satisfactory means for supporting the ends.

When mounting the dial, care should be exercised to see that it is placed so that there is no binding or stiffness in the bearings of the tuning condenser. The end supports should be tightened first, and then the screws holding the tuning-shaft bracket should be tightened to clamp this part firmly to the Tuning Unit sub-chassis. The condenser plates should be fully meshed (condenser closed), and the dial pointer set to the last mark at the low-frequency (small-number) end of the dial before tightening the set screw holding the dial drum on the condenser shaft.

CIRCUIT

The complete schematic diagram of the wired Tuning Unit is shown in Fig. 3. All parts shown thereon, except tubes, are furnished in the Tuning Unit which is completely wired. Only six connections are brought out of the unit to be wired to the remainder of the receiver. These leads are all prominently color-coded and their attachment points clearly described.

The Antenna-Doublet-Ground strip is mounted on the Tuning Unit and connected to the proper parts of the Tuning circuit. For connections see paragraph "Antenna Connections" at the end of this Instruction Sheet.

PART 2—MULTI-WAVE COIL ASSEMBLY.

The Coil and Switch Assemblies used in the Meissner All-Wave Standard Tuning Units are available separately for use in receivers designed without a Tuning Unit sub-chassis, such as the Meissner 9-Tube Multi-Wave Receiver, or for use in special receivers to suit the individual constructor's requirements.

The frequency ranges of the All-Wave Coil Assembly are as follows:

No. 13—7610		No. 13—7612	
Band	Range	Band	Range
1	133—406 KC	1	537—1754 KC
2	537—1754 KC	2	1.68—5.96 MC
3	1.68—5.96 MC	3	5.85—18.2 MC
4	5.85—18.2 MC	4	17.6—42.0 MC
5	17.6—42.0 MC		

These units may be used successfully in almost any kind of a receiver if a few important considerations are observed.

(a) The proper gang condenser must be used. This should be a high-grade, bar-type low minimum capacity condenser such as Meissner No. 21-5141B, 410-mmf condenser.

(b) The Tuning condenser should be mounted as nearly as possible directly over the coil assembly.

(c) The sockets for R. F., Detector and Oscillator tubes, the gang condenser and the coil assembly should be mounted with respect to each other in the relation shown in Fig. 1.

(d) On no account should the heavy braided leads or the green rubber-covered leads which connect to the tuning condenser be materially lengthened or shortened.

(e) The precautions concerning the characteristics of input I. F. transformers, mentioned in the paragraph "Input I. F. Transformers," should be observed.

Examination of the above mentioned leads will show that a green rubber-covered lead from each section of the coil assembly is brought out from the front wafer of each section of the range switch and connects to the stator terminal of the corresponding section of the gang condenser. A heavy braided lead is brought out from a ground bus in each section of the coil assembly to the rotor wiper terminal of the corresponding section of the gang condenser.

Schematic Diagram, Fig. 3, shows the circuit of both the complete Tuning Unit and the Coil Assembly alone. The section enclosed within the dotted lines is the Coil Assembly, while the entire circuit shows the complete Tuning Unit.

All leads which are brought out of the coil assembly to be connected to the remainder of the circuit are color-coded and clearly indicated near the dotted lines of Figure 3. The heavy braided cables mentioned above are indicated on this diagram as "rotor". The green wires should be brought through the chassis through large insulating grommets at least $\frac{3}{8}$ " in diameter and soldered to the stator terminals of the condenser. The "rotor" cables of each coil section should be brought through similar insulating grommets and soldered directly to the corresponding section of the condenser rotor wiper.

The remainder of the circuit diagram (Figure 3) indicates the connections of a suitable R. F., Mixer and Oscillator arrangement which has been found to operate most efficiently with this coil assembly. Careful observation of these circuit components will result in utmost success and satisfaction with this coil assembly.

ALIGNMENT

The Align-aies (air-dielectric trimmers) and padders on these coil assemblies have been factory-adjusted to the correct capacities. If other parts of the receiver circuit are functioning properly, reception should be obtained on all bands without further adjustment. Due to variation in location of parts and circuit wiring it is necessary to properly align and pad the coil assembly, however, to obtain most efficient operation of the receiver. For this purpose a high-grade signal-generator or service-oscillator and output-meter must be used.

The proper Dummy Antenna must be used between the signal-generator and the receiver if the antenna circuit is to be properly aligned. On the Long-Wave and the Broadcast bands a 200-mmf condenser should be used between the Antenna post of the generator and the "A" connection of the receiver. The "D" connection on the receiver should be connected to the "G" connection and to the ground side of the signal-generator.

The alignment procedure is essentially the same as usually employed in aligning any superheterodyne re-

ceiver. The intermediate-frequency channel must be accurately adjusted to 456 KC. Reference to the alignment table in Figure 2 will indicate the aligning and padding frequencies for each band as well as the low and high frequency limits of the band.

The lowest frequency band should be adjusted first by feeding into the antenna circuit a signal equivalent to the high-frequency end of that band (see column 2 in table in Fig 2) and adjusting the corresponding oscillator Align-aire to give maximum response. The band switch must be in the proper position and the tuning condenser at minimum capacity (open). The generator should then be set to the aligning frequency listed in the third column of the aligning table, the signal-tuned in on the receiver, and the Antenna and R. F. Align-aies adjusted to give maximum response. The generator frequency should now be dropped to the value given for padding and the signal tuned in by adjusting the tuning-control of the receiver. The padding condenser for the band being aligned should now be adjusted while rocking the tuning condenser to obtain maximum response. It is now well to return the generator frequency to the aligning point and adjust the receiver to receive this signal and check the Antenna and R. F. Align-aies for maximum response. The Oscillator Align-aire must not be readjusted.

If these adjustments are carefully made the band should track perfectly with the dial calibrations. The same procedure should now be repeated on the remaining bands progressing toward the higher frequencies. In each case the Oscillator Align-aire should be carefully adjusted to the high-frequency end of the band with the tuning condenser at minimum capacity, the Antenna and R. F. Align-aies adjusted with the receiver tuned to the alignment frequency and the padders adjusted near the low-frequency end of the band while rocking the gang condenser.

It will be noted that on the two highest-frequency bands there are no padding adjustments to be made. The coils for these bands will be found to give sufficiently accurate tracking when the Align-Aire trimmers are properly adjusted at the specified alignment frequency as they are wound within very close limits to proper inductance.

Typical input voltages to the Antenna for 50 Milli-watts output from a receiver using a single R. F. stage, diode detector, high-gain first-audio and pentode output are as follows:

- Five microvolts on Band 1 and Band 2.
- One microvolt or less on Band 3 and 4.
- Better than 10 microvolts on Band 5.

ANTENNA CONNECTIONS

The coil Assembly has been provided with leads to connect to three input terminals. On Meissner Kits a triple terminal strip marked "A", "D" and "G" is provided. The leads from the coil Assembly are color-coded so that they may be connected in accordance with the schematic wiring diagram in Figure 3.

If a conventional Antenna is used, it should be connected to binding post "A" and post "D" should be connected to post "G" which is connected to the nearest good ground.

If a noise reducing doublet Antenna is used, one side of the Doublet-Antenna is connected to "A" and the other side to "D", while "G" is connected to ground. The range switch automatically cuts out one side of the Doublet when turned to the Long-Wave or Broadcast bands.

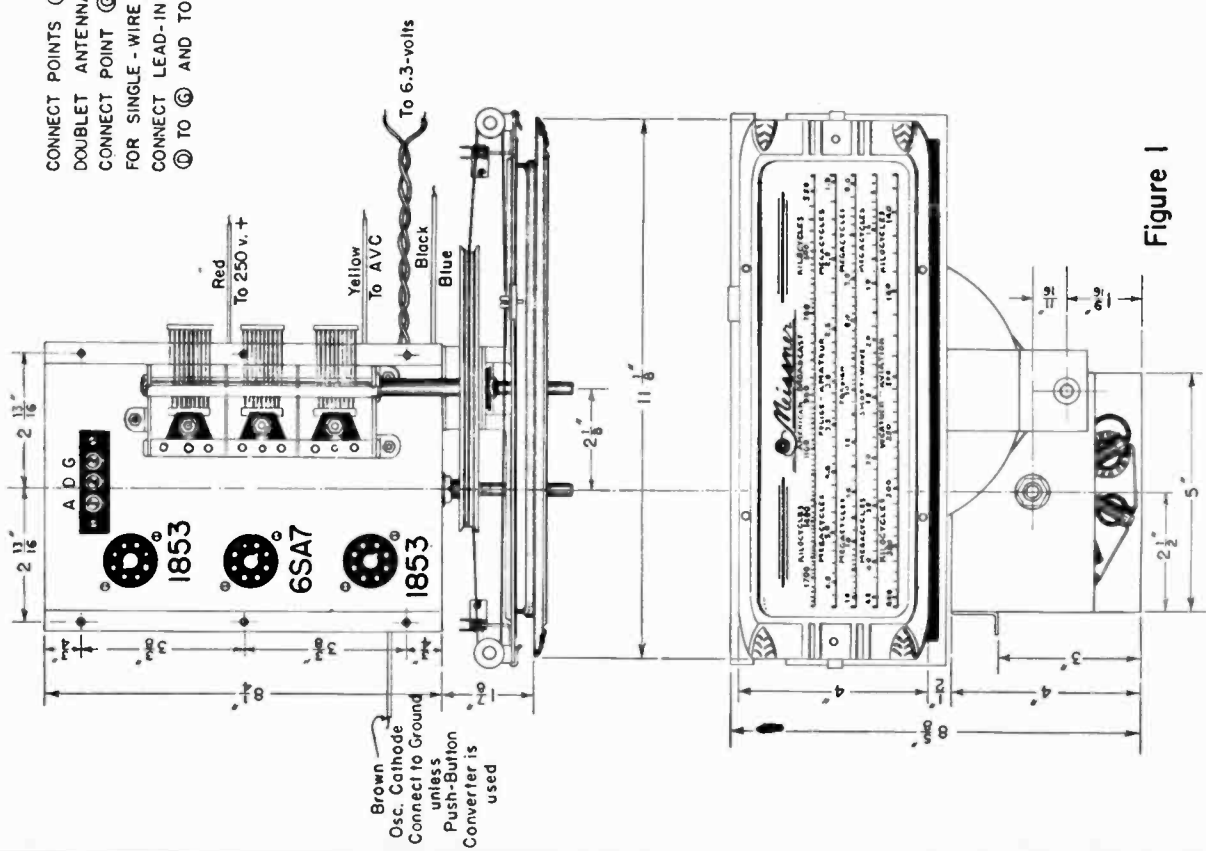

Figure 1
COMPLETELY WIRED AND ALIGNED
TUNING UNIT

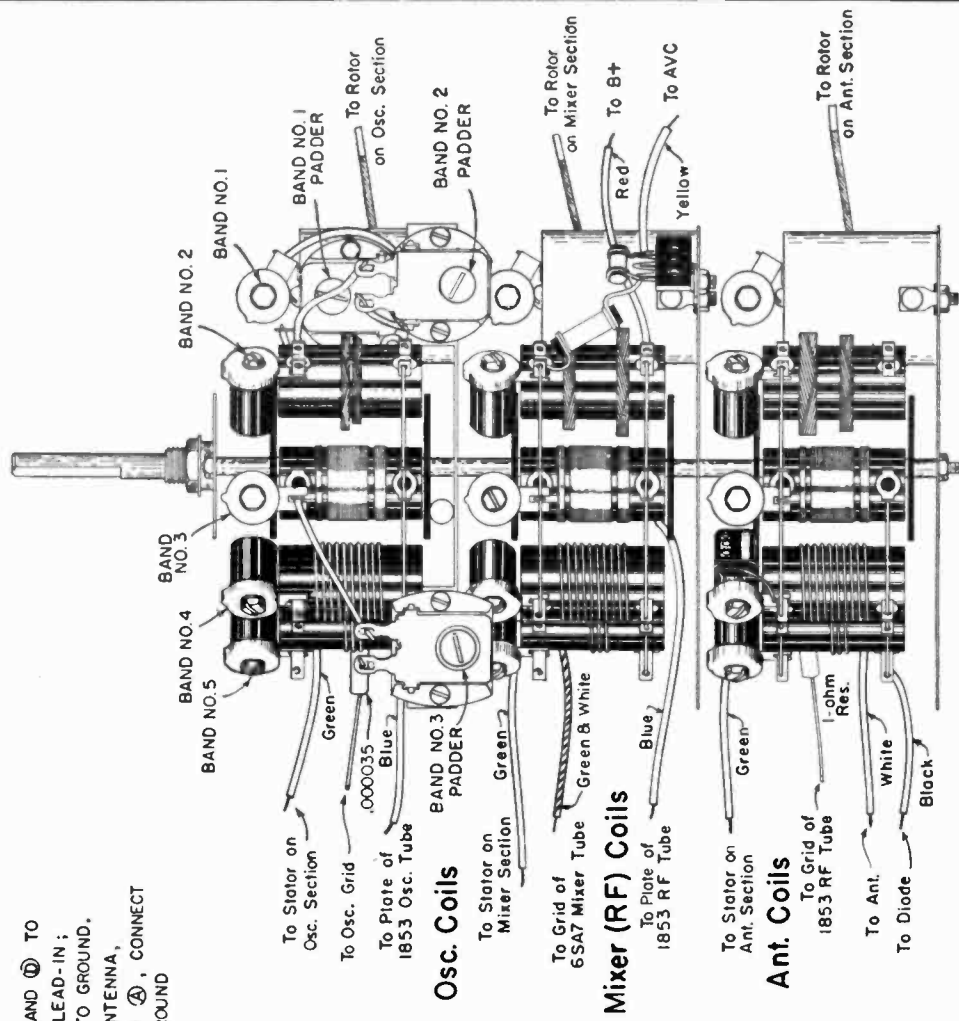

Figure 2
ALL-WAVE COIL ASSEMBLY
FOR USE WITH 410-MMFD TUNING CONDENSER

ALIGNMENT TABLE

BAND	FREQ. RANGE	ALIGN AT	PAD AT
1	133 to 406 KC	370 KC	150 KC
2	537 to 1754 KC	1600 KC	600 KC
3	1.68 to 5.96 MC	5.5 MC	1.9 MC
4	5.85 to 18.2 MC	17.0 MC	FIXED
5	17.6 to 42 MC	41 MC	FIXED

COMPLETE INSTRUCTIONS FOR



PERMEABILITY-TUNED

PUSH - BUTTON CONVERTER

NO. 9-1004

The Meissner Permeability-Tuned Push-Button Converter is a complete tuning unit having 8 push-buttons to permit the selection of any one of seven preselected stations, the eighth button being used to return to manual tuning.

It is so wired into the receiver that regardless of which wave band on the receiver may be in operation, pushing a station button tunes in the selected station without requiring that any other switch be used to change from "dial-tuning" to "push-button" operation. Pushing the "Dial-Tuning" button immediately returns the receiver to operation in the conventional manner.

It may be installed in any AC superheterodyne with a 456 or 465 K. C. I. F. system regardless of the number of sections in the gang condenser because the Push-Button Converter has its own Pentagrid converter tube, independent of the converter (and R. F. tube if used) in the receiver. The Push-Button Converter connects into the I. F. system of the receiver, so that the only thing that must be disturbed is the setting of the trimming condenser on the primary of the first I. F. Transformer, which in no way will change the calibration, alignment, image-ratio or sensitivity of the receiver.

No service man is required to set or change stations after this unit has been installed because there is only one adjustment button per station and this button projects through the escutcheon just above the station selector push-button where it is easy for anyone to adjust.

The simplicity of only one adjustment per station is made possible by a single movable two-gang iron-core assembly in a method analogous to that employed in a two-section cut-plate tuning condenser.

Because of the endless variety of switching schemes employed in receivers now on the market, it is not possible to make use of the pentagrid converter (or other detector-oscillator) in the radio set without seriously disturbing calibration and sensitivity for gang tuning. Accordingly, this Push-Button Converter uses its own pentagrid converter tube. When the Converter is working, the Oscillator in the receiver is blocked, and vice versa, so that there is never any interference between oscillators.

A cable and plug furnish connections between the receiver and the Converter Unit which obtains its power from the receiver through this cable. The voltages required to operate the Converter are 150 to 250 volts DC for plate supply and 2.5 or 6.3 volts for filament. IT IS NOT RECOMMENDED FOR AC-DC OPERATION. A 2A7 or 6A7 tube is required, whichever matches the filament voltage employed in the receiver.

CIRCUIT

The complete circuit of the Push-Button Converter is shown in Fig 1. The simplified circuits of one button are shown in Fig. 2 and Fig 3.

The change over from one oscillator tube to the other is made by a single-pole, double-throw switch which has the arm connected to ground and the contacts connected to the respective oscillator cathode circuits. At the same time another single-pole, double-throw switch is changing the Antenna connections. Both of these switching operations are taken care of by the "Dial Tuning" push-button.

INSTALLATION

When installing the Permeability-Tuned Push-Button Assembly on a radio-receiver, the first thing to be done is to determine that the change-over switch can be connected to the oscillator in the set without interfering with the operation of that tube.

The two common cathode circuits are shown in Fig. 4 together with the proper method of connecting the change-over switch.

Having determined that the cathode circuits can be switched (it is an extremely rare case where this is not possible) select a place for the Converter Unit as close to the radio set as convenient. Cut a rectangular opening $2\frac{1}{4}$ " x $5\frac{1}{2}$ " for the escutcheon and use the escutcheon to mark the location of the mounting screws. Drill very small holes for the mounting screws, taking care that the holes do not split out into the large opening.

Since the entire unit hangs on the escutcheon, it is very important that this item be properly installed. The weight of the unit, hanging far back from the panel, causes a considerable force pushing the bottom of the escutcheon away from the cabinet. Because of this pressure, it is advisable to run the mounting screws through the panel and put flat washers, lock-washers and nuts on the back to insure permanent contact of the escutcheon to the cabinet.

Before mounting the escutcheon, turn the knobs on all of the adjusting buttons until the slots in the back thereof are in line, and turn the adjusting screws so that the flats thereon all line up so that they can be inserted in the buttons all at once.

Having mounted the escutcheon, mount the Push-button Converter by means of the 4 screws in the corners of the escutcheon, using the brass spacers provided. The push-buttons may then be pressed into the shafts extending through the escutcheon.

Drill two holes in the chassis of the receiver, one a relatively small one (say $\frac{1}{4}$ "") for the blue lead (plate), and a larger hole ($\frac{3}{8}$ " to $\frac{1}{2}$ "") for the remaining wires in the cable. Both holes should be properly smoothed to eliminate sharp edges that might cut the cable. The blue lead must be connected to the plate of the First Detector tube and therefore the small hole may conveniently be drilled near that tube. The large hole may be drilled almost any place that is convenient for the wires to reach the required connections in the receiver.

Because of the fact that the blue lead from the Push-Button Converter is permanently connected to the plate of the first Detector, there is some possibility for regeneration between this lead and some leads on top of the receiver. If such occurs, put a piece of spiral shielding on the blue lead and connect the shielding to chassis. A piece of shielding has been provided for this purpose but should not be used unless required.

Because of the capacity added to the primary circuit of the Input I. F. Transformer by permanently connecting an additional tube plate and wiring to it, it will be necessary to re-align this circuit. On a few receivers this condenser may be at such a low capacity that it cannot be reduced sufficiently to align properly. In such case remove turns from the primary of the first I. F. Transformer until the circuit can be properly aligned. Care should be exercised to see that the capacity of the blue lead from the Converter to the radio set is kept as low as possible and that no more shielding is used on it than absolutely necessary. Also, if it is necessary to remove primary turns in order to reach the aligning point, that no more than 25 turns are removed between trials.

The outside antenna is connected to the white-and-blue lead coming out of the Push-button Converter. The white-and-black lead is connected to the normal antenna binding post of the radio set. Switch contacts on the "Dial Tuning" button transfer the antenna from the converter to the receiver, and vice versa, as required.

COMPLETE INSTRUCTIONS
FOR CONSTRUCTION AND OPERATION OF THE



Custom All-Wave "9"

4-Band, High-Fidelity Superheterodyne Receivers Models 10-1128 and 10-1129

The Meissner Custom All-Wave "9" is a Kit radio receiver designed to fill the requirements of a discriminating group of custom set constructors at a lower cost than the Meissner "All Wave 12" receiver.

It is a high quality Broadcast and Short Wave receiver containing the most desirable features of the "All Wave 12" without the expense of variable bandwidth or variable bass boost. It is provided with phonograph terminals which permits utilizing the high-fidelity audio system as a phonograph reproducing system of superior quality if a phonograph turn-table is provided and a high-impedance phonograph pickup is attached.

It is available in two models, one with "Magic Eye" tuning indicator, and the other with "Push Button Tuning" for stations in the "Broadcast" band. The chassis is the same for both models, the difference being in the way the cable from the "Magic Eye" or from the "Push Button Tuner" connects into the chassis wiring.

The "Push Button Tuner" is the popular No. 9-1004 Meissner-Ferrocart permeability-tuned unit with coils and core assemblies so designed that only one adjustment is required per station. This adjustment is easily made by means of an adjusting button projecting from the front panel immediately above its corresponding station Push-Button.

The tuning assembly in the receiver is the No. 13-7612 Meissner Multi-Wave Coil Assembly covering the frequency range of 540 KC to 40 MC. It is furnished complete with padding condensers and air-dielectric trimming condensers, and has been pretuned and thoroughly tested for sensitivity before leaving the factory. This receiver has an I. F. system of unusual quality employing extremely high "Q" Ferrocart (iron-core) coils in shields large enough to permit the full benefit to be obtained from the coils employed.

Adequate power output of low distortion is insured for home use by employing two 6V6 tubes in push-pull with Inverse Feed-back, driven by an audio transformer instead of the more commonly used resistance-coupled schemes which are prone to give high distortion at high outputs.

The receiver contains its own power supply and operates from a 110-volt, 60-cycle line. A sturdy and attractive steel cabinet and panel finished with black crackled lacquer are available to make a complete ensemble.

A speaker with push-pull output transformer to match 6V6 tubes in push-pull and having a field resistance of 800 to 1250 ohms is required together with the tubes shown in the Schematic Diagram.

ASSEMBLY

As the kit is unpacked, all parts should be carefully checked against the Parts List herewith. Any discrepancy should be reported at once to the supplier from whom the Kit was purchased.

In assembling the receiver, all parts should be mounted in accordance with the Top View shown on the Schematic Diagram and the bottom view shown in the Pictorial Wiring Diagram. The order of assembly is important, because certain items are difficult to reach for wiring if all parts are mounted before wiring begins.

First, mount all controls, the Multi-Wave Coil Assembly, the gang-condenser and dial temporarily to determine the proper shaft lengths when the chassis is installed in the cabinet intended for it. Determine the proper shaft lengths and then remove the units from the chassis, sawing the shafts to length when the shaft is clamped in a vise. It is not desirable to cut the shaft of a dial or a control when mounted on the chassis, because of the possibility of damaging the units.

Install all controls, electrolytic condensers, and small parts such as terminal strips, tie-lugs and sockets, paying particular attention to the type numbers stamped on the sockets so that the designations will correctly show the tube positions in the chassis and so that the sockets are installed with the key-way in the proper direction lest it be necessary to remove a number of leads if the socket is later discovered to be reversed. Since many connections are made to the socket saddles, it is advisable to solder each saddle to chassis at one spot lest trouble develop later due to poor contact.

The power transformer should next be installed, observing the position of the color-coded leads. Follow this by the I. F. Transformers.

Because of the small amount of room for wiring when the "Multi-Wave Coil Assembly" is in place, it is desirable to start the wiring before that unit has been installed.

WIRING

Having completed the assembly only as far as described above, the actual wiring may start, observing the hints given under "General Construction Hints" enclosed with the Kit.

The filament wiring should be installed first, followed by the remaining wiring in any convenient sequence. It probably will be of some assistance in wiring if all unnecessary ground lugs on the socket saddles are bent down against the chassis. All of the wiring is accessible until the Multi-Wave Coil Assembly and the push-pull transformer have been installed.

Paper by-pass condensers should be connected with the "Ground" ends to chassis whenever the condenser has one end grounded. Polarity must be observed when installing the 10-mfd 25-volt electrolytic condensers. Shielded wires should have both ends of the shield soldered to chassis and, if the shield is long, it should be soldered to chassis every three or four inches to hold it in place so as to prevent accidental movement of the shield short-circuiting some part of the wiring. It is recommended that, as each wire is installed, the corresponding line in the Pictorial Diagram be marked over with a colored pencil so that the status of wiring is obvious at a glance.

When as much wiring is finished as can be done without the "Multi-Wave Coil Assembly" and the audio transformer, make up the sub-assembly of audio transformer, resistors, condensers and terminal strip in the following manner. First, tin a spot on top of the transformer, then tin the bottom of the mounting lug on the terminal strip. Then place the two tinned parts together in the position shown in the Pictorial Diagram and solder them together. Finish the sub-assembly by adding the necessary resistors and condensers, then install the transformer in the chassis and make all necessary connections.

Install the gang condenser and the three rubber grommets beneath it, and the Multi-Wave Coil Assembly. It will be noticed that there is a buss-wire connecting each pair of switch wafers and that a heavy braided copper lead is soldered to each of these buss wires. These stranded leads should be brought through their respective grommets and connected to the rotor wipers on the gang condenser and pulled up just tight and soldered. Any surplus lead should, of course, be cut off.

The stator leads (the green wire leads attached to the switch wafers), should be attached to their respective lugs on the gang condenser stators. These lugs can easily be reached through the large holes in the chassis. Cut the leads to appropriate length, if necessary. After making these connections, the plate leads from the R. F. and oscillator sections may be connected to the plate terminals of the two 1853 tubes as shown on the Pictorial Wiring Diagram. These leads are blue. The grid leads should be connected to the proper socket terminals on the RF, Mixer and Oscillator tubes. Both grid and plate leads must be kept clear of the chassis to maintain low capacity. For the sake of clarity on this diagram the individual coils in the Multi-Wave assembly have not been shown except where external connections are made directly to these coils, in which cases the coils are shown in dotted outline.

The yellow lead connected to the front section of the coil assembly must be removed. The AVC resistors for the RF and Mixer tubes are mounted on a 3-terminal tie lug on the shield between the rear and middle section of the Coil Assembly. These, as well as all other connections are clearly shown in the Pictorial Diagram and should be wired accordingly.

The white and black leads from the rear section of the Coil Assembly to the Antenna-Ground terminal strip should be cut to such length that they will be just tight and cannot move around in the receiver.

Grid caps should then be soldered to the green lead on the input I. F. Transformer and to the grid connection for the 6F8G tube.

Slip the dial on the condenser shaft and fasten the two ends by means of the dowels and brackets provided for that purpose. Set the dial pointer to the last mark at the low frequency (small number) end of the dial scale and close the condenser, i. e. fully mesh the plates. Tighten the set screws on the shaft and fasten the bottom of the dial bracket to the chassis. Check to see that there is no binding in the dial at any part of its rotation. If binding should occur, loosen the mounting screws, free the binding and retighten the mounting.

Connect the cable from the "Magic Eye" or the Push Button Tuner to the proper points in the chassis. These points have been designated by letters in the Pictorial Diagram. The color code of leads corresponding to these letters is shown in the lower left-hand corner of the Schematic Diagram.

"MAGIC EYE" CABLE

In the model using the "Magic Eye" bring all wires in the cable through the large grommet in the chassis near the 1853 R. F. tube, cutting the wires to proper length for a neat job. Connect point "E" to point "G" thus grounding the oscillator cathode.

PUSH BUTTON CABLE

In the model using the "Push-Button Tuner," bring all the wires except the blue one through the large grommet mentioned above, and bring the blue wire through the small grommet near point "D". Cut all wires to appropriate lengths before attaching. Note that the brown wire connects to point "E" and the .01 condenser (indicated by Note "N" on the Pictorial) is connected as shown.

VOLTAGE TEST

If all connections are found to be correct, the tubes may be inserted and the line-cord plug connected to a 110-volt

60-cycle receptacle, and the speaker (800 to 1250 ohm field) plugged in. Be sure the speaker is connected to the plug so that the field is wired to the two filament pins, the output transformer primary-center-tap to the odd pin opposite, and the end connections of the primary (plate terminals) to the remaining pin on each side. A slight turn of the tone-control knob to the right will turn on the receiver. After a brief warm-up period, the voltages shown on the Schematic Diagram should be checked with a high-resistance voltmeter if available. Voltages indicated are measured from the point shown, to the chassis, with the chassis as the negative terminal. If values measured are materially different than shown on the diagram, a thorough recheck of the circuit should be made at once. **Be sure the receiver is turned off and the line-cord disconnected from the power receptacle while the wiring is being checked.**

ALIGNMENT

The alignment of this receiver should follow the standard procedure in adjusting super-heterodyne receivers. The best practice is to use a service oscillator which is calibrated to cover the full range of the receiver. The intermediate frequency transformers are first adjusted by connecting the service oscillator to the stator terminal on the middle section of the tuning condenser, through a .01 to 0.1 mfd. condenser. The oscillator is adjusted to exactly 456 KC. An output meter should be connected either to the voice coil of the speaker or in the plate circuit of the output tube. If no output meter is available, it is necessary to depend upon the ear to indicate maximum output. For this operation the range switch should be set for "Broadcast" with the dial set near 600 KC.

Turn the audio volume control and sensitivity controls on full. Increase the output of the service oscillator until a signal is just audible. Adjust each I. F. trimmer so that maximum volume is obtained. It is best to repeat this procedure two or three times on each trimmer to obtain the most accurate adjustment. These trimmers are adjusted with a small screw-driver through the opening in the top of the shield on each I. F. transformer.

The service oscillator should now be connected to the antenna terminal of the receiver, through the proper dummy antenna, and the ground return connected to the chassis. Complete information on Dummy Antennas and alignment of the Multi-Wave Coil Assembly is given in the Multi-Wave Assembly Instruction folder which is packed with the coil unit. Since these coils are pre-adjusted at the factory in a radio receiver, very little further adjustment by the constructor to compensate for differences in tubes and circuit capacities should be necessary. The complete details of these adjustments are given in the separate instruction sheet for the Multi-Wave Coil Assembly.

PHONOGRAPH

In order to utilize this radio set for phonograph reproduction a high-impedance magnetic or crystal pickup should be connected to a standard phone plug. When this is inserted in the phone jack on the rear of the chassis, radio reproduction is automatically cut off, and the connections arranged for phonograph reproduction. The volume and tone controls are effective on phonograph reproduction. Note: There are two possible ways to connect the pickup terminals to the phone plug. If wrongly connected, there will be a bad hum whenever the pickup arm is touched. The remedy is to reverse the connections to the phone plug.

ANTENNA

The receiver has been provided with three input terminals, "A", "D", and "G". If a conventional antenna is used, it should be connected to binding post "A" and terminal "D" should be connected to terminal "G" which is connected to the nearest good ground.

If a noise-reducing doublet antenna is used, one side of the doublet antenna is connected to "A" and the other to "D", while "G" is connected to ground. The range switch automatically cuts out one side of the doublet when turned to the Broadcast band.

Parts Supplied for Construction of Custom All-Wave "9"

Models No.
10-1128 and 10-1129

- | | | | |
|---|--------------------------------------------------|----|------------------------------------------------------------------------------------------------------------------------------------------|
| 1 | Prealigned Coil Assembly, 13-7612 | 2 | 250,000-ohm, $\frac{1}{4}$ watt resistor |
| 1 | Calibrated dial and escutcheon, 23-8232 | 1 | 500,000-ohm, $\frac{1}{4}$ watt resistor |
| 2 | Dial mounting brackets | 3 | Tie-lugs, single insulated terminal |
| 6 | No. 2-56 x $\frac{3}{8}$ " screws for escutcheon | 5 | Tie-lugs, two insulated terminals |
| 6 | No. 2-56 Hexagon brass nuts | 1 | Tie-lug, three insulated terminals |
| 6 | No. 2 Lockwashers | 5 | $\frac{3}{8}$ " rubber grommets |
| 2 | 6.3-volt dial lamps, bayonet base | 1 | $\frac{1}{2}$ " rubber grommets |
| 1 | 3-gang, 410-mmfd Tuning Condenser, 21-5141 B | 8 | Molded bakelite Octal sockets |
| 1 | Input I. F. Transformer, 16-5782 | 1 | 5-prong wafer socket for speaker |
| 1 | Output I. F. Transformer, 16-5784 | 1 | Phono-pickup jack |
| 1 | Push-pull audio input transformer, 19283 | 1 | A-D-G Terminal Strip |
| 1 | Power transformer (110-volt, 60 cycle), 19337 | 2 | Metal-tube grid clips |
| 1 | 500,000-ohm volume control, 19258 | 1 | AC line cord and plug |
| 1 | 25,000-ohm sensitivity control, 19288 | 5 | Black bakelite knobs |
| 1 | 250,000-ohm tone control with switch, 19287 | 38 | No. 6-32 Hexagon nuts |
| 2 | 30-mfd, 450-volt wet electrolytic condensers | 30 | No. 6-32x $\frac{1}{4}$ " steel machine screws |
| 2 | 10-mfd, 25-volt dry electrolytic condensers | 38 | No. 6 Steel Lockwashers |
| 1 | .0001-mfd mica condenser | 2 | 1" long x $\frac{1}{2}$ " dia. black spacer for dial |
| 2 | .00025-mfd mica condensers | 2 | No. 6-32 x 1 $\frac{1}{4}$ " Brass screws for dial |
| 1 | .01-mfd, 200-volt paper condenser | 4 | 1- $\frac{7}{8}$ " long x $\frac{1}{2}$ " dia. black spacer for panel |
| 6 | .01-mfd, 400-volt paper condensers | 4 | No. 6-32 x 2 $\frac{1}{4}$ " black screws for panel |
| 4 | .05-mfd, 200-volt paper condensers | 1 | Length No. 20 Stranded Shielded wire |
| 5 | .05-mfd, 400-volt paper condensers | 1 | Length Tinned braided shielding |
| 1 | .1-mfd, 400-volt paper condenser | 2 | Length Black braided sleeving |
| 1 | .25-mfd, 400-volt paper condenser | 1 | Length rosin-core solder |
| 1 | 80-ohm, $\frac{1}{4}$ watt resistor | 1 | Length No. 20 Black hook-up wire |
| 1 | 110-ohm, $\frac{1}{4}$ watt resistor | 1 | Length No. 20 Red hook-up wire |
| 1 | 200-ohm, 3-watt resistor | 1 | Length No. 20 Yellow hook-up wire |
| 1 | 200-ohm, $\frac{1}{4}$ watt resistor | 1 | Length No. 20 Blue hook-up wire |
| 1 | 500-ohm, $\frac{1}{4}$ watt resistor | 1 | Length No. 20 Brown hook-up wire |
| 1 | 1000-ohm, $\frac{1}{4}$ watt resistor | 1 | Length No. 20 Green hook-up wire |
| 2 | 5000-ohm, $\frac{1}{4}$ watt resistor | 1 | "Magic Eye" Tuning indicator assembly with cable and escutcheon, No. 19285. Furnished with Kit No. 10-1129 only |
| 1 | 10,000-ohm, 1 watt resistor | 1 | Push-Button Converter Unit No. 9-1004 complete. Furnished with Kit No. 10-1128 only |
| 1 | 15,000-ohm, 1 watt resistor | 1 | .01-mfd, 200-volt paper condenser with Kit No. 10-1128 only |
| 1 | 20,000-ohm, $\frac{1}{4}$ watt resistor | 1 | No. 11-8226 Steel Chassis completely punched to fit, black-wrinkle finish, 9" x 13" x 4 $\frac{1}{4}$ ", $\frac{3}{8}$ " flange each end |
| 1 | 30,000-ohm, $\frac{1}{2}$ watt resistor | | |
| 1 | 30,000-ohm, 1 watt resistor | | |
| 1 | 40,000-ohm, $\frac{1}{2}$ watt resistor | | |
| 1 | 40,000-ohm, 1 watt resistor | | |
| 2 | 50,000-ohm, $\frac{1}{4}$ watt resistor | | |
| 1 | 50,000-ohm, $\frac{1}{2}$ watt resistor | | |
| 2 | 100,000-ohm, $\frac{1}{4}$ watt resistor | | |

ADDITIONAL PARTS REQUIRED FOR OPERATION

- | | | | |
|---|---------------------------------------------|---|--------------------------------------------------------------------------------------------------------------------------------------------------------------------|
| 1 | 6K7 Metal tube | 1 | 6A7 Glass tube for Model 10-1128 only |
| 2 | 1853 Metal tubes | 1 | Dynamic speaker with 5-prong plug; 800 to 1250-ohm field resistance; output transformer to match 6V6's in push-pull Class A; power handling capacity 8 to 10 watts |
| 1 | 6SA7 Metal tube | 1 | High-impedance magnetic or crystal pick-up for phono-graph operation |
| 1 | 6F8G Glass tube | 1 | Phone plug for pick-up connection |
| 2 | 6V6 Metal tubes or 6V6G Glass tubes | | |
| 1 | 5Y4G Glass tube | | |
| 1 | 6G5 "Magic Eye" tube for Model 10-1129 only | | |

MEISSNER ACCESSORIES AVAILABLE

FOR MODEL 10-1129

- No. 11-8221 Steel Front Panel, punched, black wrinkle finish, 9 15/16" x 19 1/8" x 1/16"
No. 11-8222 Steel Cabinet with hinged lid, black wrinkle finish, 10" x 19 1/4" x 11 1/2"

FOR MODEL 10-1128

- No. 11-8227 Steel Front Panel, punched, black wrinkle finish, 9 15/16" x 21 5/8" x 1/16"
No. 11-8208 Steel Cabinet with hinged lid, black wrinkle finish, 10" x 21 3/4" x 11 1/2"

10-1128 & 10-1129

SCHEMATIC
CIRCUIT DIAGRAM

CUSTOM ALL-WAVE "9"
9-Tube Hi-Fidelity Superheterodyne Receiver
4-Bands, 540kc to 42 mc
I.F. = 456 kc

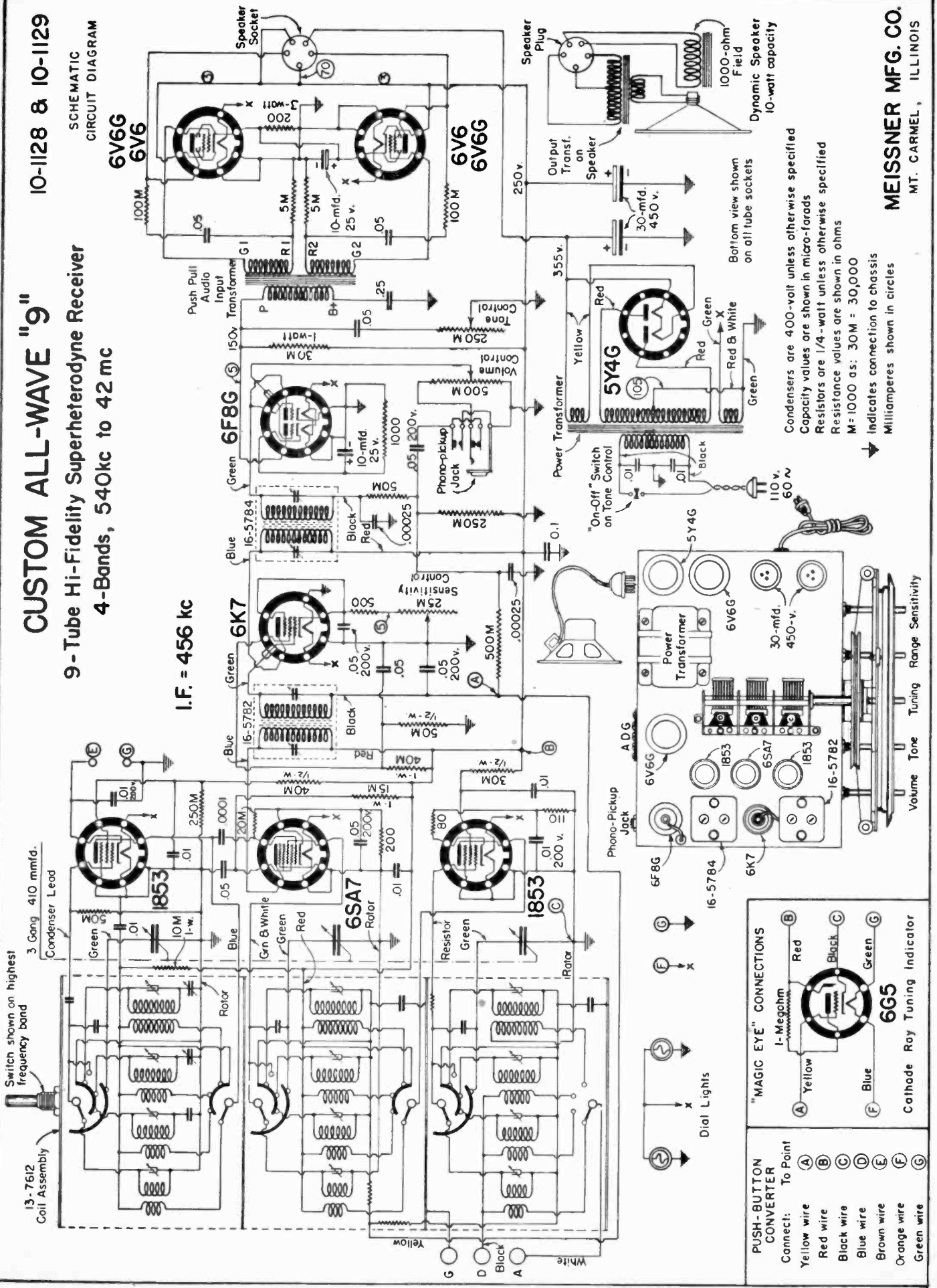

Condensers are 400-volt unless otherwise specified
Capacity values are shown in micro-farads
Resistors are 1/4-watt unless otherwise specified
Resistance values are shown in ohms
M = 1000 ohms; 30M = 30,000
Indicates connection to chassis
Milliamperes shown in circles

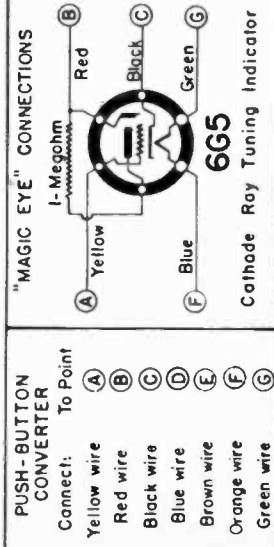

PUSH-BUTTON CONVERTER
Connect: To Point
Yellow wire (A)
Red wire (B)
Black wire (C)
Blue wire (D)
Brown wire (E)
Orange wire (F)
Green wire (G)

MEISSNER MFG. CO.
MT. CARMEL, ILLINOIS

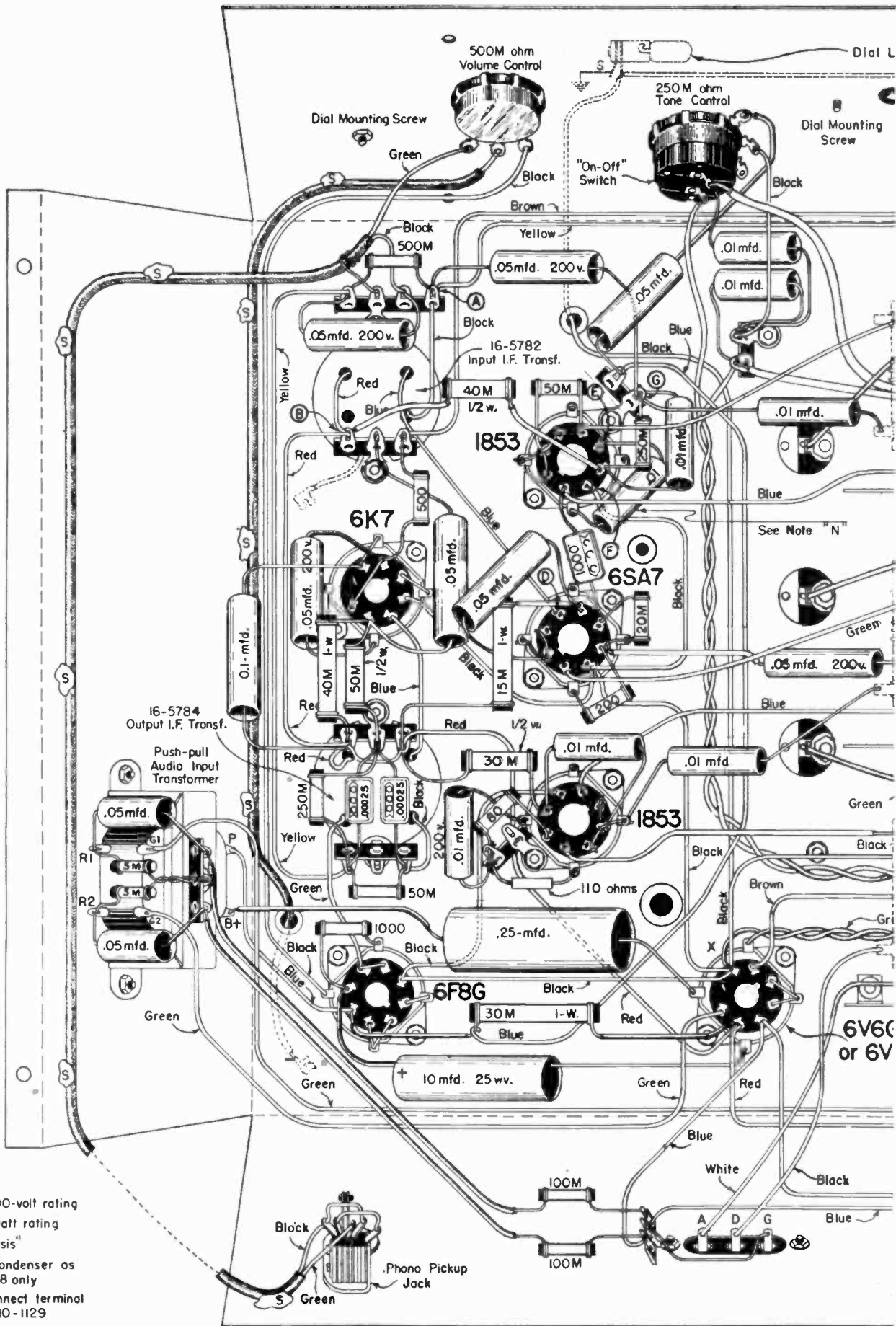

NOTES

Unmarked Condensers are 400-volt rating

Unmarked Resistors are 1/4-watt rating

"S" indicates "Solder to chassis"

"N" Connect .01mfd 200v. condenser as

shown on Model 10-1128 only

.01mfd condenser and connect terminal

(E) to lug (C) on Model 10-1129

10-1128 & 10-1129

PICTORIAL
WIRING DIAGRAM

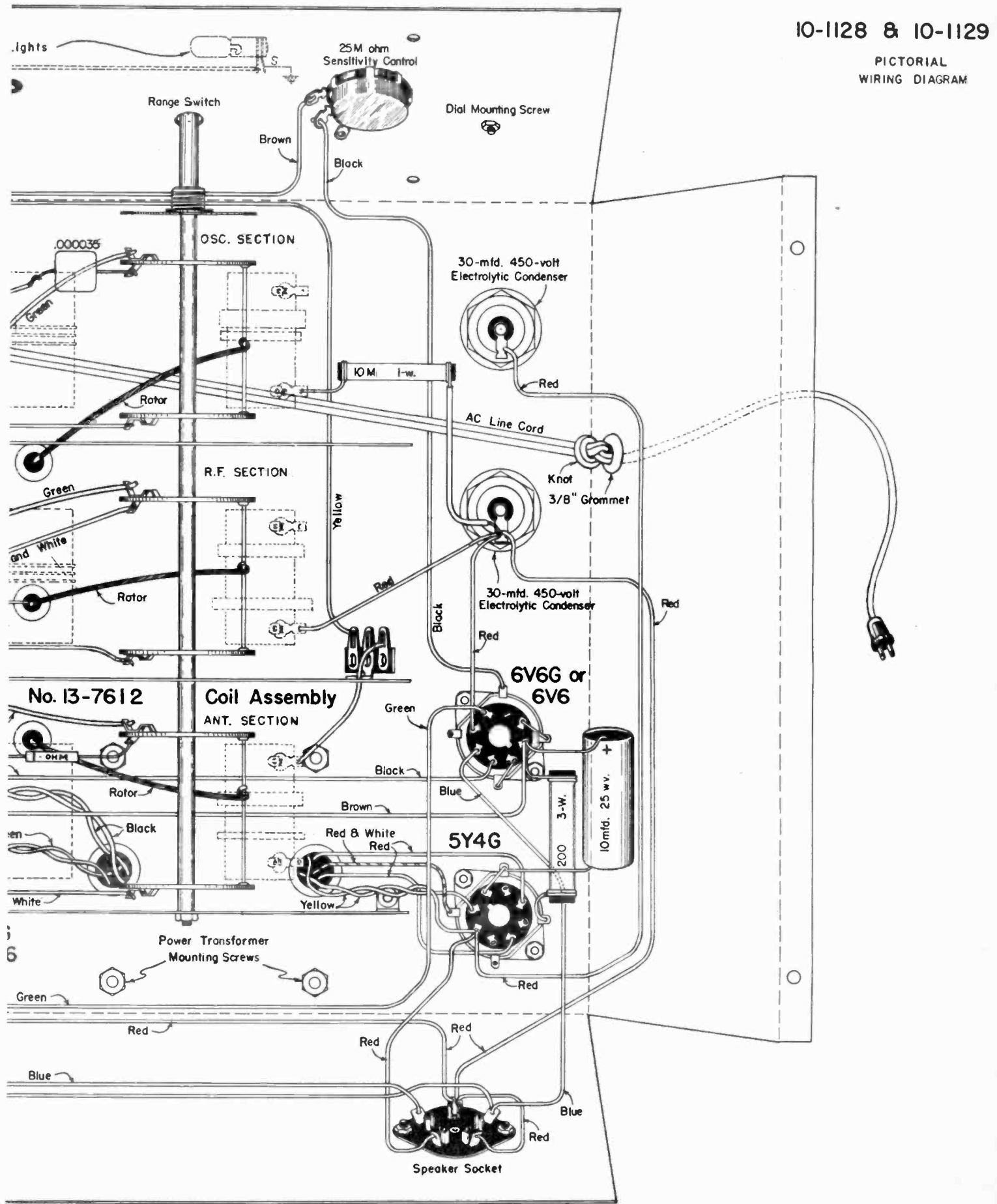

COMPLETE INSTRUCTIONS
FOR CONSTRUCTION AND OPERATION OF THE



8-Tube "Combination" Receiver

4-band Superheterodyne Model 10-1116

The 8-Tube "Combination" is a 4-band receiver kit covering the Broadcast band and the Short-Wave bands down to 42 MC. As its name implies, it may be considered as an all-around combination receiver, embodying the essential features of a good "ham" receiver while, at the same time, being provided with a simplified control arrangement, attractive appearance and excellent reproduction quality which enable it to be used in the home for Short-Wave entertainment programs.

The heart of this receiver is the Meissner Multi-Wave Coil Assembly, including in a factory-wired and pre-aligned assembly all of the Antenna, R. F. and Oscillator coils together with their aligning and padding condensers, compactly assembled directly on the four-position range switch with appropriate shielding. An R. F. stage is provided on all bands except the highest frequency range (14.5 to 42 MC).

All coils in the Multi-Wave Coil Assembly are tuned with Air-Dielectric trimmers (Meissner Align-a-ires) having a much smoother adjustment curve and far greater stability than the conventional compression type mica trimmers.

Ferrocart (iron-core) I. F. transformers, in which the high-Q coils operate in shields large enough to permit full realization of their possibilities, provide an IF system of unusual selectivity and sensitivity for the money invested.

A Beat-Frequency Oscillator is provided for C. W. reception and is connected to a switch on the front panel to provide convenient control of its operation. The beat-note is varied by a screw-driver adjustment through the top of the BFO transformer.

The receiver has the following controls reading from left to right: Phone, stand-by, loud speaker switch; sensitivity control; audio volume control; tuning control; range switch; tone control; AVC and beat-oscillator switch.

The receiver contains its own power supply and operates directly from a 110-volt, 60-cycle line. A sturdy and attractive steel panel and cabinet are available for the receiver, finished in black-crackled lacquer, to give the completed assembly a professional appearance.

The accessories required are a set of tubes as listed in the Parts List, and a dynamic speaker with a field resistance of 1500 to 2000 ohms having an output transformer to match a 6V6 tube.

ASSEMBLY

As the kit is unpacked, all parts should be carefully checked against the packing slip enclosed with the kit. Any discrepancies should be reported at once to the supplier from whom the kit was purchased.

The parts should be mounted on the chassis in accordance with the top view of the receiver shown on the Schematic Diagram, and the bottom view shown in the Pictorial Wiring Diagram. The order of the assembly is of little importance as long as the Tuning Unit and Dial are not assembled until all other wiring has been completed.

Temporarily install the Multi-Wave Coil assembly and all controls so that their proper shaft lengths may be determined when the receiver is placed in the cabinet intended for it. Mark the shafts for proper lengths, and then remove the controls from the chassis and saw each one with its shaft clamped in a vice. It is advisable not to attempt to cut the shaft of any unit while mounted on the chassis, because the heavy strains imposed on the unit may cause damage thereto.

Mount the sockets, taking care that they are installed in the proper places so that the numbers stamped on them will correctly indicate the type of tube for each location. Observe also that the keyway in the socket is properly oriented, lest it become necessary to remove all of the wires from the socket if it is later found to be reversed. It is also advisable to solder at least one spot (preferably adjacent to a mounting screw) on each socket-saddle to the chassis, since many ground connections are made to the lugs on the saddles, and trouble due to poor contact may develop unexpectedly unless a permanent good contact is insured by soldering.

Install all remaining parts except the Coil Assembly, Dial, and Filter Choke. The Filter Choke is to be installed after completion of the wiring of the 6C5 and 5Y4G sockets and the 17-6074 beat-frequency oscillator coil.

WIRING

Having completed the assembly operations described above, the actual wiring may start, observing the suggestions given on the sheet "General Construction Hints" packed with each Kit.

After bending down all socket-saddle ground-lugs not required for wiring, wire the filament circuit complete. The remaining wiring may be installed in any convenient sequence since it is all accessible. It will be found a great help in wiring if each wire in the Pictorial Diagram is marked over with a colored pencil as the corresponding wire in the set is installed.

The Coil Assembly does not interfere with wiring, but it is recommended that it be omitted until all other wiring is finished in order to prevent possible accidental damage to the coils while wiring the remainder of the receiver.

Paper by-pass condensers should be connected with their "ground" ends to chassis whenever the condenser has one end

grounded. Electrolytic condenser polarity **MUST** be observed. Shielded wires should have both ends of the shield soldered to the chassis. Where shielded wires are long, the shielding should be soldered to the chassis every three or four inches to hold it in place and present a neat appearance.

When all wiring, except the connections to the Coil Assembly, has been completed, install that unit. It will be noticed that there is a buss-wire connecting each pair of switch wafers and that a heavy, braided-copper lead is soldered to each of these buss-wires. There are also three # 27 holes in the chassis, close to the three wiper terminals on the gang condenser. A ground lug should be held in place above and below the chassis at each of these points by means of a 6-32 screw and nut. The ground lugs above the chassis are each soldered to an adjacent wiper-spring lug. Below the chassis, the braided copper leads mentioned above are soldered to the ground lugs, as shown in the Pictorial Diagram.

The grid leads, (the heavy stranded leads attached to the switch wafers) should be attached to their respective lugs on the gang condenser stators. These lugs can easily be reached through the large holes in the chassis. Cut the leads to appropriate lengths, if necessary, and stiffen the end near the condenser with solder so that there will be no danger of a short-circuit to chassis. The grid leads of the antenna and oscillator sections should be covered with spaghetti as an additional precaution against grounding. After making these connections, the plate leads from the R. F. and Oscillator sections may be connected to the 6K7 and 6J7 plate terminals respectively as shown on the Pictorial Wiring Diagram. These leads are blue and white. For the sake of clarity on this diagram, the individual coils in the Multi-Wave assembly have not been shown except in three cases where external connections are made directly to these coils, in which cases the coils are shown in dotted outline.

The white lead with yellow tracer connected to the rear section of the coil assembly and the white lead with black tracer connected to the front section must be removed as they are not required in this receiver. The AVC resistors for the RF and Mixer tubes are mounted on a 3-terminal tie-lug which must be mounted on the shield between the front and middle section of the Coil assembly. These, as well as all other connections, are clearly shown in the Pictorial Diagram and should be wired accordingly.

The white lead from the front end of the Coil assembly to the Antenna Ground Terminal strip should be cut to such length that it will be just tight and cannot move around in the receiver.

Grid caps should then be soldered to the green lead on the input I. F. Transformer and to the grid connection for the 6Q7 tube. Grid connections must also be soldered to the antenna and RF sections of the tuning condenser with grid caps for connection to the respective 6K7 and 6L7 tubes. The grid connection for the 6J7 oscillator tube should be made according to the detail drawing in the lower right-hand corner of the Pictorial Wiring Diagram, which indicates the method of mounting the oscillator grid-condenser and resistor on the rear section of the tuning condenser.

Slip the dial onto the condenser shaft and fasten loosely to the chassis by means of the single screw through the rear plate of the central drive-shaft bracket. Assemble the supporting brackets at each end of the dial, fastening each bracket to the chassis under the mounting nut of the rotary switch at each end. The 1" wood spacers are then used between the upper end of the bracket and the metal dial plate. Close tuning condenser (plates completely meshed) and set dial pointer to

the last line at the low-frequency end of the scale. Then tighten the set-screws holding the dial-drum on the condenser shaft. Exercise care to see that there is no binding in the shaft of the tuning condenser. Any tightness may be relieved by slightly shifting the dial as permitted by the relatively large holes provided for the dial-mounting screws. The dial lights may then be mounted and wired as indicated.

VOLTAGE TEST

If all connections are found to be correct, the tubes may be inserted, the line-cord plug connected to a 110-volt, 60-cycle receptacle, and the speaker (1500 to 2000 ohm field) plugged in. A slight turn of the tone-control knob to the right will turn on the receiver. After a brief warm-up period and with the "stand-by" switch in the "speaker" position, the voltages shown on the Schematic Diagram should be checked with a high-resistance voltmeter, if available. Voltages indicated are measured from the point shown to the chassis, with the chassis as the negative terminal. If values measured are materially different than shown on the diagram, a thorough recheck of the circuit should be made. **Be sure the receiver is turned off and the line-cord disconnected from the power receptacle while the wiring is being checked.**

ALIGNMENT

The Multi-Wave Coil Assembly has been aligned and tested in the factory before shipment; therefore, when tubes of the proper types are inserted in the sockets connected to this unit, the circuits will be close to maximum efficiency. Do not disturb any of the adjustments until all other instructions given below have been followed.

The alignment of this receiver should follow the standard procedure in adjusting super-heterodyne receivers. The best practice is to use a service oscillator which is calibrated to cover the full range of this receiver. The intermediate-frequency transformers are first adjusted by connecting the service oscillator to the grid cap of the 6L7 mixer tube through a small condenser. The wave-band switch is turned to the broadcast position, the "stand-by" switch turned on "speaker", and the volume and sensitivity controls turned to maximum. The service oscillator is adjusted to exactly 456 KC. An output meter should be connected either to the voice coil of the speaker or in the plate circuit of the output tube. If no output meter is available, it is necessary to depend upon the ear for proper adjustment.

Increase the output of the service oscillator until a signal is just audible. Adjust each I. F. trimmer so that maximum volume is obtained. It is best to repeat this procedure two or three times on each trimmer to obtain the most accurate adjustment. These trimmers are adjusted with a small screw-driver through the openings in the top of the shield on each I. F. transformer.

Now turn on the Beat-Frequency Oscillator and adjust the screw through the hole in the top of the beat oscillator coil until the desired beat frequency is obtained.

The service oscillator should now be connected to the receiver, through the proper dummy antenna. Complete information on Dummy Antenna and alignment of the Multi-Wave Coil Assembly is given in the Multi-Wave Assembly instruction folder which is packed with the coil unit. Since these coils are pre-adjusted at the factory in a radio receiver, only a little further adjustment by the constructor to compensate for differences in tubes and circuit capacities will be necessary.

Parts Supplied for Construction of 8-tube "Combination" Receiver

MODEL
10-1116

- | | |
|----------------------------------------------------|-----------------------------------------------------------------------------------|
| 1 Prealigned Coil Assembly, 13-7504 | 3 250,000-ohm $\frac{1}{4}$ -watt resistors |
| 1 Calibrated Dial and escutcheon | 1 500,000-ohm $\frac{1}{4}$ -watt resistor |
| 2 Dial mounting brackets | 9 Tie-lugs, two insulated terminals |
| 6 No. 2-56 x $\frac{3}{8}$ " screws for escutcheon | 2 Tie-lugs, single insulated terminal |
| 6 No. 2-56 Hexagon brass nuts | 4 $\frac{3}{8}$ " rubber grommets |
| 6 No. 2 Lockwashers | 2 $\frac{1}{4}$ " rubber grommets |
| 2 6.3-volt dial lamps, bayonet base | 8 Moulded bakelite Octal sockets |
| 1 3 gang, 410-mmfd Tuning condenser | 1 4-prong wafer socket for speaker |
| 1 Input I. F. Transformer, 16-5782 | 1 Double phone-tip jack strip |
| 1 Output I. F. Transformer, 16-5784 | 1 A-G terminal strip |
| 1 B. F. Oscillator Transformer, 17-6074 | 5 Metal-tube grid clips |
| 1 Power Transformer (110 volt 60 cycle) 19337 | 2 2-pole, 3-position switches |
| 1 Filter Choke, 19281 | 1 AC Line-cord and plug |
| 1 25,000-ohm Sensitivity Control | 7 Black bakelite knobs |
| 1 500,000-ohm Volume Control | 50 6-32 x $\frac{1}{4}$ " hexagon nuts |
| 1 250,000-ohm Tone Control with switch | 50 #6 Lockwashers |
| 3 8-mfd, 450-volt, wet electrolytic condensers | 4 8-32 x $\frac{3}{8}$ " screws |
| 2 10-mfd, 25-volt dry electrolytic condensers | 4 8-32 nuts |
| 1 .00005-mfd mica condenser | 4 #8 brass washers |
| 1 .0001-mfd. mica condenser | 4 #8 lockwashers |
| 3 .00025-mfd. mica condensers | 4 $1\frac{7}{8}$ " long x $\frac{1}{2}$ " dia. black spacers for panel |
| 2 .01-mfd. 400 volt paper condensers | 4 6-32 x $2\frac{1}{2}$ " black screws for panel |
| 2 .01-mfd. 200 volt paper condensers | 2 1" long x $\frac{1}{2}$ " dia. black spacers for dial |
| 2 .05-mfd. 400 volt paper condensers | 2 6-32 x $1\frac{1}{4}$ " brass screws for dial |
| 3 .05-mfd. 200 volt paper condensers | 1 Shaft coupling $\frac{3}{8}$ " to $\frac{3}{8}$ " |
| 1 .1-mfd. 400-volt paper condenser | 1 $\frac{3}{8}$ " brass shaft 9-16" long |
| 3 .1-mfd. 200-volt paper condensers | 35 6-32 x $\frac{1}{4}$ steel screws |
| 1 .006-mfd. 600 volt paper condenser | 10 Shakeproof ground lugs |
| 1 300-ohm, 1-watt resistor | 1 Length No. 20 Red Hook-up wire |
| 1 15,000-ohm, 1-watt resistor | 1 Length No. 20 Black Hook-up wire |
| 1 30,000-ohm, 1-watt resistor | 1 Length No. 20 Blue Hook-up wire |
| 2 40,000-ohm, 1-watt resistors | 1 Length No. 20 Brown Hook-up wire |
| 1 100,000-ohm, 1-watt resistor | 1 Length No. 20 Yellow Hook-up wire |
| 1 10,000-ohm $\frac{1}{2}$ -watt resistor | 1 Length No. 20 stranded Green wire |
| 1 50,000-ohm, $\frac{1}{2}$ -watt resistor | 1 Length No. 20 shielded lead wire |
| 2 700-ohm $\frac{1}{4}$ -watt resistors | 1 Length Tinned braided shielding |
| 1 800-ohm $\frac{1}{4}$ -watt resistor | 1 Length Black braided sleeving .053 dia. |
| 1 3,000-ohm $\frac{1}{4}$ -watt resistor | 1 Length Black braided sleeving .118 dia. |
| 2 5,000-ohm $\frac{1}{4}$ -watt resistors | 1 Length rosin core solder |
| 4 50,000-ohm $\frac{1}{4}$ -watt resistors | 1 No. 11-8283A steel chassis completely punched to fit; |
| 2 100,000-ohm $\frac{1}{4}$ -watt resistors | Black wrinkle finish, 9"x13" x $4\frac{1}{4}$ ", $\frac{3}{8}$ " flange each end. |

ADDITIONAL PARTS REQUIRED FOR OPERATION

- | | |
|-------------------|----------------------------------------------------------------------------------------------------------------------------------------------------------|
| 2 6K7 Metal tubes | 1 6V6 Metal tube |
| 1 6L7 Metal tube | 1 5Y4G Glass tube |
| 1 6J7 Metal tube | 1 Dynamic speaker with 4 prong plug; 1500 to 2000 ohm field resistance; Output transformer to match single 6V6; Power handling capacity 5 watts minimum. |
| 1 6Q7 Metal tube | |
| 1 6C5 Metal tube | |

MEISSNER ACCESSORIES AVAILABLE

No. 11-8228 steel, front panel, punched, black wrinkle finish
10 $\frac{3}{4}$ " x 15" x 1-16.

No. 11-8222 steel cabinet with hinged lid, black wrinkle finish
10 $\frac{3}{4}$ " x 15" x 11 $\frac{1}{2}$.

10-1116

8-TUBE "COMBINATION"

Metal Tube Superheterodyne Receiver

4 - Bands 530 kc to 44mc

IF = 456 kc

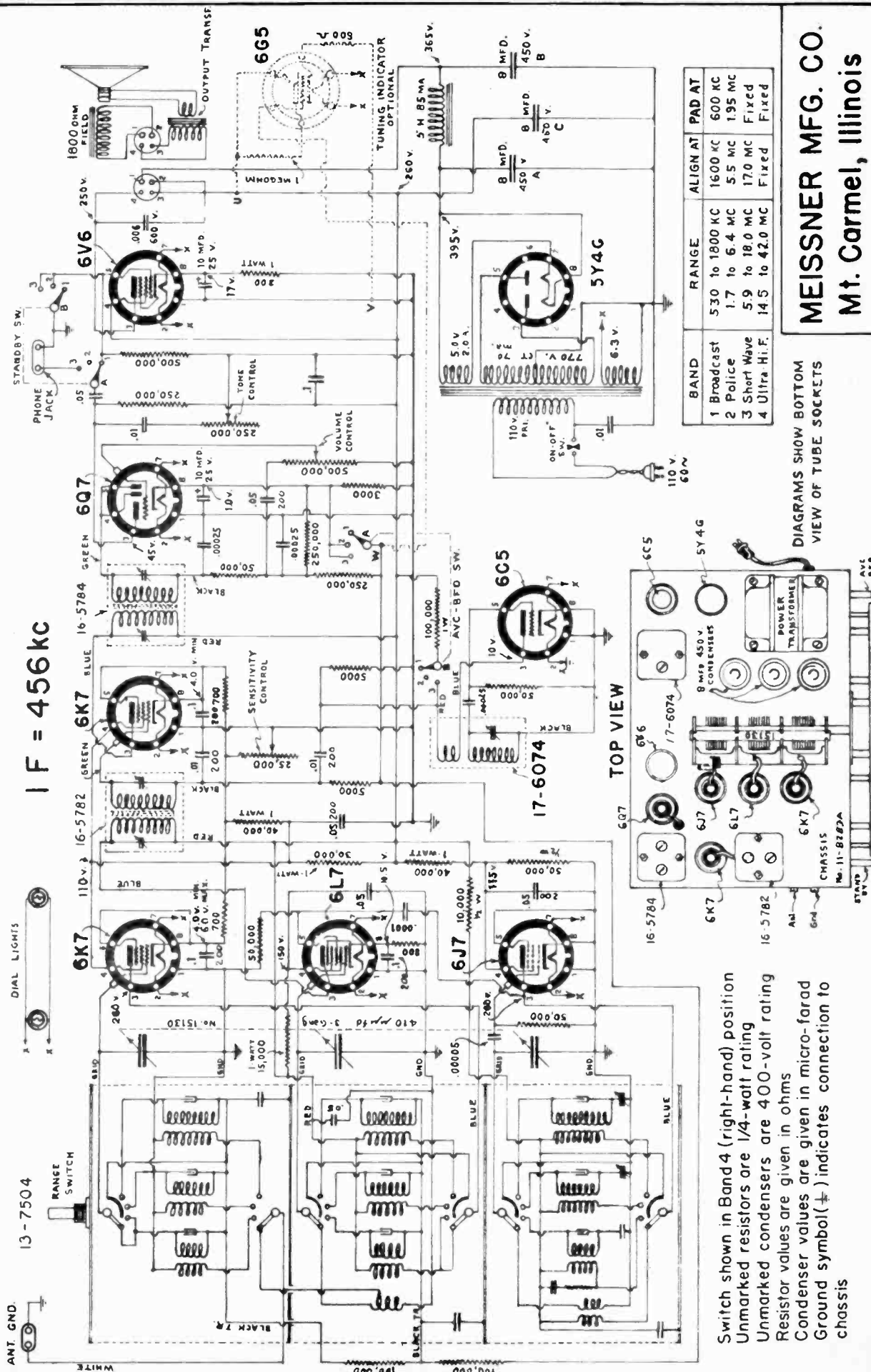

BAND	RANGE	ALIGN AT	PAD AT
1 Broadcast	530 to 1800 KC	1600 KC	600 KC
2 Police	1.7 to 6.4 MC	5.5 MC	1.95 MC
3 Short Wave	5.9 to 18.0 MC	17.0 MC	Fixed
4 Ultra-Hi-F.	14.5 to 42.0 MC	Fixed	Fixed

DIAGRAMS SHOW BOTTOM VIEW OF TUBE SOCKETS

MEISSNER MFG. CO.
Mt. Carmel, Illinois

Switch shown in Band 4 (right-hand) position
 Unmarked resistors are 1/4-watt rating
 Unmarked condensers are 400-volt rating
 Resistor values are given in ohms
 Condenser values are given in micro-farad
 Ground symbol(⊥) indicates connection to chassis

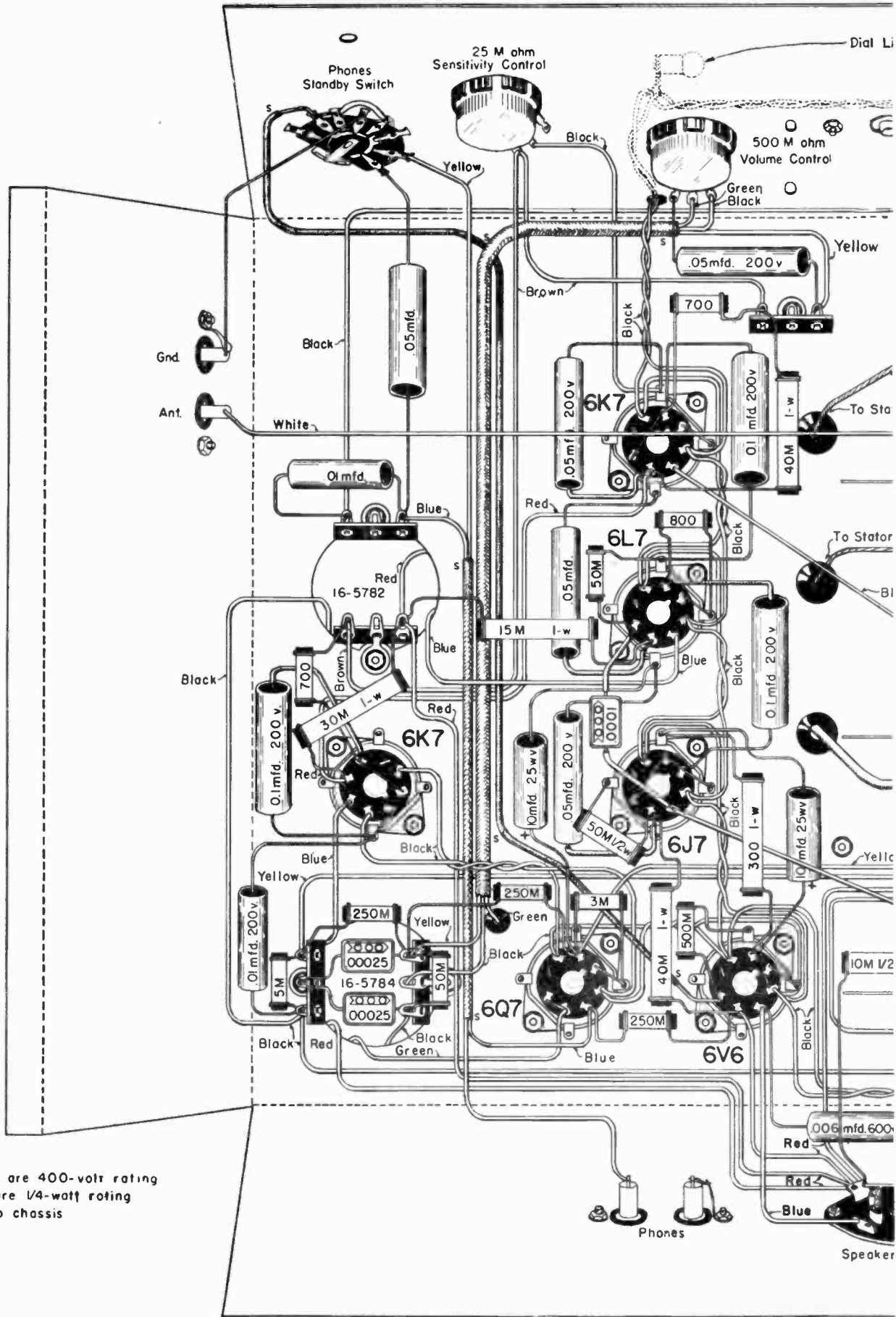

NOTES

Unmarked Condensers are 400-volt rating
 Unmarked Resistors are 1/4-watt rating
 "S" indicates solder to chassis

10-1116
PICTORIAL
WIRING DIAGRAM

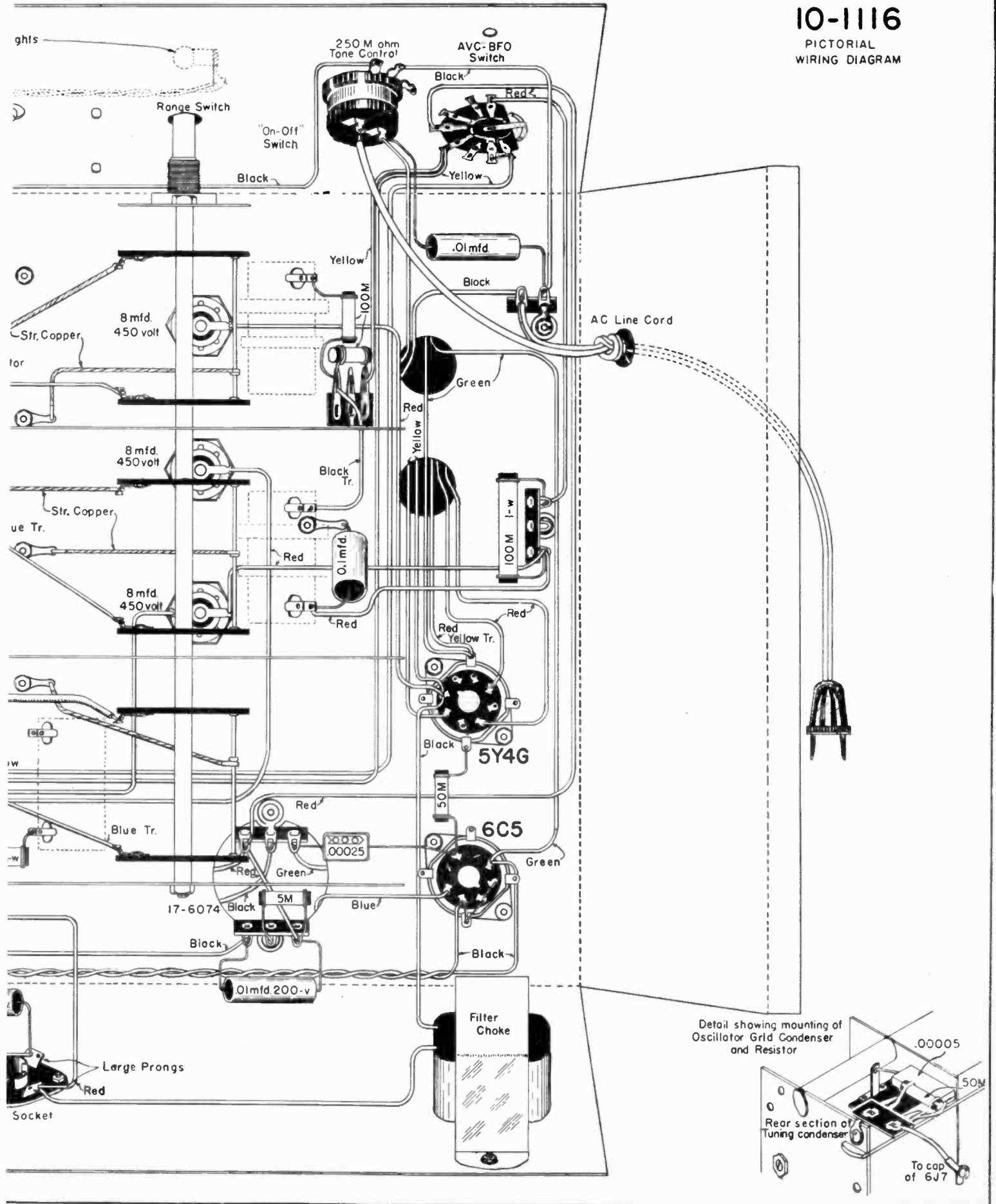

**COMPLETE INSTRUCTIONS
FOR CONSTRUCTION AND OPERATION OF THE**



7-tube AC "Utility" Broadcast

Superheterodyne Receiver

Model 10-1103

The Meissner No. 10-1103 receiver kit was designed to answer the requirements for a simple 110-volt 60-cycle receiver of excellent performance in the broadcast range.

It utilizes one stage of Radio Frequency Amplification in combination with two high-gain Ferrocart (iron-core) I. F. transformers, giving excellent selectivity and sensitivity over its entire tuning range.

The receiver has conventional AVC obtained from a diode second-detector, and is provided with manual volume control and tone control.

Its full vision 7-inch slide-rule three-color dial, rear illuminated, is very attractive whether installed in an already existing cabinet, or installed in the steel cabinet with front panel, finished in black crackled lacquer, which is available to those who desire a special cabinet for the receiver.

A "Magic Eye" Cathode Ray tuning indicator, socket, cable and escutcheon are provided as standard equipment.

The accessories required are tubes as listed in the parts list, and a dynamic speaker having a 1500 to 2000 ohm field and output transformer to match a single 6V6 tube.

ASSEMBLY

As the kit is unpacked, all parts should be carefully checked against the packing slip enclosed with the kit. Any discrepancies should be reported at once to the supplier from whom the kit was purchased.

The parts should be mounted on the chassis in accordance with the top view of the receiver shown on the Schematic Diagram, and the bottom view shown in the Pictorial Wiring Diagram.

Before beginning the wiring, temporarily install the gang condenser, dial and both controls so that their proper shaft lengths may be determined when the receiver is placed in the cabinet intended for it. Mark the shafts for proper lengths and then remove the controls from the chassis and saw each one with its shaft clamped in a vise. It is advisable not to attempt to cut the shaft of any unit while mounted on the chassis, because the heavy strains imposed on the unit may cause damage thereto.

Mount the sockets, taking care that they are installed in the proper places so that the numbers stamped on them will correctly indicate the type of tube to be inserted. Observe also that the keyway in the socket is properly oriented, lest it become necessary to remove all of the wires from the socket if it is later found to be reversed. It is advisable also to solder at least one spot (preferably adjacent to a mounting screw) on each socket saddle to chassis, since many ground connections are made to the lugs on the saddle, and trouble due to poor contact may develop unexpectedly unless a permanent good contact is insured by soldering.

Install the power transformer by means of the nuts shipped thereon, observing that the terminals on the transformer are properly placed according to the Pictorial Diagram.

WIRING

Having completed the assembly operations described above, the actual wiring may start, observing the suggestions given on the sheet "General Construction Hints" packed with each Kit.

After bending down all socket-saddle ground-lugs not required for wiring, wire the filament circuit complete. The remaining wiring may be installed in any convenient sequence. It will be found a great help in wiring if each wire in the Pictorial Diagram is marked over with a colored pencil as the corresponding wire in the set is installed.

VOLTAGE TEST

If all connections are found to be correct, the tubes may be inserted and the line-cord plug connected to a 110-volt, 60 cycle receptacle, and the speaker (1500 to 2000 ohm field) plugged in. A slight turn of the tone control knob to the right will turn on the receiver. After a brief warm-up period the voltages shown on the Schematic Diagram should be checked with a high-resistance voltmeter, if available. Voltages indicated are measured from the point shown, to the chassis, with the chassis as the negative terminal. If values measured are materially different than shown on the diagram, a thorough recheck of the circuit should be made. Be sure the receiver is turned off and the line-cord disconnected from the power receptacle while the wiring is being checked.

ALIGNMENT

The I. F. amplifier is aligned in the usual manner. Connect a service oscillator between the chassis and the grid of the 6A8 tube, using a condenser .0005 mfd. to .25 mfd. between the grid and the high side of the generator output. Do not remove the grid clip for this operation. Set the dial near 600 KC, and proceed with alignment at 456 KC.

Turn the audio volume control on full. Increase the output of the service oscillator until a signal is just audible. Adjust each I. F. trimmer so that maximum volume is obtained. It is best to repeat this procedure two or three times on each trimmer to obtain the most accurate adjustment. These trimmers are adjusted with a small screwdriver through the openings in the top of the shield on each I. F. transformer.

The service oscillator should now be connected to the antenna and ground terminals of the receiver, with a 200-mmf condenser between the antenna terminal and the service oscillator.

Set the dial and the service oscillator to 1400 KC and adjust the trimmer on the rear section of the gang condenser for maximum output, reducing the generator output as alignment proceeds. Follow this adjustment by similar adjustments on the middle and front sections of the gang condenser. After this is done the service oscillator should be set at 600 KC and the signal tuned in on the receiver. The oscillator padding condenser at the left end of the chassis, should be turned slowly in one direction while the gang condenser is rocked back and forth across the signal until a maximum is obtained. It is advisable now to return to 1400 KC and re-align at that point. The receiver should now be ready to connect to an antenna for operation.

Parts Supplied for Construction of 7-Tube AC "Utility" Broadcast Receiver

Model
10-1103

1	Calibrated slide-rule dial and escutcheon	2	250,000-ohm, ¼-watt resistors
1	Set No. 2 screws, nuts and lockwashers	2	500,000-ohm, ¼-watt resistors
2	6.3 volt dial lights, bayonet base	1	Mallory bias-cell and holder
1	Tuning indicator assembly and cable	1	Tie-lug, single insulated terminal
1	3-gang, 365 mmfd. tuning condenser	6	Tie-lugs, two insulated terminals
1	Broadcast-band antenna coil, 14-1004	1	Tie-lug, three insulated terminals
1	Broadcast-band R. F. coil, 14-1005	1	AC line cord and plug
1	Broadcast-band oscillator coil, 14-4243	4	Metal tube grid clips
1	Ferrocart input I. F. transformer, 16-5740	1	Shakeproof soldering lug
1	Ferrocart output I. F. transformer, 16-5742	1	Dual 15-mfd. 450-volt electrolytic condenser
1	Power transformer 110-volt, 60-cycle	1	Condenser mounting plate
6	Molded bakelite octal tube sockets	3	Black bakelite knobs
1	4-prong wafer socket for speaker	2	⅜" rubber grommets
1	Ant-grid terminal strip	1	¼" rubber grommet
1	500,000-ohm volume control	4	No. 6 brass washers
1	25,000-ohm tone control with AC switch	39	No. 6-32 x ¼" hexagon steel nuts
1	Adjustable padding condenser, 22-7006	40	No. 6 steel lockwashers
1	.00005-mfd. mica condenser	26	No. 6-32 x ¼" RH steel screws
3	.00025-mfd. mica condenser	4	No. 6-32 x 1" RH black screws
2	.006-mfd. 600-volt paper condenser	4	Wood panel spacers, ½" dia. x 11/16" long
5	.05-mfd., 200-volt paper condenser	1	Length black insulating sleeving
3	.05-mfd., 400-volt paper condenser	1	Length shielded wire
2	.1-mfd., 200-volt paper condenser	1	Length rosin-core solder
1	.1-mfd., 400-volt paper condenser	1	Length No. 20 hook-up wire, black
1	10-mfd., 25-volt electrolytic condenser	1	Length No. 20 hook-up wire, red
1	300-ohm, 1-watt resistor	1	Length No. 20 hook-up wire, white
1	300-ohm, ¼-watt resistor	1	Length No. 20 hook-up wire, blue
1	500-ohm, ¼-watt resistor	1	Length No. 20 hook-up wire, green
2	30,000-ohm, 1-watt resistors	1	Length No. 20 hook-up wire, yellow
1	40,000-ohm, ½-watt resistor	1	Length No. 20 hook-up wire, orange
2	50,000-ohm, ¼-watt resistors	1	Length No. 20 stranded wire, green
2	100,000-ohm, ¼-watt resistors	1	Punched steel chassis, 10" x 12" x 3"

ADDITIONAL PARTS REQUIRED FOR OPERATION

2	6K7 Metal tubes	1	6V6 or 6V6G tube
1	6A8 Metal tube	1	5Y4G rectifier tube
1	6Q7 Metal tube		

- 1 Dynamic speaker with 4-prong plug; 1500 to 2000-ohms field resistance; output transformer to match single 6V6 in Class A; power handling capacity, 5 watts minimum.

MEISSNER ACCESSORIES AVAILABLE

No. 11-8215 Punched steel panel, black wrinkle finish, 9 ½" x 14 ½" x 1/16"

No. 11-8212 Steel cabinet complete with hinged lid, black wrinkle finish 9 ½" x 14 ½" x 11 ½" deep.

**COMPLETE INSTRUCTIONS
FOR CONSTRUCTION AND OPERATION OF THE**



7-tube Broadcast & Shortwave Receiver

AC Operated Superheterodyne Model 10-1104

The Meissner No. 10-1104 receiver kit was designed to answer the requirements for a receiver covering the American Broadcast Band and the Short-Wave entertainment bands. It covers the frequency range 540 KC to 1600 KC, and 5.9 MC to 18.8 MC.

It utilizes one stage of Radio Frequency Amplification on both bands, in combination with two high-gain Ferrocart (iron-core) I. F. transformers, giving excellent selectivity and sensitivity over its entire tuning range. A Sensitivity Control has been provided to adjust the maximum sensitivity of the receiver to an amount commensurate with the prevailing noise level at the place of operation.

The receiver has conventional AVC obtained from a diode second-detector, and is provided with manual Volume Control and Tone Control.

Its full-vision 7-inch slide-rule dial with three scales (one a 0-100) in different colors, rear illuminated, is very attractive whether installed in an already existing cabinet, or installed in the steel cabinet with front panel finished in black crackled lacquer, which is available to those who desire a special cabinet for this receiver.

A "Magic Eye" Cathode Ray Tuning Indicator is provided as standard equipment.

The accessories required are tubes as listed in the parts list, and a dynamic speaker having a 1500 to 2000 ohm field and output transformer to match a single 6V6 tube.

ASSEMBLY

As the kit is unpacked, all parts should be carefully checked against the packing slip enclosed with the kit. Any discrepancies should be reported at once to the supplier from whom the kit was purchased.

The parts should be mounted on the chassis in accordance with the top view of the receiver shown on the Schematic Diagram, and the bottom view shown in the Pictorial Wiring Diagram. The order of assembly is of little importance as long as the Range Switch is omitted until the wiring around the RF and Converter sockets, and on the terminal strips mounted under the range switch, has been completed.

Before beginning the wiring, temporarily install the gang condenser, dial and all controls so that their proper shaft lengths may be determined when the receiver is placed in the cabinet intended for it. Mark the shafts for proper lengths and then remove the controls from the chassis and saw each one with its shaft clamped in a vise. It is advisable not to attempt to cut the shaft of any unit while mounted on the chassis, because the heavy strains imposed on the unit may cause damage thereto.

Mount the sockets, taking care that they are installed in the proper places so that the numbers stamped on the sockets will correctly indicate the type of tube to be installed therein. Observe also that the keyway in the socket is properly oriented, lest it become necessary to remove all of the wires from the socket if it is later found to be reversed. It is advisable also to solder at least one spot (preferably adjacent to a mounting screw) on each socket-saddle to chassis, since many ground connections are made to the lugs on the saddle, and trouble due to poor contact may develop unexpectedly unless a permanent good contact is insured by soldering.

Install the Power Transformer by means of the nuts shipped thereon, observing that the terminals on the transformer are properly placed according to the Pictorial Diagram.

WIRING

Having completed the assembly operations described above, the actual wiring may start, observing the suggestions given on the sheet "General Construction Hints" packed with each Kit.

After bending down all socket-saddle-ground-lugs not required for wiring, wire the filament circuit complete. The remaining wiring may be installed in any convenient sequence. It will be found a great help in wiring if each wire in the Pictorial Diagram is marked over with a colored pencil as the corresponding wire in the set is installed.

When all wiring has been finished except the leads to the Range Switch, install and wire that item, keeping all wires short and direct, and as well spaced from each other and from metal objects as possible.

Connect the cable from the "Magic Eye" in accordance with the Schematic and Pictorial Diagram.

VOLTAGE TEST

If all connections are found to be correct, the tubes may be inserted and the line-cord plug connected to a 110-volt 60-cycle receptacle and the speaker (1500- to 2000-ohm field) plugged in. A slight turn of the Tone-Control knob to the right will turn on the receiver. After a brief warm-up period the voltages shown on the Schematic Diagram should be checked with a high-resistance voltmeter, if available. Voltages indicated are measured from the point shown, to the chassis, with the chassis as the negative terminal. If values measured are materially different than shown on the diagram, a thorough recheck of the circuit should be made. Be sure the receiver is turned off and the line-cord disconnected from the power receptacle while the wiring is being checked.

ALIGNMENT

The I. F. amplifier is aligned in the usual manner. Connect a service oscillator between the chassis and the grid of the 6A8 tube, using a condenser .0005 mfd to .25 mfd between the grid and the high side of the generator output. Do not remove the grid clip for this operation. The Range Switch should be turned to the Broadcast band, and the dial set near 600 KC; then proceed with alignment at 456 KC.

Turn the Audio Volume Control and Sensitivity Controls on full. Increase the output of the service oscillator until a signal is just audible. Adjust each I. F. trimmer so that maximum volume is obtained. It is best to repeat this procedure two or three times on each trimmer to obtain the most accurate adjustment. These trimmers are adjusted with a small screwdriver through the opening in the top of the shield on each I. F. transformer. If no service oscillator is available tune in a weak signal and adjust trimmers as above. If the signal becomes loud use a shorter antenna and continue as above.

The service oscillator should now be connected to the antenna and ground terminals of the receiver, through the proper dummy antenna.

Close the gang condenser and see that the dial pointer position coincides with the last line at the low-frequency end of the dial. If this condition does not obtain, loosen the set-screw on the dial-drum, make the necessary correction and firmly tighten the screw.

Turn the Range Switch to the Short Wave (extreme clockwise) position, set the dial and the service oscillator to 16 MC, connect a 400-ohm resistor between the service oscillator and the antenna binding post, as a dummy antenna, turn the output of the service oscillator up to maximum, tighten the top trimmer in the oscillator coil (No. 14-7480) until just snug, then loosen it 4 turns, and then, as the trimmer is tightened, set it to the position of maximum response, reducing the output of the service oscillator as alignment proceeds. (If two responses are found of nearly equal intensity, adjust for the one with the trimmer farthest open). Now align the RF trimmer, but since the RF adjustment has a slight effect upon the oscillator frequency, it will be necessary to rock the tuning condenser slightly to keep the signal tuned in. Now adjust the antenna circuit, reducing input as alignment proceeds. If the receiver tends to "Motorboat", turn down the service oscillator output until the trouble stops. Some service oscillators, however, leak enough signal that even with the output control set at zero, the receiver is still overloaded,

in which case it is necessary to turn down the sensitivity and audio controls until the receiver behaves properly.

Set the service oscillator to 6MC and tune in the signal with the receiver dial. Now, while rocking the condenser back and forth across the signal, turn the short-wave padding condenser continuously in one direction until the output is the greatest. A few minutes spent in experiment on this adjustment will show more than a further lengthy explanation. Because of the fact that the adjustable padding condenser is but a relatively small portion of the total padding capacity on short-wave, this adjustment will not be very sharp. (The short-wave padding condenser is the one across which is connected the fixed mica condenser.)

Turn the range switch to the broadcast position, substitute a 200 mmf condenser for the 400 ohm resistor as a Dummy Antenna, set the dial and the service oscillator to 1400 KC. and align the circuits again (bottom trimmers) in the same manner as described above. Having done this, set the service oscillator to 600 KC and tune the receiver dial for maximum response. Here pad the oscillator circuit in the same manner as the Short-Wave padding described above. This adjustment will be far sharper than the Short-Wave padding operation and should therefore be done carefully. Return to 1400 KC and re-align at that frequency.

Parts Supplied for Construction of 7-Tube Broadcast & Shortwave Receiver

MODEL
10-1104

- | | |
|-----------------------------------------------|------------------------------------------------|
| 1 Calibrated slide-rule dial and escutcheon | 2 50,000-ohm, 1/4-watt resistors |
| 1 Set No. 2 screws, nuts and lockwashers | 2 100,000-ohm, 1/4-watt resistors |
| 2 6.3-volt dial lights, bayonet base | 2 250,000-ohm, 1/4-watt resistors |
| 1 Tuning indicator assembly and cable | 2 500,000-ohm, 1/4-watt resistors |
| 1 3-Gang, 365 mmfd. tuning condenser | 1 Mallory bias-cell and holder |
| 1 6-pole, 2-position Range Switch | 1 Tie-lug, single insulated terminal |
| 1 BC-SW band Antenna coil, 14-7476 | 7 Tie-lugs, two insulated terminals |
| 1 BC-SW band R. F. coil, 14-7478 | 1 AC line cord and plug |
| 1 BC-SW band Oscillator coil, 14-7480 | 4 Metal tube grid clips |
| 1 Ferrocart input I. F. transformer, 16-5740 | 2 Shakeproof soldering lugs |
| 1 Ferrocart output I. F. transformer, 16-5742 | 1 Dual 15-mfd. 450-volt electrolytic condenser |
| 1 Power transformer, 110-volt 60-cycle | 1 Condenser mounting plate |
| 6 Molded bakelite octal tube sockets | 5 Black bakelite knobs |
| 1 4-prong wafer socket for speaker | 2 3/8" Rubber grommets |
| 1 Ant-Gnd. terminal strip | 1 1/4" Rubber grommet |
| 1 500,000-ohm volume control | 2 No. 6 brass washers |
| 1 25,000-ohm sensitivity control | 41 No. 6-32 x 1/4" hexagon steel nuts |
| 1 25,000-ohm tone control with AC switch | 41 No. 6 steel lockwashers |
| 1 Adjustable padding condenser, 22-5211 | 26 No. 6-32 x 1/4" RH steel screws |
| 1 .0001-mfd. mica condenser | 4 No. 6-32 x 1" RH black screws |
| 2 .00025-mfd. mica condensers | 4 Wood panel spacers, 1/2" dia. x 11/16" long |
| 1 .004-mfd., mica condenser | 1 Length black insulating sleeving |
| 2 .006-mfd., 600-volt paper condensers | 1 Length rosin-core solder |
| 7 .05-mfd., 200-volt paper condensers | 1 Length No. 20 hook-up wire, black |
| 3 .05-mfd., 400-volt paper condensers | 1 Length No. 20 hook-up wire, red |
| 1 .1-mfd., 200-volt paper condenser | 1 Length No. 20 hook-up wire, white |
| 1 .1-mfd., 400-volt paper condenser | 1 Length No. 20 hook-up wire, blue |
| 1 10-mfd., 25-volt electrolytic condenser | 1 Length No. 20 hook-up wire, green |
| 1 300-ohm, 1-watt resistor | 1 Length No. 20 hook-up wire, yellow |
| 2 400-ohm, 1/4-watt resistors | 1 Length No. 20 hook-up wire, orange |
| 1 1500-ohm, 1/4-watt resistor | 1 Length No. 20 stranded wire, green |
| 2 30,000-ohm, 1-watt resistors | 1 Punched steel chassis, 10" x 12" x 3" |
| 1 40,000-ohm, 1/2-watt resistor | |

ADDITIONAL PARTS REQUIRED FOR OPERATION

- | | | |
|-------------------|-----------------------|------------------------------------------------------------------------------------------------------------------------------------------------------------|
| 2 6K7 Metal tubes | 1 6V6 or 6V6G tube | 1 Dynamic speaker with 4-prong plug; 1500 to 2000 ohms field resistance; output transformer to match single 6V6; power handling capacity, 5 watts minimum. |
| 1 6A8 Metal tube | 1 5Y4G rectifier tube | |
| 1 6Q7 Metal tube | | |

MEISSNER ACCESSORIES AVAILABLE

No. 11-8217 Punched steel panel, black wrinkle finish, 9 1/2" x 14 1/2" x 1/16"

No. 11-8212 Steel Cabinet complete with hinged lid, black wrinkle finish, 9 1/2" x 14 1/2" x 11 1/8" deep

No. 10-1104

SCHEMATIC
CIRCUIT DIAGRAM

BC & SW 7 Tube Superheterodyne Receiver 1600-540kc & 18.8 - 5.9mc I. F. Frequency 456kc

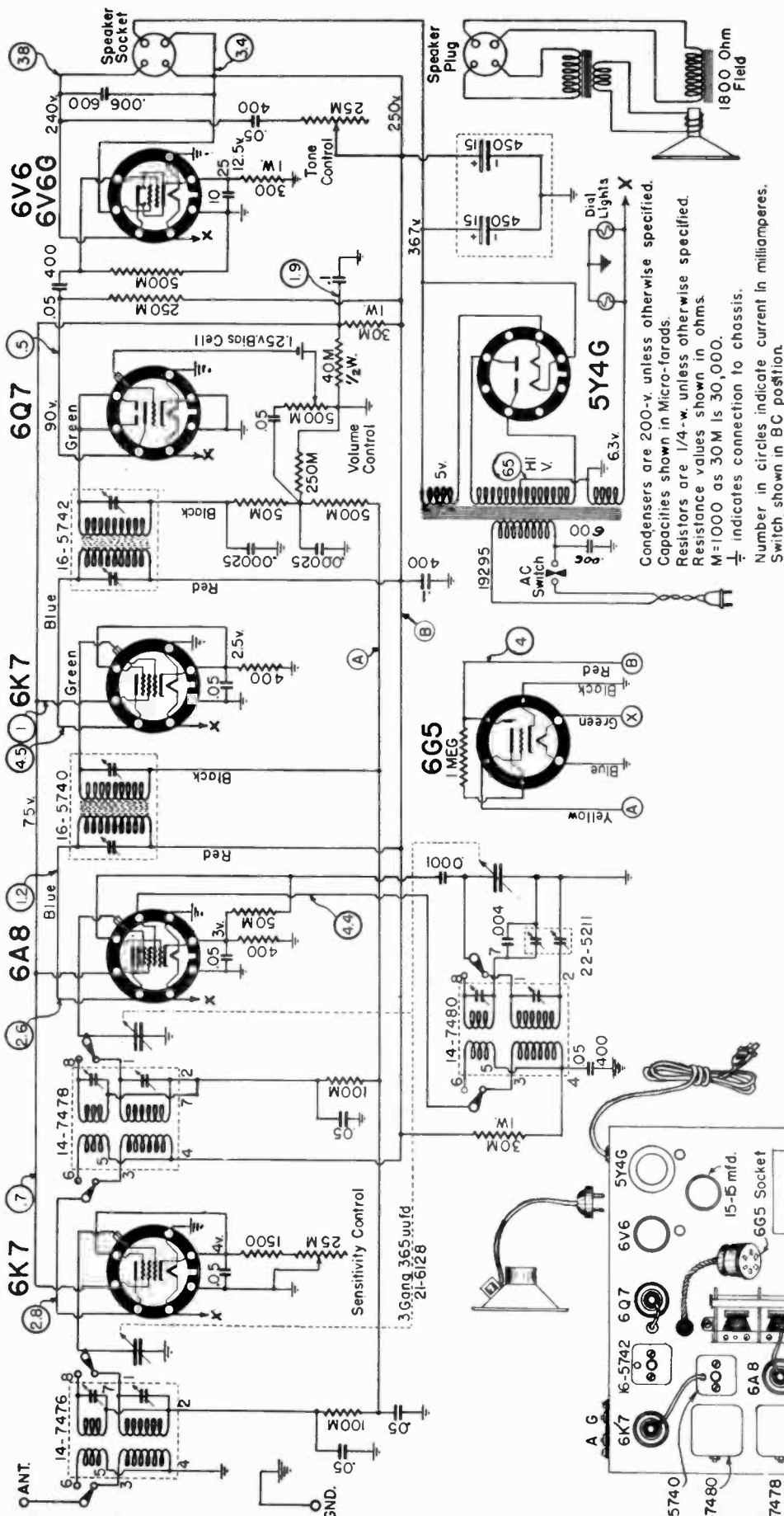

Condensers are 200-v. unless otherwise specified.
Capacities shown in Micro-farads.
Resistors are 1/4-w. unless otherwise specified.
Resistance values shown in ohms.
M=1000 as 30M is 30,000.
+ indicates connection to chassis.
Number in circles indicate current in milliamperes.
Switch shown in BC position.

MEISSNER MFG. CO.
MT. CARMEL, ILLINOIS

BAND	RANGE	ALIGN AT	PAD AT
Broadcast	1600kc-540kc	1.400kc	600kc
Short Wave	18.8mc - 5.9mc	16 mc	6 mc

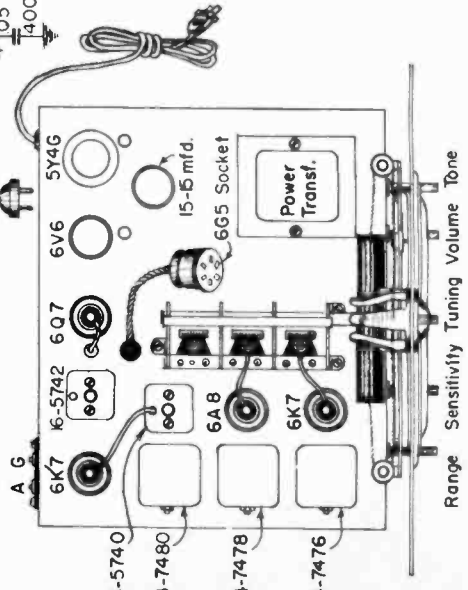

Range Sensitivity Tuning Volume Tone

10-1104
PICTORIAL
WIRING DIAGRAM

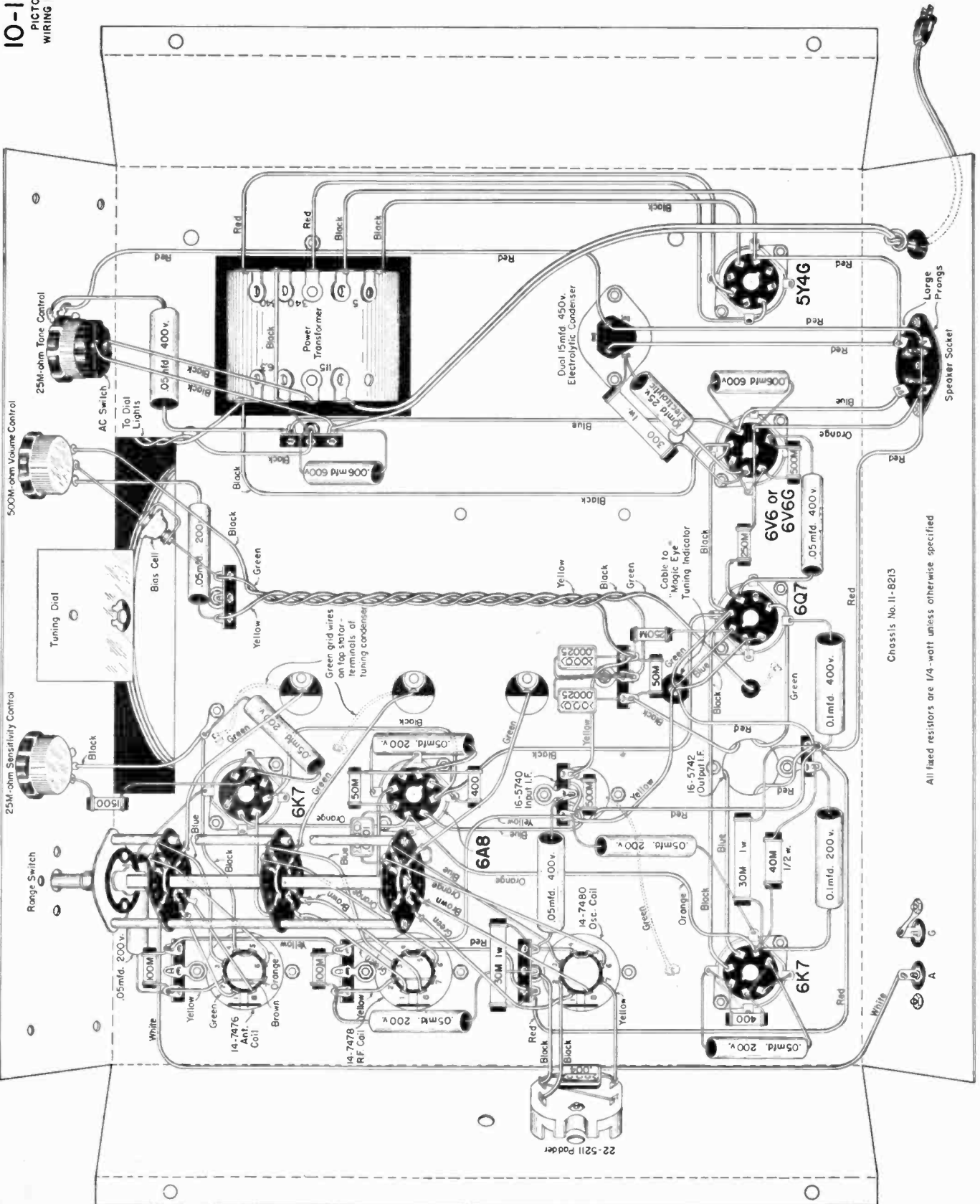

Chassis No. 11-8213

All fixed resistors are 1/4-watt unless otherwise specified

22-5211 Podder

**COMPLETE INSTRUCTIONS
FOR CONSTRUCTION AND OPERATION OF THE**



7-Tube Broadcast, Police and Shortwave Receiver

Model 10-1110

The Meissner No. 10-1110 receiver kit was designed to answer the requirements for a three-band receiver of widest utility at low cost. It covers the frequency range 550 KC to 1770 KC, 1.76 MC to 5.3 MC and 5.2 MC to 18.5 MC, thus giving reception of the American Broadcast Band and all Short Waves to 18.5 MC.

It utilizes one stage of Radio Frequency Amplification on all bands, in combination with two high-gain Ferrocart (iron-core) I. F. transformers, giving excellent selectivity and sensitivity over its entire tuning range. A Sensitivity Control has been provided to adjust the maximum sensitivity of the receiver to an amount commensurate with the prevailing noise level at the place of operation.

The receiver has conventional AVC obtained from a diode second-detector, and is provided with manual Volume Control and Tone Control.

Its full-vision, 7-inch slide-rule dial with three scales in different colors, rear illuminated, is very attractive whether installed in an already-existing cabinet, or installed in the steel cabinet with front panel, finished in black crackled lacquer, which is available to those who desire a special cabinet for this receiver.

A "Magic Eye" Cathode Ray tuning indicator is provided as standard equipment.

The accessories required are tubes as listed on the parts list, and a dynamic speaker having a 1500 to 2000 ohm field and output transformer to match a single 6V6 tube.

ASSEMBLY

As the kit is unpacked, all parts should be carefully checked against the packing slip enclosed with the kit. Any discrepancies should be reported at once to the supplier from whom the kit was purchased.

The parts should be mounted on the chassis in accordance with the top view of the receiver shown on the Schematic Diagram, and the bottom view shown in the Pictorial Wiring Diagram. The order of assembly is of little importance as long as the Range Switch is omitted until the wiring around the RF and Converter sockets, and on the terminal strips mounted under the Range Switch, has been completed.

Before beginning the wiring, temporarily install the gang condenser, dial, and all controls so that their proper shaft lengths may be determined when the receiver is placed in the cabinet intended for it. Mark the shafts for proper lengths and then remove the controls from the chassis and saw each one with its shaft clamped in a vise. It is advisable not to attempt to cut the shaft of any unit while mounted on the chassis, because the heavy strains imposed on the unit may cause damage thereto.

Mount the sockets, taking care that they are installed in the proper places so that the numbers stamped on them will correctly indicate the type of tube to be inserted therein. Observe also that the keyway in the socket is properly oriented, lest it become necessary to remove all of the wires from the socket if it is later found to be reversed. It is advisable also to solder at least one spot (preferably adjacent to a mounting screw) on each socket-saddle to chassis, since many ground connections are made to the lugs on the saddle, and trouble due to poor contact may develop unexpectedly unless a permanent good contact is insured by soldering.

Install the Power Transformer by means of the nuts shipped thereon, observing that the terminals on the transformer are properly placed according to the Pictorial Diagram.

WIRING

Having completed the assembly operations described

above, the actual wiring may start, observing the suggestions given on the sheet "General Construction Hints" packed with each Kit.

After bending down all socket-saddle-ground-lugs not required for wiring, wire the filament circuit complete. The remaining wiring may be installed in any convenient sequence. It will be found a great help in wiring if each wire in the Pictorial Diagram is marked over with a colored pencil as the corresponding wire in the set is installed.

When all wiring has been finished except the leads to the Range Switch, install and wire that item, keeping all wires short and direct, and as well spaced from each other and from metal objects as possible. Connect the five-wire cable of the "Magic Eye" Tuning Indicator to the points shown in the Pictorial Diagram.

VOLTAGE TEST

If all connections are found to be correct, the tubes may be inserted, the line-cord plug connected to a 110-volt 60-cycle receptacle, and the speaker (1500 to 2000-ohm field) plugged in. A slight turn of the tone-control knob to the right will turn on the receiver. After a brief warm-up period the voltages shown on the Schematic Diagram should be checked with a high-resistance voltmeter, if available. Voltages indicated are measured from the point shown, to the chassis, with the chassis as the negative terminal. If values measured are materially different than shown on the diagram, a thorough recheck of the circuit should be made. **Be sure the receiver is turned off and the line-cord disconnected from the power receptacle while the wiring is being checked.**

ALIGNMENT

The I. F. Amplifier is aligned in the usual manner. Connect a service oscillator between the chassis and the grid of the 6AS tube, using a condenser .0005-mfd to .25-mfd between the grid and the high side of the generator output. Do not remove the grid clip for this operation. The Range Switch should be turned to the Broadcast band and the dial set near 600 KC; then proceed with alignment at 456 KC.

Turn the audio Volume Control and Sensitivity Controls on full. Increase the output of the service oscillator until a signal is just audible. Adjust each I. F. trimmer so that maximum volume is obtained. It is best to repeat this procedure two or three times on each trimmer to obtain the most accurate adjustment. These trimmers are adjusted with a small screw-driver through the openings in the top of the shield on each I. F. transformer.

The service oscillator should now be connected to the Antenna and Ground terminals of the receiver, through the proper dummy antenna.

Close the gang condenser and see that the dial pointer position coincides with the last line at the low-frequency end of the dial. If this condition does not obtain, loosen the set-screw on the dial drum, make the necessary correction, and firmly tighten the screw.

Turn the Range Switch to the Short Wave (extreme clockwise) position, set the dial and the service oscillator to 17 MC, connect a 400-ohm resistor between the service oscillator and the antenna binding post as a dummy antenna, turn the output of the service oscillator up to maximum, tighten the top trimmer in the oscillator coil (No. 14-1014) until just snug, then loosen it 4 turns, and then as the trimmer is tightened, set it to the position of maximum response, reducing the output of the service oscillator as alignment proceeds. (If two responses are found of nearly equal intensity, adjust for the one with

the trimmer farthest open). Align the top trimmers in the RF coil, but since the RF adjustment has some effect on the oscillator frequency it will be necessary to rock the dial slightly to keep the signal tuned in. Having aligned the oscillator and RF circuits adjust the top trimmer in the Antenna coil for maximum sensitivity, reducing the output of the service oscillator as the receiver becomes progressively more sensitive. If the receiver tends to "Motor-boat", turn down the service oscillator output until the trouble stops. Some service oscillators, however, leak enough signal that even with the output control set at zero, the receiver is still overloaded, in which case it is necessary to turn down the Sensitivity and Audio controls until the receiver behaves properly.

Turn the Range Switch to the "Police" (middle) range and set the service oscillator and dial at 4.8 MC. Align first the oscillator, then the R. F. and Antenna coils on this band, (lower trimmer on all three coils), in a manner similar to that used on the Short Wave band. Both the Short Wave and Police band ranges have fixed padding condensers.

Turn the Range Switch to the Broadcast (extreme counter-clockwise) position, substitute a 200-mmfd condenser for the 400-ohm resistor as a Dummy Antenna, set the dial and the service oscillator to 1400 KC. and align the circuits again (middle trimmer) in the same manner as described above. Having done this, set the service oscillator to 600 KC and tune the receiver dial for maximum response in the neighborhood of 600 KC. Now, rock the dial back and fourth across the signal. at the same time adjusting the padding condenser, No. 22-7008, turning continuously in one direction until the output of the receiver, as it is rocked across the signal, becomes maximum. If the padder is turned too far, the output will drop off again. A few minutes experiment with this operation will show more than a lengthy description. Having completed the padding operation, return the receiver and the generator to 1400 KC and realign as before. This completes the alignment of the Broadcast Band and of the receiver. The set may then be connected to conventional Antenna and Ground for operation.

Parts Supplied for Construction of 7-Tube Broadcast, Police and Shortwave Receiver

**MODEL
10-1110**

- | | |
|--------------------------------------------------------------------------------------------------------------------------------------------------------------------------------------------------------------------------------------------------------------------------------------------------------------------------------------------------------------------------------------------------------------------------------------------------------------------------------------------------------------------------------------------------------------------------------------------------------------------------------------------------------------------------------------------------------------------------------------------------------------------------------------------------------------------------------------------------------------------------------------------------------------------------------------------------------------------------------------------------------------------------------------------------------------------------------------------------------------------------------------------------------------------------------------------------------------------------------------------------------------------------------------------------------------------------------------------------------------------------------------------------------------------------------------------------------------------------------------------------------------------------------------------------------------------------|--------------------------------------------------------------------------------------------------------------------------------------------------------------------------------------------------------------------------------------------------------------------------------------------------------------------------------------------------------------------------------------------------------------------------------------------------------------------------------------------------------------------------------------------------------------------------------------------------------------------------------------------------------------------------------------------------------------------------------------------------------------------------------------------------------------------------------------------------------------------------------------------------------------------------------------------------------------------------------------------------------------------------------------------------------------------------------------------------------------------------------------------------------------------------------------------------------------------------------------------------------------------------------------------------------------------------------------------------------------------------------------------------------------------------------------------------------------------------|
| <ul style="list-style-type: none"> 1 Calibrated slide-rule dial and escutcheon 1 Set No. 2 screws, nuts and lockwashers 2 6.3-volt dial lights, bayonet base 1 Tuning indicator assembly and cable 1 3-Gang, 450-mmfd. tuning condenser 1 Range Switch, 3-gang, 3-position 1 BC-Pol.-SW band antenna coil, 14-1012 1 BC-Pol.-SW band R. F. coil, 14-1013 1 BC-Pol.-SW band Oscillator coil, 14-1014 1 Ferrocart input I. F. transformer, 16-5740 1 Ferrocart Output I. F. transformer, 16-5742 1 Power transformer, 110-volt 60-cycle 6 Molded bakelite octal tube sockets 1 4-prong wafer socket for speaker 1 Ant-Gnd. terminal strip 1 500,000-ohm volume control 1 25,000-ohm Tone Control and Switch 1 25,000-ohm sensitivity control 1 Adjustable padding condenser, 22-7008 1 .0001-mfd. mica condenser 2 .00025-mmfd. mica condenser 1 .003-mfd. mica condenser 1 .004-mfd. mica condenser 3 .006-mfd., 600-volt paper condenser 5 .05-mfd., 200-volt paper condenser 2 .05-mfd., 400-volt paper condenser 3 .1-mfd., 200-volt paper condenser 1 .1-mfd., 400-volt paper condenser 1 10-mfd., 25-volt electrolytic condenser 1 300-ohm, 1-watt resistor 2 400-ohm, 1/4-watt resistor 1 1000-ohm, 1/4-watt resistor 2 30,000-ohm, 1-watt resistors | <ul style="list-style-type: none"> 1 40,000-ohm, 1/2-watt resistor 2 50,000-ohm, 1/4-watt resistors 2 100,000-ohm, 1/4-watt resistors 2 250,000-ohm, 1/4-watt resistors 2 500,000-ohm, 1/4-watt resistors 1 Mallory bias-cell and holder 2 Tie-lug, single insulated terminal 7 Tie-lugs, two insulated terminals 1 AC line cord and plug 4 Metal tube grid clips 3 Shakeproof soldering lugs 1 Dual 15-mfd. 450-volt electrolytic condenser 1 Condenser mounting plate 5 Black bakelite knobs 2 3/8" Rubber grommets 1 1/4" Rubber grommet 2 No. 6 brass washers 40 No. 6-32 x 1/4" hexagon steel nuts 37 No. 6 steel lockwashers 25 No. 6-32 x 1/4" RH steel screws 4 No. 6-32 x 1" RH black screws 4 Wood panel spacers, 1/2" dia. x 11/16" long 1 Length black insulating sleeving 1 Length rosin-core solder 1 Length No. 20 hook-up wire, black 1 Length No. 20 hook-up wire, red 1 Length No. 20 hook-up wire, white 1 Length No. 20 hook-up wire, blue 1 Length No. 20 hook-up wire, green 1 Length No. 20 hook-up wire, yellow 1 Length No. 20 hook-up wire, orange 1 Length No. 20 stranded wire, green 1 Punched steel chassis, 10" x 12" x 3" |
|--------------------------------------------------------------------------------------------------------------------------------------------------------------------------------------------------------------------------------------------------------------------------------------------------------------------------------------------------------------------------------------------------------------------------------------------------------------------------------------------------------------------------------------------------------------------------------------------------------------------------------------------------------------------------------------------------------------------------------------------------------------------------------------------------------------------------------------------------------------------------------------------------------------------------------------------------------------------------------------------------------------------------------------------------------------------------------------------------------------------------------------------------------------------------------------------------------------------------------------------------------------------------------------------------------------------------------------------------------------------------------------------------------------------------------------------------------------------------------------------------------------------------------------------------------------------------|--------------------------------------------------------------------------------------------------------------------------------------------------------------------------------------------------------------------------------------------------------------------------------------------------------------------------------------------------------------------------------------------------------------------------------------------------------------------------------------------------------------------------------------------------------------------------------------------------------------------------------------------------------------------------------------------------------------------------------------------------------------------------------------------------------------------------------------------------------------------------------------------------------------------------------------------------------------------------------------------------------------------------------------------------------------------------------------------------------------------------------------------------------------------------------------------------------------------------------------------------------------------------------------------------------------------------------------------------------------------------------------------------------------------------------------------------------------------------|

ADDITIONAL PARTS REQUIRED FOR OPERATION

- | | |
|-----------------------------------------------------------------------------------------------------------------------------------------------------|---------------------------------------------------------------------------------------------------------------------------------------------------------------------------------------------------------------------------------------------|
| <ul style="list-style-type: none"> 2 6K7 Metal tubes 1 6A8 Metal tube 1 6Q7 Metal tube 1 6V6 or 6V6G tube | <ul style="list-style-type: none"> 1 5Y4G rectifier tube 1 Dynamic speaker with 4-prong plug; 1500 to 2000 ohms field resistance; output transformer to match single 6V6; power handling capacity, 5 watts minimum. |
|-----------------------------------------------------------------------------------------------------------------------------------------------------|---------------------------------------------------------------------------------------------------------------------------------------------------------------------------------------------------------------------------------------------|

MEISSNER ACCESSORIES AVAILABLE

No. 11-8217 Punched steel panel, black wrinkle finish, 9 1/2" x 14 1/2" x 1/16"

No. 11-8212 Steel Cabinet complete with hinged lid, black wrinkle finish, 9 1/2" x 14 1/2" x 11 1/8" deep.

COMPLETE INSTRUCTIONS
FOR CONSTRUCTION AND OPERATION OF THE



7-Tube Longwave Broadcast and Shortwave Receiver

Model 10-1111

The Meissner No. 10-1111 receiver kit was designed to answer the requirements for a three band receiver of widest utility at low cost. It covers the frequency range 140 KC to 370 KC, 540 to 1580 KC and 5.8 MC to 18.6 MC, thus giving reception of long wave stations popular in Europe for entertainment and in America for weather reports, as well as reception on standard Broadcast and on the popular Short Wave entertainment bands.

It utilizes one stage of Radio Frequency Amplification on all bands, in combination with two high-gain Ferrocart (iron-core) I. F. transformers, giving excellent selectivity and sensitivity over its entire tuning range. A sensitivity control has been provided to adjust the maximum sensitivity of the receiver to an amount commensurate with the prevailing noise level at the place of operation.

The receiver has conventional AVC obtained from a diode second-detector, and is provided with manual volume control and tone control.

Its full-vision, 7-inch slide-rule dial with three scales in different colors, rear illuminated, is very attractive whether installed in an already existing cabinet, or installed in the steel cabinet with front panel, finished in black crackle lacquer, which is available to those who desire a special cabinet for this receiver.

A "Magic-Eye" Cathode Ray tuning indicator is provided as standard equipment.

The accessories required are tubes as listed on the parts list, and a dynamic speaker having a 1500 to 2000 ohm field and output transformer to match a single 6V6 tube.

ASSEMBLY

As the kit is unpacked, all parts should be carefully checked against the packing slip enclosed with the kit. Any discrepancies should be reported at once to the supplier from whom the kit was purchased.

The parts should be mounted on the chassis in accordance with the top view of the receiver shown on the Schematic Diagram, and the bottom view shown in the pictorial Wiring Diagram. The order of assembly is of little importance as long as the range switch is omitted until the wiring around the RF and Converter sockets, and on the terminal strips mounted under the range switch, has been completed.

Note that padding condenser No. 22-5212 has two dissimilar trimmers on one base. The total number of plates in each section must be counted in order to determine which way it should be installed in the receiver in order that it may agree with the Pictorial Diagram. An error here will prevent proper padding of the oscillator circuit. (The easiest way of counting the number of plates without danger of damaging the mica in the condenser is to count the number of soldering lugs projecting through the base at each end of the trimmer, and adding the totals.)

Before beginning the wiring, temporarily install the gang condenser, dial and all controls so that their proper shaft lengths may be determined when the receiver is placed in the cabinet intended for it. Mark the shafts for proper lengths and then remove the controls from the chassis and saw each one with its shaft clamped in a vice. It is advisable not to attempt to cut the shaft of any unit while mounted on the chassis, because the heavy strains imposed on the unit may cause damage thereto.

Mount the sockets, taking care that they are installed in the proper places so that the numbers stamped on them will correctly indicate the type of tube to be installed therein. Observe also that the keyway in the socket is properly orient-

ed, lest it become necessary to remove all of the wires from the socket if it is later found to be reversed. It is advisable also to solder at least one spot (preferably adjacent to a mounting screw) on each socket-saddle to chassis, since many ground connections are made to the lugs on the saddle, and trouble due to poor contact may develop unexpectedly unless a permanent good contact is insured by soldering.

Install the power transformer by means of the nuts shipped thereon, observing that the terminals on the transformer are properly placed according to the Pictorial Diagram.

WIRING

Having completed the assembly operations described above, the actual wiring may start, observing the suggestions given on the sheet "General Construction Hints" packed with each Kit.

After bending down all socket-saddle-ground-lugs not required for wiring, wire the filament circuit complete. The remaining wiring may be installed in any convenient sequence, as long as the range switch is not installed until all of the necessary leads have been attached to the coils first. Note: There are a few lugs on the switch to which no connections are to be made; these are marked NC. It will be found a great help in wiring if each wire in the Pictorial Diagram is marked over with a colored pencil as the corresponding wire in the set is installed.

When all wiring has been finished except the leads to the range switch, install and wire that item, keeping all wires short and direct, and as well spaced from each other and from metal objects as possible.

VOLTAGE TEST

If all connections are found to be correct, the tubes may be inserted, the line-cord plug connected to a 110-volt, 60-cycle receptacle, and the speaker (1500 to 2000 ohm field) plugged in. A slight turn of the tone-control knob to the right will turn on the receiver. After a brief warm-up period the voltages shown on the Schematic Diagram should be checked with a high-resistance voltmeter, if available. Voltages indicated are measured from the point shown, to the chassis, with the chassis as the negative terminal. If values measured are materially different than shown on the diagram, a thorough recheck of the circuit should be made. **Be sure the receiver is turned off and the line-cord disconnected from the power receptacle while the wiring is being checked.**

ALIGNMENT

The I. F. amplifier is aligned in the usual manner. Connect a service oscillator between the chassis and the grid of the 6A8 tube, using a condenser .0005 mfd to .25 mfd, between the grid and the high side of the generator output. Do not remove the grid clip for this operation. The range switch should be turned to the broadcast band, and the dial set near 600 KC; then proceed with alignment at 456KC.

Turn the audio volume control and sensitivity controls on full. Increase the output of the service oscillator until the signal is just audible. Adjust each I. F. trimmer so that maximum volume is obtained. It is best to repeat this procedure two or three times on each trimmer to obtain the most accurate adjustment. These trimmers are adjusted with a small screwdriver through the opening in the top of the shield on each I. F. transformer.

The service oscillator should now be connected to the antenna and ground terminals of the receiver, through the proper dummy antenna.

Close the gang condenser and see that the dial pointer position coincides with the last line at the low-frequency end of the dial. If this condition does not obtain, loosen the set-screw on the dial drum, make the necessary correction and firmly tighten the screw.

Turn the range switch to the Short Wave (extreme clockwise) position, set the dial and the service oscillator to 16 MC, connect a 400-ohm resistor between the service oscillator and the antenna binding post as a dummy antenna, turn the output of the service oscillator up to maximum, tighten the top trimmer in the oscillator coil (No. 14-1017) until just snug, then loosen it 4 turns, and then, as the trimmer is tightened, set it to the position of maximum response, reducing the output of the service oscillator as alignment proceeds. (If two responses are found of nearly equal intensity, adjust for the one with the trimmer farthest open.) Having aligned the oscillator, adjust the top trimmer in the antenna coil for maximum sensitivity, reducing the output of the service oscillator as the receiver becomes progressively more sensitive. (Align the top trimmer in the RF coil, rocking the dial slightly to keep the signal tuned in, since the RF adjustment has some effect on the oscillator frequency.) If the receiver tends to "motor-boat" turn down the service oscillator output until the trouble stops. Some service oscillators, however, leak enough signal that even with the output control set at zero, the receiver is still overloaded, in which case it is necessary to turn down the sensitivity and audio controls until the receiver behaves properly.

Turn the range switch to the broadcast position, substitute a 200-mmfd. condenser for the 400-ohm resistor as a Dummy

Antenna, set the dial and the service oscillator to 1400 KC, and align the circuits again (*middle* trimmers) in the same manner as described above. Having done this, set the service oscillator to 600 KC and tune the receiver dial for maximum response in the neighborhood of 600 KC. Now rock the dial back and forth across the signal, at the same time adjusting the 6-plate side of the padding condenser, turning continuously in one direction until the output of the receiver, as it is rocked across the signal, becomes maximum. If the padder is turned too far, the output will drop off again. A few minutes experiment with this operation will show more than a lengthy description. Having completed the padding operation, return the receiver and the generator to 1400 KC and realign as before. This completes the alignment of the Broadcast Band.

Turn the range switch to the Long Wave position, set the dial and the service oscillator to 150 KC and adjust the 4-plate padding condenser for maximum response. Now set the service oscillator and the receiver dial to 340 KC and align the bottom trimmer of the oscillator, followed by the antenna and RF trimmers as described above. Re-pad at 150 KC, and realign at 340 KC. It is necessary to carry out the re-alignment exactly as described because on the Long Wave band the padding and aligning adjustments are interacting far more than on the broadcast band where they are almost independent.

Because of interaction of one adjustment on another, it is advisable to repeat the entire alignment process after finishing the first alignment. Both alignments must be made in the order given above.

Parts Supplied for Construction of 7-Tube Longwave, Broadcast and Shortwave Receiver

MODEL
10-1111

- | | |
|-----------------------------------------------|------------------------------------------------|
| 1 Calibrated slide-rule dial and escutcheon | 2 50,000-ohm, 1/4-watt resistors |
| 1 Set No. 2 screws, nuts and lockwashers | 2 100,000-ohm, 1/4-watt resistors |
| 2 6.3-volt dial lights, bayonet base | 2 250,000-ohm, 1/4-watt resistors |
| 1 Tuning indicator assembly and cable | 2 500,000-ohm, 1/4-watt resistors |
| 1 3-gang, 365 mmfd. tuning condenser | 1 Mallory bias-cell and holder |
| 1 Range Switch, 3-gang, 3-position | 1 Tie-lug, single insulated terminal |
| 1 LW-BC-SW band antenna coil, 14-1015 | 7 Tie-lugs, two insulated terminals |
| 1 LW-BC-SW band R. F. coil, 14-1016 | 1 AC line cord and plug |
| 1 LW-BC-SW band Oscillator coil, 14-1017 | 4 Metal tube grid clips |
| 1 Ferrocart input I. F. transformer, 16-5740 | 3 Shakeproof soldering lugs |
| 1 Ferrocart Output I. F. transformer, 16-5742 | 1 Dual 15-mfd. 450-volt electrolytic condenser |
| 1 Power transformer, 110-volt 60-cycle | 1 Condenser mounting plate |
| 6 Molded bakelite octal tube sockets | 5 Black bakelite knobs |
| 1 4-prong wafer socket for speaker | 2 3/4" Rubber grommets |
| 1 Ant-Gnd. terminal strip | 1 1/4" Rubber grommet |
| 1 500,000-ohm volume control | 2 No. 6 brass washers |
| 1 25,000-ohm Tone Control and Switch | 40 No. 6-32 x 1/4" hexagon steel nuts |
| 1 25,000-ohm sensitivity control | 40 No. 6 steel lockwashers |
| 1 Adjustable padding condenser, 22-5212 | 25 No. 6-32 x 1/4" RH steel screws |
| 1 .0001-mfd. mica condenser | 4 No. 6-32 x 1" RH black screws |
| 3 .00025-mfd. mica condenser | 4 Wood panel spacers, 1/2" dia. x 11/16" long |
| 1 .003-mfd. mica condenser | 1 Length black insulating sleeving |
| 3 .006-mfd., 600-volt paper condenser | 1 Length rosin-core solder |
| 5 .05-mfd., 200-volt paper condenser | 1 Length No. 20 hook-up wire, black |
| 2 .05-mfd., 400-volt paper condenser | 1 Length No. 20 hook-up wire, red |
| 3 .1-mfd., 200-volt paper condenser | 1 Length No. 20 hook-up wire, white |
| 1 .1-mfd., 400-volt paper condenser | 1 Length No. 20 hook-up wire, blue |
| 1 10-mfd., 25-volt electrolytic condenser | 1 Length No. 20 hook-up wire, green |
| 1 300-ohm, 1-watt resistor | 1 Length No. 20 hook-up wire, yellow |
| 2 400-ohm, 1/4-watt resistor | 1 Length No. 20 hook-up wire, orange |
| 1 1000-ohm, 1/4-watt resistor | 1 Length No. 20 stranded wire, green |
| 2 30,000-ohm, 1-watt resistors | 1 Punched steel chassis, 10" x 12" x 3" |
| 1 40,000-ohm, 1/2-watt resistors | |

ADDITIONAL PARTS REQUIRED FOR OPERATION

- | | |
|--------------------|------------------------------------------------------------------------------------------------------------------------------------------------------------|
| 2 6K7 Metal tubes | 1 5Y4G rectifier tube |
| 1 6A8 Metal tube | 1 Dynamic speaker with 4-prong plug; 1500 to 2000 ohms field resistance; output transformer to match single 6V6; power handling capacity, 5 watts minimum. |
| 1 6Q7 Metal tube | |
| 1 6V6 or 6V6G tube | |

MEISSNER ACCESSORIES AVAILABLE

No. 11-8217 Punched steel panel, black wrinkle finish,
9 1/2" x 14 1/2" x 1/16".

No. 11-8212 Steel Cabinet complete with hinged lid, black wrinkle finish, 9 1/2" x 14 1/2" x 11 1/8" deep.

No. 10-1111
SCHEMATIC
CIRCUIT DIAGRAM

LW, BC & SKIP
7 Tube Superheterodyne Receiver

140 kc to 370kc, 540kc to 1580kc, 5.8mc to 18.6mc

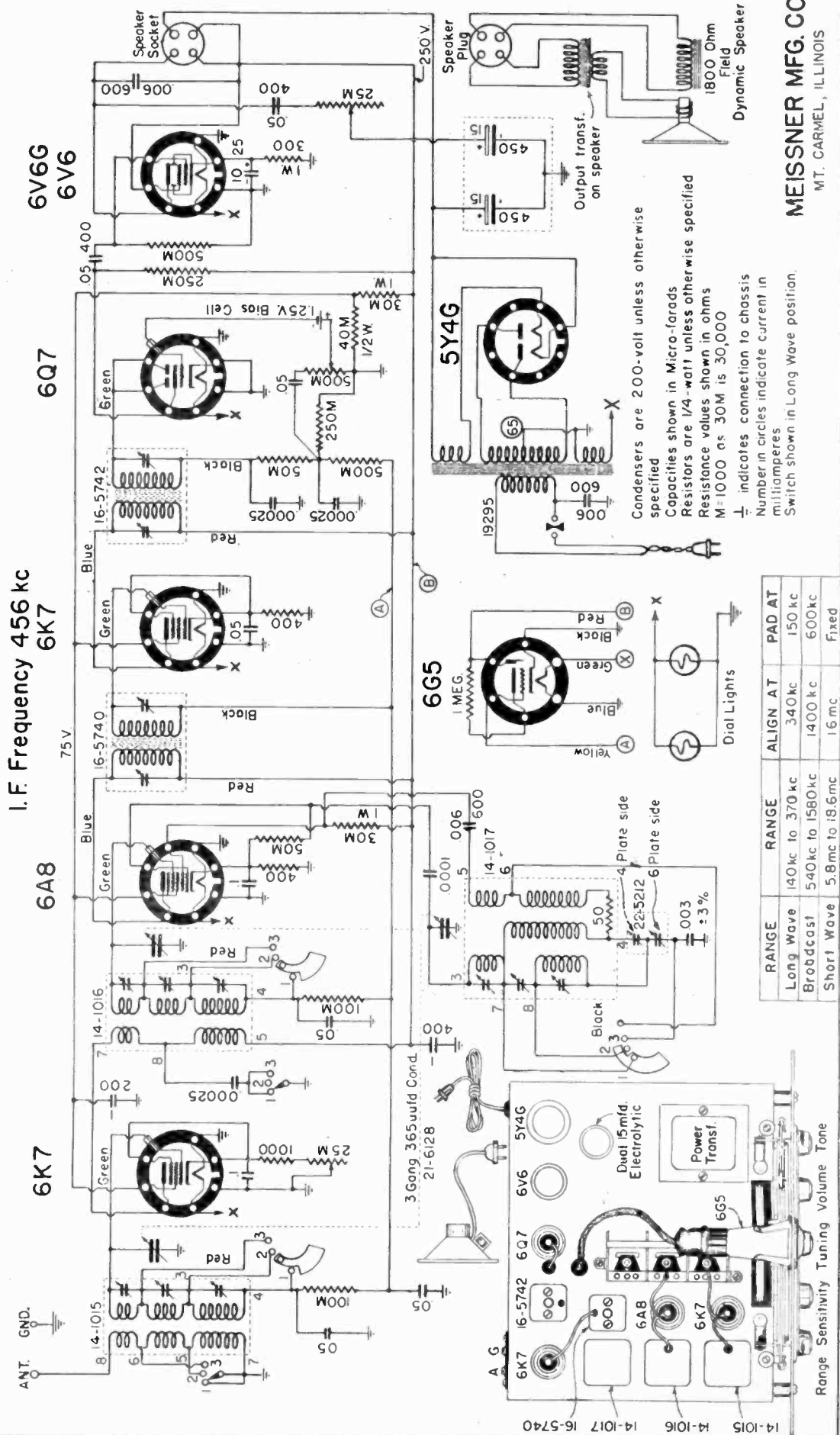

RANGE	RANGE	ALIGN AT	PAD AT
Long Wave	140kc to 370kc	340kc	150kc
Broadcast	540kc to 1580kc	1400kc	600kc
Short Wave	5.8mc to 18.6mc	16. mc	Fixed

MEISSNER MFG. CO.
MT. CARMEL, ILLINOIS

Range Sensitivity Tuning Volume Tone

10-1111
PICTORIAL
WIRING DIAGRAM

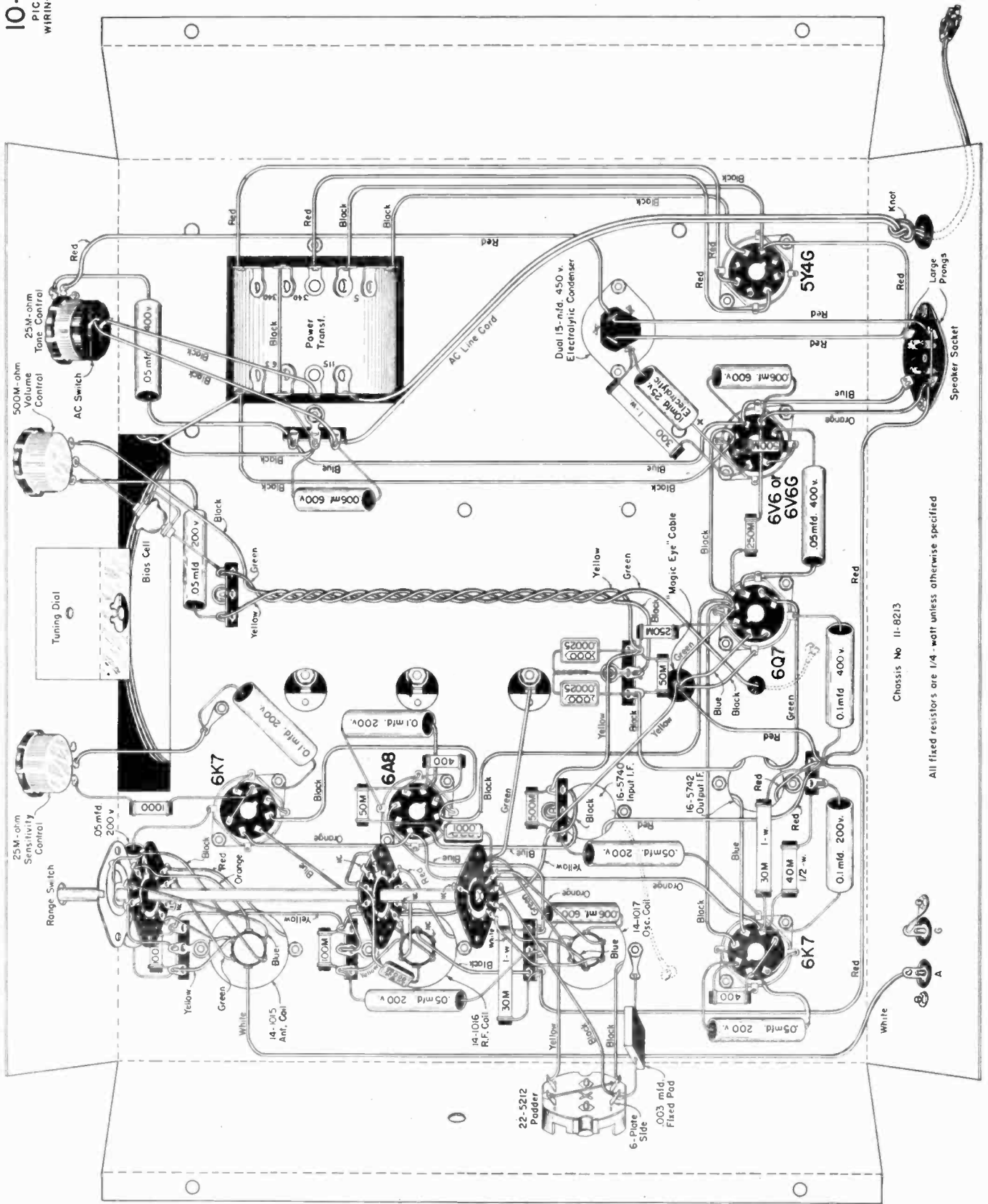

Chassis No 11-8213

All fixed resistors are 1/4-watt unless otherwise specified

COMPLETE INSTRUCTIONS
FOR CONSTRUCTION AND OPERATION OF THE



6-Volt Battery Broadcast Receiver

6-tube Superheterodyne Model 10-1107

The Meissner No. 10-1107 receiver kit was designed to answer the requirements for a simple receiver of excellent performance in the broadcast range operating from a 6-volt storage battery.

It utilizes one stage of Radio Frequency Amplification in combination with two high-gain Ferrocart (iron-core) I. F. transformers, giving excellent selectivity and sensitivity over its entire tuning range. "B" power for the receiver is obtained from a conventional type vibrator power supply exhibiting unusually low vibrator "Hash".

The receiver has conventional AVC obtained from a diode second-detector, and is provided with manual volume control and tone control.

Its full-vision, 7-inch slide-rule three-color dial, is very attractive whether installed in an already existing cabinet, or installed in the steel cabinet with front panel, finished in black crackled lacquer, which is available to those who desire a special cabinet for the receiver.

The accessories required are tubes as listed on the parts list, and a permanent-magnet dynamic speaker having an output transformer to match a single 6G6G tube (10,000 ohms).

ASSEMBLY

As the kit is unpacked, all parts should be carefully checked against the packing slip enclosed with the kit. Any discrepancies should be reported at once to the supplier from whom the kit was purchased.

The parts for the receiver should be mounted on the chassis in accordance with the top view of the receiver shown on the Schematic Diagram, and the bottom view shown in the Pictorial Wiring Diagram. The parts for the power supply should be assembled in accordance with the separate diagram for that unit. The completed power unit can then be assembled onto the main chassis and connected thereto.

Before beginning the wiring, temporarily install the gang condenser, dial and both controls so that their proper shaft lengths may be determined when the receiver is placed in the cabinet intended for it. Mark the shafts for proper lengths and then remove the controls from the chassis and saw each one with its shaft clamped in a vise. It is advisable not to attempt to cut the shaft of any unit while mounted on the chassis, because the heavy strains imposed on the unit may cause damage thereto.

Dial lights are provided. If there is an adequate supply of power they may be connected but if battery drain is important, the dial lights may be discarded.

It may appear that greater battery economy could be obtained if tubes drawing 150 MA each were to be used in place of the tubes shown, most of which draw 300 MA each on the filament but tests have shown that if the low filament current tubes are used the "B" power must be increased to offset the limited performance of the latter tubes and this increased "B" power results in higher vibrator current almost equal to the difference in filament power. For this reason the better tubes at higher filament current were chosen.

Mount the sockets, taking care that they are installed in the proper places so that the number stamped on the sockets will correctly indicate the type of tube to be installed therein. Observe also that the keyway in the socket is properly oriented, lest it become necessary to remove all of the wires from the socket if it is later found to be

reversed. It is advisable also to solder at least one spot (preferably adjacent to a mounting screw) on each socket saddle to chassis, since many ground connections are made to the lugs on the saddle, and trouble due to poor contact may develop unexpectedly unless a permanent good contact is insured by soldering.

WIRING

Having completed the assembly operations described above, the actual wiring may start, observing the suggestions given on the sheet "General Construction Hints" packed with each Kit.

After bending down all socket-saddle-ground-lugs not required for wiring, wire the filament circuit complete. The remaining wiring may be installed in any convenient sequence. It will be found a great help in wiring if each wire in the Pictorial Diagram is marked over with a colored pencil as the corresponding wire in the set is installed.

The first step in wiring the power unit is the removal of the black crackle lacquer from the chassis over the area covered by the vibrator grounding clip in the following manner:

Temporarily assemble the clip to the chassis, mark around it with a pencil or scratch around it with a sharp pointed instrument, then take off the clip and remove the paint with a sharp knife, taking care not to remove the finish too far back from the hole lest it present an unsightly appearance.

The remainder of the assembly follows ordinary practice of kit assembly in accordance with the Pictorial Wiring Diagram. It is to be noted that the parts are all drawn in reduced size for sake of clarity, and that the physical elements will not have as much space between and around them as shown in the Pictorial Diagram. As a consequence it may require a little study to discover which end of each condenser to solder first where the units are close together. It is especially important to have good soldered connections in the Power Unit and that all condenser leads are as short as possible. Long condenser leads may give rise to vibrator "Hash" that is very objectionable when listening to weak signals.

It will be noticed that several pieces of No. 14 enameled wire are specified in the Pictorial Wiring Diagram. The wire should be scraped with a knife until all enamel has been removed from the point of soldering, so that the wire will "Tin" easily.

When the power unit is completely wired, assemble the bottom on the unit and mount the complete Power Unit on the receiver chassis by means of the assembly of washers, screws, nuts and grommets shown in the Pictorial Diagram. Make the connections to the receiver as shown in the Pictorial Wiring Diagram of the receiver.

VOLTAGE TEST

If all connections are found to be correct, the tubes may be inserted, the power cord connected to a 6-volt storage battery, and the speaker plugged in. The polarity of connection is not important as the receiver will work equally well with either polarity of connections. A slight turn of the tone-control knob to the right will turn on the receiver. After a brief warm-up period the voltages shown on the Schematic Diagram should be checked with a high-resistance voltmeter, if available. Voltages indicated are

measured from the point shown, to the chassis, with the chassis as the negative terminal. If values measured are materially different than shown on the diagram, a thorough recheck of the circuit should be made. **Be sure the receiver is turned off and the power cord disconnected from the storage battery while the wiring is being checked.**

ALIGNMENT

The I. F. amplifier is aligned in the usual manner. Connect a service oscillator between the chassis and the grid of the 6A8 tube, using a condenser .0005 mfd to .25 mfd. between the grid and the high side of the generator output. Do not remove the grid clip for this operation. Set the dial near 600 KC, and proceed with alignment at 456 KC.

Turn the audio volume control on full. Increase the output of the service oscillator until a signal is just audible. Adjust each I. F. trimmer so that maximum volume is obtained. It is best to repeat this procedure two or three time on each trimmer to obtain the most accurate adjustment. These trimmers are adjusted with a small screwdriver through the openings in the top of the shield on each I. F. transformer. The output of the service oscillator should be decreased as alignment proceeds.

The service oscillator should now be connected to the antenna and ground terminals of the receiver, with a 200-mmf condenser between the antenna terminal and the high side of the service oscillator.

Close the gang condenser and check the dial pointer position. If it is not on the last line at the low frequency end of the dial, loosen the set screw in the dial drum and make the necessary correction, firmly tightening the screw.

Set the dial and the service oscillator to 1400 KC and adjust the trimmer on the rear section of the gang condenser for maximum output, reducing the generator output as alignment proceeds. Follow this adjustment by similar adjustments on the middle and front sections of the gang condenser. After this is done the service oscillator should be set at 600 KC and the signal tuned in on the receiver. The oscillator padding condenser should be turned slowly in one direction while the gang condenser is rocked back and forth across the signal until a maximum is obtained. It is advisable now, to return to 1400 KC and re-align at that point.

The set may then be connected to Antenna and ground for operation. It is essential that both be used.

BATTERY CHARGING

The storage battery can be kept charged by using a wind driven generator such as the "Windcharger" or equivalent. If such a device is used it should be installed in accordance with the instructions furnished by the manufacturer and leads run to the storage battery which should be located near the receiver.

**Parts Supplied for Construction of
6-Tube Broadcast 6-volt Receiver**

**MODEL
10-1107**

- | | |
|--------------------------------------------------------------------------------------------------------------------------------------------------------------------------------------------------------------------------------------------------------------------------------------------------------------------------------------------------------------------------------------------------------------------------------------------------------------------------------------------------------------------------------------------------------------------------------------------------------------------------------------------------------------------------------------------------------------------------------------------------------------------------------------------------------------------------------------------------------------------------------------------------------------------------------------------------------------------------------------------------------------------------------------------------------------------------------------------------------------------------------------------------------------------------------------------------------------------------------------------------------------------------------------------------------------------------------------------------------------------------------------------------------------------------------------------------------------------------------------------------|--------------------------------------------------------------------------------------------------------------------------------------------------------------------------------------------------------------------------------------------------------------------------------------------------------------------------------------------------------------------------------------------------------------------------------------------------------------------------------------------------------------------------------------------------------------------------------------------------------------------------------------------------------------------------------------------------------------------------------------------------------------------------------------------------------------------------------------------------------------------------------------------------------------------------------------------------------------------------------------------------------------------------------------------------------------------------------------------------------------------------------------------------------------------------------------------------------------------------------------------------------------------------------------------------------------------------------------------------------------------------------------------------|
| <ul style="list-style-type: none"> 1 Calibrated slide-rule dial and escutcheon 1 Set No. 2 screws, nuts and lockwashers 2 6.3-volt dial lights, bayonet base. 1 3-Gang, 365 mfd, tuning condenser 1 BC band Antenna Coil, 14-1004 1 BC band R. F. Coil, 14-1005 1 BC band Oscillator Coil, 14-4243 1 Ferrocart input I. F. transformer, 16-5740 1 Ferrocart output I. F. transformer, 16-5742 1 Vibrator Power Supply Unit No. 10-1120 5 Molded bakelite octal tube sockets. 1 4-prong wafer socket for speaker 1 4-prong male receptacle 1 Ant-Gnd. terminal strip 1 500,000-ohm volume control 1 25,000-ohm Tone Control with DPST Switch 1 Adjustable padding condenser, 22-7006 2 .0001-mfd. mica condensers 2 .00025-mfd. mica condensers 1 .002-mfd. Mica condenser 6 .05-mfd., 200-volt paper condensers 2 .05-mfd., 400-volt paper condensers 2 .1-mfd., 200-volt paper condensers 1 .1-mfd., 400-volt paper condenser 1 10-mfd., 25-volt electrolytic condenser 1 300-ohm 1/4-watt resistor 1 500-ohm 1/4-watt resistor 1 600-ohm 1/2-watt resistor 1 20,000-ohm 1/2-watt resistor 1 30,000-ohm, 1-watt resistor 1 40,000-ohm, 1/2-watt resistor 2 50,000-ohm, 1/4-watt resistors | <ul style="list-style-type: none"> 2 100,000-ohm, 1/4-watt resistors 2 250,000-ohm, 1/4-watt resistors 2 500,000-ohm, 1/4-watt resistors 1 Mallory bias-cell and holder 2 Tie-lugs, single insulated terminal 5 Tie-lugs, two insulated terminals 1 Tie-lug, three insulated terminals 1 Battery cord & plug assembly 4 Metal tube grid clips 1 Shakeproof soldering lug 3 Black bakelite knobs 1 1/4" rubber grommet 4 No. 6 brass washers 37 No. 6-32 x 1/4" hexagon steel nuts 38 No. 6 steel lockwashers 23 No. 6-32 x 1/4" RH steel screws 4 No. 6-32 x 1" RH black screws 4 Wood panel spacers, 1/2" dia. x 11-16" long 1 Length black insulating sleeving 1 Length rosin-core solder 1 Length No. 20 hook-up wire, black 1 Length No. 20 hook-up wire, red 1 Length No. 14 enameled wire 1 Length No. 20 Shielded wire 1 Length No. 20 hook-up wire, white 1 Length No. 20 hook-up wire, blue 1 Length No. 20 hook-up wire, green 1 Length No. 20 hook-up wire, yellow 1 Length No. 20 hook-up wire, orange 1 Length No. 20 stranded wire, green 1 Punched steel chassis, 10" x 12" x 3" |
|--------------------------------------------------------------------------------------------------------------------------------------------------------------------------------------------------------------------------------------------------------------------------------------------------------------------------------------------------------------------------------------------------------------------------------------------------------------------------------------------------------------------------------------------------------------------------------------------------------------------------------------------------------------------------------------------------------------------------------------------------------------------------------------------------------------------------------------------------------------------------------------------------------------------------------------------------------------------------------------------------------------------------------------------------------------------------------------------------------------------------------------------------------------------------------------------------------------------------------------------------------------------------------------------------------------------------------------------------------------------------------------------------------------------------------------------------------------------------------------------------|--------------------------------------------------------------------------------------------------------------------------------------------------------------------------------------------------------------------------------------------------------------------------------------------------------------------------------------------------------------------------------------------------------------------------------------------------------------------------------------------------------------------------------------------------------------------------------------------------------------------------------------------------------------------------------------------------------------------------------------------------------------------------------------------------------------------------------------------------------------------------------------------------------------------------------------------------------------------------------------------------------------------------------------------------------------------------------------------------------------------------------------------------------------------------------------------------------------------------------------------------------------------------------------------------------------------------------------------------------------------------------------------------|

ADDITIONAL PARTS REQUIRED FOR OPERATION

- | | |
|---------------------------------------------------------------------------------------------------------------------------------------------------------------|-----------------------------------------------------------------------------------------------------------------------------------------------------------------------------------------|
| <ul style="list-style-type: none"> 2 6K7 Metal tubes 1 6A8 Metal tube 1 6Q7 Metal tube 1 6G6G Octal-base Glass tube | <ul style="list-style-type: none"> 1 6X5 Rectifier tube 1 PM-Dynamic or Magnetic speaker with 4-prong plug; Output transformer on PM type to match single 6G6G. |
|---------------------------------------------------------------------------------------------------------------------------------------------------------------|-----------------------------------------------------------------------------------------------------------------------------------------------------------------------------------------|

MEISSNER ACCESSORIES AVAILABLE

- | | |
|------------------------------------------------------------------------------------------------------------------------------------|--------------------------------------------------------------------------------------------------------------------------------------------------------------|
| <ul style="list-style-type: none"> No. 11-8216 Punched steel panel, black wrinkle finish, 9 1/2" x 14 1/2" x 1/16". | <ul style="list-style-type: none"> No. 11-8212 Steel Cabinet complete with hinged lid, black wrinkle finish, 9 1/2" x 14 1/2" x 11 1/8" deep. |
|------------------------------------------------------------------------------------------------------------------------------------|--------------------------------------------------------------------------------------------------------------------------------------------------------------|

No. 10-1107

BROADCAST "6"

6V. Metal Tube Superheterodyne

6K7

6A8

6K7

6Q7

6G6G

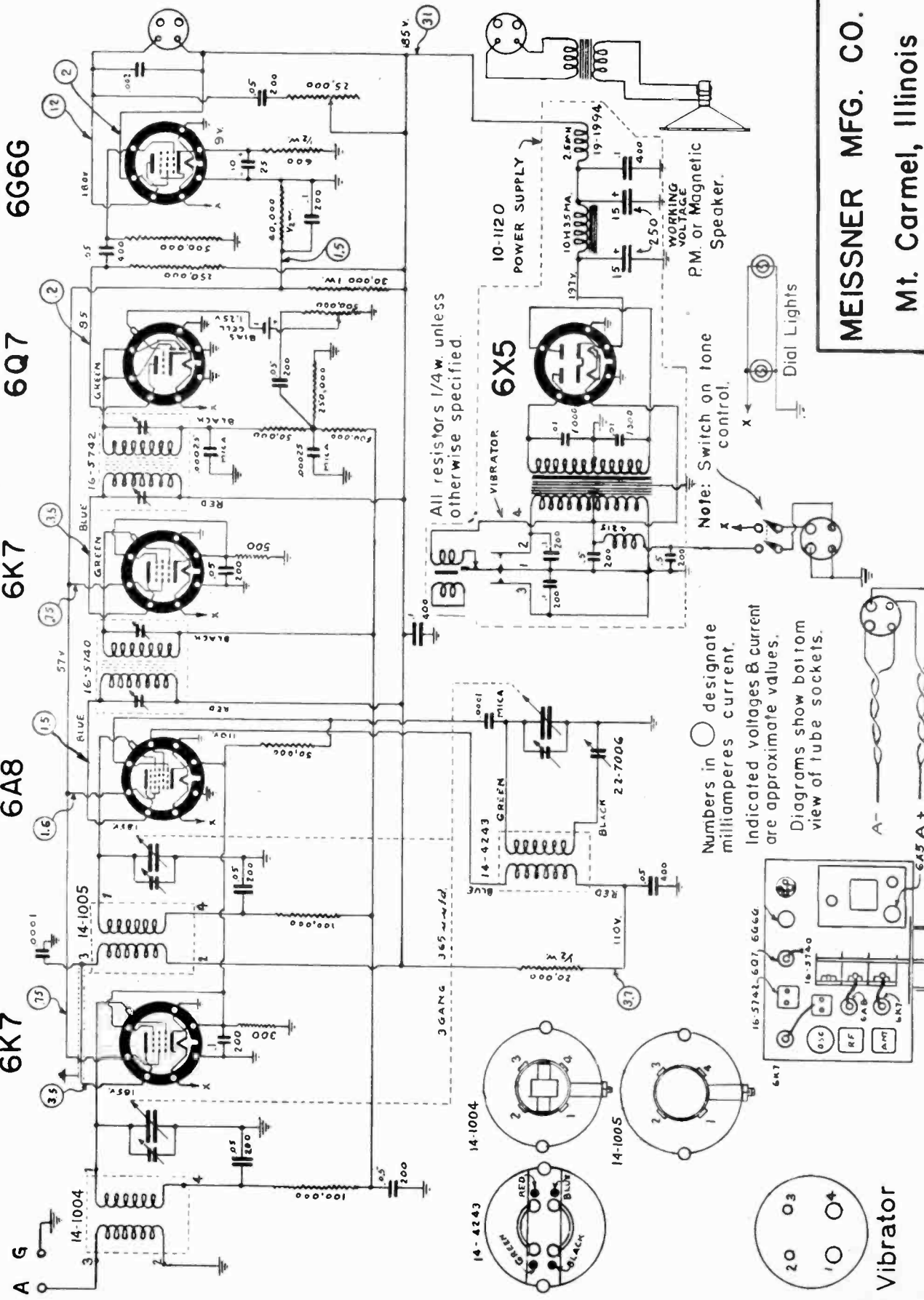

Numbers in \bigcirc designate milliamperes current.
 Indicated voltages & current are approximate values.
 Diagrams show bottom view of tube sockets.

Note: Switch on tone control.

MEISSNER MFG. CO.
 Mt. Carmel, Illinois

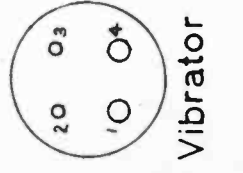
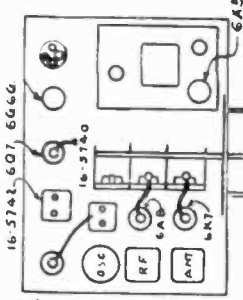

COMPLETE INSTRUCTIONS
FOR CONSTRUCTION AND OPERATION OF



6-Volt Broadcast & Shortwave Receiver

6-tube Superheterodyne Model 10-1108

The Meissner No. 10-1108 receiver kit was designed to answer the requirements for a receiver covering the American Broadcast Band and the Short-Wave entertainment bands operating from a 6-volt storage battery. It covers the frequency range 540 KC to 1600 KC, and 5.9 MC to 18.8 MC.

It utilizes one stage of Radio Frequency Amplification on both bands, in combination with two high-gain Ferrocart (iron-core) I. F. transformers, giving excellent selectivity and sensitivity over its entire tuning range. A sensitivity control has been provided to adjust the maximum sensitivity of the receiver to an amount commensurate with the prevailing noise level at the place of operation. "B" power for the receiver is obtained from a conventional type vibrator power supply exhibiting unusually low vibrator "hash".

The receiver has conventional AVC obtained from a diode second detector, and is provided with manual volume control and tone control.

Its full-vision, 7-inch slide-rule dial with three scales (one a 0-100) in different colors, is very attractive whether installed in an already existing cabinet, or installed in the steel cabinet with front panel finished in black crackled lacquer which is available to those who desire a special cabinet for this receiver.

The accessories required are tubes as listed on the parts list, and a permanent magnet dynamic speaker having an output transformer to match a single 6G6G tube.

ASSEMBLY

As the kit is unpacked, all parts should be carefully checked against the packing slip enclosed with the kit. Any discrepancies should be reported at once to the supplier from whom the kit was purchased.

The parts should be mounted on the chassis in accordance with the top view of the receiver shown on the Schematic Diagram, and the bottom view shown in the Pictorial Wiring Diagram. The order of assembly is of little importance as long as the range switch is omitted until the wiring around the RF and Converter sockets, and on the terminal strips mounted under the range switch, has been completed. The parts for the power supply should be assembled in accordance with the separate diagram for that unit. The complete power unit can then be assembled onto the main chassis and connected thereto.

Before beginning the wiring, temporarily install the gang condenser, dial and all controls so that their proper shaft lengths may be determined when the receiver is placed in the cabinet intended for it. Mark the shafts for proper lengths and then remove the controls from the chassis and saw each one with its shaft clamped in a vise. It is advisable not to attempt to cut the shaft of any unit while mounted on the chassis, because the heavy strains imposed on the unit may cause damage thereto.

Dial lights are provided. If there is an adequate supply of power they may be connected but if battery drain is important the dial lights may be discarded.

It may appear that greater battery economy could be obtained if tubes drawing 150 MA each were to be used in place of the tubes shown, most of which draw 300 MA each on the filament, but tests have shown that if the low-filament-current tubes are used, the "B" power must be increased to offset the limited performance of the latter tubes, and this increased "B" power results in higher vibrator current almost equal to the difference in filament power. For this reason the better tubes at higher filament current were chosen.

Mount the sockets, taking care that they are installed in the proper places so that the numbers stamped on them will correctly indicate the type of tube to be installed therein. Observe also that the keyway in the socket is properly oriented, lest it become necessary to remove all of the wires from the socket if it is later found to be reversed. It is advisable also to solder at least one spot (preferably adjacent to a mounting screw) on each socket

saddle to chassis, since many ground connections are made to the lugs on the saddle, and trouble due to poor contact may develop unexpectedly unless a permanent good contact is insured by soldering.

WIRING

Having completed the assembly operations described above, the actual wiring may start, observing the suggestions given on the sheet "General Construction Hints" packed with each Kit.

After bending down all socket-saddle-ground-lugs not required for wiring, wire the filament circuit complete. The remaining wiring may be installed in any convenient sequence. It will be found a great help in wiring if each wire in the Pictorial Diagram is marked over with a colored pencil as the corresponding wire in the set is installed.

When all wiring has been finished except the leads to the range switch, install and wire that item, keeping all wires short and direct, and as well spaced from each other and from metal objects as possible.

The first step in wiring the power unit is the removal of the black crackle lacquer from the chassis over the area covered by the vibrator grounding clip in the following manner:

Temporarily assemble the clip to the chassis, mark around it with a pencil or scratch around it with a sharp pointed instrument, then take off the clip and remove the paint with a sharp knife, taking care not to remove the finish too far back from the hole lest it present an unsightly appearance.

The remainder of the assembly follows ordinary practice of kit assembly in accordance with the Pictorial Wiring Diagram. It is to be noted that the parts are all drawn in reduced size for sake of clarity and that the physical elements will not have as much space between and around them as shown in the Pictorial Diagram. As a consequence, it may require a little study to discover which end of each condenser to solder first where the units are close together. It is especially important to have good soldered connections in the Power Unit and that all condenser leads are as short as possible. Long condenser leads may give rise to vibrator "Hash" that is very objectionable when listening to weak signals.

It will be noticed that several pieces of No. 14 enameled wire are specified in the Pictorial Wiring Diagram. The wire should be scraped with a knife until all enamel has been removed from the point of soldering, so that the wire will "Tin" easily.

When the power unit is completely wired, assemble the bottom on the unit and mount the complete Power Unit on the receiver chassis by means of the assembly of washers, screws, nuts, and grommets shown in the Pictorial Wiring Diagram. Make the connections to the receiver as shown in the Pictorial Wiring Diagram of the receiver.

VOLTAGE TEST

If all connections are found to be correct, the tubes may be inserted, the power-cord connected to a 6-volt storage battery, and the speaker plugged in. The polarity of connection is not important as the receiver will work equally well with either polarity of connection. A slight turn of the tone-control knob to the right will turn on the receiver. After a brief warm-up period the voltages shown on the Schematic Diagram should be checked with a high-resistance voltmeter, if available. Voltages indicated are measured from the point shown, to the chassis, with the chassis as the negative terminal. If values measured are materially different than shown on the diagram, a thorough recheck of the circuit should be made. Be sure the receiver is turned off and the power cord disconnected from the storage battery while the wiring is being checked.

ALIGNMENT

The I. F. amplifier is aligned in the usual manner. Connect a service oscillator between the chassis and the grid of the 6A8 tube, using a condenser .0005 mfd to .25 mfd

between the grid and the high side of the generator output. Do not remove the grid clip for this operation. The range switch should be turned to the broadcast band, and the dial set near 600 KC; then proceed with alignment at 456 KC.

Turn the audio volume control and sensitivity controls on full. Increase the output of the service oscillator until a signal is just audible. Adjust each I. F. trimmer so that maximum volume is obtained. It is best to repeat this procedure two or three times on each trimmer to obtain the most accurate adjustment. These trimmers are adjusted with a small screw-driver through the opening in the top of the shield on each I. F. transformer.

The service oscillator should now be connected to the antenna and ground terminals of the receiver, through the proper dummy antenna.

Close the gang condenser and see that the dial pointer position coincides with the last line at the low-frequency end of the dial. If this condition does not obtain, loosen the set-screw on the dial drum, make the necessary correction and firmly tighten the screw.

Turn the range switch to the Short-Wave (extreme clockwise) position, set the dial and the service oscillator to 16 MC. connect a 400-ohm resistor between the service oscillator and the antenna binding post as a dummy antenna, turn the output of the service oscillator up to maximum, tighten the top trimmer in the oscillator coil (No. 14-7480) until just snug, then loosen it 4 turns, and then, as the trimmer is tightened, set it to the position of maximum response, reducing the output of the service oscillator as alignment proceeds. (If two responses are found of nearly equal intensity, adjust for the one with the trimmer farthest open.) Now align the RF trimmer, but since the RF adjustment has a slight effect upon the oscillator frequency, it will be necessary to rock the tuning condenser slightly to keep the signal tuned in. Now adjust the antenna circuit, reducing input as alignment proceeds. If the receiver tends to "Motorboat", turn down the service oscillator output until the trouble stops. Some service oscillators, however, leak enough signal that even with the

output control set at zero, the receiver is still overloaded in which case it is necessary to turn down the sensitivity and audio controls until the receiver behaves properly. Signals of this high intensity are seldom observed in ordinary locations but if experienced can be controlled in a similar manner.

Set the service oscillator to 6MC and tune in the signal with the receiver dial. Now, while rocking the condenser back and forth across the signal, turn the short-wave padding condenser continuously in one direction until the output is the greatest. A few minutes spent in experiment on this adjustment will show more than a further lengthy explanation. Because of the fact that the adjustable padding condenser is but a relatively small portion of the total padding capacity on short-wave, this adjustment will not be very sharp. (The short-wave padding condenser is the one across which is connected the fixed mica condenser.)

Turn the range switch to the broadcast position, substitute a 200-mmf condenser for the 400-ohm resistor as a Dummy Antenna, set the dial and the service oscillator to 1400 KC, and align the circuits again (bottom trimmers) in the same manner as described above. Having done this, set the service oscillator to 600 KC and tune the receiver dial for maximum response. Here pad the oscillator circuit in the same manner as the Short-Wave padding described above. This adjustment will be far sharper than the Short-Wave padding operation and should therefore be done carefully. Return to 1400 KC and re-align at that frequency. The set may now be connected to a good Antenna and Ground for reception of stations. It is essential that the Ground be connected to this receiver.

BATTERY CHARGING

The storage battery can be kept charged by using a wind-driven generator such as the "Windcharger" or equivalent. If such a device is used it should be installed in accordance with the instructions furnished by the manufacturer and leads run to the storage battery which should be located near the receiver.

Parts Supplied for Construction of 6 Tube B. C. and S. W. 6-volt Receiver

- 1 Calibrated slide-rule dial and escutcheon
- 1 Set No. 2 screws, nuts and lockwashers
- 2 6.3-volt dial lights, bayonet base
- 1 3-Gang, 365 mfd, tuning condenser
- 1 BC and SW Band Antenna Coil, 14-7476
- 1 BC and SW Band R. F. Coil, 14-7478
- 1 BC and SW Band Oscillator Coil, 14-7480
- 1 Ferrocart Input I. F. transformer, 16-5740
- 1 Ferrocart Output I. F. transformer, 16-5742
- 1 3-Gang range switch, 2 pole, 2 position
- 1 Vibrator Power Supply Unit, No. 10-1120
- 5 Molded bakelite octal tube sockets
- 1 4-prong wafer socket for speaker
- 1 4-prong male receptacle
- 1 Ant-Gnd. Terminal strip
- 1 500,000-ohm volume control
- 1 25,000-ohm Tone Control with DPST Switch
- 1 25,000-ohm sensitivity Control
- 1 Adjustable padding condenser, 22-5211
- 1 .00005-mfd. mica condenser
- 1 .0001-mfd. mica condenser
- 2 .00025-mfd. mica condenser
- 1 .002 mfd. mica condenser
- 1 .004-mfd. mica condenser
- 3 .05-mfd. 200-volt paper condensers
- 2 .05-mfd. 400-volt paper condensers
- 1 .1-mfd. 200-volt paper condenser
- 1 .1-mfd. 400-volt paper condenser
- 1 10-mfd. 25-volt electrolytic condenser
- 2 400-ohm 1/4-watt resistor
- 1 600-ohm 1/2-watt resistor
- 1 800-ohm 1/4-watt resistor
- 1 20,000-ohm 1/2-watt resistor
- 1 30,000-ohm, 1-watt resistor

- 1 40,000-ohm, 1/2-watt resistor
- 2 50,000-ohm, 1/4-watt resistors
- 2 100,000-ohm, 1/4-watt resistors
- 2 250,000-ohm, 1/4-watt resistors
- 2 500,000-ohm, 1/4-watt resistors
- 1 Mallory bias-cell and holder
- 2 Tie-lug, single insulated terminal
- 6 Tie-lug, two insulated terminals
- 1 Battery cord and Plug Assembly
- 4 Metal tube grid clips
- 2 Shakeproof soldering lugs
- 3 1" Black bakelite knobs
- 2 Black Bakelite Bar Knobs
- 1 1/4" rubber grommet
- 2 No. 6 brass washers
- 39 No. 6-32 x 1/4" hexagon steel nuts
- 23 No. 6-32 x 1/4" RH steel screws
- 38 No. 6 steel lockwashers
- 4 No. 6-32 x 1" RH black screws
- 4 Wood panel spacers, 1/2" dia. x 11/16" long
- 1 Length black insulating sleeving
- 1 Length rosin-core solder
- 1 Length No. 20 hook-up wire, black
- 1 Length No. 20 hook-up wire, red
- 1 Length No. 14 enameled wire
- 1 Length No. 20 hook-up wire, white
- 1 Length No. 20 hook-up wire, blue
- 1 Length No. 20 hook-up wire, brown
- 1 Length No. 20 hook-up wire, green
- 1 Length No. 20 hook-up wire, yellow
- 1 Length No. 20 hook-up wire, orange
- 1 Length No. 20 stranded wire, green
- 1 Punched steel chassis, 10" x 12" x 3"

**MODEL
10-1108**

ADDITIONAL PARTS REQUIRED FOR OPERATION

- 2 6K7 Metal tubes
- 1 6A8 Metal tube
- 1 6Q7 Metal tube
- 1 6G6G Octal-base Glass tube

- 1 6X5 Rectifier tube
- 1 PM Dynamic or Magnetic speaker with 4-prong plug; Output transformer on PM type to match single 6G6G.

MEISSNER ACCESSORIES AVAILABLE

No. 11-8218 Punched steel panel, black wrinkle finish, 9 1/2" x 14 1/2" x 1/16"

No. 11-8212 Steel Cabinet complete with hinged lid, black wrinkle finish, 9 1/2" x 14 1/2" x 11 1/4" deep.

10-1108
PICTORIAL WIRING
DIAGRAM

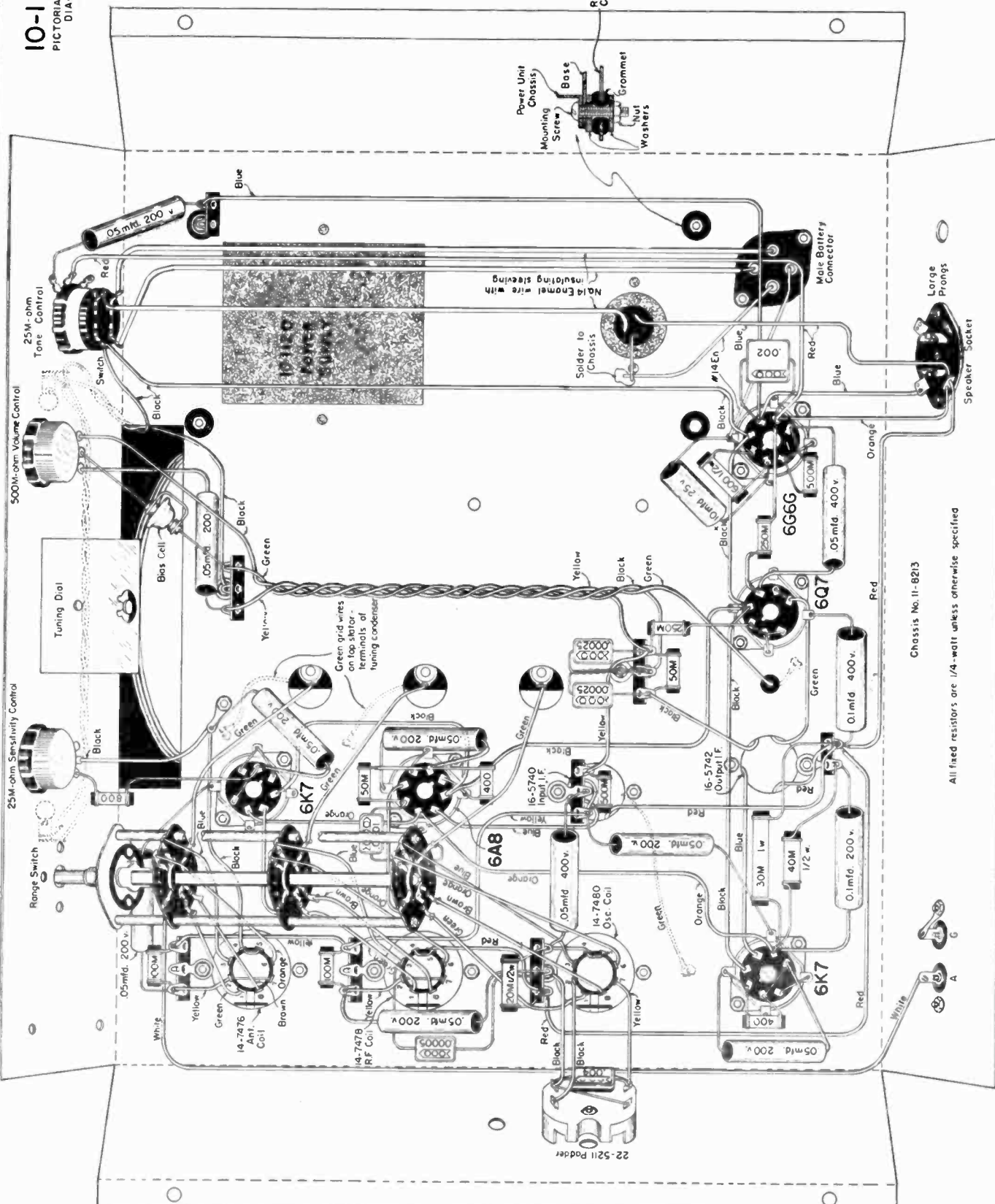

Chassis No. 11-8213

All fixed resistors are 1/4-watt unless otherwise specified

22-5211 Podder

COMPLETE INSTRUCTIONS
FOR CONSTRUCTION AND OPERATION OF THE



2-Volt Battery Broadcast Receiver

6-Tube Superheterodyne Model 10-1112

The Meissner No. 10-1112 receiver kit was designed to answer the requirements for a simple receiver of excellent performance in the Broadcast range, operating economically from batteries. Provision has been made to use any one of the three common "A" batteries, "Air Cell", 2-volt storage cell, or dry cells.

It utilizes one stage of Radio Frequency Amplification, in combination with two high-gain Ferrocart (iron core) I.F. transformers, giving excellent selectivity and sensitivity over its entire tuning range.

The receiver has conventional AVC obtained from a diode second detector and is provided with manual volume control and tone control.

Its full-vision 7-inch slide-rule dial is very attractive whether installed in an already existing cabinet, or installed in the steel cabinet with front panel, finished in black crackled lacquer, which is available to those who desire a special cabinet for this receiver.

The accessories required are tubes and batteries as listed on the parts list, and a permanent magnet dynamic speaker having an output transformer to match a single 1J6G tube. This tube has two triodes in one envelope and requires a push-pull output transformer.

ASSEMBLY

As the kit is unpacked, all parts should be carefully checked against the packing slip enclosed with the kit. Any discrepancies should be reported at once to the supplier from whom the kit was purchased.

The parts should be mounted on the chassis in accordance with the top view of the receiver shown on the Schematic Diagram, and the bottom view shown in the Pictorial Wiring Diagram.

Before beginning the wiring, temporarily install the gang condenser, dial and all controls so that their proper shaft lengths may be determined when the receiver is placed in the cabinet intended for it. Mark the shafts for proper lengths and then remove the controls from the chassis and saw each one with its shaft clamped in a vice. It is advisable not to attempt to cut the shaft of any unit while mounted on the chassis, because the heavy strains imposed on the unit may cause damage thereto. Remove the pilot light brackets and discard them. No pilot lights are used on this receiver in order to conserve filament power.

Install the sockets, taking care that they are installed in the proper places so that the numbers stamped on the sockets will correctly indicate the type of tube to be installed therein. Observe also that the keyway in the socket is properly oriented, lest it become necessary to remove all of the wires from the socket if it is later found to be reversed. It is advisable also to solder at least one spot (preferably adjacent to a mounting screw) on each socket saddle to chassis, since many ground connections are made to the lugs on the saddle, and trouble due to poor contact may develop unexpectedly unless a permanent good contact is insured by soldering.

WIRING

Having completed the assembly operations described above, the actual wiring may start, observing the suggestions given on the sheet "General Construction Hints" packed with each Kit.

After bending down all socket-saddle-ground-lugs not required for wiring, wire the filament circuit complete. The remaining wiring may be installed in any convenient sequence. It will be found a great help in wiring if each wire in the Pictorial Diagram is marked over with a colored pencil as the corresponding wire in the set is installed.

VOLTAGE TEST

Because the filaments of 2-volt tubes are fragile and are very easily burned out, it is very important to be certain that the receiver is correctly wired. It is recommended that after the wiring is finished that it again be traced, marking over each wire on the Pictorial Diagram as the corresponding wire in the receiver is checked.

If all connections are found to be correct, with the tubes out of the receiver, and the loudspeaker plugged in, connect the batteries as shown in the Schematic drawing, turn on the battery switch (clockwise) and check the voltages indicated on the Schematic drawing if a voltmeter is available. If the voltages measured are materially different than indicated, disconnect all batteries and recheck the wiring.

If no voltmeter is available, connect only the "A" Batteries, turn the filament rheostat to the proper position (see "Filament Rheostat") **TURN THE BATTERY SWITCH OFF**, install all tubes and then turn the switch on. Looking down into the tubes a just barely perceptible red filament should be visible in each tube. If this condition obtains, turn off the battery switch, connect the "B" batteries to the cable and then turn on the battery switch again.

ALIGNMENT

The I.F. amplifier is aligned in the usual manner. Connect a service oscillator between the chassis and the grid of the 1C7G tube, using a condenser .0005 mfd to .25 mfd between the grid and the high side of the generator output. Do not remove the grid clip for this operation. Set the dial near 600 KC, and proceed with alignment at 456 KC.

Turn the audio volume control on full. Increase the output of the service oscillator until a signal is just audible. Adjust each I.F. trimmer so that maximum volume is obtained. It is best to repeat this procedure two or three times on each trimmer to obtain the most accurate adjustment. These trimmers are adjusted with a small screw-driver through the opening in the top of the shield on each I.F. transformer. If no service oscillator is available, connect the receiver to antenna and ground, tune in a weak signal and adjust the trimmers as above for maximum signal. If, as the adjustment proceeds, the output becomes quite loud, tune in a weaker station and proceed.

The service oscillator should now be connected to the antenna and ground terminals of the receiver, with a 200-mmf condenser between the antenna terminal of the receiver and the high side of the service oscillator.

Close the gang condenser and see that the dial pointer position coincides with the last line at the low-frequency end of the dial. If this condition does not obtain, loosen the set-screw on the dial drum, make the necessary correction and firmly tighten the screw.

Set the dial and the service oscillator to 1400 KC and adjust the trimmer on the rear section of the gang condenser

for maximum output, reducing the generator output as alignment proceeds. Follow this adjustment by similar adjustments on the middle and front sections of the gang condenser. After this is done the service oscillator should be set at 600 KC and the signal tuned in on the receiver. The oscillator padding condenser should be turned slowly in one direction while the gang condenser is rocked back and forth across the signal until a maximum is obtained. It is advisable now, to return to 1400 KC and re-align at that point.

"FILAMENT RHEOSTAT"

The Filament Rheostat has been provided to permit the use of either "Air Cell", 2-volt storage cell, or dry cells connected in series—parallel. The rheostat should be turned counterclockwise as far as possible and then the mounting nut loosened and the body of the rheostat rotated until the handle of the rheostat points straight toward the back of the receiver. If you now imagine that this rheostat handle is the hour hand of a clock pointing to 12 o'clock, the handle can be set to the proper place as directed below by imagining or sketching the remaining hours of the clock around the rheostat.

If a 2-volt storage cell is used, turn the rheostat to the equivalent of 11 o'clock which is the extreme clockwise position possible if the rheostat has been oriented as directed

above. No further adjustment of the rheostat need be made until the Type of battery is changed. If an "Air Cell" is used set the rheostat arm permanently at the equivalent of 4 o'clock.

If dry cells are used, connect 6 No. 6 dry cells in accordance with the diagram of battery connections on the Schematic Diagram. When first connected to the radio set, the rheostat arm should be set at the equivalent of 12 o'clock. If the receiver is used approximately three hours daily the rheostat should be advanced the equivalent of 1 hour's space per week. If the use averages only 1½ hours daily the rheostat should be advanced only 1 hour's space each two weeks. The best policy is to advance the rheostat clockwise only as frequently and as much as is absolutely necessary to maintain proper operation.

BATTERIES

The "B" Batteries to give best operation are 3 45-volt heavy-duty batteries. A suggested combination is 3 Burgess "B" Batteries No. 21308 or equivalent and 1 Burgess "C" battery No. 5540 or equivalent. Note that for maximum use of the "B" Batteries, the "C" battery must be discharged at a proper rate, therefore the size of cells is important in considering the "equivalent" of the type numbers mentioned above, and also the "C" batteries should be replaced at the same time that the "B" batteries are replaced.

Parts Supplied for Construction of 6-Tube Broadcast 2-Volt Receiver

MODEL
10-1112

- | | |
|----------------------------------------------|--------------------------------------------------|
| 1 Calibrated slide-rule dial and escutcheon | 1 2-megohm, ½-watt resistor |
| 1 Set No. 2 screws, nuts and lockwashers | 2 Mallory bias-cell and holder |
| 1 3-Gang, 365-mmfd, tuning condenser | 4 Tie-lugs, single insulated terminal |
| 1 BC band Antenna Coil, 14-6862 | 6 Tie-lugs, two insulated terminals |
| 1 BC band R. F. Coil, 14-6864 | 3 Tube shield assemblies |
| 1 BC band Oscillator Coil, 14-4243 | 3 Metal tube grid clips |
| 1 Ferrocart input I.F. transformer, 16-5741 | 1 Shakeproof soldering lug |
| 1 Ferrocart output I.F. transformer, 16-5743 | 3 Black bakelite knobs |
| 1 Push-pull audio input transformer | 1 ¾" rubber grommet |
| 6 Molded bakelite octal tube sockets | 8 No. 6 brass washers |
| 1 4-prong wafer socket for speaker | 45 No. 6-32 x ¼" hexagon steel nuts |
| 1 Ant-Gnd. terminal strip | 45 No. 6 steel lockwashers |
| 1 1-megohm volume control | 30 No. 6-32 x ¼" RH steel screws |
| 1 25,000-ohm Tone Control with switch | 4 No. 6-32 x 1" RH black screws |
| 1 Adjustable padding condenser, 22-7006 | 4 Wood panel spacers, ¼" dia. x 11-16" long |
| 1 .00025-mfd. mica condenser | 1 Length black insulating sleeving |
| 3 .0001-mfd. mica condensers | 1 Length rosin-core solder |
| 1 .00025-mfd. mica condenser | 1 Length No. 20 hook-up wire, black |
| 2 .01-mfd. 200-volt paper condensers | 1 Length No. 20 hook-up wire, red |
| 5 .05-mfd., 200-volt paper condensers | 1 Length No. 20 shielded wire |
| 2 .1-mfd., 200-volt paper condensers | 1 Length No. 20 hook-up wire, white |
| 1 2.2-ohm Filament Rheostat | 1 Length No. 20 hook-up wire, blue |
| 1 16-mfd., 200-volt electrolytic condenser | 1 Length No. 20 hook-up wire, green |
| 1 1000-ohm ¼-watt resistor | 1 Length No. 20 hook-up wire, yellow |
| 1 2000-ohm ¼-watt resistor | 1 Length No. 20 hook-up wire, orange |
| 1 20,000-ohm ½-watt resistor | 1 Length No. 20 stranded wire, green |
| 2 50,000-ohm, ¼-watt resistors | 1 Punched steel chassis, 10" x 12" x 3" |
| 3 100,000-ohm, ¼-watt resistors | 1 Special hole cover plate |
| 1 250,000-ohm, ¼-watt resistors | 8 Lengths No. 20 stranded wire for Battery Cable |
| 2 500,000-ohm, ¼-watt resistors | |

ADDITIONAL PARTS REQUIRED FOR OPERATION

- | | |
|------------------------------|-------------------------------------------------------------------|
| 2 1D5G Octal-base glass tube | 1 1H4G Octal-base glass tube |
| 1 1C7G Octal-base glass tube | 1 PM-Dynamic with 4-prong plug; output transformer to match 1J6G. |
| 1 1H6G Octal-base glass tube | |
| 1 1J6G Octal-base Glass tube | |

MEISSNER ACCESSORIES AVAILABLE

- | | |
|----------------------------------------------------------------------------|---------------------------------------------------------------------------------------------------|
| No. 11-8216 Punched steel panel, black wrinkle finish, 9½" x 14½" x 1-16". | No. 11-8212 Steel Cabinet complete with hinged lid, black wrinkle finish, 9½" x 14½" x 11¼" deep. |
|----------------------------------------------------------------------------|---------------------------------------------------------------------------------------------------|

2-V. BATTERY BROADCAST RECEIVER

6-tube Superheterodyne 540 to 1600 kc

I.F. = 456 kc

IO-1112

SCHEMATIC
CIRCUIT DIAGRAM

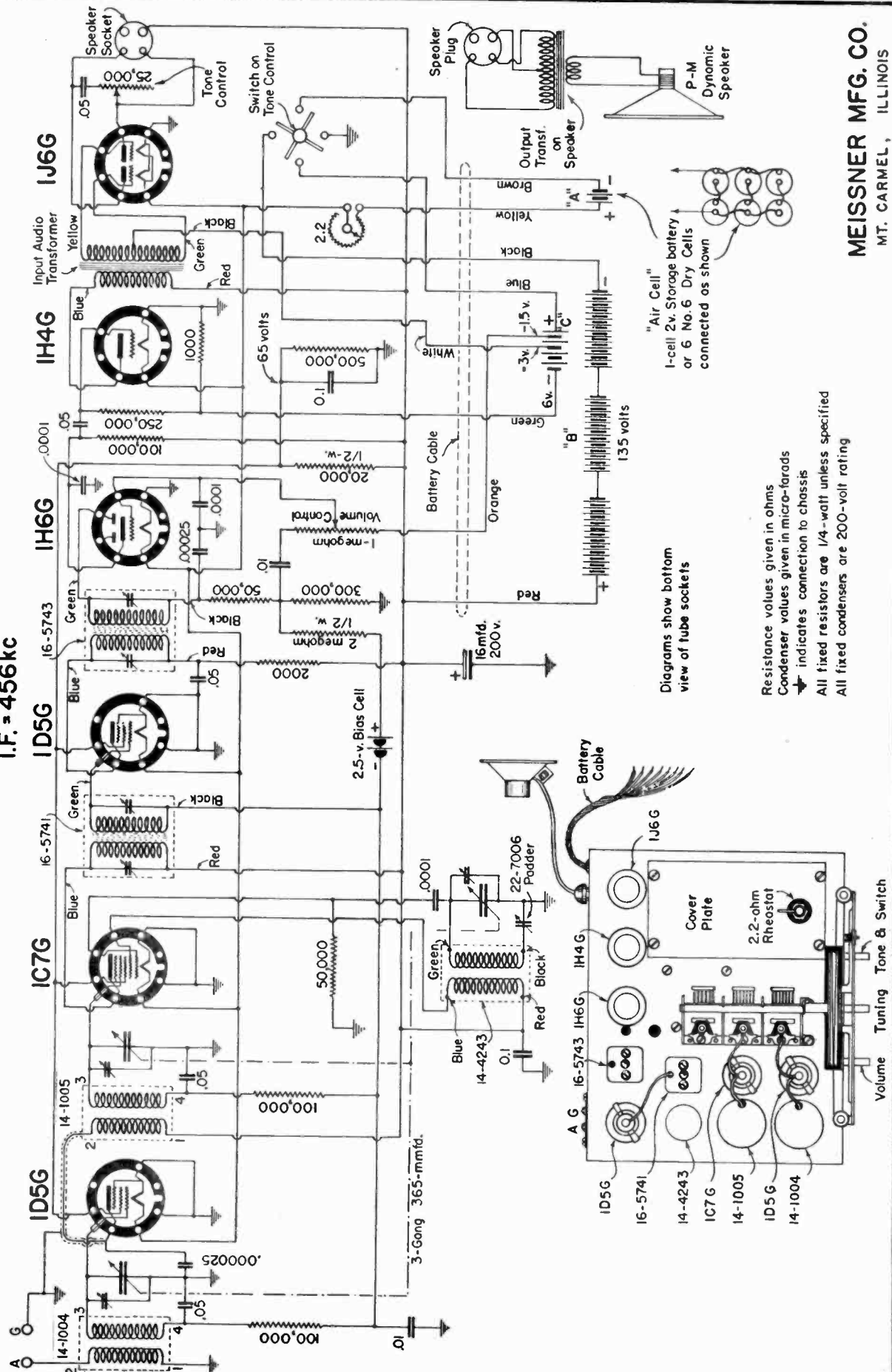

Diagrams show bottom view of tube sockets

Resistance values given in ohms
 Condenser values given in micro-farads
 ⤴ indicates connection to chassis
 All fixed resistors are 1/4-watt unless specified
 All fixed condensers are 200-volt rating

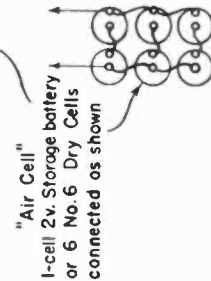

MEISSNER MFG. CO.
 MT. CARMEL, ILLINOIS

10-1112
PICTORIAL
WIRING DIAGRAM

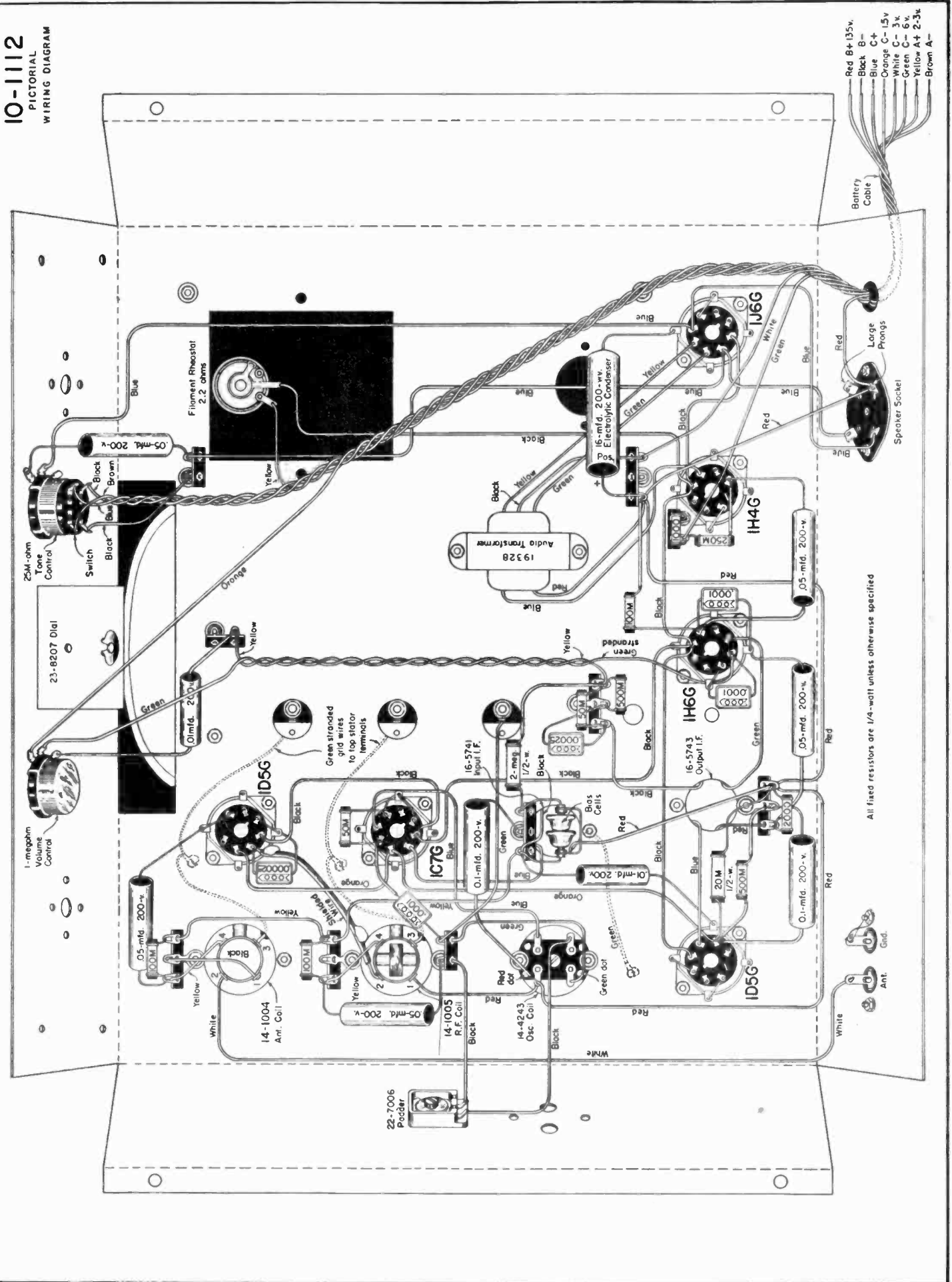

All fixed resistors are 1/4-watt unless otherwise specified

- Red B+ D5v.
- Black B-
- Blue C+
- Orange C- 15v
- White C- 3v
- Green C- 6v.
- Yellow A+ 2-3v
- Brown A-

Battery Cable

Large Prongs

Speaker Socket

Ant.

Grd.

COMPLETE INSTRUCTIONS
FOR CONSTRUCTION AND OPERATION OF THE



2-Volt Battery BC & SW Receiver

6-Tube Superheterodyne Model 10-1109

The Meissner No. 10-1109 receiver kit was designed to answer the requirements for a receiver covering the American Broadcast Band and the Short-Wave entertainment bands, operating economically from batteries. It covers the frequency range 540 KC to 1600 KC and 5.9 MC to 18.8 MC, and operates from any of the 3 common types of "A" batteries: "Air-Cell," 2-volt storage cell or dry cells.

It utilizes one stage of Radio-Frequency Amplification on both bands, in combination with two high-gain Ferrocart (iron-core) I. F. transformers, giving excellent selectivity and sensitivity over its entire tuning range.

The receiver has conventional AVC obtained from a diode second-detector, and is provided with manual volume control and tone control.

Its full-vision, 7-inch slide-rule dial with three scales (one a 0-100), is very attractive whether installed in an already existing cabinet, or installed in the steel cabinet with front panel finished in black crackled lacquer which is available to those who desire a special cabinet for this receiver.

The accessories required are tubes and batteries as listed on the parts list, and a permanent-magnet dynamic speaker having an output transformer to match a single 1J6G tube. This tube has two triodes in one envelope and requires a push-pull output transformer.

ASSEMBLY

As the kit is unpacked, all parts should be carefully checked against the packing slip enclosed with the kit. Any discrepancies should be reported at once to the supplier from whom the kit was purchased.

The parts should be mounted on the chassis in accordance with the top view of the receiver shown on the Schematic Diagram, and the bottom view shown in the Pictorial Wiring Diagram. The order of assembly is of little importance as long as the range switch is omitted until the wiring around the RF and Converter sockets, and on the terminal strips mounted under the range switch, has been completed.

Before beginning the wiring, temporarily install the gang condenser, dial and all controls so that their proper shaft lengths may be determined when the receiver is placed in the cabinet intended for it. Mark the shafts for proper lengths and then remove the controls from the chassis and saw each one with its shaft clamped in a vise. It is advisable not to attempt to cut the shaft of any unit while mounted on the chassis, because the heavy strains imposed on the unit may cause damage thereto. Remove the pilot light brackets and discard them. No pilot lights are used on this receiver in order to conserve filament power.

Mount the sockets, taking care that they are installed in the proper places so that the numbers stamped on them will correctly indicate the type of tube to be installed therein. Observe also that the keyway in the socket is properly oriented, lest it become necessary to remove all of the wires from the socket if it is later found to be reversed. It is advisable also to solder at least one spot (preferably adjacent to a mounting screw) on each socket-saddle to chassis, since many ground connections are made to the lugs on the saddle, and trouble due to poor contact may develop unexpectedly unless a permanent good contact is insured by soldering.

WIRING

Having completed the assembly operations described above, the actual wiring may start, observing the suggestions given on the sheet "General Construction Hints", packed with each Kit.

After bending down all socket-saddle-ground-lugs not required for wiring, wire the filament circuit complete. The remaining wiring may be installed in any convenient sequence. It will be found a great help in wiring if each wire in the Pictorial Diagram is marked over with a colored pencil as the corresponding wire in the set is installed.

When all wiring has been finished except the leads to the range switch install and wire that item, keeping all wires short and direct, and as well spaced from each other and from metal objects as possible.

VOLTAGE TEST

Because the filaments of 2-volt tubes are fragile and are very easily burned out, it is very important to be certain that the receiver is correctly wired. It is recommended that after the wiring is finished that it again be traced, marking over each wire on the Pictorial Diagram as the corresponding wire in the receiver is checked.

If all connections are found to be correct, with the tubes out of the receiver, and the loudspeaker plugged in, connect the batteries as shown in the schematic drawing, turn on the battery switch (clockwise) and check the voltages indicated on the Schematic drawing if a voltmeter is available. If the voltages measured are materially different than indicated, disconnect all batteries and recheck the wiring.

If no voltmeter is available, connect only the "A" Batteries, turn the filament rheostat to the proper position (see "Filament Rheostat"), **TURN THE BATTERY SWITCH OFF**, install all tubes and then turn the switch on. Looking down into the tubes a just barely perceptible red filament should be visible in each tube. If this condition obtains, turn off the battery switch, connect the "B" batteries to the cable and then turn on the battery switch again.

ALIGNMENT

The I. F. amplifier is aligned in the usual manner. Connect a service oscillator between the chassis and the grid of the 1C7G tube, using a condenser .0005 mfd to .25 mfd between the grid and the high side of the generator output. Do not remove the grid clip for this operation. Set the range switch to the broadcast band, the dial near 600 KC, and proceed with alignment at 456 KC. Turn the audio volume control on full. Increase the output of the service oscillator until a signal is just audible. Adjust each I. F. trimmer so that maximum volume is obtained. It is best to repeat this procedure two or three times on each trimmer to obtain the most accurate adjustment. These trimmers are adjusted with a small screw-driver through the opening in the top of the shield on each I. F. transformer. If no service oscillator is available connect the receiver to antenna and ground, tune in a weak signal and adjust the trimmers as above for maximum signal. If, as the adjustment proceeds, the output becomes quite loud, tune in a weaker station and proceed.

The service oscillator should now be connected to the antenna and ground terminals of the receiver, through the proper dummy antenna.

Close the gang condenser and see that the dial pointer position coincides with the last line at the low-frequency end of the dial. If this condition does not obtain, loosen the set-screw on the dial drum, make the necessary correction and firmly tighten the screw.

Turn the range switch to the Short Wave (extreme clockwise) position, set the dial and the service oscillator to 16 mc, connect a 400-ohm resistor between the service oscillator and the antenna binding post as a dummy antenna, turn the output of the service oscillator up to maximum, tighten the top trimmer in the oscillator coil (No. 14-7480) until just snug, then loosen it 4 turns, and then, as the trimmer is tightened, set it to the position of maximum response reducing the output of the service oscillator as alignment proceeds. (If two responses are found of nearly equal intensity, adjust for the one with the trimmer farthest open). Now align the RF trimmer, but since the RF adjustment has a slight effect upon the oscillator frequency, it will be necessary to rock the tuning condenser slightly to keep the signal tuned in. Now adjust the antenna circuit, reducing input as alignment proceeds. If the receiver tends to "Motor-boat" turn down the service os-

illator output until the trouble stops. Some service oscillators, however, leak enough signal that even with the output control set at zero, the receiver is still overloaded, in which case it is necessary to turn down the audio control until the receiver behaves properly.

Set the service oscillator to 6 mc and tune in the signal with the receiver dial. Now, while rocking the condenser back and forth across the signal, turn the short-wave padding condenser continuously in one direction until the output is the greatest. A few minutes spent in experiment on this adjustment, will show more than a further lengthy explanation. Because of the fact that the adjustable padding condenser is but a relatively small portion of the total padding capacity on short-wave, this adjustment will not be very sharp. (The short-wave padding condenser is the one across which is connected the fixed mica condenser.)

Turn the range switch to the broadcast position, substitute a 200-mmf condenser for the 400-ohm resistor as a Dummy Antenna, set the dial and the service oscillator to 1400 KC, and align the circuits again (bottom trimmers) in the same manner as described above. Having done this set the service oscillator to 600 KC and tune the receiver dial for maximum response in the neighborhood of 600 KC. Here pad the oscillator circuit in the same manner as the Short-Wave padding described above. This adjustment will be far sharper than the Short-Wave padding operation and should therefore be done carefully. Return to 1400 KC and re-align at that frequency.

FILAMENT RHEOSTAT

The Filament Rheostat has been provided to permit the use of either "Air Cell", 2-volt storage cell or dry cells connected in series parallel. The rheostat should be turned counter-clockwise as far as possible and then the mounting nut loosened and the body of the rheostat rotated until the handle of the rheostat points straight toward the back of the receiver. If you now imagine that this rheo-

stat handle is the hour hand of a clock pointing to 12 o'clock, the handle can be set to the proper place as directed below by imagining or sketching the remaining hours of the clock around the rheostat.

If a 2-volt storage cell is used, turn the rheostat to the equivalent of 11 o'clock which is the extreme clockwise position possible if the rheostat has been oriented as directed above. No further adjustment of the rheostat need be made until the Type of battery is changed. If an "Air Cell" is used, set the rheostat arm permanently at the equivalent of 4 o'clock.

If dry cells are used, connect 6 No. 6 dry cells in accordance with the diagram of battery connections on the Schematic Diagram. When first connected to the radio set, the rheostat arm should be set at the equivalent of 12 o'clock. If the receiver is used approximately three hours daily the rheostat should be advanced the equivalent of 1 hour's space per week. If the use averages only 1 1/2 hours daily the rheostat should be advanced only 1 hour's space each two weeks. Sometimes receivers are used more than is realized in which case the rheostat may require advancing faster than one hour's space per week. The best policy is to advance the rheostat clockwise only as frequently and as much as is absolutely necessary to maintain proper operation.

BATTERIES

The "B" Batteries to give best operation are 3 45-volt, heavy-duty batteries. A suggested combination is 3 Burgess "B" Batteries No. 21308 or equivalent and 1 Burgess "C" battery No. 5540 or equivalent. Note that for maximum use of the "B" Batteries, the "C" battery must be discharged at a proper rate, therefore the size of cells is important in considering the "equivalent" of the type numbers mentioned above, and also the "C" batteries should be replaced at the same time that the "B" batteries are replaced.

**Parts Supplied for Construction of
6-Tube BC & SW 2-Volt Receiver**

**MODEL
10-1109**

- | | |
|--------------------------------------------------------------------------------------------------------------------------------------------------------------------------------------------------------------------------------------------------------------------------------------------------------------------------------------------------------------------------------------------------------------------------------------------------------------------------------------------------------------------------------------------------------------------------------------------------------------------------------------------------------------------------------------------------------------------------------------------------------------------------------------------------------------------------------------------------------------------------------------------------------------------------------------------------------------------------------------------------------------------------------------------------------------------------------------------------------------------------------------------------------------------------------------------------------------------------------------------------------------------------------------------------------------------------------------------------------------------------------------------------------------------------|-------------------------------------------------------------------------------------------------------------------------------------------------------------------------------------------------------------------------------------------------------------------------------------------------------------------------------------------------------------------------------------------------------------------------------------------------------------------------------------------------------------------------------------------------------------------------------------------------------------------------------------------------------------------------------------------------------------------------------------------------------------------------------------------------------------------------------------------------------------------------------------------------------------------------------------------------------------------------------------------------------------------------------------------------------------------------------------------------------------------------------------------------------------------------------------------------------------------------------------------------------------------------------------------------------------------------------------------------------------------------------------------------------------------------------------------------------------------------------------------------------------------------------------------|
| <ul style="list-style-type: none"> 1 Calibrated slide-rule dial and escutcheon 1 Set No. 2 screws, nuts and lockwashers 1 3-Gang, 365-mmfd, tuning condenser 1 BC-SW band Antenna Coil, 14-7476 1 BC-SW band R. F. Coil, 14-7478 1 BC-SW band Oscillator Coil, 14-7480 1 Ferrocart input I.F. transformer, 16-5741 1 Ferrocart output I.F. transformer, 16-5743 1 Push-pull audio input transformer 1 3-Gang Range Switch, 19303 6 Molded bakelite octal tube sockets 1 4-prong wafer socket for speaker 1 Ant-Gnd. terminal strip 1 2.2-ohm Filament Rheostat 1 1-megohm volume control 1 25,000-ohm Tone Control 1 4-point Battery Switch 1 Adjustable padding condenser, 22-5211 1 .00025-mfd. mica condenser 3 .0001-mfd. mica condensers 1 .00025-mfd. mica condenser 1 .004-mfd. mica condenser 2 .01-mfd. 200-volt paper condensers 5 .05-mfd. 200-volt paper condensers 2 .1-mfd., 200-volt paper condensers 1 16-mfd., 200-volt electrolytic condenser 1 1000-ohm 1/4-watt resistor 1 2000-ohm 1/4-watt resistor 1 20,000-ohm 1/2-watt resistor 2 50,000-ohm. 1/4-watt resistors 3 100,000-ohm, 1/4-watt resistors | <ul style="list-style-type: none"> 1 250,000-ohm, 1/4-watt resistor 2 500,000-ohm, 1/4-watt resistors 1 2-megohm, 1/2-watt resistor 2 Mallory bias-cell and holder 4 Tie-lugs, single insulated terminal 6 Tie-lugs, two insulated terminals 3 Tube shield assemblies 3 Metal tube grid clips 1 Shakeproof soldering lug 3 Black bakelite knobs 1 3/8" rubber grommet 2 No. 6 brass washers 45 No. 6-32 x 1/4" hexagon steel nuts 45 No. 6 steel lockwashers 30 No. 6-32 x 1/4" RH steel screws 4 No. 6-32 x 1" RH black screws 4 Wood panel spacers, 1/4" dia. x 11/16" long 1 Length black insulating sleeving 1 Length rosin-cored solder 1 Length No. 20 hook-up wire, black 1 Length No. 20 hook-up wire, red 1 Length No. 20 hook-up wire, brown 1 Length No. 20 hook-up wire, white 1 Length No. 20 hook-up wire, blue 1 Length No. 20 hook-up wire, green 1 Length No. 20 hook-up wire, yellow 1 Length No. 20 hook-up wire, orange 1 Length No. 20 hook-up wire, green 1 Length No. 20 hook-up wire, yellow 1 Length No. 20 hook-up wire, orange 1 Length No. 20 hook-up wire, green 1 Punched steel chassis, 10" x 12" x 3" 1 Special hole cover plate 8 Lengths No. 20 stranded wire for Battery Cable |
|--------------------------------------------------------------------------------------------------------------------------------------------------------------------------------------------------------------------------------------------------------------------------------------------------------------------------------------------------------------------------------------------------------------------------------------------------------------------------------------------------------------------------------------------------------------------------------------------------------------------------------------------------------------------------------------------------------------------------------------------------------------------------------------------------------------------------------------------------------------------------------------------------------------------------------------------------------------------------------------------------------------------------------------------------------------------------------------------------------------------------------------------------------------------------------------------------------------------------------------------------------------------------------------------------------------------------------------------------------------------------------------------------------------------------|-------------------------------------------------------------------------------------------------------------------------------------------------------------------------------------------------------------------------------------------------------------------------------------------------------------------------------------------------------------------------------------------------------------------------------------------------------------------------------------------------------------------------------------------------------------------------------------------------------------------------------------------------------------------------------------------------------------------------------------------------------------------------------------------------------------------------------------------------------------------------------------------------------------------------------------------------------------------------------------------------------------------------------------------------------------------------------------------------------------------------------------------------------------------------------------------------------------------------------------------------------------------------------------------------------------------------------------------------------------------------------------------------------------------------------------------------------------------------------------------------------------------------------------------|

MEISSNER ACCESSORIES AVAILABLE

No. 11-8218 Punched steel panel, black wrinkle finish, 9 1/2" x 14 1/2 x 1/16".

No. 11-8212 Steel Cabinet complete with hinged lid, black wrinkle finish, 9 1/2" x 14 1/2" x 11 1/8" deep.

ADDITIONAL PARTS REQUIRED FOR OPERATION

- | | |
|--------------------------------------------------------------------------------------------------------------------------------------------------------------------------------------------------|----------------------------------------------------------------------------------------------------------------------------------------------------------|
| <ul style="list-style-type: none"> 2 1D5G Octal-base glass tube 1 1C7G Octal-base glass tube 1 1H6G Octal-base glass tube 1 1J6G Octal-base glass tube | <ul style="list-style-type: none"> 1 1H4G Octal-base glass tube 1 PM-Dynamic with 4-prong plug; output transformer to match 1J6G |
|--------------------------------------------------------------------------------------------------------------------------------------------------------------------------------------------------|----------------------------------------------------------------------------------------------------------------------------------------------------------|

10-1109
PICTORIAL
WIRING DIAGRAM

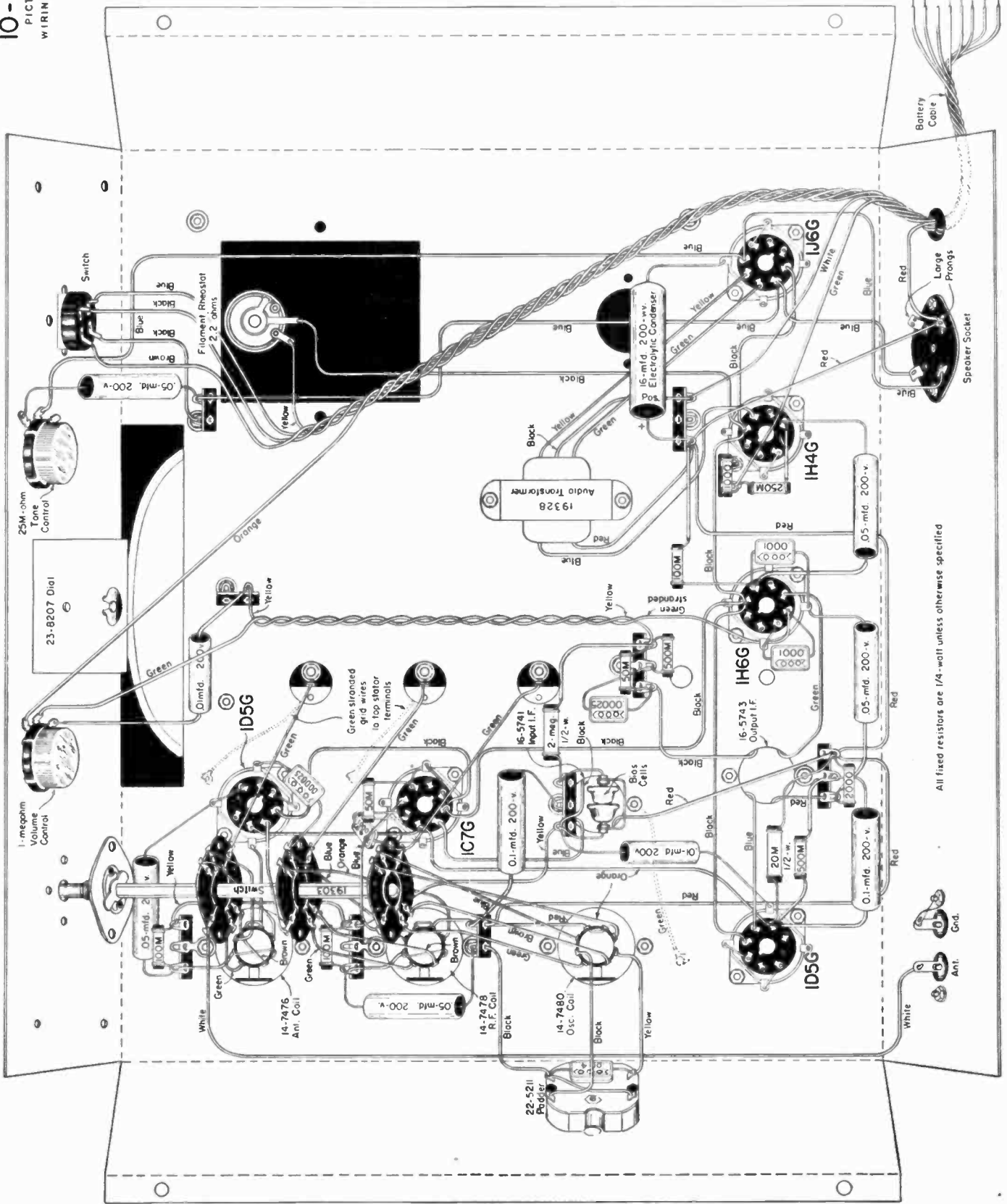

All fixed resistors are 1/4-watt unless otherwise specified

COMPLETE INSTRUCTIONS
FOR CONSTRUCTION AND OPERATION OF THE



6-tube Ferrocart T. R. F.

Broadcast Band Receiver Model 10-1102

The Meissner Ferrocart 6-tube set was designed to supply the ultimate in performance from a TRF receiver. It employs Ferrocart (iron-core) coils to give maximum selectivity per circuit, and a 4-gang tuning condenser to give overall selectivity and sensitivity adequate not only for proper enjoyment of your favorite stations, but for "DX"-ing as well. The receiver is equipped with an airplane dial of unusually accurate calibration and employs all octal-base tubes.

A sturdy steel cabinet and front panel, finished in black crackle lacquer, are available to make an attractive ensemble.

ASSEMBLY

As the kit is unpacked, all parts should be carefully checked against the packing slip enclosed. Any discrepancies should be reported at once to the supplier from whom the kit was purchased.

All parts should be mounted on the Chassis according to the top and bottom views shown in the Pictorial Diagram in the order indicated below. It will be found best to mount the small parts such as terminal-strips and sockets first. Do not mount the dial until the chassis wiring is complete.

Take care to install the sockets in the correct direction. It is recommended that at least one point on the socket saddles (preferably adjacent to a mounting screw) be soldered to the chassis since there are many connections made to the saddle, and therefore unless the saddle is grounded permanently by soldering, trouble may develop unexpectedly.

Remove the nuts from the Power Transformer and install the unit in the chassis by means of the parts removed. Care should be exercised to prevent damage to the leads or windings as these items pass through the chassis cutout when the transformer is being installed. Observe that the transformer lugs are placed as shown in the Pictorial Diagram.

Install the black grommet in the chassis under the gang condenser and place the condenser in position on the chassis. Observe how the bottom connecting lug on the front section of the gang condenser must be bent to permit a connection to be made to it and yet not short-circuit to the chassis. Observe also that the lugs on the remaining condenser sections also come very close to the chassis and consequently should be bent for greater clearance. Remove the condenser and bend the lugs as required. Attach a 3" piece of green hookup wire to the lug on the front section and re-install the condenser with this lead passing through the grommet. Do not mount the gang condenser shield or dial until later. Solder the four rotor wipers to four ground lugs installed on top of the chassis close to the rotor wipers.

Prepare the coils for mounting. One No. 14-7860 need not be altered, but the remaining coils, two No. 14-7860 and one No. 14-1496 must have the green lead removed from its lug and two new leads installed on each coil in place of the wire removed. These new leads should be flexible green stranded wire. They should be cut 5-inches long, stripped $\frac{1}{4}$ inch on one end and a pair of these wires inserted through the hole in the top of the cans of each of the three altered coils and attached to the lugs from which the original green wires were removed.

Since the coils will be placed on the chassis where the

connections cannot be inspected after the coil is installed, it is important that these connections be properly soldered and that the wires be so arranged that they cannot possibly short-circuit to either can or chassis.

Install the unaltered No. 14-7860 coil at the front of the chassis, followed by the other two coils of the same number, and lastly by the Antenna coil No. 14-1496, at the back of the chassis. The leads should be carefully threaded through the proper holes in the chassis as shown in the Pictorial Diagram. Temporarily insert the tubes in the sockets at the side of the coils and attach grid clips to the grid leads at appropriate places. One lead from the top of each can is connected to a tube grid and the other lead from each can is connected to a section of the gang condenser. Following the drawing of the top of the receiver, note where these leads go through the gang condenser shield, thread the leads through the shield accordingly, and measure the length required to reach the condenser terminals with enough slack to get a soldering iron to the lug to make the connections. The leads should be just long enough but should have no surplus. Solder these connections to the gang condenser and then screw the condenser shield in place.

The volume and tone controls should be installed temporarily, the set temporarily placed in its cabinet and the shaft lengths determined. Remove the set from the cabinet and the controls from the set. Clamp the control shafts in a vice and saw off to the proper length. It is advisable not to attempt to saw these shafts when the units are mounted on the chassis because of likelihood of damage to the units. If the Meissner front panel 11-8214 and cabinet 11-8212 are used, cut the shaft lengths to 15/16 inch measured from the **front surface of the chassis**.

The electrolytic condenser should be mounted on its mounting plate, soldering the condenser mounting lugs to the mounting plate and then securely fastening the mounting plate to the chassis. It is advisable to solder one spot on the condenser mounting plate to the chassis for the purpose of insuring permanent good contact.

WIRING

Having completed the assembly of the major parts of the Receiver as described above, the actual wiring may start, observing the hints given on the sheet "General Construction Hints," packed with each set. The actual order of wiring is of little consequence since all of the wiring is easily accessible. Socket-mounting saddles should be soldered to chassis at one point each, and shielded wires should have both ends of the shield soldered to chassis. Paper by-pass condensers should be connected with their "ground" ends to the chassis wherever the condenser has one end grounded. Electrolytic condenser polarity **must** be observed.

The tuning dial is mounted by fastening it to the condenser shaft at the central hub, using a single mounting screw at the bottom to fasten it to the chassis as shown. The tuning-condenser plates should be turned completely closed and the dial pointer set exactly on the horizontal markers on the scale before the two set-screws are tightened on the condenser shaft. Wire the dial lights and connect to the filament wire.

After completing all connections, the wiring should be very carefully checked to make sure that no errors were made or wires omitted.

ALIGNMENT

If all connections are found to be correct, the tubes may then be inserted, a speaker with a 1500 to 2000 ohm field connected, and the line-cord plug connected to a 110-volt 60-cycle receptacle. A slight turn of the tone-control knob to the right will turn on the receiver. After a brief warm-up period, the voltages shown on the Schematic Diagram should be checked with a high-resistance voltmeter, if available. Voltages indicated are measured from the point shown to the chassis, with the chassis as the negative terminal. If values measured are materially different than shown on the diagrams, a thorough re-check of the circuit should be made. **Be sure the unit is turned off and the line-cord disconnected from the power receptacle.**

Alignment of the receiver may be made with a service-oscillator, signal-generator or by tuning in broadcast signals. With a service-oscillator or signal-generator, the output of such device is connected to the antenna and ground terminals of the Receiver with a 200-mmfd mica condenser connected between the generator and the antenna terminal. For alignment on broadcast station signals, a short antenna should be connected to the antenna terminal and the ground terminal connected to a good ground.

Check the dial to be sure that the pointer is horizontal when the gang-condenser is closed. Set the service-oscillator or signal-generator and the dial of the receiver to 1400 K. C. Turn the volume control to maximum, and turn the output of the signal source up until a signal is heard. Adjust the trimmers on top of the gang-condenser, using a screw-driver through the holes in the top of the gang-condenser shield. Adjust each trimmer for maximum signal in the speaker (or on an output-meter connected across

the voice coil), reducing the input as alignment proceeds. Best alignment is accomplished with weak signals.

If the adjustment must be made without the aid of test equipment, set the dial to the frequency of a local broadcasting station near the 1400 K. C. end of the dial and perform the alignment as described above using shorter antennas as alignment proceeds until finally no antenna will be required if the station is sufficiently powerful.

If the dial is set accurately to the frequency on which alignment is made, the calibration of the receiver dial will be found to be unusually accurate over its entire scale.

SENSITIVITY

This receiver has tremendous possible sensitivity but it has purposely been limited to considerably less, to conform to the average sensitivity requirement for a Home Receiver. The sensitivity may be increased by decreasing the capacity of the mica condensers connected from the first two R. F. plates to ground, or it may be reduced by increasing these capacities. Caution: If the sensitivity is increased too much the receiver will oscillate.

OSCILLATION

If the set, with the R. F. plate condensers installed, oscillates when aligned, it is reasonably certain that either the wiring did not follow the Pictorial Diagram, that some by-pass condenser has been omitted or is open, or an incorrect value has been used. When looking for causes for oscillation, check to be sure that one of the by-pass condensers is not open, by connecting a known good by-pass condenser across each condenser in the receiver successively until the defective unit is discovered, or a poor joint or other source of trouble is found.

**Parts Supplied for Construction of
6-Tube Ferrocart T. R. F. Receiver**

**Model
10-1102**

- | | |
|---------------------------------------------------------------------------------------------------------------------------------------------------------------------------------------------------------------------------------------------------------------------------------------------------------------------------------------------------------------------------------------------------------------------------------------------------------------------------------------------------------------------------------------------------------------------------------------------------------------------------------------------------------------------------------------------------------------------------------------------------------------------------------------------------------------------------------------------------------------------------------------------------------------------------------------------------------------------------------------------------------------------------------------------------------------------------------------------------------------------------------------------------------------------------------------------------------------------------------------------------------------------------------------------------------------------------------------------------------------------------------------------------------------------------|--------------------------------------------------------------------------------------------------------------------------------------------------------------------------------------------------------------------------------------------------------------------------------------------------------------------------------------------------------------------------------------------------------------------------------------------------------------------------------------------------------------------------------------------------------------------------------------------------------------------------------------------------------------------------------------------------------------------------------------------------------------------------------------------------------------------------------------------------------------------------------------------------------------------------------------------------------------------------------------------------------------------------------------------------------------------------------------------------------------------------------------------------------------------------------------------------------------------------------------------------------------------------------------------------------|
| <ul style="list-style-type: none"> 1 Calibrated airplane dial and escutcheon, 23-8203 3 Sets No. 2 mounting screws, nuts and lockwashers. 2 6.3 volt dial lights, bayonet base. 1 4-gang, 365-mmfd tuning condenser 1 Condenser shield assembly 1 Ferrocart antenna coil, 14-1496. 3 Ferrocart R. F. coils, 14-7860 1 Power transformer, 110-volt, 60-cycle 1 500,000-ohm volume control. 1 25,000-ohm tone control with AC switch 1 Dual 15-mfd. dry electrolytic condenser, 450-v. 1 Mounting plate for electrolytic condenser 6 Molded bakelite octal sockets 1 4-prong wafer socket for speaker 4 Metal-tube grid clips 1 AC line cord and plug 1 .000025-mfd. mica condenser. 2 .0001-mfd. mica condensers 2 .00025-mfd. mica condensers 1 .0005-mfd. mica condenser 1 .006-mfd., 600-volt paper condenser 1 .01-mfd., 400-volt paper condenser 4 .05-mfd., 200-volt paper condensers 2 .05-mfd., 400-volt paper condensers 3 .1 mfd., 200-volt paper condensers 1 .1 mfd., 400-volt paper condenser 1 10-mfd., 25-volt electrolytic condenser 1 300-ohm, 1-watt resistor 1 400-ohm., ¼-watt resistor 1 700-ohm, ¼-watt resistor | <ul style="list-style-type: none"> 1 30,000-ohm, 1-watt resistor 1 40,000-ohm, 1-watt resistor 1 50,000-ohm, ¼-watt resistor 4 100,000-ohm, ¼-watt resistors 1 250,000-ohm, ¼-watt resistor 3 500,000-ohm, ¼-watt resistors 2 Tie-lugs, single insulated terminal 3 Tie-lugs, two insulated terminals 1 Tie-lug, three insulated terminals 2 ¼" rubber grommets 1 ⅜" rubber grommet 1 Mallory bias-cell and holder 3 Black bakelite knobs 1 Ant-Gnd. terminal strip. 7 Shakeproof ground lugs 5 6-32 x ¾" RH black screws 4 Wood panel spacers, ½" dia. x ⅝" long 1 Wood dial spacer, ½" dia. x 5/16" long 35 6-32 x ¼" RH steel screws 45 6-32 x ¼" hexagon nuts 45 No. 6 steel lockwashers 1 Length black braided sleeving 1 Length Rosin-core solder 1 Length shielded wire 1 Length No. 20 hook-up wire, black 1 Length No. 20 hook-up wire, red 1 Length No. 20 hook-up wire, blue 1 Length No. 20 hook-up wire, orange 1 Length No. 20 stranded wire, green 1 Punched steel chassis, 11-8211, 10" x 12" x 3" |
|---------------------------------------------------------------------------------------------------------------------------------------------------------------------------------------------------------------------------------------------------------------------------------------------------------------------------------------------------------------------------------------------------------------------------------------------------------------------------------------------------------------------------------------------------------------------------------------------------------------------------------------------------------------------------------------------------------------------------------------------------------------------------------------------------------------------------------------------------------------------------------------------------------------------------------------------------------------------------------------------------------------------------------------------------------------------------------------------------------------------------------------------------------------------------------------------------------------------------------------------------------------------------------------------------------------------------------------------------------------------------------------------------------------------------|--------------------------------------------------------------------------------------------------------------------------------------------------------------------------------------------------------------------------------------------------------------------------------------------------------------------------------------------------------------------------------------------------------------------------------------------------------------------------------------------------------------------------------------------------------------------------------------------------------------------------------------------------------------------------------------------------------------------------------------------------------------------------------------------------------------------------------------------------------------------------------------------------------------------------------------------------------------------------------------------------------------------------------------------------------------------------------------------------------------------------------------------------------------------------------------------------------------------------------------------------------------------------------------------------------|

ADDITIONAL PARTS REQUIRED FOR OPERATION

- | | |
|----------------------------------------------------------------------------------------------------------------------------------------------------------|------------------------------------------------------------------------------------------------------------------------------------------------------------------------------------------------------------------------|
| <ul style="list-style-type: none"> 3 6K7 Metal tubes 1 6Q7 Metal tube 1 6V6 or 6V6G tube 1 5Y4G rectifier tube | <ul style="list-style-type: none"> 1 Dynamic speaker with 4-prong plug; 1500 to 2000-ohm field resistance; output transformer to match single 6V6 in Class A; power handling capacity, 5-watts minimum. |
|----------------------------------------------------------------------------------------------------------------------------------------------------------|------------------------------------------------------------------------------------------------------------------------------------------------------------------------------------------------------------------------|

MEISSNER ACCESSORIES AVAILABLE

- | | |
|--------------------------------------------------------------------------------------------------------------------------------|---------------------------------------------------------------------------------------------------------------------------------------------------------|
| <ul style="list-style-type: none"> No. 11-8214 punched steel panel, black wrinkle finish, 9 ½" x 14 ½" x 1/16". | <ul style="list-style-type: none"> No. 11-8212 steel cabinet, complete with hinged lid, black wrinkle finish, 9 ½" x 14 ½" x 11 ½" deep. |
|--------------------------------------------------------------------------------------------------------------------------------|---------------------------------------------------------------------------------------------------------------------------------------------------------|

No.10-1102

6-TUBE AC DELUXE TRF

SCHEMATIC
CIRCUIT DIAGRAM

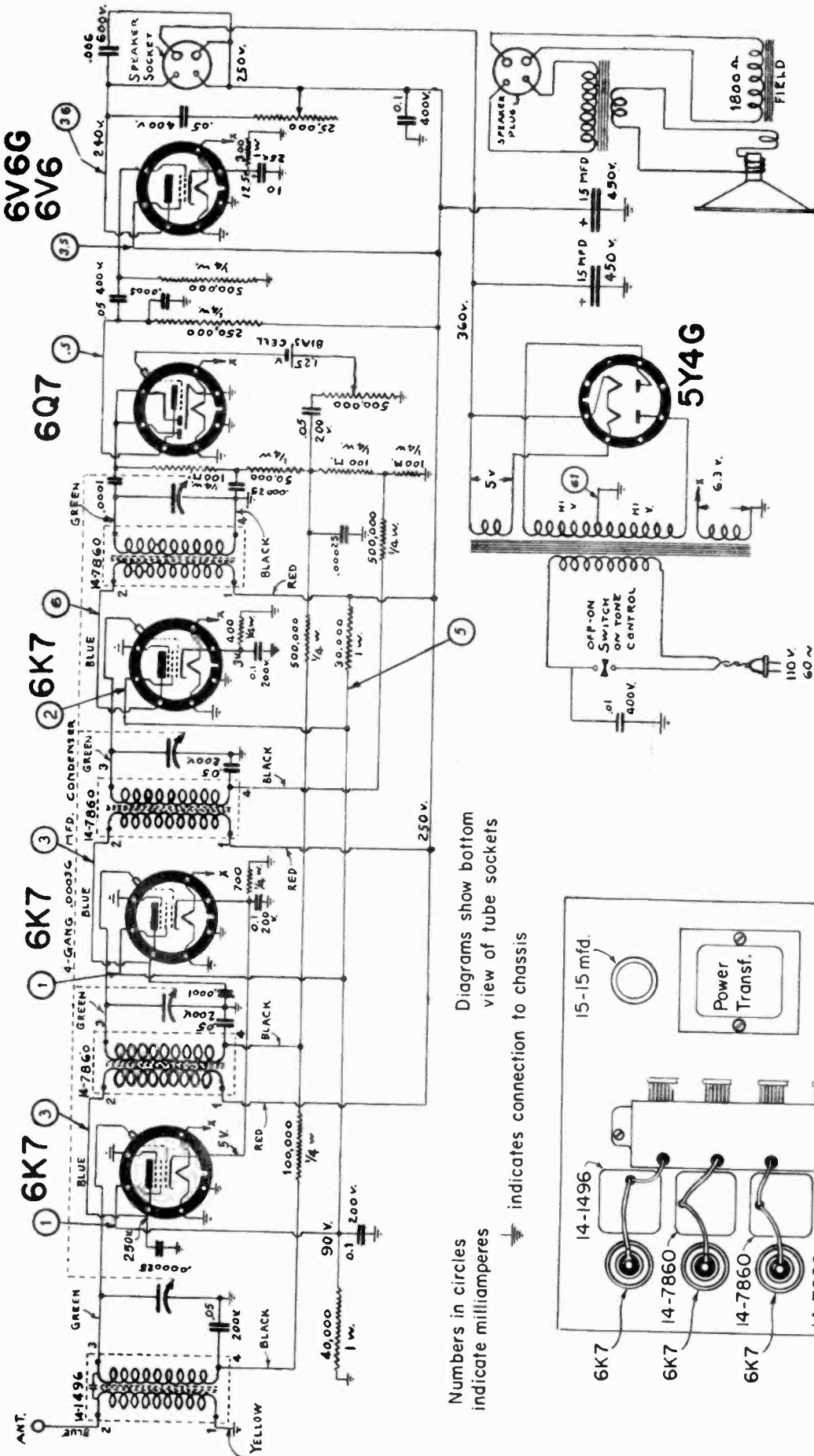

Numbers in circles indicate milliamperes

Diagrams show bottom view of tube sockets

indicates connection to chassis

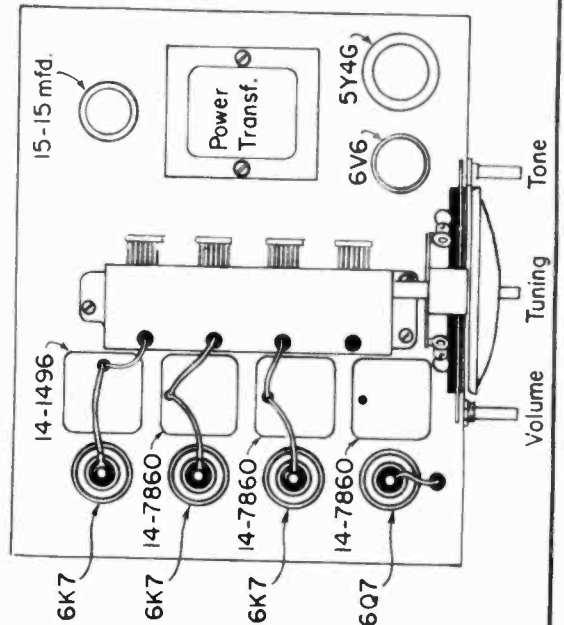

MEISSNER MFG. CO.
Mt. Carmel, Illinois

10-1102
PICTORIAL
WIRING DIAGRAM

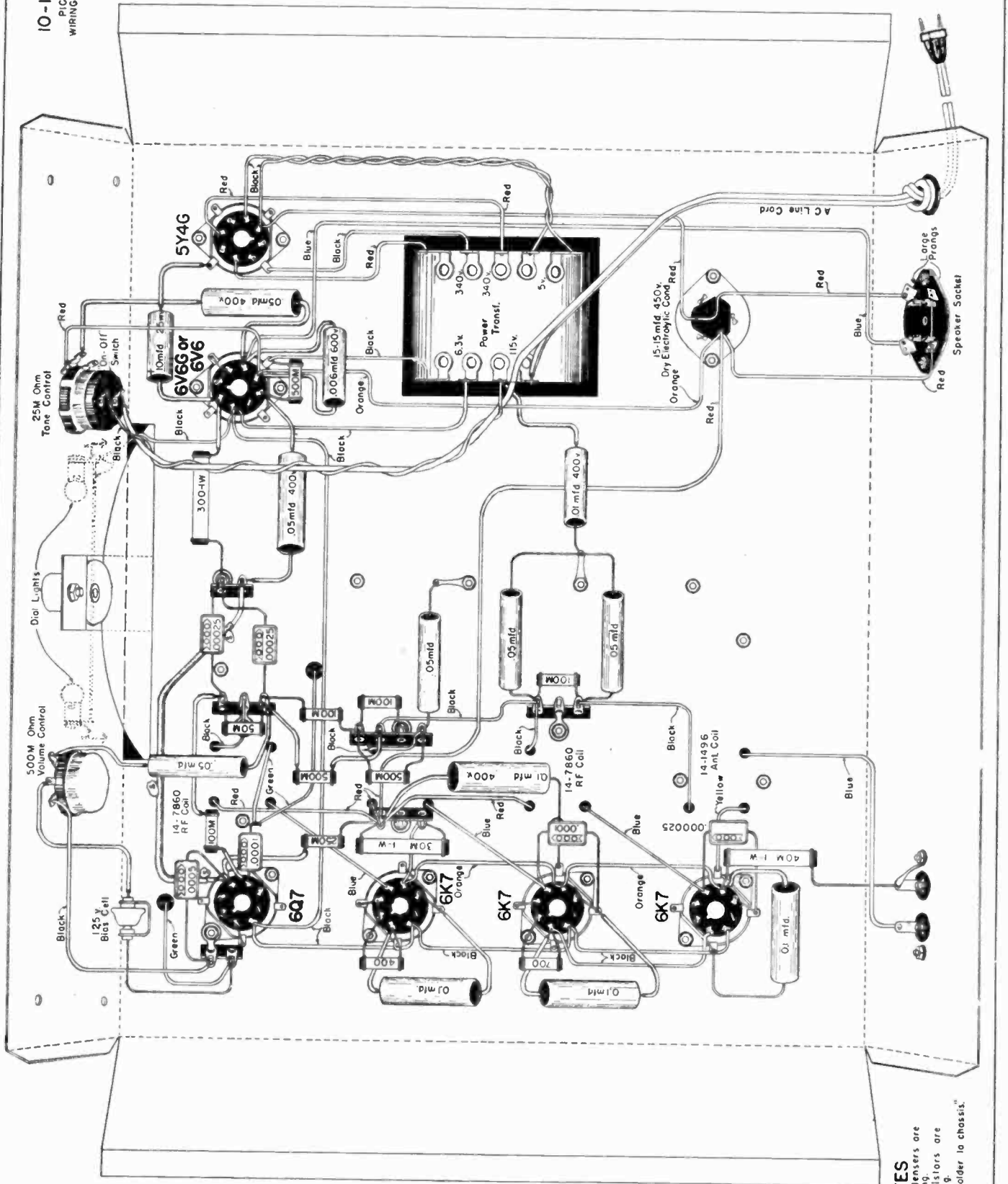

NOTES
 Unmarked Condensers are
 200-volt rating.
 Unmarked Resistors are
 1/4-watt rating.
 "S" indicates "Solder to chassis."

COMPLETE INSTRUCTIONS
FOR CONSTRUCTION AND OPERATION OF THE



5-Tube AC T.R.F. Receiver

Broadcast Band Only Model 10-1106

The Meissner 5 tube TRF receiver kit No. 10-1106 was designed to fill the requirements for a receiver kit very simple to build yet possessing performance such that it will continue to give satisfying entertainment long after the thrill of successful construction has worn off.

This receiver tunes from 550 KC to 1600 KC and has its own power supply, operating from the 110-volt, 60-cycle line. Two stages of tuned radio-frequency amplification give the receiver adequate selectivity for all purposes except the reception of weak distant stations on frequencies close to that of a local station. It has excellent tone and ample power output for home conditions.

ASSEMBLY

As the kit is unpacked, all parts should be carefully checked against the packing slip enclosed with the kit. Any discrepancies should be reported at once to the supplier from whom the kit was purchased.

The parts should be mounted on the chassis in accordance with the top view of the receiver shown on the Schematic Diagram, and the bottom view shown in the Pictorial Wiring Diagram.

Note that the gang condenser is mounted sufficiently high above the chassis, that the leads connected to two of the stator connections under the gang condenser will not be in danger of short-circuiting to the chassis. This elevated mounting can be accomplished by using nuts on the mounting spade-bolts above the chassis as well as below. The condenser, when properly mounted, has its lower edge approximately $\frac{1}{4}$ " above the chassis.

Before beginning the wiring, temporarily install the gang condenser, dial and both controls so that their proper shaft lengths may be determined when the receiver is placed in the cabinet intended for it. Mark the shafts for proper lengths and then remove the controls from the chassis and saw each one with its shaft clamped in a vice. It is advisable not to attempt to cut the shaft of any unit while mounted on the chassis, because the heavy strains imposed on the unit may cause damage thereto.

Mount the sockets, taking care that they are installed in the proper places so that the numbers stamped on them will correctly indicate the type of tube to be inserted. Observe also that the keyway in the socket is properly oriented, lest it become necessary to remove all of the wires from the socket if it is later found to be reversed. It is advisable also to solder at least one spot (preferably adjacent to a mounting screw) on each socket saddle to chassis, since many

ground connections are made to the lugs on the saddle, and trouble due to poor contact may develop unexpectedly unless a permanent good contact is insured by soldering.

Install the power transformer by means of the nuts shipped thereon, observing that the terminals on the transformer are properly placed according to the Pictorial Diagram.

WIRING

Having completed the assembly operations described above, the actual wiring may start, observing the suggestions given on the sheet "General Construction Hints" packed with each Kit.

After bending down all socket-saddle ground-lugs not required for wiring, wire the filament circuit complete. The remaining wiring may be installed in any convenient sequence. It will be found a great help in wiring if each wire in the Pictorial Diagram is marked over with a colored pencil as the corresponding wire in the set is installed.

Note that grid leads must be attached to each coil by threading the lead down through the hole in the top of the coil can and attaching the lead to the proper lug at the bottom of the coil. The coils need not be removed from the can in order to attach leads. The antenna coil, mounted closest to the front of the receiver, has two leads run through the top of the can attaching to the lug at the bottom whereas, the other two, although having two leads attached to the corresponding lug have only one through the can, the other crossing the bottom of the chassis to the bottom of the gang condenser. Small pieces of rubber tubing are provided to slip over the shanks of the grid clips so as to prevent contact between these shanks and the metal shield caps that are placed over the grids to prevent oscillation.

VOLTAGE TEST

If all connections are found to be correct, the tubes may be inserted and the line-cord plug connected to a 110-volt, 60-cycle receptacle, and the speaker (1500- to 2000-ohm field) plugged in. A slight turn of the tone-control knob to the right will turn on the receiver. After a brief warm-up period the voltages shown on the Schematic Diagram should be checked with a high-resistance voltmeter, if available. Voltages indicated are measured from the point shown, to the chassis, with the chassis as the negative terminal. If values measured are materially different than shown on the diagram, a thorough recheck of the circuit should be made. **Be sure the receiver is turned off and the line-cord disconnected from the power receptacle while the wiring is being checked.**

ALIGNMENT

Set the dial so that the pointer is horizontal when the gang condenser is completely closed.

Connect a service oscillator or signal generator to the radio set using a 200-mmf condenser between the antenna post of the receiver and the high side of the signal generator to act as a dummy antenna. Turn the volume control on full, set the dial at approximately 15, turn up the output of the signal generator and tune it until a signal is heard. Adjust the trimmers on top of the gang condenser for maximum signal, reducing the generator output as the receiver becomes progressively more sensitive. If oscillation (signal or whistle) results, retard the volume control until oscillation ceases. Oscillation is usually evidence that the receiver was not wired

accurately according to the Pictorial Diagram, which has been prepared to avoid such troubles. Check the wiring of antenna lead and all grid and plate leads associated with the 6K7 and 6J7 tubes to see that these leads are placed as shown in the diagram.

ALIGNMENT WITHOUT TEST EQUIPMENT

If no test equipment is available, connect an outside aerial to the receiver, advance the volume control to maximum and tune in a local station between 1400 and 1500 KC, adjusting the trimmer condensers on the gang condenser, retarding the volume control as the receiver becomes progressively more sensitive, using always a small output signal because more accurate alignment can be made with a weak signal.

Parts Supplied for Construction of 5-Tube AC TRF Receiver

**MODEL
10-1106**

1 Dial and Escutcheon	1 10-mfd., 25-volt Dry Electrolytic Condenser
1 Set of No. 2 Screws, Nuts and Lockwashers	2 8-mfd., 450-volt Dry Electrolytic Condenser
2 6.3-volt Dial lights	1 $\frac{3}{8}$ " Rubber Grommet
1 Antenna Coil	2 $\frac{1}{4}$ " Rubber Grommets
2 RF Coils	3 Metal tube Grid Shields
1 3-gang 365-mmf. Tuning Condenser	3 Metal Tube Grid Clips
1 Condenser Shield	3 1" Black Bakelite Knobs
1 Power Transformer 110-volt 60 cycle	3 8-32x $\frac{1}{4}$ " long RH Brass Screws
5 Molded Bakelite Octal Sockets	30 6-32x $\frac{1}{4}$ " Hexagon Steel Nuts
1 4-prong Wafer Socket for Speaker	20 6-32x $\frac{1}{4}$ " long RH Steel Screws
1 Ant.-Gnd. Terminal Strip	27 No. 6 Lockwashers
1 25,000-ohm Tone Control with Switch	3 Tie Lugs, one insulated terminal
1 10,000-ohm Volume Control	1 Tie lug, two insulated terminals
1 Line cord and plug	1 Shakeproof Soldering lug
1 300-ohm, $\frac{1}{4}$ -watt resistor	1 Length No. 20 Shielded wire
1 400-ohm, 1-watt resistor	1 Length Spring Shielding
1 40,000-ohm, 1-watt resistor	1 Length No. 20 Solid hook-up wire, Red
1 50,000-ohm, 1-watt resistor	1 Length No. 20 solid hook-up wire, Black
1 50,000-ohm, $\frac{1}{4}$ -watt resistor	1 Length No. 20 solid hook-up wire, Blue
1 250,000-ohm, $\frac{1}{4}$ -watt resistor	1 Length No. 20 solid hook-up wire, Yellow
1 500,000-ohm, $\frac{1}{4}$ -watt resistor	1 Length No. 20 solid hook-up wire, Orange
1 2-megohm, $\frac{1}{2}$ -watt resistor	1 Length No. 20 Solid hook-up wire, Brown
1 .0005-mfd. Mica Condenser	1 Length No. 20 solid hook-up wire, Green
1 .006-mfd., 600-volt Paper Condenser	1 Length No. 20 stranded wire, Green
1 .01-mfd., 400-volt Paper Condenser	1 Length Black insulating sleeving
2 .05-mfd., 400-volt Paper Condenser	1 Length Rosin core solder
3 .1-mfd., 200-volt Paper Condensers	1 Length Rubber tubing
2 .1-mfd., 400-volt Paper Condensers	1 Punched steel chassis 7"x9"x2"

ADDITIONAL PARTS REQUIRED FOR OPERATION

2 6K7 Metal Tubes	1 Dynamic Speaker with 4-prong plug; 1500- to 2000-ohm field resistance; output transformer to match single 6F6; power handling capacity, 5 watts minimum.
1 6J7 Metal Tube	
1 6F6 Metal Tube	
1 5Y4G Octal base Glass Tube	

Note: No Panel or Cabinet is available for this receiver.

No. 10-1106

5-TUBE AC STANDARD TRF

Metal Tubes

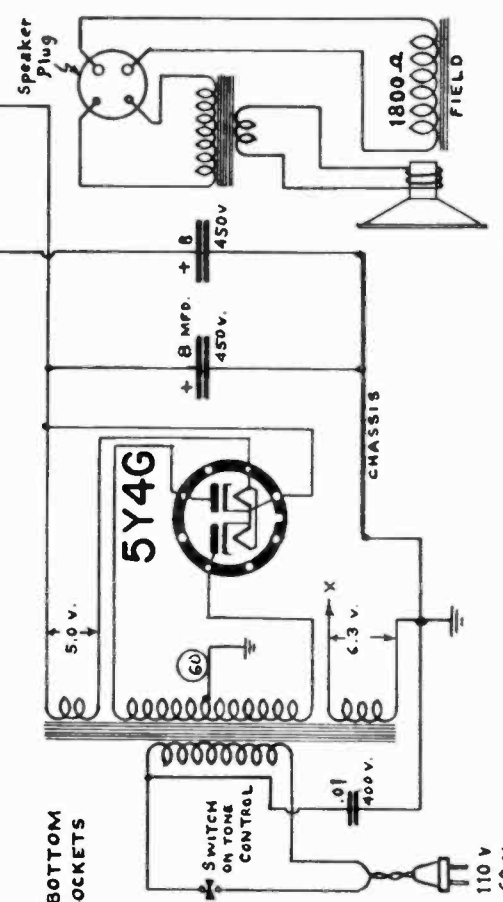
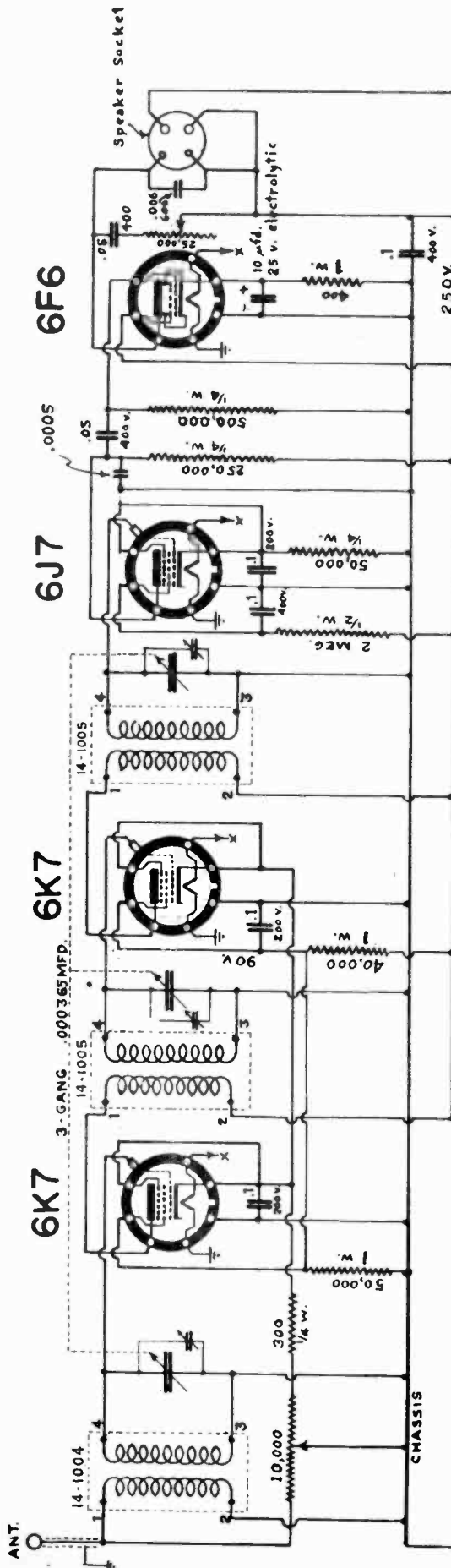

DIAGRAMS SHOW BOTTOM VIEW OF TUBE SOCKETS

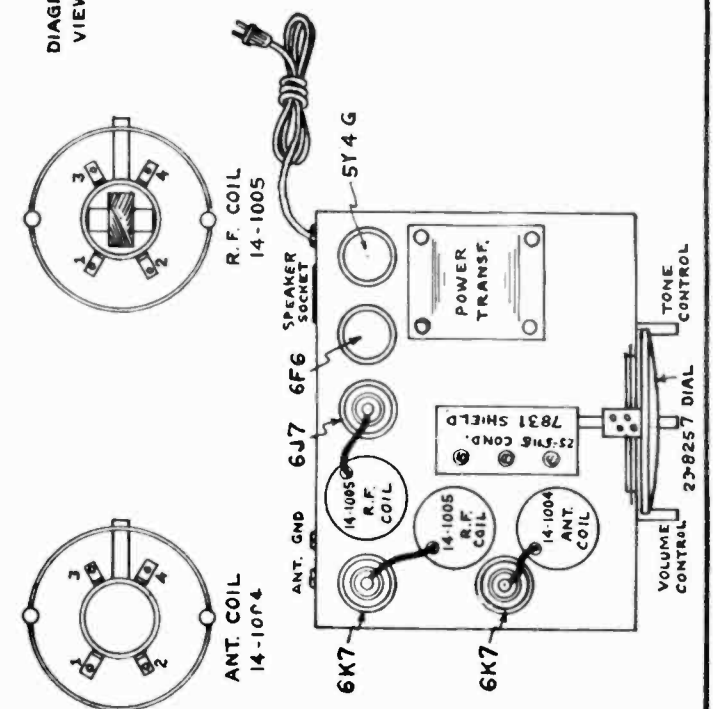

MEISSNER MFG. CO.
Mt. Carmel, Ill.

10-1106
PICTORIAL WIRING
DIAGRAM

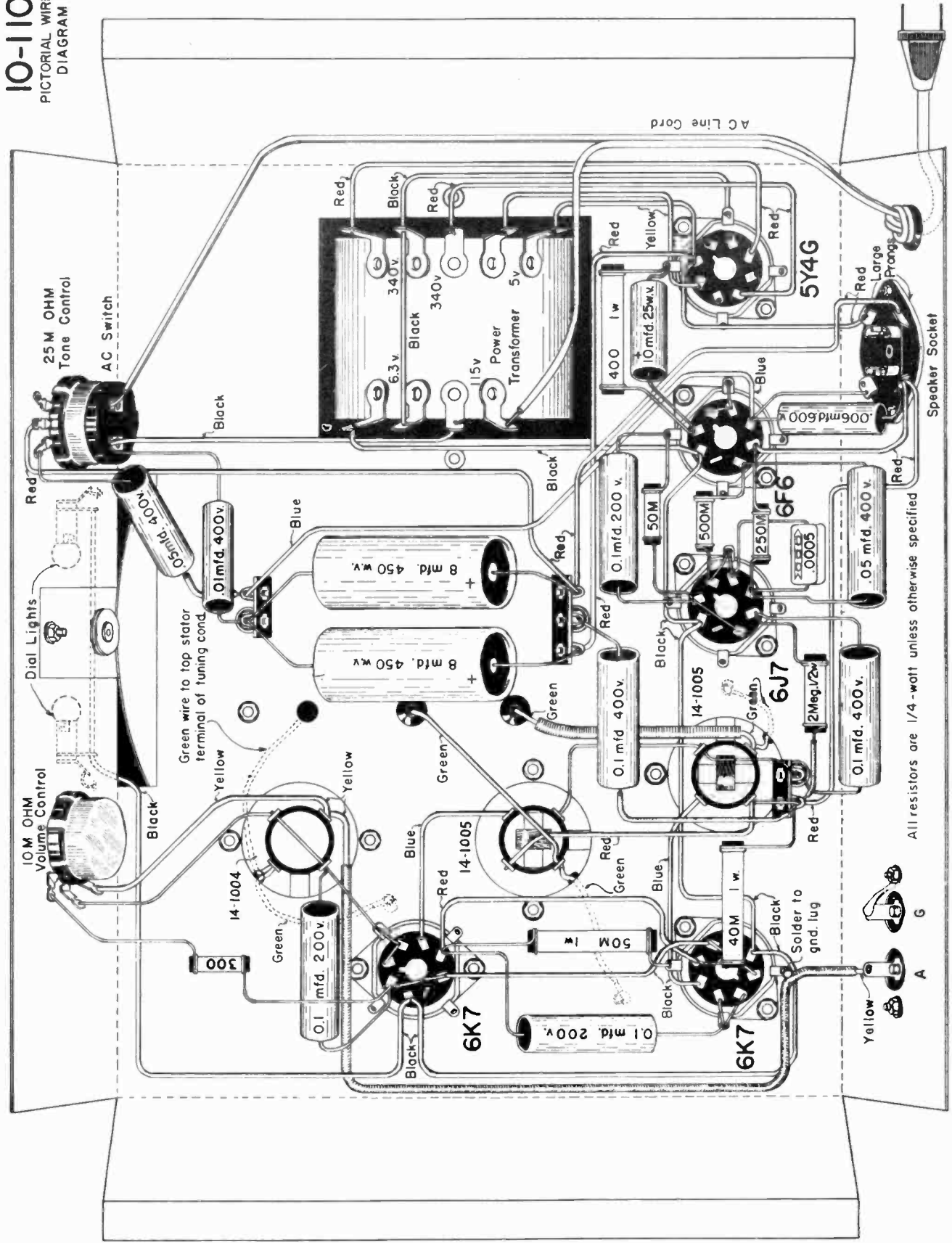

All resistors are 1/4-watt unless otherwise specified

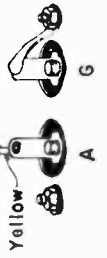

COMPLETE INSTRUCTIONS
FOR THE CONSTRUCTION AND OPERATION OF THE



4-Tube AC-DC TRF Receiver

Broadcast Band Only

Model 10-1105

The 4-tube A.C.-D.C. T. R. F. receiver Kit was designed to be one of the simplest types of self-powered broadcast receivers and to contain a minimum of parts. In accordance with Meissner Kit practice, no speaker is provided, so that the constructor may use a speaker he possibly may already possess or purchase his favorite brand of speaker to be used with the receiver. A speaker-type dial is provided, to mount across the face of a small magnetic or permanent-magnet dynamic speaker.

The accessories required are, tubes as listed in the parts list, and a magnetic or permanent-magnet dynamic speaker with output transformer to match a 25 A 6 tube.

ASSEMBLY

As the Kit is unpacked, all parts should be checked against the packing slip enclosed with the Kit. Any discrepancies should be reported at once to the supplier from whom the kit was purchased.

The parts for the receiver should be mounted on the chassis according to the top view of the receiver shown on the Schematic Diagram, and the bottom view shown in the Pictorial Diagram. The order of assembly is of little importance, as long as the choke is installed last.

Mount the sockets taking care that they are installed in the proper places so that the numbers stamped on them will correctly indicate the type of tube to be installed therein. Observe also that the keyway in the socket is properly placed, lest it become necessary to remove all of the wires from the socket if it is later found to be reversed. It is also advisable to solder at least one spot (preferably adjacent to a mounting screw) on each socket saddle to chassis, since many ground connections are made to the lugs on the saddle, and trouble due to poor contact may develop unexpectedly unless a permanent good contact is insured by soldering.

WIRING

Having completed the assembly operations described above, the actual wiring may start, observing the suggestions given on the sheet "General Construction Hints" packed with each Kit.

After bending down all socket-saddle-ground-lugs not required for wiring, wire the filament circuit complete. The remaining wiring may be installed in any convenient sequence. It will be found a great help in wiring if each wire

in the Pictorial Diagram is marked over with a colored pencil as the corresponding wire in the set is installed.

VOLTAGE TEST

If all connections are found to be correct, the tubes and pilot light may be inserted in their respective sockets. The receiver should be insulated from any grounded object and the line-cord plugged into a 110-volt AC or DC receptacle.

NOTE! THE CHASSIS IS CONNECTED DIRECTLY TO ONE SIDE OF THE POWER LINE. DO NOT STAND ON A DAMP FLOOR OR TOUCH ANY GROUNDED OBJECT WHEN ANY PART OF THE BODY IS IN CONTACT WITH THE CHASSIS WHEN THE LINE CORD IS PLUGGED IN.

A slight turn of the volume control to the right will turn on the receiver. **NOTE!** When the receiver is first turned on the pilot light will burn brightly after which its brilliance will diminish as the set heats up.

After a brief warm-up period the voltage shown on the Schematic Diagram may be checked with a high resistance voltmeter if available. **NOTE!** If the receiver is used on DC it may be necessary to reverse the line plug to obtain proper operation and to cause voltage to appear in the place shown. The voltages indicated are measured between chassis and the point shown with the chassis as the negative terminal. If voltages are materially different than shown on the diagram, a thorough recheck of the circuit should be made. **BE SURE THE LINE CORD IS DISCONNECTED WHEN WORKING ON THIS RECEIVER.**

ALIGNMENT

Set the tuning condenser so that its plates are nearly all the way open (out of mesh). If a service oscillator is available, connect it to the receiver using a 200-mmf condenser between the high side of the generator and the antenna connection of the receiver to act as a dummy antenna. Turn up the volume control and then tune the generator until a signal is heard. Adjust the two trimmers on top of the gang-condenser for maximum response. If no service oscillator is available, tune in a broadcasting station between 1300 and 1500 KC, and adjust the trimmers for maximum response, reducing the setting of the volume control as the receiver becomes progressively more sensitive, to keep the output low because more accurate alignment can be made with weak signals.

CABINET

Since the chassis is connected to one side of the power line, as is the case with most AC-DC receivers, it is recommended that the receiver be installed in some kind of a cabinet, either wood, masonite, bakelite or some other non-conductor or that it be installed in a metal cabinet, but thoroughly insulated from it so that there will be no circuit from the cabinet to either side of the power line.

The enclosure recommended above is for the purpose of avoiding accidental shocks to those not acquainted with the

fact that the chassis is connected to the line.

No cabinet or panel for this receiver is available from the manufacturer of this kit as the arrangement and construction of these parts are left to the ingenuity of the constructor. Many interesting possibilities will present themselves due to the unusually small size and the ability of the receiver to operate from universal 110 volt power outlets, either AC or DC. A compact carrying case may be provided to make this receiver a handy companion for the travelling man, tourist or vacationer.

**Parts Required for Construction of
4-Tube AC-DC TRF Receiver**

**MODEL
10-1105**

- 1 AC-DC Speaker Dial
- 1 3.2-volt Dial light, screw-type base
- 1 2-gang, 365mmfd tuning condenser
- 1 Condenser shield
- 1 Antenna Coil, No. 14-2436
- 1 R.F. Coil, No. 14-2437
- 4 Molded Bakelite Octal Sockets
- 1 25,000-ohm Volume Control with switch
- 1 Filter choke, No. 19341
- 1 16-mfd. 200wv Dry Electrolytic Condenser
- 1 8-mfd. 200wv Dry Electrolytic Condenser
- 1 .0005-mfd. Mica Condenser
- 1 .001-mfd. Mica Condenser
- 1 .006-mfd. 600-volt Paper Condenser
- 2 .01-mfd. 400-volt Paper Condensers
- 1 .05-mfd. 200-volt Paper Condenser
- 4 .1-mfd. 200-volt Paper Condensers
- 1 10-mfd. 25-volt Dry Electrolytic Condenser
- 1 300-ohm, 1/4-watt resistor
- 1 400-ohm, 1-watt resistor
- 1 50,000-ohm, 1/4-watt resistor
- 1 250,000-ohm 1/4-watt resistor
- 1 500,000-ohm, 1/4-watt resistor
- 1 2-megohm, 1/2-watt resistor
- 1 160-ohm resistance linecord and plug

- 2 Metal Tube Grid Clips
- 2 1" Black Bakelite Knobs
- 1 1/2" Rubber Grommet
- 1 3/8" Rubber Grommet
- 2 1/4" Rubber Grommets
- 2 Shakeproof soldering lugs
- 3 Tie lugs, two insulated terminals
- 1 Tie lug, single insulated terminal
- 30 6-32x1/4" hexagon steel nuts
- 15 6-32x1/4" long RH steel screws
- 28 #6 lock washers
- 4 8-32x1/4" long RH Brass screws
- 4 6-32x3/8" long RH Steel screws
- 1 Length No. 20 solid hook-up wire, black
- 1 Length No. 20 solid hook-up wire, red
- 1 Length No. 20 solid hook-up wire, blue
- 1 Length No. 20 solid hook-up wire, brown
- 1 Length No. 20 solid hook-up wire, green
- 1 Length No. 20 solid hook-up wire, orange
- 1 Length No. 20 solid hook-up wire, white
- 1 Length No. 20 stranded wire, green
- 1 Length No. 20 stranded wire, black
- 1 Length No. 20 stranded wire, red
- 1 Length rosin core solder
- 1 Length black insulating sleeving

ADDITIONAL PARTS REQUIRED FOR OPERATION

- 1 6K7 Metal tube
- 1 6J7 Metal tube
- 1 25A6 Metal tube
- 1 25Z6 Metal tube
- 1 5" Magnetic or P.M. Speaker, with output transformer to match a 25A6

MEISSNER CHASSIS AVAILABLE

No. 11-8288, completely punched, black wrinkle finish, dimensions 4 1/2" x 7" x 2", 3/8" flange each end.

No.10-1105

4-TUBE AC-DC T.R.F. METAL TUBE RECEIVER

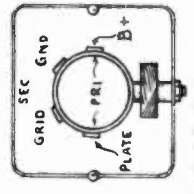
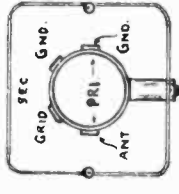
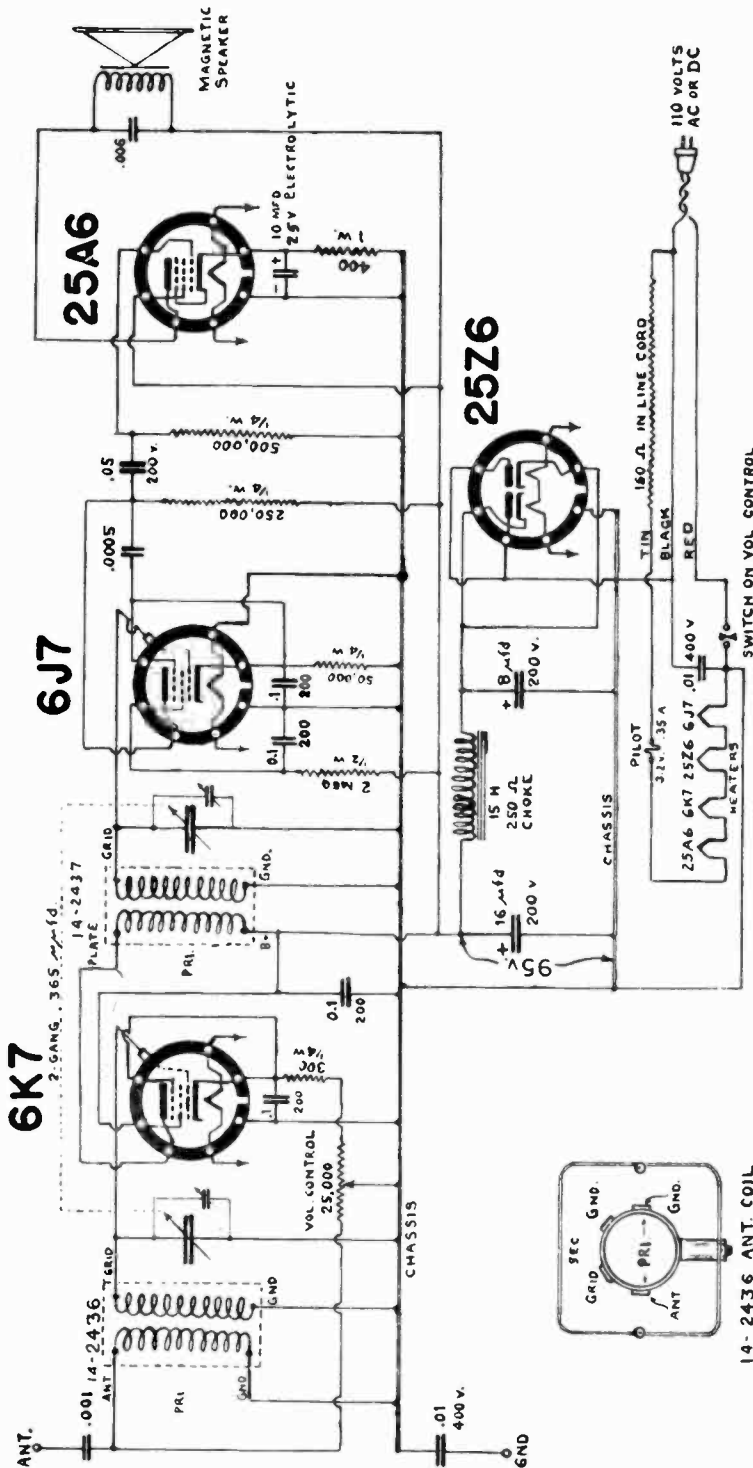

DIAGRAMS SHOW BOTTOM VIEW OF TUBE SOCKETS

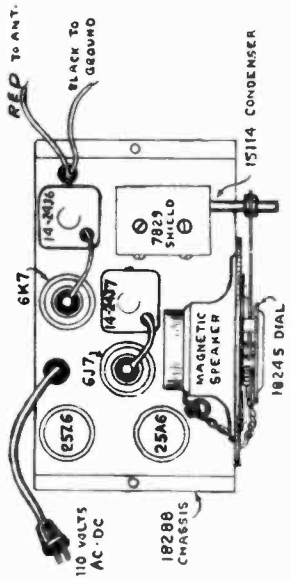

MEISSNER MFG. CO.
Mt. Carmel, Illinois

10-1105

PICTORIAL WIRING DIAGRAM

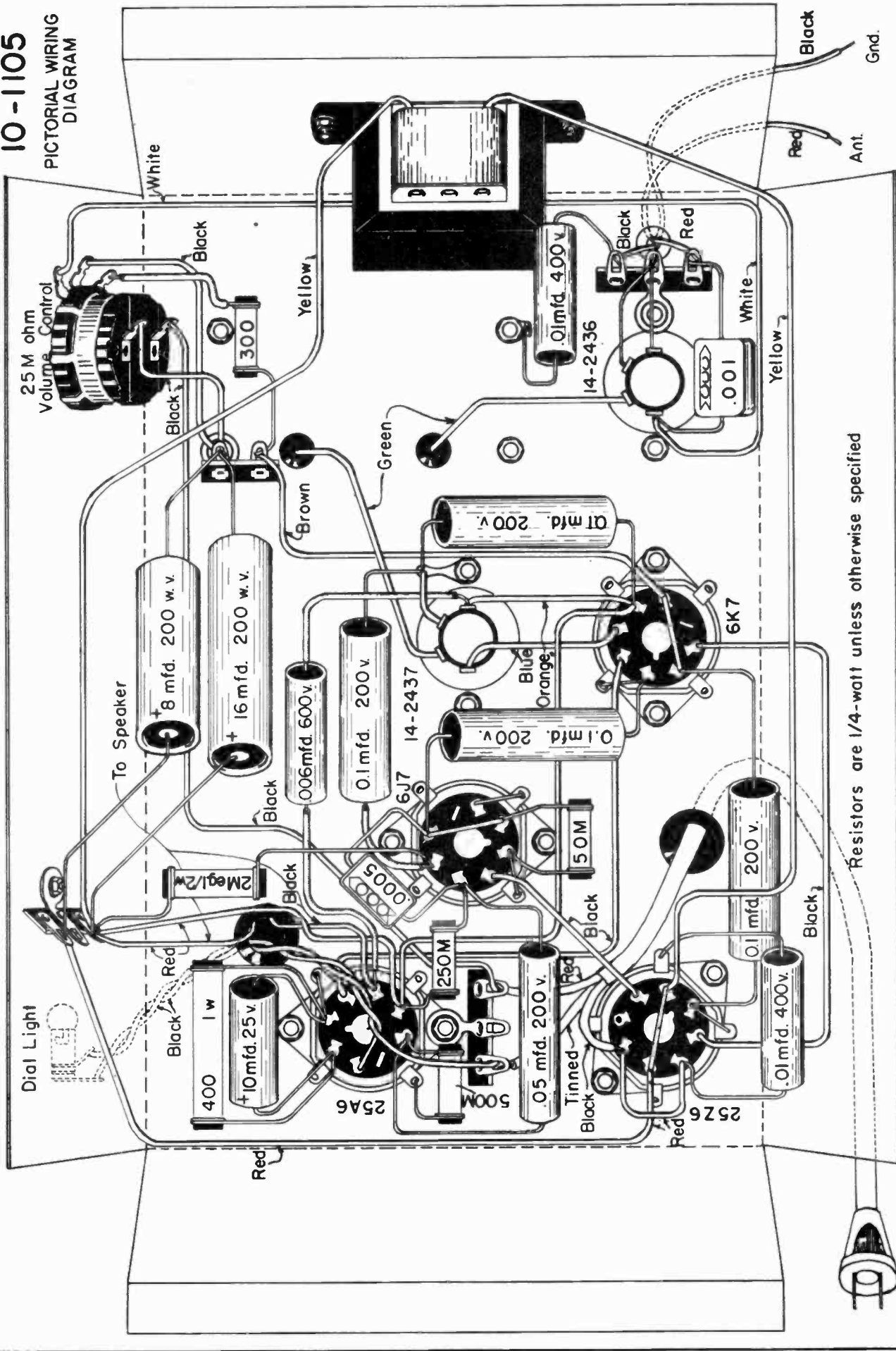



ONE-TUBE MIDGET RECEIVER

PARTS SUPPLIED FOR KIT NO. 10-1161

- | | | |
|------------------------------------------------------------|------------------------------------------------------------------|--------------------------------|
| 1 Punched steel panel | 1 .00005-mfd. mica condenser
(green, black and black dots) | 11 No. 6 steel lockwashers |
| 1 Punched steel chassis | 1 .00025-mfd. mica condenser
(red, green and brown dots) | 2 No. 8-32 x 1/4" brass screws |
| 1 360-mmfd. variable condenser | 1 .0005-mfd. mica condenser
(green, black and brown dots) | 2 No. 8 steel lockwashers |
| 1 Broadcast band plug-in coil | 1 5-megohm fixed resistor, 5Meg
green body, black tip, no dot | 1 3/8" panel hole plug |
| 1 Molded bakelite octal socket | 11 No. 6-32 hexagon nuts | 1 1" black bakelite knob |
| 1 5-prong coil socket | 11 No. 6-32 x 1/4" steel screws | 1 3" black bakelite dial |
| 1 Phone-tip connection jacks | | 5 Lengths colored hook-up wire |
| 1 5-terminal connection strip | | 1 Length insulating tubing |
| 1 10,000-ohm regeneration control
with switch attached. | | 1 Length rosin-core solder. |

ADDITIONAL MATERIALS REQUIRED

1E4G Radio tube
45-volt "B" battery
1 1/2-volt "A" battery
Headphone
A Meissner headphone, designed for use with this set.

may be obtained from your dealer.
The only tools required are:
Small screw-driver
Pair side-cutting pliers
Soldering iron

ANTENNA AND GROUND: A good antenna and ground will provide best reception. Connect to water pipe or to iron rod driven in damp earth for ground. Antenna should be 50 to 75 feet long, well insulated and 20 feet or more high. For local reception an insulated wire 20 to 30 feet long may be used inside with good results, but a ground connection should always be used.

FOLLOW THESE INSTRUCTIONS CAREFULLY

Unpack kit with great care to avoid loss of small parts. Check parts against list; report any shortage at once. Mount the two sockets on chassis with small steel screws; use lockwasher under each nut and tighten screw firmly. Be sure sockets are correctly placed so terminals are located as shown; note position of guide slot in center hole. Mount connection strip and phone jacks at rear of chassis. Mount steel panel on front of chassis with three screws; make sure that dial indicator mark is at front of panel. Mount regeneration control on front of chassis as shown. Mount tuning condenser on top of chassis with large brass screws.

Wire set exactly as shown in Pictorial Wiring Diagram. Use colored wire supplied; push back insulation 1/4" at end of wire after cutting to length; attach to terminals. Solder each connection carefully with small-tipped soldering iron; be sure iron is hot and well tinned; **heat connection thoroughly as solder is applied**; don't use too much solder; use only rosin-core solder as supplied with the kit. Connect resistors and condensers to points shown. Keep all wiring close to chassis and neatly arranged. Do not permit bare wires to touch any other wire or chassis.

Check all wiring carefully after completion. Insert panel hole plug and fasten knob to regeneration control.

Unscrew large knob from dial by turning to left; loosen brass nut several turns and push brass bushing in from front; place dial on shaft of tuning condenser; space 1-16" from panel.

See that condenser plates are completely closed and set '0' on dial to indicator mark on panel; tighten brass nut on dial.

Replace knob on dial and see that dial turns freely.

Greater volume may be obtained by enlarging your receiver to a two-tube or three-tube set. The three-tube model will operate a small loudspeaker. Meissner "Add-On" kits will enable you to make these changes at very small cost. None of your present parts are discarded. Kit No. 10-1125 will make this a two-tube set while 10-1125 and 10-1127 together will provide the parts required to make it into the three-tube model.

Insert 1E4G tube and plug-in coil in proper sockets. Connect Antenna, Ground and Headphones as shown. Connect 1 1/2-volt "A" battery (No. 6 cell) as shown. Turn on regeneration control, note dim red glow in tubes. If tube is not lit, re-check all connections and correct. Attach two wires to terminal strip for "B" batteries. **See that all wires on terminal strip are firmly fastened and that they do not touch adjacent terminals; failure to observe this important precaution may result in a burned-out tube.**

Connect two 22 1/2-volt or one 45-volt battery to wires as shown; be sure to observe plus and minus polarity signs. Put on headphone and turn regeneration control slowly to right as dial is rotated slowly back and forth.

When a whistle is heard, set the dial for the lowest tone and turn regeneration control back (to left) until whistle stops and station is heard; a little practice will enable these adjustments to be made very easily and rapidly.

Do not permit receiver to whistle any more than absolutely necessary as it will interfere with neighborhood reception.

To turn set off, rotate regeneration control to left until switch clicks.

When receiver is operating properly, cut out connection diagram below and paste to back of panel for future reference.

You can listen to short-wave broadcasts and amateur stations with this set! The following extra coils, available at your dealer, will permit you to cover these interesting bands:

- | | |
|-------------|--------------------|
| No. 18-2940 | 70 to 200 meters |
| No. 18-2941 | 35 to 70 meters |
| No. 18-2942 | 15 to 35 meters |
| No. 18-2944 | 545 to 1500 meters |

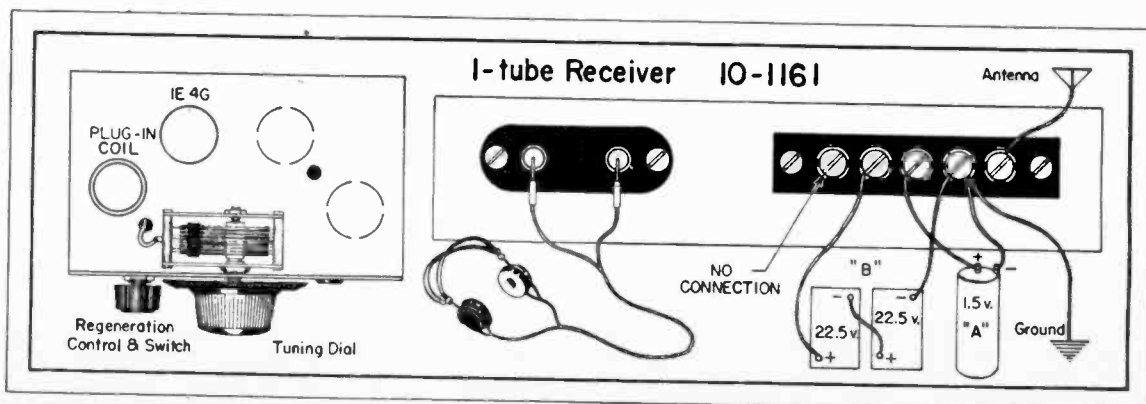

I-TUBE RECEIVER KIT

10-1161

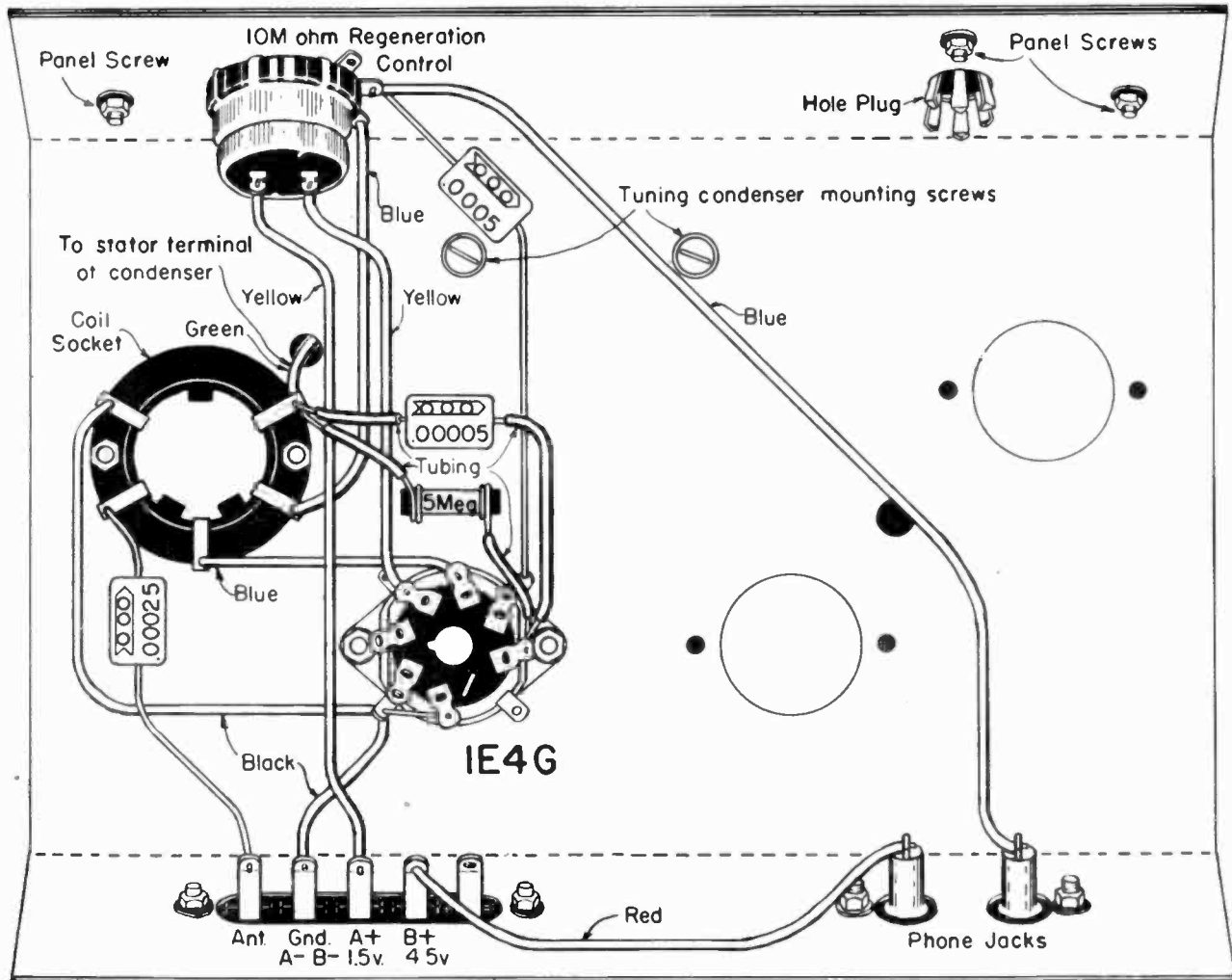
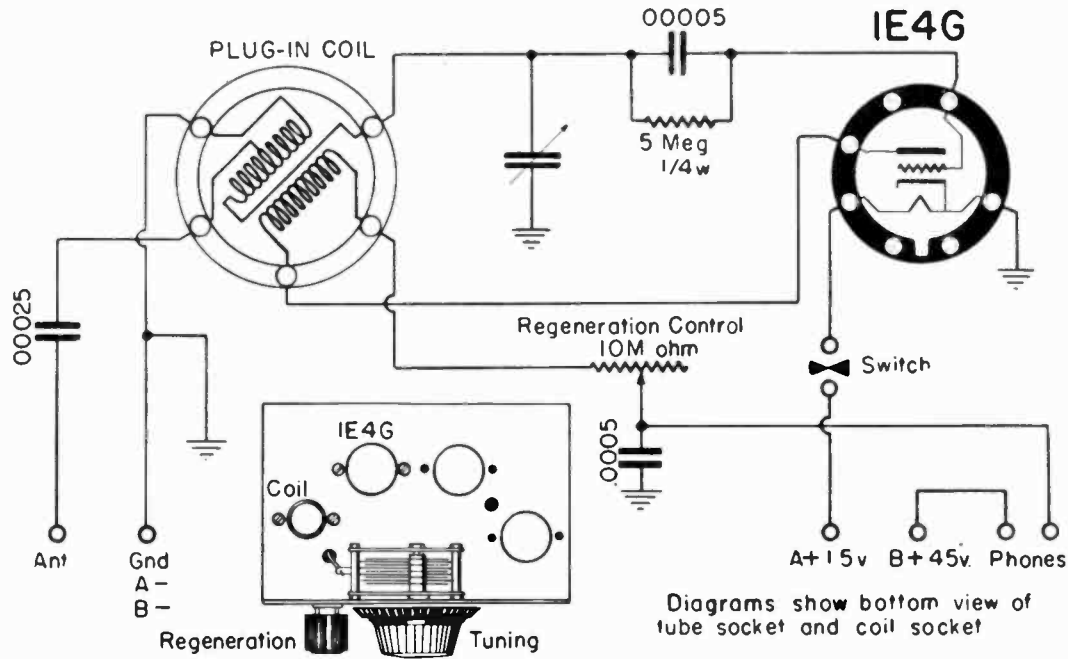



TWO-TUBE MIDGET RECEIVER

PARTS SUPPLIED FOR KIT NO. 10-1162

- | | | |
|---------------------------------------------------------|------------------------------------------------------------------|---------------------------------|
| 1 Punched steel panel | 1 .00005-Mfd. mica condenser, (green, black and black dots). | 13 No. 6-32 hexagon nuts |
| 1 Punched steel chassis | 1 .00025-mfd. mica condenser (red, green and brown dots). | 13 No. 6-32 x 1/4" steel screws |
| 1 360-mmfd. variable condenser | 1 .0005-mfd. mica condenser, (green, black and brown dots). | 13 No. 6 steel lockwashers |
| 1 Broadcast band plug-in coil | 1 5-megohm fixed resistor, 5 Meg (green body, black tip, no dot) | 2 No. 8-32 x 1/4" brass screws |
| 2 Molded bakelite octal sockets | 1 500,000-ohm fixed resistor (green body, black tip, yellow dot) | 2 No. 8 steel lockwashers |
| 1 5-prong coil socket | 1 250,000 ohm fixed resistor, (red body, green tip, yellow dot). | 1 3/8" panel hole plug |
| 1 Phone tip connection jack | | 1 1" black bakelite knob |
| 1 5-terminal connection strip | | 1 3" black bakelite dial |
| 1 Tie-lug, single insulated terminal | | 5 lengths colored hook-up wire |
| 1 10,000-ohm regeneration control with switch attached. | | 1 Length insulating tubing |
| 1 .01-mfd., 200-volt paper condenser | | 1 Length rosin-core solder |

ADDITIONAL MATERIALS REQUIRED

- | | |
|-----------------------------|--------------------------------------------------|
| 1E4G and 1C5G Tubes | with this set, may be obtained from your dealer. |
| 2 45-Volt "B" batteries | The only tools required are: |
| 7 1/2-volt "C" battery | Small screw-driver |
| 1 1/2-volt "A" battery | Pair side-cutting pliers |
| Headphone: a Meissner | Soldering iron. |
| headphone, designed for use | |

ANTENNA AND GROUND: A good antenna and ground will provide best reception. Connect to water pipe or to iron rod driven in damp earth for ground. Antenna should be 50 to 75 feet long, well insulated, and 20 feet or more high. For local reception an insulated wire 20 to 30 feet long may be used inside with good results, but a ground connection should always be used.

FOLLOW THESE INSTRUCTIONS CAREFULLY

Unpack kit with great care to avoid loss of small parts. Check parts against list; report any shortage at once.

Knock out socket opening at right-hand end of chassis.

Mount three sockets on chassis with small steel screws; use lockwashers under each nut and tighten screw firmly.

Be sure sockets are correctly placed so terminals are located as shown; note position of guide slot in center hole. Mount connection strip and phone jacks at rear of chassis.

Mount steel panel on front of chassis with three screws; make sure that dial indicator mark is at front of panel. Mount regeneration control on front of chassis as shown.

Mount tuning condenser on top of chassis with large brass screws.

Wire set exactly as shown in Pictorial Wiring Diagram.

Use colored wire supplied; push back insulation 1/4" at end of wire after cutting to length; attach to terminals.

Solder each connection carefully with small-tipped soldering iron; be sure iron is hot and well tinned; heat connection thoroughly as solder is applied; don't use too much solder; use only rosin-core solder as supplied with the kit.

Connect resistors and condensers to points shown.

Use insulating tubing on resistor and condenser leads as shown.

Keep all wiring close to chassis and neatly arranged.

Do not permit bare wires to touch any other wire or chassis.

Check all wiring carefully after completion.

Insert panel hole plug and fasten knob to regeneration control.

Unscrew large knob from dial by turning to left; loosen brass nut several turns and push brass bushing in from front; place dial on shaft of tuning condenser; space 1-16" from panel.

See that condenser plates are completely closed and set 0

Greater volume with loudspeaker operation may be obtained by enlarging your receiver to a three-tube set. Meissner "Add On" Kit, No. 10-1127, will provide the parts to make this change at small cost. All present parts used in three-tube receiver.

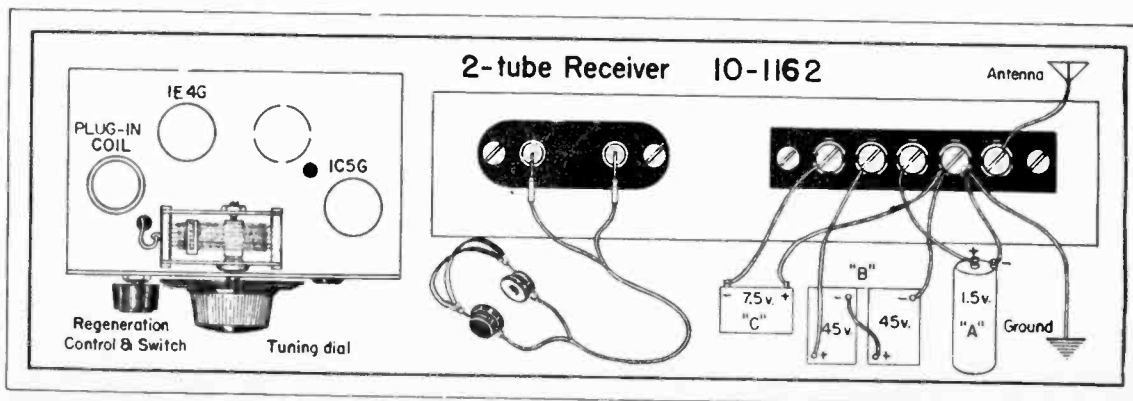

2-TUBE RECEIVER KIT

10-1162

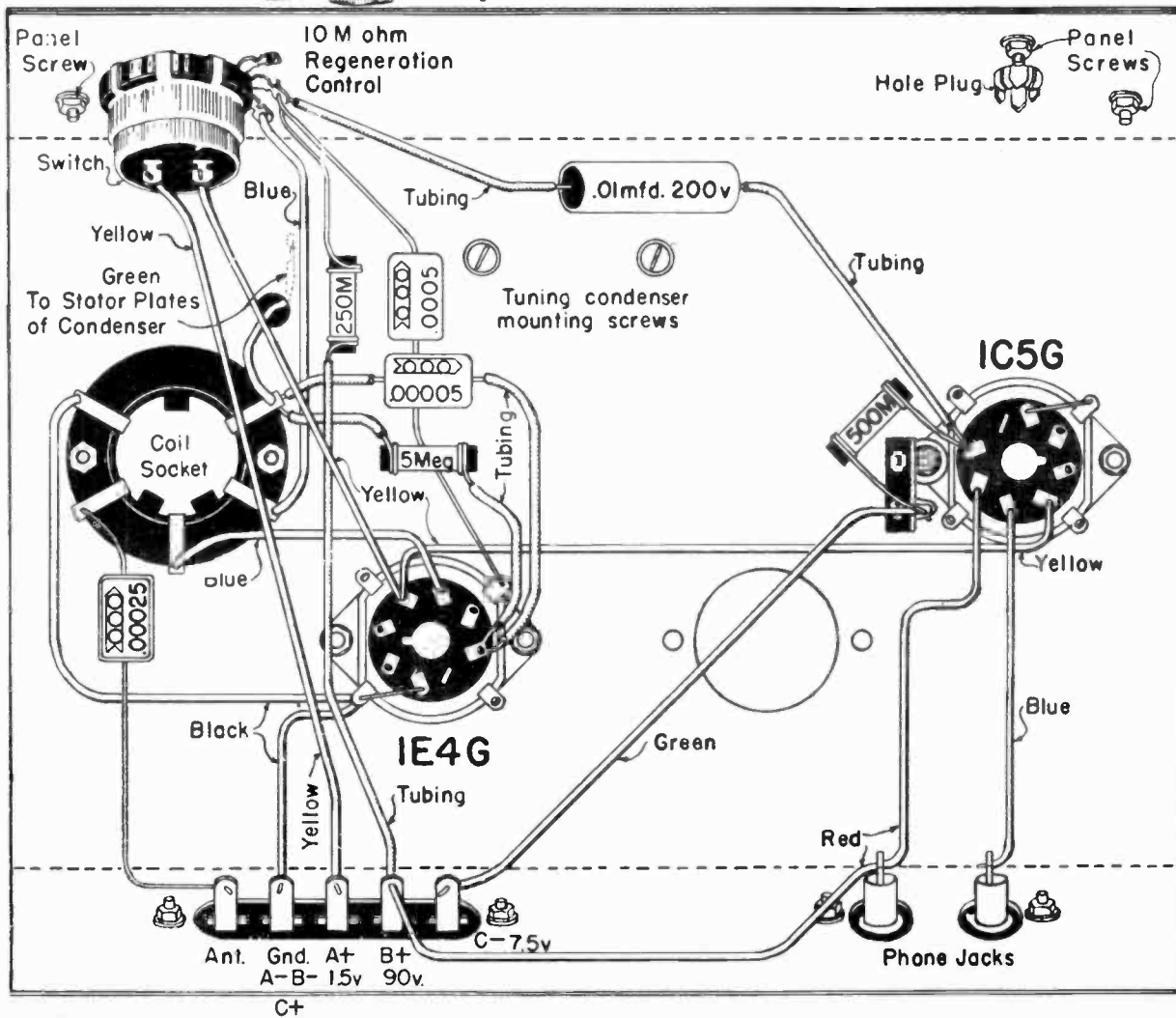
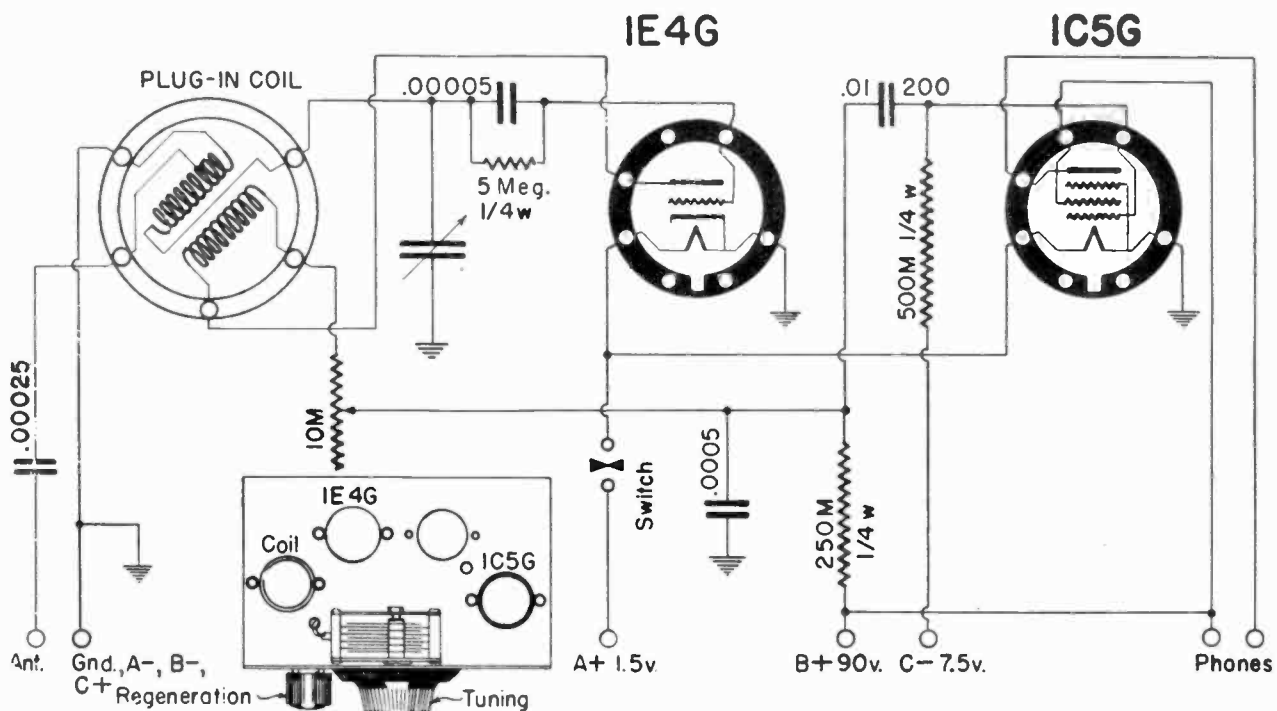



THREE-TUBE MIDGET RECEIVER

PARTS SUPPLIED FOR KIT NO. 10-1163

- | | | |
|---------------------------------------------------------|-------------------------------------------------------------------|--------------------------------|
| 1 Punched steel panel | 1 .00005-Mfd. mica condenser, (green, black and black dots). | 14 No.6-32 hexagon nuts |
| 1 Punched steel chassis | 1 .00025-mfd. mica condenser, (red, green and brown dots). | 14 No. 6-32 x ¼" steel screws |
| 1 360-mmfd. variable condenser | 1 .0005-mfd. mica condenser, (green, black and brown dots). | 14 No. 6 steel lockwashers |
| 1 Broadcast band plug-in coil | 1 16-mfd., 150-volt condenser. | 2 No. 3-32 x ¼" brass screws. |
| 3 Molded bakelite sockets | 1 5-Megohm fixed resistor, (green body, black tip, no dot). | 2 No. 8 steel lockwashers |
| 1 5-prong coil socket | 1 500,000-ohm fixed resistor, (green body, black tip, yellow dot) | 1 Grid Clip |
| 1 Phone tip connection jack | 2 250,000-ohm fixed resistors, (red body, green tip, yellow dot) | 2 1" black bakelite knobs |
| 1 5-terminal connection strip | | 1 3" black bakelite dial |
| 1 Tie-lug, single insulated terminal | | 1 3-piece metal tube shield |
| 1 10,000-ohm regeneration control with switch attached. | | 1 Length shielded wire |
| 1 500,000-ohm volume control | | 5 Lengths colored hook-up wire |
| 2 .01-mfd., 200-volt paper condensers | | 1 Length insulating tubing |
| | | 1 Length rosin-core solder |

ADDITIONAL MATERIALS REQUIRED

- | | |
|-----------------------------|--------------------------------------------------|
| 1 Each, 1E4G, 1H5G, 1C5G | with this set, may be obtained from your dealer. |
| 2 45-volt "B" batteries | The only tools required are: |
| 1 7½-volt "C" battery | Small screw-driver |
| 1 1½-volt "A" battery. | Pair side-cutting pliers |
| Headphones: a Meissner | Soldering iron. |
| headphone, designed for use | |

ANTENNA AND GROUND: A good antenna and ground will provide best reception. Connect to water pipe or to iron rod driven in damp earth for ground. Antenna should be 50 to 75 feet long, well insulated and 20 feet or more high. For local reception an insulated wire 20 to 30 feet long may be used inside with good results, but a ground connection should always be used.

FOLLOW THESE INSTRUCTIONS CAREFULLY

Unpack kit with great care to avoid loss of small parts. Check parts against list; report any shortage at once. Knock out half-punchings in chassis for tube sockets. Mount tube and coil sockets on chassis with small steel screws; use lockwashers under each nut and tighten screw firmly.

Be sure sockets are correctly placed so terminals are located as shown; note position of guide slot in center hole.

Mount connection strip and phone jacks at rear of chassis.

Mount steel panel on front of chassis with two screws; make sure that dial indicator mark is at front of panel.

Mount regeneration and volume controls on front of chassis.

Mount tuning condenser on top of chassis with large brass screws.

Wire set exactly as shown in Pictorial Wiring Diagram.

Use colored wire supplied; push back insulation ¼" at end of wire after cutting to length; attach to terminals.

Solder each connection carefully with small-tipped soldering iron; be sure iron is hot and well tinned; heat connection thoroughly as solder is applied; don't use too much solder; use only rosin-core solder as supplied with the kit.

Connect resistors and condensers to points shown.

Use insulating tubing on resistor and condenser leads as shown.

Keep all wiring close to chassis and neatly arranged.

Do not permit bare wires to touch any other wire or chassis.

Be sure that shield covering of 1H5G grid wire does not touch the grid clip.

Check all wiring carefully after completion.

Fasten knobs to regeneration and volume controls.

Unscrew large knob from dial by turning to left; loosen brass nut several turns and push brass bushing in from front; place dial on shaft of tuning condenser; space 1-16" from panel.

See that condenser plates are completely closed and set 0 on dial to indicator mark on panel; tighten brass nut on dial.

Replace knob on dial and see that dial turns freely.

Insert 1E4G tube, 1H5G tube, 1C5G tube and plug-in coil in proper sockets.

Press shield clip on base of 1H5G tube before inserting in socket; place shield on tube with lower part over clip; see diagram below. Tape shank of grid clip to prevent contact with top Cap of Tube Shield. Place small piece of tape inside the Shield top Cap to prevent contact of the cap with the grid clip.

Connect Antenna. Ground and Headphones as shown. A magnetic speaker may be connected in place of headphones.

Connect 1½-volt "A" battery (No. 6 cell) as shown.

Turn on regeneration control; note dim red glow in tubes.

If tubes do not light re-check all connections and correct.

Attach wires to terminal strip for "B" and "C" batteries.

See that all wires on terminal strip are firmly fastened and that they do not touch adjacent terminals; failure to observe this important precaution may result in burned out tubes.

Connect 7½-volt "C" battery and two 45-volt "B" batteries to wires as shown; observe plus and minus signs as indicated.

Turn volume control all the way to right; use later to control volume.

Listen for signal and turn regeneration control slowly to right as dial is rotated slowly back and forth.

When a whistle is heard, set the dial for lowest tone and turn regeneration control back (to left) until whistle stops and station is heard; a little practice will enable these adjustments to be made very easily and rapidly.

Do not permit receiver to whistle any more than absolutely necessary as it will interfere with neighborhood reception.

To turn set off, rotate regeneration control to left until switch clicks.

When receiver is operating properly, cut out the diagram below and paste to back of panel for future reference.

You can listen to short-wave broadcasts and amateur stations with this set! The following extra coils, available at your dealer, will permit you to cover these interesting bands:

- | | |
|-------------|--------------------|
| No. 18-2940 | 70 to 200 meters |
| No. 18-2941 | 35 to 70 meters |
| No. 18-2942 | 15 to 35 meters |
| No. 18-2944 | 545 to 1500 meters |

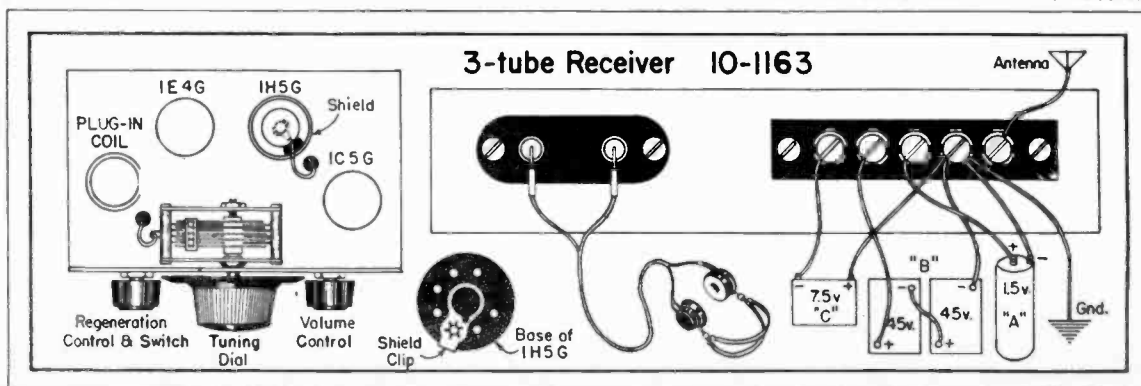

3-TUBE RECEIVER KIT

10-1163

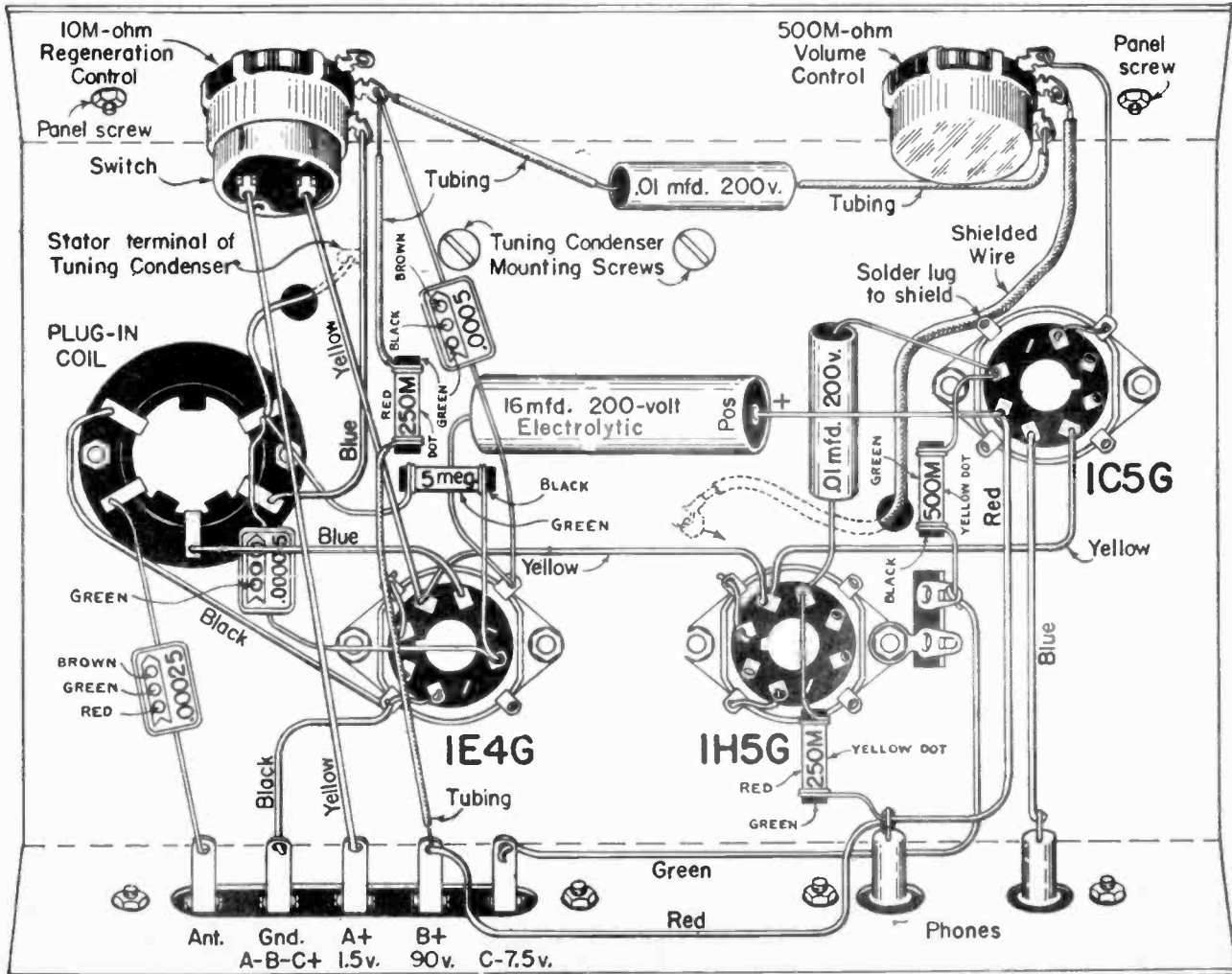
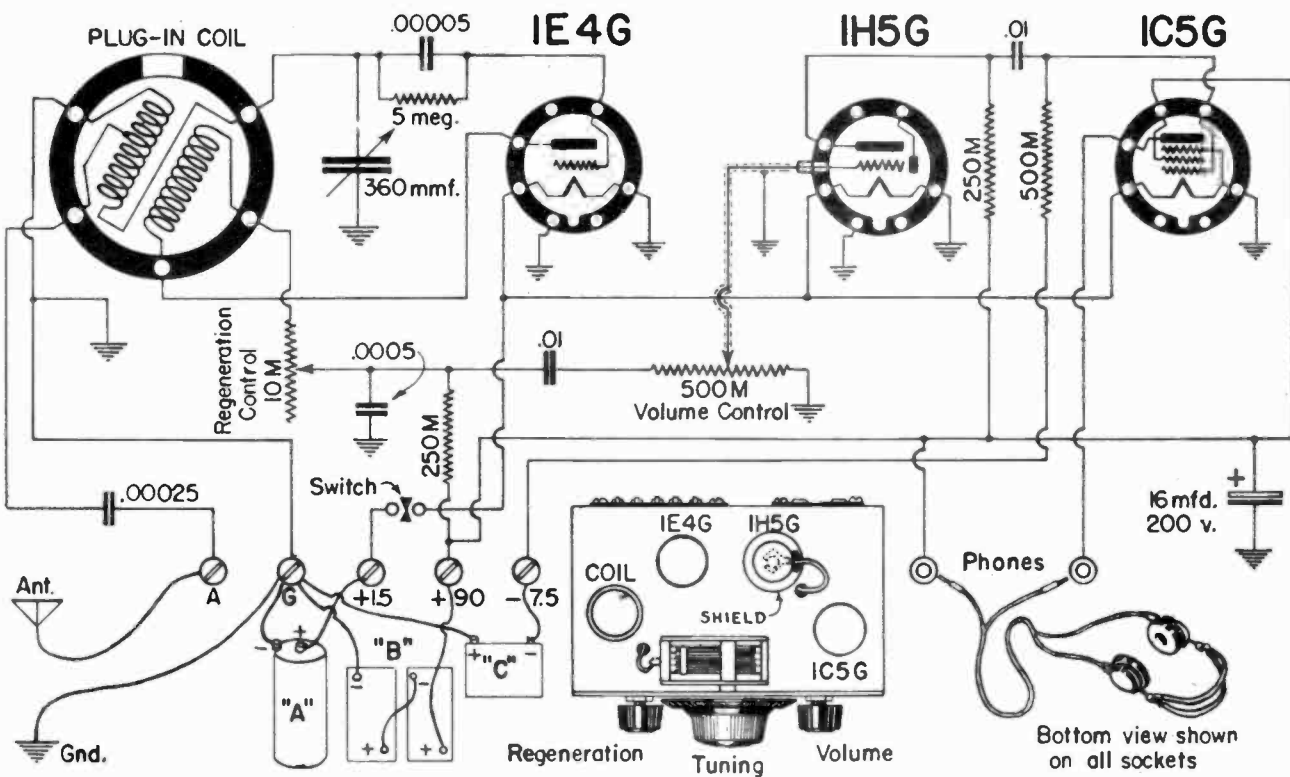

COMPLETE INSTRUCTIONS
FOR CONSTRUCTION AND OPERATION OF THE



High-Fidelity Public Address Tuner

Model 10-1152

The Meissner High-Fidelity P-A Tuner was designed to meet the demand for a tuner with an extremely flat-response curve over a wide range of audio frequencies. In order to attain good high frequency response, a band-pass R.F. system is used, which passes a band of frequencies approximately 20 kc wide, and yet is selective enough to reject undesired signals several channels away.

The tuner has sufficient sensitivity for day-time reception of strong stations one or two hundred miles distant, but its main purpose is for high-fidelity reception of local stations.

The absence of an oscillator makes this Tuner absolutely non-interfering, regardless of the number that may be grouped together in a multiple-channel P-A system such as is used in schools, hospitals, hotels, etc. to furnish a selection of programs. The shape of the Tuner was selected to facilitate close grouping, permitting two units to be mounted side by side on one relay-rack panel or in one institutional sound-system cabinet.

As a special feature for P-A work the Tuner has been provided with a dual audio-output channel, so that one channel may be used for monitoring purposes without giving, in the P-A channel, any indication of the switching done in the monitoring circuit.

This unit includes its own power supply and operates directly from 110-volt, 60-cycle lines. A sturdy steel cabinet and front panel are available to make the Tuner an entirely separate and complete unit for single installations or for portable use.

ASSEMBLY

As the kit is unpacked, all parts should be carefully checked against the parts list on the back page of this folder. Any discrepancies should be reported at once to the supplier from whom the kit was purchased.

All parts should be mounted on the chassis according to the top and bottom views shown in the Pictorial Diagram. It will be found best to mount the small parts such as terminal-strips and sockets first. Do not mount the dial until the chassis wiring is complete.

It is to be noted that the terminal strips mounted on the back of the chassis are placed on the outside of the chassis which will make the attachment of leads to the terminals much easier than if they were mounted inside the chassis.

Take care to install the sockets in the correct direction. It is recommended that at least one point on the socket saddles be soldered to the chassis since there are many connections made to the saddle, and therefore, unless the saddle is well grounded permanently by soldering, trouble may develop unexpectedly.

Remove the nuts and two flat metal straps from the power-transformer and install in the chassis by means of these same parts. Care should be exercised that the winding is not damaged as the terminals are passed through the hole in the chassis. Be sure that the position of the terminal numbers corresponds to that shown in the Pictorial Diagram.

Mount the gang condenser and the two tie lugs that are held on by the condenser mounting screws. The five coils may then be mounted, observing the location of the terminals as shown in the Pictorial Diagram and mounting the terminal-strips that are held on by the coil mounting screws. Assemble the filter condenser and filter choke, leaving the dial until after the wiring is practically completed. Volume and tone controls should then be mounted.

WIRING

Having completed the assembly of the major parts of the Tuner as described above, the actual wiring may start, observing the hints given under "General Construction Hints." The actual order of wiring is of little consequence since all of the wiring is easily accessible. Socket-mounting saddles should be soldered to chassis at one point each and shielded wires should have both ends of the shield soldered to chassis. Paper by-pass condensers should be connected with their "ground" ends to chassis wherever the condenser has one end grounded. Electrolytic condenser polarity MUST be observed.

There are a few connections not clearly shown on the Pictorial Diagram and which consequently are easily overlooked. These connections are: (1) from the bottom grid to the top grid of the 6F8G tube, and (2) those from the top connections of the gang-condenser to the grids of the R.F. tubes.

For the former connection, a length of shielded wire is to be soldered to the number-5 lug on the 6F8G tube socket (to which another shielded wire is also connected) and brought up through the adjacent 1/4-inch dia. hole to provide a top-grid connection for the tube. One of the metal-tube grid clips is to be soldered to the upper end of this wire.

For the latter connections, two pieces of stranded green wire 2 1/2" long should be soldered to the two middle sections of the gang-condenser, one to each of the top stator connections, except the front and rear section. These wires are brought through the condenser shield, the shield mounted to the condenser and a grid-clip attached to the end of each wire. The location of these connections is shown in the top view of the Tuner.

The tuning dial is mounted by fastening to the condenser shaft at the central hub, using a single mounting screw and wood spacer at the bottom to fasten it to the chassis as shown. The tuning-condenser plates should be turned completely closed and the dial pointer set exactly on the horizontal markers on the scale before the two set-screws are tightened on the condenser shaft. Wire the pilot lights and connect to the filament wiring as shown.

After completing all connections, the wiring should be very carefully checked to make sure that no errors were made or wires omitted.

ALIGNMENT

If all connections are found to be correct, the tubes may then be inserted and the line-cord plug connected to a 110-volt, 60-cycle receptacle. A slight turn of the tone-control knob to the right will turn on the unit. After a brief warm-up period the voltages shown on the Schematic Diagram should be checked with a high-resistance voltmeter. Voltages indicated are measured from the point shown to the chassis, with the chassis as the negative terminal. If values measured are materially different than shown on the diagrams, a thorough recheck of the circuit should be made at once. **BE SURE THE UNIT IS TURNED OFF AND THE LINE-CORD DISCONNECTED FROM THE POWER RECEPTACLE!**

Alignment of the Tuner may be made with a service-oscillator, signal-generator or by tuning in broadcast signals. With a service-oscillator or signal-generator, the output of such device is connected to the antenna terminal of the Tuner with a 200-mmfd mica condenser in series. For alignment on broadcast station signals a short antenna should be connected to this terminal and the ground terminal connected to a good ground.

Check the dial to be sure that the pointer is horizontal when the gang-condenser is closed. Set the service-oscillator

or signal-generator and the dial of the Tuner to 1400 kc. Plug a head-set into the phone jack, turn the volume control to maximum, and turn the output of the signal source up until a signal is heard. Adjust the trimmers on top of the gang condenser using a screw-driver through the holes in the top of the gang-condenser shield. Adjust each trimmer for maximum signal in the phones (or on an output-meter connected between terminals 4 and 5 on the back of the Tuner), reducing input as alignment proceeds. Best alignment is accomplished with weak signals.

If the adjustment must be made without the aid of test equipment, set the dial to the frequency of a local broadcasting station near the 1400 kc end of the dial and perform the alignment as described above, using a shorter antenna as alignment proceeds until finally no antenna will be required if the station is sufficiently powerful.

If the dial is set accurately to the frequency on which alignment is made, the calibration of the Tuner dial will be found to be unusually accurate over its entire scale.

OSCILLATION

If the tuner oscillates when aligned, it is reasonably certain that either the wiring did not follow the Pictorial Diagram or that some by-pass condenser has been omitted or is open, or an incorrect value has been used. When looking for causes of oscillation, check to be sure that one of

the by-pass condensers is not open, by connecting a known good by-pass condenser across each condenser in the Tuner successively until the defective unit is discovered, or a poor joint or other source of trouble is found. Oscillation may also result if the shield is omitted from the tuning condenser.

APPLICATION

The operation of the Tuner requires no explanation. Connecting the Tuner to an amplifier does warrant discussion, however. Terminals 1 and 3 furnish output matched to 10,000 ohms. They may be connected directly to the "phono" input of the power amplifier if desired and if the amplifier is close to the P-A Tuner. Terminals 2 and 3 furnish a lower output voltage at 2,500-ohms impedance which may be used in a similar manner if desired. Terminals 4 and 5 are in parallel with the monitoring jack and may be used as conditions indicate.

Connection of a 200-ohm or 500-ohm line may be made directly to terminals 2 and 3 with quite satisfactory results. A better method, however, would be to use an output transformer with a high-impedance primary connected to terminals 1 and 3, the secondary being designed to match the line impedance desired. This is especially desirable if the tuner is at some distance from the amplifier.

Some experiments may be required to determine the best connections in order to obtain the maximum power output with a minimum of distortion.

PARTS SUPPLIED FOR CONSTRUCTION OF HIGH-FIDELITY PUBLIC ADDRESS TUNER

- 1 Punched steel chassis, black wrinkle finish
- 1 365-mmfd. 4-gang tuning condenser, 21-5223
- 1 Steel condenser shield, 25-8207
- 1 5" Slide-rule dial, scale and escutcheon
- 2 6.3-volt dial lights, bayonet base
- 1 Input Antenna coil, 9820
- 1 Output Antenna coil, 9822
- 1 Input R. F. coil, 9824
- 1 Output R. F. coil, 9826
- 1 Untuned R. F. coil, 9828
- 1 Power transformer, 19518
- 1 Filter choke, 19256
- 1 16-16 mfd., 300-v. Filter Condenser
- 1 10-mfd., 25-v. tubular condenser
- 1 8-mfd., 300-v. tubular condenser
- 1 .25-mfd., 400-v. paper condenser
- 2 0.1-mfd., 400-v. paper condensers
- 2 0.1-mfd., 200-v. paper condensers
- 3 .01-mfd., 400-v. paper condensers
- 3 .05-mfd., 200-v. paper condensers
- 2 .0001-mfd. fixed mica condensers
- 3 400-ohm, 1/4-watt fixed resistors
- 1 2500-ohm, 1/4-watt fixed resistor
- 1 5000-ohm, 1/2-watt fixed resistor
- 2 25,000-ohm, 1-watt fixed resistors
- 1 25,000-ohm, 1/4-watt fixed resistor
- 2 30,000-ohm, 1-watt fixed resistor
- 3 50,000-ohm, 1/4-watt fixed resistors
- 2 100,000-ohm, 1/4-watt fixed resistors
- 2 2-Megohm, 1/4-watt fixed resistors
- 1 AC Line Cord and Plug

- 1 Antenna-Ground terminal strip
- 1 5-terminal Output connection strip
- 5 Molded bakelite octal tube sockets
- 1 25,000-ohm Tone Control with switch
- 1 500,000-ohm Volume Control, 19394
- 1 Monitor phone jack
- 2 Tie-lugs, one insulated terminal
- 2 Tie-lugs, two insulated terminals
- 1 Tie-lug, three insulated terminals
- 3 Molded bakelite control knobs
- 2 Rubber grommets
- 4 Rubber mounting bumpers
- 3 Grid clips
- 5 Shakeproof soldering lugs
- 4 No. 2-56x3/8" bronze screws
- 4 No. 2-56 hexagon brass nuts
- 4 No. 2 steel lockwashers
- 5 No. 6-32 x 1/4" black screws
- 28 No. 6-32 x 1/4" steel screws
- 36 No. 6-32 hexagon steel nuts
- 38 No. 6 steel lockwashers
- 1 Length insulating sleeving
- 1 Length shielded wire
- 1 Length woven wire shielding
- 1 Length No. 20 stranded green wire
- 6 Lengths No. 20 solid colored wire
- 1 Length rosin-cored solder
- 1 No. 6-32 x 1" flat-head screw
- 1 No. 6-32 x 1/2" flat-head screw
- 1 Black wood spacer, 3/8" dia.

TUBES REQUIRED

- 2 6K7 1 6H6 1 6F8G 1 5Z4

CABINET AND PANEL AVAILABLE

Steel Cabinet complete, black crackle finish, 8 3/8"x8 3/8"x12 1/2" deep.

No. 11-8200 List \$4.75 ----- Net \$2.85

Steel Panel, completely punched, black crackle finish, 8 3/8"x 8 3/8"x1/16" thick.

No. 11-8243 List \$1.25 ----- Net \$0.75

**COMPLETE INSTRUCTIONS
FOR CONSTRUCTION AND OPERATION OF THE**



Dual Band Public Address Tuner

Broadcast and Short-Wave Superheterodyne

MODEL 10-1151

The Meissner Model 10-1151 Broadcast and Short Wave P-A Tuner kit was designed to fill the need for a tuner to cover the Broadcast and principal Short Wave entertainment bands. It has sufficient sensitivity for good reception of Short Wave programs and, because of its iron-core I.F. transformers, is particularly recommended for the reception of distant Broadcast stations. Frequency coverage is 540 to 1600 kc and 5.9 to 18.8 mc.

It utilizes one stage of Radio Frequency amplification on both bands, in combination with two high-gain Ferrocort (Iron Core) I.F. transformers, giving excellent selectivity over its entire tuning range. A sensitivity control has been provided to adjust the maximum sensitivity of the Tuner to an amount commensurate with the prevailing noise level at the place of operation. The Tuner has conventional A.V.C. obtained from a diode second-detector and is provided with manual volume control and tone control.

As a special feature for Public Address work, the Tuner has been provided with a dual audio-output system, so that one channel may be used for monitoring purposes without giving, in the P-A channel, any indications of the switching done in the monitoring circuit. The output impedance is 10,000 or 2,000 ohms working out of a 6F6G tube.

The dial is of the "Slide-Rule" type with $7\frac{1}{4}$ " scales calibrated in kilocycles on the Broadcast band and in megacycles on the Short Wave band. A "Magic Eye" tuning indicator tube is provided for accurate tuning. The Tuner includes its own power supply and operates directly from 110-volt, 50 to 60 cycle lines. Tuners for special voltages or frequencies are available.

A sturdy steel cabinet and front panel are available to make the Tuner a complete unit for single installations or for portable use.

The tubes required are 2 6K7's, 1 6K8, 1 6H6, 1 5Z4 and 1 6F6G.

ASSEMBLY

As the kit is unpacked, all parts should be carefully checked against the Parts List supplied herewith. Any discrepancies should be reported at once to the supplier from whom the kit was purchased.

The parts should be mounted on the chassis in accordance with the top view of the Tuner shown on the Schematic Diagram, and the bottom view shown in the Pictorial Wiring Diagram. The order of assembly is of little importance as long as the Range Switch is omitted until the wiring around the R.F. and Converter sockets, and on the terminal strips mounted under the Range Switch, has been completed.

It is to be noted that the terminal strips mounted on the back of the chassis are mounted on the outside of the chassis which will make the attachment of leads to the terminals much easier than if the terminal strips are mounted inside the chassis.

If the Tuner is to be used with the Meissner steel front panel No. 11-8236, the shafts on the various controls and the dial should be cut off with a hack saw so that they project $\frac{1}{4}$ inches from the front of the chassis when properly mounted. If the Tuner is to be used with some other front panel, temporarily install the gang condenser, dial and all controls so that their proper shaft lengths can be determined when the Tuner is placed in the cabinet intended for it. The shafts should be marked for proper length and then dismounted so that they may be sawed with a hack saw when the shafts are firmly clamped in a vise. It is advisable not to attempt to cut the shaft of any unit while mounted on the chassis because the heavy strain imposed by sawing may cause damage to the unit.

Mount the sockets, taking care that they are installed in the proper places so that the numbers stamped on the sockets will correctly indicate the type of tube to be installed therein. Observe also that the keyway in the socket is properly oriented, lest it become necessary to remove all of the wires from the socket if it is later found to be reversed. It is advisable also to solder at least

one spot (preferably adjacent to a mounting screw) on each socket-saddle to the chassis, since many ground connections are made to the lugs on the saddles, and trouble due to poor contact may develop unexpectedly unless a permanently good contact is insured by soldering.

Remove the nuts and two flat metal straps from the power transformer and install the latter item in the chassis by means of these same parts. Care should be exercised that the winding is not damaged as the terminals are passed through the hole in the chassis. Be sure that the position of the terminal numbers corresponds to the position shown in the Pictorial Diagram.

WIRING

Having completed the assembly operations described above, the actual wiring may start observing the suggestions given on the sheet "General Construction Hints" packed with each kit.

After bending down all socket-saddle ground-lugs not required for wiring, wire the filament circuit completely. The remaining wiring may be installed in any convenient sequence. It will be found a great help in wiring if each wire in the Pictorial Diagram is marked over with a colored pencil as the corresponding wire in the set is installed. When all wiring has been finished except the leads to the Range Switch, install and wire that item, keeping all wires short and direct, and as well spaced from each other and from metal objects as possible.

Connect the cable from the "Magic Eye" in accordance with the Schematic and Pictorial Diagrams.

VOLTAGE TEST

If all connections are found to be correct, the tubes may be inserted and the line-cord plug connected to a 110-volt, 60-cycle receptacle. A slight turn of the Tone-Control knob to the right will turn on the Tuner. After a brief warm-up period the voltages shown on the Pictorial Diagram (in circles) should be checked with a high-resistance voltmeter, if available. Voltages indicated are measured from the point shown, to the chassis, with the chassis as the negative terminal. If values measured are materially different from those shown on the diagram a thorough recheck of the circuit should be made. Be sure the receiver is turned off and the line-cord disconnected from the power receptacle while the wiring is being checked.

ALIGNMENT

For aligning the I.F. amplifier the connections are made in the following manner: Connect a service oscillator between the chassis and the grid of the 6K8 tube, using a .0005 to .25 mfd. condenser between the grid and the high side of the generator output. Do not remove the grid clip for this operation. The Range Switch should be in the Broadcast position and the dial set near 600 kc. Output may be determined aurally by listening to a headset plugged into the monitoring jack or by listening to a loudspeaker and amplifier connected to the output of the Tuner. The output may be determined visibly by means of the "Magic Eye" or an output meter connected to the output of the amplifier following the Tuner. The output of the Tuner itself is so low (comparable to a phonograph reproducer) that it will not operate the conventional output meter satisfactorily if the latter is connected directly to the output terminals of the Tuner.

The procedure for aligning the I.F. amplifier is as follows: Turn the Audio Volume Control and Sensitivity Controls on full (clockwise extreme of rotation). Increase the output of the service oscillator until a signal is just audible. Adjust each I.F. trimmer so that maximum volume (or visual indication) is obtained. It is best to repeat this procedure two or three times on each trimmer to obtain the most accurate adjustment. These trimmers are adjusted with a small screwdriver through the opening in the top of the shield on each I.F. transformer. If no service oscillator is available tune in a weak signal and adjust trimmers as above. If the signal becomes loud use a shorter antenna and continue as above.

Having aligned the I. F. amplifier the remainder of the Tuner should be aligned. The first operation is to check the position of the dial-pointer with reference to the condenser since this largely determines the calibration of the Tuner. Close the gang condenser and see that the dial-pointer position coincides with the last line at the low-frequency end of the dial. If this condition does not obtain, loosen the set screw on the dial-drum, make the necessary correction and firmly tighten the screw.

The ground side of the service oscillator should be connected to the ground terminal of the Tuner and the high side of the service oscillator should be connected through a 400-ohm resistor to the antenna post of the Tuner. This resistor is used to simulate the effects of an outside antenna on Short Waves and is known as a "Dummy Antenna." On the Broadcast range a condenser of 200 mmfd. is used instead of the resistor since at that frequency a capacity more nearly simulates the characteristics of a real antenna.

With the 400-ohm "Dummy Antenna" connected, turn the Range Switch to the Short Wave (right-hand) position, set the Tuner dial and the service oscillator to 16 mc, turn the output of the service oscillator up to maximum, tighten the upper trimmer in the oscillator coil (No. 14-7480) until just snug, then loosen it four turns, and then, as the trimmer is tightened, set it to the position of maximum response, reducing the output of the service oscillator as alignment proceeds. (If two responses are found of nearly equal intensity, adjust for the one with the trimmer farthest open.) Now align the R. F. trimmer (upper No. 14-7478), but since the R. F. adjustment has a slight effect upon the oscillator frequency, it will be necessary to rock the tuning condenser slightly to keep the signal tuned in. Now adjust the antenna coil (upper trimmer, No. 14-7476), reducing input as alignment proceeds. If the Tuner tends to "motorboat," turn down the service oscillator output until the trouble stops. Some service oscillators, however, leak enough signal that even with the output control set at zero, the receiver is still overloaded, in which case it is necessary to turn down the sensitivity and audio controls until the receiver behaves properly.

Set the service oscillator to 6 mc and tune in the signal with the receiver dial. Now, while rocking the condenser back and forth across the signal, turn the short-wave padding condenser continuously in one direction until the output is the greatest. This operation is known as "Padding the Oscillator Circuit." A few minutes spent in experiment on this adjustment will show more

than a further lengthy explanation. Because of the fact that the adjustable padding condenser is but a relatively small portion of the total padding capacity on short wave, this adjustment will not be very sharp. The short-wave padding condenser is the one across which is connected the fixed mica condenser and is adjusted through the upper opening in the left end of the chassis.

Turn the Range Switch to the Broadcast position (left-hand), substitute a 200-mmfd condenser for the 400-ohm resistor as a Dummy Antenna, set the Tuner dial and the service oscillator to 1400 kc, and align the circuits again (bottom trimmers) in the same manner as described above, the oscillator coil being adjusted first. Having done this, set the service oscillator to 600 kc, and tune the receiver dial for maximum response. Then pad the oscillator circuit in the same manner as described above for the Short Wave band except adjust through the lower opening in the end of chassis. This adjustment will be far sharper than the short-wave padding operation and should therefore be done carefully. Re-tune Tuner and service oscillator to 1400 kc and re-align at that frequency.

CONNECTIONS TO AMPLIFIER

The operation of the Tuner requires no explanation. Connecting the Tuner to an amplifier does warrant discussion, however. Terminals 1 and 3 furnish output matched to 10,000 ohms. They may be connected directly to the "phono" input of the power amplifier if desired, and if the amplifier is close to the P-A Tuner. Terminals 2 and 3 furnish a lower output voltage at 2,500-ohms impedance which may be used in a similar manner if desired. Terminals 4 and 5 are in parallel with the monitoring jack and may be used as conditions indicate.

Connection of a low-impedance line may be made directly to terminals 2 and 3 with frequently quite satisfactory results. A better method, however, would be to use an output transformer with a high-impedance primary connected to terminals 1 and 3, the secondary being designed to match the line impedance desired. This is especially desirable if the Tuner is to be at some distance from the amplifier.

Some experiments may be required to determine the best connections in order to obtain the maximum power output with a minimum of distortion.

Parts Supplied for Construction of Dual Band P-A Tuner

MODEL 10-1151

- | | |
|-----------------------------------------------------------------------------------------------------------------------------------------------------------------------------------------------------------------------------------------------------------------------------------------------------------------------------------------------------------------------------------------------------------------------------------------------------------------------------------------------------------------------------------------------------------------------------------------------------------------------------------------------------------------------------------------------------------------------------------------------------------------------------------------------------------------------------------------------------------------------------------------------------------------------------------------------------------------------------------------------------------------------------------------------------------------------------------------------------------------------------------------------------------------------------------------------------------------------------------------------------------------------------------------------------------------------------------------------------------------------------------------------------------------------------------------------------------------------------------------------------------------------------------------------------------------------------------------------------------------------------------|------------------------------------------------------------------------------------------------------------------------------------------------------------------------------------------------------------------------------------------------------------------------------------------------------------------------------------------------------------------------------------------------------------------------------------------------------------------------------------------------------------------------------------------------------------------------------------------------------------------------------------------------------------------------------------------------------------------------------------------------------------------------------------------------------------------------------------------------------------------------------------------------------------------------------------------------------------------------------------------------------------------------------------------------------------------------------------------------------------------------------------------------------------------------------------------------------------------------------------------------------------------------------------------------------------------------------------------------------------------------------------------------------------------|
| <ul style="list-style-type: none"> 1 Punched steel chassis, black wrinkle finish 1 365-mmfd., 3-gang tuning condenser 1 Dial, calibrated scale and escutcheon 2 6.3-volt dial lights, bayonet base 1 Tuning indicator socket assembly 1 B.C. and S.W. antenna coil, 14-7476 1 B.C. and S.W. R. F. coll., 14-7478 1 B.C. and S.W. oscillator coil, 14-7480 1 Input I. F. transformer, 16-5740 1 Output I. F. transformer, 16-5742 1 Padder kit No. 22-5203 including: Dual 6-plate adjustable condenser .004-mfd. fixed mica condenser 1 3-gang range switch 1 1-megohm volume control, 19329 1 25,000-ohm sensitivity control, 19288 1 25,000-ohm tone control with switch 1 Power transformer, 110-v., 60-cycle 2 Filter chokes, 19256 1 15-15 mfd., 450-v. filter condenser 1 Special mounting plate 1 8-mfd., 450-v. tubular condenser 1 10-mfd., 25-v. tubular condenser 7 .05-mfd., 200-v. paper condensers 2 .05-mfd., 400-v. paper condensers 1 0.1-mfd., 200-v. paper condenser 2 0.1-mfd., 400-v. paper condensers 1 .25-mfd., 400-v. paper condenser 1 .01-mfd., 400-v. paper condenser 2 100-mmfd. fixed mica condensers 1 50-mmfd. fixed mica condenser 1 300-ohm, 1/4-watt fixed resistor 3 400-ohm, 1/4-watt fixed resistors 1 2500-ohm, 1/4-watt fixed resistor 1 10,000-ohm, 2-watt fixed resistor | <ul style="list-style-type: none"> 1 25,000-ohm, 1/4-watt fixed resistor 2 25,000-ohm, 1-watt fixed resistors 1 30,000-ohm, 1/2-watt fixed resistor 1 40,000-ohm, 1/2-watt fixed resistor 2 50,000-ohm, 1/4-watt fixed resistors 2 100,000-ohm, 1/4-watt fixed resistors 1 500,000-ohm, 1/4-watt fixed resistor 1 1-megohm, 1/4-watt fixed resistor 1 A.C. line-cord and plug 1 Antenna-ground terminal strip 1 5-terminal output strip 6 Molded bakelite tube sockets 4 Double tie-lugs 1 Single tie-lug 1 Triple tie-lug 3 Shakeproof soldering lugs 1 Monitor headphone jack 1 Goat tube shield, 5-piece 5 Black bakelite knobs 1 1/4" rubber grommet 3 3/8" rubber grommets 4 Black wood panel spacers 42 No. 6-32 x 1/4" hexagon steel nuts 42 No. 6 Steel lockwashers 24 No. 6-32 x 1/4" steel screws 4 No. 6-32 x 1" black screws 4 No. 2-56 x 3/8" bronze screws 4 No. 2-56 hexagon brass nuts 4 No. 2 steel lockwashers 1 18" length insulating sleeving 1 30" length shielded wire 1 8" length green grid wire 7 Lengths No. 20 colored hookup wire 1 Length rosin-core solder |
|-----------------------------------------------------------------------------------------------------------------------------------------------------------------------------------------------------------------------------------------------------------------------------------------------------------------------------------------------------------------------------------------------------------------------------------------------------------------------------------------------------------------------------------------------------------------------------------------------------------------------------------------------------------------------------------------------------------------------------------------------------------------------------------------------------------------------------------------------------------------------------------------------------------------------------------------------------------------------------------------------------------------------------------------------------------------------------------------------------------------------------------------------------------------------------------------------------------------------------------------------------------------------------------------------------------------------------------------------------------------------------------------------------------------------------------------------------------------------------------------------------------------------------------------------------------------------------------------------------------------------------------|------------------------------------------------------------------------------------------------------------------------------------------------------------------------------------------------------------------------------------------------------------------------------------------------------------------------------------------------------------------------------------------------------------------------------------------------------------------------------------------------------------------------------------------------------------------------------------------------------------------------------------------------------------------------------------------------------------------------------------------------------------------------------------------------------------------------------------------------------------------------------------------------------------------------------------------------------------------------------------------------------------------------------------------------------------------------------------------------------------------------------------------------------------------------------------------------------------------------------------------------------------------------------------------------------------------------------------------------------------------------------------------------------------------|

TUBES REQUIRED

2 6K7, 1 6K8, 1 6H6, 1 6F8G and 1 5Z4

CABINET AND PANEL AVAILABLE

Steel Cabinet complete with hinged lid, black crackle finish, 9 1/2" x 14 1/2" x 11" deep.
No. 11-8212. List \$4.50 Net \$2.70

Steel Panel, completely punched, black crackle finish, 9 1/2" x 14 1/2" x 1/16" thick.
No. 11-8236. List \$1.85 Net \$1.11

10-1151
SCHEMATIC
CIRCUIT DIAGRAM

BC & SW PA TUNER
1600-540kc & 188-5.9mc
L.F. = 456 kc

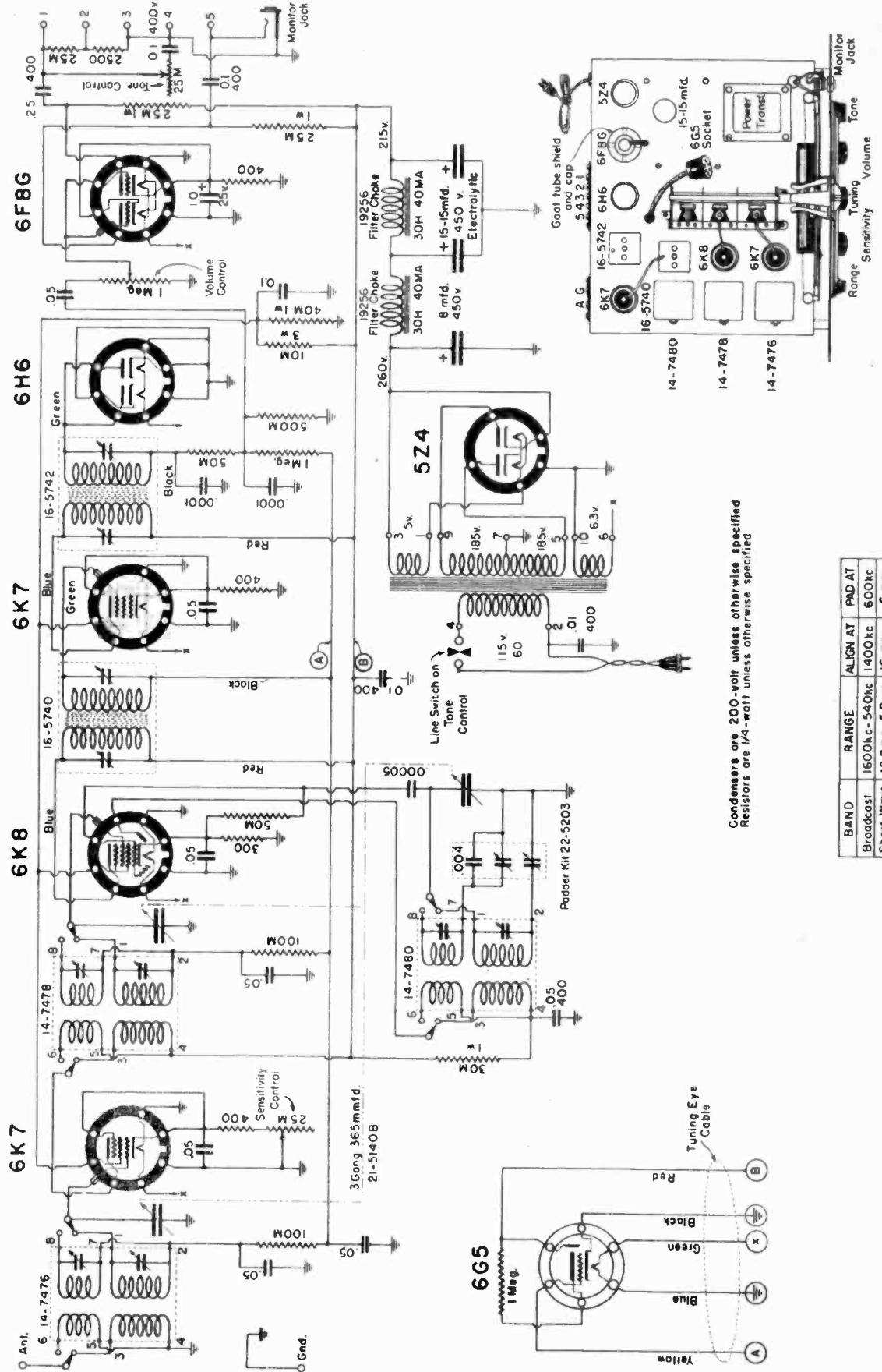

Condensers are 200-volt unless otherwise specified
Resistors are 1/4-watt unless otherwise specified

10-1151
PICTORIAL WIRING
DIAGRAM

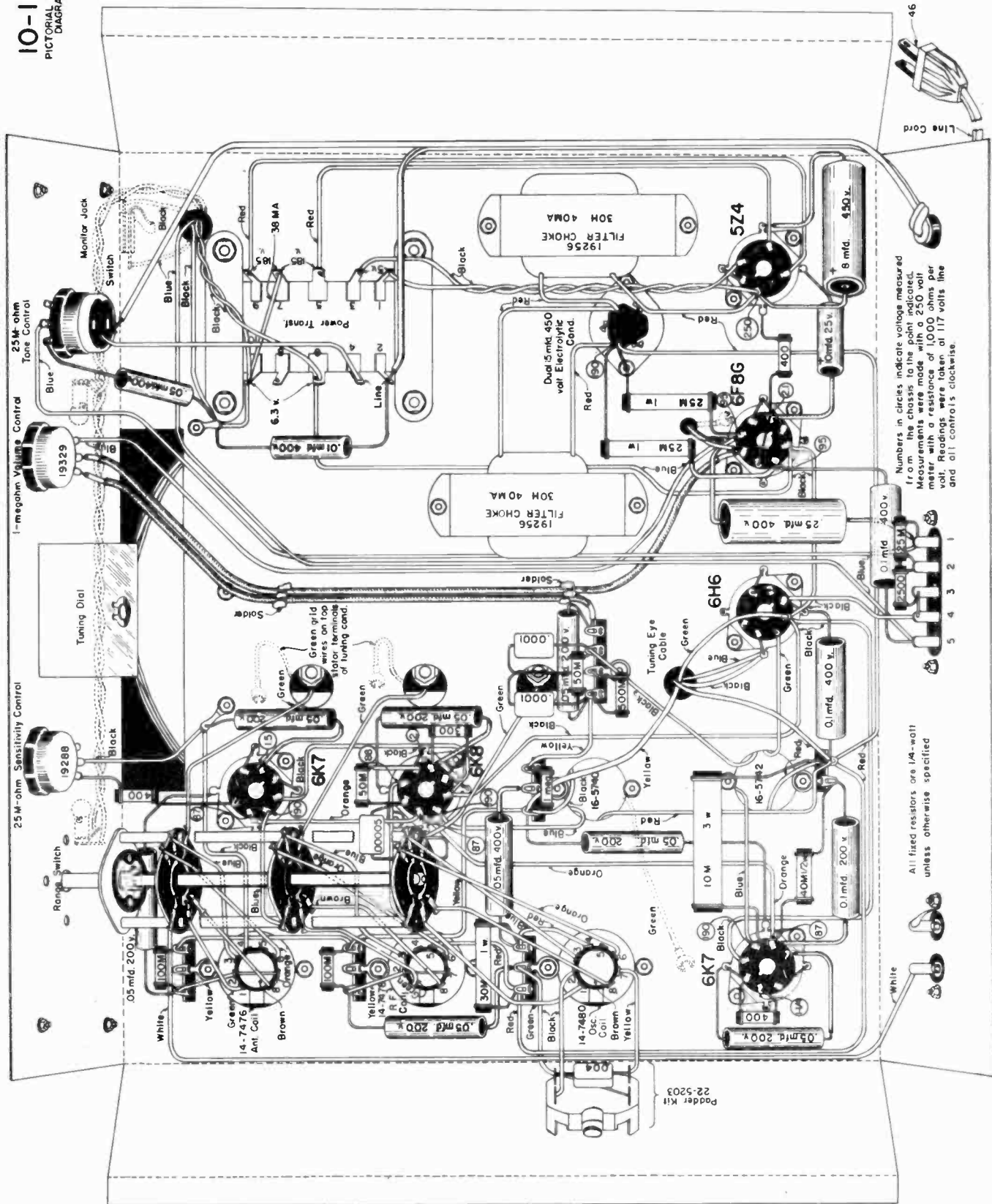

Numbers in circles indicate voltage measured from the chassis to the point indicated. Measurements were made with a 250 volt meter. Resistor values are in ohms per cent. Radio Shack parts are taken in 117 volts line and all controls clockwise.

All fixed resistors are 1/4-watt unless otherwise specified

Podder Kit
22-5203



COMPLETE INSTRUCTIONS
FOR CONSTRUCTION AND OPERATON OF THE



UTILITY PUBLIC ADDRESS TUNER

MODEL 10-1119

The Meissner Utility P-A Tuner has been designed to fill the need for a practical radio tuner capable of supplying undistorted, high-quality reproduction of broadcast programs to the input stage of a power-amplifier system.

The Tuner employs a TRF circuit to supply that quality so sought after for Public Address work. It uses Ferrocart (iron-core) coils to obtain the selectivity and sensitivity required.

The absence of an oscillator makes these tuners absolutely non-interfering regardless of the number that may be grouped together in a multiple-channel P-A system such as is used in schools, hospitals, leading hotels, etc. to furnish a selection of programs. The shape of the Tuner is designed to facilitate close grouping, permitting two units to be mounted side by side on one relay-rack panel or in one institutional sound-system cabinet.

As a special feature for Public Address work the Tuner has been provided with a dual audio-output channel, so that one channel may be used for monitoring purposes without giving, in the P-A channel, any indication of the switching done in the monitoring circuit.

This unit includes its own power supply and operates directly from 110-volt, 60-cycle lines. A sturdy steel cabinet and front panel are available to make the Tuner an entirely separate and complete unit for single installations or for portable use.

ASSEMBLY

As the kit is unpacked, all parts should be carefully checked against the parts list supplied herewith. Any discrepancies should be reported at once to the supplier from whom the kit was purchased.

All parts should be mounted on the chassis according to the top and bottom views shown in the Pictorial Diagram. It will be found best to mount the small parts such as terminal-strips and sockets first. Do not mount the dial until the chassis wiring is complete.

Take care to install the sockets in the correct direction. It is recommended that at least one point on the socket saddles be soldered to the chassis since there are many connections made to the saddle, and therefore, unless the saddle is well grounded permanently by soldering, trouble may develop unexpectedly.

Remove the nuts and two flat metal strips from the power-transformer and install in the chassis by means of these same parts. Care should be exercised that the winding is not damaged as the terminals are passed through the hole in the chassis. Be sure that the position of the terminal numbers corresponds to the position shown in the Pictorial Diagram.

Mount the gang-condenser and the tie-lug that is held on by the condenser mounting screw. Do not mount the gang-condenser shield until the grid leads described below are put on.

Prepare the four coils for mounting by first removing the blue leads and replacing them with pieces of shielded wire of appropriate length, cutting the shielding back about 1 inch so that it cannot short-circuit to any of the coil lugs. The four coils may then be mounted, observing the location of the terminals as shown in the Pictorial Diagram and mounting the terminal-strips that are held on by the coil mounting screws. Solder the shielding to the chassis as shown in the Pictorial Diagram.

Volume and tone-controls should be mounted as shown. Then assemble the filter condenser and filter choke, leaving the dial until after the wiring is practically completed.

WIRING

Having completed the assembly of the major parts of the Tuner as described above, the actual wiring may start, observing the hints given under "General Construction Hints." The actual order of wiring is of little consequence since all of the wiring is easily accessible. Socket-mounting saddles should be soldered to chassis at one point each and shielded wires should have both ends of the shield soldered to chassis. Paper by-pass condensers should be connected with their "ground" ends to chassis wherever the condenser has one end grounded. Electrolytic condenser polarity MUST be observed.

There are a few connections not clearly shown on the Pictorial Diagram and which consequently are easily overlooked. These connections are: (1) from the bottom grid to the top grid of the 6F8G tube, and (2) those from the top connections of the gang-condenser to the grids of the R. F. tubes.

For the former connection, a length of the shielded wire is to be soldered to the number 5 lug on the 6F8G tube socket (to which another shielded wire is also connected) and brought up through the adjacent hole in the chassis, to provide a top-grid connection for the tube. One of the grid-clips is to be soldered to the upper end of this wire.

For the latter connections, three pieces of the green braid-covered wire $2\frac{1}{2}$ " long should be soldered to the gang-condenser, one to each of the top stator connections except the front section. These wires are brought through the condenser shield, the shield mounted to the condenser and a grid-clip attached to the end of each wire. The location of these connections is shown in the top view of the Tuner, on the schematic circuit diagram.

The tuning dial is mounted by fastening to the condenser shaft at the central hub, using a flat-head mounting screw and wood spacer at the bottom to fasten it to the chassis as shown. The tuning-condenser plates should be turned completely closed and the dial pointer set exactly on the end point at the low-frequency end of the scale before the two set-screws are tightened on the condenser shaft. Wire the dial lights and connect to the filament wiring as indicated.

After completing all connections, the wiring should be very carefully checked to make sure that no errors were made or wires omitted.

ALIGNMENT

If all connections are found to be correct, the tubes may then be inserted and the line-cord plug connected to a 110-volt 60 cycle receptacle. The 6F8G tube should be fitted with the shield provided with the kit. A slight turn of the tone-control knob to the right will turn on the unit. After a brief warm-up period the voltages shown on the Schematic Diagram should be checked with a high-resistance volt-meter. Voltages indicated are measured from the point shown to the chassis, with the chassis as the negative terminal. If values measured are materially different than shown on the diagrams, a thorough recheck of the circuit should be made at once. Be sure the unit is turned off and the line-cord disconnected from the power receptacle!

Alignment of the Tuner may be made with a service-oscillator, signal-generator or by tuning in broadcast signals. With a service-oscillator or signal-generator, the output of such device is connected to the antenna terminal of the Tuner with a 200-mmfd mica condenser in series. For alignment on broadcast station signals a short antenna should be connected to this terminal and the ground terminal connected to a good ground.

Check the dial to be sure that the pointer is at the low-frequency end of the scale when the gang-condenser is closed. Set the service-oscillator or signal-generator and the dial of

the Tuner to 1400 kc. Plug a head-set into the phone jack, turn the volume control to maximum, and turn the output of the signal source up until a signal is heard. Adjust the trimmers on top of the gang-condenser using a screw-driver through the holes in the top of the gang-condenser shield. Adjust each trimmer for maximum signal in the phones (or on an output-meter connected between terminals 4 and 5 on the back of the Tuner), reducing the input as alignment proceeds. Best alignment is accomplished with weak signals.

If the adjustment must be made without the aid of test equipment, set the dial to the frequency of a local broadcasting station near the 1400-kc end of the dial and perform the alignment as described above, using a shorter antenna as alignment proceeds until finally no antenna will be required if the station is sufficiently powerful.

If the dial is set accurately to the frequency on which alignment is made, the calibration of the Tuner dial will be found to be unusually accurate over its entire scale.

SENSITIVITY

This Tuner has tremendous possible sensitivity but has purposely been limited to considerably less to conform to the average sensitivity requirement for a P-A Tuner. The sensitivity may be increased by decreasing the capacity of the mica condensers connected from the R.F. tube plates to ground, or may be reduced by increasing these capacities. If the sensitivity is increased too much the Tuner will oscillate.

OSCILLATION

If the Tuner, with the .0001-mfd. R.F. plate condensers installed, oscillates when aligned, it is reasonably certain

that either the wiring did not follow the Pictorial Diagram or that some by-pass condenser has been omitted or is open, or an incorrect value has been used. When looking for causes of oscillation, check to be sure that one of the by-pass condensers is not open, by connecting a known good by-pass condenser across each condenser in the Tuner successively until the defective unit is discovered, or a poor joint or other source of trouble is found.

APPLICATION

The operation of the Tuner requires no explanation. Connecting the Tuner to an amplifier does warrant discussion, however. Terminals 1 and 3 furnish output matched to 10,000 ohms. They may be connected directly to the "phono" input of the power amplifier if desired, and if the amplifier is close to the P-A Tuner. Terminals 2 and 3 furnish a lower output voltage at 2,500-ohms impedance which may be used in a similar manner if desired. Terminals 4 and 5 are in parallel with the monitoring jack and may be used as conditions indicate.

Connection of a 200-ohm or 500-ohm line may be made directly to terminals 2 and 3 with quite satisfactory results. A better method, however, would be to use an output transformer with a high-impedance primary connected to terminals 1 and 3, the secondary being designed to match the line impedance desired. This is especially desirable if the tuner is at some distance from the amplifier.

Some experiments may be required to determine the best connections in order to obtain maximum power output with a minimum of distortion.

Parts Supplied for Construction of

"UTILITY" PUBLIC-ADDRESS TUNER

Model 10-1119

- 1 Punched steel chassis, black wrinkle finish
- 1 365-mmfd., 4-gang tuning condenser, 21-5223
- 1 Steel condenser shield, 25-8207
- 1 5" slide rule dial, scale and escutcheon
- 2 6.3-volt dial lights, bayonet base
- 1 Ferrocart Antenna coil, 14-1496
- 3 Ferrocart R.F. coil, 14-7860
- 1 Power Transformer, 19518
- 1 Filter Choke, 19256
- 1 16-16 mfd., 300-v. Filter condenser
- 1 10-mfd., 25-v. tubular condenser
- 1 8-mfd., 300-v. tubular condenser
- 1 .25-mfd., 400-v. paper condenser
- 2 0.1-mfd., 400-v. paper condensers
- 4 0.1-mfd., 200-v. paper condensers
- 4 .05-mfd., 200-v. paper condensers
- 1 .01-mfd., 400-v. paper condenser
- 2 .00025-mfd. fixed mica condensers
- 3 .0001-mfd. fixed mica condensers
- 3 400-ohm, 1/4-watt fixed resistors
- 1 2,500-ohm, 1/4-watt fixed resistor
- 1 5,000-ohm, 1/2-watt fixed resistor
- 1 25,000-ohm, 1/4-watt fixed resistor
- 2 25,000-ohm, 1-watt fixed resistors
- 2 40,000-ohm, 1-watt fixed resistors
- 1 50,000-ohm, 1/4-watt fixed resistor
- 4 100,000-ohm, 1/4-watt fixed resistors
- 1 500,000-ohm, 1/4-watt fixed resistor
- 1 2-megohm, 1/4-watt fixed resistor
- 1 AC Line Cord and Plug
- 1 Antenna-Ground terminal strip

- 1 5-terminal output connection strip
- 6 Molded bakelite octal tube sockets
- 1 25,000-ohm Tone Control with switch
- 1 500,000-ohm Volume Control, 19394
- 1 Monitor phone jack
- 2 Tie-lugs, one insulated terminal
- 4 Tie-lugs, two insulated terminals
- 1 Tie-lug, four insulated terminals
- 3 Molded bakelite control knobs
- 2 Rubber grommets
- 4 Rubber mounting bumpers
- 4 Grid clips
- 1 Shakeproof soldering lug
- 4 No. 2-56 x 3/8" bronze screws
- 4 No. 2-56 hexagon brass nuts
- 4 No. 2 Steel lockwashers
- 4 No. 6-32 x 1/4" black screws
- 5 No. 6-32 x 1/4" drive screws
- 28 No. 6-32 x 1/4" steel screws
- 36 No. 6-32 hexagon steel nuts
- 38 No. 6 steel lockwashers
- 1 Length insulating sleeving
- 1 Length shielded wire
- 1 Length woven wire shielding
- 1 Length No. 20 stranded green wire
- 4 Lengths No. 20 solid colored wire
- 1 Length rosin-cored solder
- 1 No. 6-32 x 1" flat-head screw
- 1 No. 6-32 x 1/2" flat-head screw
- 1 Black wood spacer, 3/8" dia.
- 1 Tube shield for 6F8G tube

TUBES REQUIRED

3 6K7 1 6H6 1 6F8G 1 5Z4

CABINET AND PANEL AVAILABLE

Steel Cabinet complete, black crackle finish, 8 3/8" x 8 3/8" x 12 1/2" deep.
 No. 11-8200 List \$4.75 Net \$2.85

Steel Panel, completely punched, black crackle finish, 8 3/8" x 8 3/8" x 1/16" thick.
 No. 11-8243 List \$1.25 Net \$0.75

UTILITY P.-A. TUNER

10-1119

SCHEMATIC CIRCUIT DIAGRAM

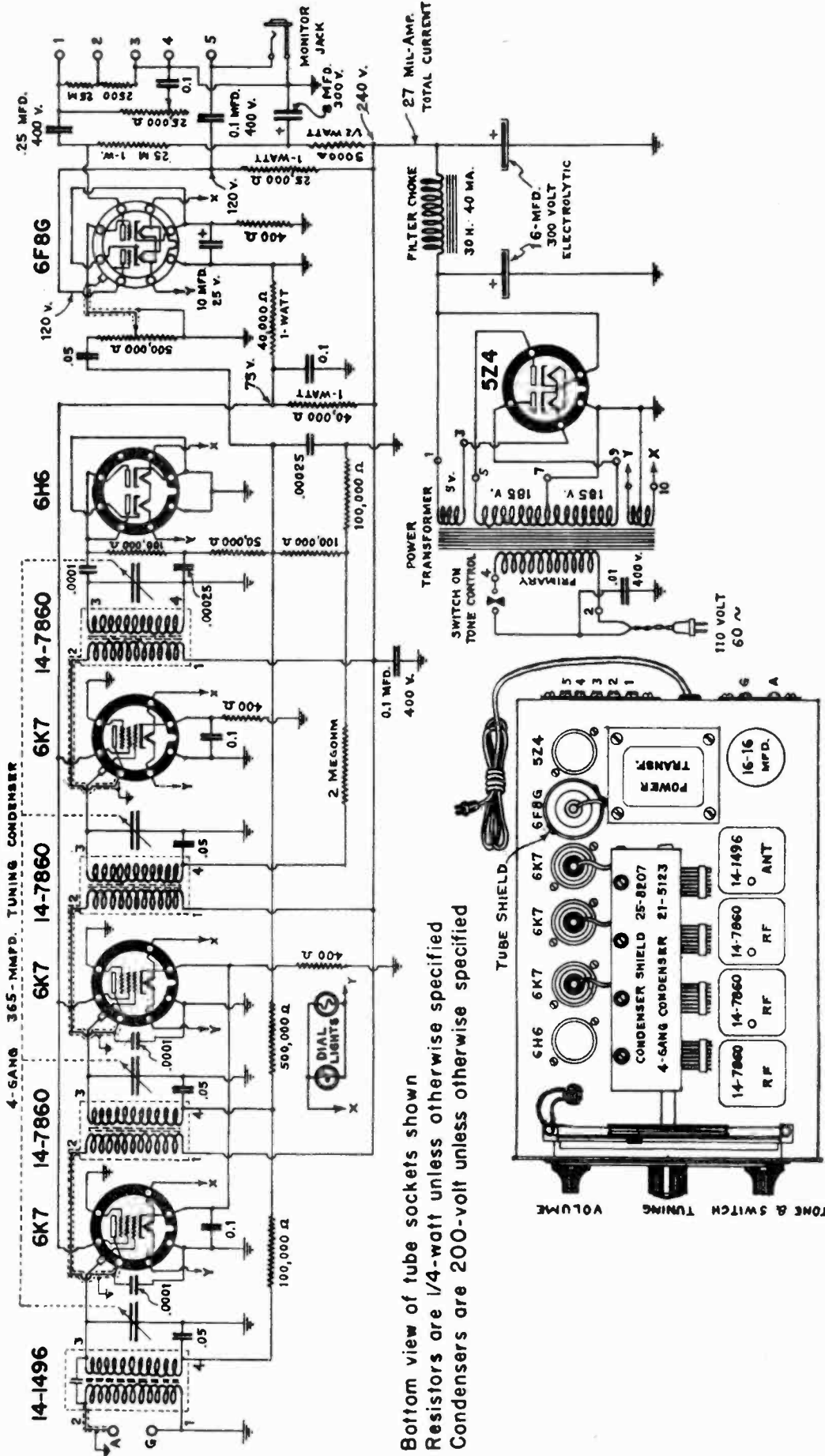

MEISSNER MFG. CO.
Mt. Carmel, Illinois

10-1119
PICTORIAL
WIRING DIAGRAM

UTILITY P-A TUNER

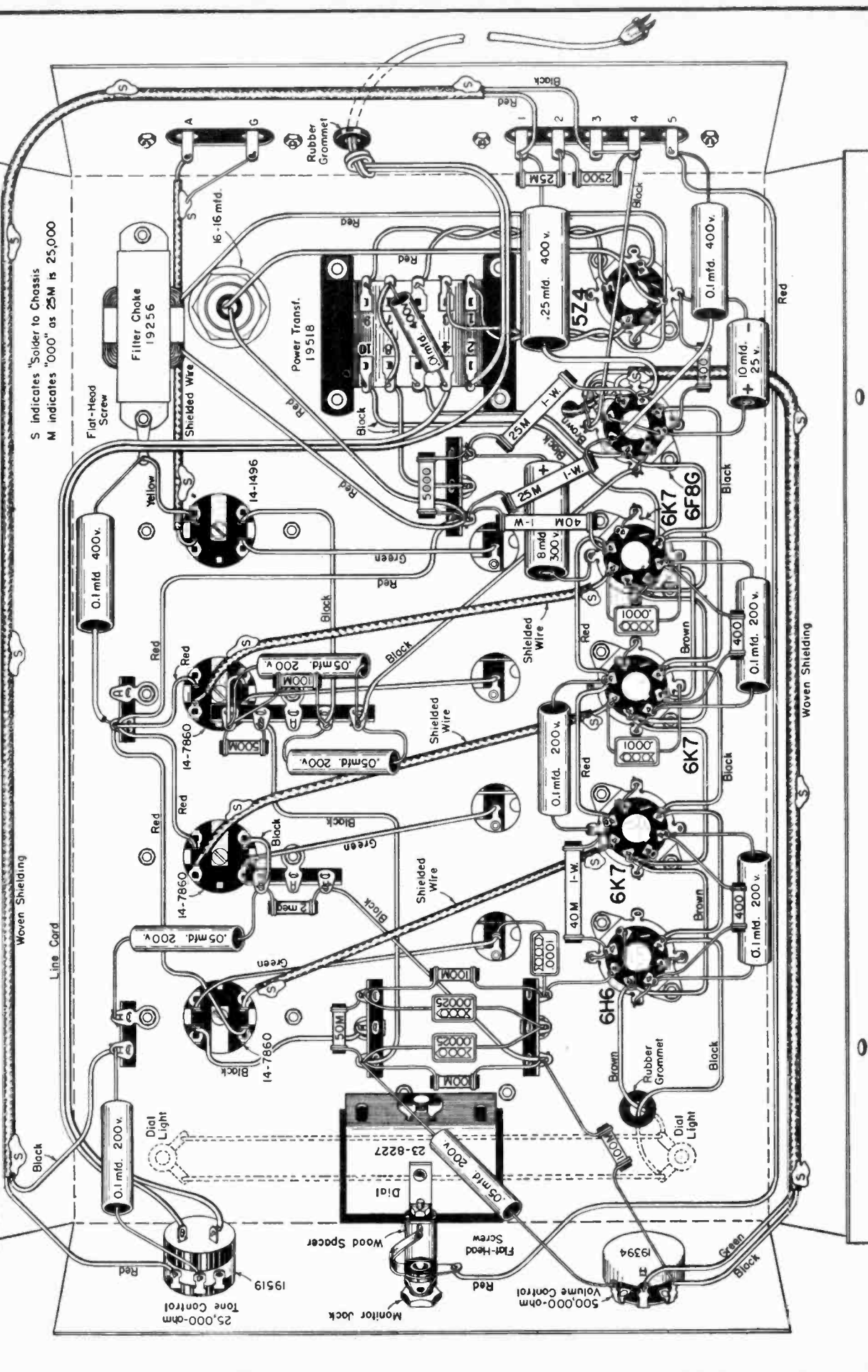

Woven Shielding

**COMPLETE INSTRUCTIONS
FOR CONSTRUCTION AND OPERATION OF THE**



PORTABLE "5"

BATTERY OPERATED SUPERHET RECEIVER

Model 10-1187

In order to obtain the most satisfactory results in construction and operation of this receiver the following instructions should be carefully followed, placing each part in the position shown and arranging the wiring as indicated in the Pictorial Wiring Diagram.

ASSEMBLY

Unpack the entire kit carefully and check the parts against the Parts List, noting the values of color-coded resistors and mica condensers according to the chart shown on the General Construction Hints. If any parts are missing, report at once to your supplier for adjustment. Before proceeding with the actual assembly of the receiver it is recommended that the constructor complete the reading of this folder as well as the General Construction Hints. After obtaining a general view of the situation in this manner the assembly may be begun.

1. Mount the five tube sockets with $\frac{1}{4}$ " screws and nuts. Use a lockwasher under each nut in the assembly. Note the tube type numbers so that sockets will be installed in the correct opening in the chassis. Also be sure to turn each socket so that the key-way in the central hole points in the direction shown in the Pictorial Diagram.
2. Take the 3-gang Tuning Condenser and place a nut on each of the three mounting studs. Then place the condenser on the chassis and fasten in place with three nuts and lockwashers. The three nuts placed on the studs first will serve as spacers to raise the condenser slightly above the chassis.
3. Solder a four-inch length of green stranded wire to the top terminal on the front section of the Tuning Condenser and a three-inch length of the same wire to the corresponding terminal on the rear section.
4. Mount the Tuning Condenser shield, using three 8-32 brass screws to hold it to the left side of the condenser.
5. Mount the metal shield fin on top of the RF coil (T1) and mount the coil on the chassis as shown.
6. Place the five rubber grommets in the chassis openings provided in the positions indicated.
7. Mount the two I.F. Transformers (T3 and T4), bringing the wire leads out through the rubber grommets according to the Pictorial Diagram. Place two of the tie-point strips on the mounting studs of T3 before applying the lockwashers and nuts.
8. Mount the remaining tie-point strip having three insulated terminals near the right side of the chassis as shown on the Pictorial Diagram.
9. Mount the Oscillator coil (T2) as shown, turning the coil so that the terminal base is in the position indicated. Mount the padder condenser (C11) on the rear of the chassis in the position shown.
10. Remove the large nut and lockwasher from the volume control (VC) and mount this unit on the front of the chassis. The projecting metal tip fits into a small hole in the chassis to locate the control and prevent it from turning.
11. Mount the remaining tie-point (with two insulated terminals) on the rear plate of the tuning condenser at the top as shown on the top and rear views of the receiver.

WIRING

Having completed the assembly of all the parts which are fastened to the chassis, the wiring of the set may be started. The assembly of the "Off-On" indicator disc and the Tuning dial will be left until after the wiring has been completed.

1. Have the soldering iron clean and hot. Solder one point on each socket-mounting to the chassis. A small spot of solder applied near one of the mounting screws on each socket and sweated to the chassis with the soldering iron will do this job nicely.
2. On each socket, locate the terminals which are connected to the ground lugs on the socket mounting saddle. There are two of these on each socket except the 1H5G. Make these connections with short lengths of bare wire.

3. Cut the wires from the I.F. Transformers (T3 and T4) to the proper length and solder them to the terminals indicated. Follow the color code carefully.

4. Place and connect all other wiring as shown, in any convenient order. The battery and speaker wires which extend through the grommet at the rear of the chassis should be left a foot or more long. The green wire which extends up through the same grommet is connected to one of the end terminals on the tie-point strip mounted on the back of the tuning condenser. This is the same terminal to which the outside turn of the loop antenna will later be connected and is clearly indicated on the top view of the receiver. A piece of stranded green wire about eight inches long is connected to the middle terminal on the volume control and brought up to the top of the chassis through the rectangular opening. This wire will provide a top grid connection for the 1H5G tube.

5. Connect the condensers and resistors as shown on the Pictorial Wiring Diagram. Use the braided insulating sleeving on bare wires where indicated or where ever else it may seem necessary to prevent such wires from touching each other or the chassis.

6. On top of the chassis, connect C4 between the center and left-end terminals as shown on the Top View.

7. Insert tubes in the sockets and determine the proper length of grid leads for top connections. Solder the four grid clips to the grid wires as shown. Note that two wires are connected to one clip on the 1A7G tube.

8. Check all wiring and connections very carefully.

9. Place the red and white "Off-On" indicator disc on the volume control shaft and then mount the dial. Use the two black wood spacers between the dial plate and the front of the chassis. See that the tuning condenser plates are completely closed and then turn the dial so that the pointer is exactly on the horizontal mark at the low-frequency end of the dial scale. Tighten the set screws on the condenser shaft in this position.

LOOP CONSTRUCTION

Having completed the assembly and wiring of the receiver itself, the next step is the winding of the Loop Antenna. First mount the two small brackets on the side of one of the wood cross-arms using two long screws for this purpose. Then fasten the A-G terminal strip to these brackets with two short screws. This location of the terminal strip is shown in the small sketch of the loop antenna above the top view of the receiver.

Then, holding the frame in the position illustrated, begin at the lower left cross-arm and wind twenty-seven and three quarters turns of brown wire in the slots, proceeding in a counter-clockwise direction. The wire should be drawn tight enough to keep it straight and in place but should not be drawn so that adjacent turns tend to pull alongside each other in the slot. A neat, flat winding should be the result. A single turn of yellow wire is placed around the outside of this winding and the two ends of this wire connected to the A-G terminals. This turn constitutes the primary of the "antenna coil" when an external antenna is used while the loop winding itself is then the "secondary".

Connect the inside end of the brown winding to the right-hand terminal on the tie-point strip on the back of the tuning condenser and the outside end to the left-hand terminal as shown on the top view. The loop antenna frame is then to be screwed to the inside of the back of the cabinet.

TUBES AND BATTERIES

Remove all tubes from the receiver and connect the batteries as shown. Connect the two "B" batteries together and run the Black wire from the receiver to the negative (-) terminal and the Red wire to the positive (+). The Yellow wire connects to positive "A" and the Brown wire to the negative. Use the small two-terminal battery plug on the

"A" battery if necessary; be sure the Yellow wire connects to the large pin in this case. Connect the speaker to the orange and blue wires from the receiver marked "speaker" on the Pictorial Diagram. Tape connections to avoid shorting.

Turn the chassis over and check the voltage on the filament terminals of the tube sockets. These are terminals 2 and 7 on each socket and should show very close to 1.5 volts. It is necessary, of course, that the volume control be turned on so that the battery circuits will be closed. Then measure the "B" voltage on terminal 4 of the 1C5G socket, using the chassis as negative terminal. This should be practically 90 volts. If the filament voltage is higher than 1.7 volts or if the "B" voltage is lower than 80 volts, remove the batteries at once and re-check all connections. Some error has been made in the wiring of the receiver which would probably result in the destruction of a set of tubes unless it were corrected.

If these voltages are found to be correct, the tubes may then be inserted in their respective sockets. The 1H5G requires no shield. On the other four tubes, however, a small flat ground clip must be placed on the base of the tube before inserting it in the socket. This clip will fit in only one position as located by the key-way in the central hole. The small hole with toothed edges fits over one of the tube pins (No. 1). The free end of the clip is bent up along the side of the tube base and the tubular part of the shield is then placed over the tube and fitted over the clip so that a tight connection is made between the shield and the clip. Then insert the shielded tube in the socket.

Place the grid clips on the top grid connections of each tube and bend the metal grid shield (mounted on top of the RF coil) so that it lies close to the grid wire coming out of the top of the coil but not touching the grid clip.

ALIGNMENT

For alignment purposes, a good service oscillator will be very helpful and is recommended if available. Satisfactory results may be obtained, however, by tuning in strong broadcast signals near the alignment frequencies specified.

Connect the output of the service oscillator to the top grid of the 1A7G tube through a .01 to 1.0-mfd. condenser. Connect a suitable output meter to the voice-coil of the speaker. If no output meter is available, the variation in volume of sound from the speaker may be used as an indication of maximum signal for each adjustment. Set the oscillator output to 456 kilocycles and the receiver dial to 600 kc; then adjust the trimmers in the top of each I.F. transformer for maximum output. Use only enough output from the oscillator to obtain a satisfactory reading on the output meter or an audible note in the speaker. Best results will be obtained on the lowest possible signal input to the receiver. Repeat the adjustment of these trimmers several times to make sure that the best possible adjustment has been obtained.

Remove the service oscillator connection from the 1A7G tube grid and connect it to the A-G terminals on the Loop

antenna. Use a 200-mmfd condenser in series with the "hot" side of the oscillator output. Place the loop against the back of the receiver in the same position it will have when mounted in the cabinet and proceed with the alignment. Turn the volume control on full and set the oscillator and receiver dial to 1400 kc. Increase the output of the oscillator and adjust the trimmer on the center section of the tuning condenser through the opening in the top of the condenser shield until an output reading or audible signal is obtained. Set this trimmer for maximum output as accurately as possible and then adjust the other two trimmers on the front and rear sections for the same condition. Reduce the signal input to the receiver from the service oscillator as alignment proceeds in order to keep the receiver output low at all times.

Next set the oscillator at 600 kc and tune the receiver to receive this signal. With a small screw-driver, adjust the padding condenser (C11) on the rear of the chassis, turning it slowly in one direction as the tuning condenser is "rocked" back and forth across the signal. The signal output of the receiver should reach a maximum at some point in the rotation of the padder and then start to drop off. Return the padder to obtain the maximum signal output. If the initial adjustment of the padder produces a decrease in the output, reverse the direction of rotation immediately and proceed as above.

After adjusting for maximum output at 600 kc, retune the service oscillator and the receiver to 1400 kc and repeat the alignment adjustments as previously outlined.

CABINET INSTALLATION

Remove the shelf from the cabinet and mount the chassis on it, using four short 6-32 screws through the holes in the shelf into the four corner brackets at the corners of the chassis. Mount the "A" battery on the shelf in the position shown, using the metal strap to clamp it in place. Place the dynamic speaker carefully on the four studs projecting at the edge of the speaker opening in the cabinet and fasten in place with lockwashers and nuts. Insert the Cro-glass dial crystal in the dial opening from the inside of the cabinet and tack in place. Then replace the shelf, seeing that the dial clearance is satisfactory and that the control shafts are centered in the holes provided. The red and white indicator disc should be visible through the opening to the right of the volume control and should show white when the control is turned "off". Fasten the shelf in place and mount the control knobs on the two shafts.

With the set turned "off" connect the batteries and place the "B" batteries in the space below the shelf. See that the terminals of the batteries are well separated and cannot possibly touch each other. Place a small block of wood or a folded piece of corrugated cardboard between the batteries to wedge them in place and keep them from moving about.

Make sure that the loop is properly connected and that the set is working satisfactorily before placing the back cover on the cabinet and screwing it in place.

PARTS SUPPLIED FOR CONSTRUCTION OF PORTABLE "5" MODEL 10-1187

- | | |
|------------------------------------------------------------------------------------------------------------------------------------------------------------------------------------------------------------------------------------------------------------------------------------------------------------------------------------------------------------------------------------------------------------------------------------------------------------------------------------------------------------------------------------------------------------------------------------------------------------------------------------------------------------------------------------------------------------------------------------------------------------------------------------------------------------------------------------------------------------------------------------------------------------------------------------------------------------------------------------------------------------------------------------------------------------------------------------------------------------------------------------------------------------------------------------------------------------------------------------------------------------------------------------------------------------------------------------------------------------------------------------------------------------------------------------------------------------------------------------------------------------------------------------------------------------------------------------------------------------------------------------------------------------------------------------------------------|------------------------------------------------------------------------------------------------------------------------------------------------------------------------------------------------------------------------------------------------------------------------------------------------------------------------------------------------------------------------------------------------------------------------------------------------------------------------------------------------------------------------------------------------------------------------------------------------------------------------------------------------------------------------------------------------------------------------------------------------------------------------------------------------------------------------------------------------------------------------------------------------------------------------------------------------------------------------------------------------------------------------------------------------------------------------------------------------------------------------------------------------------------------------------------------------------------------------------------------------------------------------------------------------------------------------------------------------------------------------------------------------------------------------------------------------------------------------------------------------------------------------------------------------|
| <ul style="list-style-type: none"> 1 Punched steel chassis, black wrinkle finish, 11-8251 1 5" P-M Dynamic speaker with transformer, 19532 1 Dial plate assembly, Broadcast band, 19531 1 Rectangular Cro-glass dial crystal, 19535 1 3-gang, 365-mmfd. Tuning Condenser, 9919 C1 - C2 - C3 1 Cadmium steel condenser shield, 25-7831 1 Shielded R. F. Coil, 9914 T1 1 Unshielded Oscillator Coil, 9916, T2 1 456-kc Input I. F. Transformer, 16-5741 T3 1 456-kc Output I. F. Transformer, 16-5743 T4 1 1-megohm Volume Control with switch, 19533 VC 1 Red and white "Off-on" indicator disc 1 0.1-mfd, 200-volt paper condenser C5 2 .05-mfd, 200-volt paper condensers C4 - C6 6 .01-mfd, 400-volt paper condensers C7 - C9 - C12 - C13 - C14 - C16 3 .0001-mfd. Mica Condensers C8 - C15 - C20 1 .00001-mfd. Mica Condenser C-10 1 Adjustable Padder Condenser, 22-7008 C11 1 .00005-mfd. Mica Condenser C17 1 10-mfd., 25-volt Electrolytic Condenser C18 1 16-mfd., 150-volt Electrolytic Condenser C19 3 100,000-ohm, 1/4-watt fixed resistors R1 - R2 - R3 2 50,000-ohm, 1/4-watt fixed resistors R4 - R6 1 200,000-ohm, 1/4-watt fixed resistor R5 1 2-megohm, 1/4-watt fixed resistor R6 1 2,000-ohm, 1/4-watt fixed resistor R7 2 500,000-ohm, 1/4-watt fixed resistors R9 - R10 1 1-megohm, 1/4-watt fixed resistor R11 1 800-ohm, 1/4-watt fixed resistor R12 5 Molded bakelite octal tube sockets | <ul style="list-style-type: none"> 4 Type G1225 Metal tube shields, 19396 1 Special shield fin to mount on R.F. coil 1 Tie-lug, single insulated terminal 1 Tie-lug, two insulated terminals 2 Tie-lugs, three insulated terminals 4 3/8" Rubber grommets 1 3/8" Rubber grommet 2 Special connection plugs for "B" batteries 1 Special connection plug for "A" Battery 1 Mounting clamp for "A" Battery 4 Grid Clips for top grid connections on tubes 2 Walnut Bakelite Control Knobs 1 Wood frame for Loop Antenna 1 A-G Terminal strip 2 Mounting brackets for A-G strip 1 65-ft. length No. 22 Brown wire for Loop Antenna 2 Black wood spacers for dial mounting 2 6-32 x 1/4" long screws for dial mounting 3 8-32 x 1/4" brass screws for condenser shield 2 6-32 x 1/4" long screws for mounting A-G strip 4 No. 6 x 3/4" brass wood screws for mounting Loop 4 No. 3 cut tacks for mounting dial crystal 18 6-32 x 1/4" steel machine screws 34 6-32 x 1/4" hexagon steel nuts 31 No. 6 steel lockwashers 1 Length Green stranded wire for grid connections 6 Lengths stranded colored wire 5 Lengths solid colored wire 1 Length braided insulating sleeving 1 Length rosin-core solder 1 Portable Cabinet with leather handle, 11-8244 |
|------------------------------------------------------------------------------------------------------------------------------------------------------------------------------------------------------------------------------------------------------------------------------------------------------------------------------------------------------------------------------------------------------------------------------------------------------------------------------------------------------------------------------------------------------------------------------------------------------------------------------------------------------------------------------------------------------------------------------------------------------------------------------------------------------------------------------------------------------------------------------------------------------------------------------------------------------------------------------------------------------------------------------------------------------------------------------------------------------------------------------------------------------------------------------------------------------------------------------------------------------------------------------------------------------------------------------------------------------------------------------------------------------------------------------------------------------------------------------------------------------------------------------------------------------------------------------------------------------------------------------------------------------------------------------------------------------|------------------------------------------------------------------------------------------------------------------------------------------------------------------------------------------------------------------------------------------------------------------------------------------------------------------------------------------------------------------------------------------------------------------------------------------------------------------------------------------------------------------------------------------------------------------------------------------------------------------------------------------------------------------------------------------------------------------------------------------------------------------------------------------------------------------------------------------------------------------------------------------------------------------------------------------------------------------------------------------------------------------------------------------------------------------------------------------------------------------------------------------------------------------------------------------------------------------------------------------------------------------------------------------------------------------------------------------------------------------------------------------------------------------------------------------------------------------------------------------------------------------------------------------------|

ACCESSORIES REQUIRED: 2 1N5G tubes, 1 1A7G tube, 1 1H5G tube, 1 1C5G tube, 1 1.5-volt "A" battery (Eveready 742 or equivalent) and 2 45-volt "B" batteries (Eveready 762 or equivalent).

IO-1187

SCHEMATIC
CIRCUIT DIAGRAM

PORTABLE "5" Battery - Operated Superheterodyne Broadcast Band Receiver

I. F. = 456 kc

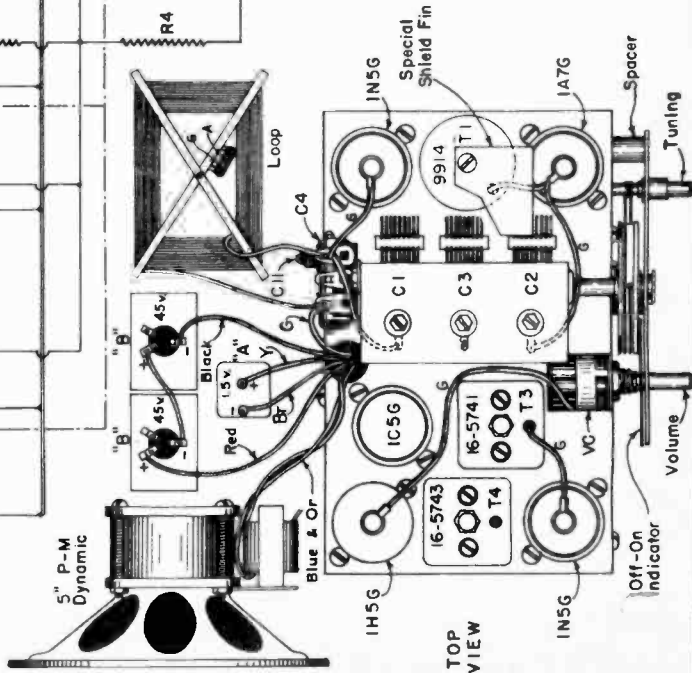
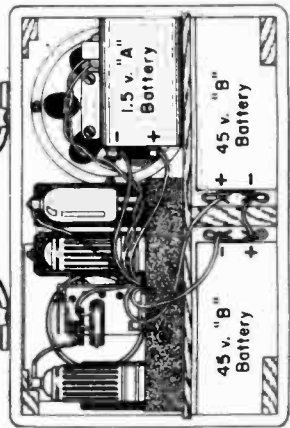
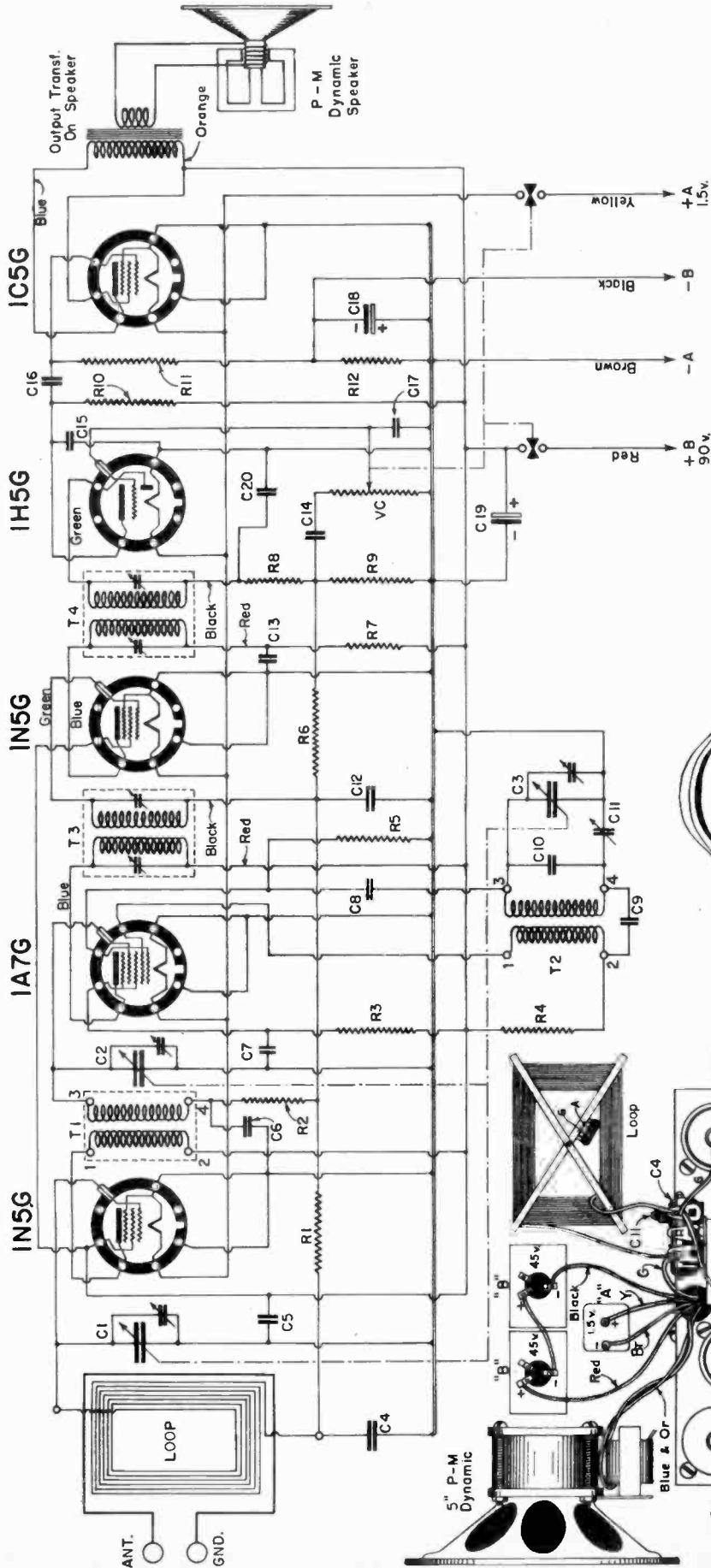

MEISSNER

PORTABLE "5"

IO-1187
PICTORIAL
WIRING DIAGRAM

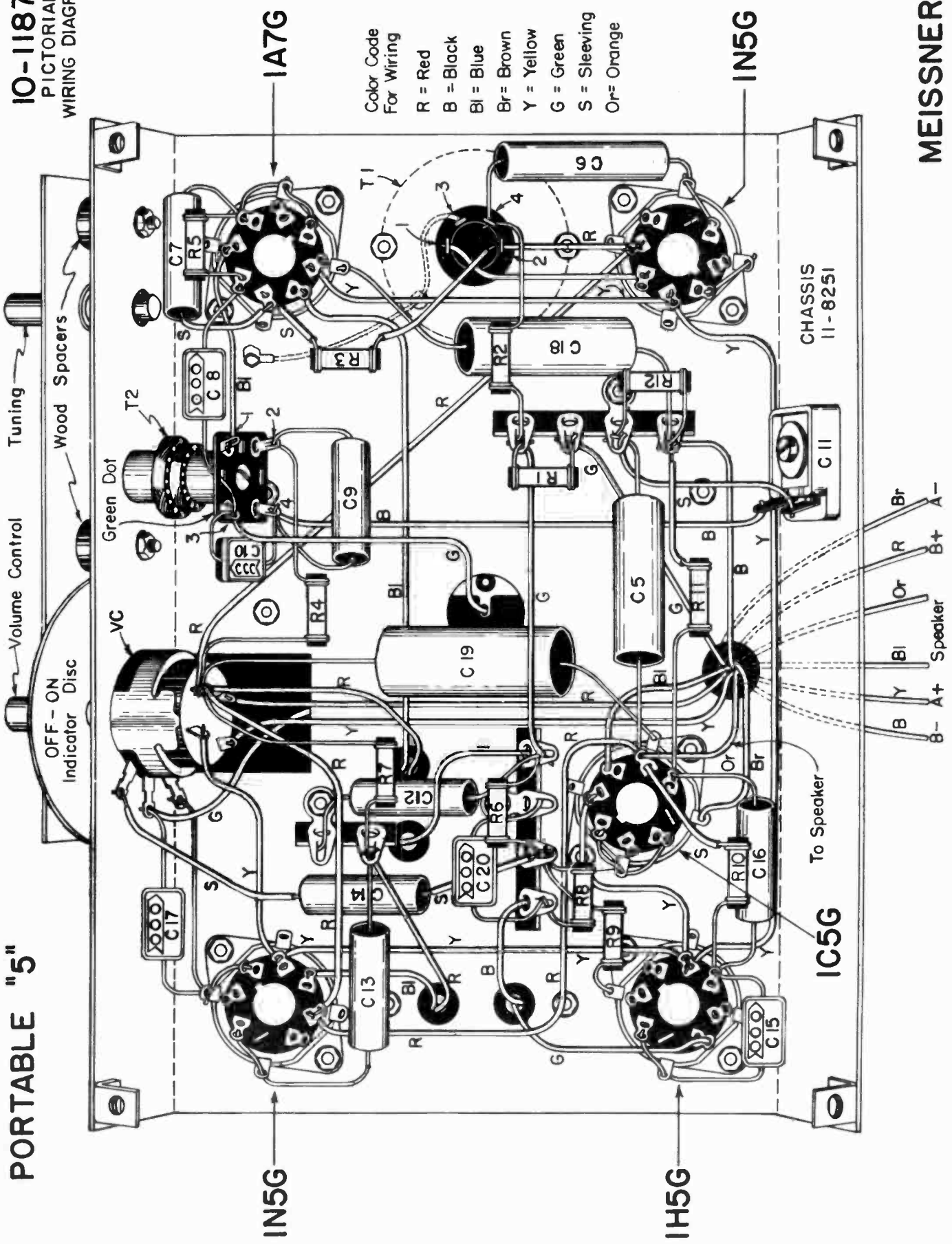

MEISSNER



WIRELESS PHONOGRAPH OSCILLATOR

Adapter Unit No. 10-6380

The Meissner Wireless Phonograph Oscillator No. 10-6380 is a device to permit any radio receiver to be utilized as an electric phonograph without any wires connecting the **Wireless Phonograph Oscillator** to the radio receiver and without in any way altering the receiver.

WIRELESS OPERATION

The Wireless Phonograph Oscillator is actually a radio transmitter of very low power. (Federal laws prevent raising the power output.) It will radiate a signal in the broadcast band that can be picked up by any broadcast receiver of sufficient sensitivity within a radius of 20 to 50 feet from the phonograph oscillator, when the set is tuned to pickup the signal. Sometimes however, because of peculiar wiring conditions, antenna arrangements, or placement of ungrounded metallic bodies, the signal will radiate particularly well in one direction and may be picked up on a neighbor's set if located sufficiently close. It is also possible that reception of the signal from the Phonograph Oscillator may be hampered by inadequate sensitivity in the receiver or by shielding caused by pipes, girders, metal lath, etc. and that the useful range of the wireless oscillator may be less than the specified 20 to 50 feet.

In such cases it will be necessary to select a new location for either the set or the oscillator, run the antenna lead of the set closer to the phonograph oscillator, or to use the "Wired Connection" (which does not alter the radio set in any way) but requires two wires to run from the phonograph oscillator to the receiver.

When using the "Wireless" arrangement it must be remembered that the antenna of the receiver is still connected and that it is capable of picking up outside signals and interference. When heavy local noise, as from a vacuum cleaner motor, is experienced, or a local thunderstorm gives rise to objectionably loud static interference, it will be found that the "Wired Connection" will give much more satisfactory results.

WIRED CONNECTION

In the "Wired Connection", the antenna is connected to the binding post marked "A" on the phonograph oscillator and the receiver connected to the phonograph oscillator by means of two wires; one connects together the "G" (or "Gnd") binding posts on both the receiver and the oscillator while the other wire connects the "A" (or "Ant") binding post of the receiver to the green wire projecting from the top of the phonograph oscillator.

If the phonograph oscillator is to be used *only* in the "wired" connection it is recommended that the "coupling condenser" marked in the schematic and Pictorial diagram be omitted. This will reduce the likelihood of interference with your neighbor's reception.

DOUBLET CONNECTIONS

If the receiver employs a doublet antenna for short-wave reception and it is desired to use it in the "Wired Connection" the one side of the doublet connection to the binding post marked "D" on the set (or any other designation other than antenna and ground) should be left so connected, and the other antenna binding post and the ground binding post connected to the phonograph oscillator as instructed in the section "Wired Connection". For the "Wireless" arrangement, no change is necessary. Where a transmission line and coupler are used the "Wireless" arrangement may not work satisfactorily and recourse must be made to the "Wired Connection."

PHONOGRAPH PICKUP

The phonograph pickup should be of the high-impedance type, either crystal or magnetic. If a low-impedance pickup is used a step-up transformer must be used between the pickup and the phonograph oscillator. A voltage dividing resistor network has been provided in the phonograph oscillator to accommodate, to some extent, the differences in pickups. The connections for this network are discussed in the section "Distortion".

POWER SUPPLY

The Meissner Phonograph Oscillator No. 10-6380 is designed to operate from a 110-volt source, either AC or DC. On the latter type current it may be necessary to reverse the line plug (as in the case of all AC-DC radio devices operat-

ing on DC) before the device will function. The standard unit is not recommended for 25-cycle operation, but by adding two 4-mfd. 200-volt electrolytic condensers as indicated by dotted lines in the circuit diagram, operation will be satisfactory on 25-cycle current.

ASSEMBLY

The parts should be mounted on the chassis in accordance with the bottom view of the chassis shown in the Pictorial Wiring Diagram. The order of assembly is of little consequence.

WIRING

Having completed the assembly operations described above, study the sheet of suggestions, "General Construction Hints," packed with the kit. When finished, start the wiring in accordance with the practices suggested in that sheet, following the position of wires shown in the Pictorial Diagram.

TEST

When the wiring has been completed and has been checked for accuracy against the Pictorial Diagram, the tubes may be inserted, the pickup connected and the unit made ready for test. On the first test it is best to place the oscillator near the receiver or at least near the antenna leadin (which must not be shielded if wireless operation is to be obtained.)

The Chassis of the Wireless Phonograph Oscillator must not be grounded since the signal radiates from the chassis.

The switch on the end of the chassis should be turned clock-wise to heat up the unit. (When the unit is operating the line cord will become quite warm. This is normal to the operation of this and certain other types of AC-DC apparatus.)

When the tubes have warmed up, usually about one minute, start a record playing and, if there is a volume control on the pickup, turn the volume control to maximum. Turn the volume control on your radio set to approximately the position used for local broadcasting stations and tune the receiver (on the broadcast range) as if looking for a local station. The phonograph record will be heard some place on the dial.

In the top of the coil can on the oscillator there is a hole through which an adjusting screw is visible. A shaft with a tuning knob also projects from this end of the coil can. Both of these adjustments are tuning adjustments on the oscillator. The former is the rough adjustment while the knob and shaft actuate the fine adjustment.

If the phonograph signal is being interfered with by any strong signal it is a simple matter to shift the frequency of the oscillator by turning either or both adjustments, re-tuning the set to the new oscillator frequency until a frequency free from interference is found.

If the radio hums when the phonograph pickup arm is touched, the connections from the pickup to the Phonograph Oscillator should be reversed. (On some pickups this phenomena will not be present.)

DISTORTION

The phonograph oscillator, being a miniature transmitter, can be over-modulated by too great an input voltage from the phonograph pickup. This overmodulation gives rise to objectionable raspy distortion on loud notes. If reproduction is of poor quality on loud notes, the flexible grid connection of the 6F7 tube should be connected to the junction indicated in the schematic and Pictorial Diagram, for pickups with high output voltage.

MICROPHONE

Where a microphone is used in connection with the phonograph oscillator to permit announcements to be made, it is well to remember that the signals may be picked up by a neighbor.

CONVENIENCE OUTLET

A power outlet has been provided on the Phonograph Oscillator so that the power cord of the radio or the phonograph motor may be plugged into it. Power is available at this outlet as long as the line cord is plugged in.

When finished with phonograph operation, turn the switch counter-clockwise which turns off the oscillator and automatically connects the antenna to the receiver for normal reception.

PHONOGRAPH OSCILLATOR

10-6380

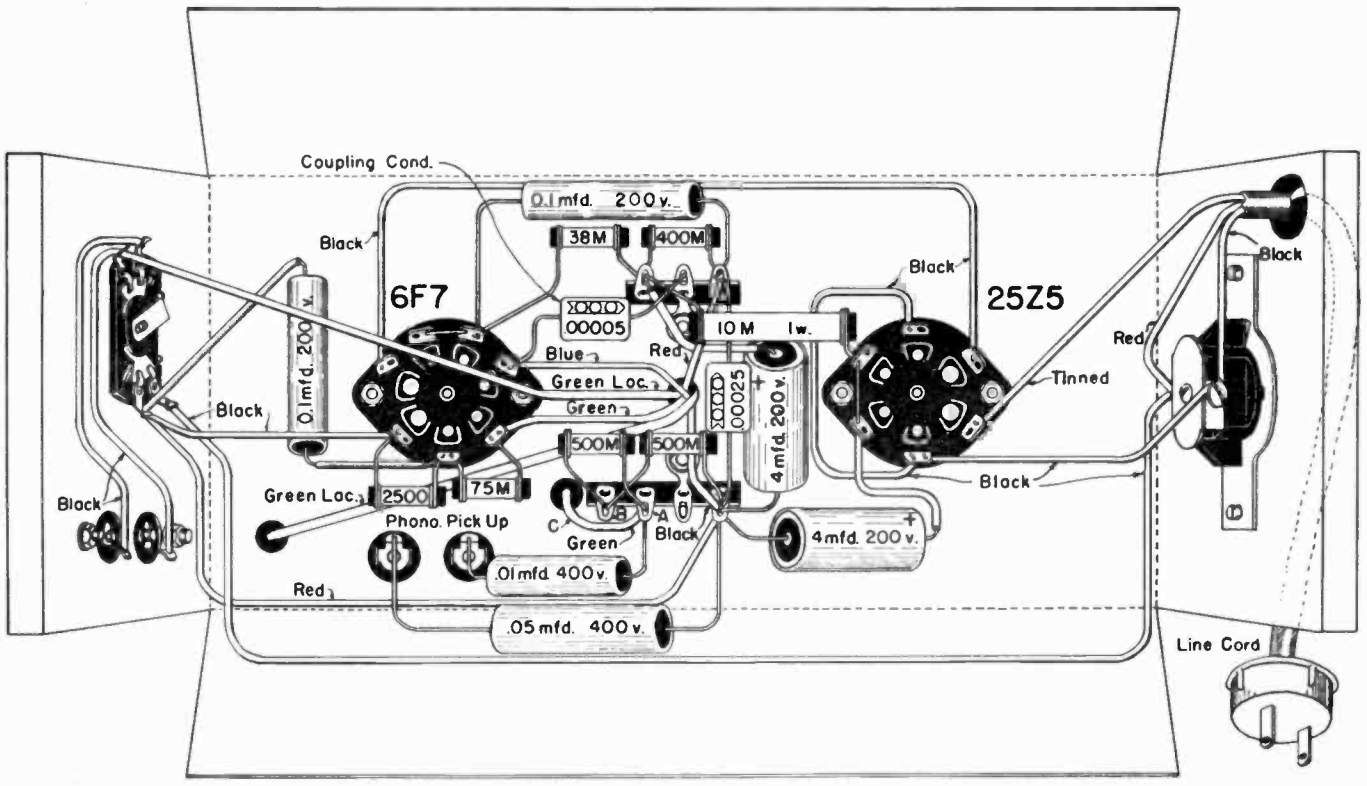
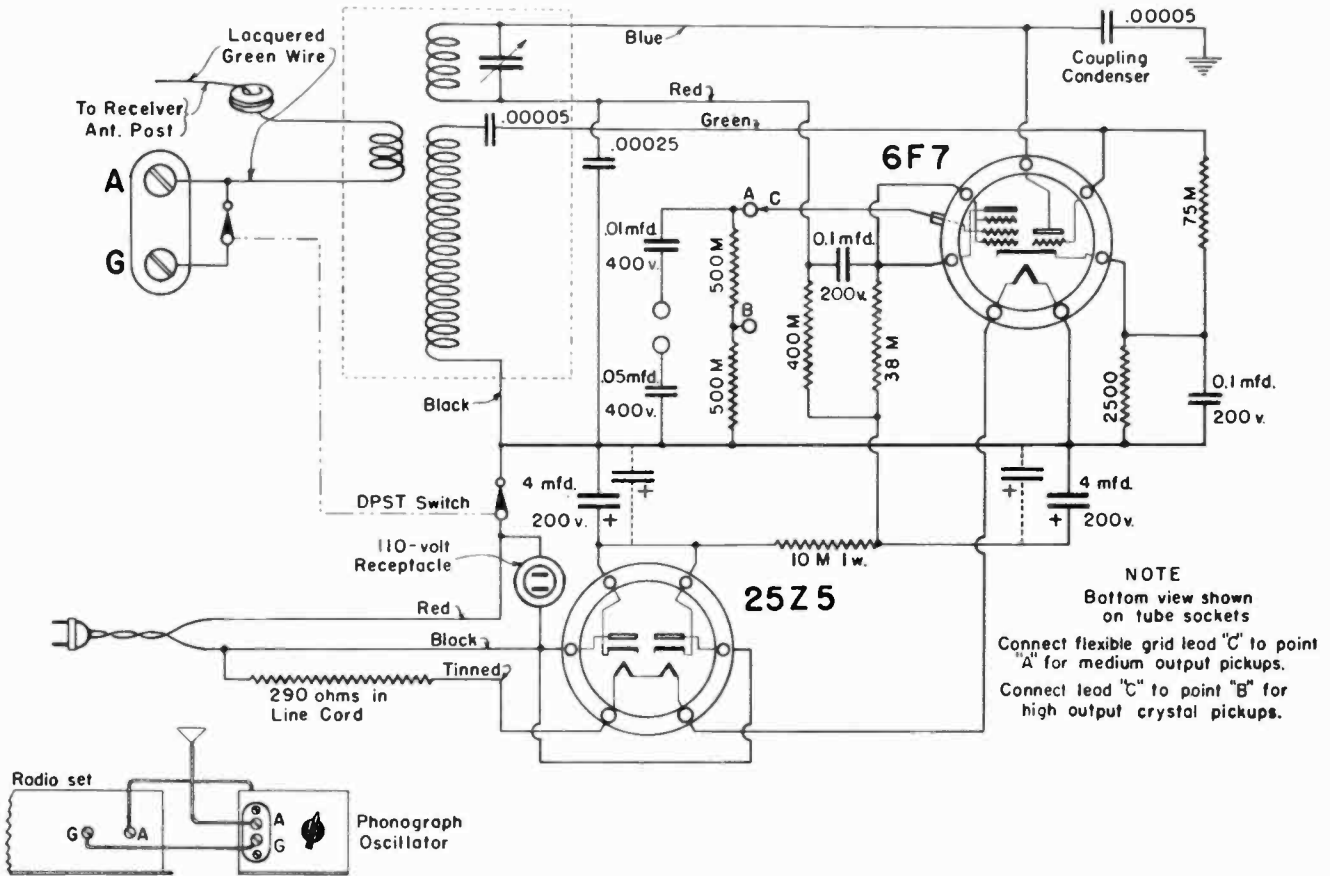

INSTRUCTIONS FOR



Noise Silencer Adapter

Model 10-7516

The Meissner No. 10-7516 Noise Silencer Kit was designed to permit the experimenter to quickly and easily add the famous Lamb type Noise Silencer to his receiver regardless of the number of stages in the I. F. amplifier.

The unit will greatly reduce noise of the high-intensity, short-duration type, such as ignition noise, and the noise from switching transients and lightning flashes. It will not and cannot eliminate all noise, and is not entirely automatic in its action. It will greatly reduce certain types of interference, making some signals intelligible that previously were blanketed by interference, but there are other types of interference on which the Noise Silencer has no effect.

ASSEMBLY

As the kit is unpacked, all parts should be carefully checked against the packing slip enclosed. Any discrepancies should be reported at once to the supplier from whom the kit was purchased.

All parts should be mounted on the chassis in the position shown in the Pictorial Wiring Diagram.

WIRING

Having completed the assembly of all parts, study the suggestions given on the sheet "General Construction Hints" packed with the Kit. When finished, start wiring the kit, observing the practices suggested, and placing the wires in the positions shown in the Pictorial Diagram.

CONNECTIONS

The connections to the "B" supply of the receiver should be made by connecting to the negative "B" connection in the receiver (usually the chassis) the wire from the adapter covered with black lacquered braid. The red lead of similar type is connected to some point in the receiver furnishing well-filtered direct current at 180 to 250 volts. Usually the plus-B connection to the I. F. transformers is a satisfactory place to attach this lead.

The shielded wire is plugged into the plate of the tube removed from the receiver, and the grid connection formerly made to that tube, is lengthened (if necessary) to reach the grid of the 6K7 tube in the adapter which should be mounted in such a position that the lead will be as short as possible. Two single pin plugs have been provided one fitting the clips in the octal socket, and the other fitting the small clips in the older glass tube sockets. Thus regardless of the type of tube removed from the receiver, the shielded lead can be plugged into the Plate clip of the socket.

The plug on the line cord should be inserted into a receptacle supplying 110 volts.

The Noise Silencer is usually substituted for the last I. F. tube. In receivers employing a separate AVC amplifier, the substitution is to be made in the signal channel, not in the AVC channel.

For phone reception it is recommended that the Noise Silencer be substituted for the last I. F. tube as described above. This can be easily tried without any work on the receiver. If the receiver is used essentially for code reception and it is desired to obtain the best possible performance from the combination of crystal filter and Noise Silencer, the following experiments may be carried out if the experimenter is of the enthusiastic type, willing to try several schemes in order to arrive at the best.

First become familiar with the performance of the Noise Silencer when substituted for the last I. F. tube, second, check this performance against the arrangement described below which rearranges the circuit elements so that silencing is accomplished ahead of the crystal.

The crystal filter, almost universally placed between the first detector and the first I. F. tube, should be rewired to operate between the first and second I. F. tube, and the transformer removed should be wired as the input I. F. transformer. If the receiver has three I. F. stages, the crystal filter should be rewired to work into the last I. F.

tube provided that the layout will not give prohibitive feedback or provided that the transformers can be moved to prevent feedback. Then by substituting the Noise Silencer for the first I. F. tube (second I. F. tube if three I. F. tubes are used), the silencing action occurs ahead of the crystal and protects it from shock excitation. Proper precautions against feedback must be observed to prevent the I. F. amplifier from oscillating with the new routing of the circuit. Several metal shields may be necessary to stop oscillation if caused by the rewiring.

When the rewiring is finished and the receiver (without the Noise Silencer) is stable, substitute the Noise Silencer in place of the crystal-driver tube in accordance with the directions given under "Adjustments." Determine now whether the action is better than the simple arrangement of crystal filter first, followed by the Noise Silencer.

ADJUSTMENTS

The Noise Silencer incorporates an amplifier tube for the purpose of making up any loss in sensitivity occasioned by the introduction of the Noise Silencer tube. On receiver already employing two or more stages of I. F. amplification, the gain added by this stage may cause the I. F. amplifier to oscillate, therefore, an adjustable bias has been provided on the adapter to set the gain of that stage to the proper level.

Having substituted the Noise Silencer in place of one of the I. F. tubes as directed in the section "Connections" it is necessary to align the I. F. transformers on the Noise Silencer and the transformers on the receiver feeding into and out of the Noise Silencer.

With a Signal Generator or Service oscillator, start alignment in the normal manner but with the "Threshold Control" at its counter-clockwise extreme (but not far enough to snap the line switch). As alignment of the adapter proceeds, aligning only the transformer with two grid leads and the transformers in the receiver feeding into and out of the adapter, oscillation may result. If it does, turn down the R. F. gain control on the receiver, or the bias control on the adapter, until oscillation stops. Now advance the "Threshold Control" until there is a diminution of signal just noticeable. On the adapter, align the transformer without grid leads adjusting for **Minimum** signal.

To set the Noise Silencer bias control to give neither gain nor loss it is necessary to determine a sensitivity reference level. First, tune in a weak signal of constant amplitude, even if it is necessary to short-circuit antenna and ground binding posts and listen to a local broadcasting station, noting the indication on the "R" meter without Noise Silencer. After changing to Noise Silencer (aligned and with Threshold control at its counter-clockwise position) set the bias control (shaft through top of Noise Silencer) to give the same indication on the "R" meter. With this adjustment, the receiver should perform as before. If greater sensitivity is usable, the bias control may be set as desired with satisfactory performance as long as the I. F. amplifier does not oscillate.

OPERATION.

Some experiment will be necessary in order to become familiar with the adjustment of the Noise Silencer and to learn its capabilities. To aid in rapidly becoming acquainted with the adjustments it is suggested that either the experimenter listen to some 10-meter Amateur phone stations or short-wave broadcasting station of comparable frequency where automobile ignition noise is usually a very strong source of interference, or that a local buzzer be temporarily set up to generate similar interference. By varying the "Threshold Control" a point will be reached where the interference will be greatly reduced without materially affecting the signal.

NOISE SILENCER UNIT

10-7516

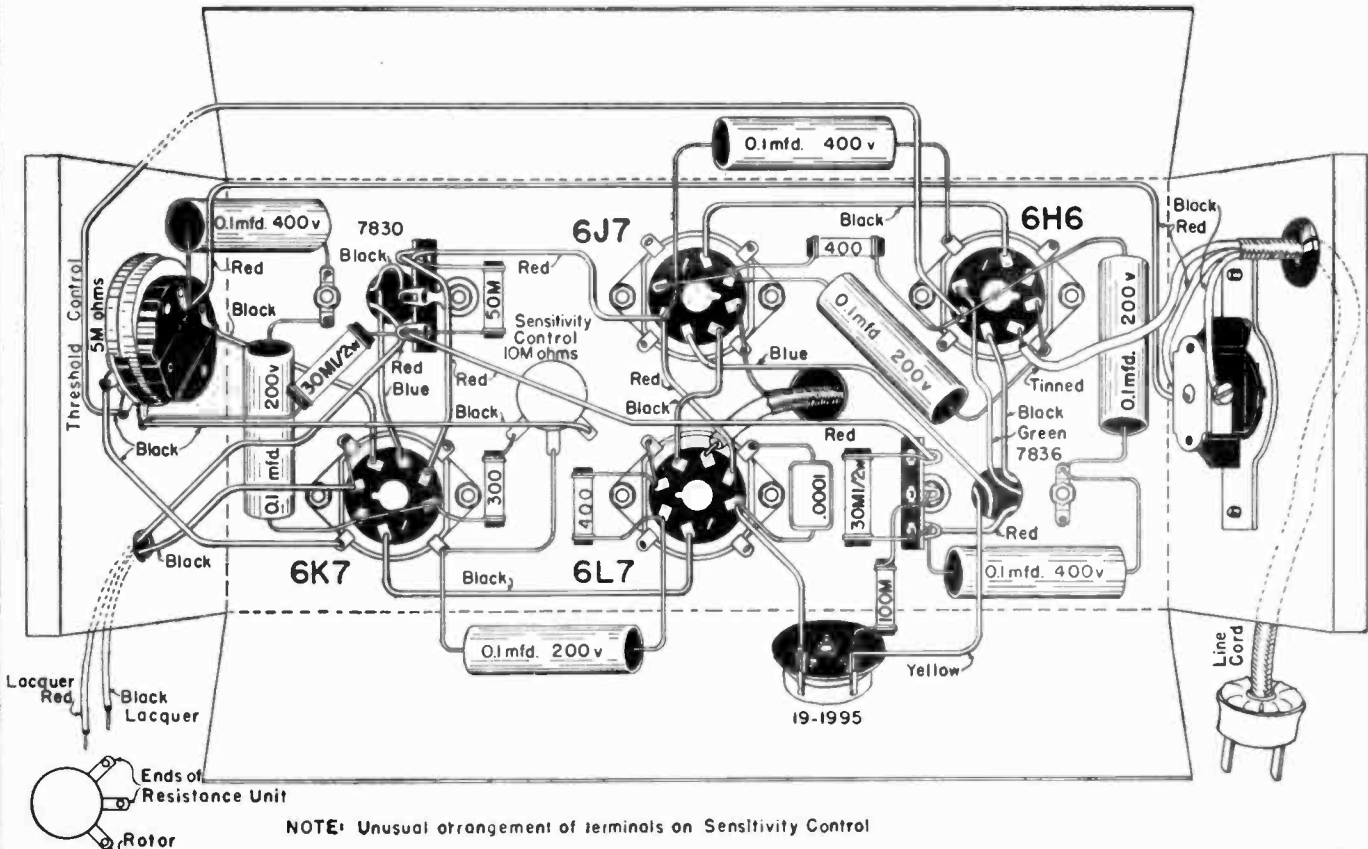
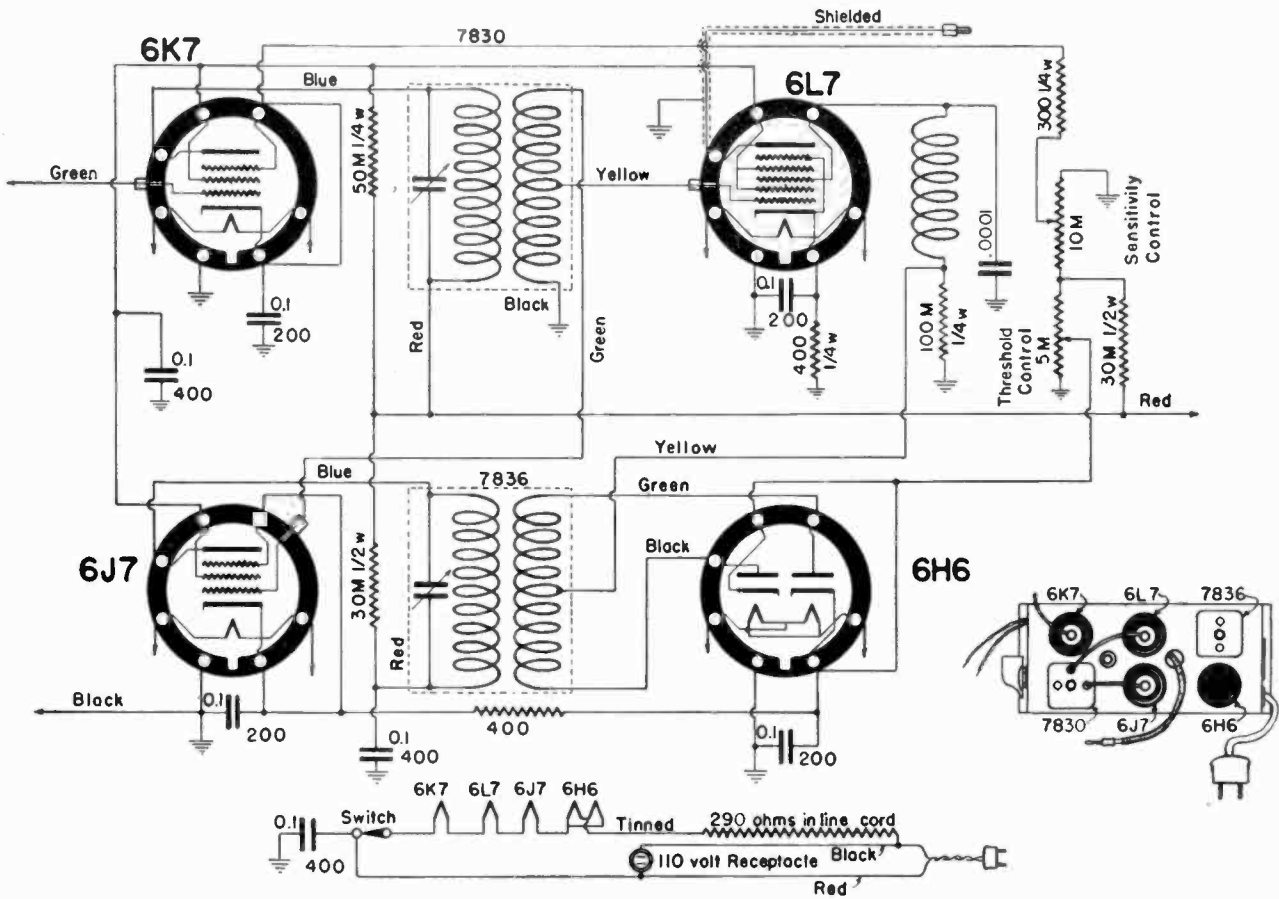

NOTE: Unusual arrangement of terminals on Sensitivity Control

INSTRUCTIONS FOR



Beat-Frequency Oscillator Adapter

Model 10-6350

The Meissner Beat-Frequency Oscillator Kit was designed in answer to a demand for an easily-built beat-frequency oscillator that could be attached to any existing super-heterodyne radio set without disturbing the receiver in any way. Its principle use is as a station finder for short-wave stations and as a heterodyne oscillator for code reception on standard All-Wave receivers.

It has its own built-in power supply operating from 110 volts AC or DC.

If this unit is to be operated on 25-cycle current it will be necessary to use additional filter capacity shown in the schematic diagram in dotted lines. The kit is supplied in knocked-down form and can easily be assembled and wired by even the most inexperienced constructor by closely following the Pictorial Wiring Diagram.

ASSEMBLY

As the kit is unpacked, all parts should be carefully checked against the packing slip enclosed. Any discrepancies should be reported at once to the supplier from whom the kit was purchased.

All parts should be mounted in accordance with the Pictorial Diagram, taking care to install the sockets in the CORRECT DIRECTION so that the position of the Key-way corresponds to that shown in the diagram. If this is not done it will be necessary to disconnect all socket wires and reverse the sockets, should they have originally been installed backwards.

WIRING

Having completed the assembly operations, study the hints given on the sheet "General Construction Hints," after which the wiring may be started.

All parts are so easily accessible that the order of wiring is of little consequence. Where several wires connect to one lug, attach all wires before soldering. The wires should be inserted in the hole in the lug and then bent around the lug to hold them in place until they are soldered.

CONNECTIONS

The Beat-Frequency Oscillator should be mounted in such a position, relative to the radio set, that the loop at the end of the shielded wire can readily be slipped over the grid of the last IF tube and the grid cap slipped on after it. The switch attached to the end of the two-wire cable should be mounted in some convenient place so that the beat note may be turned on or off at will. The terminals of the switch should be relatively inaccessible or else be taped up to prevent accidental contact with them. They carry a potential of approximately 100 volts.

On AC-DC sets, the chassis is frequently connected to one side of the power line. Disconnect the power cord of such a radio set while installing the Beat-Frequency Oscillator. If the shielding on the output lead of the Beat-Frequency Oscillator touches the chassis, the shielding is effectively connected to the power line and should be treated with respect accordingly when the line cord of the receiver is connected or precautions should be taken to prevent the shield from touching the chassis of the radio set.

ADJUSTMENT

Plug the power cord into a receptacle supplying 110 volts and plug the radio set into the outlet on the Beat-Frequency Oscillator chassis. By so doing, only one power cord need run to the wall receptacle.

Turn the volume control clockwise as far as possible. This turns on the filaments of the tubes and adjusts the

"B" voltage for maximum output. When the control switch on the end of the cord is turned "ON" the Beat-Frequency Oscillator will begin to oscillate but will probably not be at the correct frequency. It is then necessary to adjust the frequency as follows:

1. Turn on the radio set and tune in a relatively weak station in the broadcast band.

2. Turn the knob on top of the can until a whistle is heard simultaneously with the weak station. If the unit is operating on DC and no whistle is heard, reverse the line plug and try again.

3. If no whistle is heard in the range of 3 turns of the knob from the tight position, set the knob one turn from the tight position, and with a screw driver, adjust the screw visible through the hole in the top of the can. When a whistle is obtained, set the screw to produce a note of low pitch. Further adjustments may be made with the knob. By turning down the volume control on the end of the unit the strength of the beat-frequency voltage can be adjusted to the desired value.

4. Since there are several incorrect beat notes possible and only one correct adjustment it will be necessary to test the adjustments made above as follows:

Slightly detune the receiver listening carefully to the whistle. If it shifts very rapidly upward until no longer audible, the adjustment may be correct and should be tested by tuning in other stations. Each station tuned in should be accompanied by a whistle starting at a very high note and dropping rapidly in pitch to a very low note as the station is tuned in and rising again as the station is turned out. As the test is made on each of several stations it would be well to operate the "On-Off" switch several times to be sure that the whistle to which you are listening is produced by the Beat-Frequency Oscillator.

If the above performance is not obtained after the first adjustment, it will be necessary to try again. If several whistles are heard as the adjusting knob is turned it is probable that the loudest, or the one that can be heard with the Beat Oscillator volume control turned farthest down will be the correct adjustment.

OPERATION

When all adjustments have been completed, the operation of the Beat-Frequency Oscillator is very simple. Turning the volume control clockwise heats up the tubes in the Beat-Frequency Oscillator and determines the strength of the beating signal.

Turning the switch, at the end of the cable, to the "ON" position connects the "B" voltage to the oscillator and permits operation. When a station has been found, by means of the Beat-Frequency Oscillator, the control switch is turned "OFF" in order to listen to the program.

If the Beat-Frequency Oscillator is not required during long intervals of listening, the volume control on the unit should be turned to its counter-clock-wise extreme to shut off the unit and thus conserve power.

TUBES

The tubes specified for this unit are purposely of the glass type. Metal tubes are not recommended because their shells will assume a DC potential with respect to ground and may give a shock to anyone touching them while in contact with a grounded metal object.

The tubes used are 6C5G and 25Z6G.

BEAT FREQUENCY OSCILLATOR

10-6350

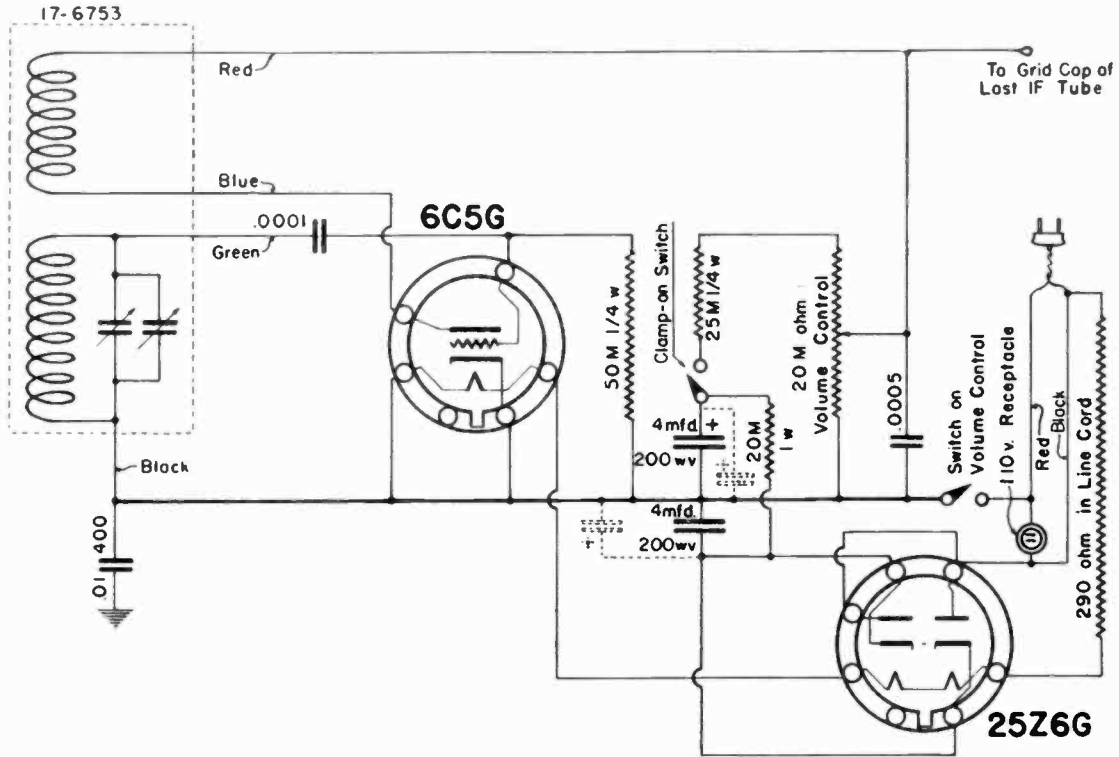

Condensers shown in dotted lines, (4 mfd. 200 wv) must be added for 25 cycle operation.

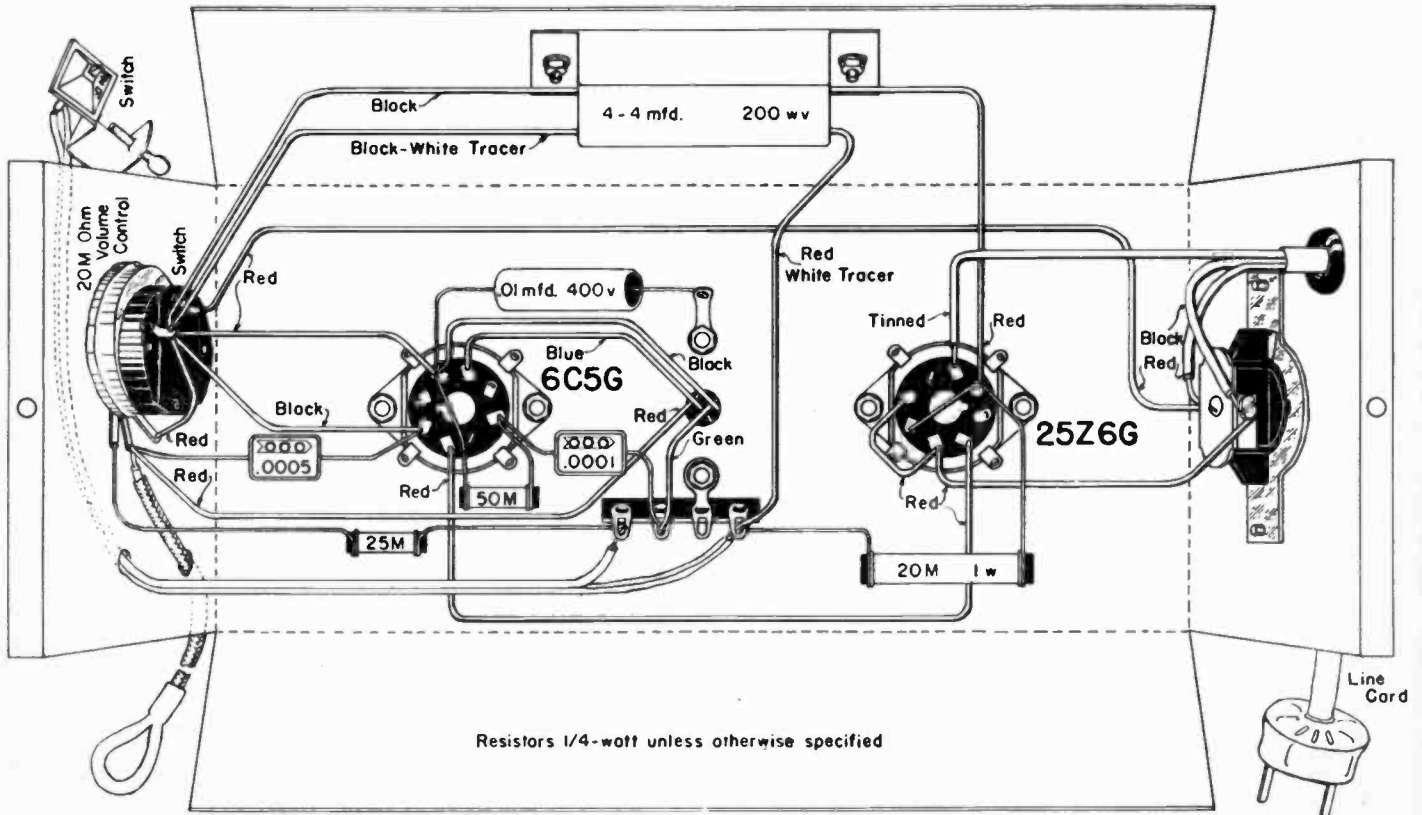

Resistors 1/4-watt unless otherwise specified

COMPLETE INSTRUCTIONS
FOR INSTALLATION, ADJUSTMENT AND OPERATION OF THE



AUTOMATIC PUSH-BUTTON TUNER

This Automatic Push-Button Tuner may be used with any super-heterodyne or TRF receiver having a two- or three-section tuning condenser. It is particularly recommended for modernizing single-band, two-gang receivers, providing excellent full-automatic operation on such sets. On receivers with three-gang condensers, only two sections are tuned by the push-button condenser assembly with consequent loss in performance. If, however, the signal-strength of the stations selected is adequate to give good reception on a four-tube receiver, a five- or more-tube receiver will usually give satisfactory performance when used with the Meissner Push-Button Condenser Assembly.

When this assembly is used on the broadcast and long-wave bands there will be no change in calibration providing the slight additional capacity introduced by the push-button switch is properly compensated for by adjustment of the trimmers on the receiver. Unfortunately, however, this does not hold true on the police and higher-frequency bands. The additional inductance of the connecting wires, etc., associated with the switch, cannot be corrected by any adjustment in the receiver and the dial calibration will therefore be off considerably on these bands and it is quite possible that the set will be inoperative on the short-wave bands. This means that full-automatic operation will have to be foregone when the tuner is to be used with receivers incorporating the short-wave bands if any operation of a satisfactory nature is to be expected of such bands. For such use, two of the wires will be removed from the switch, as described below, and the receiver dial will have to be set to the highest-frequency position (minimum capacity of the tuning condenser) when the push-button tuner is being used.

INSTALLATION

After carefully unpacking the unit, check all the parts to make sure that none have been mislaid or lost. The carton should contain 1 switch and condenser assembly, 1 bronze plate escutcheon, 2 small wood screws, 2 No. 8-32 mounting screws, 2 washers, 8 push-button knobs and 1 set of station call-letter sheets.

Determine a suitable location in your radio cabinet to mount the tuner. It may be placed in any position or location where space is available altho an effort should be made to locate it as near the tuning condenser as conveniently possible. In most cases, this may be accomplished by mounting the unit on the front panel of the receiver, directly over the dial, with the push-buttons projecting through the panel. It may also be mounted in the top of the cabinet with the buttons extending vertically through the top. In this position the station buttons are readily identified while the operator is standing.

After deciding upon the location and position of the tuner, the escutcheon-plate should be placed on the outside of the cabinet in the position it will occupy, and the location of all the holes marked on the cabinet. The center of each hole should then be determined as nearly as possible and center-punched. A center-line drawn through the row of push-button holes is to be extended at each end and an additional punch-mark made at a distance of $\frac{3}{8}$ " from each of the end push-button holes. These two marks will indicate the center of $\frac{1}{8}$ " dia. holes for the No. 8-32 flat-head mounting screws. Drill $\frac{1}{2}$ " diameter holes for the push-buttons. Care must be used in drilling so as not to split or otherwise mar veneered cabinet surfaces.

Before mounting the tuner in the cabinet it should be noted whether the receiver is designed for AC or AC-DC operation. In AC-DC receivers the chassis is usually "hot," having one side of the line connected to it. In this case it will be necessary to remove the jumper connection indicated (see diagram below) which connects the trimmer terminals to the back shield plate of the tuner. This jumper is to be replaced with a .01-mfd, 400-volt fixed tubular paper condenser as shown on the diagram. If the receiver is not an AC-DC model, this change will not be required.

The tuner may then be mounted in the cabinet, using the washers between the tuner and the inner side of the cabinet on the mounting screws. The mounting screws should be drawn well into the surface of the cabinet so as not to interfere with the escutcheon. If wood of unusual thickness is encountered, these screws may be replaced with longer ones of smaller diameter (No. 6-32) and a nut used on the

inside end. The escutcheon is then mounted in position by means of the small wood screws. Heavy cutting pliers may then be used to clip the flat push-button shafts so that they are $\frac{3}{8}$ " to $\frac{1}{4}$ " long from the surface of the escutcheon when in their outermost position. The push-button knobs may then be pressed firmly onto the ends of the shafts and should enter the holes in the escutcheon smoothly.

CONNECTIONS

NOTE: In the following discussion the term "full-automatic" will be used to designate the condition where the tuner is used with a straight broadcast or broadcast-longwave receiver for full automatic operation. The term "semi-automatic" will be used where the tuner is connected to a broadcast-shortwave or other all-wave receiver where it is desired to retain the calibration and original operation of the short-wave bands.

For "full-automatic" operation, examination of the tuning condenser will disclose the fact that each of the stator sections (stationary plates) of the condenser is connected to a coil and a tube. These connections may both be at the top or bottom of the condenser or one above and one below depending on the physical arrangement of the parts. It is necessary to disconnect all such connections from the stator plates of each section (on a 2-gang condenser) both above and below, and then reconnect the tube and coil together if they have been disconnected by this proceeding. See diagrams for typical arrangements of these parts.

As an illustration, the top grid of a tube may be found connected to the upper stator connection of the tuning condenser while the corresponding coil will be found connected to the lower terminal of the same section of the condenser. In this case, the grid connection wire on top of the condenser is to be removed and also the connection to the lower terminal. The wire (or coil connection) that was connected to the lower stator terminal must then be extended through the chassis and provided with a clip to fit the grid-cap of the tube. Thus we have completed the same circuit as before except that the tuning condenser has been completely disconnected from the coil circuit and the tube grid.

The yellow wire from one side of the push-button switch is now to be soldered to the stator terminal of the tuning condenser, while the brown wire from the same side of the switch is to be connected to the coil connection leading to the tube grid that has just been removed from this section of the condenser. The other section of the tuning condenser will then be treated in a similar manner using the brown and yellow wires from the opposite side of the switch.

In the event that the coil connections are above the chassis or the parts concerned are otherwise differently arranged than described in the above illustration, the essential procedure and the results obtained will be the same. The important features of properly connecting the system are to have the two yellow wires connected to the stator terminals of the antenna and oscillator sections of the tuning condenser (other connections to such terminals having been removed) and to have the corresponding brown wires each connected to the tube-and-coil grid-connection which was removed from the corresponding terminal of the condenser.

In receivers having a three-gang tuning condenser, the connections on one section of the condenser should not be disturbed. The oscillator section must be identified (usually has no top-grid connection) and one pair of wires from the push-button switch connected to it in the manner described. The other side of the switch will then be connected to either of the remaining condenser sections and the black wire is to be soldered to the frame of the tuning condenser.

It should be noted that the efficiency of the receiver will be somewhat reduced when this tuner is used on a three-gang condenser. Good results will be obtained, however, if the stations selected for push-button tuning are reasonably powerful and generally well-received in your locality. The receiver will not be affected when "Dial Tuning" is used. No loss in reception efficiency occurs in a receiver with a two-gang condenser.

For "semi-automatic" operation the connections are somewhat simpler as the yellow wires are to be removed from the switch entirely and are not used. No changes are to be made in the existing connections to the tuning condenser on the receiver. It is only necessary to connect the brown wires from the tuner to the stator ter-

minals of the condenser (one on each section) making sure that one of these connections is on the oscillator section if it is a three-gang condenser. The statements regarding operation with a three-gang tuning condenser which were made above for "full-automatic" operation will apply equally well for "semi-automatic" operation.

In either type of connection it should be kept in mind that the connecting wires should be as short and direct as possible, at the same time keeping them clear of any mechanically operating parts such as the dial mechanism or tuning condenser plates. All connections should be well soldered (use rosin-core solder) to make a good electrical connection.

ADJUSTMENT

The Meissner Automatic Push-Button Tuner provides for selection of any of seven pre-determined broadcasting stations when properly adjusted. These stations must be decided upon before adjustment of the tuner but may be changed at any time by re-adjustment as described below. An eighth push-button is used to return the receiver to normal tuning condition when desired. This release button will be marked "Dial Tuning" and is located at the end of the switch from which the connecting wires extend.

After all connections have been made, the "Dial Tuning" button should be pushed in and the receiver turned on for reception of broadcast stations. Tune in several stations in order to get the set working properly at moderate volume level. Adjustment of the trimmer condensers at the back of the Automatic Tuner may then be made for "full-automatic" operation without regard to the position of the tuning dial. For "semi-automatic" operation, the tuning dial must be turned as far as it will go toward the higher frequency readings (highest kilocycles or lowest meters). In this position the rotor plates of the tuning condenser will be completely out of mesh with the stator plates, or in "minimum-capacity" position.

Favorite stations are to be decided upon and the corresponding call-letter strips removed from the sheets supplied. These strips are then pressed into the rectangular openings in the escutcheon plate in regular order of station frequency, placing the highest-frequency station next to the "Dial Tuning" button and the lowest at the opposite end. The strip marked "Dial Tuning" or "Release" should be used for the release button. They will not require any adhesive and may be readily removed with a pin if necessary.

Horizontal call-letter strips are supplied with the tuner but if it is desired to mount the escutcheon in a vertical position, vertical-reading call-letter strips may be obtained. It is only necessary to return the present set of sheets with 10c in coin or stamps and the vertical-reading sheets will be mailed to you at once.

Press button 1 as far as it will go until it stays in. Then adjust trimmer 1A (see figure) until station indicated on button is heard as well as possible. Note: This trimmer must be the one on side of switch connected to the "oscillator" section of tuning condenser as

shown. Then adjust trimmer 1B until the station comes in with maximum volume. A careful re-adjustment of 1A and 1B will result in the station being perfectly tuned in when button 1 is depressed.

Do not use force in adjusting trimmers. Make sure the station frequency is in the proper range for the button you are using. Threads may be stripped and the unit permanently damaged if this precaution is not observed.

Adjustment of button 2 should then be made, making sure that this button is depressed and the first one released. Adjust trimmers 2A and 2B to bring in the station for button 2 as described above. Repeat this process for the remaining positions until all the trimmers have been adjusted and each station shown on the escutcheon is available by pressing the corresponding button. Remember that the main tuning control should not be disturbed during this procedure if semi-automatic operation is being used.

It is very important that adjustments described above be made as carefully as possible. Check the adjustments of each trimmer for possible improvement after the initial setting. For best results it will be advisable to re-adjust all trimmers a few days after the initial adjustment in order to compensate for any changes due to room-temperature, humidity, etc. If these precautions are not observed the receiver will not be perfectly tuned to the stations indicated and may be troubled with distortion and lack of volume.

OPERATION

Operation of the Meissner Automatic Push-Button Tuner is very simple and self-evident. With the "full-automatic" connections as described above, the receiver being in operation on the regular broadcast band, it is only necessary to press the button bearing the call-letters of the desired station and that station will be automatically tuned in. No attention need be given to the position of the receiver tuning dial. With the "semi-automatic" connections, it is necessary to make sure that the receiver dial is turned as far as it will go toward the high-frequency end of the scale before using the push-button tuner. Selection of stations is then made in the same manner by pressing the proper station button. In either case, the receiver is returned instantly to regular tuning condition by pressing the "dial tuning" button.

On a receiver with short-wave bands (using "semi-automatic" connections) the tuning dial must not be disturbed while using the automatic tuner as this will temporarily destroy the adjustment of the tuner until the dial is returned to its highest-frequency setting.

NOTE: When the automatic tuner is not in use and "Dial Tuning" button is depressed there may be a slight shift in calibration (on tuning dial) of the higher-frequency broadcast stations unless the receiver is re-trimmed on the broadcast band to compensate for the added capacity of connecting wires and automatic tuner switch. This may be done very easily by any experienced serviceman.

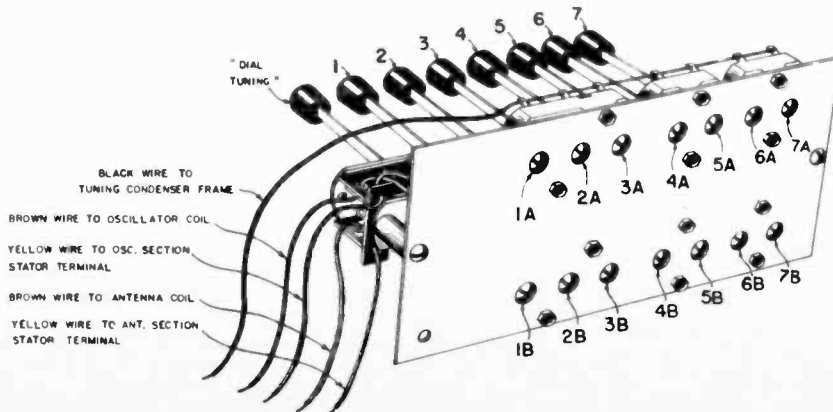
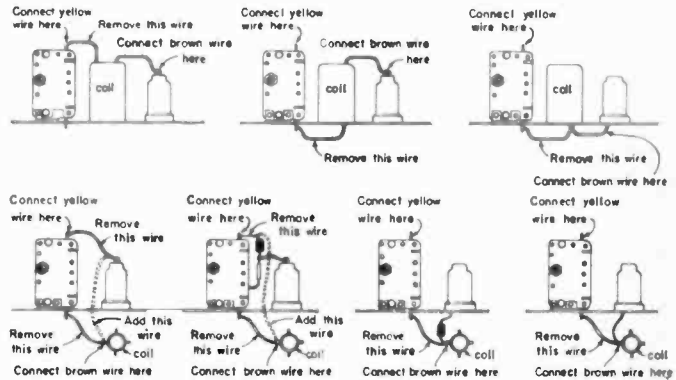
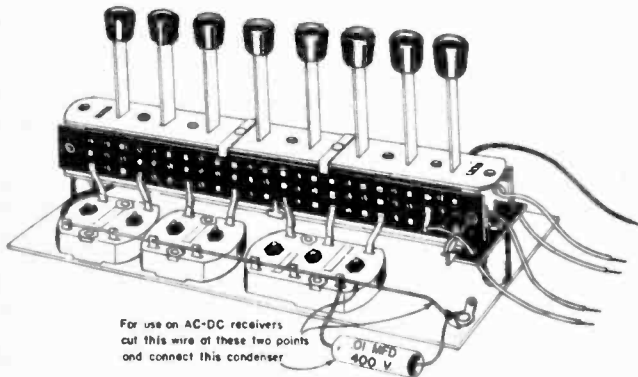

Push-Button Remote Control

Models 9-1000 & 9-1003

The Meissner No. 9-1000 Remote Control is a broadcast converter similar to the short-wave converters that preceded all-wave receivers, but operates entirely in the broadcast band.

It provides arm-chair control of a radio receiver located at some distance from the listener by changing the frequency of all received signals to a fixed frequency in the broadcast band to which the normal broadcast receiver remains constantly tuned. A volume control is provided on the Remote Control so that it is not necessary for the listener to leave his chair to adjust volume.

This device is essentially a local-station tuning device and is not recommended for the reception of weak distant stations. If certain out-of-town stations supply consistently strong signals, satisfactory operation on such signals may be obtained.

ATTACHMENT CORDS

The Remote Control is provided with two cables; one is the power supply cord, and the other is the connection to the antenna and to the radio receiver. The power cord contains the necessary resistor for AC-DC operation and becomes rather warm to the touch when operating, which is normal for this type of equipment. This cord should not be bunched, but should be allowed to spread out naturally in order to give the best dissipation of the heat developed. Because of the special design of this cord it should never be cut. To shorten the cord or replace it with a standard attachment cord would seriously damage the entire Remote Control unit.

A three-conductor cable of special construction connects the Remote Control to the radio receiver. This cord consists of one shielded wire and one unshielded wire both enclosed in one woven covering. The shield serves the dual purpose of shielding one of the wires and of acting as one of the conductors in the cable.

The standard cable furnished with each Remote Control is fifteen feet long. Additional fifteen-foot lengths of this special cord are available if the cable supplied is not long enough.

CONNECTIONS

The Remote Control hooks up to the radio set without changing the receiver in any manner. No particular skill or technical knowledge is required.

The cable connecting the Remote Control to the radio receiver is color coded, each conductor being a different color. The connections are clearly shown in the connection diagram on bottom of unit.

It is strongly recommended that care be exercised in attaching the wires to their respective terminals so that there is no chance for the wires to accidentally touch either the chassis or each other or to come loose. If the former happens, the unit will not operate as long as the short circuit exists, and if the latter happens, the radio program will be interrupted by noise at every movement of the cable. A clamp is provided for fastening the cable firmly to the Remote Control so that movement of the cable cannot occur near the terminals to cause a short circuit. It is important to see that this clamp is firmly fastened.

SPECIAL PRECAUTIONS FOR AC-DC RECEIVERS

Most AC-DC receivers do not have a ground connection. If the Remote Control is to be used with such a receiver, satisfactory operation may be obtained if the shield lead, silver colored, is covered with tape so that no part of the braided connection is allowed to come in contact with any object, especially not the chassis, or any part of the receiver.

In some cases, particularly where stations are weak, some reduction in background noise may be obtained if the braided connection is fastened to one terminal of a .25-mfd., 400-volt condenser and the other terminal of the condenser attached to the radio chassis.

When the Remote Control is connected to the Radio Receiver in accordance with the directions given above, plug the power cord into a receptacle supplying 110 to 120 volts AC or DC. If the electric supply furnishes direct current, it may be necessary to reverse the line plug before satisfactory operation is obtained.

220-VOLT MODEL NO. 9-1003

For 220-volt operation, Model No. 9-1003 is supplied, which is a standard 110-volt unit plus an additional resistance cord to permit operation on 220-volt lines.

The special cord is plugged into the power receptacle and the Remote Control cord plugged into the socket on the end of the special cord.

NOTE: The cord supplied for 220-volt operation is designed especially for use with the Remote Control. It will not permit satisfactory 110-volt operation of any other device from a 220-volt source. Unlike a step down transformer which furnishes nearly constant voltage irrespective of any load within its rating, the voltage furnished by the voltage reducing cord is directly related to the load connected and will furnish the required 110 volts only to the load for which it was designed.

If additional load is attached to the output of the voltage-reducing cord by means of a multiple plug, satisfactory operation of the Remote Control will be prevented, and the additional equipment attached may be damaged when the Remote Control is turned off.

ADJUSTMENT

In the general description of the Remote Control it was mentioned that the function of the Remote Control is to convert all received signals to one frequency in the broadcast band. For best operation, this frequency has been chosen at 530 to 560 KC.

In order for the station adjustments to remain fixed, it is necessary for the receiver to be set at the same dial marking every time that the Remote Control is used.

In order to make this setting practically automatic, it is suggested that the dial be set as far as it will travel below 550 KC on the Broadcast range of the receiver. Thus, if the dial is set against the stop, it will automatically be set at the same frequency each time the receiver is set for remote control operation.

If the receiver tunes in some strong local station when the dial is set against the stop at the low end of the dial, it will be necessary to select some other point on the dial relatively free from interference. Such spot should preferably be one where the dial pointer is set accurately on one of the lines on the dial scale so that the receiver may be accurately retuned to the same setting each time that remote control operation is desired.

Having selected the proper operating point for the receiver as described above, the Remote Control should be placed in operation by pressing any one of the "Station Selector" buttons, and should be allowed a few moments for the tubes to warm up to proper operating temperature. The volume control of the receiver should be set as for normal local-station reception. The volume control of the Remote Control unit should be set at maximum (clockwise) and a local station tuned in by rotating the "adjustor" button directly above the "station selector" button. With a screw driver, through a hole in the bottom of the Remote Control located near the cable clamp, adjust the trimmer screw for maximum sound output from the receiver. This adjustment probably will not be very critical and need not be repeated until a new operating frequency for the receiver is chosen. The Remote Control is now ready to be adjusted for the stations desired.

The frequency range covered by each button has been shown in the diagram attached to the bottom of the Remote Control. For each button, a strong station should be selected, the "station selector" button pressed down, and the "adjustor" knob rotated until the station is tuned in. The adjusting knobs rotate approximately 16 turns from one end of their tuning range to the other. The lowest frequency is obtained at the counterclockwise extreme of

rotation and the highest frequency at the clockwise extreme of rotation. Having found the position of one station the remainder should be relatively easy to locate.

Due to production variations, it may sometimes be found that a station whose operating frequency coincides with the specified limit of frequency for a given group of buttons, may be receivable on one button in the group and not on another, and for the same reason some stations just outside of the specified range may be receivable.

VOLUME CONTROL ACTION

All modern superheterodyne radio receivers are provided with automatic volume control, the function of which is to maintain nearly constant output regardless of input signal strength.

When such receivers are used in combination with the Remote Control, the automatic volume control in the receiver is working against the volume control in the Remote Control. Actually, the Remote volume control is effective only by virtue of the deficiencies of the automatic volume control action in the radio set. Receivers having Amplified A. V. C. will not work well with the Remote Control because their automatic control of volume is too near perfect, offsetting every change made by the Remote volume control.

What actually happens when a signal passes through the Remote Control is that its frequency is changed to that frequency to which the radio receiver is tuned (530 to 560 KC) and whose strength depends upon the Remote volume control setting. Because of the opposing action of the Remote volume control and the automatic volume control in the receiver, volume control from the Remote unit is a compromise that may not give results as good as the normal audio volume control in the receiver but this is the only method of obtaining remote volume control without extensive alterations in the receiver which might not be satisfactory. The method for obtaining best operation of the Remote volume control is described below.

ADJUSTING VOLUME CONTROL

With the Remote Control operating but with its volume control set to zero (counterclockwise), adjust the volume control on the radio receiver until a hiss is just barely perceptible. This is now the maximum sound that the receiver will make when the remote volume control is turned down. If the receiver has an adjustable sensitivity control it is desirable to turn the audio volume control well up and to limit the hiss or noise by adjusting the sensitivity control.

Having made the above adjustments, the remote volume control is now used for all further control of volume.

Experiment with the volume control setting will soon show the best combination of adjustments for a given receiver in a given location.

DRIFT

Practically all radio receivers exhibit some drift in calibration with severe changes in temperature or humidity. It may be necessary to adjust either your receiver dial or the station selector knobs very slightly on occasions, to compensate for this usually unnoticed drift.

DIAL TUNING

When the Remote Control is made inactive by pressing the red button, the antenna is automatically switched from the input of the Remote Control back to the normal antenna connection on the receiver. The capacity of the cable remains across the input of the receiver, reducing its sensitivity somewhat. If the receiver is to be frequently used for long distance reception, a double-pole double-throw switch is recommended to completely cut out the capacity of the remote control cable, when tuning for such stations. Connections should be made in accordance with Figure 2.

SHORT WAVE RECEPTION

If good short-wave reception is desired, it is recommended that the switch described above be provided, or that the remote control cable be disconnected at the receiver and the antenna connected in the normal manner.

Receivers having doublet connections should be treated in a similar fashion, leaving one side connected to the doublet post of the receiver and the antenna post treated as if the doublet did not exist as long as Remote Control operation is desired.

TRACKING

For the greatest convenience to the user, the antenna and oscillator coils in this unit have been so designed and constructed that a single adjustment tunes both adjustable coils simultaneously, maintaining proper tracking conditions, in a manner analogous to the gang condenser that has oscillator-section plates shaped differently than the antenna-section plates for purposes of tracking.

No attempt should ever be made to alter the cores or coils. The adjustment of these parts can be made only by skilled operators using factory equipment.

The capacities used to tune the antenna and oscillator to the proper frequencies are held to close tolerance and are made in the most modern method to prevent drifting. No adjustment need be made on these values.

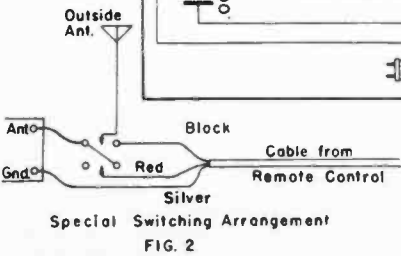
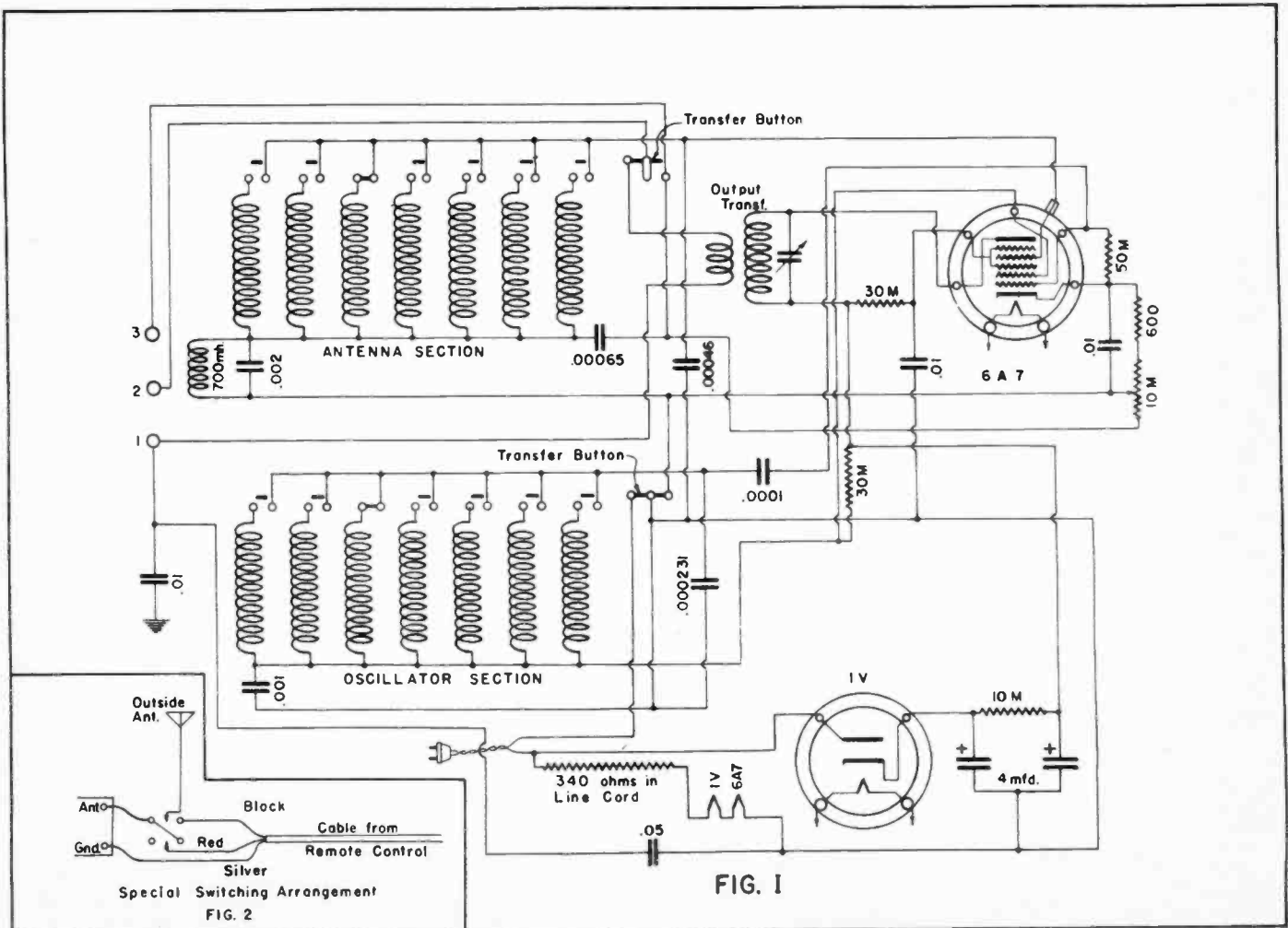

FIG. I

FIG. 2

10-1120

PICTORIAL
WIRING DIAGRAM

6-V. VIBRATOR POWER SUPPLY

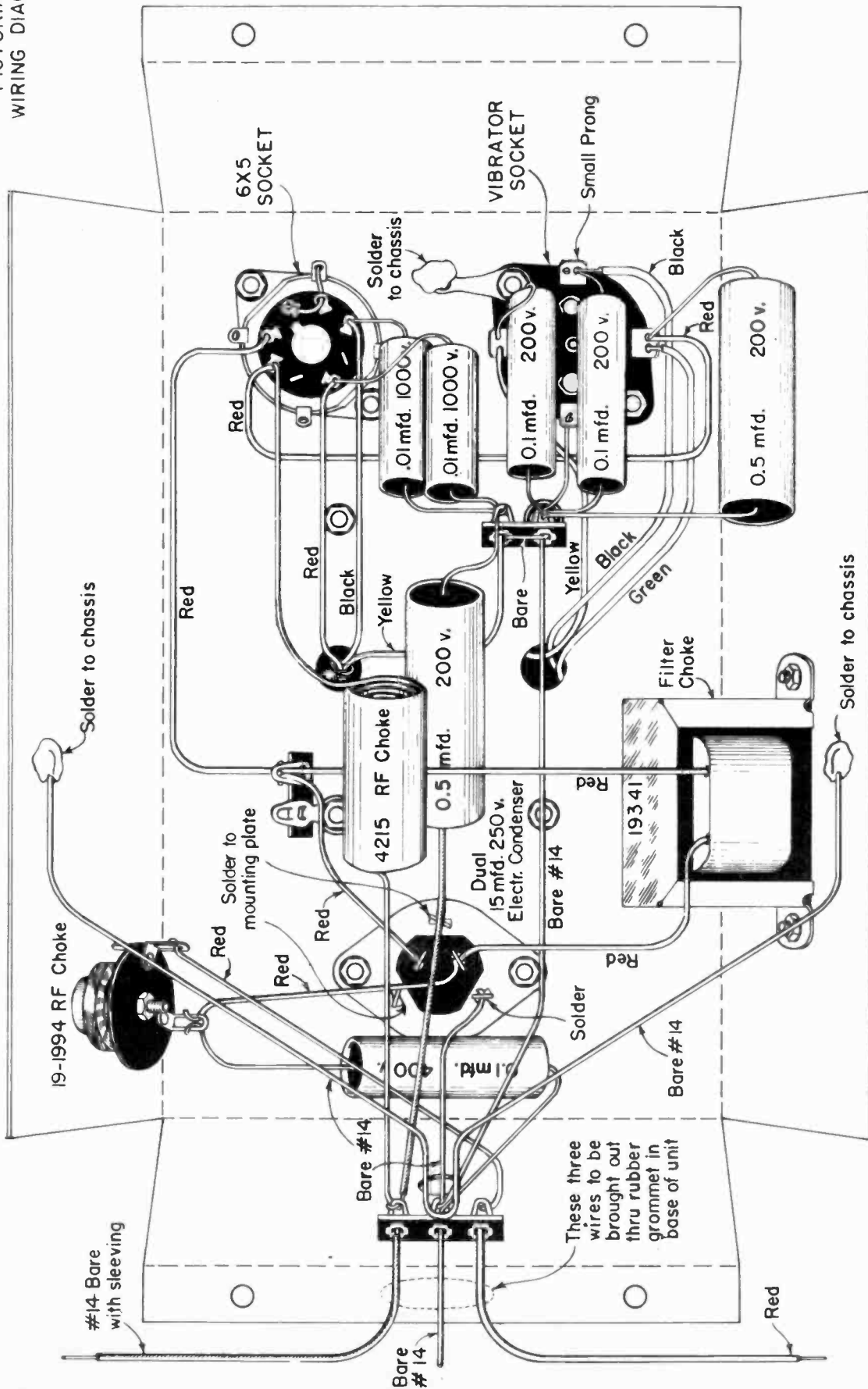

MEISSNER MFG. CO.
MT. CARMEL, ILLINOIS

COMPLETE INSTRUCTIONS
FOR ASSEMBLY, WIRING AND ADJUSTMENT OF THE

MEISSNER ANALYST

MODEL 10-1154

The Meissner ANALYST is a test instrument designed to permit rapid location of faults in defective radio receivers or sound equipment without recourse to circuit diagrams, elaborate point-to-point resistance measurements, complete voltage measurements on all tube elements, or tedious tracing of circuit wiring. The basic principle of the ANALYST lies in the fact that it checks the one thing that is common to all receivers, regardless of type . . . the signal. This instrument enables the serviceman to listen to the quality and to measure the amount of the signal at any point in the receiver. It permits the serviceman to detect troubles where they occur rather than several stages later. The localization of trouble eliminates much of the time formerly spent searching for defects.

Convenient test prods of special design on the ends of shielded cables permit connecting the ANALYST to any point in a receiver, where it is desired to check the quality or strength of the signal, without disturbing the signal, the circuit, or the circuit performance.

The panel arrangement of the ANALYST is patterned after the familiar "Rock-and-Panel" construction of high-grade communication equipment. The titles of the individual panels and a brief description of their use is given here below:

AUDIO

For tests on any part of the receiver in which voltages or currents (of audio frequency) exist, such as the detector, the audio amplifier, the output transformer or voice coil and the power-supply.

DC VOLTS

For measuring any D. C. voltage such as power-supply, plate, screen, cathode, A. F. C., A. V. C. or grid.

OSCILLATOR

For tests of oscillator frequency or output voltage and high-level R. F. signals falling within the frequency range of this section.

R. F.—I. F.

For checking those portions of the receiver operating in the Broadcast or intermediate frequency range.

LINE CURRENT

For measurement of line current consumption of any 110-volt, 50-60 cycle receiver.

All controls, the input and output jacks, and the indicator tube associated with a given function of the ANALYST, are grouped on one panel section to facilitate the use of the instrument.

The few hours spent in the assembly and wiring of this instrument will give a better understanding of the individual channels that make up the ANALYST, and will consequently make the owner more proficient in the operation of the instrument.

As the ANALYST kit is unpacked all parts should be carefully checked against the parts list contained in this instruction sheet. Any discrepancies should be reported immediately to the supplier from whom the kit was purchased.

The tubes required for operation are 5 6E5, 3 6SK7, 1 1852, 1 6F5G, 1 6SQ7, 1 6H6 and 1 6X5G.

ASSEMBLY

For ease in operation and to permit mounting on a test rack, all terminals, controls and indicators which require connections, manipulation or observation when the ANALYST is in use, have been placed on the front panel in a logical arrangement, based on the function of each part. Because of this panel layout, the wiring and placement of components behind the panel is somewhat unconventional and the parts must be assembled and wired in a definite order if "back-tracking" is to be avoided.

While assembling and wiring, observe the suggestions given in the "General Construction Hints" packed with each kit. The wiring procedure will be simplified if each wire in the Pictorial Wiring Diagram is marked over with a colored pencil as the corresponding wire is installed in the proper place.

In constructing the ANALYST, it will be found convenient to carry the mounting of parts and the wiring along together. The bottom view of the chassis, the top-rear view of the panel and chassis, and the circuit diagram should be continually referred to, as the placement of leads and components has been carefully studied for greatest ease of wiring and assembly, as well as for the best performance of the instrument. While it is not essential to follow the order of operations outlined, experience has shown that time can be saved by assembling and wiring in the order given.

1. Bolt the sockets to the chassis. *Be sure that the key-ways in the octal sockets are pointed in the same direction as shown in the drawing, and that the stampings on the sockets will correctly indicate the type of tube for each location.* The tie-lugs shown mounted on the 1852, 6F5G and 6SQ7 sockets should be bolted in place when the sockets are mounted.

2. Attach the six-prong wafer-type sockets to the channel-shaped indicator tube socket mounting strip. The sockets fit on the outside of the U-shaped section. The sockets are so placed that the large filament holes are upward. This will insure the shadow of the indicator tube pointing downward when the instrument is completed.

3. Attach the four brackets to the socket-mounting strip.

4. Mount both transformers, the filter choke, electrolytic condenser, the shielded oscillator coil and the variable condensers in the order named. The tie lugs shown in the bottom view should also be placed at this time.

5. Slip the coil assembly temporarily into place, and mark with a soft pencil where the shields fit against the chassis. Then slip the shield cover over the coil assembly and mark where it fits against the chassis. These areas should be cleaned with sandpaper to permit good contact with the shields and must be kept clear of wires or other parts when wiring. Then remove the shield and coil assembly.

6. Wire all heater connections of the octal sockets. Solder all socket saddles securely to the chassis at some point near a mounting screw. This is done to insure permanently good contact to ground. It will now be convenient to make and solder all connections to any grounded pins on the socket saddle.

7. Wire the power supply.

8. Assemble the volume controls, switches and jacks *on that part of the panel which does not fit against the chassis.* Flat nickel-plated washers are provided for the outside of the panel on volume controls, switches and phone jacks. Lockwashers are provided for use behind the panel on phonejacks, but are not required for the switches and controls, which have locating keys. The nickel-plated washers which fit under the nuts are packed separately from the controls and switches.

9. Solder the voltage multiplier resistors to the multiplier switch of the DC Voltmeter section. The *green* lead from the multiplier to the 6F5G top grid should be $6\frac{1}{2}$ " long, and should have the grid clip soldered to the free end.

10. Insert the 6E5 tubes in their sockets, and assemble the indicator tube mounting strip to the panel.

11. Wire the sockets of the 6E5 tubes except the leads contained in the cables which will be connected later. Wire all connections between controls and jacks, and between jacks and indicator tubes.

12. Assemble the panel to the chassis by means of the controls, jacks and switches which appear on that part of the panel which touches the chassis. The AC receptacle, however, is assembled later.

13. Mount the two calibrating controls on the rear of the chassis.

14. Solder all resistors and by-pass condensers in place and wire all control terminals which are not connected to cables.

15. Pull the cables through the holes in the chassis as shown on the Pictorial Diagrams, and solder the ends of the wires to the points shown. Observe the color-coding carefully.

16. Wire all 110-volt connections, including the current transformer and line-current receptacle. One end of the primary (a black lead) of the current transformer must be attached to the side of the receptacle next to the end of the chassis, before the receptacle is fastened in place.

17. Solder the free end of the rubber-covered ground lead to the ground terminal of the R. F. jack as shown.

18. Wire all controls, condensers, resistors, switches and tube sockets not previously wired. Placement of components around the 6SK7 sockets must be carefully made, so that the coil assembly can later be slipped into place. If the coil assembly is placed in the ANALYST chassis occasionally as these parts are installed, proper clearance can easily be allowed.

19. Fasten the coil assembly in place and solder the connections to the plates, grids, B-plus and tuning condenser. Assemble the shield cover to the coil assembly and chassis. Be sure that all self-tapping screws are drawn down tight. Note: The self-tapping screws are black, have a shallow hexagonal head and a tapered point. Considerable pressure must be exerted to start these screws in the untapped holes but once started they drive like ordinary screws.

20. Note that a 90,000 ohm resistor on a tie-lug is mounted on top of the chassis. Install and connect this.

21. Connect all jacks on the panel. Be sure that an inch or two of slack is left in all leads from the indicator-tube mounting strip to the panel to permit moving the mounting strip far enough to insert and remove tubes.

22. Assemble the knobs on the control shafts, observing the following precaution: All knobs, except the line current knobs, should be fastened on their respective shafts so that any difference in the angle of rotation of the control and the calibration on the panel will be split evenly at both ends. In the case of the line current knob, the pointer should be lined up at the three-ampere mark at maximum rotation of the shaft.

23. The tuning condenser knobs should be set so that the pointer lines up with the horizontal marker extending to the left, when the condenser is at maximum capacity, (plates fully meshed). The knobs must not be aligned on the condenser shaft in the minimum capacity (clockwise) position.

24. Check all wiring, proper placement and values of components.

VOLTAGE TEST

Insert the remainder of the tubes in their respective sockets. Be sure to put the tube shield and grid clip on the 6F5G tube.

Plug the ANALYST power cord into a 110-volt, 50 to 60-cycle outlet, and check voltages against those shown on the circuit diagram. Voltages shown are measured from the points indicated to the chassis and are *positive* unless marked negative. If the values measured are materially different than those shown on the diagram, a thorough recheck of the circuit should be made. Be sure the ANALYST is turned off and the line cord disconnected from the power receptacle while the wiring is being checked.

A complete voltage table has been provided showing the DC voltage on every terminal of every socket in the ANALYST, but these voltages are best measured after the Electronic D. C. Voltmeter has been calibrated, in which case the electronic D. C. Voltmeter can be used to check practically all of the voltages in the table, giving the constructor practice in the use of the instrument. Another reason for postponing voltage measurements until after the electronic D. C. Voltmeter has been calibrated is that the calibrating resistor has an influence on some of the voltages shown in the table.

ADJUSTMENT & CALIBRATION

The electronic D. C. Voltmeter has two adjustments, the "zero set" on the front panel, and the voltmeter calibrating resistor at the rear of the chassis.

The simplest method of calibrating the electronic D. C. Voltmeter requires a conventional high-resistance voltmeter (1000 or more ohms-per-volt) capable of being read accurately in the vicinity of 10 volts. Set the voltage scale pointer at zero volts, and adjust the "zero set" control near to the middle of its range. Connect one terminal of the high-resistance voltmeter to each end of the *Volts Scale Potentiometer*. Set the RF-IF attenuator at the 1, and the Oscillator at 4, then adjust the voltmeter calibrating resistor with a screw driver until the conventional voltmeter reads 9.7 volts across the Volts Scale Potentiometer. This adjustment should be made, if possible, at nearly average line voltage, which is usually 117 volts. The final step in this calibration is to adjust the "zero set" control until the indicator tube shadow just closes.

Correctness of connections to the voltmeter multiplier switch can be checked by plugging the electronic D. C. voltmeter cable (blue tracer) into the jack at the left of the panel, and using it and the ground clip, measuring the voltage of batteries or known receiver voltages. The accuracy of the electronic DC Voltmeter is not as great as a good conventional type DC meter, but measurements with it on high-resistance circuits are generally much more accurate because it disturbs the circuit less than the conventional voltmeter with a resistance of 1000 ohms per volt.

Variations in line voltage have about the same effect on the electronic DC Voltmeter as on receivers which are plugged into the same line, so the effect of line voltage variation is largely compensated, and voltages shown in circuit diagrams need not be corrected for line voltage variation.

The Oscillator section is operative without adjustment but has trimmer condensers so that each range may be made to indicate the frequency to which the oscillator section is tuned. Since the frequency of a signal is sometimes the only evidence of trouble in a receiver, it is wise to adjust calibration as accurately as possible. Signal generators that have been in use for some time should not be relied upon to be correct in frequency, but should be checked for accuracy before being used as frequency standards for adjusting the calibration of the ANALYST.

The range switch should next be set to the proper band, the *black* test cable should be plugged into the Oscillator input jack, the prod connected to the output terminal of the signal generator and the ground lead from the ANALYST connected to the ground post of the signal generator. The attenuator should be turned counterclockwise, the dial and the signal generator should be set to the proper calibrating frequency and the corresponding trimmer on the small coil adjusted for minimum shadow angle. If the generator output is more than enough to close the shadow, the attenuator should be adjusted so that the eye nearly closes, since a narrow shadow angle promotes accuracy of adjustment. The aligning frequencies and trimmer positions are given below:

BAND	CALIBRATING FREQUENCY	TRIMMER POSITION
1	12.0 MC	Bottom
2	4.0 MC	Middle
3	1.4 MC	Top

The *black* test lead is used in the operation above to get enough sensitivity to operate from the signal generator. Ordinarily when checking the voltage from an oscillator tube, the *brown* test lead should be used.

The RF-IF channel requires practically the same accuracy in frequency calibration as the Oscillator section. Accordingly, a signal generator should be used in adjusting the RF-IF channel so that it has an accurate frequency calibration.

The connections from the signal generator to the ANALYST are the same as for the Oscillator adjustment except that the cable with the *red* tracer is used and is plugged into the input jack of the RF-IF test panel.

The RF-IF tuning assembly consists of a three stage TRF amplifier without an antenna coil and is aligned in exactly the same manner as a TRF receiver.

The range switch should be set to the desired range, the RF-IF tuning knob and the signal generator set to the proper aligning frequency and the trimmers adjusted for minimum shadow angle on the RF-IF tuning indicator. This alignment is recommended even though the coil assembly has been realigned and tested, because greater sensitivity and greater accuracy of calibration is obtained thereby. The trimmers are reached through holes in the coil shield. The isolated holes at one edge of the unit are for band 1 trimmers, the center holes for band 2 and the remaining holes are for band 3. The aligning frequencies are listed below:

BAND	ALIGN AT
1	200 KC
2	530 KC
3	1400 KC

As the aligning progresses and sensitivity improves, the attenuator and multiplier should be adjusted to keep the indicator shadow angle very narrow, thereby obtaining greatest sensitivity of indication.

In order to calibrate the Line Current indicator with the greatest precision, an accurate AC ammeter is necessary, but since the normal power consumption of most receivers is not accurately known, the necessity for extreme accuracy is less urgent on this calibration than on some of the other calibrations. Therefore if an AC ammeter is not available, the calibration can be made with acceptable accuracy by setting the calibrating controls when a soldering iron of known power input or a lamp of known wattage is connected to the power socket in the ANALYST. The current drawn by any resistance load such as a lamp or soldering iron is quickly determined by dividing watts by line volts; for example, a 100 watt soldering iron at 115 volts draws 100 divided by 115 or .87 amp. approximately.

Check the arc of rotation of the line current pointer. It should stop exactly at the last line at the high-current end of the travel. If it does not do so, it should be so adjusted.

Set the pointer to indicate the current being drawn by the load, whether radio set, lamps, soldering iron, or what not. The value of current either being measured on an AC ammeter or calculated as described above.

Adjust the line current calibrating control at the bottom and rear of the chassis until the tuning indicator shadow just closes.

The audio channel requires no calibration or adjustment.

OPERATING INSTRUCTIONS

For the convenience of the users of the ANALYST the Operating Instructions and hints for the easy solution of service problems have been fully covered in a separate instruction book packed with the instrument.

MEISSNER ANALYST

13-TUBE SIGNAL-TRACING TEST INSTRUMENT

10-1154 SCHEMATIC CIRCUIT DIAGRAM

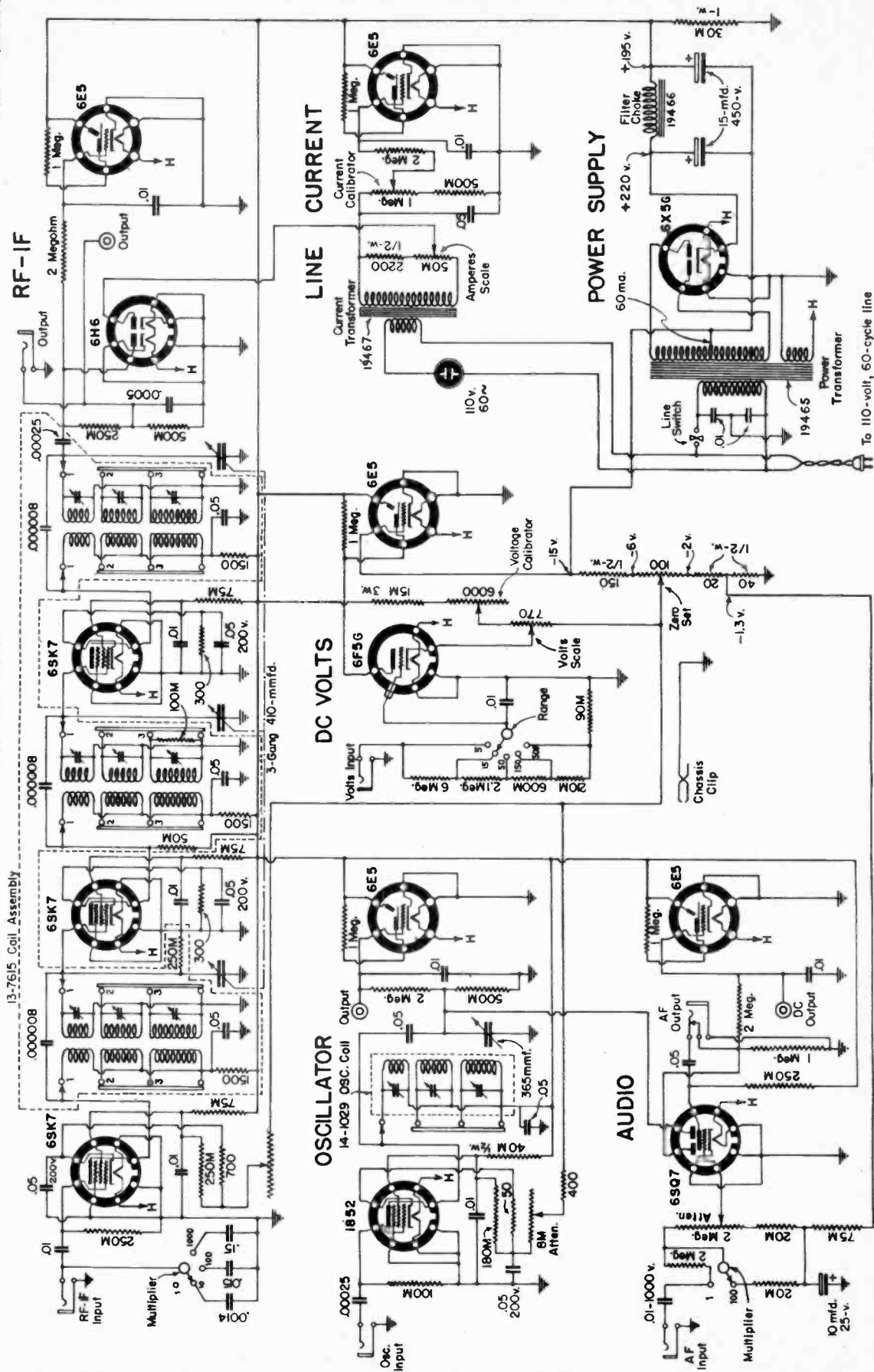

⚡ Indicates connection to chassis
 Resistor values shown in ohms
 M=1000 as 30M means 30,000
 All resistors are 1/4-watt unless specified
 Condenser values shown in microfarads
 All condensers are 400-volt unless specified

MEISSNER ANALYST

Back of Panel and Top of Chassis
PICTORIAL WIRING DIAGRAM

10-1154

REAR VIEW
PICTORIAL

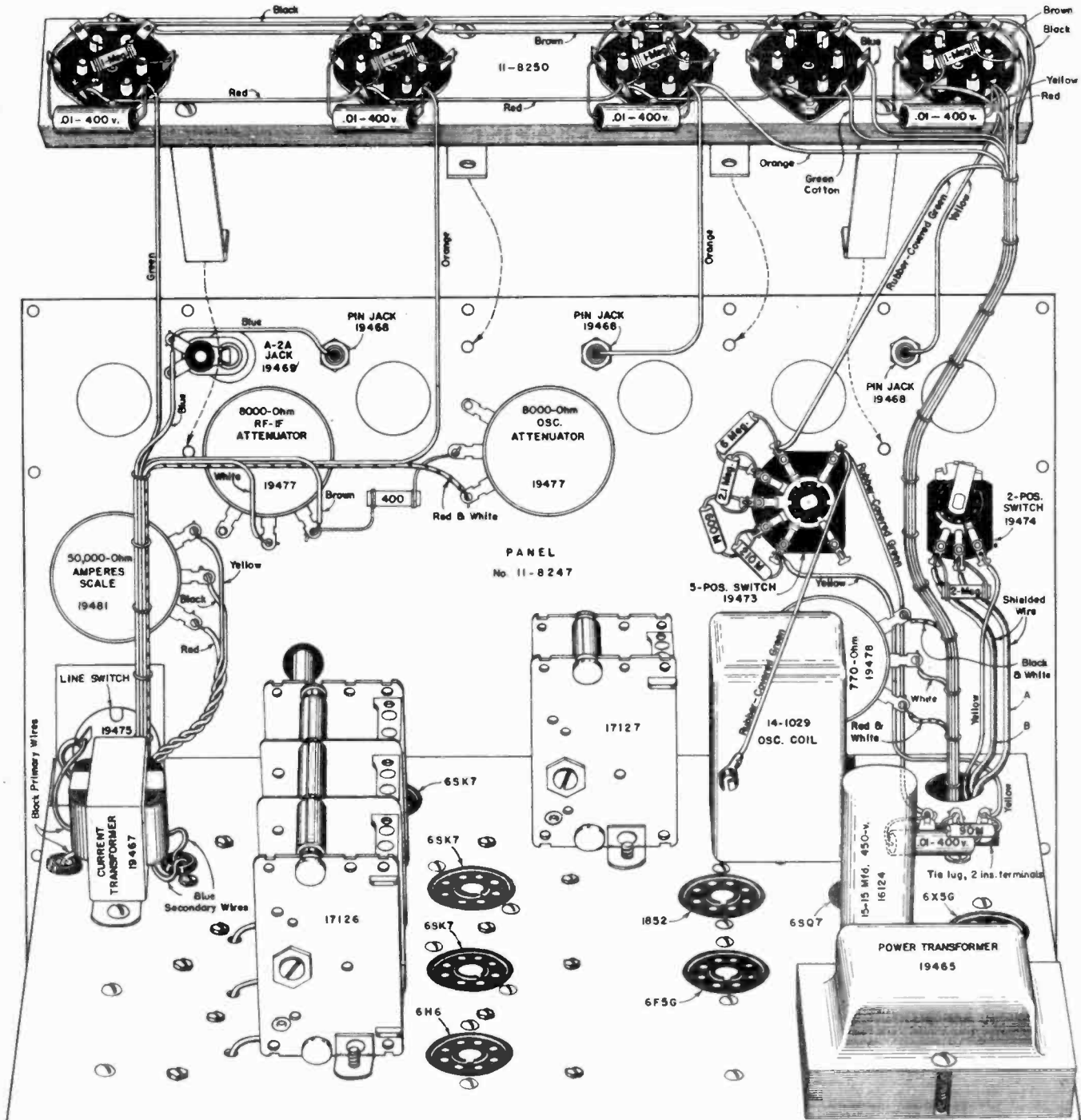

VOLTAGE CHART Line Volts 117, 50-60~v

PIN NO.	6SK7 1st RF	6SK7 2nd RF	6SK7 3rd RF	6H6 Det.	1852 Amp.	6F5G VM	6SQ7 Audio	6X5G Rect.	6ES5 Audio	6E5 VM	6ES6 Osc.	6E5 RF-#	6ES6 Current
1	0	0	0	0	0	0	0	0	AC	AC	AC	AC	AC
2	AC	AC	AC	0	0	-1.2	0	20P	115	20	20	20	20
3	0	0	0	0-1	0	0	0	AC	0-1	-15	0-1	0-1	0-1
4	0	0	0	0	0	115	0-1	—	195	195	195	195	195
5	2	3	3	0-1	1	—	0-1	AC	0	0	0	0	0
6	60	60	60	—	80	—	120	—	0	0	0	0	0
7	0	0	0	0	AC	AC	AC	AC	*	*	*	*	*
8	190	190	190	0	195	X	0	220					

* = Measure with electronic Voltmeter
X = Varies, depending on position of Voltage Scale knob.



MEISSNER ANALYST

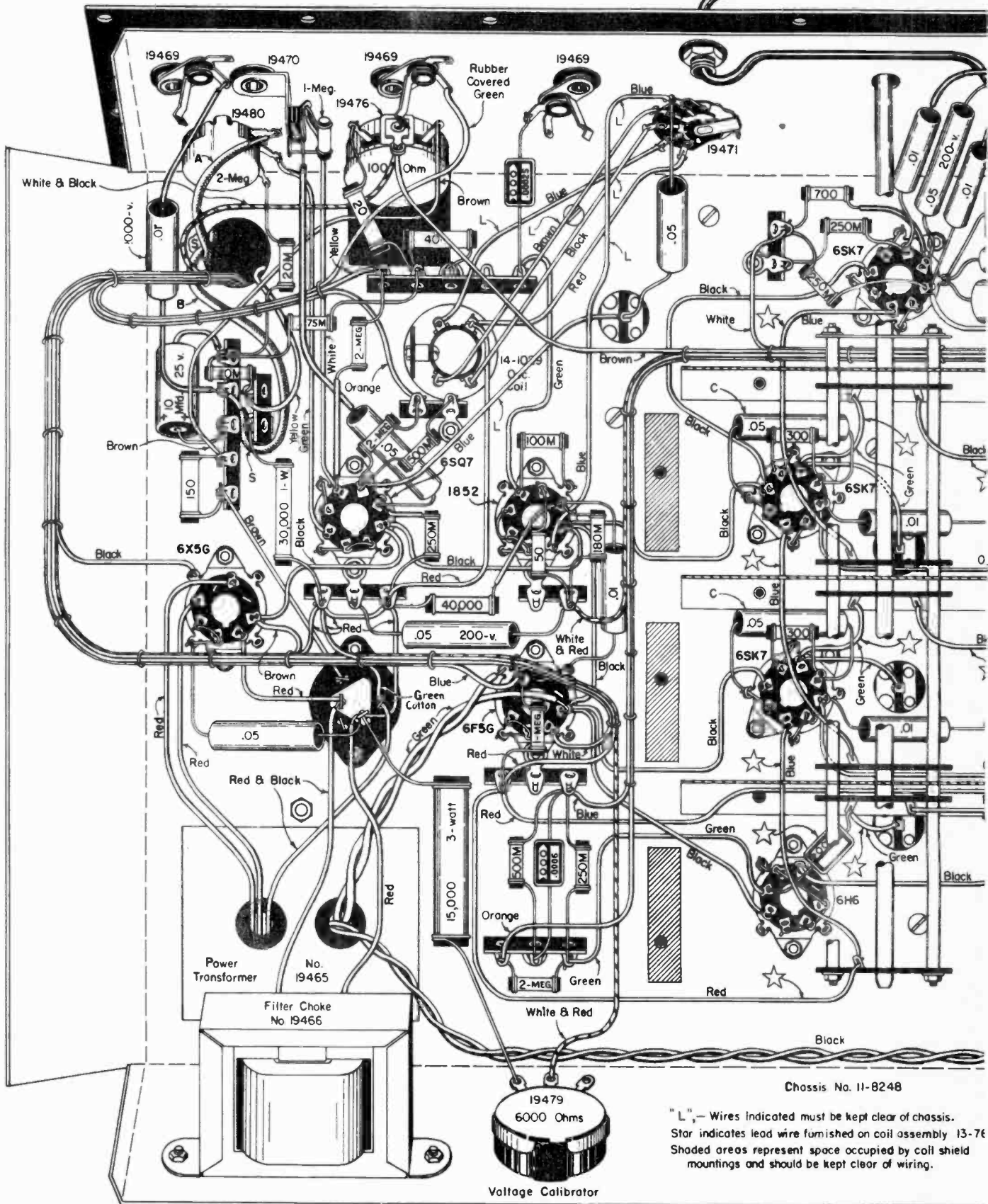

Chassis No. 11-8248

"L" - Wires Indicated must be kept clear of chassis.
 Star indicates lead wire furnished on coil assembly 13-76
 Shaded areas represent space occupied by coil shield
 mountings and should be kept clear of wiring.

"C" - Condensers indicated are to be mounted directly across tube socket.
 All condensers are 400-volt rating unless otherwise marked.
 Capacity values on condensers are shown in Micro-farads.

Resistance values are shown in
 M=1000 as: 25M means 25,
 S indicates solder to chassis

Parts Supplied With
MEISSNER ANALYST KIT

MODEL 10-1154

10-1154
UNDERCHASSIS
PICTORIAL

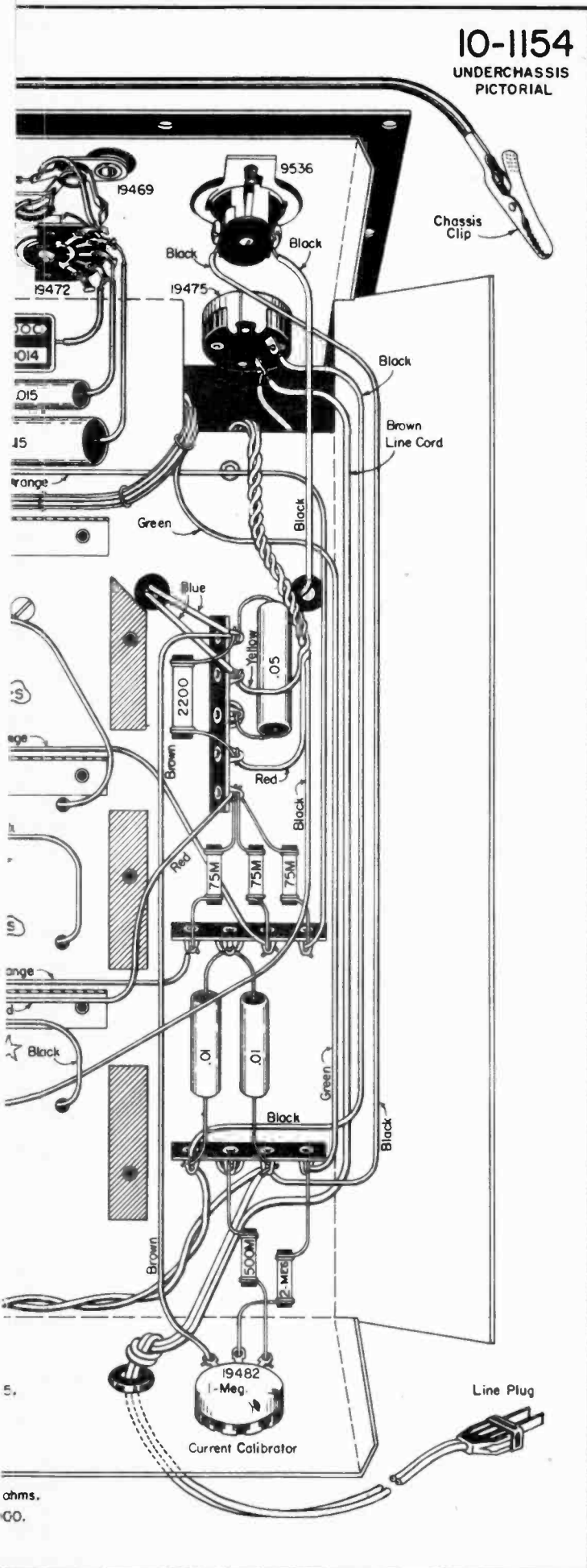

- 1 Engraved Front Panel, 11-8247
- 1 Steel chassis, punched, 11-8248
- 1 Steel cabinet, 11-8249
- 1 Steel socket mounting strip, 11-8250
- 4 Brackets for mounting strip, 9623
- 1 Power transformer, 19465
- 1 Filter choke, 10466
- 1 Current transformer, 19467
- 1 Line Current receptacle, 9536
- 2 Large indicator knobs, 9631
- 1 Small indicator knob, 9633
- 11 1/4" Bakelite pointer knobs, 19508
- 3 Pin jacks with insulating washers, 19468
- 5 Single-circuit phone jacks, 19469
- 1 Closed-contact phone jack, 19470
- 1 3-gang, 410-mmfd. condenser, 17126
- 1 Single, 365-mmfd. condenser, 17127
- 1 Three-band Oscillator Coil, 14-1029
- 1 Three-band, three-stage Coil and Switch Assembly, 13-7615
- 1 Dual 15-mfd., 450-volt condenser, 16124
- 1 Bakelite mounting plate for above, 19450
- 1 10-mfd., 25-volt Electrolytic Cond. 15192
- 1 Line Cord and plug, 12434
- 5 6-prong Wafer sockets, 19236
- 8 Molded Octal sockets, 6 tube types
- 1 Single-pole, three-position switch, 19471
- 1 Single-pole, four-position switch, 19472
- 1 Single-pole, five-position switch, 19473
- 1 Single-pole, two-position switch, 19474
- 1 Rotary type Line switch, 19475
- 2 8000-ohm wire-wound Attenuators, 19477
- 1 100-ohm Zero Set control, 19476
- 1 770-ohm Voltage Scale Control, 19478
- 1 6000-ohm Voltage Calibrator, 19479
- 1 2-megohm Audio Attenuator, 19480
- 1 50,000-ohm Current Scale Control, 19481
- 1 1-megohm Current Calibrator, 19482
- 1 20-ohm, 1/2-watt fixed resistor, 17140
- 1 40-ohm, 1/2-watt fixed resistor, 17129
- 1 50-ohm, 1/4-watt fixed resistor, 16143
- 1 150-ohm, 1/2-watt fixed resistor, 17141
- 2 300-ohm, 1/4-watt fixed resistors, 14175
- 1 400-ohm, 1/4-watt fixed resistor, 15141
- 1 700-ohm, 1/4-watt fixed resistor, 16126
- 1 2200-ohm, 1/2-watt fixed resistor, 17142
- 1 15,000-ohm, 3-watt fixed resistor, 17136
- 2 20,000-ohm, 1/4-watt fixed resistors, 17130
- 1 30,000-ohm, 1-watt fixed resistor, 15189
- 1 40,000-ohm, 1/2-watt fixed resistor, 15155
- 4 75,000-ohm, 1/4-watt fixed resistors, 14195
- 1 90,000-ohm, 1/4-watt fixed resistor, 17135
- 1 100,000-ohm, 1/4-watt fixed resistor, 14144
- 1 180,000-ohm, 1/4-watt fixed resistor, 17139
- 1 210,000-ohm, 1/4-watt fixed resistor, 17134
- 4 250,000-ohm, 1/4-watt fixed resistors, 14150
- 3 500,000-ohm, 1/4-watt fixed resistors, 14155
- 1 600,000-ohm, 1/2-watt fixed resistor, 17133
- 6 1-megohm, 1/4-watt fixed resistors, 17144
- 5 2-megohm, 1/4-watt fixed resistors, 17109
- 1 2.1-megohm, 1/4-watt fixed resistor, 17132
- 1 6-megohm, 1/2-watt fixed resistor, 17131
- 1 .00025-mfd. mica condenser, 14102
- 1 .0005-mfd. mica condenser, 14139
- 1 .0014-mfd. mica condenser, 17143
- 12 .01-mfd., 400-volt paper condensers, 14110
- 1 .01-mfd., 1000-volt paper condenser, 16136
- 1 .015-mfd., 400-volt paper condenser, 17136
- 4 .05-mfd., 200-volt paper condensers, 14160
- 4 .05-mfd., 400-volt paper condensers, 14181
- 1 .15-mfd., 400-volt paper condenser, 17137
- 4 Tie lugs, single insulated terminal, 25-5732
- 4 Tie lugs, two insulated terminals, 25-5731
- 2 Tie lugs, three insulated terminals, 25-6715
- 3 Tie lugs, four insulated terminals, 25-6716
- 1 Metal tube shield, 19333
- 1 Complete set screws, nuts, lockwashers, etc.
- 1 1/4" bushing and nut for Ground wire, 19504
- 1 Leather handle and mounting loops, 19505
- 1 Metal shield for coil assembly, 9640
- 4 Rubber bumpers for cabinet base, 14269
- 1 RF-IF Test lead assembly, 19485
- 1 Oscillator test lead assembly, 19486
- 1 Rubber covered Ground lead and chassis clip
- 1 Voltmeter test lead, 19488
- 1 Audio test lead assembly, 19489
- 4 Special threaded test clips, 19490
- 2 Special threaded Grid fittings, 19491
- 9 Lengths colored hook-up wire
- 1 Length shielded wire
- 1 Length rosin-core wire solder
- 2 Lengths insulating sleeving
- 2 Special laced hook-up cables

COMPLETE INSTRUCTIONS

FOR THE

Meissner "SIGNAL SHIFTER"

STANDARD AND DE LUXE MODELS

This booklet has been prepared to provide complete information on the Installation, Adjustment and Operation of the following Meissner "Signal Shifter" units:

- Model 9-1001 Standard, black wrinkle finish, 110-volt AC.
- Model 9-1015 Standard, black wrinkle finish, 220-Volt AC.
- Model 9-1017 De Luxe, gray wrinkle finish, 110-Volt AC.
- Model 9-1018 De Luxe, black wrinkle finish, 110-Volt AC.
- Model 9-1019 De Luxe, black or gray finish, 220-Volt AC.
- Model 9-1020 De Luxe, black or gray finish, rack panel

One complete set of (3) coils for operation on any specified band, is supplied with each "Signal Shifter". Coils for operation on the other amateur bands are available in sets of three according to the following table:

- | | |
|-------------|------------------------------------------|
| No. 18-2015 | Complete set of coils for 160-meter band |
| No. 18-2016 | Complete set of coils for 80-meter band |
| No. 18-2017 | Complete set of coils for 40-meter band |
| No. 18-2018 | Complete set of coils for 20-meter band |
| No. 18-2019 | Complete set of coils for 10-meter band* |

*Coverage of these coils is 14 to 15 mc; designed to double in the transmitter to the 10-meter band, 28 to 30 mc.

Tubes Required for
STANDARD MODELS

- 1 6F6 Metal Tube
- 1 6L6 Metal Tube
- 1 -80 Rectifier

Tubes Required for
DE LUXE MODELS

- 1 6F6 Metal Tube
- 1 6L6 Metal Tube
- 1 5X4G Rectifier
- 1 VR-105-30
- 1 VR-150-30

GENERAL INFORMATION

The Meissner Signal Shifter is a variable-frequency exciter permitting frequency control of a transmitter over the entire range of the amateur bands. Due to its inherent stability, flexibility, and ease and simplicity of operation, the Signal Shifter has rightfully earned its place on the amateur's operating table—beside his key or mike, in order that he can completely control the frequency of his transmitter.

The Signal Shifter uses a 6F6 metal tube in a high-C, electron-coupled oscillator circuit operating on one-quarter of the output frequency, except on 160 meters where it operates on one-half the output frequency. The oscillator frequency is doubled in the tuned plate circuit of the 6F6, which is capacitively coupled to the grid circuit of a 6L6 metal tube. The 6L6 operates as a frequency doubler except on the 160-meter band, in which case it functions as a neutralized buffer.

The Meissner Signal Shifter has a self-contained power supply for operation on alternating current and will NOT operate on 110 or 220-volt direct current.

OUTPUT—BANDSPREAD—
FREQUENCY RANGE

The Signal Shifter delivers a fundamental signal of approximately 7.5 watts on each of the commonly-used amateur bands, except 28 MC. For operation in this band, coils are supplied that cover 14 to 15 MC, permitting full dial-spread on the 28-MC band when the Signal Shifter is followed by a frequency-doubling stage.

The three coils used for each band are so designed that each amateur band is spread over approximately 90% of the dial scale, thus permitting accurate calibration and setting of frequencies.

STABILITY

An extremely high order of frequency-stability in the Signal Shifter is achieved by the use of the 6F6, a tube which has a minimum of thermal frequency-drift, in a high-C circuit, using sturdy, high-quality components, together with temperature-coefficient condensers, and a "Stand-by" circuit which holds steady the currents flowing in the tube under either operating or "stand-by" conditions.

ADJUSTMENT

The Meissner Signal Shifter is thoroughly tested before shipment, but is shipped without tubes. In order to compensate for variations in tube characteristics, the Shifter should be re-adjusted and re-aligned before an attempt is made to use it "on the air." It is suggested that the following procedure be used in making the preliminary test:

Turn the AC switch (left side of the panel) to OFF. Plug in the line cord to an AC outlet of suitable voltage and frequency.

Connect a telegraph key or knife switch to the keying terminals. If a key is used, connect the key frame to the "grounded" key terminal which is the screw terminal nearest the front of the Shifter. Open key or switch. These terminals must be connected together later if Phone operation is desired.

Place all tubes in their respective sockets as shown on Figure 2 or 4. Place one complete set of coils, preferably that of the highest-frequency band to be used, in their respective sockets.

Turn the "operating switch" (right of panel) to "Stand-by" and turn the AC switch to "ON." This permits the tubes to warm-up and places the entire unit in operating condition, but does not allow the oscillator to start.

After a warm-up of thirty minutes, turn the "operating switch" to "ON" and rotate the tuning dial to 90 degrees. Set a calibrated receiver, monitor or frequency meter on the high-frequency end of the band corresponding to the set of coils in the Shifter. Adjust the Band-Setting condenser (C4 in Figure 2 or 4) until the output of the Signal Shifter corresponds to the end of the band. If a super-heterodyne receiver is used to locate the frequency of the Shifter, the receiver may give beat notes at several different points, but there should be no question as to which is the correct signal, as it will be much stronger than the spurious signals caused by beats between harmonics. Before the Signal Shifter is actually placed in service, a calibrated frequency standard must be used to actually determine the frequency in use!

Then, with a 7.5-watt, 110-volt lamp connected across the output terminals, depress the key or close the switch and adjust the trimming condensers (C5 and C6) to give maximum brilliance of the lamp. This will serve as a preliminary check of alignment. The adjustments made on the highest frequency band will be found satisfactory on the lower-frequency bands.

NEUTRALIZATION

Since the Signal Shifter is shipped without tubes, it is impossible to completely pre-neutralize the 6L6 for 160-meter operation. It is therefore important, before attempting to operate the

STANDARD MODEL "SIGNAL SHIFTER"

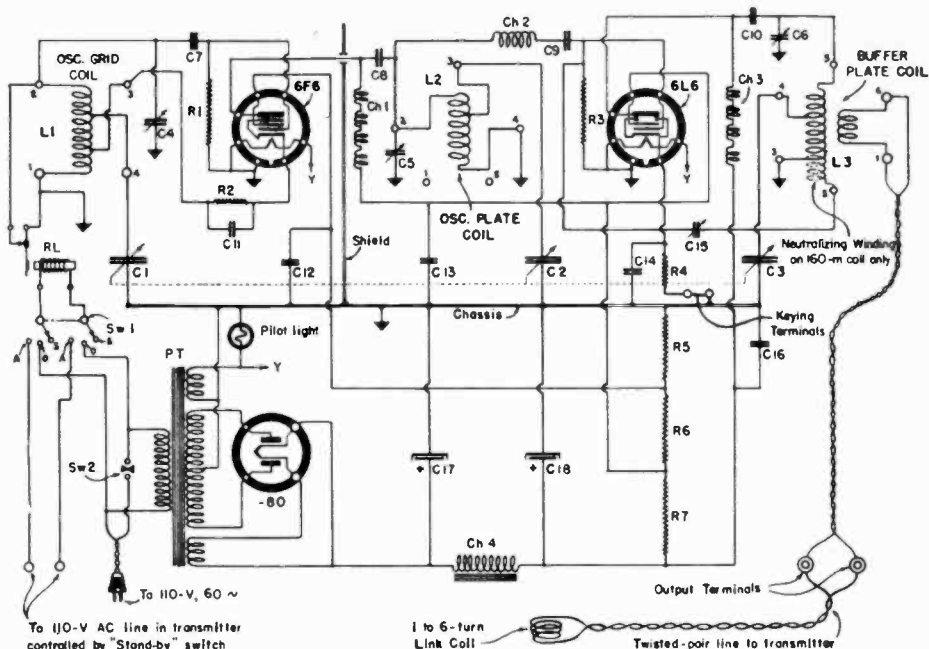

Fig. 1 STANDARD MODEL — CIRCUIT DIAGRAM

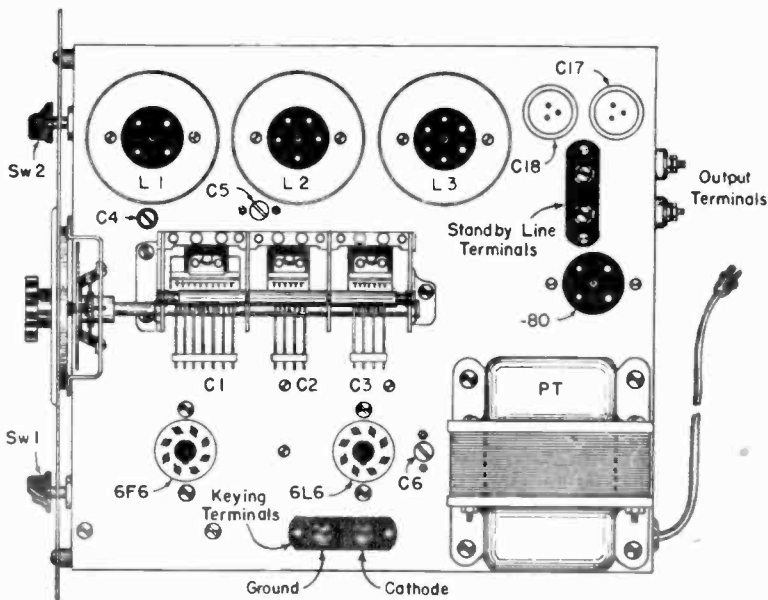

Fig. 2 STANDARD MODEL — TOP VIEW

Shifter on that band, that the amplifier be carefully neutralized. Remove the cabinet and place the Shifter on its side. Turn the switch to "stand-by" then carefully adjust the screw in the cylindrical brown bakelite neutralizing condenser (C15), located underneath the chassis between the 6L6 socket and the output coil, for minimum glow in a small neon bulb held on the output tank circuit. This is a good indicator for determining the condition of neutralization, since with the "operating switch" in "Stand-by" position and the keying terminals shorted (Key down), almost no glow should be visible when the 6L6 is neutralized. If a bright glow

does occur, adjust the condenser (C15) until the neon bulb goes out or becomes very dim.

Neutralization is NOT required for operation on bands other than 160 meters, and the neutralizing components are automatically switched out of the circuit on the other bands.

— FREQUENCY CALIBRATION —

The Signal Shifter is now ready to calibrate. In order that the calibration will remain within desirable limits of accuracy, care must be taken to permit warm-up before the unit is to be used.

DE LUXE MODEL "SIGNAL SHIFTER"

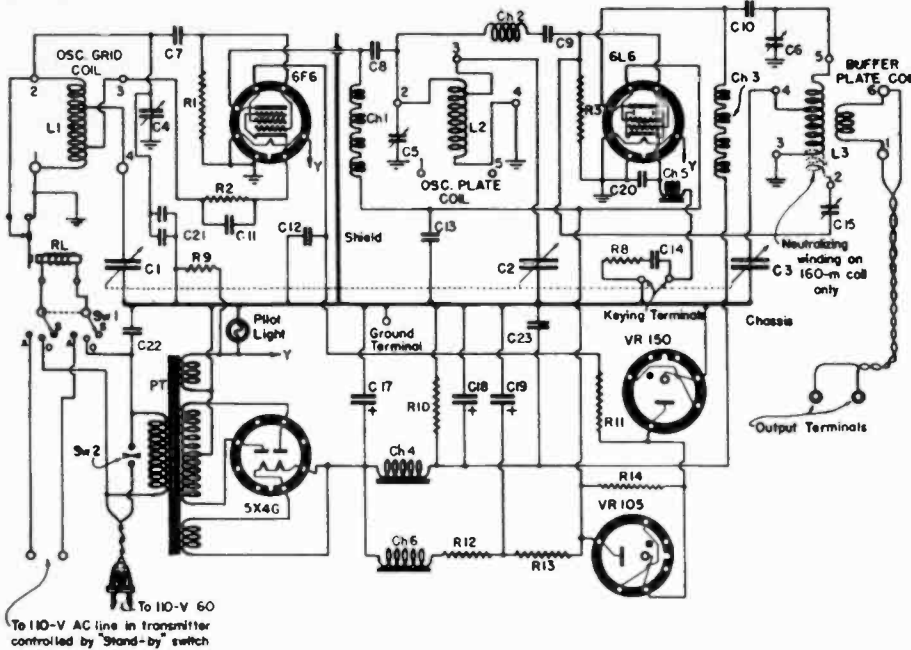

Fig. 3 DE LUXE MODEL — CIRCUIT DIAGRAM

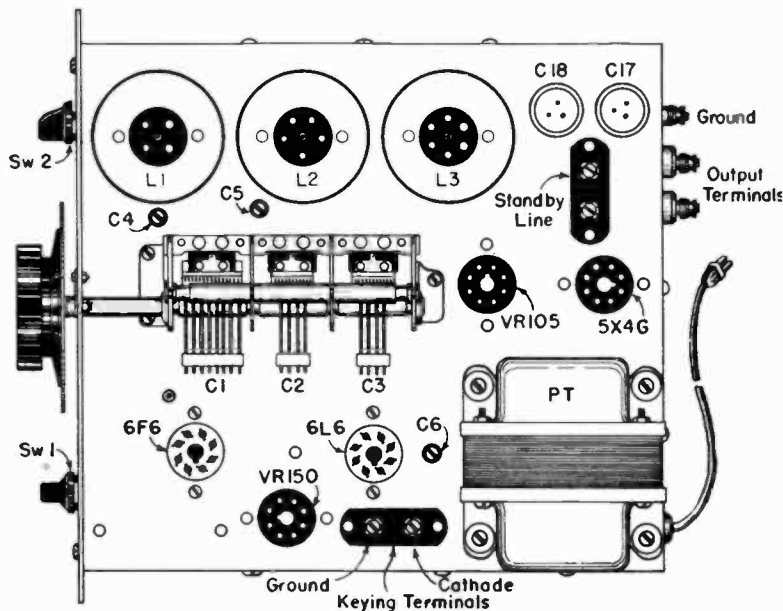

Fig. 4 DE LUXE MODEL — TOP VIEW

Whenever coils are changed, the coil shields must be firmly seated to prevent mechanical shift of the oscillator frequency. The Shifter can be calibrated by any standard frequency-checking procedure as outlined in radio technical handbooks using heterodyne frequency meters which have been previously calibrated, a receiver and either an incoming signal of known frequency or a crystal-controlled frequency standard such as the Meissner Signal Calibrator.

A complete calibration curve (See Figure 11) should be drawn for each band to be used. Points should be

drawn on graph paper using known frequencies at the ends of the band, and at as many other points as can be accurately recorded using a frequency meter or frequency standard. It should be possible to draw a smooth curve (not necessarily a straight line) through all of the points. If no frequency-marking points are available at the ends of the band the approximate band edges may be taken from the projected curve drawn from known frequencies inside the band. However, where the band edges are determined by a projected curve, extreme care should be taken in operating near band limits and exact band-edge operation

should be avoided.

The high-frequency end of each band is found between 85 and 90 on the Signal Shifter dial. If the calibration curve places this point elsewhere on the dial, the band-setting condensers should be readjusted as described previously.

Calibration should be re-checked at frequent intervals and must positively be checked whenever tubes are changed or replaced.

Do not rely upon your frequency curve to determine your operating frequency. An actual check of the output signal frequency of your transmitter must be made to meet the requirements of the authorities controlling radio operation.

COUPLING TO THE TRANSMITTER

After the Signal Shifter has been adjusted, aligned, and calibrated, it is then ready to be coupled to the transmitter. This may be done by any of the standard methods of coupling. In a medium- or low-power transmitter, the Shifter may be link-coupled to the grid coil of the output stage in the transmitter. The exciter may also be coupled by means of a link to the buffer stage of the transmitter or to the grid or plate circuit of the tube previously used as a crystal oscillator. If the transmitter has crystal control with the grid of the output stage capacity coupled to the crystal plate tube, the link-coupling can be conveniently made to the plate circuit with the crystal tube removed and the plate circuit re-tuned. If the output of the Signal Shifter is linked to a buffer amplifier, care should be taken to prevent self-oscillation in the buffer stage by means of neutralization or adequate shielding in the case of screen-grid tubes.

The output terminals of the Signal Shifter may be coupled to the transmitter through a concentric cable, E01 cable, or any other good low-impedance transmission line, such as a pair of No. 14 rubber-covered wires twisted loosely. Ordinary twisted lamp cord will not be as satisfactory as solid wire, twisted. Type E01 cable is highly recommended. The inherent loss in such transmission lines will determine the length of line which can be used satisfactorily. Due to the relatively high output of the Signal Shifter, standard transmission lines can be used up to 25 feet without seriously reducing the input to the transmitter itself. Typical methods of coupling are shown in figures 5, 6 and 7.

If possible, the degree of coupling between the **Signal Shifter** and a tuned circuit in the transmitter should be varied at the transmitter in order to obtain the maximum output of each band with the minimum of coupling to the transmitter. It will not be necessary to change the link-coupling turns on the output coil of the **Signal Shifter**, but better to vary the coupling at the transmitter by means of a variable coupling link-circuit or by the "cut and try" method.

CONTROLLING THE SIGNAL SHIFTER

There are but three controls on the front panel of the **Signal Shifter**, the AC "on and off" switch, (left-hand side of the panel) which controls the line voltage input to the **Signal Shifter** itself; the operating switch (right-hand side of the panel), which has three positions, "Automatic—On—Standby" and the tuning dial. The standby relay (RL) is incorporated in the **Signal Shifter** to permit automatic standby of the oscillator when the final amplifier is turned off in the transmitter. This means that the operator can control the **Signal Shifter** merely by operating the "on and off" switch on his transmitter.

In the "Automatic" position of the switch, the relay is connected to the twin terminal-strip near the rectifier (or power supply) socket at the rear of the chassis. For automatic operation these terminals should be connected across any line in the transmitter where 110 volts AC is controlled by the transmitter "stand-by" switch. This is usually the line to the primary of the high-voltage power supply. Thus, the "send-receive" switch simultaneously controls the transmitter and the "Signal Shifter."

In the "Automatic" position of the switch the relay contacts are open when

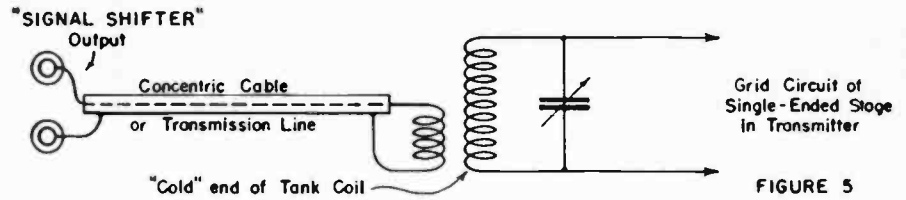

FIGURE 5

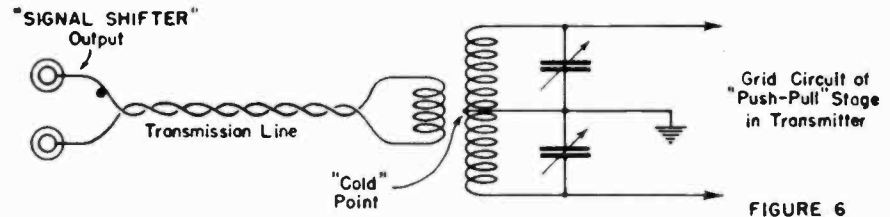

FIGURE 6

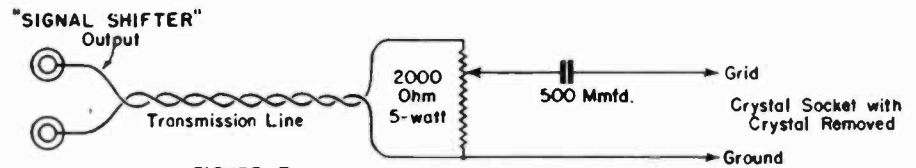

FIGURE 7

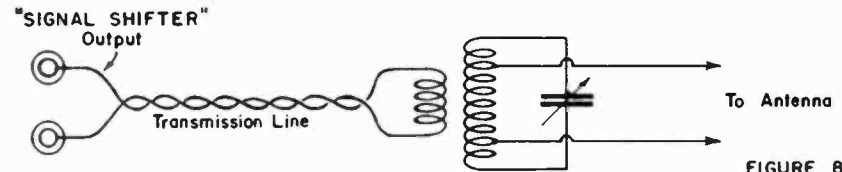

FIGURE 8

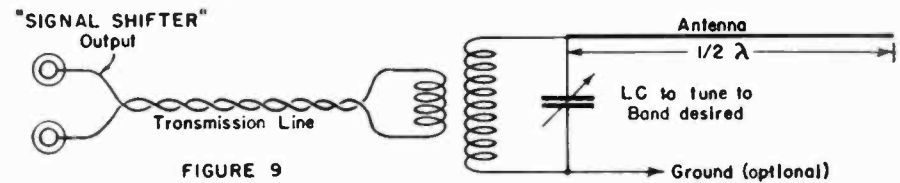

FIGURE 9

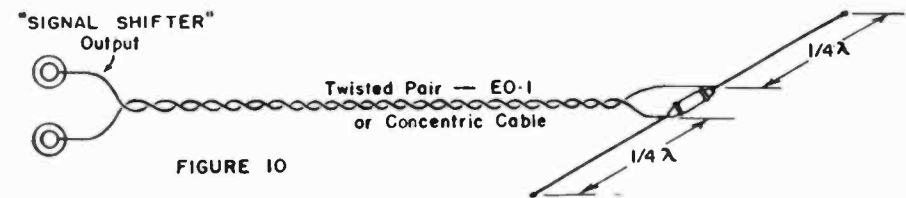

FIGURE 10

the "final stage" is on, thus permitting the oscillator to function. In the "On" position, the relay is held down with the contacts open, by the 110

volts obtained from the power-line cord of the **Signal Shifter**. In this position of the switch, continuous operation of the oscillator is maintained regardless of whether or not the remainder of the transmitter is operating. This feature is very useful in calibrating the **Signal Shifter**, locating its position in the band and in furnishing a local signal for use as a frequency standard. The oscillator alone will furnish a weak signal in a receiver placed nearby.

In the "Standby" position, the relay contacts are closed, thus short-circuiting the oscillator in the **Signal Shifter**. Due to circuit balance, the current flowing on the 6F6 tube remains practically constant whether the tube is oscillating or not, thus preventing drift during the "Standby" period. The tube is thus

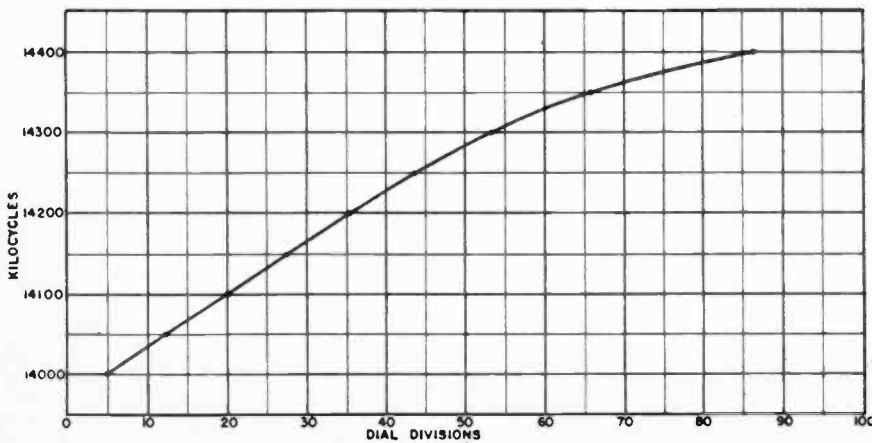

FIGURE 11

TYPICAL CALIBRATION CURVE

kept at a constant temperature permitting instantaneous use of a desired frequency without warm-up or re-setting of the frequency control.

ADJUSTING TRANSMITTER TO SIGNAL SHIFTER

After coupling the exciter to a transmitter, an adjustment should be made in the transmitter to provide efficient energy transfer from the **Signal Shifter**. While the basic idea of the **Shifter** is to provide single dial bandspread control of transmitter frequency, it is obvious that complete single-dial control (with all circuits in the transmitter and antenna network tracking) is impossible due to the wide variations in transmitter and antenna. It has been found that with the proper coupling from the **Signal Shifter** to the stage which is being excited, it is possible to operate over a wide frequency range in a given band without readjustment of the grid circuit of the stage under excitation. The plate circuit naturally must be returned in the transmitter to provide maximum efficiency. The use of "flat-lines" in connecting the transmitter to the antenna will greatly eliminate tuning variations in the amplifier stage itself when operating over a wide frequency range.

The output of the **Signal Shifter** is practically constant over the entire frequency range of each band, but the exact decrease in power at the edges of the band (when originally tuned up in the center of the band) is a function of the number of circuits following the **Shifter**, and the degree of coupling between circuits.

SIGNAL SHIFTER AS FREQUENCY STANDARD

In using the Meissner **Signal Shifter** as a frequency standard, care should be taken to accurately calibrate the various frequency bands. Extreme care should be taken in re-setting the dial to the calibrated or calculated point. It is not necessary to use the output (key down) of the **Signal Shifter** as a frequency standard as the harmonics of the oscillator will ordinarily provide sufficient signal strength for frequency measurements. The accuracy of the unit will be increased if care is taken to prevent mechanical vibration of the **Signal Shifter**, especially while being used as a frequency standard. Adequate warm-up should be provided for before attempting to use the unit as a frequency standard.

SIGNAL SHIFTER AS A TRANSMITTER

The **Signal Shifter** may be used as a low-powered or emergency transmitter by connecting the output terminals to a tuned circuit as shown in Figs. 8 and 9. Also, the output can be connected directly to a twisted pair feeder line, which in turn is connected to the center of a dipole antenna. The twisted pair can be of any normal length, without loss. This circuit is shown in Fig 10.

ETHICAL OPERATION OF AN ECO

With the Meissner **Signal Shifter** connected to a transmitter and the aligning, adjustment and calibration completed, the exciter is now, ready to operate. It must be remembered that the operator of an ECO now becomes a part of his equipment. He can operate in a decent, sporting manner, turning off his carrier when placing his signal

on the band, and by keeping a few kilocycles from the station called or he can "swish", park right on the weak DX station, or slide back and forth across the station already working the DX station, in the hope of attracting his attention.

Many paragraphs have been printed in the amateur technical journals pleading with the operators for sensible operation of ECOs. Nothing can be added except this—THE MEISSNER SIGNAL SHIFTER HAS BEEN SO DESIGNED AND SO CONSTRUCTED AS TO PERMIT TRANSMITTER OPERATION WITH AN ABSOLUTE MINIMUM OF INTERFERENCE AND ANNOYANCE TO OTHER OPERATORS, IN FULL ACCORD WITH THE BEST "HAM ETHICS" BUT IT NOW BECOMES THE DUTY OF EACH OPERATOR TO SEE TO IT THAT HIS OPERATION AT HIS STATION UTILIZES THESE FEATURES, AND THEREBY MEETS THE ETHICAL REQUIREMENTS!

"SIGNAL SHIFTER" REPLACEMENT PARTS LIST

Circuit Designation	Meissner Part. No.	Description	Net Price Each
C1, C2, C3,	15176	3-gang Special Tuning Condenser	\$3.50
C4	15177	Oscillator Grid-Tank Condenser	1.25
C5	15240	Oscillator Plate-Tank Condenser	.75
C6	15260	Buffer Plate-Tank Condenser	.75
C7, C9	14101	100-mmfd. Mica Condenser	.15
C8, C10	14100	500-mmfd. Mica Condenser	.20
C11, C14	15142	0.1-mfd., 200-volt paper Condenser	.12
C12, C13, C20	14110	.01-mfd., 400-volt Paper Condenser	.12
C15	6765	Align-Aire Neutralizing Condenser	.13
C16	15143	0.1-mfd., 400-volt Paper Condenser	.12
C17, C18	15186	12-mfd., 450-volt Electrolytic Cond.	.75
C19	16113	8-mfd., 450-volt Electrolytic Cond.	.35
C22	14181	.05-mfd., 400-volt Paper Condenser	.12
C23	16166	0.1-mfd., 600-volt Paper Condenser	.15
R1	15155	40,000-ohm, 1/2-watt Resistor	.15
R2	15184	400-ohm, 1-watt Resistor	.20
R3	15183	50,000-ohm, 1-watt Resistor	.20
R4	15182	300-ohm, 2-watt Resistor	.25
R5	15179	12,000-ohm, 3-watt Resistor	.35
R6	15180	13,000-ohm, 5-watt Resistor	.50
R7	15181	4,000-ohm, 5-watt Resistor	.50
R8	16143	50-ohm, 1/4-watt Resistor	.10
R9, C21	9910	Temperature Compensator	2.50
R10	17165	60,000-ohm, 5-watt Resistor	.50
R11	17168	30,000-ohm, 1/2-watt Resistor	.15
R12	17166	4,000-ohm, 10-watt Resistor	.60
R13	17167	1,000-ohm, 5-watt Resistor	.50
R14	17154	60,000-ohm, 1/2-watt Resistor	.15
CH1, CH3	19-1996	4-pie RF Choke Coil	.33
CH2	8822	Parasitic RF Choke Coil	.20
CH4	19251	7-Henry Filter Choke	1.50
CH5	19528	2-Henry Filter Choke	1.00
CH6	19341	6-Henry Filter Choke	1.00
PT	19253	Power Transformer, 110-volt	4.00
PT	19428	Power Transformer, 220-volt	5.00
RL	19229	Automatic Stand-by Relay	3.00
SW1	19223	3-Position Selector Switch	.65
SW2	19475	"On-Off" AC Line Switch	.30
2 Required	8437	Ceramic Octal Tube Socket	.24
3 Required	17917	Aluminum Coil Shield	.25
2 Required	25-8222	Bakelite Bar Knob	.09
1 Required	25-8224	Tuning Knob for Standard Models	.12

INDEX

	Page
Fore-word	1
The Radio Frequency Spectrum, Chart	2
How to Tell What Resistor to Use, Chart	3
Handy Radio Formulae, Chart	4
Capacity—Frequency—Inductance Chart	5
General Construction Hints	6
Radio Coils and Circuit Applications	8
Design and Construction of Receiving Antennas	19
Television in Theory and Practice	20
Meissner Television Receiver	27
"Traffic Master"; 14-tube Communications Receiver	38
Band-Spread Tuning Unit and Coil Assembly	44
"Signal Booster";—Preselector	48
"MC 28-56", —5 and 10 Meter Converter	50
"Signal Calibrator"	52
12-tube "Custom" Super Receiver	56
Standard Tuning Unit and Coil Assembly	62
Push Button Converter	66
9-tube "Custom" Super Receiver	68
8-tube "Combination" Super Receiver	74
7-tube "Utility" Broadcast Band Receiver	80
7-tube "Utility" Broadcast & Short-Wave Receiver	84
7-tube "Utility" Broadcast, Police & Short-Wave Receiver	88
7-tube "Utility" Long-Wave, Broadcast & Short-Wave Receiver	92
6-tube, 6-volt Broadcast Band Receiver	96
6-tube, 6-volt, Broadcast and Short-Wave Receiver	100
6-tube, 2-volt Broadcast Band Receiver	104
6-tube, 2-volt, Broadcast and Short-Wave Receiver	108
6-tube Ferröcart T.R.F., Broadcast Receiver	112
5-tube AC T.R.F. Broadcast Receiver	116
4-tube AC-DC T.R.F. Receiver	120
1-tube Student "Midget" Receiver	124
2-tube Student "Midget" Receiver	126
3-tube Student "Midget" Receiver	128
High Fidelity Public Address Tuner	130
Dual Band Public Address Tuner	134
"Utility" Public Address Tuner	138
Portable Battery-Operated Receiver	142
"Wireless" Phonograph Oscillator Adapter Unit	146
"Lamb" Noise Silencer Adapter Unit	148
Beat Frequency Oscillator Adapter Unit	150
Push Button Tuner	152
Push Button Remote Control Unit	154
6-volt Vibrator Power Supply Unit	157
Meissner "Analyst"	158
Meissner "Signal Shifter"	164



Kit Guarantee

When you build a radio receiver from a Meissner Kit of parts exactly in accordance with the Meissner Pictorial Diagram and Instructions, that receiver will either work satisfactorily, or you have the privilege of shipping it (prepaid) to the Meissner plant for inspection and mechanical or electrical adjustment! If the fault is due to a defective part, or to an error in instructions or diagrams, no charge whatsoever will be made for putting that receiver in perfect operating condition. Before you ship, just write the Meissner Manufacturing Company, Mt. Carmel, Illinois, for instructions, thoroughly explaining your difficulty. We will even supply a shipping carton so that you will not have the burden of packing.