

ELECTRIC RECTIFIERS AND VALVES

By

Prof. Dr.-Ing. A. GÜNTHERSCHULZE

OF THE PHYSIKALISCH-TECHNISCHE REICHSANSTALT

Translated and Revised by

NORMAN A. DE BRUYNE

B.A.(Cantab.)

AUTHOR OF "THE ELECTROLYTIC RECTIFIER"

NEW YORK
JOHN WILEY & SONS, INC.
1928

(Printed in Great Britain)

TRANSLATOR'S PREFACE

THOSE who compare this translation of Güntherschulze's "Elektrische Gleichrichter und Ventile" with the original will see that a large number of alterations have been made. Apart from such typographical changes as the division of the book into chapters, the substitution of the usual type of line block for the reversed form used in the German edition, and the interspersing of the figures in the text, there are various additions and a few omissions made necessary by the advance of knowledge. Most of these additions have been made from information supplied by Dr. Güntherschulze; a few, such as the paragraphs on the tantalum rectifier and the Moullin voltmeter, have been written by me. The help of Dr. Güntherschulze in the expedition of the work will always be one of its pleasantest associations.

Lest this book should fall into the hands of a purist I will forestall his criticism by admitting that he will probably find much in it to offend his prejudices; but in a scientific book clearness is worth an occasional redundancy, and exact expression is more important than elegance of style.

First in my list of acknowledgments I must thank Mr. L. B. W. Jolley, who suggested the undertaking of this translation, and who made a number of relevant criticisms when it was done. I must also tender my thanks to Messrs. Burndept, the Cambridge Instrument Co., Experimental Wireless, Frau Negrioli, Mr. C. C. Paterson, Power Rectifiers, Ltd.

NORMAN A. de BRUYNE.

TRINITY COLLEGE, CAMBRIDGE,
August 25th, 1927.

AUTHOR'S INTRODUCTION

THE importance of electric valves is due to a number of different and unrelated causes. The installation of large alternating current generating stations to replace a number of scattered direct current stations is one of the contributing factors to the increasing importance of mercury arc rectifiers, since by their use the direct current machinery need not be replaced. Of late years broadcasting has brought a strong demand for small rectifiers ; it has also led to a remarkable development in the design of detectors, but this book is primarily concerned with rectifiers for currents bigger than those encountered in high-frequency work. Other uses of valves are the production of high-frequency oscillations, the use of valves as cut-out switches to prevent reverse currents, the production of any kind of wave form, the measurement of small alternating currents, and so on.

In comparison with rotary converters, even disregarding the question of efficiency, rectifiers require very little care and attention. On this score alone they are therefore preferable to rotating machinery.

It would be hard to find any-branch of electrical engineering in which one purpose was attained in so many different and physically interesting ways as in the rectification of alternating current. Mercury arc, thermionic, electrolytic, gas discharge, and contact rectifiers are all in use ; each one of them involves a different physical process, though all use the same fundamental principle.

In no other branch of electrical engineering, therefore, is a knowledge of physical principles so important. For this reason the first part of the book is devoted to an introduction to the physical basis of valve action, and the second part to the methods of applying these principles in practice.

A. GÜNTHERSCHULZE.

CONTENTS

PHYSICAL THEORY SECTION

CHAP.	PAGE
I. DEFINITION AND CLASSIFICATION OF VALVES AND RECTIFIERS	1
II. ATOMIC STRUCTURE AND IONISATION PROCESSES	4
III. ELECTRIC CONDUCTION IN GASES	11
IV. ACTIONS AT THE ANODE	23
V. ACTIONS AT THE CATHODE	29
VI. THE ARC DISCHARGE	53
VII. ELECTROLYTIC RECTIFIERS	81
VIII. DETECTORS	96

TECHNICAL SECTION

IX. CONNECTIONS AND MATHEMATICAL THEORY OF VALVES	106
X. MECHANICAL RECTIFIERS	136
XI. ELECTROLYTIC RECTIFIERS	145
XII. GLOW DISCHARGE RECTIFIERS	153
XIII. MERCURY VAPOUR RECTIFIERS: GLASS BULB TYPE	157
XIV. METAL-CASED MERCURY VAPOUR RECTIFIERS AND THE PROPERTIES OF RECTIFIER INSTALLATIONS	169
XV. COMMERCIAL TYPES OF METAL-CASED RECTIFIERS	186
XVI. MISCELLANEOUS TYPES	193
XVII. VARIOUS APPLICATIONS OF VALVES	200

ELECTRIC RECTIFIERS AND VALVES

PHYSICAL THEORY SECTION

CHAPTER I

Definition and Classification of Valves and Rectifiers

An electric valve is a conducting system having such physical properties that its volt/ampere curve, the so-called "characteristic," is dependent upon the current direction. The phenomenon is called Valve Action or Unipolarity. An electric valve therefore has the property of allowing a different current to flow in one direction as in the other with a given applied voltage. Apparatus which attains this end by moving parts, such as switches, vibrating reeds or rotating commutators, does not come within this definition of an electric valve.

The purpose of a rectifier is to transform A.C. into D.C. This can be achieved either physically by valves, or mechanically by systems vibrating in phase with the A.C. (mechanical rectifiers). The D.C. voltage supplied by a rectifier is determined by the value of the A.C. voltage supplied; the wave form of the pulsating D.C. is also related to that of the A.C.

As an example of an electric valve we can take a device having the characteristic shown in Fig. 1. In the positive quadrant only a vanishingly small current flows as long as the voltage remains below the value a , while in the negative quadrant a current of as large a magnitude as desired can pass as long as the voltage is greater than the value a .

But a device which has a characteristic equally curved in both quadrants, as in Fig. 2, can also act as a valve if the zero point of its characteristic be displaced from its sym-

2 ELECTRIC RECTIFIERS AND VALVES

metrical position by an auxiliary current. For example, suppose one sends a constant auxiliary current i_0 through the system of Fig. 2 so that the voltage becomes equal to e_0 , then if an A.C. voltage $E \sin \omega t$ be superimposed, the mean value of the voltage remains at e_0 . On the other hand, the mean value of the current becomes i_1 , which is less than i_0 ; this is due to the curvature of the characteristic as clearly shown in Fig. 2, without further discussion. It is also clear that if the curve were convex upwards, i_1 would be greater than i_0 . Therefore one has to distinguish between two types

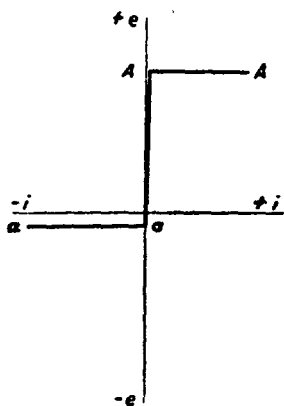

True Rectifier

FIG. 1.

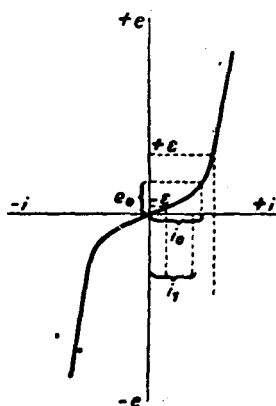

Valve with
Auxiliary Voltage

FIG. 2.

of valve, the self-acting valve and the supported or auxiliary voltage valve.

Since an electric current is a transport of electricity by electrons or ions a true valve can also be defined as a contrivance which offers to electrons or ions a hindrance differing in one direction from that in the other. This is inconceivable in a homogeneous body. Therefore the characteristic of a true valve is the existence of a division between two different bodies in which the electrons or ions move in different manners. There are as many kinds of valves conceivable as there are kinds of boundaries, so that we see straight away that the classification of true valves should be according to

the boundaries on which their actions depend. These divisions are :—

- (1) Metal—Metal.
- (2) Gas—Gas.
- (3) Electrolyte—Electrolyte.
- (4) Metal—Gas (or Vacuum).
- (5) Metal—Electrolyte.
- (6) Gas—Electrolyte.
- (7) Miscellaneous Boundaries.

In the above classification the word “metal” must be taken to mean not only the actual metals, but all bodies having metallic conduction such as carbon, selenium, tellurium, many oxides and sulphides, and the heavy metals. Of the above theoretically possible combinations only (1), (4), (5), (6), (7) are of practical importance.

The Metal-Metal Boundary. *Thermo-electric Valves*

Although the division between two metals has doubtless a characteristic dependent on the current direction, it is not used as a valve because it is impossible to complete a metallic circuit in which the actions at the different boundaries are not annulled. On the other hand, A.C. can be transformed into D.C. in a roundabout way by using heat as an intermediary. By making two contacts at different temperatures between two metals a thermo-electric E.M.F. is set up. The A.C. can be made to produce this difference of temperature by giving one cross section a large area so that it remains cool, and the other a very small area so that it becomes hot ; thus the A.C. produces a thermo-electric D.C. Yet this process cannot be spoken of as a true rectification of A.C. or as a true valve action because no relation exists between the form of curve of the D.C. and A.C., nor is there any difference between the permeable and impermeable directions. The A.C. remains symmetrical, the thermo-electric current is superimposed on it. Only by the use of capacitance and inductance or by a combination with more valves can both currents be separated. Various workers have used the phenomenon for the measurement of small A.C.'s by transformation into D.C.

CHAPTER II

Atomic Structure and Ionisation Processes

For a review of the extraordinarily diverse phenomena of electric conduction in gases we must go back to the fundamental elements of all electric phenomena—the positive and negative ions. The unit of electric charge, the electric atom, is the electron for negative electricity, and for positive electricity is the nucleus of the hydrogen atom; this nucleus is also called the Proton. The charge on both is $\pm 1.56 \times 10^{-20}$ E.M.U. The mass of the proton is 1,850 times greater than that of the electron, in an electric field the mobility of an electron is, therefore, incomparably greater than that of the most mobile of ions.

All the elements, from the lightest (hydrogen) to the heaviest (uranium), can be arranged in a series in such a way that to each element is assigned a fixed number, the atomic number. According to Bohr's theory of atomic structure the structure of atoms is to a certain extent similar to that of the solar system. In the middle of the atom is the nucleus, which is extraordinarily small and composed of different and distinct parts, with which we are not here concerned. The number of positive charges on this nucleus is equal to the atomic number of the element, so that for hydrogen it is 1, and for uranium 92. Around this nucleus electrons, equal in number to the atomic number of the element, travel in paths whose shape has not yet been fixed with certainty. These electrons may be divided into different groups, according to their distances from the nucleus. For instance, the electrons of the two elements, chlorine (At. No. 17), and potassium (At. No. 19), have the arrangement shown in Fig. 3.

It must be emphasised, however, that this representation is only symbolical. In reality the electrons are probably not arranged in circles, but in spheres or ellipsoids. One

speaks, therefore, of the various electron shells which are represented as circles in Fig. 3 for simplicity.

It will be seen at the first glance that the arrangement of the electrons in such completely different elements is extraordinarily similar. The principal difference is that one electron is needed in the third shell of the chlorine atom to complete its eightfold symmetry, while the third shell of the potassium atom has all its eight electrons, and in addition has one electron outside as the beginning of a fourth shell. Now experiment shows that the electrons of the outer-

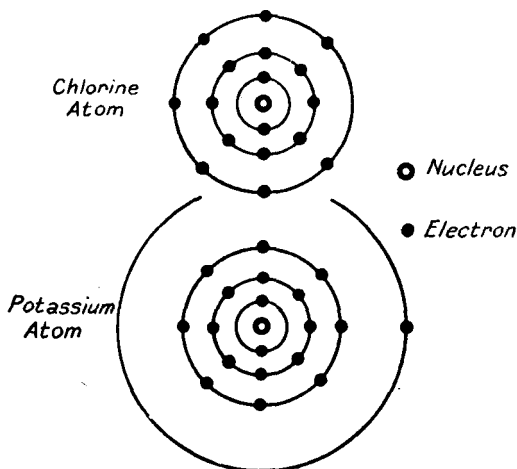

FIG. 3.—Symbolical structure of Chlorine and Potassium Atoms showing Positive Nuclei and Revolving Electrons.

most shell of an atom can be comparatively easily removed, as long as it is only partly occupied. An outermost shell of eight electrons is, however, a very stable structure, into which all atoms try to pass. Therefore every atom which needs one or more electrons to complete its outermost shell tries to catch other electrons ; while an atom which has but one or a few electrons in its outermost shell is only able to hold them lightly, so that they can easily be pulled off. Chlorine belongs to the first-mentioned class of atoms which endeavour to attract electrons, potassium belongs to the second class,

which easily give up their single electrons. In this way are two kinds of ions produced, namely a univalent negatively charged chlorine ion and a univalent positively charged potassium ion, and their structure is similar.

These different attractive powers of atoms for electrons are of the greatest importance in gas discharges. An electric current is carried through the gas by migrating electrons, which are continually colliding with the gas molecules on their path through the gas. If the gas molecules have an avidity for electrons they will hold fast to them, and thus heavy, slow atom ions take the place of easily moving and very fast electrons, and a much greater voltage is necessary to send a given current strength through the gas as when free electrons are available. The behaviour of gases, with regard to their electron avidities, ranges from that of the greediest gases like fluorine, which capture every electron in their neighbourhood, to that of the indifferent gases like argon, which do not trouble themselves at all with electrons. With these indifferent gases the collisions between the atoms and the electrons take place purely elastically, according to the laws of impact. Now, with an elastic impact the energy given up by a colliding electron to a particle, which was stationary before the collision, is

$$a = 2m/m_1 \dots \dots \dots (1)$$

where m = mass of electron
 m_1 = mass of atom.

If we put $m = 8.98 \times 10^{-28}$ gms. and $m_1 = 1.65 \times 10^{-24}$ M gms. (M = At. Wt.), we get

$$a = \frac{1.088 \cdot 10^{-3}}{M} \dots \dots \dots (2)$$

If one takes the thermal agitation of the atoms into consideration one gets, according to K. T. Compton,*

$$a = 2 \frac{m}{m_1} \left[1 - \frac{\Omega}{U} \right] \dots \dots \dots (3)$$

where Ω is the mean kinetic energy of the atoms and U that of the electrons.

* *Physical Review*, 21, 717, 1923.

At room temperature $\left[1 - \frac{\Omega}{U}\right]$ lies between .98 and 1, so that this correction can be neglected.

The energy loss can then be calculated for purely elastic impacts.

Gas.	$10^4 a.$
He	2.72
Ne	.539
Ar	.273
N ₂	.398
H ₂	5.40
O ₂	.314
H ₂ O	.604
Hg	.0543

The conditions become more complicated with gases which consist of molecules instead of atoms. The atoms of which the molecules consist are caused to rotate about a common axis, by collisions with the electrons; the necessary energy for this is abstracted from the electrons. Therefore the loss of energy with electron collisions in polyatomic gases, even when they have no electron avidity, is greater than that with monatomic gases. All this, however, only applies as long as the velocity of the electrons does not exceed a certain limit.

As a measure of the velocity of an electron a very convenient but logically incorrect expression has been adopted. The velocity which an electron attains in an electric field depends, if no loss of energy occurs, on the voltage through which it has fallen. The energy it gains in the field is given by the product Ve , where V is the voltage through which it drops and e is its charge. One speaks briefly, therefore, of an electron having a velocity of V volts, and means by it that velocity which the electron attains after having fallen through V volts.

According to Bohr's theory, the electrons of the outer-

most shell can rotate not only in the paths specified in Fig. 3, but also in a large number of other paths whose radii increase regularly according to definite laws. Moreover, the electrons can jump from one orbit to another if they are supplied with sufficient energy by collision or radiation. In order that an electron may jump from its normal orbit to one farther away from the nucleus an amount of energy $V_a e$ must be given to it, where V_a is the potential difference between the two paths. Since e is constant, this energy can be characterised by V_a . V_a is called a "resonance," or "excitation," potential.

Not all collisions with the necessary energy, however, cause such an energy change; this is obvious since the cross section of the struck atom is very much greater than that of the orbit of the rotating electron to which the energy should be transferred. It seems that the percentage of energy-delivering collisions increases with the velocity of the impacting electrons to a maximum slightly above the critical velocity V_a , and then quickly decreases. Opinions are still very divergent about the absolute magnitude of this percentage. The amount of energy required by the rotating electron is the greater the farther away is the orbit into which it jumps. Ultimately, at the ionisation voltage V_i , the electron is completely removed from the atom so that two individual charged particles are formed.

Univalent positive ions similarly take up energy Ve when they have fallen freely through a voltage V . Since their mass is greater than that of electrons, their velocity for the same energy is much smaller.

If energy were the only decisive factor in ionisation the positive ions would be able to produce ionisation just as well as the electrons; but the ionisation produced depends not only on the energy but on the velocity of the colliding particles. If this latter be insufficient even a big energy will not suffice. One might compare the two kinds of collision to the impact of a locomotive going at full speed (positive ions) to that of a heavy artillery projectile (electrons) against an obstruction. Both have about the same energy, but the projectile will smash through the obstruction and

the locomotive will push it back ; and ions behave similarly. In general, the cations can only cause excitation or ionisation after they have travelled through a much higher voltage than that necessary with electrons.

In the following table are collected the resonance and ionisation voltages of electrons for different molecules as far as they have been measured to date. The table shows that the alkali metals are excited and ionised the most easily, while helium requires the highest voltages.

TABLE I
Ionisation and Resonance Voltages of Gases

Gas.	Resonance Voltage.	Ionisation Voltage.
Li	—	5.36 Volts.
Na	—	5.13 "
K	—	4.13 "
Rb	—	4.16 "
Cs	—	3.96 "
Hg	4.86 Volts.	10.4 "
He	20.5 "	25.4 "
Ne	16.6 "	22.8 "
Ar	11.5 "	15.2 "
H ₂	10.1 "	17.2 "
N ₂	7.5 "	17.0 "
O ₂	8.0 "	14.0 "
S	—	12.2 "
I	—	10.1 "
CO	—	10.1 ; 14.3 "
ZnCl ₂	—	12.9 "
HgCl ₂	—	12.1 "

[Summarised from Franck, *Phys. Zeitschr.*, 22, 388, 1921 ; Hicks, *Phil. Mag.*, 45, 480, 1923 ; Horton and Davies, *Proc. Roy. Soc.*, 97, 1, 1920.]

Apart from ionisation by collision, gases can also be ionised by X-rays and light of short wave-length. Neither of the

methods, however, come within the subject of the use of gas discharges in valves.

If in a gas two ions of opposite sign approach each other to a distance comparable with their size, the mutual attraction becomes so great that they unite to form a neutral atom. This process is called "recombination." It is proportional to the square of the ionic concentration; because of recombination, not all the molecules of a gas are turned into ions when a constant source of ionisation is used, but a balance is created between the rates of ionisation and recombination.

The smaller is the velocity of the ions, the greater is the recombination; when the velocity of the ions is large, and therefore when the field is strong, the effect of recombination can be neglected. On recombination taking place, the energy, which had been stored by ionisation, is again released and is sent out in the form of radiation of a definite wavelength from the newly formed neutral atom. This radiation causes resonance in atoms of the same kind; it is absorbed by them and again produces excitation or ionisation. Final recombination only takes place when this energy disappears from the gas or is used up in doing other work.

CHAPTER III

Electric Conduction in Gases

A definite dissociation takes place in an electrolyte. If it be attempted to reduce this dissociation by the removal of ions, the electrolyte will produce new ions until its characteristic dissociation is again reached ; thus a constant and uniform density of ions is available for current conduction.

No marked dissociation can exist in a gas *per se* ; special sources of energy must be used and maintained. If these stop working recombination removes the ions again. Moreover, the ions are removed by diffusion from the place where they are produced. As soon as they meet an obstruction in their path they are held fast. They unite with ions of opposite charge to form neutral molecules. Therefore, in the conduction of electricity through gases the path of the individual particles is important for a knowledge of the processes involved. The arrangement of the walls bounding the gas also often has a decisive effect.

At atmospheric pressure, so long as the electric field is not extremely great, the negative ions in most gases consist of atoms, or molecules, or yet greater complexes, and have as a result a small mobility. Gas discharges at atmospheric pressure play only a small part in valve action.

The Electron Stream

With small pressures of the order of 1 mm. Hg. the negative ions are for the most part electrons, so that when a space is full of equal numbers of positive ions and electrons, the current is almost entirely carried by the much faster moving electrons.

A knowledge of the laws of electron currents in rarefied gases is therefore indispensable for an understanding of valve action.

With self-sustained discharges in gases, the number of ions supplied by the electrodes is proportional to the current density. Therefore the voltage drop is independent of the current strength, and also of the cross-sectional area, but it is proportional to the pressure. It obeys the simple law

$$e = \sigma_g \cdot l \cdot p \text{ volts} \dots \dots \dots (4)$$

where p is the gas pressure in mm. mercury.

σ_g the potential fall across a centimetre of path length at a pressure of 1 mm. Hg. and a standard temperature of 27° (300° Abs.); it will be called the "normal gradient."

Of course this law holds just as far as all the remaining parameters, especially the temperature, are constant, just as with Ohm's law. If the current warms the conducting gas, σ_g is altered just as much as the specific conductivity in Ohm's law is altered with the temperature.

To make clear the passage of electrons through a gas with a complete discharge (glow discharge or arc light), let us consider the following simple case:—

(1) The electrons can stream from a plane cathode to an anode parallel to it.

(2) The distance between the electrodes is very large compared with the mean free path of the electrons.

(3) As many positive ions as electrons are everywhere present per unit volume, so that no space charge exists.

Then there are two extreme cases possible for the electron stream.

Extreme 1.—The electrons collide with the gas molecules without loss of energy. They will then be reflected from the gas molecules in all directions and with equal velocity. The consequent electron motion can be split up into two components. One component has the direction of the field lines and is the carrier of the electric current. The other is perpendicular to the field lines and can be regarded as a diffusion of the electrons; it is, however, a diffusion process in which the diffusion constant is proportional to the field velocity of the electrons. The combination of the two com-

ponents gives the actual motion. The electrons in Extreme 1 endeavour to spread out sideways on their path from the cathode to the anode.

Extreme 2.—The electrons lose all their field energy at each collision with the gas molecules. In this case, if the field energy gained in a free path is large compared with the energy of thermal agitation, they travel only in the direction of the field lines ; there is no lateral diffusion. The current travels with constant width from the cathode to the anode.

The first extreme is approximated to with monatomic gases below the lowest resonance potential ; this approximation is the closer the greater is their atomic weight.

The second extreme is approached with gases, as for instance chlorine, which have a strong electron avidity, and also with electron-catching compounds, like water vapour.

The Cation Stream

The collisions of the cations with the gas molecules are of the kind that take place between two equally massive bodies. If the collision is head-on the colliding cation will lose its entire velocity ; if it is tangential there will only be a slight alteration of direction. We may therefore say without closer analysis that the deviation by collision of the cations from the direction of the field lines is much smaller than that of the electrons in Extreme 1. On account of their greater mass their diffusion coefficient is much smaller than that of the electrons. As a consequence the cations do not diffuse in a direction perpendicular to the lines of force as much as the electrons. On the whole the cations travel across from anode to cathode in a stream of constant cross section. As soon as the electrons spread out sideways from the cross sectional area of the cation stream, a negative space charge is created. This speeds up the cations and slows down the electrons so that both eventually travel at the same speed. Exactly similar conditions prevail when hydrochloric acid diffuses through water, the hydrions first diffuse quickly, but in so doing they create a space charge which decreases their speed and accelerates the chlorions till both the hydrions and chlorions travel at the same speed.

The ion distributions are represented schematically in Fig. 4, according to the above considerations. As is customary with metals and electrolytes, the discharge usually occurs in an enclosed space, such as a cylinder W . Fig. 4 shows that when the diameter of the cylinder is small compared with a , the wall of the cylinder has a great effect through absorption and neutralisation of the ions. Even if the diameter of the cylinder is made equal to a , it will still cause a disturbance in Extreme 1; in Extreme 2, however, it will produce no effect.

In reality, Extreme 2 is never attained. The sides of the

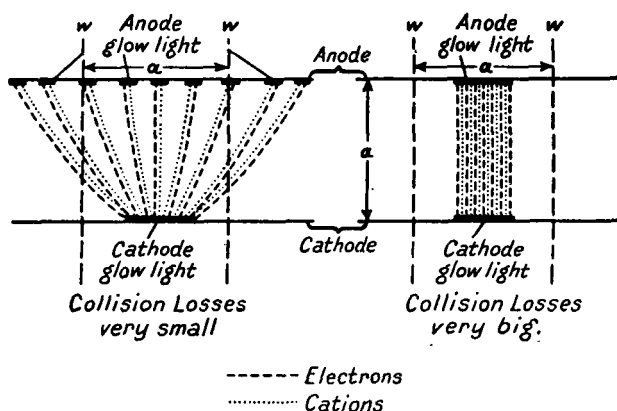

FIG. 4.—Lines of Flow of Electrons and Cations between Plane Parallel Electrodes.

vessel are always neutralising the ions, and this process becomes more and more pronounced as the current approaches Extreme 1, *i.e.*, the smaller are the energy losses of the electrons.

In a steady state every pair of ions neutralised must be replaced, and the potential difference across the gas will grow till, through electron collisions, as many new pairs of ions are produced as disappear.

The number of ions reaching the sides is dependent on the current strength, and therefore on the potential difference. This again increases the temperature of the gas, and this alters the free path of the molecules, which alters the

potential difference in the reverse direction. Moreover, as the losses increase the character of conduction approaches Extreme 2, and the result is a mix-up of contrary factors which it is very difficult to express in any law. Therefore, as a further consideration, we will assume that the sides of the containing vessel are so far apart that they cause no interference, and that the rise of temperature caused by the current can be neglected.

The table of energy losses on p. 7 shows that these losses are negligibly small, provided the number of collisions is not too great. We can therefore assume that in gases in which purely elastic collisions take place, the velocity of the electrons corresponds to the total potential difference through which they have fallen.

Such a case, however, rarely occurs in a glow discharge. If a glow discharge takes place we have to deal with thousands of collisions (except perhaps in the mercury arc at low pressure) in 1 cm. along the direction of the field lines. This is also true of gaseous conduction in general. In this case there appears even after a short distance a constant average electron velocity V and a velocity of progression u in the direction of the electric field, proportional to the field strength.

Now if X is the strength of the electric field,
 m the mass of an electron,
 λ the M.F.P. of an electron,

the acceleration of an electron along the field lines is given by Xe/m , so that

$$u = \frac{Xe}{m} \cdot \frac{\lambda}{V} \text{ cms/sec} \quad (5)$$

The electron takes a time, $t = \frac{1}{u}$ secs. to traverse 1 cm. Since its uncontrolled velocity is V , it will in time, t , travel a distance

$$b = Vt = \frac{V^2}{e/m X\lambda} \text{ cms.} \quad (5a)$$

If this distance be divided up into mean free paths, the

number of collisions which the electron undergoes in 1 cm. is obtained. Therefore

$$N = \frac{V^2}{e/mX\lambda^2} \dots \dots \dots (6)$$

The K.E. of an electron is $\frac{1}{2}mv^2$. At each collision it loses a fraction α of this energy. On the average an equal amount of energy α must be gained between two collisions through the field acceleration, as V remains constant.

Therefore $\frac{1}{2}mv^2\alpha = Xe\lambda = \frac{Xe}{N} \dots \dots \dots (7)$

which on transposition gives

$$V = \sqrt{\frac{2eX}{m.N.\alpha}}$$

substituting for N from (6) we get

$$V = \sqrt{\frac{e}{m}} \frac{X \lambda}{\alpha} \sqrt{\frac{2}{\alpha}} \dots \dots \dots (8)$$

The greater is V in comparison with u , the greater is the diffusion of the electrons to the sides. The quotient V/u can therefore be taken as a measure of this diffusion.

Equations (4) and (5) give

$$\frac{V}{u} = \sqrt{\frac{2}{\alpha}} = \sqrt{\frac{m}{m_1}} \dots \dots \dots (9)$$

The lateral diffusion is therefore dependent only on α and not on the field strength.

The product $X\lambda$ was called by Gehlhoff the free path gradient g . The value of this conception is that it relates the voltage loss in the gas to the mean free path and thereby forms a basis for the comparison of different gases. In making use of this conception, however, we must not forget that it is only identical with the potential difference across a mean free path in the unattainable case of Extreme 2. If the electrons collide with the gas molecules almost without loss of energy they will, on the average, undergo many collisions in travelling one mean free path in the direction of the field.

The collected averaged values of σ_g and g for different gases are as follows :

TABLE II

Gas.	σ_g	g
Ar	1.04 v/cm.	0.0305 volts.
He	0.80 "	0.066 "
Ne	0.493 "	0.0277 "
N ₂	3.25 "	0.088 "
H ₂	2.23 "	0.115 "
O ₂	13.1 "	0.38 "
H ₂ O	50.0 "	0.93 "

From this the values below were calculated straight away for the inert gases. With the other gases it is necessary to assume that the conduction-velocity of the electrons amounts to the same fraction of the velocity necessary for ionisation as with the inert gases.

TABLE III

Gas.	$\frac{V}{U}$	U cms/sec	N	Degree of Dissociation.
He	86	1.14×10^{-6}	1080	2.0×10^{-9}
Ne	193	0.50×10^{-6}	3500	7.8×10^{-9}
Ar	271	0.45×10^{-6}	9300	6.7×10^{-8}
N ₂	94	1.3×10^{-6}	3500	6.4×10^{-8}
H ₂	32	2.5×10^{-6}	620	7.6×10^{-9}
O ₂	37	4.3×10^{-6}	1300	2.8×10^{-8}
H ₂ O	15	10.4×10^{-6}	800	3.5×10^{-9}

The table shows that the electrons follow a very round-about course through the gas. The degree of dissociation in the glow discharge is extremely small, since only one pair of ions exists in a milliard gas molecules.

Of greater importance for the understanding of self-supported discharges in gases is the action of impurities

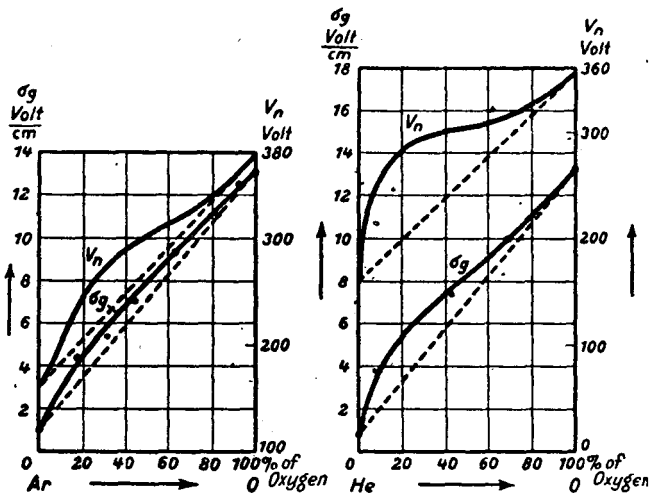

FIG. 5.—Variation of Normal Cathode Fall V_n and Normal Gradient σ_g with Constitution of Mixtures of Argon and Oxygen.

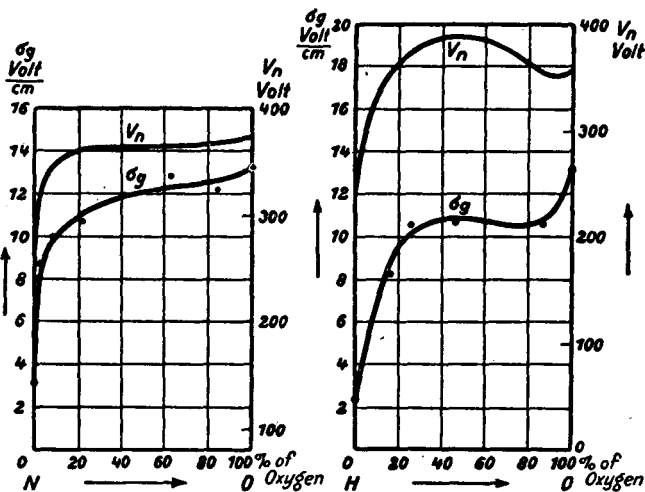

FIG. 6.—Variation of Normal Cathode Fall V_n and Normal Gradient σ_g with Composition of the Mixtures O_2-N_2 and O_2-H_2 .

on the normal gradient σ_g . Figs. 5 and 6 show the alteration in σ_g produced by the addition of oxygen to other gases to form a mixture ranging from pure gas to pure oxygen.

Apart from the little-used halogens, oxygen has the strongest action of all gases.

It will be seen that small quantities of the impurity oxygen increase σ_g most with gases which combine chemically with oxygen. Therefore small quantities of oxygen in argon and helium only influence σ_g a little, but with hydrogen the effect is important and with nitrogen very marked.

On the other hand (as is shown in Fig. 7), with two gases which do not react chemically with other, as, for instance,

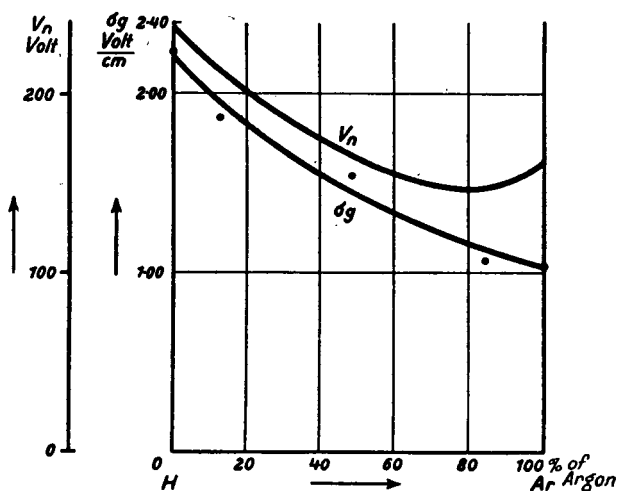

FIG. 7.—Variation of Normal Cathode Fall V_n and Normal Gradient σ_g with Composition of the Mixture of H_2 -Ar.

hydrogen and argon, σ_g changes uniformly from one value to the other.

The values given above for σ_g are limiting values which are obtained when neither the disturbing effect of the sides of the containing vessel are present nor the temperature of the gas is raised. In practice these two requirements are seldom fulfilled.

The action of the sides of the vessel in raising the voltage has already been referred to. The smaller the cross section of a tube the greater is the voltage per centimetre necessary for a discharge to take place.

The rise of temperature of a gas depends first upon the current density, and secondly on the gas pressure. The potential difference per centimetre is directly proportional to the gas pressure, while the heat conductivity of gases is unaffected by the pressure.

A rise of temperature causes an alteration of the form of discharge, so that the arc path is differentiated from the so-called positive column. The difference between the two discharges is therefore not one of principle, but only a gradual change brought about by an alteration of current density.

In order to understand this let us consider the phenomena which occur when an arc is formed in a big glass sphere full of mercury vapour. The following cases can be distinguished :—

(1) Mercury vapour pressure very small. The electrons only have a small number of free paths in the distance AK, so that their lateral diffusion is small. The current distribution is actually the same as the

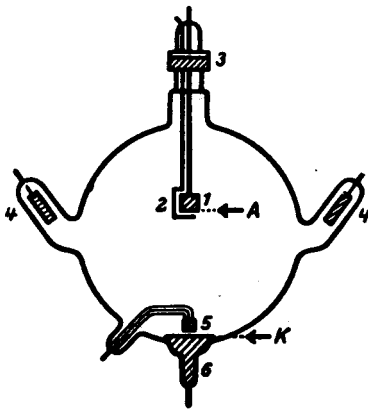

- 1. Anode
- 2. Special conductor to anode, insulated with glass and asbestos. (not shown)
- 3. Anode lead-in with mercury seal.
- 4. Carbon anodes.
- 5. Starting anode.
- 6. Cathode.

FIG. 8.—Large Spherical Vessel for the Elimination of Wall Disturbances.

field line distribution (Fig. 9). At K is situated the light cathode spot (see p. 55), and at the anode a narrow luminous zone. In between these the discharge is completely non-luminous, because the electrons in consequence of the very small voltage drop, do not attain to the necessary resonance potential of 4.68 volts.

(2) Medium vapour pressure. The electrons have a considerable number of free paths between AK. The loss of energy through collision causes a marked heating of the gas. The temperature is highest in the axis of the discharge,

where the current density is the greatest. Consequently in this axis we have the smallest gas density, greatest mean free path, and smallest voltage. Due therefore to this heating there is a tendency for the current, under the lowering of the voltage, to close up into a thread.

This tendency is opposed, at a certain diameter of the discharge dependent on the pressure gas and current strength, by the heat conductivity. The higher the temperature of the current thread rises, the more heat is withdrawn from it by conduction, and this withdrawal increases even faster than the temperature, because the heat conductivity itself rises with temperature.

Therefore, with medium gas pressures there arises a well-defined arc discharge of fixed diameter, which is the smaller the higher the gas pressure chosen. If the arc discharge takes place in a tube, which has a smaller diameter than the free-burning arc would have had, it fills the whole cross section of the tube uniformly. If, however, by a rise of pressure its proper diameter is lowered below that of the

tube, it detaches itself from the sides of the tube and forms a light rod round the axis of the tube.

Table XV. serves as an illustration of this behaviour in pure Hg vapour. The values given were obtained by measurements in the big glass sphere of 40 cms. diameter (shown in Fig. 8), while it was in a heat jacket.

The closing up of the current to a thin rod at high temperature, small gas pressure, big mean free path, and low field strength has another consequence, as shown in Table XV. Those electrons and positive ions which through diffusion pass outside the current rod into the surrounding colder

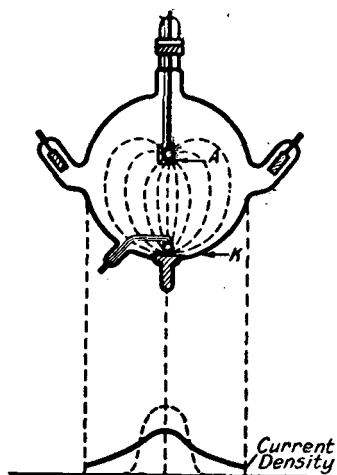

FIG. 9.—Current Lines of an Arc in a Large Vessel containing Pure Mercury Vapour.

and therefore much denser gas become, so to speak, stuck on account of the smaller field strength ; they then disappear through recombination. In order to make up for the loss of charge thus caused, the field strength must rise until ionisation produces as many pairs of ions as disappear by recombination. The molecules are therefore excited and the discharge consequently becomes luminous as soon as any marked contraction takes place. This is clearly shown in Table XV. The cold gas surrounding the arc rod has therefore an effect which is similar to, but milder than, the walls of the containing vessel. Further details of the arc discharge will be given when discussing mercury arc rectifiers.

CHAPTER IV

Actions at the Anode

It is a paradox of gas discharge rectifiers that while the seat of the valve action is the anode of the permeable direction, it is the cathode which is the decisive factor when discussing the nature of the valve, and the cathode has no valve action. It is probably best to begin a consideration of the actions at the anode with a review of the processes occurring in mercury arcs.

(1) In the positive column of the mercury arc there are equal numbers of positive ions and electrons per unit volume.

(2) Owing to their greater velocity, a much larger number of electrons stream through a given cross section in a given time than positive ions.

(3) The degree of dissociation in the positive column is of the order of 10^{-4} at small mercury vapour pressures. The mean free path of the electrons, on the other hand, is of the order of 1 cm. As a result the rates of recombination and ionisation are exceedingly small. With sufficiently wide tubes the current, as Schottky suggested, is really a stream of electrons going from cathode to anode.

(4) The ionisation voltage of unexcited mercury atoms is 10.4 volts ; if the atom or molecule has already been excited, the voltage necessary to cause ionisation will be the smaller the stronger was the excitation. This excitation can take place equally well by electron collisions or by the reception of quanta through resonance radiation from other atoms. The lowest point of excitation corresponds to 4.68 volts, and as long as the electrons have not attained this velocity neither excitation nor ionisation can take place. When the excitation is sufficiently strong, ionisation can begin at a little over 4.68 volts.

Several conclusions about the anode fall may be drawn

from these facts. Suppose that the ionisation were as small at the anode as in the positive column, *i.e.*, practically negligible. The positive ions would stream away from the anode and a zone of negative space charge would be set up in the neighbourhood of the anode due to the preponderating number of electrons. The thickness of this zone and the value of the space charge would increase until ionisation by collision produced as many positive ions as were used up in the positive column. According to Schottky's hypothesis, one positive ion would be formed for every 400 electrons reaching the anode.

The anode fall is therefore the voltage drop produced by a negative space charge. This space charge causes the necessary number of positive ions to be formed. Thus we arrive at the following conclusions about the dependence of the anode fall on the various variables.

A. Dependence on Mercury Vapour Pressure

The pressure of the mercury vapour acts in three different ways.

(a) The space charge zone must be wide enough for at least one out of every 400 electrons to be able to collide with and ionise a mercury atom. Therefore the zone must become wider as the number of mercury atoms per unit volume is decreased, or, in other words, as the pressure is reduced at a given temperature. If therefore the intensity of excitation is so small as to be ineffective, the anode fall grows in comparison with the widening of the space charge zone, as the pressure is decreased, from the minimum value of 10·4 volts to higher values.

(b) The smaller the dissipation of the exciting energy the greater is the intensity of excitation at the anode. This dissipation is caused by diffusion of quanta and excited mercury molecules; both these causes become less important as the pressure of the mercury vapour is reduced. Therefore, the greater the vapour pressure the more is the anode fall decreased below the value given in (a).

(c) The bigger the current density the greater is the intensity of excitation at the anode. Since the anode fall

decreases with a rising intensity of excitation, it is to be expected that the area of anode surface covered by the current stream will decrease until maximum excitation is attained, *i.e.*, until that value is attained close above 4.68 volts at which ionisation is still possible.

A closer analysis shows, however, that this concentration of current at the anode is only possible with a sufficient mercury vapour pressure. Fig. 10 shows the distribution of the field lines between cathode and anode at the beginning

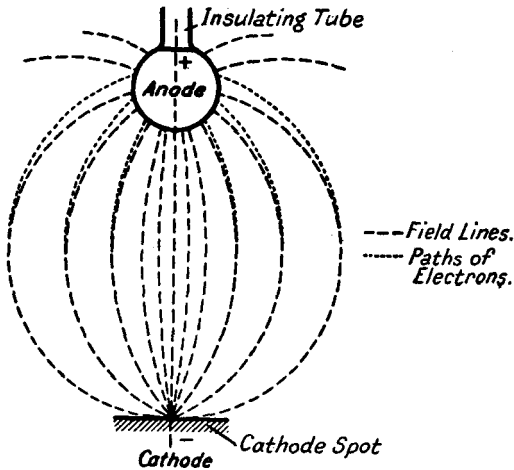

FIG. 10.—Field Lines and Electron Paths in a Mercury Arc in a very large vessel.

of the discharge. If the electrons follow these field lines, the highest current density, the strongest excitation and the lowest anode fall exist along the axis; a further concentration of current therefore takes place. However, the electrons only follow the field lines so long as their mean free path is small in comparison with the curvature of these field lines. If they have a big mean free path they go off in a direction tangential to the field lines. A glance at Fig. 10 shows that this action opposes the concentration of the current into the axis. Therefore the anode fall rises with decrease of gas pressure because the concentration of the current on a given

spot, and with it the intensity of excitation, decreases with decreasing gas pressure.

B. Dependence on the Shape of the Electrodes

How far the current can concentrate on a spot and how strong the intensity of excitation may become depends also on the shape of the electrode. Electrodes with a convex surface favour the dissipation of energy and therefore increase the anode fall; concave surfaces act in the opposite way. It is possible to alter the anode fall considerably by altering the form of the electrode.

C. The anode fall is independent of the temperature of the anode

D. Dependence on the Material of the Anode

Since the intensity of excitation depends on the facility with which the resonance radiation is absorbed by the surface of the electrodes, the anode fall must depend on the material of the anode.

E. The Anode Fall is Independent of the Current Strength

As a summary it may be said: if the intensity of excitation is negligibly small the anode fall decreases down to a little more than 10·4 volts with rising pressure; after reaching this value it becomes independent of the pressure. If, however, maximum excitation exists, the anode fall decreases with rising pressure to somewhere about 4·68 volts and then remains constant. The boundaries of the anode fall are given schematically by the two curves in Fig. 11. At what point it lies between the two curves, at any given mercury vapour pressure, depends on the intensity of excitation, and therefore on the shape and material of the anode.

It must be borne in mind that all the above statements hold only if the electrons arrive at the anode with small velocities. If their velocity is forced up by such methods as enclosing the arc in a narrow space, then the anode drop has only to supply them with a small increase of velocity; the

anode drop will then be small. Since the velocities of the electrons are distributed according to Maxwell's law, and as only 1 out of 400 causes ionisation, the anode fall may thus be reduced to zero.

The addition of foreign gases produces the same effect as an increase of pressure and a simultaneous weakening of the intensity of excitation; the anode fall therefore rises.

All the effects described above for the particular case of mercury vapour apply equally to other gases, but since as a

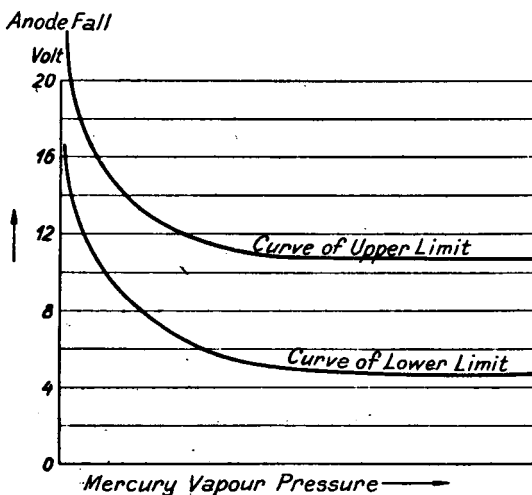

FIG. 11.—Dependence of Anode Fall on Mercury Vapour Pressure.

rule their resonance and ionisation voltages are a little higher than those of mercury, the curves of the anode fall are also higher. In the case of a glow discharge in which the current strength is so small that the resonance radiation is insufficient to lower the anode fall, one can reckon on an anode fall of 20 to 30 volts. At higher current densities the anode fall decreases to a greater or lesser extent according to the nature of the gas.

The anode fall is only of secondary importance in valve action, it decreases the effectiveness of the valve through the energy loss caused by heating of the anode [the anode

is also heated by the heat of neutralisation of the charge of the electrons, apart from the heat due to their kinetic energy]. With insufficient precautions the anode may even become white hot, and then the arc will "strike back" and the impermeable direction will become permeable.

CHAPTER V

Actions at the Cathode

At the cathode of a valve during its permeable cycle we have to consider the different methods of producing the electrons which are necessary for the conduction of the current to the anode. Below are three usual methods :—

- (1) Photoelectric electron production.
- (2) Thermionic electron production.
- (3) Electron production through self-supported discharge.
 - (a) Glow discharge.
 - (b) Arc discharge.
 - (c) Spark discharge..

(1) Photoelectric Production

The photoelectric effect is the name given to the process of releasing electrons from metals by the influence of light rays. The more electropositive the metal, the more pronounced is the photoelectric effect. A physical picture of the phenomenon may be obtained by supposing that the electrons, which in the strongly electro-positive metals are only loosely bound to the atoms, are set into resonant oscillations by the light waves. [Although this is a convenient physical picture it is not meant to be in accordance with modern physical conceptions.—*Trans.*] These oscillations become so strong that the electrons fly away from the atom and, when they reach the surface of the metal, out of the metal. The velocity which they thus obtain corresponds to a voltage of from 0-4 volts. Thus not only does the photoelectric production of electrons at the cathode not use up any voltage, but the electrons add an extra voltage which they receive from the energy of the rays falling on the cathode.

The alkali metals are the most photoelectrically active

of all the metals. In order to make the most of their activity, they are used in the form of a thin layer in very pure helium or argon.

By using a photoelectric alkali electrode and a photoelectrically inactive electrode (such as iron) in one of the rare gases at a low pressure, a photoelectric valve can be obtained. In the permeable direction (alkali metal as cathode) not only is no voltage necessary to make a current flow, but a voltage of 4 volts already exists. Therefore there is only the small voltage drop in the gas and the anode fall to be made up. In the resistant direction the cell will be permeable if the normal cathode fall of a rare gas and an iron cathode is exceeded; this is about 180 volts. A glow discharge then sets in which can be made very slight by making the area of the iron electrode small. Thus valve action can be obtained above the normal cathode fall. Such a valve, however, is of no use for strong current work, since it only allows small currents to pass.

(2) Thermionic Electron Production

Electrons in the inside of a metal are more or less free to move and have a velocity corresponding to the absolute temperature. Because of this they can rise above the metal surface, but at room temperature they can only rise through an extremely small height. Thus every metal is covered by an outer electron cloud which with present means cannot be detected. The electron velocity increases with the temperature, and this causes the density and thickness of the cloud to grow. Eventually the velocity of the fastest electrons becomes so great that they overcome the attraction of the atoms at the surface and finally leave the metal. The number of electrons thus released increases rapidly with the temperature, and at white heat becomes considerable. But while with other methods of electron production gas molecules must always be present, the thermionic electron emission only takes place properly in the highest vacuum. This is a great benefit since the second cold electrode can stand the highest tensions in the impermeable direction, without allowing any current to pass, since nothing is present

to cause an escape of electrons. The laws of thermionic emission were formulated by Richardson.

If an electrode in a high vacuum sends out thermionic electrons, the surrounding space becomes negatively charged. The electric field thus set up increases until no further electrons can escape from the metal, and all are sent back by the field into the metal. However, if the electrons situated in the space are removed by a second and positively-charged electrode, new electrons can flow. That is to say, when the voltage between the two electrodes increases, the current also increases in the permeable direction until finally, at a given temperature, all the electrons emitted reach the other electrode. The current strength cannot increase further. The saturation current I_s is attained. According to Richardson, it is given by

$$I_s = a.F. \sqrt{T}. \epsilon^{-b/T} \dots \dots \dots (10)$$

where F = area of cathode.

T = Abs. Temp.

b = a constant dependent only on the nature of the thermionic electrode.

For tungsten, according to Langmuir, $a = 2.36 \times 10^7$ and $b = 5.24 \times 10^4$. When the current is not saturated the current density I between two plane parallel electrodes d cms. apart is given by equation (11) below, if it is assumed that the electrons have no velocity on leaving the thermionic electrode.

$$I = \frac{\sqrt{2}}{9\pi} \sqrt{\frac{e}{m}} \frac{V^{3/2}}{d^2} \dots \dots \dots (11)$$

where e is the charge, m the mass, of an electron, and V is the voltage between the two electrodes, all values being in E.S.U.

Expressed in amperes and volts, this becomes

$$I = 2.37 \times 10^{-5} \frac{V^{3/2}}{d^2} \dots \dots \dots (12)$$

According to some new work of Langmuir's,* however, an error of up to 30 per cent. results from assuming that the

* *Phys. Rev.*, 21, 419, 1923.

electrons have no initial velocities. The exact but rather complicated formula which avoids this error is given in his paper.

If the thermionic electrode is a straight wire of length l inside an encircling anode of radius R , the total current (not the current density) is given by

$$I = \frac{1.5 \times 10^{-5} l \cdot V^{3/2}}{R} \dots (13)$$

if I and V are measured in amperes and volts respectively ; this equation only holds when the ratio of the anode radius to the filament radius is greater than 10 : 1. For smaller ratios a correction must be applied. Therefore the temperature, and in the last example also the nature of the thermionic electrode, have little influence on the current I . The thermionic valves made according to these principles are used for high voltages. On the other hand, it is very difficult to use them for big currents because no material exists which can stand a temperature high enough to cause the emission of the necessarily great quantity of electrons per unit area. One is therefore compelled to make the thermionic cathode very large if one wishes to work with big currents. The potential drop in the permeable direction is moreover proportionately high. Since the current consists only of negative electrons, a negative space charge exists in front of the cathode. The electrons coming out of the thermionic cathode have to move against this space charge. To enable them to do this a voltage is employed which is the higher the greater is the space charge, *i.e.*, the greater is the current density.

TABLE IV

V	R = .1 cm.	R = 1 cm.	R = 10 cms.
10 volts	.047 amp.	.0047 amp.	.00047 amp.
100 „	1.5 amps.	.15 „	.015 „
1,000 „	47 „	4.7 amps.	.47 „

Table IV. shows how greatly such a space charge hinders the flow of current. It gives the current in amperes which flows from a cathode 10 cms. long to an encircling anode of radius R and at voltage V . The temperature of the cathode was so high that in no case was the saturation current attained.

Only when the anode and cathode are very close together is it possible to obtain measurable currents without great voltage loss, if the cathode emits sufficient quantities of electrons. Therefore, pure thermionic cathode valves have as yet only found application in high-frequency work, in which very small currents are dealt with. Should it be required to use the thermionic cathode as a strong current valve, it is essential to fulfil the following injunction: get rid of the space charge by the production of positive ions!

The elucidation of these laws of the thermionic emission of electrons from pure metals is one of the successes of the last few years. Long ago Wehnelt* found out that cathodes which were covered with oxides of the earth metals give off great quantities of electrons at relatively low temperatures without the vacuum being especially high: Wehnelt, in his first experiments, succeeded in sending a current of 1 amp. at a voltage of 110 volts through a discharge tube with a thermionic cathode. The space charge was removed through ionisation by collision in the gas-filled discharge tube.

Since the oxide was disintegrated by the discharge, it had to be continually renewed. Lately an oxide mixture has been discovered which disintegrates only slightly so that only a small quantity is sufficient, without any peeling of the material occurring.

With the Wehnelt valve the electrons emerge with a remarkable velocity which corresponds to about 2 or 3 volts, so that when only small currents are needed the cathode receives a voltage of this amount. With higher loads a slight additional voltage of 3 volts must be used to draw the necessary quantity of electrons from the cathode. A thin platinum strip was first used as a heating base for the oxide, nowadays pure iridium is used. It is sufficient to heat the oxides to a yellow glow.

* Wehnelt, *Ann. Phys.*, 14, 425, 1904; 16, 80, 1905.

TABLE V

*Saturation current density in 10^{-8} amps./sq. cm. from glowing oxides. According to F. Jentsch.**

Oxide.	800° C.	1,000° C.	1,200° C.	1,400° C.
CaO	6.94	2840	—	—
BaO	2.10	1080	—	—
SrO	.11	86.8	—	—
Y ₂ O ₃	.13	28.8	1420	—
ZrO ₂	—	7.8	410	—
CeO ₂	—	1.53	85.7	—
La ₂ O ₃	—	.29	17.9	—
ThO ₂	—	—	4.51	—
BeO ₂	.31	25.3	356	—
CuO	—	—	3.08	21.5
CdO	—	—	1.75	22.1
CoO	—	—	.45	27.5
Fe ₂ O ₃	—	—	.30	9.83
NiO	—	—	—	5.87
Al ₂ O ₃	—	—	.25	5.48
MgO	—	—	—	978
ZnO	—	—	—	.95

Formerly, Wehnelt cathode tubes were given the highest possible vacua, in order that the electrons might reach the anode without difficulty. Later it was realised that it was just the Wehnelt cathode which offered the opportunity of removing the space charge, which is such an inconvenience with the tungsten glow cathode. If the valve be filled with an easily ionisable gas, like argon or neon, as many positive as negative ions are formed by collision, the space charge disappears and with a small voltage drop strong currents can be sent through the valve. Consequently rectifiers for low or medium voltages are filled with argon, while neon is used for high voltages. Unfortunately the gases are eventually absorbed by the glow discharge flowing in the

* Inaug. Diss., Berlin.

impermeable direction, and thus a limit is set to the length of life of the rectifier.

Therefore the gas pressure is made as high as the danger of "striking back" permits, from about 4 mm. pressure at low voltages, down to fractions of a millimetre at high voltages. Consequently the high-voltage rectifiers have a considerably shorter life than those for low voltages.

Sometimes a small quantity of mercury is also put into the valves. The mercury vapour thus formed has the valuable property of a very high cathode fall at very low glow current strengths, so that the losses are greatly lowered in the permeable direction. Further, the impoverishment of the gas ceases. But on the other hand we have the drawback that these rectifiers when cold are very difficult to start on account of the low mercury vapour pressure.

Both electrodes, the tungsten as well as the Wehnelt cathode, have the drawback that they need a special source of energy to heat them up to the necessary temperature.

The actual seat of the valve action, the cold electrode, consists either of a cylinder in which the hot wire is concentrically fixed, or of two plates on each side of the zig-zag shape wire. In Wehnelt valves the anode is usually a steel rod.

(3) Production of Electrons by Self-supported Discharge

(a) *Glow discharge*

The self-supported discharge is the most important method of freeing electrons from a cathode for valve purposes. Glow, arc and spark discharges are distinguished from each other by the processes that occur in the discharge. In Fig. 12 K is a spherical cathode which may be, for instance, of iron. A is the anode, and the sides of the vessel are so far distant that they do not interfere with the phenomena. To fix our ideas we will suppose the gas to be nitrogen at 1 mm. pressure. The discharge tube is connected in series with a rheostat r to a variable voltage source V , and the voltage is gradually raised from zero. As long as the voltage lies below a definite minimum value, V_0 of about 300 volts,

no noticeable current flows through the vessel. As soon as this value is reached the current jumps suddenly to a value dependent on the resistance r . If r is so chosen that this current is very small, part of the surface of K is covered with a luminous patch; if the current is increased the patch grows out towards the sides without change of structure, until at a certain current-strength it covers the whole surface. The following layers can then be distinguished, as shown in Fig. 12:—

- (1) A very thin glow layer, d_1 , lying directly on the sur-

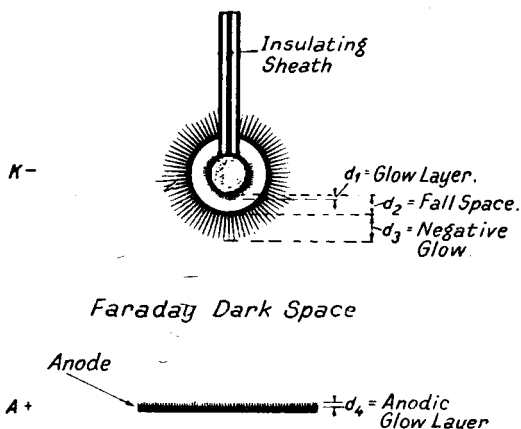

FIG. 12.—Cross-sections of Glow Discharge in a Large Vessel.

face. Its outer boundary is difficult to fix, since its luminosity disappears gradually with increase of distance from the surface. This is the cathode glow.

(2) Joined to this is a zone which is almost without luminosity. This is the Hittorf or Crookes dark space. The cathode glow + non-luminous zone are called the "fall-space" d_2 .

(3) Next to the Hittorf or Crookes dark space, and rather sharply defined from it, is another luminous zone, the negative glow. Its luminosity also decreases to zero without forming a sharp boundary towards the anode.

(4) Next to this is an absolutely non-luminous space.

This is the Faraday dark space, and in Fig. 12 it reaches right to the anode on which there is a thin glow layer, d_4 , the anode glow layer. At higher pressures and current strengths this glow layer develops into a so-called positive column, which under certain conditions split up into a number of luminous striations. The mechanism of conduction is as follows :—

From the anode glow positive ions or cations are sent out through the fall space to the cathode. The fall space is the seat of a high potential drop of about 300 volts. In passing through this the cations gain a big velocity, which is partly lost by collisions with gas molecules. Those which arrive with the greatest velocity at the cathode are able to free electrons from it. These electrons travel in the opposite direction, from the cathode to the anode glow ; they also collide with the gas molecules, but less frequently because of their bigger mean free path. Thus they produce cations, as well as new electrons, partly in the fall space and partly in the anode glow. The strength of the electric field is made up at any point by the sum of the actions of the anions and cations at that point. The field in the negative glow is known from the measurements of Brose. To be sure, Brose's measurements were made in the abnormal cathode fall with voltages of several 1,000 volts, but as there are no better measurements available at the moment, and as there are no reasons why the field distribution should differ from that of the normal cathode fall, they may be used as a basis for the following discussion. The field distribution measured by Brose in the normal cathode fall of hydrogen is shown in Fig. 13. Apart from the field strengths, the potential in the fall space is also given in Fig. 13.

The glow discharge can only be correctly understood by tracing the paths of an electron and a cation through the fall space. Unfortunately, to do this it is essential to have a knowledge of certain processes which have only been studied very scantily. The following remarks are therefore only to be regarded as preliminary :—

1. *The motion of the electrons.* In order to get convenient figures we will assume that at a given time 1,000

electrons leave the cathode. They begin their journey with a small initial velocity which can be neglected in comparison with the greater velocities afterwards attained. After they have covered a space of $\cdot 3$ mm. they reach the excitation velocity of the hydrogen of 10·8 volts. Up to this distance they have made almost elastic collisions with the gas molecules, and indeed 520 such collisions have taken place. Since the electrons were reflected at these collisions they diffuse in all directions; the electrons therefore spend a

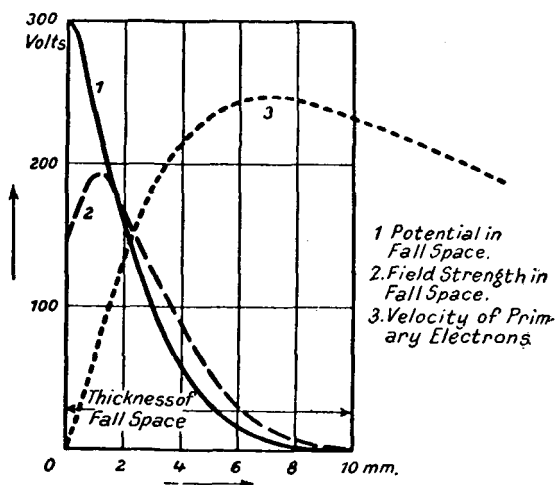

FIG. 13.—Voltage Curves in the Fall Space of the Glow Discharge.

considerable time, and make a large number of collisions, in this zone.

Since now their contribution of charge to the total field is inversely proportional to their velocity, and the time spent in a given section is directly proportional, the cations form in the first zone a relatively strong negative field.

As there is no excitation in this zone, it is completely non-luminous, so long as radiating gas from other sections does not diffuse through and thereby cause luminosity, as is the case, for instance, with nitrogen. This first very narrow dark space is the wider, the higher is the resonance voltage

and the smaller the potential fall in the glow light. It is therefore the widest in He and was first discovered in this gas by Aston.*

Further on in their path the velocity of the electrons rapidly increases. At .4 mm. distance they attain the ionisation voltage. For every millimetre of their path they make 1,730 collisions with the gas molecules. With increasing electron velocity these collisions change their character, however, in various ways.

(1) The greater the velocity attained, the more the excitation decreases in comparison with the ionisation; so that with velocities of 100 V and more excitation can be neglected at the first approach of ionisation. Therefore the fall space is comparatively weak in light.

(2) The scattering of the electrons by diffusion in consequence of collisions decreases with increasing velocity. With velocities of the order of 100 V. the great majority go straight from the cathode surface to the glow light.

(3) When the ionisation velocity has been attained a certain fraction α_1 of the collisions lead to ionisation. This ionisation function α_1 is of great importance in the discussion of the processes at the cathode. It has been investigated by Hughes and Klein; their results are shown in Fig. 14. In Fig. 14 (a) η_i is the number of pairs of ions produced by an electron at different velocities in a distance of 1 cm. in a gas at 1 mm. pressure. Fig. 14 (b) gives the fraction of collisions leading to ionisation; the results of Fig. 14 (b) are obtained from those of Fig. 14 (a) by assuming a value for the mean free path of the electrons.

With the help of these three facts we can calculate approximately how many new electrons are produced in the fall space from the 1,000 original electrons. The number of electrons is constantly increasing from the cathode to the glow light. The biggest increase takes place in the number of slow electrons because the nearer the electrons are produced to the glow light the smaller is the potential fall through which they have to pass.

* *Proc. Roy. Soc.*, A80, 45, 1907.

This rapid increase of slow electrons in the neighbourhood of the glow light will now once again increase the number of slow electrons reflected by collision with the gas molecules. The smaller their velocity becomes the greater will be the excitation, as distinct from ionisation, that they cause; eventually their velocity is no longer sufficient to cause ionisation. This collision process makes it intelligible, that at a definite place in the cathode fall the very small light intensity jumps suddenly to a high value, so that the glow light has a sharp boundary. At the same time the negative

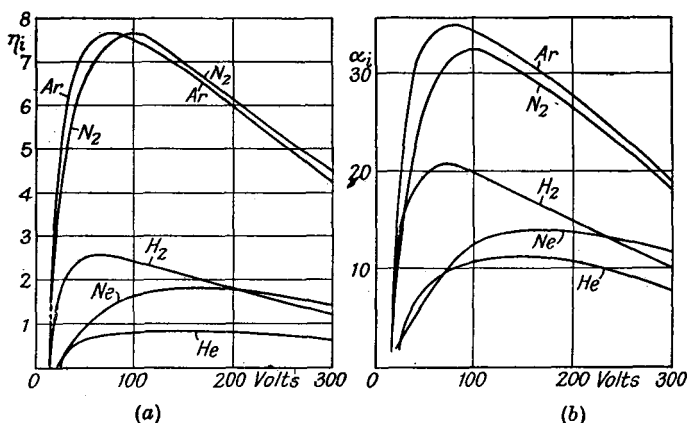

FIG. 14.—Curves obtained by Hughes and Klein, showing η_i the number of pairs of ions produced by an electron per cm. (at 1 mm. pressure) and α_i the percentage of ionising collisions.

field produced by the electrons is increased strongly; in Fig. 15 it has, therefore, a sharply-bent shape.

2. *The cation movement.* Our knowledge of the movements of the cations is unfortunately as scanty as that of the electron motion. We can only say:

(a) The collisions with the gas molecules take place between two equally massive structures. If the collision is central, the colliding cation loses its entire velocity; if it is tangential the loss of velocity, and also of direction, is small. If one integrates over all angles of collision, not forgetting the fact that directly after collision the cation again comes

under the action of the strong field, one finds that on the average there is only a small deviation of the cations from the direction of the field accompanied by considerable loss of average velocity.

Still, the average velocity of the cations, on their way from the anode glow light to the cathode, increases considerably. The field-forming action of the individual cations is therefore strong. But, on the other hand, the number of cations, due to the production of cations by electrons, increases

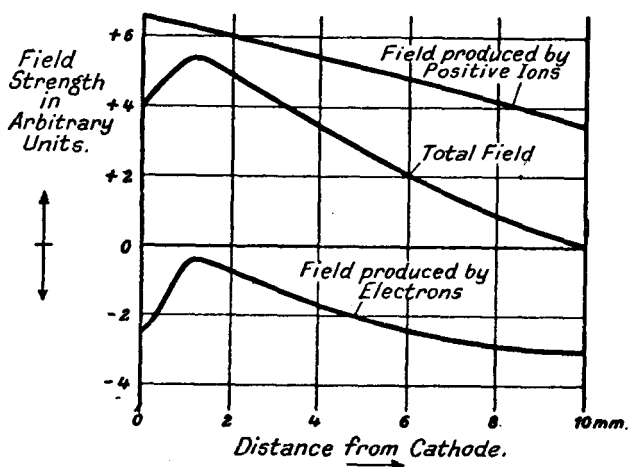

FIG. 15.—Curves Illustrating the Formation of the Field in the Fall Space.

towards the cathode, and again, therefore, it is always the slowest cations which have a big field action.

In Fig. 15 the top curve gives the field distribution produced by the positive ions. By combining this with the field of the electrons, the field shown in Fig. 13 is obtained.

These considerations enable us to review the entire phenomena of the glow discharge at the cathode; they are as follows:—

1. The Normal Thickness of the Cathode Fall, d_n .

According to the above facts, the thickness of the cathode fall d_n is determined by the point at which the original elec-

trons leaving the cathode must have produced so many new slow electrons that the positive electric field, produced by the slow electrons, is neutralised. At the place at which this is almost the case, the edge of the negative glow appears.

Thus follows :—

(a) d_n is proportional to the mean free path of the electrons, in a given gas it is therefore proportional to $1/p$ or $pd_n = \text{constant}$ (14)

In different gases d_n is the greater the bigger is the mean free path of the gas.

(b) d_n increases with the ionisation voltage ; since the higher the ionisations voltage the later begins the production of electrons.

(c) d_n increases as the number of collisions causing ionisation decreases.

(d) d_n is the greater the smaller is the proportion of primary electrons to the total stream.

These consequences are fully confirmed by experiment. The law $d_n p = C$ where C is dependent on the gas has been known for a long time.

The empirical law

$$d_n p = C_1 \lambda V_1 \quad (15)$$

where

$$\lambda = \text{M.F.P.},$$

$$V_1 = \text{ionisation voltage of the gas,}$$

$$C_1 = \text{a constant dependent on the cathode material,}$$

was discovered by the author.

The emission of electrons from the cathode requires the more energy the greater is the work done by an electron in leaving the cathode. On account of this an increase in this work of exit ϕ will decrease the proportion of primary electrons in the total stream. Therefore, according to (d), d_n increases with the work of exit of the electrons. This law has also been empirically confirmed. Below are given some numerical values of d_n and ϕ for various materials.

2. The Normal Cathode Fall, V_n .

The normal cathode fall V_n is determined by the fact that the fastest cations, which are produced directly or in-

TABLE VI

Cathode Metal.	d_n in Hydrogen at 1 mm. Press.	ϕ	d_n/ϕ
Mg.614	2.7	2.28
Al669	3.0	2.23
Zn807	3.4	2.37
Ta823	—	—
Pb839	—	—
Cd869	—	—
Fe880	3.7	2.38
Hg890	4.1	2.17
Ni893	—	—
Cu893	4.0	2.23
C900	—	—
Pt	1.026	4.4	2.33
		Mean :	2.28

directly by the 1,000 primary electrons, and which stream towards the cathode, must have such a velocity that they are able by collision to set free 1,000 new electrons from the cathode; since only then can the discharge keep itself going. The energy necessary for this is proportional to the work of exit of the electrons

$$V_n = C_2 \phi \dots \dots \dots (16)$$

where C_2 is characteristic of the nature of the gas used. In order that they can cause ionisation at the cathode, the cations must possess not only a certain energy, but also a certain minimum velocity.

In order to attain this it is necessary to use a voltage which must be higher the greater is the bulk or the atomic weight of the cation. Further, only quite a few out of a given quantity of cations attain that velocity which is necessary for ionisation. In order, therefore, to free an electron from the cathode, a certain not inconsiderable quantity of cations must be produced in the glow discharge. Now with a given cathode fall V_n the number of cations

produced is the smaller the greater is the ionisation voltage V_1 (with which, for calculation, must be combined a loss factor α , conditioned by inelastic collisions). Thus is obtained the empirical expression

$$V_n = (.245M + 4)V_1\alpha V \dots \dots (17)$$

in which $M =$ atomic weight.

α , for all monatomic gases, equals 1, while for the biatomic gases it is a function of the energy losses and the effectiveness of the collisions. By combining equations (16) and (17) we get

$$V_n = 44.4\phi + (.313M + 5)V_1\alpha - 177.6V \dots (18)$$

In Table VII. ϕ is given for a number of cathode materials, and in Table VIII. V_1 and α are given for a number of gases.

TABLE VII

Metal.	ϕ (after Langmuir).	Metal.	ϕ (after Langmuir).
Li	2.35 volts.	Sn	3.8 volts
No	1.82 „	Cu	4.0 „
Ti	2.40 „	Ag	4.1 „
Mg	2.70 „	C	4.1 „
Al	3.00 „	Ta	4.3 „
Zn	3.4 „	Mo	4.3 „
Th	3.4 „	Pt	4.4 „
Bi	3.7 „	W	4.52 „
Fe	3.7 „		

3. The Normal Current Density, I_n .

As Fig. 13 shows, there is a very strong field in the dark space produced by the positive charges of the cations. Therefore we must use in some form or other the so-called space-charge equation developed by Child, Langmuir, Schottky, and others.

The simplest form of the space-charge equation, derived on the assumption of a pure cation stream for plane parallel

TABLE VIII

Gas.	V_1 .	a	Gas.	V_i .	a
No	5.13 volts	1	Ar	15.5 volts	1
K	4.13 „	1	Kr	11.12 „	1
Ca	6.01 „	1	Xe	10.11 „	1
Mg	7.01 „	1	H ₂	17.2 „	3.4
Zn	9.35 „	1	N ₂	17.0 „	1.71
Cd	8.96 „	1	O ₂	14.0 „	2.97
Pb	7.38 „	1	Cl ₂	8.2 „	2.81
Hg	10.38 „	1	Br ₂	10.0 „	1.56
He	25.4 „	1	I ₂	10.1 „	1.05
Ne	21.4 „	1			

electrodes (namely, cathode on one side and glow light on the other), is as follows :

$$I_n = \frac{1}{9\pi} \sqrt{\frac{2e}{m}} \frac{V_1^{3/2}}{d_n^2} \dots \dots \dots (19)$$

It contains no arbitrary constants. Now, experiments have produced the surprising conclusion that this simple form, considering that it entirely neglects collisions and the presence of electrons, represents the results with astonishing accuracy. This can only be explained by supposing that in most gases the two influences counteract one another ; still the deviations from the simplest form of the space-charge equation exceed the limits of experimental error.

By combining the space charge equation with equation (15) one obtains

$$I_n = \frac{C_3 V_n^{3/2} p^2}{(\lambda V_1)^2} \dots \dots \dots (20)$$

We can deduce straight away that

(1) I_n is proportional to the square of the pressure. This has been confirmed experimentally.

(2) I_n is inversely proportional to the square of λ , *i.e.*, those gases in which λ or V_1 is great have a small normal current density. Since both values are big in helium, while

V_n is small, I_n is by far the smallest in this gas. Then follow neon and hydrogen, while the majority of gases have medium values of λ and V_1 , and therefore also of $I_n\lambda$.

For co-axial cylinders, in which the diameter of the inner one is small compared with that of the outer, the space-charge equation reads :—

$$I_n = C_4 \frac{V_n^{3/2}}{d} = C_5 \frac{V_n^{3/2} p}{\lambda V_1} (21)$$

That is, with thin wire cathodes whose diameter is small compared with the thickness of the dark space, I_n is no longer proportional to the square, but to the first power, of the pressure. This too has been empirically found out. Further, I_n alters less with the nature of the gas in this case than with plane electrodes, because it only varies with the first power of $V_1\lambda$.

Therefore, the space-charge equation shows at a glance why I_n depends on both values V_n and d_n . It ought not to be forgotten, however, that the constant C_3 is given with only approximate accuracy by the universal space-charge equation.

The explanation of valve action is already contained in formula (18). A discharge vessel fitted with inert gas and containing a platinum and an alkali metal electrode, is permeable in one direction at about 80 volts, in the other at about 180 volts. In the impermeable direction, therefore, between these two voltages, it acts as a perfect valve.

This valve action with the normal cathode fall can be still further improved with the help of the abnormal cathode fall. At the beginning of this explanation of the cathode fall it was stated that it only persists as long as the glow light can grow laterally, *i.e.*, as long as the current density I_n can remain constant. This follows immediately from the space-charge equation. If now I_n is increased by force, since the current increases beyond that value necessary to cover the cathode completely, the normal cathode fall changes into the abnormal cathode fall. The space-charge equation can act as a guide in this case also. It shows that when I_n increases V must also increase ; consequently the

electrons emitted from the cathode, and also those produced in the fall space, attain the velocity giving the greatest percentage of collisions in a shorter distance than with the normal cathode fall.

Therefore, even at short distances there will be a sufficient quantity of slow electrons to reduce the field of the cations to zero and to produce the glow column; the thickness of the dark space decreases, therefore, with increasing current density. The values of V and d alter themselves in such a way that the space charge equation remains fulfilled. These variations have not yet been reduced to a formula. The author has found the following simple empirical relation

$$I_a = C_6 V^4 \dots \dots \dots (22)$$

which by combination with the space-charge equation gives

$$d_a = C_7 I_a^{-5/8} \dots \dots \dots (23)$$

This gives reliable constants for the separate gases as shown in the following Table IX.

TABLE IX

Gas.	C.	Gas.	C.
He	·322	N	·787
Ne	·367	H	·448
Ar	·613	O	·860

Equations (22) and (23) show that when V_a increases I_a very quickly increases and d_a slowly decreases.

In reality, however, these relations are often blotted out by the alteration of temperature caused by the discharge. Even in the case of the abnormal cathode fall, in which V is big as well as I_a , much energy is set free at the cathode and in the dark space. The gas in the dark space is therefore heated and its density diminishes.

This increases d_a , which works against the decrease, according to equation (23). Therefore it often happens that with

an increasing voltage d_a only decreases to a certain minimum value, then remains approximately constant till the glow discharge suddenly changes into an arc discharge when the current is further increased.

It should be self-evident, after the above explanation about the glow discharge, that any part of the cathode that is so closely covered by the walls of the discharge vessel that the dark space and the negative glow have not sufficient space to form themselves is as good as non-existent as far as discharge purposes are concerned.

If therefore a wire cathode is surrounded by a glass tube at a distance that is smaller than the distance of the negative glow only the front surface of the wire can act as a cathode. A valve depending on this action is called a constriction valve. It is hardly ever used, since it is just as simple to insulate the wire cathode up to the point.

Gas Mixtures

In technical applications gas mixtures and not pure gases are often used. Therefore the phenomena of discharges in gas mixtures will be dealt with briefly. Suppose that to a gas 1 is added a small fraction, say 10 per cent., of a gas 2. Then the electrons emitted from the cathode will collide practically as before with the molecules of gas 1. They will also occasionally produce cations of gas 2; the properties of these cations are of great importance for what follows. First it will be assumed that the two gases cannot combine chemically with each other. If then the cations of gas 2 have a mass and mean free path practically the same as those of gas 1, their action will scarcely differ from that of the cations of gas 1. d_n and V_n are calculated approximately according to the simple arithmetical law of mixtures.

On the other hand, if the cations have an appreciably smaller mass or greater mean free path, or both together, than the cations of gas 2, their capability of ionisation at the cathode will be very much greater than that of the cations of gas 1; since for this only the few fastest are effective, extremely small quantities of cations of 2 are able considerably to increase the production of electrons at the

cathode. Consequently fewer cations are now produced as in the pure gas 1.

On account of this fewer electrons are necessary, consequently V_n and d_n can decrease.

An instructive example of this case is given by a mixture of the gases H_2 and N_2 . The two do not combine chemically with one another to any extent. The H-ions (protons) have not only a very much smaller mass, but also a very much greater mean free path than the N-ions. Consequently the

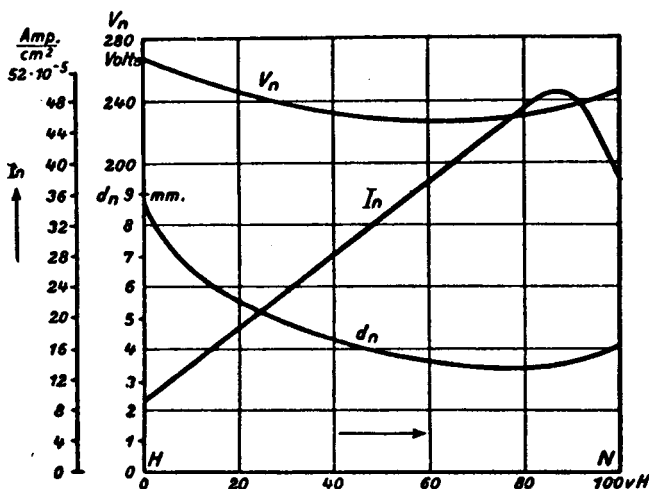

FIG. 16.—Variation of V_n , I_n and d_n in the Mixture H_2-N_2 , using an Iron Cathode at a pressure of 1 mm.

addition of a small quantity of hydrogen to nitrogen causes, as Fig. 16 shows, a decrease in d_n as well as in V_n .

By the addition of a second gas with a higher cathode fall it is therefore possible to diminish the cathode fall of a gas. The two most used gases are H_2 and He, and perhaps Ne should come as a third.

So far it has been assumed that the two mixed gases cannot combine chemically with one another. If such a possibility of combination exists, the reactivity will be greatly increased by the formation of ions, and then the ions of one gas will combine with the molecules of the other.

So they are lost for the discharge processes. But since a quite definite quantity of ions is required for its maintenance, V_n must increase until the necessary quantity of ions is again supplied.

Mixtures of gases which can combine chemically with one another, therefore, show an increased V_n and a hump in the V_n curve, whose position and magnitude are specified by the particular ions and the particular intensity of the chemical

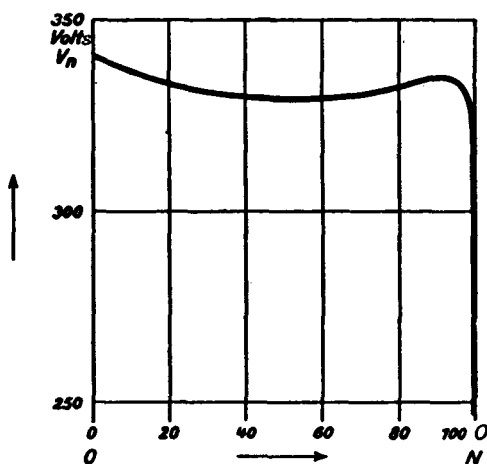

FIG. 17.—Normal Cathode Fall V_n in the Mixture O_2-N_2 using an Iron Cathode.

reaction. Fig. 17 gives an example of such phenomena in the V_n curve of the mixture O_2-N_2 .

By means of the abnormal cathode fall a second kind of valve can be obtained. Suppose two electrodes, one of which has an effective area of $\cdot 1$ sq. cm. and the other of 10 sq. cms., are contained in a vessel. An alternating current voltage V is applied to the electrodes, and all losses in other parts of the valve are neglected in comparison with that of the cathode fall. Then the current flowing in the two directions is approximately proportional to the areas of the electrodes. At a pressure of 1 mm. with steel electrodes in nitrogen the following results were obtained :—

V Volts.	i when the cathode is 0.1 sq. cm.	i when the cathode is 10 sq. cms.
1,000	3.04 milliamperes	304 milliamperes
2,000	7.13 ,,	713 ,,
3,000	11.22 ,,	1,122 ,,

According to this it would seem that we have here a really good valve action. The useful valve action is, however, very small, for the currents given in the table flow only when the full voltage is applied to the cell. Suppose we have 3,000 R.M.S. volts at our disposal and that we want a rectified current at 2,000 volts. Then in the impermeable direction nearly 3,000 volts are applied to the cell, causing a current of 11.2 milliamperes; on the other hand, in the permeable direction there are only 1,000 volts for disposal, and this will cause a current of 304 milliamperes to flow.

Therefore $3,000 (11.2 + 304) = 944$ watts are employed to produce a useful amount of 1,000 $(304 - 11.2) = 293$ watts; the efficiency is therefore 31 per cent. On account of this bad efficiency valves of this kind have attained no real importance.

However, their efficiency can be substantially increased by combining the valve action produced by the different cathode falls of different materials with that given by different surface areas. As an example a large alkali metal electrode in argon set opposite to a very small iron electrode can be taken. Such valves as glow discharge tubes have attained a certain importance for many purposes.

Transition from Glow to Arc Discharge

The current density is stable in the region of the abnormal cathode fall, since the voltage increases with the current density. The greater part of the energy used in the cathode fall is given up to the cathode and heats it. This rise of temperature causes first a further increase in the

abnormal cathode fall. But as the temperature rises the increase in the cathode fall slows down and finally attains a maximum value beyond which it again decreases. This decrease is produced by the appreciable quantity of thermionic electrons which the cathode begins to emit. When this point is reached the current becomes unstable, it comes from those spots at which the electron emission is fortuitously largest; consequently the energy of the discharge becomes concentrated on these spots and produces a very high temperature. This causes so strong an emission of electrons that the cathode fall decreases from the high value corresponding to the glow discharge to the very small value of the arc-cathode fall, since the instability of the glow discharge causes it to change over to an arc discharge.

(b) Arc discharge

The electrons production of the cathode spot of an arc is the most productive method of all; and for this reason the arc valve is also the most important. In large mercury arc rectifiers rectified currents of more than 1,000 amperes are used. It is considered in the following chapter.

CHAPTER VI

The Arc Discharge

So long as the use of the mercury arc rectifier was confined to the production of moderate D.C. voltage and current strengths, and completely airtight glass walls were used, a superficial knowledge of the physical processes involved was sufficient. Since, however, higher voltages and currents are being rectified by large metal-cased mercury arc rectifiers, while on the other hand a complete airtightness is not reached with them, it has been proved beyond any doubt that it is necessary to investigate the physical properties of the mercury valve as completely as possible.

This work is still being carried out, so that final results cannot yet be given here. Still, sufficient measurements have already been made to justify a complete treatment of the subject.

It has been known for a long time that an ordinary electric arc exhibits a decided valve action under certain conditions. This is not necessarily to be anticipated, since with ordinary arcs not only the cathode but also the anode becomes hot enough to cause an appreciable emission of electrons.

Therefore no valve action appears with big current densities or small electrode separations. As soon as the separation is increased to more than 4 mm. and a current of about 5 A is used with a carbon electrode set opposite to a metal electrode, the current only flows in that direction in which the carbon is cathode. The reason lies in the collective action of the following circumstances :—

(1) The heat conductivity of carbon is much lower than that of metals.

(2) The temperature of about $3,000^{\circ}$ C. which is necessary

to produce an appreciable electron emission is below the boiling temperature of carbon, but far above that of most metals. Consequently a turbulent state exists in the cathode spot on the metal cathode. The surface particles are heated by the impact of the cations to a high temperature; the moment that they attain this temperature they are thrown off as from a powerful vapour ray. On account of this the high temperature disappears at once with any stoppage of the ion impacts. Therefore as soon as the current through a metal cathode is for the shortest instant reduced to zero, it can only be begun again by the roundabout way of applying the very much higher voltage necessary to produce a glow discharge. (Tungsten is an exception, since its boiling point is considerably above that necessary for the cathode spot.) Carbon, however, and also, under certain circumstances, tungsten remain during a half period of a 50 period A.C. at so high a temperature that the current can pass once again.

Every metal-carbon arc can be used as a valve. The decisive advance which has been made by the use of the vacuum mercury arc rectifier is due first to the fact that mercury is a fluid metal, and therefore, after being vaporised, is condensed on the walls of the vessel, so that it can always be returned to a cathode placed underneath; thus no loss of material takes place. Secondly, the voltage drop is very small in pure Hg vapour. Thirdly, the anode can be removed from the cathode sufficiently far to be no longer affected by its radiation. Fourthly, the anode in a vacuum arc remains comparatively cold. The requirements of small voltage drop in the permeable direction, small current in the impermeable direction, high limit to back starting in the impermeable direction, are fulfilled to a considerable extent by the Hg arc rectifier.

For purposes of description, the phenomena essential to the action of the valve can be divided into two main groups.

- (1) Flow or arc discharge direction.
- (2) Impermeable or glow discharge direction.

Each main group can be sub-divided so as to discuss:

- (a) Cathode, (b) The Gas Path, (c) The Anode.

(1) (a) The Arc Discharge Cathode:

Stark obtained 5.27 volts as the cathode fall in a mercury arc. He used, however, an exploring wire, and this method is faulty; his value is much too low. The true value comes near to the ionisation voltage 10.4 volts, but precise measurements are not possible owing to some as yet unknown disturbances. The following kinds of energy loss take place at the cathode:—

(1) Conduction away from the cathode spot to the surrounding mercury of the cathode.

(2) Radiation from the cathode spot.

(3) Heat of vaporisation taken by the vaporising mercury.

(4) Work of exit of electrons from the cathode.

The small white hot cathode spot, wandering irregularly over the surface of the mercury, accounts for 2.68 watt-seconds per ampere per second of the energy given up to the cathode. The cross section of the cathode spot amounts to 2.53×10^{-4} sq. cms. per ampere, so that the current density has the extremely high value of 4,000 amperes/cm². The radiation from the cathode spot has not as yet been measured; on account of the small size of the spot it is not important. If the temperature of the spot be assumed as 2,000° C., the radiation reaches .0366 watts per ampere. The mercury vaporises briskly from the spot on account of its high temperature. The quantity vaporised in a second amounts to 2.08×10^{-3} gms. In order to vaporise this quantity a supply of energy of 2.20 watts per second is necessary.

It can be deduced from below that .58 of the total current at the cathode is carried by electrons, the rest by positive ions; assuming this to be true, then the work of exit of the electrons is $3.9 \times .588 = 2.29$ watts/ampere.

According to the above data, we have at the cathode

(a) Heat conduction into the mercury of the cathode	2.68 W.
(b) Radiation (2,000° C.)	.04 W.
(c) Heat of vaporisation of mercury	2.20 W.
(d) Heat of exit of the electrons	2.29 W.

Total 7.21 W.

This energy must be provided by the positive ions which hit the cathode. It consists of

(1) Energy gained in cathode fall = $\cdot 412 \times 10 \cdot 4$	= 4.28 W.
(2) Energy of neutralisation of positive ions = $\cdot 412 \times 7 \cdot 1$	= 2.93 W.
	7.21 W.

Therefore practically the whole energy produced in the cathode fall is used up in the cathode spot. For further information see Güntherschulze, *Zeits. f. Phys.*, 31, 509, 1925.

As already mentioned, the existence of an arc light is bound up with the condition that on the cathode there exists a place with a very high temperature and from which an appreciable quantity of electrons is emitted. If this emission of electrons from the cathode is interrupted, even for the shortest time, the arc goes out. This extinction occurs in a time which actually appears to be shorter than a hundred-thousandth of a second. The necessary high temperature has been shown to be produced by the positive ions, the cations, bombarding the cathode. These cations gain such energy in falling through the cathode fall that they heat the cathode to white heat. It is necessary, therefore, that they should concentrate themselves on quite a small spot; otherwise their energy is insufficient. But also from this spot, because of its high temperature, a stream of mercury vapour pours out and drives the oncoming ions to the side. They have therefore to seek a new place of arrival on the cathode. Therefore the cathode spot wanders here and there over the mercury surface with great speed. The smaller the current density and the quicker the movement of the spot the more difficult is it for the cations to stay on any particular spot when it has attained the temperature necessary for vaporisation. It is therefore possible for an arc to work at a small current density for one or two minutes and then to go out suddenly with a particularly fast motion of the spot. Moreover, the concentration of cations on a spot becomes more difficult as the gas pressure is reduced,

because their mean free path becomes greater, and they are scattered in all directions instead of being concentrated on a spot.

In a rectifier vessel free from foreign gases in which only mercury vapour is present, the vapour pressure decreases very rapidly with the temperature. Therefore in such a rectifier the arc is extinguished at a current density which is the higher the colder is the rectifier. The following series of experiments will serve as an illustration :

In a 20-ampere single phase rectifier which was maintained at various temperatures, a direct current arc was produced with an operating voltage of 120 volts and the current was reduced at once till the rectifier went out. At each temperature a large number of measurements of this kind were carried out, and the mean was taken. Thus were obtained :

Starting Temperature of Rectifier.	Minimum Current.
- 2.3° C.	6.00 amperes
+ 5.0°	4.45 ,,
+ 23°	2.95 ,,
+ 70°	1.95 ,,

(1) (b) Processes in the Arc Gas Path.

In the gas path of the arc free electrons stream towards the anode, and free cations towards the cathode. Both are present in practically equal quantities per unit volume. On account of the very small velocity of the cations in comparison with that of the electrons, the current is almost entirely carried by the latter. The conduction in the gas path is practically electron conduction, exactly like conduction in metals, although this obeys completely different laws. The closeness with which these laws are related to one another has already been stated. Also, the great influence of the walls of the vessel on the voltage drop and the luminous phenomena of the discharge are there discussed. Accordingly, the most favourable case would appear to be when

the walls are far removed from the electrodes. Doubtless a low voltage loss in the gas path is thereby attained, but unfortunately also the smallest surety against back starting is simultaneously produced, therefore this arrangement is only used with rectifiers for small voltages. With higher voltages the surety against back starting demands a longer gas path, if possible, bent back one or more times on itself. On account of this the voltage drop in the gas path is considerably higher.

The behaviour of the mercury arc in the gas path is thereby complicated, since the mercury vapour pressure depends on the temperature, and this again on the load. The mercury vapour pressure in a rectifier vessel can be derived only with the help of the proposition that everywhere where the Hg condenses the vapour pressure is equal to the saturation pressure at the temperature of condensation.

A rectifier vessel of the A.E.G., with three arms for 30 amperes without cooling (100 amperes with ventilator cooling), Type S.D.L.E., gave the measurements of temperature and pressure shown in Fig. 18. According to this, the parts of the walls situated in the neighbourhood of the cathode become the hottest, probably because there the current density is the greatest, and also because the very hot cathodic light tuft is likely to wander about there. The anode arms are not quite so hot. With a load of 30 amperes, condensation on the walls begins at the bottom at a temperature of 100° and a pressure of 280μ . In the higher part it goes on with decreasing temperature and pressure down to a pressure of 14μ .

Different pressures in a vapour presuppose currents in this vapour. When 100-ampere rectifiers are loaded with 30 amperes the total condensation surface is 3,830 sq. cm. in the cooling chamber. At 30 amperes $\cdot 216$ gm. Hg. vaporises per second. An equal quantity condenses. The mean temperature of the Hg in the condensation space can be estimated at about 200° , the vapour pressure in the zone A is 280μ . Thus the density of the vapour in this zone is 1.9×10^{-6} gm./cm³. The cross section a of the cooling

chamber amounts to 85 sq. cm. Thus it follows that the velocity of the vapour going through the cross section is 1.34×10^3 cm./sec. This is the velocity of a strong blast. Similarly, the velocity with which the vapour streams on to the condensing surface can be calculated to be 3×10^2 cm./sec. By loading the rectifiers with 100 amperes and fan-cooling, almost the same temperature relations prevail in the cooling chamber as with 30 amperes without cooling; the velocities attained are 3.3 times as great, therefore 4.5×10^3

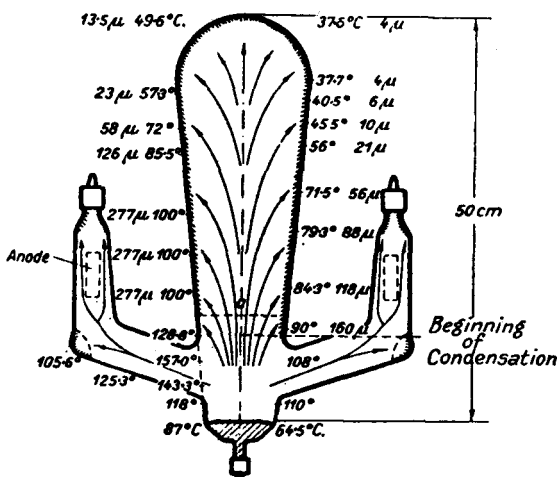

FIG. 18.—Temperature in Degrees Centigrade and Pressure in Thousandths of a Millimetre in a Mercury Arc Rectifier.

and 10^3 cm./sec. Such mercury vapour rays have a strong sucking-out action on all foreign gases and suspensions, and compress them into the upper part of the cooling chamber; but the upward shooting vapour rays from the cathode produce violent vortex motions, and mix everything up again. The weaker vapour rays produced by condensation of mercury in the anode arms act similarly, and their action, in spite of their small velocity, is proportionately great, since they stream into the long narrow arms. They collect the foreign gases and dust particles in the neighbourhood of the anode.

According to the above measurements and calculations, it follows that one cannot speak of a uniform pressure in a mercury rectifier even when loaded with direct current. Only in the anode arms can one speak of a pressure that is in some degree uniform, because in these the condensation is small.

The simplest way of finding this pressure in the anode arms is to measure the temperature of condensation at the bend of the arms.

TABLE X

100-Ampere Type of Rectifier for Ventilator Cooling. Experiments with Direct Current without Cooling

Total Current.	Voltage Drop in the Gas Path.	Temperature.			Vapour Pressure in Anode Arms.
		of Glass Walls of Anode Arms.	of Condensation in Bend of Arms.	of the Cathode.	
Amps.	Volts/cm.	°C	°C	°C	mm. Hg.
10	.370	87	80	58	.092
20	.276	103	92	64	.148
30	.252	125	106	73	.320
40	.293	181	121	84	.580
50	.580	295	151	134	1.40

Table X. and Fig. 19 show the dependence of the voltage drop, temperatures of the anode arms and the cathode, and vapour pressure of 100 ampere type S.D.L.E. rectifier, on the direct current load. The direct current was equally divided among the three arms, no cooling was used, and the temperature of the surroundings was 20° C.

The figure shows that the temperature, pressure and voltage loss begin to increase rapidly above 40 amperes. Therefore, above 30 amperes ventilator cooling is used with this type.

TABLE XI
Mean free path (l) of Mercury Atoms as Function of Temperature

<i>t</i> C.	<i>l</i> at 1 atmosphere 10^{-8} cm.	<i>l</i> at .1 mm. Hg. in 10^{-4} cm.
0	66.4	5.04
100	110	8.35
200	161	12.2
400	281	21.4
600	435	33.0
800	574	43.6
1,000	776	59.0
1,200	978	24.3

Table XI. contains the mean free paths of mercury vapour atoms as a function of the temperature. The more

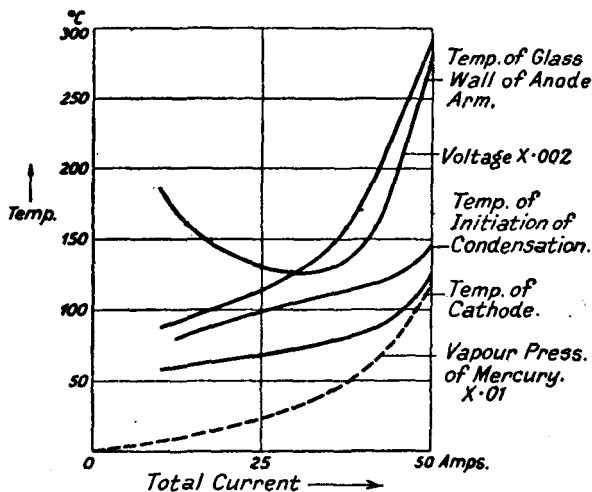

FIG. 19.—Voltage Characteristic, Temperature and Vapour Pressure in Relation to Load.

important mean free path of the electrons is given by multiplying the figures in the table by $4\sqrt{2} = 5.66$.

The heat conductivity of mercury is 7.72×10^{-5} Joules per

square centimetre per second per unit temperature gradient at 203° C.

The temperature coefficient is about .0025.

It is hopeless to measure the temperature of the positive column with the aid of instruments placed inside the rectifier. Because of the extremely small heat capacity of the rarefied mercury vapour and the great loss by radiation from all solid bodies at high temperatures, such solid bodies reduce the temperature of the mercury vapour so greatly that they do not even indicate its order of magnitude. The temperature in the positive column can only be found by calculations based on the given values of heat conductivity, and only with uncertainty, first because the temperature coefficient of the heat conductivity is not well known, secondly, because the assumption which must be made for the calculation, viz., that the whole energy $V \times I$ is given up to the gas, is not exact. A part of this energy is needed for the ionising process. The ions diffuse to the walls and deliver their energy to them, when recombining. Thus the calculated temperatures are too high. The error increases as the gas pressure is reduced. According to Langmuir, it amounts to

$$\begin{aligned} &45 \text{ per cent. at } p = 7.5 \times 10^{-4} \text{ mm.} \\ &\text{and } 15 \text{ per cent. at } p = 1.1 \times 10^{-2} \text{ mm.} \end{aligned}$$

When the pressure exceeds one millimetre this correction may be neglected. Fig. 20 shows how the temperature rises in an anode arm of 2.86 cm. radius at 10 amperes current strength and a voltage loss of 2.52 V per cm. from the sides of the tube to the axis. Further, Table XII. gives a summary of the calculated temperature in the axis of the positive column for various kinds of walls. The values are meant to be of an informatory character only.

On account of the small heat capacity of the mercury vapour, the temperature quickly follows any current fluctuations; on the other hand, the variations of pressure take place considerably slower. Therefore, if the current in an anode arm jumps to its full value, the temperature can follow without delay, but the density does not change immediately. Thus, in the first instant the arc burns in a

vapour of a density, calculated for the above example, of ten times the normal value, and therefore in a pressure ten times above the normal. However, a strong rush of vapour at once occurs, which blows out the excess of gas in the anode arm and brings the vapour pressure in the neighbourhood of the anode arm down to the ordinary value. As soon as the current ceases the high temperature disappears almost instantaneously, so that the density and pressure fall to a tenth of their previous value, and this time a jet of vapour rushes into the anode arm. The velocity of this jet, though somewhat smaller than that of the inflowing vapour, is always very big. Possibly any ions, foreign gases, and

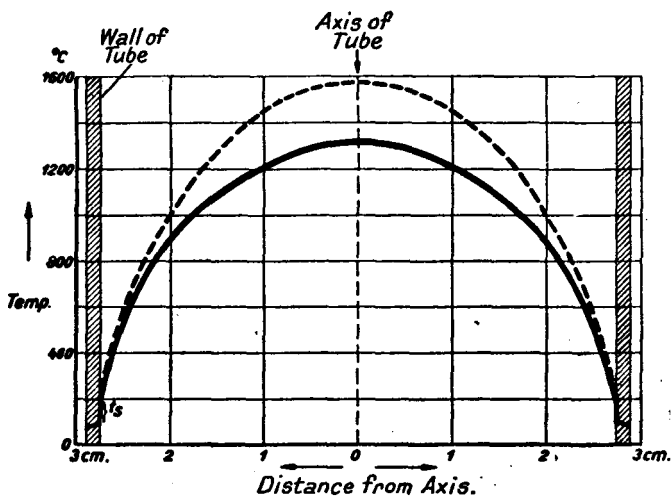

FIG. 20.—Temperature Distribution in a Mercury Arc over the Cross-section of a Glass Tube.

suspended dust particles which are still present are thrown on to the anode by this rush of vapour.

These violent mercury vapour jets, pulsating hither and thither in the anode arm, are the stronger the higher is the temperature of the positive column. The greater is the length of the anode arm the longer they last in each cycle. Table XIII. gives the dependence of the temperature t_0 on the current density in the axis of the positive column,

TABLE XII

Run No.	Nature of Vessel.	Dia- meter of Anode Arms, cm.	i for each Anode Arms, amperes.	V Volts/cm.	t_1 °C.	t_0 °C.	Vapour Pressure, mm. Hg.	Observer.	Remarks.	
1	Glass rectifier for 100 am- peres with ven- tilator cooling)	5.5	.50	2.20	200	850	.120	The Author	Without cooling.	
2			16.67	.578	350	2,700	1.4			
3			100	.26	300	4,800	—			
4	Glass rectifier for 500 amperes with cooling	6.5	500	app. .20	300	10,900	—	A.E.G.	With cooling.	
5	Large rectifier with iron con- tainer	—	600	app. .09	40	7,400	—	A.E.G.	With cooling.	
6	Glass tube.	{	3.0	9.0	.67	200	2,067	.280	Arons.	In water bath.
7			1.5	4.0	2.4	200	2,680	.002?		
8			1.2	4.0	1.75	200	2,216	—		
9			1.2	4.0	5.0	300	4,120	—		
10			1.2	4.8	16.1	700	9,400	—		
11	Quartz tube.	{	1.2	4.0	23.6	1,000	11,400	—	Küch and Retschinski.	

i = Current strength ; V = voltage per cm. ; t_1 = temperature of glass wall ; t_0 = temperature of axis of arc.

TABLE XIII

Alteration of Current Strength at Constant Vapour Pressure; t being constant at 200° C.

Current in Amperes.	Voltage Fall. Volts/cm.	t_0 °C.	Degree of Dissociation.
·50	2·20	845	$1·94 \times 10^{-5}$
1·10	1·04	863	$6·23 \times 10^{-5}$
2·50	·507	910	$20·08 \times 10^{-5}$
5·20	·356	1,108	$54·04 \times 10^{-5}$
7·50	·315	1,252	73×10^{-5}
12·50	·259	1,487	171×10^{-5}

TABLE XIV

Alteration of Vapour Pressure at Constant Current Strength (5·00 amperes)

Vapour Pressure. mm. Hg.	V Volts/cm.	t_i °C	t_0 °C.	Mean Free Path of Electrons. cm.	Voltage across Mean Free Path Volts/cm.	Degree of Dissociation.
·003	1·42	250	2,275	177	251	—
·067	·580	250	1,418	5·30	3·08	65×10^{-5}
·081	·516	250	1,320	4·10	2·12	61×10^{-5}
·167	·471	260	1,256	1·90	·892	44×10^{-5}
·290	·516	260	1,230	1·14	·587	33×10^{-5}
·570	·580	270	1,418	·622	·361	—
·690	·646	280	1,504	·540	·349	—
1·54	·904	310	1,800	·286	·259	—
4·16	1·181	350	2,060	·116	·137	—
8·20	1·419	390	2,317	·0655	·0929	—
13·5	1·677	430	2,542	·0437	·0732	$·84 \times 10^{-5}$

t_i = temperature of glass wall.

t_0 = temperature of axis of arc.

while the pressure was kept constant by the help of the current in the second anode arm. The table shows that the voltage drop at first decreases strongly with increasing current; consequently the temperature rises only a little with the current strength. An increase of current from $\cdot 5$ ampere to $12\cdot 5$ amperes, *i.e.*, a twenty-five-fold increase, raises the absolute temperature from $1,118^\circ$ to $1,760^\circ$, only 57 per cent. In reality, the temperature increase is even smaller than the calculated value, since with the smallest current strength of $\cdot 5$ ampere the current distribution is distinctly irregular, so that the temperature in the axis is higher than that calculated.

Table XIV. gives the dependence of the temperature and voltage loss on the pressure of the mercury vapour at constant current load. The pressure was produced partly by increasing the current load in the other arms, partly by putting the rectifier in a heating chamber.

The table shows that with increasing vapour pressure the voltage and temperature at first decrease, pass through a minimum, and then increase to the pressures producing the high voltage loss and high temperatures that KÜCH and Retschinski have observed in the quartz light. At higher pressures the arc has a tendency to come away from the walls and close in on the axis, consequently at pressures of 1 mm. the real temperature in the increased mass is higher than that calculated.

If the walls of the vessel are so far apart that they do not disturb the phenomena, the following relations can be distinguished:—

(1) *Mercury Vapour Pressure Very Small*

The distance AK contains only a small number of electron mean free paths, and the current spreads itself over the entire cross section at its disposal, the density of the field lines changing correspondingly.

On the cathode is found the light cathode spot, and at the anode is a narrow luminous zone; in this anode fall the necessary cations are formed by collisions. Between these the discharge is completely non-luminous. The heating of

the gas is small. Fig. 21 gives a picture of this lightless arc.

(2) *Medium Mercury Vapour Pressure*

The potential difference near the cathode spot attains the value 4.68 volts at some distance from the cathode, and at this point excitation begins. The field strength drops in the region of excitation. According to Fig. 9, the current density, and consequently also the excitation, is greatest in the axis. Therefore the current density increases here, and with it the excitation; and so on. Through the decrease of the field strength the current has a tendency to contract into a line. This tendency is counteracted by the fact that this increase of current density and ion density increases the rate of recombination, which is proportional to the square of the ion density.

But the contraction of the current path has another result. The gas is heated by the energy loss produced by excitation. Its density is therefore decreased and the mean free path of the electrons is lengthened. Therefore, while the forward velocity of the electrons increases, the density of the cations and electrons decreases. Thus the concentration of the current lines bounding the area of recombination also decreases, and once more the current has a tendency to contract to a thread through the decrease of the field strength. But this time this tendency is counteracted by the heat conductivity of the gas. The higher grows the temperature of the current thread the more heat is dissipated by conductivity. This abstraction of heat increases faster than the rise of temperature, because the heat conductivity itself increases with the temperature.

These two tendencies—the diminution of field strength by excitation and the rise of temperature—are the more effective the higher is the strength of the field, *i.e.*, the greater the gas density. Thus in Fig. 9 is obtained the closing in of the current distribution at the bottom; a well-defined arc of fixed diameter results.

So it will be seen that if the gas density be gradually increased, beginning with a very small density, at a certain

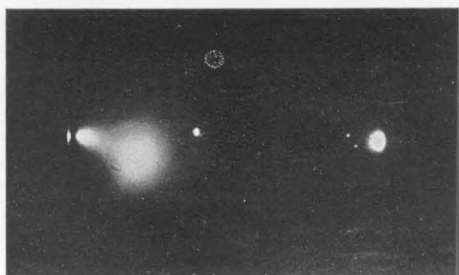

FIG. 21.—NON-LUMINOUS ARC IN PURE
MERCURY VAPOUR IN A LARGE VESSEL.

[To face p. 67.]

value a luminous zone will begin to grow from the anode towards the cathode. As the gas density is still further increased the zone finally reaches the cathode. At the same time the zone becomes brighter and narrower, and at high gas densities it is an almost filament-like brightly luminous rod.

Table XV. serves as an illustration of these relations in pure mercury vapour. It contains the measurements of current, voltage and anode fall in a glass sphere (shown in Fig. 8) contained in a heating box into which air was blown strongly by a fan. The condensation temperature, and from it the pressure of the mercury vapour, was calculated from the temperature of the heating box and a knowledge of the relation, which was specially found for this case, between the temperature of the glass sphere and the electrical load. Before the measurements were made the gas was carefully extracted from the glass sphere by many hours of pumping, with an arc of 30 amperes and a temperature of 160° in the heating jacket.

Table XV. shows the expected results in each case when the voltage loss in the entire gas path, with small mercury vapour pressures, is smaller than 4.68 volts, and accordingly the gas path is fully non-luminous. At .68 mm. pressure a column of light begins to move from the anode to the cathode, and at first has a diameter of 8 cm. At 4.08 mm. pressure it almost reaches the cathode and its diameter has fallen to 5 cm., its brightness having correspondingly grown. At the same time the voltage across the gas path has risen from 3.2 to 11.4 volts.

If the phenomena are investigated in a glass tube instead of a sphere, the completely non-luminous part of the phenomena is not obtained. From the first the glass tube is filled uniformly across the whole cross section with a luminous column; the necessary voltage loss is also present. At high pressures the luminous column detaches itself from the glass wall.

Addition of Foreign Gases

Various complications occur when foreign gases are added, and these make the phenomena very involved.

TABLE XV

T Conden- sation Tem- perature. °C.	Pressure of Mercury Vapour.		Voltage between Elec- trodes. Volts.	Anode fall. Volts.	Voltage drop in Gas Path. Volts.	Dia- meter of Arc. cm.	Luminosity of Arc.
	<i>p</i> mm.	<i>p</i> ₁₈ mm.					
30	·004	·004	22·0	13·0	3·7	—	Non-luminous.
60	·028	·024	20·3	11·6	3·4	—	”
106	·36	·276	14·6	5·8	3·5	—	”
118	·68	·506	16·5	5·6	5·6	—	Luminous column exists at anode.
128	1·07	·776	18·0	5·5	7·2	8	Luminous column grows towards cathode.
140	1·82	1·28	21·0	6·0	9·7	7	”
150	2·73	1·88	24·5	6·8	12·4	6	Luminous column reaches cathode.
160	4·08	2·74	23·5	6·8	11·4	5	”

$$p_{18} = p \frac{291}{T}$$

The simplest relations are found when the foreign gas is similar to the mercury vapour to the extent that the electrons make equally pure elastic collisions with its atoms. Such a gas is argon. Its resonance voltage is 12 volts, in comparison with the 4.68 volts of mercury. Therefore, so long as the partial pressure of the mercury is not very small in comparison with that of the argon, the electrons cannot attain the velocity necessary to excite the argon atoms, because their energy is used up beforehand in collisions with the mercury

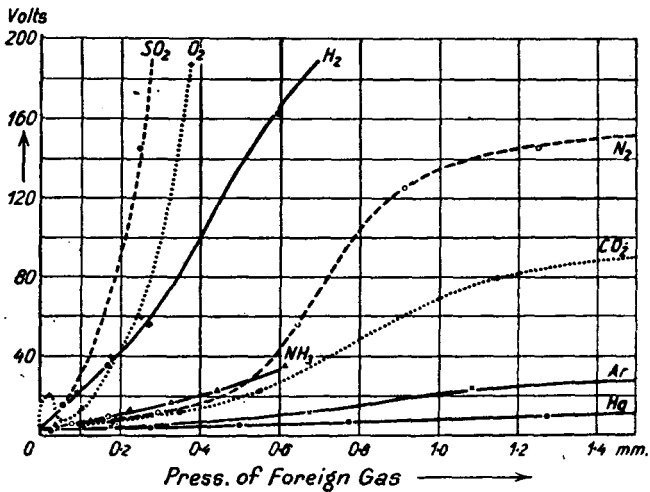

FIG. 22.—Effect of additions of Foreign Gases on Voltage Loss in Rectifier.

atoms. In practice, the action of the argon is merely to produce an apparent increase in the density of the mercury. But there is one difference; the heat conductivity of mercury (at 0° C.) is 1.23×10^{-6} (using calories as heat units), while that of argon is 3.89×10^{-5} , which is three times as great.

Because of this the temperature in the current path cannot rise so high as with pure mercury vapour, so that the voltage is higher and the positive columns broader than with mercury vapour of the same pressure. Table XVI. and Fig. 22 show that this is in fact the case.

The relations are more complicated with the other gases investigated, H_2 , O_2 , N_2 , CO_2 , SO_2 , NH_3 , since with them the collisions are not elastic.

TABLE XVI

Pressure of Argon. mm.	Voltage between Electrodes. Volts.	Anode fall. Volts.	Voltage drop in Gas Path. Volts.	Diameter of Arc. cm.	Luminosity of Arc.
·042	18·8	10·4	3·1	—	Non-luminous.
·110	19·5	10·5	3·7	—	„
·180	22·7	11·9	5·5	—	„
·319	23·0	11·7	6·0	—	„
·668	30·0	12·0	12·7	8	Luminous column from anode to the middle of the fall.
1·087	43·0	13·2	24·5	9	Luminous column up to the cathode.
1·67	47·0	13·1	28·6	4	—
2·28	140	14·2	120·5	3	—

The partial pressure of the mercury vapour was always small in comparison with that of the argon.

The resonance voltages, as far as they are known, are as follows :—

TABLE XVII

Gas.	Resonance Voltage.
Hg	4·86 volts
Ar	11·5 „
CO_2	—
N_2	8·4 „
H_2	10·1 „
O_2	8·0 „
NH_3	—
SO_2	—

Here also, therefore, only the mercury is excited and ionised. The foreign gases have no important direct share in the process of conduction. The statement about the heat conductivity of argon is also valid for them; the greater the heat conductivity the quicker must the voltage increase with the partial pressure of the foreign gas. The effect of the loss of energy of the electrons on collisions is harder to grasp. This energy loss is caused partly by the fact that the electrons on collision give up energy to the inner degrees of freedom of the molecules, but partly also that they are caught by the electron-greedy gases, so that their energy goes over to the catching molecule, and they only win back their freedom, but not their energy, on a subsequent occasion. The following cases can be anticipated:—

(1) *Small Gas Pressure.* Total voltage drop in the gas path under 4.68 volts. If a part of the mercury vapour is replaced by a foreign gas, that deprives the electrons at each collision of a part of their energy without catching them, V will decrease; therefore, according to the formula

$$\frac{dx}{dt} = \frac{\gamma \cdot \lambda}{V}$$

the forward velocity of the electrons increases, the field decreases, and the voltage falls. (This is only noticeable when only the action of energy deprivation, not also the influence of the heat-conducting properties, is visible.)

(2) *Mean Gas Pressure.* After the ions have travelled a part of their way, they reach the velocity of excitation and the arc becomes luminous. With completely elastic, but not numerous, collisions the electrons up to the point of a collision have a velocity almost corresponding to the potential difference through which they have fallen. On the other hand, if with voltage a across a mean free path the loss of energy on collision is a/n , no matter if the electrons fall through the whole voltage, they can never reach a greater velocity than that corresponding to na .

For example, suppose a is .2 volts and the loss of energy on collision is 5 per cent. of the existing energy, then $n = 20$, so that the greatest velocity the electrons can attain is

4 volts. If the voltage is increased so much that 4 volts fall on a free path, the following summary between the total voltage fallen through by the electrons and the velocity is obtained :—

TABLE XVIII

Voltage Fallen Through.	Velocity Attained.
5.6 volts.	4.0 volts.
7.6 „	5.0 „
11.0 „	6.0 „
15.2 „	7.0 „
∞	8.0 „

Therefore, while in pure mercury vapour excitation and luminosity begin at small densities as soon as the voltage drop in the gas path becomes greater than 4.68 volts, the voltage in the gas path grows, on the addition of a foreign gas, simultaneously with the loss of energy on collision, without the gas path beginning to become luminous.

(3) *Greater Gas Pressure. Excitation and ionisation in the gas path.* In a region of excitation the electrons can be deprived of their energy even if they have not yet attained the velocity of 4.68 volts, because a small quantity of energy is sufficient for the further excitation of an already excited atom.

The resonance radiation emitted by an excited electron falling back into its normal atomic path is absorbed again by the surrounding mercury atoms, and so on, so that the radiation can only be slowly diffused away. Moreover, excited atoms join up with unexcited to form stable molecules and thereby retain the excitation. If now a foreign gas is added, the resonance radiation will also be partly absorbed and finally converted into heat by the molecules of the foreign gas. Therefore the degree of excitation in the excitation region will decrease and the voltage will grow.

There is, moreover, a further complication. As soon as the voltage in the gas path increases, because of the introduction

of a foreign gas, the temperature in the vessel also increases. In consequence the partial pressure of the mercury vapour rises and therefore also the density. Because the number of mercury atoms is increased in comparison with the number of foreign molecules, the voltage decreases. But because simultaneously the mean free path becomes smaller, the voltage increases. It is impossible to say off hand which influence will predominate. If the second influence is the greater and the voltage becomes increasingly greater, the arc will become unstable. Voltage, temperature and density mutually force each other ever higher until either the arc is extinguished or it changes into the thread-like white luminous form 3.

The influence of the addition of a foreign gas on the voltage drop in a 25 cms. long gas path of an arc, in a large glass sphere is shown graphically in Fig. 22.

(1) (c) The processes at the anode of the arc have already been discussed thoroughly on pp. 23 and following.

(2) (a) **The Cathode of the Glow Discharge in the Impermeable Direction**

At high voltages the processes at the impermeable cathode, the so-called "anode" of rectifiers, are of the greatest importance because the utility of rectifiers at high voltages seems to be limited by the existence of back starting. At a certain voltage the glow current, which was uniformly distributed over the surface of the cathode, contracts into an arc stream emanating from a point on the cathode. At the same time the high voltage of the abnormal cathode flow falls to a few volts and the current increases tremendously; thus the impermeable direction becomes permeable, and the rectifier becomes in effect a short circuit. Back starting has taken place. The future of mercury arc rectifiers depends on the security with which they can be used at high voltages and therefore how successfully back starting can be overcome.

In pure mercury vapour the normal cathode fall of a completely gas-freed iron cathode is 530 volts. This is much

higher than that of other gases ; a fact which is favourable to the prevention of back starting. Moreover, the current increases only very slowly with the voltage. Fig. 23 gives a picture of the relation between current density and voltage in pure mercury vapour at different vapour pressures. When all gases have been carefully removed from a glass rectifier

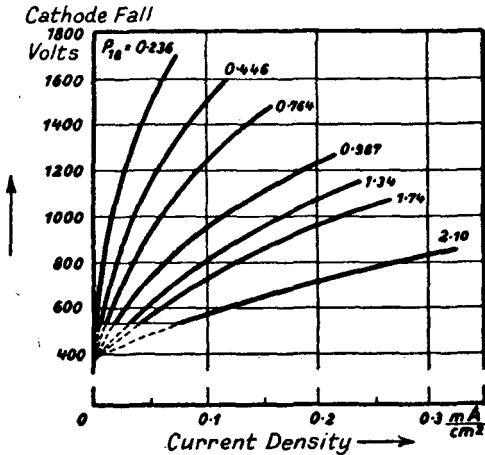

FIG. 23.—Dependence of Cathode Fall (Iron Cathode in Mercury Vapour) on Current Density and Pressure.

it is not difficult with cooling to keep the pressure below 100 μ and even below 20 μ with small loads. In this way the following results were obtained between the voltage and current density at the cathode :—

TABLE XIX

Voltage.	Current Density at the Cathode with a Mercury Vapour Pressure of	
	20 μ	100 μ
3,000	·02 milliamps. per sq. cm.	·10 milliamps. per sq. cm.
6,000	·044 " "	·22 " "
10,000	·076 " "	·38 " "
20,000	·156 " "	·76 " "

How high the point of back starting can be pushed is not yet known with certainty. Ch. Jotte * has obtained a rectified voltage of more than 20,000 volts with a glass rectifier and good cooling.

The addition of foreign gases to the mercury vapour has two effects. First it increases the total pressure, and this necessarily produces an increase in the glow current. Secondly, the value of the glow current will approximate more and more to that of the pure foreign gas the greater is its partial pressure. The abnormal cathode fall increases not unimportantly with a rise of temperature of the glow cathode up to red heat. This property can be explained for the abnormal cathode fall by supposing that the gas nearest to the cathode becomes heated, so that its density decreases. Because of this property it is found in the operation of rectifiers that a glowing "anode" stands a much higher back voltage than a cold one.

This behaviour has still another basis. A high cathode temperature means also a high mercury vapour pressure in contrast with which the influence of the ever-present foreign gases disappears. With a cold "anode," on the other hand, and a very small mercury vapour pressure, the foreign gases predominate and the back voltage is decreased.

If the temperature of the cathode reaches a light white heat the high field strength collapses and the glow discharge changes into an arc discharge. The details of this process have not yet been investigated.

The possibility of back starting is increased—

- (1) By a high voltage on the valve electrode.
- (2) By a big vapour pressure, since this means a big glow current.
- (3) By impurities on the cathode that are likely to cause an emission of electrons.
- (4) By a large amount of foreign gas.

Dällenbach, Gerecke and Stoll † have investigated the effect of (3). If a glow discharge is set up with a cathode covered with suitable impurities, the cathode surface shows

* Ch. Jotte, *Revue Générale d'Electricité*, **11**, 322, 1922.

† *Phys. Zeits.*, 26, 10, 1925.

a number of minute sparks or scintillations. It was assumed that the appearance of these sparks marks the point of back firing, which owing to the amount of resistance in circuit did not actually occur as an arc discharge. Their results for sodium chloride on a platinum cathode are shown in Fig. 24. It is probable that such scintillations do not lead to an arc discharge if the impurities form a thin layer of high resistance.

Here again we see how complicated are the properties of the mercury arc rectifier; and how small hardly observable impurities can turn the relations completely upside down. It is therefore just as important to assemble the rectifier with a most painstaking care for cleanliness as it is to keep out foreign gases. A little sweat from the hand on the anode is sufficient to bring about back starting.

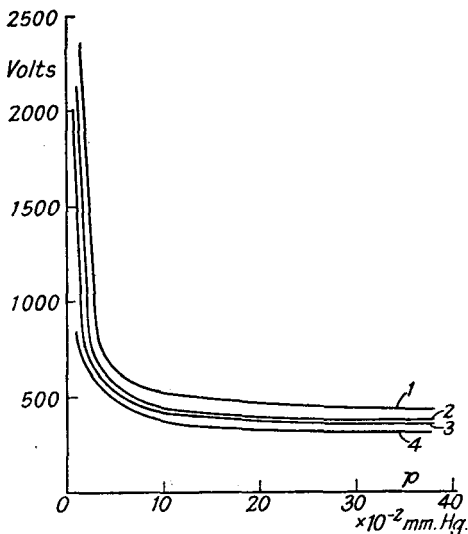

FIG. 24.—Dependence of Back-firing Voltage on pressure with Cathode covered with Sodium Chloride.

Foreign gases have a further very unpleasant action.

The oxygen of any air that has penetrated into the rectifier combines with the iron anode to form iron oxide. This is scattered as dust, and with the mercury forms a sticky conducting grease which covers the walls and the insulating parts of the vessel. With nitrogen and carbon, mercury forms an even worse grease, which comes into the vessel straight from the iron walls or perhaps in the form of dust.

As soon now as this grease bridges the insulator between the cathode and the metal container it becomes possible for the cathode spot of the arc to travel over this bridge on

to the metal container. On this it wanders till it reaches the neighbourhood of the anode. The current then flows from the cathode spot through the container and over the conducting bridge to the cathode. The bridge thereby becomes heated and destroyed. On account of this heating the cathode spot is extinguished on the container before it reaches the dangerous neighbourhood of the anode ; sometimes, however, back starting occurs.

So long as it is not possible, therefore, completely to exclude foreign gas from large rectifiers, the insulating parts between the cathode and the container must be made as long as possible, and very difficult to bridge. It is recommended at the same time that the anode should be separated from the walls of the container by an encircling insulating screen. Both precautions, however, have the unpleasant consequence of raising the "pervious voltage." By "pervious voltage" is meant that voltage which is necessary in each anode arm of a rectifier to start the arc at the beginning of each permeable cycle. If now air enters, it causes a further important rise of the pervious voltage. This may result in the extinction of the rectifying arc, and it will not start again without what in certain cases can be an unpleasant disturbance, like a back start.

The oscillogram given in Fig. 25 shows this property further ; it was taken with a multiphase rectifier for 10 amperes with long anode arms, two of which were loaded with direct current, while the third was supplied with alternating current. The mercury vapour pressure was made large in order to get a high pervious voltage.

The figure shows that the voltage in the anode arm grows to a point *a* before any noticeable current flows. As soon as the point *a* is attained, however, the voltage falls on account of the sudden inception of a strong current and then falls in a somewhat distorted curve to the end value of the arc voltage.

The pervious voltage is dependent on the mercury vapour pressure in the same way, but much more markedly, as the arc voltage. With very small pressures it is big, it decreases with increasing pressure to a minimum value, after which it again increases to a high value. The following Table XX.

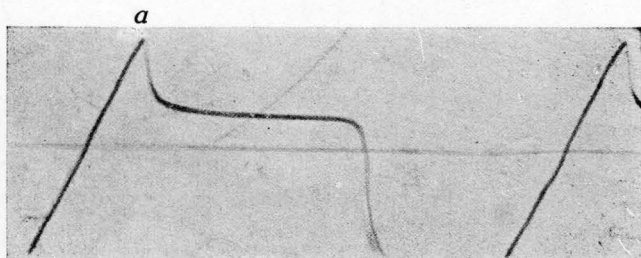

FIG. 25.—VOLTAGE AT ONE ARM OF A 10 AMP. MULTIPHASE RECTIFIER.

[To face p. 78.]

gives some numerical results. The amount by which the pervious voltage lies above the arc voltage grows rapidly as the anode arm is lengthened. With a cold anode the pervious voltage lies with small pressures below, with higher pressures above, that of a hot anode.

TABLE XX

Pervious voltage in an arm of a 10 amp. multiphase rectifier, whose other arms are loaded with 10 amperes. Rectifier in Heating Jacket

Number of Run.	D.C. Voltage in the Anode Arm.	Mean Current in Third Arm.	Pervious Voltage.	Mercury Vap. Pressure.
1	20.5 volt.	4.0 amp.	130 volt.	.030 mm. Hg.
2	18.0 „	3.3 „	40.0 „	.081 „
3*	17.3 „	3.1 „	27.5 „	.167 „
4	21.0 „	3.0 „	41.0 „	.580 „
5	25.0 „	3.3 „	86.7 „	1.500 „
6	29.8 „	3.6 „	118 „	4.200 „
7	36.0 „	3.3 „	153 „	13.500 „

Spark Discharge—Spark Valves

We have yet to mention the spark discharge as the last process by which valve action can be produced at the metal gas boundary. A spark can be physically described as a momentary change of a glow discharge into an arc immediately followed by extinction as a result of the exhaustion of the supply of energy. A glow discharge sets in at a fixed field strength at the cathode, and this field strength is much greater at a point than at a plate. A valve can therefore be obtained when a point and a plate are placed opposite to each other at atmospheric pressure. In order to make this valve effective, however, a few precautions must be observed. If the discharge were allowed to pass into an arc, the high temperature of the arc would make permeable the impermeable direction of the valve. According to Wolcott

* Normal operating conditions.

and Erikson, this can be avoided by directing a current of air from the point to the plate. The diameter of the plate must be great enough to prevent the discharge from the point taking place to its edge. In their experiments Wolcott and Erikson * used a plate of 10 cms. diameter, and an air-blast opening of 4 mm., while the anode rod had a diameter of 1.57 mm.

The distance of the opening to the point was 9.5 mm., that of the point to the plate was 17.6 mm. ; the A.C. voltage was 25,000 volts. Without air-blast the oscillograms showed pure A.C. curves ; with an air-blast of 5 cms. above atmospheric pressure a very clean valve action was produced. The current in the impermeable direction was zero. A direct reading instrument showed 12.3 milliamperes of direct current at 14,500 volts. When the current was increased to 104 milliamperes, the discharge was white and stratified, with rectification, and quite different from the coloured discharge without air-blast. The rectification of a few thousand volts was difficult ; on the other hand, at high voltages the apparatus worked unobjectionably up to 350,000 volts and 500 periods per second. If the point were inside the air-blast opening, aluminium electrodes were best ; if it were outside, iron or brass gave good results. If the blast pressure were increased from zero, the rectification rose to a maximum, whose value depended on the position of the electrodes and the diameter of the air-blast opening. M. S. Cohen has described a similar arrangement. He, however, used an undisturbed atmosphere of ammonia of seven atmospheres excess pressure instead of an air-blast. He obtained a rectification efficiency of 85 per cent. The strong cooling action of the ammonia prevents the production of an arc. Such an arrangement forms an extremely simple method for rectifying very high voltages.

The process of rectifying high voltages with thermionic tubes requires a special heating battery with regulating resistance and current-measuring instruments which must be insulated or else a heating transformer, specially insulated for high voltages, must be used. This method is therefore complicated.

* *Phys. Rev. II.*, 9, 480, 1917.

CHAPTER VII

Electrolytic Rectifiers

The Metal Electrolyte Boundary

A large quantity of combinations of the metal electrolyte boundary appear to be possible. Its valve action depends on the fact that every anion or cation at a given electrolytic concentration requires a perfectly definite voltage for its deposition. Suppose, for example, that a cell is made up of a copper and a platinum electrode in an acid solution of copper sulphate. The current will flow even with the smallest voltage in that direction in which the copper is anode, while in the opposite direction the decomposition voltage (+ .247 volts) of hydrogen at the platinum electrode must be attained before any current can pass.

But this example also illustrates the defect of such combinations. As soon as a current flows in the direction Cu-Pt, copper is deposited on the platinum. Thus it is changed into a copper electrode, and the current is able to flow in the opposite direction without marked minimum voltage, until the copper deposited on the platinum is again removed. Consequently this combination is useless as a valve.

Obviously only such combinations can be used with which the metal deposited on the cathode in the permeable direction does not stick. The most suitable material is mercury, which completely runs off from a suitable cathode.

Suppose, therefore, that a cell is made up of a mercury electrode, a platinum electrode, and the complex mercury salt K_2HgI_4 , so that the platinum electrode is at the top and the mercury electrode is at the bottom of the vessel. The current can flow through the cell from the mercury to the platinum with as small a voltage as desired for any length of time ; it will not alter the make-up of the cell. As soon as the current direction is reversed, however, the decom-

position voltage of the iodine ($\cdot 6$ volts) must be applied at the platinum electrode.

The cell, therefore, acts as a valve up to $\cdot 6$ volts ; in the flow direction there is no back voltage, a case that very seldom occurs with valves.

The use of this valve, depending on the metal electrolyte boundary, is subject, however, to another very real limitation. The valve action is produced when a certain very small quantity of current has flowed through the cell and deposited a film of molecular thickness of the cations concerned. This is as much a nuisance when the valve is being used for the rectification of alternating current, as it is unimportant in statical applications. With fifty-period A.C. the current has each time only $\frac{1}{100}$ of a second for deposition and redissolving. Consequently the current must be fairly strong to supply the necessary quantity of electricity in this short time. Therefore permeability exists in both directions at the beginning of each half-cycle.

With electrodes of very different sizes the connection between current and voltage is straight away dependent on the current direction. If, for example, a valve be made of an extremely small and an extremely large platinum electrode with sulphuric acid solution as electrolyte, then the ions will be deposited as gas at the small electrode before the big electrode is markedly covered with the opposite ion. It can therefore be considered as an indifferent electrode. The cell acts as a valve up to a voltage which, in the example above, is the difference between the deposition potentials of hydrogen and oxygen at the small electrode.

The Gas Electrolyte Boundary. The Electrolytic Rectifier

The so-called electrolytic rectifier depends, according to a theory advanced by the author, on the valve action of the gas-electrolyte boundary. It is necessary to use a high potential gradient to free electrons from a cold metallic electrode, but an even higher potential gradient must be used to get the electrons from a cold electrolytic electrode. This is especially true when the gas bounding the electrode

is under a high pressure so that the mean free path of the ions becomes exceedingly small.

A valve is therefore obtained when an electrolyte is separated from an electrode by a very thin gas film. This arrangement cannot be obtained artificially for various reasons, but it is made automatically during the formation of a valve metal, in which the following phenomena take place :

Let an electrolytic cell, consisting of a valve metal as an anode, a suitable electrolyte and any indifferent metal as cathode, be supplied with a constant direct current. Then,

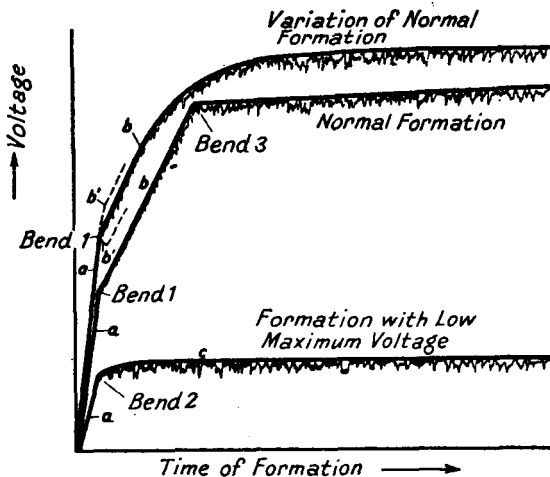

FIG. 26.—Typical Curves of formation of Tantalum at a Constant Current Density.

in order to maintain the current through the cell, the voltage rises in proportion to the time of formation up to a sharply defined voltage at which sparks suddenly appear over the surface of the valve metal. After this the voltage across the cell increases at a rate which is slower, but again proportional, to the time of formation, while the sparks become brighter. A second equally sharply defined voltage is then reached ; a new kind of sparking sets in and the voltage quite, or almost quite, stops rising. The formation of the cell is complete. The first voltage is called the sparking voltage, the second the maximum voltage. Fig. 26 gives a typical example

of the rise of voltage during formation with a constant current density.

Thus there are five characteristics of formation to be distinguished :—

- (1) The rate of voltage rise between 0 and A, or, shortly, “gradient *a*.”
- (2) The similar curve between A and B ; “gradient *b*.”
- (3) The curve after B ; “gradient *c*.”
- (4) The sparking voltage.
- (5) The maximum voltage.

During formation a tenacious, porous and exceedingly thin skin is formed on the valve metal ; for the most part it is composed of the oxide of the valve metal used. It grows with the time of formation. Its thickness Δ can be determined from its interference colours, which it shows in great purity.

At the same time an even thinner film grows ; owing to its high resistance it acts as the dielectric of a condenser. The capacity of such a condenser can be determined with the formation voltage applied to the cell by a bridge using superimposed alternating currents. The absolute thickness δ could be calculated from the capacity if the dielectric constant K were known. As this is not the case we must be content with the determination of the relative thickness (the thickness for which $K = 1$).

Thus we obtain the further characteristics :—

- (6) The thickness of the solid skin.
- (7) The thickness of the effective layer.

During formation free oxygen is evolved at the valve anode, therefore

- (8) The evolution of oxygen.

If a constant voltage be applied to the cell the current sinks to a very small value, therefore

- (9) The residual current.

If voltages of all values from 0 up to the formation voltage be applied to a formed cell and the current be determined at each applied voltage, the static volt/ampere curve will be obtained ; thus

- (10) The static characteristic.

These are the essential characteristics in the resistant direction. The investigation of the permeable direction is more difficult. If direct current be used, the effective layer, built up during formation, is at once seriously altered by the evolution of hydrogen. Therefore in order to cause the minimum amount of damage to the effective layer, when investigating its properties in the permeable direction, experiments must be made as soon as possible after the change from the impermeable to the permeable direction, and the current density must be small. Alternating current is therefore used and the phenomena are investigated with the help of oscillograms. It is then found that below a characteristic voltage, the minimum voltage, the cell is impermeable in the permeable direction. The cell becomes permeable at the attainment of the minimum voltage without any further increase in the voltage across the effective layer. Here then the cell behaves exactly like a mercury arc rectifier.

Thus is obtained the characteristic :—

(11) The minimum voltage.

In the permeable direction very peculiar phenomena are shown if the cations are formed from heavy metals. Therefore :—

(12) The deposition of metals in the permeable direction.

Electrolytic valve action has up till now been found to be given by the following 18 metals ; Cu, Ag, Be, Mg, Zn, Cd, Al, Sn, Pb, Nb, Ta, Sb, Bi, W, U, Fe, Co, Ni. Of these one shows the phenomenon in all, some in many, and others in only a few electrolytes.

Each of the twelve above characteristics depends in a complicated way on the variables valve metal, electrolyte, concentration, temperature, current density, voltage. From such a multiplicity of phenomena only the most important can be picked out here.

A systematic treatment of the phenomena became possible when the difference between complete and incomplete valve action became clear.

Complete valve action exists when the valve metal is not markedly soluble in the electrolyte, incomplete valve action when the solubility of the valve metal modifies the pheno-

mena. The circumstance that aluminium, with which originally all researches into valve action were carried out, shows an incomplete valve action, in most electrolytes, has made the clearing up of the phenomena very difficult. The solubility of the valve metal and electrolyte depends on the temperature, and this among other factors depends on the current density; the concentration of the electrolyte is also important. This tangle of complications has not been successfully unravelled. When research was directed to the valve metal tantalum, which shows a complete valve action in all electrolytes, the following laws were discovered:—

(1) Gradient a is independent of the concentration of the electrolyte. It decreases considerably with increasing temperature. The value of the decrease is dependent on the electrolyte. Gradient a falls about $\frac{1}{2}$ from 0° C. to 100° C.

At high current densities the gradient a is almost inversely proportional to the current density, so that equal quantities of electricity through the cell produce equal formation voltages. At small current densities the necessary quantities of electricity are greater, till with extremely small current densities a state of formation no longer occurs, and a kind of passivity sets in. The way in which gradient a depends on the valve metal and the electrolyte has not yet been reduced to a law. The greatest speed of formation of tantalum at a current density of 2 milliamperes per sq. cm. is 60 volts per minute in aqueous solution, and 240 volts per minute in pure sulphuric acid.

(2) Gradient b is noticeably smaller than gradient a , but it seems to behave in the same way. Its systematic investigation has yet to be carried out.

(3) Gradient c is generally zero.

(4) The sparking voltage depends on the valve metal and the nature and concentration of the electrolyte, but not on the temperature and the current density. With tantalum it lies between 150 and 220 volts in .05 normal solutions of most electrolytes. It appears to be that voltage at which sparks begin to come from the anode of the gas path, that is from the metal.

(5) As far as research has gone it seems that the maximum

voltage is independent of the valve metal, current density and temperature. But the nature and concentration of the electrolyte have a great influence; and it is the concentration of the free ions, not the total concentration, which is effective.

Table XXI. gives the maximum voltages of a number of non-metallic ions. The cations used in the experiments (they were actually alkali cations) are not given, since the cations do not influence the phenomena as long as they are not heavy metal cations. The table shows that the maximum voltage does not greatly vary with these metal-free anions.

The state of affairs is quite different from Table XXI., however, when anions containing metals are considered. Tables XXII. and XXIII. give information about this. From Table XXII. we get the following: the maximum voltage, which with metal-free anions in .05 N solutions scarcely varied from 478 volts, becomes greatly lowered when a metal like Pt, Fe or Cr enters into the anion. The very small maximum voltage is dependent first on the metal in the anion and to a secondary extent on the nature of the combination.

TABLE XXI

Maximum Voltage of Tantalum in .05 N Solutions of the following Metal-free Anions

Anion.	Maximum Voltage.	Per cent. Deviation from Mean.	Anion.	Maximum Voltage.	Per cent. Deviation from Mean.
OH' . . .	446	- 6.8	NO ₃ ' . . .	475	- 0.8
HCOO' . . .	488	+ 2.0	H ₂ PO ₄ ' . . .	435	- 9.1
C ₃ H ₇ COO' . . .	508	+ 6.2	1/2HAsO ₄ " . . .	447	- 6.6
C ₄ H ₉ COO' . . .	520	+ 8.7	BO ₂ ' . . .	487	+ 1.8
C ₆ H ₁₃ COO' . . .	560	+ 17.0	1/2SiF ₆ " . . .	495	+ 3.4
SH' . . .	463	- 3.3	F' . . .	531	+ 10.9
1/2SO ^o . . .	449	+ 6.2	BrO ₃ ' . . .	480	+ 0.3
CNS' . . .	480	+ 0.3	J' . . .	488	+ 2.0
CN' . . .	465	- 2.8	Mean value.	478.6	

TABLE XXII

Maximum Voltage of Tantalum in .05 N Solutions of various Anions of the Metals Chromium, Iron and Platinum

Metal.	Anion.	Maximum Voltage.	Metal.	Anion.	Maximum Voltage.
Cr	$1/2\text{Cr}_2\text{O}''_7$	131	Fe	$1/2\text{Fe}(\text{CN})_5\text{NO}''$	76
	$1/2\text{CrO}''_4$	141		$1/2\text{Fe}(\text{C}_2\text{O}_4)''_3$	85
	$1/3\text{Cr}(\text{C}_2\text{O}_4)''_3$	134		$1/3\text{Fe}(\text{CN})''_6$	82
	$1/3\text{Cr}(\text{CN})''_6$	126		$1/4\text{Fe}(\text{CN})''_6$	91
Mean		133	Mean		84

Metal.	Anion.	Maximum Voltage.
Pt	$1/2\text{PtCl}''_6$	20
	$1/2\text{PtCl}''_4$	35
Mean		28

The results of investigations with as many metals as possible are contained in Table XXIII. It shows that each metal by its entry into the anion lowers the maximum voltage by quite a definite amount.

Platinum and gold are the most effective, then follows iron, while the action is only weak with the rest. Moreover, all those metals which produce a low maximum voltage by their entry into the anion, do so also when they are constituents of the cation of an undissociated molecule, but the lowering of voltage is smaller than with the entry of the molecule into the anion.

From this behaviour of the maximum voltage the author * has drawn various conclusions about the tenacity of binding of electrons in electrolytic ions.

* Güntherschulze, *Zeits. f. Phys.*, 3, 349, 1920.

TABLE XXIII

Maximum Voltage of Tantalum in .05 N solutions for different Metals containing Anions

Metal.	Anion.	Maximum Voltage.	Metal.	Anion.	Maximum Voltage.
Pd	$1/2\text{PdCl}''_4$	19.5	Cu	$\text{Cu}(\text{CN})'_2$	(355)
Rh	$1/2\text{RhCl}''_5$	23	W	$1/2\text{WO}''$	363
Au	AuCl'_4	24	Ag	$\text{Ag}(\text{CN})'_2$	422
Pt	s.Tab. ₂	28	Zn	$1/2\text{Zn}(\text{CN})''_4$	425
Ir	$1/2\text{IrCl}''_6$	32	Sb	$\text{K}_2\text{Sb}_2\text{O}'_7$	435
Mn	MnO'_4	46	H	OH'	448
Fe	s.Tab. ₂	84	Bi	$1/2\text{BiI}''_5$	(450)
Cr	s.Tab. ₂	133	Hg	$1/2\text{Hg}(\text{CN})''_4$	453
Ni	$1/3\text{Ni}(\text{CN})''_4$	181	Mo	$1/2\text{MoO}''_4$	457
Sn	$1/2\text{SnO}''_3$	190	Cd	$1/2\text{Cd}(\text{CN})''_4$	478
Co	$1/3\text{Co}(\text{CN})'''_6$	243	Al	AlO'_2	660

The maximum voltage increases with increasing dilution in all electrolytes. Between the concentration of .05 and .5 N an increase of dilution of 1 per cent. corresponds on the average to an increase in the maximum voltage of .24 per cent. With higher concentrations the change of maximum voltage becomes irregular.

With very small concentrations the maximum voltage reaches very high values. Using aluminium as the valve metal and a mixture of boric acid and borax as the electrolyte, the author found that for small concentrations the following empirical formula holds good :—

$$V = 514.5 \log D - 330$$

where V = maximum voltage,

D = ionic dilution in litres per gram equivalent.

The highest maximum voltage measured was 1,900 volts.

6. The thickness of the solid layer Δ in the case of tantalum appears to be proportional to the formation voltage

under all circumstances ; this is also true of the thickness δ of the effective layer. Its thickness on tantalum amounts to $\cdot 6\mu$ at 200 volts formation voltage.

With aluminium there is no fixed relation between Δ and δ . It is possible for the oxide layer on aluminium to be more than one-tenth of a millimetre in thickness. Probably this abnormal growth plays a decisive part in its incomplete valve action.

7. The relative thickness δ/K of the effective layer is unaffected by

- (a) The electrolyte, if aqueous solutions are used (so long as very strong, almost water-free concentrations are not used).
- (b) The temperature.
- (c) The nature and manner of formation.

It is affected by the valve metal and the formation voltage, to which it is at first proportional. At higher voltages it increases somewhat faster. The following Table XXIV. gives δ/K for various valve metals at different voltages, while Table XXV. shows the thickness of the effective layer in some non-aqueous electrolytes.

TABLE XXIV

Forma- tion. Voltage.	Relative Thickness δ/K in						
	Mg.	Sb.	Bi.	Zn.	Al.	Nb.	Ta.
50	12.1	11.0	9.2	16.5	6.4	5.0	4.1
100	26.3	23.8	18.7	—	10.3	10.4	7.1
150	41.4	38.7	29.1	—	16.1	—	11.6
200	60.1	58.0	42.0	—	22.3	—	17.0
250	86.0	84.4	60.8	—	29.3	—	22.9
300	120.5	119.4	—	—	37.1	—	28.8
350	165.5	—	—	—	46.6	—	34.6
400	—	—	—	—	58.0	—	40.3
450	—	—	—	—	71.0	—	45.0
500	—	—	—	—	85.9	—	49.1

TABLE XXV

Electrolyte.	Relative Thickness δ/K at 50 volts after 30 minutes' formation.	
	Tantalum.	Aluminium.
Dilute aqueous solutions .	4.10	6.36
Pure sulphuric acid . .	6.69	10.65
Fused water-free—		
NH_4NO_3	6.26	—
KHSO_4	6.98	13.1
AgNO_3	7.12	220
TlNO_3	10.1	—
LiNO_3	7.93	—
NaNO_3	12.5	133
KNO_3	11.1	142
$\text{K}_2\text{Cr}_2\text{O}_7$	18.2	30

8. The evolution of gas during formation is to a certain extent correlated with the speed of formation. Since the current can either evolve oxygen or form the valve metal, the evolution of oxygen from insoluble valve metals is the greater the smaller is the speed of formation.

The sparks at the maximum voltage cause an abnormal evolution of gas which begins suddenly during formation on the attainment of the maximum voltage. The sparks that take place between the sparking and the maximum voltages do not produce this effect.

By the use of aluminium and a very dilute aqueous solution of boric acid with a current of 100 milliamperes at a maximum voltage of 1,890 volts, the sparks at the maximum voltage decomposed ten times as much water as that decomposed by electrolysis. The gases produced were Knall-gas (oxygen and hydrogen in the ratio produced by electrolysis), hydrogen peroxide and hydrogen.

In solutions of boric acid and borax the total excess of Knall-gas u increases slowly up to a maximum voltage of

1,150 volts, after which it rises rapidly with the voltage. With quick current variations the gas excess is proportional to i^2 in dilute aqueous solutions, with lengthy experiments u is very much affected by the cooling. With poor cooling u can fall to zero. In concentrated solutions of ammonia, formic acid and acetic acid u is given by

$$u = b(i - i_0)$$

where i_0 = the residual current flowing through the effective layer as distinct from that due to sparking.

The experiments on the dependence of the gas excess u on the concentration of the ammonia solution lead to the supposition that ammonia reacts with the water up to a concentration of .4 N as NH_4OH ; above this concentration it is dissolved as NH_3 molecules.

For u we have

$$u = 19.1 \sqrt[3]{n} - .4 \dots \dots \dots (24)$$

where n = content of ammonia in solution in gram equivalents per litre.

With tantalum in formic acid

$$u = 1.305 n \sqrt[3]{n} \dots \dots \dots (25)$$

Acetic acid only obeys equation (25) up to a concentration of 20 per cent. Above this disturbances appear caused by too low a maximum voltage.

9. The residual current has as yet been little investigated. It seems that it decreases with time to the value necessary to make up the loss caused by diffusion from the effective layer. Since this diffusion is made difficult by the oxide layer, lying over the effective layer, the residual current attains extremely small values. With aluminium in ammonia, for instance, at 110 volts formation voltage it becomes 1.5×10^{-7} amps./sq. cm.

10. The static characteristic in the resistant direction consists of a steep line up to the maximum voltage at which it becomes horizontal. It has the same shape in the permeable direction, the bending point being determined by the minimum voltage. In the almost vertical part (corre-

sponding to impermeability) the quotient volts/amperes decreases markedly with increasing voltage. The dependence of the static characteristic on the different variables has scarcely been investigated.

11. The minimum voltage depends on the valve metal, the thickness of the effective layer (the magnitude of the formation voltage), and on the nature and concentration of the electrolyte. It is unaffected by the temperature. The minimum voltage of tantalum is 1.51 times that of aluminium when both metals are formed at the same voltage.

Valve metals like Sb, Bi, Zn, Cd, with which the insulating oxide layers formed on the anode are reduced when the current is reversed, show no valve action with normal alternating current.

The minimum voltage increases only a little with the formation voltage or the thickness of the effective layer.

Halving the ionic concentration of the electrolyte increases it about 7 per cent. Table XXVI. shows its dependence on the anion and Table XXVII. on the cation.

TABLE XXVI

Minimum Voltage of Tantalum after Formation at 85 volts in .05 N Solutions

Electrolyte.	Minimum Voltage.	Electrolyte.	Minimum Voltage.
KOH	9.6 volt	K ₂ CrO ₄	11.2 volt
KAgCy ₂	11.1 "	Na ₂ MoO ₄	10.2 "
K ₂ CdCy ₄	7.9 "	Na ₂ WO ₄	9.6 "
K ₂ HgCy ₄	13.3 "	KMnO ₄	7.9 "
KaIO ₂	4.3 "	KF	14.3 "
NaHCO ₃	13.2 "	NaCl	18.2 "
NaCH ₃ COO	9.6 "	KClO ₃	9.7 "
NaN ₃	14.4 "	KBr	9.5 "
KNO ₃	11.7 "	KBO ₃	14.1 "
NaNO ₂	17.2 "	KJ	11.5 "
KH ₂ PO ₄	9.3 "	KJO ₃	8.3 "
Na ₂ SO ₃	9.0 "	K ₂ PdCl ₄	11.0 "
Na ₂ S ₂ O ₃	14.0 "		

TABLE XXVII

Minimum Voltage of Tantalum after Formation in .02 N Solutions of the Nitrates of the Following Cations

H	46.3 volt	Zn	25.4 volt.
Li	11.6 "	Cd	32.3 "
Na	10.5 "	Hg	30.9 "
K	10.8 "	Al	27.2 "
Rb	10.2 "	Tl	16.4 "
Cs	9.8 "	Pb	31.2 "
NH ₄	20.7 "	Bi	32.0 "
Cu	26.0 "	Cr	27.2 "
Ag	8.5 "	UO ₂	14.8 "
Mg	28.0 "	Mn	23.2 "
Ca	35.1 "	Fe	39.7 "
Sr	32.9 "	Co	15.8 "
Ba	35.2 "	Ni	26.6 "

W. Winter tried to imitate valve action artificially. He started from the consideration that if a porous skin on aluminium is necessary for its valve action, the valve action must also be produced with any other metal when covered with a non-conducting porous skin. Winter used the metal to be investigated in the form of a rectangular plate $2\frac{1}{2}$ sq. cms. big. After it had been rubbed with emery it was pressed against the wall of a carefully cleaned clay cell. Using potassium hydroxide as electrolyte he obtained valve action with all the metals investigated (Mg, Al, Zn, Cd, Fe, CO, Ni, Pb, Sn, Sb, Bi, Cu, Ag, Pt, Au, Cr); in sulphuric acid, platinum, gold and chromium refused to work.

Winter thought that the phenomena observed by him had two causes. First, the clay cell limited the access of the aqueous solution to the metal. A high concentration of the products of electrolysis was thereby produced; these products were then partly precipitated and formed a skin of high resistance. Then, secondly, this acted in very much the same way as the skin in true electrolytic valves.

Unfortunately, Winter took no oscillograms, so that there is no confirmation of his hypothesis. A clay cylinder is

much too coarse in comparison with the thickness of an aluminium oxide skin, which is a fraction of a μ thick, and lies on top of the metal without the smallest gap, to be able to cause the same phenomena as an aluminium valve.

It is more likely that the phenomena are similar to those given by the use of electrodes of widely different areas.

CHAPTER VIII

Detectors

In general, a detector is an apparatus which permits high frequency oscillations of very small intensity to be measured. One distinguishes thermal, magnetic and contact detectors. Only contact detectors depend on true valve action. One distinguishes valve detectors with a fluid, such as the Schlömilch cell, from those depending on solid semi-conductors, like graphite, tellurium, metallic sulphides, glance, pyrites, blende, carborundum, etc.

The Schlömilch cell consists of a vessel containing dilute sulphuric acid in which dip two platinum electrodes, one of which is extremely thin and enclosed in a glass tube, so that only quite a minute electrode surface is exposed. The thin wire is connected to the positive pole, the thick one to the negative pole, of a battery whose E.M.F. is only slightly greater than the decomposition voltage of the sulphuric acid of the Schlömilch cell. A small permanent current therefore flows through the cell.

As soon as the cell receives a high-frequency current, the direct current flowing through the cell increases, so that a crack, or a musical note with synchronous spark transmission, is heard in a telephone connected in circuit.

Contact detectors in a narrow sense have been the subject of numerous investigations. In Fig. 27 is reproduced a curve obtained by Ettenreich with a lead glance—nickel detector. The detector consisted of a pointed nickel wire of 6.8 mm. diameter which was set with an impressed force of 6 gms. on a cleavage surface of a good cube formed lead glance crystal. Fig. 27 is typical of a crystal detector. In the majority of the investigations on detectors the error has been made of supposing that phenomena, which were shown with commutated direct current or low-frequency alternating current,

could be applied straight away to high-frequency valve action.

By analogy with the Schlömilch cell, in which electrolytic valve action seems to be self-evident, it was supposed up till a short time ago that most crystal detectors likewise depend on an electrolytic valve action partly in the crystal itself and partly in the film of water clinging to it. In the cases in which there was unquestionably no electrolysis, thermoelectric action was adduced as an explanation.

This theory of electrolytic valve action received a support from investigations of Huizinga, who observed visual electrolytic processes at the place of contact. And yet both opinions are wrong. Not even the action of the Schlömilch cell depends on electrolytic valve action.

The theory of the electrolytic valve action of detectors is easily disproved. An electrolytic valve is produced when the ions moving in the electrolyte reach a boundary at which they deposit themselves;

thereby the boundary is altered in such a way that a counter-electromotive force is set up. If for example a large and a small platinum electrode are immersed in sulphuric acid, as in the Schlömilch cell, gaseous hydrogen will be formed at the small electrode in one current direction, and oxygen in the other. At the large electrode no marked polarisation occurs on account of the extremely small current density. Since now the potential of hydrogen deposition in sulphuric acid is $\cdot 274$ volts, and that of oxygen deposition is $-\cdot 86$ volts, a potential difference of $-\cdot 586$ volts remains over.

Therefore an electrolytic valve first becomes effective in each direction when the necessary quantity of ions has

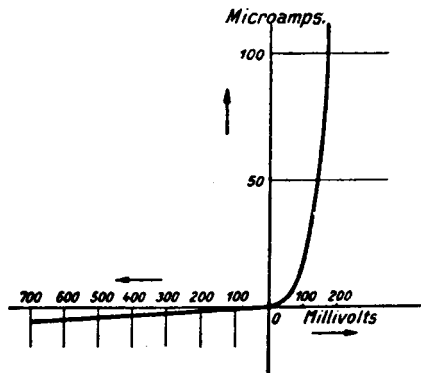

FIG. 27.—Current Voltage characteristic of a Lead Sulphide—Nickelin Detector (after Ettenreich).

been deposited; when, therefore, a current has flown for a time or a certain quantity of electricity has been used. Moreover, the layer formed by the previous current direction must first be removed, and the layer corresponding to the new current direction be substituted. Now, a good detector is still effective for high frequency currents of 10^{-8} amperes and a frequency of 10^6 periods per second. Therefore in each direction there is for disposal only a quantity of electricity which is small compared with $\cdot 5 \times 10^{-14}$ coulombs and which may be estimated at 10^{-15} coulombs. Such a quantity of electricity deposits 10^{-20} gms. of hydrogen.

To this must be added the fact that the deposition of ions is not a process which takes place with any speed. It is therefore clear that ionic valve action does not in general

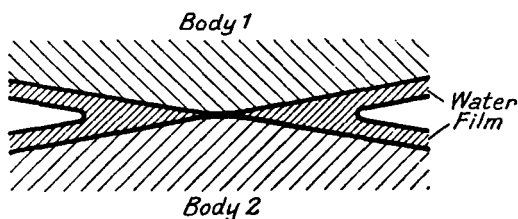

FIG. 28.—Diagram of Water Film between Two Bodies in contact.

come into the question of high-frequency work. All high-frequency valves are without exception electron valves, the Schlömilch cells as much as the crystal detectors.

That electrolytic processes were observed by Huizinga at the place of contact is not in the least at variance with this. It is known that when two bodies are placed together they only touch at a few points.

Even with a small force the pressure at these points is so great that the water film, that covers the surface, is squeezed out. Thus results the effect shown in Fig. 28. If the two dissimilar bodies forming the contact have metallic conductivities they make with the water film a short circu- lated cell in which electrolysis takes place. If the two bodies are separated at their contact place by a bad conducting layer due to themselves (for example lead glance by a layer

of sulphur atoms), they will form with the water film an open cell with a definite E.M.F. Neither phenomenon has anything to do with the electronic valve action of contact spots.

In the last few years the real processes underneath the valve action of contact detectors have been brought to light through the work of Szekely, Ettenreich, Hoffman and Rother, and a short time ago were dealt with by Schottky in a very clear exposition. Schottky argues from the following conceptions :--

All metallic conductors are full of a large number of loosely held electrons which behave similarly to the atoms of an ideal gas. As soon as the electrons pass through the surface of a conductor and reach the surrounding space, a force corresponding to a few volts and dependent on the nature of the metal acts on them and pulls them back to the metal. Only those electrons which by chance have an abnormal velocity can overcome this force and leave the metal. The mean velocity of the electrons at room temperature corresponds to $\cdot 045$ volt, so that at room temperature practically no electrons can leave the metal.

Schottky represents these relations very clearly by the picture of a flat basin with a high curved side. Elastic spheres (the electrons) can roll undisturbed here and there on the bottom of this basin. But as soon as they wish to leave the basin they must have so great a velocity that they can run up the side. (This corresponds to overcoming the attractive force of the metal.) The height of the side corresponds to the total voltage opposing the exit from the basin, and the steepness of the walls to the potential gradient.

We can now try to assist the electrons to escape from the metal by applying an external field that pulls the electrons out. This means in the picture of Fig. 29 that the side of the basin is bent down and thereby becomes lower ; the question is what potential gradient is necessary for this ? Schottky comes to the conclusion, as the result of a calculation whose derivation would take us too far, that the maximum field strength pulling the electrons back to the metal amounts to 1.4×10^8 volts per centimetre for tungsten and 2.8×10^7 volts per centimetre for sodium.

But in applying this field a very important phenomenon comes into consideration. The irregularities that can be observed on a surface with a microscope are greater than 10^{-5} cm.; but irregularities of 10^{-6} cm. and smaller are everywhere present. If a half cylinder be placed on an even surface the potential gradient is doubled. If a second cylinder of half the diameter is placed on top of this a further doubling of the potential gradient occurs. In this way it is estimated that surfaces which show no visible irregularities have real field strengths at the exposed points

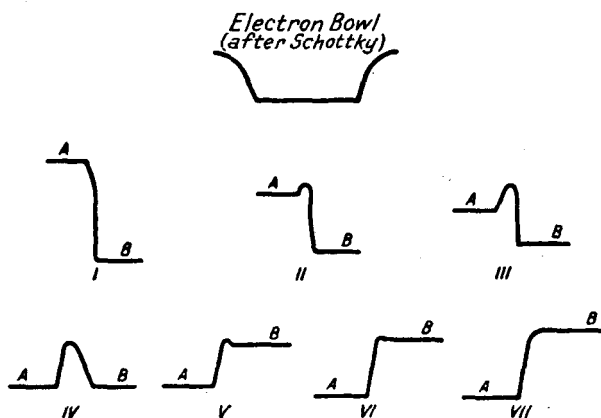

FIG. 29.—Various Positions of the Common Wall joining two Electron Bowls Corresponding to Different Voltages (after Schottky).

of ten times the magnitudes due to their macroscopic shapes. Therefore a given applied potential produces not only a mere increase of the average external field but also a local excess of potential gradient. Because of the presence of these points, therefore, the field strength necessary for the initiation of the cold electron discharge amounts to 1.8×10^7 volts per centimetre for tungsten.

These conceptions are the basis for the explanation of the processes of current conduction across short spaces. Rother and Hoffman have investigated these phenomena closer.

Hoffman finds the critical strength in volts/cm., at which the electron flow sets in, to be 4.8×10^6 for platinum, and

3.5×10^6 for copper, 3.4×10^6 for aluminium, 2.7×10^6 for zinc, 2.2×10^6 for lead. Rother obtained 7.6×10^6 volts per centimetre with platinum. These experimentally determined values, although probably still too small, approximate closely to those required by the theory.*

Schottky explains the action of contact detectors with the help of the conceptions advanced below. As a picture of a contact detector he uses that of two electron bowls placed side by side and so near to each other that their sides flow together. [This is a two-dimensional illustration; the bowls in this case are not to be considered as round bowls, but rather as two troughs whose traces are as shown in Fig. 29.—*Trans.*] The level of the bottom of each electron bowl corresponds to the free energy of the electrons, and indeed to their total energy, and therefore at thermal equilibrium and without applied field the two levels are the same. But even when the levels of the bottoms are the same, the shape of the common side depends not only on the internal fields of the two bodies, but also on the external field that is produced by the collection of oppositely placed charges on the surfaces of the two bodies. [This external field is caused by the flow of electrons from the body having the greater electron concentration to that having the smaller; it is, in other words, caused by the contact difference of potential.—*Trans.*]

If now two electron bowls are placed at a constant small separation from each other and the bottom of one is raised or lowered with respect to the other, the relations shown in Fig. 27 will result, if A has a higher and steeper side than B. With a sufficiently strong applied potential difference, the side between A and B disappears, whether B is negative to A, or *vice versa*; but the potential differences necessary for the two cases are different. Consequently the current voltage curve will be unsymmetrical, because a flow of electrons from B to A takes place with voltages much smaller than that necessary to cause a flow in the opposite direction. That is to say, the current voltage characteristic of Fig. 30 must

* Recent work by Rother with thoroughly out-gassed electrodes shows that the order of magnitude of the field required approximates even more closely to that demanded by theory.—*Trans.*

result in which e is the voltage across the place of contact. If instead of e one takes the voltage across the two external ends of two crystals placed at a slight separation from each other, so that their voltage drop is also taken into account, the curve of Fig. 30 results. But this is absolutely the type of curve that, for example, Huizinga found with his supposed electrolytic detectors. Huizinga's assumption, that a current flows only when a polarisation force differing in each direction has been overcome, corresponds to the behaviour shown in Fig. 29.

Thus it is clearly shown that detection is always a

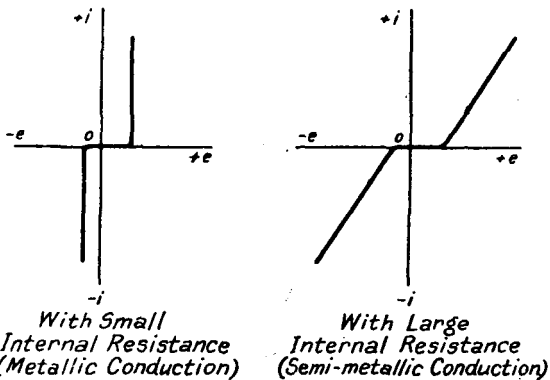

FIG. 30.—Theoretical Current Voltage characteristic of a Detector (after Schottky).

process of electronic valve action. The details of the theory have yet to be cleared up. Very complicated phenomena can exist in some cases. For example, the different contact spots between two bodies can cause first a complete contact without any separating layer, secondly a contact with an intermediate insulating layer of molecular thickness, and thirdly an approximation to a very small air-filled separation. All three spots are electrically in parallel with each other; and together make up the current voltage curve. The theory also makes intelligible the part played by electrolysis in such detectors as it is really necessary, as in the Schlömilch cell. It merely serves to produce and maintain the necessary separation layer. Under certain circumstances the direct

current, which is caused by the rectification of the high-frequency alternating current, can produce a secondary polarisation which increases the efficiency of the rectification far above the original value. The time necessary for this is very large compared with the time of a high-frequency oscillation, and very small in comparison with the time of observation.

Iwen Stransky * has attempted to develop Schottky's theory. Schottky's theory does not explain why there often exist spots where the rectified current is in a direction opposite to the normal one, nor does it explain how rectification takes place between a lead sulphide crystal and a lead sulphide point. Stransky supposes that the very big contact pressure causes the heteropolar linkages to change into homopolar linkages and thus reduces the force necessary to pull out the electrons. Therefore, according to Stransky, an easily deformable heteropolar linkage and a sufficient contact pressure are required to produce rectification.

Valves with Auxiliary Voltage

The advantage of valves with auxiliary voltage over those needing no auxiliary voltage is their ability to withstand shocks. During the war they were therefore used extensively.

A general formal theory of those valves has been given by Brandes. Fig. 31 shows the various possible methods of application. The following direct deductions can be made from it :—

1. If the valve be loaded with a constant direct current i_{g1} and an alternating voltage $\pm e_1$ be superimposed, an ordinary A.C. variation of $\pm i_1$ will be produced. No alteration of the direct current i_{g1} or any rectification of the A.C. will take place.

2. If the valve be loaded with the same alternating voltage $\pm e_1$, but a greater direct current i_{g2} , the value of the current $-i_1$ will be greater than $+i_1$. Thus a weakening of the current i_{g2} or a rectification of the A.C. in the negative sense will result.

* *Zeits. f. Phys. Chem.* 113, 131, 1925.

3. Correspondingly, a rectification of the A.C. in the positive sense will follow if the direct current is smaller than i_{g1} (for example, when it is zero).

Therefore, by increasing the direct current through the valve the valve action originally present can be weakened,

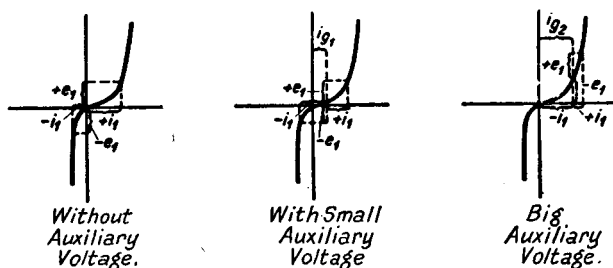

FIG. 31.—Influence of Auxiliary Voltage on Rectification.

destroyed and reversed. The sharper the curvature of the characteristic at the point corresponding to the added direct current, the greater will be the rectifying action produced.

The following Table XXVIII., obtained by Leimbach with a tellurium-silicon detector, will serve as an illustration.

TABLE XXVIII

Auxiliary Voltage.	Direct Current in amperes.	Direct Current due to High-frequency Oscillations. Amperes.
0	0	- 80 $\times 10^{-8}$
·082	1×10^{-8}	- 78 "
·615	5·8 "	- 39 "
·820	10·5 "	+ 2 "
1·050	17·0 "	+ 135 "
2·10	84·0 "	+ 5040 "
2·94	864·0 "	+ 18240 "

As well as crystal detectors, Schlömilch cells (as already mentioned) are used, and also in modern times thermionic valves with auxiliary voltage. These latter surpass all other detectors in the loads with which they can deal ; it is most

probable that they alone will survive in the contest with other types.

The valves without a grid behave like crystal detectors, and can therefore only change a fraction of the high-frequency A.C. supplied into useful D.C. The valves with a grid work in quite another way. They do not produce the current necessary to affect the receiving phones by changing a fraction of the high frequency A.C. into direct current, but the high-frequency energy is supplied to a grid circuit so that the grid is charged electrostatically and increases or decreases the anode current according to the nature of the charge. In this case the high-frequency energy is only used up in covering the losses in the grid circuit. It is not itself rectified, but acts as an "energy-controller," while the value of the anode current depends, among other things, on the voltage of the anode battery.

The properties and applications of valves with grids is a complete subject in itself, and is outside the scope of this book.

TECHNICAL SECTION

CHAPTER IX

Connections and Mathematical Theory of Valves

In this place only such general connections will be given as are applicable to the majority of valves. Connections which, through special peculiarities, are possible for particular valves will be given in the discussion of the valves concerned.

When a valve is used statically the connection is obvious ; the valve is connected in the current circuit, so that only one current direction is possible.

When it is used dynamically or as a rectifier, this simple connection has the disadvantage that one direction of the A.C. is suppressed, and the individual rectified current pulsations are therefore separated by intervals of zero current. Therefore this circuit, as far as low-frequency current is concerned, is used only for rough-and-ready valves in laboratories or for small low voltage rectifiers.

It can be considerably improved by choosing an inductance having the smallest possible losses instead of using an ohmic regulating resistance. This prolongs the time of permeability over almost a full period instead of over half the period obtained with an ohmic resistance. Yet it is not possible to remove or even only to diminish the strong pulsations associated with this connection.

If both directions of the alternating current are to be utilised, more than one valve must be used. In the so-called Grätz connection for the rectification of single-phase current four valves are connected together in the way shown in Fig. 32. The valves are symbolised by arrows showing the direction of free flow. Six valves are needed in the Grätz circuit for the rectification of three-phase current, as is shown by Fig. 33.

The transformer circuit of Figs. 34 and 35 is the customary one used in the practical rectification of A.C. It is

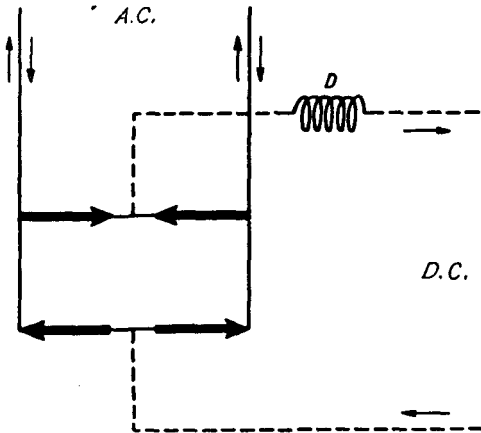

FIG. 32.—Grätz Circuit for Single-phase A.C.

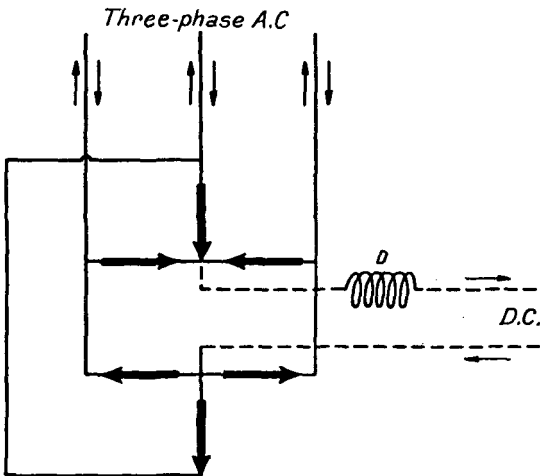

FIG. 33.—Grätz Circuit for Three-phase A.C.

a so-called auto-transformer across the ends of which the A.C. voltage E is applied. The potential e is governed by the number of turns, and for single-phase current is supplied to two, for three-phase current to three, valves. The

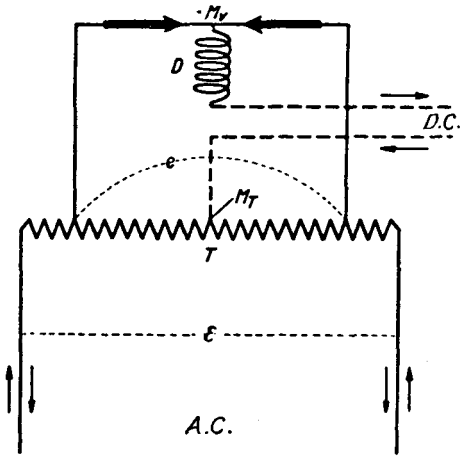

FIG. 34.—Transformer Circuit for Single-phase A.C.

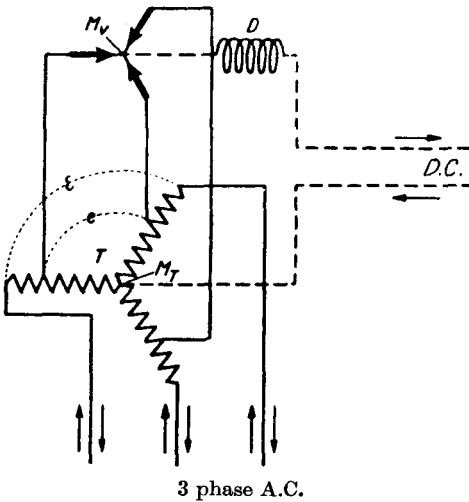

FIG. 35.—Transformer Circuit for Three-phase A.C.

circuit traversed by the rectified current is between the middle point M_v of the valves and the middle point M_T of the transformer.

For bigger outputs six valves are used in the circuit

shown in Fig. 36. The transformer supplies hexaphase current. The currents of the separate phases overlap to such an extent on the direct current side that the fluctuation of the current is small without any throttling.

A choking coil in the direct current circuit is necessary with mercury arc rectifiers and single-phase current. This prevents the current from falling below the minimum current density necessary for operation. With multi-phase current the arc travels from one anode to another, remaining at each one as long as it has a positive voltage higher than the others.

The disadvantage of this circuit is that it needs a trans-

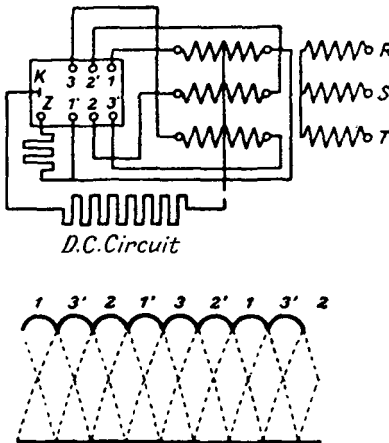

FIG. 36.—Connections and Output Curve of Hexaphase Rectifier.

former ; its advantage is that any relation desired between the A.C. and D.C. voltages can be obtained, and that the current only flows through one valve instead of two, as in the Grätz circuit, so that the energy losses in the valve system are half as small.

A back conversion of energy from the direct current to the alternating current side is not possible with a simple valve. Gas discharge valves are unaffected by the frequency of the A.C. They rectify high-frequency oscillations just as well as low-frequency A.C. Electrolytic rectifiers, on the other hand, are ineffective at high frequencies on account of their big

electrostatic capacity. The voltage of mercury arc rectifiers can only be regulated on the anode side, and indeed it is for this reason that tapped or polyphase transformers are used. Mercury arc rectifiers must be provided with anode chokes if they are to be run in parallel, in order that each rectifier should have a rising characteristic.

Greinacher has devised a circuit for the production of a constant D.C. voltage when small currents are required. It is shown in Fig. 37 (a). A number of circuits have also

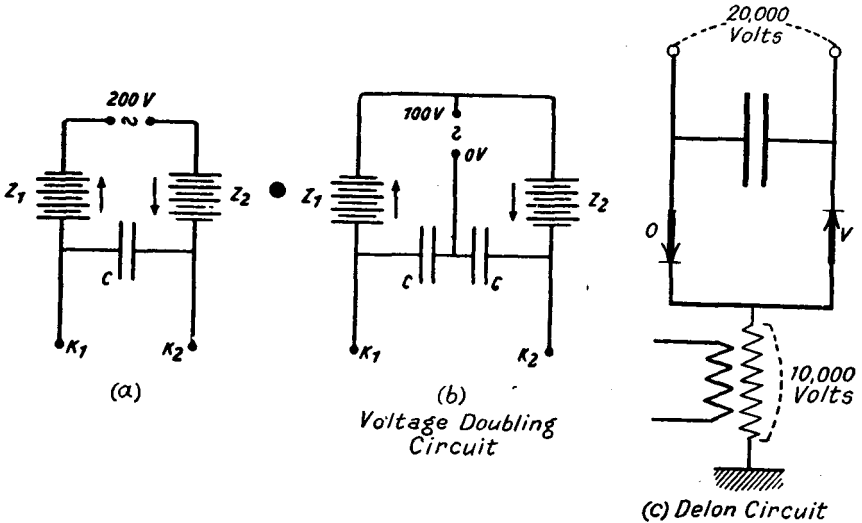

FIG. 37.—Greinacher and Delon Circuits.

been devised which produce a voltage multiplication. These circuits are applicable to any type of rectifier, but find their most useful application when used with thermionic rectifiers for the production of high D.C. voltages for X-ray work. One such circuit due to Greinacher is shown in Fig. 37 (b), and a variation specially suitable for X-ray work, known as the Delon circuit, is shown in Fig. 37 (c). Both these circuits are voltage doublers; if, for instance, the A.C. has a peak value of 10,000 volts it will vary between $\pm 10,000$ volts, and the D.C. voltage produced will be 20,000 volts. The process can, of course, be repeated. Jaeger and von Stein-

wehr have investigated mathematically what are the best values of capacitance and resistance ; their equations are complicated since transient quantities, which do not occur in ordinary A.C. calculations, have to be taken into account. Their results have been confirmed experimentally, and are represented by the curves in Fig. 38, which correspond to the simple Greinacher circuit of Fig. 37 (a).

v is the voltage on the condenser of capacity c farads, R_2

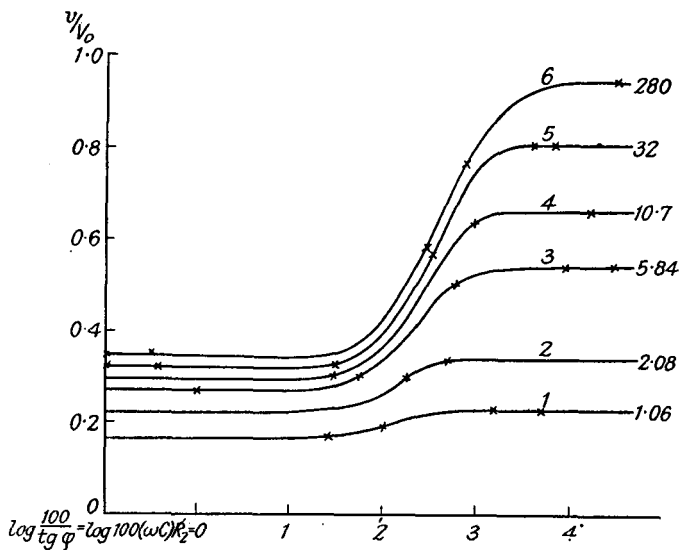

FIG. 38.

is a resistance across k_1k_2 , representing the load. R_1 is the resistance between the condenser and the valves. The curves show that v approximates more and more closely to V_0 , and the voltage fluctuations become smaller and smaller, as R_2 , w and C increase and R_1 decreases.

The Energy Losses in Valves and in the Rectification of Alternating Current

Four kinds of losses can be distinguished in the rectification of A.C. by valves :

- (1) Energy losses in the valve in the impermeable direction.
- (2) Energy losses in the valve in the direction of free flow.
- (3) Energy losses in the circuit using the D.C. by the delivery of pulsating D.C. by the valve.
- (4) Energy losses, in the circuit using the D.C., caused by current flowing in the impermeable direction of the valve.

Therefore there are two efficiencies to be distinguished, the efficiency of the valve and the efficiency of rectification; since the losses in the valve are dependent on its volt/ampere curve in both current directions, and since this differs in every valve, general laws cannot be laid down for the calculation of the losses. It is only certain that these losses cannot be regarded as caused by ohmic resistance, because there is no valve whose characteristic consists of two straight lines of different slopes. In the majority of valves used in practice the calculation of the losses is very simple. The losses in the impermeable direction are neglected because no appreciable current is let through, while in the direction of flow a constant voltage loss e_0 takes place which is unaffected by the current density at any moment. The loss in the rectifier is therefore obtained by multiplication of this voltage loss by the mean value of the rectified D.C. i_M as measured by a moving coil instrument. The efficiency of the valve is equal to the quotient of the energy delivered q_a to the energy supplied q_e , or equal to $q_a/q_a + e_0 \cdot i_M$. A calculation of losses in this way is permissible with the mercury arc rectifier, the inert gas rectifier, the Wehnelt valve, and some others, but not on the other hand with the aluminium electrolytic rectifier or the dry plate rectifier.

The losses that occur in addition to those of rectification exist not in the valve, but in the apparatus consuming the D.C. The peculiarity of these losses is that with a given rectifier characteristic they vary between zero and a maximum value according to the use to which the D.C. is put.

The mode of action of all rectifiers is that apart from losses they suppress the reversing impulses of the alternating current, either in a common direction, or in one of two

directions. Thus they supply intermittent or pulsating direct current, and therefore in every case a direct current on which an alternating current is superimposed. The relative proportion of direct current to alternating current can be found by expressing the rectified wave form as a Fourier series.

The energy associated with this superimposed A.C. is therefore only useful energy if it is used in ways that are independent of the current direction, such as heating or lighting.

Let it be assumed, for the sake of argument, that an electric works shuts down its machines and from a central regional station draws A.C., which is changed by rectifiers into pulsating D.C., which is supplied to the town network.

From this network can be fed—

(1) *Glow Lamps and Heating Apparatus*

These make use of both the D.C. and superimposed A.C. If the energy supplied is measured with a watt-hour meter, the readings will be correct. If the measurements, however, are made with an ampere-hour meter, the user will receive the A.C. energy free.

(2) *Shunt Motors*

The shunt winding, on account of its big inductance, offers a much higher impedance to the pulsations than to the D.C. Therefore the current in the shunt winding and the magnetic field of the motor pulsate only to a negligible extent, and the motor only uses the direct current. But the pulsations going through the armature cause eddy current and hysteresis losses. The energy used by the motor is measured correctly by an ampere-hour meter, but too high by a watt-hour meter.

(3) *Series Motors*

These motors make use of the D.C. and A.C. energy. Therefore the remarks under (1) hold. In addition, however, heat losses exist through eddy currents and hysteresis.

(4) *Accumulators*

On account of the very small internal resistance of these batteries the voltage across them does not pulsate markedly ; but the voltage pulsations are reflected in extremely big current fluctuations. Of course, the accumulators only make use of the D.C. The energy used is correctly measured by ampere-hour meters.

(5) *Plating Baths*

The baths receive both energies, but only use the D.C. energy, while the A.C. energy is completely converted into heat.

The following summarising table brings these facts out :—

Current-using Apparatus.	Energy Delivered.	Useful Energy.	Additional Losses.
Lamps and Heating Apparatus.	(D.C.) + (A.C.)	(D.C.) + (A.C.)	0
Shunt Motors	(D.C.) + (A.C.)/ <i>n</i>	(D.C.)	(A.C.)/ <i>n</i>
Series Motors.	(D.C.) + (A.C.)	(D.C.) + (A.C.)	(A.C.)/ <i>n</i>
Accumulator Batteries	(D.C.) + (A.C.)	(D.C.)	(A.C.)
Plating Baths	(D.C.) + (A.C.)	(D.C.)	(A.C.)

The current let through by the valve, on account of its incomplete action in the impermeable direction, is even more objectionable in this connection. This is not only pure loss, but annuls the intended action of the required D.C., and consequently must be made innocuous by an equally large amount of the flow direction. But valves with incomplete effectiveness in the impermeable direction are seldom found.

The A.C. supplied from the rectifier and superimposed on the D.C. has the additional effect that the value of the current supplied from the rectifier as measured by a moving coil instrument differs from that measured by a hot wire instrument. Special care is required, therefore, in measuring electric quantities in connection with rectifiers.

For example, if it is required to know the losses in a rectifier, the energy supplied and delivered is determined with a dynamometer wattmeter. If, however, it is a matter of the determination of the efficiency of rectification, the energy supplied must be measured with a dynamometer wattmeter, and the D.C. energy delivered with a wattmeter or by multiplication of the readings of D.C. current and

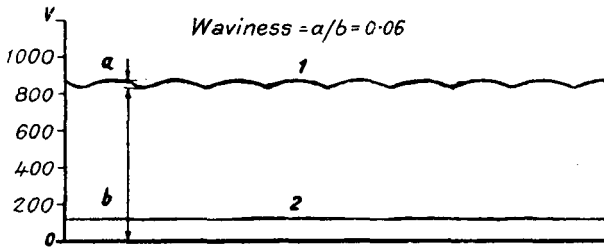

FIG. 39.—Oscillograph of D.C. Voltage of a large B.B.C. Rectifier. 1 = Voltage at 200 amps. approximately of Rectified Current, A.C. of 50 \sim . 2 = Calibration Voltage.

voltage of moving coil instruments, according to the use made of the D.C.

The above statements are only correct so long as the higher harmonics in the rectified wave form do not introduce a frequency error. If the amplitudes of the higher harmonics are not negligible even a dynamometer will give incorrect readings, and an electrometer must be used.

All these difficulties are obviated in practice, since in large rectifiers the A.C. superimposed on the D.C. is decreased by the connection of a choking coil, in the anode branch or before the cathode, with small loss to a harmless value. Fig. 39, for example, shows an oscillograph of the voltage of a large rectifier of the B.B.C. The "fluctuation" has the small value .06.

Power Factor and Phase Displacement of Valves

There is often a considerable confusion of ideas about the power factor and the phase displacement of valves. In ordinary electrical work it is customary to calculate with a sinusoidal current and voltage, $e = E \sin \omega t$. If, on the one hand, the current i and the voltage e are measured separately to give the effective values, and, on the other hand, the power W is measured with a wattmeter, the relation $W/e.i$ is equal to the cosine of the phase displacement between e and i . The consequence of this phase displacement is that $i/\cos \phi$ must be used instead of i for the attainment of a fixed output,

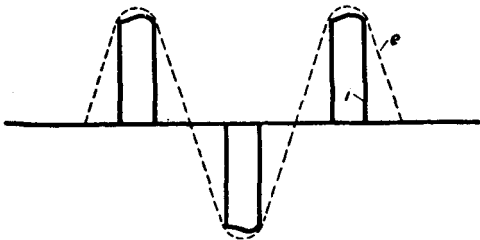

FIG. 40.—Current i and Voltage e on the A.C. side of a Three-phase Rectifier with Large Inductance in D.C. circuit.

and consequently the heat losses in the generators and conductors are greater than without phase displacement.

This whole procedure, however, is completely beside the point if the current and voltage curves depart observably from a sinusoidal form. Now this is nearly always the case with rectifiers, as, for example, Fig. 40 shows.

The formulæ necessary for the calculation of the currents, voltages, and powers have been summarised clearly by Orlich as follows :—

The following simplifying assumptions are presupposed :—

(1) No voltage loss takes place in the rectifier (it can be taken into account later without difficulty).

(2) No choking coils are used.

(3) The rectifier is loaded with an ohmic resistance.

(4) The transformers have neither loss nor dissipation.

The rectifier can rectify a current of n phases with the

help of n anode arms. The time of action of one anode is then $2\pi/n$.

For the calculation of the effective and mean values the maximum value of the sine curve is taken as unity.

Then at the cathode

Effective value of the current

$$i_{ek} = \sqrt{\frac{1}{2} + \frac{n}{4\pi} \sin \frac{2\pi}{n}} \dots \dots \dots (26)$$

Arithmetical mean of current

$$i_{mk} = \frac{n}{\pi} \sin \frac{\pi}{n} \dots \dots \dots (26a)$$

At the anode

Effective value of the current

$$i_{ea} = \sqrt{\frac{1}{2\pi} + \frac{1}{4\pi} \sin \frac{2\pi}{n}} \dots \dots \dots (27)$$

Arithmetical mean of current

$$i_{ma} = \frac{1}{\pi} \sin \frac{\pi}{n} \dots \dots \dots (27a)$$

And $i_{ea}/i_{mk} = C_i = \frac{\pi}{n \sin \pi/n} \sqrt{\frac{1}{2n} + \frac{1}{4\pi} \sin \frac{2\pi}{n}} \dots \dots (28)$

$$\frac{\text{Phase voltage }_{eff.}}{\text{D.C. voltage }_{mean}} = C_e = \frac{\pi}{\sqrt{2} \sin \pi/n} \dots \dots (29)$$

For C_e and C_i the following values result :—

n .	C_i	C_e
2	.79	1.11
3	.59	.86
6	.41	.74

There are no less than six different values to be distinguished with respect to the power :

(1) $W_{=} = e_{mk} \times i_{mk}$ the D.C. power on the cathode side of the rectifier.

(2) W_∞ the actual A.C. power. Since the efficiency is supposed to be 100 per cent., it is of no consequence for what part of the circuit this load is calculated.

(3) W_{aL} the apparent power in the network on the primary side of the transformer.

(4) W_{a1} the apparent power in the primary winding of the transformer.

(5) W_{a2} the apparent power on the secondary winding of the transformer.

(6) $W_T = 1/2[W_{a1} + W_{a2}]/2 =$ rating of transformer. [In England the rating of a transformer is taken as W_{a2} in K.V.A.]

These powers can be connected together by the following formulæ :—

$$\frac{W_\infty}{W_=} = K = \frac{\frac{1}{2} + \frac{n}{4\pi} \sin \frac{2\pi}{n}}{\frac{n^2}{\pi^2} \sin^2 \frac{\pi}{n}} \dots \dots (30)$$

n	$=$	2	3	6
K	$=$	1.23	1.03	1.00

$$\frac{W_{a2}}{W_=} = \frac{\pi^2 \sqrt{\frac{1}{n} + \frac{1}{2\pi} \sin \frac{2\pi}{n}}}{2 n \sin^2 \pi/n} \dots \dots (31)$$

W_{a1}/W_{a2} and W_{aL}/W_{a1} depend on the kind of connection of the transformer.

Fig. 40 gives the most important numerical values according to an investigation by Kaden.

Further, Orlich gives the following numerical example :

- The required D.C. output is $e_{mk} = 180$ volts
- $i_{mk} = 100$ amperes
- $W_= = 18$ k.w.

Voltage drop in vessel = 20 volts.

Transformer : star, star ; primary, three phase : secondary, hexaphase :

$$i_{ea} = C_1 i_{mk} = 40.9 \text{ amperes.}$$

$$e_{\text{eff. phase}} = C_e e_{mk} = .74 \times 200 = 148 \text{ volts.}$$

$$W_{a2} = 6 \times 148 \times 40.9 = 36.6 \text{ K.V.A.}$$

The transformer has an efficiency of .98 and an output efficiency .95. The output efficiency is the ratio of the maximum load with sinusoidal current to the maximum load with rectified current.

$$W_{a1} = \frac{20 \times 1.05}{.98 \times .95} = 22.5 \text{ K.V.A. type load.}$$

$$= 29.6 \text{ K.V.A.}$$

$$W_{aL} = 22.5 = \sqrt{3}Ei$$

For example $e = 220$ volts $i = 59$ amperes.

No rectifier produces any phase displacement whatever.

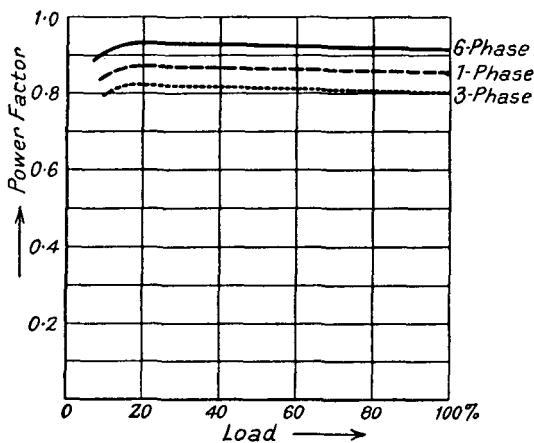

FIG. 41.—Power Factors of One-, Three- and Hexa-phase Glass Bulb Rectifiers.

Such a phase displacement is only caused in a rectifying installation by the transformer of the installation itself. On the other hand, the power factor of a rectifier is smaller than unity if the current curve which it regulates deviates appreciably from the sinusoidal form of the applied voltage. In Fig. 41 are reproduced the power factors of one, three and hexaphase rectifiers, according to investigations by G. W. Müller.

Now, it is immaterial to the electric station whether a decreased power factor which leads to an increase in the losses is produced by a phase displacement or a wave dis-

tortion. What is important for the central station to know is the magnitude of the power factor when a rectifier with wave distortion is connected in parallel with a motor having phase displacement.

This has been calculated by Krijger ; but simplifications have to be made which greatly limit the value of the calculation. It is advisable to represent the relations for a simple case in a purely graphical way.

For example, if one draws the current curve in phase with the voltage of a single-phase rectifier with a strong cathode choke, and over it the current curve having a certain phase displacement of a motor of equal power, and then one adds the two current curves, it will be seen straight away that the current displacement nearly disappears and the total current curve becomes noticeably closer to a sinusoidal form. That is to say, if an apparatus with phase displacement is connected in parallel with a rectifier giving a distorted wave form, the total power factor is greater than the mean of the separate power factors.

Krijger, by calculation, reaches the same result for three- and hexa-phase rectifiers.

Krijger's calculations are completely confirmed by the measurements of the author. A collection of apparatus was specially set up by Gleichrichter G.m.b.H. for this purpose. It consisted of two 10-ampere three-phase rectifiers and a regulating inductance for 10 amperes, and it showed that the power factor of an inductively loaded network is really improved by the connection of a rectifier. The improvement is greatest if the current densities in the two circuits are equal, the phase displacement in the inductive circuit is big, and the rectifier is fitted with anode and cathode chokes.

Central stations can therefore improve the power factor of their networks by installing rectifiers, at least as far as the power factor is lowered by phase displacement.

Special Peculiarities of Rectification. Alteration of Phase Time by Valves

Ordinary A.C. work is concerned with permanent states and built-up currents. With a valve or rectifier, on the

other hand, every period of free flow is a process of connection, since the circuit is broken during the previous period of impermeability. On the one side this leads, in practical rectification, to many disturbing and puzzling phenomena which occasionally cause an inexplicable destruction of the rectifier, but also on the other side to interesting new processes. Originally the general widely spread idea had prevailed that the action of a valve consisted in weakening or strengthening one phase of the current with respect to the other, without altering the relative times of the two phases.

Papalexii was the first to show that this assertion is only correct if neither capacity nor inductance is present in the valve circuit.

If the valve circuit contains inductance the time of free flow is increased at the expense of the time of impermeability; and this action becomes more pronounced the greater is ωL ($\omega =$ angular velocity, $L =$ inductance) in comparison with the ohmic resistance R of the circuit. If R can be neglected in comparison with ωL the time of free flow is prolonged over the whole period, if the valve behaves as a device having very different and constant ohmic resistances in the two current directions, and if it has no minimum voltage but allows a current to flow in the permeable direction, no matter how small the voltage.

At first sight, a period of free flow of 360° appears paradoxical. One is inclined in the first moment to assume that the current, which at the beginning of the phase sets in with the voltage, suffers a lag of 90° on account of the presence of the inductance, and therefore stops again after $180^\circ + 90^\circ = 270^\circ$. A more detailed analysis shows, however, that the matter must be treated in another way. A pulsating direct current can be thought of mathematically as resolved into a constant D.C. and a superimposed A.C. In Fig. 42 the thick continuous current in relation to the zero line is pulsating D.C. In relation to the line of constant D.C., on the other hand, it is an A.C. which oscillates about the line AB with unsymmetrical form, but on both sides with equal mean intensity.

Now the D.C. A flows through unimpeded by the induct-

ance, but the A.C. experiences a resistance which increases with its frequency. The A.C. of Fig. 42 consists of a Fourier series of sinusoidal terms with a strongly preponderating fundamental wave. Since the first harmonic, which has three times the frequency of the fundamental wave, is weakened by the inductance nine times as much as the fundamental frequency, and since the high harmonics are even more reduced, the current flowing through the inductance approximates to a pure sine form. Since it is simultaneously displaced back through 90° , the curve drawn in Fig. 42 results. Since actually it only touches the zero line

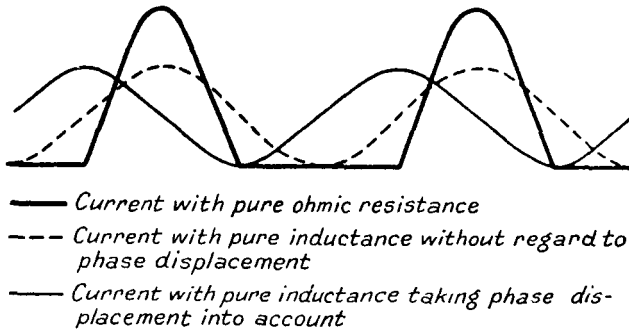

FIG. 42.—Action of Inductance on form of Rectified Current.

point-wise, it therefore consists of current impulses lasting approximately through 360° .

Papalexí founded his investigations on the electrolytic aluminium valve, and was misled by the erroneous work of Taylor (who took the current and voltage curves of a heavily overloaded valve) to the assumption of very different constant ohmic resistances in the two directions. An aluminium cell loaded almost to the point of breakdown does, in fact, show an approximately constant ohmic resistance in the two directions. In the impermeable direction the capacity current is small in comparison with the current load, and in the flow direction the minimum voltage hardly comes into the question in comparison with the ohmic voltage drop in the electrolyte and oxide film.

Papalexí also worked with greatly overloaded valves with

a current density of 20 amperes per sq. dm. in his own experiments to test his formulæ. Papalexis's researches also lose in value because with normally loaded valves the assumption of constant ohmic resistances is not even approximately correct.

The author and Lindemann have further investigated the effect of a parallel connected capacity on the form of the current and voltage curves of a valve. They showed that the decrease of the rectifying action of electrolytic valve

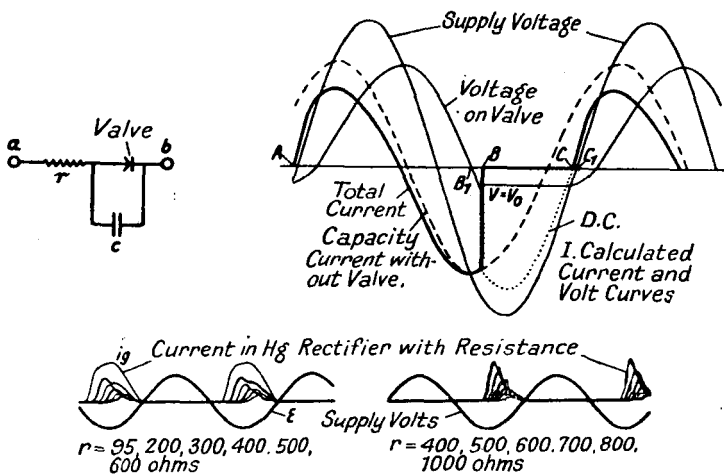

FIG. 43.—Synthesis of Electrolytic Rectifier by Mercury Arc Rectifier, Parallel Capacity and Series Resistance.

cells with increasing frequency, observed by Zenneck, can be traced to the electrostatic capacity and minimum voltage of these valves.

According to the author, an electrolytic valve can be conceived as the network shown in the top left corner of Fig. 43.* V is the actual valve formed by the effective layer, r the resistance of the electrolyte, and C the big electrostatic capacity of the effective layer.

* Such a network can only approximately represent the behaviour of an electrolytic valve over a wide frequency range. See N.A. de Bruyne & R. W. Sanderson, *Trans. Faraday Soc.* 1927—*Trans.*

Now this network can easily be synthesised by a mercury arc valve connected to a resistance r in series and a capacity C in parallel. This substitution has the great advantage of well-defined absolutely constant experimental conditions.

The theoretical treatment of the phenomena is facilitated, if one makes oneself clear beforehand, with the help of Fig. 43, how the capacity C and the minimum voltage V_0 act on the ratio i_g/i_f . If the capacity were absent the voltage across the cell would equal the supply voltage, so long as the cell were impermeable. But since the capacity current flows also during the impermeable cycle and produces a voltage drop in the resistance r , the voltage across the cell will decrease, and therefore the minimum voltage will be attained later as the capacity current increases and as r increases. That is, i_g will be confined to an ever smaller fraction of the period as the capacity current and r increase, while the capacity current will take up an ever greater part of the period. In complete correspondence, an increase of minimum voltage causes a shortening of the time of D.C. If finally the voltage drop in r produced by the capacity current is so great that the peak value of the cell voltage just reaches the minimum voltage, i_g will be zero. i_f is now pure capacity current and has the value

$$i_f = \frac{E}{\sqrt{r^2 + \left(\frac{1}{\omega C}\right)^2}} \dots \dots \dots (32)$$

E = supply voltage ; $\omega = 2\pi f$; f = frequency of A.C.

Further, for the critical point, we have the equation

$$r_0 = \frac{\sqrt{\frac{E^2}{V_0^2} - 1}}{\omega C} \dots \dots \dots (33)$$

if V_0 = minimum voltage

r_0 = resistance for which i_g is zero.

Equation (33) shows that r_0 is inversely proportional to ωC and also approximately to V_0 . The condition for the presence of a D.C. component is that $r < r_0$. With a given capacity, operating voltage and minimum voltage, therefore

an increase in frequency must be accompanied by decrease of series resistance and therefore an increase of load on the cell, if the cell is still to deliver D.C. Zenneck's result is straight away given here qualitatively. But his surmise that i_g/i_f becomes zero simultaneously with i_f is not confirmed.

The more exact theory of the phenomena can be developed from Fig. 43 (I), which has been drawn from oscillograph photographs. In Fig. 43 (I), the operating voltage is E , V is the voltage across the mercury arc rectifier and parallel capacity, i'_c the capacity current which would flow were the valve not present, i_c is the total current. From oscillograph results $E = 130$ volts R.M.S., $r = 500$ ohms, $c = 12$ mfd. $n = 50$, $1/\omega C = 250$ ohms, $V_0 = 18$ volts. The curves for V , i_c and i_g show clearly the two time intervals of impermeability AB and permeability BC during each period of the A.C. Since we disregard transient effects immediately after the connection of the cell, the point A is chosen as the beginning point of the time. At this instant the operating voltage E has the phase angle α ; it is therefore

$$E = E_0 \sin (\omega t - \alpha)$$

The point B corresponds to time t_1 . The first full period $\tau = 2\pi/\omega$ is completed at the point C. During time 0 to t_1 the capacity current i_c flows, we have the equation for it

$$i_c r + V = E_0 \sin (\omega t - \alpha)$$

if V means the voltage across the cell at time t

The relation
$$i_c = C \frac{dV}{dt}$$

(in which C stands for the capacity of the valve as above) gives the general differential equation for V .

$$\frac{dV}{dt} + \frac{V}{rc} = \frac{E_0}{rc} \sin (\omega t - \alpha) \dots (36)$$

Its solution, putting $V = -V_0$ when $t = 0$, is

$$V = E_0 \sin \phi \cos (\omega t - \alpha - \phi) - e^{\omega t \tan \phi} [E_0 \sin \phi \cos (\alpha + \phi) + V_0] \dots (37)$$

where $\tan \phi = -1/r\omega C$.

At time t_1 the valve becomes permeable, because the valve

voltage V again reaches the value of the maximum voltage

$$\therefore t = t_1; V = -V_0$$

On applying this case, equation (37) gives a defining equation for the time t_1 which can be written in the form

$$\begin{aligned} \cos(\omega t_1 - \alpha - \phi) - \cos(\alpha + \phi) \epsilon^{\omega t_1 \tan \phi} & \dots (38) \\ &= \frac{-\sin \alpha}{\sin \phi} (1 - \epsilon^{\omega t_1 \tan \phi}) \end{aligned}$$

At the time of permeability of the valve $t_1 < t < \tau$ the capacity current i_c is zero on account of the constancy of $V = -V_0$. Since the self induction in the completing circuit may be neglected in comparison with r , Ohm's law holds good

$$i_g r - V_0 = E_0 \sin(\omega t - \alpha) \dots (39)$$

At time $t = \tau$ $i_g = 0$, therefore

$$-V_0 = E_0 \sin(2\pi - \alpha)$$

Hence the phase angle α is fixed

$$\sin \alpha = V_0/E_0$$

The equations formulated state straight away the value of the square of the R.M.S. current as measured by a hot wire instrument

$$I_f^2 = \frac{1}{\tau} \int_0^\tau i^2 dt \dots (40)$$

And the direct current flowing through the valve as measured by a D.C. instrument is

$$I_g = \frac{1}{\tau} \int_0^\tau i dt \dots (41)$$

On account of the complication of the expression for I_f , only that for I_g is given here

$$I_g = \frac{1}{\tau} \int_0^\tau i_g dt = \frac{E_0}{2\pi r} [\cos(\omega t_1 - \alpha) - \cos \alpha] + \frac{V_0}{r} \cdot \frac{\tau - t_1}{\tau} (42)$$

Equation (42) was tested by the author by the oscillogram reproduced in Fig. 43. This photograph gives the direct current i_g in the valve circuit itself for different

resistances r . The operation voltage, which amounted to 69 R.M.S. volts, is also on it. C was 12.7 mfd. and $\omega = 314$.

The oscillograms show clearly how an increase of resistance and therefore an increase of the effectiveness of the capacity in comparison with the resistance, shortens the period of permeability.

Finally, W. Jaeger has treated exhaustively the case of a valve that is practically non-conducting in the impermeable direction, that in the direction of flow has a minimum voltage independent of the instantaneous current density and that possesses no marked electrostatic capacity. Since the most practically important valves, like the mercury arc rectifier, inert gas rectifier, and the Wehnelt valve fulfil these assumptions, Jaeger's investigations are of great importance. Jaeger puts :

Operating voltage E	$= V \sin (\omega t + \phi)$
Valve voltage in impermeable direction	$= V$
Valve voltage in flow direction (minimum voltage)	$= V_0$
Current	$= i$
Time of flow direction	$= t$
Time of complete period	$= T$
	$j = \sqrt{-1}$

Using symbolic notation, he derives the following :

1. *Valve in Series with Resistance R and Inductance L .*

The resistance is represented by R and the inductance by L . For the permeable period $t = 0$ to t_1 (*vide* Fig. 44), the valve voltage is constant and equal to the minimum voltage

$$V_0, \text{ and moreover } E - V_0 = Ri + L \frac{di}{dt}$$

Hence it follows if the value of E at time $t = 0$ is represented by E_0

$$i = \frac{E}{R + j\omega L} - \frac{V_0}{R} - \frac{E_0}{R + j\omega L} - \frac{V_0}{R} e^{-\frac{Rt}{L}} \dots \quad (43)$$

I
II
III

Moreover, the value of E at time $t = 0$ is

$$E_0 = V \sin \phi = V_0 \quad \dots \quad (44)$$

by which the phase ϕ is given. Since also when $t = t_1$ the current is zero, we get for t_1 if

$$\alpha = \frac{\omega L}{R} \quad \dots \quad (45)$$

$$e^{-\frac{Rt}{L}} = \frac{E_1 - (1 + j\alpha)V_0}{E_0 - (1 + j\alpha)V_0} = \frac{(1 - j\alpha)E_1 - (1 + \alpha^2)V_0}{(1 - j\alpha)E_0 - (1 + \alpha^2)V_0} \quad (46)$$

and
$$E_1 - V_0 = L \left(\frac{di}{dt} \right) t_1$$

in which E_1 means the value of E at time t_1 .

In the impermeable period from $t = t_1$ to T the current $i = 0$ and the valve voltage is equal to the operating voltage ($v = E$).

If the resistance R is very small we get for the current during the flow period

$$i = \frac{E}{R + j\omega L} - \frac{E_0}{R + j\omega L} - \frac{V_0 t}{L} + \frac{R}{L} \left(\frac{E_0}{R + j\omega L} t + \frac{V_0 t^2}{2L} \right) \quad (47)$$

and for a pure self induction ($R = 0$) or for very big values of ωL

$$i = \frac{1}{\omega L} \left(\underbrace{jE_0 - jE}_I - \underbrace{2\pi V_0 t/T}_{II} \right) \quad \dots \quad (48)$$

If there were no minimum voltage ($V_0 = 0$) the above expression reduces to

$$i = \frac{E - E_0}{j\omega L} \quad \dots \quad (49)$$

The equations are illustrated in Fig. 44.

The curves hold for all frequencies and are actually determined by the ratio V_0/V . The construction elements (*vide* equation 48) are reproduced in the figure in easily visible dotted fashion. The current curve which is obtained

if V_0 were zero is also likewise drawn in. It will be seen that only in this case is the period of permeability prolonged by the self induction over the complete period. In general, on account of the minimum voltage, or also if no ohmic resistance is present in the arrangement, there is an impermeable zone left over, whose width is conditioned by the ratio V_0/V . In the above case also with pure self induction an impermeable zone of approximately $\cdot 2T$ remains.

When taking oscillographs these curves can be considerably

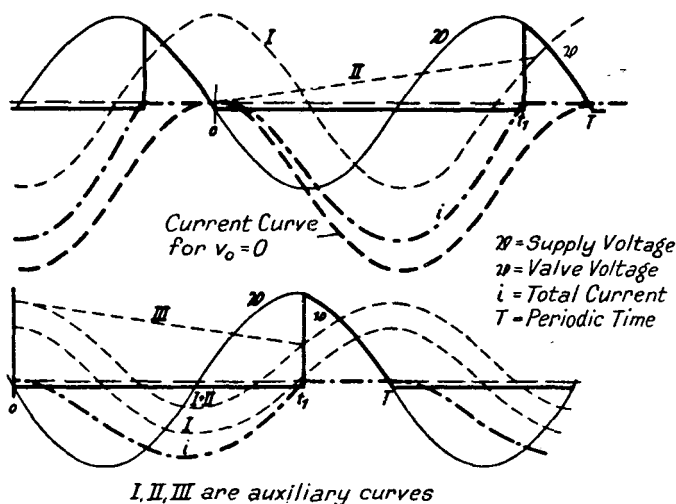

FIG. 44.—Valve in Series with Resistance and Inductance.

altered by the resistance of the apparatus, as is illustrated in the following figure (45). The points of the curves are rounded off in certain cases by ϵ functions coming in.

2. Resistance and Inductance in Series with the Valve and a Parallel Resistance.

This arrangement is represented in the top left corner of Fig. 45. The resistance R' can represent the resistance of the oscillograph circuit used to record the voltage across the valve. The impermeable period is here taken from $t = 0$ to t_1 , the flow period from t_1 to T . In the latter period there

are two branch currents i_1 and i_2 to be distinguished, in the impermeable period $i_2 = i$.

In the impermeable period we have equations

$$v = E - Ri - L \frac{di}{dt} = R'i \quad \dots \quad (50)$$

with the condition that at times $t = 0$ and $t = t_1$ the valve voltage $V = V_0$ (minimum voltage).

Hence if $R_1 = R + R'$

$$i = \frac{E}{R_1 + j\omega L} - \left(\frac{E_0}{R_1 + j\omega L} - \frac{V_0}{R'} \right) e^{-\frac{Rt}{L}} \quad \dots \quad (51)$$

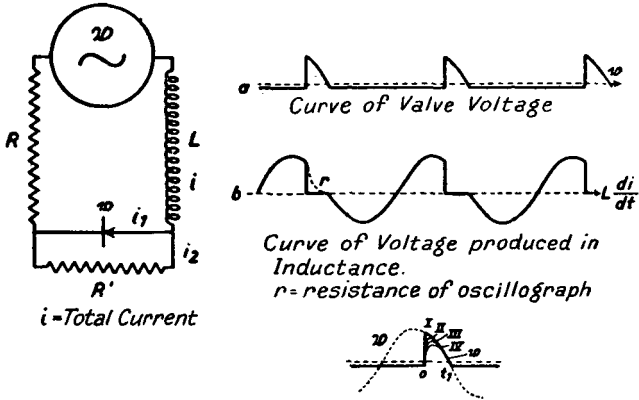

FIG. 45.—Valve in Series with Resistance and Inductance, and in Parallel with Resistance.

$$v = \frac{R'E}{R_1 + j\omega L} - \left(\frac{R'E_0}{R_1 + j\omega L} - V_0 \right) e^{-\frac{Rt}{L}} \quad \dots \quad (52)$$

From (52) also results the condition for t_1 (since at this time $V = V_1$ and $V = V_0$), which is again represented by a transcendental equation.

$$i = V_0/R' \text{ for } t = 0$$

If $R' = \infty$ the equations pass into those of case 1 ($V = V$, $i = 0$).

In the flow period $V = V_0$ and therefore $i_2 = V_0/R'$

and
$$E - V_0 = Ri + L \frac{di}{dt} \quad \dots \quad (53)$$

Since when $t = T$ the operating voltage $E = E_0$ and $i = V_0/R'$ we therefore get for the current

$$i = \frac{E}{R + j\omega L} - \frac{V_0}{R} - \left(\frac{E_0}{R - j\omega L} - \frac{V_0}{R'} - \frac{V_0}{R} \right) e^{-\frac{Rt}{L}(t-T)} \quad (54)$$

$$i_2 = V_0 R'$$

and for the valve current i_1 :

$$i_1 = i - i_2 \dots \dots \dots (55)$$

For big values of R' the current during the impermeable cycle approximates to

$$i = \frac{1}{R'} \left[E - (E_0 - V_0) e^{-\frac{Rt}{L}} \right] \text{ or approx. } i = \frac{E}{R'} \quad (56)$$

$$v = R'i = E - (E_0 - V_0) e^{-\frac{Rt}{L}}$$

For $R' = \infty$ $v = E$ as in case 1, *i.e.*, the curves of Fig. 44 are obtained.

But in general the points of the curves are rounded off by the exponential function ; the value of v then increases more or less gradually to that of the operating voltage. Instead of a curve of the form *a* in the top part of Fig. 45 the distorted curves shown at the bottom of Fig. 45 are obtained. These distorted curves are based on the relations in the diagram in the left-hand corner of Fig. 45 under the assumption that $L = 1$ Henry $R' = 10,000$ (II), $5,000$ (III), and $2,000$ (IV) ohms ; (I) corresponds to $R = \infty$. It will therefore be seen that a very great resistance is necessary to avoid the distortion of the curves.

3. Inductance and Resistance in Parallel with each other and in Series with the Valve

This arrangement is shown in the top of Fig. 46. Time $t = 0$ is taken as the beginning of the permeable period (bottom of Fig. 46). The resistance R can represent, for example, the resistance of the oscillograph circuit used to

obtain the voltage induced in L, but the case has other interests apart from this application.

For the total current $i = i_1 + i_2 \dots \dots \dots (57)$
 the conditions of case 2 hold; but the individual currents i_1 and i_2 are opposite and equal at the beginning and end

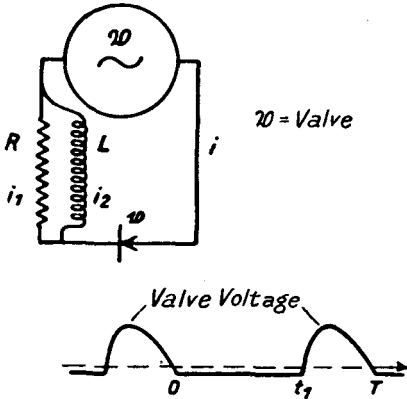

FIG. 46.—Inductance and Resistance in Parallel with each other and in Series with the Valve.

of the permeable period, and have a phase displacement of 90° to one another.

In the permeable period $t = 0$ to t_1 we have the equations

$$Ri_1 = L \frac{di_2}{dt} = E - V_0 \dots \dots \dots (58)$$

with the conditions given above for $i_1 + i_2$

The equations for the three currents are

$$i_1 = \frac{E - E_0}{R}$$

$$i_2 = \frac{E - E_0}{j\omega L} - \frac{2V_0 t}{\omega L T} - \frac{E_0 - V_0}{R} \dots \dots \dots (59)$$

$$i = \frac{E - E_0}{j\omega L} - \frac{2V_0 t}{\omega L T} + \frac{E - E_0}{R}$$

$$= (E - E_0) \left(\frac{1}{j\omega L} + \frac{1}{R} \right) - \frac{V_0 t}{L}$$

At time $t = 0, i_1 = -i_2 = \frac{E_0 - V_0}{R}$

Likewise when $t = t_1$; $i_1 = -i_2 = \frac{E_1 - V_0}{R}$ under consideration of the following limitation which results from the equation for i , since at time $t = t_1$ (as also for $t = 0$) the total current i is zero :

$$V_0 t_1 = \frac{(E_1 - E_0)(R + j\omega L)}{j\omega R} \dots (60)$$

For the impermeable period (t_1 to T) we have

$$V = E - Ri_1 \quad i = 0 \dots (61)$$

Since at time t_1 the relation given above holds good, we obtain for the current which subsides in the circuit formed by L and R during the impermeable zone :

$$Ri_1 - L \frac{di_2}{dt} = 0 \therefore i_1 = -i_2 \dots (62)$$

$$= \frac{E_1 - V_0}{R} \epsilon^{-\frac{Rt}{L}(t-t_1)}$$

for $t = T$ this is

$$\frac{E_1 - V_0}{R} \epsilon^{-\frac{R}{L}(T-t_1)} = \frac{E_0 - V_0}{R}$$

which gives a further limiting equation for V_1 and V_0

The expression for the valve voltage is

$$V = E - [E_1 - V_0] \epsilon^{-\frac{Rt}{L}(t-t_1)} \dots (63)$$

For the voltage across the ends of R and L

$$(E_1 - V_0) \epsilon^{-\frac{Rt}{L}(t-t_1)} \dots (64)$$

The curve of the valve voltage is therefore altered by the resistance R in a manner analogous to the previous case. Just as the curve b in Fig. 45 is distorted, instead of the jump at the beginning of t_1 a decrease follows according to equation 64, as Fig. 45 (curve b dotted line of the first period) shows.

4. Resistance in Series, Inductance in Parallel with Valve

Fig. 47 shows the arrangement. In the impermeable zone (in this case from $t = 0$ to t_1 left) a current flows only

through L and R ; the E.M.F. induced in L at the end of the impermeable zone is the minimum voltage V_0 , which from this moment till $t = T$ remains constant. The current in the self-induction circuit varies from this time point in inverse proportion to the inductance. When the inductance has a very small value the current can reach very high values in a short time. Further information results from the equations given below.

For the impermeable zone ($t = 0$ to t_1) the equations are

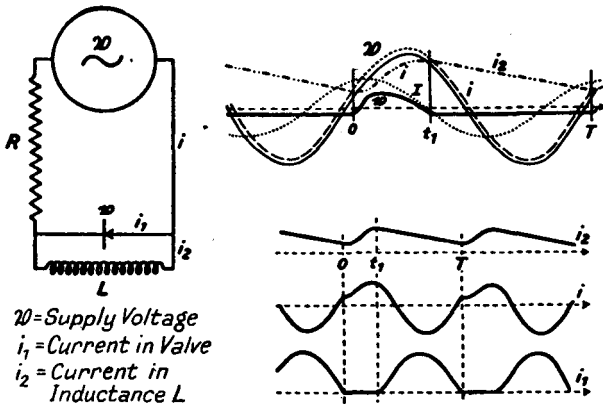

W = Supply Voltage
 i_1 = Current in Valve
 i_2 = Current in Inductance L

FIG. 47.—Resistance in Series and Inductance in Parallel with Valve.

$$i = i_2 \quad V = E - Ri = L \frac{di}{dt} \quad E = Ri + L \frac{di}{dt} \quad (65)$$

with the limitation that at $t = 0$ or t_1 the valve voltage $V = V_0$. Hence the following equations are given :

$$i = \frac{E}{R + j\omega L} + \frac{1}{R} \left(\frac{j\omega L E_0}{R + j\omega L} - V_0 \right) \epsilon^{-\frac{Rt}{L}} \quad (66)$$

$$V = \frac{j\omega L E}{R + j\omega L} - \left(\frac{j\omega L E_0}{R + j\omega L} - V_0 \right) \epsilon^{-\frac{Rt}{L}}$$

When $t = 0$ $i = \frac{E_0 - V_0}{R}$; a transcendental equation for t_1 results from the condition for V at time t_1 :

$$e^{-\frac{Rt_1}{L}} = \frac{j\beta E_1 - V_0}{j\beta E_0 - V_0} \text{ where } \beta = \frac{\omega L}{R + j\omega L} \dots (67)$$

whence follows further that $i = \frac{E_1 - V_0}{R}$ at time t_1 .

During the permeable period t_1 to T the equations are :

$$Ri = E - V_0 \quad L \frac{di_2}{dt} = V_0 \quad V = V_0 \dots (68)$$

Observing the condition that at time t_1

$$i = i_2 = \frac{E_1 - V_0}{R} \quad V = V_0 \quad E = E_1$$

we get the equations

$$i = \frac{E - V_0}{R}; \quad i_2 = \frac{E_1 - V_0}{R} + \frac{V_0}{L} (t - t_1) \dots (69)$$

$$= \frac{E_1 - V_0}{R} + \frac{2\pi V_0}{\omega L} \left(\frac{t - t_1}{T} \right)$$

At the end of the period ($t = T$) $i = i_2$ and $E = E_0$, whence follows the equation below :

$$E_0 - E_1 = V_0 \frac{R}{L} (T - t_1) \dots (70)$$

The simplest way of dealing with the transcendental equations (67) and (70) for t_1 and ϕ is to find out the same time point t_1 by construction and then eventually to calculate it more accurately with the help of the equations.

The three currents i, i_2, i_1 in the resistance, inductance branch and the valve are drawn again in the lower half of Fig. 47 on a smaller separate scale, since the low one is somewhat difficult to see. The current i_2 represents an undulating D.C.

Therefore the marked prolongation of the permeable period existing at small frequencies disappears at high frequencies and returns to the width of a half period. Simultaneously the current in the induction circuit disappears, if the self induction is not decreased correspondingly to the increase of periodicity.

CHAPTER X

Mechanical Rectifiers

Mechanical rectifiers had achieved a limited use in the last decade, before there were any physical rectifiers for small currents. Later this deficiency was remedied by the introduction of inert gas and thermionic rectifiers. The use of mechanical rectifiers consequently decreased because of their various faults, until broadcasting brought a strong demand for rectifiers for charging six-volt batteries, for which these rectifiers are very suitable.

A. Rectifiers with Vibrating Contacts

The principle of rectifiers with vibrating contacts is that an oscillating contact system regulated synchronously by the A.C., closes the circuit for one half period and keeps it open during the other. By using only one contact one current direction will be suppressed. If the system vibrates between two fixed contacts, both current directions can be brought into the same direction by suitable circuits. If an oscillatory contact be set into vibration by A.C. magnets, there will be a phase displacement between the vibrations and the exciting A.C. due to the inertia of the system. Consequently the contacts do not open and close at the times when the current is zero. Quite apart from the diminution of the current output, this would lead to sparks at break of contact, and in a short time the contact would be unusable. However, the phase of an A.C. can be given any value desired by the use of capacity and inductance; thus there is no difficulty in arranging the rectifier so that the phase displacement due to the moment of inertia is completely compensated. To be sure, this compensation is only effective for a certain frequency; therefore rectifiers

with vibrating contacts work badly if used with a frequency materially different from that for which they were adjusted.

The fact that the current must fall to zero twice in each period, so that the contact may be opened with no current passing, has the consequence that the current delivered by the rectifier cannot be smoothed with choke coils. The shape of the output curves when accumulators are charged is shown in Fig. 48. (Current curves below and voltage curves above.) As the figure makes clear, this composite current can be regarded as a constant mean D.C. and a

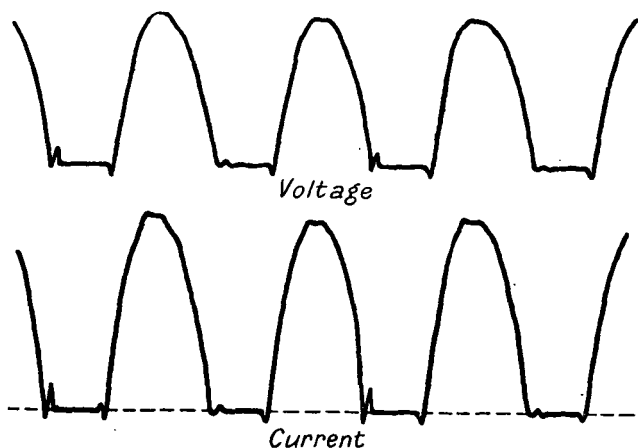

FIG. 48.—Current and Voltage Oscillograms obtained with Deutsche Telephonwerke Rectifier when charging Accumulators.

superimposed A.C. of amount $i_g\sqrt{2}$ if i_g is the mean D.C. This superimposed A.C. is pure loss, and decreases the efficiency of the rectifier not inconsiderably. Since this loss takes place in the consuming apparatus and not in the rectifier, and the apparatus is heated by the superimposed A.C. without it doing anything useful, it is easily completely overlooked. Now the sphere of use of rectifiers with vibrating contacts is limited to small currents of a few amperes and low voltages, and therefore to small amounts of energy. Under these circumstances a cheap and reliable apparatus of low efficiency is superior to an expensive

apparatus of higher efficiency, because energy costs play only a small part in comparison with the interest and depreciation of the apparatus.

The older rectifiers, with vibrating contacts, were very unpleasant because of the noise that they made. This noise has been so completely suppressed in the newer types that it is no longer disturbing.

Rectifiers with vibrating contacts are manufactured by the Elektrizitäts-Aktiengesellschaft Hydrarwerke of Charlottenburg, the Deutsche Telephonwerke of Berlin, Koch and Sterzel of Dresden, and Velios-Werke A.-G. of Dresden.

Small Rectifier Type G.R. of the Hydrarwerke

The most important parts of the small rectifier of the Hydrarwerke are shown diagrammatically in Fig. 49. The rectifier consists of a permanent magnet M with pole pieces P_1 and P_2 , an A.C. coil S and iron armature reed F , which is tightly held with the side springs t_1 and t_2 in the cast frame G .

The A.C. coil S receives from the A.C. mains an A.C. displaced sufficiently in phase by a condenser. S makes the lower end of the iron reed alternately north and south magnetic, so that it is attracted by each of the pole pieces P_1 and P_2 of the permanent magnet in turn, and establishes the contact arrangement situated above the coil S . The side springs t_1 t_2 lie close, and at rest firmly, on the stops A_1 A_2 . They free themselves from A_1 or A_2 as soon as the vibrating reed makes contact with k_1 or k_2 and thereby enable the reed to fly away freely after making contact, as is illustrated in Fig. 49.

The great value of this arrangement is that the moving system does not rest in a position that can give rise to various disturbances, but consists of a tightly held vibrating reed so that no rubbing parts subject to wear are present.

While earlier the firm produced a whole number of different types, they have recently used their great practical experience to turn out by mass production a single type of small rectifier, for charging from two to four lead accumu-

lators at a current strength of 2 amperes. In this way the greatest reliability and the simplest manipulation are attained.

The apparatus is manufactured in two forms for 100 to 140 volts and for 200 to 250 volts A.C. at 50 cycles. It is enclosed in a polished wood case provided on the sides and back with perforated ventilation sheets for the dissipation of the heat developed in operation. The supply-flex with connector for the A.C. side and the + and - terminals for the battery are on the cover. On opening the lid the inside

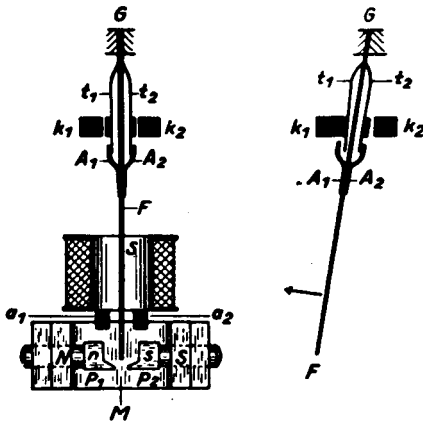

FIG. 49.—Construction of Pendulum Rectifier.

of the apparatus is easily accessible, since everything is mounted on a base plate and can be easily lifted up with it. For the contact material a special metal is chosen that has been proved by experiment to have a long life.

The transformer and the fixed charging resistance have been calculated out to give the greatest economy. The efficiency reaches 50 per cent. Fuses are not provided, since the apparatus is so proof against short circuit that the ordinary fuses of the A.C. mains suffice. Fig. 50 gives the diagram of connections of the type for 100 to 130 volts, and is quite intelligible without further explanation.

A further special arrangement of the apparatus is used

in German railway and post office practice. The arrangement charges two sets of accumulators which must be connected in series during charge, and work in parallel during discharge. On the right side of a common connecting board are mounted the actual pendulum rectifier, a slow acting relay, a regulating resistance and current and voltage measuring instruments. On the left side at the top are two four-pole double-throw switches which connect the batteries, according to requirements, in parallel for operation or in series for charging. In the middle is a two-pole

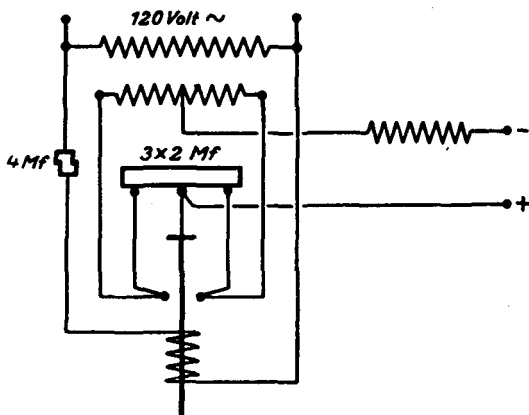

FIG. 50.—Connections of Pendulum Rectifier of the Hydrarwerke for 100–130 Volts A.C.

voltage switch which serves to connect the voltmeter at choice to the different batteries. Both the A.C. and D.C. sides have their current circuits fitted with double-pole fuses. This design is made for all A.C. or D.C. voltages up to 250 volts and charges a maximum of 12 cells at 5 amperes.

The Mechanical Rectifier of the Falkenthal System

This rectifier is manufactured by the firm of Paul Hardegen & Co., Berlin (Deutsche Telephonwerke). It has been considerably improved in the last few years. Fig. 51 gives its diagram of connections. It differs from the Hydrarwerke rectifier principally in its contact system. This consists of a

contact lever, which is connected with an iron core polarised uniformly by a permanent magnet or a winding, and is lightly pivoted in the stray field of the iron core of the transformer. This lever strikes against the contact surface, which is supported on thin springs, and which give way to its motion and accompany it till they are caught by an abutment on the return journey. The contacts, however, are not of metal, but are small carbon blocks of $.8 \times .8$ sq. cm. contact surface. The advantage of this is that a surface resistance cannot be formed by oxidation. The contact surfaces quickly burn into each other so that they touch over a large area. Moreover, they are so mounted that they are easily interchanged. The play of the armature reed is very small.

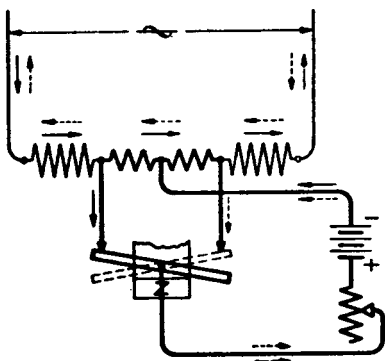

FIG. 51.—Connections of the Deutsche Telephonwerke Rectifier for Accumulator Charging.

This rectifier is also manufactured in a model for charging 6-volt batteries at a current of two amperes. The different parts of the apparatus are very neatly put together.

The A.C. Relay Rectifier of the Koch System

This rectifier is manufactured by the firm of Koch and Sterzel, Dresden, in three types—for accumulator charging, for plating work, and for the direct supply of apparatus using D.C. It is very similar to the rectifier of the Falkenthal system. The chief difference is that it has a somewhat different armature construction. In this case also the armature is polarised by a strong magnet and vibrates synchronously with the A.C. under the influence of a field coil through which the A.C. flows.

The synchronous vibrations are also changed to phase displaced vibrations by compensating for the moment of

inertia and self induction. The armature carries at its end a tongue with a strong contact, whose play is limited by an opposing contact and a stop. This contact is so made and broken by the armature that only current impulses of the same direction can enter the current-using circuit, and the make and break occurs exactly at the time of zero current. This simple form of rectifier therefore only uses one current direction. The accumulator charging type is constructed on this principle.

The arm of the polarised relay carries a second winding as well, which is connected through a suitable series resistance across the battery to be charged in such a way that the armature is given a halting kind of motion, so that only the excess voltage of the operating voltage over the battery voltage acts on the contact key. The contact is therefore closed at the exact moment when the battery and A.C. voltages are equal.

On account of this accurate compensation by phase displacement an accumulator battery of 60 cells can be charged from the lowest voltage to the maximum at 15 amperes, without disturbance and without attendance, with a relay rectifier. In the type constructed for electrolytic work a double contact is used so that full wave rectification is obtained. In this case the connections are the same as in Fig. 51.

Such apparatus has been built by the firm for currents up to 500 amperes for charging cells in a telephone exchange. An apparatus for 100 amperes has stood the test of plating work.

The Mercury Stream Rectifier

As far as the author has been able to ascertain, an extremely interesting mechanical rectifier has been constructed by a Danish scientist, Professor Hartmann, for big powers according to a principle very similar to that above. Professor Hartmann substitutes the magnetically vibrated reed by a fluid mercury stream set into vibration electro-magnetically. A stream of fluid mercury is sprayed, between the poles of a

strong D.C. magnet, with great velocity vertically from top to bottom; the A.C. is conducted by this stream. The stream is consequently deflected by the magnetic field and carries out a to and fro swinging motion in step with the A.C. But below on the bottom of the vessel it strikes against two contact collecting bars lying in its plane of oscillation and separated by a gap. It is arranged by phase displacement that one contact bar receives one, the other bar the other current direction. The two bars have sharp quartz knife edges at the gap, which cut through the mercury stream and provide for a momentary break of current.

The great advantage of the replacement of a solid contact arrangement by this fluid stream is that no limit is set to the power by the risk of burning out the contact. The rectifier ought to be usable for currents of over 100 amperes and pressures of more than 100 volts. In order to avoid the contamination of the mercury the contact arrangement is in an atmosphere of hydrogen, which, however, in practical operation is likely to be replaced by other suitable gases, because of the danger of an explosion.

Unfortunately, the author has not been successful in finding out more about the efficiency and the behaviour of this rather secret apparatus, so that he must confine himself to the explanation of the principle given above.

Rectifiers with Vibrating Flames

Besides rectifiers with vibrating solid contacts and those with vibrating fluid streams there is a third possibility—that of using vibrating gases. This also has been tried.

If a flame is brought into the neighbourhood of one of two electrodes placed opposite to each other, it produces a certain rectifying action, since the flame forms a large quantity of negative ions. This action can be considerably improved, according to J. J. Dowling and J. T. Harris, if the flame rises and falls synchronously with the A.C. voltage. Hence the gas feeding the flame is led through a König manometer capsule *M* (Fig. 52) whose diaphragm is either an iron plate or an indiarubber disc having a piece of iron

stuck on the middle. An electromagnet *J* with two separate windings *W* and *G* is arranged underneath it. The full primary current of the high-voltage transformer goes through the winding *W*. The winding *G* carries D.C. from an accumulator *E*. The D.C. is used so that the magnetisation only rises and falls once in each period. The capsule must be as flat as possible, the flame 8 to 10 cm. high; the inflow tube

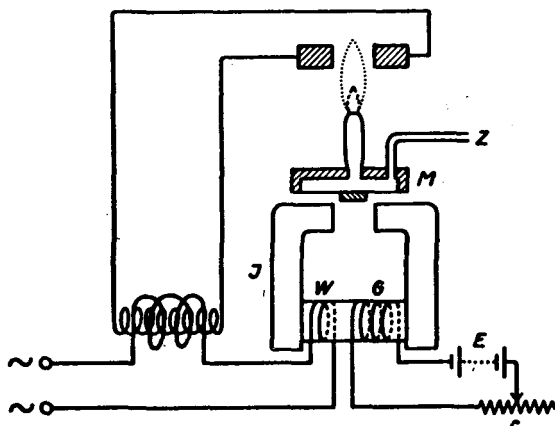

FIG. 52.—Connection of Vibrating Flame Rectifier of Dowling and Harris.

Z must be either constricted or lightly plugged with wadding at its aperture.

With a capsule of 2 c.cm. volume, a burner tube of 1 cm. and a rubber membrane of 3 cm. diameter, the flame oscillations were between 1 and 10 cm. high. With an A.C. voltage of 6,000 volts a D.C. of 20 milli-amperes and complete rectification resulted. Markedly higher voltages cannot be used with a flame because the flame is then influenced electrostatically.

CHAPTER XI

Electrolytic Rectifiers

(*Physical Theory, pages 81 to 95*)

To be of practical use an electrolytic rectifier must fulfil the following conditions :

- (1) The valve action must be complete.
- (2) The maximum voltage must be a good deal higher than the peak value of the A.C. to be rectified.
- (3) The electrostatic capacity must be as small as possible on account of the disturbing capacity currents that it causes.
- (4) The minimum voltage in the permeable direction must be low.
- (5) The electrolyte should have a small specific resistance.
- (6) The cooling surface of the cell must be big enough to prevent the temperature of the cell rising above 40° in continuous operation at full load. At higher temperatures the valve action almost completely disappears.

If 100 volts D.C. be required, it is necessary, because of losses with full wave rectification, for the cell to stop fully 300 volts. Consequently the minimum voltage is relatively high. The electrolyte must be strongly diluted in order that the maximum voltage should lie sufficiently above 300 volts. Therefore a commensurately higher specific resistance of the electrolyte results. In order that the losses caused by this resistance and the minimum voltage should not heat the cell above the permissible value (see (6) above), the cell must have large dimensions. This in turn leads to a big electrostatic capacity and troublesome capacity currents.

In consequence of these difficulties, attempts to produce a durable electrolytic rectifier for 100 volts D.C. are always failures.

However, it will be seen at once that all difficulties dis-

appear if 6 volts D.C. are dealt with. Solutions of any concentration whatever can then be used without any worry about the maximum voltage being too low. Therefore, one can select the best conducting electrolyte and a combination in which the electrostatic capacity and the minimum voltage are small.

. The Phywe Rectifier

An apparently well constructed and enduring rectifier is manufactured under the name of the "Phywe Rectifier" by the Physikalische Werkstätten Göttinger. The firm uses a strong iron cylinder as container and cathode; this obviates the disadvantages of a glass vessel. The aluminium anode is in the form of a rod of the purest aluminium possible; it is insulated by the lid of the container. The electrolyte is ammonium carbonate (salt of hartshorn). The electrolyte can easily be changed by a filler-vent.

The firm recommends covering the solution in the cells with a layer of oil about 2 mm. thick. This is partly to diminish the corrosion of the aluminium, which takes place most vigorously at the boundary between the solution and the atmosphere, and partly to prevent an excessive evaporation of the electrolyte. Since the ammonium carbonate rapidly decomposes above 50°C ., the temperature must remain below this value; moreover, the rectifying action decreases greatly above this temperature. Since, on the other hand, the conductivity of the electrolyte increases considerably with rise of temperature, the rectifier works best at a temperature of the electrolyte of about 40°C . The Physikalische Werkstätten recommend the use of either (1) single cells, which only make use of one current direction, up to a directly connected A.C. voltage of 30 volts, higher voltages being stepped down through a transformer or (2) four cells in the Grätz four-cell circuit for the utilisation of both current directions. In this case the aggregate can be loaded up to 60 volts, since two cells are always connected in series.

In order to make the cells completely effective again when they have deteriorated after long runs, the aluminium anodes

in the cells should be scraped with a sharp steel edge or knife while the current is passing; strong crackling sparks will result. The D.C. efficiency of the rectifier, inclusive of the transformer, is from 10 to 30 per cent., according to the degree of loading with the average time of use.

Fig. 53 shows one of the larger Phywe rectifiers. It consists of a tapped transformer with eleven studs contained in a box of $20 \times 20 \times 30$ cm. Four rectifier cells are fixed on two opposite sides of the box. Their dimensions are

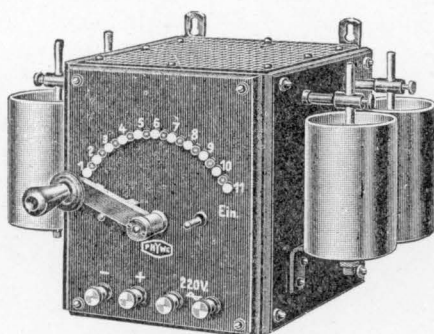

FIG. 53.—Aluminium Electrolytic Rectifier with Tapped Transformer; made by the Physikalische Werkstätten of Göttingen.

$7 \times 7 \times 22$ cm., being filled with 850 cubic centimetres of solution. The radial arm switch, by means of the transformer tapplings, gives D.C. voltages from 20 to 70 volts at 222 supply volts. A special regulating resistance is not supplied.

Tantalum Rectifiers

The most successful type of electrolytic rectifier is that using a tantalum effective electrode in an electrolyte of dilute sulphuric acid to which a small quantity of ferrous sulphate has been added. The rectifying action of tantalum has been known for some time, and was fully investigated by Güntherschulze twenty years ago. Tantalum behaves as a noble metal as regards its resistance to corrosion, and it shows complete valve action in all electrolytes; but it has one disadvantage which has till recently prevented its

successful use in a rectifier. It absorbs hydrogen with great ease, and despite its hardness soon crumbles away into a powder ; when used as an effective electrode it has therefore a very limited life.

The Fansteel Company of Chicago succeeded in preventing this disintegration by adding a small quantity (say .8 per cent.) of ferrous sulphate to the sulphuric acid. No detailed investigation into the mode of action of the ferrous sulphate has yet been published. Two ways in which it might prevent disintegration seem possible. The nascent hydrogen might be used up in reducing the ferric sulphate (continually formed by the oxidation of the ferrous sulphate) to the ferrous condition ; or the nascent hydrogen might be prevented from attacking the tantalum by the deposition of iron during the permeable period. The translator has obtained strong evidence for such a deposition since he has found that all metals which can be deposited from aqueous solutions affect the shape of the current and voltage wave forms in the same way as iron.

But the addition of ferrous sulphate has another and very important practical effect. It increases the efficiency of the rectifier. Below are given some results obtained by E. H. Robinson (*Exp. Wireless*, November, p. 889, 1925) :

Voltage across each half of centre tapped transformer.	D.C. without FeSO ₄ .	D.C. with FeSO ₄ .	Remarks.
15 volts	2.6 amps.	8.2 amps.	No accumulator in out-put.
25 "	6.0 "	12.3 "	
15 "	.75 "	3.5 "	6-volt accumulator on charge.
25 "	2.0 "	7.5 "	

The oscillograms reproduced in Fig. 54, obtained by the translator also bring out the decisive effect of adding ferrous sulphate to the electrolyte. The rectified current was measured by a moving coil instrument in series with a resistance and was kept constant at .5 ampere in both cases.

It will be seen that the voltage drop in the flow direction is very greatly reduced and that the voltage curve becomes almost flat. Similar results were obtained with Cu, Zn, Ni, but not with Mg, Li or K. The decrease in resistance may therefore be due to the deposition of iron in the pores of the oxide-coated tantalum electrode.

Messrs. Burndept, Ltd., manufacture in England a tantalum rectifier suitable for the trickle charging of low-voltage accumulators (see Fig. 55). The transformer has two primary windings so that it can be used for voltages of

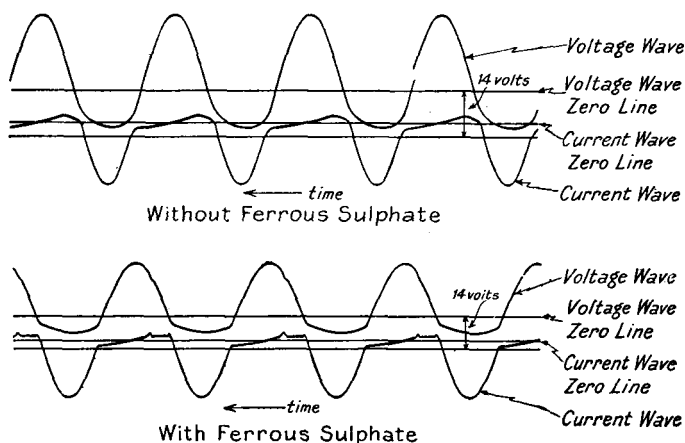

FIG. 54.—Effect of adding Ferrous Sulphate to Tantalum Rectifier.

100 to 110 and 210 to 230 at will. Half-wave rectification is used, since full-wave rectification has no advantages in trickle charging and causes a bigger temperature rise than half-wave rectification. A 7-ohm resistance is connected in series with the secondary and the rectifier; the secondary winding delivers 19 volts and about .8 amperes (R.M.S. values). The current density is, on the average, .2 ampere per square inch, the charging rate varying from .5 ampere at 2 volts to .3 ampere at 6 volts. Since trickle charging is necessarily a lengthy process, a considerable volume of electrolyte is used so that distilled water need not be added at frequent intervals. A lead rod is used as the indifferent electrode: the quality of

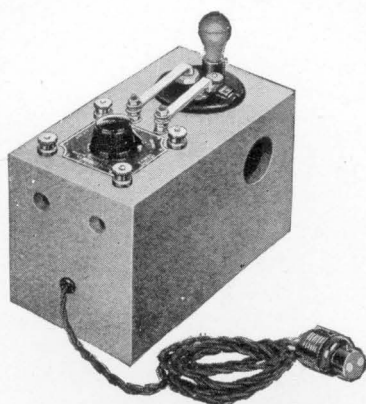

FIG. 55.—TANTALUM RECTIFIER FOR TRICKLE CHARGING.

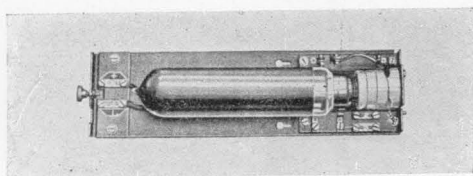

FIG. 57.—GLOW DISCHARGE RECTIFIER OF THE ELEKTRIZITATS A.G. HYDRAWERKE.



FIG. 59.—GLOW DISCHARGE RECTIFIER FOR H.T. BATTERY ELIMINATOR.

the lead is of importance ; it should be as pure as possible, and antimonial lead is unsuitable. The tantalum strip is brought through a washer in the cover and clamped under a terminal ; this is found to make the most satisfactory connection, since it is impossible to join lead and tantalum by lead burning. The cover is of ebonite to withstand the action of the acid ; what is popularly and deservedly known as " muckite " is quite unsuitable.

In U.S.A. the Fansteel Company manufacture a number of different types of tantalum rectifier, including H.T. battery eliminators. Güntherschulze found that the overall efficiency of the 110 volts A.C. type was 30 per cent. when supplying 6 volts at 2.5 amperes D.C. The efficiency was not markedly decreased after several hundred hours' operation.

The Andre Colloid Rectifier

H. Andre (*L'Onde Electrique* 5, 28, 1926) has devised a rectifier working on a new principle. It consists of a silver and nickel electrode, almost touching each other and immersed in pure anhydrous sulphuric or phosphoric acid ; the theory of the rectifier has not been developed, but the action seems to depend upon the formation of colloidal silver. During operation the silver electrode is consumed ; the rectifier works best at a temperature of 50° C. Such rectifiers are manufactured by the Raytheon Corporation of U.S.A. to supply 2.5 ampere D.C.

Undeveloped Types of Electrolytic Rectifier

Güntherschulze (*Zeits. für Elektrochem.*, 18, 326, 1912) has found that iron shows a good valve action effective up to 80 volts in concentrated sulphuric acid. The small conductivity of the pure sulphuric acid can be increased by adding anhydrous sodium sulphate.

Güntherschulze (*Zeits. für Elektrochem.*, 17, 510, 1911) has also found that aluminium when used in molten potassium or sodium potassium nitrate has particularly small losses and an abnormally low minimum voltage. The electrostatic capacity is also small, and high-frequency

currents can also be rectified (see Güntherschulze and Alberti, *Phys. Zeits.*, 23, 188, 1922). The maximum voltage is about 80 volts. The use of a eutectic mixture of the potassium and sodium nitrates is advantageous, since such a mixture melts at a much lower temperature than its constituents.

Connections of Electrolytic Rectifiers

Several ingenious connections have been given by Bairsto for the aluminium rectifier. First the Grätz four-cell arrangement can be simplified if two aluminium electrodes are placed in one cell, as shown in Fig. 56, so that a three-cell

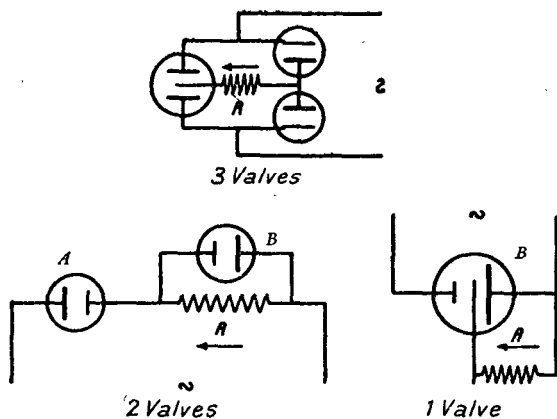

FIG. 56.—Bairsto's Connections for Electrolytic Rectifiers, giving full wave rectification with one, two or three valves.

arrangement results. It is not possible to put the two other aluminium electrodes into one cell, since rectification would then cease, as is seen straight away by following out the path of the current. Nevertheless, Bairsto found a circuit which uses two cells and gives full wave rectification, and which makes use of the big electrostatic capacity of the formed aluminium electrodes. The circuit is given on the left side of Fig. 56, R is the apparatus using the D.C. In one current direction A allows the current to go through R, in the other A closes but B discharges its capacity charge (stored up in the previous current direction) through R in the same

direction as the current from A had flown. Bairsto has even succeeded in utilising both halves of the current with one cell, as shown on the right-hand side of Fig. 54. In the two latter cases the best results are obtained if the electrode B, which acts in virtue of its capacity, is made approximately eight times as big as the electrode A.

CHAPTER XII

Glow Discharge Rectifiers

(Physical Theory, pages 35 to 52)

Glow Discharge Rectifiers are manufactured by the firm of Julius Pintsch A.-G. Berlin (distributed by the Hydrawerke A.-G. Charlottenburg) and by the Osram Company (distributed by the A.E.G.). The glow discharge rectifier of J. Pintsch, shown in Fig. 57, has a shape similar to an incandescent electric lamp, and is fitted with an ordinary Edison screw cap. These rectifiers contain a mixture of helium and neon at about 10 mm. pressure and free from impurities. The cathode in the rectifiers for 220-volt mains consists of a big cylindrical plate of pure iron. For 110-volt mains this plate is coated on the inside with sodium-potassium alloy, liquid at room temperature. The anode is a thin iron wire at the axis of the cylinder, which is surrounded by a protecting sheath of porcelain so that only its point in the middle of the cylinder is left for discharge purposes. The rectifier is made for currents up to .2 ampere. It is difficult to make bulbs for larger currents because the dimensions become so big. To be sure, there is no need for this, because the efficiency of the rectifier is very low, since the greater part of the voltage available is used up in it. But in the use of an apparatus in practice the efficiency does not alone come into the question, but also the economy of the apparatus which results from the sum of the energy costs and those for interest and depreciation. Now, the energy expenses with an apparatus for very small energies are so slight in comparison with the other expenses that an apparatus of low efficiency is cheaper than one of higher efficiency but greater cost. The case is very different, however, when large amounts of energy are rectified. With large rectifiers an improvement

of efficiency of a few per cent. can effect great economies. But a glow discharge rectifier is relatively very cheap because it needs no apparatus other than the glow discharge bulb and a regulating resistance. The battery to be charged is connected in series with a rheostat directly to the A.C. voltage. By using one current direction a transformer and choking coil can be dispensed with and small accumulators can be charged without any attention.

Fig. 58 gives the actual current curve *b* of a glow discharge tube for 220 volts A.C. connected in series with an ohmic resistance and supplied with an approximately sinusoidal voltage *d*. The indentations in the curves are probably enlargements of harmonics in the A.C. voltage.

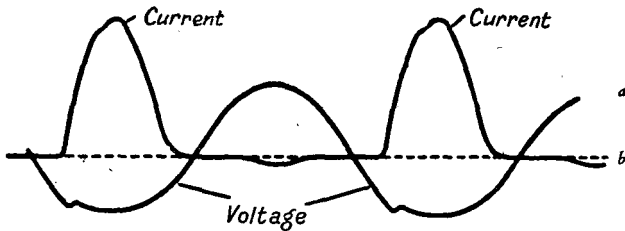

FIG. 58.—Current and Voltage Curves of a Glow Discharge Rectifier with Alkali Cathode. 120 Volts A.C. Input.

The curves show the great permeability in the direction of flow and the negligible current in the impermeable direction.

The fact that these rectifiers use up 80 volts independently of the current strength, and that therefore only 30 volts are left over from a D.C. voltage of 110, gives them a second sphere of use, which to be sure has nothing to do with their valve action. It is possible to operate weak current arrangements from strong current mains of 110 volts D.C. without any fear that the voltages higher than 30 volts will occur in the weak current circuit.

These rectifiers are handicapped by the big difference between the starting and operating voltages. The following table shows how these two voltages change with duration of working.

Time in Hours.	Starting Voltage.	Working Voltage.
0	192	184
8	182	180
71	206	184
130	260	184
200	330	184
440	343	184
700	343	184

The table shows that while the working voltage is steady, the starting voltage, after a small decrease caused by cleaning of the gas, rises to a final value almost double its initial value.

Glow discharge rectifiers are also extensively used in H.T. battery eliminators. They have the advantage of requiring no filament heating current, and their life is very long, provided the rectifier is suitably designed. The greatest trouble experienced with them is their tendency to break into oscillations of the order of 180,000 cycles per second, when large currents are passed through them. A rectifier of this type arranged for full wave rectification is shown in Fig. 59; it is manufactured by Messrs. Burndept. Similar rectifiers are manufactured in England by the General Electric Company, and in America by the Raytheon Corporation.

Short Path Rectifiers

Bush and Smith have devised an interesting form of gas discharge rectifier known as the "S" tube. It is a development of the glow light rectifier in that not only are differences in surface area made use of, but the electrodes are separated from each other by a distance less than that of a mean free path of an electron. The essential construction is shown in Fig. 60. One electrode A is hollow and the other B is flat. The distance between AB is less than the mean free path of an electron; it is obvious that the discharge

cannot take place straight across AB but only from B to the inside of A, where there is space for ionisation by collision to occur. When A is a cathode current will flow, but when B is a cathode current will not flow, since the positive ions inside A are surrounded by a positively charged enclosure

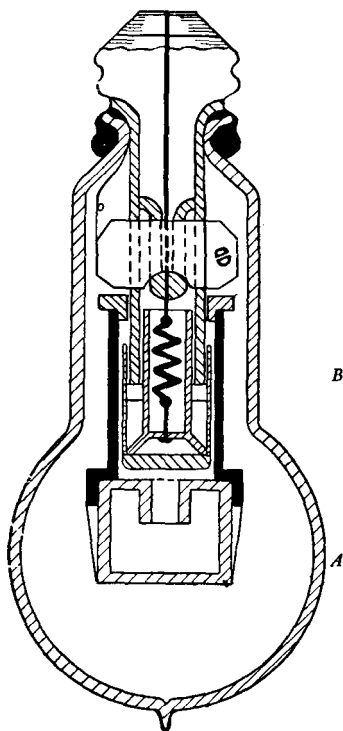

FIG. 60.—The "S" Tube.

and therefore are not accelerated towards B. The positive ions cannot therefore bombard B and cause a self-sustained discharge to occur. The current in the impermeable direction is therefore much smaller than that which would be expected from considerations of the differences in electrode area alone.

CHAPTER XIII

Mercury Vapour Rectifiers ; Glass Bulb Type

(Physical Theory, pages 53 to 79)

By a mercury arc rectifier is meant in engineering not only the actual rectifier, but the complete apparatus for converting the alternating current into direct current consisting of the actual rectifier vessel, a transformer, choking coils, measuring instruments, fuses, etc.

The manufacture of mercury vapour rectifiers was originally limited to that of rectifiers in glass containers for small currents of 5 to 10 amperes. This was due to the great difficulties at first experienced in leading strong currents in a completely air-tight manner into a metal vessel, at the same time insulating the leads from the metal sides. Such small types are put together with the necessary accessory apparatus into very compact portable charging arrangements for small car batteries and the like. Fig. 61 shows such a small portable rectifier for 5 amperes made by the A.E.G. Considerable advances were soon made, however. Kinds of glass were first discovered which were equal to the extreme temperature variations; and big currents were led in by a number of thin parallel platinum wires. Before the war the A.E.G. had had success with currents of 100 amperes. Yet at that time these rectifiers still suffered from teething troubles. Even the rectifiers for 30 amperes in the years just previous to the war still suffered from frequent back-starting, which acts as a short circuit and generally destroys the rectifier. Even without back-starting their life was moderate, while the smaller type for 10 amperes reached several thousand hours of operation. On the other hand the demand for large rectifiers was not so extremely pressing because the smaller types could be connected in parallel to produce the desired current strength. This pro-

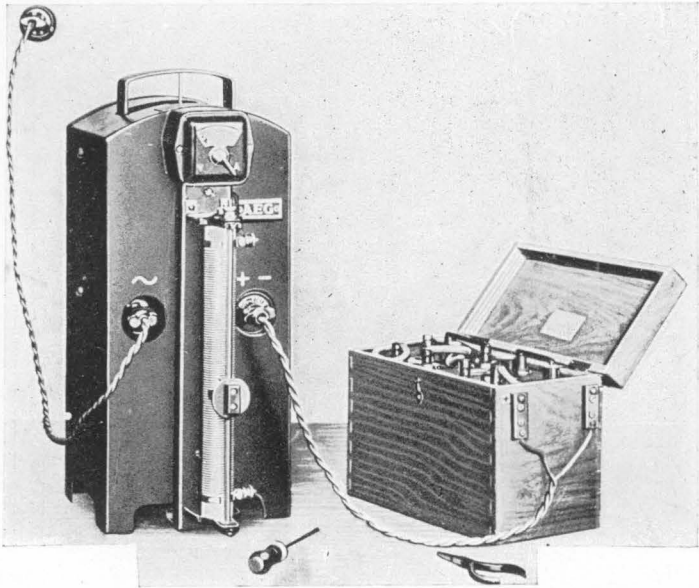

FIG. 61.—PORTABLE A.E.G. MERCURY ARC RECTIFIER.

[To face p. 157.]

cedure has even the advantage that the failure of one rectifier scarcely disturbs operation, while the breakage of a single big rectifier, supplying the total current, brings everything to a standstill. This fact caused the Physikalisch-Technische Reichsanstalt before the war to use exclusively a 10-ampere type connected in parallel for charging their accumulators; and quite excellent results have been obtained. These rectifiers were originally supplied by the Westinghouse Cooper Hewitt Company, and were later produced in the workshops of the Reichsanstalt itself. They have already attained a life of far over 10,000, and in some cases 30,000 hours of operation. Twenty three-phase rectifiers are connected in all; they can be joined all together in parallel with a common transformer. On the D.C. side there are two parallel iron wire resistances, each one for 5 amperes, connected in series with each rectifier. These prevent the increase of the current strength beyond 10 amperes and take up the excess voltage at the beginning of charge. There is also a separate choking coil for smoothing out the D.C. pulsations. The charging arrangement has been in operation since 1913 and still (1927) works excellently.

However, this method of parallel connection of numerous small units was only to be recommended as long as the small types were more reliable than the big. The disadvantages of the procedure, the big space taken up, the increase in the number of regulating resistances and choke coils, the high cost of having many small pieces of apparatus instead of one big one, are obvious.

In recent years various decisive advances have been made in the production of large glass mercury vapour rectifiers. The use of these big types, which are now reliable enough, is in many cases to be recommended—the more so as it pays to use various subsidiary apparatus with them which make their operation surer, more convenient, and more economical, and whose use is not possible with the parallel connection of many small rectifiers.

There are three advances which have more than anything else had a revolutionary effect—artificial cooling, new methods of making current leads, and the control of back-starting.

The artificial cooling of the rectifier is attained by mounting an electric fan under the rectifier vessel. This fan is turned on at the same time as the rectifier and blows a powerful stream of air on to it. Fig. 62, which has been placed at the author's disposal by the Gleichrichter G.m.b.H., illustrates how this cooling acts on the rectifier. Curve 1 gives the curve of the characteristic of a rectifier without cooling. It shows that the voltage at first falls with increasing current as with all arcs, but then bends round and at about 50 amperes increases considerably. The reason for this phenomenon is that the temperature of the rectifier grows as the

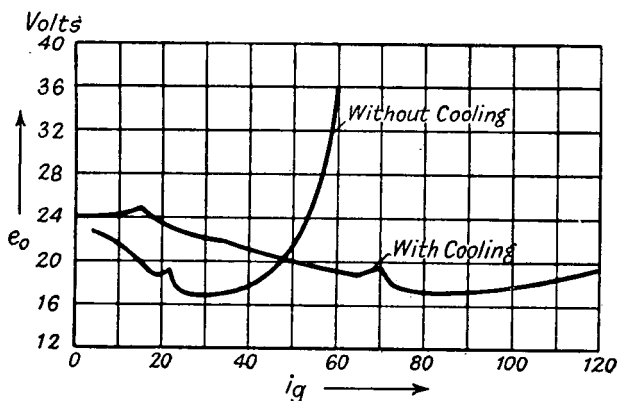

FIG. 62.—Effect of Air Cooling on Current Voltage Curve of a Glass Bulb Rectifier.

current load is increased, and this sends up the vapour pressure of the mercury, so that the resistance of the vapour path is greatly increased. The losses in the rectifier go up at the same time, and this in turn causes an increase of heating which sends up the pressure, and so on in a vicious circle, so that the limiting permissible load of the rectifier investigated is at 50 amperes. Curve 2 shows in contrast the characteristic of the same rectifier after the artificial cooling has been turned on. It will easily be seen that curve 2 results from curve 1 if the abscissa of the latter be multiplied by three (the kinks in the curves are probably not real, however, but are experimental errors). Curve 2 shows that

below 50 amperes the cooling increases the voltage drop in the rectifier. It is therefore brought into use above this load.

The carrying capacity, however, is only increased three times by artificial cooling as far as the rectifier vessel is concerned.

The leading-in wires are hardly affected by the cooling, since they are situated in the inside of the vessel; they must therefore have a size proportionate to the higher current strength.

The fan already mentioned is not needed with small loads; in the rectifier set of the A.E.G. there is therefore a relay which connects the fan into circuit when the load reaches 40 per cent. of full load. In order to avoid a continual cutting in and out in the neighbourhood of this load, the relay is so adjusted that it does not cut out till the load falls to 25 per cent. of full load.

It is obvious that the cooling of the rectifier can be made very much more effective if the container is immersed in cooling water so that only the projections stick out. It is found, however, that the glass cannot stand up to this treatment and cracks. It was then attempted instead of water to use oil that was cooled on one side by water. But this experiment also has had no satisfactory result, principally because the oil rapidly becomes resinous through the great heat given off by the anode arms.

The second advance, the air-tight introduction of big currents into the rectifier vessel, was attained in two different ways. Originally, as already mentioned, this end was attained by fusing a number of fine parallel platinum wires into the glass. But it was found very difficult to make the resistances of the very short pieces of platinum wire used sufficiently equal. The unequal loading soon makes itself apparent by the fusing of one of the leads. More than 50 amperes cannot be reached in this way. It was then discovered that molybdenum makes an excellent fused air-tight joint in a borosilicate glass, a kind of old Jena apparatus glass. This glass is therefore called molybdenum glass. Wires up to 10 mm. thickness were successfully fused in and

could be loaded with currents up to 500 amperes. To be sure, the great brittleness of molybdenum, which is aggravated by working the metal, was troublesome. The General Electric Co. of America have successfully patented this method.

The rectifiers of the A.E.G. are equipped with such current leads; Fig. 63 gives an example. *c* is a graphite anode, *b* the molybdenum wire, *d* the glass wall, *a* is a safety cap for the mechanical protection of the wire. If a short circuit does exist in the glass container it never lasts long enough for the molybdenum wire to assume a dangerous temperature. The seal is therefore not damaged by short circuits. The molybdenum glass, which is made by the firm of Schott and Genossen, has as well the great advantages of a very high softening point, great toughness, and an astounding insensitivity to temperature variations. It is therefore admirably suited for rectifier vessels.

The second method of making airtight leads for big currents is used by the Gleichrichter G.m.b.H. No limit is set to the current entering by this method. The current lead coming from the cathode is welded on to the inside

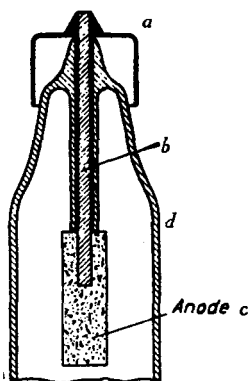

FIG. 63.—Seal of Lead-in at Anode in an A.E.G. Glass Bulb Rectifier.

of a thin platinum cap, the external current lead is welded on to the outside, while the glass vessel is fused ring fashion on to the thin wall of the cap. The sealing place is mechanically protected by another cap. The sealing is here, therefore, in part brought about by the walls of the platinum cap. The critical sealing place is the joint between the fused glass and the wall of the platinum cap. Since this is very thin, and therefore very pliable, and the heat imparted to the bottom of the cap by the leading-in wires is in great part given up again on its way to the wall of the cap by radiation, the wall of the cap is not especially warm. No kind of special demand is therefore made of the seal so that it keeps

quite tight. A disadvantage of this very reliable seal is the high price of platinum.

The method has recently been simplified and improved. A cap of pure soft copper, on to the bottom of which the two current leads are joined, is rolled out at its open end to .01 mm. It is then heated uniformly together with a suitable glass tube up to the softening point, slipped over the glass tube till it meets a groove, and is there blown with the glass tube. The thin shell is then completely fused with the tube. The union between the two is very intimate, because the glass dissolves in the copper oxide formed during the heating, and also to a certain extent in the copper itself. When cool, the copper cap is plated electrolytically with a thin layer of iron to protect it from the amalgamating mercury vapour.

This cheap and simple sealing method has proved successful. The Gleichrichter G.m.b.H. uses ordinary lead glass; it likewise behaves very satisfactorily. The biggest danger to the durability of the glass vessel is the internal strains in the glass which are set up in too quick cooling after the individual parts have been blown together. Every glass vessel made by the Gleichrichter G.m.b.H. is examined in polarised light with a Nicol prism, for the discovery of these strains. The strains betray themselves by coloured patches, which are then removed by renewed heating.

Back-starting is the objectionable phenomenon which sets a limit to the use of mercury vapour vapours for high voltage. Physically it is the change of the glow discharge, which is present in the impermeable direction at voltages over 500 volts, into an arc discharge.

In order to get the correct idea of the voltage relations in the rectifier it must be remembered that if, for example, a rectifier has to rectify at 500 volts, the voltage at the cathode of the impermeable direction (the so-called "anode" of a rectifier), will be fully double this amount in a single-phase rectifier, and therefore more than 1,000 volts. The circumstances most favourable to back-starting have already been mentioned in the physical section. They are (1) placing the rectifier anode and cathode in the same compartment so

that the rays sent out from the cathode can strike the anode directly, (2) impurities at the anode, especially alkali and calcium salts (sweat from the hand), (3) presence of foreign gases in the rectifier. The first danger is avoided by disposing the anodes in not too short and bent side arms. The avoidance of impurities is a matter of clean manufacture. The sufficient removal of foreign gases is the most difficult problem. If a completed rectifier vessel is pumped out in a cold state to a very high vacuum and then fused off and put into operation, the electrodes at once give up such quan-

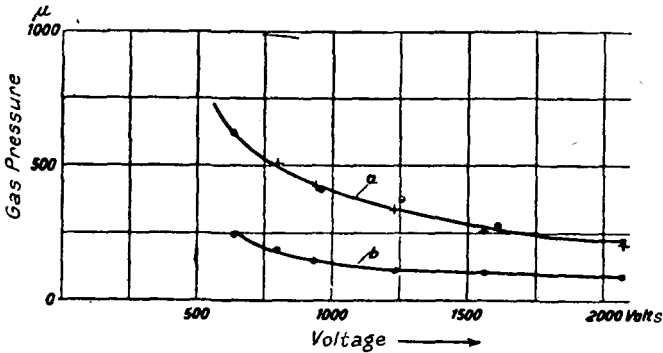

FIG. 64.—Dependence of Back-firing Voltage on Pressure.

- a* 000. Current 25 amps.; anodes at high temperature.
a + + +. Current 7.5 amps.; anodes at same high temperature.
b 000. Current 7.5 amps.; cold anodes.

tities of gas that the rectifier is destroyed. Fig. 64, which Herr Krämer has kindly lent the author, shows to how great an extent the point of back-starting is lowered by small quantities of air.

It is therefore absolutely essential to load the rectifier during evacuation with as much current as it can stand so that the anode reaches a light-red heat. It is also extremely desirable to put the rectifier at the same time into a heating jacket which can be heated up to 200° C. In order to facilitate this baking-out of the rectifier, the Gleichrichter G.m.b.H. lead in the cathode current not as usually done from underneath, but through a side attachment from which

comes out an iron rod immersed in the cathode mercury and insulated up to its point by a glass tube.

In practice rectifiers are continually found which at first have an excellent vacuum and are able to rectify 6,000 volts or more without back-starting. But as soon as they have once been thoroughly loaded, they still evolve so much gas that it back fires at 1,000 volts.

Ever since the out-gassing of vessels at the Physikalisch-Technische Reichsanstalt has been carried out with great thoroughness in the way mentioned above, rectifiers have been obtained which operate for over 30,000 hours and yet show no signs of deterioration. It cannot therefore be sufficiently emphasised that the heating and loading during out-gassing should be taken as far as the strength of the rectifier vessel allows.

Fig. 65 illustrates the connection between back-starting and the loading of a rectifier according to measurements of the A.E.G. It shows that (in a gas-free vessel) the voltage of back-starting decreases rapidly with increase of load. The cause of this lies in the increase of the mercury vapour pressure with the load. The dimensions of a vessel must therefore increase, with a given current strength, the higher is the voltage to be rectified. The curve of Fig. 65 holds for runs of long periods. Short overloads, insufficient to send up the temperature of the rectifier to a high value, scarcely lower the point of back-firing. Likewise a sudden connection of full load does not damage the vacuum.

A further advance of recent years is the improvement of means of starting up. The simplest method of starting up, as mentioned above, by shaking the rectifier by hand, is not sufficient for works in which there are no professional electricians. Therefore it was early replaced by an electromagnetic tilting apparatus, which came into operation on switching in the rectifier and tilted the rectifier to and fro until it had started up. But since in this way the right direction of current was not always immediately struck, some time, even if only a fraction of a minute, elapsed between the act of switching in and starting up. This delay, which in continuous operation, as for example in accumu-

lator charging, is immaterial, is extremely troublesome if the rectifier must be continually switched in and out of circuit. It can even be disastrous. Suppose that the current falls below 3 amperes because of strong variations in the load. The arc will go out. The starting-up process immediately begins just at that moment when the load is particularly big, to make up for its previous decrease. In such cases it is essential that the rectifier is so arranged that it is not interrupted at all and does not require momentary switching in. This was attained formerly by having a small

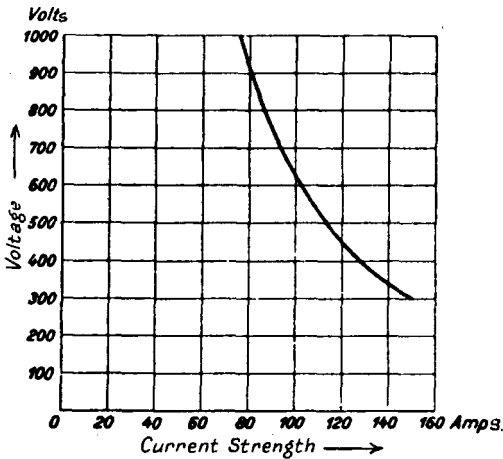

FIG. 65.—Back-firing Boundary in a normal Glass Bulb Rectifier.

auxiliary arc supplied from a special D.C. source between a separate anode and the rectifier cathode. But the D.C. source increased the cost and space, and complicated the installation, while the energy consumption was at least 200 watts.

The rectifier is now given a much simpler and cheaper means of excitation. Two special small anodes are fitted in the rectifier vessel. These are connected to a special small transformer, whose mid-point is connected to the common cathode of the rectifier through a choking coil of special construction. In other words, a small single-phase

rectifier is constructed, as it were, in the big rectifier, and short-circuits it through a choke coil. This small rectifier burns continuously as long as the set is in use, and uses at 4 amperes only 100 watts, which is insignificant with the load of perhaps 100 kw. on the main rectifier. Fig. 66 shows how the A.E.G. connect this auxiliary exciter.

Rectifiers in which frequent and sure starting up is not so very important are excited by tilting as before, the glass apparatus being pivoted in a frame and tilted by an electromagnet. This has the double advantage that the vessel cannot be endangered by clumsy hand tilting, and it imme-

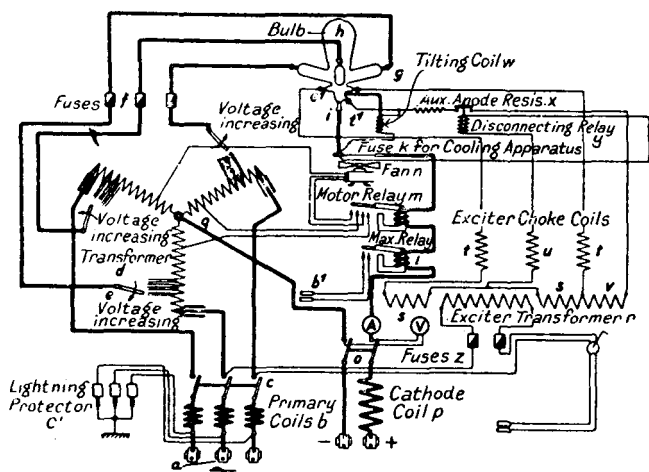

FIG. 66.—Normal Connections of Glass Bulb Rectifier.

diately tilts itself into operation again if the multiphase current is switched on after an interruption.

The exciting anode has recently been considerably improved by the A.E.G. Formerly this consisted of a glass attachment filled with mercury near the cathode. When tilted the mercury in this attachment ran over the cathode and completed the circuit. On breaking contact a spark occurs which often excited the arc, but often did not. This is because if a mercury contact is opened in a vacuum tube the arc formed is interrupted in a fraction of an A.C. cycle. It is therefore pure chance if this break of contact is made

just at exactly the time at which the current flows in the right direction. Therefore the mercury anode is replaced by a carbon anode, as shown in Fig. 67. With this material

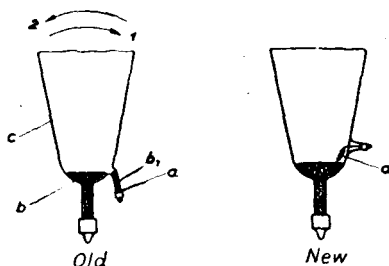

FIG. 67.—Old and New Construction of Exciting Anode.

the arc at break lasts for a full cycle, so that the excitation becomes very much more certain. Fig. 68 gives information about the dependence of the efficiency of a rectifier on the load.

Glass bulb mercury vapour rectifiers are manufactured

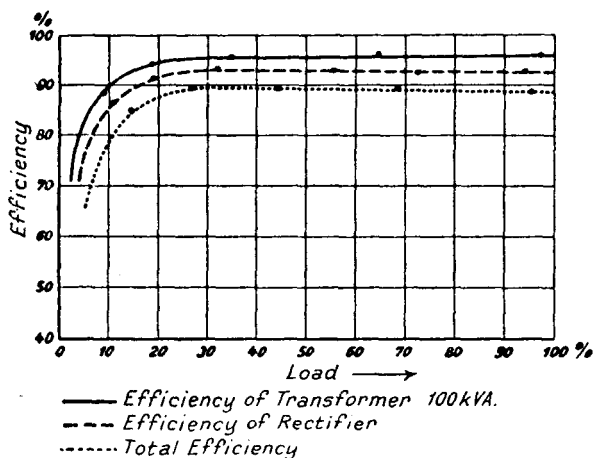

FIG. 68.—Efficiency of Transformer and Glass Bulb Rectifier.

in Germany by the A.E.G. ; the Gleichrichter G.m.b.H. ; the Siemens-Schukert-Werke ; and the Westinghouse Cooper Hewitt G.m.b.H. of Berlin. The smallest types of mercury

arc rectifiers are for 5 to 6 amperes. For such small current strengths they are made as single-phase rectifiers with two anode arms. This type are specially used for charging small accumulators. The A.E.G. has gone furthest in increasing the capacity of these rectifiers and produces rectifiers for 250 amperes commercially, and has made an experimental rectifier for 500 amperes. These big types have six or more anode arms. Fig. 69 shows such a six-armed rectifier, a real masterpiece of glass blowing. A difficulty to be overcome with these big types is to give the bulb the necessary cooling surface without the bulb becoming altogether too long. The form of cooling chamber illustrated in Fig. 69 was therefore chosen. It has a narrow neck on which is a further sphere-shaped bulb. The Gleichrichter G.m.b.H. have also recently constructed six-phase rectifiers for 250 amperes.

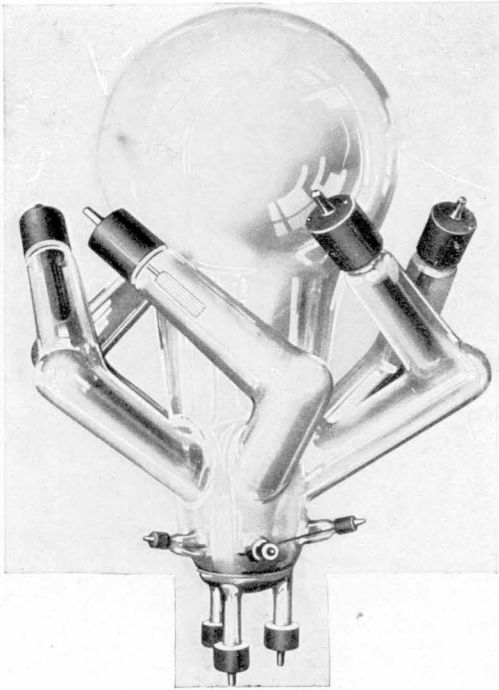

FIG. 69.—A.E.G. HEXAPHASE GLASS BULB RECTIFIER.

[To face p. 168.]

CHAPTER XIV

Metal Cased Mercury Vapour Rectifiers and the Properties of Rectifier Installations

Extraordinary difficulties had to be overcome in the production of large rectifiers. Since it was impossible a few years ago to lead currents of 500 amperes into a glass bulb and to make glass bulbs which could stand a production of energy of 10 kw. inside them without breaking, investigation was directed to metal containers. The problem was not only to seal these up completely air-tightly without making occasional necessary openings too difficult, but also to arrange insulated and air-tight electrodes, for currents of 500 amperes, in the vessel. In addition the enclosure must remain at a high vacuum and be guaranteed air-tight in operation, despite the great amount of heat evolved and the heating of the walls caused thereby. In Germany it was through the untiring exertions of the engineer Bela Schäfer, of Brown, Boveri et Cie, that these difficulties were successfully surmounted and usable big rectifiers were produced. Apparently big rectifiers were constructed simultaneously in America by the General Electric Co., and then taken up by the A.E.G. In recent times the Siemens-Schukert-Werke have begun manufacture.

The firm of Brown, Boveri et Cie produced their first big rectifiers as long ago as 1909–1911, so that they have now had more than fifteen years' practical experience. In the first years numerous troubles occurred in operation, but these did not cause much damage, since by way of precaution complete reserves were provided. Thus valuable experience could be obtained in normal works operation, and the defects of the first big rectifiers be removed without disturbing the work too much. The rectifier has now become so reliable that a daily inspection is sufficient control.

Necessity for Continual Pumping

The big rectifier loses its vacuum when left unused for long ; it is easily seen that it is a mistake only to evacuate the rectifier before starting up, in order to avoid a breakdown. The air that leaks into the rectifier is absorbed in great quantities quite slowly in the course of days by the walls of the container, the anodes and the mercury. If then pumping is carried on for an hour before starting up the air will indeed be very thoroughly removed from the space inside the container, but not from the solid parts. If the rectifier is thereupon put into operation, the absorbed air will suddenly be given up again by the heated apparatus, and the vacuum will quickly deteriorate so that dangerous back-starting will occur.

Therefore the vacuum of a rectifier should not, in general, be allowed to fall appreciably, whether it is in operation or not. If there is any suspicion that a bad vacuum has existed for a long time, the rectifier must be heated and pumped with a big load and a high cooling water temperature for some time before putting it into operation if back-starting is to be avoided. If there are reserve rectifiers it is recommended that they should be changed round twice or three times a week. If this is done and care is taken that the vacuum is always unexceptionable, the reliability of a rectifier is greater than that of a rotary converter, since starting and synchronisation troubles are absent. Moreover, the overload capacity of rectifiers is very great ; short overloads of 100 per cent. or more do not injure them.

Pumping Equipment

The pumping equipment of a metal rectifier is shown in Fig. 70. The rectifier is connected through a cock to a Macleod gauge and a mercury diffusion pump. The diffusion pump is backed by a rotary oil pump working through a mercury trap. The purpose of the mercury trap is to prevent access of air to the rectifier should a failure of the oil pump occur. A reservoir is also fitted on the vacuum side of the oil pump to prevent oil from reaching

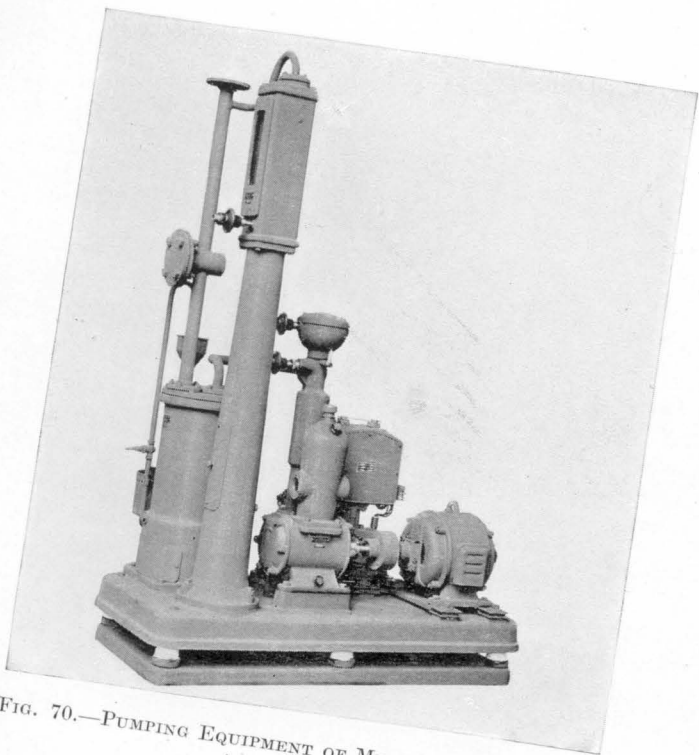

FIG. 70.—PUMPING EQUIPMENT OF METAL CASED MERCURY
ARC RECTIFIER.

[To face p. 170.]

the mercury trap. The heating of the diffusion pump takes 400 to 500 watts ; the oil pump is driven by an A.C. motor taking 100 watts. The pumping equipment can be made to start up and stop automatically by suitable relays worked by a manometer.

Method of Excitation

Metal rectifiers are always excited by contact arc formation. An electromagnet is arranged to pull down an iron anode into the mercury pool and then to release it ; this process is repeated until an arc is formed and the rectifier starts up. If auxiliary excitation anodes are fitted these are the first to start up ; if there are no excitation anodes the contact anode is supplied with D.C. from a small rotary converter in order to make the production of an arc more certain.

The Insulation of Metal Rectifiers

If the positive pole of the network which is supplied with D.C. by the rectifier can be earthed, the insulation of the rectifier presents no difficulties, since the rectifier vessel can be kept at earth potential. It is, however, more usual to earth the negative wire, in which case the whole rectifier must be well insulated and the cooling water must be supplied through long rubber tubes.

Protection from Voltage Surges

A good rectifier free from foreign gases will stand up in the impermeable direction to voltages as high as 10,000 volts or more ; consequently any surges in the network will be partly reflected by it and dangerously high voltages can occur. The rectifier itself in certain cases can also give rise to over voltages.

According to the explanation given on p. 55, the existence of an arc is bound up with the condition that a very high temperature spot exists on the cathode, from which the necessary number of electrons is emitted. If this electronic emission be interrupted for the shortest conceivable time,

the arc will go out. The extinction occurs in a time that appears to be considerably shorter than a hundred thousandth of a second. The high temperature necessary is produced by the bombardment of the cathode by positive ions or cations. These cations in falling through the cathode fall receive so much energy that they raise the temperature of the cathode to white heat. It is necessary for this that all their energy should be concentrated on quite a small spot, otherwise it is insufficient. But this spot because of its high temperature sends out mercury vapour rays which drive the bombarding ions to one side. The cations must therefore continually find a new bombarding place. Therefore the cathode spot runs here and there over the surface of the mercury with great speed. Now the smaller the current density and the quicker the movement of the spot, the more difficult is it for the cations to stay on any particular spot when it has attained the temperature necessary for vaporisation. It is therefore possible for an arc to work at a small current density for one or two minutes and then to go out suddenly with a particularly fast motion of the spot. Moreover, the concentration of the cations on a spot becomes more and more difficult as the pressure is reduced, because their mean free path becomes greater and they are therefore scattered in all directions.

In a rectifier vessel free from foreign gases in which only mercury vapour is present, the vapour pressure decreases very rapidly with the temperature. Therefore the colder such a rectifier is, the higher is the current density at which the arc goes out.

It might be thought that this tendency of the rectifier to go out could be effectively opposed by connecting in a big inductance. But this is not the case.

The extinction process is completed so quickly that the high voltage of break across the inductance is not formed until the arc has already gone out.

Due to the extreme speed with which the circuit is broken when the arc goes out, the considerable quantities of energy present in the transformer and choking coil have no chance of equalising themselves even partially.

Since the rectifier is out of operation all this energy rushes for the weakest spot in the plant. If this happens to be the gas path of the rectifier the energy equalises itself through that and causes ignition again. But if the bulb is not the weakest link, equalisation in the form of a breakdown may occur anywhere in the set. The important fact to bear in mind, in understanding this breakdown, is that the equalising energy rushes into the plant with a very steep-fronted voltage wave because of the extreme speed of the process. One of the consequences of this is that parallel safety resistances, such as silite resistances, are completely disdained if their conducting wires have any sharp bends. Other wires, however, although highly insulated, will be caught if they lie in the direct path of the surge. On account of these high voltage surges safety apparatus only fulfils its purpose when it is connected, without any bends whatever, directly between the anodes or between anode and cathode.

If the rectifier is the weakest place, so that it is again ignited, the whole circuit-breaking process is run through so quickly that nothing can be seen on an ammeter or in the rectifier bulb itself; but it can be heard. If the current strength of a rectifier, fed with direct current, and which goes out at 3.0 amperes, be gradually lowered to 3.5 amperes, cracks will be heard in the regulating resistance every few seconds; these are similar to the well-known telephone cracks. These cracks signify that the rectifier has gone out but immediately been excited again by the energy-equalising process. The further the current density is lowered, the louder are the cracks, until the equalising energy no longer suffices to excite the rectifier and it finally goes out.

It will now be seen how important it is that the gas path should be the weakest link in the plant, *i.e.*, that the breakdown voltage across the gaseous path is lower than the breakdown voltage in any other part of the plant. Only then is the plant protected against ruinous surges.

Now the breakdown voltage increases with decreasing pressure. If it is taken for simplicity as inversely proportional to the pressure, which is made up of a constant gas pressure a due to foreign gases and a mercury vapour

pressure p dependent on the temperature, we may write

$$V_{\max} = \frac{C}{a + p}. \quad \text{In the particular case in which the rectifier}$$

contains no foreign gases $a = 0$, and as the temperature decreases, V_{\max} will increase and the bulb will become harder.

It will therefore be seen that the actions of low temperatures and well-evacuated bulbs are very important for two reasons. First, they increase the minimum current density, and therefore the equalising energy, and secondly, they increase the breakdown voltage of the rectifier until it no longer forms the weakest link in the plant. The equation above shows what must be done. The pressure a of the foreign gas should never be zero, and then V_{\max} can never exceed the value C/a , so that the rectifier always remains soft.

It is hardly necessary to add that the above-mentioned effect of low temperatures is only present shortly after the switching on of the bulb, while it is still cold. As soon as it has worked for some time, and warmed up sufficiently to produce a mercury vapour pressure of a few tenths of a millimetre, it is always soft and can extinguish itself without any danger to the plant. Fig. 71 shows how the mean temperature in a big glass rectifier grows with time after switching on the full load.

It is not necessary to introduce foreign gases artificially into the rectifier in order to make it soft at low temperatures. Far more gas is evolved, in spite of the most careful pumping, by the rectifier from the electrodes and walls, at the beginning of operation, than is required by the above equation. It would be a difficult matter to find so well-evacuated a rectifier that it was hard in this sense. If rectifiers containing foreign gases are used in such a way that the maximum voltage across the rectifier is below the glow discharge voltage of the mercury vapour (about 530 volts), the quantity of foreign gases in the rectifier will scarcely be altered during the time of operation.

But the behaviour is quite different if the rectifier is loaded with higher voltages. Suppose, for example, 440 volts D.C. are supplied, and therefore 900 volts between the anodes. A glow discharge will then take place in the im-

permeable direction which leads to sputtering of the anodes (cathodes of the glow discharge). But this sputtering carries down and precipitates the foreign gases, so that the rectifier becomes completely freed from them. It is exactly the same process that leads to the hardening of ordinary Röntgen tubes. Therefore rectifiers used for high voltages and that have been sealed up perfectly air-tightly, cause an increasing danger to the plant when they cool down to low temperatures. It is therefore emphatically recommended that rectifiers for high voltages should not be used in rooms in which they are exposed to temperatures much lower than $+ 5^{\circ} \text{C}$. If low temperatures cannot be avoided, the rectifier

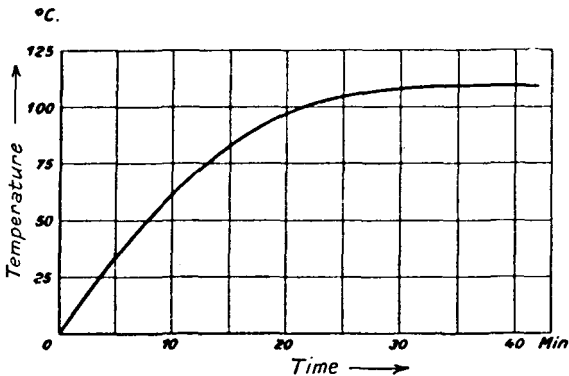

FIG. 71.—Rise of Temperature in a large Glass Bulb Rectifier.

should be at least warmed before starting up on a cold day by switching on the auxiliary excitation for some time. The small amount of energy used up in the auxiliary excitation together with the small separation between the exciting anode and the cathode, make the risk of breakdown in the auxiliary excitation circuit small.

So far as the author's experiments go, the minimum current density depends only on the behaviour of the cathode spot, therefore for example on the size of the mercury surface, but not on the length of the anode arms.

On the other hand, the breakdown voltage V_{\max} increases with the length and the bending of the anode arms. Other things being equal, therefore, the danger to a plant through

the hardness of a rectifier increases with the length and curvature of the anode arms.

What is finally of great importance is that the risk of breakdown through the extraordinary speed of extinction of the arc can be increased in the following way: it can happen that a high frequency surge caused by switching-in processes can compensate the voltage across the rectifier and thus cause the arc current to fall to zero for an immeasurably short instant. The arc will then go out, while the ammeter under certain circumstances shows a current of

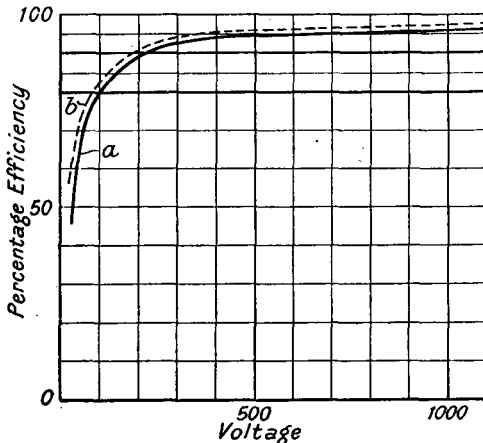

FIG. 72.—Variation of Efficiency with Rectified Voltage; (a) Whole Plant; (b) Rectifier Alone.

many times the minimum current. If the rectifier is not the weakest point in the plant, ruptures will occur which are particularly disastrous because of the great energy involved.

Connected with this peculiarity of rectifiers of momentary extinction is such a fact, for example, as that a rectifier can be extinguished much quicker by connecting a sufficient capacity in parallel with it, than by switching off the current. After the causes of breakdowns in rectifier plants have been elucidated it is not difficult to avoid them by softening the bulb, and by the proper installation of silite safety resistances. A rectifier plant can thereby be made just as reliable as a transformer plant, with which also in early times serious surges occurred.

Efficiency

The chief factors affecting the efficiency of a rectifier are the voltage drop in the rectifier and the losses in the trans-

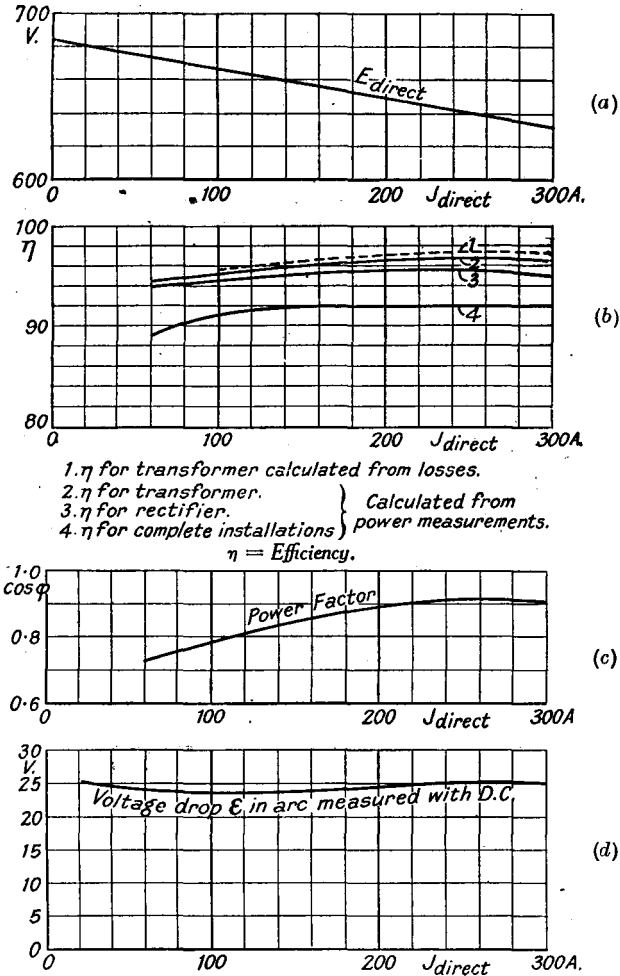

FIG. 73.—Various Graphs obtained by Idelberger and Schenkel.

former and leads. Since the voltage drop is constant, the efficiency increases with the rectified voltage. This is shown in Fig. 72. Fig. 73(b) shows how the efficiency depends on the

load ; the curves were obtained by Idelberger and Schenkel (*Siemens Zeits.*, 2, 271, 1922). Referring to Fig. 73(b), the fourth curve shows that the efficiency does not vary greatly between 60 amperes and 300 amperes, in marked contrast to the kind of curves given by a rotary converter. The curves were obtained with a rectifier for 350 amperes at 600 volts D.C. for railway work. At full load the efficiency is 92 per cent. See also Fig. 68 for the efficiency of a glass bulb rectifier.

Power Factor

We can define the power factor of a rectifier as the ratio of the power as measured by a wattmeter to that measured

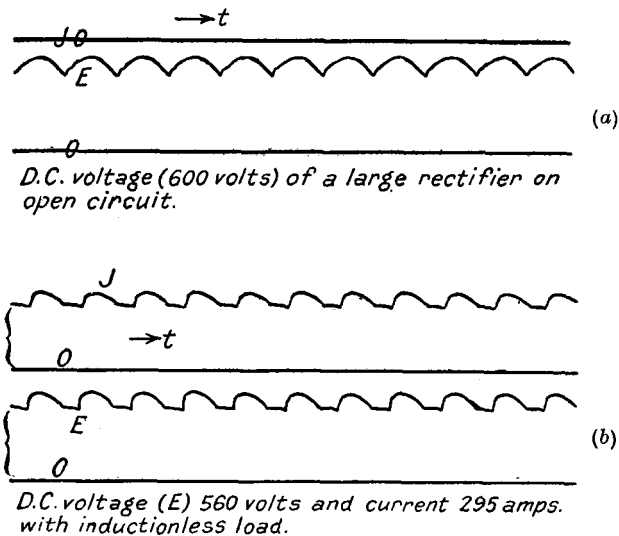

FIG. 74.

by multiplying the separately measured current and voltage. But we must be careful to remember that the value thus obtained cannot be equated to $\cos \phi$ where ϕ is the angle of phase displacement, the reason being that we are not dealing with even approximately sinusoidal currents. No phase displacement takes place. The values of the power factor thus obtained vary between .7 for installations of about

200 watts capacity to .95 for the very largest installations. See also Fig. 41 and p. 116.

Current and Voltage Relations in Mercury Rectifiers

The oscillograms shown in Fig. 74 were obtained by Idel-

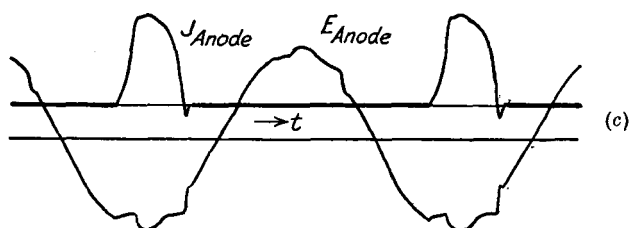

Anode voltage (454 volts efficiency) and anode current (135 amps. efficiency) of a large rectifier with inductionless load.

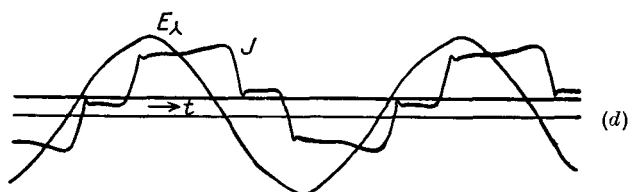

Primary voltage (5700 volts efficiency) and primary current (23.3 amps. efficiency) of a large rectifier with inductionless load.

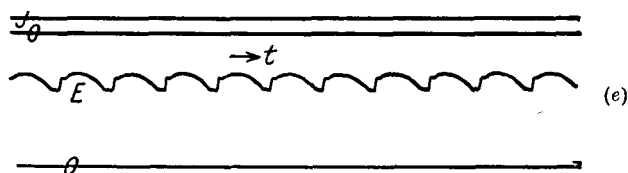

D.C. voltage (600 volts) and current (60 amps.) of a large rectifier connected to a tram network.

FIG. 74 (continued).

berger and Schenkel (*Siemens Zeits.*, 2, 271, 1922), with a large rectifier for 600 volts D.C. designed for tramway operation. Fig. 74 (a) shows the voltage on open circuit, the

current J being zero and equal to J_0 . Fig. 74 (b) shows the voltage and current curves for an inductionless load equal to 85 per cent. of full load, the undulations are now spaced out by horizontal lines, giving the time taken by the current to pass from one anode to the other.

In (c) J is the current flowing to a single anode ; it will be seen that a certain finite time is taken for the current to rise and fall. The curve E is of the voltage between the

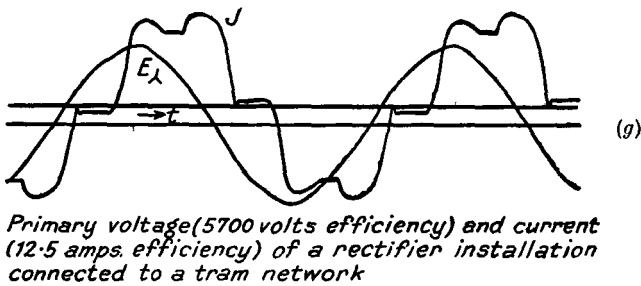
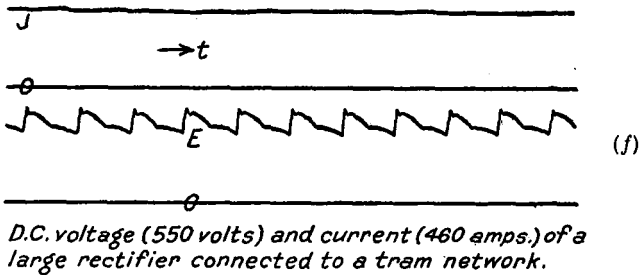

FIG. 74 (continued).

anode and the zero point of the transformer. (d) shows the current and voltage on the high voltage side of the transformer in the case of (b) ; the transformer had a delta-connected primary and a hexaphase star connected secondary. The supplied voltage is approximately sinusoidal, the current curves show the waves of (b). One of the current cusps is somewhat higher than the other because in the one case the magnetising current of the transformer acts in the same sense, in the other case in the opposite sense. The oscillograms (e), (f) and (g) correspond to (b) and (d), but were

taken with the rectifier connected to an actual tramway network. The big inductance of the tram motors smooths out the current fluctuations almost completely, similarly on the high voltage side (see (g)) the cusps have been replaced by almost straight lines. Exactly opposite conditions occur when a rectifier is used for charging accumulators; in this case the voltage is smoothed out and the current fluctuates. In general, these curves show how far the current and voltage depart from a sinusoidal shape.

Connections of Mercury Vapour Rectifiers

Figs. 75 to 80 give the construction and circuits of a number of different installations, and are self-explanatory.

In constructing large rectifiers one is placed in an un-

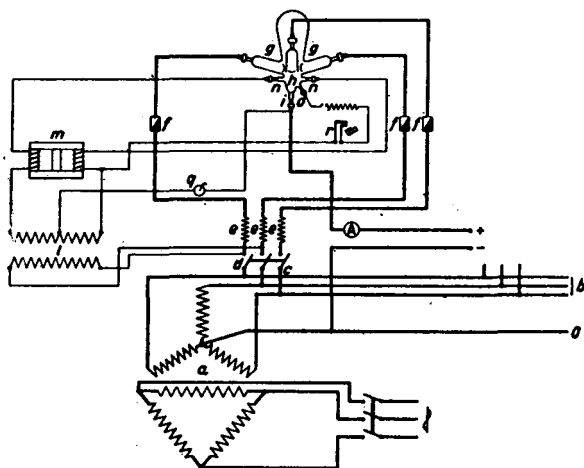

a-Main Transformer. *b*-3-phase Mains. *e*-Primary Choke Coils. *l*-Exciter Transformer. *o*-Mains Neutral Wire. *r*-Exciting Switch.

FIG. 76.—Connections of Glass Bulb Rectifier for 40-60 amps.

pleasant dilemma. If 1,000 amperes are to be rectified with three anodes, each anode must take 1,000 amperes during a third of a period. This leads to very inconvenient dimensions of the anodes and also increases the risk of back-starting. One therefore endeavours to increase the number of

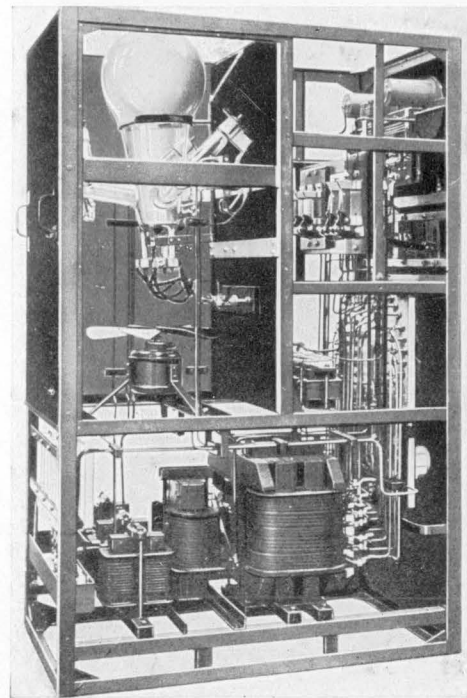
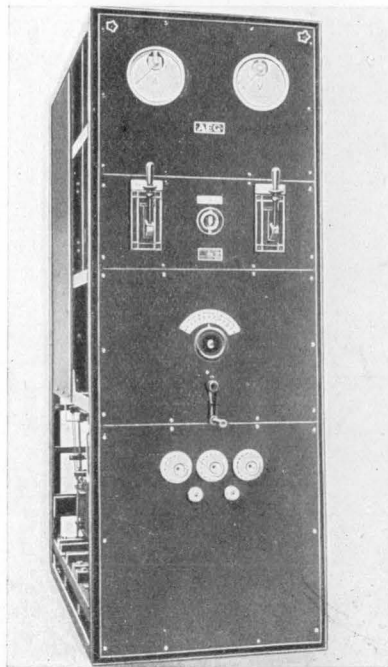

FIG. 75. A.E.G. GLASS BULB RECTIFIER INSTALLATION.

[To face p. 181.]

anodes, and one's next thought is to connect a number of anodes in parallel. This is not practical, however, because

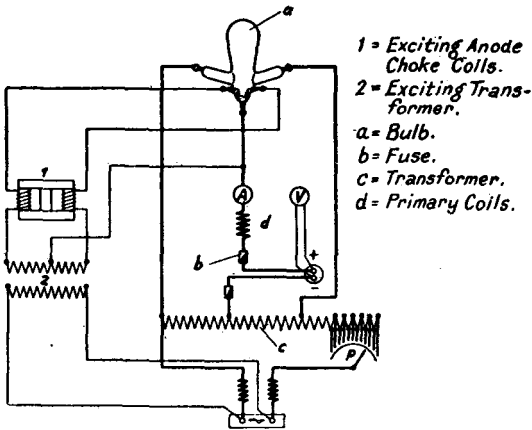

FIG. 77.—Single-phase Glass Bulb Rectifier, with Tapped Auto-transformer, for 20–60 Amps.

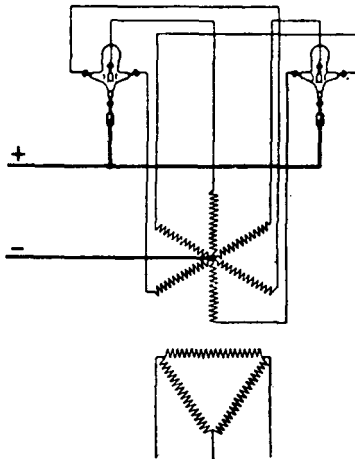

FIG. 78.—Connections of Hexaphase Rectifier using Transformer and Two Three-phase Bulbs.

only units with a rising characteristic can be connected in parallel, so regulating resistances or choking coils must be used for each anode, and thus losses are caused. It is simpler

to increase the number of phases at the same time as the number of anodes. With six phases the current passes

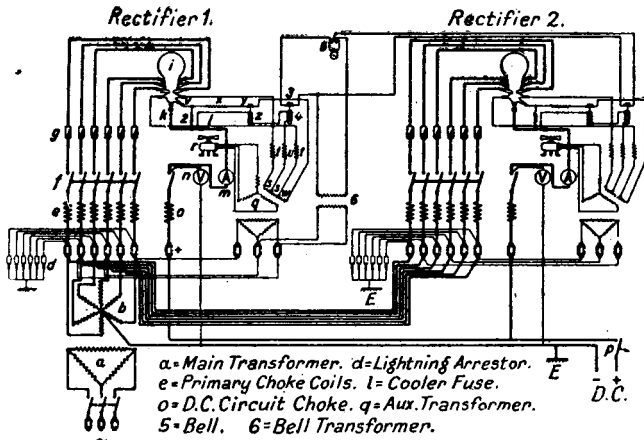

FIG. 79.—Hexaphase Rectifier Installation. Two Glass Bulb Rectifiers in parallel.

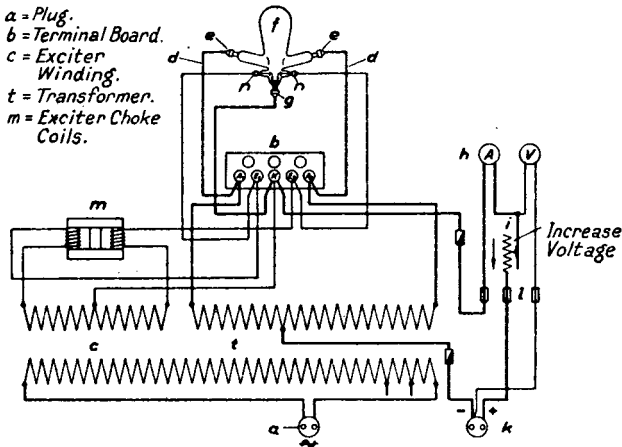

FIG. 80.—Connections of 5-10 amps. Accumulator Charging Rectifier.

through each anode during only a sixth of each period, and since the voltage drop in the rectifier is independent of the current strength, the evolution of heat in each anode arm

is only a sixth of that which would be produced by a continuous current of the same strength. But the heating of the conductors and transformers is a different matter. If the rectified current is 1,000 amperes and there are six phases present, there will be a mean current of $\frac{1,000}{6}$ amperes in each phase. But the heating of a conductor which experiences 1,000 amperes for a sixth of a period and zero current





No. of Phases	D.C.			A.C.			Ratios					
	Form	Highest	Effective	Mean	Form	Highest	Effective	Mean	Eff. Anode Current	Mean D.C.	Eff. Phase Voltage	Mean D.C.-Y.
1(2)		1.00	0.71	0.64		1.00	0.50	0.32	0.785	1.110		
3		1.00	0.84	0.83		1.00	0.49	0.28	0.587	0.855		
6		1.00	0.95	0.95		1.00	0.39	0.16	0.409	0.740		

FIG. 81.

for the rest of the time is six times as great as that of a conductor carrying a continuous current of $\frac{1,000}{6}$ amperes.

Therefore the transformer and all the conductors must have the dimensions necessary for carrying a current of i/n where n is the number of phases.

If a choking coil is inserted in front of each anode, the advantage is obtained, besides that of a rising characteristic, of having the time of current flow greater than the time of one phase (cf. p. 121). The heating of the conductors and

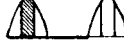
transformer is therefore smaller than that corresponding to the expression above. For this reason the A.E.G. fit their large rectifiers for 1,500 amperes with six-phase circuits and twelve anodes, so that every two anodes are connected in parallel with the same choking coil and the same phase. The parallel anodes are arranged opposite to each other in the chamber, so that two diametrically opposite arcs rotate in operation inside the rectifier chamber.

The curve forms obtained with different leads, as well as the processes at excitation and the equations determining these phenomena, have been completely treated by F. Kleeberg "Der Quecksilber Dampfgleichrichter der Glastype, seine Theorie und praktische Ausführung," E.T.Z. 1920.

The Siemens-Schukert-Werke have given a very clear summary of the current forms obtained in glass-bulb rectifiers without the use of a choking coil and of the relations between maximum R.M.S. and mean values. This is reproduced in Fig. 81. The numbers given approximate more and more to unity as the inductance of the choking coil in the anode branches, or D.C. circuit, is increased.

CHAPTER XV

Commercial Types of Metal-Cased Rectifiers

B.B.C. Rectifiers

The firm B.B.C. use a seal of asbestos and mercury. Asbestos sheets are placed between the parts to be joined and are screwed down under great pressure. Mercury is poured on top of the asbestos to a few centimetres depth. Such a seal is unexceptionably vacuum tight. It might be thought that if one could succeed in making the vacuum chamber, including the electrodes and insulators, completely free from pores and fissures and then bake out sufficiently with a big load, the vacuum would be permanent.

Unfortunately it is not so. As already mentioned, iron can dissolve large quantities of air. The dissolved air diffuses in the iron from the places of greater to those of smaller air concentration. If therefore there is air at atmospheric pressure (or what amounts to the same thing, cooling water containing air) on one side of an iron plate and a vacuum on the other, there will be a permanent, although very small, diffusion of air into the iron, which becomes saturated with air to a fixed degree. Still the disturbance is small. According to information given by the B.B.C., large rectifiers in steady commercial operation show only an inappreciable fall of vacuum after many months.

In this lies another great disadvantage of iron in comparison with glass. The solubility of air in glass is extraordinarily small. A glass rectifier can keep a vacuum unaltered for many years, but a completely sealed iron rectifier cannot. This is the second reason why it is recommended that rectifiers should never be allowed to stand unused for long periods. On starting up because of the heating the walls of the vessel suddenly give up great quantities of air with which they

have become full during the period of rest. Even the best sealed iron rectifier cannot dispense with the air pump. A further difficulty is that iron sheet is seldom free from pores. While it is easy to trace the big pores which quickly bring down the vacuum, it is hopeless to look for the small ones, which only allow appreciable quantities of gas through in a week. Such troubles are capricious. One rectifier is completely free from them and keeps its vacuum permanently, while another must be pumped out from time to time.

The vacuum vessel in the big rectifiers of Brown, Boveri and Co. consists, as shown in Fig. 82, of a big cylindrical vessel below with a smaller one placed on top. It is made of welded sheet metal with horizontally attached flat steel plates. The bottom cylinder is the actual rectifier space. The upper serves as a cooling chamber. The cover of the working cylinder is easily removed, and carries the iron anodes, the bottom one carries the mercury cathode. A vacuum of $\cdot 01$ mm. Hg. is kept up in the working cylinder by a high vacuum pump. In the earlier rectifiers the anodes were enveloped by porcelain cups to prevent the arc passing over on to the walls of the container and thus easily producing back-starting. On account of the difficulties experienced with porcelain, which often cracked at high temperatures, sheet-iron tubes held in a short porcelain insulator have recently been used in place of the porcelain cups. The insulator is then no longer in contact with the hot arc gases. Fig. 83 shows the new construction. The condensing cylinder, operating vessel and sealing surfaces are cooled by running or circulating water in special cooling jackets.

Should the rectifier be used with strongly varying, very low or temporarily suspended loads, it is maintained by special auxiliary anodes (in the same way as the glass-bulb rectifier, see p. 165). This, however, may only be done if the intervals between operation do not exceed about half an hour, since as the rectifier cools down the percentage of foreign gas (expelled previously by the strong heating) greatly exceeds that of the mercury vapour, and consequently causes back-starting (*vide*, p. 162). It is therefore

safer when long interruptions are made to leave a small permanent useful load on the rectifier, sufficient to keep up the necessary mercury vapour pressure. After long complete disconnections it is strongly recommended that the rectifier be evacuated for some time, before connecting into circuit, in order to remove foreign gases.

The B.B.C. build rectifiers in three standard sizes. The anodes of the biggest type are water cooled, the anodes of the high-voltage type are air cooled. The smallest type has generally no anode cooling. Big current strengths are

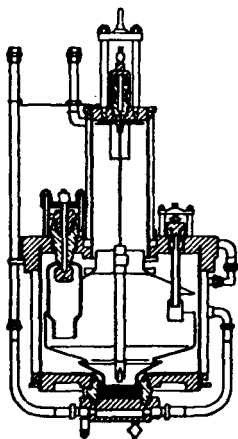

FIG. 82.—B.B.C. Metal-cased Rectifier.

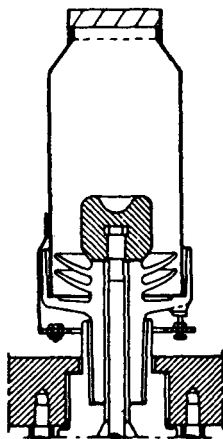

FIG. 83.—Construction of Anode in B.B.C. Rectifier.

obtained by the parallel connection of a number of rectifiers. The B.B.C. have already been successful in putting 3,000 volts D.C. rectifiers into practical operation.

A.E.G. Rectifiers

The large rectifiers of the A.E.G. differ chiefly from the B.B.C. rectifiers in their external construction. In order to prevent the troublesome wandering of the arc from one anode to another, the A.E.G. (following the General Electric Co.) originally made a radical innovation. They put each anode into a special vessel, which then, of course, needed an auxiliary D.C. arc. After this procedure was seen to be too

far going, they put their trust in the design of the glass rectifier and put each anode in a special iron arm out of the main vessel. Since in this way the upper part of the glass vessel was freed from the arc, it was made into a condensation chamber. For this purpose a pot-shaped cover was used that was filled with cooling water. This water had to be renewed every twenty-four hours, and always kept the main vessel cool.

A few years ago the A.E.G. big rectifier was reconstructed and received the form shown in cross-section in Fig. 84, and in three dimensions in

Fig. 85. The rectifier chamber has the form of a shallow double cone with welded tubes on top for the reception of the anodes, and a welded flange for the cathode at the apex of the lower cone. The shell contains the mercury for the cathode. All joints are autogenously welded. The openings in the chamber are stopped up by porcelain insulators in combination

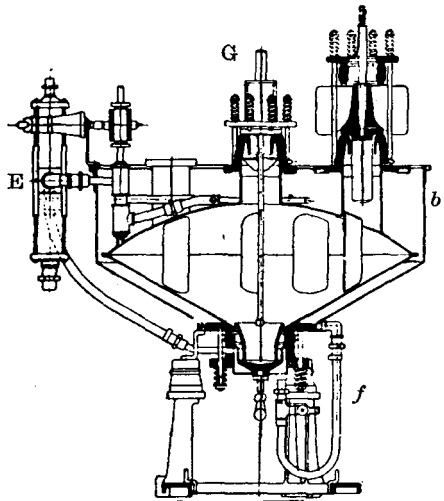

FIG. 84.—A.E.G. Rectifier for 500 amps.

with lead seals. The porcelain insulators, as also the supporting surfaces of the tube flanges and the anodes, are ground smooth and have a ring-formed grooved-shaped depression in the middle. Round the inside and outside of these grooves are imbedded lead rings, and on top of these are thin aluminium rings. The seal is pressed together at high pressure by means of very strong levers. The soft lead completely clings to the surfaces. The aluminium rings prevent the lead from reaching the vessel itself. The air penetrating from outside must pass the grooves and is there sucked off by the fore-vacuum that is evacuated with the

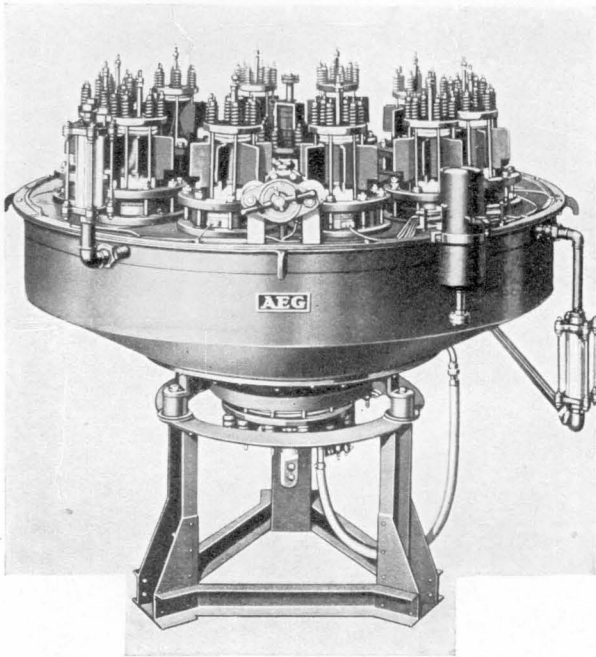

FIG. 85.—EXTERNAL APPEARANCE OF A.E.G. RECTIFIER.

[To face p. 189.]

same pump as the principal vacuum. The fore-vacuum has a large volume so that the penetrating air can only slowly cause the fore-vacuum to deteriorate.

This arrangement also offers the possibility of testing the tightness of each separate sealing place without dismantling the rectifier. For this purpose the individual seals that are not to be tested are shut off by small lead linings, so that only the seals to be tested are in connection with the pump and vacuum gauge.

The iron anodes have cooling fins at their top ends outside the vessel. The anodes are so disposed that they cannot be directly struck by the cathode rays. In order to increase the security against this they are partly surrounded by quarter cylindrical safety shields, so that the arc must describe an exceedingly curved path.

The A.E.G. therefore, like the B.B.C., shut in the positive column in a special channel. But they do not use an insulated cylinder for this channel, as do the B.B.C., but the container itself. The risk of back-starting, by the cathode spot passing over to the container and then wandering on to the anode, is consequently not quite so certainly obviated. The effective middle part of the cathode, at which the cathode spot exists, is screened from the container by an asbestos cylinder, in a similar fashion to the anode.

The chamber *b* forms a cooling jacket for the efficient removal of the heat developed. The circulation of the cooling water takes place through the glass tube *E*, through which the water flows as a stream of drops so that there is no direct connection between the container and earth. The cooling water is fed to the cathode through the tube *f*. The temperature of the water should not exceed 38° C.

The mechanism *G* is for the excitation of the rectifier. It consists of an iron rod reaching down to the surface of the cathode. This iron rod is connected to the positive pole of a small exciting dynamo and the cathode to its negative pole. By switching on the excitation converter an arc is formed at this auxiliary anode and the cathode spot is produced.

In addition in order to facilitate the starting up of the rectifier an auxiliary resistance is provided with which the rectifier can be put into operation without the bush bars being connected in. It is so adjusted that the rectifier is loaded with the minimum current density necessary for the working of the anodes. It is expedient to put this auxiliary loading resistance in parallel when small loads up to 12 amperes are being drawn. With very variable loads that may decrease to zero it is recommended that the auxiliary exciter should be kept going.

S.S.W. Rectifiers

The S.S.W. have departed in many ways in the construction of their rectifiers from that of the B.B.C. and the A.E.G. They make types for 350, 600 and 1,000 amperes. They use wide rubber rings as sealing material. These are pressed, similarly to the lead rings of the A.E.G., between the insulator and container on the one side and the electrode on the other. Instead of a lead-protecting aluminium ring they use a similar ring of an undescribed metal which diminishes the escape of gas from the rubber discs.

Since rubber is much more sensitive to high temperatures than lead or asbestos, the seals must be more rigorously cooled. This is achieved partly through good external air cooling, partly by cooling the anodes, from which the greater part of the injurious heat is evolved, in oil. This oil is in turn cooled by the cooling devices fitted to each anode. Another difference of construction in the rectifiers of the S.S.W. is that a mercury vapour pump is connected in front of the oil pump, instead of using the oil pump alone. Because of the great capacity of the mercury pump the S.S.W. consider that the sealing question is no longer the chief problem of the rectifier. Recently other firms have also changed over to the mercury vapour pump combination to improve the vacuum.

The S.S.W. put three exciting anodes, as is usual in glass rectifiers, in their big rectifiers. These are fed from a second winding of the exciting transformer through a choke coil. The transformer supplies 12 amperes at 60 volts D.C. and

uses a total of 1 kw. The auxiliary excitation current can be switched over to the heating resistance of the mercury vapour pump and thus be made of use.

The cathode is insulated from the lower part of the container by a high porcelain ring. It is cooled by water, which is supplied through rubber tubes about 1 mm. long, for its better insulation. If there is no badly conducting flowing water available, recourse must be made to a circulatory cooler. The cathode, and therefore the positive pole of the D.C. arrangement, is connected to earth to facilitate the insulation. Moreover, there is a special cooling chamber between the six anodes; this reaches up to the neighbourhood of the vapour that mounts up from the cathode, and thus helps in the cooling of the walls. This cooling water-tank is constructed on the bed plate of the rectifier vessel; this bed plate also carries the accessory apparatus and mercury vapour pump. Observation windows enable the inside of the rectifier to be inspected during operation.

Excitation is carried out by dipping and withdrawing an exciting anode into the cathode mercury by a magnet coil. The connections of the big rectifier of the S.S.W. are naturally not appreciably different from those of other makes.

CHAPTER XVI

Miscellaneous Types

The Argonal Rectifier

The ordinary mercury vapour rectifier has the disadvantage for low current work that it goes out as soon as the current falls below 2 to 3 amperes, and must be started again by tilting or shaking. The procedure indicated of making its operation independent of the load, and therefore reliable, by fitting it with two auxiliary anodes connected to a special small transformer is uneconomical, since the energy consumption can scarcely be decreased below 100 watts. Fortunately, however, there is another and more elegant way. According to the formulæ given in the theoretical section the normal cathode fall in argon with an alkali cathode is 64 volts. With increasing voltage the strength of the glow current grows rapidly till with small separations between the electrodes and a few hundred volts P.D. it can be expected quite surely to change into an arc. It is not necessary that the cathode should consist of pure alkali metal; a mercury cathode containing a small percentage of alkali metal is sufficient for the purpose. Because of the ease with which such an arc is excited at this cathode, rectifiers constructed on this principle will remain in operation down to currents of $\cdot 1 - \cdot 3$ ampere. Rectifiers of this kind are made commercially by the Deutsche Telephonwerke under the name of the "Argonal Rectifier." They contain a mercury cathode with a quantity of added alkali, insufficient to attack the glass, and the usual carbon anode, and are filled with argon at a very low pressure. An exciting anode in a special arm is connected to a separate winding on the rectifier transformer. This winding supplies 600 volts, and consequently causes certain excitation in each permeable phase. The

necessary current strength is only 50 milliamperes. As soon as the arc is struck, a relay disconnects the exciting electrode and connects it again as soon as the arc goes out.

The voltage drop in the rectifier amounts to 15 volts with small types, according to the makers. The life of the rectifier is very great and should reach 10,000 working hours. The circumstance that excitation is facilitated by the use of the alkali and argon also means that back-starting occurs at much smaller voltages than with the mercury rectifier. This fault, however, can be corrected by the use of narrow repeatedly bent anode arms. In this way voltages up to 700 volts have been successfully rectified.

A real advantage of Argonal over pure mercury rectifiers is that the presence of the argon prevents the existence of high over-voltages in the rectifier. They equalise themselves through the rectifier before they have reached high values. The Argonal rectifier works in a softer state than the mercury vapour rectifier. The chief use for this rectifier is for small currents as used for the operation of relays, magnets, small motors and small plating baths. The rectifiers of the Deutsche Telephonwerke are therefore built for maximum current strengths of 3 to 6 amperes and D.C. voltages of 28 to 200 volts. Recently, however, this firm has also given attention to the production of bigger types for higher voltages and currents of many hundred amperes.

The Wehnelt Rectifier (*Physical Theory*, pp. 33 to 35)

The Wehnelt rectifier is produced by the Akkumulatorenfabrik A.-G. Berlin-Oberschöneweide chiefly in two types for high and low voltages, and is used by the German post office administration in increasing quantities. The low-voltage type is principally suited for the trickle charging of accumulators, in switching and protective gear, in emergency lighting, telephone exchanges, for the charging of portable accumulators and other purposes.

They are arranged for D.C. strengths of 0-3, 6, 10, 20 amperes for connection to 110 or 220 volts D.C. On the D.C. side they supply 35, 80 or 110 volts, according to the ratio of the transformer.

The most important component parts are, the transformer disposed at the bottom, which also supplies the heating current for the thermionic cathode by means of a special winding, and the Wehnelt bulb, with two or three anodes for single-phase or three-phase A.C. Directly underneath the thermionic cathode is a small exciting electrode, which is connected by a silite resistance to an anode. As soon as the rectifier is switched on the sharp voltage drop between cathode and exciting anode produces ionisation in the neighbourhood of the cathode. This reaches the anodes almost instantaneously and starts the current flowing. The anodes are made of the purest iron possible. Iron containing carbon is liable to form inflammable growths which seriously decrease the life of the lamp. Since these growths take place at the edges, the anodes are rounded off as smoothly as possible.

The glass bulbs of the low-voltage type are filled with argon at a pressure of a few millimetres. The life is about 800 hours, and is limited by the slow disappearance of the oxide on the cathode and of the gas. The makers will take back the bulb when exhausted in order to recover the iridium.

The high-voltage type is shown in Fig. 86. It is manufactured in three types, which all supply a current of 1 ampere and have two arms for single-phase and three for three-phase current. They are filled with pure neon at a low pressure. As Fig. 86 makes clear, the glass wall is pressed as close as possible to the anode and constricted directly below it in order to make the formation of a glow discharge in the impermeable direction as difficult as possible, so that the discharge remains limited to a part of the front surface of the electrodes. A special excitation anode is not necessary when high voltages are rectified.

The glass bulb on the right of Fig. 86 possesses a Bauer regeneration valve by which, after about 200 hours of operation after the original gas-filling, air can be let in by a strong force on a rubber ball or by an air pump. This regeneration can be carried out many times. If, however, each con-

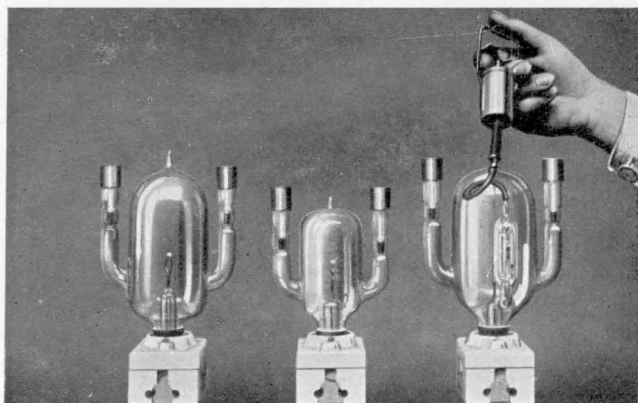

FIG. 86.—WEHNELT HIGH VOLTAGE VALVES.

[To face p. 195

striction in the arms shows a green light it means that too much air has been let in and the voltage must be lowered until enough gas has been used up to bring the valve back to its original impermeability.

The life of the valve is finished when no current passes in the permeable direction in spite of a brightly glowing oxide film and an applied potential of 6,000 volts. But even if there is sufficient gas present, as is ensured if a drop of mercury be added to the argon so that there is at least a pressure due to the mercury vapour ($\cdot 015$ mm. at 50° C.), the bulb may appear to be exhausted. This is a case of what is called a pseudo high vacuum.

Such a pseudo high vacuum is caused by electrostatic charges on the inside of the glass container. These charges prevent the electrons from reaching the anodes in the side arms and thus interrupt the flow of current. The electrons will be sent out from the cathode towards the anode along the field lines (many of which pass outside the vessel). On their way the electrons produce ions by collision, and these positive ions neutralise the negative space charge so that a big current flows. But the electrons will strike the walls of the vessel in following the field lines, and will form a negative charge there of a kind which will not be neutralised by positive ions, since these travel towards the cathode. Ordinarily such charges are conducted away by the water film that is always present on a glass surface, but in the course of working this water film is partly covered up by, and partly reacts chemically with, the oxides deposited by the Wehnelt cathode. The charges are then no longer conducted away, and they grow until finally they prevent the passage of the electrons into the side arms. A pseudo high vacuum results.

The regeneration of the rectifier by the Bauer valve is therefore partly due to the entrance of moisture with the air. This moisture can form a new water film.

The efficiency of the valves is controlled directly by their voltage drop of 17 to 30 volts, and is therefore only moderate if 35 volts D.C. are required ; on the other hand, it reaches 99 per cent. when 3,000 volts D.C. are produced. If the

rectifier is used without smoothing apparatus the wave form of the current supplied has a very pronounced ripple. For many purposes, as, for instance, in accumulator charging, this causes no trouble; in other cases, such as the direct connection of a telephone plant to A.C. mains through a rectifier, the ripples are completely smoothed out without difficulty by a combination of capacities and inductances.

On account of the long narrow arms the exciting voltage of the Wehnelt rectifier is much higher than the operating

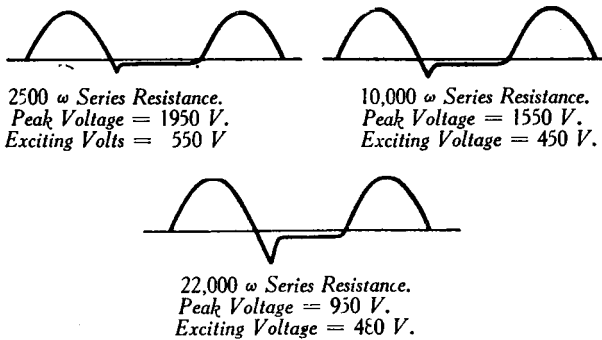

FIG. 87.—Oscillograms of Voltage between Anode and Cathode of Wehnelt Rectifier supplied with 1,500 volt. A.C.

voltage, as is shown by the oscillograms in Fig. 87. The Wehnelt rectifier is manufactured exclusively in Germany.

The Argon-filled Tungsten Rectifier

The General Electric Company of U.S.A., and other firms, have placed a thermionic rectifier, with a tungsten cathode and an argon filling, on the market. While the Wehnelt rectifier works in argon at a pressure of about 1 mm., it is necessary, with the use of the tungsten cathode, to raise the pressure to several centimetres. Otherwise the tungsten is rapidly disintegrated and a life of any practical use cannot be attained. A further difficulty with this so-called "Tungar" rectifier, and one not shared by the Wehnelt and alkali rectifiers, is that special chemical agents must be provided to remove the residual gases which are liberated during the

discharge and are very injurious to the tungsten filament. If this is not done the tungsten wire quickly burns out. In the alkali vapour and Wehnelt rectifiers the residual gases are removed by the vaporising material of the cathodes without causing any harm.

The Tungar rectifier is usually manufactured only for half-wave rectification, and has two thermionic electrodes, one of which serves as an anode and which can be used as a thermionic cathode when the other tungsten spiral has burnt out.

The pressure of the inert gas must be high in comparison with that in the Wehnelt rectifier in order to diminish the disintegration of the tungsten. It sets a limit to the voltage that can be rectified without danger of back-starting. On the other hand, the Tungar rectifier has the advantage that it uses tungsten, which is much cheaper than iridium.

Dry Plate Rectifiers (*Physical Theory*, pp. 96 to 103)

Recently the principles of contact detectors as used in wireless work have been successfully applied in the construction of large current rectifiers. The rectifying action is due, as already explained in the theoretical section, to the difference in the work of exit of an electron from metals and from electronically conducting metallic compounds. The "Elkon" is an example of such a dry plate rectifier; it is essentially a giant detector and supplies $\cdot 15$ ampere at 6 volts D.C. The valve consists of a hard disc $\cdot 2$ cm. thick and 2.85 cm. in diameter, made of a compressed mixture of copper and zinc sulphides; this disc is tightly clamped between a copper and magnesium plate. Four such valves are connected up in a Grätz circuit; this circuit was chosen because it gives some protection against voltage surges in the transformer. The rectification is not perfect since a measurable current flows in the impermeable direction. The static volt-ampere curve is exactly similar to that of a crystal detector. In the direction of flow, current is passed at voltages above $\cdot 5$ volt. In the impermeable direction the current increases rapidly as the voltage is raised.

Considerable progress has recently been made in Germany

in the improvement of the characteristics of the dry plate rectifier. Rectifiers having a plate diameter of 4 cm. have been constructed to deliver 3 amperes D.C. at voltages higher than 10 volts without breakdown in the impermeable direction. Since research is still in progress full information cannot yet be given.

CHAPTER XVII

Various Applications of Valves

Uses of Valves for the production of High Frequency Oscillations

There are two ways of producing high-frequency oscillations by valves. First, it is possible to arrange by suitable connections that a valve sends a short current impulse during each period into an oscillation circuit, which is thus excited so that it can oscillate freely during the permeable period of the valve. If the natural frequency of the circuit is made a large multiple of the frequency of the current impulses, and care is taken that the amplitude of the oscillations in the oscillatory circuit does not decrease too greatly between two current impulses, approximately continuous oscillations can be obtained.

The second method is simply based on the fact that a rectified A.C. contains an A.C. component of double the initial frequency, and a rectified three-phase current contains an A.C. component of three times the initial frequency, and so on.

Neither method meets with any difficulties, and both have been repeatedly suggested. The real point at issue is their efficiency. It is found that the efficiency of a frequency doubling according to the second method is about 30 per cent., so that a continuous repetition of this doubling in order to produce higher frequencies results in a quite insufficient efficiency. The first method of exciting an oscillatory circuit, though it appears to have better prospects, has, however, been neither theoretically nor practically worked out, because the problem has now lost its importance since the introduction of three electrode valves.

Use of Rectifiers for Measuring Purposes

The measurement of small alternating currents and voltages has up till now been very difficult due to the insensitivity of A.C. instruments and the magnitude of the energy used by them. These difficulties are accentuated in high-frequency work. The obvious solution of the problem is to rectify the alternating current and then use direct current instruments; but for this purpose it is essential to use a rectifier in which the A.C. and the rectified current are connected by a perfectly definite and permanent relation. Hitherto the only rectifier fulfilling these requirements was a thermoelectric couple; instruments making use of this principle have been developed to a high pitch of perfection. Even the most sensitive of them—the Duddell thermo galvanometer—however, only gives a deflection of 1 mm. (at 1 m. distance) for a current of 2 microamperes when the heater has a resistance of 1,000 ohms. The sensitivity of these instruments is therefore far below that of D.C. instruments; they are, moreover, essentially current and not voltage measurers.

The invention of the Moullin thermionic voltmeter has made it possible to carry out accurate measurements of very small A.C. voltages. The Moullin voltmeter uses a three-electrode valve; it has the following important advantages:—

- (1) Its calibration remains constant over long periods.
- (2) It has a small electrostatic capacity.
- (3) Its readings are independent of frequency up to at least a million cycles per second.
- (4) The rectifier is a potential operated instrument and consumes no power.

The Cambridge Instrument Co. manufacture two types; both are “anode-bend” rectifiers, *i.e.*, their rectification depends on the curvature of the anode-current grid-voltage characteristic. The connections of type A are shown in Fig. 88, and the external appearance of the instrument in Fig. 89. No anode battery is used, so that errors due to fluctuations in the voltage of the anode battery are obviated.

The filament battery also supplies the necessary negative grid bias. The only adventitiously variable factor is the voltage of the filament battery; the instrument is brought to a standard state before use by adjusting the filament rheostat until the galvanometer shows some definite value corresponding to zero A.C. volts. The range of the instrument is 0 to 1.5 volts, and the scale is divided to .02 volt over most of the range; at full scale the power absorbed is not more than 6 microwatts. This type needs an external conducting path between grid and filament.

Type B is shown in Fig. 90; it is also an anode-bend rectifier, but is used where there is no conducting path between grid

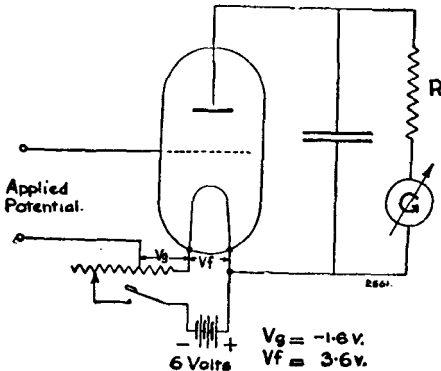

FIG. 88.—Connections of Moullin Voltmeter, Type A.

and filament. The negative grid bias is applied through a high resistance. The connections are shown in Fig. 91. The range of the instrument is from 0 to 10 volts, and it can be read accurately to .5 volt.

Leaky grid rectification can be used in thermionic voltmeters with an increase of sensitivity; but the load imposed on the circuit limits the utility of this form. The thermionic voltmeter can be used as a null instrument by applying a D.C. voltage to the grid sufficient to reduce the anode current to zero. It is better, however, as Medlam and Oswald have pointed out, to reduce the anode current to some small but finite value since the point of zero anode current is indefinite because the anode current approaches



3136.

FIG. 89.—MOULLIN VOLTMETER, TYPE A.



3135

FIG. 90.—MOULLIN VOLTMETER, TYPE B.

[To face p. 202.]

zero asymptotically as the grid voltage increases. When used as a null instrument the thermionic voltmeter has great permanency of calibration; the voltage necessary to produce zero current being practically independent of the voltages of the anode or filament batteries.

Further particulars about the Moullin voltmeter will be found in the original paper of Moullin in *Journ. Inst. Elect. Engin.*, December, 1922, in two articles by W. B. Medlam

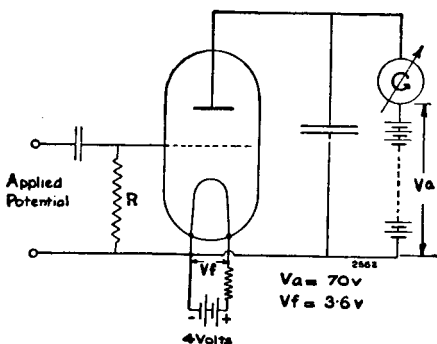

FIG. 91.—Connections of Moullin Voltmeter, Type B.

and U. A. Oschwald in *Exp. Wireless*, November and December, 1926, and in "Radio Frequency Measurements," by Moullin, published by Griffin.

Use of Valves as Automatic Cut-outs

Valves as such, *i.e.*, valves for the prevention of an accidental reverse of current, are very seldom used. The need for some such device occurs, for example, when a dynamo of very varying speed is used to charge accumulators, so that there is danger of the battery voltage overcoming the E.M.F. of the dynamo at low speeds, and so discharging through the dynamo. Such an arrangement is found in train lighting sets, where the dynamo may be driven off one of the locomotive axles and used to charge up accumulators for the lights. As soon as the train stops the battery would be short-circuited by the dynamo. Electrolytic valves have therefore been connected in the circuit to allow

the charging current to pass freely but to prevent a discharge through the dynamo.

The method of allowing the total current through the valve is rather clumsy, however. It is far better to let the valve work a relay, which then establishes the contact. The valve is used in this way by the Vereinigte Windturbinwerke of Dresden. In dynamos coupled to wind-mills, the conditions are quite similar to those of train lighting. The windmill uses the circuit shown in Fig. 92. An aluminium electrolytic valve is used, but recently this has been replaced by the tantalum electrolytic valve, which has the great advantage that it uses an electrolyte of the same sulphuric acid

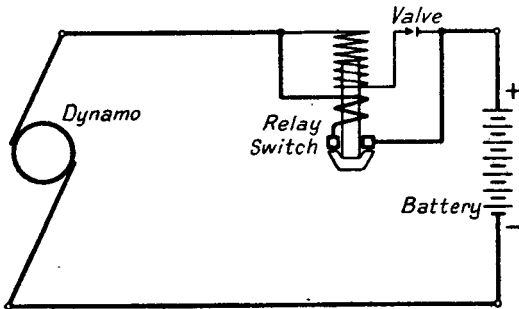

FIG. 92.—Use of Tantalum Valve as cut out in Wind-driven Electric Light Installations.

that is used in the accumulators; the maintenance of the valve is therefore very simple. The internal resistance of this cell is also much smaller than that of the aluminium cell with borax or ammonium carbonate solution.

Valves can also be used very well for constructing alarm signals which respond if apparatus is connected up with the poles reversed. A glow lamp in series with an electrolytic valve, consisting of a strip of aluminium sheet and a strip of lead in a solution of borax in a glass tube, are connected in parallel with the apparatus to be protected. If the voltage is applied to the apparatus in the wrong direction the valve becomes permeable and the lamp lights up. If the polarity is correct the lamp remains unlit. If the lamp is placed

behind a transparency with the words "reversed polarity" on it, the attendant is made aware of his mistake.

The same arrangement can also be used as a pole tester. It is not difficult to make up a portable apparatus out of a small glow lamp and a valve which gives the polarity straight away.

Finally, the boundary metal-electrolyte, in spite of its small voltage range, has found an ingenious application by a special connection as an electrolytic coulomb meter. The anode of the meter consists of mercury, the cathode of a platinum iridium sheet, and the electrolyte of a solution of K_2HgI_4 . The cell is connected in series with a resistance to

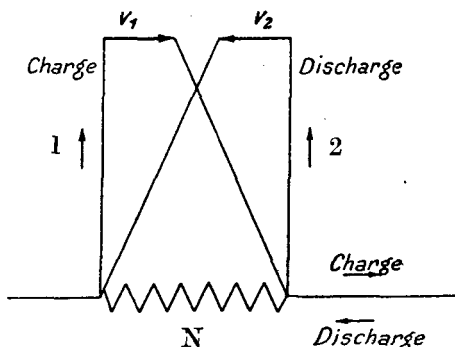

FIG. 93.

compensate its negative temperature coefficient, and the whole is shunted by a resistance which shunts the greater part of the current to be measured. There is no opposing electromotive force in the cell in the current direction from mercury to the platinum iridium, since mercury is lost at the anode and deposited at the cathode. But in the opposite direction current can only pass with deposition of iodine, and a voltage of .6 volt is necessary for this. Therefore up to this voltage the cell acts as a complete static valve.

Fig. 93 shows the application of such a valve. Two cells V_1 and V_2 are connected in opposite directions across a common shunt N which is so chosen that the voltage drop across it at full load remains under .6 volt. Consequently, in the direction 1, current can only flow through the cell V_1 ,

in the direction 2 it can only flow through the cell V_2 . If the whole arrangement is connected in the leads to a battery of accumulators, V_1 will measure only the quantity of charging current, and V_2 only the quantity of discharge current, without making any change-over connections whatever.

If a relay is connected in series with each of the two cells, the arrangement can be put to a variety of uses as a controlling instrument.

Use of Valves for the Production of any Wave Form Desired

The majority of valves are only conductors in the permeable direction for voltages above the minimum voltage,

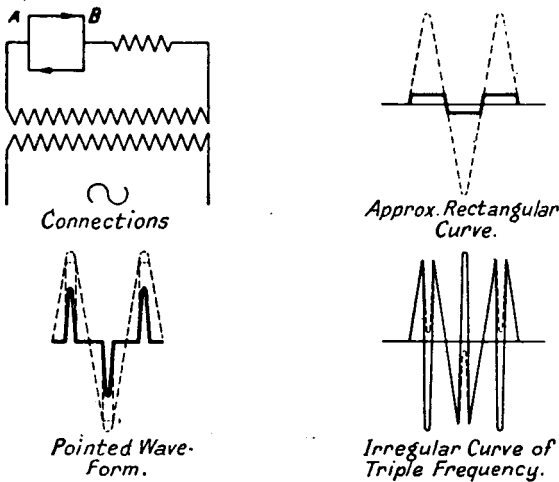

FIG. 94.—Production of any Wave Form.

and for such voltages they have zero resistance. In the impermeable direction their resistance is practically infinite for all voltages. These circumstances make it possible to obtain any A.C. wave form desired by the use of valves. Only a few examples of this are given below.

Let us assume that there is a sinusoidal wave form at our disposal, and that we wish

- (1) A rectangular wave form. An A.C. voltage is used

which is big compared with the minimum voltage. By the use of the circuit shown in the top left-hand corner of Fig. 94, the voltage between A and B, shown in the right-hand corner, results. By the displacement of the point of voltage decrease across the resistance r , this wave form can be changed continuously into the point form shown.

(2) Quite narrow voltage points. The same connection and current curve is used as in the top left-hand corner of Fig. 94, but the peak value of the A.C. voltage is only just greater than minimum voltage. If the current curve is not narrow enough the procedure is repeated by using a second transformer.

(3) If the sinusoidal A.C. voltage is connected to a winding on the primary coil of a transformer, and the current of the bottom left-hand corner of Fig. 94 is connected to a second winding on the primary coil, then the oppositely set current forms of the bottom right-hand corner of Fig. 94 result, according to the strength with which the second current is induced. Combinations of (1) and (2) give very similar but angular curves. By combining the curves derived by Jaeger (see pp. 127 to 135), it is possible to produce almost any required wave form.

Useful Ranges of the Different Rectifiers

If, in conclusion, we review the advantages of the different kinds of rectifier, and in particular their different load capacities, we see that each type has its own useful range peculiar to itself. This is brought out by the following table better than could be done by any long-winded discussion.

TABLE XXIX.

Voltage.	Current in Amperes.				
	.1	1	10	100	1000
10	Glow light Electro- lytic	Mechanical Argonal Wehnelt Electrolytic	Mechanical Argonal Wehnelt Electrolytic	Rotary Converter	
100	Glow light	Mechanical Argonal Wehnelt	Mercury vapour glass type. Argonal Wehnelt	Rotary Converter Mercury vapour glass type	Large mercury vapour
500	Wehnelt	Wehnelt Mercury vapour glass type		Mercury vapour glass type	Large mercury rectifier
1,000	Thermionic cathode <i>in vacuo.</i>	Wehnelt Mercury vapour with special auxiliary apparatus.		—	—
10,000	Thermionic cathode <i>in vacuo.</i>	—	—	—	—

INDEX

A.

A.E.G., 58, 157, 161, 164, 166, 168, 169, 188 foll.
Akkumulatoren-fabrik A.-G., 194
Alberti, 151
Alkali metals, photoelectric activity of, 30
Andre, 150
Anode, actions at the, 23
Arc,
 cathode, 55
 discharge, 53
 path, 57
Argonal Rectifier, 193, 194
Aston, 39
Atomic
 number, 4
 structure, 4 foll.
Automatic cut-outs, 203 foll.
Author, 42, 56, 64, 82, 123, 147, 150, 151
Avidity of gases, 6

B.

Backstarting, 28, 35, 74, 162 foll., 194
Bairsto, 151, 152
Bauer regeneration valve, 195
Bohr, 4, 7
Boundaries forming valves, 3
Brown, Boverie et Cie, 169, 186 foll.
Brose, 37
Burndept, Ltd., 149, 155

C.

Cambridge Instrument Co., 201
Capacity of electrolytic rectifier, 84, 123, 145

Cathode, actions at the, 29, 74
 fall, 18, 19, 37, 41, 42, 50
 spot, 20, 55
Cations, 13, 40
Child, 44
Chlorine atom, 4
Cohen, 80
Collisions, elastic, 6
Colloid rectifier, 150
Compton, K. T., 6
Conductions in gases, 11 foll.
Connections of electrolytic rectifiers, 151
Connections of mercury vapour rectifiers, 181
Cooling of glass bulb rectifiers, 159
Cooling of metal cased rectifiers, 188, 190, 191
Crookes dark space, 36
Current and voltage relations in mercury arc rectifiers, 179

D.

Dällenbach, Gerecke & Stoll, 76
Delon circuit, 110
Detectors, 96 foll.
Deutsche Telephonwerke, 194
Dissociation, 11, 23
Dowling & Harris, 143
Dry plate rectifier, 198

E.

Efficiency of mercury arc rectifiers, 177
Efficiency of valve and rectification, 112
Elastic impact of electrons, 6
Electrolytic coulombmeter, 205
Electrolytic rectifier 82 foll., 145 foll.

- Electron, 4
 bowl, 99
 cloud, 30
 density in position column, 23
 diffusion, 16
 mean free path, 15
 shells, 4
 stream, 11
 Elkon rectifier, 198
 Energy loss
 with electric impact, 7
 in rectifiers, 111
Ettenreich, 96
 Excitation
 of glass bulb rectifier, 164
 of metal cased rectifier, 171
 potential, 8
- F.
- Falkenthal rectifier, 140
 Fall space, 36
Fansteel Co., 148, 150
 Faraday dark space, 37
 Ferrous sulphate, action of, 148
 Ferrous distribution in cathode
 fall, 41
 Formation of tantalum, 83
Franck, 9
- G.
- Gas,
 addition of foreign, 68 foll., 173
 mixtures in glow discharge, 48
Gehlhoff, 16
General Electric Co., Ltd., 155
General Electric Co. (U.S.A.),
 161, 169, 197
Gleichrichter, G.m.b.H., 120, 161,
 162, 163, 167, 168
 Glow discharge, 35
 Glow discharge rectifier, 153 foll.
 Gradient,
 free path, 16, 17
 normal, 12, 17, 18
 Grätz circuit, 106 foll., 198
Greinacher, 110
- H.
- Hardegen & Co.*, 140
Hicks, 9
 High frequency oscillations, pro-
 duction of, 200
 Hittorf dark space, 36
Hoffman, 99, 101
Horton & Davies, 9
Huizinga, 97, 98
Hughes & Klein, 39
 Hydrarwerke rectifier, 138 foll.
- I.
- Idelberger & Schenkel*, 178
 Inductance, action of, 120
 Insulation of metal cased recti-
 fiers, 171
 Ion distributions, 14
 Ion, velocity of, 15
 Ionisation below ionisation volt-
 age, 23
 Ionisation
 by collision, 8
 by light, 9
 by X-rays, 9
 Ionisation voltage, 8
- J.
- Jaeger*, 127, 207
Jotte, 76
- K.
- Kleeberg*, 185
 Knall gas, 91
 Koch rectifier, 141
Koch & Sterzel, 141
Krämer, 163
Krijger, 120
Küch & Retschinski, 64, 66
- L.
- Langmuir*, 31, 44, 62
Leimbach, 104
Lindemann, 123

M.

Macleod gauge, 170
 Maximum voltage, 84, 87-89, 145
 Mean free path of mercury atoms, 61
 Measurement of rectified current, 113 foll.
 Mechanical rectifiers, 136 foll.
Medlam & Oswald, 202, 203
 Mercury arc rectifier
 glass bulb, 157 foll.
 metal cased, 169 foll.
 Mercury stream rectifier, 142
 Metal electrolyte boundary, 81
 Minimum voltage, 85, 93, 94, 145
 Molybdenum seal, 160, 161
Moullin, 203
 Moullin voltmeter, 201 foll.
 Müller, 119

N.

Non-luminous discharge, 20, 67

O.

Orlich, 116
 Oxide coated filament, 33

P.

Papalex, 121, 122, 123
 Parallel connection
 of anodes, 181
 of mercury arc rectifiers, 157, 158
 Pervious voltage, 78
 Photoelectric effect, 29
Physikalische Werkstätten, 146
 Phywe rectifier, 146
Pintsch, 153
 Positive column, 37
 Positive ion density in positive column, 23
 Potassium atom, 4
 Power factor, 116, 178

Pressure distribution in mercury arc rectifier, 59, 60
 Protection from surges, 171
 Proton, 4
 Pseudo high vacuum, 196
 Pumping equipment, 170
 Pumping, necessity for continual, 170

R.

Ranges of rectifiers, 207
Raytheon Corp., 155
 Recombination, 10
 Rectifier, purpose of, 1
 Resonance potential, 8, 71
Richardson, 31
Robinson, 148
Rother, 99, 101

S.

S tube, 155, 156
Sanderson, 123
Schäfer, 169
 Schlömilch cell, 96 foll.
Schott & Genossen, 161
Schottky, 24, 44, 99
 Seal in glass bulb rectifier, 161
 Seals in metal cased rectifier, 186, 189, 191, 192
Siemens-Schukert-Werke, 167, 169, 185, 191 foll.
 Space charge, 13, 24, 33, 34
 Spark discharge, 79, 80
 Sparking voltage, 84
Stark, 55
Stransky, 103
Szekely, 99

T.

Tantalum rectifier, 147 foll.
Taylor, 122
 Temperature,
 distribution in mercury arc rectifier, 58, 59
 effect of, 20
 in positive column, 62, 63

- Thermal agitation of atoms, 6
 Thermionics, 30 foll.
 Thermionic valves, utility of,
 31, 105, 208
 Thermo-electric valves, 3
Translator, 123, 148
 Tungar rectifier, 197
- U.
- Unipolarity, 1
- V.
- Valve,
 action, 1
 constriction, 48
 electrolytic, 82 foll.
 glow discharge, 153 foll.
 mercury arc, 54, 157 foll.
 metal carbon, 53
 metal electrolyte, 81
 photoelectric, 30
 spark, 79
 thermionic, 32
- Valves, connections of, 106 foll.
 Valves, mathematical theory of,
 116 foll.
 Velocity of electron, 7
Vereinigte Windturbinwerke, 204
 Vibrating flame rectifier, 143
 Vessel, effect of, 14, 19, 26, 68
 Voltage doubling circuits, 110
 Voltage surges, protection from,
 171
- W.
- Wave form, use of valves for
 production of any, 206
Wehnelt, 33
 Wehnelt valves, 34, 194 foll.
Westinghouse Cooper Hewitt Co.,
 158, 167
Winter, 94
Wolcott & Erikson, 79, 80
- Z.
- Zenneck*, 123, 125