

40 - 96

Price 1⁰⁰

→ ARCHER → TRANSISTOR SUBSTITUTION GUIDE

SUBSTITUTION FOR UP TO 15,000 TYPES

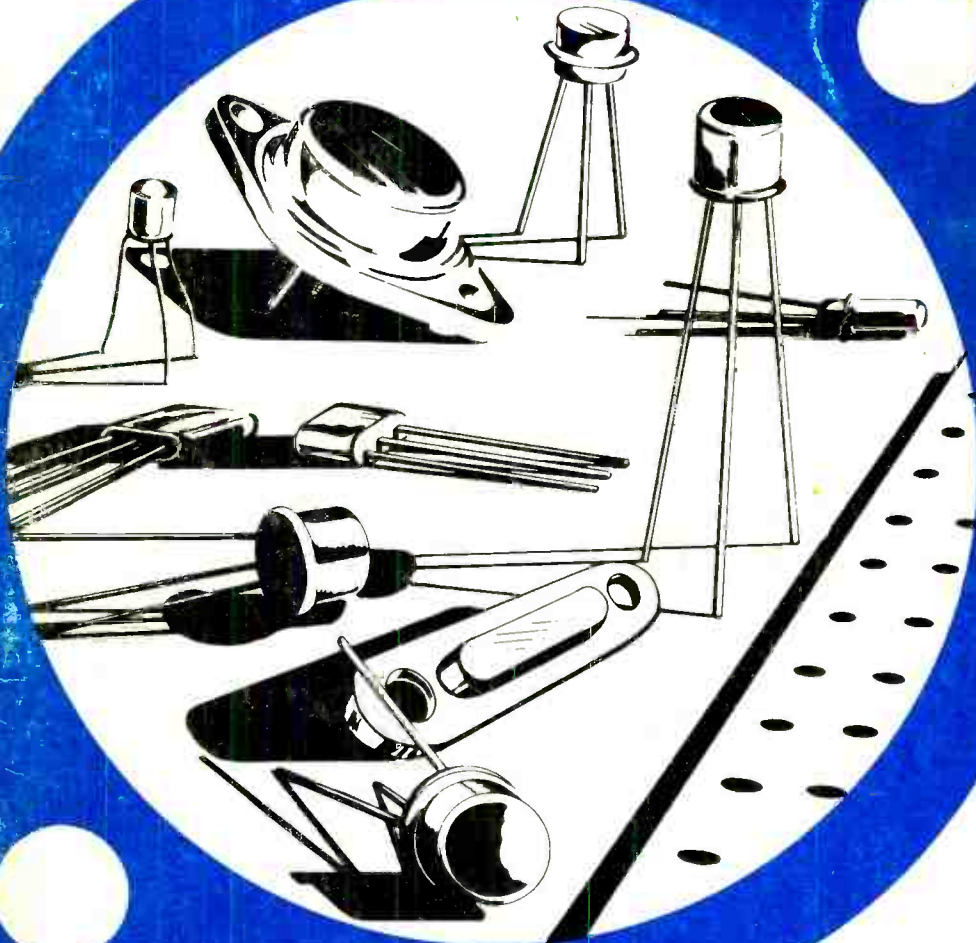

Radio Shack 276-2000

Look to Radio Shack for Famous Trademarks— Known World-Wide for Quality!

Our EXCLUSIVE brands are your assurance of top VALUE and top performance. We make 'em, we sell 'em, so you get a "built-in discount" with no middleman mark-up! Nationwide service too, with original factory parts available through all our stores. We're the leader in audio, communications, home entertainment equipment—stop in at our store near you and find out why!

REALISTIC[®]

PATROLMAN[®]

NOVA[®]

MICRONTA[®]

OPTIMUS[®]

Science Fair[®]

ENERCELL[®]

ArcherKit^{T.M.}

ARCHER[®]

One-Stop shopping at Radio Shack for Over 1200 Tube Types!

Check these

4 BIG REASONS TO BUY

REALISTIC® Lifetime Tubes

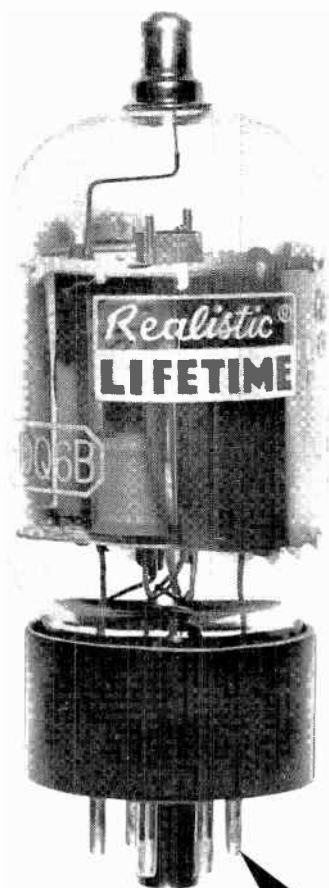

24K Gold-Clad
Contacts—Usually
Reserved for "Military"
Components—Maintain
Positive Contact—Are
NON-Oxidizing!

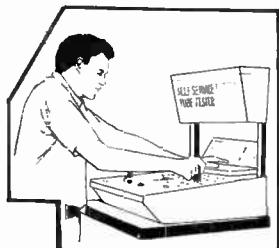

FREE Tube Testing at
all stores in 49 states

90% of Most
Popular Types

IN STOCK
at All Stores

Lifetime Guarantee

Lasts
as long as
your set, or we replace
it FREE. (Except for
Physical Damage)

SAVE!

Up to 40%
Off Installer's
Resale Price!

RADIO SHACK

YOUR BATTERY HEADQUARTERS

1½-V "D" Cell



1½-V "C" Cell



9-V Rectangular



1½-V "AA" Cell

Radio Shack has the batteries to meet your needs, including many hard-to-find types. All our batteries are factory fresh, designed for long life and steady performance. From standard cells to rechargeables—we're your best bet for battery power!

**"NEW FORMULA" 50% EXTRA LIFE!
NOVA CELL! ENERCELL ALKALINE!
ENERCELL NICKEL CADMIUM!**

THIS CARD ENTITLES BEARER
TO RECEIVE FREE EACH MONTH
ONE RADIO SHACK BATTERY
FOR 12 MONTHS Worth Up to \$4.20

SAMPLE

**Join Our Battery-A-Month Club!
Fresh Batteries for a Year—FREE!**

Stamp out stale batteries! Join Radio Shack's Battery-A-Month club and receive your choice of one Radio Shack 1½-V "D", "C", or "AA" cell, or 9-volt radio battery each month—FREE! (That's a value worth up to \$4.20!) Pick up your club card at our store near you. No obligation, nothing to buy, no cost! It's our way of saying "thanks" for shopping at Radio Shack!



TABLE OF CONTENTS

Introduction	Page 2
How to Use This Book	Page 2
Care and Handling of Transistors	Page 3
Silicon or Germanium?	Page 3
Testing a Transistor	Page 4
Important Suggestions on the Use and Replacement of Transistors	Page 6
Specifications and Electrical Characteristics of ARCHER Transistors	Page 7
Cross-Reference/Substitution Listing	Page 37

The ARCHER TRANSISTOR SUBSTITUTION GUIDE and cross-reference listing has been prepared by the Technical Staff of Radio Shack for hobbyists, experimenters, service technicians, students, educators and engineering personnel. The 29 ARCHER transistors are cross-referenced for substitution or replacement of up to 15,000 commercial transistor types.

Radio Shack takes great pride in offering top-quality devices with known JEDEC, EIA or Manufacturer's numbers for each ARCHER device. Most of the ARCHER devices are standard numbers as supplied by Texas Instruments Incorporated (except where **not** noted as a Texas Instruments device). These devices carry specifications as guaranteed by Texas Instruments Incorporated. Thus, you are assured of only the finest quality devices with known parameters. Detailed specifications are listed for each ARCHER device.

The replacement listings are based on careful analysis of important parameters of the listed devices. The information has been carefully compiled and cross-referenced with the published specifications of each device noted. Each ARCHER replacement should meet or exceed the required parameters. However, due to differences in Quality Control and Manufacturing procedures (which often allow for or result in broad parameter variations), and because many of the ARCHER devices are capable of better performance than the original, Radio Shack does not guarantee, nor does it imply, that the listed items will provide an exact replacement in **every** instance. Therefore we recommend that you check the voltage and current requirements of the circuit (and other pertinent specifications) before replacement and compare with the specifications listed for that particular ARCHER device.

HOW TO USE THIS BOOK

This book has been prepared to aid in both replacement and original application of transistors. The information included will be invaluable for the service technician as well as the circuit designer (whether he be an engineer, hobbyist, student or electronics experimenter).

We have included hints on handling transistors, installation precautions and some simple tests to aid you in evaluating the quality of transistors in existing equipment (and thus the need for replacement). Also, a complete section on the specifications for each of the ARCHER devices is included; if there is any question in your mind about replacement equivalents or original use, refer to the section ARCHER TRANSISTOR SPECIFICATIONS. You will find the important characteristics specified there.

The final section is an extensive listing of replacement and cross-reference between other manufacturer's numbers (both JEDEC(EIA 2N-numbers and in-house designations) and the ARCHER devices. This listing provides for the substitution of over 15,000 transistors with ARCHER devices.

CARE AND HANDLING OF TRANSISTORS

Most modern transistors are somewhat immune from mechanical shock; however, it is always a good idea to keep them from excessive mechanical shock (avoid dropping, etc.).

When cutting transistor leads, use scissor-type cutting tools (rather than diagonal cutting tools which use a crimping action). Crimp type cutting tools produce a mechanical shock along the lead which when transmitted to the semiconductor chip or material can cause fracture. Consider the force with which the cut lead flies off the crimp-type cutting tool and you have a good idea of the intensity of the equal and opposite force which acts on the lead going into the device.

It is always a good practice to use a heat-sink tool on a transistor lead when soldering (use a low-wattage iron -- 30-watts or less). Heat from soldering can cause problems (especially with certain types of semiconductor devices). Thus, to be sure, always use a heat-sink on the lead when soldering. Gripping the lead with long nose pliers between the solder connection and the case of the device makes a good heat-sink; or use a tool designed for such use.

SILICON OR GERMANIUM?

The quickest way to determine if a transistor is germanium or silicon type, is to check the normal emitter-base voltage drop. With NPN devices, if the base is approximately 0.25 volts positive with respect to the emitter, it is a germanium type. If the voltage is about 0.65 volts, it is a silicon type. For PNP devices, the voltage will be the same value, but opposite in polarity (0.25 volts for germanium and 0.65 for silicon).

TESTING A TRANSISTOR

Before replacing a transistor you want to be sure it needs to be replaced. Always check the entire circuitry to be sure the transistor requires replacement.

The best method for checking transistors is to use a good transistor checker (dynamic in-circuit and out-of-circuit type). However, a sensitive VOM can give you a good indication of the quality of the device.

I. IN-CIRCUIT TESTING

- A. First, check to see if the emitter-base junction is forward-biased. An NPN transistor should show the base 0.2 to 0.65 volts **positive** with respect to the emitter (approximately 0.25 volts for a germanium type and 0.6 volts for silicon). A PNP transistor should show the base 0.2 to 0.65 volts **negative** with respect to the emitter (0.25 volts for germanium and 0.6 volts for silicon).
- B. Check to see if the device is functioning as an amplifier. Short the emitter-base junction to remove forward bias. Voltage at the collector lead should rise to approximately the potential of the collector supply buss line. Any difference is caused by I_{CES} (collector-to-base leakage current). The closer the collector voltage approaches the buss line, the lower I_{CES} is and the better the transistor.

II. OUT-OF-CIRCUIT TESTING

Again, for the best indication of transistor quality, use a good transistor checker. However, an ohmmeter can be used as described here.

Before using the ohmmeter, find out which polarity of the internal ohmmeter battery is connected to which test lead (not all ohmmeters have the + battery polarity connected to the red lead and the - battery polarity connected to the black lead). To determine the polarity of the leads when using the ohmmeter function, use an external voltmeter or study the schematic of your VOM.

Also, remember that in most transistor circuits you are dealing with low voltages and currents (in some cases, **very** low). Therefore, never use the RX1 scale (extensive currents can flow through a junction, permanently damaging the transistor). It is best to determine the maximum amount of current available in each resistance range before using an ohmmeter for testing semiconductor junctions.

After you have evaluated your VOM for the above and are sure you will not damage a transistor (with excessive current or voltage in any given ohmmeter range), proceed as follows.

A. Small Signal PNP Germanium Transistors

1. Connect the positive lead of your ohmmeter to the emitter. Connect the negative lead to the base. You should read 200-500 ohms:
2. Connect the negative lead to the collector. You should read 10K-100K. Shorting collector to base, the resistance should decrease.

B. Small Signal NPN Germanium Transistors

Reverse the polarity of the leads; the readings should be approximately the same.

C. Power PNP Germanium Transistors

1. Connect the positive lead to the emitter. Connect the negative lead to the base. The reading should be 30-50 ohms.
2. Connect the negative lead to the collector. The reading should be several hundred ohms. Shorting collector to base, the resistance should decrease.

D. Power NPN Germanium Transistors

Reverse the polarity of the leads; the readings should be approximately the same.

E. Small Signal PNP Silicon Transistors

1. Connect the positive lead to the emitter. Connect the negative lead to the base. The reading should be 1K-3K.
2. Connect the negative lead to the collector. The reading should be very high (may show as an "open").

F. Small Signal NPN Silicon Transistors

Reverse the polarity of the leads; the readings should be approximately the same.

G. Power PNP Silicon Transistors

1. Connect the positive lead to the emitter. Connect the negative lead to the base. The reading should be 200-1K.
2. Connect the negative lead to the collector. The reading should be about 1 megohm or more.

H. Power NPN Silicon Transistors

Reverse the polarity of the leads; the readings should be approximately the same.

The resistance readings noted above can only be approximate; as long as you obtain somewhat proportionate readings (emitter-base readings as compared to emitter-collector), you can safely assume the transistor is OK.

IMPORTANT SUGGESTIONS ON THE USE AND REPLACEMENT OF TRANSISTORS

You can use various styles and sizes of transistors in any given circuit application, as long as the electrical characteristics of the device are within the required range of operation. Thus, a tab-type device can be used to replace a TO-3 or TO-66 case device; or a small epoxy-type device can be used in place of a TO-5 or other size transistor.

Generally speaking, you must observe the following maximum characteristics of a transistor when contemplating substitution or selection:

- Power dissipation
- Maximum collector current
- Maximum collector-to-emitter voltage
- Maximum collector-to-base voltage
- Maximum emitter-to-base voltage

Also, it is useful to consider the following characteristics for actual circuit operation:

- Gain
- Frequency limitations

Caution: It may be necessary in some cases to adjust bias values to achieve required operation. With tuned circuits, it is a good practice to check alignment after replacing any transistor.

When replacing power transistors, always check driver devices to be sure they are OK. Also, check other circuit components to be sure they were not shorted (or otherwise defective) when the original device failed. If you fail to correct such problems before applying power to the circuit once again, the replacement transistor could easily be permanently damaged. Be sure to use proper heat-sink precautions and use silicon grease to reduce the thermal resistance between the case of the transistor and the heat-sink.

Always observe temperature limitations as specified with transistor ratings.

It almost goes without saying, but let us remind you anyway --

Always observe voltage polarity with all semiconductor devices.

SPECIFICATIONS
and
ELECTRICAL CHARACTERISTICS
of
ARCHER TRANSISTORS

NPN LOW POWER ALLOY-JUNCTION GERMANIUM TRANSISTOR

High-Frequency Transistor for Switching and Computer Project Applications

- Texas Instruments type 2N1304
- TO-5 hermetically sealed, welded case with glass-to-metal insulation around leads
- Complementary to RS-2007

THE BASE IS IN ELECTRICAL CONTACT WITH CASE

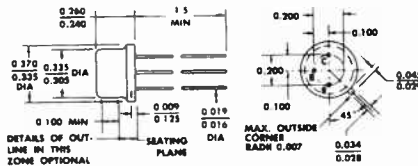

DIMENSIONS ARE IN INCHES UNLESS OTHERWISE SPECIFIED

Absolute Maximum Ratings at 25° C Free Air

Collector-Base Voltage	25 volts
Emitter-Base Voltage	25 volts
Collector Current	300 ma
Maximum power dissipation	150 mw
h_{FE}	115 (typical)

Typical application switching characteristics:

Delay Time	0.07 μ sec
Rise Time	0.20 μ sec
Storage Time	0.70 μ sec
Fall Time	0.40 μ sec

NPN LOW POWER ALLOY-JUNCTION GERMANIUM TRANSISTOR

Amplification applications up to approximately 1 MHz

- Direct commercial equivalent, 2SA221
- TO-1 case with collector lead identification

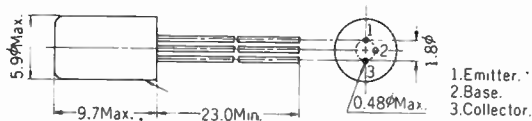

Absolute Maximum Ratings at 25° C Free Air

Collector-Base Voltage	25 volts
Emitter-Base Voltage	12 volts
Collector Current	150 ma
Maximum Power Dissipation	200 mw

Typical Electrical Characteristics:

h_{FE}	100 (typical)
I_{CBO}	7 μa
I_{EBO}	4 μa

PNP LOW POWER DRIFT-JUNCTION GERMANIUM TRANSISTOR

Small Signal Transistor for General Applications up to approximately 50 MHz

- Direct commercial equivalent, 2SD187
- TO-1 case with collector lead identification
- Drift-junction type for radio frequency applications in the High Frequency/Short Wave bands

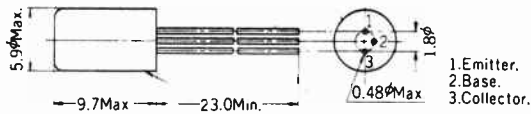

Absolute Maximum Ratings at 25° C Free Air

Collector-Base Voltage	20 volts
Emitter-base Voltage	1.5 volts
Collector Current	15 ma
Maximum Power Dissipation	70mw

Typical Electrical Characteristics:

h_{FE}	80 at 1 KHz (typical)
	10 at 6 MHz (typical)
Alpha Cutoff Frequency (f_a)	55 MHz
I_{CBO}	15 μa (max)
I_{EBO}	40 μa (max)

PNP LOW POWER ALLOY-JUNCTION GERMANIUM TRANSISTOR

General purpose

Audio Amplification

- Direct commercial equivalent, 2SB22 orange Beta code
- TO-1 case with collector lead identification

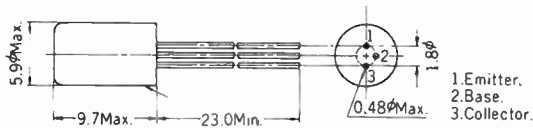

Absolute Maximum Ratings at 25° C Free Air

Collector-Base Voltage	25 volts
Emitter-Base Voltage	12 volts
Collector Current	200 ma
Maximum Power Dissipation	150 mw

Typical Electrical Characteristics:

h_{FE}	90-140 (100 typical)
I_{CBO}	15 μ a (max)
I_{EBO}	12 μ a (max)

PNP LOW POWER ALLOY-JUNCTION GERMANIUM TRANSISTOR

General Purpose
Audio Amplification

- Direct commercial equivalent, 2SB22 yellow Beta code
- TO-18 case with collector lead identification

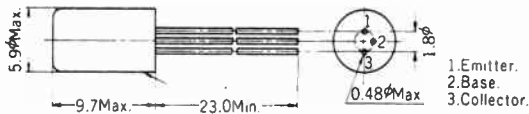

Absolute Maximum Ratings at 25° C Free Air

Collector-Base Voltage	25 volts
Emitter-Base Voltage	1.5 volts
Collector Current	200 ma
Maximum Power Dissipation	150 mw

Typical Electrical Characteristics:

h_{FE}	135-190
I_{CBO}	15 μa (max)
I_{EBO}	12 μa (max)

PNP HIGH POWER ALLOY-JUNCTION GERMANIUM TRANSISTOR

Medium and High Power Audio Amplification Applications

- Direct commercial equivalent, 2SB407 (30-50 Beta)
- TO-3 case
- 15-18 watts Output in Push-Pull configuration
- Typical replacement for Audio Output in Auto Radios

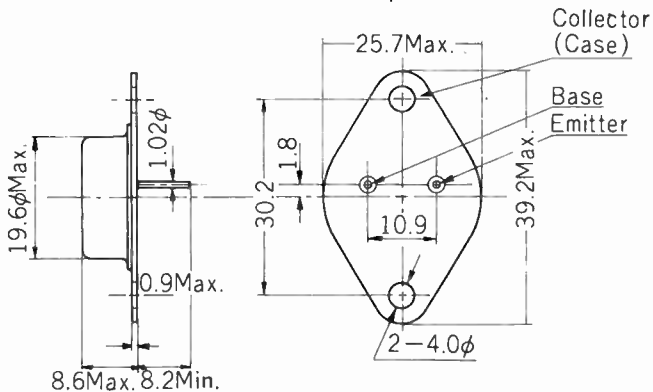

Absolute Maximum Ratings at 25° C Free Air

Collector-Base Voltage	30 volts
Emitter-Base Voltage	10 volts
Collector Current	7 amperes
Power Dissipation	30 watts (25° C case temperature)

Typical Electrical Characteristics:

I_{CBO}	500 μ a (max)
I_{EBO}	500 μ a (max)
Alpha Cutoff Frequency (f_a)	500 KHz
h_{FE}	30-50

PNP LOW POWER ALLOY-JUNCTION GERMANIUM TRANSISTOR

High-Frequency Transistor for Switching and Computer Project Applications

- Texas Instruments type 2N1305
- TO-5 hermetically sealed, welded case with glass-to-metal insulation around leads
- Complementary to RS-2001

THE BASE IS IN ELECTRICAL CONTACT WITH CASE

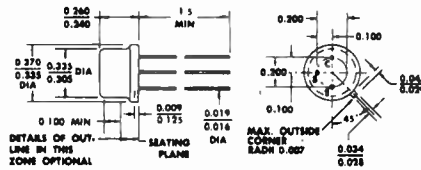

DIMENSIONS ARE IN INCHES UNLESS OTHERWISE SPECIFIED

Absolute Maximum Ratings at 25° C Free Air

Collector-Base Voltage	30 volts
Emitter-Base Voltage	25 volts
Collector Current	300 ma
Maximum power dissipation	150 mw

Typical Electrical Characteristics:

h_{FE} 130 typical

Typical application switching characteristics:

Delay Time	0.06 μ sec
Rise Time	0.18 μ sec
Storage Time	0.80 μ sec
Fall Time	0.38 μ sec

NPN 5-WATT HIGH-VOLTAGE EPITAXIAL PLANAR SILICON TRANSISTOR

General Purpose Amplifier,
Line-Operated Project Applications

- Texas Instruments type 2N5058
- TO-5 Case

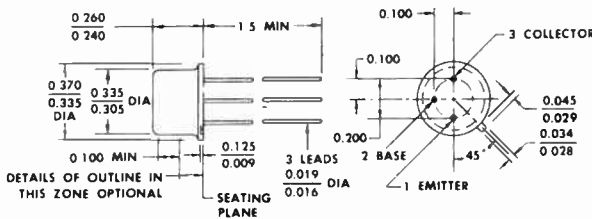

THE COLLECTOR IS IN ELECTRICAL CONTACT WITH THE CASE.

ALL JEDEC TO-5 DIMENSIONS AND NOTES ARE APPLICABLE.

ALL DIMENSIONS ARE IN INCHES UNLESS OTHERWISE SPECIFIED

Absolute Maximum Ratings at 25° C Free Air

Collector-Base Voltage	300 volts
Collector-Emitter Voltage	300 volts
Emitter-Base Voltage	7 volts
Collector Current (continuous)	150 ma
Maximum Power Dissipation	1 watt
Continuous Dissipation at 25° C case temp	5 watts
Derate linearly to 175° C case temperature at rate of 33.3 mw/degree	

Typical Electrical Characteristics:

I_{CBO}			50 na (max)
I_{EBO}			10 na (max)
h_{FE}	$V_{CE} = 25v$	$I_C = 5\text{ ma (pulsed)}$	10 (min)
		$I_C = 30\text{ ma (pulsed)}$	35-150 (min-max)
		$I_C = 100\text{ ma (pulsed)}$	35 (min)

NPN EPITAXIAL PLANAR SILICON TRANSISTOR

High Reliability Silicon Transistor Suitable for High-Speed, Medium-Power Switching and General Purpose Amplifier Applications

- Texas Instruments type 2N2222
- TO-18 case
- High Transistion Frequency (f_T), 350 MHz typical

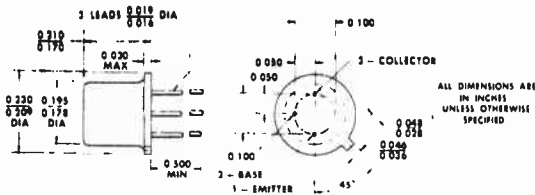

THE COLLECTOR IS IN ELECTRICAL CONTACT WITH THE CASE.

ALL JEDEC TO-18 DIMENSIONS AND NOTES ARE APPLICABLE.

Absolute Maximum Ratings at 25° C Free Air

Collector-Base Voltage	60 volts
Collector-Emitter Voltage	30 volts
Emitter-Base Voltage	5 volts
Collector Current	800 ma
Maximum Dissipation	500 mw
Maximum Dissipation at 25° C case temp.	1.8 watts
Derate linearly to 175° C case temperature at rate of 12.0 mw/C°	

Typical Electrical Characteristics:

I_{CBO}		10 na (max)
I_{EBO}		10 μ a (max at 150° C)
h_{FE}	$V_{CE} = 10v$	10 na (max)
	$I_C = 100 \mu a$	35 (min)
	$I_C = 1 ma$	50 (min)
	$I_C = 10 ma$	75 (min)
	$I_C = 150 ma$	100-300 (min-max)
	(pulse)	
	$I_C = 500 ma$	30
	(pulse)	
f_T (transistion frequency)		350 MHz (typical)

Switching Characteristics:

Turn-On Time	25 nsec
Turn-Off Time	200 nsec

NPN PLANAR SILICON TRANSISTOR

Low-Power, Low-Noise Transistor suitable for High Gain Small Signal Amplification Applications

- Texas Instruments type 2N2484
- TO-18 Case
- Low Noise Characteristics
- High Collector-Emitter Breakdown Voltage

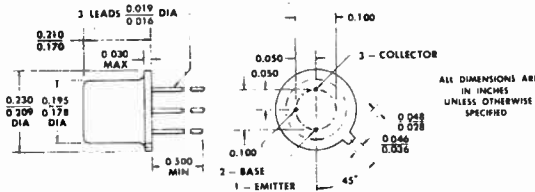

THE COLLECTOR IS IN ELECTRICAL CONTACT WITH THE CASE.

ALL JEDEC TO-18 DIMENSIONS AND NOTES ARE APPLICABLE.

Absolute Maximum Ratings at 25° C Free Air

Collector-Base Voltage	60 volts
Collector-Emitter Voltage	60 volts
Emitter-Base Voltage	6 volts
Collector Current (continuous)	50 ma
Maximum Dissipation	360 mw
Maximum Dissipation at 25° C case temp	1.2 watts
Derate linearly to 200° C case temperature at rate of 6.85 mw/C°.	

Typical Electrical Characteristics:

I_{CEO}		10 na (max)
I_{EBO}		10 μ a (max at 150° C)
h_{FE}	$V_{CE} = 5v$	10 na
	$I_C = 1 \mu a$	30 (min)
	$I_C = 10 \mu a$	100-500 (min-max)
	$I_C = 100 \mu a$	175 (min)
	$I_C = 500 \mu a$	200 (min)
	$I_C = 1 ma$	250 (min)
	$I_C = 10 ma$ (pulse)	800 (max)
Average Noise Figure		3 dB (max)
Spot Noise Figure,		
100 Hz (20 Hz bandwidth)		10 dB (max)
1 KHz (200 Hz bandwidth)		3 dB (max)
10 KHz (2 KHz bandwidth)		2 dB (max)

NPN EPITAXIAL PLANAR SILICON TRANSISTOR

Low Power Transistor for Low-Noise, High-Gain
Small Signal Amplification at VHF and UHF Frequencies

- Texas Instruments type 2N918
- TO-72 case
- Low Noise Figure – 3 dB at 60 MHz, typical
- High Gain – 18 dB at 200 MHz, typical

THE ACTIVE ELEMENTS ARE ELECTRICALLY INSULATED FROM THE CASE

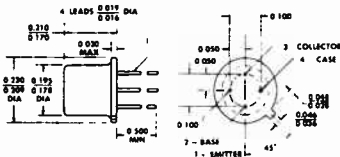

DIMENSIONS ARE IN INCHES
UNLESS OTHERWISE SPECIFIED

ALL JEDEC TO-72 DIMENSIONS
AND NOTES ARE APPLICABLE

Absolute Maximum Ratings at 25° C Free Air

Collector-Base Voltage	30 volts
Collector-Emitter Voltage	15 volts
Emitter-Base Voltage	3 volts
Collector Current	50ma
Maximum Dissipation	200 mw

Typical Electrical Characteristics:

I_{CBO}	10 na (max) 1 μ a (max at 150° C)
h_{FE}	20 (minimum)
Collector-Base Time Constant	8 psec
Noise Figure at 60 MHz	3 dB (typical) 6 dB (maximum)
Power Gain (functioning as a neutralized, common-emitter amplifier at 200 MHz)	15 to 18 dB
Typical Power Output (500 MHz oscillator common base configuration)	30 to 50 mw

NPN EPITAXIAL PLANAR SILICON TRANSISTOR

Medium-Power High-Voltage Transistor for General Purpose Amplifier Applications in Line-Operated Projects

- Texas Instruments type A5T5058
- Epoxy case with standard TO-18 100-mil pin-circle

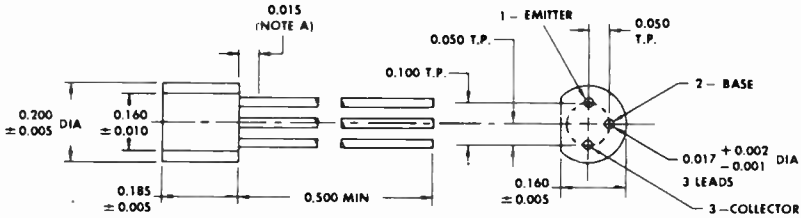

- NOTES: A. Lead diameter is not controlled in this area.
 B. Leads having maximum diameter (0.019) shall be within 0.007 of their true positions measured in the gaging plane 0.054 below the seating plane of the device relative to a maximum-diameter package.
 C. All dimensions are in inches.

Absolute Maximum Ratings at 25° C Free Air

Collector-Base Voltage	300 volts
Collector-Emitter Voltage	300 volts
Emitter-Base Voltage	7 volts
Collector Current	150 ma
Maximum Dissipation	800 mw
Maximum Dissipation at 25° C case & lead temperature (derate linearly to 150° C case-and-lead temp at a rate of 12.8 mw/C°).	1.6 w

Typical Electrical Characteristics:

I_{CBO}		50 na (max)
I_{EBO}		2 μ a (max at 75° C free-air)
h_{FE}	$V_{CE} = 25v$	10 na
	$I_C = 5\text{ ma (pulse)}$	10 (min)
	$I_C = 30\text{ ma (pulse)}$	35-150 (min-max)
	$I_C = 100\text{ ma (pulse)}$	35 (min)

NPN EPITAXIAL PLANAR SILICON TRANSISTOR

High-Frequency Transistor for Small Signal Amplification Applications

- Texas Instruments type 2N4996
- Epoxy Case with standard TO-18 100-mil pin-circle

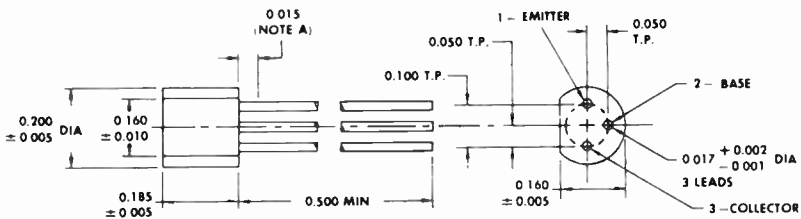

- NOTES
- A Lead diameter is not controlled in this area
 - B Leads having maximum diameter (0.019) shall be within 0.007 of their true positions measured in the gaging plane 0.054 below the seating plane of the device relative to a maximum-diameter package.
 - C All dimensions are in inches.

Absolute Maximum Ratings at 25° C Free Air

Collector-Base Voltage	30 volts
Collector-Emitter Voltage	18 volts
Emitter-Base Voltage	4 volts
Collector Current	50 ma
Maximum Dissipation	250 mw

Typical Electrical Characteristics:

I_{CBO}	100 na (max)
h_{FE}	50 (min)
h_{fe} (f = 100 MHz)	10 (typical)
Spot Noise Figure (f = 100 MHz)	2.5 dB (typical)

NPN SINGLE-DIFFUSED MESA SILICON POWER TRANSISTOR

Power-Amplifier and High-Speed Switching Applications

- Texas Instruments type SP8918
- Tab-Type case, mechanically interchangeable with TO-66 case
- 20-watt dissipation
- Complementary to RS-2025

THE COLLECTOR IS IN ELECTRICAL CONTACT WITH THE MOUNTING TAB

MECHANICAL INTERCHANGEABILITY OF PLASTIC PACKAGE WITH TO 66 OUTLINE

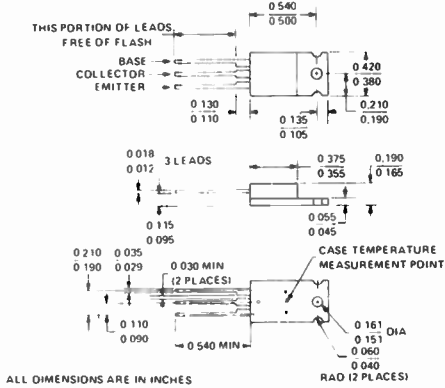
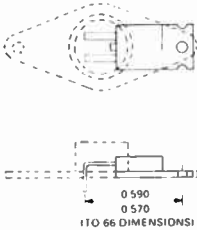

Absolute Maximum Ratings at 25° C Case Temperature

Collector-Base Voltage	30 volts
Collector-Emitter Voltage	30 volts
Emitter-Base Voltage	5 volts
Collector Current (continuous)	3 amperes
Peak Collector Current	5 amperes
Base Current	1 ampere
Maximum Dissipation	20 watts
Derate linearly to 150° C case temperature at rate of 0.32 w/C°.	

Safe Operating Region 3 amps I_C up to 15 volts V_{CE}
Derate linearly to 1 amp at 40 volts

Typical Electrical Characteristics:

I_{CEO}	0.5 ma (max)
I_{EBO}	1 ma (max)
h_{FE} $V_{CE} = 4 v$ $I_C = 1 \text{ amp (pulsed)}$	10 (min)
	$I_C = 3 \text{ amp (pulsed)}$ 10-50 (min-max)

Junction-to-Case thermal Resistance 3.125 deg/w (max)

Switching Characteristics:

Turn-On Time	0.5 μ sec (typical)
Turn-Off Time	2 μ sec (typical)
Transition Frequency (f_T) at 10 v, 0.5 a	3 MHz (min)

NPN SINGLE-DIFFUSED SILICON POWER TRANSISTOR

Power-Amplifier and High-Speed Switching Applications

- Texas Instruments type TIP29
- Tab-Type case, mechanically interchangeable with TO-66 case
- 30-watt dissipation
- Complementary to RS-2026

THE COLLECTOR IS IN ELECTRICAL CONTACT WITH THE MOUNTING TAB

MECHANICAL INTERCHANGEABILITY OF PLASTIC PACKAGE WITH TO-66 OUTLINE

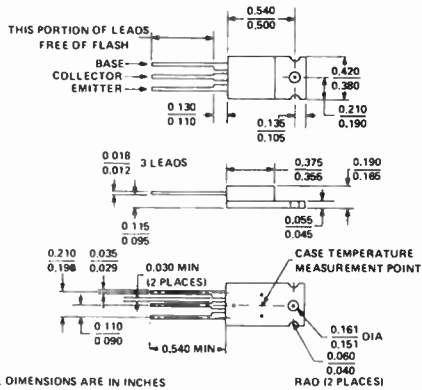
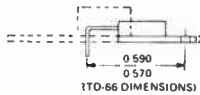
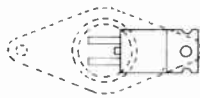

Absolute Maximum Ratings at 25° C Case Temperature

Collector-Base Voltage	40 volts
Collector-Emitter Voltage	40 volts
Emitter-Base Voltage	5 volts
Collector Current	1 ampere
Base Current	400 ma
Maximum Dissipation	30 watts
Derate linearly to 150° C case temperature at rate of 0.24 w/C°.	

Safe Operating Region 1 amp I_C up to 30 volts V_{CE}
Derate linearly to 750 ma at 40 volts V_{CE}

Typical Electrical Characteristics:

I _{CEO}			300 a (max)
I _{EBO}			1 ma (max)
h _{FE}	V _{CE} = 4v	I _C = 0.2 a (pulsed)	40-200 (min-max)
	V _{CE} = 4v	I _C = 1 a (pulsed)	10 (min)
h _{fe}	(f = 1 KHZ)		20 (min)
Junction-to-Case thermal Resistance			4.17 deg/w (max)

Switching Characteristics:

Turn-On Time	0.35 μsec (typical)
Turn-Off Time	1.1 μsec (typical)

Transistion frequency (f_T) at 10 volts, 200 ma 3 MHz (min)

NPN SINGLE-DIFFUSED SILICON POWER TRANSISTOR

Power-Amplifier and High Speed Switching Applications

- Texas Instruments type TIP33
- Tab-Type case, mechanically interchangeable with TO-3 case
- 80-watt dissipation
- Complementary to RS-2027

THE COLLECTOR IS IN ELECTRICAL CONTACT WITH THE MOUNTING TAB

MECHANICAL INTERCHANGEABILITY OF PLASTIC PACKAGE WITH TO-3 OUTLINE

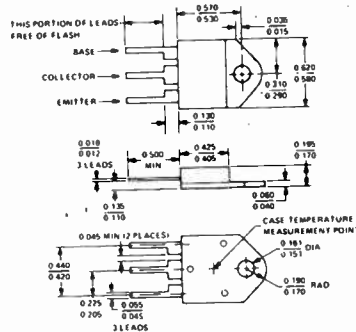
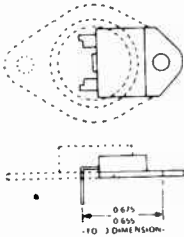

Absolute Maximum Ratings at 25° C Case Temperature

Collector-Base Voltage	40 volts
Collector-Emitter Voltage	40 volts
Emitter-Base Voltage	5 volts
Collector Current	10 amperes
Base Current	3 amperes
Maximum Dissipation	80 watts
Derate linearly to 150° C case temperature at rate of 0.64 w/C°.	

Safe Operating Region I_C up to 8 volts V_{CE}

Derate linearly to 2.5 amp at 30 v V_{CE}

Derate further to 1 amp at 40 v V_{CE}

Typical Electrical Characteristics:

I_{CEO}		700 μ a (max)
I_{EBO}		1 ma (max)
h_{FE}	$V_{CE} = 4v$ $I_C = 1$ a (pulsed)	25-125 (min-max)
	$V_{CE} = 4v$ $I_C = 3$ a (pulsed)	12 (min)
	$V_{CE} = 4v$ $I_C = 10$ a (pulsed)	4 (min)
h_{fe}	(f = 1 KHz)	20 (min)
Junction-to-Case Thermal Resistance		1.56 deg/w (max)

Switching Characteristics:

Turn-On Time	0.45 μ sec (typical)
Turn-Off Time	0.35 μ sec (typical)

Transition Frequency (f_T) at 10 volts, 500 ma 3 MHz (min)

NPN SINGLE-DIFFUSED MESA SILICON POWER TRANSISTOR

Power-Amplifier and High-Speed Switching Applications

- Texas Instruments type TIP3055
- Tab-type case, mechanically interchangeable with TO-3 case
- 90-watt dissipation

THE COLLECTOR IS IN ELECTRICAL CONTACT WITH THE MOUNTING TAB

MECHANICAL INTERCHANGEABILITY OF PLASTIC PACKAGE WITH TO-3 OUTLINE

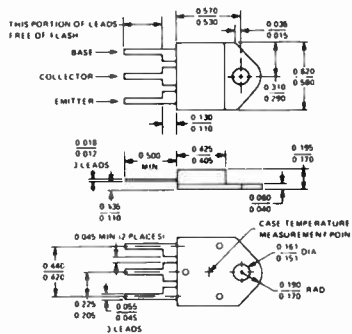
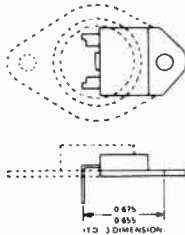

ALL DIMENSIONS ARE IN INCHES

Absolute Maximum Ratings at 25° C Case Temperature

Collector-Base Voltage	100 volts
Collector-Emitter Voltage	70 volts
Emitter-Base Voltage	7 volts
Collector Current	15 amperes
Base Current	7 amperes
Maximum Dissipation	90 watts
Derate linearly to 150° C case temperature at rate of 0.72 w/C°.	

Safe Operating Region 15 amps I_C up to 6 volts V_{CE}
 Derate linearly to 3 amps at 30 volts
 Derate further to 400 ma at 70 volts

Typical Electrical Characteristics:

I_{CEO}		0.7 ma (max)
I_{EBO}		5 ma (max)
h_{FE}	$V_{CE} = 4v$	$I_C = 4$ amps (pulsed) 20-70 (min-max)
		$I_C = 10$ amps (pulsed) 5 (min)
		1.39 deg/w (max)
Junction-to-Case Thermal Resistance		1.39 deg/w (max)

Switching Characteristics:

Turn-On Time	0.6 μ sec (typical)
Turn-Off Time	1 μ sec (typical)

PNP EPITAXIAL PLANAR SILICON TRANSISTOR

Medium-Power Transistor for High-Speed Switching and General Purpose Amplification Applications

- Texas Instruments type 2N2907
- TO-18 case
- High Breakdown Voltage vs Low Saturation Voltage

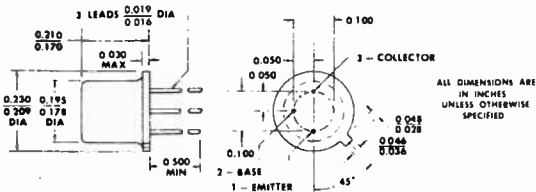

THE COLLECTOR IS IN ELECTRICAL CONTACT WITH THE CASE.

ALL JEDEC TO-18 DIMENSIONS AND NOTES ARE APPLICABLE.

Absolute Maximum Ratings at 25° C Free Air

Collector-Base Voltage	60 volts
Collector-Emitter Voltage	40 volts
Emitter-Base Voltage	5 volts
Collector Current	600 ma
Maximum Dissipation	400 mw

Typical Electrical Characteristics:

I_{CBO}			20 na (max)
I_{CEX}	$V_{CE} = 30v$	$V_{BE} = 0.5v$	20 na (max)
I_B	$V_{CE} = 30v$	$V_{BE} = 0.5v$	50 na (max)
h_{FE}	$V_{CE} = 10v$	$I_C = 100 \mu a$	35 (min)
		$I_C = 1 ma$	50 (min)
		$I_C = 10 ma$	75 (min)
		$I_C = 150 ma$ (pulsed)	100-300 (min-max)
		$I_C = 500 ma$ (pulsed)	30 (min)
$V_{CE(sat)}$	$I_B = 15 ma$	$I_C = 150 ma$ (pulsed)	0.4 v (max)
	$I_B = 50 ma$	$I_C = 500 ma$ (pulsed)	1.6 v (max)

Switching Characteristics:

Delay Time	10 nsec (max)
Rise Time	40 nsec (max)
Turn-On Time	45 nsec (max)
Storage Time	80 nsec (max)
Fall Time	30 nsec (max)
Turn-Off Time	100 nsec (max)

PNP EPITAXIAL PLANAR SILICON TRANSISTOR

Very Low-Level, Low-Noise, High-Gain Small-Signal Applications

- Texas Instruments type 2N2605
- TO-46 case
- Guaranteed Characteristics at very low levels

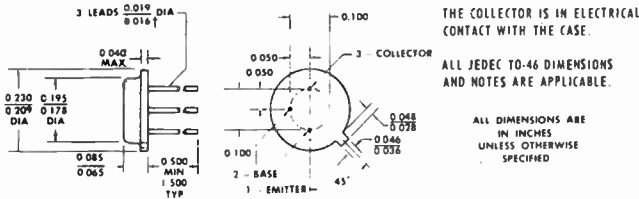

Absolute Maximum Ratings at 25° C Free Air

Collector-Base Voltage	60 volts
Collector-Emitter Voltage	45 volts
Emitter-Base Voltage	6 volts
Collector Current	30 ma
Maximum Dissipation	400 mw

Typical Electrical Characteristics:

I_{CBO}			10 na (max)
I_{EBO}			2 na (max)
h_{FE}	$V_{CE} = 5v$	$I_C = 10 \mu a$	100-300 (min-max)
		$I_C = 500 \mu a$	150 (min)
		$I_C = 10 ma$	600 (max)
Average Noise Figure			3 dB (max)

PNP EPITAXIAL PLANAR SILICON TRANSISTOR

Medium-Power Transistor for High-Speed Switching and General Purpose Amplifier Applications

- Texas Instruments type A5T2907
- Epoxy case with standard TO-18 100-mill pin-circle

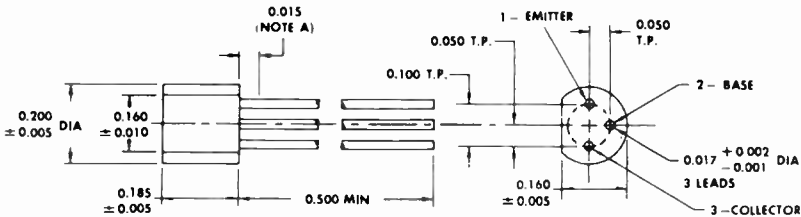

- NOTES: A. Lead diameter is not controlled in this area.
 B. Leads having maximum diameter (0.019) shall be within 0.007 of their true positions measured in the gaging plane 0.054 below the seating plane of the device relative to a maximum-diameter package.
 C. All dimensions are in inches.

Absolute Maximum Ratings at 25° C Free Air

Collector-Base Voltage	60 volts
Collector-Emitter Voltage	40 volts
Base-Emitter Voltage	5 volts
Collector Current	600 ma
Maximum Dissipation	360 mw

Typical Electrical Characteristics:

I_{CEO}		20 na (max)
I_{EBO}		50 na (max)
h_{FE}	$V_{CE} = 10V$	$I_C = 100 \mu a$ 35 (min)
		$I_C = 1 ma$ 50 (min)
		$I_C = 10 ma$ (pulsed) 75 (min)
		$I_C = 150 ma$ (pulsed) 100-300 (min-max)
		$I_C = 500 ma$ (pulsed) 30 (min)

Switching Characteristics:

Delay Time	10 nsec (max)
Rise Time	40 nsec (max)
Turn-On Time	45 nsec (max)
Storage Time	80 nsec (max)
Fall Time	30 nsec (max)
Turn-Off Time	100 nsec (max)

PNP EPITAXIAL PLANAR SILICON TRANSISTOR

Medium-Power Transistor for General Purpose Audio Amplifier Applications

- Texas Instruments type 2N5447
- Epoxy case with standard TO-18 100-mil pin-circle
- Complementary to RS-2014

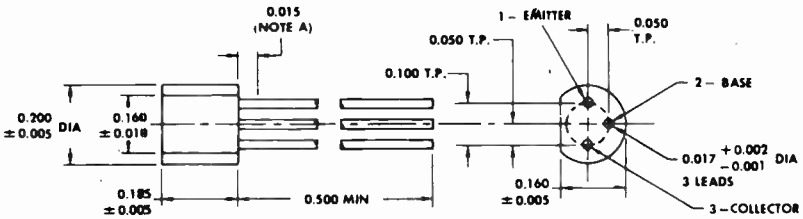

- NOTES: A. Lead diameter is not controlled in this area.
 B. Leads having maximum diameter (0.019) shall be within 0.007 of their true positions measured in the gaging plane 0.054 below the seating plane of the device relative to a maximum-diameter package.
 C. All dimensions are in inches.

Absolute Maximum Ratings at 25° C Free Air

Collector-Base Voltage	40 volts
Collector-Emitter Voltage	25 volts
Emitter-Base Voltage	5 volts
Collector Current	250 ma
Maximum Dissipation	360 mw

Typical Operating Characteristics:

I_{CBO}	100 na (max)
I_{EBO}	100 na (max)
h_{FE}	200 (typical)

PNP SINGLE-DIFFUSED MESA POWER TRANSISTOR

Silicon Power Transistor for Power-Amplifier
and High-Speed Switching Applications

- Texas Instruments type SP8919
- Tab-Type case, mechanically interchangeable with TO-66 case
- 20-watt dissipation
- Complementary to RS-2017

THE COLLECTOR IS IN ELECTRICAL CONTACT WITH THE MOUNTING TAB

MECHANICAL INTERCHANGEABILITY OF
PLASTIC PACKAGE WITH TO 66 OUTLINE

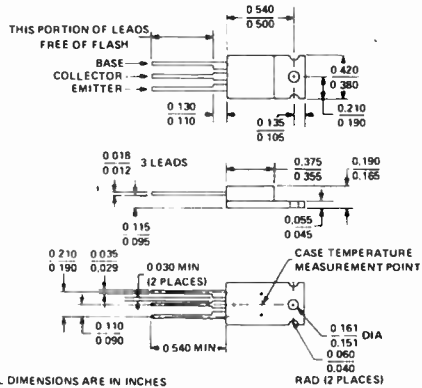
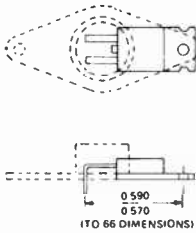

ALL DIMENSIONS ARE IN INCHES

Absolute Maximum Ratings at 25° C Case Temperature

Collector-Base Voltage	30 volts
Collector-Emitter Voltage	30 volts
Emitter-Base Voltage	5 volts
Collector Current (continuous)	3 amperes
Peak Collector Current	5 amperes
Base Current	1 ampere
Maximum Dissipation	20 watts

Derate linearly to 150° C case temperature at rate of 0.32 w/C°.

Safe Operating Region 3 amps I_C up to 15 volts V_{CE}

Derate linearly to 1 amp at 40 volts

Typical Electrical Characteristics:

I_{CEO}		0.5 ma (max)
I_{EBO}		1 ma (max)
h_{FE}	$V_{CE} = 4v$	10 (min)
	$I_C = 1$ amp (pulsed)	10-50 (min-max)
	$I_C = 3$ amps (pulsed)	3.125 deg/w (max)
Junction-to-Case Thermal Resistance		

Switching Characteristics:

Turn-On Time	0.3 μ sec (typical)
Turn-Off Time	1.0 μ sec (typical)
Transistion frequency (f_T) at 10v, 0.5 a	3 MHz (min)

PNP SINGLE-DIFFUSED SILICON POWER TRANSISTOR

Power-Amplifier and High-Speed Switching Applications

- Texas Instruments type TIP30
- Tab-Type case, mechanically interchangeable with TO-66 case
- 30-watt dissipation
- Complementary to RS-2018

THE COLLECTOR IS IN ELECTRICAL CONTACT WITH THE MOUNTING TAB

MECHANICAL INTERCHANGEABILITY OF PLASTIC PACKAGE WITH TO 66 OUTLINE

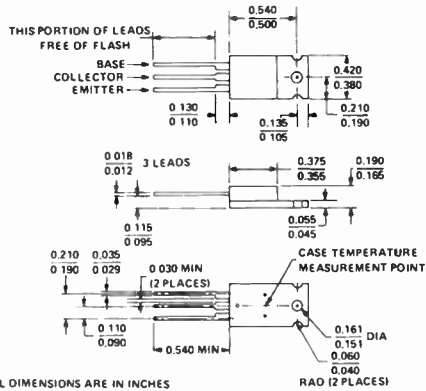
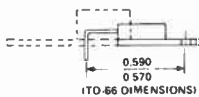
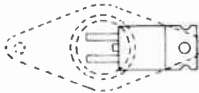

ALL DIMENSIONS ARE IN INCHES

Absolute Maximum Ratings at 25° C Case Temperature

Collector-Base Voltage	40 volts
Collector-Emitter Voltage	40 volts
Emitter-Base Voltage	5 volts
Collector Current	1 ampere
Base Current	400 ma
Maximum Dissipation	30 watts
Derate linearly to 150° C case temperature at rate of 0.24 w/C°.	

Safe Operating Region 1 amp up to 30 volts V_{CE}
Derate linearly to 750 ma at 40 v, V_{CE}

Transistion Frequency (f_T) at 10 volts, 200 ma 3 MHz (min)

Typical Electrical Characteristics:

I_{CEO}		300 μ a (max)
I_{EBO}		1 ma (max)
h_{FE}	$V_{CE} = 4$ v	$I_C = 0.2$ a (pulsed) 40-200 (min-max)
		$I_C = 1$ a (pulsed) 10 (min)
h_{fe} (f = 1 KHz)		20 (min)
Junction-To-Case Thermal Resistance		4.17 deg/w (max)

Switching Characteristics:

Turn-On Time	0.25 μ sec (typical)
Turn-Off Time	0.95 μ sec (typical)

PNP SINGLE-DIFFUSED SILICON POWER TRANSISTOR

Power-Amplifier and High-Speed Switching Applications

- Texas Instruments type TIP34
- Tab-Type case, mechanically interchangeable with TO-3 case
- 80-watt dissipation
- Complementary to RS-2019

THE COLLECTOR IS IN ELECTRICAL CONTACT WITH THE MOUNTING TAB

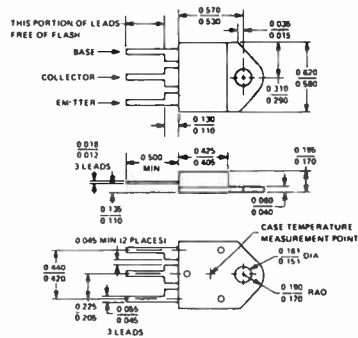
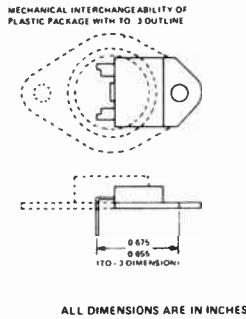

Absolute Maximum Ratings at 25° C Case Temperature

Collector-Base Voltage	40 volts
Collector-Emitter Voltage	40 volts
Emitter-Base Voltage5 volts
Collector Current	10 amperes
Base Current	3 amperes
Maximum Dissipation	80 watts
Derate linearly to 150° C case temperature at rate of 0.64 w/C°.	

Safe Operating Region 10 amp I_C up to 8 volts V_{CE}
 Derate linearly to 2 amps at 40 v V_{CE}

Transistion Frequency (f_T) at 10 volts, 500 ma 3 MHz (min)

Typical Electrical Characteristics:

I_{CEO}		700 μ a (max)
I_{EBO}		1 ma (max)
h_{FE}	$V_{CE} = 4v$	$I_C = 1$ amp (pulsed) 25-125 (min-max)
		$I_C = 3$ amp (pulsed) 12 (min)
		$I_C = 10$ amp (pulsed) 4 (min)
h_{fe} (f = 1 KHz)		20 (min)
Junction-to-Case Thermal Resistance		1.56 deg/w (max)

Switching Characteristics:

Turn-On Time	0.35 μ sec (typical)
Turn-Off Time	0.80 μ sec (typical)

N-Channel EPITAXIAL PLANAR SILICON FIELD-EFFECT TRANSISTOR

Symmetrical N-Channel Silicon Field-Effect Transistor for Small Signal Applications

- Texas Instruments type A5T3821
- Epoxy case, with standard TO-18 100-mil pin-circle
- Low Leakage
- High High-Frequency Figure-of-Merit

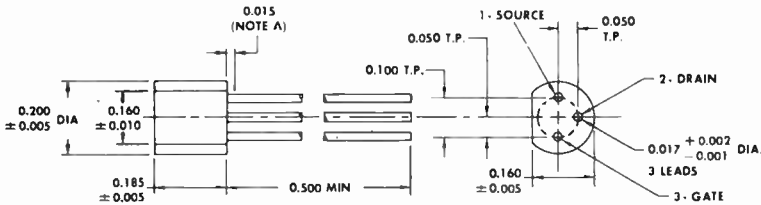

NOTES: A. Lead diameter is not controlled in this area.
 B. Leads having maximum diameter (0.019) shall be within 0.007 of their true positions measured in the gaging plane 0.054 below the seating plane of the device relative to a maximum-diameter package.
 C. All dimensions are in inches.

Absolute Maximum Ratings at 25° C Free Air

Drain-Gate Voltage	50 volts
Drain-Source Voltage	50 volts
Reverse Gate-Source Voltage	50 volts
Forward Gate Current	10 ma (max)
Maximum Dissipation	300 mw

Typical Electrical Characteristics:

I_{GSS}	$V_{GS} = 30\text{ v}$	$V_{DS} = 0$	0.1 na (max)
$V_{GS(off)}$	$V_{DS} = 15\text{ v}$	$I_D = 0.5\text{ ma}$	6 volts
I_{DSS}			0.5-2.5 ma (min-max)
Average Noise	Figure		5 dB (max)

PN PLANAR UNIJUNCTION SILICON TRANSISTOR

General Purpose Unijunction Applications

- Texas Instruments type 2N4891
- Epoxy case with standard TO-18 100-mil pin-circle
- Planar process results in high-reliability, extremely low leakage and low driving current requirements

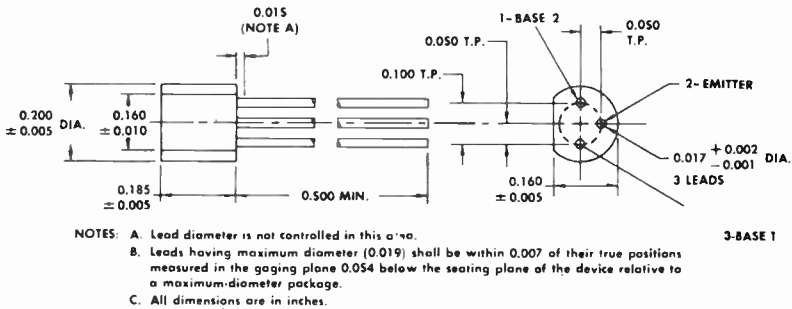

Absolute Maximum Ratings at 25° C Free Air

Emitter-Base-Two Reverse Voltage	30 volts
Emitter Current	50 ma
Peak Emitter Current	1 ampere
Maximum Dissipation	360 mw

Typical Electrical Characteristics:

I_{EB2O} (Emitter Reverse Current)	10 na (max)
I_p (Peak-Point Emitter Current)	5 μ a (max)
$V_{EB1(sat)}$ (Emitter-Base 1 Saturation V)	4 volts
I_V (Valley-Point Emitter Current)	2 ma

CROSS-REFERENCE/SUBSTITUTION LISTING

Most users of transistors realize that it is almost impossible to guarantee absolute equivalents (as in the case of tubes). Thus, the only way to create replacement or cross-reference listings is by carefully evaluating each characteristic of both devices (original transistor and the possible alternate). This is how the Technical Staff of Radio Shack went about preparing the following cross-reference/replacement lists.

We caution you that in many cases the listed cross reference ARCHER device may be different in appearance, size or mounting style. Thus, before beginning replacement or installation procedures, check to be sure you have enough room for proper mounting.

Also, when making substitutions or replacements in radio or high frequency circuitry, it may be necessary to realign tunable circuit elements. This is true even when making **exact** replacements (junction capacitances normally vary between devices even from the same production run).

Information contained in this guide is based on the latest available data and is believed to be accurate. Every care has been taken to assure technical accuracy. However, Radio Shack does not assume responsibility for any contingencies of the use of this information. Nor does Radio Shack assume any responsibility for any infringements of patents or other rights of third parties which may result from its use.

DEVICE	RS 276-	DEVICE	RS 276-	DEVICE	RS 276-	DEVICE	RS 276-
2A	2005	2N32	2004	2N109WHT	2007	2N175	2005
2AC128	2005	2N34	2005	2N109YEL	2007	2N176	2006
2AD149	2006	2N34/5	2005	2N109(M1)	2007	2N176BLK	2006
2B	2003	2N34A	2005	2N109/5	2005	2N176BLU	2006
2C	2003	2N35	2001	2N111	2007	2N176GRN	2006
2D	2003	2N35/5	2001	2N111A	2007	2N176PUR	2006
2E	2003	2N36	2004	2N111B	2005	2N176RED	2006
2G	2003	2N37	2004	2N111(M1)	2005	2N176WHT	2006
2G103	2003	2N38	2004	2N111(M2)	2005	2N176A	2006
2G104	2003	2N38A	2004	2N112	2005	2N176-1BLU	2006
2G106	2003	2N39	2005	2N112A	2004	2N176-1WHT	2006
2G210	2006	2N40	2005	2N112(M1)	2005	2N176-1YEL	2006
2G220	2006	2N41	2005	2N113	2005	2N176-3PUR	2006
2G221	2006	2N42	2005	2N117	2009	2N176-4PUR	2006
2G222	2006	2N43	2005	2N118	2009	2N176-5WHT	2006
2G223	2006	2N43A	2005	2N118A	2009	2N176-6WHT	2006
2G224	2006	2N44	2004	2N119	2009	2N178	2006
2G225	2006	2N44A	2004	2N120	2009	2N179	2006
2G240	2006	2N45	2004	2N124	2002	2N180	2005
2G301	2003	2N45A	2004	2N125	2002	2N181	2005
2G302	2003	2N46	2005	2N126	2002	2N182	2001
2G303	2003	2N47	2005	2N127	2002	2N183	2001
2G304	2003	2N48	2004	2N128	2003	2N185	2003
2G306	2003	2N48A	2004	2N129	2003	2N185BLU	2003
2G308	2003	2N49	2005	2N130	2007	2N186	2007
2G309	2003	2N50	2005	2N130A	2007	2N186A	2004
2G319	2004	2N51	2005	2N131	2007	2N187	2007
2G320	2005	2N52	2004	2N131A	2007	2N187A	2004
2G321	2005	2N54	2005	2N132	2007	2N188	2003
2G322	2004	2N55	2004	2N132A	2007	2N188A	2005
2G323	2005	2N56	2004	2N133	2007	2N189	2005
2G324	2005	2N59	2005	2N133A	2007	2N190	2004
2G339A	2001	2N59A	2005	2N135	2007	2N191	2003
2G344	2003	2N59B	2005	2N136	2007	2N192	2003
2G345	2003	2N59C	2005	2N137	2007	2N193	2002
2G371	2003	2N60	2005	2N138	2007	2N194	2002
2G374	2003	2N60A	2005	2N138A	2007	2N194A	2002
2G376	2003	2N60B	2005	2N138B	2007	2N195	2005
2G377	2003	2N60C	2005	2N139	2003	2N196	2004
2G381	2003	2N61	2005	2N140	2003	2N197	2004
2G382	2003	2N61A	2005	2N140(M1)	2003	2N198	2004
2G383	2004	2N61B	2005	2N140(M2)	2003	2N199	2004
2G384	2005	2N61C	2005	2N145	2001	2N200	2004
2G385	2005	2N62	2005	2N146	2001	2N204	2001
2G386	2005	2N63	2004	2N147	2001	2N205	2001
2G387	2005	2N64	2005	2N148	2001	2N206	2005
2G395	2004	2N65	2005	2N149	2001	2N207	2003
2G396	2004	2N75	2004	2N149A	2001	2N207BLU	2003
2G397	2004	2N76	2004	2N150	2001	2N207A	2004
2G413	2003	2N77	2005	2N150A	2001	2N207B	2004
2G414	2003	2N78	2001	2N151	2005	2N211	2002
2G415	2003	2N78A	2001	2N155	2006	2N212	2002
2G416	2003	2N79	2005	2N156	2006	2N213	2002
2G417	2003	2N80	2005	2N157	2006	2N213A	2002
2G508	2005	2N81	2004	2N157A	2006	2N214	2002
2G524	2004	2N82	2005	2N160	2009	2N214A	2002
2G525	2004	2N83	2006	2N160A	2009	2N215	2005
2G526	2005	2N94	2002	2N161	2009	2N216	2002
2G527	2005	2N94A	2002	2N161A	2009	2N217	2005
2G577	2005	2N96	2004	2N162	2009	2N217RED	2005
2G605	2005	2N97	2001	2N162A	2009	2N217WHT	2005
2G1024	2004	2N97A	2001	2N163	2009	2N217YEL	2005
2G1025	2004	2N98	2001	2N163A	2009	2N218	2003
2G1026	2005	2N98A	2001	2N164	2002	2N219	2005
2G1027	2005	2N99	2001	2N164A	2002	2N220	2005
2H1254	2023	2N100	2001	2N165	2002	2N222	2004
2H1255	2023	2N103	2001	2N166	2002	2N223	2005
2H1256	2023	2N104	2004	2N167	2002	2N224	2005
2H1257	2023	2N105	2004	2N167A	2002	2N225	2005
2H1258	2023	2N106	2004	2N168	2002	2N226	2005
2H1259	2023	2N107	2004	2N168A	2002	2N227	2005
2K48	2003	2N108	2005	2N169	2002	2N228	2001
2N27	2004	2N109	2003	2N169A	2002	2N229	2001
2N28	2002	2N109BLU	2007	2N170	2002	2N230	2006
2N29	2002	2N109GRN	2007	2N172	2002	2N231	2005

DEVICE	RS 276-	DEVICE	RS 276-	DEVICE	RS 276-	DEVICE	RS 276-
2N231BLU	2005	2N292	2002	2N362(B)	2003	2N414B	2003
2N231YEL	2005	2N292A	2002	2N363	2005	2N414C	2003
2N231YEL-RED	2005	2N293	2002	2N364	2002	2N415	2003
2N232	2003	2N296	2006	2N365	2002	2N415A	2003
2N233	2002	2N297	2006	2N366	2002	2N416	2003
2N233A	2002	2N297A	2006	2N367	2004	2N417	2003
2N234	2006	2N299	2003	2N368	2004	2N418	2006
2N234A	2006	2N300	2003	2N369	2005	2N419	2006
2N235	2006	2N301	2006	2N370	2003	2N420	2006
2N235A	2006	2N301A	2006	2N370/33	2003	2N420A	2006
2N235B	2006	2N302	2005	2N370A	2003	2N422	2005
2N236	2006	2N303	2005	2N371	2003	2N422A	2004
2N236A	2006	2N306	2001	2N371/33	2003	2N425	2004
2N236B	2006	2N307	2006	2N372	2003	2N426	2004
2N237	2005	2N307A	2006	2N372/33	2003	2N427	2004
2N238	2007	2N307B	2006	2N373	2003	2N428	2004
2N238ORN	2007	2N308	2005	2N374	2003	2N428A	2004
2N238(D)	2003	2N309	2005	2N375	2006	2N431	2009
2N238(E)	2003	2N310	2005	2N376	2006	2N432	2009
2N238(F)	2003	2N311	2003	2N376A	2006	2N433	2009
2N240	2003	2N312	2002	2N377	2001	2N438	2001
2N241	2003	2N313	2002	2N377A	2001	2N439	2001
2N241A	2005	2N314	2002	2N378	2006	2N440	2001
2N242	2006	2N315	2004	2N379	2006	2N444	2001
2N247	2005	2N315A	2004	2N380	2006	2N444A	2001
2N247	2003	2N315B	2005	2N381	2005	2N445	2001
2N248	2003	2N316	3003	2N382	2005	2N445A	2001
2N249	2004	2N316A	2004	2N383	2005	2N446	2001
2N250	2006	2N317	2003	2N384	2003	2N446A	2001
2N250A	2006	2N317A	2003	2N384/33	2003	2N447	2001
2N251	2006	2N319	2007	2N385	2002	2N447A	2001
2N251A	2006	2N320	2004	2N385A	2002	2N447B	2001
2N252	2014	2N321	2005	2N386	2006	2N448	2001
2N253	2001	2N322	2005	2N387	2006	2N449	2001
2N254	2001	2N323	2005	2N388	2001	2N450	2005
2N255	2006	2N324	2005	2N388A	2001	2N456	2006
2N255A	2006	2N325	2006	2N392	2006	2N456A	2006
2N256	2006	2N329	2021	2N393	2003	2N456B	2006
2N256A	2006	2N329A	2021	2N394	2005	2N457	2006
2N257	2006	2N329B	2021	2N394A	2005	2N457A	2006
2N257A	2006	2N331	2005	2N395	2005	2N457B	2006
2N257B	2006	2N332	2009	2N396	2005	2N458	2006
2N257G	2006	2N332A	2009	2N396A	2005	2N458A	2006
2N257W	2006	2N333	2009	2N397	2003	2N458B	2006
2N262	2004	2N333A	2009	2N399	2006	2N459	2006
2N263	2009	2N334	2009	2N400	2006	2N460	2004
2N264	2009	2N334A	2009	2N401	2006	2N461	2004
2N265	2003	2N335	2009	2N402	2004	2N462	2005
2N266	2004	2N335A	2009	2N403	2004	2N464	2004
2N268	2006	2N335B	2009	2N404	2021	2N465	2004
2N268A	2006	2N336	2009	2N404A	2021	2N466	2005
2N269	2003	2N336A	2009	2N405	2004	2N467	2005
2N270	2006	2N337	2009	2N406	2004	2N468	2005
2N270(5M)	2006	2N337A	2009	2N406BLU	2004	2N470	2009
2N270A	2005	2N338	2009	2N406BRN	2004	2N471	2009
2N271	2004	2N338A	2009	2N406GRN	2004	2N471A	2009
2N271A	2005	2N344	2003	2N406GRY	2004	2N472	2009
2N272	2005	2N345	2003	2N406ORN	2004	2N472A	2009
2N273	2004	2N346	2003	2N406RED	2004	2N473	2009
2N274	2003	2N350	2006	2N407	2004	2N474	2009
2N274BLU	2003	2N350A	2006	2N407BLK	2004	2N474A	2009
2N274WHT	2003	2N351	2006	2N407GRN	2004	2N475	2009
2N276	2003	2N351A	2006	2N407RED	2004	2N475A	2009
2N279	2004	2N352	2006	2N407WHT	2004	2N476	2009
2N280	2005	2N353	2006	2N407YEL	2004	2N477	2009
2N281	2004	2N356	2001	2N408	2004	2N478	2009
2N282	2005	2N356A	2001	2N408WHT	2004	2N479	2009
2N283	2005	2N357	2001	2N409	2003	2N479A	2009
2N284	2004	2N357A	2001	2N410	2003	2N480	2009
2N284A	2004	2N358	2001	2N411	2003	2N480A	2009
2N285	2006	2N358A	2001	2N412	2003	2N481	2004
2N285A	2006	2N359	2005	2N413	2004	2N482	2004
2N285B	2006	2N360	2005	2N413A	2004	2N483	2004
2N286	2005	2N361	2005	2N414	2003	2N483(B)	2003
2N291	2007	2N362	2004	2N414A	2005	2N483(6M)	2003

DEVICE	RS 276-	DEVICE	RS 276-	DEVICE	RS 276-	DEVICE	RS 276-
2N484	2005	2N551	2009	2N634A	2001	2N706B	2009
2N485	2004	2N552	2009	2N635	2001	2N706B/46	2009
2N486	2003	2N553	2006	2N635A	2001	2N706C	2009
2N486(B)	2003	2N554	2006	2N636	2001	2N706C/46	2009
2N495	2023	2N555	2006	2N636A	2001	2N707	2009
2N495/18	2023	2N556	2001	2N637	2006	2N707A	2009
2N496	2023	2N557	2001	2N637A	2006	2N708	2009
2N496/18	2023	2N558	2001	2N637B	2006	2N708/46	2009
2N497	2018	2N559	2003	2N638	2006	2N708A	2009
2N497A	2018	2N560	2009	2N638A	2006	2N709	2009
2N498	2009	2N561	2006	2N639	2006	2N709/52	2009
2N499	2003	2N563	2004	2N639A	2006	2N709A	2009
2N499A	2005	2N564	2004	2N639B	2006	2N709A/46	2009
2N500	2003	2N565	2005	2N640	2005	2N710	2003
2N500BLU	2003	2N567	2002	2N641	2005	2N710A	2003
2N500RED	2003	2N568	2005	2N641RED M/F	2003	2N711	2003
2N500WHT	2003	2N569	2005	2N642	2005	2N711A	2003
2N501	2003	2N570	2005	2N643	2004	2N711B	2003
2N501/18	2003	2N571	2005	2N644	2004	2N715	2009
2N501A	2003	2N572	2005	2N645	2004	2N717	2009
2N502	2005	2N573	2003	2N646	2002	2N718	2009
2N502A	2005	2N573BRN	2007	2N647	2002	2N721	2023
2N503	2003	2N573ORN	2003	2N649	2002	2N721A	2023
2N504	2003	2N573RED	2003	2N650	2007	2N722	2023
2N505	2005	2N576	2002	2N650A	2005	2N722A	2023
2N506	2004	2N576A	2002	2N651	2005	2N725	2003
2N507	2001	2N578	2004	2N651A	2005	2N726	2023
2N508	2005	2N579	2004	2N652	2003	2N727	2023
2N508A	2005	2N580	2004	2N652A	2005	2N728	2009
2N515	2002	2N581	2004	2N653	2007	2N729	2009
2N516	2002	2N582	2005	2N654	2003	2N741	2003
2N517	2002	2N583	2004	2N655	2003	2N741A	2003
2N518	2005	2N584	2005	2N655GRN	2003	2N742	2009
2N519	2004	2N585	2001	2N655RED	2003	2N742A	2009
2N519A	2004	2N586	2005	2N656	2018	2N743	2009
2N520	2005	2N587	2002	2N656A	2018	2N743/46	2009
2N520A	2005	2N588	2003	2N658	2004	2N744	2009
2N521	2005	2N588A	2003	2N659	2004	2N744/46	2009
2N521A	2005	2N589	2006	2N660	2005	2N745	2009
2N522	2005	2N591	2005	2N661	2005	2N746	2009
2N522A	2005	2N591(6M)	2003	2N662	2004	2N747	2009
2N523	2005	2N591/5	2005	2N663	2006	2N748	2009
2N523A	2005	2N591A	2005	2N665	2006	2N749	2009
2N524	2004	2N597	2005	2N669	2006	2N750	2009
2N524A	2004	2N598	2005	2N670	2006	2N751	2009
2N525	2004	2N599	2005	2N672	2006	2N753	2009
2N525A	2004	2N602	2004	2N674	2004	2N753/46	2009
2N526	2005	2N602A	2004	2N677	2006	2N754	2009
2N526A	2004	2N603	2005	2N677A	2006	2N756	2009
2N527	2005	2N603A	2005	2N677B	2006	2N756A	2009
2N527A	2005	2N604	2005	2N677C	2006	2N757	2009
2N529	2004	2N604A	2005	2N678	2006	2N757A	2009
2N530	2004	2N605	2005	2N678A	2006	2N758	2009
2N531	2004	2N606	2005	2N678B	2006	2N758A	2009
2N532	2004	2N607	2005	2N678C	2006	2N758B	2009
2N533	2004	2N608	2005	2N679	2002	2N759	2009
2N534	2003	2N609	2005	2N680	2003	2N759A	2009
2N535	2005	2N610	2005	2N694	2003	2N759B	2009
2N535A	2005	2N611	2004	2N695	2003	2N760	2009
2N535B	2005	2N612	2004	2N696	2009	2N760A	2009
2N536	2005	2N613	2004	2N697	2009	2N760B	2009
2N537	2003	2N614	2004	2N700	2003	2N761	2009
2N539A	2006	2N615	2004	2N700/18	2003	2N762	2009
2N541	2009	2N616	2004	2N700A	2003	2N768	2003
2N542	2009	2N617	2004	2N700A/18	2003	2N769	2003
2N542A	2009	2N618	2006	2N701	2009	2N770	2009
2N543	2009	2N624	2003	2N702	2009	2N771	2009
2N543A	2009	2N627	2006	2N703	2009	2N772	2009
2N544	2003	2B828	2006	2N705	2003	2N773	2009
2N544/33	2003	2N629	2006	2N705A	2003	2N774	2009
2N546	2009	2N631	2005	2N706	2009	2N775	2009
2N547	2009	2N632	2005	2N706/46	2009	2N776	2009
2N548	2009	2N633	2003	2N706A	2009	2N777	2009
2N549	2009	2N633(B)	2003	2N706A/46	2009	2N778	2009
2N550	2009	2N634	2001	2N706A/51	2009	2N779	2003

DEVICE	RS 276-	DEVICE	RS 276-	DEVICE	RS 276-	DEVICE	RS 276-
2N779A	2003	2N914/46	2009	2N984	2003	2N1082	2009
2N779B	2003	2N914/51	2011	2N985	2003	2N1086	2002
2N780	2009	2N914A	2009	2N987	2003	2N1086A	2002
2N781	2003	2N916	2009	2N988	2009	2N1087	2002
2N782	2003	2N916A	2009	2N989	2009	2N1090	2002
2N783	2009	2N917	2011	2N990	2005	2N1091	2002
2N784	2009	2N917/46	2011	2N991	2003	2N1092	2018
2N784A	2009	2N917A	2011	2N992	2003	2N1093	2004
2N784A/46	2009	2N918	2011	2N993	2005	2N1094	2004
2N789	2009	2N918/46	2011	2N994	2003	2N1097	2005
2N790	2009	2N919	2009	2N995	2023	2N1098	2005
2N791	2009	2N920	2009	2N995A	2023	2N1101	2001
2N792	2009	2N921	2009	2N996	2023	2N1102	2001
2N793	2009	2N922	2009	2N1000	2001	2N1102/5	2001
2N794	2003	2N923	2023	2N1005	2011	2N1103	2009
2N795	2003	2N924	2023	2N1006	2009	2N1104	2009
2N796	2003	2N925	2023	2N1007	2006	2N1107	2003
4N797	2001	2N926	2023	2N1008	2005	2N1108	2003
2N799	2005	2N927	2023	2N1008A	2005	2N1108RED	2003
2N801	2005	2N928	2023	2N1008B	2005	2N1109	2003
2N803	2005	2N929	2009	2N1009	2005	2N1110	2003
2N805	2005	2N929/51	2009	2N1010	2002	2N1111	2003
2N807	2005	2N929A	2009	2N1011	2006	2N1111RED	2003
2N809	2005	2N930	2013	2N1012	2002	2N1111A	2003
2N811	2005	2N930/46	2009	2N1014	2006	2N1111B	2003
2N813	2005	2N930A	2009	2N1017	2004	2N1114	2002
2N815	2005	2N930A/46	2009	2N1018	2004	2N1115	2005
2N817	2004	2N930	2003	2N1021	2006	2N1115A	2005
2N819	2004	2N934	2003	2N1021A	2006	2N1116	2009
2N821	2002	2N935	2023	2N1022	2006	2N1117	2009
2N822	2002	2N936	2023	2N1022A	2006	2N1118	2021
2N823	2002	2N937	2023	2N1023	2003	2N1118A	2021
2N824	2002	2N938	2023	2N1024	2021	2N1119	2021
2N825	2005	2N939	2023	2N1025	2021	2N1120	2006
2N827	2003	2N940	2023	2N1026	2021	2N1121	2001
2N828	2003	2N941	2023	2N1026A	2021	2N1122	2003
2N828A	2003	2N942	2023	2N1027	2021	2N1122A	2003
2N829	2003	2N943	2023	2N1028	2021	2N1124	2005
2N834	2009	2N944	2023	2N1029	2006	2N1125	2005
2N834/46	2009	2N945	2023	2N1029A	2006	2N1128	2005
2N834/51	2004	2N946	2023	2N1029B	2006	2N1129	2005
2N834A	2009	2N947	2009	2N1029C	2006	2N1130	2005
2N835	2009	2N955	2002	2N1030	2006	2N1131	2021
2N835/46	2009	2N955A	2002	2N1030A	2006	2N1131A	2021
2N837	2003	2N956	2009	2N1030B	2006	2N1132	2021
2N838	2003	2N957	2009	2N1030C	2006	2N1132/46	2023
2N839	2009	2N960	2003	2N1031	2006	2N1132A	2021
2N840	2009	2N960/46	2003	2N1031A	2006	2N1132A/46	2023
2N841	2009	2N961	2003	2N1031B	2006	2N1132B	2021
2N841/46	2009	2N961/46	2003	2N1031C	2006	2N1132B/46	2023
2N842	2009	2N962	2003	2N1032	2006	2N1135	2021
2N843	2009	2N962/46	2003	2N1032A	2006	2N1135A	2021
2N844	2009	2N963	2003	2N1032B	2006	2N1136	2006
2N846	2003	2N964	2003	2N1032C	2006	2N1136A	2006
2N846A	2003	2N964A	2003	2N1033	2006	2N1136B	2006
2N846B	2003	2N964/46	2003	2N1034	2021	2N1137	2006
2N849	2011	2N965	2003	2N1035	2021	2N1137A	2006
2N851	2011	2N966	2003	2N1036	2021	2N1137B	2006
2N858	2023	2N967	2003	2N1037	2021	2N1138	2006
2N859	2023	2N968	2003	2N1038	2006	2N1138A	2006
2N860	2023	2N969	2003	2N1039	2006	2N1138B	2006
2N861	2023	2N970	2003	2N1046	2006	2N1139	2009
2N862	2023	2N971	2003	2N1046A	2006	2N1144	2005
2N863	2023	2N972	2003	2N1046B	2006	2N1145	2005
2N864	2023	2N973	2003	2N1051	2009	2N1146	2006
2N864A	2023	2N974	2003	2N1054	2009	2N1146A	2006
2N865	2023	2N975	2003	2N1056	2004	2N1146B	2006
2N865A	2023	2N976	2003	2N1057	2005	2N1146C	2006
2N866	2009	2N977	2003	2N1058	2001	2N1147	2006
2N867	2009	2N978	2023	2N1059	2001	2N1147A	2006
2N869	2023	2N979	2003	2N1065	2005	2N1147B	2006
2N869A	2023	2N980	2003	2N1066	2003	2N1147C	2006
2N909	2009	2N981	2023	2N1073	2006	2N1149	2009
2N913	2009	2N982	2003	2N1073A	2006	2N1150	2009
2N914	2009	2N983	2003	2N1081	2009	2N1151	2009

DEVICE	RS 276-	DEVICE	RS 276-	DEVICE	RS 276-	DEVICE	RS 276-
2N1152	2009	2N1257	2021	2N1362	2006	2N1492	2009
2N1153	2009	2N1258	2021	2N1363	2006	2N1499	2003
2N1159	2006	2N1259	2021	2N1364	2006	2N1499A	2003
2N1160	2006	2N1264	2004	2N1365	2006	2N1499B	2003
2N1168	2006	2N1265	2005	2N1366	2001	2N1500/18	2003
2N1171	2004	2N1265/5	2005	2N1367	2001	2N1515	2003
2N1173	2001	2N1266	2005	2N1370	2004	2N1516	2003
2N1174	2005	2N1273	2004	2N1371	2004	2N1517	2003
2N1175	2005	2N1273BLU	2003	2N1372	2004	2N1524	2003
2N1175A	2005	2N1273GRN	2003	2N1373	2004	2N1525	2003
2N1176	2006	2N1273ORN	2003	2N1374	2003	2N1526	2005
2N1176A	2004	2N1273RED	2007	2N1375	2004	2N1526/33	2003
2N1176B	2004	2N1273YEL	2003	2N1376	2005	2N1527	2003
2N1177	2005	2N1274	2004	2N1377	2005	2N1528	2009
2N1178	2005	2N1274BLU	2003	2N1378	2005	2N1529	2006
2N1179	2005	2N1274BRN	2007	2N1379	2005	2N1529A	2006
2N1180	2005	2N1274GRN	2003	2N1380	2004	2N1530	2006
2N1182	2006	2N1274ORN	2003	2N1381	2004	2N1530A	2006
2N1183	2006	2N1274RED	2007	2N1382	2004	2N1531	2006
2N1183A	2006	2N1274VIO	2003	2N1383	2004	2N1531A	2006
2N1184	2006	2N1276	2009	2N1386	2009	2N1532	2006
2N1184A	2006	2N1277	2009	2N1387	2009	2N1532A	2006
2N1185	2005	2N1278	2009	2N1388	2009	2N1534	2006
2N1186	2004	2N1279	2009	2N1389	2009	2N1534A	2006
2N1187	2005	2N1280	2005	2N1391	2002	2N1535	2006
2N1188	2005	2N1281	2005	2N1395	2003	2N1535A	2006
2N1189	2005	2N1282	2005	2N1396	2003	2N1536	2006
2N1190	2005	2N1284	2005	2N1397	2003	2N1536A	2006
2N1191	2007	2N1285	2003	2N1404	2005	2N1537	2006
2N1192	2003	2N1287	2004	2N1405	2005	2N1537A	2006
2N1193	2003	2N1287A	2005	2N1406	2003	2N1539	2006
2N1194	2003	2N1288	2002	2N1407	2003	2N1539A	2006
2N1198	2002	2N1289	2002	2N1411	2003	2N1540	2006
2N1199A	2009	2N1291	2006	2N1413	2004	2N1540A	2006
2N1200	2009	2N1292	2006	2N1414	2004	2N1541	2006
2N1201	2009	2N1293	2006	2N1415	2005	2N1541A	2006
2N1204	2004	2N1294	2006	2N1416	2005	2N1542	2006
2N1204A	2004	2N1295	2006	2N1417	2009	2N1542A	2006
2N1205	2009	2N1296	2006	2N1418	2009	2N1544	2006
2N1213	2005	2N1297	2006	2N1419	2006	2N1544A	2006
2N1214	2005	2N1299	2001	2N1420	2009	2N1545	2006
2N1215	2005	2N1300	2005	2N1425	2003	2N1545A	2006
2N1216	2005	2N1301	2005	2N1426	2003	2N1546	2006
2N1217	2001	2N1302	2001	2N1427	2003	2N1546A	2006
2N1218	2004	2N1303	2007	2N1428	2021	2N1547	2006
2N1219	2021	2N1304	2001	2N1429	2021	2N1547A	2006
2N1220	2021	2N1305	2007	2N1430	2006	2N1549	2006
2N1221	2021	2N1306	2001	2N1431	2001	2N1549A	2006
2N1222	2021	2N1307	2007	2N1432	2003	2N1550	2006
2N1223	2021	2N1308	2002	2N1439	2021	2N1550A	2006
2N1224	2005	2N1309	2007	2N1440	2021	2N1551	2006
2N1225	2003	2N1309A	2005	2N1441	2021	2N1551A	2006
2N1226	2003	2N1313	2005	2N1442	2021	2N1552	2006
2N1227	2006	2N1314	2006	2N1443	2021	2N1552A	2006
2N1227A	2006	2N1316	2005	2N1446	2004	2N1553	2006
2N1227-3	2006	2N1317	2005	2N1447	2005	2N1553A	2006
2N1227-4	2006	2N1318	2005	2N1448	2005	2N1554	2006
2N1227-4R	2006	2N1319	2004	2N1449	2005	2N1554A	2006
2N1228	2021	2N1343	2004	2N1450	2004	2N1555	2006
2N1229	2021	2N1344	2005	2N1451	2004	2N1555A	2006
2N1230	2021	2N1345	2005	2N1452	2005	2N1556	2006
2N1231	2021	2N1346	2005	2N1469	2005	2N1556A	2006
2N1232	2021	2N1347	2005	2N1471	2005	2N1557	2006
2N1233	2021	2N1348	2005	2N1473	2002	2N1557A	2006
2N1245	2006	2N1349	2005	2N1474	2021	2N1558	2006
2N1246	2006	2N1350	2005	2N1474A	2021	2N1558A	2006
2N1247	2009	2N1351	2005	2N1475	2021	2N1559	2006
2N1248	2009	2N1352	2005	2N1478	2005	2N1559A	2006
2N1249	2009	2N1353	2005	2N1479	2018	2N1560	2006
2N1251	2002	2N1354 & 355	2005	2N1480	2018	2N1560A	2006
2N1252	2009	2N1356	2005	2N1481	2018	2N1561	2003
2N1253	2009	2N1357	2005	2N1482	2018	2N1562	2003
2N1254	2021	2N1359	2006	2N1483	2018	2N1570	2004
2N1255	2021	2N1360	2006	2N1485	2018	2N1581	2004
2N1256	2021	2N1361	2004	2N1491	2009	2N1583	2004

DEVICE	RS 276-	DEVICE	RS 276-	DEVICE	RS 276-	DEVICE	RS 276-
2N1584	2004	2N1782	2003	2N2005	2021	2N2180	2003
2N1585	2002	2N1783	2002	2N2006	2021	2N2181	2021
2N1586	2009	2N1784	2003	2N2007	2021	2N2182	2021
2N1587	2009	2N1808	2001	2N2017	2018	2N2183	2023
2N1589	2009	2N1838	2009	2N2038	2009	2N2184	2023
2N1590	2009	2N1839	2009	2N2039	2009	2N2185	2023
2N1591	2009	2N1840	2009	2N2040	2009	2N2186	2023
2N1592	2009	2N1853	2004	2N2041	2009	2N2187	2023
2N1593	2009	2N1853/18	2004	2N2059	2003	2N2194	2009
2N1594	2009	2N1954	2004	2N2061	2006	2N2194A	2009
2N1605	2001	2N1865	2003	2N2061A	2006	2N2194B	2009
2N1605A	2001	2N1891	2002	2N2062	2006	2N2205	2009
2N1606	2021	2N1892	2002	2N2062A	2006	2N2206	2009
2N1607	2021	2N1893	2009	2N2063	2006	2N2208	2003
2N1608	2021	2N1905	2006	2N2063A	2006	2N2209	2004
2N1614	2004	2N1907	2006	2N2064	2006	2N2212	2006
2N1622	2002	2N1908	2006	2N2064A	2006	2N2220	2009
2N1623	2021	2N1917	2021	2N2065	2006	2N2221	2009
2N1624	2001	2N1918	2021	2N2065A	2006	2N2222	2009
2N1631	2003	2N1919	2021	2N2066	2006	2N2236	2009
2N1632	2003	2N1920	2021	2N2066A	2006	2N2237	2009
2N1635	2003	2N1921	2021	2N2084	2003	2N2240	2009
2N1635	2003	2N1924	2007	2N2085	2002	2N2241	2009
2N1637	2003	2N1925	2005	2N2089	2003	2N2242	2009
2N1637/33	2003	2N1926	2005	2N2090	2003	2N2244	2009
2N1638	2005	2N1944	2009	2N2091	2003	2N2245	2009
2N1638/33	2003	2N1945	2009	2N2092	2003	2N2246	2009
2N1639	2005	2N1946	2009	2N2093	2003	2N2247	2009
2N1639/33	2003	2N1947	2009	2N2094	2009	2N2248	2009
2N1643	2021	2N1948	2009	2N1094A	2009	2N2249	2009
2N1644	2009	2N1949	2009	2N2095A	2009	2N2250	2009
2N1644A	2009	2N1950	2009	2N2096A	2009	2N2251	2009
2N1646	2003	2N1951	2009	2N2097A	2009	2N2252	2009
2N1651	2006	2N1952	2009	2N2104	2021	2N2253	2009
2N1652	2006	2N1953	2009	2N2105	2021	2N2254	2009
2N1663	2009	2N1954	2005	2N2106	2018	2N2255	2009
2N1666	2006	2N1955	2005	2N2107	2018	2N2256	2009
2N1667	2006	2N1956	2005	2N2108	2018	2N2257	2009
2N1668	2006	2N1957	2005	2N2137	2006	2N2258	2003
2N1669	2006	2N1958	2009	2N2137A	2006	2N2259	2003
2N1672	2002	2N1958/18	2009	2N2138	2006	2N2271	2005
2N1672A	2002	2N1959	2009	2N2138A	2006	2N2272	2009
2N1673	2005	2N1959/18	2009	2N2139	2006	2N2273	2003
2N1674	2009	2N1960	2003	2N2139A	2006	2N2274	2023
2N1676	2021	2N1961	2003	2N2140	2006	2N2275	2023
2N1677	2021	2N1962	2009	2N2140A	2006	2N2276	2023
2N1681	2005	2N1962/46	2009	2N2141	2006	2N2277	2023
2N1682	2009	2N1963	2009	2N2141A	2006	2N2278	2023
2N1683	2005	2N1963/46	2009	2N2142	2006	2N2279	2023
2N1684	2004	2N1964	2009	2N2142A	2006	2N2280	2023
2N1685	2001	2N1964/46	2009	2N2143	2006	2N2281	2023
2N1694	2001	2N1965	2009	2N2143A	2006	2N2285	2006
2N1700	2018	2N1965/46	2009	2N2144	2006	2N2286	2006
2N1704	2009	2N1969	2005	2N2144A	2006	2N2287	2006
2N1705	2005	2N1971	2006	2N2145	2006	2N2288	2006
2N1706	2005	2N1972	2009	2N2145A	2006	2N2289	2006
2N1707	2005	2N1973	2009	2N2146	2006	2N2290	2006
2N1708	2009	2N1974	2009	2N2146A	2006	2N2291	2006
2N1708A	2009	2N1975	2009	2N2147	2006	2N2292	2006
2N1711	2009	2N1983	2009	2N2148	2006	2N2293	2006
2N1730	2002	2N1984	2009	2N2160	2029	2N2294	2006
2N1731	2004	2N1985	2009	2N2161	2009	2N2295	2006
2N1732	2001	2N1986	2009	2N2162	2021	2N2296	2006
2N1742	2003	2N1987	2009	2N2163	2021	2N2303	2021
2N1743	2004	2N1988	2009	2N2164	2021	2N2303/46	2021
2N1744	2004	2N1991	2021	2N2165	2021	2N2304	2018
2N1745	2003	2N1992	2009	2N2166	2021	2N2309	2009
2N1746	2003	2N1993	2001	2N2167	2021	2N2310	2009
2N1747	2003	2N1997	2005	2N2171	2005	2N2312	2009
2N1750	2003	2N1998	2005	2N2172	2005	2N2314	2009
2N1763	2009	2N2000	2005	2N2173	2004	2N2315	2009
2N1764	2009	2N2001	2005	2N2175	2005	2N2318	2010
2N1779	2002	2N2002	2021	2N2176	2005	2N2319	2009
2N1780	2002	2N2003	2021	2N2177	2005	2N2320	2009
2N1781	2002	2N2004	2021	2N2178	2023	2N2331	2010

DEVICE	RS 276-	DEVICE	RS 276-	DEVICE	RS 276-	DEVICE	RS 276-
2N2332	2023	2N2533	2009	2N2853	2018	2N3081	2021
2N2333	2023	2N2534	2009	2N2855	2018	2N3081/46	2021
2N2334	2023	2N2539	2009	2N2856	2018	2N3115	2009
2N2335	2023	2N2540	2009	2N2860	2003	2N3116	2009
2N2336	2023	2N2564/5	2006	2N2861	2023	2N3117	2009
2N2337	2023	2N2565/5	2006	2N2862	2023	2N3121	2021
2N2349	2009	2N2569	2009	2N2865	2011	2N3122	2009
2N2353	2009	2N2570	2009	2N2869	2006	2N3125	2006
2N2353A	2009	2N2571	2009	2N2869/2N301	2006	2N3132	2006
2N2354	2001	2N2572	2009	2N2870	2006	2N3133	2021
2N2357	2006	2N2586	2009	2N2870/2N301A	2006	2N3134	2021
2N2358	2006	2N2587	2003	2N2873	2003	2N3135	2021
2N2363	2003	2N2595	2023	2N2894	2023	2N3136	2021
2N2368	2009	2N2596	2023	2N2894A	2024	2N3137	2011
2N2369	2009	2N2597	2023	2N2904	2021	2N3148	2003
2N2369/46	2009	2N2601	2023	2N2904A	2021	2N3153	2003
2N2369A	2009	2N2602	2023	2N2905	2021	2N3202	2025
2N2370	2021	2N2603	2023	2N2905A	2021	2N3203	2025
2N2371	2021	2N2604	2023	2N2906	2023	2N3208	2025
2N2372	2023	2N2605	2023	2N2906A	2023	2N3210	2009
2N2373	2023	2N2605A	2023	2N2907	2023	2N3211	2009
2N2374	2005	2N2610	2009	2N2907A	2023	2N3217	2023
2N2375	2005	2N2613	2003	2N2921	2009	2N3218	2023
2N2376	2005	2N2614	2003	2N2922	2009	2N3219	2023
2N2377	2023	2N2616	2011	2N2923	2009	2N3227	2011
2N2378	2023	2N2617	2023	2N2924	2009	2N3241	2009
2N2380	2009	2N2618/46	2009	2N2925	2009	2N3241A	2009
2N2400	2003	2N2630	2003	2N2926	2013	2N3242	2009
2N2401	2003	2N2635	2003	2N2926GRN	2013	2N3242A	2009
2N2402	2003	2N2646	2029	2N2926ORN	2009	2N3246	2009
2N2411	2023	2N2647	2029	2N2926-6	2016	2N3247	2009
2N2412	2023	2N2654	2005	2N2927	2021	2N3248	2009
2N2413	2009	2N2656	2009	2N2927/46	2023	2N3249	2009
2N2415	2003	2N2671	2003	2N2928	2003	2N3250	2009
2N2416	2003	2N2672	2003	2N2931	2016	2N3250A	2009
2N2423	2006	2N2672BLK	2003	2N2932	2016	2N3251	2009
2N2424	2021	2N2672GRN	2003	2N2933	2016	2N3251A	2009
2N2425	2021	2N2673	2009	2N2934	2016	2N3261	2009
2N2426	2002	2N2674	2023	2N2935	2016	2N3267	2003
2N2427	2009	2N2675	2009	2N2938	2009	2N3268	2009
2N2428	2005	2N2676	2009	2N2944	2023	2N3279	2003
2N2429	2004	2N2677	2009	2N2945	2023	2N3280	2003
2N2430	2001	2N2678	2009	2N2945A	2023	2N3281	2003
2N2431	2006	2N2692	2009	2N2946	2023	2N3282	2003
2N2432	2009	2N2693	2009	2N2946A	2023	2N3283	2003
2N2446	2006	2N2695	2023	2N2949	2018	2N3284	2003
2N2447	2007	2N2696	2023	2N2951	2009	2N3285	2003
2N2448	2007	2N2699	2001	2N2952	2009	2N3286	2003
2N2449	2003	2N2706	2003	2N2953	2005	2N3287	2011
2N2450	2003	2N2708	2011	2N2955	2003	2N3288	2011
2N2451	2003	2N2709	2021	2N2956	2003	2N3289	2011
2N2456	2003	2N2710	2011	2N2957	2003	2N3290	2011
2N2466	2009	2N2711	2009	2N2958	2007	2N3291	2011
2N2467	2006	2N2712	2009	2N2959	2009	2N3292	2011
2N2475	2011	2N2713	2016	2N2960	2009	2N3293	2011
2N2476	2009	2N2714	2016	2N2961	2009	2N3294	2011
2N2477	2009	2N2715	2009	2N2996	2003	2N3301	2009
2N2481	2009	2N2716	2009	2N2997	2003	2N3302	2009
2N2482	2002	2N2717	2003	2N2998	2003	2N3305	2021
2N2483	2009	2N2719	2009	2N3009	2009	2N3306	2021
2N2484	2009	2N2729	2011	2N3010	2011	2N3307	2023
2N2487	2003	2N2784	2011	2N3011	2011	2N3308	2023
2N2488	2003	2N2784/52	2011	2N3012	2023	2N3310	2009
2N2489	2003	2N2795	2003	2N3013	2011	2N3317	2023
2N2494	2003	2N2796	2003	2N3014	2011	2N3318	2023
2N2501	2009	2N2800	2021	2N3053	2018	2N3319	2023
2N2520	2009	2N2800/46	2023	2N3054	2017	2N3320	2003
2N2521	2009	2N2801	2021	2N3058	2023	2N3321	2003
2N2522	2009	2N2801/46	2023	2N3059	2023	2N3322	2003
2N2523	2009	2N2831	2009	2N3060	2023	2N3323	2003
2N2524	2009	2N2836	2006	2N3062	2023	2N3324	2005
2N2529	2009	2N2837	2023	2N3072	2023	2N3325	2003
2N2530	2009	2N2838	2023	2N3073	2023	2N3340	2009
2N2531	2009	2N2845	2023	2N3074	2003	2N3341	2009
2N2532	2009	2N2847	2023	2N3075	2004	2N3342	2021

DEVICE	RS 276-	DEVICE	RS 276-	DEVICE	RS 276-	DEVICE	RS 276-
2N3343	2021	2N3613	2006	2N3845	2009	2N4258	2023
2N3344	2021	2N3614	2006	2N3845A	2009	2N4259	2009
2N3345	2021	2N3615	2006	2N3854	2009	2N4274	2009
2N3346	2021	2N3616	2006	2N3854A	2009	2N4275	2009
2N3371	2003	2N3617	2006	2N3855	2009	2N4286	2016
2N3390	2013	2N3618	2006	2N3855A	2009	2N4287	2016
2N3391	2013	2N3633	2011	2N3856	2009	2N4288	2024
2N3391A	2013	2N3638	2021	2N3856A	2009	2N4290	2024
2N3392	2009	2N3638A	2021	2N3857	2009	2N4291	2024
2N3393	2009	2N3639	2024	2N3858	2009	2N4313	2023
2N3394	2009	2N3640	2024	2N3859	2009	2N4354	2021
2N3395	2013	2N3641	2009	2N3860	2009	2N4355	2021
2N3396	2009	2N3642	2009	2N3866	2009	2N4356	2021
2N3397	2009	2N3643	2009	2N3867	2025	2N4387	2025
2N3398	2013	2N3644	2021	2N3868	2025	2N4388	2025
2N3399	2003	2N3645	2021	2N3880	2009	2N4400	2009
2N3401	2021	2N3646	2009	2N3900	2009	2N4401	2009
2N3402	2016	2N3648	2011	2N3900A	2009	2N4402	2021
2N3403	2016	2N3662	2011	2N3901	2009	2N4403	2021
2N3404	2016	2N3663	2011	2N3903	2009	2N4409	2008
2N3405	2016	2N3671	2021	2N3904	2009	2N4410	2008
2N3415	2009	2N3672	2024	2N3905	2021	2N4433	2009
2N3416	2009	2N3673	2024	2N3906	2021	2N4851	2029
2N3417	2009	2N3677	2023	2N3924	2009	2N4852	2029
2N3427	2005	2N3682	2011	2N3932	2011	2N4853	2029
2N3428	2005	2N3688	2013	2N3933	2011	2N4870	2029
2N3449	2003	2N3689	2013	2N3948	2009	2N4871	2029
2N3451	2023	2N3690	2013	2N3959	2013	2N4898	2025
2N3461	2006	2N3692	2013	2N3976	2009	2N4899	2025
2N3462	2009	2N3693	2013	2N3983	2011	2N4900	2025
2N3463	2009	2N3694	2013	2N3984	2011	2N4901	2027
2N3464	2021	2N3702	2021	2N3985	2011	2N4904	2017
2N3469	2018	2N3703	2024	2N4037	2025	2N4910	2017
2N3478	2011	2N3704	2009	2N4058	2023	2N4911	2017
2N3485	2021	2N3705	2009	2N4059	2023	2N4912	2017
2N3485A	2021	2N3706	2009	2N4060	2023	2N4916	2023
2N3486	2021	2N3707	2009	2N4061	2023	2N4917	2023
2N3486A	2021	2N3708	2009	2N4062	2023	2N4918	2027
2N3493	2011	2N3709	2009	2N4072	2011	2N4919	2026
2N3496	2023	2N3710	2009	2N4073	2009	2N4921	2018
2N3502	2021	2N3711	2009	2N4074	2009	2N4922	2018
2N3503	2021	2N3719	2025	2N4078	2006	2N4923	2018
2N3504	2021	2N3720	2025	2N4086	2009	2N4934	2011
2N3505	2021	2N3721	2016	2N4087	2009	2N4935	2011
2N3508	2011	2N3740	2025	2N4087A	2009	2N4995	2013
2N3509	2011	2N3740A	2025	2N4106	2006	2N4996	2011
2N3510	2009	2N3741	2025	2N4121	2023	2N4997	2011
2N3511	2011	2N3741A	2025	2N4122	2021	2N5023	2021
2N3527	2023	2N3762	2025	2N4123	2009	2N5024	2011
2N3544	2011	2N3763	2025	2N4124	2009	2N5027	2009
2N3545	2023	2N3764	2025	2N4125	2023	2N5028	2009
2N3546	2024	2N3765	2025	2N4126	2024	2N5031	2011
2N3547	2023	2N3766	2017	2N4140	2009	2N5032	2011
2N3548	2023	2N3770	2003	2N4141	2009	2N5040	2021
2N3549	2023	2N3774	2025	2N4142	2023	2N5041	2021
2N3550	2023	2N3775	2025	2N4143	2024	2N5053	2011
2N3563	2015	2N3778	2025	2N4220	2028	2N5056	2023
2N3564	2015	2N3779	2025	2N4220A	2028	2N5057	2023
2N3565	2009	2N3782	2025	2N4221	2028	2N5058	2008
2N3566	2009	2N3783	2003	2N4221A	2028	2N5059	2008
2N3567	2009	2N3784	2003	2N4222	2028	2N5065	2009
2N3568	2009	2N3785	2003	2N4222A	2028	2N5066	2009
2N3569	2009	2N3793	2011	2N4234	2025	2N5081	2009
2N3576	2023	2N3794	2009	2N4235	2025	2N5082	2009
2N3579	2023	2N3798	2024	2N4337	2018	2N5086	2021
2N3580	2023	2N3799	2024	2N4238	2018	2N5087	2024
2N3581	2023	2N3825	2009	2N4241	2006	2N5088	2013
2N3582	2023	2N3828	2009	2N4248	2021	2N5089	2013
2N3588	2003	2N3829	2023	2N4249	2021	2N5107	2009
2N3600	2011	2N3832	2011	2N4250	2024	2N5110	2025
2N3605	2009	2N3840	2023	2N4251	2011	2N5126	2009
2N3606	2009	2N3843	2009	2N4254	2011	2N5127	2009
2N3607	2009	2N3843A	2009	2N4255	2011	2N5128	2009
2N3611	2006	2N3844	2009	2N4256	2009	2N5129	2009
2N3612	2006	2N3844A	2009	2N4257	2024	2N5130	2011

DEVICE	RS 276-	DEVICE	RS 276-	DEVICE	RS 276-	DEVICE	RS 276-
2N5131	2009	2N5482	2009	2S42	2006	2S3221	2023
2N5132	2009	2N5550	2008	2S43	2005	2S3230	2023
2N5133	2009	2N5551	2008	2S44	2005	2S3240	2023
2N5134	2009	2N5589	2009	2S45	2004	2SA12	2004
2N5135	2009	2N5597	2025	2S49	2004	2SA12A	2004
2N5136	2009	2N5599	2025	2S52	2004	2SA12C	2004
2N5137	2003	2N5601	2025	2S53	2004	2SA12H	2004
2N5138	2023	2N5636	2009	2S54	2005	2SA13	2004
2N5139	2023	2N5641	2009	2S56	2005	2SA14	2004
2N5142	2021	2N5644	2009	2S60	2003	2SA15	2004
2N5143	2021	2N5650	2011	2S91	2004	2SA15H	2004
2N5144	2009	2N5651	2011	2S92	2004	2SA15V	2003
2N5160	2021	2N5652	2011	2S92A	2004	2SA16	2004
2N5172	2011	2N5688	2009	2S93	2004	2SA17	2021
2N5179	2011	2N5697	2009	2S93A	2004	2SA17H	2021
2N5180	2011	2N5702	2009	2S001	2021	2SA18	2021
2N5181	2013	2N5710	2009	2S002	2021	2SA18H	2021
2N5182	2011	2N5763	2021	2S003	2009	2SA19	2003
2N5186	2009	2N5783	2025	2S005	2021	2SA20	2003
2N5187	2009	2N5786	2025	2S014	2021	2SA21	2003
2N5190	2019	2N5810	2009	2S017	2018	2SA26	2004
2N5191	2019	2N5811	2021	2S019	2018	2SA28	2003
2N5193	2027	2N5812	2009	2S022	2023	2SA29	2003
2N5194	2027	2N5813	2021	2S023	2023	2SA30	2003
2N5200	2015	2N5814	2009	2S101	2009	2SA31	2005
2N5201	2015	2N5815	2021	2S102	2009	2SA32	2004
2N5208	2023	2N5816	2009	2S103	2009	2SA33	2004
2N5209	2013	2N5817	2021	2S104	2009	2SA35	2003
2N5210	2013	2N5818	2009	2S109	2005	2SA36	2005
2N5219	2009	2N5819	2021	2S110	2005	2SA37	2004
2N5220	2011	2M5820	2018	2S111	2005	2SA38	2004
2N5221	2021	2N5821	2025	2S112	2005	2SA39	2004
2N5222	2015	2N5822	2018	2S131	2023	2SA40	2005
2N5223	2009	2N5823	2025	2S141	2005	2SA41	2007
2N5224	2009	2N5824	2013	2S142	2005	2SA42	2007
2N5225	2011	2N5825	2013	2S143	2003	2SA43	2005
2N5226	2021	2N5826	2013	2S145	2003	2SA44	2004
2N5232	2009	2N5827	2013	2S146	2003	2SA49	2003
2N5236	2009	2N5827A	2013	2S155	2004	2SA50	2003
2N5243	2021	2N5828	2013	2S159	2004	2SA51	2004
2N5244	2023	2N5828A	2013	2S160	2004	2SA52	2003
2N5272	2009	2N5830	2008	2S163	2005	2SA53	2003
2N5292	2015	2N5831	2008	2S167	2004	2SA54	2003
2N5296	2018	2N5832	2008	2S174	2004	2SA55	2004
2N5332	2023	2N5833	2008	2S178	2004	2SA56	2003
2N5354	2021	2N5893	2006	2S179	2005	2SA58	2003
2N5355	2021	2N5897	2006	2S302	2021	2SA59	2003
2N5356	2021	2N5914	2009	2S303	2021	2SA60	2003
2N5365	2021	2N5916	2009	2S304	2021	2SA61	2003
2N5366	2021	2N5917	2009	2S306	2021	2SA64	2004
2N5367	2021	2N5947	2009	2S307	2021	2SA65	2004
2N5368	2009	2NJ8A	2004	2S322	2023	2SA66	2004
2N5369	2009	2NJ9A	2005	2S322A	2023	2SA67	2004
2N5370	2009	2NJ9D	2005	2S323	2023	2SA69	2003
2N5371	2009	2NJ50	2005	2S324	2023	2SA70	2003
2N5372	2021	2NJ51	2004	2S326	2023	2SA70L	2003
2N5373	2021	2NJ52	2004	2S327	2023	2SA70MA	2003
2N5374	2021	2NJ53	2005	2S501	2009	2SA71	2003
2N5375	2021	20C72	2004	2S502	2009	2SA72	2003
2N5376	2009	2S13	2005	2S503	2009	2SA72BLU	2003
2N5377	2009	2S14	2005	2S512	2023	2SA72BLU BLU	2003
2N5378	2021	2S15	2005	2S701	2021	2SA72BRN	2003
2N5379	2921	2S15A	2005	2S702	2021	2SA72ORN	2003
2N5380	2009	2S22	2005	2S703	2021	2SA72WHT	2003
2N5381	2009	2S30	2005	2S711	2009	2SA73	2003
2N5377	2009	2S31	2004	2S712	2009	2SA74	2005
2N5378	2021	2S32	2004	2S731	2023	2SA75	2005
2N5379	2021	2S33	2005	2S732	2023	2SA76	2003
2N5380	2009	2S34	2005	2S733	2023	2SA77	2003
2N5381	2009	2S37	2005	2S741	2021	2SA80	2003
2N5455	2021	2S38	2005	2S742	2021	2SA81	2005
2N5456	2009	2S39	2005	2S744	2021	2SA82	2005
2N5457	2028	2S40	2005	2S745	2021	2SA83	2005
2N5458	2028	2S41	2006	2S3210	2023	2SA84	2005
2N5481	2009	2S41A	2006	2S3220	2023	2SA85	2005

DEVICE	RS 276-	DEVICE	RS 276-	DEVICE	RS 276-	DEVICE	RS 276-
2SA86	2003	2SA155	2003	2SA245	2003	2SA337	2003
2SA87	2005	2SA156	2003	2SA246	2003	2SA338	2003
2SA88	2005	2SA157	2003	2SA246V	2003	2SA339	2003
2SA89	2005	2SA159	2003	2SA247	2003	2SA340	2003
2SA90	2005	2SA160	2003	2SA250	2003	2SA341	2003
2SA92	2003	2SA161	2005	2SA251	2003	2SA342	2003
2SA93	2003	2SA162	2005	2SA252	2003	2SA343	2003
2SA94	2003	2SA763	2005	2SA253	2005	2SA344	2005
2SA100	2003	2SA164	2005	2SA254	2003	2SA345	2003
2SA100B	2003	2SA165	2005	2SA255	2003	2SA346	2003
2SA100C	2003	2SA166	2005	2SA256	2003	2SA347	2003
2SA101	2005	2SA167	2004	2SA257	2003	2SA348	2003
2SA101A	2005	2SA169	2004	2SA258	2003	2SA349	2003
2SA101AA	2005	2SA170	2004	2SA259	2003	2SA350	2003
2SA101BA	2003	2SA171	2004	2SA260	2003	2SA350A	2003
2SA101BB	2003	2SA172A	2005	2SA261	2003	2SA351	2003
2SA102	2005	2SA173	2004	2SA262	2003	2SA352	2003
2SA102AA	2005	2SA174	2004	2SA263	2003	2SA353	2003
2SA102BA	2005	2SA175	2003	2SA264	2003	2SA354	2003
2SA103	2005	2SA176	2005	2SA265	2003	2SA354B	2003
2SA103A	2005	2SA183	2003	2SA266	2003	2SA355	2003
2SA103C	2005	2SA188	2005	2SA267	2003	2SA356	2003
2SA103CA	2005	2SA189	2003	2SA268	2003	2SA357	2003
2SA103CG	2005	2SA197	2003	2SA269	2003	2SA359	2003
2SA104	2005	2SA198	2003	2SA270	2003	2SA360	2003
2SA105	2003	2SA201	2004	2SA271	2003	2SA361	2003
2SA106	2003	2SA201B	2004	2SA272	2003	2SA362	2003
2SA107	2003	2SA202	2004	2SA273	2005	2SA364	2003
2SA108	2003	2SA202D	2003	2SA274	2005	2SA365	2003
2SA109	2003	2SA203	2004	2SA275	2005	2SA366	2003
2SA110	2003	2SA204	2007	2SA276	2003	2SA367	2003
2SA111	2003	2SA205	2007	2SA277	2004	2SA368	2003
2SA112	2003	2SA206	2007	2SA278	2004	2SA369	2003
2SA113	2007	2SA207	2007	2SA279	2005	2SA371	2004
2SA114	2007	2SA208	2004	2SA280	2005	2SA372	2005
2SA115	2007	2SA209	2004	2SA281	2005	2SA375	2003
2SA116	2003	2SA210	2004	3SA282	2004	2SA377	2003
2SA117	2003	2SA211	2004	2SA283	2005	2SA378	2003
2SA118	2003	2SA212	2007	2SA284	2005	2SA379	2003
2SA121	2003	2SA213	2003	2SA285	2003	2SA380	2003
2SA122	2003	2SA214	2003	2SA286	2003	2SA381	2003
2SA123	2003	2SA215	2003	2SA287	2003	2SA382	2003
2SA124	2003	2SA216	2003	2SA288	2003	2SA383	2003
2SA125	2003	2SA217	2004	2SA289	2003	2SA384	2003
2SA126	2003	2SA218	2014	2SA290	2003	2SA385	2004
2SA130	2003	2SA219	2003	2SA291	2005	2SA391	2005
2SA131	2003	2SA220	2003	2SA292	2005	2SA392	2005
2SA132	2003	2SA221	2003	2SA293	2005	2SA393	2005
2SA133	2003	2SA222	2003	2SA294	2005	2SA393A	2005
2SA134	2003	2SA223	2003	2SA295	2005	2SA394	2005
2SA135	2003	2SA224	2003	2SA296	2005	2SA395	2005
2SA136	2003	2SA225	2003	2SA297	2005	2SA396	2005
2SA137	2003	2SA226	2003	2SA298	2005	2SA397	2005
2SA138	2004	2SA227	2003	2SA301	2005	2SA398	2005
2SA139	2005	2SA229	2003	2SA304	2004	2SA399	2005
2SA141	2005	2SA230	2003	2SA305	2004	2SA400	2003
2SA141B	2004	2SA231	2007	2SA306	2005	2SA401	2003
2SA141C	2004	2SA232	2005	2SA307	2005	2SA402	2023
2SA142	2005	2SA233	2003	2SA308	2003	2SA403	2003
2SA142A	2004	2SA234	2003	2SA309	2003	2SA404	2003
2SA142C	2005	2SA234B	2003	2SA313	2005	2SA405	2003
2SA143	2004	2SA234C	2003	2SA314	2005	2SA406	2007
2SA144	2005	2SA235	2003	2SA215	2005	2SA407	2007
2SA144C	2005	2SA235A	2003	2SA216	2005	2SA408	2003
2SA145	2005	2SA235C	2003	2SA321	2003	2SA409	2003
2SA145C	2005	2SA235H	2003	2SA322	2003	2SA410	2003
2SA146	2003	2SA236	2003	2SA323	2003	2SA411	2003
2SA147	2003	2SA237	2003	2SA324	2003	2SA413	2003
2SA148	2003	2SA238	2003	2SA325	2005	2SA414	2007
2SA149	2003	2SA239	2003	2SA326	2005	2SA415	2007
2SA150	2003	2SA240	2003	2SA327	2005	2SA417	2003
2SA151	2004	2SA241	2003	2SA329	2003	2SA419	2003
2SA152	2004	2SA242	2003	2SA330	2003	2SA420	2003
2SA153	2003	2SA243	2003	2SA332	2004	2SA421	2003
2SA154	2003	2SA244	2003	2SA335	2003	2SA422	2003

DEVICE	RS 276-	DEVICE	RS 276-	DEVICE	RS 276-	DEVICE	RS 276-
2SA427	2005	2SA517	2003	2SB52	2004	2SB130	2006
2SA428	2005	2SA518	2003	2SB53	2004	2SB131	2006
2SA430	2003	2SA522	2023	2SB54	2003	2SB131A	2006
2SA431	2003	2SA522A	2023	2SB55	2005	2SB132	2006
2SA431A	2003	2SA525	2023	2SB56	2003	2SB132A	2006
2SA432	2003	2SA527	2025	2SB56A	2007	2SB134	2004
2SA432A	2003	2SA528	2025	2SB57	2005	2SB135	2004
2SA433	2003	2SA530H	2021	2SB59	2005	2SB135B	2003
2SA434	2003	2SA532	2021	2SB60	2004	2SB135C	2003
2SA435	2003	2SA537	2021	2SB60A	2004	2SB136	2004
2SA436	2003	2SA538	2003	2SB61	2004	2SB136A	2005
2SA437	2003	2SA539	2021	2SB63	2006	2SB136B	2005
2SA438	2003	2SA542	2024	2SB64	2006	2SB136C	2005
2SA440	2003	2SA544	2021	2SB65	2004	2SB137	2006
2SA440A	2003	2SA545	2021	2SB66	2004	2SB138	2006
2SA447	2005	2SA548	2021	2SB66H	2003	2SB138A	2006
2SA448	2003	2SA550	2024	2SB67	2007	2SB138B	2006
2SA450	2003	2SA550A	2021	2SB67A	2007	2SB140	2006
2SA450H	2003	2SA552	2021	2SB69	2006	2SB141	2006
2SA451	2003	2SA561	2021	2SB71	2005	2SB142	2006
2SA451H	2003	2SA562	2021	2SB73	2003	2SB143	2006
2SA452	2003	2SA564	2024	2SB74	2005	2SB143P	2006
2SA452H	2003	2SA564A	2024	2SB75	2004	2SB144	2006
2SA453	2003	2SA565	2021	2SB75A	2007	2SB144P	2006
2SA454	2003	2SA567	2024	2SB75AH	2007	2SB145	2006
2SA455	2003	2SA568	2023	2SB75B	2005	2SB146	2006
2SA456	2003	2SA569	2021	2SB75C	2003	2SB147	2006
2SA457	2003	2SA570	2021	2SB75H	2004	2SB149	2006
2SA458	2007	2SA594	2021	2SB76	2004	2SB151	2006
2SA459	2003	2SA597	2025	2SB77	2004	2SB152	2006
2SA460	2003	2SA603	2021	2SB77A	2003	2SB153	2004
2SA461	2003	2SA608	2023	2SB77AH	2003	2SB154	2004
2SA462	2003	2SA609	2023	2SB77B	2003	2SB155	2004
2SA463	2003	2SA613	2025	2SB77C	2003	2SB156	2004
2SA464	2003	2SA614	2025	2SB77H	2003	2SB156A	2004
2SA466BLK	2003	2SA628	2023	2SB78	2004	2SB161	2004
2SA466BLU	2003	2SA628A	2021	2SB79	2004	2SB163	2004
2SA466YEL	2003	2SA629	2024	2SB80	2006	2SB165	2005
2SA467	2021	2SB16A	2006	2SB83	2006	2SB167	2005
2SA468	2003	2SB17A	2006	2SB84	2006	2SB168	2004
2SA469	2003	2SB18A	2003	2SB89	2007	2SB169	2004
2SA470	2003	2SB19	2006	2SB89A	2007	2SB170	2004
2SA471	2003	2SB20	2006	2SB89AH	2007	2SB171	2005
2SA471-1	2003	2SB21	2006	2SB89H	2007	2SB172	2005
2SA471-2	2003	2SB22	2003	2SB90	2005	2SB172A	2005
2SA472	2003	2SB22A	2003	2SB92	2005	2SB173	2005
2SA474	2005	2SB22B	2003	2SB94	2005	2SB173A	2005
2SA475	2005	2SB23	2003	2SB95	2003	2SB173B	2005
2SA476	2003	2SB24	2003	2SB98	2005	2SB173C	2005
2SA477	2003	2SB25	2006	2SB99	2005	2SB174	2005
2SA480	2023	2SB26	2006	2SB100	2005	2SB175	2005
2SA482	2021	2SB26A	2006	2SB101	2004	2SB175A	2005
2SA494	2009	2SB27	2006	2SB103	2004	2SB175B	2005
2SA494GR	2023	2SB28	2006	2SB105	2007	2SB176	2003
2SA4940	2023	2SB29	2006	2SB107	2006	2SB177	2007
2SA494Y	2023	2SB30	2006	2SB107A	2006	2SB178	2005
2SA495	2023	2SB31	2006	2SB108	2007	2SB178A	2005
2SA495G	2023	2SB32	2004	2SB108A	2007	2SB178T	2005
2SA496	2026	2SB33	2004	2SB110	2004	2SB180	2006
2SA496-0	2026	2SB34	2004	2SB111	2004	2SB180A	2006
2SA496-R	2026	2SB37	2003	2SB112	2005	2SB181	2006
2SA497	2025	2SB38	2004	2SB113	2005	2SB181A	2006
2SA498	2021	2SB39	2004	2SB114	2004	2SB183	2004
2SA499	2023	2SB40	2005	2SB115	2005	2SB184	2005
2SA500	2023	2SB41	2006	2SB116	2005	2SB185	2007
2SA501	2021	2SB42	2006	2SB117	2005	2SB186	2003
2SA503	2021	2SB43	2007	2SB120	2004	2SB187	2003
2SA504	2021	2SB43A	2003	2SB122	2006	2SB188	2003
2SA505	2026	2SB44	2004	2SB123	2006	2SB189	2005
2SA505-0	2026	2SB46	2005	2SB126	2006	2SB199	2005
2SA505-R	2026	2SB47	2005	2SB126F	2006	2SB200	2005
2SA506	2003	2SB48	2004	2SB126V	2006	2SB200A	2005
2SA507	2003	2SB49	2004	2SB127	2006	2SB201	2005
2SA508	2003	2SB50	2005	2SB128	2006	2SB202	2005
2SA509	2023	2SB51	2004	2SB129	2006	2SB215	2006

DEVICE	RS 276-	DEVICE	RS 276-	DEVICE	RS 276-	DEVICE	RS 276-
2SB216	2006	2SB317	2004	2SB427	2007	2SC32	2009
2SB217	2006	2SB318	2006	2SB428	2007	2SC33	2009
2SB218	2005	2SB321	2005	2SB431	2005	2SC34	2001
2SB219	2004	2SB322	2004	2SB439	2004	2SC35	2001
2SB220	2005	2SB323	2005	2SB440	2004	2SC36	2001
2SB221	2005	2SB324	2005	2SB443A	2005	2SC37	2009
2SB221A	2005	2SB326	2005	2SB443B	2005	2SC38	2009
2SB222	2005	2SB327	2005	2SB444A	2005	2SC39	2011
2SB223	2005	2SB328	2005	2SB444B	2005	2SC39A	2011
2SB224	2007	2SB329	2005	2SB445	2006	2SC40	2011
2SB225	2007	2SB335	2005	2SB448	2006	2SC45	2009
2SB226	2005	2SB336	2005	2SB449	2006	2SC47	2009
2SB227	2005	2SB337	2006	2SB450	2005	2SC50	2002
2SB228	2006	2SB338	2006	2SB450A	2005	2SC51	2018
2SB229	2006	2SB345	2003	2SB451	2006	2SC52	2009
2SB230	2006	2SB346	2003	2SB452	2006	2SC53	2009
2SB233	2006	2SB348	2005	2SB452A	2006	2SC54	2009
2SB235	2006	2SB349	2005	2SB453	2005	2SC55	2009
2SB236	2006	2SB350	2004	2SB454	2005	2SC56	2009
2SB238	2006	2SB355	2006	2SB455	2005	2SC60	2001
2SB240	2006	2SB358	2006	2SB457	2005	2SC61	2009
2SB240A	2006	2SB361	2006	2SB457A	2005	2SC62	2009
2SB242	2006	2SB362	2006	2SB458	2006	2SC63	2009
2SB242A	2006	2SB364	2005	2SB458A	2006	2SC67	2009
2SB243	2006	2SB365	2005	2SB459	2005	2SC68	2009
2SB243A	2006	2SB267	2006	2SB460	2003	2SC71	2002
2SB246	2006	2SB367H	2006	2SB461	2007	2SC72	2002
2SB247	2006	2SB368	2006	2SB463 <i>WRONG</i>	2006	2SC73	2002
2SB248	2006	2SB368H	2006	2SB465	2006	2SC74	2009
2SB248A	2006	2SB370	2005	2SB466	2006	2SC75	2001
2SB249	2006	2SB370A	2005	2SB467	2006	2SC76	2001
2SB250	2006	2SB370B	2005	2SB470	2005	2SC77	2001
2SB250A	2006	2SB371	2003	2SB471	2006	2SC78	2001
2SB251	2006	2SB372	2006	2SB471A	2006	2SC79	2011
2SB251A	2006	2SB373	2006	2SB471B	2006	2SC80	2009
2SB252	2006	2SB374	2006	2SB472	2006	2SC87	2009
2SB253	2006	2SB376	2005	2SB472A	2006	2SC89	2002
2SB254	2006	2SB377	2005	2SB472B	2006	2SC90	2002
2SB255	2006	2SB378	2004	2SB473 <i>WRONG</i>	2006	2SC91	2002
2SB256	2006	2SB379	2004	2SB474	2006	2SC98	2009
2SB257	2003	2SB380	2005	2SB475	2005	2SC99	2009
2SB261	2004	2SB380A	2005	2SB476	2006	2SC100	2009
2SB262	2005	2SB381	2004	2SB482	2003	2SC101	2017
2SB263	2004	2SB382	2005	2SB486	2003	2SC101A	2017
2SB264	2005	2SB383	2005			2SC103	2009
2SB265	2003	2SB384	2004	2SB492	2006	2SC103A	2009
2SB266	2004	2SB385	2004	2SB493	2006	2SC104	2009
2SB267	2004	2SB386	2003	2SB494	2006	2SC104A	2009
2SB268	2003	2SB387	2005	2SB495	2006	2SC105	2011
2SB269	2004	2SB389	2003	2SB495A	2006	2SC109	2009
2SB270	2005	2SB390	2006	2SB496	2005	2SC110	2009
2SB271	2005	2SB391	2006	2SB497	2004	2SC111	2009
2SB272	2005	2SB392	2004	2SB502	2025	2SC115	2009
2SB273	2005	2SB393	2004	2SB503	2025	2SC116	2009
2SB274	2006	2SB394	2004	2SBF1	2004	2SC120	2009
2SB282	2006	2SB395	2004	2SBF1A	2004	2SC121	2009
2SB283	2006	2SB396	2004	2SBF2	2005	2SC122	2009
2SB284	2006	2SB400	2005	2SBF5	2006	2SC123	2009
2SB290	2005	2SB401	2007	2SC11	2001	2SC124	2009
2SB291	2005	2SB402	2007	2SC12	2009	2SC125	2003
2SB292	2004	2SB403	2007	2SC13	2002	2SC127	2009
2SB292A	2007	2SB405	2006	2SC14	2002	2SC128	2001
2SB293	2005	2SB405A	2006	2SC15	2009	2SC129	2001
2SB294	2004	2SB405B	2006	2SC16	2009	2SC131	2009
2SB295	2006	2SB405C	2006	2SC16A	2009	2SC132	2009
2SB299	2005	2SB407	2006	2SC17	2009	2SC133	2009
2SB301	2006	2SB408	2004	2SC17A	2009	2SC134	2009
2SB302	2005	2SB414	2006	2SC18	2009	2SC135	2009
2SB303	2003	2SB415 <i>WRONG</i>	2006	2SC19	2009	2SC137	2009
2SB304	2005	2SB416	2004	2SC20	2009	2SC140	2018
2SB304A	2007	2SB417	2004	2SC27	2009	2SC147	2018
2SB309	2006	2SB423	2005	2SC28	2009	2SC150	2009
2SB312	2006	2SB424	2006	2SC29	2009	2SC150T	2009
2SB315	2004	2SB425	2006	2SC30	2009	2SC151	2009
2SB316	2004	2SB426	2006	2SC31	2009	2SC154C	2008

DEVICE	RS 276-	DEVICE	RS 276-	DEVICE	RS 276-	DEVICE	RS 276-
2SC155	2009	2SC289	2011	2SC402A	2009	2SC605	2011
2SC156	2009	2SC291	2018	2SC402B	2013	2SC606	2011
2SC157	2009	2SC300	2011	2SC403	2009	2SC611	2011
2SC158	2009	2SC301	2011	2SC403A	2009	2SC612	2011
2SC159	2009	2SC302	2013	2SC403B	2013	2SC619	2009
2SC160	2011	2SC306	2009	2SC404	2009	2SC620	2009
2SC166	2009	2SC313	2011	2SC405	2002	2SC621	2009
2SC167	2009	2SC316	2009	2SC406	2002	2SC621A	2009
2SC170	2009	2SC318	2013	2SC423	2009	2SC622	2009
2SC171	2009	2SC318A	2013	2SC424	2009	2SC627	2017
2SC172	2011	2SC319	2009	2SC425	2009	2SC629	2011
2SC172A	2011	2SC320	2009	2SC426	2009	2SC631	2009
2SC174	2011	2SC321H	2009	2SC429	2011	2SC631A	2009
2SC179	2002	2SC323	2009	2SC429J	2011	2SC632	2009
2SC180	2002	2SC324	2016	2SC430	2011	2SC632A	2009
2SC181	2002	2SC324H	2016	2SC430H	2011	2SC633	2011
2SC182	2011	2SC350	2009	2SC440	2009	2SC633A	2009
2SC183	2011	2SC350H	2009	2SC441	2009	2SC634	2009
2SC184	2011	2SC351	2011	2SC442	2009	2SC634A	2009
2SC185	2011	2SC352	2009	2SC454	2009	2SC639	2009
2SC186	2009	2SC352A	2009	2SC454L	2009	2SC640	2009
2SC187	2009	2SC356	2009	2SC458	2009	2SC641H	2009
2SC188	2009	2SC360	2009	2SC458B	2013	2SC644	2009
2SC189	2009	2SC361	2011	2SC458L	2009	2SC645	2011
2SC190	2009	2SC362	2011	2SC458LG	2009	2SC648H	2009
2SC191	2009	2SC363	2009	2SC460	2009	2SC649	2009
2SC192	2009	2SC366	2009	2SC461	2009	2SC650	2009
2SC193	2009	2SC366G	2009	2SC464	2011	2SC652	2009
2SC194	2009	2SC367	2009	2SC465	2011	2SC654	2009
2SC195	2009	2SC367G	2009	2SC466	2011	2SC657	2011
2SC196	2009	2SC368	2009	2SC468H	2009	2SC658	2011
2SC197	2009	2SC369	2009	2SC469	2011	2SC659	2009
2SC200	2009	2SC369G	2009	2SC475	2009	2SC660	2011
2SC201	2009	2SC370	2009	2SC476	2009	2SC661	2011
2SC203	2009	2SC370G	2013	2SC477	2009	2SC662	2011
2SC204	2009	2SC371	2009	2SC478	2013	2SC663	2011
2SC206	2011	2SC371B	2009	2SC479H	2009	2SC668	2011
2SC210	2009	2SC371G	2009	2SC482	2018	2SC668E	2015
2SC211	2009	2SC372	2009	2SC490	2017	2SC668F	2015
2SC212	2008	2SC372G	2009	2SC491	2017	2SC674	2011
2SC214	2009	2SC373	2009	2SC495	2018	2SC682	2011
2SC216	2009	2SC373G	2009	2SC495-0	2018	2SC682A	2011
2SC217	2009	2SC374	2009	2SC495-R	2018	2SC683	2011
2SC220	2009	2SC375	2011	2SC496	2018	2SC684	2011
2SC221	2009	2SC377	2013	2SC496-0	2018	2SC689H	2009
2SC226	2009	2SC378	2013	2SC496-R	2018	2SC693	2009
2SC227	2009	2SC379	2011	2SC497	2018	2SC694	2009
2SC231	2009	2SC380	2011	2SC503	2009	2SC695	2011
2SC232	2009	2SC381	2009	2SC504	2009	2SC705	2011
2SC237	2009	2SC382	2011	2SC509	2011	2SC707	2011
2SC238	2009	2SC382G	2011	2SC517	2018	2SC707H	2011
2SC239	2009	2SC382R	2011	2SC535	2011	2SC708	2018
2SC250	2009	2SC384	2011	2SC536	2011	2SC708A	2018
2SC251	2009	2SC385	2011	2SC537	2011	2SC709	2011
2SC251A	2009	2SC385A	2011	2SC538	2016	2SC710	2011
2SC252	2011	2SC386	2011	2SC538A	2013	2SC711	2009
2SC253	2011	2SC386A	2009	2SC539	2009	2SC711A	2013
2SC266	2011	2SC387	2011	2SC539R	2009	2SC712	2009
2SC267	2011	2SC387A	2011	2SC540	2011	2SC712A	2011
2SC267A	2009	2SC387G	2011	2SC545	2011	2SC713	2009
2SC269	2011	2SC388	2011	2SC554	2009	2SC715	2011
2SC271	2011	2SC388A	2009	2SC556	2009	2SC716	2011
2SC272	2011	2SC389	2011	2SC559	2009	2SC717	2011
2SC281	2011	2SC391	2011	2SC561	2009	2SC732	2013
2SC281H	2009	2SC392	2011	2SC562	2009	2SC733	2013
2SC282	2011	2SC394	2009	2SC563	2011	2SC735	2009
2SC283	2013	2SC395	2009	2SC567	2011	2SC738	2009
2SC283H	2013	2SC395A	2009	2SC568	2011	2SC739	2009
2SC285	2009	2SC396	2009	2SC587	2013	2SC740	2011
2SC285A	2009	2SC397	2011	2SC587A	2013	2SC741	2009
2SC286	2011	2SC398	2011	2SC588	2009	2SC752	2009
2SC287	2011	2SC399	2011	2SC594	2009	2SC752G	2009
2SC287A	2011	2SC400	2009	2SC595	2011	2SC761	2011
2SC288	2011	2SC401	2009	2SC601	2011	2SC762	2011
2SC288A	2011	2SC402	2009	2SC602	2011	2SC763	2009

DEVICE	RS 276-	DEVICE	RS 276-	DEVICE	RS 276-	DEVICE	RS 276-
2SC772	2011	2SC1056	2008	2SD167	2001	2T204	2003
2SC773	2009	2SC1060	2018	2SD178	2001	2T230	2005
2SC784	2011	2SC1061	2018	2SD178A	2001	2T231	2005
2SC785	2011	2SC1117	2011	2SD182	2018	2T311	2005
2SC786	2011	2SCF1	2009	2SD184	2018	2T312	2005
2SC787	2015	2SCF2	2013	2SD186	2002	2T313	2005
2SC796	2009	2SCF-2	2009	2SD187	2002	2T314	2005
2SC797	2009	2SCF5	2009	2SD191	2001	2T315	2005
2SC800	2011	2SCF11	2011	2SD192	2001	2T321	2005
2SC814	2009	2SCD11	2002	2SD193	2001	2T322	2005
2SC815	2009	2SD19	2002	2SD195	2001	2T323	2005
2SC821	2009	2SD20	2002	2SD219	2018	2T324	2005
2SC828	2009	2SD21	2002	2SD220	2018	2T402	2009
2SC828A	2013	2SD22	2002	2SD222	2018	2T403	2009
2SC829	2009	2SD23	2002	2SD223	2018	2T404	2009
2SC830	2017	2SD25	2001	2SD226	2017	2T918	2009
2SC837	2011	2SD28	2017	2SD226A	2017	2T2708	2009
2SC838	2013	2SD29	2017	2SD226B	2017	2T2857	2009
2SC839	2013	2SD30	2001	2SD227	2009	2T3011	2006
2SC844	2009	2SD31	2001	2SD228	2009	2T3021	2006
2SC847	2009	2SD32	2001	2SD234	2018	2T3022	2006
2SC848	2009	2SD32	2001	2SD2340	2018	2T3030	2006
2SC849	2009	2SD33	2001	2SD234R	2018	2T3031	2006
2SC850	2009	2SD34	2001	2SD235	2019	2T3032	2006
2SC858	2009	2SD35	2001	2SD2350	2018	2T3033	2006
2SC859	2009	2SD36	2001	2SD235R	2018	2T3041	2006
2SC864	2009	2SD37	2001	2SD236	2017	2T3042	2006
2SC870	2009	2SD38	2001	2SD237	2017	2T3043	2006
2SC871	2009	2SD43	2001	2SD256	2017	2V362	2005
2SC876	2009	2SD43A	2001	2SD261	2009	2V363	2004
2SC890	2009	2SD44	2001	2SDF1	2001	2V464	2004
2SC894	2009	2SD57	2019	2SE4002	2001	2V465	2004
2SC899	2013	2SD58	2018	2SK17	2028	2V466	2005
2SC900	2009	2SD61	2002	2SK24	2028	2V467	2005
2SC903	2009	2SD62	2002	2T11	2005	2V482	2004
2SC904	2009	2SD63	2002	2T12	2005	2V483	2005
2SC905	2009	2SD64	2002	2T13	2004	2V484	2005
2SC912	2011	2SD65	2002	2T14	2005	2V485	2005
2SC913	2009	2SD66	2002	2T15	2005	2V486	2005
2SC920	2009	2SD72	2001	2T16	2005	2V559	2005
2SC921	2011	2SD72A	2001	2T17	2005	2V560	2005
2SC923	2009	2SD72B	2001	2T21	2005	2V561	2005
2SC924	2009	2SD72C	2001	2T22	2005	2V562	2005
2SC927	2011	2SD75	2002	2T23	2005	2V563	2005
2SC928	2011	2SD75A	2002	2T24	2005	2V631	2005
2SC929	2011	2SD75AH	2002	2T25	2005	2V632	2005
2SC930	2011	2SD75H	2002	2T26	2005	2V633	2004
2SC931	2018	2SD77	2002	2T40	2009	3L4-6004	2019
2SC932	2018	2SD77A	2002	2T41	2009	3L4-6005-1	2018
2SC933	2009	2SD77AH	2002	2T42	2009	3L4-6005-3	2018
2SC941	2011	2SD77H	2002	2T43	2009	3L4-6007-1	2016
2SC943	2009	2SD90	2018	2T44	2009	3L4-6007-2	2016
2SC944	2013	2SD91	2017	2T51	2002	3L4-6007-3	2016
2SC947	2011	2SD96	2001	2T52	2002	3MC	2005
2SC948	2011	2SD101	2001	2T53	2002	2N22	2002
2SC957	2011	2SD104	2001	2T54	2002	3N23	2002
2SC966	2018	2SD105	2001	2T55	2002	3N23A	2002
2SC968	2018	2SD120	2018	2T56	2002	3N23B	2002
2SC971	2018	2SD122	2018	2T57	2002	3N23C	2002
2SC984	2009	2SD127	2002	2T58	2002	3N29	2002
2SC991	2009	2SD127A	2002	2T63	2002	3N30	2002
2SC992	2009	2SD128	2002	2T64	2002	3N31	2002
2SC994	2009	2SD128A	2002	2T65	2002	3N34	2003
2SC997	2011	2SD130	2017	2T66	2002	3N35	2009
2SC1003	2019	2SD136	2008	2T67	2002	3N35A	2003
2SC1010	2013	2SD137	2008	2T69	2002	3N36	2001
2SC1012A	2008	2SD141	2018	2T71	2002	3N37	2001
2SC1024	2017	2SD142	2018	2T72	2002	3N90	2023
2SC1035	2011	2SD143	2017	2T73	2002	3N91	2023
2SC1036	2011	2SD146	2019	2T76	2002	3N92	2023
2SC1038	2009	2SD147	2018	2T78	2002	3N93	2023
2SC1039	2009	2SD150	2017	2T85	2002	3N94	2023
2SC1041	2009	2SD154	2017	2T201	2003	3N95	2023
2SC1042	2009	2SD155	2017	2T202	2009	3S004	2009
2SC1047	2011	2SD162	2001	2T203	2003	3SB347	2005

DEVICE	RS 276-	DEVICE	RS 276-	DEVICE	RS 276-	DEVICE	RS 276-
3T201	2001	6-88	2005	09-302012	2011	13-15808-2	2009
3T202	2001	6-89X	2001	09-302016	2011	13-15810-1	2015
3T203	2001	6A10227	2009	09-302020	2009	13-15833-1	2009
4-46	2009	6A10228	2016	09-302030	2013	13-15835-1	2013
4-47	2009	6A10229	2006	09-302034	2009	13-15840-1	2013
4-48	2006	6A10422	2009	09-302037	2011	13-15840-2	2013
4-142	2006	6A10423	2016	09-302039	2009	13-15841-1	2011
4-297	2003	6A10520	2016	09-302040	2011	13-15842-1	2009
4-280	2005	6A10622	2005	09-302078	2009	13-15842-2	2009
4-283	2018	6A10624	2003	09-303005	2017	13-16570-1	2021
4-432	2003	6A10851	2009	09-303013	2001	13-16744-1	2011
4-433	2011	6A10855	2009	09N1	2011	13-16769-1	2009
4-434	2011	6A11223	2011	10-1	2011	13-18034-1	2006
4-435	2006	6A12515	2005	10-2	2011	13-18087-1	2016
4C28	2009	6A12516	2003	10P1	2021	13-18087-2	2009
4C29	2009	6A12517	2005	11C1057	2009	13-18158-1	2009
4C30	2009	6A12725	2013	12-4	2009	13-18198-1	2006
4C31	2009	6A12788	2009	12M2	2006	13-18363-3	2013
4D20	2009	6D122	2004	12X047	2009	13-18364-1	2013
4D21	2009	6D122R	2004	13-0006	2021	13-18365-1	2013
4D22	2009	6D122V	2004	13-0009	2013	13-18654-1	2001
4D24	2009	6X97047A02	2005	13-0010	2013	13-18927-1	2016
4D25	2009	7-4	2011	13-0020	2015	13-18944-1	2021
4D26	2009	7-9	2011	13-0021	2009	13-18944-2	2021
4JD3B1	2001	7-10	2011	13-0022	2013	13-18947-1	2003
4JX1A520B	2005	7-17	2013	13-0040	2015	13-18948-1	2003
4JX1A520C	2005	8-0060	2005	13-0043	2023	13-18948-2	2005
4JX1A520D	2004	8A10521	2006	13-0044	2021	13-18950-1	2011
4JX1A520E	2004	8A11667	2006	13-0048	2016	13-18951-1	2005
4JX1C850	2005	8A11721	2006	13-0049	2018	13-18951-2	2005
4JX1C850A	2004	8A12359	2006	13-0058	2016	13-22581-1	2009
4JX1E821	2004	8A12789	2011	13-0061	2021	13-22582-1	2024
4JX1E850	2004	8A13718	2005	13-1032-5	2011	13-22739-1	2006
4JX2A60	2004	8H303	2006	13-1836-1	2016	13-22741-1	2006
4JX2A801	2002	8L201	2006	13-10321-5	2011	13-23785-1	2005
4JX8D404	2006	8L201B	2006	13-10321-6	2015	13-23822-1	2011
4JX16A667/G	2009	8L201R	2006	13-10321-7	2011	13-23824-1	2011
4JX16A667/O	2009	8L201V	2006	13-10321-8	2011	13-23826-1	2023
4JX16A667/R	2009	8P73BLU	2019	13-10321-10	2011	13-23826-2	2023
4JX16A667/Y	2016	8P73GRN	2019	13-10321-11	2011	13-23826-3	2023
4JX16A668/G	2016	8P73YEL	2019	13-10321-12	2011	13-23840-1	2009
4JX16A668/O	2016	8P404	2006	13-10321-14	2011	13-23916-1	2009
4JX16A668/Y	2016	8P404ORN	2006	13-10321-15	2015	13-26009-1	2011
4JX16A669/G	2016	8P404R	2006	13-10321-16	2015	13-26377-1	2006
4JX16A669/Y	2016	8P404T	2006	13-10321-17	2015	13-26386-1	2024
4JX16B670/G	2016	8P404V	2006	13-10321-20	2011	13-26576-1	2011
4JX16B670/R	2009	8P-505	2006	13-10321-21	2011	13-26576-2	2011
4JX16B670/Y	2009	9TR1	2009	13-10321-29	2011	13-26577-1	2009
5-8	2013	9TR2	2013	13-10321-31	2011	13-26577-2	2009
6-4	2013	9TR3	2011	13-10321-32	2011	13-26577-3	2009
6-9	2013	9TR4	2021	13-14085-3	2011	13-26666-1	2018
6-04GRN	2013	9TR5	2013	13-14085-4	2011	13-27050-1	2001
6-04ORN	2013	9TR9	2017	13-14085-6	2011	13-27404-1	2009
6-05YEL	2013	9TR10	2009	13-14085-7	2011	13-27404-2	2013
6-11	2013	02P1B	2021	13-14085-9	2004	13-27432-1	2018
6-13	2005	03-57-102	2003	13-14085-10	2004	13-27433-1	2011
6-19	2013	03-57-202	2003	13-14085-11	2005	13-27974-4	2008
6-30	2013	09-033006	2001	13-14085-12	2004	13-28222-1	2026
6-31	2021	09-300006	2004	13-14085-13	2009	13-28222-2	2018
6-32	2009	09-300012	2003	13-14085-15	2011	13-28336-1	2026
6-33	2021	09-300015	2003	13-14085-16	2011	13-28336-2	2018
6-38	2021	09-300016	2003	13-14085-17	2011	13-28391-1	2023
6-53	2005	09-300024	2003	13-14085-18	2003	13-28391-2	2023
6-53/63	2005	09-300037	2023	13-14604-1	2006	13-28392-1(METAL)	2018
6-60	2004	09-301002	2004	13-14605-1	2018	13-28392-1(PLAS)	2009
6-60B	2005	09-301003	2003	13-14606-1	2009	13-28392-2(METAL)	2018
6-60D	2004	09-301004	2003	13-14735-1	2006	13-28392-2(PLAS)	2009
6-60P	2004	09-301009	2003	13-14777-1	2006	13-28392-3(METAL)	2018
6-61	2004	09-301010	2006	13-14778-1	2006	13-28392-3(PLAS)	2009
6-61D	2004	09-301015	2006	13-14886-1	2003	13-28394-3	2018
6-61P	2004	09-301016	2003	13-14887-1	2003	13-28432-1	2008
6-62	2004	09-301020	2005	13-14888-3	2003	13-28471-1	2018
6-62D	2004	09-301024	2006	13-14889-1	2003	13-28584-1	2015
6-62P	2004	09-301036	2003	13-15804-1	2013	13-29033-1	2013
6-63	2005	09-302009	2015	13-15808-1	2009	13-29033-2	2013

DEVICE	RS 276-	DEVICE	RS 276-	DEVICE	RS 276-	DEVICE	RS 276-
13-29033-3	2013	19-020-076	2013	24MW61	2014	31-0180	2003
13-29033-4	2013	19-3349	2009	24MW70	2004	31-0196	2006
13-29432-1	2013	19-3415	2005	24MW77	2004	31-0205	2005
13-29776-1	2013	19-2316	2005	24MW111	2004	31-0239	2016
13-29947-1	2013	19-3934-643	2009	24MW115	2004	31-0241	2003
13-33595-1	2013	20-1	2015	24MW116	2004	32-20738	2009
13-22595-2	2013	20A0007	2005	24MW130	2001	33-070	2009
13-36386-1	2024	20A0009	2005	24MW132	2005	33-090	2018
13-50484-1	2003	20A0015	2005	24MW179	2005	33-096	2026
13-50486-1	2003	20A0017	2006	24MW185	2005	33-1000-00	2004
13-50631-1	2005	20A10849	2009	24MW187	2004	33-1001-00	2004
13-50944-1	2004	20C71	2005	24MW256	2006	33-1004-00	2006
13-55061-1	2013	20C72	2005	24MW441	2005	33-1009-01	2004
13-55063-1	2015	20V-HG	2005	24MW454	2009	33-1019-00	2005
13-55065-1	2011	21-28	2006	24MW458	2009	33-1020-00	2005
13-55066-1	2013	21-36	2005	24MW460	2009	33-1021-00	2003
13-55066-2	2009	21-37	2005	24MW461	2009	34-1002	2018
13-55067-1	2013	21A015-001	2021	24MW535	2011	34-1003	2026
13-55068-1	2009	21A015-003	2006	24MW584	2011	34-1027	2025
13-55069-1	2021	21A015-008	2023	24MW595	2009	34-6000-16	2005
13-86420-1	2002	21A015-009	2021	24MW596	2009	34-6000-69	2011
13-87433-1	2002	21A015-011	2021	24MW597	2009	34-6000-72	2011
13-94096-2	2004	21A015-012	2024	24MW598	2003	34-6000-76	2003
14-1	2009	21A015-013	2009	24MW599	2005	34-6000-79	2003
14-2	2009	21A015-014	2013	24MW600	2004	34-6000-80	2003
14-3	2011	21A015-016	2015	24MW601	2003	34-6000-81	2003
14-577-10	2005	21A015-018	2013	24MW608	2004	34-6000-83	2004
14-602-03	2016	21A015-019	2013	24MW609	2009	34-6001-6	2016
14-602-13	2016	21A015-020	2013	24MW613	2004	34-6001-15	2025
14-602-35	2009	21A015-022	2006	24MW614	2004	34-6001-16	2005
14-602-41	2013	21A040-003	2011	24MW615	2003	34-6001-28	2005
14-602-48	2011	21A040-004	2011	24MW618	2006	34-6001-33	2005
14-602-49	2009	21A040-005	2005	24MW789	2005	34-6001-43	2005
14-603-02	2011	21A040-007	2011	24MW790	2009	34-6001-44	2005
14-603-03	2011	21A040-010	2011	24MW795	2009	34-6001-54	2009
14-603-05	2011	21A040-014	2005	24MW799	2005	34-6001-55	2009
15-1	2013	21A040-023	2011	24MW801	2009	34-6001-56	2009
15-2	2013	21A040-024	2009	24MW805	2009	34-6001-57	2009
15-3	2024	21A040-025	2009	24MW815	2009	34-6001-58	2009
15-4	2024	21A040-032	2013	24MW855	2013	34-6001-60	2009
15-5	2023	21A040-034	2009	24MW856	2003	34-6001-61	2018
15-082019	2009	21A040-035	2007	24MW857	2004	34-6001-63	2016
15-088002	2021	22-1	2006	24MW863	2011	34-6001-64	2016
15-088003	2011	22-001001	2009	24T-015-013	2011	34-6001-66	2005
15Z3	2021	22-001002	2011	24T-016	2011	34-6001-69	2016
16A545-7	2013	22-001003	2011	24T-016-001	2015	34-6001-70	2016
16A1938	2013	22-001004	2011	24T-016-010	2011	34-6001-73	2009
16G2	2009	22-001005	2011	24T002	2011	34-6001-74	2009
16GN	2015	22-001006	2009	25A	2009	34-6001-76	2005
16J1	2011	22-001007	2016	25A1	2009	34-6001-77	2009
16L2	2011	22-001008	2017	25A2	2013	34-6001-80	2018
16L2	2011	22-001009	2017	25A1273-001	2013	34-6001-86	2025
16L3	2011	22-001010	2021	25B	2009	34-6008	2005
16L5	2011	22-002001	2006	25B1	2009	34-6009	2005
16L22	2011	22-002006	2003	25B2	2013	34-6015-1	2009
16L23	2011	22-002007	2005	25B378	2004	34-6015-2	2016
16L42	2009	22-002008	2006	29V12H01	2004	34-6015-3	2016
16L43	2009	22-002009	2006	29V0038H03	2005	34-6015-4	2016
16L44	2009	23	2009	29V008M01	2004	34-6015-5	2009
16L62	2009	23-1	2021	29V011H01	2004	34-6015-6	2009
16L63	2009	23-2	2021	30-090	2018	34-6015-7	2016
16L64	2009	23-3	2021	30V-H6	2005	34-6015-8	2009
16X1	2011	24-002	2016	31-0017	2005	34-6015-9	2009
16X2	2009	24A	2009	31-0018	2005	34-6015-10	2009
17-443	2018	24A1	2009	31-0025	2004	34-6015-11	2016
17-451	2009	24B	2009	31-0026	2004	34-6015-12	2016
17-459	2021	24B1	2009	31-0035	2005	34-6015-17	2009
19-1	2021	24MW27	2004	31-0065	2003	34-5015-18	2016
19-2	2021	24MW28	2004	31-0107	2005	34-6015-19	2009
19-3	2021	24MW29	2003	31-0134	2005	34-6015-20	2009
19-020-070	2021	24MW34	2004	31-0139	2005	34-6015-21	2016
19-020-071	2009	24MW43	2004	31-0150	2003	34-6015-22	2009
19-020-072	2009	24MW44	2003	31-0172	2005	34-6015-24	2018
19-020-073	2009	24MW55	2003	31-0177	2016	34-6015-25	2009
19-020-074	2009	24MW59	2003	31-0178	2013	34-6015-26	2005

DEVICE	RS 276-	DEVICE	RS 276-	DEVICE	RS 276-	DEVICE	RS 276-
34-6015-29	2011	43P7C	2005	48-10074A01	2003	48-64978A27	2003
34-6015-30	2018	45N2M	2016	48-10074A02	2003	48-64978A28	2003
34-6015-37	2011	45N3	2009	48-10074A03	2005	48-64978A29	2003
34-6015-41	2009	45N4	2016	48-10079A01	2003	48-64978A41	2021
34-6016-1	2005	45N4M	2016	48-10079A02	2003	48-65112A65	2011
34-6016-11	2005	46-119-3	2011	48-13470	2013	48-65112A67	2011
34-6016-15	2009	46-8610-3	2003	48-40118B01	2023	48-65113A88	2011
34-6016-16	2018	46-8611	2003	48-40170G01	2009	48-65118A64	2011
34-6016-17	2009	46-8611-3	2003	48-40171G01	2009	48-65123A67	2011
34-6016-18	2018	46-8613-3	2004	48-40246G01	2013	48-65123A95	2011
34-6016-25	2018	46-8629	2011	48-40247G01	2013	48-65144A72	2011
34-6016-26	2018	46-8671-3	2002	48-40247G02	2013	48-65146A61	2011
34-6016-27	2018	46-8677-2	2011	48-42098B01	2021	48-65146A62	2011
34-6016-63	2016	46-8677-3	2011	48-43351A01	2005	48-65146A63	2015
35P1	2005	46-8679-3	2003	48-43351A02	2011	48-65147A72	2013
36P1	2005	46-8680-3	2003	48-43351A03	2011	48-90165A01	2021
36P1C	2005	46-8681-3	2003	48-43351A04	2011	48-90172A01	2009
36P1F	2005	46-8682-3	2011	48-43351A05	2011	48-90232A17	2011
36P2F	2005	46-8695-3	2009	48-60022A13	2013	48-90232A18	2011
36P3	2005	46-84120-3	2011	48-63005A66	2016	48-90232A19	2011
36P3A	2005	46-85285-3	2015	48-63005A72	2009	48-87046A02	2004
36P3C	2005	46-86107-3	2011	48-63026A46	2009	48-97046A03	2003
36P4	2005	46-86108-3	2011	48-63026A47	2009	48-97046A04	2011
36P4C	2005	46-86112-3	2011	48-63029A16	2014	48-97046A05	2010
36P5	2005	46-86113-3	2011	48-63029A17	2005	48-97046A06	2011
36P5C	2005	46-86114-3	2011	48-63029A18	2004	48-97046A07	2011
36P7C	2005	46-86118-3	2011	48-63029A19	2004	48-97046A08	2005
38P1	2005	46-86119-3	2011	48-63029A60	2003	48-97046A09	2005
39A9	2005	46-86120-3	2011	48-63029A90	2003	48-97046A10	2003
39P1	2006	46-86126-3	2011	48-63029A91	2004	48-97046A15	2006
40-601	2003	46-86127-3	2011	48-63029A92	2004	48-97046A16	2003
40P1	2005	46-86131-3	2011	48-63029A93	2004	48-97046A17	2011
40P2	2005	46-86132-3	2009	48-63029A94	2004	48-97046A18	2009
41N1	2011	46-86133-3	2011	48-63075A72	2003	48-97046A19	2009
41N2	2013	46-86140-3	2015	48-63075A73	2003	48-97046A20	2009
41N2M	2013	46-86143-3	2009	48-63075A74	2014	48-97046A21	2009
41N3	2013	46-86144-3	2011	48-63075A75	2003	48-97046A22	2013
42-17444	2013	46-86145-3	2015	48-63075A76	2004	48-97046A23	2013
42-18109	2006	46-86163-3	2003	48-63076A52	2009	48-97046A24	2009
42-18111	2009	46-86170-3	2023	48-63076A81	2011	48-97046A25	2016
42-19670	2009	46-86171-3	2011	48-63076A82	2011	48-97046A26	2021
42-19862	2005	46-86172-3	2011	48-63076A83	2009	48-97046A27	2021
42-19862A	2001	46-86195-3	2005	48A63077A03	2005	48-97046A28	2009
42-19863	2005	46-86196-3	2006	48-63077A10	2009	48-97046A30	2018
42-19864	2005	46-86207-3	2011	48-63077A29	2011	48-97046A31	2006
42-22008	2021	46-86208-3	2011	48-63077A30	2009	48-97046A32	2005
42-22158	2009	46-86209-3	2011	48-63077A31	2009	48-97046A33	2005
42-22532	2011	46-86210-3	2009	48-63078A26	2011	48-97046A34	3009
42-22533	2009	46-86211-3	2001	48-63078A52	2011	48-97046A36	2024
42-22534	2003	46-86213-3	2006	48-63078A54	2011	48-97046A48	2005
42-22535	2005	46-86224-3	2011	48-63078A59	2004	48-97046A50	2009
42-22778	2003	46-86226-3	2017	48-63078A60	2004	48-97127A05	2005
42-22779	2003	46-86228-3	2011	48-63078A61	2003	48-97127A06	2009
42-22780	2003	46-86229-3	2023	48-63078A62	2003	48-97127A08	2009
42-22781	2003	46-86230-3	2023	48-63078A63	2005	48-97127A12	2009
42-22784	2003	46-86231-3	2009	48-63078A64	2004	48-97127A13	2009
42-22785	2009	46-86232-3	2008	48-63078A65	2004	48-97127A18	2011
42-22786	2013	46-86234-3	2018	48-63078A66	2004	48-97127A19	2009
42-22787	2013	46-86235-3	2026	48-63078A68	2003	48-97127A20	2004
42-22809	2009	46-86238-3	2021	48-63078A69	2009	48-97162A01	2011
42-22810	2021	46-86240-3	2011	48-63078A70	2009	48-97162A02	2011
42-22811	2013	46-86244-3	2011	48-63078A71	2009	48-97162A03	2003
42-22812	2009	46-86251-3	2011	48-63079A97	2011	48-97162A04	2009
42-22834	2006	46-86252-3	2009	48-63081A82	2005	48-97162A05	2009
42-22847	2013	46-86256-3	2004	48-63082A15	2003	48-97162A06	2004
42-23348	2013	46-86257-3	2009	48-63082A16	2005	48-97162A10	2009
42-23349	2013	46-86265-3	2011	48-63082A24	2003	48-97162A11	2004
43P1	2004	46-86268-3	2023	48-63082A25	2009	48-97162A12	2013
43P2	2005	46-86269-3	2015	48-63082A26	2009	48-97162A16	2003
43P3	2004	46-86300-3	2005	48-63082A27	2009	48-97162A17	2005
43P4	2005	46-86301-3	2011	48-63082A45	2009	48-97162A18	2003
43P4C	2005	46-86302-3	2011	48-63082A71	2009	48-97162A19	2005
43P6	2005	48-8613-3	2005	48-63084A01	2003	48-97162A20	2003
43P6A	2005	48-10073A01	2007	48-63084A05	2003	48-97162A21	2009
43P6C	2004	48-10073A02	2003	48-63086A19	2005	48-97162A22	2005

DEVICE	RS 276-	DEVICE	RS 276-	DEVICE	RS 276-	DEVICE	RS 276-
48-97221A01	2005	48-124354	2003	48-134422	2007	48-134544	2003
48-97221A02	2005	48-124355	2003	48-134423	2007	48-134545	2003
48-97221A03	2003	48-124357	2003	48-134424	2003	48-134547	2003
48-97221A04	2005	48-124358	2003	48-134425	2003	48-134553	2007
48-97221A05	2005	48-124359	2003	48-134426	2003	48-134554	2007
48-97238A01	2003	48-124360	2005	48-134427	2003	48-134555	2007
48-97238A02	2003	48-124364	2003	48-134428	2003	48-134556	2003
48-97238A03	2003	48-124365	2003	48-134429	2007	48-134557	2003
48-97238A04	2009	48-124366	2005	48-134431	2006	48-134558	2003
48-97238A05	2004	48-124367	2005	48-134432	2003	48-134559	2003
48-97238A06	2006	48-124368	2003	48-134433	2003	48-134560	2006
48-97238A07	2005	48-124370	2003	48-134443	2005	48-134561	2005
48-97271A01	2003	48-124373	2007	48-134444	2005	48-134562	2007
48-97271A02	2003	48-124377	2003	48-134445	2005	48-134563	2005
48-97271A03	2003	48-124378	2003	48-134446	2005	48-134564	2005
48-97238A06	2006	48-124379	2003	48-134447	2006	48-134565	2007
48-97238A07	2005	48-124380	2007	48-134448	2006	48-134567	2003
48-97271A01	2003	48-124398	2003	48-134449	2006	48-134570	2006
48-97271A02	2002	48-124443	2005	48-134450	2005	48-134574	2006
48-97271A03	2003	48-124444	2005	48-134454	2005	48-134575	2006
48-97271A04	2003	48-124445	2005	48-134456	2005	48-134576	2005
48-97271A05	2003	48-124446	2005	48-134457	2005	48-134577	2005
48-97271A06	2003	48-125204	2006	48-134458	2003	48-134578	2005
48-124204	2006	48-125208	2006	48-134462	2007	48-134579	2003
48-124216	2001	48-125228	2003	48-134463	2006	48-134585	2006
48-124217	2001	48-125229	2007	48-134464	2009	48-134591	2009
48-124218	2001	48-125230	2007	48-134465	2009	48-134592	2006
48-124219	2003	48-125231	2003	48-134466	2007	48-134600	2003
48-124220	2002	48-125232	2003	48-134468	2007	48-134601	2003
48-124221	2002	48-125233	2001	48-134469	2007	48-134602	2003
48-124246	2006	48-125234	2001	48-134470	2007	48-134603	2005
48-124247	2006	48-125235	2001	48-134471	2007	48-134604	2005
48-124255	2005	48-125236	2001	48-134472	2007	48-134605	2003
48-124256	2005	48-125237	2007	48-134473	2007	48-134610	2007
48-124258	2007	48-125238	2007	48-134474	2007	48-134611	2006
48-124259	2007	48-125239	2003	48-134475	2007	48-134612	2006
48-124275	2007	48-125240	2003	48-134476	2005	48-134613	2006
48-124276	2003	48-125242	2007	48-134477	2005	48-134625	2003
48-124279	2003	48-125267	2006	48-134479	2005	48-134626	2003
48-124285	2006	48-125271	2003	48-134480	2005	48-134631	2003
48-124286	2007	48-125276	2003	48-134481	2005	48-134633	2003
48-124296	2003	48-125278	2003	48-134482	2003	48-134634	2006
48-124297	2007	48-125282	2004	48-134483	2003	48-134635	2003
48-124300	2005	48-125286	2006	48-134484	2003	48-134636	2003
48-124302	2006	48-125294	2007	48-134485	2003	48-134637	2003
48-124303	2003	48-125296	2007	48-134486	2003	48-134638	2006
48-124304	2003	48-125332	2006	48-134487	2006	48-134639	2006
48-124305	2005	48-128093	2003	48-134488	2006	48-134641	2003
48-124306	2003	48-128094	2003	48-134493	2006	48-134644	2006
48-124307	2003	48-128095	2003	48-134494	2005	48-134645	2006
48-124308	2003	48-128096	2003	48-134495	2005	48-134646	2006
48-124309	2007	48-128219	2003	48-134496	2005	48-134647	2006
48-124310	2005	48-128239	2002	48-134500	2003	48-134649	2006
48-124311	2005	48-128303	2004	48-134501	2005	48-134651	2006
48-124312	2005	48-129934	2006	48-134507	2005	48-134654	2009
48-124314	2003	48-129935	2006	48-134508	2003	48-134655	2005
48-124315	2003	48-129936	2006	48-134509	2005	48-134656	2005
48-124316	2003	48-129937	2006	48-134510	2005	48-134657	2005
48-124318	2005	48-134101	2003	48-134512	2003	48-134664	2009
48-124319	2005	48-134173	2009	48-134514	2003	48-134665	2009
48-124322	2003	48-134302	2006	48-134519	2006	48-134666	2009
48-124327	2003	48-134372	2003	48-134520	2001	48-134667	2009
48-124328	2003	48-134404	2003	48-134521	2005	48-134668	2009
48-124332	2006	48-134405	2003	48-134522	2003	48-134669	2009
48-124343	2005	48-134406	2003	48-134524	2005	48-134670	2006
48-124344	2005	48-134407	2003	48-134525	2021	48-134672	2006
48-124345	2005	48-134408	2003	48-134535	2005	48-134673	2013
48-124346	2003	48-134414	2003	48-134536	2003	48-134674	2013
48-124347	2003	48-134415	2003	48-134537	2003	48-134675	2009
48-124348	2003	48-134416	2007	48-134538	2007	48-134676	2003
48-124349	2003	48-134417	2007	48-134539	2007	48-134677	2003
48-124350	2003	48-134418	2003	48-134540	2003	48-134678	2003
48-124351	2003	48-134419	2003	48-134541	2003	48-134679	2003
48-124352	2003	48-134420	2003	48-134542	2003	48-134680	2003
48-124353	2003	48-134421	2003	48-134543	2003	48-134681	2003

DEVICE	RS 276-	DEVICE	RS 276-	DEVICE	RS 276-	DEVICE	RS 276-
48-134682	2003	48-134792	2029	48-134905	2009	48-137025	2004
48-134683	2003	48-134795	2003	48-134906	2009	48-137026	2006
48-134684	2003	48-134796	2003	48-134907	2006	48-137031	2006
48-134690	2009	48-134797	2003	48-134908	2009	48-137032	2021
48-134691	2009	48-134798	2003	48-134909	2021	48-137033	2011
48-134693	2003	48-134800	2009	48-134910	2021	48-137037	2019
48-134694	2003	48-134801	2009	48-134911	2021	48-137039	2006
48-134696	2006	48-134802	2009	48-134913	2024	48-137040	2009
48-134697	2003	48-134803	2013	48-134914	2024	48-137041	2009
48-134700	2002	48-134804	2009	48-134915	2024	48-137043	2013
48-134703	2009	48-134805	2009	48-134918	2013	48-137044	2013
48-134705	2009	48-134806	2009	48-134922	2009	48-137045	2021
48-134706	2015	48-134807	2009	48-134923	2009	48-137046	2021
48-134709	2009	48-134808	2009	48-134924	2013	48-137047	2009
48-134711	2003	48-134809	2009	48-134925	2013	48-137055	2011
48-134713	2009	48-134810	2009	48-134926	2013	48-137056	2011
48-134714	2009	48-134811	2013	48-134927	2008	48-137057	2011
48-134717	2009	48-134814	2009	48-134928	2009	48-137058	2029
48-134718	2013	48-134815	2021	48-134929	2009	48-137059	2011
48-134719	2009	48-134817	2013	48-134930	2027	48-137067	2023
48-134720	2009	48-134818	2009	48-134931	2001	48-137068	2023
48-134721	2013	48-134820	2015	48-134932	2011	48-137069	2023
48-134722	2006	48-134821	2013	48-134933	2009	48-137071	2009
48-134723	2006	48-134822	2013	48-134935	2009	48-137072	2009
48-134724	2009	48-134823	2013	48-134936	2017	48-137073	2009
48-134725	2009	48-134824	2013	48-134937	2011	48-137075	2009
48-134726	2013	48-134825	2009	48-134938	2006	48-137076	2009
48-134727	2006	48-134826	2009	48-134940	2023	48-137077	2009
48-134731	2006	48-134827	2009	48-134942	2009	48-137078	2006
48-134732	2013	48-134828	2009	48-134943	2021	48-137080	2019
48-134733	2013	48-134829	2024	48-134944	2028	48-137088	2018
48-134734	2013	48-134830	2024	48-134945	2009	48-137089	2009
48-134737	2009	48-134831	2024	48-134946	2011	48-137090	2021
48-134738	2006	48-134832	2024	48-134947	2006	48-137095	2019
48-134739	2016	48-134833	2021	48-134948	2011	48-137096	2009
48-134741	2006	48-134837	2011	48-134949	2015	48-137102	2006
48-134742	2006	48-134839	2013	48-134950	2009	48-137104	2009
48-134743	2006	48-134840	2013	48-134952	2009	48-137105	2009
48-134744	2006	48-134841	2013	48-134956	2005	48-137106	2013
48-134745	2021	48-134842	2013	48-134960	2009	48-137107	2013
48-134746	2006	48-134844	2009	48-134961	2009	48-137108	2013
48-134747	2006	48-134845	2009	48-134962	2009	48-137109	2013
48-134748	2006	48-134846	2009	48-134963	2009	48-137110	2009
48-134749	2006	48-134847	2009	48-134964	2009	48-137111	2013
48-134750	2006	48-134852	2013	48-134965	2009	48-137115	2013
48-134751	2006	48-134854	2009	48-134966	2009	48-137118	2006
48-134752	2006	48-134855	2009	48-134967	2021	48-137119	2006
48-134753	2006	48-134856	2006	48-134970	2013	48-137120	2006
48-134757	2006	48-134857	2011	48-134973	2023	48-137121	2006
48-134758	2006	48-134859	2003	48-134974	2006	48-137122	2006
48-134759	2006	48-134860	2003	48-134975	2023	48-137123	2006
48-134760	2006	48-134861	2003	48-134979	2011	48-137124	2006
48-134761	2006	48-134862	2003	48-134980	2013	48-137125	2006
48-134763	2006	48-134865	2024	48-134981	2009	48-137126	2009
48-134764	2006	48-134866	2024	48-134983	2009	48-137127	2021
48-134765	2009	48-134867	2024	48-134985	2009	48-137136	2009
48-134766	2006	48-134868	2024	48-134987	2027	48-137137	2009
48-134767	2006	48-134869	2024	48-134988	2011	48-137138	2009
48-134768	2013	48-134870	2024	48-134989	2021	48-137139	2013
48-134772	2009	48-134871	2024	48-134992	2009	48-137140	2009
48-134773	2009	48-134880	2003	48-134994	2013	48-137144	2009
48-134774	2009	48-134888	2006	48-134997	2013	48-137145	2019
48-134775	2009	48-134889	2009	48-136665	2009	48-137146	2019
48-134776	2009	48-134891	2009	48-137002	2008	48-137147	2019
48-134777	2009	48-134892	2009	48-137003	2009	48-137148	2019
48-134779	2009	48-134893	2009	48-137004	2009	48-137153	2027
48-134780	2009	48-134894	2009	48-137005	2009	48-137154	2027
48-134782	2009	48-134895	2013	48-137007	2009	48-137155	2027
48-134783	2009	48-134896	2013	48-137010	2013	48-137156	2027
48-134784	2009	48-134897	2013	48-137013	2011	48-137157	2027
48-134785	2009	48-134898	2008	48-137014	2013	48-137158	2011
48-134786	2009	48-134899	2009	48-137015	2013	48-137165	2029
48-134787	2009	48-134902	2011	48-137019	2009	48-137166	2011
48-134789	2013	48-134903	2009	48-137020	2024	48-137171	2013
48-134791	2011	48-134904	2009	48-137022	2013	48-137172	2013

DEVICE	RS 276-	DEVICE	RS 276-	DEVICE	RS 276-	DEVICE	RS 276-
48-137173	2021	51D189	2005	57B160-8	2009	61B021-1	2003
48-137174	2013	51F2	2003	57C5-1	2003	61B022-2	2003
48-137176	2021	54	2009	57C5-2	2003	61B022-3	2003
48-137190	2009	54BLK	2009	57C5-3	2004	61B023-1	2003
48-137191	2009	54BLU	2013	57C5-4	2003	61B026-1	2004
48-137192	2009	54BRN	2013	57C5-5	2004	61B027-1	2005
48-137193	2005	54GRN	2009	57C5-6	2011	61J001-1	2009
48-137194	2015	54ORN	2009	57C5-7	2011	61J002-1	2009
48-137195	2021	54RED	2009	57C5-8	2011	61J003-1	2009
48-137196	2015	54WHT	2016	57C6-3	2006	61J004-1	2003
48-137197	2011	54YEL	2009	57C6-4	2016	61P1	2004
48-137199	2004	54A	2009	57C6-5	2005	64T1	2005
48-137200	2019	54B	2009	57C6-6	2005	65-1	2009
48-137206	2013	54C	2009	57C6-6A	2005	65A	2024
48-137211	2019	54D	2013	57C6-6B	2005	65B	2024
48-137213	2006	54E	2009	57C6-6C	2005	65C	2024
48-137214	2006	55-1016	2004	57C6-8	2006	65D	2024
48-137215	2006	55-1027	2002	57C6-9	2016	65E	2024
48-137216	2006	55-1029	2005	57C6-11	2016	65F	2024
48-137217	2006	55-1082	2009	57C6-15	2021	65T1	2005
48-137218	2006	55-1083	2021	57C6-32	2009	68P1B	2006
48-137219	2006	55-1084	2009	57C6-33	2021	69N1	2015
48-137220	2006	55-1085	2021	57C10-1	2011	70N1	2009
48-137256	2027	55P2	2003	57C10-2	2011	70N2	2013
48-137257	2009	56P3	2003	57C15-1	2013	70N3	2011
48-137258	2026	57A2-15	2005	57C15-2	2013	72N1B	2009
48-137259	2027	57A21-2	2011	57C15-3	2024	72N2B	2009
48-137260	2013	57A21-6	2015	57C15-4	2024	73N1B	2013
48-137265	2013	57A21-7	2015	57C15-5	2023	73A01	2007
48-137267	2006	57A141-4	2011	57C20-1	2015	73A02	2003
48-137268	2006	57A142-4	2011	57D1-11	2005	73N1	2009
48-137269	2006	57A151-6	2009	57D1-26	2005	74NA01	2003
48-137270	2006	57A153-9	2009	57D1-56	2005	74A02	2003
48-137271	2006	57A160-8	2009	57D1-80	2004	74A03	2005
48-137277	2019	57A166-12	2009	57D1-84	2004	74P1	2021
48-137278	2008	57B2-3	2005	57D1-86	2004	76	2013
48-137282	2029	57B2-4	2004	57D1-87	2004	76-13570-39	2011
48-137300	2009	57B2-11	2003	57D1-120	2005	76-13570-59	2011
48-137303	2026	57B2-12	2003	57D1-121	2005	76-13866-19	2015
48-137304	2026	57B2-13	2003	57D1-123	2016	76N1	2016
48-137307	2018	57B2-14	2003	57D1-124	2016	76N1B	2009
48-137308	2006	57B2-15	2005	57D4-1	2006	76N2	2016
48-137311	2019	57B2-19	2005	57D14-1	2009	76N2B	2009
48-137312	2027	57B2-22	2003	57D14-2	2009	76N3B	2009
48-137315	2009	57B2-23	2005	57D14-3	2009	77	2003
48-137318	2021	57B2-24	2003	57D19-1	2021	77N1	2011
48-137321	2021	57B2-25	2003	57D19-2	2021	77N2	2016
48-137323	2019	57B21-2	2011	57D19-3	2021	77N2B	2011
48-137324	2021	57B21-6	2011	57D68	2005	77N4	2011
48-137325	2009	57B21-7	2011	57D156	2005	77N5	2016
48-137329	2006	57B102-4	2011	57D169	2005	78BLK	2003
48-137331	2027	57B103-4	2015	57D170	2005	78GRN	2003
48-137332	2008	57B105-12	2009	57D180	2004	78RED	2003
48-137336	2013	57B106-12	2021	57D184	2004	78YEL	2003
48-137339	2011	57B107-8	2013	57D186	2004	78N1	2016
48-137350	2013	57B108-6	2021	57D187	2004	78N2B	2011
48-137351	2013	57B109-9	2009	57D188	2005	79P1	2021
48-137352	2009	57B110-9	2021	57D189	2005	80P1	2005
48-137353	2009	57B124-10	2006	57D1127	2005	83-1056	2006
48-137354	2009	57B126-12	2009	57D1143	2005	83P1	2024
48-137355	2009	57B136-12	2009	57DG-23	2006	83P1B	2024
48-137483	2009	57B137-12	2021	57P1	2005	83P1M	2024
48-137988	2011	57B138-4	2013	61B002-1	2003	83P2	2024
48-644676	2003	57B139-4	2011	61B003-1	2003	83P2B	2024
48-644677	2003	57B141-4	2011	61B004-1	2007	83P3	2024
48-644678	2003	57B142-4	2011	61B005-1	2003	83P3B	2024
48-644679	2003	57B143-12	2009	61B006-1	2003	83P3M	2023
48-645867	2003	57B144-12	2009	61B007-2	2011	84	2006
48S50	2025	57B145-12	2021	61B009-1	2003	86-46-2	2004
49-1	2011	57B146-12	2009	61B015-1	2003	86-47-2	2004
49P1C	2006	57B148-12	2021	61B016-1	2003	86-48-2	2004
50P2	2003	57B151-6	2009	61B017-1	2007	86-77-2	2005
51	2013	57B152-12	2009	61B018-1	2003	86-78-2	2005
51D170	2005	57B153-9	2009	61B019-1	2003	86-79-2	2005
51D188	2005	57B159-12	2021	61B020-1	2003	86-80-2	2005

DEVICE	RS 276-	DEVICE	RS 276-	DEVICE	RS 276-	DEVICE	RS 276-
86-81-2	2002	86X8-2	2016	99S025	2013	102-4	2011
86-82-2	2005	86X8-3	2016	99S031	2013	103-4	2015
86-83-2	2005	86X8-4	2009	99S032	2013	105-12	2009
86-84-2	2005	86X006-001	2013	99S033	2009	106RED	2021
86-95-2	2005	86X006-001	2013	99S034	2008	106-12	2021
86-109-2	2004	86X0007-004	2015	99S035	2009	106P1	2006
86-110-2	2016	86X0008-001	2011	99S036	2009	106P1T	2006
86-111-2	2004	86X0017-001	2005	99S037	2009	107BRN	2013
86-114-2	2005	86X0022-001	2009	99S038	2013	107-8	2013
86-115-2	2004	86X0029-001	2011	99S039	2023	108GRN	2021
86-116-2	2004	86X0030-001	2006	99SA7	2001	108-1	2003
86-123-2	2016	86X0030-100 (two)	2006	99SK5	2001	108-2	2021
86-126-2	2005	86X0031-001	2013	99SQ7	2001	108-6	2003
86-127-2	2006	86X0031-002	2013	001	2029	109	2009
86-128-2	2005	86X0031-003	2013	002-009501	2013	109	2021
86-129-2	2005	86X0034-001	2015	002-009502	2013	110P1	2021
86-130-2	2005	86X0035-001	2009	002-009600	2013	110P1AA	2024
86-131-2	2004	86X0036-001	2023	002-010100	2006	112-2	2021
86-132-2	2004	86X0037-001	2001	002-010300	2021	112-8	2023
86-133-2	2004	86X0037-002	2005	002-010400	2009	112-001	2004
86-138-2	2015	86X0038-001	2015	002-010500	2024	112-003	2005
86-139-2	2016	86X0044-001	2024	002-010600	2011	112-004	2005
86-142-2	2006	86X0045-001	2009	002-010700	2021	119	2013
86-143-2	2011	86X0029-001	2011	002-010800	2013	120BLU	2011
86-146-2	2006	87B02	2018	002-010900	2021	120-1	2009
86-147-2	2006	91A	2009	002-012100	2025	120-2	2011
86-159-2	2005	91B	2009	002-012200	2018	120-3	2009
86-160-2	2005	91BGRN	2009	002-012800	2021	120-8	2011
86-163-2	2003	91C	2009	012E	2009	120-190	2005
86-173-2 (two)	2006	91D	2013	014-611	2021	120-00-19	2004
86-188-2	2011	91E	2013	014-652	2021	120-001190	2003
86-253-2	2003	91F	2013	014-696	2009	120-001192	2004
86-255-2	2016	92N1	2011	014-784	2013	120-00-1195	2005
86-276-2	2025	91N1B	2011	014-862	2013	120-001795	2007
86-277-2	2011	94N1	2013	016B12	2013	120-001798	2009
86-278-2	2003	94N1B	2013	016B810	2013	120-002012	2004
86-279-2	2003	96-5192-01	2006	016B812	2013	120-002013	2004
86-280-2	2003	97A83	2006	017E824	2013	120-002014	2004
86-281-2	2004	98-1	2007	018B	2011	120-002513	2003
86-282-2	2004	98-2	2007	019-003934	2009	120-002515	2003
86-339-2	2018	98-3	2007	019-005006	2015	120-002518	2003
86-340-2	2025	98-4	2007	019-005010	2021	120-002520	2004
86-342-2	2018	98-5	2007	020-1110-008	2018	120-002521	2004
86-344-2	2018	98-6	2007	020-1110-009	2025	120-002656	2003
86-348-2	2005	98-7	2007	002-3504-040	2021	120-002748	2004
86-370-2BLU	2006	99AT6	2005	022-3504-060	2005	120-003150	2006
86-370-2GRN	2006	99B5	2005	022-3505-910	2005	120-003151	2009
86-370-2ORN	2006	99BA6	2004	022-3511-770	2003	120-004048	2003
86-370-2VIO	2006	99BE6	2004	022-3511-780	2003	120-004492	2005
86-370-2YEL	2006	99L6	2001	022-3511-790	2003	120-004493	2005
86-392-2	2005	99P1	2021	022-3640-253	2004	120-004494	2005
86-396-2	2026	99P1M	2024	024	2025	120-004495	2005
86-399-2	2016	99S07	2002	025-100012	2011	120-004496	2011
86-416-2	2011	99S002	2003	025-100013	2011	120-004497	2011
86-417-2	2011	99S003	2007	025-100014	2013	120-004722	2003
86-419-2	2024	99S004	2006	025-100026	2011	120-004723	2011
86-420-2	2011	99S005	2003	025B	2013	120-004728	2003
86-421-2	2006	99S006	2003	025BYEL	2009	120-004880	2009
86-442-2	2011	99S007	2003	031A	2013	120-004882	2009
86-449-2	2003	99S010	2003	033A	2009	120-004883	2009
86-452-2	2018	99S011	2003	034A	2008	120-004888	2002
86-1392	2016	99S011A	2003	037	2009	120P1	2023
86-5042-2	2005	99S012	2009	038	2013	121-1	2023
86-5043-2	2006	99S012A	2009	039	2023	121-1RED	2023
86A327	2013	99S012E	2009	051-0046	2013	121-6	2002
86A338	2017	99S013	2006	051-0047	2013	121-7	2002
86A339	2025	99S013A	2006	051-0049	2011	121-8	2002
86C04	2026	99S015	2006	051-0062	2003	121-9	2007
86X6-1	2016	99S016	2011	051-0063	2003	121-10	2007
86X6-4-518,	2016	99S017	2011	051-0079	2005	121-11	2004
86X7-2	2016	99S018	2011	051-0107	2021	121-12	2004
86X7-4	2011	99S019	2011	100N1	2011	121-14	2004
86X7-6	2011	99S019A	2011	101A	2003	121-15	2001
86X7-6013	2011	99S019B	2011	101B	2003	121-16	2001
86X8-1	2016	99S020	2009	101M	2003	121-17	2001

DEVICE	RS 276-	DEVICE	RS 276-	DEVICE	RS 276-	DEVICE	RS 276-
121-19	2005	121-146	2003	121-294	2005	121-432	2003
121-21	2002	121-147	2003	121-295	2005	121-433	2013
121-22	2002	121-148	2004	121-296	2005	121-434	2009
121-24	2002	121-150	2003	121-297	2003	121-437	2003
121-25	2002	121-151	2005	121-298	2003	121-441	2021
121-26	2002	121-153	2003	121-299	2003	121-442	2021
121-27	2004	121-154	2003	121-300	2007	121-445	2021
121-33	2001	121-160	2004	121-301	2005	121-447	2013
121-34	2004	121-161	2003	121-302	2001	121-448	2009
121-44	2003	121-162	2003	121-303	2001	121-450	2009
121-45	2003	121-163	2004	121-304	2011	121-462	2011
121-46	2003	121-164	2004	121-305	2005	121-470	2011
121-47	2003	121-180	2003	121-306	2005	121-471	2011
121-48	2003	121-181	2003	121-307	2005	121-472	2015
121-49	2003	121-184	2003	121-308	2006	121-480	2015
121-50	2001	121-185	2003	121-309	2007	121-481	2015
121-51	2001	121-186	2004	121-310	2005	121-483	2015
121-52	2005	121-187	2004	121-311	2003	121-490	2005
121-53	2004	121-189	2004	121-312	2003	121-491	2005
121-54	2003	121-190	2005	121-313	2003	121-492	2005
121-59	2001	121-191	2005	121-314	2003	121-493	2013
121-60	2001	121-192	2004	121-319	2004	121-494	2005
121-61	2004	121-193	2005	121-320	2004	121-495	2021
121-62	2003	121-205	2003	121-321	2002	121-496	2024
121-63	2013	121-206	2004	121-327	2004	121-497	2021
121-64	2004	121-207	2004	121-333	2003	121-497WHT	2021
121-65	2003	121-208	2004	121-334	2003	121-498	2011
121-66	2003	121-219	2004	121-335	2003	121-499	2013
121-67	2005	121-220	2004	121-336	2003	121-500	2011
121-68	2005	121-221	2004	121-347	2003	121-501	2011
121-69	2005	121-222	2004	121-348	2003	121-502	2011
121-70	2002	121-225	2004	121-349	2003	121-503	2005
121-71	2002	121-226	2004	121-350	2003	121-505	2011
121-72	2004	121-227	2004	121-351	2003	121-505/501	2009
121-73	2003	121-228	2003	121-352	2003	121-506	2011
121-74	2003	121-229	2003	121-353	2003	121-506/5	2009
121-75	2003	121-230	2003	121-354	2004	121-506/502	2009
121-76	2003	121-231	2003	121-360	2003	121-521	2011
121-78	2003	121-232	2003	121-362	2007	121-522	2011
121-79	2004	121-233	2003	121-363	2006	121-523	2011
121-80	2004	121-234	2004	121-364	2009	121-524	2011
121-81	2004	121-235	2004	121-365	2001	121-538	2003
121-82	2004	121-236	2004	121-366	2009	121-539	2003
121-83	2004	121-237	2004	121-367	2009	121-540	2003
121-84	2004	121-238	2004	121-368	2007	121-541	2003
121-85	2004	121-239	2004	121-369	2009	121-541B	2003
121-86	2004	121-240	2003	121-371	2006	121-542	2003
121-87	2004	121-240-X	2004	121-372	2005	121-542B	2003
121-88	2004	121-242	2003	121-374	2007	121-544	2005
121-89	2004	121-243	2003	121-375	2005	121-546	2015
121-90	2004	121-244	2003	121-381	2003	121-547	2009
121-91	2004	121-245	2005	121-382	2006	121-551	2011
121-92	2004	121-246	2005	121-384	2003	121-552	2005
121-93	2004	121-247	2002	121-385	2003	121-553	2003
121-94	2004	121-248	2002	121-388	2001	121-581	2009
121-95	2004	121-256	2003	121-389	2006	121-585	2011
121-96	2004	121-257	2003	121-395	2003	121-587	2009
121-100	2001	121-258	2003	121-396	2005	121-600	2009
121-101	2003	121-259	2003	121-397	2005	121-601	2003
121-102	2003	121-260	2003	121-398	2006	121-602	2021
121-103	2003	121-266	2004	121-399	2005	121-603	2021
121-104	2003	121-267	2004	121-411	2003	121-612	2011
121-105	2003	121-268	2003	121-412	2003	121-613	2011
121-106	2004	121-269	2003	121-413	2003	121-614	2011
121-107	2004	121-270	2006	121-414	2003	121-615	2021
121-113	2005	121-271	2006	121-415	2003	121-616	2013
121-120	2005	121-272	2005	121-417	2021	121-630	2011
121-128	2003	121-273	2005	121-418	2006	121-632	2003
121-134	2005	121-274	2005	121-420	2005	121-634	2004
121-135	2005	121-275	2005	121-426	2003	121-635	2004
121-136	2005	121-276	2016	121-427	2003	121-636	2007
121-137	2005	121-277	2016	121-428	2003	121-637	2013
121-138	2005	121-278	2016	121-429	2003	121-638	2013
121-139	2005	121-279	2016	121-430	2013	121-638B	2013
121-145	2003	121-292	2003	121-431	2011	121-639	2009

DEVICE	RS 276-	DEVICE	RS 276-	DEVICE	RS 276-	DEVICE	RS 276-
121-671	2009	130VIO	2021	229-0050-15	2009	297V043H01	2004
121-675	2009	130-104	2006	229-0151-3	2011	297V049H01	2016
121-676	2009	130-138	2011	229-0180-32	2011	297V049H03	2016
121-677	2009	130-149	2009	229-0180-33	2011	297V049H04	2016
121-695	2011	130-150	2009	229-0180-119	2015	297V050H01	2005
121-697	2003	130-152	2011	229-0180-124	2011	297V051H01	2005
121-699	2021	130-172	2009	229-0204-4	2011	297V051H02	2005
121-706	2013	130-174	2009	229-0204-6	2011	297V051H03	2005
121-707	2026	130-245	2009	229-0204-23	2011	297V052H01	2005
121-708	2018	130-40214	2013	229-0210-14	2011	297V053H01	2005
121-709	2026	130-40215	2009	229-0220-9	2011	297V053H02	2005
121-710	2018	130-40294	2009	229-0250-10	2011	297V057H01	2005
121-714	2003	130-40311	2013	229-5100-15U	2011	297V057H02	2005
121-722	2009	130-40312	2009	229-5100-31V	2011	297V059H01	2016
121-732	2009	130-40315	2021	229-5100-32V	2011	297V072C06	2013
121-734	2007	130-40349	2006	229-5100-33V	2015	297V073C04	2023
121-744	2011	132-024	2025	229-5100-224	2011	297V074C02	2016
121-745	2013	132N1	2018	229-5100-225	2011	297V074C03	2016
121-746	2021	134P1	2021	229-5100-227	2003	297V074C06	2009
121-748	2013	135ORN	2009	229-5100-228	2011	297V074C09	2015
121-753	2009	136RED	2013	235	2004	297V083C01	2021
121-762	2001	138-4	2013	260P02908	2011	297V083C02	2011
121-765	2025	139-4	2011	260P05901	2011	297V083C03	2023
121-766	2018	139N1	2013	260P11303	2016	297V083C04	2013
121-775	2009	142N3	2009	260P11304	2016	297V085C01	2013
121-776	2008	146T1	2006	260P11305	2016	297V085C02	2013
121-823	2013	147T1	2006	260P11403	2025	297V085C03	2011
121-824	2015	150N1	2011	260P11502	2018	297V085C04	2013
121-827	2011	151N11	2011	260P11503	2018	297V086C01	2023
121-830	2004	154T1	2003	260P11504	2018	297V086C02	2011
121-834	2009	155T1	2003	281	2009	297V086C03	2009
121-846	2009	156WHT	2013	296-50-9	2009	297V086C04	2026
121-1032	2004	156T1	2003	296-51-9	2009	297V087B02	2018
121-1033	2005	157YEL	2021	296-56-9	2009	300	2005
121-1034	2005	157T1	2003	296-58-9	2018	301	2005
121-1035	2005	159T1	2003	296-59-9	2009	302	2005
121-1036	2005	160T1	2003	296-60-9	2004	310	2005
121-1124	2006	161T1	2003	296-61-9	2006	310-68	2003
121-1134	2006	161T2	2011	296-62-9	2004	310-123	2003
121-1330	2004	162T1	2003	297V003H03	2005	314-6005-1	2018
121-1350	2004	162T2	2011	297V003H09	2005	314-6007-1	2016
121-1360	2004	171-015-9-001	2006	297V003M01	2005	314-6007-2	2016
121-1390	2004	171-016-9-001	2006	297V004H03	2005	314-6007-3	2016
121-1400	2004	173A4419-2	2006	297V004H06	2005	322T1	2004
121G3019	2009	173A4420-5	2006	297V004H10	2005	323T1	2004
121G3020	2009	173A4422-1	2006	297V004H14	2005	324	2005
122GRN	2021	173A4424	2005	297V004M01	2005	324-0027	2003
122YEL	2021	173A4469	2006	297V011H01	2004	324-0028	2003
122-1	2013	174-002-9-001	2001	297V012H08	2004	324-0029	2003
122-2	2013	175-006-9-001	2005	297V012H09	2004	324-0079	2005
122-229	2004	175-007-9-001	2003	297V012H10	2004	324-0083	2005
124-1	2006	176-008-9-001	2011	297V025H02	2005	324-0086	2003
124N1	2001	176-014-9-001	2011	297V025H04	2005	324-0087	2003
124N16	2011	176-016-9-001	2009	297V025H15	2005	324-0089	2004
125P1	2003	176-017-9-001	2009	297V026H03	2004	324-0090	2004
126-12	2009	176-024-9-001	2009	297V032H01	2005	324-0091	2004
126N2	2001	176-025-9-001	2009	297V033H01	2005	324-0092	2004
126P1	2005	176-026-9-001	2011	297V034H01	2004	324-0095	2003
127	2009	176-029-9-001	2009	297V035H01	2004	324-0129	2003
128	2011	176-029-9-002	2009	297V036H01	2004	324-0130	2003
128WHT	2013	189	2015	297V037H01	2005	324-0131	2003
129	2011	200-011	2018	297V038H05	2004	324-0133	2004
129BRN	2009	200-052	2021	297V038H06	2004	324-0134	2002
129-4	2006	200-057	2009	297V038H07	2004	324-0144	2004
129-5	2006	200-058	2009	297V038H09	2004	324-0187	2003
129-6	2006	201A	2003	297V040H01	2005	324-6013	2018
129-7	2006	201B	2003	297V040H08	2005	324T1	2005
129-8	2003	201M	2003	297V040H10	2005	324T2	2005
129-9	2003	201-25-4343-12	2011	297V040H11	2005	325-0025-329	2003
129-16	2005	217-1	2009	297V040H12	2005	325-0025-330	2003
129-30	2001	223	2009	297V040H13	2005	325-0025-331	2003
129-31	2005	226-3	2023	297V040H15	2006	325-0028-79	2005
129-34	2003	226-4	2013	297V040H16	2005	325-0028-80	2005
130	2009	229-0050-13	2009	297V041H01	2006	325-0028-81	2005
130ORN	2009	229-0050-14	2009	297V041H06	2006	325-0028-83	2005

DEVICE	RS 276-	DEVICE	RS 276-	DEVICE	RS 276-	DEVICE	RS 276-
325-0028-84	2011	417-145	2026	576-0003-012(NPN)	2011	675-206	2006
325-0028-85	2005	417-150	2004	576-0003-012(PNP)	2023	690V028H28	2011
325-0030-315	2005	420T1	2004	576-0003-017	2024	690V028H48	2011
325-0030-317	2005	421-6	2003	576-0003-018	2016	690V028H89	2011
325-0030-318	2003	421-6B	2003	576-0003-019	2024	690V034H29	2005
325-0030-319	2005	421-7	2003	576-0003-020	2011	690V034H30	2005
325-0031-303	2016	421-7B	2003	576-0003-021	2011	690V034H31	2005
325-0031-304	2016	421-8	2003	576-0003-022	2009	690V040H56	2003
325-0031-305	2011	421-8B	2003	576-0003-023	2011	690V040H57	2003
325-0031-306	2018	421-11	2005	576-0003-024	2003	690V040H58	2005
325-0031-310	2009	421-11B	2004	576-0003-026	2009	690V040H59	2003
325-0036-536	2005	421-12	2004	576-0003-027	2011	690V040H60	2003
325-0036-564	2005	421-12B	2004	576-0003-028	2009	690V040H61	2004
325-0036-565	2003	421-13	2005	576-0004-002	2009	690V040H62	2003
325-0042-351	2009	421-13B	2004	576-0004-006	2009	690V043H62	2005
325-0047-516	2005	421-14	2007	576-0004-010	2009	690V043H63	2005
325-0054-310	2005	421-14B	2007	576-0005-001	2029	690V049H81	2011
325-0054-311	2005	421-15	2004	576-0006-003	2028	690V052H23	2004
325-0076-306	2009	421-15B	2004	576-0036-847	2009	690V056H33	2003
325-0076-307	2013	421-16	2003	576-0036-916	2009	690V056H34	2003
325-0076-308	2010	421-17	2003	576-0036-917	2009	690V057H25	2003
325-0081-100	2016	421-20B	2003	576-0040-253	2004	690V059H21	2003
325-0081-101	2011	421-26	2003	576-0040-254	2006	690V059H52	2003
325-0081-102	2005	421T1	2005	576-2000-990	2005	690V059H55	2003
325-0670-1	2005	429-0093-69	2003	576-2000-993	2005	690V061H98	2004
325-1370-19	2009	429-0910-50	2003	614X1	2004	690V061H99	2004
325-1375-10	2003	429-0910-51	2007	614X2	2004	690V066H89	2005
325-1375-11	2003	429-0910-52	2007	614X3	2004	690V068H29	2003
325-1375-12	2003	429-0958-42	2009	614X4	2004	690V068H30	2004
325-1376-53	2005	429-0986-12	2011	614X5	2005	690V068H31	2004
325-1376-54	2003	473A31	2006	614X6	2005	690V070H49	2011
325-1376-55	2003	473B6-2	2005	614X7	2005	690V073H59	2003
325-1376-56	2005	473B6-2A	2005	614X8	2016	690V073H85	2003
325-1376-57	2005	473B6-4	2005	614X9	2005	690V077H36	2003
325-1376-58	2005	473B6-5	2005	614X10	2005	690V077H73	2005
325-1378-18	2009	473B6-7	2005	617-10	2009	690V080H39	2004
325-1378-19	2009	499-1	2009	617-29	2013	690V080H41	2016
325-1378-20	2003	503T1	2003	617-63	2009	690V080H42	2006
325-1378-21	2006	504T1	2003	617-64	2009	690V081H07	2011
325-1378-22	2003	505T1	2003	617-65	2011	690V082H47	2004
325-1771-15	2013	506T1	2003	617-67	2013	690V084H60	2003
325-1771-16	2009	507T1	2003	617-68	2013	690V084H61	2005
326T1	2005	508T1	2003	617-69	2006	690V084H62	2009
344-6005-5	2018	512RED	2009	617-70	2003	690V084H63	2005
344-6011-2	2018	515ORN	2009	642-151	2005	690V086H51	2011
344-6012-1	2025	520T1	2004	642-229	2009	690V086H52	2011
344-6013-1B	2018	521T1	2005	642-230	2009	690V086H87	2011
344-6014-1B	2025	524WHT	2009	642-242	2009	690V086H94	2011
344-6017-1	2025	551	2011	642-261	2026	690V086H95	2011
344-6017-2	2018	572-0040-051	2006	642-264	2006	690V086H96	2011
350	2004	576-0001-002	2021	642-268	2013	690V088H44	2015
352	2005	576-0001-003	2005	642-269	2009	690V088H45	2015
353	2005	576-0001-005	2016	642-270	2013	690V088H46	2009
353-9012-001	2004	576-0001-009	2005	642-271	2006	690V088H47	2011
353-9306-001	2009	576-0001-012	2016	642-274	2009	690V088H48	2011
353-9306-003	2009	576-0001-013	2021	642-277	2001	690V088H49	2009
353-9310-001	2009	576-0002-001	2018	642-316	2006	690V088H50	2018
353-9314-001	2009	576-0002-002	2006	642-319-	2011	690V088H51	2018
353-9315-001	2009	576-0002-004	2004	656-136	2004	690V088H52	2003
364-6004	2019	576-0002-005	2006	656-137	2004	690V089H46	2009
364-10048	2028	576-0002-006	2018	656-138	2005	690V089H86	2011
365T1	2005	576-0002-008	2021	656-139	2004	690V089H90	2004
417-18	2004	576-0002-011	2018	660-220	2009	690V099H79	2013
417-29BLK	2006	576-0002-012	2006	660-221	2009	690V099H80	2003 +
417-29GRN	2006	576-0003-001	2015	660-222	2009	693G	2009
417-29WHT	2006	576-0003-002	2015	660-224	2005	703-1	2009
417-59	2009	576-0003-003	2009	660-225	2009	739H01	2009
417-60	2006	576-0003-004	2009	660-227	2005	750C838-125	2009
417-67	2009	576-0003-005	2011	660-228	2002	750D858-212	2013
417-71	2005	576-0003-006	2011	660B	2005	750D858-213	2009
417-79	2003	576-0003-007	2009	669	2024	753-2000-003	2009
417-90	2006	576-0003-008	2005	675-153	2005	753-2000-006	2017
417-113	2006	576-0003-009	2005	675-154	2005	753-2000-008	2009
417-132	2021	576-0003-010	2005	675-155	2005	753-2000-011	2013
417-144	2018	576-0003-011	2013	675-156	2005	753-2100-002	2006

DEVICE	RS 276-	DEVICE	RS 276-	DEVICE	RS 276-	DEVICE	RS 276-
753-2100-008	2009	916-31007-5B.	2004	964-16598	2005	1436-17	2005
753-4000-010	2013	916-31012-6	2004	964-16599	2006	1476-17	2005
753-4000-024	2028	916-31012-6B	2004	964-17142	2003	1493-17	2009
753-4000-537	2011	916-31019-3	2003	964-17444	2013	1553-17	2025
753-4000-668	2011	916-31019-3B	2003	964-17887	2006	1558-17	2021
753-4000-929	2011	916-31024-3	2009	0036-001	2023	1559-17	2006
753-4001-474	2006	916-31024-5	2009	0121	2013	1561-17	2006
753-4004-248	2021	916-31025-4	2011	0123	2027	1567	2016
773RED	2009	916-31025-5	2009	0124(Hoffman)	2019	1634-17	2011
774ORN	2009	921-1B	2003	0124(Knight)	2021	1717-17	2013
775BRN	2009	921-2B	2003	0125	2009	1712-17	2010
776GRN	2009	921-3B	2003	0126	2013	1723-17	2009
779BLU	2009	921-4B	2003	0127	2011	1751-17	2009
780WHT	2009	921-5B	2002	0128	2009	1761-17	2011
783RED	2009	921-6B	2002	0131	2013	1777-17	2005
784ORN	2009	921-9B	2003	0133	2021	1792-17	2011
785YEL	2009	921-10B	2003	0134	2013	1799-17	2009
786	2009	921-11B	2003	0142	2015	1800-17	2009
787BLU	2009	921-12B	2004	0770	2026	1827-17	2004
791	2011	921-13B	2003	0772	2019	1840-17	2006
800-310	2005 + 2002	921-14B	2004	0773	2027	1841-17	2009
800-501-00	2016	921-15B	2003	1002	2021	1843-17	2013
800-502-00	2004	921-16B	2003	1003	2005	1844-17	2025
800-505-00	2005	921-17B	2003	1004-17	2011	1845-17	2011
800-507-00	2006	921-20B	2016	1005	2016	1854-0003	2009
800-509-00	2016	921-21B	2016	1005-17	2004	1866-17	2013
800-522-02	2018	921-22B	2016	1007-17	2004	1867-17	2021
800-523-02	2026	921-23B	2016	1009	2005	1879-17	2009
800-526-00	2018	921-24B	2004	1009-17	2009	1880-17	2011
800-527-00	2023	921-25B	2003	1012	2016	1890-17	2015
800-528-00	2002	921-26B	2009	1013	2021	1893-17	2013
800-530-01	2013	921-27B	2009	1016-17	2011	1915-17	2009
800-536-00	2015	921-28B (two)	2009	1020-17	2009	1929-17	2016
800-537-01	2002	921-29B	2021	1021-17	2004	1931-17	2009
801B	2009	921-30B	2009	1023-17	2004	1932-17	2009
818WHT	2009	921-31B	2009	1030	2023	1933-17	2018
822A	2013	921-32B	2009	1032	2005	1934-17	2028
822ABLU	2013	921-33B	2009	1034	2005	1935-17	2024
822B	2013	921-34B	2009	1035	2005	1936-17	2017
823WHT	2013	921-35B	2003	1036	2005	1951-17	2003
823B	2013	921-36B	2004	1052-17	2003	1954-17	2005
827BRN	2009	921-37B	2003	1057-17	2005	1955-17	2006
828GRN	2009	921-38B	2005	1060-17	2003	1958-17	2002
829	2024	921-39B	2005	1102-17	2005	1961-17	2013
829A	2024	921-40B	2003	1124	2006	1966-17	2009
829B	2024	921-41B	2005	1124A	2006	1969-17	2018
829C	2024	921-43B	2009	1124B	2006	1983-17	2011
829D	2024	921-44B	2004	1128-17	2004	2001	2018
829E	2024	921-45B	2003	1140-17	2003	2002	2006
829F	2024	921-46B	2018	1145-17	2005	2004	2004
830	2004	921-48B	2009	1148-17	2007	2005	2006
833	2021	921-49B	2009	1210-17	2011	2006	2018
847BLK	2009	921-50B	2009	1214	2023	2008	2017
881.250.107	2021	921-51B	2004	1227-17	2011	2011	2018
881.250.108	2013	921-52B	2005	1228-17	2009	2012	2006
881.250.109	2009	921-55B	2011	1241A	2005	2057A2-37	2003
884.250.011	2018	921-56B	2011	1272	2009	2057A2-87	2009
904-945B	2013	921-57B	2011	1277-17	2003	2057A2-113	2009
904-96B	2009	921-72B	2011	1316-17	2004	2057A2-116	2023
909-27125-140	2013	921-73B	2009	1317-17	2005	2057A2-117	2009
909-27125-160	2009	930X1	2009	1320	2005	2057A2-120	2011
910X1	2005	930X2	2009	1329	2002	2057A2-145	2018
910X2	2005	930X3	2009	1330	2005	2057A2-146	2018
910X3	2004	930X4	2011	1349-17	2001	2057A2-148	2003
910X4	2004	930X5	2011	1350	2004	2057A2-163	2009
910X5	2004	930X6	2003	1360	2005	2057A2-165	2003
910X6	2004	930X7	2003	1362-17	2005	2057A2-167	2002
910X7	2005	930X8	2003	1364-17	2005	2057A2-204	2009
910X8	2005	930X9	2003	1371-17	2002	2057A100-4	2002
910X9	2005	930X10	2003	1373-17	2009	2057A100-14	2003 + 2002
910X10	2005	935-1	2009	1374-17	2009	2057A100-15	2005
916-31001-1	2004	945	2029	1390	2004	2057A100-18	2006 + 2002
916-31001-7B	2003	955-1	2003	1396	2002	2057A100-21	2004
916-31003-5B	2003	955-2	2003	1400	2004	2057B-3	2002
916-31007-5	2004	955-3	2003	1410	2004	2057B2-4	2004

DEVICE	RS 276-	DEVICE	RS 276-	DEVICE	RS 276-	DEVICE	RS 276-
2057B2-14	2009	2057B100-13	2005	3022	2009	4367	2005
2057B2-23	2005	2057B100-17	2018	3023	2011	4368	2003
2057B2-29	2003	2061B45-14	2005	3026	2009	4398	2003
2057B2-34	2004	2093A41-40	2004	3027	2011	4442	2021
2057B2-37	2003	2160	2029	3028	2009	4450	2005
2057B2-38	2009	2180-151	2009	3054	2017	4454	2005
2057B2-60	2003	2180-152	2016	3111	2013	4456	2005
2057B2-61	2006	2180-153	2016	3112	2005	4457	2005
2057B2-62	2009	2180-154	2016	3113	2016	4462	2007
2057B2-64	2011	2180-155	2017	3227E	2011	4463	2006
2057B2-65	2003	2243	2006	3370	2011	4464	2009
2057B2-66	2003	2263	2009	3425	2004	4465	2009
2057B2-67	2003	2269	2021	3434	2004	4466ORN	2007
2057B2-68	2003	2270	2009	3435	2004	4468BRN	2007
2057B2-70	2003	2271	2013	3458	2004	4469RED	2007
2057B2-71	2003	2272	2021	3500	2004	4470	2011
2057B2-72	2003	2295	2017	3504	2004	4470ORN	2007
2057B2-73	2011	2402-453	2005	3508	2011	4470-31	2011
2057B2-77	2009	2402-454	2003	3509	2013	4470-32	2011
2057B2-79	2005	2402-455	2003	3513	2021	4470-33	2011
2057B2-80	2005	2402-456	2006	3517	2004	4471YEL	2007
2057B2-81	2003	2402-457	2003	3544	2004	4472GRN	2007
2057B2-83	2005	2405-453	2005	3546	2009	4473	2007
2057B2-87	2009	2405-454	2003	3551	2003	4473-1	2009
2057B2-88	2003	2405-455	2003	3551A	2003	4473-2	2009
2057B2-89	2003	2405-456	2003	3551ABLU	2003	4473-3	2009
2057B2-90	2003	2405-457	2003	3551AGRN	2003	4473-4	2009
2057B2-93	2003	2408-326	2005	3553	2003	4473-5	2009
2057B2-94	2005	2408-328	2003	3570P	2021	4473-5X	2013
2057B2-97	2009	2408-329	2006	3571P	2021	4473-6	2009
2057B2-99	2005	2450	2016	3571R	2013	4473-7	2009
2057B2-103	2013	2487B	2005	3577	2004	4473-8	2009
2057B2-104	2003	2488A	2003	3600	2005	4473-9	2013
2057B2-105	2003	2489A	2005	3607	2001	4473-11	2009
2057B2-108	2011	2490A	2005	3609	2001	4473-12	2009
2057B2-109	2009	2603-180	2003	3851	2004	4474YEL	2007
2057B2-110	2009	2603-181	2003	3852	2004	4475GRN	2007
2057B2-111	2009	2603-182	2003	3867	2009	4476BLU	2005
2057B2-112	2003	2603-183	2004	3881	2011	4477VIO	2005
2057B2-113	2009	2603-184	2011	3907	2005	4483	2009
2057B2-114	2009	2703-384	2005	3907/2N404	2021	4484	2003
2057B2-115	2011	2703-385	2003	3999	2013	4485	2003
2057B2-116	2009	2703-386	2003	4001-222	2003	4486	2003
2057B2-117	2009	2703-387	2006	4001-223	2003	4491-6	2019
2057B2-118	2003	2703-388	2006	4001-224	2004	4491-9	2019
2057B2-119	2011	2704-384	2005	4001-225	2004	4501	2005
2057B2-120	2011	2704-385	2003	4001-226	2005	4509	2005
2057B2-121	2013	2704-386	2003	4002	2009	4510	2005
2057B2-122	2009	2704-387	2006	4006	2009	4545	2003
2057B2-123	2009	2780	2006	4010	2009	4545BLU	2003
2057B2-124	2004	2780-4	2006	4013	2021	4545WHT	2003
2057B2-125	2009	2781	2005	4021	2009	4553BLU	2003
2057B2-129	2003	2787	2009	4022	2009	4553BRN	2007
2057B2-130	2011	2797	2003	4066	2009	4553GRN	2003
2057B2-133	2006	2798	2023	4085	2009	4553ORN	2007
2057B2-135	2004	2901-010	2006	4086	2023	4553RED	2007
2057B2-137	2003	2904-008	2006	4087	2023	4553VIO	2003
2057B2-138	2011	3001	2015	4167	2011	4553YEL	2003
2057B2-139	2011	3003	2009	4168	2015	4562	2007
2057B2-142	2004	3004	2009	4169	2013	4563	2005
2057B2-143	2011	3005	2011	4247	2006	4564	2005
2057B2-153	2013	3006	2011	4309	2016	4565	2007
2057B2-155	2009	3007	2009	4310	2021	4567	2003
2057B2-160	2011	3008	2005	4313	2005	4570	2006
2057B2-161	2011	3009	2005	4315	2003	4582BRN	2006
2057B2-162	2011	3010	2005	4348	2005	4583RED	2006
2057B2-192	2013	3011	2009	4349	2005	4584GRN	2006
2057B2-206	2004	3011(E. F. Johnson)	2013	4363	2003	4586	2003
2057B100-1	2004	3012(NPN)	2011	4363BLU	2003	4589	2003
2057B100-3	2004 + 2002	3012(PNP)	2023	4363GRN	2003	4590	2021
2057B100-4	2002	3017	2024	4363ORN	2003	4594	2009
2057B100-7	2004	3018	2011	4363WHT	2003	4595	2005
2057B100-8	2005	3019	2024	4364	2003	4596	2003
2057B100-9	2005	3020	2011	4365	2003	4603	2005
2057B100-12	2005	3021	2011	4366	2005	4604	2005

DEVICE	RS 276-	DEVICE	RS 276-	DEVICE	RS 276-	DEVICE	RS 276-
4605	2003	7128	2009	25642-031	2005	36917	2009
4605RED	2003	7131	2009	25642-040	2005	38091	2005
4607	2003	7132	2009	25642-041	2005	38094	2006
4608	2006	7133	2009	25642-110	2003	38095	2021
4619RED	2006	7134	2009	25642-115	2003	38716	2018
4620GRN	2006	7214	2011	25642-120	2003	38785	2011
4621	2003	7215	2011	25651-020	2004	38787	2009
4624	2009	7216	2011	25651-021	2004	38788	2009
4627	2003	7217	2011	25651-033	2004	38789	2018
4630	2009	7218	2011	25655-021	2004	39458	2018
4632	2003	7219	2011	25655-055	2004	39750	2018
4649	2006	7220	2011	25655-056	2004	40004	2003
4677	2003	7221	2011	25657-050	2004	40005	2005
4700	2002	7398-6117P1	2011	25658-120	2006	40006	2003
4705	2009	7398-6119P1	2009	25658-121	2006	40022	2006
4706	2015	7425	2009	25661-020	2006	40034	2005
4709	2013	7426	2009	25661-022	2006	40035	2004
4714	2009	7427	2009	25671-020	2011	40036	2005
4722	2006	7428	2009	25671-021	2011	40037	2002
4722BLU	2006	7429	2009	25671-023	2011	40038	2005
4722GRN	2006	7430	2009	30201	2005	40050	2006
4722ORN	2006	7431	2013	30202	2005	40051	2006
4722RED	2006	7432	2013	30203	2006	40051-2	2006
4722VIO	2006	7433	2013	30208	2004	40053	2018
4722VEL	2006	7510(TRANSISTOR)	2017	30210	2009	40080	2009
4727	2006	7810	2009	30211	2006	40084	2009
4732	2013	7811	2009	30213	2005	40217	2011
4733	2013	7812	2009	30214	2003	40218	2009
4734	2013	7813	2009	30215	2003	40219	2009
4737	2009	7814	2009	30216	2003	40220	2009
4745	2021	7815	2009	30218	2003	40221	2009
4756	2011	7816	2009	30221	2003	40222	2009
4765	2009	7817	2009	30222	2005	40231	2009
4768	2013	7818	2013	30227	2009	40232	2009
4789	2013	8003-114	2009	30229	2009	40233	2009
4792	2029	8405	2021	30230	2003	40234	2009
4802-00006	2009	8500-201	2005	30235	2013	40235	2011
4802-00009	2011	8500-202	2003	30238	2003	40236	2011
4802-00012	2011	8500-203	2003	30239	2003	40237	2011
4802-00014	2009	8500-204	2006	30240	2003	40238	2011
4802-00015	2009	8503	2011	30241	2016	40239	2011
4815	2021	8540	2021	30242	2009	40240	2011
4820	2015	8867	2021	30243	2009	40242	2009
4821	2013	9600	2013	30254	2017	40243	2011
4825	2009	05253	2006	30256	2017	40244	2011
4826	2009	09500	2013	30268	2009	40245	2009
4837	2011	09501	2013	30269	2009	40246	2009
4839	2013	09800	2021	30270	2021	40250V1	2019
4840	2013	10036	2005	30271	2026	40253	2004
4841	2013	10037	2005	30272	2018	40254	2006
4842	2013	10038	2004	30289	2009	40259	2011
4844	2009	10039	2004	30290	2021	40260	2011
4845	2009	10300	2021	30291	2025 + 2018	40261	2013
4852	2013	12074E	2004	30294	2018	40263	2005
4854	2009	12112-C	2016	30302	2006	40268	2003
4855	2009	12112-D	2016	35168	2003	40269	2004
4857	2011	12112-E	2016	35449	2011	40280	2009
4888A	2006	12112-F	2016	35452-2	2005	40283	2009
4888B	2006	12539	2025	35454-1	2005	40294	2011
5001	2029	12593	2013	35454-3	2005	40295	2011
5093	2009	12594	2024	35628	2005	40309	2009
5226-1	2021	12888	2023	35677	2005	40311	2009
5226-2	2011	15024	2006	35678	2005	40314	2009
6100	2005	15027	2006	35728	2005	40315	2009
6313	2003	15840-1	2016	35816	2004	40317	2009
6440	2005	17143	2004	35817	2004	40319	2021
6445	2004	28509	2016	35819	2005	40320	2009
6452	2005	18529	2004	35820-1	2005	40323	2009
6990	2003	18530	2005	35820-2	2005	40326	2009
7122	2009	18555	2016	35820-3	2005	40329	2005
7123	2009	18601	2004	35824	2003	40347	2018
7124	2009	18731	2004	35885A	2006	40348	2018
7125	2009	22158	2009	36304	2006	40350	2009
7126	2009	25642-020	2005	36842	2009	40351	2009
7127	2009	25642-030	2005	36847	2009	40352	2009

DEVICE	RS 276-	DEVICE	RS 276-	DEVICE	RS 276-	DEVICE	RS 276-
40359	2004	42321	2006	95129	2011	112520	2009
40361	2018	42322	2004	95130	2011	112521	2009
40362	2021	42324	2003	95131	2011	112522	2009
40364	2017	43119	2020	95201	2005	112523	2009
40372	2017	44763	2018	95202	2005	113938	2011
40395	2005	44764	2025	95203	2005	114267	2011
40396(N)	2001	44765	2018 + 2025	95204	2005	115063	2006
40396/P	2005	44766	2028	95208	2005	115225	2005
40397	2009	50477-4	2006	95209	2005	115227	2003
40398	2009	50957-03	2009	95211	2001	115228	2003
40399	2011	51194	2018	95212	2005	115268	2006
40400	2009	51213	2009	95213	2005	115527-1	2017
40403	2003	51213-2	2009	95214	2005	115792	2025
40404	2011	51429-02	2009	95216	2009	115875	2016
40405	2009	51429-03	2013	95216RED	2009	115910	2009
40406	2025	51441	2013	95216YEL	2009	116074	2016
40407	2018	51442	2009	95218	2005	116079	2016
40421	2006	51545	2009	95219	2005	116093	2006
40432	2009	51547	2013	95221	2013	116199	2009
40452	2018	51650	2006	95223	2009	116201	2004
40453	2009	57000-5452	2009	95224-3	2005	116202	2003
40454	2009	57000-5503	2009	95224-4	2002	116203	2005
40455	2009	61003-4	2005	95226-2	2013	116206	2004
40456	2009	65804-63	2004	95226-3	2018	116207	2003
40459	2018	67193-82	2004	95226-4	2018	116208	2003
40461	2028	67193-85	2004	95226-003	2025	116209	2003
40462	2006	67802	2013	95226-004	2025	116588	2016
40468	2028	69107-42	2005	95227	2021	116685	2003
40469	2011	69107-43	2003	95250	2006	116686	2003
40470	2011	69107-45	2003	95251	2006	116687	2003
40471	2011	70434	2006	95257	2006	116757	2007
40476	2011	70511	2009	95258-1	2025	116996	2003
40477	2009	72003	2003	95258-2	2018	116998	2003
40478	2011	72004	2003	99101	2003	117209	2003
40479	2011	72006	2003	99102	2003	117727	2003
40480	2011	72190	2005	99104	2003	117728	2003
40481	2011	72191	2002	99105	2003	117867	2005
40482	2011	72193	2006	99106	2003	119982	2009
40487	2005	72204	2009	99107	2003	120144	2004
40488	2003	72206	2009	99108	2003	121467	2023
40489	2005	72207	2009	99201	2004	121655	2009
40490	2005	78331	2021	99203	2003	121658	2013
40500	2009	79855	2013	99204	2005	121661	2011
40517	2011	79856	2009	99205	2005	121662	2011
40518	2011	79922	2017	99206-2	2016	121664	2013
40519	2009	80050	2006	99207-2	2016	122243	2005
40537	2021	80416C	2006	99218	2005	122244	2003
40538	2021	80540	2009	080224	2005	122519	2009
40539	2009	80544	2009	080228	2005	122901	2004
40577	2009	80545	2005	080258	2003	122902	2009
40611	2009	80817VM	2002	081026	2005	122904	2015
40612	2006	80818VM	2005	081027	2005	123274	2011
40613	2019	88687	2009	081029	2005	123379	2004
40616	2009	88688	2009	081059	2005	123511	2003
40618	2013	88803	2009	082006	2009	123791	2005
40621	2019	88834	2009	082019	2009	123792	2006
40622	2018	88862	2009	082020	2009	123805	2005
40623	2006	94017	2005	082022	2009	123807	2009
40626	2006	94033	2003	082028	2009	123808	2006
40629	2018	94036	2003	084001	2021	123809	2004
40630	2018	94037	2021	101973	2005	123877	2005
40631	2018	94039	2005	101974	2004	123940	2009
40634	2025	94040	2006	104080	2002	124097	2003
40635	2018	94042	2018	111118	2003	124412	2011
40637	2009	94043	2018	111303	2009	124623	2011
40852	2005	94044	2009	111954	2005	124624	2011
40853	2005	95108	2003	111955	2005	124625	2003
41178	2018	95110	2003	111956	2003	124626	2004
41179	2026	95112	2002	111957	2005	124755	2021
41342	2027	95113	2001	112355	2011	124757	2011
41344	2019	95114	2001	112356	2009	125138	2011
41440	2021	95115	2001	112357	2009	125139	2013
42304	2005	95117	2001	112358	2009	125140	2016
42305	2005	95127	2011	112359	2009	125141	2013
42311	2003	95128	2011	112360	2009	125143	2011

DEVICE	RS 276-	DEVICE	RS 276-	DEVICE	RS 276-	DEVICE	RS 276-
125144	2011	131543	2011	215089	2006	610056-3	2003
125264	2011	131544	2011	223484	2005	610068-1	2006
125330	2005	131545	2011	229392	2011	610070-1	2009
125389	2009	131848	2018	231588	2004	610070-2	2013
125390	2009	131849	2018	240003	2005	610070-3	2011
125475	2009	132175	2011	240006	2005	610076-1	2016
125703	2006	132176	2021	249588	2003	610076-2	2016
125761	2006	162002-033	2006	452077	2028	610077-1	2011
125790	2003	162002-040	2003	489751-025	2009	610077-2	2016
125972	2003	162002-041	2003	489751-026	2009	610077-4	2011
125994	2009	162002-042	2003	489751-027	2013	610077-5	2016
125995	2011	162002-090	2009	489751-028	2021	610078-1	2016
126023	2015	165667	2004	489751-029	2016	610079-1	2004
126024	2015	165735	2018	489751-030	2011	610080-1	2005
126025	2011	165738	2017	489751-031	2021	610083-1	2024
126150	2009	165827	2009	489751-032	2026	610083-2	2024
126184	2005	165828	2011	489751-033	2018	610083-3	2023
126185	2003	165932	2011	510007	2003	610092-1	2011
126186	2005	165995	2011	514023	2009	610094-1	2013
126187	2005	166400	2005	514045	2009	610099-1	2021
126524	2021	166997	2004	543995	2021	610106-1	2006
126525	2011	170376	2006	551015	2005	610110-1	2021
126526	2009	170376-1	2006	552308	2009	610120-1	2023
126698	2011	170407-1	2006	552503	2023	610124-1	2002
126707	2021	170479-1	2006	570009-01504	2009	610125-1	2003
126708	2003	170666-1	2006	570030	2026	610132-1	2018
126709	2003	170753-1	2015	570031	2018	610134-1	2021
126710	2003	170756-1	2011	573012	2004	610139-1	2013
126716	2011	170827-1	2006	573152	2005	610142-3	2009
126717	2011	170906-1	2011	573153	2005	610150-1	2018
126719	2021	170968-1	2011	573166	2006	610151-1	2011
127297	2004	171009	2011	573200	2005	611020	2004
127354	2009	171016	2003	573422	2003	618139-1	2006
127355	2009	171026	2009	573469	2009	618580	2028
127397	2006	171027	2009	573475	2011	652085	2006
127589	2005	171028	2011	573480	2011	660077	2006
127590	2006	171029	2011	573494	2011	660084	2003
127793	2016	171030	2011	573495	2011	660085	2003
127978	2018	171031	2011	573518	2003	660097	2006
128343	2004	171032	2011	573529	2004	660138	2025
128938	2003	171033	2015	601040	2013	770523	2005
128940	2004	171052	2011	602032	2006	770524	2005
129144	2011	171162-075	2003	602040	2004	770525	2005
129145	2011	171162-076	2003	603020	2003	770730	2005
129146	2011	171162-080	2003	603031	2006	772716	2005
129147	2009	171162-082	2006	603040	2004	772717	2003
129284	2003	171162-083	2006	604030	2003	772718	2005
129286	2005	171162-086	2006	605030	2005	772719	2005
129289	2003	171162-108	2006	606020	2005	772720	2005
129291	2003	171162-118	2011	610035	2005	772721	2005
129347	2003	171162-119	2009	610035-1	2005	772722	2005
129389	2003	171162-120	2004	610036-1	2005	772723	2005
129392	2011	171162-121	2005	610036-2	2005	772724	2005
129393	2009	175007-277	2018	620036-3	2005	772725	2005
129394	2009	175027-021	2009	610036-4	2005	772727	2003
129398	2009	175027-022	2006	610036-5	2005	772728	2005
129507	2005	175043-023	2006	610036-7	2005	772729	2005
129508	2005	175043-062	2011	610039-1	2006	772732	2005
129509	2013	175043-063	2009	610040-1	2005	772733	2005
129510	2013	175043-064	2009	610040-2	2005	772736	2003
129511	2013	175043-065	2006	610041-2	2013	772737	2005
129512	2013	190425	2006	610041-3	2013	772738	2011
129513	2013	190426	2009	610042-1	2011	772739	2011
129604	2011	190427	2005	610043-3	2005	814044A	2005
129697	2021	190428	2009	610043-4	2004	815020	2005
129698	2009	190429	2021	610043-6	2004	815021	2004
129699	2021	190714	2013	610043-7	2005	815022	2005
130139	2023	190715	2013	610045-3	2016	815023	2005
131161	2018	198023-2	2009	610045-4	2016	815024	2005
131221	2011	198063-1	2025	610045-5	2016	815025	2004
131239	2018	198794-1	2001	610050-1	2003	815025A	2004
131240	2011	215072	2016	610051-1	2003	815027	2004
131241	2021	215074	2009	610052-1	2005	815028	2004
131242	2023	215075	2016	610053-2	2005	815029	2005
131243	2011	215081	2016	610055-1	2003	815030	2005

DEVICE	RS 276-	DEVICE	RS 276-	DEVICE	RS 276-	DEVICE	RS 276-
815031	2005	982284	2003	0573103	2003	2003342-109	2011
815034	2005	982285	2005	0573114	2003	2003342-244	2011
815036	2004	982289	2004	0573117	2005	2003779-22	2011
815037	2004	982300	2018	0573119	2003	2003779-23	2009
815038	2005	982321	2011	0573125	2005	2003779-24	2009
815041	2004	982322	2003	0573142	2005	2003779-25	2009
815043	2004	982374	2003	0573152	2007	2004358-123	2005
815065	2004	982375	2003	0573153	2004	2004358-168	2004
815066	2004	982397	2003	0573166	2006	2006227-51	2009
815069	2005	982511	2013	0573185	2005	2006334-31	2005
815070	2005	982512	2009	0573187	2005	2006334-115	2009
815070A	2005	982523	2017	0573200	2005	2006334-155	2009
815070B	2005	982531	2003	0573202	2009	2006513-39	2011
815070C	2005	982532	2003	0573204	2005	2006514-59	2006
815070D	2005	982815	2011	0573212	2006	2006514-60	2009
815074	2005	982816	2011	0573328	2004	2006514-61	2009
815103	2004	982817	2011	0573335	2003	2006582-25	2013
815104	2005	982818	2011	0573366	2003	2006607-59	2006
815105	2004	982819	2011	0573398	2003	2006607-60	2009
815114	2005	982820	2005	0573422	2003	2006623-88	2018
815115	2005	983012	2003	0573428	2003	2006623-145	2009
815116	2005	983236	2003	0573468	2011	2006681-94	2011
815117	2005	983237	2005	0573469	2011	2006681-95	2009
815118	2005	983238	2003	0573474	2011	2008292-56	2009
815120	2005	983271	2004	0573475	2011	2008292-87	2005
815120A	2005	983272	2004	0573479	2009	2008299-1	2009
815120B	2005	983405	2005	0573480	2013	2057013-0004	2021
815120C	2005	983406	2005	0573481	2009	2057013-0701	2021
815120D	2005	983407	2003	0573485	2009	2057013-0702	2021
815120E	2005	983408	2003	0573486	2009	2090056-1	2006
815133	2016	983409	2005	0573487	2009	2090056-5	2006
815134	2016	983411	2005	0573490	2009	2090056-27	2006
815136	2005	983742	2009	0573491	2009	2090924-008	2005
815139	2005	983743	2009	0573492	2009	2090924-8	2005
815171	2016	984191	2009	0573494	2011	2090924-8A	2005
815174	2016	984192	2009	0573495	2011	2091241-0013	2004
815189	2005	984193	2003	0573501	2008	2091241-0014	2004
815202	2016	984221	2003	0573507	2009	2091241-0015	2004
815203-3	2006	984228	2005	0573509	2011	2091241-1	2004
815203-5	2006	984229	2009	0573510	2011	2091241-2	2004
815209	2013	984261	2006	0573511	2009	2091241-5A	2004
825065	2004	984521	2006	0573517	2009	2091241-7	2004
910799	2009	984577	2011	0573518	2003	2091241-13	2004
910952	2027	984590	2009	0573529	2004	2091241-13A	2004
965074	2016	984591	2013	0573529	2004	2091241-14	2004
970245	2009	984593	2009	0573532	2011	2091241-15	2004
970246	2021	984685	2005	0573541	2018	2091251-15A	2004
970247	2009	984685	2013	0573542	2021	2091260-1	2005
970248	2021	984687	2009	0573570	2011	2091260-2	2005
970249	2009	984688	2006 + 2002	0573607	2009	2091260-3	2001
970250	2009	984746	2005	0576001	2005	2091578-1	2005
970251	2021	985609	2004	1221615	2006	2091858-11	2006
970252	2009	985610	2004	1221648	2003	2091859-0008	2006
970254	2021	985619	2011	1471132-2	2018	2091859-0011	2006
980505	2003	995016	2013	1961479	2006	2091859-0712	2006
980506	2003	995017	2013	1961480	2006	2091859-0713	2006
980507	2003	0004201	2003	2000625-31	2003	2091859-0714	2006
980508	2007	0004202	2003	2000646-111	2006	2091859-0715	2006
980510	2005	0004203	2006	2000648-21	2003	2091859-0716	2006
980511	2003	0320031	2009	2000648-22	2004	2091859-0717	2006
980540	2003	0573001	2003	2000648-23	2004	2091859-2	2006
980960	2005	0573003	2003	2001653	2005	2091859-4	2006
980961	2003	0573005	2003	2001653-22	2005	2091859-6	2006
981143	2003	0573012	2004	2001653-24	2005	2091859-8	2006
981144	2003	0573018	2003	2001809-47	2007	2091859-9	2006
981145	2003	0573022	2005	2001809-48	2003	2091859-10	2006
981146	2003	0573023	2005	2001812-65	2003	2091859-11	2006
981147	2004	0573024	2003	2002151-18	2003	2092417-1	2003
981148	2004	0573030	2006	2002151-19	2003	2092417-2	2003
981149	2004	0573031	2006	2002152-14	2003	2092417-3	2003
982244	2005	0573036	2003	2002153-60	2003	2092417-6	2003
982267	2003	0573037	2001	2002153-83	2001	2092417-0017	2009
982268	2009	0573040	2006	2002403-19	2003	2092417-0018	2009
982269	2009	0573055	2003	2003073-9	2011	2092417-0019	2009
982283	2003	0573066	2011	2003239-65	2013	2092417-0708	2003

DEVICE	RS 276-	DEVICE	RS 276-	DEVICE	RS 276-	DEVICE	RS 276-
2092417-0709	2003	2498508-2	2009	8037353	2009	80339440	2009
2092417-0711	2009	2498508-3	2009	13040096	2002	80383930	2013
2092417-0712	2009	2498512	2018	13040236	2004	80383940	2013
2092417-0713	2009	2498837	2003	13040304	2009	80389910	2013
2092417-0717	2003	2498903-2	2011	13040313	2009	80414130	2017
2092418-1	2003	2498903-3	2011	13040317	2009	1522210300	2004
2092418-2	2003	2712080	2016	13040318	2009	1522211200	2005
2092418-5	2003	2904014	2006	13040347	2002+2005	1522214400	2003
2092418-6	2003	3170757	2008	13040352	2005	1522216500	2004
2092418-7	2003	3403787	2013	13040362	2009	1522216600	2003
2092418-071	2003	4080187-0506	2017	13040421	2009	1522217400	2003
2092418-0023	2009	4080838-0001	2017	13040429	2023	9511410100	2004
2092418-0024	2009	4080866-0006	2018	13040459	2009	9511410200	2003
2092418-0711	2002	4080873-0001	2018	23114001	2011	9511410900	2004
2092418-0712	2003	4080879-0006	2018	23114023	2011	9511414000	2006
2092609-1	2002	4082501-0001	2006	23114036	2011	16207190405	2006
2092609-2	2001	43022860	2009	23114043	2011	A01	2003
2092609-3	2016	43022861	2009	23114050	2023	A1A	2008
2092609-0001	2016	43023221	2018	23114051	2023	A1B	2009
2092609-0002	2016	43023222	2018	23114056	2011	A1E	2011
2092609-0022	2016	43023223	2025	23114057	2011	A1F	2009
2092609-0705	2016	4813466	2016	23114082	2011	A1G	2009
2092609-0706	2016	5320003	2017	23124037	2011	A1G-1	2009
2092609-0707	2016	5320022	2009	25114101	2004	A1H	2009
2092609-0713	2016	5320023	2009	25114102	2003	A1J	2009
2092609-0718	2016	5320051	2011	25114103	2003	A1K	2009
2093308-0701	2002	5320074	2011	25114116	2009	A1L	2013
2093308-0702	2002	5320101	2004	25114104	2005	A1M-1	2009
2093308-0703	2002	5320111	2009	25114121	2009	A1P	2009
2093308-0704	2016	5320151	2018	25114161	2013	A1P-1	2009
2093308-0705	2016	5320372	2009	27125090	2016	A1R	2013
2093308-0706	2016	5958539	2003	27125140	2009	A1R-1	2013
2243255-1	2007	7287452	2016	27125150	2005	A1R-2	2013
2320011	2005	7570003-01	2006	27125160	2009	A1S	2008
2320031	2009	7570004-01	2009	27125170	2006	A1T	2009
2320041	2009	7570005-01	2016	27125270	2009	A1T-1	2009
2320042	2009	7570005-02	2009	27125300	2009	A1U	2011
2320084	2017	7570005-03	2016	27125310	2001	A1V	2009
2320111	2009	7570009-01	2009	27125330	2003	A1W	2009
2320141	2011	7570030-01	2026	27125340	2003	A1Y	2017
2320161	2021	7570031-01	2018	27125350	2003	A1Z	2011
2320191	2008	7570032-01	2025	27125360	2004	A2B	2009
2320302	2004	7581323	2005	27125460	2009	A2C	2009
2320331	2001	7851325	2009	27125470	2009	A2D	2011
2495012	2005	7851326	2009	27125480	2005	A2F	2011
2495013	2005	7851327	2009	27125490	2002	A2FGRN	2009
2495014	2005	7851949-01	2013	27125500	2009	A2G	2015
2495078	2003	7851952-01	2013	27125540	2006	A2H	2009
2495079	2003	7851953-01	2009	27125550	2003	A2J	2009
2495080	2003	7851955-01	2006	43021017	2013	A2L	2009
2495082	2003	7852775-01	2003	43021198	2009	A2M	2009
2495200	2005	7852776-01	2005	43023212	2013	A2M-1	2009
2495376	2023	7852778-01	2003	43023221	2009	A2N	2009
2495377	2003	7852779-01	2005	43025763	2011	A2N-1	2009
2495378	2003	7852781-01	2013	43025764	2011	A2N-2	2009
2495379	2003	8014711	2003	43025765	2011	A2P	2009
2495388	2003	8015613	2021	43025766	2011	A2T	2013
2495388-1	2003	8020540	2003	43025767	2011	A2V	2011
2495388-2	2003	8020560	2003	43025832	2028	A2W	2013
2495488-1	2003	8022631	2004	43025834	2006	A2Y	2009
2495488-2	2003	8023643	2005	80053600	2015	A3A	2009
2495520	2009	8024152	2005	80104900	2003	A3C	2009
2495521	2009	8024390	2004	80105200	2003	A3E	2011
2495522-1	2009	8024400	2005	80105300	2003	A3F	2009
2495522-4	2009	8031825	2011	80205400	2003	A3G	2013
2495523-1	2009	8033690	2009	80205600	2003	A3K	2013
2495567-2	2003	8033696	2009	80226310	2005	A3M	2008
2495567-3	2003	8033720	2009	80236400	2005	A3N	2009
2495568-2	2003	8033730	2009	80236430	2005	A3P	2009
2496125-2	2009	8033803	2011	80243900	2004	A3R	2009
2497473-1	2005	8033944	2009	80318250	2011	A3T	2009
2497496	2003	8034903	2017	80337390	2009	A3W	2013
2498456-2	2011	8037330	2013	80338030	2011	A3Z	2011
2498507-2	2009	8037332	2013	80338040	2011	A4A	2013
2498507-3	2009	8037333	2013	80339430	2009	A4B	2013

DEVICE	RS 276-	DEVICE	RS 276-	DEVICE	RS 276-	DEVICE	RS 276-
A4E	2009	A14-1004	2003	A108	2009	A485	2011
A4F	2013	A14-1005	2003	A110	2013	A486	2011
A4G	2011	A14-1006	2003	A111	2013	A489	2011
A4K	2019	A14-1007	2003	A115	2009	A490	2011
A4M	2009	A14-1008	2003	A116	2009	A492	2011
A4N	2013	A14-1009	2003	A133	2008	A494	2011
A4P	2013	A14-1010	2003	A137	2013	A495	2011
A4R	2009	A15-1001	2003	A138	2013	A496	2009
A4T	2011	A15-1002	2003	A139	2013	A497	2011
A4U	2011	A15-1003	2003	A141	2009	A515	2008
A4V	2011	A15-1004	2003	A142	2009	A567	2016
A4W	2011	A15-1005	2003	A143	2013	A593	2013
A4Y-1	2009	A25-1001	2003	A151	2009	A595	2005
A4Y-2	2009	A25-1002	2003	A152	2009	A640	2009
A5A	2019	A25-1003	2003	A153	2013	A640L	2009
A5A-1	2019	A25-1004	2003	A157	2013	A641	2009
A5A-2	2019	A25-1005	2003	A157A	2013	A641L	2009
A5A-3	2018	A25-1006	2003	A157B	2013	A642	2013
A5A-4	2018	A059-100	2003	A157C	2013	A642L	2013
A5A-5	2018	A059-101	2003	A158	2013	A649L	2009
A5B	2018	A059-102	2003	A158B	2009	A649S	2009
A5C	2009	A059-103	2003	A158C	2013	A747	2013
A5G	2019	A059-104	2003	A159	2013	A747A	2013
A5H	2009	A059-105	2003	A159B	2009	A747B	2009
A5J	2009	A059-106	2003	A159C	2013	A748	2013
A5K	2009	A059-107	2003	A160	2023	A748B	2009
A5L	2013	A059-115	2006	A161	2023	A748C	2013
A5M	2013	A059-116	2005	A162	2024	A749	2013
A5N	2013	A060-100	2009	A168	2016	A749B	2009
A5P	2013	A061-105	2009	A170	2021	A749C	2013
A5R	2009	A061-106	2009	A171	2023	A757	2009
A5S	2013	A061-107	2003	A177	2021	A758	2021
A5U	2013	A061-108	2009	A178A	2023	A758B	2023
A5W	2009	A061-109	2009	A178B	2023	A759A	2021
A6B	2009	A061-110	2003	A179A	2023	A759B	2023
A6CGRN	2019	A061-111	2003	A179B	2023	A909-1008	2003
A6C-1	2019	A061-114	2005	A194	2028	A909-1009	2003
A6C-1RED	2019	A061-115	2003	A195	2028	A909-1010	2005
A6C-2	2019	A061-116	2006	A196	2028	A909-1011	2005
A6C-2BLK	2019	A065-105	2005	A244(AMC)	2011	A909-1012	2005
A6C-3	2019	A065-106	2003	A245(AMC)	2015	A909-1013	2005
A6C-3WHT	2019	A065-108	2009	A246(AMC)	2009	A1109	2009
A6E	2011	A065-109	2013	A247(AMC)	2008	A1170	2011
A6F	2011	A065-110	2009	A248(AMC)	2013	A1220	2003
A6H	2013	A065-111	2006	A249(AMC)	2009	A1243	2003
A6J	2013	A065-112	2005	A301	2009	A1377	2005
A6K	2013	A065-113	2013	A306	2009	A1378	2003
A6P	2009	A066-109	2009	A307	2009	A1379	2009
A6R	2009	A066-111	2011	A321	2009	A1380	2009
A6S	2009	A066-112	2009	A322	2009	A1383	2003
A6T	2015	A066-113	2023	A323	2009	A1384	2003
A6U	2015	A066-114	2018	A324	2009	A1460	2013
A6V	2011	A066-115	2011	A344	2009	A1462	2009
A6W	2019	A066-116	2009	A345	2009	A1518	2009
A7A	2013	A066-117	2018	A346	2009	A1519	2009
A7C(Motorola)	2019	A066-118	2021	A411	2005	A1520	2009
A7S	2009	A066-143	2013	A415	2009	A1521	2009
A7T	2013	A068-108	2009	A417	2009	A2410	2009
A7Y	2013	A068-109	2021	A418	2011	A2411	2009
A7Z	2019	A068-111	2011	A419	2011	A2412	2009
A8A	2008	A068-112	2011	A420	2011	A2413	2011
A8B	2009	A068-113	2009	A427	2015	A2414	2006
A8C	2026	A069-101	2009	A430	2011	A2428	2021
A8D	2018	A069-102/103	2009	A451	2011	A2746	2011
A8F	2019	A069-104/106	2009	A454	2011	AA1	2004
A8G	2009	A069-105	2005	A455	2011	AA2	2002
A8K	2019	A069-107	2005	A466	2009	AA3	2003
A8L	2009	A069-114	2011	A467	2011	AA4	2006
A8N	2008	A069-116	2009	-A472	2013	AC107	2003
A8R	2013	A069-119	2009	A473	2011	AC108	2005
A8S	2011	A069-120	2009	A480	2011	AC109	2005
A06-1-12	2009	A069-121	2005	A481	2011	AC110	2005
A14-1001	2003	A069-122	2011	A482	2011	AC116	2005
A14-1002	2003	A104	2009	A483	2011	AC117	2005
A14-1003	2003	A106	2013	A484	2011	AC120	2005

DEVICE	RS 276-	DEVICE	RS 276-	DEVICE	RS 276-	DEVICE	RS 276-
ACY19	2004	ACY27	2005	AF172		ASY61	2001
ACY20	2005	ACY28	2005	AF188	2003	ASY62	2002
ACY21	2005	ACY29	2005	AF192	2001	ASY63	2004
ACY22	2005	ACY30	2005	AF193	2003	ASY67	2003
ACY23	2005	ACY31	2005	AF200	2005	ASY70	2005
AC126	2004	ACY32	2005	AF201	2005	ASY70	2001
AC127	2001	ACY33	2005	AF202	2005	ASY73	2001
AC128	2005	ACY34	2004	AF202S	2005	ASY74	2001
AC128/01	2005	ACY35	2004	AF239	2003	ASY75	2001
AC129	2003	ACY36	2004	AFY12	2003	ASY76	2004
AC130	2002	ACY40	2004	AFY14	2005	ASY77	2004
AC131	2005	ACY41	2005	AFY15	2005	ASY80	2004
AC132	2005	ACY44	2005	AFY16	2003	ASZ15	2006
AC134	2005	AD103	2006	AFY34	2003	ASZ16	2006
AC135	2005	AD104	2006	AFY37	2003	ASZ17	2006
AC136	2005	AD105	2006	AFY39	2003	ASZ18	2006
AC137	2005	AD130	2006	AFY40	2003	ASZ20	2003
AC138	2005	AD131	2006	AFY40K	2003	ASZ21	2003
AC139	2004	AD132	2006	AFZ11	2003	AT6	2005
AC141	2002	AD133	2006	AFZ12	2003	AT6A	2005
AC141B	2002	AD138	2006	APB-11H-1001	2003	AT10H	2005
AC141K	2002	AD138/50	2006	APB-11H-1004	2003	AT10M	2004
AC150	2005	AD139	2006	APB-11H-1007	2003	AT10N	2004
AC151	2005	AD140	2006	APB-11H-1008	2004	AT11	2003
AC151R	2005	AD143	2006	APB-11H-1010	2004	AT12	2003
AC152	2005	AD148	2006	AR4	2006	AT13	2003
AC153	2005	AD149	2006	AR5	2006	AT14	2003
AC153K	2005	AD150	2006	AR6	2006	AT15	2003
AC157	2001	AD162	2006	AR7	2006	AT16	2003
AC160	2003	ADY22	2006	AR8	2006	AT17	2003
AC160A	2003	ADY23	2006	AR9	2006	AT20H	2003
AC161	2005	ADY24	2006	AR10	2006	AT20M	2003
AC162	2005	ADY27	2006	AR11	2006	AT20N	2007
AC163	2005	AF101	2004	AR12	2006	AT30H	2005
AC168	2002	AF102	2003	AR13	2006	AT30M	2007
AC170	2005	AF105	2003	AR14	2006	AT30N	2007
AC171	2005	AF106	2003	AR17	2018	AT100H	2006
AC172	2002	AF109	2003	AR107	2016	AT100M	2006
AC175	2002	AF114	2003	AR108	2016	AT100N	2006
AC176	2002	AF115	2003	AR200	2016	AT342	2011
AC176K	2006	AF116	2003	AR201	2016	AT343	2011
AC179	2001	AF117	2003	AR202	2016	AU100N	2005
AC180	2005	AF118	2003	AR200	2009	AU100N	2005
AC181	2002	AF120	2005	AR201	2009	AU101	2006
AC182	2004	AF121	2003	AR202	2009	AU102	2006
AC183	2001	AF124	2005	AS477	2007	AUY10	2006
AC184	2004	AF125	2005	AS33867	2005	AUY19	2006
AC185	2001	AF126	2005	AS33868	2005	AUY20	2006
AC186	2002	AF127	2005	AS34280	2005	AUY21	2006
AC187	2001	AF128	2004	ASY12-1	2003	AUY22	2006
AC188	2005	AF129	2005	ASY12-2	2003	B-22-4	2004
ACR83-1001	2003	AF130	2005	ASY13-1	2003	B-23-1	2003
ACR83-1002	2003	AF131	2005	ASY13-2	2003	B-24-1	2007
ACR83-1003	2003	AF132	2005	ASY14	2004	B-26-1	2003
ACR83-1004	2003	AF133	2005	ASY14-1	2004	B-315-1	2005
ACR83-1005	2003	AF134	2005	ASY14-2	2004	B-1511	2006
ACR83-1006	2003	AF135	2005	ASY14-3	2004	B5	2005
ACR810-101	2003	AF136	2005	ASY24	2005	B5A	2005
ACR810-102	2003	AF137	2005	ASY26	2004	B131	2018
ACR810-103	2003	AF138	2005	ASY27	2004	B132	2026
ACR810-104	2003	AF139	2003	ASY28	2001	B134	2006
ACR810-105	2003	AF143	2003	ASY29	2001	B134A	2006
ACR810-106	2003	AF144	2003	ASY31	2004	B134C	2006
ACY17	2004	AF146	2003	ASY32	2004	B169	2016
ACY18	2004	AF147	2003	ASY48	2004	B177	2006
ACY19	2004	AF148	2003	ASY50	2004	B178	2006
ACY20	2005	AF149	2003	ASY51	2004	B179	2006
ACY21	2005	AF150	2003	ASY52	2004	B224	2006
ACY22	2005	AF164	2003	ASY53	2002	B601-1006	2003
ACY23	2005	AF165	2003	ASY54	2004	B601-1007	2003
AC121	2005	AF166	2003	ASY55	2005	B601-1008	2003
AC122	2005	AF168	2003	ASY56	2004	B601-1009	2005
AC123	2005	AF169	2003	ASY57	2004	B601-1010	2005
AC124	2009	AF170	2003	ASY58	2004	B1017	2006
AC125	2005	AF171	2003	ASY59	2005	B1022	2005

DEVICE	RS 276-	DEVICE	RS 276-	DEVICE	RS 276-	DEVICE	RS 276-
B1085	2006	BC178A	2023	BF168	2011	BSY25	2009
B1151	2006	BC178B	2028	BF169	2009	BSY26	2009
B1151A	2006	BC180	2009	BF173	2011	BSY27	2009
B1151B	2006	BC239	2009	BF176	2009	BSY28	2009
B1152	2006	BC261	2021	BF187	2011	BSY29	2009
B1152A	2006	BC261A	2021	BF188	2011	BSY34	2009
B1152B	2006	BC1073	2006	BF189	2011	BSY38	2009
B1154	2005	BC1073A	2006	BF194	2009	BSY39	2009
B1274	2006	BC1274	2006	BF195	2009	BSY58	2009
B1274A	2006	BC1274A	2006	BF200	2011	BSY62	2009
B1274B	2006	BC1274B	2006	BFX18	2011	BSY63	2009
B1368	2006	BC6500	2011	BFX19	2011	BSY70	2011
B1368A	2006	BCY10	2021	BFX20	2011	BSY72	2009
B1368B	2006	BCY11	2021	BFX21	2011	BSY73	2009
B1368C	2006	BCY12	2023	BFX31	2011	BSY74	2009
B1368D	2006	BCY13	2009	BFX37	2023	BSY75	2009
B1368E	2006	BCY15	2009	BFX44	2011	BSY76	2009
B1368F	2006	BCY17	2023	BFX48	2023	BSY80	2009
B5000	2018	BCY18	2023	BFY10	2009	BSY93	2011
B10064	2006	BCY19	2023	BFY11	2009	BSY95A	2011
B10069	2006	BCY21	2023	BFY12	2009	BSY168	2009
B10162	2006	BCY22	2023	BFY15	2009	BT67	2013
B10163	2006	BCY23	2023	BFY17	2009	BT71	2013
B10474	2006	BCY24	2023	BFY18	2009	BTX068	2018
B10475	2006	BCY25	2023	BFY19	2009	BTX070	2005
BA6	2004	BCY26	2023	BFY25	2009	BTX071	2001
BA6A	2004	BCY27	2023	BFY26	2009	BU67	2013
BA67	2013	BCY28	2023	BFY28	2009	BV67	2013
BA71	2013	BCY30	2023	BFY29	2016	BV71	2013
BB71	2013	BCY31	2023	BFY30	2016	BW67	2013
BC71	2013	BCY32	2023	BFY33	2009	BW71	2013
BC107	2009	BCY33	2023	BFY37	2009	BX67	2013
BC107A	2009	BCY34	2009	BFY37I	2009	BX71	2013
BC107B	2009	BCY38	2023	BFY39	2009	BY67	2013
BC108	2009	BCY39	2023	BFY39I	2009	BY71	2013
BC108A	2009	BCY40	2023	BFY47	2009	BZ67	2013
BC108B	2009	BCY42	2009	BFY48	2009	BZ71	2013
BC108C	2009	BCY43	2009	BFY49	2009	C6-15	2021
BC109B	2009	BCY49	2023	BFY51	2009	C63	2009
BC109C	2009	BCY50	2009	BFY63	2009	C64	2009
BC113	2016	BCY50I	2009	BFY64	2021	C73	2005
BC114	2016	BCY51	2009	BFY74	2009	C75	2005
BC115	2016	BCY51I	2009	BFY76	2016	C76	2005
BC116	2023	BCY54	2023	BFY77	2016	C111E	2009
BC118	2009	BCY56	2009	BFY78	2011	C444	2009
BC119	2009	BCY58	2009	BFY79	2011	C673	2028
BC120	2009	BCY59	2009	BFY90	2011	C684	2028
BC125	2009	BCY69	2009	BG71	2013	C684A	2028
BC126	2023	BCY70	2023	BH71	2013	C685	2028
BC129	2009	BCY72	2023	BI71	2013	C764	2028
BC130	2009	BCZ10	2023	BLY61	2018	C1437	2004
BC131	2009	BCZ11	2021	BP67	2013	C1438	2004
BC132	2009	BCZ12	2023	BP5263	2003	C9080	2021
BC134	2009	BCZ13	2023	BQ67	2013	C9081	2021
BC139	2023	BCZ14	2023	BR67	2013	C9082	2023
BC143	2021	BD71	2013	BS67	2013	C9083	2023
BC147	2013	BE6	2005	BSX24	2009	C9084	2023
BC147A	2013	BE6A	2005	BSX25	2011	C9085	2073
BC147B	2013	BE71	2013	BSX26	2011	C-2053	2006
BC148	2009	BF71	2013	BSX27	2011	CCS6168	2011
BC148A	2009	BF109	2009	BSX28	2011	CCS6168F	2016
BC148B	2009	BF115	2009	BSX29	2011	CCS6168G	2011
BC148C	2013	BF152	2011	BSX35	2011	CCS6225F	2009
BC149	2009	BF153	2009	BSX38	2009	CCS6226G	2016
BC149B	2009	BF154	2009	BSX69	2009	CCS6227F	2016
BC149C	2013	BF155	2011	BSY10	2009	CCS6227G	2016
BC153	2009	BF158	2011	BSY11	2009	CD8000	2016
BC154	2024	BF159	2011	BSY17	2009	CDC430	2013
BC169	2009	BF160	2011	BSY18	2009	CDC587	2009
BC171	2013	BF162	2011	BSY19	2009	CDC745	2011
BC172	2013	BF163	2011	BSY20	2009	CDC746	2021
BC173	2013	BF164	2011	BSY21	2009	CDC1203B	2009
BC173B	2009	BF165	2009	BSY22	2009	CDC5000	2009
BC173C	2013	BF166	2011	BSY23	2009	CDC5028A	2011
BC178	2023	BF167	2009	BSY24	2009	CDC8011B	2018

DEVICE	RS 276-	DEVICE	RS 276-	DEVICE	RS 276-	DEVICE	RS 276-
CDC-13000-1C	2009	CK759	2004	CST1743	2006	D171	2005
CDQ10001	2009	CK759A	2004	CST1744	2006	D172	2005
CDQ10002	2009	CK760	2005	CST1745	2006	D173	2003
CDQ10003	2009	CK760A	2004	CST1746	2006	D174	2005
CDQ10004	2009	CK761	2005	CT1122	2006	D185	2011
CDQ10005	2009	CK762	2005	CT1124	2006	D188	2011
CDQ10006	2009	CK766	2005	CT1124A	2006	D190	2016
CDQ10008	2009	CK766A	2005	CT1124B	2006	D1101	2028
CDQ10009	2009	CK768	2005	CTP1104	2006	D1102	2028
CDQ10010	2009	CK776A	2005	CTP1108	2006	D1301	2028
CDQ10016	2009	CK790	2005	CTP1109	2006	D1302	2028
CDQ10017	2009	CK791	2005	CTP1111	2006	D1303	2028
CDQ10018	2009	CK793	2005	CTP1117	2006	D1666	2011
CDQ10019	2009	CK870	2005	CTP1124	2006	DAT1A	2023
CDQ10020	2009	CK871	2003	CTP1133	2006	DAT2	2023
CDQ10021	2009	CK872	2004	CTP1135	2006	DC-9	2005
CDQ10022	2009	CK875	2004	CTP1136	2006	DC-10	2003
CDQ10023	2009	CK878	2004	CTP1137	2006	DC-12	2006
CDQ10024	2009	CK879	2004	CTP1500	2006	DS3	2005
CDQ10026	2009	CK882	2004	CTP1503	2006	DS8	2004
CDQ10027	2009	CK888	2004	CTP1504	2006	DS14	2005
CDQ10032	2009	CK891	2005	CTP1508	2006	DS16	2005
CDQ10035	2009	CK892	2005	CTP1511	2006	DS17	2005
CDQ10036	2009	CQT940A	2006	CTP1513	2006	DS19	2004
CDT1309	2006	CQT940B	2006	CTP1514	2006	DS21	2004
CDT1310	2006	CQT940BA	2006	CTP1550	2006	DS22	2004
CDT1311	2006	CQT1110	2006	CTP1551	2006	DS23	2004
CDT1319	2006	CQT1110A	2006	CTP1728	2006	DS24	2003
CDT1320	2006	CQT1111	2006	CTP1729	2006	DS25	2003
CDT1321	2006	CQT1111A	2006	CTP1730	2006	DS26	2005
CDT1349	2006	CQT1112	2006	CTP1731	2006	DS29	2003
CDT1349A	2006	CRT1602	2006	CTP1732	2006	DS34	2003
CDT1350	2006	CRT3602A	2006	CTP1733	2006	DS36	2003
CDT1350A	2006	CS1166-H	2001	CTP1735	2006	DS37	2003
CE0088	2004	CS1168E	2016	CTP1736	2006	DS38	2003
CE0089	2005	CS1168F	2016	CTP1739	2006	DS41	2003
CK13A	2005	CS1168G	2016	CTP2010-1001	2003	DS42	2003
CK14	2005	CS1168H	2009	CTP2010-1002	2003	DS44	2001
CK14A	2005	CS1225E	2009	CTP2010-1003	2005	DS45	2016
CK16	2005	CS1226	2009	CTP2010-1004	2005	DS46	2016
CK16A	2005	CS1227E	2016	CTP2010-1005	2005	DS47	2016
CK17	2005	CS1227F	2016	CTP2010-1006	2005	DS51	2003
CK17A	2005	CS1227G	2016	CTP2010-1007	2003	DS52	2003
CK22	2004	CS1228F	2025	CTP2010-1008	2003	DS53	2003
CK22A	2005	CS1229F	2016	CTP2010-1009	2003	DS56	2003
CK22B	2004	CS1235G	2009	CTP3500	2006	DS62	2003
CK22C	2004	CS1236H	2009	CTP3503	2006	DS63	2003
CK25	2005	CS1255H	2018	CTP3504	2006	DS64	2003
CK25A	2005	CS1256HG	2025	CTP3508	2006	DS65	2003
CK26	2005	CS1308	2021	CTP-2001-1001	2005	DS66	2009
CK26A	2005	CS1330	2009	CTP-2001-1002	2005	DS67	2016
CK27	2005	CS1330A	2009	CTP-2001-1003	2005	DS503	2006
CK27A	2005	CS1349	2009	CTP-2001-1004	2005	DS515	2006
CK64	2004	CS1555	2009	CTP-2001-1009	2003	DS520	2006
CK64A	2004	CS3906	2021	CTP-2006-1001	2003	DS-66	2009
CK64C	2004	CS9011	2016	CTP-2006-1002	2003	DS-67	2016
CK65	2004	CS9011G	2016	CTP-2006-1003	2003	DS-68	2023
CK65A	2004	CS9011H	2016	D1Y	2009	DS-71	2009
CK65B	2004	CS9011I	2016	D7A32	2018	DS-72	2009
CK66	2004	CS9012	2025	D16E7	2009	DS-73	2009
CK66A	2004	CS9013	2016	D16E9	2009	DS-74	2011
CK66B	2004	CS9013H	2016	D16K1	2011	DS-76	2009
CK66C	2004	CS9014	2016	D16K2	2011	DS-78	2009
CK67	2004	CS9014B	2018	D16K3	2011	DS-81	2009
CK67A	2004	CS9016	2016	D28A9	2018	DS-83	2021
CK67B	2004	CS9017G	2009	D29A4	2021	DS-85	2009
CK67C	2004	CS9017H	2009	D29A5	2023	DT41	2006
CK261	2002	CS9018E	2009	D29A6	2021	DT401	2006
CK262	2002	CS9103C	2018	D66	2003	DT1040	2006
CK721	2004	CS9600-4	2001	D101B	2005	DT1110	2018
CK722	2004	CS9600-5	2001	D102	2011	DT1111	2018
CK725	2004	CST1739	2006	D105B	2004	DT1120	2018
CK727	2004	CST1740	2006	D134	2005	DT1122	2018
CK751	2004	CST1741	2006	D135	2005	DT1311	2018
CK754	2005	CST1742	2006	D149	2003	DT1321	2018

DEVICE	RS 276-	DEVICE	RS 276-	DEVICE	RS 276-	DEVICE	RS 276-
DT1610	2011	EA15X94	2009	ER15X22	2005	ES65	2021
DT6110	2006	EA15X96	2009	ER15X23	2005	ES68	2025
DTG110	2006	EA1343	2016	ES1	2005	ES73	2009
DU1	2003	EA1346	2005	ES2	2005	ES503	2006
DU3	2004	EA1562	2011	ES3	2003	ES3110	2004
DU4	2005	EA1563	2011	ES4	2006	ES3111	2004
DU5	2004	EA1564	2016	ES5	2002	ES3112	2004
DU6	2006	EA1628	2009	ES6	2002	ES3113	2004
DU12	2003	EA1629	2009	ES7	2006	ES3114	2005
E1A	2009	EA1630	2009	ES8	2003	ES3115	2005
E132	2004	EA1696	2009	ES9	2006	ES3116	2005
E158	2005	EA1697	2009	ES11	2005	ES3120	2004
E241	2004	EA1698	2009	ES13	2006	ES3121	2004
E241A	2005	EA1700	2006	ES14	2005	ES3122	2004
E241B	2005	EA1703	2009	ES15	2003	ES3123	2005
E2412	2004	EA1733	2009	ES15X1	2005	ES3124	2005
E2430	2016	EA1735	2009	ES15X4	2005	ES3125	2005
E2465	2005	EA2219	2016	ES15X7	2016	ES3126	2005
E2466	2002	EA2220	2016	ES15X8	2005	ET1	2003
E2467	2005	EA1-380	2018	ES15X10	2016	ET3	2004
E2474	2003	ECG100	2007	ES15X11	2016	ET4	2005
E2475	2003	ECG101	2001	ES15X12	2016	ET5	2004
E2476	2004	ECG102	2003	ES15X14	2016	ET6	2006
E2477	2004	ECG102A	2003	ES15X16	2016	ET12	2003
E2478	2003	ECG103	2001	ES15X17	2006	ET15X1	2005
E2479	2003	ECG103A	2001	ES15X18	2011	ET15X3	2015
E2480	2004	ECG104	2006	ES15X19	2011	ET15X4	2006
E2481	2004	ECG106	2023	ES15X20	2016	ET15X5	2006
E2482	2005	ECG107	2011	ES15X23	2016	ET15X7	2009
EA15X1	2016	ECG108	2011	ES15X24	2016	ET15X9	2009
EA15X2	2005	ECG121	2006	ES15X30	2011	ET15X10	2016
EA15X3	2005	ECG123	2009	ES15X31	2005	ET15X11	2016
EA15X4	2005	ECG123A	2009	ES15X32	2005	ET15X12	2016
EA15X5	2009	ECG126	2005	ES15X37	2016	ET15X14	2016
EA15X7	2005	ECG131	2006	ES15X42	2016	ET15X16	2016
EA15X8	2005	ECG133	2028	ES15X43	2006	ET15X17	2006
EA15X9	2016	ECG152	2018	ES15X48	2001	ET15X18	2011
EA15X10	2006	ECG153	2026	ES15X49	2005	ET15X19	2011
EA15X11	2003	ECG154	2008	ES15X50	2003	ET15X20	2016
EA15X12	2006	ECG158	2006	ES15X51	2006	ET15X21	2009
EA15X13	2003	ECG159	2021	ES15X53	2004	ET15X23	2009
EA15X15	2006	ECG160	2005	ES15X55	2003	ET15X24	2016
EA15X18	2016	ECG161	2011	ES15X56	2011	ET15X29	2003
EA15X19	2005	ED51	2003	ES15X57	2011	ET15X30	2011
EA15X22	2016	ED52	2004	ES15X58	2013	ET15X31	2005
EA15X24	2016	ED53	2004	ES15X60	2009	ET15X32	2005
EA15X26	2006	ED54B	2004	ES15X61	2003	ET15X37	2016
EA15X31	2016	ED55	2005	ES15X62	2009	ET15X40	2006
EA15X33	2006	ED56	2005	ES15X63	2004	ET15X42	2016
EA15X35	2006	ED57	2005	ES15X64	2011	ET15X43	2006
EA15X36	2005	EN10	2009	ES17	2005 + 2001	ET1511	2005
EA15X37	2016	EN30	2009	E18	2006	ETS-070	2018
EA15X38	2006	EN40	2009	ES19	2003	ETS071	2025
EA15X41	2003	EN697	2009	ES20	2013	ETx18	2016
EA15X44	2016	EN706	2009	ES21	2006	EU15X1	2009
EA15X45	2016	EO44A	2005	ES23	2003	EU15X3	2015
EA15X48	2011	EO65	2004	ES25	2003	EU15X27	2009
EA15X49	2011	EO66	2004	ES26	2005	EU15X34	2009
EA15X50	2011	EO67	2004	ES29	2006	EVS-828A	2013
EA15X51	2016	EO68	2004	ES34	2021	EW162	2013
EA15X52	2016	EO70	2004	ES36	2017	EW163	2009
EA15X53	2006	EO105	2004	ES37	2006	EW164	2009
EA15X54	2011	EP20	2024	ES41	2003	EW165	2009
EA15X55	2011	EP25	2024	ES44	2017	EW165Y	2009
EA15X56	2016	EP35	2024	ES45	2017	EW181	2009
EA15X63	2016	ER15X10	2006	ES47	2029	EW182	2009
EA15X68	2016	ER15X11	2003	ES49	2025	EW183	2026
EA15X75	2009	ER15X12	2003	ES50	2006	EW183B	2017
EA15X76	2009	ER15X13	2003	ES52	2015	EW212	2017
EA15X77	2009	ER15X14	2003	ES53	2013	F121-603	2021
EA15X83	2009	ER15X17	2005	ES54	2009	F121-60216	2021
EA15X84	2009	ER15X18	2005	ES58	2018	F501	2011
EA15X85	2009	ER15X19	2003	ES60	2026	F502	2011
EA15X86	2009	ER15X20	2003	ES61	2006	F523	2011
EA15X88	2006	ER15X21	2003	ES63	2006	F4706	2015

DEVICE	RS 276-	DEVICE	RS 276-	DEVICE	RS 276-	DEVICE	RS 276-
F4709	2009	GC464	2005	GME2001	2009	GT1605	2004
FE100	2028	GC466	2005	GME2002	2009	GT1606	2003
FE100A	2028	GC520	2005	GME3001	2011	GT1607	2003
FE102	2028	GC521	2005	GME3002	2011	GT1608	2002
FE102A	2028	GC578	2005	GME4001	2009	GT1609	2002
FE104A	2028	GC579	2005	GME4002	2009	GT1644	2021
FE400	2028	GC580	2005	GME4003	2009	GT1665	2005
FE402	2028	GC581	2005	GME6003	2009	GT2693	2003
FE402A	2028	GC608	2002	GME9001	2011	GT2694	2005
FE404A	2028	GC609	2002	GME9002	2011	GT2695	2004
FF400	2028	GC640	2005	GME9021	2011	GT2696	2005
FK2894	2023	GC641	2006	GME9022	2011	GT2765	2002
FK3502	2021	GC856	2005	GMO290	2003	GT2766	2002
FK3962	2021	GC864	2005	GMO375	2003	GT2768	2002
FM708	2009	GC4022	2004	GMO376	2003	GT2883	2005
FM709	2011	GC4144	2005	GMO377	2003	GT2884	2001
FM914	2011	GC5000	2005	GMO378	2003	GT2885	2005
FM2368	2011	GE2	2004	GT11	2004	GT2886	2001
FM2369	2011	GE3	2006	GT12	2004	GT2887	2005
FM2846	2009	GE5	2001	GT13	2004	GT2888	2002
FM2894	2011	GE6	2001	GT14	2005	GT2906	2002
FM3014	2011	GE7	2001	GT20	2005	GT3150	2002
FPR40-1001	2009	GE8	2001	GT20R	2005	GT5116	2003
FPR40-1003	2011	GE9	2003	GT31	2005	GT5117	2003
FPR40-1004	2003	GE9A	2003	GT32	2005	GT5148	2003
FPR40-1005	2003	GE10	2009	GT33	2005	GT5149	2003
FPR50-1001	2009	GE11	2011	GT34	2005	GT5151	2004
FPR50-1002	2009	GE13MP (two)	2006	GT40	2003	GT5153	2003
FPR50-1003	2011	GE16	2006	GT41	2004	GTE1	2004
FPR50-1004	2011	GE17	2013	GT42	2005	GTE2	2004
FPR50-1005	2003	GE20	2009	GT43	2003	GTV	2004
FPR50-1006	2003	GE21	2021	GT44	2004	H10	2005
FSP165	2011	GE22	2021	GT45	2004	H931	2011
FSP242-1	2011	GE23	2017	GT46	2003	HA234	2003
FT001	2009	GE24MP (two)	2017	GT47	2003	HA353	2003
FT002	2009	GE26	2025	GT74	2005	HA2001	2028
FT003	2009	GE208	2003	GT75	2005	HA2010	2028
FT004	2009	GE-27	2008	GT81	2005	HA5001	2001
FT004A	2009	GE-28	2018	GT81HS	2005	HA5002	2001
FT005	2021	GE-19	2025	GT81R	2005	HA5033	2001
FT006	2021	GE-30	2006	GT82	2005	HA5005	2001
FT008	2021	GE-31MP (two)	2006	GT109	2005	HA5009	2001
FT008A	2021	GE-FET-1	2028	GT109R	2005	HA5010	2001
FT0019M	2024	GE-M10D	2003	GT122	2005	HA5011	2001
FT023	2009	GE-X8	2001	GT123	2005	HA5012	2001
FT024	2009	GE-X9	2004	GT132	2005	HA5014	2001
FT025	2009	GE-X10	2029	GT167	2001	HA5016	2001
FT026	2009	GE-X16A1938	2013	GT222	2004	HA5020	2001
FT052	2021	GET691	2003	GT229	2001	HA5021	2001
FT709	2011	GET692	2003	GT364	2001	HA5022	2001
FT1315	2011	GET693	2003	GT365	2001	HA5023	2001
FT1324B	2011	GET882	2004	GT366	2001	HA5024	2001
FT1324C	2011	GET885	2004	GT751	2005	HA5025	2001
FT1341	2023	GET889	2004	GT758	2004	HA5026	2001
FT1746	2023	GET890	2004	GT759	2005	HA-12	2004
GO4-701-A	2006	GET892	2004	GT759R	2005	HA-15	2003
GO4-704-A	2006	GET896	2004	GT760	2005	HA-30	2003
GO5-010-A	2009	GET897	2004	GT760R	2005	HA-49	2003
GO5-011-A	2009	GET898	2005	GT761	2005	HA-52	2003
GO5-015-D	2009	GET5116	2003	GT761R	2005	HA-53	2003
G11	2004	GET5117	2003	GT762	2005	HA-102	2003
G12	2005	GF20	2005	GT762R	2005	HA-104	2003
G13	2003	GF21	2005	GT763	2005	HA-201	2004
G14	2005	GF32	2005	GT766	2005	HA-202	2004
G19	2006	GFT44	2003	GT766A	2005	HA-235	2003
G16506	2001	GFT45	2003	GT792	2002	HA-235A	2003
G101079	2001	GFT3008/40	2005	GT832	2003	HA-235C	2003
GA53270	2001	GI6506	2001	GT904	2001	HA-240	2003
GC60	2004	GM656A	2003	GT905R	2001	HA-267	2003
GC61	2004	GM770	2011	GT948	2001	HA-268	2003
GC181	2004	GME040-1	2023	GT949	2001	HA-269	2003
GC182	2004	GME0404	2023	GT949R	2001	HA-350	2003
GC285	2002	GME0404-2	2023	GT1202	2001	HA-350A	2003
GC286	2002	GME1001	2009	GT1223	2005	HA-353	2003
GC408	2005	GME1002	2009	GT1604	2004	HA-353C	2003

DEVICE	RS 276-	DEVICE	RS 276-	DEVICE	RS 276-	DEVICE	RS 276-
HA-354	2003	HEP242	2025	HF3M	2004	HR-50	2004
HA-354B	2003	HEP243	2018	HF6H	2005	HR-58	2009
HA-471	2003	HEP245	2018	HF6M	2004	HR-59	2009
HA-505	2026	HEP246	2026	HF12H	2005	HR-60	2009
HA-525	2023	HEP250	2004	HF12M	2004	HR-61	2004
HAM-1	2005	HEP251	2005	HF12N	2005	HR-62	2016
HB-32	2004	HEP252	2004	HF20H	2005	HR-63	2016
HB-33	2004	HEP253	2004	HF20M	2004	HR-64	2016
HB-54	2003	HEP254	2005	HF35	2003	HR-65	2018
HB-56	2003	HEP310	2029	HF50	2003	HR-67F	2018
HB-75	2004	HEP623	2006	HF75	2005	HR-40336	2003
HB-75C	2005	HEP624	2006	HF-1	2009	HR-40836	2003
HB-77	2009	HEP628	2006	HF-2	2016	HR-43835	2003
HB-77B	2003	HEP629	2007	HF-3	2016	HR-45838	2003
HB-77C	2003	HEP630	2005	HF-4	2016	HR-45910	2003
HB-156	2004	HEP631	2007	HF-5	2009	HR-448636	2003
HB-156C	2005	HEP632	2003	HF-6	2009	HS5	2005
HB-172	2005	HEP633	2003	HF-7	2016	HS17D	2005
HB-175	2005	HEP634	2003	HF-8	2016	HS22D	2005
HB-176	2005	HEP635	2003	HJ15	2005	HS23D	2005
HB-178	2005	HEP636	2005	HJ15D	2003	HS-40021	2009
HB-186	2003	HEP637	2003	HJ17	2005	HS-40022	2016
HB-187	2005	HEP638	2005	HJ17P	2005	HS-40023	2016
HB-263	2004	HEP639	2003	HJ22	2005	HS-40024	2016
HB-270	2005	HEP640	2003	HJ22D	2005	HS-40025	2016
HB-324	2005	HEP641	2002	HJ23	2005	HS-40026	2011
HB-365	2005	HEP642	2006	HJ23D	2005	HT100	2023
HB-367	2006	HEP643	2006	HJ32	2003	HT101	2023
HB-415	2006	HEP700	2027	HJ34	2003	HT400	2009
HB-459	2005	HEP701	2019	HJ35	2006	HT401	2009
HB-461	2007	HEP702	2025	HJ37	2003	HT040519C	2002+2005
HB-475	2005	HEP703	2017	HJ50	2005	HT040519C-D	2006+02
HB-00176	2005	HEP705	2027	HJ51	2005	HT101021A	2005
HC-56	2009	HEP706	2008	HJ54	2004	HT102341B	2003
HC-371	2009	HEP708	2021	HJ55	2003	HT102341C	2003
HC-372	2009	HEP709	2011	HJ56	2003	HT102351A	2003
HC-373	2009	HEP715	2021	HJ57	2003	HT103501A	2003
HC-380	2011	HEP716	2021	HJ60	2004	HT104951B	2023
HC-381	2009	HEP717	2023	HJ60A	2003	HT04951B-0	2023
HC-394	2011	HEP718	2011	HJ62	2004	HT104951C	2023
HC-454	2009	HEP719	2011	HJ71	2004	HT200540A	2003
HC-458	2009	HEP720	2015	HJ72	2004	HT200541B	2003
HC-460	2009	HEP721	2011	HJ73	2004	HT200541B-0	2003
HC-461	2009	HEP722	2009	HJ74	2004	HT200561C	2003
HC-495	2018	HEP723	2009	HJ226	2004	HT200561C-0	2003
HC-535A	2011	HEP724	2009	HJ228	2004	HT200751B	2005
HC-535B	2011	HEP725	2009	HJ230	2004	HT20771B	2003
HC-537	2009	HEP726	2013	HJ315	2005	HT203701B	2005
HC-539	2009	HEP727	2009	HJX2	2004	HT204051E	2006
HC-545	2011	HEP728	2013	HK040519B	2006+2001	HT204053A	2006
HC-561	2009	HEP729	2013	HKT-158	2009	HT204736	2006
HC-645	2011	HEP730	2013	HKT-161	2009	HT303620B	2009
HC-668	2011	HEP731	2013	HR1	2004	HT303711A	2009
HC-772	2009	HEP732	2009	HR2	2004	HT303711B	2009
HC-784	2011	HEP733	2009	HR4	2004	HT303711B-0	2009
HC-828	2013	HEP734	2009	HR6	2004	HT3037210-0	2009
HC-829	2009	HEP735	2009	HR7	2004	HT303801B	2011
HC-00828	2013	HEP736	2009	HR8	2004	HT303801B-0	2011
HD-187	2002	HEP737	2013	HR9	2004	HT304580B	2009
HEP1	2003	HEP738	2013	HR13	2016	HT304580K	2013
HEP3	2003	HEP739	2021	HR17	2016	HT304581B	2009
HEP50	2009	HEP801	2028	HR101	2006	HT304581C	2009
HEP51	2021	HEPS0001	2008	HR-15	2009	HT306451A	2011
HEP52	2023	HEPS0003	2009	HR-16	2009	HT308291A	2009
HEP53	2009	HEPS0004	2009	HR-17	2009	HT308291A-0	2009
HEP54	2016	HEPS0005	2008	HR-17A	2009	HT308291B	2009
HEP55	2009	HEPS0005	2009	HR-18	2009	HT308291B-0	2009
HEP56	2011	HEPS001	2020	HR-19	2009	HT400721E	2001
HEP57	2024	HEPS002	2027	HR-28	2018	HT400723A	2001
HEP75	2009	HEPS0003	2019	HR-30	2005	HT3036210	2011
HEP76	2021	HEPS0007	2027	HR-36	2016	HT3037010	2009
HEP200	2006	HEPS0008	2027	HR-37	2016	HT3037201	2009
HEP230	2006	HEPS0009	2027	HR-38	2018	HT3037210	2009
HEP232	2006	HEPS0010	2027	HR-47	2009	HT3037310	2009
HEP238	2006	HF3H	2004	HR-48	2009	HV12	2005

DEVICE	RS 276-	DEVICE	RS 276-	DEVICE	RS 276-	DEVICE	RS 276-
HV15	2005	L5022A	2005	M829B	2024	M4595	2004
HV16	2005	L5025	2005	M829C	2024	M4596	2003
HV17	2004	L5025A	2005	M829D	2024	M4597	2003
HV17B	2005	-LS52	2006	M829E	2024	M4597GRN	2003
HV19	2005	M24A	2009	M829F	2024	M4597RED	2003
HV0000405-0	2005	M24B	2009	M833	2021	M4603	2005
HX-50001	2009	M25	2009	M844	2009	M4604	2005
HX-50002	2018	M25A	2009	M847BLK	2009	M4605	2003
HX-50003	2009	M25B	2009	M1400-I	2009	M4605RED	2003
IF65	2005	M54	2009	M3519	2013	M4607	2003
IR2160	2029	M54BLK	2009	M4313	2005	M4608	2006
IRFE100	2028	M54BLU	2013	M4315	2003	M4619RED	2006
IRTR50	2006	M54BRN	2009	M4363	2003	M4620GRN	2006
IRTR51	2008	M54GRN	2009	M4363BLU	2003	M4621	2003
IRTR52	2021	M54ORN	2009	M4363GRN	2003	M4624	2009
IRTR53	2008	M54RED	2009	M4363ORN	2003	M4627	2003
IRTR54	2021	M54WHT	2013	M4363WHT	2003	M4630	2009
IRTR57	2017	M54YEL	2009	M4364	2003	M4632	2003
IRTR58	2025	M54A	2009	M4365	2003	M4649	2006
ISB51	2005	M54B	2009	M4366	2005	M4700	2001
J24561	2011	M54C	2009	M4367	2005	M4705	2009
J24562	2009	M54D	2013	M4398	2003	M4709	2011
J24563	2009	M54E	2009	M4442	2021	M4714	2009
J24564	2009	M65	2024	M4450	2005	M4722	2006
J24565	2009	M65A	2024	M4454	2005	M4722BLU	2006
J24620	2003	M65B	2024	M4456	2005	M4722GRN	2006
J24621	2003	M65C	2024	M4457	2005	M4722ORN	2006
J24622	2003	M65D	2024	M4462	2007	M4722RED	2006
J24623	2003	M65E	2024	M4463	2006	M4722VIO	2006
J24624	2011	M65F	2024	M4464	2009	M4722YEL	2006
J24625	2011	M76	2003	M4465	2009	M4727	2006
J24626	2005	M77	2003	M4466ORN	2007	M4732	2013
J24635	2009	M78	2003	M4468BRN	2007	M4733	2009
J24636	2016	M78BLK	2003	M4469RED	2007	M4734	2013
J24637	2016	M78GRN	2003	M4470ORN	2007	M4737	2009
J24639	2003	M78RED	2003	M4471YEL	2007	M4739	2016
J24640	2025	M78YEL	2003	M4472GRN	2007	M4745	2021
J24641	2016	M78A	2003	M4473	2007	M4756	2011
J24642	2006	M78B	2003	M4474YEL	2007	M4765	2009
J24752	2009	M78C	2003	M4475GRN	2007	M4768	2013
J24753	2021	M78D	2003	M4476	2005	M4789	2013
J24754	2018 + 2026	M84	2006	M4477VIO	2005	M4815	2021
JR5	2003	M91	2009	M4484	2003	M4820	2015
JR15	2003	M91A	2009	M4485	2003	M4821	2013
JR30	2003	M91B	2009	M4486	2003	M4825	2009
JR30X	2005	M91BGRN	2009	M4501	2005	M4837	2011
JR40	2006	M91C	2009	M4509	2005	M4839	2013
JR100	2003	M91D	2013	M4510	2005	M4840	2013
JR200	2003	M91E	2013	M4521	2005	M4841	2013
K4-500	2005	M91F	2013	M4545	2003	M4842	2013
K4-501	2001	M100	2028	M4545BLU	2003	M4844	2009
K4-505	2023	M101	2028	M4545WHT	2003	M4852	2013
K4-506	2009	M108	2005	M4553BLU	2003	M4854	2009
K4-507	2009	M773RED	2009	M4553BRN	2007	M4855	2009
K4-510	2011	M774ORN	2009	M4553GRN	2003	M4857	2011
K4-520	2006	M775BRN	2009	M4553ORN	2007	M4888A	2006
K4-521	2006	M776GRN	2009	M4553RED	2007	M4888B	2006
K2001	2011	M779BLU	2009	M4553YEL	2003	M5010	2021
K2501	2011	M780WHT	2009	M4562	2007	M8014	2004
K2502	2011	M783RED	2009	M4563	2005	M8124	2003
K2507	2011	M784ORN	2009	M4564	2005	M8640	2005
K4002	2011	M785YEL	2009	M4565	2007	M8640A	2005
KGS1000	2004	M786	2009	M4567	2003	M9348	2025
K04774	2006	M787BLU	2009	M4570	2006	M9348-1	2011
KR-Q1010	2003	M791	2011	M4573	2003	M9482	2011
KR-Q1011	2003	M818WHT	2009	M4576	2005	M9484	2027
KR-Q1012	2003	M822	2013	M4577	2005	M9514	2023
KV1	2005	M822A	2013	M4578	2005	M9531	2021
KV4	2004	M822ABLU	2013	M4582BRN	2006	M9532	2009
L-417-29BLK	2006	M822B	2013	M4583RED	2006	M9556	2019
L-417-29GRN	2006	M823WHT	2013	M4584GRN	2006	M9582	2019
L-417-29WHT	2006	M823B	2013	M4586	2003	MA1	2003
L417-60	2006	M827BRN	2009	M4589	2005	MA23	2001
L5021	2005	M828GRN	2009	M4590	2021	MA23B	2002
L5022	2005	M829A	2024	M4594	2009	MA112	2004

DEVICE	RS 276-	DEVICE	RS 276-	DEVICE	RS 276-	DEVICE	RS 276-
MA113	2005	ME216	2023	MN32	2006	MPS6513	2013
MA114	2005	ME217	2023	MN46	2006	MPS6514	2013
MA115	2004	ME900	2023	MN48	2006	MPS6515	2013
MA116	2005	ME900A	2023	MN52	2005	MPS6516	2021
MA117	2005	ME901	2024	MN53	2005	MPS5417	2021
MA286	2004	ME901A	2024	MN53BLU	2003	MPS6518	2024
MA287	2004	ME1001	2009	MN53GRN	2003	MPS6519	2024
MA288	2005	ME1002	2009	MN53RED	2005	MPS6520	2013
MA393	2003	ME2001	2009	MN60	2003	MPS6521	2009
MA393A	2003	ME2002	2009	MN73	2006	MPS6522	2024
MA393B	2003	ME3001	2011	MN73BLK	2006	MPS6523	2024
MA393C	2003	ME3002	2011	MN73WHT	2006	MPS6528	2009
MA393F	2003	ME4001	2009	MN76	2006	MPS6529	2009
MA393G	2003	ME4002	2009	MN194	2006	MPS6530	2009
MA393R	2003	ME4003	2009	MP110	2006	MPS6531	2009
MA815	2005	ME50001	2011	MP1509-1	2006	MPS6532	2009
MA881	2005	ME6001	2009	MP1509-2	2006	MPS6533	2021
MA882	2005	ME6002	2009	MP2060	2006	MPS6534	2021
MA883	2005	ME6003	2009	MP2061	2006	MPS6535	2021
MA884	2005	ME8201	2011	MP2062	2006	MPS6539	2011
MA885	2004	ME9001	2011	MP2076	2006	MPS6540	2011
MA886	2004	ME9002	2011	MPF103	2028	MPS6541	2015
MA887	2005	MF3304	2023	MPF104	2028	MPS6542	2011
MA888	2005	MHT2002	2001	MPF105	2028	MPS6543	2011
MA889	2005	MHT2003	2002	MPS404	2021	MPS6546	2011
MA890	2004	MHT2004	2001	MPS404	2021	MPS6547	2011
MA891	2005	MHT2008	2002	MPS706	2009	MPS6548	2011
MA892	2005	MHT2009	2001	MPS706A	2009	MPS6552	2016
MA893	2005	MHT2010	2002	MPS918	2015	MPS6553	2016
MA894	2004	MHT4483	2018	MPS2369	2009	MPS6554	2016
MA895	2004	MHT7401	2018	MPS2711	2009	MPS6555	2016
MA896	2005	MHT7411	2018	MPS2712	2009	MPS6562	2021
MA897	2005	MHT7414	2018	MPS2715	2009	MPS6563	2021
MA898	2004	MHT7417	2018	MPS2716	2009	MPS6565	2009
MA899	2004	MJ420	2008	MPS2923	2009	MPS6566	2009
MA900	2005	MJ421	2008	MPS2924	2009	MPS6568	2011
MA901	2004	MJ2253	2025	MPS2925	2013	MPS6569	2009
MA902	2004	MJ2254	2025	MPS2926	2009	MPS6570	2013
MA903	2004	MJ3701	2025	MPS2926BRN	2009	MPS6571	2013
MA904	2005	MJ4101	2017	MPS2926GRN	2009	MPS6573	2016
MA909	2004	MJ4102	2017	MPS2926ORN	2009	MPS6574	2016
MA910	2004	MJE370	2027	MPS2926RED	2009	MPS6575	2016
MA1700	2005	MJE371	2026	MPS2926YEL	2009	MPS6576	2016
MA1702	2005	MJE520	2018	MPS3392	2009	MPS-A70	2021
MA1703	2005	MJE521	2018	MPS3393	2009	MPS-L01	2008
MA1704	2005	MJE2955	2027	MPS3394	2009	MT102351A	2003
MA1705	2003	MJE3055	2020	MPS3395	2009	NA20	2001
MA1706	2005	MM709	2011	MPS3396	2013	NA30	2002
MA1707	2005	MM1139	2003	MPS3397	2013	NA1022-1001	2003
MA1708	2005	MM1387	2015	MPS3398	2013	NA1022-1007	2004
MA4670	2006	MM1601	2009	MPS3563	2015	NA5018-1001	2003
MAS20	2003	MM1742	2004	MPS3568	2009	NA5018-1002	2003
MAS21	2003	MM1755	2009	MPS3638	2021	NA5018-1003	2003
MAS23	2003	MM1757	2009	MPS3638A	2021	NA5018-1004	2003
MD420	2003	MM1941	2011	MPS3642	2009	NA5018-1005	2003
MD501	2003	MM2503	2003	MPS3646	2009	NA5018-1006	2003
MD501B	2003	MM2550	2003	MPS3693	2013	NA5018-1007	2003
MDS31	2003	MM2552	2003	MPS3694	2013	NA5018-1008	2003
MDS32	2003	MM2554	2003	MPS3702	2021	NA5018-1009	2005
MDS33	2003	MM3005	2018	MPS3703	2021	NA5018-1010	2005
MDS33A	2003	MM3905	2023	MPS3704	2011	NA5018-1011	2005
MDS33C	2003	MM3906	2023	MPS3705	2011	NA5018-1012	2005
MDS33D	2033	MM5005	2025	MPS3706	2011	NA5018-1013	2004
MDS34	2033	MM8003	2009	MPS3707	2013	NA5018-1014	2004
MDS35	2003	MN13-B	2004	MPS3708	2013	NA5018-1015	2004
MDS36	2003	MN22	2006	MPS3709	2013	NA5018-1016	2004
MDS37	2003	MN23	2006	MPS3710	2013	NA5018-1219	2005
MDS38	2003	MN24	2006	MPS3711	2013	NA5018-1220	2005
MDS39	2003	MN25	2006	MPS3721	2013	NA-1114-1001	2003
MDS40	2003	MN26	2006	MPS3826	2009	NA-1114-1002	2003
ME0404	2021	MN29	2006	MPS3827	2009	NA-1114-1004	2004
ME0404-1	2023	MN29BLK	2006	MPS5172	2013	NA-1114-1005	2004
ME0404-2	2024	MN29GRN	2006	MPS6507	2015	NA-1114-1006	2004
ME213	2024	MN29PUR	2006	MPS6511	2015	NA-1114-1007	2004
ME213A	2023	MN29WHT	2006	MPS6512	2013	NA-1114-1008	2004

DEVICE	RS 276-	DEVICE	RS 276-	DEVICE	RS 276-	DEVICE	RS 276-
NA-1114-1009	2004	NKT232	2005	NS733A	2009	OC171	2003
NA-1114-1010	2004	NKT242	2004	NS734	2009	OC200	2023
NA-1114-1011	2004	NKT243	2005	NS734A	2009	OC201	2023
NC30	2005	NKT244	2005	NS1000	2021	OC202	2023
NC32	2006	NKT246	2005	NS1001	2021	OC203	2023
NC33	2001	NKT247	2005	NS1500	2009	OC204	2023
NC34	2006	NKT249	2005	NS1510	2009	OC205	2023
NKT4	2003	NKT251	2005	NS1672	2023	OC207	2023
NKT5	2003	NKT252	2004	NS1673	2023	OC303	2004
NKT24	2003	NKT253	2004	NS1674	2023	OC304	2004
NKT25	2003	NKT254	2005	NS1675	2023	OC304/1	2004
NKT32	2003	NKT255	2004	NS1861	2021	OC304/2	2005
NKT33	2005	NKT261	2004	NS1862	2021	OC304/3	2005
NKT42	2003	NKT262	2004	NS1863	2023	OC305	2005
NKT43	2005	NKT263	2004	NS1864	2023	OC305/1	2005
NKT52	2005	NKT264	2005	NS1972	2009	OC305/2	2005
NKT53	2005	NKT265	2004	NS1973	2009	OC306/1	2004
NKT54	2005	NKT270	2005	NS1974	2009	OC306/2	2005
NKT62	2005	NKT271	2005	NS1975	2009	OC306/3	2005
NKT63	2005	NKT272	2004	NS6062	2023	OC307	2004
NKT64	2004	NKT273	2005	NS8083	2023	OC307-1	2004
NKT72	2004	NKT274	2004	NS8084	2023	OC307-2	2005
NKT73	2004	NKT275	2004	NS8085	2023	OC307-3	2005
NKT74	2004	NKT275A	2004	NS9710	2011	OC308	2004
NKT102	2003	NKT275E	2005	OC16	2006	OC309	2004
NKT103	2005	NKT275J	2005	OC22	2006	OC309-1	2004
NKT104	2005	NKT278	2005	OC23	2006	OC309-2	2004
NKT105	2005	NKT401	2006	OC24	2006	OC309-3	2005
NKT106	2005	NKT402	2006	OC25	2006	OC318	2005
NKT107	2005	NKT403	2006	OC26	2006	OC330	2005
NKT108	2005	NKT404	2006	OC27	2006	OC331	2003
NKT109	2005	NKT405	2006	OC28	2006	OC340	2005
NKT123	2005	NKT415	2006	OC29	2006	OC341	2003
NKT126	2005	NKT416	2006	OC34	2005	OC342	2003
NKT132	2004	NKT450	2006	OC35	2006	OC343	2003
NKT133	2004	NKT451	2006	OC36	2006	OC350	2005
NKT141	2004	NKT552	2006	OC38	2005	OC351	2003
NKT142	2004	NKT452-S1	2006	OC41	2004	OC360	2005
NKT143	2004	NKT453	2006	OC42	2003	OC361	2003
NKT144	2004	NKT454	2006	OC43	2003	OC362	2003
NKT151	2005	NKT618	2003	OC44	2003	OC363	2003
NKT152	2005	NKT675	2003	OC45	2003	OC364	2005
NKT53/25	2005	NKT676	2003	OC46	2005	OC390	2003
NKT54/25	2005	NKT677	2003	OC47	2005	OC430	2023
NKT162	2005	NKT713	2001	OC57	2004	OC430K	2023
NKT163	2005	NKT717	2001	OC58	2005	OC440	2023
NKT163/25	2005	NKT734	2002	OC59	2005	OC440K	2023
NKT164	2005	NKT736	2001	OC60	2005	OC443	2023
NKT164/25	2005	NKT753	2002	OC65	2004	OC443K	2023
NKT202	2005	NKT773	2001	OC66	2004	OC445	2023
NKT203	2005	NKT781	2002	OC70	2004	OC445K	2023
NKT204	2004	NPS6518	2026	OC71	2004	OC449	2021
NKT205	2004	NR5	2001	OC71A	2005	OC449K	2023
NKT206	2005	NR10	2002	OC71N	2005	OC450	2021
NKT207	2005	NR700	2001	OC72	2005	OC460	2021
NKT208	2005	NS404	2021	OC73	2005	OC460K	2023
NKT211	2005	NS475	2009	OC74	2005	OC463	2023
NKT212	2005	NS476	2009	OC75	2005	OC463K	2023
NKT213	2005	NS477	2009	OC75N	2005	OC465	2023
NKT214	2005	NS478	2009	OC76	2004	OC465K	2023
NKT215	2004	NS479	2009	OC77	2004	OC466	2023
NKT216	2005	NS480	2009	OC77M	2004	OC466K	2023
NKT217	2005	NS661	2021	OC79	2004	OC467	2023
NKT218	2005	NS662	2021	OC80	2005	OC467K	2023
NKT221	2004	NS663	2021	OC81	2005	OC468	2023
NKT222	2005	NS664	2021	OC83	2004	OC468K	2023
NKT222S1	2004	NS665	2023	OC84	2005	OC469	2023
NKT222S2	2004	NS666	2023	OC122	2005	OC469K	2023
NKT223	2005	NS667	2023	OC123	2005	OC470	2023
NKT224	2004	NS668	2023	OC130	2003	OC470K	2023
NKT225	2004	NS731	2009	OC139	2001	OC602	2005
NKT226	2005	NS731A	2009	OC140	2002	OC602SP	2004
NKT227	2005	NS732	2023	OC141	2001	OC603	2005
NKT228	2004	NS732A	2023	OC169	2003	OC604	2005
NKT231	2005	NS733	2009	OC170	2003	OC604SP	2004

DEVICE	RS 276-	DEVICE	RS 276-	DEVICE	RS 276-	DEVICE	RS 276-
OC614	2003	P3D	2004	PT236C	2006	R244	2004
OC615	2003	P3EBLK	2006	PT242	2006	R255	2005
ON174	2005	P3EBLU	2006	PT255	2006	R290	2005
ON271	2013	P3EGRN	2006	PT256	2006	R291	2005
P1A	2006	P3ERED	2006	PT285	2006	R324	2007
P1B	2021	P3M	2027	PT285A	2006	R428	2005
P1C	2021	P3N-1	2026	PT301	2006	R488	2004
P1D	2021	P3N-2	2026	PT301A	2006	R506	2004
P1E	2027	P3N-3	2026	PT307	2006	R516	2006
P1E-1BLK	2027	P3N-4	2026	PT307A	2006	R530	2005
P1E-1BLU	2027	P3R	2006	PT530A	2005	R581	2003
P1E-1GRN	2027	P3R-1	2006	PT554	2006	R592	2001
P1E-1RED	2027	P3R-2	2006	PT555	2006	R608A	2005
P1E-1VIO	2027	P3R-3	2006	PT703	2009	R714	2004
P1E-2BLK	2027	P3R-4	2006	PT855	2003	R715	2004
P1E-2BLU	2027	P3S	2026	PT856	2003	R2003	2006
P1E-2GRN	2027	P3T	2006	PT886	2009	RCA35953	2005
P1E-2RED	2027	P3Z	2021	PT887	2009	RS406	2005
P1E-2VIO	2027	P4B	2021	PT888	2009	RS1192	2005
P1E-3BLK	2027	P4C	2021	PT896	2018	RS1540	2005
P1E-3BLU	2027	P4D	2006	PT897	2009	RS1541	2005
P1E-3GRN	2027	PA1000	2023	PT898	2009	RS1542	2005
P1E-3RED	2027	PA1001	2023	PT1835	2009	RS1543	2005
P1E-3VIO	2027	PA10889-1	2005	PT1836	2009	RS1544	2005
P1G	2006	PA10889-2	2005	PT2760	2009	RS1546	2005
P1H	2023	PA10890	2006	POWER12	2006	RS1548	2005
P1J	2021	PADT20	2003	POWER25	2006	RS1555	2005
P1KBLK	2006	PADT21	2003	POWER99	2006	RS2350	2005
P1KBLU	2006	PADT23	2003	POWER299	2006	RS2351	2005
P1KBRN	2006	PADT24	2003	Q1	2004	RS2352	2005
P1KGRN	2006	PADT25	2003	Q4	2004	RS2353	2005
P1KORN	2003	PADT28	2003	Q6	2005	RS2354	2005
P1KRED	2003	PADT30	2003	Q7	2005	RS2355	2005
P1KYEL	2006	PADT31	2003	Q8	2005	RS2367	2005
P1L	2005	PAR12	2006	Q16	2005	RS2373	2005
P1N	2021	PB110	2006	Q-1A	2005	RS2375	2005
P1N-1	2021	PBE3014-1	2005	Q-5	2001	RS2677	2005
P1N-2	2021	PBE3014-2	2005	Q-35	2016	RS2689	2005
P1N-3	2021	PBE3020-1	2005	Q-36	2021	RS2697	2005
P1P	2023	PBE3020-2	2001	QA-8	2009	RS3211	2005
P1P-1	2023	PBE3162	2005	QA-10	2018	RS3275	2005
P1R	2006	PEP2	2009	QA-11	2025	RS3280	2005
P1V	2027	PEP5	2009	QA-14	2009	RS3281	2004
P1V-2	2027	PEP6	2009	QA-15	2009	RS3282	2005
P1V-3	2027	PEP7	2009	QA-17	2025	RS3283	2005
P1V-4	2027	PEP8	2009	QA-20	2028	RS3285	2005
P1W	2021	PEP9	2009	QP-13	2027	RS3286	2005
P2A	2024	PET1002	2013	QP-14	2019	RS3289	2005
P2B	2004	PET8004	2013	QSE1001	2013	RS3293	2005
P2C	2006	PM195	2011	QSE3001	2015	RS3299	2005
P2DBLU	2006	PMT1767	2011	QSE5020	2011	RS3301	2005
P2DBRN	2006	PN26	2017	R16	2005	RS3316	2005
P2DGRN	2006	PQ27	2003	R24-1001	2003	RS3726	2005
P2DORN	2006	PQ28	2005	R24-1002	2005	RS3756	2005
P2DRED	2006	PQ29	2005	R24-1004	2005	RS3858-1	2006
P2DYEL	2006	PQ30	2003	R35	2001	RS3862	2003
P2E	2021	PQ31	2006	R52	2003	RS3863	2003
P2F	2006	PS1	2006	R56	2005	RS3864	2003
P2G	2021	PT0139	2005	R64	2005	RS3866	2005
P2H	2021	PT2A	2003	R65	2005	RS3867	2005
P2M-1	2023	PT2S	2003	R66	2005	RS3868	2003
P2M-2	2023	PT6	2006	R67	2005	RS3880	2005
P2M-3	2023	PT12	2006	R79	2002	RS3897	2005
P2P	2021	PT25	2006	R80	2001	RS3898	2003
P2R	2006	PT30	2006	R87	2005	RS3900	2003
P2S	2021	PT32	2006	R98	2007	RS3902	2003
P2T	2027	PT40	2006	R119	2004	RS3903	2003
P2T-1	2027	PT155	2006	R120	2005	RS3904	2005
P2T-2	2027	PT176	2006	R152	2005	RS3907	2003
P2T-3	2027	PT234	2006	R163	2004	RS3911	2003
P2T-4	2027	PT235	2006	R164	2005	RS3912	2003
P2W	2021	PT235A	2006	R177	2001	RS3913	2005
P2Y	2021	PT236	2006	R186	2004	RS3914	2004
P3B	2005	PT236A	2006	R227	2004	RS3915	2004
P3C	2021	PT236B	2006	R242	2005	RS3925	2005

DEVICE	RS 276-	DEVICE	RS 276-	DEVICE	RS 276-	DEVICE	RS 276-
RS3929	2003	RS5740-1	2005	RS-109	2011	S5327E	2011
RS3959-1	2006	RS5742	2005	RS-110	2023	S5328E	2011
RS5008	2005	RS5743	2005	RT929H	2016	S5670E	2011
RS5101	2003	RS5743-1	2005	RT930H	2016	S15657	2011
RS5102	2005	RS5743-2	2005	RT2329	2003	S15658	2011
RS5103	2005	RS5743-3	2005	RT2331	2003	S95101	2003
RS5104	2004	RS5746	2005	RT3466	2003	S95102	2003
RS5109	2003	RS5747	2005	RT3467	2004	S95103	2003
RS5201	2003	RS5748	2005	RT3468	2003	S95201	2004
RS5202	2005	RS5749	2005	RT3564	2005	S95202	2016
RS5203	2005	RS5752	2005	RT3566	2005	S95203	2005
RS5204	2003	RS5753	2005	RT3568	2005	S95204	2005
RS5205	2003	RS5753-2	2005	RT4525	2005	S95214	2005
RS5206	2003	RS5754	2005	RT4624	2003	S99101	2003
RS5207	2003	RS5755	2005	RT4625	2005	S99102	2003
RS5209	2004	RS5756	2005	RT4761	2009	S99103	2003
RS5301	2003	RS5761	2004	RT4762	2006	S99201	2005
RS5302	2004	RS5765	2005	RT5063	2005	S99203	2005
RS5303	2004	RS5766	2005	RT5520	2003	S-85	2018
RS5305	2003	RS5767	2005	RT5521	2004	S-86	2018
RS5306	2003	RS5768	2005	RT5522	2004	S-1316	2011
RS5311	2003	RS5802	2003	RT5637	2005	S-1682	2011
RS5312	2003	RS5818	2003	RT6787	2011	S-2172	2011
RS5313	2003	RS5852	2005	RT6988	2005	S-2617	2011
RS5401	2003	RS5853	2016	RT6989	2011	S-99218	2005
RS5402	2004	RS5854	2005	RT6990	2005	S-95218	2005
RS5403	2004	RS5855	2006	RT6991	2011	SA7	2001
RS5406	2005	RS5857	2016	RT7400	2001	SA29	2005
RS5502	2005	RS7101	2011	RT7401	2007	SA33	2004
RS5503	2005	RS7102	2011	RT7557	2018	SA33BRN	2004
RS5504	2005	RS7104	2011	RT7558	2005	SA33RED	2004
RS5505	2005	RS7105	2011	RT-61014	2005	SA50	2023
RS5506	2005	RS7106	2011	RT-61015	2005	SA51	2023
RS5507	2005	RS7107	2011	RT-71016	2005	SA52	2023
RS5511	2004	RS7108	2011	S01	2003	SA52A	2023
RS5530	2005	RS7114	2009	S02	2003	SA52B	2023
RS5532	2005	RS7117	2009	S03	2003	SA53	2023
RS5533	2005	RS7140	2009	S025	2005	SA54	2023
RS5534	2005	RS7143	2009	S031A	2013	SA55	2023
RS5535	2005	RS7202	2011	S037	2009	SA56	2023
RS5536	2005	RS7217	2009	S065	2004	SA70	2023
RS5542	2005	RS7218	2009	S065A	2003	SA128-1	2007
RS5543	2005	RS7219	2009	S088	2005	SA197	2007
RS5544	2005	RS7511	2016	S1019	2011	SA197-1	2007
RS5545	2005	RS7512	2016	S1037	2011	SA197-2	2007
RS5563	2005	RS7514	2018	S1041	2015	SA197-3	2007
RS5564	2005	RS7515	2016	S1044	2011	SA204	2007
RS5565	2005	RS7516	2016	S1058	2009	SA205BLU	2003
RS5566	2005	RS7517	2016	S1059	2011	SA205BRN	2007
RS5567	2005	RS7518	2018	S1060	2011	SA205GRN	2003
RS5568	2005	RS7519	2016	S1061	2016	SA205ORN	2005
RS5602	2005	RS7527	2009	S1062	2009	SA205RED	2005
RS5603	2005	RS7609	2016	S1065	2016	SA205VIO	2003
RS5605	2005	RS7610	2016	S1069	2016	SA205WHT	2003
RS5607	2005	RS7611	2016	S1078	2011	SA205YEL	2007
RS5608	2005	RS7612	2016	S1079	2009	SA240	2007
RS5610	2005	RS7613	2016	S1143	2016	SA310	2021
RS5612	2006	RS7614	2016	S1153	2009	SA311	2021
RS5613	2006	RS7623	2016	S1227	2009	SA312	2021
RS5614	2006	RS7624	2016	S1286	2011	SA313	2021
RS5704	2005	RS7625	2016	S1313	2011	SA314	2021
RS5704-2	2005	RS7626	2016	S1318	2011	SA315	2021
RS5708	2005	RS7627	2016	S1361	2013	SA316	2021
RS5708-2	2005	RS7628	2016	S1362	2015	SA410	2023
RS5709	2005	RS8442	2003	S1363	2013	SA411	2023
RS5717	2005	RS9510	2009	S1364	2013	SA412	2023
RS5717-1	2005	RS9512	2009	S1367	2021	SA413	2023
RS5717-3	2005	RS57042	2005	S1368	2009	SA414	2023
RS5717-6	2005	RS57062	2005	S1369	2009	SA415	2023
RS5720	2005	RS-101	2003	S1642	2009	SA416	2023
RS5733	2005	RS-102	2005	S1835	2013	SA495	2023
RS5734	2005	RS-104	2001	S1897	2011	SA495A	2023
RS5735	2005	RS-105	2006	S2020	2011	SA496	2023
RS5736	2005	RS-107	2009	S2038	2011	SA496A	2023
RS5737	2005	RS-108	2016	S5021	2011	SA496B	2023

DEVICE	RS 276-	DEVICE	RS 276-	DEVICE	RS 276-	DEVICE	RS 276-
SA537	2023	SFT213	2008	SJE243	2028	SK3019	2011
SA538	2023	SFT214	2008	SJE244	2018	SK3020	2009
SA539	2023	SFT221	2004	SJE245	2028	SK3024	2018
SA540	2023	SFT222	2004	SJE246	2018	SK3025	2025
SA585	2004	SFT223	2006	SJE248	2018	SK3034	2008
SA848	2004	SFT228	2004	SJE253	2018	SK3038	2009
SA881	2004	SFT227	2003	SJE254	2019	SK3039	2011
SB188	2005	SFT228	2003	SJE255	2019	SK3048	2018
SB189	2005	SFT229	2003	SJE258	2027	SK3049	2018
SC12	2005	SFT237	2006	SJE257	2028	SK3052	2008
SC66	2005	SFT238	2008	SJE261	2018	SK7181	2011
SC832	2018	SFT239	2006	SJE262	2018	SK-3041	2018
SC4044	2018	SFT240	2006	SJE265	2026	SKA4074	2011
SC4131	2018	SFT241	2004	SJE267	2026	SM578-1	2009
SDD420	2008	SFT243	2005	SJE271	2018	SM578-2	2009
SDD421	2009	SFT250	2006	SJE272	2018	SM843	2004
SDD821	2009	SFT251	2004	SJE273	2028	SM0843	2004
SDD1220	2009	SFT252	2004	SJE274	2018	SM2492	2003
SDD3000	2021	SFT253	2005	SJE275	2028	SM2700	2009
SE1001	2013	SFT259	2001	SJE278	2028	SM2701	2009
SE1001-1	2009	SFT260	2002	SJE277	2028	SM3014	2003
SE1001-2	2009	SFT281	2001	SJE278	2018	SM3104	2009
SE1002	2013	SFT296	2001	SJE279	2028	SM3505	2009
SE1002-1	2013	SFT308	2004	SJE280	2018	SM3988	2009
SE1002-2	2013	SFT307	2004	SJE283	2027	SM3987	2021
SE1010	2015	SFT308	2003	SJE284	2019	SM4547	2023
SE1019	2011	SFT315	2003	SJE288	2027	SM4719	2023
SE1044	2011	SFT316	2003	SJE289	2019	SM5379	2009
SE2001	2013	SFT317	2003	SJE305	2018	SM5564	2002
SE2002	2013	SFT319	2003	SJE320	2019	SM5643	2018
SE3001	2015	SFT320	2003	SJE340	2018	SM7545	2009
SE3002	2015	SFT321	2004	SJE401	2019	SM9253	2013
SE3003	2011	SFT322	2005	SJE402	2019	SM-716	2009
SE3005	2015	SFT323	2004	SJE403	2027	SN60	2009
SE3646	2013	SFT325	2005	SJE404	2019	SN80	2009
SE4001	2013	SFT337	2004	SJE405	2019	SP47	2006
SE4002	2013	SFT351	2004	SJE407	2019	SP70	2021
SE4010	2009	SFT352	2004	SJE408	2026	SP90	2023
SE5001	2011	SFT353	2005	SJE527	2018	SP230	2006
SE5002	2011	SFT354	2003	SJE583	2018	SP404T	2008
SE5003	2011	SFT357	2003	SJE584	2026	SP441	2006
SE5006	2011	SFT357P	2003	SJE721	2018	SP441D	2006
SE5020	2011	SFT358	2003	SJE723	2027	SP441G	2006
SE5021	2011	SFT377	2001	SJE724	2019	SP441S	2006
SE5022	2011	SFT526	2004	SJE736	2026	SP485	2006
SE5023	2011	SFT713	2009	SJE737	2018	SP485BLK	2006
SE5024	2011	SFT714	2009	SJE743	2019	SP485BLU	2006
SE5025	2015	SJ819	2017	SJE768	2027	SP485BRN	2006
SE5030A	2013	SJ1152	2025	SJE769	2018	SP485WHT	2006
SE5050	2011	SJ1171	2025	SJE781	2019	SP485B	2006
SE5051	2011	SJ1284	2025	SJE783	2019	SP485W	2006
SE5052	2011	SJ3408	2017	SJE784	2019	SP486	2006
SE5055	2009	SJE42	2019	SJE785	2019	SP486WHT	2006
SE6001	2011	SJE100	2018	SJE797	2026	SP486W	2006
SE6002	2011	SJE106	2018	SJE799	2026	SP634	2006
SE6010	2009	SJE108	2026	SJE1518	2026	SP744	2006
SE8001	2009	SJE111	2026	SJE1519	2018	SP777	2006
SE8002	2009	SJE112	2026	SJE1520	2018	SP819R	2006
SF1713	2009	SJE113	2018	SK7	2001	SP834 -	2006
SF1714	2009	SJE114	2026	SK1320	2011	SP875	2006
SF1726	2009	SJE133	2018	SK1856	2024	SP880	2006
SF1730	2009	SJE202	2026	SK2604	2024	SP880-1	2006
SFT124	2004	SJE203	2018	SK3003	2004	SP880-3	2006
SFT125	2005	SJE210	2026	SK3004	2005	SP891	2006
SFT125P	2005	SJE211	2018	SK3005	2003	SP891BLU	2006
SFT143	2004	SJE220	2019	SK3006	2003	SP891GRN	2006
SFT144	2005	SJE221	2026	SJE221	2003	SP891WHT	2006
SFT162	2003	SJE222	2018	SK3008	2005	SP891B	2006
SFT163	2003	SJE227	2026	SK3009	2006	SP891G	2006
SFT171	2003	SJE228	2018	SK3010	2001	SP891R	2006
SFT172	2003	SJE229	2018	SK3011	2001	SP891W	2006
SFT173	2003	SJE231	2027	SK3013	2006	SP1013B	2006
SFT174	2003	SJE237	2018	SK3014	2006	SP1108	2006
SFT194	2002	SJE241	2026	SK3015	2006	SP1271	2006
SFT212	2006	SJE242	2018	SK3018	2011	SP1323	2006

DEVICE	RS 276-	DEVICE	RS 276-	DEVICE	RS 276-	DEVICE	RS 276-
SP1403	2006	SPS3015	2009	SPS4055	2011	SPS5007-1	2023
SP1481	2006	SPS3370	2011	SPS4056	2021	SPS5007-2	2023
SP1481-1	2006	SPS3724	2024	SPS4059	2013	SPS5008	2021
SP1481-3	2006	SPS3735	2011	SPS4060	2009	SPS5809	2009
SP1481-4	2006	SPS3786	2021	SPS4061	2011	SPS6109	2024
SP1481-5	2006	SPS3787	2009	SPS4062	2009	SPS6111	2013
SP1482-2	2006	SPS3900	2009	SPS4063	2013	SPS6112	2013
SP1482-3	2006	SPS3907	2013	SPS4064	2023	SPS6113	2011
SP1482-4	2006	SPS3908	2013	SPS4066	2009	SPS7652	2009
SP1482-5	2006	SPS3909	2011	SPS4067	2009	SQ7	2001
SP1482-6	2006	SPS3912	2009	SPS4068	2011	ST01	2009
SP1482-7	2006	SPS3914	2009	SPS4069	2013	ST02	2009
SP1483-1	2006	SPS3915	2009	SPS4072	2021	ST03	2009
SP1483-2	2006	SPS3923	2013	SPS4073	2021	ST04	2009
SP1483-3	2006	SPS3924	2021	SPS4074	2011	ST05	2009
SP1556	2006	SPS3925	2013	SPS4075	2013	ST28A	2004
SP1556-1	2006	SPS3926	2009	SPS4076	2021	ST28B	2004
SP1556-2	2006	SPS3927	2021	SPS4077	2011	ST28C	2004
SP1556-4	2006	SPS3929	2011	SPS4078	2023	ST37C	2004
SP1563-2	2006	SPS3930	2013	SPS4079	2009	ST37D	2004
SP1595BLK	2006	SPS3931	2021	SPS4080	2011	ST37E	2004
SP1595BLU	2006	SPS3936	2009	SPS4081	2013	ST50	2009
SP1595GRN	2006	SPS3937	2009	SPS4082	2021	ST51	2009
SP1595RED	2006	SPS3938	2011	SPS4083	2013	ST53	2009
SP1596BLK	2006	SPS3940	2011	SPS4084	2013	ST54	2009
SP1596BLU	2006	SPS3948	2009	SPS4085	2009	ST55	2009
SP1596GRN	2006	SPS3951	2013	SPS4086	2023	ST56	2009
SP1596RED	2006	SPS3952	2009	SPS4087	2023	ST57	2009
SP1600	2006	SPS3957C	2009	SPS4088	2009	ST58	2009
SP1603-1	2006	SPS3967	2013	SPS4089	2009	ST59	2009
SP1603-2	2006	SPS3968	2009	SPS4090	2021	ST60	2011
SP1603-3	2006	SPS3971	2009	SPS4091	2009	ST61	2011
SP1619	2006	SPS3972	2009	SPS4095	2013	ST62	2011
SP1651	2006	SPS3973	2009	SPS4167	2011	ST63	2009
SP1657	2006	SPS3987	2021	SPS4168	2015	ST64	2009
SP1844	2006	SPS3988	2021	SPS4169	2013	ST70	2011
SP1927	2006	SPS3990	2021	SPS4300	2011	ST71	2011
SP1938	2006	SPS3999	2013	SPS4301	2021	ST72	2011
SP1950	2006	SPS4002	2011	SPS4302	2024	ST80	2011
SP2072	2006	SPS4003	2011	SPS4303	2009	ST82	2011
SP2076	2006	SPS4004	2009	SPS4309	2016	ST122	2005
SP2094	2006	SPS4005	2009	SPS4310	2021	ST123	2005
SP2155	2006	SPS4006	2009	SPS4311	2009	ST150	2009
SP2234	2006	SPS4007	2021	SPS4312	2021	ST151	2009
SP2247	2006	SPS4008	2009	SPS4313	2013	ST152	2009
SP2361	2006	SPS4009	2013	SPS4314	2021	ST153	2009
SP2361BLU	2006	SPS4013	2021	SPS4354	2024	ST154	2009
SP2361BRN	2006	SPS4014	2021	SPS4355	2023	ST155	2009
SP2361GRN	2006	SPS4016	2009	SPS4356	2013	ST156	2009
SP2361ORN	2006	SPS4017	2013	SPS4359	2009	ST157	2009
SP2361RED	2006	SPS4018	2021	SPS4363	2013	ST160	2009
SP2361YEL	2006	SPS4019	2021	SPS4365	2021	ST161	2009
SP2431	2006	SPS4020	2009	SPS4367	2013	ST162	2009
SP2493	2006	SPS4025	2021	SPS4368	2009	ST163	2009
SP2541	2006	SPS4026	2021	SPS4446	2009	ST301	2005
SP2551	2006	SPS4027	2021	SPS4450	2013	ST302	2005
SPC40	2009	SPS4028	2021	SPS4451	2009	ST303	2005
SPC42	2009	SPS4029	2009	SPS4452	2021	ST304	2005
SPC50	2009	SPS4030	2011	SPS4453	2013	ST332	2005
SPC51	2009	SPS4031	2024	SPS4455	2009	ST370	2004
SPC52	2009	SPS4032	2011	SPS4456	2013	ST382	2005
SPF024	2028	SPS4034	2009	SPS4457	2009	ST501	2009
SPS4	2009	SPS4039	2009	SPS4458	2021	ST502	2009
SPS12	2023	SPS4040	2009	SPS4459	2013	ST503	2009
SPS20	2013	SPS4041	2013	SPS4460	2021	ST504	2009
SPS38	2013	SPS4042	2011	SPS4472	2013	ST1242	2021
SPS43-1	2009	SPS4043	2011	SPS4473	2021	ST1243	2021
SPS514	2021	SPS4044	2013	SPS4476	2013	ST1244	2021
SPS0121	2025	SPS4045	2013	SPS4480	2021	ST1290	2021
SPS0122	2018	SPS4049	2009	SPS4610	2009	ST1506	2009
SPS1523	2021	SPS4050	2011	SPS4920	2013	ST1607	2009
SPS2269	2021	SPS4051	2011	SPS5006	2013	ST6110	2023
SPS2271	2013	SPS4052	2009	SPS5006-1	2013	ST8014	2021
SPS2272	2021	SPS4053	2009	SPS5006-2	2013	ST8033	2021
SPS3003	2011	SPS4054	2021	SPS5007	2023	ST8034	2021

DEVICE	RS 276-	DEVICE	RS 276-	DEVICE	RS 276-	DEVICE	RS 276-
ST8035	2023	SYL4280	2018	T1388	2003	T-279	2003
ST8038	2023	SYL4315	2001	T1389	2003	T-291	2009
ST8065	2021	T1P31	2019	T1390	2003	T-339	2018
ST8500	2021	T1S18	2011	T1391	2003	T-340	2025
ST8509	2021	T1XM15	2011	T1400	2003	T-342	2018
STC5810	2025	T1XM17	2011	T1401	2003	T-344	2018
STC5811	2025	T23	2004	T1402	2003	T-348	2005
STC5812	2025	T39	2004	T1430	2003	T-396	2028
STX0011	2025	T45	2005	T1418	2018	T-399	2018
STX0013	2018	T46	2004	T1485	2016	TA1575	2005
STX0020	2026	T47	2004	T1524BRN	2003	TA1575B	2004
STX0028	2019	T48	2004	T1524BRN/RED	2003	TA1614	2008
STX0028	2008	T81	2005	T1546	2005	TA1628	2003
STX0029	2025	T72	2005	T1573	2005	TA1655B	2004
STX0030	2025	T74	2005	T1574	2005	TA1658	2003
STX0033	2003	T78	2004	T1577	2005	TA1859	2003
STX0034	2003	T82	2005	T1583	2005	TA1660	2003
STX0038	2003	T83	2004	T1854	2003	TA1862	2003
STX0085	2005	T84	2004	T1854BLU	2003	TA1882	2006
STX0087	2003	T87	2004	T1857	2003	TA1882A	2006
STX0089	2003	T95	2004	T1890	2003	TA1697	2005
STX0090	2005	T99	2004	T1891	2003	TA1704	2004
STX0096	2003	T100	2004	T1892	2003	TA1705	2006
STX0099	2003	T101	2004	T1737	2003	TA1706	2004
STX0104	2003	T102A	2004	T1738	2003	TA1730	2005
STX0105	2003	T108	2004	T1740	2005	TA1731	2003
STX0110	2003	T109	2004	T1814	2003	TA1757	2003
STX0114	2007	T118	2004	T1831	2003	TA1783	2004
STX0121	2005	T126	2004	T1904	2004	TA1783A	2004
STX0123	2003	T127	2004	T1961	2004	TA1785	2006
STX0224	2005	T129	2004	T2015	2003	TA1766	2006
STX0260	2007	T130	2004	T2016	2003	TA1773	2006
STX0263	2007	T139	2006	T2017	2003	TA1778	2004
STX0264	2007	T344	2018	T2019	2003	TA1782	2004
STX0285	2003	T345	2026	T2021	2003	TA1783	2004
STX0268	2003	T417	2016	T2022	2003	TA1794	2006
STX0269	2003	T811	2003	T2159	2004	TA1796	2003
SV31	2005	T814	2005	T2172	2004	TA1797	2003
SX50	2009	T815	2005	T2173	2004	TA1798	2003
SX3001	2011	T1000	2005	T2384	2004	TA1828	2003
SX3702	2021	T1001	2005	T2379	2003	TA1846	2003
SX3709	2013	T1003	2005	T2384	2003	TA1847	2003
SX3711	2013	T1004	2005	T2439	2004	TA1860	2003
SX3826	2013	T1005	2005	T2440	2004	TA1861	2003
SYL105	2004	T1006	2005	T2441	2004	TA1881	2006
SYL106	2004	T1007	2005	T2788	2003	TA1890	2006
SYL107	2005	T1008	2005	T2878	2004	TA1891	2006
SYL108	2005	T1008-834	2009	T2896	2003	TA2322	2003
SYL109	2006	T1010	2005	T2945	2003	TA2503	2011
SYL152	2016	T1013	2005	T2946	2003	TA2911	2018
SYL160	2004	T1023	2005	T3005	2004	TC3123036722	2009
SYL1326	2001	T1040	2006	T6028	2004	TC3123036900	2009
SYL1327	2002	T1041	2006	T6029	2004	TC3123037111	2009
SYL1380	2001	T1042	2005	T6030	2004	TC3123037222	2009
SYL1408	2001	T1043	2005	T6031	2004	TC3123037412	2009
SYL1454	2002	T1046	2005	T6032	2004	TC3123041557	2005
SYL1468	2001	T1047	2005	T10010	2005	TF30	2005
SYL1583	2005	T1167	2006	T11618	2004	TF49	2005
SYL1591	2001	T1168	2006	T13000	2005	TF65	2004
SYL1608	2004	T1202	2004	T50339A	2005	TF65/30	2004
SYL1617	2002	T1203	2005	T50631	2003	TF66	2004
SYL1655	2003	T1224	2003	T50818	2003	TF66/30	2004
SYL1665	2005	T1225	2003	T52159	2005	TF66/60	2004
SYL1668	2005	T1250	2003	T59235A	2016	TF70	2001
SYL1690	2005	T1300	2005	T59247	2005	TF71	2001
SYL1697	2004	T1310	2005	T59249	2005	TF72	2002
SYL1717	2005	T1326	2004	T59276	2001	TF75	2005
SYL1750	2001	T1327	2004	T59277	2002	TF77	2005
SYL2189	2003	T1328	2004	T-131	2004	TF78	2006
SYL2248	2005	T1334	2004	T-163	2003	TF78/30	2006
SYL2249	2005	T1346	2004	T-203	2009	TF80/302	2006
SYL2250	2005	T1352	2005	T-246	2021	TG48	2005
SYL2300	2005	T1363	2004	T-251	2021	T-H2SC313	2011
SYL3613	2003	T1364	2004	T-255	2016	T1363	2003
SYL4131	2011	T1387	2003	T-278	2003	T1364	2003

DEVICE	RS 276-	DEVICE	RS 276-	DEVICE	RS 276-	DEVICE	RS 276-
TI365	2003	TIXA01	2005	T0015	2006	TR1512-80	2011
TI366	2006	TIXA02	2005	T0033	2009	TR310025	2005
TI366A	2006	TIXA03	2003	T0038	2009	TR310065	2005
TI367	2006	TIXA04	2003	T0039	2009	TR310075	2004
TI367A	2006	TIXA05	2003	T0040	2009	TR310159	2003
TI368	2006	TIXM01	2003	T0041	2005	TR310224	2003
TI368A	2006	TIXM02	2003	T01-101	2013	TR310225	2007
TI369	2006	TIXM03	2003	T01-104	2016	TR310231	2009
TI369A	2006	TIXM04	2003	T01-105	2009	TR310243	2009
TI370	2006	TIXM05	2003	T0101	2005	TR310244	2011
TI370	2006	TIXM06	2003	T0102	2005	TR310250	2011
TI370A	2006	TIXM07	2003	T0103	2005	TR310251	2004
TI387	2003	TIXM08	2005	T0104	2005	TR310252	2005
TI388	2003	TIXM15	2003	TP4123	2009	TR-1R33	2009
TI389	2003	TIXM17	2003	TP4124	2009	TR-2R33	2009
TI390	2003	TIXM101	2003	TP4125	2023	TR-3R33	2009
TI391	2003	TIXM201	2003	TP4126	2024	TR-4R33	2016
TI395	2003	TIXM202	2003	TPS6512	2013	TR-5R33	2016
TI397	2003	TIXM203	2003	TPS6513	2013	TR-6R33	2016
TI398	2003	TIXM204	2003	TPS6514	2013	TR-01	2006
TI399	2003	TIXM205	2003	TPS6515	2013	TR-02	2006
TI400	2003	TIXM206	2003	TPS6516	2021	TR-04	2005
TI401	2003	TIXS28	2011	TPS6517	2021	TR-05	2005
TI402	2003	TIXS29	2011	TPS6518	2024	TR-06	2004
TI403	2003	TIXS30	2011	TPS6519	2024	TR-10	2001
TI407	2011	TIXS31	2011	TPS6520	2013	TR-11	2003
TI408	2011	TK23C	2003	TPS6521	2009	TR-12	2003
TI409	2011	TK33C	2001	TPS6522	2024	TR-13	2003
TI410	2011	TK41C	2003	TPS6523	2024	TR-14	2005
TI411	2009	TK42C	2003	TR34	2004	TR-15	2004
TI415	2009	TK45C	2003	TR43	2004	TR-16	2006
TI416	2009	TK1228-1001	2003	TR44	2004	TR-17	2003
TI417	2009	TK1228-1002	2004	TR45	2004	TR-19	2021
TI418	2009	TK1228-1003	2004	TR51	2003	TR-20	2023
TI419	2009	TK1228-1004	2004	TR53	2004	TR-21	2009
TI480	2009	TK1228-1005	2004	TR54	2005	TR-22	2009
TI482	2009	TK1228-1006	2004	TR55	2004	TR-24	2011
TI483	2009	TK1228-1007	2004	TR56	2006	TR-25	2018
TI484	2009	TK1228-1008	2009	TR62	2003	TR-28	2021
TI485	2009	TK1228-1009	2009	TR71	2005	TR-29	2027
TI492	2009	TK1228-1010	2016	TR72	2005	TR-30	2024
TI493	2009	TK1228-1011	2016	TR81	2005	TR-8004-4	2009
TI494	2009	TK1228-1012	2016	TR167	2001	TR-8004-5	2009
TI495	2009	TN56	2009	TR182	2002	TR-8007	2021
TI496	2009	TN60	2009	TR183	2001	TR-8019	2025
TI904	2009	TN62	2009	TR184	2002	TR-8020	2025
TI3012	2006	TN64	2009	TR193	2001	TR-8021	2018
TI3027	2006	TNC61689	2009	TR194	2002	TR-8025	2009
TI3028	2006	TNC61690	2021	TR211	2001	TR-8026	2021
TI3029	2006	TNC61702	2013	TR212	2002	TR-8028	2011
TIA03	2004	TNC61703	2021	TR213	2001	TR-8029	2011
TIA04	2005	TNJ60066	2003	TR214	2002	TR-8030	2011
TIA05	2004	TNJ60070	2009	TR216	2001	TR-8031	2011
TIP24	2018	TNJ60071	2009	TR320	2005	TR-8032	2011
TIS03	2023	TNJ60073	2009	TR321	2005	TR-C44	2005
TIS04	2023	TNJ60074	2009	TR323	2005	TR-C45	2004
TIS14	2028	TNJ60075	2005	TR332	2005	TR-C70	2004
TIS18	2011	TNJ60079	2005	TR333	2006	TR-C71	2005
TIS22	2009	TNJ60080	2005	TR383	2005	TR-C72	2005
TIS23	2009	TNJ60604	2015	TR482	2004	TS162	2005
TIS37	2023	TNJ60611	2003	TR508	2004	TS163	2005
TIS60	2016	TNJ60612	2006	TR650	2004	TS164	2005
TIS61	2026	TNJ61217	2011	TR653	2004	TS165	2005
TIS62	2011	TNJ61220	2009	TR721	2004	TS166	2005
TIS63	2011	TNJ61221	2005	TR722	2004	TS173	2006
TIS64	2011	TNJ61222	2005	TR760	2003	TS176	2006
TIS86	2011	TNJ61282	2005	TR761	2003	TS603	2005
TIS87	2011	TNJ61671	2002	TR762	2003	TS604	2005
TIS90	2009	TNJ61673	2028	TR763	2005	TS610	2006
TIS91	2021	TNJ61679	2011	TR1036-1	2026	TS612	2006
TIS92	2009	T0003	2003	TR1036-2	2026	TS613	2006
TIS93	2021	T0004	2003	TR1036-3	2026	TS614	2006
TIX91	2003	T0005	2005	TR1037-1	2018	TS616	2005
TIX92	2003	T0012	2006	TR1037-2	2018	TS617	2005
TIX3032	2003	T0014	2005	TR1037-3	2018	TS618	2005

DEVICE	RS 276-	DEVICE	RS 276-	DEVICE	RS 276-	DEVICE	RS 276-
TS619	2005	TV24878	2008	WC19882A	2005	ZT81	2009
TS827	2005	TV24884	2011	WC19883	2005	ZT83	2009
TS829	2005	TV24806	2011	WC19884	2005	ZT84	2009
TS739	2005	TVS-1S18	2011	WRR1952	2009	ZT87	2009
TS739B	2005	TVS-828A	2013	WRR1953	2009	ZT111	2009
TS740	2005	TX102-1	2018	WRR1954	2009	ZT112	2009
TS785	2005	TX102-2	2018	WRT114	2003	ZT113	2009
TS1007	2005	TX106-1	2005	WTV8PWR	2008	ZT114	2009
TS1288	2005	TX128-1	2018	WTV12PWR	2006	ZT117	2009
TS1657	2006	TX134-1	2025	WTV15VMG	2004	ZT131	2023
TS1727	2005	TX138	2011	WTV20VH8	2005	ZT152	2023
TS1728	2005	TX139	2025	WTV20VMG	2005	ZT153	2023
TV17	2018	TX140	2018	WTV25PWR	2008	ZT154	2023
TV18	2018	TX141	2011	WTV30VH6	2005	ZT180	2023
TV23	2018	TX-104-3	2005	WTV30VMG	2005	ZT182	2023
TV29	2025	TX107-3	2011	WTV40PWR	2006	ZT183	2023
TV32	2018	TX107-12	2011	WTV99PWR	2008	ZT184	2023
TV35	2009	TX-119-1	2013	WTV199PWR	2008	ZT187	2023
TV38	2018	TX-122-1	2021	WTVAT6	2005	ZT202	2009
TV37	2009	TX-135	2018	WTVB5A	2004	ZT203	2009
TV38	2009	TX-136	2025	WTVBA6A	2005	ZT204	2009
TV39	2018	U1177	2028	WTVBMC	2005	ZT210	2018
TV40	2009	U1176	2028	X18A545-7	2013	ZT280	2023
TV42	2018	U1180	2028	X18A1938	2013	ZT281	2023
TV43	2009	U1181	2028	X1005	2006	ZT282	2023
TV44	2009	U1265	2028	XA101	2003	ZT283	2023
TV45	2018	U1322	2028	XA102	2003	ZT284	2023
TV47	2005	U1323	2028	XA111	2003	ZT287	2023
TV50	2011	U1324	2028	XA112	2003	ZT402	2009
TV51	2018	UC20	2028	XA122	2005	ZT403	2009
TV52	2018	UC100	2028	XA123	2003	ZT404	2009
TV53	2018	UC105	2028	XA124	2003	ZT696	2009
TV54	2011	UC110	2028	XA126	2003	ZT897	2009
TV2429	2003	UC115	2028	XA131	2003	ZT706	2009
TV2434	2003	UC120	2028	XA701	2001	ZT708A	2009
TV2455	2003	UC125	2028	XA702	2002	ZT708	2009
TV24102	2015	V6/2R	2004	XA703	2001	ZT709	2011
TV24137	2003	V6/2RC	2004	XB1	2005	ZT917	2011
TV24142	2006	V6/2RJ	2004	XB2	2005	ZT918	2011
TV24154	2005	V6/4R	2004	XB3	2005	ZT1481	2018
TV24156	2005	V6/4RC	2004	XB4	2001	ZT1700	2018
TV24158	2003	V6/4RJ	2005	XB5	2006	ZT1708	2009
TV24160	2011	V6/8R	2005	XB7	2006	ZT2205	2009
TV24161	2011	V6/8RJ	2005	XB8	2003	ZT2206	2009
TV24164	2008	V10/1SJ	2003	XB102	2005	ZT2368	2011
TV24172	2003	V10/2S	2004	XB103	2005	ZT2369	2011
TV24189	2005	V10/2SJ	2004	XB104	2003	ZT2369A	2011
TV24194	2005	V15/10DP	2006	XB112	2005	ZT2475	2011
TV24209	2011	V15/20DP	2006	XB113	2005	ZT2476	2009
TV24210	2011	V15/20R	2003	XC101	2005	ZT2477	2009
TV24214	2021	V15/30DP	2006	XC121	2005	ZT2708	2011
TV24215	2009	V30/10DP	2006	XC155	2006	ZT2938	2011
TV24216	2016	V30/20DP	2006	XC156	2006	ZT3600	2011
TV24281	2009	V30/30DP	2006	XJ13	2005		
TV24313	2011	V60/10DP	2006	XN12A	2006		
TV24363	2021	V60/20DP	2006	XN12B	2006		
TV24370	2005	V60/30DP	2006	XN12C	2006		
TV24372	2009	V120	2003	XN12E	2006		
TV24380	2011	V205	2003	YV1	2005		
TV24382	2011	V220	2011	YV2	2005		
TV24385	2011	V221	2011	ZT20	2009		
TV24387	2015	V222	2011	ZT21	2009		
TV24399	2011	V405	2011	ZT22	2009		
TV24436	2011	V410	2021	ZT23	2009		
TV24437	2011	VB11	2005	ZT24	2009		
TV24438	2011	VFG2745B	2006	ZT40	2009		
TV24453	2009	VFP2746C	2006	ZT41	2009		
TV24454	2009	VFP6537C	2006	ZT42	2009		
TV24458	2009	VFQ2745F	2005	ZT43	2009		
TV24495	2023	VFS2745J	2004	ZT44	2009		
TV24571	2011	VFS2745J	2005	ZT60	2009		
TV24573	2011	VFT2745H	2004	ZT61	2009		
TV24574	2009	VFU2746B	2006	ZT63	2009		
TV24576	2009	W1A	2028	ZT64	2009		
TV24589	2011	WC19862	2001	ZT80	2009		

NOTES

NOTES

NOTES

NOTES

NOTES

NOTES

NOTES

NOTES

NOTES

NOTES

NOTES