

RADIO LIBRARY N° 1

*Thanks Joe,
: Joe :*

RADIO SET ANALYZERS

AND

How to Use Them

with full instructions and descriptions of
set analyzers, tube checkers, oscillators, etc.

by L. Van der Mel
Famous Radio Instructor

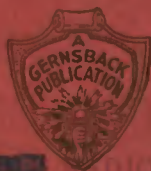

RADIO SHOP
WASCO, CALIF. PHONE

Price 50c

PUBLISHED BY
GERNSBACK PUBLICATIONS, Inc.
98 PARK PLACE - NEW YORK

O.R.S.M.F.



RADIO'S greatest servicing magazine

NEEDFUL to everyone interested in radio is a radio magazine that includes in each issue all of the outstanding developments of the month. It is important that such news be carried which is most advantageous to the largest number of readers. **THIS IS EXACTLY WHAT RADIO-CRAFT DOES.** In it you will find articles which broadly cover topics that should be known thoroughly by everyone in radio. From the radio man's point of view these articles are written and they come from authorities in the field.

Such radio leaders as Lee de Forest, C. H. W. Nason, Bertram M. Freed, Sylvan Harris, C. E. Denton and others contribute articles regularly to RADIO-CRAFT.

You will find important articles in RADIO-CRAFT on:

Servicing	Automobile radio
New tubes	Latest in radio
Converters	Radio construction
Testing equipment	Money-making ideas
Short waves	and dozens of other
Airplane radio	articles

*Special
Offer!*

8

*Months for
\$1.00*

RADIO-CRAFT is thoroughly illustrated with photographs, schematic diagrams of radio receivers, also midget sets, illustrations of new equipment, sketches of radio kinks, etc. Each issue usually contains over 150 illustrations.

RADIO-CRAFT Magazine

98A Park Place

New York, N. Y.

Chuck Roark

~~WASCO~~ RADIO SHOP
WASCO, CALIF. - PHONE

RADIO SET ANALYZERS

and

How To Use Them

*With full instructions and descriptions of modern,
Set, Analyzers, Tube Checkers, Oscillators, etc.*

by L. Van der Mel



GERNSBACK PUBLICATIONS, Inc.
Publishers

98 PARK PLACE

NEW YORK, N. Y.

Contents

	Pages
Chapter 1—Introduction	3-6
Chapter 2—The Analyzer	7-18
Chapter 3—Trouble Shooting with the Analyzer	19-29
Chapter 4—Commercial Set Analyzers	30-57
R.M.A. Resistor Color Code	31
Characteristics of Vacuum Tubes	58-59

Printed in U. S. A.

Copyright 1931 by G. P. Inc.

CHAPTER 1

Introduction

With the expansion of radio broadcasting in 1923, there developed a new profession, which demanded, almost overnight, thousands of men who possessed both the knowledge and the facilities to install and repair broadcast receivers. At the time, such men were almost all amateurs; since there did not exist a similar profession prior to that period.

The broadcast receivers of those days were extremely simple; storage batteries being used to supply filament current, and dry batteries for plate current. Dynamic speakers were unheard of; the simple horn with a magnetic unit, or telephone headsets, reigned supreme. In general, the receivers themselves did not have over three or four tubes and, furthermore, at the time, it was considered good engineering practice to have all coils, sockets, condensers, wiring, etc. completely exposed to the eye by the mere manipulation of the cabinet cover. Naturally, the circuits of the receivers themselves were very simple and rigidly standardized.

During this era, the problems of the Service Man were few. The electrical tests necessary to locate trouble were mastered in a very short time and so-called thoroughly-trained Service Men were made overnight. The public played no small part in creating this condition. Any man who had the experience to know exactly which tube to replace, (in a three-tube set), to obtain music was considered a genius. In short, radio being one of those new-fangled offspring of modern science, the public welcomed it as a duck welcomes water; creating such a tremendous demand for radio receivers, with its consequent demand for Service Men, that anyone who had been engaged in radio for six months was considered an expert.

With the creation of a demand for radio receivers, the field became highly competitive. Advances in receiver design were made to meet this competi-

tion. The introduction of the superheterodyne into the broadcast field, the invention of the various bridge and neutrodyne methods of neutralization, were distinct examples of advancement. Up to this time service methods remained the same. The low-resistance voltmeter and the milliammeter persisted as the guiding tools in radio trouble-shooting; for it must be remembered that, with the component parts of the receiver exposed, it was a relatively simple matter to obtain voltage and current readings at any point in the receiver, since visual inspection was possible. But, around 1927, one of the most insistent demands of the public was satisfied by the creation of the "all-electric" A. C. operated receiver.

The appearance upon the market of A. C. receivers was, from the public's viewpoint, the most significant advancement in radio since 1923. A demand for higher-grade Service Men was immediately created; not only because the receivers themselves were more complicated, but because the public by this time, had passed the first stage and insisted upon more efficient service. This, in a measure, was the most beneficial thing that could happen to the Service Man; for, it must be remembered, a Service Man earns his livelihood by repairing sets—and it is evident that, the more receivers he can service in a day, and the more efficient the servicing, the greater will be his financial return.

Modern receivers are in no manner constructed like those of 1923. The extremely high sensitivity; the precision-aligning of condensers; the small tolerances allowed for tube voltages and currents; and, what is far more important, the advanced education of the public in the radio field necessitates a class of service that is not comparable with that of 1923. This standard, in turn, requires test equipment that will permit both rapid and accurate determinations of trouble.

The circuit diagrams are relatively far more complex than those of previous years. Let us describe, in a general way, the connections of a six-tube set consisting of three stages of tuned R. F. using screen-grid tubes; a 227-type power detector; and two '45-type tubes in a push-pull arrangement, feeding into a dynamic speaker, the field coil of which is one of the chokes in the filter unit. The power unit then will consist of a power transformer working into two '81 type rectifier tubes, (for full-wave rectification), and then into, let us say, a two-section filter unit; which, in turn, will terminate across the ends of a bleeder resistor. Taps are then taken from this bleeder resistor to supply the necessary "C" biases, plate voltages and screen-grid voltages. The value of this bleeder resistance may be anywhere between 10,000 and 20,000 ohms; the entire unit being completely isolated and shielded to prevent mutual coupling between itself and any other circuits. The coils, condensers and some of the tubes are also, usually, shielded to prevent interstage coupling; and any attempt to make tests with these shields removed is bound to give erroneous results. The tubes' socket prongs, together with their associated wiring, are completely hidden from view. These are necessary precautions in modern, high-gain, precision-built receivers. To make any sort of voltage or current measurements at the tube socket with isolated voltmeters or ammeters requires, not only the tedious removal of the entire receiver (and sometimes the power unit) from the cabinet but, very often, the breaking down of the chassis proper, just to measure the voltage on the plate of a tube!

A theoretical analysis of receiver design, (which will not be attempted here) will convince anyone that the removal of a single tube from its socket will alter the voltages of all the other tubes in the receiver. Hence we may say that one of the first requisites, of volt-

age or current measurement in any part of a radio receiver, is to do the measuring with all the tubes in their proper sockets. This, in view of the physical construction of the chassis,

The value of an analyzer depends upon the fact that nearly every form of trouble in a radio set manifests itself in irregular voltages or currents. General methods of localizing trouble, the details of which will be discussed in Chapter 3, will now be given.

When a Service Man arrives on the job after receiving a call, he should first satisfy himself that the trouble lies in the receiver itself. If the symptoms seem to indicate that tubes are bad, they should be tested first; merely because that is the easiest operation to perform and, usually, indicates the greatest source of trouble. If defective tubes are found, they should be immediately replaced by good ones before any other tests are made.

Plate, screen-grid and control-grid voltages should then be measured, and the value checked by reference to manufacturers' data or tube charts. (The Service Man should make it a point to always have such information with him for reference purposes.) If it is found, for instance, that only one tube has no plate voltage, then reference should be made to the circuit diagram, to determine what can possibly cause the lack of voltage on the particular tube in question. Do not jump at conclusions; but conduct a systematic test from the tube's plate through every single piece of apparatus in that plate circuit, right down to the power unit. In this manner the defective piece of apparatus is bound to be checked.

On the other hand, if, to take another instance, three tubes that should have the same voltage have none, then the trouble lies either in the power unit, or else in a piece of equipment that is common to those three tubes; and the attention of the repair man should be directed accordingly.

If it is found that the plate and screen voltages are very nearly normal, but the plate currents very high, then the polarity of the "C" voltages should be closely checked, to determine whether it has been reversed; as a positive grid will manifest itself in high plate current.

A check of the tube voltages and currents may show that they are perfectly

stage, and then test each and every piece of equipment in that stage separately for shorts or opens.

It should be noted that, obviously, if the set once functioned properly, yet the wiring, voltages, currents, and individual pieces of apparatus test O.K. then there is nothing wrong with the set.

The above general analysis which, as previously stated, will be discussed in detail in Chapter 3, illustrates the absolute necessity of a device which will facilitate the measurement of tube voltages and currents and permit the testing of individual pieces of equipment. These fundamental essentials are to be found in modern analyzers. With modern competition in the field, **rapid accurate service is not only desirable but absolutely essential**, if a Service Man is to get a livelihood out of his business. **THE RADIO SET ANALYZER IS THE ONLY PIECE OF EQUIPMENT AT THE PRESENT TIME THAT AFFORDS THE NECESSARY EASE AND RAPIDITY.**

From the above it may seem that all that one has to do is to plug in his analyzer, manipulate a few buttons, and the trials and tribulations of the receiver will be laid bare. This is not so. The only thing that can be expected of any analyzer is that it shall be a means for conveniently measuring the various voltages and currents at any tube socket with the tube connected to the socket. The interpretation of the readings is left to the Service Man himself. However, by proper reference to tube charts and circuit diagrams, coupled with a little knowledge and common sense, the average Service Man can locate trouble in a relatively short time.

Some of the more costly analyzers have, as an integral part of the device, an output meter, and a modulated R. F. oscillator which is very useful in lining up tuning condensers, taking sensitivity curves, adjusting oscillators in super-heterodyne receivers, etc. If the Service Man can afford such complete equipment, the investment is a good one. Its justification, however, is dependent upon the class of clientèle served. For the average Service Man, the above mentioned additions are not absolutely essential; since most tests and adjustments can be made with the standard instruments.

One of the most desirable advantages of an analyzer, aside from its primary function, is its ability to test tubes. The correct method of tube testing has long been a question of dispute. In this connection, the Service Man is usually not in a position to expend large sums of money on elaborate bridges which accurately measure such characteristics as mutual conductance (incidentally now, by the recent ruling of the I. R. E. "mutual conductance" has been changed to "transconductance", S_m), A.C. plate resistance, amplification constant, etc. The Service Man is, usually, only interested, so far as tube checking is concerned, to know whether the emission is normal. For a transconductance test, the same instruments are usually employed but a calculation is necessary. (This will be explained in a succeeding chapter.) As an added feature, most analyzers have arrangements which permit the use of each instrument, independently of the analyzer. This is a very useful device; especially if tests are to be made on the bench aside from regular receiver work.

A small 1.5 volt "C" battery is housed in some analyzers, in order to permit the use of one of the voltmeters as an ohmmeter; the scale of the meter is then directly calibrated in ohms. This feature is a distinct advantage, where resistor replacement is necessary. Some manufacturers have even gone so far as to include calibration charts for inductance and capacity measurements on the A.C. ammeter scale, when such a meter is included in the analyzer.

It is in the nature of things, that different manufacturers should include various incidental refinements which they believe valuable (some of which have already been mentioned and will be discussed in detail later) with the result that the Service Man is usually at a loss to determine just what kind of an analyzer to secure for his purpose. Unfortunately, another man's advice usually does not apply to a particular case, and the Service Man is usually left to choose for himself. His choice will, probably, be determined first by the amount of money he has available to spend, and then by his requirements.

In order to aid him in this decision, Chapter 2 will treat in detail the theory and construction of analyzers in gen-

eral; Chapter 3 will describe methods of trouble shooting with analyzers; and the remainder of the book will be devoted to a comprehensive description of commercial analyzers.

By following this procedure, it is hoped that the choice of an analyzer will be based on concrete knowledge, rather than upon the vicissitudes of philosophical speculation.

Full details about the

**OFFICIAL
R A D I O
SERVICE
MANUAL**

will be found

on the back cover

of this book

CHAPTER 2

The Analyzer

In order that an analyzer shall be capable of everyday use, it should satisfy several fundamental requirements, namely: compactness, accuracy and stability. At the same time there should be, if possible, a sufficient amount of spare space available for small tools. It should be simple to operate; and should not have such an abundance of scales on a single instrument that reading any one of them becomes difficult. At the same time,

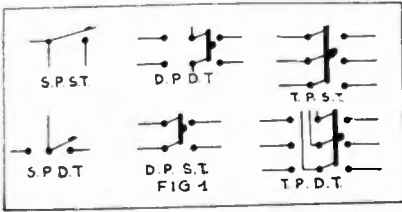

The principal types of switches used in radio work. Knife switches are indicated; but there are many different mechanical methods of making connections.

however, economy demands that one instrument be used for as many purposes as possible. Just what the happy medium is, depends of course, upon the dexterity of the user. Last but not least, the device should be "foolproof"; this means that it should not be possible to ruin any instrument by manipulating the wrong switch.

The Switches

The switches used on analyzers must be very carefully constructed. Each contact must be positive and have the same resistance at all times; furthermore, its resistance must be extremely low, or else some of the scales on the meters will not read correctly.

So very many kinds of switches are used that it is an impossibility to describe them all. An attempt will be made to discuss some of the more commonly-used types, so that the reader

may become familiar with the methods used in switching.

Fig. 1 shows diagrams of some of the more commonly-used knife switches. The abbreviations used are standard and are listed below for convenience.

- S.P.S.T.—Single-Pole, Single-Throw.
- S.P.D.T.—Single-Pole, Double-Throw.
- D.P.S.T.—Double-Pole, Single-Throw.
- D.P.D.T.—Double-Pole, Double-Throw.
- T.P.S.T.—Triple-Pole, Single-Throw.
- T.P.D.T.—Triple-Pole, Double-Throw.

These knife switches are rarely used in analyzer construction; not because they are inefficient, but because of the great deal of space required to house and manipulate them. The basic principle of switching is the same, regardless of the mechanical arrangement of the switch.

A type commonly used in analyzers is shown in Fig. 2A; this switch, known as a push-button type, is composed of four blades a, b, c and d. Blades a and c are tied together by a bakelite strip k. When the button S is pushed in, the plug P pushes down blades a and c; so that blade a makes contact with blade b, and blade c with blade d. When the finger is released from S, the spring T removes P from the blades, and both circuits are open. It is seen that this switch is similar in action to the D.P.S.T. knife switch of Fig. 1. This type of switch (sometimes called a Jack Switch) is very small, rapid of operation and quite fool-proof.

This jack or push-button switch may, by simple mechanical changes, be made

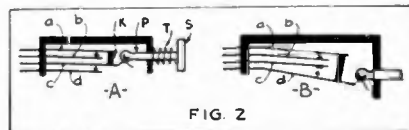

Two different types of double-pole switches, operated by push-buttons.

to perform a variety of purposes. For instance, Fig. 2B shows a push-button switch which opens one circuit at the same instant that it closes another. It may sometimes be desirable to open one circuit a little before the second circuit closes; this can easily be accomplished by making the contact on blade d of Fig. 2B slightly shorter than that on blade a. By having a sufficient number of blades, it is possible to switch a multiplicity of circuits simultaneously.

A type of switch that is used in a great many analyzers, and has some inherent advantages, is the rotary switch; this is shown diagrammatically in Fig. 3. In this class there are two types, the single- and double-arm, shown respectively at A and B.

As seen by an inspection of Fig. 3A, the arm of the switch may be connected directly to any one of nine circuits; this single arm switch is used only when one side of the line being switched is common to all nine circuits. This is the only disadvantage placed upon this method of switching. It is stable in the sense that, when the arm is placed on a given tap, and a definite circuit thus established, positive contact is assured, and is not subject to variations that may be imposed upon it by jarring, age, etc.

When it is desirable to switch both sides of the line, the arrangement shown in Fig. 3B is used; this is similar to that of A, except that it employs a double set of taps to make contact with two switch arms which are insulated from each other. With this arrangement extreme flexibility is secured.

It has been truly said that switching is one of the most interesting problems that the layman can find in electrical

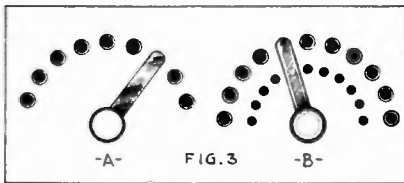

Left, the ordinary tap switch with arm leading to one common return circuit; right, a more "flexible" switch.

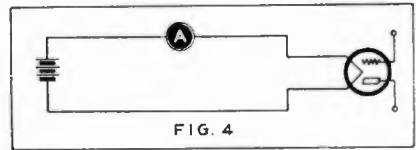

All the current in a series circuit must flow through the meter.

work. It taxes the ingenuity of the mind, without requiring detailed technical knowledge. No better examples of switching technique can be given than those employed in the modern set analyzer. At this time we will not enter into a detailed account of the possible switching arrangements which are obtained with the types of switches described heretofore; as that will be treated at the end of this chapter, when we show how a simple analyzer is to be designed.

Suffice to say that it is possible to design a switch for almost any imaginable circuit arrangement. Some of these will be presented from time to time as the occasion arises.

The Milliammeter

The milliammeter and the voltmeter constitute in reality, the major part of the analyzer and, as a consequence, will be discussed in more or less detail. It is beyond the scope of this book to enter into a detailed theoretical discussion of meter operation; but it is felt that a sufficient amount of space should be devoted to the subject, so that the Service Man may have an idea of just why certain things are done.

Fundamentally, every kind of electrical instrument (whether it be a voltmeter, ammeter, wattmeter, etc.) works simply because an electric current is flowing through it. As an example, assume the battery of Fig. 4 to be lighting the tube connected to the battery. If it is now desired to measure the current passing through the filament of the tube, an instrument called an ammeter is inserted, in either leg of the line, as shown at A. Now it does not matter in which leg of the line the meter is inserted; since it will read the same in either case, because the

current coming out of the battery into the filament must be exactly the same as the current coming out of the filament at the other end, into the battery. Stated in another manner, the filament and the meter are connected in series across the battery terminals. Furthermore, it is a universal law that the value of the current in a series circuit is the same throughout each and every part of the circuit. Since that is the case, it does not matter in which leg the meter is inserted; the same amount of current flows through the

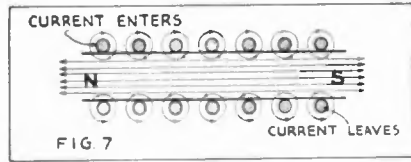

The polarity of the magnetic field of a coil; current is taken as flowing from "—" to "+."

will be as shown in Fig. 7. If the coil is placed between the pole faces of a bar magnet, as shown in Fig. 8, then end N, (see Figures 7 and 8), will tend to move in one direction and end S in the other. If the coil is pivoted, it will rotate; and a needle rigidly attached to the coil will move with it.

The two leads from such a moving coil, in a meter, are connected in series with the circuit whose current is to be measured, in Fig. 8. The greater the current consumed by the filament, the more current will flow through the meter, and the greater will be the reading of the ammeter. There is a limit to the amount of current that can be sent through the instrument; for, if it is rated at 3 amperes, no more than 3 amperes should flow through it—otherwise there is great danger of burning out the meter.

It would seem therefore, that a different meter would be required to measure currents greater than the 3 amperes; this is not necessarily so, however, since shunts may be employed to increase the range of an instrument to almost any degree desired. By using these shunts a single instrument may be given two, three or even four different ranges. Any instrument having

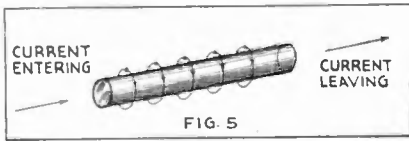

Every coil of wire in which a current is flowing is surrounded by a magnetic field.

instrument. It should be particularly noted that, with the instrument connected as shown in Fig. 4, the current that flows through the filament must of necessity flow through the meter.

The next question is, "What makes a meter read?" The answer is to be found in the elementary laws of magnetism. Whenever a wire is carrying current, it generates a magnetic field; the intensity of this field depends upon the length of the wire and the strength of the current. The direction of this magnetic field is as shown in Fig. 5.

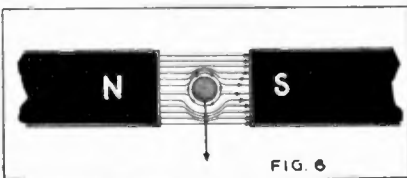

One magnetic field exerts a pressure on another: this is the principle of the electric motor.

If this wire now be placed between the pole faces of a magnet, as shown in Fig. 6, the magnetic field will be as shown; and, furthermore, the wire will tend to move and, if free, will move downward. When the wire is wound in the form of a coil, the magnetic field

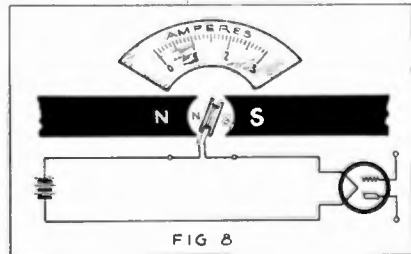

An ammeter (any current meter) "reads" because the moving coil is twisted in the field of the fixed magnet.

more than one scale is called a multi-scale instrument.

What is a shunt, and how may one be constructed? These questions will now be answered.

The moving coil is of extremely light construction, in order that it may rotate easily; therefore it must be wound with very fine wire. Practically, this means that the amount of current that can safely flow through this coil is very small—only a few thousandths of an ampere. If the safe current-carrying capacity of the wire is, for example, ten one-thousandths of one ampere, (10 milliamperes or 10 mills.), how can the meter be safely placed in a circuit in which 2 amperes are flowing?

The answer is that not all of the current flowing in the circuit passes through the moving coil. As an example, let us assume that we have a meter with a moving coil so designed that, when ten one-thousandths of an ampere flow through it, the meter reads full-scale. This means that under no conditions can more than 10/1000 of an ampere safely flow through the coil. As the instrument is now, it is a 10-milliamperere meter.

If now a resistance which is equal to the resistance of the moving coil is placed in parallel with the moving coil of the meter, then one half the current in the circuit will flow through the moving coil, and the other half through the resistance.

For example, the resistance of our moving coil is, say, one ohm, and it requires 10/1000 of an ampere through it to give full-scale deflection. We now place a one-ohm resistor in parallel with it, giving the circuit of Fig. 9. If the current flowing in a circuit in which the meter is now connected is 10 mills.,

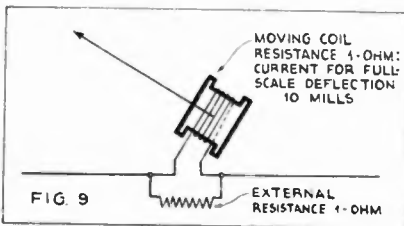

A shunt across a milliammeter allows it to register only a certain portion of the current in the whole circuit.

then 5 mills. will go through the meter, and 5 mills. through the resistance. The current through the meter being now one-half of what it was before the resistance was connected, the meter will, of course, only read half as much. If the current in the circuit be increased to 20 mills., 10 mills. will go through the moving coil of the meter, and the other 10 mills. through the resistance. The meter will now read full-scale.

It should now be noted that, without the external resistance, the actual current through the circuit goes through the moving coil; and the meter reads

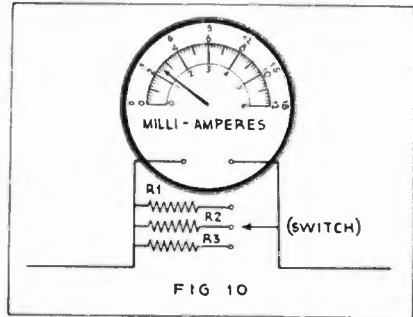

An ammeter (milliammeter) may be used to give several scales of readings by using several shunts.

the actual current in the circuit. With the resistance connected across the moving coil, only one half of the current in the circuit will flow through the moving coil, and the meter will read only one-half the actual current in the entire circuit. To obtain the correct current, then, it is necessary to multiply the meter reading by the factor 2.

If, instead of the one-ohm resistor (which resistor is known as a shunt) a 2-ohm resistor was connected in, then only one third of the total line current would pass through the moving coil, and the remaining two thirds would pass through the shunt. The meter would then read only $\frac{1}{3}$ of the actual current in the entire circuit; so that it would be necessary to multiply the meter reading by the factor 3, in order to obtain the actual current flowing.

The addition of these shunts, then, permits the extension of the amount of current that can be measured by an instrument. The same meter whose moving coil can safely carry but 10 mills.,

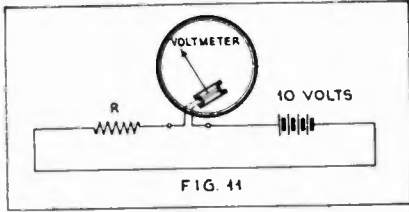

A voltmeter is only a current meter with a resistance to limit the current passing through it.

can, with the use of the proper shunt, be arranged to measure several amperes. For convenience a switch may be provided, to throw in any one of a number of different shunts; so that different ranges on the instrument are available. This is shown in Fig. 10. By setting the switch on the proper tap, any one of three ranges can be selected.

If the internal resistance of the meter is known, then the resistance of the shunt necessary to extend the range of the instrument may be calculated from the following formula,

$$R = \frac{r}{n-1}$$

in which:

- R is the resistance of the shunt;
- n is the number indicating how many times the meter range is to be extended or multiplied;
- r is the internal resistance of the meter.

As an example of the use of this formula, assume a milliammeter which has an internal resistance of .005-ohm (1/200 of an ohm) and has a maximum scale reading of 10 mills. It is desired to extend the range from 10 up to 50 mills. The factor, n, by which we wish to multiply the meter scale reading, is five (50/10=5). Then, for this case

$$r = .005\text{-ohm}$$

$$n = 5.$$

Placing in equation (1) the numbers instead of the letters, we get:

$$R = \frac{.005}{5-1} = \frac{.005}{4} = .00125\text{-ohm}$$

(1/800 of an ohm).

How one can purchase a resistor of extremely low value, and have it accurate to about 5%, is indeed a problem.

A method which is used practically is as follows: Assume we have a 10-mill. meter whose range we wish to extend to 50 mills. A current of about 9.5 mills. is sent through the meter and the exact reading noted; let us say it is 9.7 mills. Then, after the proper shunt is put on the meter, it should read 9.7/5, or 1.94 mills. We next proceed to short-circuit the meter with a good grade of low-resistance wire until the meter DOES read 1.94 mills., with the same current through the circuit as before. The value of the resistance will then be the required amount.

Using the same procedure with the new shunt, the process can be repeated successively; and the meter can be thus calibrated so as to read up to almost any required amount.

The Voltmeter

As stated previously, in order that an electrical measuring instrument may function, a current must flow through it. The voltmeter is no exception to the rule. Contrary to a somewhat general opinion, a voltmeter also, in a sense, measures current—as we shall soon see.

In any electrical circuit, a current flows for the sole reason that a potential difference (a voltage) causes it to flow. If the resistance of the circuit is constant, then the amount of current flowing is directly proportional to the voltage that causes this current to flow: If the voltage is doubled, the current doubles; if the voltage is tripled, the current triples, etc—provided always that the resistance of the circuit is constant. (The above statement, of course, applies only to a D.C. circuit.) This

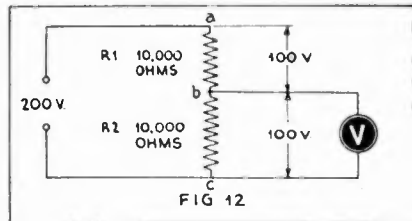

If a voltmeter is placed across a resistance, it "shunts" or diverts part of the current, reducing the reading.

means, then, that if an instrument is connected ACROSS (in shunt with the circuit) the voltage to be measured, and if furthermore, the resistance of the instrument is constant (as it always is), then the current through the instrument will be directly proportional to the voltage across which the instrument is connected. In the formula of Ohm's Law, I (current Intensity) equals E (Electromotive force or voltage) divided by R (resistance). We may write this also $E=RI$, which comes to the same thing.

It is seen, then, that a voltmeter, connected across a certain voltage, has a current flowing through it; for the same reason that any resistance connected across a voltage has a current flowing through it. It is this current flowing through the meter that actuates it; the manner of its operation being identical with that of the ammeter discussed above (Fig. 8). Let it be stated at this time that exactly the same movement ("works") is used in the voltmeter as in the ammeter; the only difference being in the mode of connection. Let us examine the mode of connection more closely.

Assume we have the same moving coil that was used in the ammeter (that is, of 1 ohm resistance, and giving a full-scale deflection with 10 mills. through it). In order then, that the meter shall read full scale, it must be connected across a voltage of

$$(E=RI) \quad 1 \times \frac{10}{1000} = \frac{10}{1000} = .01\text{-volt.}$$

The measurement of such extremely small voltages is of no importance to the Service Man; and therefore some means must be found to enable the me-

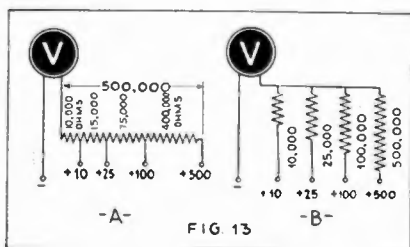

Two methods of connecting the limiting resistors of a multi-scale voltmeter; that of B is more expensive, but better.

ter to be used on higher voltages and, at the same time, keep the current through the moving coil below its rated limit. This is accomplished by placing a resistance R in series with the coil, as shown in Fig. 11. Suppose the full-scale reading of the voltmeter is to be 10 volts. The current that must flow through the moving coil and, hence through the resistance R, must be 10

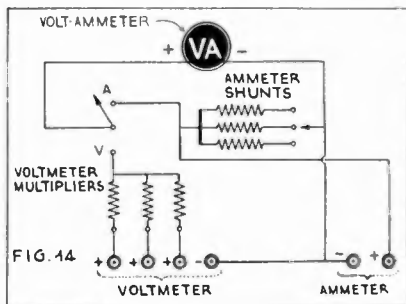

The resistors of a voltmeter are of high value, and in series with it; the resistors of an ammeter are of low value, and in shunt with it.

mills. By Ohm's Law the total resistance of the circuit should be

$$R = \frac{E}{I} = \frac{10}{.01} = 1000 \text{ ohms.}$$

The resistance of the moving coil is 1 ohm; therefore the value of the external resistance R which must be placed in series is 999 ohms. This external resistance R is called the multiplier.

One important thing should be borne in mind, and that is the fact that, regardless of the voltage applied, (in the above case from 0 to 10 volts), the resistance of the meter is the same. It does not and cannot alter with changes in values of voltages applied. For our case, then, we see that to read a maximum of 10 volts we require a total resistance of 1000 ohms; or 100 ohms for every volt. Our meter has a resistance of 100 ohms per volt. This is a common method of expressing the resistance of voltmeters, and must not be misinterpreted. It simply means that, to obtain the resistance of the meter (regardless of the voltage that

WILL be applied), we multiply the ohms per volt by the maximum voltage reading of the meter.

This method of expression is useful in determining how much additional resistance must be inserted to increase the range of a voltmeter. For instance, with the same voltmeter described above, we wish to increase our range from 0-10 volts to 0-100 volts. Our increase in range is 90 volts. For every volt we need 100 ohms and, therefore, for a 90-volt increase we need $90 \times 100 = 9000$ ohms additional. This makes a total resistance of the meter 10,000 ohms for a maximum scale of 100 volts; which is obviously 100 ohms per volt.

The consumption of 10 milliamperes for full-scale deflection is sufficient to cause appreciable discrepancies when measuring voltages in "B" eliminators. Why this is so can be seen from an analysis of Fig. 12.

Assume that R_1 and R_2 are two sections of a "bleeder" resistance in a power unit, and that there is 200 volts across the outside terminals. A little consideration will show that the voltage across either R_1 or R_2 is 100 volts when the voltmeter V is not connected. The current flowing through the resistors is

$$I = \frac{E}{R} = \frac{200}{20000} = .01 \text{ ampere} = 10 \text{ mills.}$$

If the voltmeter V is now connected across R_2 , and the voltmeter has a resistance of 10,000 ohms, then the resistance of V in shunt with R_2 gives a combined resistance of only 5000 ohms between b and c. The resistance across the 200-volt supply is only 15,000 ohms, from a to c; and the current flowing in the circuit now is

$$I = \frac{E}{R} = \frac{200}{15000} = .0133\text{-amp.} = 13.3 \text{ mills.}$$

The voltage across R_2 , which will be the voltage indicated by the meter, will be

$$5000 \times .0133 = 66.5 \text{ volts}$$

which corresponds to an error of 33 volts in 100, or a 33% error; which is certainly not permissible in service work.

To obviate this difficulty, voltmeters suitable for service work have a resist-

ance of 1000 ohms per volt; so that a 0-100 volt meter will have an internal resistance of 100,000 ohms. The shunting effect of the meter, for all practical purposes, will then be negligible.

Voltmeters may have several multipliers, each one suitable for a different range; and in this manner we may utilize one meter for measuring either small or large voltages. There are two methods of connecting multipliers for multi-scale voltmeters; these are shown in Figs. 13A and 13B.

The circuit of Fig. 13A uses one resistor, which is tapped at various points to secure the proper multiplier value for each scale, as indicated; it has the advantages of low cost and simplicity. It has the serious disadvantage that an open circuit in the 10-volt multiplier opens all the other ranges. The second method, shown in Figure 13B, has a separate multiplier for each scale; the advantages of such construction being obvious.

Earlier in the discussion it was stated that the meter construction is the same for both a voltmeter and an ammeter; the difference being that, in the ammeter, resistors are placed in shunt with the meter; while, in the voltmeter, resistors are placed in series with the meter. By using a proper switching arrangement, a single instrument may be used either as a voltmeter or as an ammeter; either use having a multiplicity of ranges. This is shown in Fig. 14.

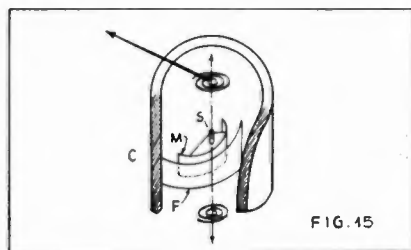

An A. C. meter is so arranged that the polarities of the fixed and moving coils change at the same time and are always opposite.

The A. C. Voltmeter

An analysis of the D.C. meter will show that, if the direction of the current through the meter be reversed,

then the pointer of the meter will move to the left instead of to the right. This means that, if A.C. is sent through the meter, then during one half of the cycle the meter will tend to move in one direction and during the other half of the cycle it will tend to move in the opposite direction. The result is that, at 60 cycles (commercial power frequencies), the needle does not move at all. To be able to read A.C., it is necessary to have a device that will move in the same direction regardless of the direction of the current through the meter. This is what the A.C. meter does.

There are numerous types of A.C. meters, but only one of them will be described; since the A.C. voltmeter used in analyzers are of this type. This is designated as the Soft-Iron, or Iron-Vane, type of meter. A sketch showing its internal construction is given as Fig. 15.

A small strip of soft iron M, bent into a cylindrical form, is mounted axially on a spindle S which is free to turn. Another similar strip F, which is more or less wedge-shaped, and which is larger than M, is fixed inside a cylindrical coil; this coil C is wound with fine wire and connected in series with a high resistance, (the multiplier). When current flows through the coil, both iron vanes become magnetized. The upper edges of F and M both have the same magnetic polarity—for instance, both "north" poles; and the lower edges have the same magnetic polarity—both "south" poles. The two upper edges repel each other, and so do the two lower edges; with the result that the free vane M moves. The pointer therefore moves with it. When the cycle reverses, the magnetic polarity reverses (the upper edges become south poles and the lower edges north

poles), but the repulsive force is still there; consequently the meter moves in one direction only. The multiplier calculations for the A.C. meter are exactly the same as for the D.C. meters described above.

Design of a Simple Analyzer

In developing a simple analyzer, the reader should bear in mind that the finished product is not suitable for home construction; since no mechanical or electrical constants will be given. By describing such a theoretical analyzer, the author hopes to accomplish but one purpose: to present the fundamental principles behind all analyzers. By doing this, thus illustrating the methods of design, the more complicated commercial types will be more fully appreciated than if this mode of approach were not used.

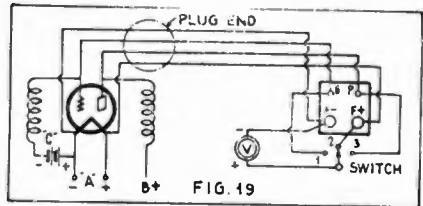

The connections to the socket of the analyzer enable us to measure the tube voltages, just as if the tube were in the set (left) instead of the analyzer socket (right.)

Suppose a stage of A.F. amplification, such as that shown in Fig. 16, is to be examined. For a very complete test it would be necessary to know the following constants:

- (1) Filament voltage;
- (2) Plate voltage;
- (3) Grid voltage;
- (4) Plate current;
- (5) Grid current.

Let it also be assumed that we wish to measure each of these with a few instruments as possible. To measure the constants listed above, a milliammeter would have to be inserted at X to measure plate current; at Y for grid current, between points 1 and 2 for plate voltage; between 2 and 3 for grid voltage; and between 2 and 4 for filament voltage. Let it be further assumed that we cannot break any leads in the set to insert these instruments.

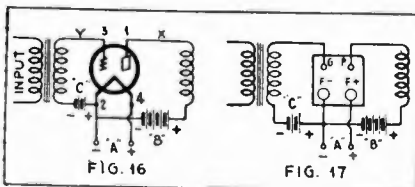

The usual way of showing a tube circuit, at the left, is altered to show merely the connections to the socket in the receiver.

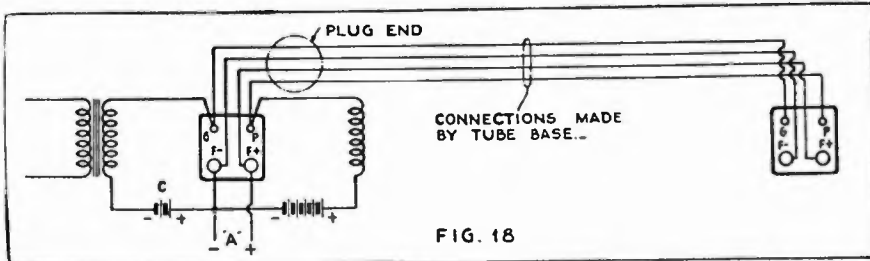

The socket in the set is now connected to the socket in the analyzer, by means of a cable and adapter plug. The same voltages present in the circuit of the receiver (at the left) are impressed on the analyzer socket terminals (right).

If the tube of Fig. 16 be removed, then the connections to the socket remain as in Fig. 17. Suppose now, we take the base of an old tube and solder leads from the prongs of the tube base to a socket outside the set. The set will function exactly the same, whether a tube is inserted in the original tube socket, or in the one outside the set with the tube base plugged into the original socket, to complete the connections. This is depicted in Fig. 18. It is now possible to break any leads or insert meters between any two points in the external socket and, at the same time, keep a tube connected in the circuit. This, it will be recalled, is a necessary precaution in all tube service work.

The next problem is to devise a means of using, say, one meter to do all the measuring. This is a problem in switching. Suppose, for the sake of simplicity, we devise a switching arrangement to measure the grid, filament and plate voltages and then tackle the measurement of plate currents. **ONE THING MORE BEFORE WE START, AND THAT IS: ALL GRID AND PLATE VOLTAGES ARE MEASURED WITH RESPECT TO THE NEGATIVE END OF THE FILAMENT. THIS IS STANDARD PRACTICE.**

A study of Fig. 16 shows that, by means of a single-pole double-throw switch, a single meter can be used to measure filament and plate voltages. By using a three-point rotary switch the meter can be switched to the plate, the positive leg of the filament, and the grid; this is shown in Fig. 19. When the arm is on point 1 the meter is connected between grid and filament, and

so reads grid voltage; when on point 2, the meter is connected between the filament terminals, and so reads filament voltage; and when on point 3, the meter is connected between plate and filament, and so reads plate voltage. This switching arrangement does not take care of changing multipliers; or of the fact that, when the arm of the rotary switch is on point 1, for grid voltage, the positive terminal of the voltmeter is connected to the grid while the "C" bias makes the grid negative with respect to the filament. The result of the latter fact is that when grid voltage is being measured the meter reads reversed. The above effect necessitates the use of a switching arrangement which facilitates the insertion of any multiplier desired and at the same time reverses the meter connections when grid voltage is being measured.

The first requirement can be satisfied by inserting the multipliers in the voltmeter leads; so that, when plate voltage is being measured, any one of a number of ranges may be secured. This refinement is shown in Fig. 20.

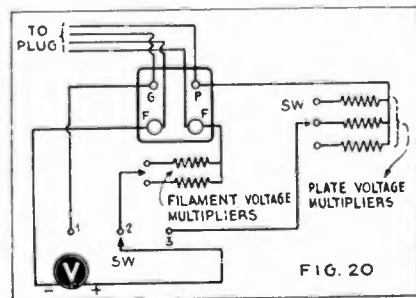

Since the tube voltages vary widely, it is necessary to have several multipliers to take the readings conveniently on a single voltmeter.

This mode of connection has the distinct advantage that, when measuring plate voltage, it is impossible to burn out the meter by accidentally pressing a low-voltage filament multiplier.

The problem now is to satisfy our second requirement; that is, to reverse the meter connections when measuring grid voltage. This may be accomplished by changing our single-arm rotary switch to a double-arm rotary switch, so connected that when grid voltage is measured the meter connections are reversed. This is shown in Fig. 21, in which the filament and plate circuit connections to the meter have been omitted, for the sake of simplicity.

With the arrangement as shown, and the arms in position 1, for grid voltage, the negative side of the voltmeter connects to the grid and the positive side to the filament—which is as it should be. On the other hand, in either position 2 or 3 the negative side of the meter connects to the filament, and the positive side to either the filament or the plate. Fig. 21 also shows grid-voltage multipliers.

Our entire circuit arrangement, as we have reached it, so far, is shown in the full lines of Fig. 22.

To complete our simple analyzer, we now must make provisions to measure plate and grid currents. Plate current is measured by breaking the lead at point X (Fig. 22) and inserting a milliammeter at that point; the two leads are then brought down through a connection of shunts to a fourth set of

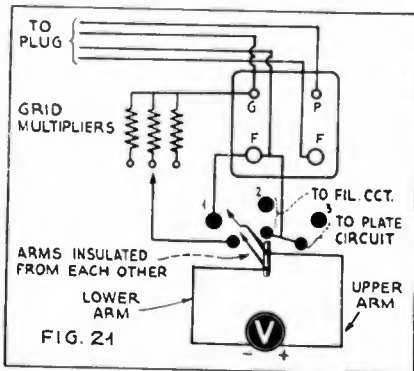

The connections shown permit us to read grid, filament or plate voltages at once; the grid voltage on any one of three scales.

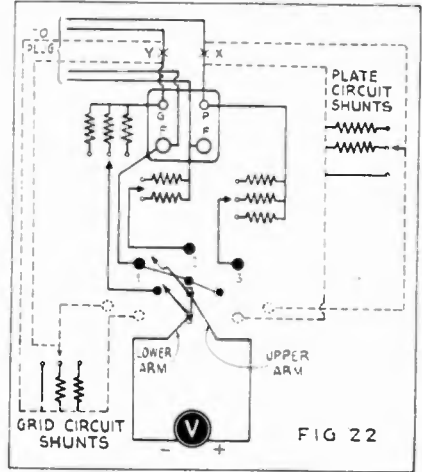

Arrangement of a single meter to read any of the voltages or currents (except filament current) of a tube.

terminals on our rotary switch, as shown by the dotted lines at the right. The same operation is performed in the grid circuit by breaking it at point Y and bringing the two leads down through a connection of shunts to a fifth set of contact points. This is depicted by the dotted lines at the left of Fig. 22.

In the grid and plate circuit shunts shown, a short-circuit arm is present. This is placed there in order to close the open circuit when any one of the other taps on the rotary switch is being used.

The arrangement shown uses one meter for all measurements; this meter having twelve different scales. The use of two or more meters would simplify the connections, if anything; so that the arrangement worked out here represents a more complicated hook-up than that ordinarily found in practice.

In all of the multiplier and shunt connections shown in the diagrams, push-button switches are almost invariably used in practice instead of the tap switches diagrammatically shown in the various schematics. The manner in which these push buttons are connected will now be shown.

Suppose the meter is to be used to measure the plate voltage on a tube, one of three different scales being available. The rotary switch is placed on

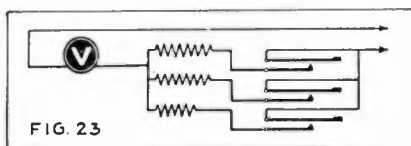

FIG. 23

How push-buttons are used to change from one scale of a voltmeter to another.

the tap marked "Plate Voltage," and the push button corresponding to the multiplier desired is pressed. The method of connecting the push buttons is shown in Fig. 23. For the selection of the proper shunts a somewhat similar connection is used. This is shown in Fig. 24. When push button No. 1 is pushed down, contacts c and d open; disconnecting the short-circuit from the line and connecting in shunt No. 1. If button No. 2 is pushed, contacts c1 and d1 open, disconnecting the short-circuit and connecting in shunt No. 2. As previously stated, the short-circuit is necessary in the plate and grid connections; because, when the meter is used for voltage measurements, the points in the circuit at which the plate and grid currents are measured must be closed.

The complete diagram of connections using the push buttons is given in Fig. 25.

No provision has been made in these diagrams to show the use of the meter externally with any of the shunts or

multipliers; since the insertion of any more switches would only tend to complicate the drawings. Commercial analyzers which have these additions are discussed in the latter part of the book, and the inclusion of them at this point would only cause a repetition.

The use of twelve different scales on a single instrument is not the best practice. It has been used in this design, more to indicate the manner in which the switching is done, than to illustrate general practice. However, there are

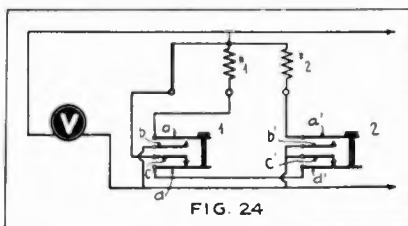

FIG. 24

Push-buttons are used here to change from one current scale to another.

several single-meter sets now available; so that our discussion is not entirely void of practicality.

The use of alternating current for heating the filaments of tubes is now almost universal practice; so that present-day analyzers have a low-range A.C. voltmeter for measuring filament

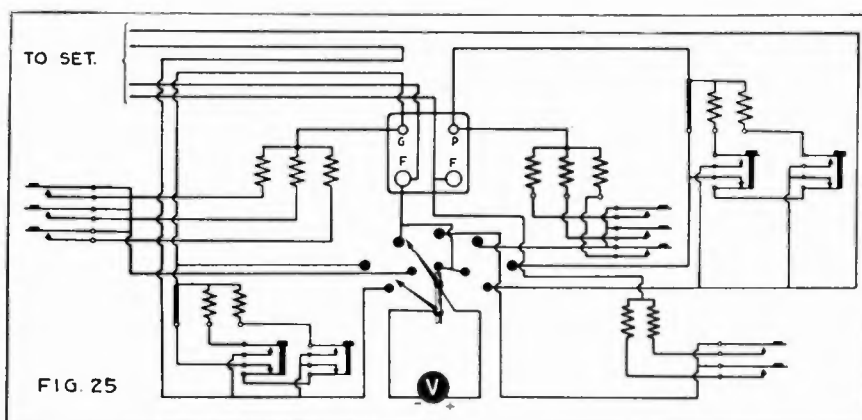

FIG. 25

A complete analyzer, using push-buttons to obtain the various connections shown more simply in Fig. 22. This may be

compared with the various switching arrangements of commercial analyzers shown in the latter part of this book.

voltage. This could have been incorporated in our little analyzer very easily by unsoldering wire **a** and **b** from the rotary switch and bringing them directly to the terminals of the A.C. voltmeter.

IN THE HEATER TYPE OF TUBES, ALL VOLTAGES ARE MEASURED FROM THE CATHODE. For our analyzer to be suitable for such tubes, it is necessary to use a five-prong ("UY") socket instead of a four-prong ("UX") socket; and change the filament connections slightly. The general principles of design are, however, identical. When this is done, and a 4-prong tube is to be tested, an adapter is used which

connects the cathode directly to the "F-" prong; and our circuit is essentially as shown in Fig. 25.

It is impossible to design a theoretical analyzer such as we have done here, and at the same time be perfectly impartial. Different manufacturers have various opinions as to what an analyzer should have, and how it should be constructed. It is the aim of this book to give an impartial discussion of analyzers in general, and so our attention must be confined to the fundamentals of all analyzers.

We will next discuss how to use the analyzer in locating trouble in modern radio receivers.

Make Extra Money

In your Spare Time

SERVICING

ELECTRIC REFRIGERATORS

FULL DETAILS ON INSIDE BACK COVER

ABOUT THE

OFFICIAL REFRIGERATION SERVICE
MANUAL

CHAPTER 3

Trouble Shooting with the Analyzer

Before any attempt is made to use the analyzer, the Service Man should be sure that the trouble lies in the receiver itself. Trouble in radio sets may be classified under two general headings:

- (1) Outside the receiver.
- (2) Inside the receiver.

There are various methods of determining whether the trouble lies outside or inside the receiver. One of these—which should always be followed—is to question the owner of the set very closely, and attempt to determine from the symptoms exhibited by the receiver just before it became faulty, the probable source of trouble. Typical questions that should be asked are:

“Does the set function at all?”

“If not, did it stop working suddenly?”

“If the set did not stop suddenly, how long did it work poorly?”

These question will, in turn, lead to others; and it is surprising how much information may sometimes be gleaned by proper quizzing of an intelligent customer. At times, a customer may not be quite sure of what happened, but he does not care to show his ignorance; in which case the Service Man is misled. However, in the majority of cases, the owner wishes to aid, rather than confuse, the Service Man; so that a good close quiz should be made first.

The owner of a receiver may say that the set works all right but, every five or ten minutes, a loud buzzing sound is heard. The Service Man should listen to the set for the stated period of time and, after a few simple tests, determine if the source of noise is inside the receiver or not. While the noise is on, the antenna and ground connections should be removed. If the noise then disappears almost entirely, it is evidently coming from the outside. If not, then

the noise is in the receiver itself, or the test has not been sufficiently thorough.

Trouble from the outside almost always exhibits itself in the form of noise; so that, as soon as the symptoms indicate noise of some sort, the above-mentioned simple tests should be made. Methods of dealing with inductive interference will not be discussed here, as they are beyond the scope of this book.

Trouble in the receiver itself may be again subdivided into two headings, namely:

- (1) Mechanical troubles.
- (2) Electrical troubles.

Mechanical troubles (such as broken or worn-out wires, sockets, shafts, dials, drive cables, etc.) are due either to carelessness or tinkering on the part of the owner, or to natural wear and tear on the device itself. Troubles of this nature are the most easily found, although not always the most easily repaired. How good or complete a job is made, usually depends upon the mechanical ability of the Service Man. Manufacturer's service notes almost invariably give the procedure to be followed in replacing any part of a receiver. Because of the extreme mechanical variations in present day receivers, it is almost impossible to describe here the general methods of repairing mechanical troubles; this will be left to the individual Service Man himself.

To give a list of all the electrical troubles possible in a receiver would be both impractical and confusing. Fortunately, however, the methods of attack and the testing of the individual units are the same, regardless of the make of receiver; so that a detailed analysis of the methods of testing is most helpful.

Upon satisfying himself, that the trouble lies in the receiver, the next procedure of the Service Man is to test all the tubes in the set. One method

is to substitute a new tube for each one in the set, one at a time, until the bad tube or tubes are located, or until the Service Man is sure that all the tubes are good.

This method has one advantage and several disadvantages. The advantage lies only in the speed with which the tube checking can be performed. The disadvantages are:

(1) If two or more tubes in the set are bad, they will be difficult to locate unless all the tubes are replaced at the same time.

(2) If the set is bad, as well as the tubes, then—after all the replacement possible the Service Man will not know which tubes are poor. This is because the fault in the receiver may not allow the set to function, regardless of whether the tubes are good or bad.

(3) The Service Man is never quite sure that the tube he is using for replacement is itself good.

(4) The Service Man never knows exactly what is wrong with the tube that he pronounces bad.

The second, and by far the most scientific method, is to test the tube—right on the job—by means of a tube tester. This method enjoys the distinct

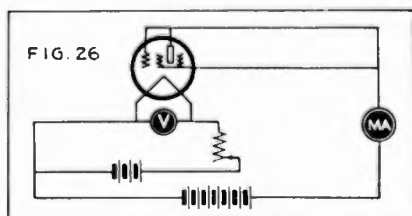

The use of both grids to add to the attraction of the plate draws all the electrons emitted by the filament, and gives the maximum reading.

advantage that accurate determinations can be made, regardless of tube or receiver trouble. Furthermore, tubes which are in the stage of going bad can be picked out and replaced; thus performing a higher grade of service work than would otherwise be possible.

The next question is, "What tests should be given a tube in order to determine if it is good or bad?"

For accurate checking of tubes, two tests should be performed: an emission test and a transconductance (or mutual conductance) test.

An emission test is made by applying proper voltages to both the filament and plate of a tube; connecting the grid or grids of the tube directly to the plate; and then measuring the plate current by means of a milliammeter. The results should then be compared with the manufacturer's emission current rating. If the emission is below the rated value, the tube should be replaced; if it is much too high, then a transconductance test should be made.

A diagram showing how to measure emission is given in Fig. 26. This test set is easily constructed by a Service Man for himself but it is not sufficient to determine whether a tube is good or bad; since the emission of a tube may be normal, and yet the grid or plate may be so displaced that proper operation is impossible. To complete the checking, the transconductance should be measured.

A tube functions in a radio set because the signal voltage on the grid causes the plate current to increase and decrease alternately. The greater this increase or decrease for a given signal voltage, the louder the signal. The amount of increase or decrease of plate current, per volt of increase or decrease of grid voltage, is called the Transconductance of the tube, and is measured in MHOS (or micromhos, as explained below).

Transconductance is therefore a measure of the "goodness" of a tube. Stated in another way,

$$\frac{\text{Change in plate current}}{\text{Change in grid voltage}} = \text{transconductance}$$

To measure transconductance then, all that need be done is to apply the normal grid, filament and plate voltages to a tube, and then change the grid voltage by a certain known amount. The plate current will change, in response to this change in grid voltage. This change in plate current, divided by the change in

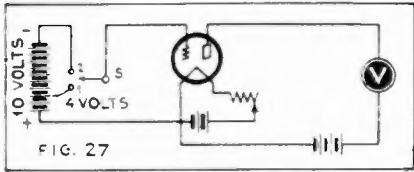

A simple arrangement for giving the (approximate) transconductance, or mutual conductance, of a tube.

grid voltage, gives the transconductance.

For example, suppose a tube be connected as shown in Fig. 27, with the switch S on tap 1; and that, at this position, the tube has 4 volts (negative) on the grid, and a plate current of 10 milliamperes flows. The switch is then thrown on tap 2; which places 10 volts (negative) on the grid. The plate current consequently drops to, say, 3 milliamperes. We know, now, that a 6-volt change in grid voltage causes a 7-milliampere change in plate current. The transconductance is then

$$\frac{.007}{6} = .001166 \text{ mhos.}$$

The use of such small numbers as .001166 is rather unwieldy; so that, in practice, the micromho is used as the unit. One micromho is one millionth of a mho. To obtain micromhos from mhos, then, multiply the fraction by 1,000,000. Performing this operation in the case above, we get .001166 (mho) \times 1,000,000 = 1,166 micromhos.

Ordinarily, provision is not made in set analyzers to perform both the emission and transconductance tests. These two jobs are left to separate tube testers, which are readily available on the market.

The ordinary set analyzer has, however, provision for making transconductance tests; this is done by keeping a small dry cell in the analyzer. Then, by pressing a push-button, this battery is connected in the grid circuit; which changes the plate current. The transconductance is then readily computed by the method used above. A typical tube tester will be described later on. For convenience in comparing the measured emission and transconductance with

rated values, a table is given showing the average emission and transconductance of several standard types of tubes, with the stated voltages.

For an emission test, the Service Man usually finds it sufficient to keep normal filament, grid and plate voltages on the tube. Then, if the plate current is normal, he assumes that the emission is normal. This assumption is justified in practical work.

By using a tube tester or an analyzer, tubes can be accurately tested; the results being dependable and not subject to the uncertainties of guesswork.

After the Service Man has tested all tubes, and replaced the defective ones with good ones, he is ready to proceed with his tests. The next job is to localize the trouble to as small a portion of the set as possible. The radio set itself may be considered as being divided into three separate units, namely:

- (1) Radio-frequency end (R.F.);
- (2) Audio-frequency end (A.F.);
- (3) Power unit.

The trouble must be localized in one of the three sections listed above; and the suspected unit then tested until the trouble is located. There are two ways of starting the localization: (1) by past experience; (2) by actual test of the circuit.

TABLE OF TUBE TESTS					
Type	E _f	E _p (Em.)	Emission ma. (mic.)	T C mhos.	E _p (V)
'59	3.3	50	6.0	425	90
'01A	5.0	50	20	725	90
'40	6.0	50	14	200	135
'12A	(cannot take)			1600	135
'71A	5.0	50	50	1360	135
'1C	6.0	100	85	1600	400
'26	1.5	50	35	1100	135
'27	2.5	50	35	1000	90
'80	5.0	80	100
'81	7.5	150	200		
'50	7.5	250	560	2100	450

E_f, Filament Voltage. Emission in milliamperes. E_p, Plate Voltage used (Em.) for Emission test; (TC) for Transconductance Test.

A table of average tube readings.

After a little experience, troubles in the audio end of the set can be separated from those in the radio-frequency end by a few simple tests. For instance, if the detector or any of the audio tubes is tapped with the fingers a musical sound, not unlike that of a clear bell, will be heard from the loud speaker. If this occurs, then—as a first approximation—the audio part of the set can be assumed to be normal; if not, then this part of the set should be suspected and tested thoroughly.

Let us assume for the moment that the audio-frequency end is normal. If the set uses a grid condenser-and-leak detector, then placing the finger on the grid condenser will usually result in a loud whistle. If this does not happen, then the detector should be suspected and also tested.

If everything seems normal so far, then the radio-frequency part of the set should be given a finger test. If the forefinger is slightly moistened, and the grid connection of each tube tapped, a dull thud should be heard before and after each tap. If tapping the grid, of a certain tube, does not produce any sound then that tube should be suspected. This latter test can be used, with the same results, also in the audio end of the set.

The above mentioned finger-grid tests are based on the assumption that the grid prongs are easily accessible. This is not always so; with the result that a set analyzer must be resorted to in order to localize and locate the trouble.

Remove the first R.F. tube from the socket, and plug it into the analyzer. Put the plug of the analyzer in the

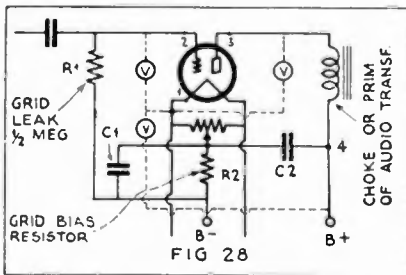

The voltmeter is in series with the grid leak, or the choke; and it gives a low reading, for reasons explained in the text.

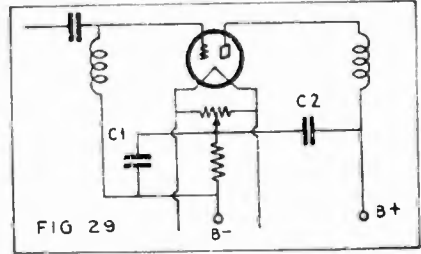

In a radio-frequency circuit, with low-resistance coils, the voltmeter reading is practically correct.

same socket of the set from which the tube was removed. By manipulating the proper switches and buttons, measure the filament voltage, plate voltage, plate current and grid bias. Compare these values with what the manufacturer says they should be. (If you do not know what the manufacturer's specifications are, then compare the results of the tube measurements with a tube chart.) In any case, they should check very closely. This process should be repeated for every tube in the radio set. If a grid leak and grid condenser are used, very little, or no grid-voltage reading will be obtained in the detector stage.

The interpretation of the analyzer's readings depends upon the design of the receiver; that is, on the type of grid bias, and the type of coupling used between stages. This is an extremely important consideration, and particular attention should be paid to what follows. It also emphasizes the fact that a knowledge of the circuit diagram of the receiver under test is absolutely essential to intelligent servicing. Figs. 28, 29, 30 and 31 depict the four usual methods of amplification; each of which will now be discussed.

Fig. 28 shows, in elementary form, a stage of amplification; the input or grid circuit of which is resistive, and the output or plate circuit of which is inductive. This is representative of a typical audio-frequency stage. Now, when grid voltage is being measured, the voltmeter in the analyzer is connected between points 1 and 2 (see diagram). It should then theoretically read the voltage across the grid-bias resistance or leak; but (as previously

pointed out) a voltmeter draws current and the current necessary to flow through the meter must flow also through the grid leak R_1 . This current causes a drop in voltage, principally across the leak; so that the meter reads only a small fraction of the actual bias present. The Service Man is usually then led to believe that the bias is low, when it actually is not. A tube operating normally, as an amplifier, has a negative bias on the grid, so that grid current is usually very small. Now, when there is no current through the leak, there is no voltage drop across it; consequently the full biasing voltage is applied to the grid. But, when a volt-

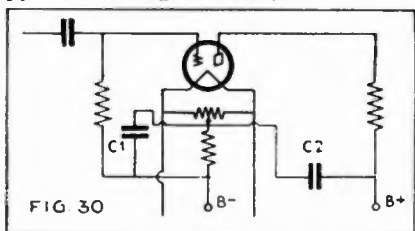

FIG 30

Caution must always be observed with resistance-coupled circuits, in order to know what the voltmeter readings really mean.

meter is connected between grid and filament, the circuit is complete; and a current does flow, causing the discrepancy mentioned above. Let us consider a typical example of how great this error can be.

A '26 type tube, having a plate voltage of 135 volts, uses a 1500-ohm resistor R_2 to obtain its normal bias of 9 volts. It is being measured by a 0-10-scale voltmeter V with a resistance of 1000 ohms per volt. What does the meter actually read when connected between grid and filament (Fig. 28)? The 9-volt bias sends a current through the 500,000-ohm grid leak R_2 and the 10,000-ohm voltmeter V , in series. The current flowing through this circuit is

$$I = \frac{E}{R} = \frac{9}{510,000} = .000017\text{-amps.}$$

The drop across the grid leak is

$$E = RI = 500,000 \times .000017 = 8.8 \text{ volts.}$$

leaving only 0.2-volts, which the meter reads.

If you know that the input circuit of a tube is resistive, then either make al-

lowances for the drop in voltage, or else short-circuit the grid leak, and measure the actual bias in the circuit. The author has seen many men jump to conclusions, due to neglect of this consideration, and start to hunt for trouble in the grid circuit; when, in reality, there was no trouble there at all.

Exactly the same conditions prevail in the plate circuit. When plate voltage is being measured, the voltmeter in the analyzer is connected between points 1 and 3 (Fig. 28). The resistance of the choke, or primary of an audio transformer, is usually small, compared to the resistance of the voltmeter; so that very close to normal voltage is indicated.

In the circuit of Fig. 29, the input to the tube is inductive; so that a grid-voltage reading would be more nearly correct than that of Fig. 28; this is due to the relatively low resistance of the coils ordinarily used.

Fig. 30 is the circuit of a resistance-coupled amplifier. In this case the actual plate and grid voltages will be higher than those indicated by the meters; because the resistance of the voltmeter is comparable with that of the coupling units. Therefore, it will be necessary to make allowances for the decreased voltage, due to this comparatively low meter resistance.

In the circuit of Fig. 31, the plate voltage will read low and the grid voltage nearly correct; so that the proper allowances should be made to compensate for the irregularity.

Each and every receiver is a problem in itself; and the best that the Service Man can do, without taking the set apart, is to familiarize himself with the circuit of the set he is servicing, and use the analyzer intelligently.

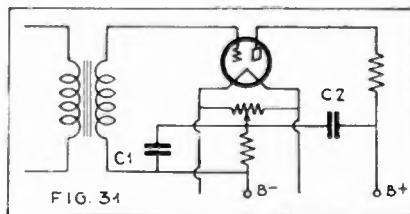

FIG 31

A fourth type of tube circuit; the same caution applies to its interpretation as to Fig. 28—but with grid and plate reversed.

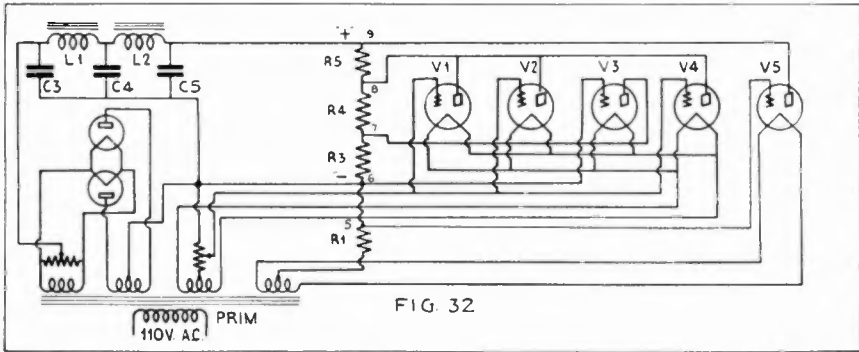

FIG. 32

The power unit of an electric set, with grid and plate connections simplified to show merely their direct-current voltage relations and biases. Their relationship

Suppose that, during the course of our tube measurements, it is found that the plate voltage is nearly normal, while the plate current is either too low or too high (either plate current condition may result), and there is no grid bias. Assume the circuit is similar to that shown in Fig. 28. The fact that plate voltage exists indicates that the grid-bias resistor R2 (which is in the plate return circuit to "B—") is not open. It may be shorted; the condenser C1 may be shorted; or the tube's input circuit may be open.

Short-circuited condensers are not uncommon; so that the first place to look for the trouble is in the condenser. This should be removed from the circuit and tested. (Methods of testing condensers and coils are given near the close of this chapter.) If the condenser is shorted, then its removal should restore normal bias to the tube. If this does not restore the bias then C1 is not shorted. The input device to the tube's grid whether it be a resistance (as R1) a choke, or the secondary of a transformer, should then be tested for an open. Finally the grid-bias resistor should be tested for a short.

In many circuits a single grid-bias resistor is used for several tubes. If this (corresponding to R2) is shorted then none of the tubes getting their bias from the same resistor will have grid voltage.

In testing a piece of apparatus, it should be completely isolated from the circuit electrically before any tests are made.

must be considered when analyzing the voltages to determine where any fault lies. When the set is detached from the power unit, the measured "B" voltage should increase.

Suppose our analyzer shows no plate voltage on a tube. Our next procedure is to test for voltage between points 1 and 4 (see Fig. 28). If voltage is present between these points, then—obviously—the plate coupling device (choke or primary of A.F. transformer) is open and should be replaced. If no voltage exists between 1 and 4, then the condenser C2 should be removed; if its removal restores voltage to the tube, then C2 should be replaced with a good condenser. If the removal of C2 does not restore plate voltage, then the grid-bias resistor R2 should be tested for an open; since the plate current of the tube passes through this resistor. If this resistor also proves to be good, then the trouble lies somewhere in the power unit.

A conventional power-unit connection is indicated in Fig. 32. The connections from the "bleeder" resistor R₃, R₄, R₅ to the grids, plates, and filaments of several tubes are shown; but the coils, transformers, etc., have been omitted for the sake of clarity.

Tubes V₁ and V₂ are R.F. tubes; V₃ is the detector; V₄ is the first audio tube; and V₅ is the power tube. R₁ is the biasing resistor for the power tube, and R₂ the biasing resistor for the remainder of the tubes. Notice that a grid-bias detector is used and, therefore, its bias must be greater than that of the R.F., or first audio tubes.

With zero voltage on the plate of a tube (assume the one we are measuring is V₂) then it is obvious that V₁

should also have zero plate voltage. In other words, if several tubes obtain their plate voltages from the same point on the bleeder resistance, and one of these tubes has no plate voltage, then the others cannot have any (that is, if the coils, resistors and condensers in the set are good). We have now localized our trouble down to the power unit.

We next disconnect the set from the power unit and measure the voltage between points 6 and 7. Regardless of whether the resistance R_3 is open, or good, we will obtain a voltage between points 6 and 7 that is not normal, but too high; this is because the load on the power unit has been removed. The same result will be observed if the voltages between points 6-8 and 6-9 are measured; a high voltage reading will be obtained, whether any one of the resistors, R_3 , R_4 or R_6 is good or shorted. The only safe and sure method is to isolate each resistance unit, (with the set disconnected), and test them one at a time for continuity.

If C_3 , C_4 or C_7 is shorted, very little or no voltage will be obtained anywhere. If this condition is found, then the filter condenser should be tested first; since a shorted filter condenser is about the only piece of apparatus that can be bad and affect the voltage on all the tubes. Another indication of a shorted filter condenser is the white heat of the plates of the rectifier tubes. With C_3 shorted, the rectifier tubes become white-hot, with no voltage on the bleeder resistance. With C_4 shorted, both the rectifier tubes and L_1 become very hot, and there is no voltage on the bleeder. With C_5 shorted, the rectifier tubes, V_6 and V_7 , become very hot, with no voltage on the bleeder.

With the filter unit testing normal, and the voltages on the bleeder still low or zero, the voltages on the plates of the rectifier tubes should be measured. By proceeding in this manner, defective apparatus is bound to be found.

The problem of trouble shooting finally resolves itself down to the testing of individual units. For this purpose the analyzer is indispensable. Fortunately there are only three properties used in radio sets, namely, inductance, capacity and resistance: and they are supplied,

respectively, by coils, condensers and resistors. We will take these up in their order.

Testing the Coils

There are two types of coils used in radio sets; air-cored and iron-cored. Either type may be open, partially shorted or entirely shorted. Now most analyzers have, as an integral part of the device, a continuity tester or ohmmeter. This is nothing more or less in its essentials than a voltmeter V connected in series with a small battery, as shown in Fig. 33. With terminals 1 and 2 shorted, the voltmeter reads the battery voltage; which is the same as the full-scale deflection of the meter. If a resistance R is inserted between terminals 1 and 2, the voltmeter reads less than the battery voltage, because of the drop in voltage caused by current passing through R . The more resistance between points 1 and 2, the less the voltmeter reads. This makes it possible to mark or calibrate the scale of the voltmeter directly in ohms; so that, when a resistor is connected to points 1 and 2, the meter reads a certain figure which is the value of the resistance in ohms so connected.

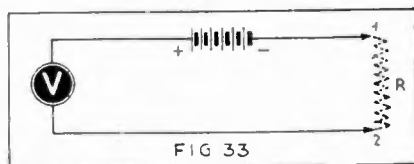

FIG 33

Since the voltage drops are directly proportional to the resistances, the higher the value of R , the less the voltage read across V .

The coil to be tested is connected to points 1 and 2 of the ohmmeter. If the meter reads nothing at all (0), then the coil is defective. If the meter does read, it is difficult to tell whether the coil is partially shorted or is good, unless the resistance of the coil is known. For instance, an R.F. transformer is wound with only a few turns of wire, and consequently its resistance is low. An ohmmeter test then, can only indicate whether the coil is open or closed.

On the other hand, a large iron-cored coil is usually wound with many turns of wire and may have a resistance of

several hundred or even several thousand ohms. In this case, the Service Man cannot tell the difference between a partially-shortened coil and a good one, unless he knows the approximate resistance of the coil when good. This may usually be found in the service notes of the radio set; or, if there is a similar coil in the same or another set, the resistance of one may be compared with the resistance of another. Coils should be tested, not only for shorts and opens, but also for a "ground" (short-circuit) to cores.

In many cases, the cores of chokes, transformers, etc. are grounded to the frame of the set (which is usually at ground potential); the coils themselves are above ground potential, so that a coil grounded to its core constitutes a short-circuit.

Fortunately, however, when a coil in a radio set is defective, it usually either is open or has a dead short; so that the continuity tester or ohmmeter is all that is necessary to locate defective ones.

Testing the Condensers

When a condenser is good it should do two things: (1) it should not allow D.C. (direct current) to pass through it; and (2) it should therefore accumulate and hold a charge, when its rated D.C. voltage is applied. When a condenser is leaky it allows D.C. to pass; so that, to test for a leak in a condenser, all that is necessary is to connect the terminals of the condenser to the ohmmeter. The needle of the ohmmeter should move a little (with the flow of current into the condenser to charge it, if its capacity is large); and then return to its normal position and stay there. If it does not return to its normal position, but stays somewhere on the scale, the condenser is leaky and should be discarded.

It is perfectly possible for a condenser to test O.K. on the small voltage used in the ohmmeter, but break down completely when normal voltage is applied. To completely test a condenser, the rated D.C. voltage should be applied for a few moments, and then removed. The condenser should be allowed to stand charged for several min-

utes, and then discharged. If a spark occurs during discharge, the condenser is good; if there is a weak spark or none at all, the condenser is defective.

The above statement applies only to condensers of large capacity; about $\frac{1}{4}$ to $\frac{1}{2}$ mf. and over. For the smaller sizes, the continuity test described above is sufficient; it being merely sufficient to determine whether or not the condenser is shorted.

It is perfectly possible for a condenser to be open, even though it is a rare occurrence; an open condenser is one which passes neither D.C. nor A.C. This is due usually to broken or unsoldered leads from the condenser plates to its terminals. To locate an open in a condenser of small capacity, without taking it apart, is practically impossible. In the larger sizes, an open may be easily found by connecting the condenser to the ohmmeter of the analyzer. If the needle of the meter does not move and return to its original position, then the condenser is probably open.

It is very useful to be able to measure condenser capacity. Some analyzers, which use a high-resistance A.C. meter (which is nothing more than a sensitive D.C. meter with a copper-oxide rectifier in series) are calibrated in microfarads; to enable the user to measure capacities from about 0.25 to 15 microfarads, with an A.C. line-voltage of 115 volts at 60 cycles.

Testing Resistors

Testing resistors really involves only the measurement of the value of the resistance. If the result of the measurement is within 10% of the rated value of the resistance, then it may be assumed to be good. If it is far from the 10% tolerance, then it should be discarded. For all practical purposes, resistors may be measured with the ohmmeter included in the analyzer.

Additional Features of the Analyzer

Up to this point, it can be seen that the analyzer can be used to test almost every piece of apparatus in the set. There are other uses of the analyzer, some of which are obtained only with

the more elaborate instruments, while others are common to all types.

Since the advent of single-control sets, tuning condensers must be lined up very accurately in order to secure maximum sensitivity from the receiver. For various reasons, tuning condensers may go out of line; so that the Service Man is called upon to adjust them. One method of lining condensers is to tune in a broadcast station; loosen the tuning condensers from their shafts; and then tune each one separately, or adjust the trimmers until the station sounds loudest. The ear is sometimes very deceiving; so that precise alignment, or "lining up" is not always possible, especially if the broadcast station is strong. However an analyzer simplifies the problem greatly. All that need be done is to plug the analyzer into the detector socket and manipulate the proper switches and buttons to read the plate current. Then adjust the trimmers or tuning condensers until the plate current reads **maximum**, if a grid-bias detector is used; or **minimum**, if a grid leak-and-condenser detector is used. The job is finished and the results are not dependent upon the unreliable ear.

In the superheterodyne receiver, the intermediate-frequency (I.F.) transformers also go out of line sometimes; so that again we have a lining-up problem. Exactly the same procedure is used. This time the analyzer plug is placed in the second detector's socket; a broadcast station is tuned in; and the I.F. transformers are adjusted so that a maximum or minimum plate current reading is obtained in our analyzer. Whether we adjust for maximum or minimum depends, as mentioned above, upon the type of detector used.

Note: the intermediate-frequency amplifiers can be lined up in this manner only when the oscillator condenser is correctly set; that is when the difference between the signal frequency, from the broadcast station, and the oscillator frequency, generated in the set, is exactly equal to the intermediate frequency used.

The oscillator tuning condenser may also be adjusted in a somewhat similar manner; provided the intermediate-frequency transformers are lined up. The

analyzer is plugged into the second detector's socket, and the plate current is read. The oscillator trimmer condensers are then adjusted until a maximum or minimum reading is obtained (depending upon the type of detector used).

Another question may arise. Suppose the Service Man does not know whether the oscillator or the intermediate-frequency transformers are lined up or not; and he wants to line them up. Which should be lined up first, the oscillator or the transformers? The answer is that neither one can be lined first by using the method described above; for the following reasons:

A superheterodyne's intermediate-frequency amplifier is a low frequency amplifier; since it amplifies the difference in frequency between the broadcast station being received and a local oscillator placed in the set. This difference-frequency is always the same, regardless of the frequency of the broadcast station being received. It is maintained at a constant value, since the R.F. tuning condenser and the oscillator tuning condenser are mounted on the same shaft (in modern superheterodynes); so that turning the dial changes both frequencies by the same amount and the resulting difference is always constant.

If, therefore the intermediate-frequency transformers (I. F. T.), are correctly tuned to a predetermined frequency, but the oscillator condenser is placed out of line, the result would be poor quality and very weak signals. The same results would be obtained if the oscillator were lined up, but the I. F. T. are out of line. Suppose, for example, there are three I. F. T. in a set whose working frequency should be 180 kilocycles (k.c.). Furthermore, for some reason two of them are out of line: one is tuned to 170 k.c.; the second to 180 k.c.; and the third to 190 k.c.

If the Service Man makes a bad guess and attempts to adjust the oscillator condenser for maximum response, the same output will be obtained at three different settings of the oscillator condenser; corresponding to the three intermediate frequencies. Therefore the oscillator cannot be lined up unless the I.F.T. are all matched. If on the other

hand, an attempt is made to line up the "intermediates", and the oscillator is off, then we may line them up to a maximum; but they may all be tuned to some other frequency such as 170 or 190 k.c. If the transformers are designed to operate at 180 k.c., then the operation of the receiver will not be normal.

THE PROCEDURE, THEN, IS FIRST TO LINE UP THE INTERMEDIATES TO THEIR RATED FREQUENCY, AND THEN LINE UP THE OSCILLATOR. This is done by means of an external oscillator. Portable oscillators, tuned to standard intermediate frequencies are available. The output of the oscillator is coupled to the input of the I.F. amplifier by means of a small loop of wire (provided with the oscillator). The oscillator tube is removed from the set and the analyzer is inserted in the second detector socket. When the I.F.T. are lined up, we are now sure that they will all be tuned to a maximum at their rated frequency. We may then proceed to line up the oscillator as described above.

Use of Modulated R.F. Oscillator

In lining up receivers the use of a broadcast station as a signal is not the most desirable practice since the output of the station changes continually; especially while an orchestral selection is being given. It is best to use a small modulated oscillator, instead of the broadcast station; for the reason mentioned above, and also because the output of an oscillator can be varied at will to suit any given condition. Some makes of analyzers come equipped with such an oscillator (built into the analyzer itself) and needless to say this is very handy—especially during "S O S" periods.

The Output Meter

A D.C. meter cannot read A.C. and the low-frequency A.C. meters cannot be used above about 150 cycles. This makes it difficult to read voltages whose frequency lies in the audio range; that is between 60 and 5000 cycles (per second). Recently a very novel idea has been incorporated in many analyzers to

meet this condition. A small dry rectifier is connected in series with a sensitive D.C. meter. The A.C. to be measured is thus rectified; and the meter reads the resultant D.C. This arrangement gives a high-resistance A.C. meter, heretofore impossible, and an uncrowded linear scale on the instrument. It may be used across the loud speaker's terminals for making sensitivity and frequency-response tests, hum measurements, etc.

Care and Maintenance of Analyzers.

The most important, and the most costly part, of any analyzer is its meters. Some of the meters used in analyzers are built with the precision of a fine watch, and they should be handled as such. Anything that would tend to severely jar the meter should be avoided.

When measuring voltages or currents, the values of which are unknown, always use the highest scale on the instrument first; and then reduce to one that gives a reading at about two-thirds of full-scale deflection.

Accidents are bound to happen and, if so, do not attempt to repair the damaged part yourself. The analyzer is the basis of all your work and the utmost faith should be placed in its reliability. If the instrument does not function properly, go to the manufacturer—who is in the same position to repair an analyzer as the Service Man is to repair a radio set.

Conclusion

As stated earlier in this book, an analyzer is, primarily, used for conveniently measuring voltages and currents. Additional features, such as external use of voltmeters and ammeters, capacity and inductance calibrations, output meters, ohmmeters, etc., make the use of an analyzer all the more desirable.

When locating trouble in a set, first satisfy yourself that the trouble is in the receiver and not in the loud speaker or outside the receiver itself, before any detailed analysis is started. The next step is to test all tubes (using a tube tester or the analyzer itself) and replace all defective tubes with good ones.

After all bad tubes have been replaced, measure the voltages and currents in each stage before localizing the trouble. If only a single stage has abnormal readings, confine your attention to that stage; if several tubes have abnormal readings, then look for trouble in apparatus that is common to those stages. Test each piece of apparatus in its log-

ical sequence and the faulty one will be found.

Unless you are thoroughly familiar with the receiver, do not fail to use tube charts and circuit diagrams, together with a good analyzer.

Remember, the analyzer is a means to an end, rather than an end in itself.

Join the ORSMA

Ever since the appearance of the commercial radio broadcast receiver as a household necessity, the Radio Service Man has been an essential factor in the radio trade; and, as the complexity of electrical and mechanical design in receivers increases, an ever-higher standard of qualifications in the Service Man becomes necessary.

The necessity, also, of a strong association of the technically-qualified radio Service Men of the country is forcing itself upon all who are familiar with radio trade problems; and their repeated urging that such an association must be formed has led us to undertake the work of its organization.

This is the fundamental purpose of the OFFICIAL RADIO SERVICE MEN'S ASSOCIATION, which is not a money-making institution, or organized for private profit; to unite, as a group

with strong common interests, all well qualified Radio Service Men; to make it readily possible for them to keep up with the demands of their profession; and, above all, to give them a recognized standing in that profession, and acknowledged as such by radio manufacturers, distributors and dealers.

To give Service Men such a standing, it is obviously necessary that they must prove themselves entitled to it; any Service Man who can pass the examination necessary to demonstrate his qualifications will be elected as a member and a card will be issued to him under the seal of this Association, which will attest his ability and prove his identity.

The terms of the examination have been drawn up in co-operation with a group of the best-known radio manufacturers, as well as the foremost radio educational institutions.

The following firms are co-operating with us in formulating the examination papers.

THE CROSLLEY RADIO CORPORATION, CINCINNATI, OHIO.

Mr. D. J. Butler, Service Mgr.

GRIGSBY-GRUNOW COMPANY (Majestic), CHICAGO, ILLINOIS.

Mr. L. G. Wilkinson, Service Mgr.

STROMBERG - CARLSON TELEPHONE MFG. CO., ROCHESTER, N. Y.

Mr. E. S. Browning, Service Mgr.

COLIN B. KENNEDY CORP., SOUTH BEND, IND.

Mr. B. F. McNamee, Prod. Mgr.

RCA-VICTOR COMPANY, INC., CAMDEN, N. J.

Mr. H. C. Grubb, Vice-President

STEWART-WARNER CORPORATION, CHICAGO, ILLINOIS.

Mr. T. N. Golten, Service Mgr.

The schools who have consented to act as an examination board are:
International Correspondence Schools, Scranton, Penna.

Mr. D. E. Carpenter, Dean.

RCA Institutes, Inc., New York, N. Y.

East Bay Radio Institute, Oakland, Calif.

Mr. T. T. Tonnehill, Director.

Radio Training Association of America, Chicago, Ill.

Mr. A. G. Mohaupt, President.

School of Engineering of Milwaukee, Milwaukee, Wis.

Mr. W. Werwath, President.

Radio Division, Coyne Electrical School, Chicago, Ill.

Mr. H. C. Lewis, President.

We shall not attempt to grade the members into different classes. A candidate will be adjudged as either passing or not passing. If the school examining the papers passes the prospective member as satisfactory, we shall issue to him an identification card with his photograph.

If the candidate does not pass this examination the first time, he may apply for another examination three or six months later.

There is absolutely no cost attached to any service rendered by the Association to its members, no dues, no contributions.

If you wish to become a member, just write your name and address on a post card and mail it to us. We will send you all the papers necessary to become a member.

OFFICIAL RADIO SERVICE MEN'S ASSOCIATION, Inc.
98AB Park Place

New York, N. Y.

CHAPTER 4

Commercial Set Analyzers

The development of the commercial set analyzer, as previously stated, has extended through a period of years. Naturally, with the very simple receivers of a few years ago, all that was necessary to analyze a set completely was an arrangement for measuring merely the plate voltage and the plate current; since some of the receivers did not even use a "C" bias.

With the advent of the high-vacuum tube, the use of "C" bias on amplifiers became necessary. With regard to the analyzers, this meant a change in their design, which would facilitate the measurement of the grid voltage. Some designers of analyzers even went so far as to provide a means of measuring, not only the grid voltage, but also the grid current. This step represented a distinct advancement in the design of analyzers.

The superheterodynes by this time had grown increasingly popular; with the result that external modulated oscillators were found necessary, in order to conduct an intelligent investigation of the characteristics of this type of receiver. Three frequencies are necessary: the oscillator frequency; the signal frequency; and the intermediate frequency. However, occasions arise when the Service Man is not able to utilize a broadcast station, or the receiver's own oscillator output to intelligently "line up" a receiver of this type. This meant that superheterodynes could not be adjusted for maximum efficiency in the home of the customer, but had to be brought to the service stations; where the necessary facilities were to be had. Also, an output meter was necessary. Only the more elaborate service stations then boasted of vacuum-tube voltmeters which are now such common apparatus in any up to date service station. The cost of this equipment was necessarily large; a condition due mainly to the limited demand among the servicing profession.

The earliest analyzers, many of which are still in use (with various attach-

ments prompted by the ingenuity of the Service Men who own them, and of the manufacturers of adapter plugs) were designed for battery tubes only. The appearance of the heater-cathode tube, with its 5-prong or UY base, at once worked a revolution in analyzer design: additional problems of this nature have again been lately brought up by the popularity of the pentode, with its additional element. In addition to this, the alternating-current set at once necessitated the incorporation of A.C. meters for filament- and transformer-voltage measurements. How ingeniously the multiplied demands on the modern set analyzer are being met, by the use of special switches, adapters, rectifiers, etc., will be most instructively evident by a study of the following pages; which reproduce the manufacturers' diagrams of the arrangements followed in their latest test equipment.

With the increasing complexity of receivers, and the close competition in the service field today, one of the first requisites in a commercial analyzer is the reliability of its operation. Since intermediate frequencies are now standardized at about 175 kilocycles, the more expensive analyzers now have incorporated in them thoroughly-shielded oscillators, to permit rapid and accurate testing of the I.F. stages. This feature can be appreciated only when you attempt to line up I.F. transformers by using a broadcast signal and the oscillator in the receiver; the results, even then, are never known to be accurate, since it is perfectly possible for the oscillator condenser to be mis-aligned, so that the intermediate frequency is, for example, 160 kc. instead of 175. When the I.F. transformers are then adjusted for greatest response, they will be tuned to only 160 kc., and their efficiency will not be maximum.

If, on the other hand, we apply a frequency known to be 175 kc. to the I.F. amplifier, and then adjust the latter for maximum response, we are

sure that the final result will be independent of any mis-alignments in either the oscillator or R.F. stages.

The majority of analyzers also have become equipped with output meters, which may be used for so many purposes (such as adjustment and alignment of receivers; hum measurements; determination of signal-to-noise ratios; determination of phonograph-scratch frequencies, etc.) that it should be now considered an indispensable part of the equipment of the modern Service Man.

An increasing number of new tubes have also made their appearance on the market. Socket connections have been changed and new types of sockets have been added; all of which require, for best results, that engineering skill be brought into play in order to design a

single piece of equipment which may be used by the Service Man and will enable him to make a rigid test on any type of receiver, using any type of tube.

It is now possible for the Service Man to bring into the home of a customer a complete laboratory, all in one case, which gives him the same facilities in the field that he obtains in his own shop.

Since space does not permit a list of all the analyzers, both past and present, that are available on the open market, we reproduce in the following pages a description of the latest instruments of the leading manufacturers; from which the Service Man is sure to obtain a complete picture of the analyzer field as it is today.

R. M. A. Color Code

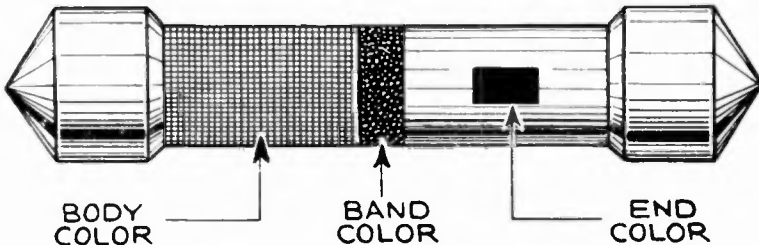

Body Color indicates first significant figure.
 End Color indicates second significant figure.
 Band Color indicates third significant figure.

Body Color	End Color	Band Color
1 — Brown	0, — Black	.0 — Black
2 — Red	1 — Brown	0. — Brown
3 — Orange	2 — Red	00. — Red
4 — Yellow	3 — Orange	000. — Orange
5 — Green	4 — Yellow	0,000. — Yellow
6 — Blue	5 — Green	00,000. — Green
7 — Violet	6 — Blue	000,000. — Blue
8 — Gray	7 — Violet	
9 — White	8 — Gray	
0 — Black	9 — White	

For example, a resistor has a blue body, a yellow end color and a red band color. What is the resistance in ohms? Answer, 6400 ohms.

Beede "Preston" 1931 Model

The Preston set analyzer has been designed to perform routine tests on radio sets of both the D.C. and A.C. types. Three instruments are used: an A.C. voltmeter; a D.C. voltmeter;

and a D.C. milliammeter. No rotary switches are used, all meters being inserted in the circuit by means of need be depressed to obtain the desired reading.

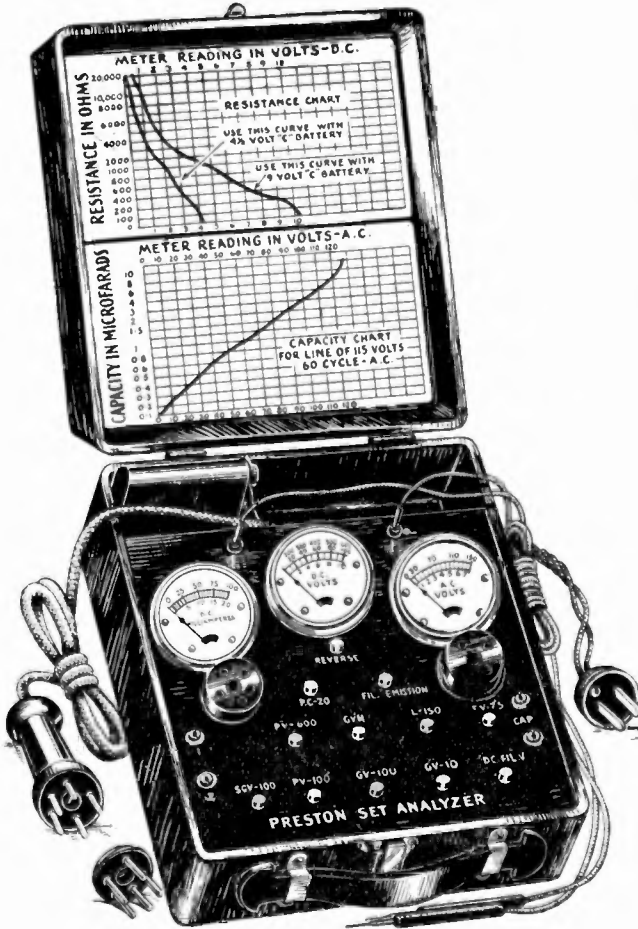

and a D.C. milliammeter. No rotary switches are used, all meters being inserted in the circuit by means of need be depressed to obtain the desired reading.

The plate-current meter is so con-

nected that readings are normally obtained on the 100-ma. scale. By pressing the "P.C. 20" button, the 20-ma. scale is used. This arrangement is used in order to prevent burning out of the meter, due to the possible use of the wrong scale of the instrument.

The plate voltage may also be measured by depressing the proper button. The "P.V. 600" should be pressed first. If the reading is under 100 volts, then the "P.V. 100" button should be pressed. This precaution also is to prevent burning out of the voltmeter, due to the use of too much voltage for the scale being used.

There are three grid-voltage buttons: "G.V. 100" for power tubes; "G.V. 10" for general-purpose tubes (such as '01A, '26, etc); and "G.V.H." for heater-type tubes. The selection of the proper button to be used depends upon the grid bias of the tube that is to be measured. Detector tubes using a grid leak and condenser will give no grid-voltage reading.

There are two buttons for filament-voltage measurements: one for A.C. — "F.V. 7.5"; and one for D.C. tubes — "D.C. FIL. V." With D.C. tubes, the meter may give a reversed reading, due to reversed "A" connections to the socket of the tube. Some manufacturers connect leads one way, and some another. If the meter reads reversed,

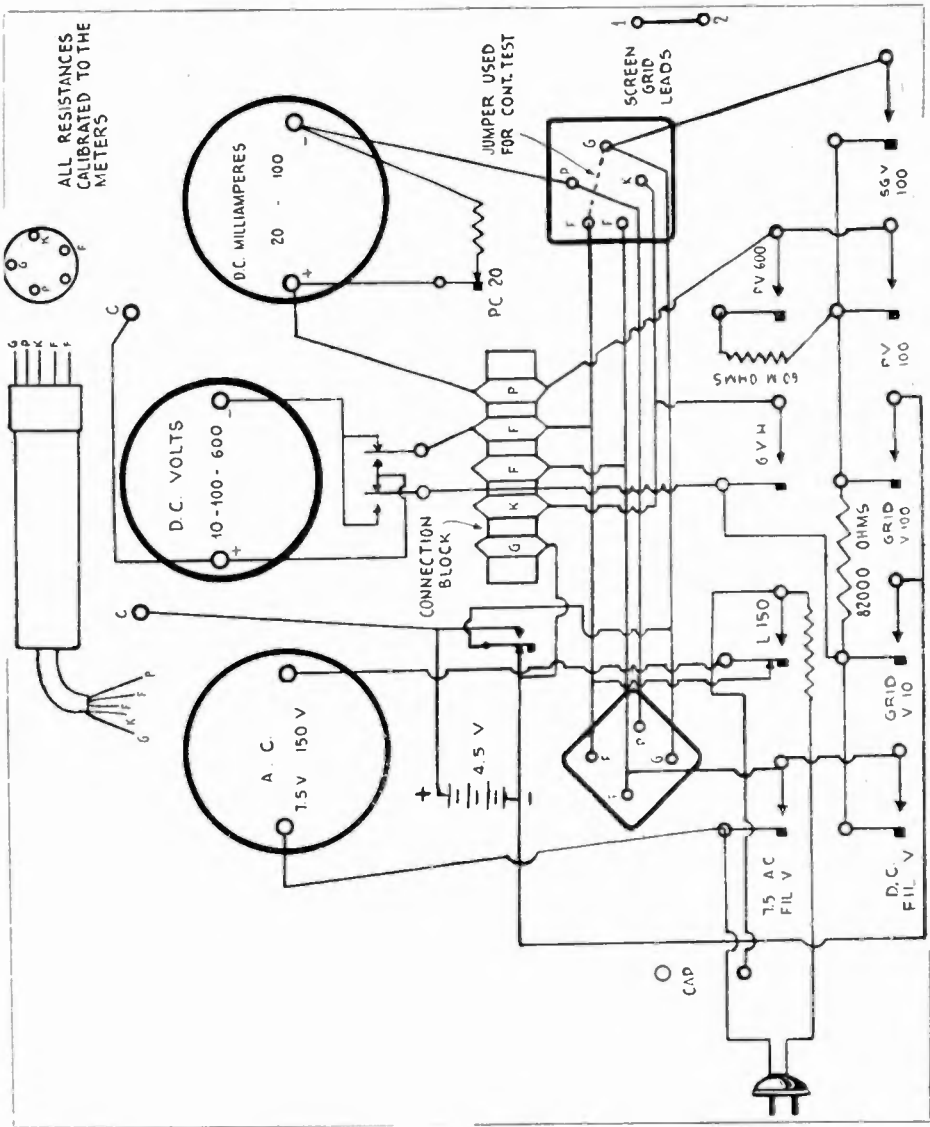

Schematic Circuit of the
Beede "Preston" 1931 Model

it can be made to read correctly by pressing the "Reverse" button.

To facilitate measuring line-voltages, the two-prong plug is inserted in the 110 volt A.C. receptacle. The button marked "L-150" is pressed, and the reading will be obtained on the 150 scale of the A.C. meter.

To test tubes, a small 4.5-volt battery is housed in the Analyzer. By depressing the button marked "Filament Emission" the positive terminal of this battery is connected to the grid. This should cause the plate current to increase; the amount of increase indicates the condition of the tube.

To make a grid test on '24 type tubes, there are provided two leads; a long and a short one. The prod of the long lead is inserted in pin jack No. 2, and the cap at the other end of this lead is inserted into the cap of the lead, in the radio set, which normally goes to the top of the tube. The cap at the end of the short lead goes to the top of the tube in the analyzer; while the other end of this lead goes to pin jack No. 1. The removal of this last lead from pin jack No. 1 should cause the plate current to decrease to nearly zero; the change in plate current is indicative of the condition of the tube.

Continuity and resistance measurements are also possible with this little Analyzer. The test prods supplied are inserted into the pin jacks marked "C". A jumper is placed in the five-prong socket, connecting one of the heater terminals to the grid. The test

prods are then placed across the part of the circuit to be tested. By referring the meter readings to a chart, the values of resistance may be determined. The resistance tests are made with the 4.5-volt battery in the analyzer; however, by connecting another 4.5 volts in series (giving a total of 9 volts), much higher resistance values may be measured.

To test and measure capacities, the test prods are inserted into the pin jacks marked "CAP", and the two-prong plug is inserted in the 110-volt A.C. line. By connecting the prods to the condenser to be measured, a reading will be obtained on the 150-volt scale of the A.C. instrument. A capacity chart is supplied with the instrument; so that, by referring the readings on the A.C. instrument to this chart, the capacity of the condenser under test is determined.

When measuring either condensers or resistors, the 5-prong plug should not be connected to the radio set.

A glance at the diagram will show the extreme simplicity of this Analyzer. The fact that the milliammeter is always in the circuit enables the plate current to be measured while other tests are being performed.

An adapter is used to test four-prong tubes, since the cable plug applied to the radio set has five prongs. The adapter is snapped over this five-prong plug, thus permitting the measurement of both heater and filament types of tubes.

Dayrad "Type 880" Set Analyzer

The "Type 880" Radio Set Analyzer is complete and ready to use. A set of test prods is included; the necessary adapters for all types of sockets are attached to the Analyzer's cable plug.

The Analyzer consists of: two meters, one for A.C. and the other for D.C. measurements; three switches (one with 17 positions, called the Selector Switch; one with 3 positions for changing the A.C. Meter ranges, called the A.C. Meter Switch; and one with 3 positions for changing the output ranges, called the Output Meter Switch); 12 push-button switches (8 locking type; 4 nonlocking type) all properly marked; twenty-five tip jacks, all properly marked; a battery compensating rheostat for use with the Ohmmeter, called the Compensator; a cable and connecting plug, called the Analyzer Plug; and its associated adapters, distinguished as the UX and UV Adapters; and a 4½-volt battery.

By setting the Selector Switch at the extreme left, the following readings may be obtained, in sequence.

(1) Plate M.A. — Three Ranges, 5-25-125 Milliamperes.

(2) Plate Volts—Three Ranges, 125-250-500 Volts.

(3) Second Plate—'80 Rectifiers — 125 Milliampere-Scale only.

(4) Screen-Grid Current—5 Milliamperes.

(5) Screen-Grid Volts — Two Ranges, 125-250 Volts.

(6) Control-Grid Volts — Three Ranges, 125-50-5 Volts.

(7) Cathode Volts — Two Ranges, 125-25 Volts.

(8) Filament Volts A.C. — Three Ranges, 4-8-20 Volts (also A.C. Meter Switch).

(9) Filament Volts D.C.—5 Volts.

In making a circuit analysis it is necessary, in order to obtain a meter reading, to press one of the "Read Meter" Buttons. Three of these are provided: the first, "Read A.C. Meter," is located to the left and below the A.C. Meter. The second and third are the "Read D.C. Meter" and "Reverse D.C.

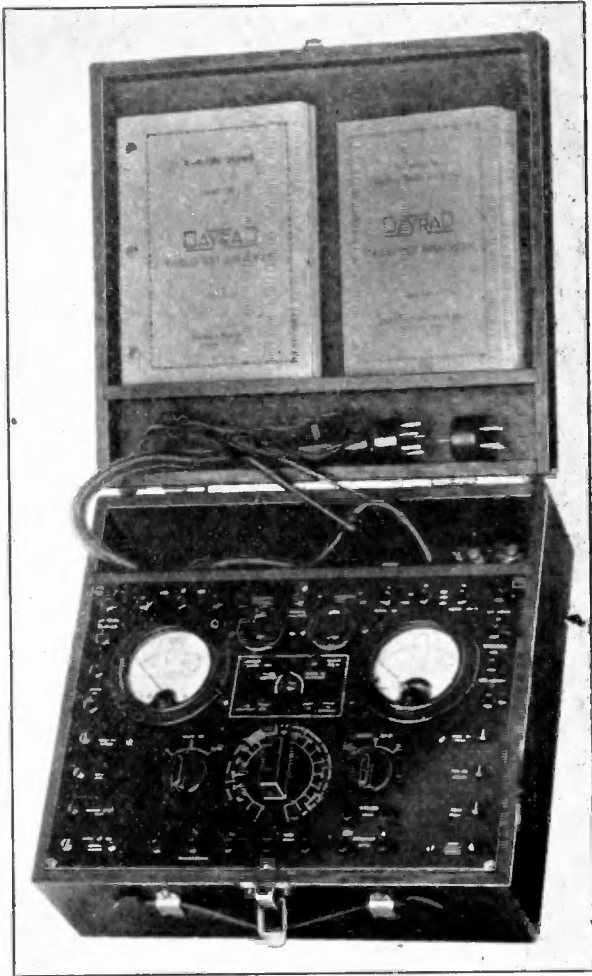

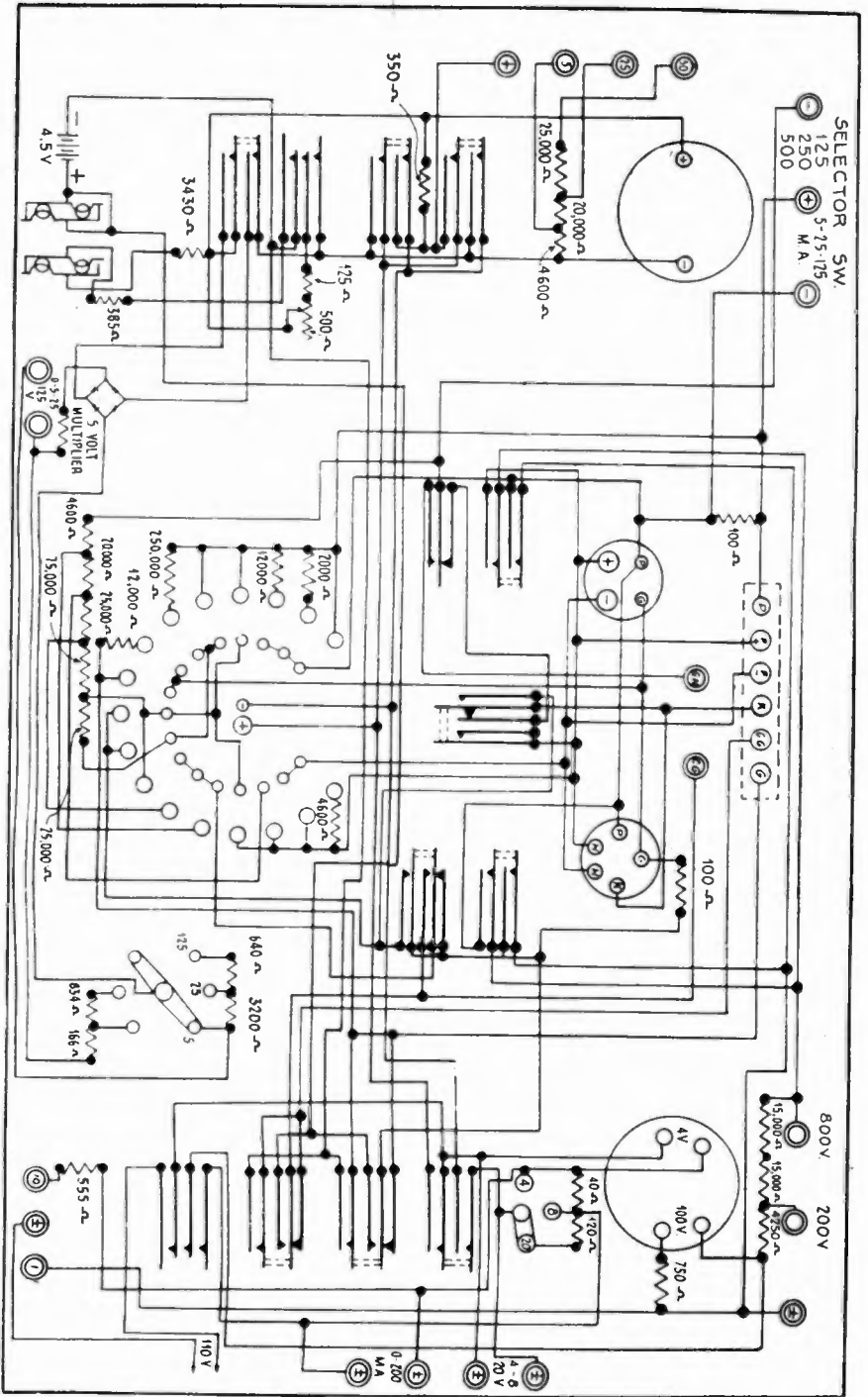

Schematic Circuit of the DAYRAD "TYPE 880" Set Analyzer

Meter," which are located to the right and below the D.C. Meter. The "Reverse D.C. Meter" button is used only in cases where the cathode is at a positive instead of a negative potential with respect to the filament.

When testing amplifier circuits, the "Grid Test" button should be depressed after the first reading of plate current is obtained. This button shifts the grid voltage and, usually, gives an indication of the value of the mutual conductance of the tube.

For measuring screen-grid tubes, the button marked "Screen-Grid Analysis" must be depressed and locked when analyzing their circuits. Its purpose is to rearrange connections in the Analyzer so that the control-grid circuits and the screen-grid circuits will fall in the proper positions for test. The control-grid connection in the set must be connected to the tip jack marked "Control Grid" by means of the short connecting lead which is supplied with the Analyzer. Always release this button when you have finished analyzing circuits using screen-grid tubes.

Pentode output circuits, employing the type-'38 tube, have terminal arrangements identical with those of heater-type screen-grid tubes ('24, '35, '51); and analysis is therefore performed on these circuits exactly as if a screen-grid type were under test.

For all other types of pentode tubes, it is necessary to press the "Pentode Analysis" button before taking readings.

Rectifier tubes of both the '80 and '81 types may also be tested in a manner similar to that for other tubes. The total secondary A.C. voltage from the power transformer may be measured by pressing the button marked "A.C. 800 Volts—Plate to Grid". The

voltage from one of the plates, of the '80, to the filament may be measured by pressing the button marked "A.C. Volts—Plate to Filament".

As in all other analyzers, provision is made to use both meters with any scale desired for external purposes.

A very useful arrangement is the use of the A.C. meter to read A.C. milliamperes. This is accomplished by removing the multipliers from the circuit of the A.C. meter (by means of a switch marked "A.C. MA Microfarads"); in this manner up to 200 A.C. milliamperes may be read.

The D.C. meter scale is directly calibrated in ohms, so that it may be used as an ohmmeter. It has two ranges, 0-10,000 and 0-100,000 ohms. A small 4.5-volt "C" battery, housed in the analyzer, provides the necessary voltage. Adjustments necessary, because of varying battery voltage, are accomplished by means of an adjustable resistor.

Capacity measurements may also be made directly, since the A.C. meter is calibrated in microfarads. There are two ranges possible, 0-1- and 0-10-mf. The readings, however, are only accurate when the instrument is connected to a 115-volt 60-cycle line.

A 4000-ohm constant impedance output meter is available in this analyzer. A dry rectifier used in a bridge circuit (see diagram of connections) allows the D.C. meter to be used on A.C., with a sensitivity of 1000 ohms per volt. Three ranges of voltage are available, 5-25 or 125 volts maximum. The 4000-ohm impedance is maintained constant on all ranges, a very desirable feature.

The appended diagram gives the detailed connections of the analyzer, together with the values of all the resistors used; this may be referred to for any details desired.

Hickok "Model SG-4700"

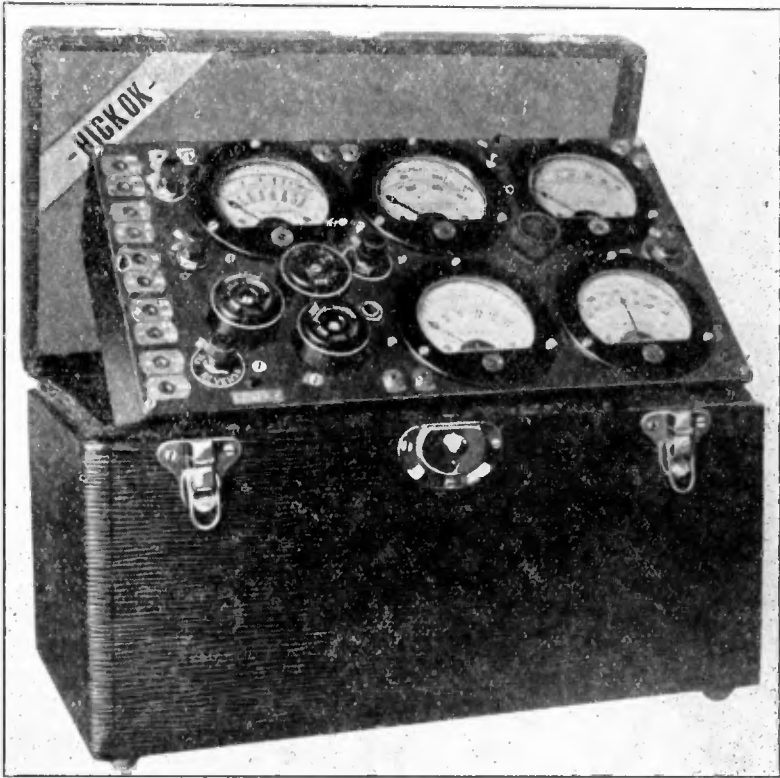

The Hickok "Model SG-4700" set tester is an example of an analyzer which uses a separate meter for each of the circuits entering a radio tube. This feature greatly simplifies the internal circuit; eliminates complicated switching arrangements; prevents the possibility of burning out the meters by operating them on an incorrect scale; and greatly speeds up the actual testing operations, since all the values to be found are indicated simultaneously. Furthermore, all multipliers and shunts are self-contained; obviating the necessity of auxiliary apparatus.

The D.C. voltmeters have a resistance of 1333 ohms per volt, using only 0.75-milliamperes for full-scale deflection. The plate voltmeter has two

scales; 0-300 and 0-600 volts; giving a meter resistance on the 300-volt scale of 400,000 ohms and on the 600-volt scale of 800,000 ohms.

The D.C. filament voltmeter has one range of 0-30 volts, and an internal resistance of 40,000 ohms. When testing a screen-grid tube, this same meter also reads the control-grid voltage.

The grid voltmeter is of the same type as the others, having two ranges with the zero mark in the center of the scale; these two are 30-0-30 and 150-0-150, with internal resistances of 80,000 and 400,000 ohms respectively.

The A.C. voltmeter in this analyzer, designed for the special requirements of radio testing, is of the dynamic type, having a practically uniform

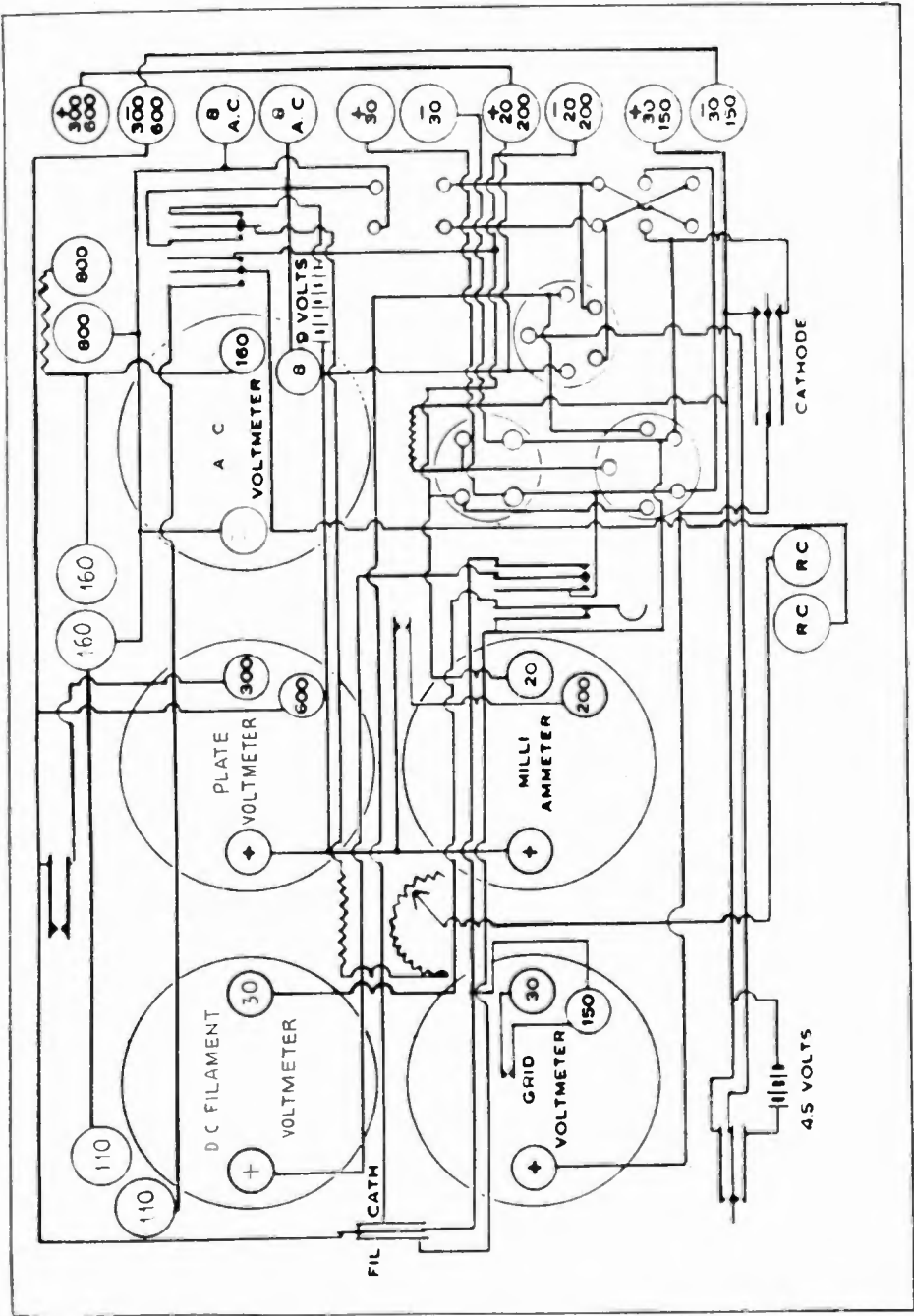

Schematic Circuit of the
Hickok "Model SG-4700"

scale. The low-range scale of 8 volts contains 80 graduations, by which all values from 1 to 8 volts may be read in 1/10-volt values. The next range, of 160 volts, gives accurate indications of line voltages. The high range, of 800 volts, enables the user to measure the voltages of the power transformer secondaries which supply the plates of rectifier tubes. Both the 160- and the 800-volt ranges are of high resistance; thus assuring accurate readings under all conditions.

The A.C. voltmeter is also calibrated to read directly in microfarads; enabling the measurement of capacities from 0.25 to 15 mf. directly. The regular 110-volt A.C. line is used as the source of power; connections to the tester being made by a set of leads, which are supplied as standard equipment. The value of all fixed condensers in a receiver under test can be found by making connections with insulated prods (which are also supplied as standard equipment) without removing the condensers from the receiver.

The plate milliammeter is equipped with scales of 20 and 200 milliamperes; which afford sufficient range to measure accurately the milliamperes consumed by individual tubes, as well as the entire plate current consumed by any receiver.

The plate milliammeter is also equipped with a direct-reading ohmmeter scale; operating as an ohmmeter from a self-contained battery of 4.5 volts. In conjunction with an adjustable rheostat, resistance values from 20 to 20,000 ohms may be read directly from the milliammeter scale.

The "SG-4700" Analyzer contains a 4.5-volt "C" battery, which is intro-

duced into the grid circuit of the tube under test by pressing a button. This definite change in the grid bias results in a definite change in the plate current, by which the mutual conductance is easily found (as explained in Chapter 3).

Pin jacks are provided, for each individual meter, to permit use of all meters as separate instruments. The insulated prods are equipped with a special plug, which is inserted in the pin jacks; making the operation of connecting to the meter desired, a matter of a few seconds. The "No. 4A" binding-post adapter (supplied as standard equipment) instantly changes the pin jacks to binding posts; thus giving the user his choice of either pin jacks or binding posts for connection to each meter.

The set-to-analyzer cable is not connected permanently to the tester. This connection is made by means of a special plug, which is inserted in the socket marked "Connector"; thus eliminating the cable from the tester when the meters are used individually. The 5-to-4 (UY to UX) prong adapter for insertion in the receiver is provided with a locking device.

The circuit diagram of the analyzer is appended; its obvious simplicity is due to the use of separate meters in each tube circuit. The circles with numbers in them represent the pin jacks, connections to which allow the use of external meters.

A filament-cathode switch is provided, to connect the heater to the cathode when desired. A filament-reversing switch is provided, in order to reverse the filament connections, since this is necessary in some types of battery-operated receivers.

Jewell "No. 444"

The Jewell "Pattern No. 444" Radio Set Analyzer has been designed for the analysis of the conditions in any radio set, whether operated from batteries or from an alternating-current line. It will take care of D.C. plate voltages up to 600 volts of all tubes used in commercial sets today, and of all standard types of D.C. or A.C. filament excitation.

The analyzer is provided with two instruments. That at the left is a combination A.C. voltmeter, ammeter and milliammeter equipped with scales to read 0-4-8-160-180 volts; 0-4-8 amperes; and 0-20-100 milliamperes. (The above numbers refer to full-scale readings; that is, there are eight scales on this instrument.) The right-hand instrument is a combination D.C. voltmeter, milliammeter, ohmmeter and Output Meter. This instrument is equipped with three scales—0-6-12-30—on the lower arc, and an ohmmeter scale graduated to read directly the low range of 0-1000 ohms, on the upper arc. Additional ohmmeter ranges are also available, from 0-10,000 and from 0-100,000 ohms.

The Output Indicator consists of a copper-oxide rectifier in conjunction with this D.C. meter. Three ranges of output volts are possible; 0-1, 0-10 and 0-50 volts. This output meter is fairly accurate over the entire audio-frequency band; except that the 0-50 range will approach 45 volts at the higher frequencies, because of decreasing reactance of the blocking condenser placed in series with this range. (See diagram of connections.)

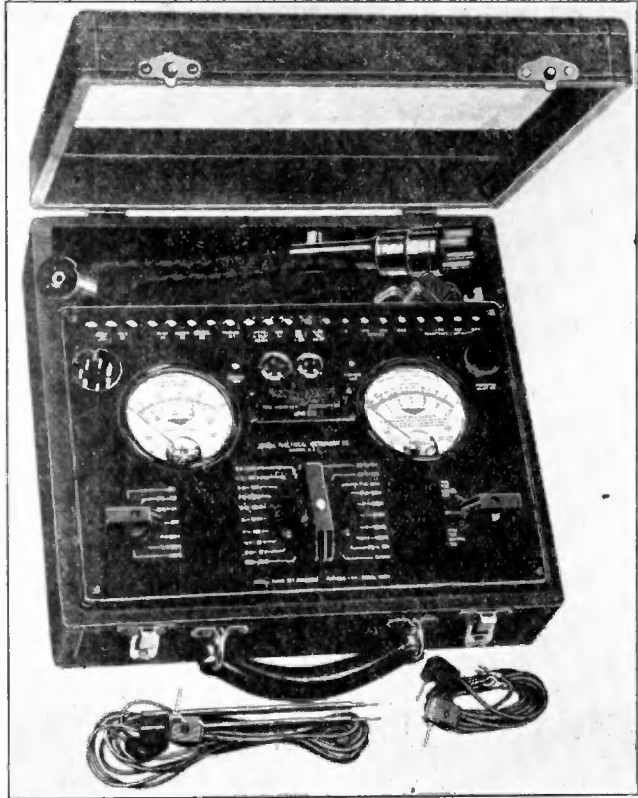

Seven ranges of D.C. voltages are available, namely; 6, 12, 30, 60, 120, 300 and 600 volts. Current readings of 12, 60 and 120 milliamperes may also be measured. Note that all of these ranges are even multiples of the scales marked on the instrument.

To facilitate the use of the analyzer, the various terminals of the UX and UY sockets have been designated by the letters K, G, P, H¹ and H; referring respectively to cathode, grid, plate and the two heater leads. The selector switch is engraved, showing the proper combinations of these letters. For taking voltmeter readings, the letters shown indicate the two terminals between which the voltmeter is connected. In the case of a current reading, a single letter is used; indicating the circuit

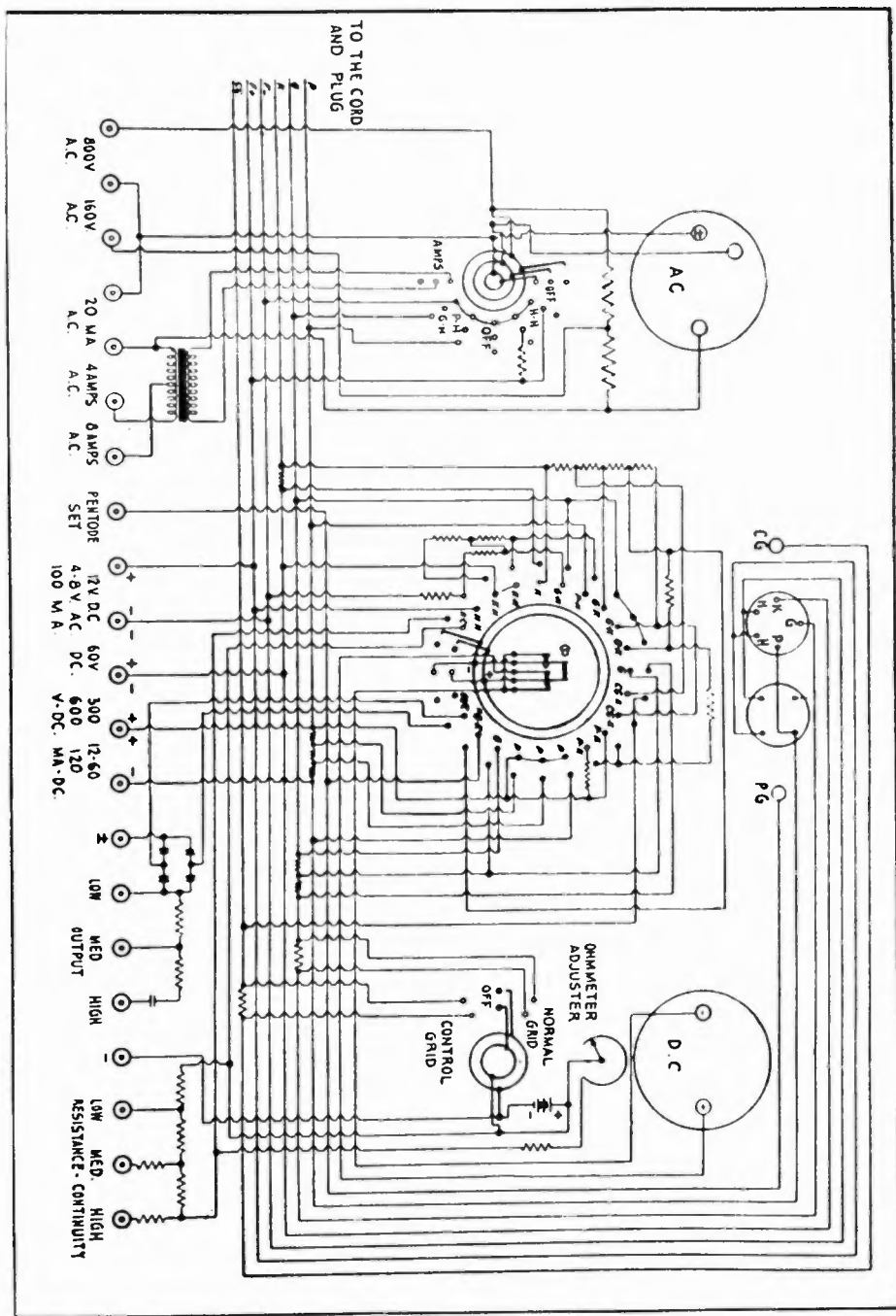

Schematic Circuit of the
Jewell "Pattern 444" Analyzer

in which the instrument is connected as a ammeter or milliammeter. To carry out this scheme, the control-grid terminal at the top of the tube is labeled CG, and the pentode-grid terminal (on the side of the base of an R.F. pentode) by the letters PG. When using these designations, it must be born in mind that these letters are symbols referring only to certain socket terminals, and not to the elements within the tube itself.

As in other analyzers, tube checking is performed by the use of a small "C" battery which is inserted in the grid circuit, by the manipulation of a switch, changing the plate current by a definite amount. The change in plate current is indicative of the condition of the tube.

The panel of the analyzer is supplied with UY and UX adapters, to accommodate all types of tubes now used in commercial radio receivers. The plug is a UY plug and, in order to insert it in a UX socket, a UY-to-UX adapter is used. The total current drain from an '81 rectifier tube may be measured by inserting the analyzer plug in the rectifier socket and turning the dial to "P-120 MA." If an '80 is being tested, the total current is the sum of the readings taken when the selector switch is in positions "P-120 MA" and "G-120 MA".

Two ranges of capacity measurements are available in this instrument. The low range covers, very well, values from .05 to 1.0 microfarad; and the

high range from .25 to 10 mf. This calibration is valid only when the line-voltage is approximately 110 volts at 60 cycles. If the voltage is higher or lower than the stated value, then the capacity indicated will be higher or lower by a corresponding amount. If the frequency is 50 cycles, instead of 60 cycles, then the reading will be only 5/6 of the actual value. The readings of the A.C. milliammeter are referred to a chart from which the capacity is obtained. These charts and the necessary instructions are supplied with the instrument.

This analyzer is equipped with two sets of test leads, each lead of which has pin tips on one end to fit the tip jacks on the analyzer panel. These pin tips are moulded into a special elbow handle, to facilitate the use of the tip jacks and to prevent unnecessary wear on the leads. One pair of test leads is supplied with long insulated test prods, for making measurements throughout the chassis of a radio set. The other pair is supplied with spade terminals, which can be used when more permanent connections are required.

A glance at the appended diagram will reveal the almost universal use of rotary switches, of both the two- and three-arm types. A very novel feature in the analyzer is the use of a tapped current transformer, instead of shunts on the A.C. meter, to facilitate changing the current scales on this instrument.

Readrite "Model 600"

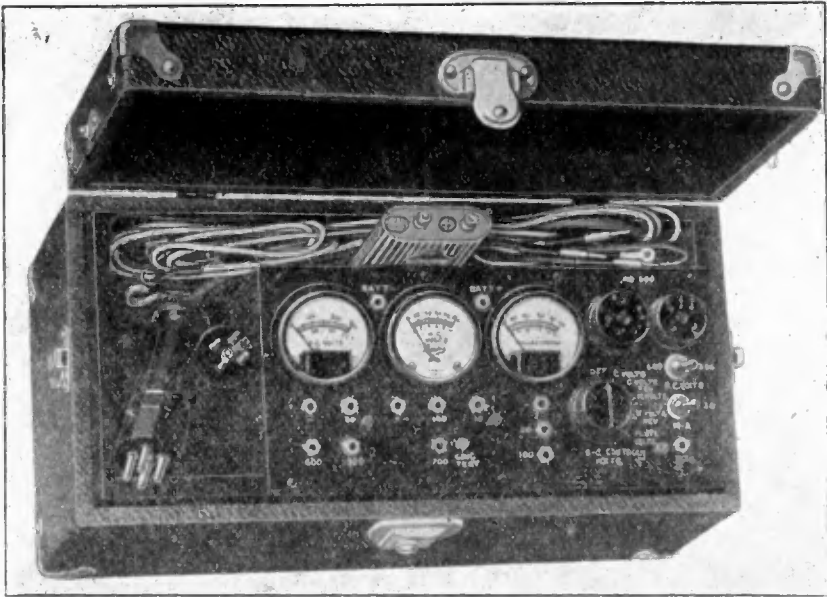

The Readrite "Model 600" and "Model 700" Radio Set Analyzers are identical electrically: the only difference between them being in the type of carrying case. The "No. 600" is housed in a large leatherette case, with sufficient room for tubes, tools and supplies. The test equipment and panel is located in a removable tray in the top of the case.

This instrument uses three meters: a D.C. voltmeter; a D.C. milliammeter; and an A.C. voltmeter. A selector switch is provided for checking all parts of the tube circuits, by connecting one of the three meters in the proper circuit.

Three ranges of D.C. voltages are available for plate or grid readings; 0-60, 0-300 and 0-600 volts.

Three ranges of A.C. voltages are available; 0-10, 0-140 and 0-700 volts.

Two ranges of direct-current readings are available; 0-20 and 0-100 milliamperes.

Measurement of tube constants is

performed by setting the selector switch to the proper position; and then flipping one of the toggle switches to obtain a better reading, if so desired.

A small 4.5-volt "C" battery is housed in the carrying case for grid-test and resistance measurement work. For grid tests (which really means tube tests) the grid-test push-button is pressed; this places the small "C" battery in series with the grid, making the grid more positive and increasing the plate current. The increase in plate current is indicative of the condition of the tube.

For testing screen-grid tubes, another button is pressed; this connects the control-grid directly to the cathode, changing the control-grid voltage which, in turn, changes the plate current. As before, the change in plate current is indicative of the condition of the tube.

Charts are furnished, showing how resistors up to 100,000 ohms may be measured. Capacities of the sizes or-

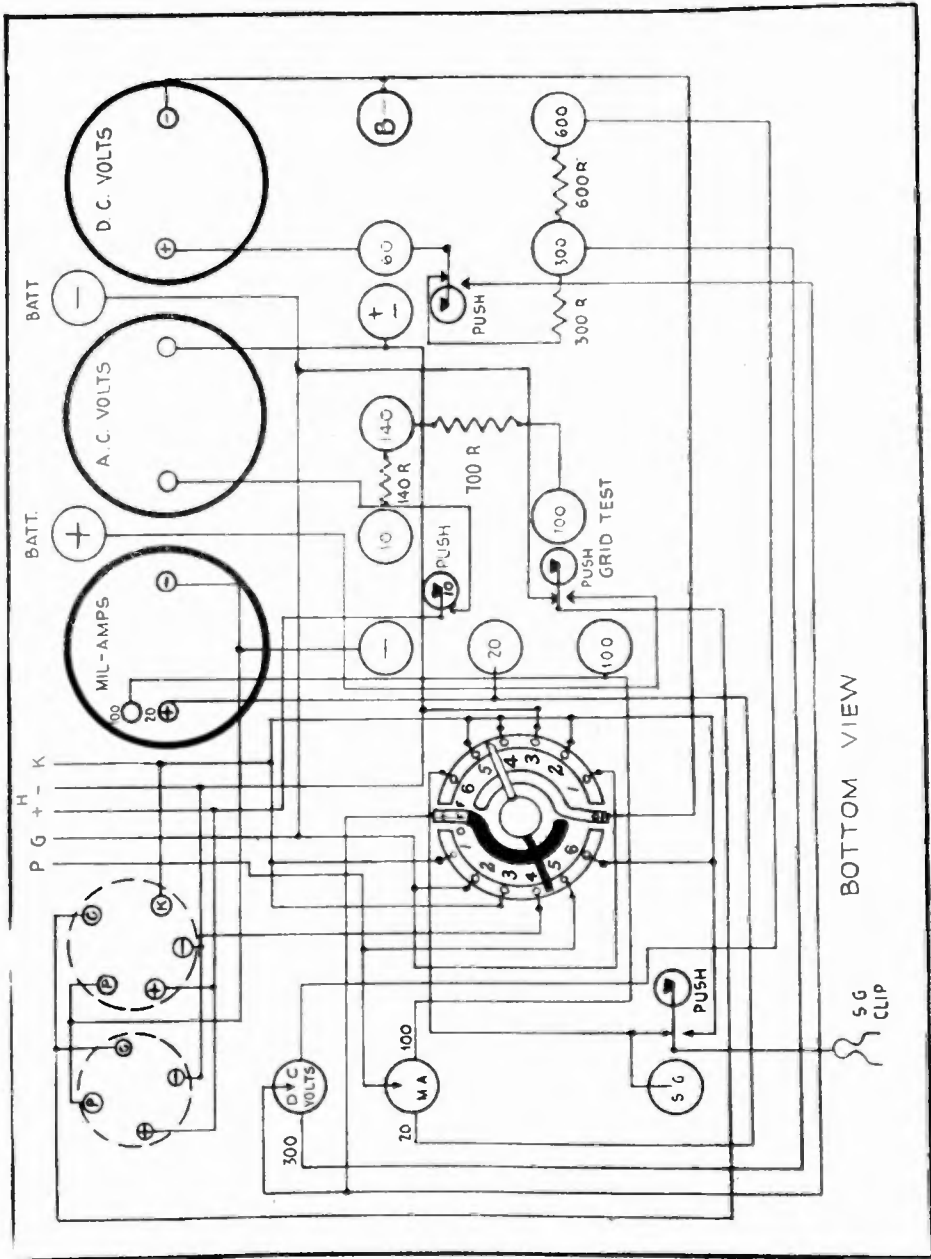

Schematic Circuit of the
Readrite "Model 600" and "Model 700"

dinarily found in radio receivers are also measurable with this instrument.

Pin jacks, clearly marked, are mounted on the panel for the use of the meters externally; a two-arm, 180-degree rotary switch is used for the selection of the proper circuit. Both five- and four-prong sockets are mounted on the panel, to obviate the necessity of having too many adapters.

The high-range A.C. voltmeter permits the measurement, not only of the line-voltage, but of power-transformer and rectifier-plate voltages.

Unlike many other analyzers, this model does not house the "C" battery used for testing in the analyzer com-

partment. This probably makes for ease in replacement and also results in a saving of room.

The D.C. voltmeter is of the low-resistance type, having a resistivity of 200 ohms per volt. While such a low-resistance meter will not give accurate readings of voltages, nevertheless the results are sufficiently indicative of the correct values for all practical work.

Care should be taken to remove the cable from the radio set when any of the meters are being used externally, when condensers or resistors are being measured, or when a continuity test is being made.

Sterling "R-517" Mutual Conductance Meter

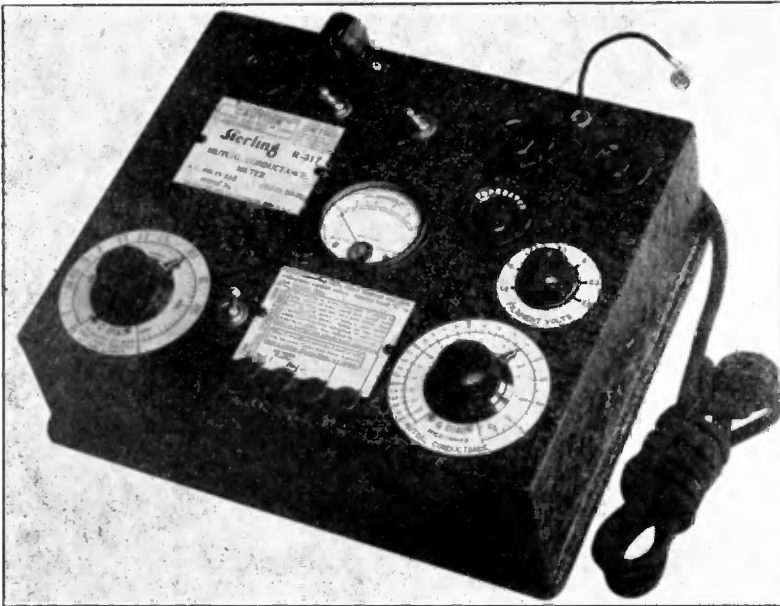

The Sterling "R-517" Mutual Conductance Meter is designed solely for the purpose of testing tubes; this means two things, an emission test and a mutual conductance test, as explained before. As we have said, if the mutual conductance is normal, when normal plate, filament and grid voltages are applied, then (for all practical purposes) the tube is good.

The direct measurement of mutual conductance is valuable in testing tubes with which the Service Man is not familiar. This is especially so at the present time, when many new tubes are being placed upon the market.

The "R-517" is designed to measure mutual conductance. It does this, not by applying a voltage in series with the grid and computing the mutual conductance, but by means of a bridge circuit built into the tester.

An examination of the appended circuit diagram and illustration reveals four sockets: one to be used only for testing rectifier tubes; one for preheating heater-cathode tubes about to be

tested; and the third and fourth for four- and five-prong tubes under test.

Filament voltage is adjusted by means of a rotary switch (at the right of the instrument) which is connected to a tapped transformer; each tap corresponds to a different filament voltage (see diagram of connections).

Plate voltage is adjusted by means of a toggle switch at the upper left of the instrument. For tubes requiring less than 250 volts on the plate, the switch is thrown to the left; for tubes requiring more than 250 volts, it is thrown to the right. As will be seen by the diagram, this switch merely changes the turns-ratio of the transformer used for supplying plate voltage.

To measure mutual conductance, all that need be done is to set the toggle switch to the proper side for plate voltage, and set the filament and "C" bias switches correctly. The milliammeter will then read.

Now, on pushing the button marked "G_m" (the one nearest the mutual-con-

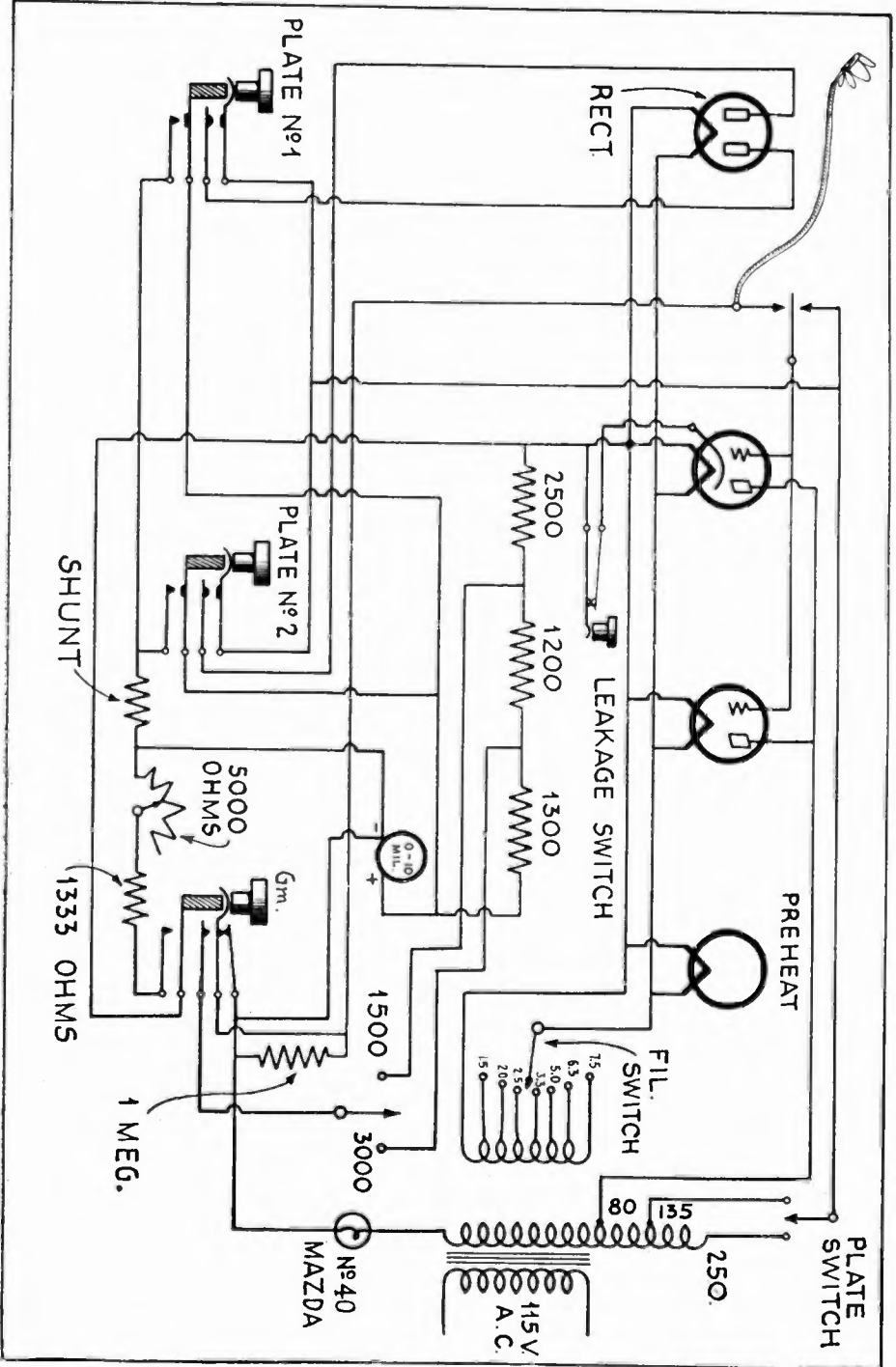

Sterling "R-517" Mutual Conductance Meter

ductance dial) the milliammeter reading will change. Adjust the "G" knob until the milliammeter reading does not change whether the button is up or down. The dial then indicates the Mutual Conductance directly.

Two ranges are available; one up to 1500 micromhos, and the second to 3000 micromhos. The values then can be directly compared with the manufacturer's chart.

When measuring the '47, '33 or PZ pentodes, it is necessary to use the special pentode adapter which is furnished with the instrument. This adapter is not necessary when measuring the '38 pentodes.

Leakage between the cathode and the heater of heater-type tubes (such as the '24) may also be measured. The test for leakage is made by pressing the second button from the right. This should cause the milliammeter pointer to return to zero. If the pointer does not return all the way to zero, leakage exists.

Rectifier tubes are to be tested only in the socket at the upper left of the instrument. No reading will occur until the buttons "No. 1" and "No. 2" are pressed; these control the two plates of the '80 tube separately. These buttons apply a fixed voltage to the plates of the tube and, at the same time, connect a shunt across the milliammeter.

The "C" dial should be turned to the extreme left, to give zero bias, when testing rectifier tubes.

The fuse in this instrument is a "Type 40" Mazda pilot lamp, rated at

6 volts, 0.15-amp. In testing amplifier tubes this bulb will not glow; but when testing rectifier tubes (because of the heavy current drawn) a glow will be seen. If both buttons controlling the plates of the '80 tube are pressed at the same time, the bulb will light brightly; however, this current will be within the capacity of the bulb and will do no harm.

In case of a short-circuit between elements, within the tube being tested, the bulb will blow very quickly; thus protecting the milliammeter and resistor with the tester. This type of tube can be obtained, for replacement, almost anywhere.

The milliammeter in the "R-517" tester has a range of 0-10 mills. However, because the meter integrates the average current over a complete cycle, and sine-wave current flows only during a half cycle, the actual peak current is 3.14 times the meter reading. For example, when testing a '45 tube, the milliammeter may read 8 mills. Then, $8 \times 3.14 = 25.1$ mills; which is the actual peak current flowing.

When measuring tubes, variations of 25% above or 20% below the rated values of mutual conductance may be expected; because tube manufacturers generally do not hold their product to closer limits.

This instrument is small, compact and of relatively light weight. The appended diagram of connections may be consulted for a more detailed analysis of the circuit used.

Supreme AAA1 Diagnometer

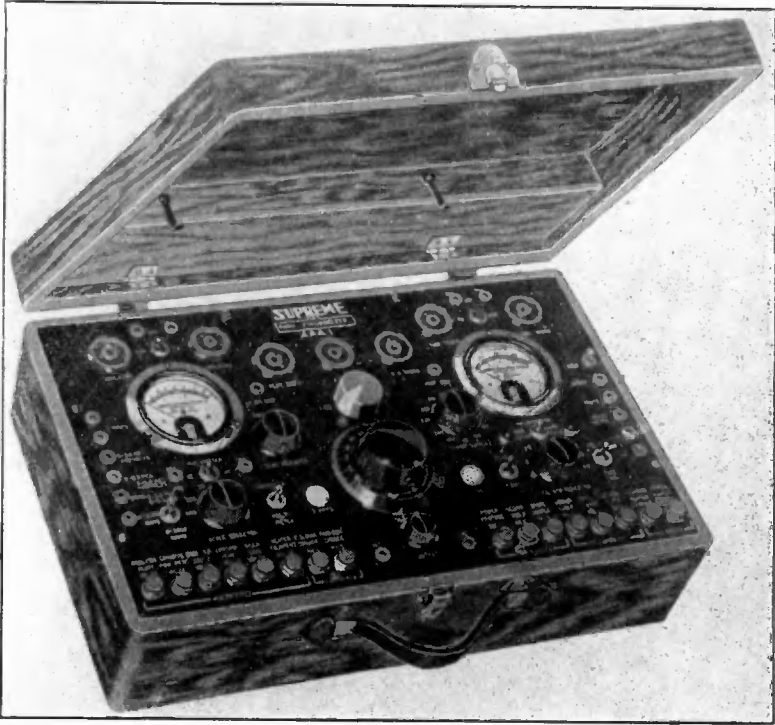

The "AAA1 Diagnometer" is an Analyzer incorporating in one instrument all the essentials required of a multiplicity of servicing instruments. The combination includes no less than five service instruments built as a single unit which can be used either as a portable radio laboratory or complete shop equipment; it may be carried in a case, or mounted on the wall, or back of a test bench, as a test panel. Special brackets, which, for wall mounting may be obtained with the "Diagnometer", accommodate the slip hinges and snap lock on the carrying case. In this manner the "AAA1" is instantly convertible from a portable laboratory to a complete test panel. The five major testing functions of this instrument are listed as follows:

- (1) Analyzer
- (2) Tube Tester
- (3) Shielded Oscillator
- (4) Ohmmeter—Megohmmeter
- (5) Capacity Tester.

The Analyzer circuits of the "AAA1 Diagnometer" comprise a universal A.C. and D.C. meter (of the copper-oxide rectifier type) with a tandem scale-selector switch, and a D.C. milliammeter which is always connected in the plate circuit. This arrangement provides plate-current readings of circuits and tubes under analysis without the manipulation of any current switches while testing the various potentials of other circuits terminating at the tube sockets.

The Analyzer's circuits are designed to meet all practical radio service re-

quirements on all types of radios and tubes, including the new power pentode, variable-mu, and two-volt radio tubes. Provisions are also made for testing the older types of battery operated radios, and the helium types of non-filament rectifier tubes. This instrument is adaptable also for an analytical A.C. voltage (1000 ohms per volt) test up to 1000 volts, on each side of center-tapped plate supply transformers, through the rectifier tube socket. Provision is also made for the reading of the A.C. line-voltage through the A.C. line-supply cord by means of a push-button; external connections being unnecessary for this purpose. The analyzer plug utilized with the "AAA1 Diagonometer" has a UY base; since most sockets in the newer types of radios are of the UY or 5-prong type. A 4-prong adapter is furnished as a part of the equipment for analysis on rectifiers and on the older type UX sockets.

For the radio-frequency pentode tubes a circuit is provided which terminates at the necessary terminal of the analyzer plug; so that this terminal may be connected to a suitable adapter for these tubes. Milliampere ranges of 0-2.5-10-25-100 and 250 mils. and 2.5 amperes are available for external use, for either A.C. or D.C. current; utilizing the copper oxide rectifier type meter and its associated scale selector switch. An external D.C. voltage range of 2500 volts is provided, in addition to the external A.C. and D.C. ranges of 0-2.5-10-25-100-250 and 1000 volts. The high-resistance (2500-ohm-per-volt) D.C. voltmeter ranges of 0-40 and 0-200 volts are also available, through external connections, for testing automotive and airplane installations. The two principal current- and potential-measuring scales of the meter are associated with the scale-selector switch; the first two points of which correspond to these two ranges of the meter. High ranges are obtained by rotating the scale selector through the high readings; the two major scales of the meter being multiplied by the values indicated by the scale selector. This meter is probably the most unique feature of the analyzer.

The "Multi-Meter" is not in any analytical or tube checker circuit until

a push button is depressed for the desired reading; thus affording a maximum of protection to the meter at all times. Tests have shown that this instrument will stand a 3000% voltage overload.

The tube-checker circuits of the "AAA1 Diagonometer" include five tube testing sockets; with the necessary switches for connecting to these the proper potentials for tube tests. A.C. power-supply potentials ranging from 100 to 240 volts may be utilized for these tests; a suitable switch being included for selecting the proper potential. A "filameter-heater" selector switch, with filament ratings from 1.5 to 7.5 volts provides for all tubes. The grid potentials of the tube-checker circuits are provided by the voltage drop across a biasing resistor; this arrangement permits what is commonly known as grid test or mutual conductance test. An oscillation test is also included, for matching tubes for the radio-frequency stages of radios. Another test is provided, for all types of amplifier tubes, indicating the gas content of the tube under test. An arrangement has been provided also for indicating the cathode-heater leakages of the cathode type of tube.

Another valuable feature of the "AAA1 Diagonometer" is the completely shielded and attenuated Oscillator, which is designed for tuning over a range of approximately 90 to 1500 kilocycles. The harmonic tuning principle is utilized in this instrument; and frequencies higher than 1500 kilocycles can be calibrated where desired.

The tuning multiples are obtained by operating the generating vacuum tube with a comparatively high negative grid-biasing potential obtained by the voltage drop resulting from the flow of grid current through a resistor in the grid circuit, the grid current being produced by the oscillatory impulses or potentials existing in the grid circuit. This has the effect of operating the tube on the "lower bend" of the grid-voltage plate-current characteristic curve of the tube; so that the resultant wave-form of the oscillator's output signal is composed of a fundamental frequency, which is determined by the setting of the tuning dial, and several multiples of the fundamental frequency.

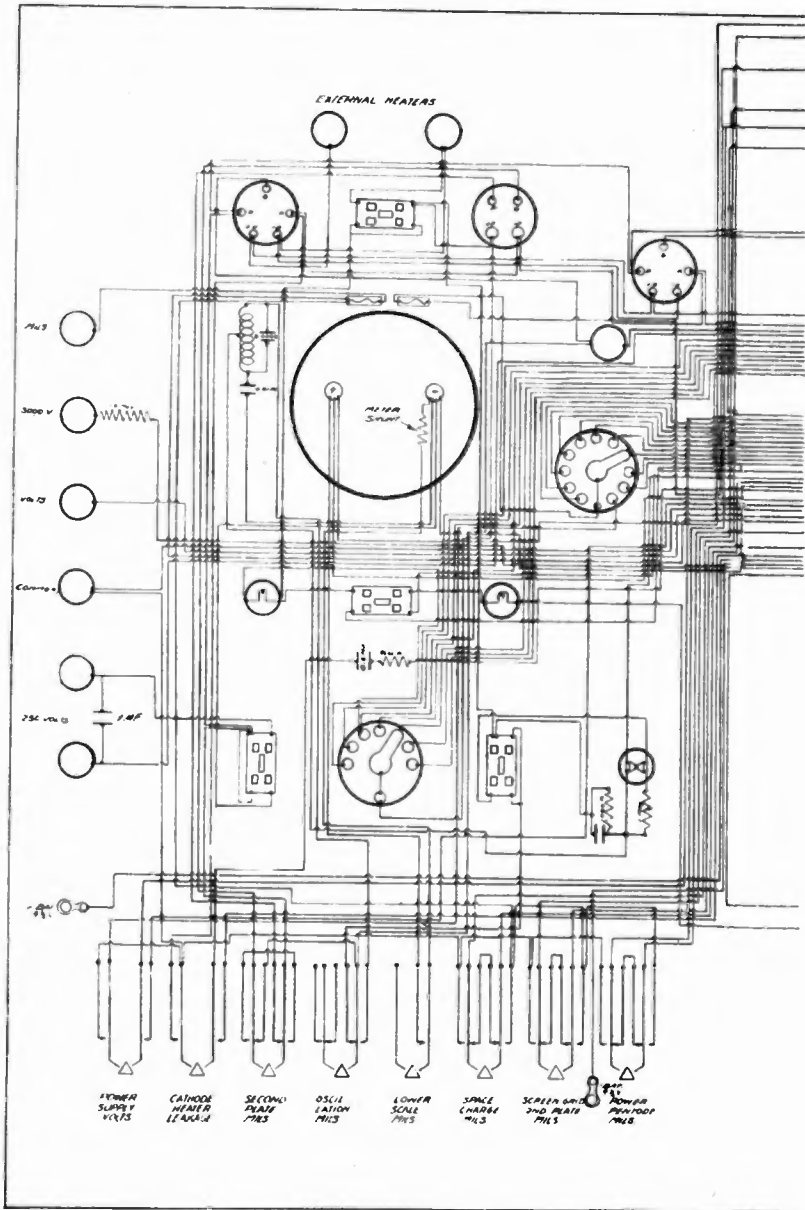

Schematic Circuit of the

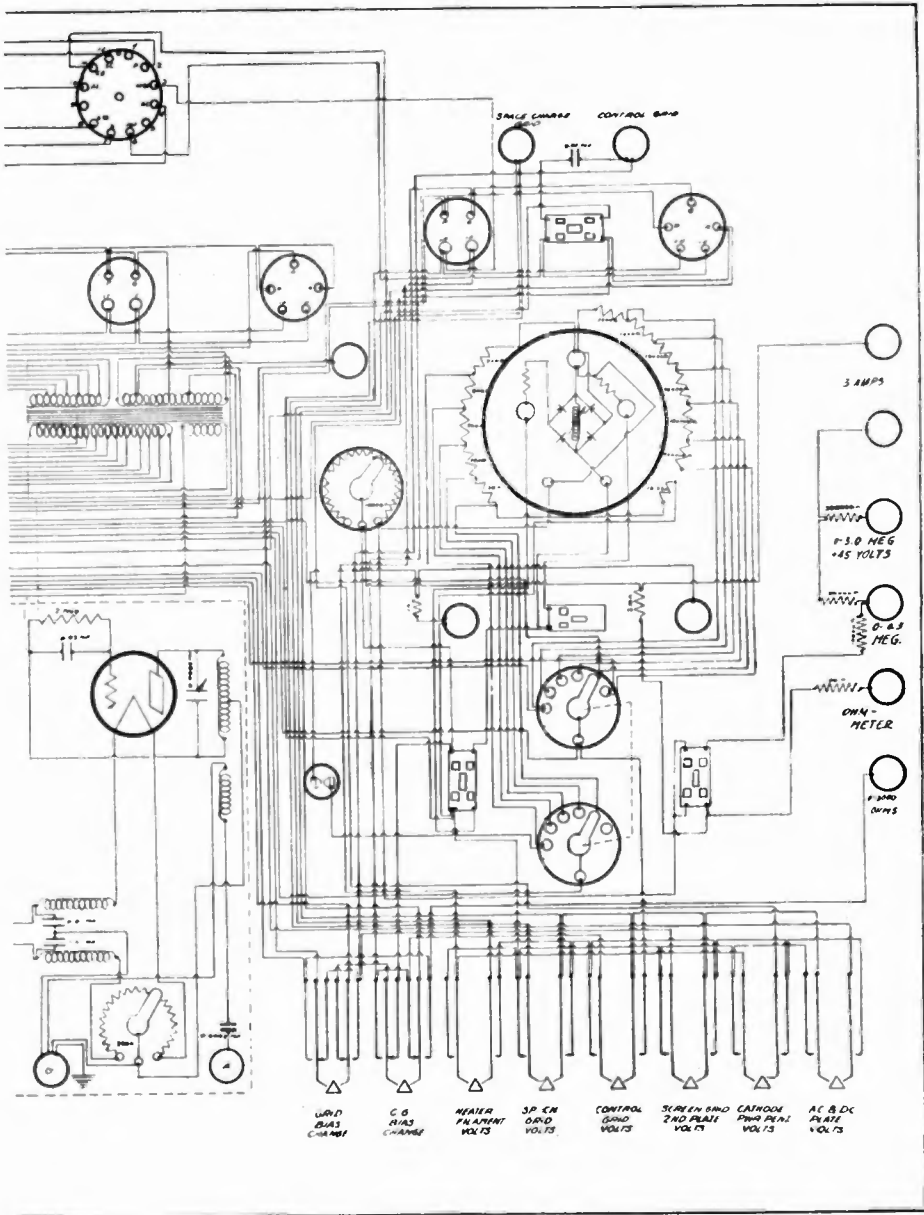

Supreme "AAA1" Diagnometer

The Oscillator is provided with a tapered output control, for controlling the strength of the radio-frequency signals applied through the "dummy antenna" to the radio. The Oscillator's output is so controlled that no leakage may be detected on the higher broadcast harmonics when the oscillator is directly connected to a very sensitive radio receiver. For broadcast adjustments, tuning of any required degree of sharpness is accomplished by choosing higher multiples of lower fundamental tuning frequencies, with proper settings of the output control.

A vernier tuning dial is used on the Oscillator, which enables the user to obtain very fine adjustments in service work. A type '31 tube is used as the oscillator tube. For output measurements the Multi-Meter, connected in series with a self-contained condenser, is used; providing a very wide range for output measurements.

The resistance-measuring ranges of the "Diagnometer" are indicated as the top scale of its Multi-Meter. External connections are provided for two

ranges, indicated as "low" and "high". The low range covers 0 to 5000 ohms; while the high range covers approximately 0 to 500,000 ohms. The self-contained 3-cell flashlight battery is utilized with these two ranges, and a zero corrector is provided for maximum accuracy. Provisions are made for utilizing an external 45-volt battery with the Ohmmeter circuit, to obtain an indicating range from 0 to approximately 5 megohms. Provisions are also made for obtaining a potential of 250 volts (direct current) which may be utilized for continuity testing up to 25 megohms.

The "Diagnometer" has provisions for applying 250 volts D.C. to paper condensers under test; leakage (up to approximately 4 megohms) can be indicated very satisfactorily by this test. In addition to this leakage test of condensers, provisions are made for indicating the capacities of condensers, from approximately .002- up to 10-mf. Charts, included with the instructions, are carried in the top of the Diagnometer, for determining the capacities of condensers.

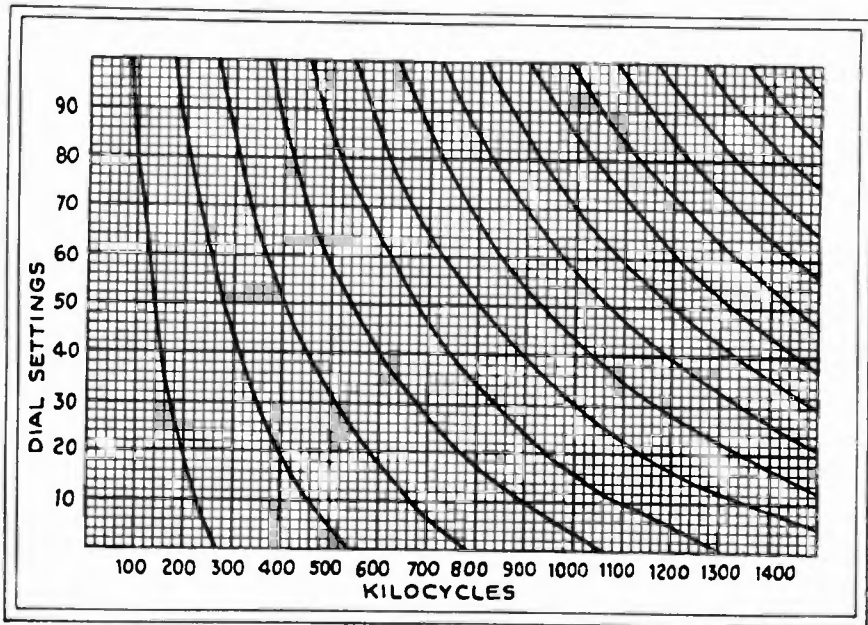

The curve at the very left is the fundamental frequency of the oscillator; its 15 harmonics, in their order, cover the whole range of servicing. The difference between two oscillator settings immediately indicates the position of one frequency adjustment, with relation to the other.

Weston "Model 566" Set Analyzer

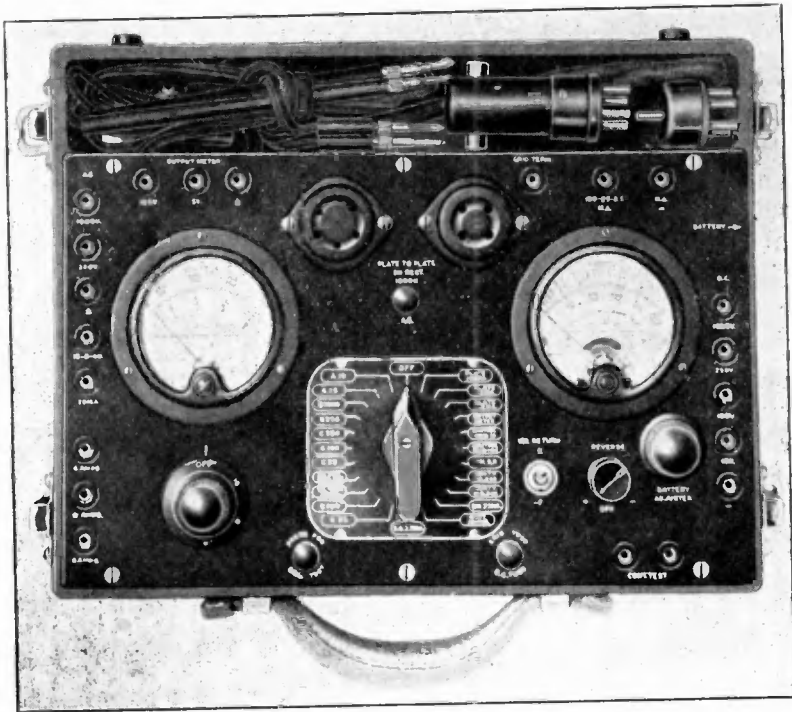

The Weston "Model 566" Radio Set Analyzer is an example of an instrument which relies almost entirely upon a single selector-switch for its operation. This, it has been conceded by many, is a decided advantage over the push-button types. A glance at the appended illustration reveals the simplicity of operation obtained by this type of switching.

Directly under the A.C. meter (seen at the extreme left) is a 3-point dial to change the multiplier scale for low voltage A.C. filament readings. These three scales are convenient, especially in view of the low-voltage tubes now available. Directly to the right, and a little below this rotary switch, is a "Grid-Test" push-button; pressing this changes the bias by 4.5 volts. The resultant plate-current change is an indication of the condition of the tube.

Directly to the right of this button is a "S.G. Tube-Grid Test" push-button; pressing the latter connects the control grid to the cathode; which also changes the plate current, indicating the condition of screen-grid tubes.

Directly above this button is a toggle switch marked "VM Return: K-F"; this is provided for the purpose of changing the voltmeter return from cathode to filament. It is set in the "K" (cathode) position for all tubes except pentodes; in which case it is flipped to the "F" position. At the right of this toggle switch is a reversing switch for the D.C. meter, which is sometimes very handy.

The scale of the D.C. meter is also calibrated in ohms for use as an ohmmeter. This analyzer offers two ranges, one from 0-10,000 ohms, and another from 0-100,000 ohms. A study of the

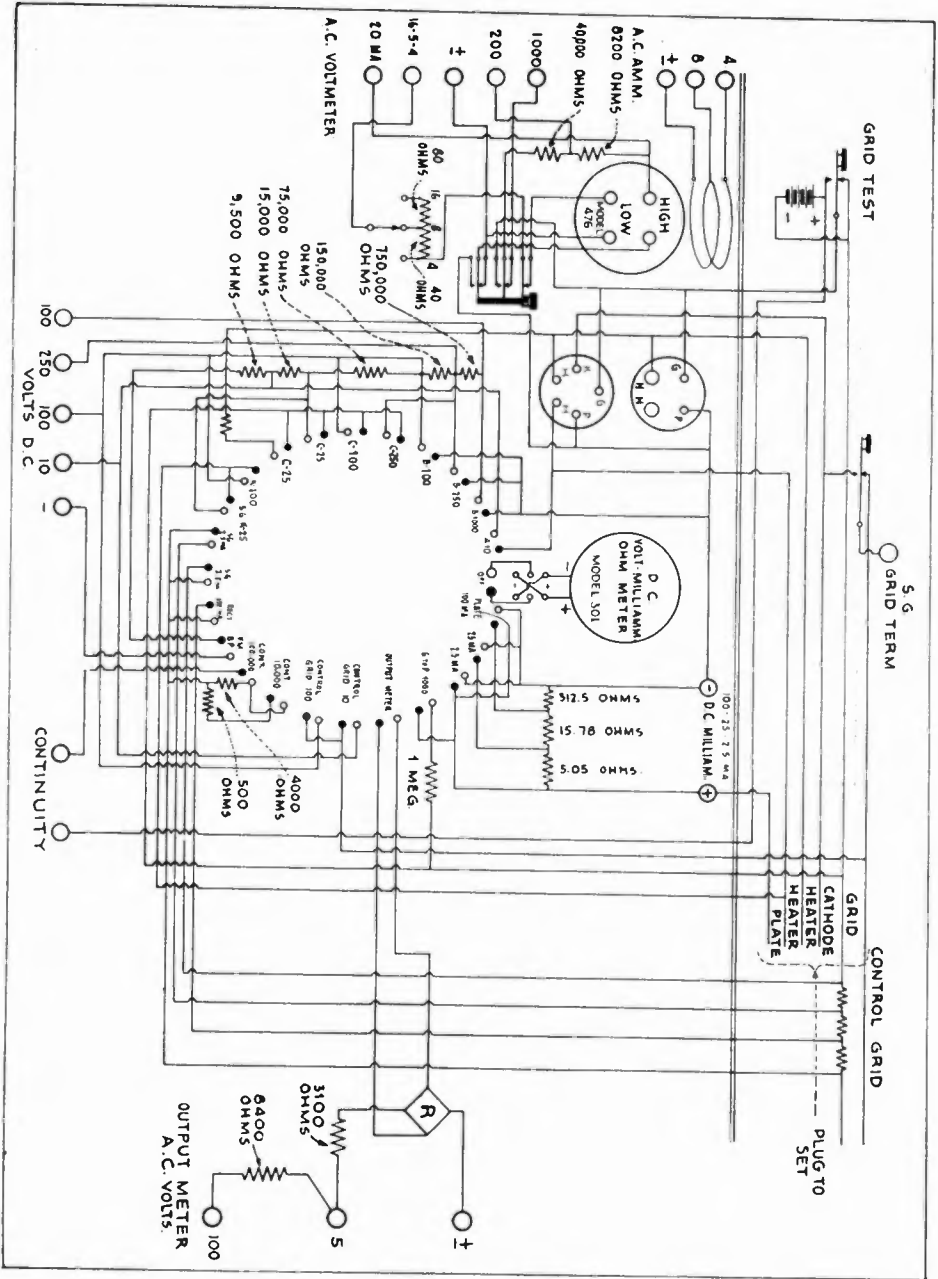

Schematic Circuit of the
Weston "Model 566"
 Set Analyzer

diagram of connections shows that the 4.5-volt grid-test battery is used in this circuit. Provision is also made to adjust the reading of the ohmmeter, to compensate for battery voltage changes.

The D.C. meter may also be used as an output meter. By referring to the diagram of connections, it can be seen that a dry-rectifier bridge circuit is used to rectify the A.C. to be measured. Two scales are provided; one 0-5 volts, and the second 0-100 volts.

Of course, either the A.C. or the D.C. meter may be used externally; each with its selection of voltage and current ranges.

As may be seen from both the diagram and the picture, the D.C. meter may be used independently with the following scales:

Voltage, four ranges—10-100-250-1000 Volts;

Current, three ranges—2.5-25-100 Milliampères.

Provision is also made so that, by additional shunts which may be purchased, current measurements up to 10 amperes may be obtained.

The A.C. meter may also be used externally. Here again a variety of ranges is offered, as follows:

Voltage, five ranges—4-8-16-200-1000 Volts;

Current, four ranges—20 ma.—100 ma.—4 Amps.—8 Amps.

The A.C. milliamperé scales should be particularly valuable for work on the measurement of distortion.

For capacity measurements, a number of ranges are available. The D.C. meter is used in conjunction with the dry rectifier.

For capacities from .001- to .05-microfarad, the large selector switch is turned to "Output Meter B.P." (see diagram). One lead of a line-voltage

test cord is connected to the "+" binding post of the Output Meter's terminals. A connection is made to the 100-volt terminal of the Output Meter. The condenser to be measured is connected between the other end of the A.C. line and the 100-volt post. Readings are then taken on the 100 scale of the D.C. Volt-Milliammeter. A chart which is provided gives the capacity for any scale reading.

For capacities from .05- to 0.5-mf., one lead from the A.C. line cord is connected to the 200-volt binding post at the left of the A.C. meter, and another connection is made to the binding post directly under this. This condenser to be measured is then connected between this lead and the remaining lead of the A.C. line. In this scale the A.C. meter is calibrated for capacity.

For capacities between 0.5 and 2 mf., the procedure is the same as above; except that the 16-8-4-volt scale is used instead of the 200-volt scale.

All of the above calibrations apply when the line voltage is 115 volts at 60 cycles.

For filter condensers up to 6 microfarads, external resistors are used. A diagram of connections and a calibration curve is supplied for the purpose.

Another handy feature is an inductance calibration chart. The inductance to be measured is connected in series with the A.C. line, (115 volts 60 cycles), and the 200-volt range on the A.C. meter. The chart giving the inductance for various scale readings.

This analyzer can be used for cathode-heater voltage and leakage tests, space-charge currents; voltages and currents in rectifier circuits. All types of screen-grid and pentode tubes may also be analyzed.

Vacuum Tube Characteristics

Since the results obtained from the use of an analyzer are to be interpreted in the light of the characteristics of the tubes used in the receiver under test, it is appropriate at this point to introduce for reference the standard (average) values found in the tubes generally employed. The table on the following page shows these at a glance.

Most electric receivers employ the 280-type rectifier tube, or its equivalent. This, with an A.C. voltage on each plate of 350 R.M.S. (root-mean-square) delivers a maximum direct-current output of 125 milliamperes; for 400 volts on each plate, 110 ma.; for 550 volts, a maximum of 135 ma. It draws 2 amperes at 5 volts on the filament.

With the 210 and 250 power tubes, the 281 rectifier is employed; and with 700 volts on its single plate, it gives a D.C. output of 85 ma. maximum. Its filament requires 1.25 amperes at 7½ volts.

In addition to this, certain models of sets incorporate the UX-874 tube, intended to regulate the voltage applied to certain tubes; this maintains a voltage of 90 across its terminals, with a starting voltage of 125.

While the tubes listed in the table provide for the great majority of receiver requirements, there are nevertheless well-known commercial receivers using tubes with special filament voltages. For the benefit of the Service Man who may encounter them, therefore, the following data are given.

In addition to these figures, the Service Man should provide himself, so far as possible, with the more elaborate data books and literature issued by tube manufacturers, giving characteristic curves, and detailed information as to the response of tubes. At the present time, many tubes are used in receiver

circuits under voltages which do not conform to the standard amplifier values given here.

The 551 Variable-Mu Tube

This tube, which is found in recent receivers, differs from the 235 variable-mu listed in the table, in several particulars. Its characteristics are:

Plate voltage, maximum, 250; plate current, maximum, 6.5 ma.; plate resistance, 400,000 ohms; control-grid bias, minimum, 3 volts; screen-grid voltage, 90; amplification factor, theoretical, 440; mutual conductance, 1100. Like the 224 and the 235, it draws 1.75 amperes with 2.5 volts on the heater-filament.

Arcturus 15-Volt Tubes

Type	22	26-28	30	32	40	48
Plate Voltage (max.)	135	90	180	135	180	90
Plate Current (ma.)	2.0	7.5	22	1.5	21	4.5
Plate Resistance (thousands of ohms)	475	9	3.5	32	2	9.2
Grid Bias (volts)	1.5	1.5	27	3	40.5	4.5
Amplification Factor (mu)	300	10.5	3.8	30	3	11
Mutual Conductance (Gm) or Transconductance (micro-mhos)	630	1165	1085	940	1500	1185

The filament consumption is 350 ma., except for the 40 type, which takes 400 ma.

The 26 is a detector, the 28 an amplifier. The 22 is a screen-grid tube, using 45 volts on the screen-grid, with 135 on the plate.

The Arcturus 15-volt tubes have but four terminals in the base; the cathode being connected to one side of the filament.

The Sonora RA-1 and SO-1 are equivalent, respectively, to the Arcturus 48 and 40.

Kellogg 2½-Volt A.C. Tubes

Type	K-24	K-27
Plate Voltage	180	90
Plate Current (minimum)	2.0	—
Plate Resistance (ohms)	400,000 to 1,000,000	—
Grid Bias (volts)	1.5	4.5
Amplification Factor	—	8 to 10
Mutual Conductance	800 to 1600	800 to 1200

These tubes draw 1.75 amperes at 2.5 volts across their filaments. The K-24 takes 75 volts on its screen grid.

Characteristics of Standard Vacuum Tubes

DETECTORS AND AMPLIFIERS

TYPE	RATING			PLATE SUPPLY VOLTS	SCREEN MAX. VOLTS	NEGATIVE GRID BIAS VOLTS		SCREEN VOLTS	PLATE CURRENT MILLI-AMP.	A C PLATE RESISTANCE OHMS	MUTUAL CONDUCTANCE MICRO-MHOS	VOLTAGE AMPLIFICATION FACTOR	OHMS LOAD FOR STATED POWER OUTPUT	POWER OUTPUT MILLI-WATTS
	FILAMENT (OR HEATER)					O C ON FIL.	A C ON FIL.							
	VOLTS	AMPERES	SUPPLY											
WD-11	1 1	0 25	D C	135	90	4 5	---	---	2 5	15500	425	6 6	15500	7
					135	10 5	---	---	3 0	15000	440	6 6	18000	35
WX-12	1 1	0 25	D C	135	90	4 5	---	---	2 5	15500	425	6 6	15500	7
					135	10 5	---	---	3 0	15000	440	6 6	18000	35
UX-112-A	5 0	0 25	D C	180	90	4 5	---	---	5 2	5600	1500	8 5	5600	30
					135	9 0	---	---	6 2	5300	1600	8 5	8700	115
UV-199	3 3	0 063	D C	90	90	4 5	---	---	2 5	15500	425	6 6	15500	7
UX-199	3 3	0 06	D C	90	90	4 5	---	---	2 5	15500	425	6 6	15500	7
UX-200-A	5 0	0 25	D C	45	45	Grid Return to (-) Filament	---	---	1 5	30000	666	20	---	---
					90	4 5	---	---	2 5	11000	725	8 0	11000	15
UX-201-A	5 0	0 25	D C	135	135	0 0	---	---	3 0	10000	800	8 0	20000	55
					135	1 5	---	45	1 5	850000	350	300	---	---
UX-222	3 3	0 132	D C	135	135	1 5	---	67 5	3 3	600000	480	290	---	---
UX-222	3 3	0 132	D C	135	180†	1 5	---	22 5	0 3	2000000	175	350	---	---
UY-224	2 5	1 75	A C or D C	275	180	1 5	1 5	75	4 0	400000	1050	420	---	---
					180	3 0	3 0	90	4 0	400000	1000	400	---	---
					250	3 0	3 0	90	4 0	600000	1025	615	---	---
UY-224	2 5	1 75	A C or D C	275	275†	5	5	20 to 45 approx. approx.	Plate Current to be adjusted to 0.1 ma. with no Input Signal					
UY-224	2 5	1 75	A C or D C	275	250*	1 0	1 0	25	0 5	2000000	500	1000	---	---
UX-226	1 5	1 05	A C or D C	180	90	5 0	6 0	---	3 8	8600	955	8 2	9800	39
					135	8 0	9 0	---	6 3	7200	1135	8 2	8800	80
					180	12 5	15 5	---	7 4	7000	1170	8 2	10500	180
UY-227	2 5	1 75	A C or D C	275	90	6 0	6 0	---	2 7	11000	820	9 0	14000	30
					135	9 0	9 0	---	4 5	9000	1000	9 0	13000	80
					180	13 5	14 5	---	5 0	9000	1000	9 0	18700	165
					250	21 0	21 0	---	5 2	9250	975	9 0	34000	300
UY-227	2 5	1 75	A C or D C	275	275	50 0 approx.	50 0 approx.	---	Plate Current to be adjusted to 0.2 ma. with no Input Signal					
RCA-230	2 0	0 06	D C	90	90	4 5	---	---	1 8	13000	700	9 3	15000	16
RCA-232	2 0	0 06	D C*	150	155	3 0	---	67 5	1 4	1150000	505	580	---	---
RCA-232	2 0	0 06	D C	150	174*	6 approx.	---	67 5	Plate Current to be adjusted to 0.2 ma. with no Input Signal					
RCA-232	2 0	0 06	D C	150	180*	1 0	---	22 5	0 25	---	---	---	---	---
RCA-235	2 5	1 75	A C or D C	275	180	1 5	1 5	75	5 8	350000	1100	385	---	---
					250	3 0	3 0	90	6 5	350000	1050	370	---	---
RCA-236	6 3	0 3	D C	135	90	1 5	---	---	1 8	700000	850	170	---	---
					135	1 5	---	---	67 5	300000	1050	315	---	---
RCA-237	6 3	0 3	D C	135	90	6 0	---	---	2 6	11500	780	9 0	17500	30
					135	9 0	---	---	4 3	10000	900	9 0	14000	80
UX-240	5 0	0 25	D C	180	135	1 5	---	---	0 2	150000	200	30	---	---
					180†	3 0	---	---	0 2	150000	200	30	---	---

POWER AMPLIFIERS

UX-112-A	5 0	0 25	A C or D C	180	135	9 0	11 5	---	6 2	5300	1600	8 5	8700	115
					180	13 5	16 0	---	7 6	5000	1700	8 5	10800	260
UX-120	3 3	0 132	D C	135	90	16 5	---	---	3 0	8000	415	3 3	9600	45
					135	27 5	---	---	6 5	6300	525	3 3	6500	110
UX-171-A	5 0	0 25	A C or D C	180	90	16 5	19 0	---	12 0	2750	1330	3 0	3200	125
					135	27 0	29 5	---	17 5	1960	1520	3 0	3500	370
					180	40 5	43 0	---	20 0	1850	1620	3 0	5350	700
UX-210	7 5	1 25	A C or D C	425	250	18 0	22 0	---	10 0	6000	1330	8 0	13000	400
					250	37 0	31 0	---	16 0	5150	1550	8 0	11000	900
					425	45 0	39 0	---	18 0	5000	1600	8 0	10200	1600
RCA-231	2 0	0 130	D C	135	135	22 5	---	---	6 8	4950	760	3 8	9000	150
RCA-233	2 0	0 26	D C	135	135	13 5	---	135†	14 0	50000	1500	75	7000	700
RCA-238	6 3	0 5	D C	135	135	13 5	---	135††	9 0	102000	975	100	13500	525
UX-245	2 5	1 5	A C or D C	275	180	33 0	36 5	---	27 0	1900	1850	3 5	3500	780
					250	48 5	50 0	---	34 0	1750	2000	3 5	3900	1600
					275	54 5	56 0	---	36 0	1670	2100	3 5	4600	2000
RCA-247	2 5	1 75	A C or D C	250	250	15 0	16 5	250†††	32 0	35000	2500	90	7000	2500
					250	41 0	45 0	---	28 0	2100	1800	3 8	4300	1000
					250	59 0	63 0	---	45 0	1900	2000	3 8	4100	2400
UX-250	2 5	1 25	A C or D C	450	400	66 0	70 0	---	55 0	1800	2100	3 8	3670	3400
					450	80 0	84 0	---	55 0	1800	2100	3 8	4350	4600

Milliamperes. ††Screen Current 2.5 Milliamperes. †††Screen Current 7.5 Milliamperes.



THE BIGGEST THING IN RADIO SINCE '28

Supreme Diagnometer AAA1

THAT'S what leading service-men, technicians and dealers are saying of the new SUPREME DIAGNOMETER AAA1—"the Biggest Thing in Radio Service Since '28." Not since that season, which introduced the first DIAGNOMETER, has the service world welcomed such a revolutionary and versatile testing instrument. The BIG 5 of service—SUPER-DIAGNOMETER, OSCILLATOR, TUBE TESTER, OHM-MEGOHMMETER, CAPACITOR TESTER,—combined and condensed into one smaller, handier case!

No matter how much you have heard of the wonders of this "Supreme" product, you will be amazed at an actual demonstration. The instrument that the radio world wanted and waited for SUPREME to sponsor. You must see it—compare it—Ask your jobber to demonstrate, or write us for full data and name of local jobber. Soon pays for itself in savings of time and labor and increased profits.

Supreme Instruments Corporation
 117 SUPREME BLDG., GREENWOOD, MISS.
 Distributors in all Principal Cities.
 Foreign Division: 130 West 42nd St., New York City
 Cable Address: LOPREH, New York

- Super Diagnometer
plus
Shielded Oscillator
plus
Advanced Tube Tester
plus
Ohm-Megohmmeter
plus
Capacitor Tester

Dealers' Net Price
 F.O.B. Greenwood, Miss.

\$147.50

Radio Service Man Increases Salary 100%

AFTER 15 YEARS RADIO WORK LANDS JOB AS MANAGER SERVICE DEPARTMENT, PARKS & HULL, Baltimore Distributors

"TRAINING NECESSARY FOR REAL SUCCESS"

"I spent 15 years building and repairing Radios, but felt that I could refresh my memory on some of the technicalities and learn about the developments which I had overlooked," states J. E. McLaurine, 1031 Cathedral Street, Baltimore, Md. "After studying what each school advertising Radio training offered, I finally decided that the National Radio Institute had the most complete course. After starting, I discovered that there were many fundamentals of Radio that I did not even know and beginning with the first lesson, found the entire course very interesting and instructive. When, upon completion, I was appointed Manager of the Service Department of Parks & Hull, I was immediately repaid for the cost and time spent in study. I give the N.R.I. full credit for my success in the Radio field—it immediately increased my earnings 100% and placed me in a position of responsibility. The majority of Radio service men have much to learn. Radio is a growing field, but the man who will succeed in this profession must be technically trained and I know of no school where he can secure better training than the National Radio Institute."



J. E. McLaurine at work in his laboratory

SPECIALIZED TRAINING NOW AVAILABLE

New developments and uses for Radio and Radio principles have opened up wonderful opportunities for "practical Radio men". Fellow who are interested in getting a bigger and better job—who want to fill in the gaps of their present knowledge—who want to be up to the minute on modern engineering practices and the new designs of manufacturers, are using the National Radio Institute's method of organized study

for increased profits and earnings. Separate and distinct Advanced Courses enable students to SPECIALIZE in any one of these five fields—Sound Pictures and Public Address Systems; Advanced Radio Servicing and Merchandising; Broadcasting, Commercial and Ship Radio Stations; Aircraft Radio; Television. Training like this increases the value of N.R.I. training to the man who already has had Radio experience.

EXPERIENCED MEN PRAISE COURSE

"When I enrolled, I had already been working in Radio for a number of years. From the first lesson to the last, I found that there were hundreds of things about Radio a person could never find out by experimenting."—R. I. McDONALD, 732 5th Ave., Antigo, Wis.

"I have been in the Radio game for nine years and built the first Radio set I ever saw back in 1920. I learned more from the N.R.I. Course than in all the years I worked in Radio before taking it."—ALVA B. MANSUR, R.F.D. No. 1, Hardin, Mo.

"I had been tinkering with Radio for a couple of years before I started your Course, but I didn't know what it was all about. Thanks to the N.R.I., I soon began to see the whys and wherefores of certain things that I was unable to understand before."—LEON J. HALL, 2992 McKoon Ave., Niagara Falls, N. Y.

"Although I held the best Radio service position in this city at the time I started the N.R.I. Course, I greatly benefited from this training and can highly recommend it to anyone interested in any branch of Radio."—CHARLES W. BELT, 40 S. 22nd Street, Newark, Ohio.

Write or use this Coupon for Full Information

A free copy of "Rich Rewards in Radio", a 61-page book giving outlines of N.R.I. Courses will be mailed without obligation to anyone interested in pushing ahead in Radio. This book has an important message for every man now in Radio who wants to learn to earn more money, as well as for the fellow who wants to break in. Write or mail this coupon for a copy.

J. E. Smith, President,
National Radio Institute,
Dept. 1MJS, Washington, D. C.

Send me your free book. I understand this does not obligate me and that no salesman will call.

Name
Address
City State

DAYRAD SET ANALYZERS

Complete «» Compact «» Accurate

This Type 880 DayraD Set Analyzer is up-to-date because it provides:

1. **Complete Set Analysis**

Screen grid, Pentode, Volts to Ground, Power Transformer, Secondary A.C. Voltages, in addition to all usual features.

2. **Direct Reading Ohmmeter**

3. **Direct Reading Capacity Meter**

4. All Meter Ranges Available for external use.

5. **Constant Impedance Output Meter**

The meters are 3 inch flush flange type with clear, distinct scales (Weston, Jewell, etc.)

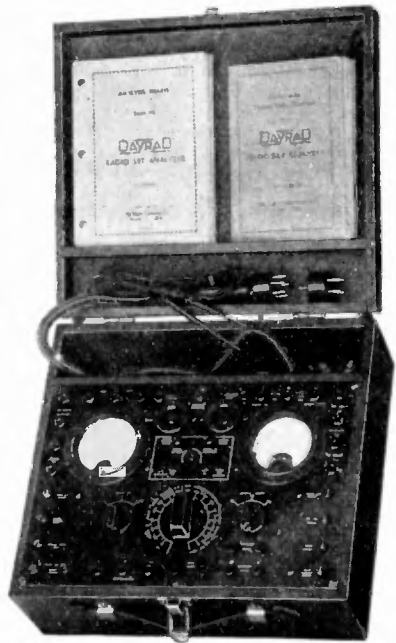

❖ Net Price to Service Men **\$84.00** ❖

Send for Catalog 31-B which describes the DayraD Tube Testers, Set Analyzers, Oscillators, and Test Panels designed by engineers specializing in Service Problems.

THE RADIO PRODUCTS COMPANY

DEPT. P.

5th & NORWOOD

DAYTON, OHIO

Train *with* R.T.A. *for* Radio Service Work

Important and far-reaching developments in Radio create sudden demand for specially equipped and specially trained Radio Service Men.



*This excellent
set analyzer
and trouble
shooter included
with our course
of training*

MANY skilled Radio Service Men are needed now to service all-electric sets. By becoming a certified R. T. A. Service Man, you can make big money, full time or spare time, and fit yourself for the big-pay opportunities that Radio offers.

We will quickly give you the training you need to qualify as a Radio Service man. . . . certify you . . . furnish you with a marvelous Radio Set Analyzer. This wonder instrument, together with our training, will enable you to compete successfully with experts who have been in the radio business for years. With its help you can quickly diagnose any ailing Radio set. The training we give you will enable you to make necessary analysis and repairs.

Serving as a "radio doctor" with this Radio Set Analyzer is but one of the many easy ways by which we help you make money out of Radio. Wiring rooms for Radio, installing and servicing sets for dealers, building and installing automobile Radio sets, constructing and installing short wave receivers . . . those are a few of the other ways in which our members are cashing in on Radio.

As a member of the Radio Training Association, you receive personal instruction from skilled Radio Engineers. Upon completion of the training, they will advise you personally on any problems which arise in your work. The Association will help you make money in your spare time, increase your pay, or start you in business. The easiest, quickest, best-paying way for you to get into Radio is by joining the Radio Training Association.

This amazing Radio Set Analyzer plus the instructions given you by the Association will transform you into an expert quickly. With it, you can locate troubles in all types of sets, test circuits, measure resistance and condenser capacities, detect defective tubes. Knowing how to make repairs is easy; knowing what the trouble is requires expert knowledge and a Radio Set Analyzer. With this Radio Set Analyzer, you will be able to give expert service and make big money. Possessing this set analyzer and knowing how to use it will be but one of the benefits that will be yours as a member of the R. T. A.

✦ Write for No-Cost Membership Plan ✦

We have worked out a plan whereby a membership enrollment need not cost you a cent. Our thorough training and the valuable Radio set analyzer can be yours. Write at once and find out how easily both of these can be earned.

Now is the time to prepare to be a Radio Service Man. Greater opportunities are opening up right along. For the sake of extra money in your spare time, bigger pay, a business of your own, a position with a future, get in touch with the Radio Training Association of America now.

Send for this No-Cost Membership Plan and Free Radio Handbook that will open your eyes as to what Radio has in store for the ambitious man. Don't wait. Do it now.

Radio Training Association of America

Dept. RSA-10 4513 Ravenswood Ave. Chicago, Ill.

Fill Out and Mail Today!

RADIO TRAINING ASSOCIATION OF AMERICA
Dept. RSA-10, 4513 Ravenswood Ave., Chicago, Ill.

Gentlemen: Send me details of your No-Cost Membership Enrollment Plan and information on how to learn to make real money in radio quick.

Name _____
Address _____
City _____
State _____

E.R.

WHAT ARE YOU DOING ABOUT YOUR FUTURE IN RADIO?

...prepare now for these adventurous exciting branches

Aircraft Radio . . . Broadcast Station or Studio . . . Talking Pictures . . . Direction Finder or Radio Compass . . . Disc and Film Recording . . . Servicing of Home Entertainment Equipment . . . Television.



Look! Short wave operation . . . from ground to airplanes!

RAUDIO offers 7 interesting branches for you to choose from, each filled with possibilities of adventure, advancement, excitement!

It is easy to learn these thrilling branches of radio at the RCA Institutes, through advanced methods, and association with the largest, most complete research laboratory in the radio industry. No rubber stamp courses at RCA Institutes—the man who already has a radio background can enter a course fitted to his particular needs. The four resident schools—at New York, Philadelphia, Boston and Chicago—offer elementary and advanced courses in practical radio. Courses constantly revised to include latest developments.

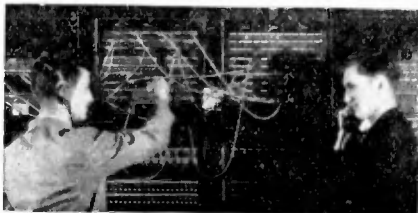

Control room inside a great broadcast studio

Win Radio Scholarship

If you cannot attend the resident schools, RCA Institutes Extension Courses enable you to study at home. Special laboratory equipment furnished. Outstanding graduates of extension courses become eligible for free scholarship at nearest resident school. All tuition costs moderate. So write today for catalog, full details. The coupon makes it easy.

RCA INSTITUTES, Inc.

RCA Institutes, Inc., Dept. RSA 31,
75 Varick St., New York, N. Y.

Gentlemen: Please send me your General Catalog. I am checking below the phase of radio in which I am particularly interested.

- | | |
|---|---|
| <input type="checkbox"/> Aircraft Radio | <input type="checkbox"/> Disc and Film Recording |
| <input type="checkbox"/> Broadcast Station or Studio | <input type="checkbox"/> Servicing Home Entertainment Equipment |
| <input type="checkbox"/> Talking Pictures | <input type="checkbox"/> Television |
| <input type="checkbox"/> Direction Finder and Radio Compass | |

Name _____

Address _____

Occupation _____ Age _____

EXTRA MONEY for you in spare time Servicing Refrigerators . . .

THE idea of electricians and radio service men servicing refrigeration units is self-evident and the thought has occurred to perhaps untold thousands ever since electric refrigeration started. Yet nothing was done, because the average man knows little or nothing about refrigeration. Compared with servicing a radio set or wiring a home for electricity, the servicing of a refrigerator is absurdly simple, once you get the hang of it.

The Official Refrigeration Service Manual has been edited by L. K. Wright, who is an expert and a leading refrigeration authority. He is a member of the American Society of Mechanical Engineers, American Society of Refrigeration Engineers, The National Association of Practical Engineers, etc.

In this Refrigeration Manual every page is profusely illustrated; every refrigerator part is carefully explained; diagrams are furnished of every known machine; special care is given to the servicing end. The tools needed are illustrated and explained; there are trouble shooting charts, and other service data.

Remember, there is big money in the refrigeration servicing business. There are thousands of firms selling refrigerators every day and they need to be cared for often. Eventually there will be more refrigerators than radios. Why not increase your earnings with a full or spare time business by servicing refrigerators?

Here are some of the important chapters:
Introduction to the Refrigeration Servicing Business

History of Refrigeration
Fundamentals of Refrigeration
Description of All Known Types of Refrigeration
Service Tools and Shop Equipment
Motors
Trouble Shooting
Unit Parts, Valves and Automatic Equipment
Makes and Specification of Units.
Manufacturers of Cabinets
Refrigerants and Automatic Equipment
and Many Other Important Chapters.

Already hundreds of copies of the Official Refrigeration Service Manual have been sold; and there still remains the greatest opportunity for thousands more to learn how to make more money in a short time through openings in this new field.

To Radio and Refrigeration Dealers and Service Men this Book Is Invaluable.

OVER 1,000 DIAGRAMS

352 Pages

Flexible Loose-Leaf Binder

Complete Service Data

\$5.00 The Copy

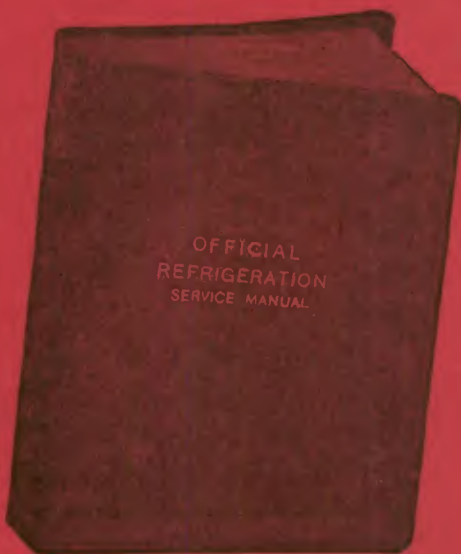

GERNSBACK PUBLICATIONS, Inc.

98AB Park Place

New York, N. Y.

FREE

Supplements are mailed every 30 days to owners of the Manual

Free Questions and Answers Service

Schematic Diagrams of All Latest Midget Receivers

OVER 1,000 PAGES

Over 2,000 Charts
Hook-ups and
Illustrations

Flexible Loose-Leaf
Binder

9 x 12 Inches

Complete Directory of All 1931-
1932 Radio Receivers
Full Radio Service Guide
For Radio Service Men, Dealers,
Jobbers, Manufacturers
and Set Builders

\$5.00 The
Copy



EXPERT servicing or installation of radio receivers requires that the dealer, service man or radiotrician be thoroughly experienced in handling sets of any manufacture. Needless to mention how important are modern methods of servicing, and how easy it is to complete any service job when the OFFICIAL RADIO SERVICE MANUAL is on hand. The 1932 MANUAL contains a Full Radio Service Guide and a most complete Directory of all 1931-1932 Radio Receivers as well as models of older design. Everyone employed in the Radio Industry should have a copy available for his own use.

Here is a resumé of the 1932 Manual:

A step-by-step analysis in servicing a receiver which embodies in its design every possible combination of modern radio practice; it is fully illustrated and thoroughly explained. It is the greatest contribution to the radio service field.

Charts showing the operation of all types of vacuum tubes, whether new, old or obsolete. An exclusive resume of the uses of the Pentode and Variable Mu Tubes and their characteristics. Complete discussion of the superheterodyne and its inherent peculiarities. Also a special chapter on tools used on superheterodyne circuits.

Schematic diagrams and circuits complete with color codings.

Important chapters on commercial aircraft radio equipment; new data on commercial short wave receivers and converters.

Servicing and installation of public address systems and talking machine equipment.

Standardized color coding for resistors. Operation of old and new testing equipment: tube voltmeters, output meters, oscillators and aligning tools.

A full section on Midget radios—their design, circuits and types. How to service them most economically.

Hundreds of schematic diagrams of older radio receivers which have never been published.

Blank pages for recording notes, diagrams and sketches; these pages are transferable to any part of the book.

GERNSBACK PUBLICATIONS, Inc.
98AB Park Place, New York, N. Y.