

TRANSISTORS

- **how to test them**
- **how to build all-transistor test equipment**

D. B. TARAPOREVALA SONS & CO. PVT. LTD.

TREASURE HOUSE OF BOOKS

210 Dr. DADABHAI NAOROJI ROAD, BOMBAY 1.

© 1957, 1958, 1959, 1960 Gernsback Publications, Inc.

© 1961 Gernsback Library, Inc.

First Printing — March, 1961

Second Printing — April, 1962

Third Printing — June, 1963

Fourth Printing — July, 1964

*All rights reserved under Universal, International, and
Pan-American Copyright Conventions.*

Copyright 1966 in India, Pakistan, Burma and Ceylon
by D. B. Taraporevala Sons & Company Private Limited
by arrangement with Gernsback Library Inc.

Second Indian Reprint 1966.

This book has been published with the assistance of the
Joint Indian-American Standard Works Programme.

It includes every word and illustration contained in the
latest original higher priced edition of this title and is a
complete and authentic copy thereof.

Sales Territory : All countries of Asia and Africa.

*This edition can be exported from India only by the publishers,
D. B. Taraporevala Sons & Company Private Limited.*

Price in India : Rs. 2.40

Printed by K. L. Bhargava at K. L. Bhargava & Co., 89 Bhawani Shankar
Road, Bombay 28 and published by Russi Jal Taraporevala for D. B.
Taraporevala Sons & Co. Private Ltd., 210, Dr. D. Naoraji Rd., Bombay 1

contents

section 1

how to test transistors

Power Transistor Tester 9

Power gain. Collector-to-base current amplification. Available input power. Leakage and shorts. Shorted collector. Excessive leakage. Base-to-emitter short. Checking for opens. Complete tester. Operation.

Simple Power Transistor Test 16

Gain test. Emitter-collector leakage. Dc gain or dc beta. Transistor punch-through. Test results. Matching transistors. Limitations in checking low-power transistors. Lead polarity. Power transistor types.

Direct-Reading Transistor Tester 23

Current amplification factor. Alpha and beta. Test circuit at work. Testing n-p-n and p-n-p types. Construction, calibration and operation. Leaky, shorted or open transistors. Power-transistor adapter.

Lab Type Transistor Checker 29

Transistor parameters. Dc gain. Alternating-current gain. Circuit theory. Basic dc gain test circuit. Dc gain test set using resistance-null technique. Construction, calibration and operation.

section 2 how to build all-transistor test equipment

Measure Harmonic Distortion 43

Distortion measurements at low levels. How the harmonic distortion measuring instrument works. Wien-bridge null network. Amplification of harmonic content. Construction and calibration of the analyzer.

Noise Squirter 48

Signal injection. Common-emitter coupled multivibrator. Construction details of the test instrument. Component wiring. Using the unit. Signal injection methods in vacuum-tube and transistor receivers.

Mini-Tracer**52**

Uses for a signal tracer. Circuit of a portable, compact tracer. Rf and audio probes. Construction kinks. Final check of the tracer. Methods of using the tracer. Signal tracing in transistor and vacuum-tube receivers.

TV Bar Generator**58**

Circuit details. Carrier oscillator, vertical bar generator and horizontal bar generator. Details of the vertical bar generator. Construction. Wiring the generator. Method of using the unit.

A-I-R Generator**66**

Need for a three-way signal generator. A-I-R generator supplies fixed audio tone, intermediate frequency and rf signals. Circuit of the generator and its construction. Adjusting the generator.

Black Box Oscillator**71**

Circuit of the two-transistor oscillator. Maximum oscillating frequency. Circuit theory. Circuit for measuring black-box output at rf. Transistor substitution. Construction hints. Using the unit.

Scope Calibrator**78**

Unit for making your scope into a wide-range electronic voltmeter. Advantages of transistorized scope calibrator. Circuit details. Square-wave output. Design considerations. Construction and calibration.

The Kilovolt**84**

Devices that require high voltage at low current. Getting 1,000 volts from 1.5 volts. Circuit diagram of the kilovolt. Layout of the kilovolt. Getting variable output. Construction and application.

Direct-Reading AF Meter**89**

Uses for a direct-reading audio-frequency meter. Circuit of the unit. Limiting and shaping amplifier. One-shot multivibrator. Construction hints. Calibrating the meter. Putting the frequency meter to work.

introduction

IN many areas of electronics the transistor has not only been welcomed but has become so firmly established that the argument of tube vs transistor suitability is purely academic. In some types of equipment the transistor swept in like a storm and ousted the long-established vacuum tube.

In the matter of low-price test equipment, however, the transistor seems to have made somewhat slower progress. However, if we were to analyze the advantages of the transistor, one of the strongest arguments in its favor would be its complete independence from the power outlet. Along these same lines, the transistor lends itself very nicely to equipment which is compact, hence easily portable, and light in weight.

But there is still another factor to be considered. Quite often the service technician will want a particular piece of test equipment for needs which he considers quite important. He might want to be able to measure harmonic distortion. He might want a bar generator for TV. Or possibly his fancy might be moved toward possession of a scope calibrator.

The purpose of this book is to show how easily specialized test equipment of this sort can be built. Carefully selected from articles which have been published in *Radio-Electronics Magazine*, the projects described were chosen for their broad appeal to the service technician and, quite possibly, to the constructor-experimenter.

Every one of these projects has been built. They have been put to use and made to prove their worth. Some of the units are very simple and might represent the work of one or two evenings.

Others are a little more complex and will require more effort. But if you feel the need for one or more of these instruments, then you at least will have the knowledge that all of the pioneering work has been done, and that, insofar as is humanly possible, the "bugs" have been removed.

The danger inherent in a book of this sort is that manufacturers of parts and transistors may remove items from the market. For components, there should be little difficulty in making adequate substitutions. For transistors, manufacturers supply interchangeability charts. These will permit you to make either a direct substitution or one involving a small amount of modification.

This is a two-part book. The first section explains how to test transistors or how to make equipment which will do this for you. The second section gives you a choice of various types of all-transistor test equipment which you can build. Parts lists are given in each instance for the convenience of the constructor.

Modifications can be made to adapt each unit to your own particular needs. Cautions are given wherever parts placement or component values are critical.

The editorial staff of Gernsback Library acknowledges with thanks the use of material supplied by these authors: W. F. Jordan, H. C. Lin, William C. Caldwell, Elliott A. McCready, Carl David Todd, Glenn E. Johnson, Irvin C. Chapel, David Stone, Edwin Bohr, I. Queen.

MARTIN CLIFFORD

section 1

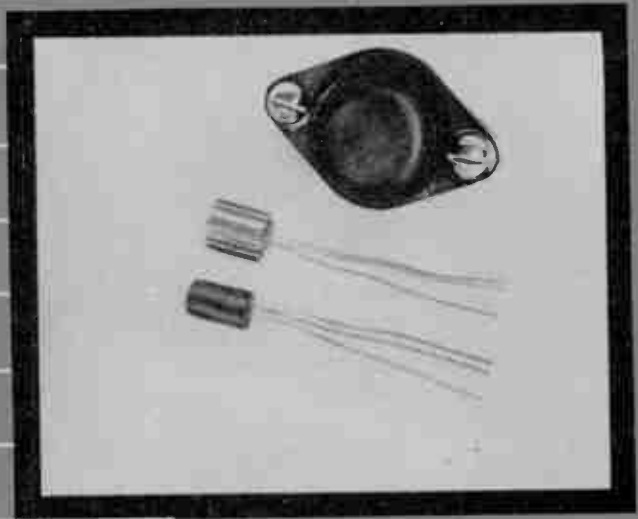

testing transistors

To make a complete check of a transistor, about 65 different transistor parameters would need to be studied and evaluated. For practical purposes, a few, simple tests will do. While an ohmmeter can be used, it has its limitations. In this first section, instruments are described for testing transistors found in all stages of receivers, from input to output. Parts lists are given for each project with full information on construction and uses. Each of the units is a worthwhile addition to any service bench.

power transistor tester

SERVICE technicians and dealers need a simple and inexpensive device for checking the power transistors used in the audio-amplifier sections of hybrid and all-transistor auto radios, in amplifiers, in test apparatus and wherever power transistors might be used. The instrument described here accurately tests for power gain and any one of or a combination of opens, shorts, leakage and voltage breakdown in the transistor.

To measure power gain you usually need bulky and expensive instruments, such as an audio signal generator and ac voltmeter. This tester makes ac power-gain measurements by using a dc test. This simplifies operation and reduces the testers cost.

Power gain

Power gain in a transistor amplifier, as defined by most auto radio manufacturers, is the ratio (in decibels) of output power

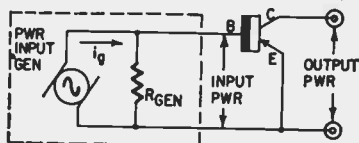

Fig. 101. Equivalent input circuit of a power transistor amplifier stage. The generator current is proportional to the square root of the input power.

to the maximum power available from a generator of a specified impedance (R_{gen}). We can represent the equivalent input circuit of an amplifier by a *current* generator and shunt impedance, R_{gen} , as in Fig. 101.

Essentially, power gain depends on two quantities — collector-to-base current amplification (h_{re}) and input resistance. Measur-

ing either alone does not measure power gain, since both vary over a wide range.

Power input

On the other hand, when output power and generator impedance are fixed, generator current i_g is proportional to the square root of the available power input:

$$\text{Available input power} = i_g^2 R_{gen}/4$$

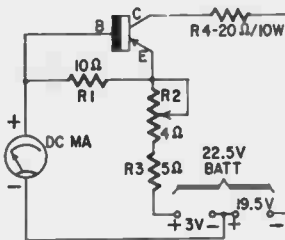

Fig. 102. This circuit tests for gain. R1, the 10-ohm resistor shunted between base and emitter, is the constant generator impedance. R4, the 20-ohm, 10-watt resistor in series with the collector, is the constant load impedance.

(The equation is divided by 4 as auto radio manufacturers feel this represents actual available input power — it takes into account all receiver losses.)

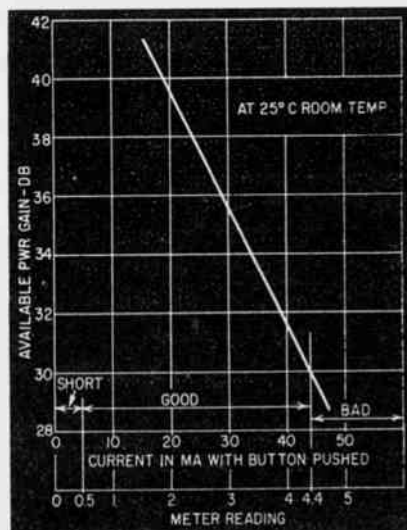

Fig. 103. Power gain vs meter reading for use on gain tests. Above 2.2 ma can be marked bad on the meter face and below 2.2 ma can be marked good.

Therefore, i_c is inversely proportional to the power gain in decibels because power gain in decibels equals

$$10 \log \frac{\text{output power}}{\text{available input power}}$$

In the tester, this generator current indicates power gain and is simulated with a dc source (the battery in Fig. 102). Using dc is

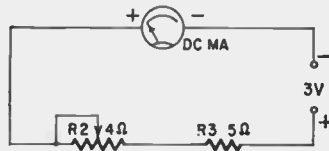

Fig. 104. To get a constant output current, adjust R2 in this calibration circuit.

justified because the ac signal amplification (h_{fe}) is very nearly proportional to the direct-current amplification (h_{FE}) for these transistors.

Dc output power is maintained constant by holding the collector current constant. Since collector current is nearly equal to

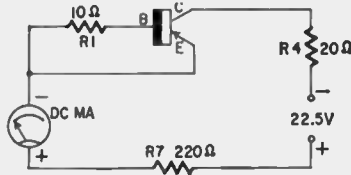

Fig. 105. Leakage test circuit checks the reverse biased diode current of the collector.

emitter current, the consistency of collector current is handled by emitter degeneration (R2 and R3 in Fig. 102). The input circuit is represented by a current source I_s (3-volt battery section) shunted by the specified source resistance. The current source is then a "straightline" function of power gain in (db). A graph comparing them is shown in Fig. 103 and using it you can calibrate the milliammeter dial in decibels.

Emitter current in the test circuit (Fig. 104) is essentially equal to the 3-volt supply divided by R2 plus R3. Any change in the 3-volt supply is compensated for by adjusting R2 to maintain emitter current constant at the predetermined level.

Leakage and shorts

In the leakage test, the circuit is connected as in Fig. 105. The meter reads the collector reverse current with the base connected to the emitter through a 10-ohm resistor, R1. If the collector is shorted or has excessive leakage to either the base or emitter, the meter will give a high reading. A base-to-emitter short is detected by the power-gain test.

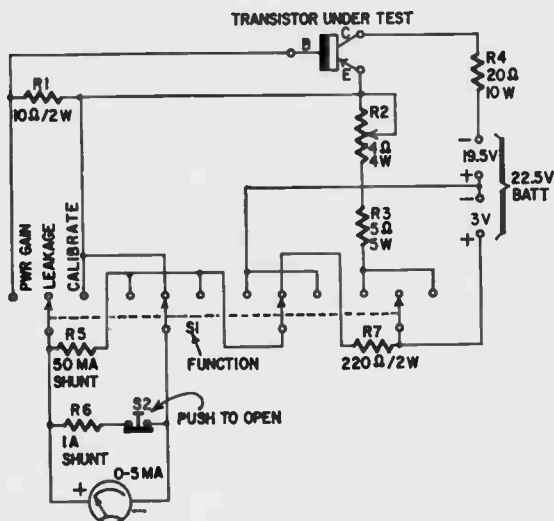

Fig. 106. Complete circuit of the transistor-checker powered by a 22.5-volt battery.

A pushbutton shunt, S2, and a series resistance, R6, protect the meter (Fig. 106). Always test first without the pushbutton depressed. If the reading is high — over 0.1 on leakage or 0.5 on gain — the meter can be damaged if the pushbutton is depressed.

Checking for opens

During power-gain tests, open electrodes are detected. If the collector is open, emitter current is diverted to the base, resulting in a heavy current through the meter.

When the emitter is open, no emitter current flows through R2 and R3 and the voltage drop across these resistors is greatly reduced, voltage at the emitter rises and again current through the meter is high.

If the base lead is open, collector current is equal to h_{FE} times I_{CBO} , where h_{FE} is the collector-to-base current amplification

and I_{CBO} is the open-emitter collector current. If h_{FE} times I_{CBO} is high, the meter reads high in the leakage test. If h_{FE} times I_{CBO} is low, the voltage drop across R2 and R3 in the power gain test is small and a high voltage appears across the meter, making the reading high. A base-to-emitter short is also detected during this test. Heavy base current flows through the meter due to zero power gain.

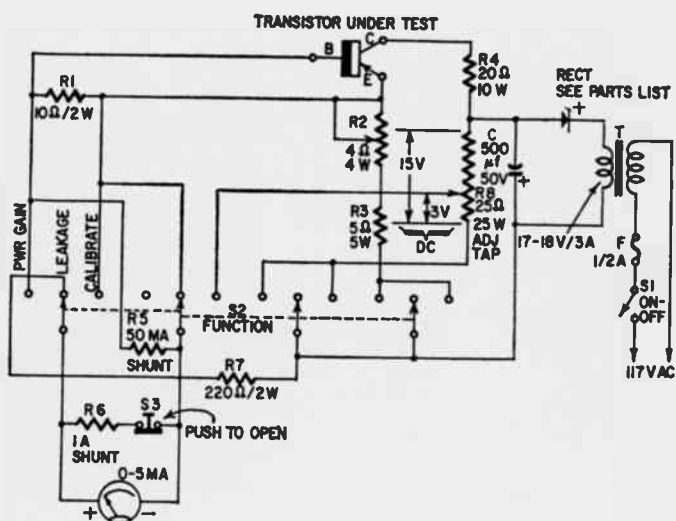

parts list for power transistor tester

- | | |
|--|---|
| R1—10 ohms, 2 watts | S3—spst pushbutton, normally closed |
| R2—pot, 4 ohms, 4 watts | T—rectifier transformer: primary, 117 volts;
secondary, 17-18 volts; 3 amps (Triad
F-47U or equivalent) |
| R3—5 ohms, 5 watts | Rectifier, 1 amp, 50 piv; collector-base junction
is satisfactory |
| R4—20 ohms, 10 watts | Socket, 9-pin miniature (to plug transistor
into) |
| R5—50-ma shunt to suit meter | Meter, 5-ma full scale |
| R6—amp shunt to suit meter | Case, to suit |
| R7—220 ohms, 2 watts | Miscellaneous hardware |
| R8—25 ohms, 25 watts, with adjustable
slider | |
| C—500 µf 50 volts, electrolytic | |
| F—0.5-amp fuse and holder | |
| S1—spst toggle | |
| S2—4-pole 3-position lever type, spring re-
turn to center position | |

Fig. 107. Complete circuit of the transistor-checker for operation from an ac power supply. If a transformer with an 18-volt secondary isn't readily available, use one having three 6.3 volt windings and connect them in series-aiding. Each winding must be rated at 3 amperes.

The complete tester

Two versions of the tester were constructed¹, one for dc operation (Fig. 106) and another for ac (Fig. 107). (A photo of the ac unit is shown in Fig. 108). The dc tester uses a 22.5-volt battery as its power supply. The ac tester uses a stepdown transformer and a half-wave rectifier. The transformer delivers 17 to 18 volts across its secondary winding. It is followed by a very simple filter.

There are three test positions — LEAKAGE, POWER GAIN AND CALIBRATE.

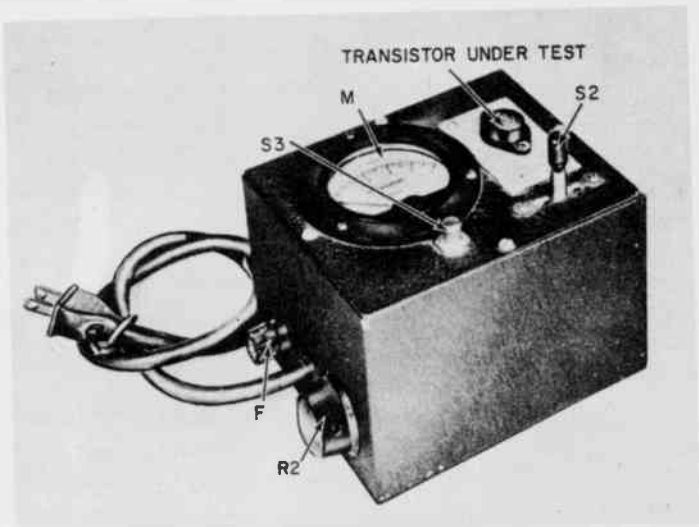

Fig. 108. This is the ac version of the power transistor tester.

The normal operating position is LEAKAGE and a spring-return switch is used to insure that the switch returns to this position when released. In the leakage position, power consumption is low, while in the other positions it is high. If the tester were left in either of the high-consumption positions for an extended period, a larger transformer or battery would be needed. The spring-return 4-pole, 3-position lever switch, an automatic protective device, makes this unnecessary.

¹The designs shown are accurate for transistors rated up to 5 watts. Higher-power transistors may be tested, but operation at full power will not be indicated. The current level must be raised by redesigning the circuit to simulate higher-power operation.

Operation

Use the tester following the steps shown in the Table below. This Table also shows what the meter readings represent.

Table of Operating Instructions

Calibrate

(Do not push button)

Dc tester: Set to 2 (400 ma). If you can't, replace battery.

Ac tester: Set to 1.5 (300 ma).

Leakage

Greater than 0.1 meter reading (20 ma) is C-B, C-E or C-B-E short.

Less than 0.1 meter reading. Push button.

(1) Greater than 2 (2 ma) is excessive leakage.

(2) Upscale creeping is leakage.

Gain

(Good—bad based on 30-db gain point)

Greater than 0.5 (100 ma) is B-E short or any open.

Less than 0.5 meter reading. Push button.

(1) Less than 1.0 (10 ma) is C-B, C-E or C-B-E short.

(2) Greater than 4.4 (44 ma) is poor gain.

Any inaccuracy in power-gain measurements is caused by variations in the initial bias of the dc input characteristics for different transistors or under different temperatures and the variations in collector cutoff currents.

Initial bias may vary from transistor to transistor. However, for the same type of transistor the variation is usually quite small.² The initial bias value also goes down about 2.5 mv for every degree (C) increase in temperature.³ To correct for temperature, add 1 db to the power-gain reading for every 20° temperature increase.

The cutoff current (I_{CBO}) creates a forward bias when it flows through the base circuit resistances. This bias tends to offset the collector current's consistency. Making the base circuit resistances small removes this objection.

If the temperature is within 10° of 27°C (80°F), power-gain measurements are accurate within 1 db.

Leakage current is a function of voltage and temperature. Therefore, the accuracy of this reading is good only if the supply voltage and temperature are held relatively constant.

²L. J. Giacoletto, "Study of PNP Alloy-Junction Transistor from Dc through Medium Frequencies," *RCA Review*, 15, December, 1954.

³H. C. Lin and A. A. Barco, "Temperature Effects in Circuits Using Junction Transistors," *Transistor 1*, RCA Labs, 1956.

simple power transistor test

ALTHOUGH much has been written about ohmmeters being dangerous in transistor testing, *power transistors* can be checked in this way without damaging them. The real danger is in the use of ohmmeters in checking small, low-power transistors which can be damaged much easier.

The first project in this book, beginning on page 9, described the construction and use of a tester designed specifically for testing power transistors. However, until you get that project completed, you can use your ohmmeter as a temporary aid.

The transistor, unlike the vacuum tube, is a solid device with no element insulated by air or vacuum from its associated elements. It will generally operate at lower voltages than a tube, and depends more on current than voltage to activate it. All these factors point to using an ohmmeter as a measuring stick, since it has a self-contained low-voltage supply and is capable of measuring current, which is inversely proportional to resistance.

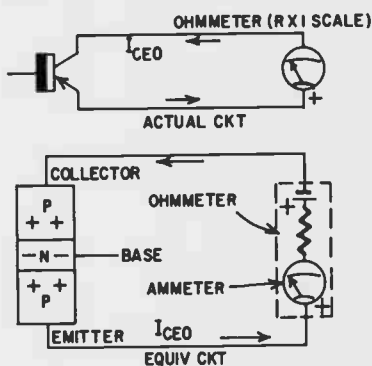

Fig. 109. Test for leakage between emitter and collector.

The first test of a p-n-p power transistor is for leakage between emitter and collector with the base left open. As seen in Fig. 109, with a voltage of opposite polarity applied to the emitter and collector, one of these elements has a reverse bias, drawing all available current carriers away from the junction between collector and base. The negative collector voltage is chosen because this is the way it will be required to operate in the amplifier circuit.

The resulting current is known as I_{CEO} (current between collector and emitter with base open) and becomes excessive if the transistor is shorted, leaky, or has suffered a voltage breakdown. The same circuit can be represented by an ammeter and battery in series, exactly what an ohmmeter contains. The internal battery of the ohmmeter, usually 1.5 or 3 volts, supplies the voltage,

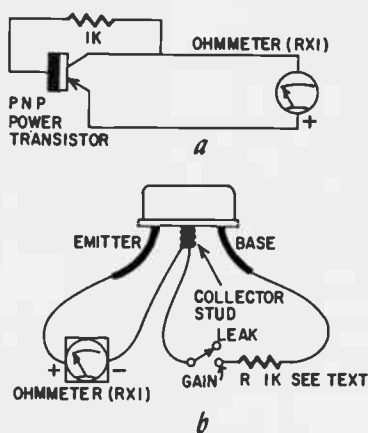

Fig. 110. Method for making a quick gain test of a power transistor. The circuit (a) shows the test circuit. The lower drawing (b) is the physical arrangement.

and the resistance reading indicates what I_{CEO} the transistor is capable of drawing at the applied voltage. The lower the resistance, the greater the leakage current will be. Zero ohms indicates the transistor has suffered a complete punch-through where areas of the collector material are actually touching the emitter internally. This is the most common cause of transistor failures.

Transistor temperature and ohmmeter scale used play important roles in obtaining leakage readings. The transistor should be at *room temperature*, as low-resistance readings may be obtained at high temperatures on normal transistors. *The only scale used should be $R \times 1$.* Readings taken on other scales will be confusing and meaningless for this test. Disconnect the base and emitter leads from the circuit before attempting to check the transistor. (The ohmmeter should be a low-resistance series type. Certain

meters, such as low-ohm shunt types or a very-high-resistance series meter, will not give intelligible results.)

Gain test

The next step is to make certain the transistor will amplify. For this check, the same ohmmeter connections that were employed during the leakage test are used, and a 1,000-ohm resistor is added, as shown in Figs. 110-a,-b between the transistor base and collector. A notable decrease in resistance should be observed on the ohmmeter as this is done. This is due to the ohmmeter being in the collector circuit and responding to changes in current through it. The greater the collector current, the lower the resistance.

As the 1,000-ohm resistor is added, the base receives some negative voltage from the ohmmeter battery, causing a difference in potential between base and emitter. This draws current carriers out of the emitter, reducing the internal emitter-to-collector resistance and also causing more collector current (I_c) to flow. If, during the gain test, the resistance reading does not change from what it was during the leakage test, the base is probably open. If the reading after the resistor is added is over 50 ohms, the power transistor has very low gain. Typical gain readings are 10-30 ohms, with extra-high-gain units measuring 5-10 ohms and some lower-gain types 30-50 ohms. *Caution: Meter polarity may have been wrong. Try reversing the leads before rejecting the transistor.*

The dc gain, or dc beta, in a common-emitter circuit may be easily estimated by this extremely simple test. The formula for this is:

$$\text{Approximate current gain} = \frac{1,200}{R}$$

where R is the direct reading in ohms.

The accuracy of base-to-collector gain factor thus obtained is usually best for transistors measuring between 13 and 50 ohms, which represents current gain factors of about 25 to 90. Higher-gain units usually tend to be estimated conservatively by this formula, as will be shown by the following data taken during the experiments with this test.

The equivalent circuit during the gain test shown in Fig. 111. R2 represents the internal resistance in the meter, which includes a series resistor to adjust zero ohms and a minute amount of

meter resistance. A typical value for R_2 may be 8-15 ohms, depending on the meter design. This resistance has a slight effect on base current, since base current I_B must flow through both R_1 and R_2 . This means that as the collector current increases, which it will do for higher-gain units, the corresponding voltage drop across R_2 will tend to retard the base current slightly. If the base current is decreased, the collector current will also be affected. However, the gain estimates by the formula given have

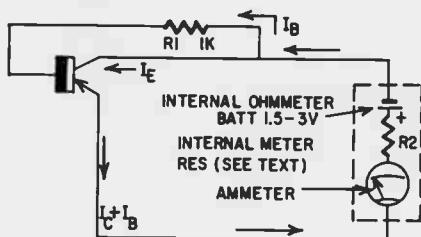

Fig. 111. Equivalent circuit during the gain test.

a higher degree of accuracy than might be imagined at first glance, as shown by the following data. Power transistors used were of various types and applied into the simple gain-test circuit:

Transistor	R	V_{BE}	I_B (mA)	I_C (mA)	Gain	Gain
					I_C	1,200
A	11.5	0.13	0.55	60	109	105
B	15.0	0.12	0.65	51	79	80
C	19.0	0.12	0.72	45	63	63
D	42.0	0.12	1.00	28	28	29

The ohmmeter used for this test was an RCA model WV-77A. R is the measured resistance in ohms during the gain test (Fig. 110-a); V_{BE} is the voltage between base and emitter (shown because it remains almost constant). I_B is the base current (calculated by the voltage drop across the 1,000-ohm resistor) and I_C is the collector current (measured with a separate ammeter).

Test results

Note how closely the measured current gain I_C/I_B for each transistor compares to the current gain estimated by our formula $1,200/R$. This represents the current gain at fairly low values of I_C and would probably be very close to small signal beta. To obtain an estimate of large signal gains, higher values of forward bias are used in laboratory checks and the collector load resistance is removed (the collector is connected directly to the power

source). The collector current is then set at a much higher value, and the base current is read. To determine how closely our simple gain test compares to the larger current gain tests, a series of over 1,000 transistors were run through both tests. The following are examples of 10 transistors from various manufacturing sources, checked first by our simple ohmmeter test and then through the laboratory 1.2-ampere I_C test:

Transistor	Leakage (Ohms) (R X 1 Scale)	Ohms in Our Gain Test (R)	Estimated Gain 1200/R	Actual Gain (Lab test)
A	750+	42	29	30
B	500	38	32	32
C	750+	25	48	49
D	300	23	52	44
E	750+	15	80	88
F	300	14	86	88
G	200	13	92	92
H	100	11	109	130
I	150	9	133	160
J	45	7	171	220

Note: + indicates meter near high end of scale, but the exact reading is unimportant. Meter used for above test: Simpson model 260.

All of the ohmmeters used in these checks had a lead potential of 1.5 volts on the $R \times 1$ scale. Models using 3 volts on the $R \times 1$ scale have been tried, with very little change in readings. This is due to the stabilizing effect of the 1,000-ohm resistor on the base current. Slightly higher than actual gain readings (lower resistance readings) may be obtained in some cases, when the lead potential is 3 volts on the $R \times 1$ scale.

The leakage-gain test does not check diode voltage ratings on the transistor. However, most power transistors which have suffered voltage breakdowns in service are completely shorted between emitter and collector. Those prone to breakdowns may show excessive leakage or extremely high gain on the test.

Matching transistors

This system of measuring gain may be used to match transistors for reliable push-pull amplifier operation. Transistors which are not well matched cause distortion in push-pull audio amplifiers. The amount of distortion which can be tolerated depends principally upon the application in which the amplifier is employed.

Limitations

This test *is not designed* for the small low-power transistors. It

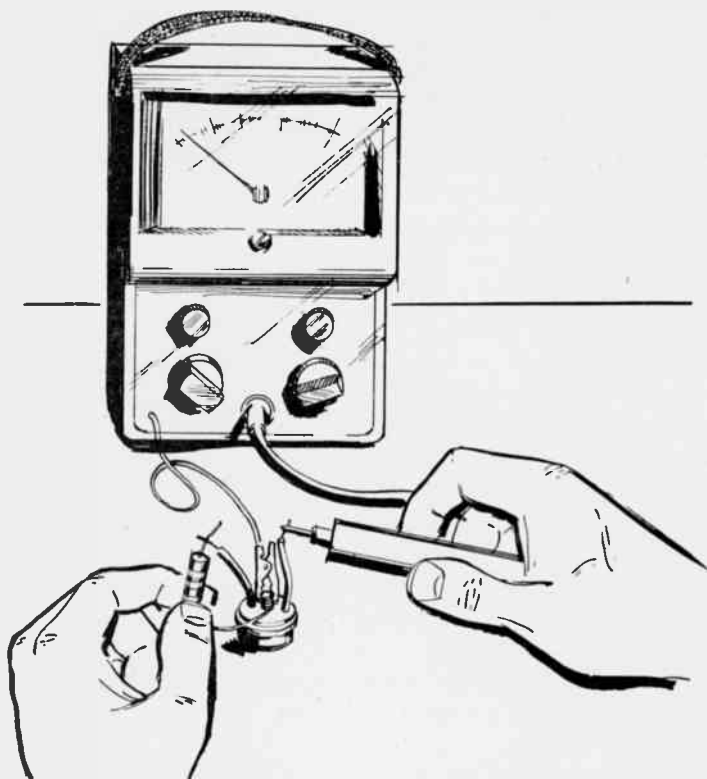

Fig. 112. Power transistor being checked for gain with the help of a volt-ohm-milliammeter and a resistor.

should not be used on small medium-power transistors sometimes found in audio driver stages. It is designed *only for the power units* used in the output stage of auto radio receivers, which are capable of handling about 0.5 ampere or more collector current. Only p-n-p units have been used for this type of application to date, due to the techniques involved in the manufacturing of these transistors and the characteristics of the materials used. However, if power n-p-n units should come into the picture, it is expected that this test will give reliable readings simply by using the opposite meter polarity during the checks.

Lead polarity

Almost any ohmmeter employing an $R \times 1$ range may be used. (See Fig. 112.) Since lead polarity is extremely important, it

would be well to determine this by checking with a separate voltmeter. Simply place the ohmmeter to be used for transistor testing on the $\times 1$ scale, and connect to a voltmeter. With the two common leads tied together, if the voltmeter goes in a negative direction (against the bottom pin), the common lead of the ohmmeter is actually connected to the positive pole of the internal battery. However, if the voltmeter reads correctly, the common lead is the negative one. The voltage, in either case, should be 1.5 to 3.0 for this test.

Power transistor types

Knowing test-lead polarity is important, but it is also necessary to be able to identify the base and emitter leads. Finding the collector is easy. If the transistor has two leads, the case is the collector. If it has two leads and a stud, the stud is the collector. To identify emitter and base leads, hold the transistor so that one lead is directly above the other. If you will examine the transistor, you will see that the two leads are off center. Hold the transistor so that the leads are to the left of the center line. When held in this way, the top lead is the emitter and the bottom lead is the base.

This method of identification holds true in many, but not in all cases. Some p-n-p power transistors have three color coded leads (collector, red; base, black; emitter, yellow). In other power transistors, the mounting holes and the leads are all in the same line. You will note that one lead is close to a mounting hole. This lead is the base, the other lead is the emitter, while the case itself is the collector.

When in doubt, you can make a quick check of forward and reverse resistances (using your ohmmeter) to help you identify the leads.

Power transistor applications

P-n-p's are used in auto radio receivers in audio output stages. N-p-n's are also found in some audio applications. Power transistors are used as high-current switching units for dc-to-dc converter and dc-to-ac inverter circuits. They have other applications, such as power-supply regulators, relay replacements, motor control, etc.

direct-reading transistor tester

ONE of the simplest indicators of transistor quality is its current gain or beta. A transistor's beta is the ratio of output current to input current inducing it, and is a characteristic usually listed in the manufacturer's specifications.

There are two types of current amplification factor used in connection with transistors. One of these, alpha, is the ratio of a change in collector current to a change in emitter current. This ratio, in junction transistors, is always a fraction (less than one) since the collector current is never as much as emitter current.

The other type of current amplification factor, beta, is always larger than one, since the collector current is always greater than emitter current. Note that in discussing current amplification factor, collector current is always used, but whether we get a gain factor of more than one, or less than one, depends on whether we are comparing it with emitter or base current. Of the two, emitter is much greater than base current, while collector current is the sum of the base and emitter currents.

Current gain

If we find a way to determine quickly a transistor's current gain or beta, we can check it against the spec sheet and end up with a pretty good estimate of how the transistor will perform in a circuit. The transistor beta test, like the emission test of a vacuum tube, is not 100% infallible, but is a fairly reliable indication of quality.

This transistor tester can be built inexpensively. It not only indicates open, shorted or excessively leaky transistors, but lets the operator read transistor beta directly from a calibrated control.

Test circuit at work

The transistor under test is connected in a common-emitter configuration (Fig. 113) with a milliammeter in the collector circuit. When switch S is open, no current flows from base to emitter and the milliammeter indicates transistor leakage current which, in a good transistor, should be no more than a small fraction of a milliampere.

When switch S is closed, current flows between base and emitter. The amount of current is determined by the resistance of po-

tentiometer R. The meter should now indicate an increased current — the amount of increase depending on the transistor's beta.

Beta

We can now calculate beta:

$$\text{Beta} = \frac{I_C}{I_B}$$

where I_C is equal to the *increase* in collector current, and I_B is equal to the base current. In this circuit, the base current, for our

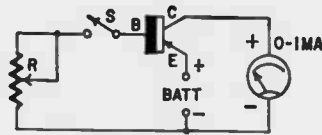
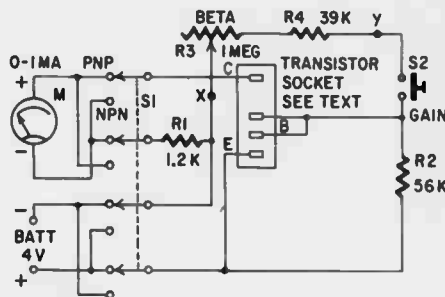

Fig. 113. Simplified circuit of the transistor tester.

purpose, is equal to the battery voltage divided by the resistance of potentiometer R.

Now, if we use a constant value of I_C in all tests and vary R's resistance to produce this predetermined constant, we can calibrate R in units of beta.



parts list for direct-reading transistor tester

R1—1,200 ohms
 R2—56,000 ohms
 R3—pot, 1 megohm, semi-logarithmic with reverse taper (IRC type Q17-137 or equivalent)
 R4—39,000 ohms
 All resistors ½ watt 10%
 M—0-1 ma dc

S1—4-pole 2-position rotary
 S2—spsst pushbutton, normally open
 Battery, 4 volts (RCA VS400, Burgess H233 or Eveready E233)
 Socket, 5-pin miniature hearing aid
 Case, 5¼ x 3 x 2½ inches
 Miscellaneous hardware

Fig. 114. Switching arrangement permits transistor checker to test both n-p-n and p-n-p types. With the help of an adapter, power transistors can also be tested.

For example: suppose we use 1 ma as the constant increase in collector current, and adjust R to induce this value, then:

$$\text{Beta} = \frac{.001}{I_B}$$

But I_B is equal to the battery voltage divided by the resistance of R. We know the battery voltage (let's say 10 volts) and can measure the resistance of R (say 100,000 ohms). For this particular set of values:

$$\text{Beta} = \frac{.001}{10/100,000} = 10$$

Knowing this, every time we must set R to 100,000 ohms to get a collector current increase of 1 ma, we know the beta of the

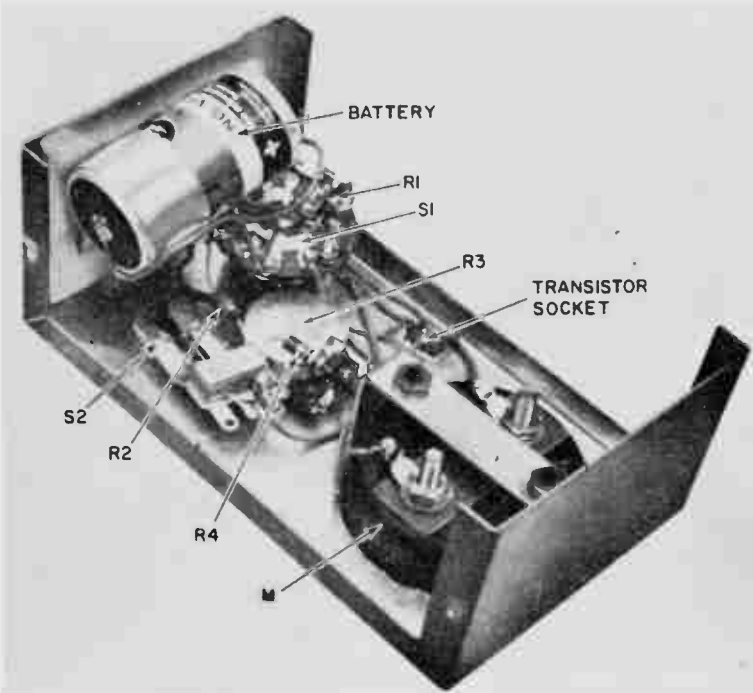

Fig. 115. Layout of the transistor tester. Even with such a small case, there is enough room so that you can get at all the parts. Wire the rotary switch before mounting the battery.

transistor we are testing is 10. It is now relatively simple to calibrate R for other values of beta.

Fig. 114 is the transistor tester's circuit. A 0-1 milliammeter is

the indicating device, and a collector current increase of 0.5 ma is used in all tests. This much current increase, together with a 4-volt mercury battery, allows a variable resistance of 1 megohm to cover beta values between 5 and 125, which is adequate for all practical purposes.

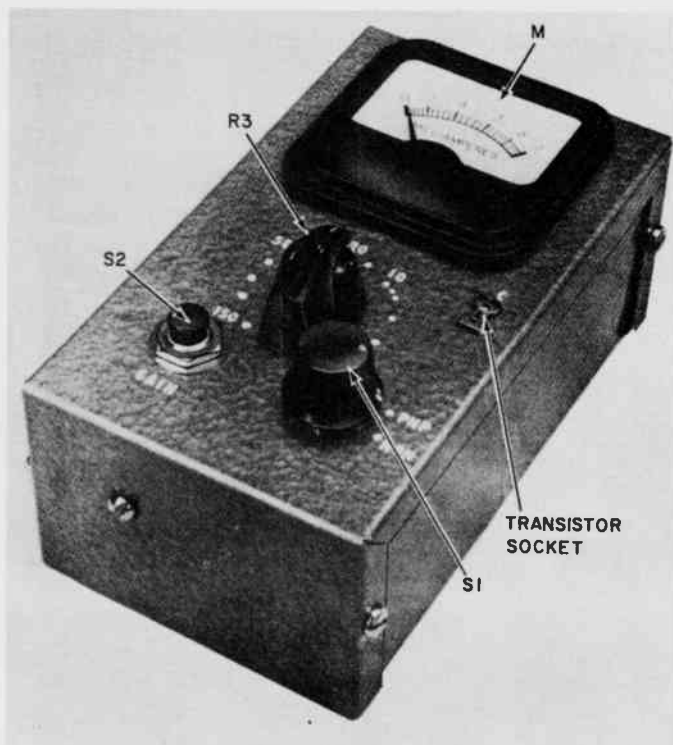

Fig. 116. Outside view of the transistor tester. It has a neat, professional appearance.

R1 is a current-limiting resistor which keeps the meter from being damaged if the transistor being tested is shorted. R2 is an arbitrary resistance used to approximate actual in-circuit conditions. It gives a more realistic value of transistor leakage current than a floating base would. R4 is a current-limiting resistor which prevents transistor damage when potentiometer R3 is set for minimum resistance.

Switch S1 is a multiple-pole unit used to reverse meter and battery polarities, eliminating the need for separate sockets for p-n-p and n-p-n transistors.

Construction notes

The transistor tester is housed in a two-piece aluminum chassis measuring $5\frac{1}{4} \times 3 \times 2\frac{1}{8}$ inches. All components are mounted on the top half of the chassis, as shown in Fig. 115. An outside view (Fig. 116) will give you an indication of where the controls are placed. While the wiring is not critical, space is limited and all components should be located as illustrated.

Potentiometer R3 is wired so that clockwise rotation lowers the resistance. Although this results in a scale which runs counter-clockwise, it agrees with the natural tendency to back off a control to reduce excessive meter readings. Be sure to use a control with the specified taper, as an audio taper will cause crowding at the low end of the scale.

The transistor socket is from a miniature hearing-aid socket. Remove pin 4 and plug the hole with a toothpick. Pin 1 is now the emitter connection, pins 2 and 3 the base, and pin 5 the collector. This type socket accommodates the two most common transistor bases. Of course, other sockets can be used if desired.

The power-transistor adapter is shown in Fig. 117. Remove all five contacts from a miniature hearing-aid socket. Solder flexible leads to three short lengths of No. 26 tinned wire and insert them into the socket as shown. *Caution: Wire much larger than No. 26 will spring the tester socket contacts.* The clipped excess leads of a transistor will do very nicely.

Clip the wires protruding from the socket base to about $\frac{1}{4}$ inch and cement the flexible leads to the socket. Solder miniature alligator clips to the free ends of the flexible leads. To eliminate possible confusion, paint a stripe of red fingernail polish on the collector ends of both the tester and adapter sockets.

Calibration and operation

After the transistor tester is wired and checked, connect an ohmmeter between points X and Y as indicated in Fig. 114. Now adjust R3 until the ohmmeter reads 40,000 ohms and mark this point 5 on R3's scale. Other resistance measurements together with their corresponding values of beta are shown in the table appearing at the top of page 28. The potentiometer used in this tester has a maximum resistance of 1.2 megohms, so this resistance was included in the table.

When calibration of the unit has been completed, plug a transistor into the socket, first placing switch S1 in either the PNP

Beta	Resistance (X to Y) (Ohms)	Beta	Resistance (X to Y) (Ohms)
5	40,000	30	240,000
6	48,000	40	320,000
7	56,000	50	400,000
8	64,000	75	600,000
9	72,000	100	800,000
10	80,000	125	1.0 megohm
15	120,000	150	1.2 megohms
20	160,000	150	

or NPN position, as necessary. Note the reading on the milliammeter. This reading should be a small fraction of a milliampere and indicates transistor leakage current. Now depress GAIN switch S2 and adjust R3 until the meter reads 0.5 ma *plus* the value of

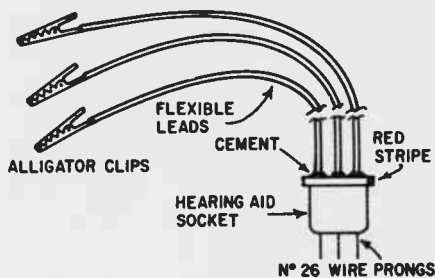

Fig. 117. Construction of the power-transistor adapter.

leakage current noted previously. R3 now indicates the beta of the transistor being tested. Compare this value with the manufacturer's specifications to determine its quality.

Leaky, shorted or open transistors

If, when the transistor is first plugged in, the meter reads 0.5 ma or more, the unit is either excessively leaky or shorted. An open transistor produces a zero reading when GAIN switch S2 is depressed.

When using the adapter to test power transistors, connect the alligator clips to the transistor before plugging the adapter into the tester. Failure to do this may result in pegging the meter if the clips inadvertently come in contact with each other.

As an added precaution, make the adapter leads of unequal length. It will also help to coat the top and bottom sides of the alligator clips with lacquer. Use nail polish if you don't have lacquer available. Make sure the lacquer doesn't touch the sides of the clips.

lab type transistor checker

If you are a service technician, you have been repairing transistor radios, intercoms and hi-fi preamps. (Or soon will be!) This means that you must have the equipment to test transistors properly.

There are some 65 transistor parameters which can be measured for a complete evaluation study. Fortunately, only a few need be measured to determine if a transistor's characteristics have changed markedly from those it should have.

One of these parameters is dc gain. Frequently current gain decreases as the transistor ages. This results in less amplification in the circuit in which it is used, and can create distortion and circuit mismatching due to changes in impedance.

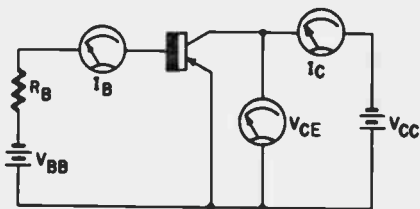

Fig. 118. Simple circuit for measuring dc gain. Its disadvantage is that it requires several milliammeters. Also, the technique involves some calculation, with possibility of error.

The technician usually finds the transistor in an ac amplifier circuit. But a more meaningful parameter in many circuit applications is the dc gain in the common-emitter configuration, h_{FE} . What is h_{FE} and how does it compare? There is fairly good correlation of h_{fe} (alternating-current gain) and h_{FE} (dc gain) at low levels and some knowledge of h_{FE} is a must for power output work. Dc gain is also a very important parameter in switching, control or logic circuits. This factor also enters into bias circuit design for rf amplifiers.

By definition: h_{FE} is the ratio of the collector current (dc) to the base current (dc) or,

$$h_{FE} = \frac{I_C}{I_B}$$

A possible measuring circuit is shown in Fig. 118. A collector-

to-emitter voltage is applied; a base current caused to flow and the value of h_{FE} is calculated by dividing collector current by base current.

This method has several disadvantages. First, it requires two good milliammeters. And if any reasonable accuracy is required, the meters must be better than those usually in the shop.

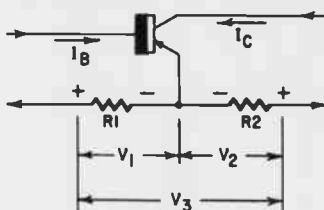

Fig. 119. Basic circuit for using resistors to measure dc gain.

The calculation required is a nuisance and increases the possibility for error. It would be convenient in many respects if one or more meters and the calculation could be omitted.

The test set to be described needs only one milliammeter and does the calculating internally. The resulting h_{FE} value is displayed by a reading on a multiturn dial.

Circuit theory

As previously stated, h_{FE} is the ratio of the collector current,

Fig. 120. Curve showing relation between R_2 and dc gain (h_{FE}) when R_1 is fixed.

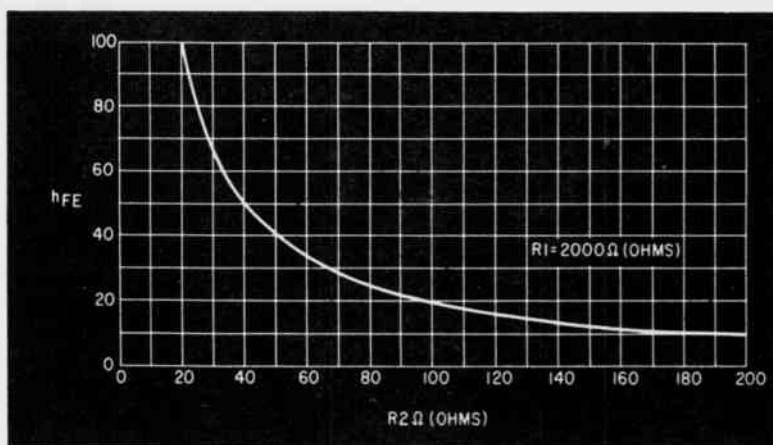

I_C to the base current, I_B . We are interested only in this ratio. By inserting two resistors, as shown, in the simplified circuit of Fig. 119, two voltages V_1 and V_2 will be produced which are directly proportional to I_B and I_C , respectively.

Note that the polarities of voltages V_1 and V_2 are such that the voltage V_3 is the difference of the two. If a dc null detector is used to measure V_3 and either R_1 or R_2 adjusted until V_3 is

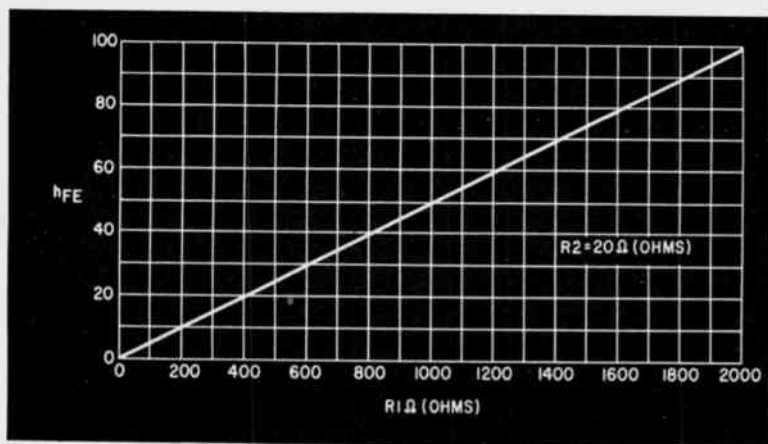

Fig. 121. Relation between R_1 and (h_{FE}) when R_2 is fixed.

zero, then the two voltages must be equal. This leads to a simpler expression,

$$h_{FE} = \frac{R_1}{R_2}$$

Now h_{FE} is expressed only as a function of two resistances. Since only the ratio of R_1 to R_2 is important, either may be varied to produce the null in V_3 . If R_2 were varied, the h_{FE} reading would be a nonlinear function as in Fig. 120. However, if R_1 were the variable and R_2 were held constant, a linear relation as in Fig. 121 would be obtained between h_{FE} and R_1 .

It is impractical to vary R_1 in the circuit since this requires a base-resistor current generator with a very high impedance with respect to R_1 . R_1 must have a value in the order of several thousand ohms to obtain sufficient voltages for V_1 and V_2 when small currents are involved. This would require an unreasonable base-current generator, so the base current — and indirectly the collector current — could remain constant when the null is being obtained.

This problem may be avoided by using a circuit like that in Fig. 122. Here, the equivalent R is, in effect, only a portion of $R1''$. A potentiometer could have been used in place of $R1''$, but it is hard to get an accurate potentiometer that has the required wattage rating.

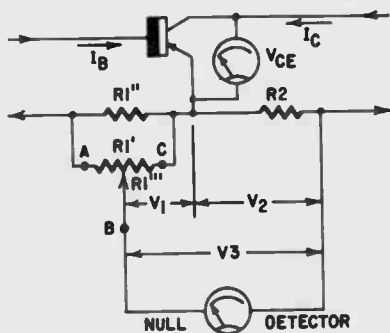

Fig. 122. Basic dc gain test circuit modified to allow high base current.

The maximum value of h_{FE} that may be measured is determined by the ratio of the parallel equivalent of $R1''$ and $R1'$ to the value of $R2$.

Circuit description

Fig. 123 is a block diagram of a test set using the resistance-null technique. Fig. 124 is the unit's schematic.

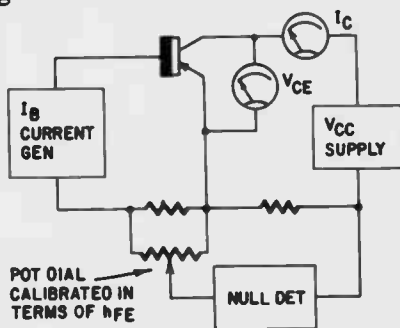

Fig. 123. Block diagram of a dc gain test set that uses the resistance-null technique.

The internal base-current supply consists of a voltage-doubler power supply and a network of resistances. T1 is a 25-volt fila-

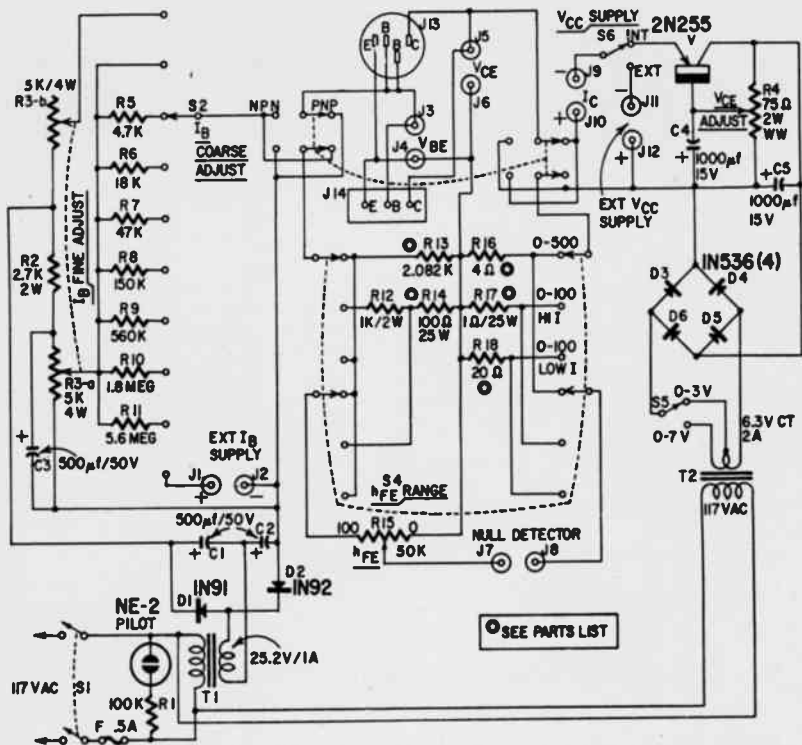

Fig. 124. Circuit of the transistor tester. Base current supply is a voltage-doubler. Provision is made for an external supply. Resistance networks are used for coarse and fine adjustments of base current. The collector supply is a full-wave bridge circuit.

ment transformer. Switch S2 is for coarse adjustment of I_B while potentiometer R3 is for fine adjustment.

Base current can be varied from zero to some maximum value determined by the setting of S2 for all ranges up to 10 ma. The highest current range is adjusted with an additional potentiometer section ganged with R3. This is necessary because of power dissipation requirements. Protective resistor R12 helps limit the maximum current that can be drawn when the h_{FE} RANGE switch is in the 0-100 high-current position.

Base current can come from an external supply if desired.

The collector supply uses a full-wave bridge rectifier and a transistor voltage control. Transistor V does two jobs. It adjusts the collector supply voltage and is a filter. The basic circuit is in

parts list for lab type transistor checker

R1—100,000 ohms	C1, 2, 3—500 μ f, 50 volts, electrolytic
R2—2,700 ohms, 2 watts	C4, 5—1000 μ f, 15 volts, electrolytic
R3—Dual pot, 5,000 ohms per section, 4 watts, wirewound	D1, 2—IN91, IN92 (General Electric)
R4—pot, 75 ohms, 2 watts, wirewound	D3, 4, 5, 6—IN536 (General Electric)
R5—4,700 ohms	F—0.5 amp
R6—18,000 ohms	J1-J12—bonona jacks
R7—47,000 ohms	J13—transistor socket (Lofoyette MS-395 or equivalent)
R8—150,000 ohms	J14—transistor socket, 3 pin
R9—560,000 ohms	S1—dpst toggle
R10—1.8 megohms	S2—1-pole 10-position rotary
R11—5.6 megohms	S3—4-pole 2-position wiper
R12—1,000 ohms, 2 watts	S4—4-pole 3-position wifer
R13—2,082 ohms (four 500-ohm 1-watt, 1% and 82-ohm $\frac{1}{2}$ -watt, 5% in series)	S5, 6—spdt toggle
R14—100 ohms, 25 watts (selected for close tolerance)	T1—filament transformer: primary, 117 volts; secondary, 25.2 volts, 1 amp (Stancor P6469 or equivalent)
R15—10-turn pot 50,000 ohms	T2—filament transformer: primary, 117 volts; secondary, 6.3 volts ct, 2 amps (Stoncor P6134 or equivalent)
R16—4 ohms (four 1-ohm 1-watt 5% in series)	V—2N255 (Clevite)
R17—1 ohm, 25-watts (selected for close tolerance)	NE-2 neon pilot-lamp assembly
R18—20 ohms (four 5-ohm 1-watt, 1% in series)	10-turn dial for R15
All resistors $\frac{1}{2}$ -watt 10% unless noted	Chassis to suit
	Miscellaneous hardware

Fig. 125. This is merely a dc emitter-follower stage and for reasonable values of R_L (the effective loading resistance of the transistor under test) the output voltage, V_{OUT} , will be very nearly equal to the base voltage. (That is, V_{BE} will be quite small.) V_{OUT} will actually be somewhat less than V_{BB} because of the

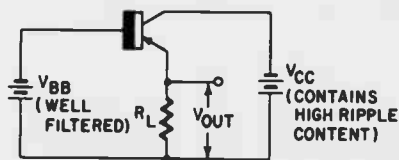

Fig. 125. Transistor voltage control and filter circuit.

forward emitter-base drop. Nevertheless, varying the base voltage varies the output. So, if the base is held constant, the output will be constant for practical purposes even though the collector supply voltage may vary.

With the simple shunt-capacitor filter alone, ac ripple would be very high. Passive filtering is always a problem for high-current supplies. However, by using the transistor as an active filter, ripple content is greatly diminished.

The base voltage is held constant by the R-C filter network consisting of C4 and a portion of R4 as shown in Fig. 124. With the filter described, ripple is in the order of 1 mv rms or less. Should the 1 ampere or so available from the internal supply be insufficient, a set of terminals for external V_{CC} supply is provided.

The actual measuring portion of the test set shown in Fig. 123 has three ranges of h_{FE} . One 0-100 range is for low-current operation and the other for high-current use. The 0-500 range is suitable for both high and low currents.

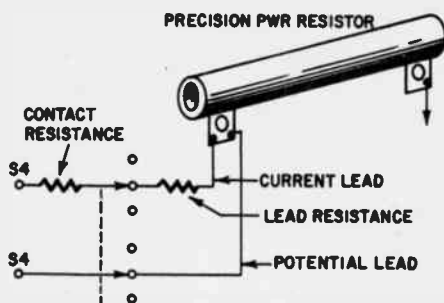

Fig. 126. How to connect potential lead to high current resistor without running into trouble with switch-contact or lead resistance.

All h_{FE} range changing is done by switching in various base- and collector-current reading resistors with S4.

Two extra switch sections are used for S4. These are "potential" switches for the null detector circuitry used to eliminate errors caused by voltage drops across the switch contacts at high currents. As indicated in Fig. 126, this technique eliminates difficulty due to contact resistance and resistance in the leads.

Terminals are provided for monitoring V_{CE} , V_{BE} and I_C , and for connecting the null detector into the circuit.

Switch S3 reverses both base and collector supplies to accommodate either n-p-n or p-n-p transistors.

Construction

Rack-mount construction techniques were used in the original model of the h_{FE} test set since it was to be included with other test panels mounted in a standard relay rack. The general layout is straightforward but is not critical since the primary concern is for dc conditions.

Wiring may be either from point to point or square-cornered as the builder wishes. Fig. 127 shows how the parts appear at the rear of the front panel, Fig. 128 illustrates the mounting of the transformers, rectifiers and capacitors. The only critical points to watch when wiring the units are switch S4 and the dress of the leads to and from potentiometer R15. When wiring S4, be sure

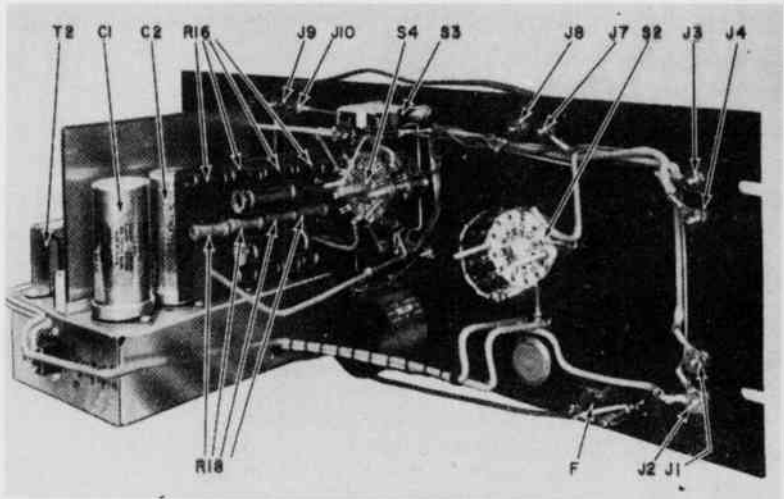

Fig. 127. A look backstage. The layout isn't critical and can be changed.

that connections to the current reading resistors R13, R14, R16, R17, R18 are made as shown in Fig. 126. Keep all wiring to and from R15 away from the 117-volt line to prevent ac pickup which may give a false null-detector reading.

Heat sink

To increase the power dissipation capabilities of regulator transistor V, mount it on a heavy sheet of copper, brass or aluminum. A 5 x 6-inch sheet of $\frac{1}{8}$ -inch stock of any of these metals should be adequate.

What can it do?

The test set shown in Fig. 124 measures h_{FE} up to 100 for a maximum collector current of 400 ma in the low-current range and up to 5 amps in the high-current range, provided the maximum base current does not exceed 40 or 500 ma, respectively. In the 0-500 range, I_C may be a maximum of 1 amp with the I_B maximum being 40 ma.

Collector voltage available depends upon the collector current. The primary limitations are the power dissipation capabilities of the voltage control transistor, and the voltage drop across the I_C reading resistor. The difference between the desired V_{CE} voltage and the total unfiltered supply voltage of approximately 7 volts appears partially across the collector-current reading resistor (R_C) and the remainder across transistor V. An equation which relates the variables involved is:

$$V_{CE} = V_{CC} - I_C R_C - V_{CE2}$$

(V_{CE2} is the collector-to-emitter voltage of transistor V.)

To determine the maximum value of collector current permissible, several factors must be studied. First of all, since a transistor's current gain is a function of the collector current and voltage, there is a maximum value of collector current and a minimum value of collector voltage at which the regulator transistor will have sufficient h_{FE} to be effective. For the transistor used, the maximum value of I_C is roughly 3 amperes and the minimum voltage is roughly 0.5.

Thus the maximum value of V_{CE} available to be applied to the transistor under test will be:

$$V_{CE \text{ MAX}} = V_{CC} - I_C R_C - 0.5$$

For the test set described, V_{CC} is approximately 7 or 3.5 volts, depending on the position of S5.

Oddly enough, for a given value of I_C there is also a minimum value of V_{CE} which may be applied to the transistor under test, because all voltage not dropped either across the current reading resistor, R_C , or across the transistor under test must appear across the regulator transistor. To avoid damaging V, the applied V_{CE} to the transistor under test must be greater than a value given by the following expression:

$$V_{CE \text{ MIN}} = V_{CC} - I_C R_C - \frac{P_{C \text{ MAX } 2}}{I_C}$$

where $P_{C \text{ MAX } 2}$ is the maximum collector power rating of transistor V. Thus, for small values of I_C , the minimum value of V_{CE} is not important. At large currents, however, this factor must be considered. Switch S5 has been provided to give some aid to this problem.

Using the tester

To measure h_{FE} , a transistor is plugged into the socket, the

V_{CE} ADJUST control is set to give a voltage on the meter connected to the V_{CE} terminals which is somewhat higher than for the operating point desired and the base-current control adjusted to give the required value of I_C . Some readjustment of the V_{CE} control may be necessary. Once the operating point has been set,

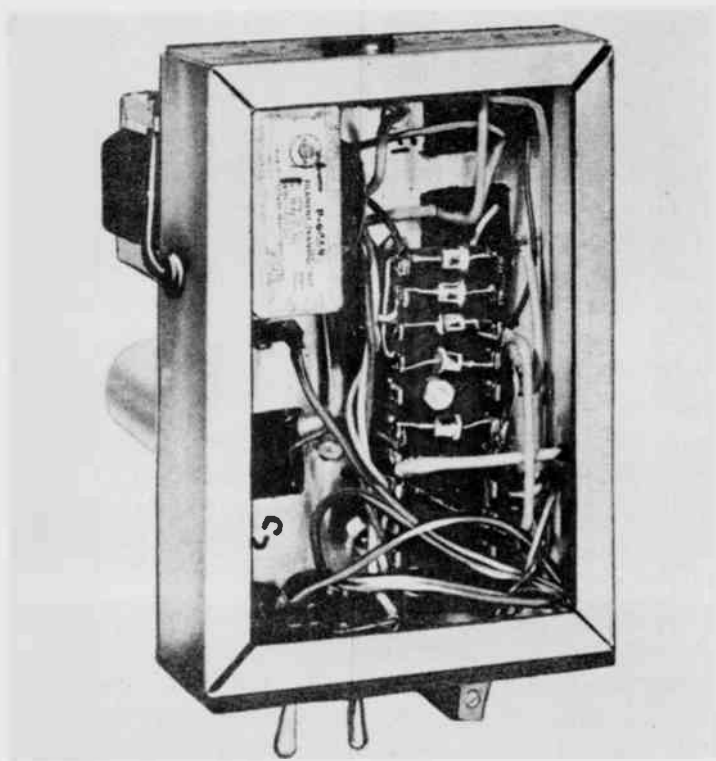

Fig. 128. Transformers, rectifiers and capacitors are on the chassis attached to the panel.

turn the h_{FE} dial until the meter connected to the NULL DETECTOR terminals reads zero.

The sensitivity required for the null detector depends on the operating I_C and the desired accuracy. The higher the value of I_C , the less sensitive the detector has to be. For points near the null, the null-detector voltage is given by the expression:

$$V_N = h_{FE}^* = I_C R_C$$

where h_{FE}^* is the *percent* change of h_{FE} from the null value. Thus, if measurements are being made at a collector current of

20 ma on the 0-100 range, a null detector capable of detecting 12 mv is required if an h_{FE}^* of 3% is desired. The h_{FE} dial reads directly from 0 to 100 on the 0-100 range. On the 0-500 range the dial reading is multiplied by 5.

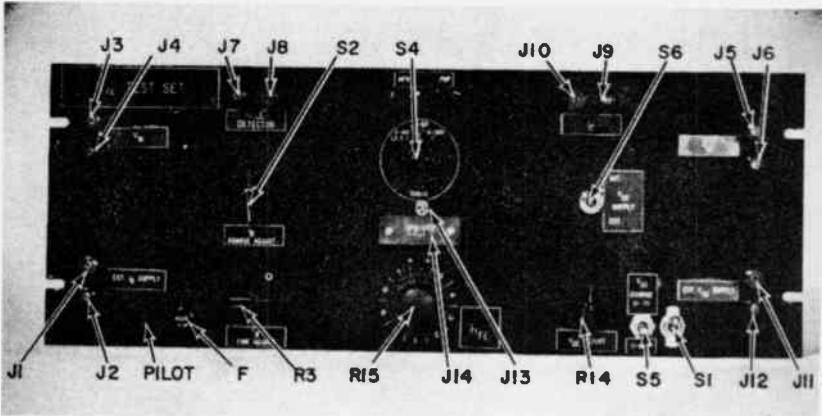

Fig. 129. A clean front-panel layout gives the instrument a professional appearance. Because of the large number of controls, each should be clearly identified. The edges of the panel are notched for mounting on a rack.

Values of dc current gain

Manufacturers supply design values of dc current gain in three ranges: minimum, average and maximum. The separation between the two extremes, minimum and maximum, is fairly large. As an example, in a representative high frequency, diffused junction, n-p-n silicon power transistor, the minimum is 45, the maximum 135. The average value of dc current gain in this case is 90. Incidentally, no units are assigned to dc current gain.

Other parameters

H parameters, such as those that have been used in connection with the construction and use of this tester, are those that are also used by manufacturers of transistors in the specifications of their products.

Actually, there are three types of parameters. These are the h, the R and the Y parameters. The R parameters are written on an impedance basis, the Y parameters on an admittance basis, while the h parameters are a hybrid unit, consisting of both.

Considering a transistor operating in a common-emitter configuration, h_{FE} corresponds to h_{22} . When working with a param-

eter such as h_{22} , it is necessary to specify the circuit arrangement that is being used. Working with h_{FE} , though, tells us immediately that a common emitter circuit is being used.

In describing h_{22} , we say that it is the output admittance with the input open circuited. Sometimes the word conductance is used instead of admittance. In this particular instance, the two words means the same.

section 2

2

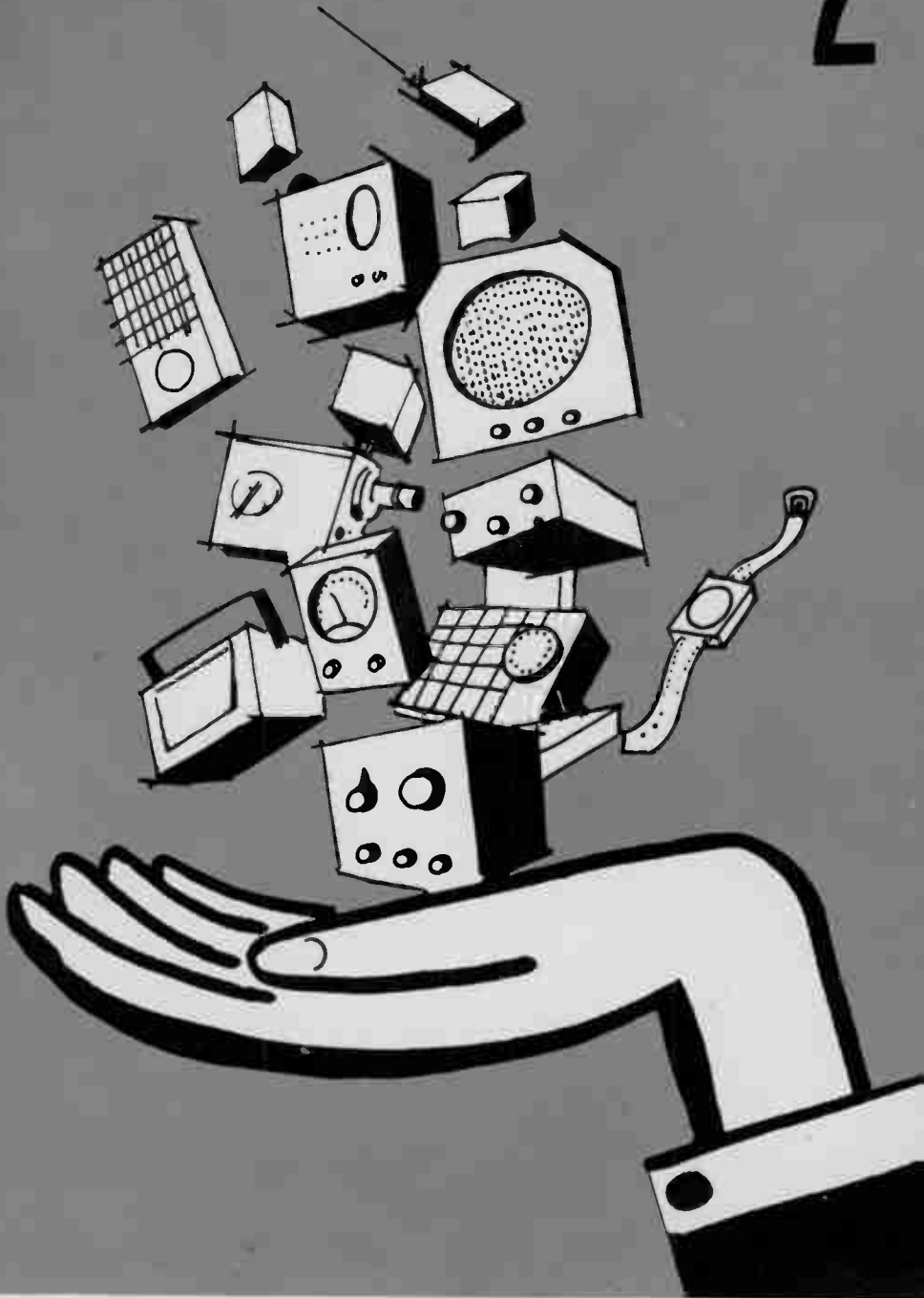

all-transistor test equipment

The words transistor and portability are immediately apparent as being closely related. Not only is the transistor associated with smallness, but a whole line of components have been specifically designed to keep company with this miniature semiconductor. For the experimenter and the hobbyist, but more particularly for the service technician, the ability to carry test equipment in convenient size and weight has been advantageous. The equipment described in the following pages demonstrates what can be done.

measure harmonic distortion

As the number of transistor devices increases, an instrument that can make distortion measurements at low levels is needed. Some transistor output circuits develop only 25 mw into 8- or 4-ohm loads. Any test of distortion at this level means that the output voltage is less than 0.5.

With the instrument described here, a 70-mv input is large enough to give the calibrating 1 volt out. The unit's sensitivity is not improved by sacrificing its ability to go into a deep null, and distortion measurements can be made down to 0.1% without noise becoming a problem.

Three transistors are used in the analyzer, and they offer distinct advantages. Power supply problems are eliminated — batteries put an end to filtering and regulation. Low-impedance circuitry throughout, coupled with the absence of hum, makes a deep null possible, uncluttered with confusing noise and hum.

How it works

Performance and action of the transistor circuitry compare favorably with its vacuum-type brother. (See the schematic shown in Fig. 201). The input voltage is fed to a phase divider (V1) that develops twice the voltage at the collector as at the base. This meets the requirements for the Wien-bridge null network. The Wien bridge suppresses the fundamental without materially affecting the harmonic content. The residual voltages that represent the distortion content are amplified and measured.

The other essential requirements are to maintain a low distortion level and make sure the second harmonic is not attenuated with the fundamental. Both are met with a generous amount of feedback. The output of the first audio amplifier, V2, is fed back to the analyzer's input through a 68,000-ohm resistor (R3). The negative feedback introduced in this way reduces the distortion

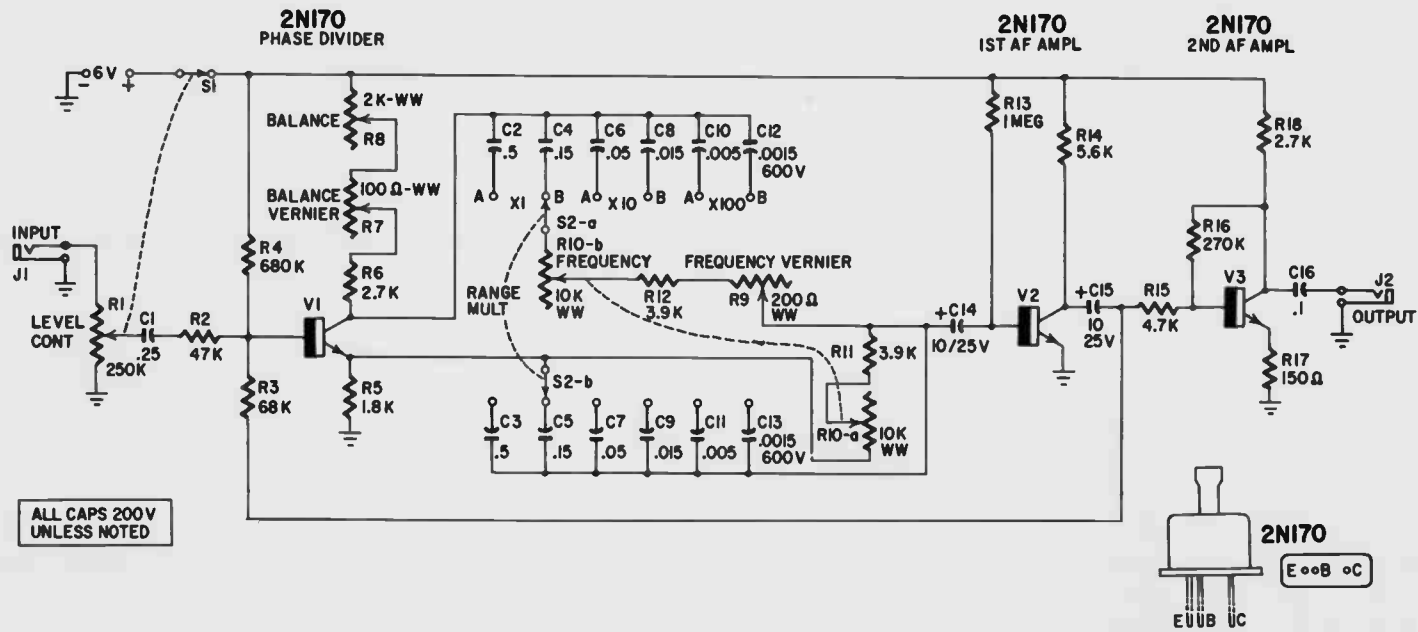

Fig. 201. Circuit of the harmonic distortion measuring instrument. Three inexpensive transistors give the circuit its 70-mv sensitivity. Resistors are used as the variable element of the null network.

parts list for harmonic distortion measuring unit

R1—pot, 250,000 ohms, with spst switch	C1—0.25 μ f
R2—47,000 ohms	C2, 3—0.5 μ f
R3—68,000 ohms	C4, 5—0.15 μ f
R4—680,000 ohms	C6, 7—.05 μ f
R5—1,800 ohms	C8, 9—.015 μ f
R6—2,700 ohms	C10, 11—.005 μ f
R7—pot, 100 ohms, wirewound	C12, 13—.0015 μ f, 600 volts
R8—pot, 2,000 ohms, wirewound	C14, 15—10 μ f, 25 volts, electrolytic
R9—pot, 200 ohms, wirewound	C16—0.1 μ f
R10—pot, dual 10,000 ohms, wirewound	All capacitors 200 volts unless noted
R11, 12—3,900 ohms	J1, 2—phone jacks
R13—1 megohm	S1—spst on R1
R14—5,600 ohms	S2—2-pole 6-position rotary
R15—4,700 ohms	V1, 2, 3—2N170 (General Electric)
R16—270,000 ohms	Battery, 6 volts, (4 flashlight cells in series)
R17—150 ohms	Chassis, 8 x 6 x 3½-inch aluminum box
R18—2,700 ohms	Knobs
All fixed resistors ½ watt	Miscellaneous hardware

created by the analyzer and sharpens the null. Use of a low signal level in the input circuit also tends to lower inherent distortion.

Using transistors rather than tubes has made some circuit changes necessary. Instead of variable capacitors as the variable element of the null network, the resistance is varied. This is done because low impedances are necessary. The FREQUENCY control (R10) is, therefore, a dual 10,000-ohm wirewound potentiometer, limited in range by the series-connected 3,900-ohm fixed resistors (R11 and R12). The RANGE MULT switch (S2) has six positions covering 23 to 27,000 cycles. Every other switch position decades, so the control has two scales: 23-80 and 75-270. To have used only three ranges would have made it difficult to get a null on the low-resistance end of R10. The six ranges make it possible for the operator to get a fine null, even without using the FREQUENCY VERNIER control (R9).

Range capacitors may have to be selected. Even though the BALANCE control (R8) can be adjusted to compensate for misbalance between capacitors, extreme misbalance may exceed its range. If poor tolerance capacitors (20%) are used, frequency decading will not be accurate, but in this type of instrument this is not necessary.

The instrument's input impedance, at its maximum sensitivity of 70 mv, is 50,000 ohms. This increases rapidly as the LEVEL CONT (R1) is turned down for higher input levels. For example, at an input voltage of 0.3, the input impedance is above 200,000 ohms.

The harmonic content amplified by V2 is fed to V3 for further amplification, and on to an external indicator — audio vtvm or scope. A set level of 1 volt is used, and the distortion percentage is arrived at by determining the percentage of the residual compared to the 1-volt set level — 10 mv becomes 1% distortion. The 1-volt set level is set at a frequency beyond the second harmonic of the test frequency. For example, if 400 cycles is to be used to check harmonic distortion, the LEVEL CONT is adjusted for a 1-volt output at some frequency beyond 800 cycles.

Construction and calibration

The unit is built into an 8 x 6 x 3½-inch aluminum box as shown in Fig. 202. Transistors and associated components are

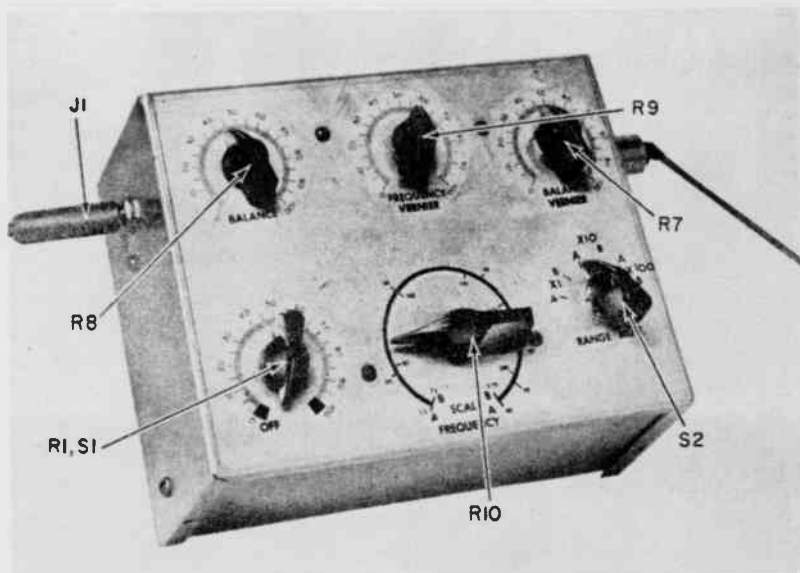

Fig. 202. Outside view of the completed instrument. Note the two frequency scales (R9 and R10) on the front panel.

mounted on three terminal strips. The 2N170 transistors are easily available and prove satisfactory for the job.

It is best to calibrate the FREQUENCY control against actual frequency. If you use 20% capacitors in the null network, the actual frequency will appear a little to the left or right of the calibrated point, representing the amount of capacitor inaccuracy. The calibration chart shows the frequency calibrating points related to resistance measured from the arm of potentiometer R10-b

to the far end of resistor R12. In other words, 3,900 ohms plus the variable value of the pot.

The grouping of the controls is not critical and is governed by convenience. The central control is the frequency-setting dual pot R10. Other controls are arranged around it. If you find some other setup more convenient, use it.

In operation, the unit's null is sharp. The wirewound controls cause no difficulty since fine controls are provided for both balance and frequency settings. A greatly misbalanced circuit — R8 at the extreme end of its range — may cause it to oscillate because of feedback through R3. This resistor (R3) is connected between the output of V2 and the input of V1.

As the unit is calibrated by making resistance measurements, panel markings may not be exact. However, in making distortion measurements this causes no problems. The panel markings give you a starting point and the null will fall slightly to the right or left of this point.

Calibration Chart

Range A		Range B	
Frequency (cycles)	Resistance (ohms)	Frequency (cycles)	Resistance (ohms)
23	13.9K	75	13.9K
25	12.7K	85	12.5K
30	10.6K	100	10.6K
40	7.95K	125	8.48K
50	6.35K	180	7.08K
60	5.3K	200	5.3K
70	4.55K	225	4.7K
80	3.9K	270	3.9K

If accurately calibrated — use a laboratory audio generator or audio signals of known frequency — the analyzer can be used to determine the frequency of an unknown tone.

Sensitivity

The analyzer's final sensitivity will depend to a large extent on the gain of the transistors use. Of several that were tested, many showed gains of over 70. This is a great deal more than the expected gain of 32. The gain variation may make it necessary to adjust the value of feedback resistor R3. It should be set for a minimum of variation in the set level when the range switch is rotated. Too low a value will make the analyzer susceptible to oscillation and reduce its sensitivity.

noise squirter

SIGNAL injection is a commonly used audio circuit servicing technique. The usual signal injector is an audio signal generator. But it is sometimes annoying to use. It has to warm up, you have to attach a probe — these are all time-consuming tasks. For speedy signal injection, try a portable unit. The one described here measures only 1 x 2½ inches, is completely self-contained, and goes into operation at the push of a button.

Circuit arrangement

Two transistors (V1 and V2) are connected in a multivibrator circuit (see Fig. 203) in which the feedback signal is fed from

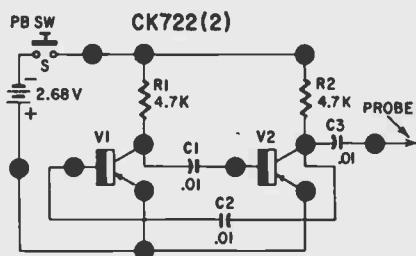

parts list for the noise squirter

R1, 2—4,700 ohms, ½ watt, carbon
 C1, 2, 3—.01 μ f, disc ceramics, 600 volts
 S—see Fig. 204
 V1, 2—CK722
 Battery, 2 mercury cells, 1.34 volts (Mallory RM630R or equivalent)
 Machine screw 4-36, 2½ inches long
 Machine screw, 4-36, 3 inches long

Blank washers, Micarta or fiber, ⅛-inch thick (to fit dust cover) (2)
 Dustproof case (used to package small screw and nut attachments) approximately 1 x 3 inches
 Solder lug
 Miscellaneous hardware

Fig. 203. Simple common-emitter coupled multivibrator circuit forms the heart of the Noise Squirter. The numbers refer to construction information given in the text.

the collector of each transistor to the base of the opposite one. The emitters are connected directly to the positive side of the battery supply — limiting resistors are not used. Base-return resistors, which are normally used to generate a bias voltage, are not necessary in this circuit. Collector current is limited to a very small value by the near-cutoff characteristics of CK722's. This is unusual, but practical when transistors are used instead of vacuum tubes.

Basically, the circuit is a free-running multivibrator (that is, it

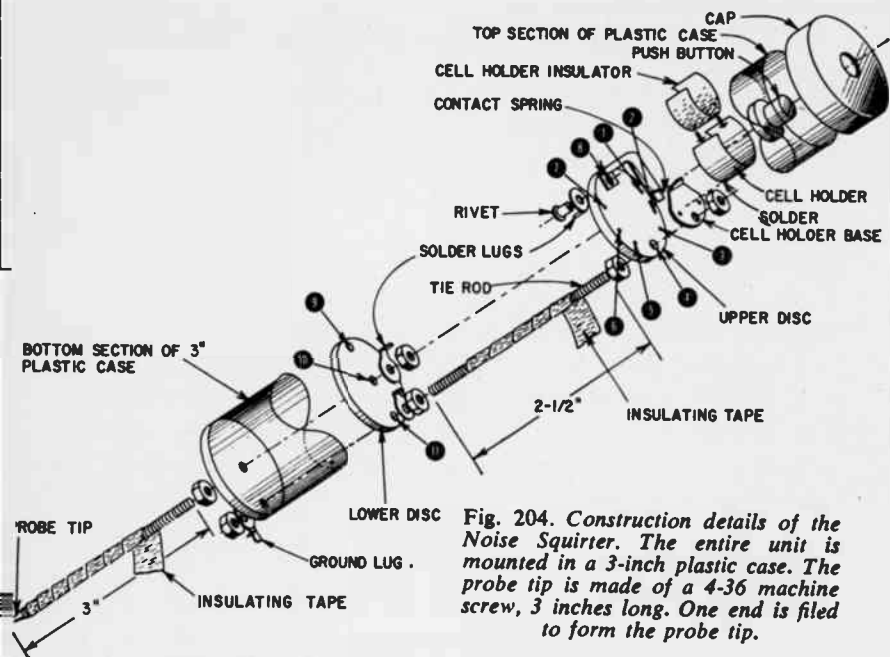

Fig. 204. Construction details of the Noise Squirter. The entire unit is mounted in a 3-inch plastic case. The probe tip is made of a 4-36 machine screw, 3 inches long. One end is filed to form the probe tip.

is not under the control of an externally applied sync pulse). One transistor is driven from the saturated-current condition to current cutoff by the other transistor. The frequency of this alternation is the fundamental audio tone produced by the Noise Squirter. You can change the tone of the oscillator by substituting new values of capacitance for C1 and C2. They should both be increased or decreased by the same amount. The frequency of oscillation is inversely proportional to the capacitance. Increase the capacitance and you lower the frequency. Reducing the capacitance will increase the frequency. The oscillator's output is fed to the probe affixed to one end of the Squirter. A switch on the other end turns the unit on and off.

How to build one

Construction of the unit is divided into four parts: making the upper disc; making the lower disc; mounting resistors and capacitors; testing and assembling in its case (see Fig. 204).

The upper disc is a Micarta or fiber washer about 1/16-inch thick that will fit inside the dustproof case. The cell holder is made from thin tin-can stock — use a strip 1/2 inch wide and 1 1/2-inches long. The cell-holder base can be made of the same mate-

rial. It extends inside the cell holder far enough to contact the outside shell of the lower mercury cell. Cut the cell-holder base to size and drill three holes in it, as shown. One is for the tie rod and the other two are for connecting the transistors' emitters. Solder the center of the cell holder to the cell-holder base. Now drill all holes for connecting resistors and capacitors, through the insulated washer before mounting the cell holder and base. The hole drilled at point 8 is for the rivet that holds the spring contact to the upper disc. Insulate the inside of the cell holder to keep it from contacting the shell of the upper mercury cell.

The lower disc is another insulated washer. It has three holes in it. No. 11 holds the lower end of the tie rod; 10 is the top support for the test prod, and 9 is a solder terminal. The tie rod is a 4-36 machine screw, long enough to space and support the upper and lower discs.

Component wiring

Mount capacitor C2 between points 2 and 7, letting it hang about $\frac{3}{8}$ -inch below the upper disc.

Mount C3 between points 7 and 10. Cover the lead to point 10 with spaghetti.

Mount C1 between points 1 and 6. Cover the lead to 6 with spaghetti.

Mount R1 between points 1 and 9.

Mount R2 between points 7 and 9.

Check all resistors and capacitors to be sure they are in the correct position. Then solder them together at the various points.

Feed V1's emitter lead through point 3, and solder.

Feed V1's base lead to point 2 and solder.

Solder V1's collector lead to point 1.

Leave the leads long enough so the transistor hangs below the capacitors.

Feed V2's emitter lead through point 5 and solder.

Solder V2's base lead to point 6.

Solder V2's collector lead to point 7.

While soldering transistor leads, use pliers or other form of heat sink between the soldered connection and the transistor.

Connect points 8 and 9.

Connect points 3 and 4.

Check all joints for mechanical and electrical connections and possibility of shorts.

Testing the squirter

Insert the mercury cells with the positive side down and the instrument is now ready for testing. Hook up a pair of headphones to the prod and ground connection and close the switch. A tone should be heard. If the unit is working satisfactorily insert it in its plastic case, put the pushbutton (from an old ballpoint pen) in the cap and place the cap on the assembly.

Using the squirter

Using the instrument is easy. (It is shown in action in Fig. 205.) If the prod is touched to a high-gain section of an operating amplifier, the tone will be heard. If it is not loud enough connect a flexible wire from the ground lug at point 11 to the chassis of the amplifier under test.

When using signal injection, start with the plate circuit of the last stage, then its grid circuit, the plate of the preceding stage and so on toward the front of the amplifier.

When servicing transistor receivers, start at the collector of the last stage, then move to the base, the collector of the preceding stage, etc.

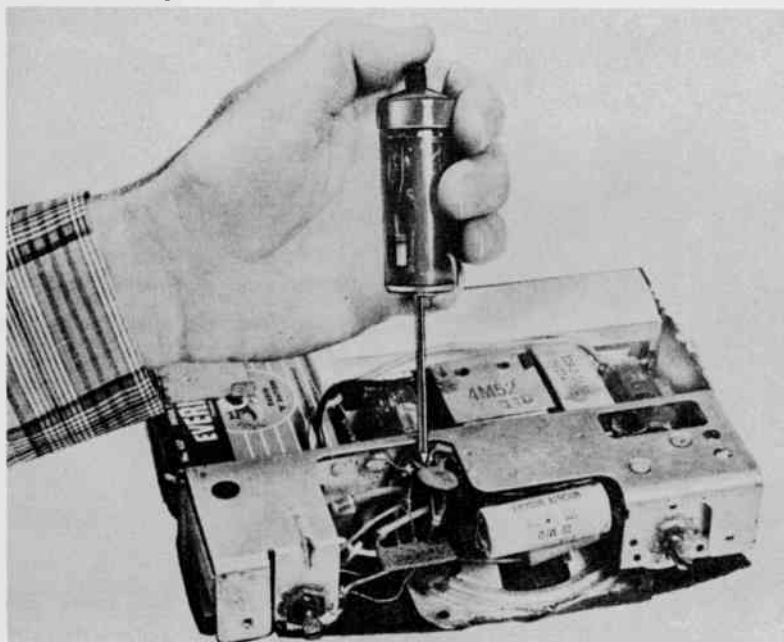
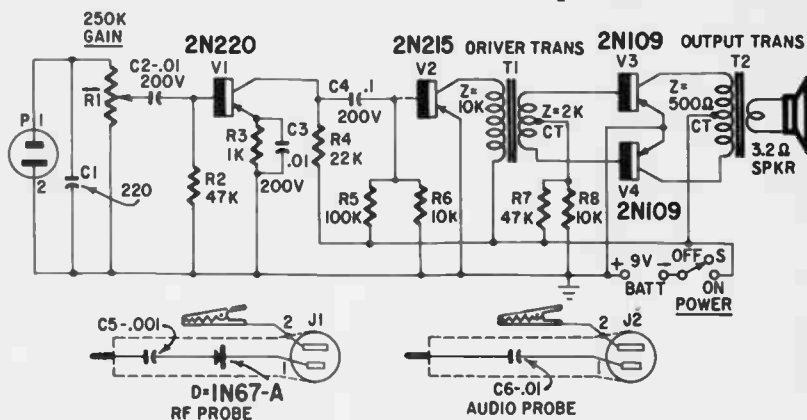

Fig. 205. *The Noise Squirter in action. No waiting for this little generator to heat up. It's ready for action when you are.*

mini-tracer

THE signal tracer is a time-honored instrument universally used for troubleshooting and isolating defective stages in many types of electronic equipment. It is used as a detector-amplifier to check the operation of rf and if amplifiers. It can be used as a straight audio amplifier to check phono cartridges, microphones and pre-amps and the operation of audio circuits and to detect noise and hum in amplifiers.

This test instrument is so versatile and useful that it was built as a compact transistor unit to fit into a rear pocket or small tool-



parts list for the mini-tracer

R1—pot, 250,000 ohms
 R2, 7—47,000 ohms
 R3—1,000 ohms
 R4—22,000 ohms
 R5—100,000 ohms
 R6, 8—10,000 ohms
 All resistors ½ watt, 10%
 C1—220 μ f mica
 C2, 3—.01 μ f 200 volts, paper
 C4—.1 μ f, 200 volts, paper
 C5—.001 μ f, miniature paper (Aerovox P83Z or equivalent)
 C6—.01 μ f, miniature paper (Aerovox P83Z or equivalent)
 BATT—9 volts
 D—1N67-A
 J1, 2—jacks (Cinch-Jones Series 300, No. S302-CCT)
 P—plug (Cinch-Jones Series 300, No. P302-AB)

S—spst toggle
 T1—driver transformer: primary, 10,000 ohms; secondary 2,000 ohms ct; primary dc resistance 240 ohms; secondary dc resistance 60 ohms. (Lafayette TR-98 or equivalent)
 T2—output transformer: primary, 500 ohms ct; secondary 3.2 ohms; primary dc resistance 42 ohms; secondary dc resistance 0.7 ohm. (Lafayette TR-99 or equivalent)
 V1—2N220 (RCA)
 V2—2N215 (RCA)
 V3, 4—2N109 (RCA)
 Speaker, miniature, 3.2 ohms
 Case, 5½ x 3 x 2½ inches (Bud Minibox CU-3006 or equivalent)
 Test probes
 Miscellaneous hardware

Fig. 206. Circuit diagram of the mini-tracer. Two probes are used. One is for rf signals, the other for audio.

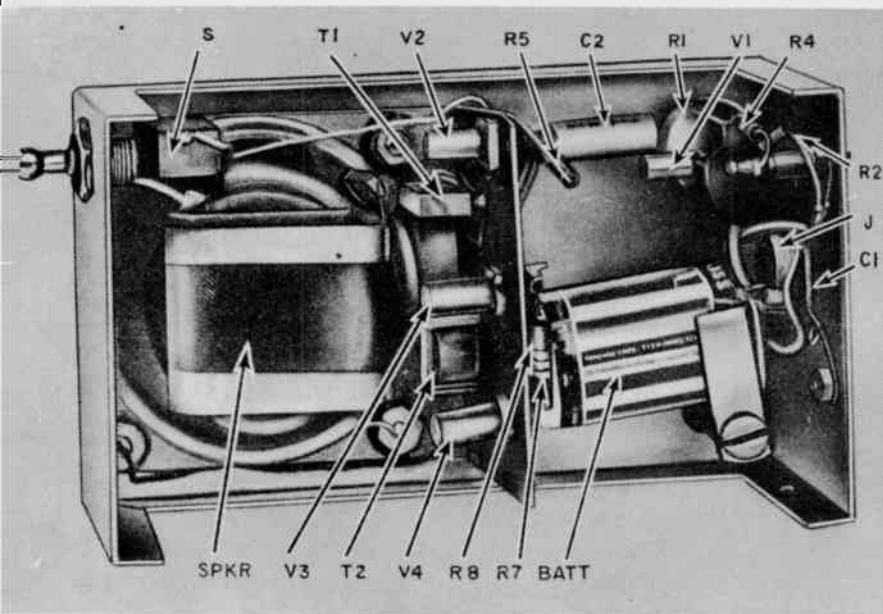

Fig. 207. Inside view of the tracer. Although the unit is very compact, there is ample room for all the parts.

box so it could be on hand at all times. Battery requirements are modest and the transistors are almost indestructible. This combination of long life, ruggedness and dependability is hard to beat. (The circuit is shown in Fig. 206.)

Basically, the unit is an audio amplifier. As such, it can be used to substitute for the audio amplifier (or any portion of it) in the receiver being tested. To test for audio signals, anywhere from the detector load resistor (up to and including the speaker) the tracer is used in conjunction with an audio probe.

For use in rf and if sections, some form of demodulation is necessary. This is done with the help of an rf probe containing a 1N67-A diode.

An rf signal is applied to the unit through the rf probe's dc-blocking capacitor C5 to the diode, for detection. For audio use, C6 serves as a dc-blocking capacitor, and the signal is applied directly to potentiometer R1, which doubles as the diode load and its GAIN control. The detected audio signal is coupled to V1's base.

The push-pull output stage (V3, V4) is driven by a 2N215 voltage-amplifier driver (V2), and produces more than adequate

sound output from the miniature speaker. A 100- μ v input at V1's base gives an audible response, at a total battery drain of 6 to 8 ma.

Construction kinks

The only critical consideration is the location of the 2N220 input stage and GAIN potentiometer R1. They must be mounted close to plug P, and as far as possible from the output stage to minimize coupling between input and output.

The rest of the circuit is straightforward. You can use two pieces of copper-clad laminate board for a chassis — one to mount the input circuit, the other for the driver and push-pull output. Driver transformer T1 and output transformer T2 are mounted at right angles to each other to minimize coupling. See Fig. 207.

The input probe connector can be any good quality type that is strong enough to support the probe's weight and stand the pressures for use. Cinch series 300 plugs and sockets are desirable because they are rugged enough to take rough handling and are easily adapted for probe construction.

The rf probe is fabricated from a standard test probe and connector. If necessary, enlarge the inner diameter of the probe body by drilling carefully. Then slip the capacitor and diode into the probe housing. Solder the probe tip to the capacitor and the diode lead and ground wire to the connector terminals. File a little notch in the connector shell to allow the ground lead to pass through freely, then assemble the shell over the connector and probe body and fasten in place.

It will not always be necessary to touch the probe tip of the squirter directly to the plate lead of a tube or the collector lead of a transistor. When working at the input side of a high gain amplifier you may find that the squirter has enough leakage to permit signal pickup without direct contact. In any event, if you should have an instance in which the signal blasts, just move the squirter away far enough so that the volume comes down. While it is true that the receiver's volume control can be adjusted, you may be working *after* the volume control and not before it, in which case the control will be ineffective.

When you find a spot where the signal is weaker or disappears, the faulty stage has been located.

The Noise Squirter uses components that will stand up under normal bench usage. It can be stored in any position, except with

the button down. Power drawn from the two mercury cells is 230 μa at 2.68 volts — little enough to insure long battery life.

The audio probe is made from a banana plug and plug connector. It may also be necessary to enlarge the inner diameter of

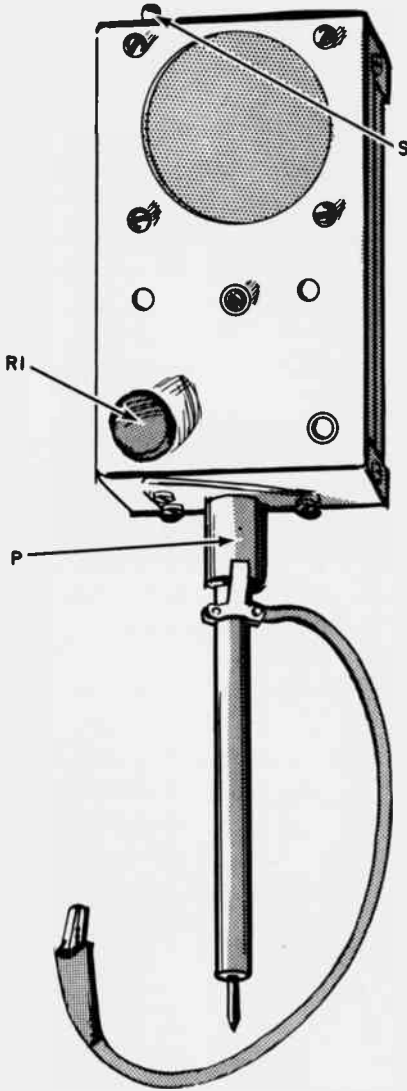

Fig. 208. Outside view of the tracer. Care in assembly produces a professional-looking product.

the banana-plug body to admit capacitor C6, which is soldered to the plug tip. The other capacitor lead and the ground lead are attached to the connector terminals and assembled the same as the rf probe.

A 24-inch cord with mating connectors on each end extends the probe's reach into tight corners or deep chassis. The battery is a small 9-volt unit and can be mounted with a mounting clamp in any position where space is available.

Final check

When the unit is completed, carefully check transistor connections and battery polarity. Incorrect polarity may ruin the transistors! Throw the POWER switch S to ON and listen for the characteristic rushing noise produced by the first transistor stage. The 2N220's internal noise is amplified by the succeeding stages and indicates that the amplifier is working. If nothing is heard, remove the battery power immediately and recheck the circuit or transistors.

If all seems well, apply an audio signal from a generator or phono cartridge for a check of the amplifier's performance. Then connect the rf probe and test it with an operating broadcast receiver tuned to a strong local station. Connect the probe ground to the receiver ground and place the probe tip at the detector tube's diode pin or the plate of the last if amplifier. The station program should be heard loud and clear if the probe is wired correctly.

The completed, professional-looking unit is shown in Fig. 208. The ON-OFF switch, S, is conveniently mounted on top of the case. The gain control, R1, is at the lower-left. These two parts, the gain control and the switch, could be a combined unit. Because of the absence of any other variable controls, the unit is simple and easy to use.

Using the tracer

Very little audio input is needed to operate the signal tracer as a straight audio amplifier. Always start with the GAIN control turned down, for it is easy to overload and distort the small speaker's response with too much input. Don't use the tracer for a check of fidelity for it is designed for maximum sensitivity without regard to frequency response.

For rf testing, the probe's ground lead must be connected to the power supply ground of the receiver under test. This may be the

chassis or, in ac-dc types, the common ground at the power switch or the filter capacitor negative lead.

Start at the detector diode side of the last rf transformer and work your way toward the front of the set. The sequence should be detector diode, last if amplifier plate, then grid, next if amplifier plate, and so on. If there is no output at any of these test points, the stage is defective and the defective components can be isolated.

The probe may load the mixer plate or input if grid in some receivers. If this happens, inject a tone-modulated rf or if signal into the receiver's front end to get an output from the tracer.

Proceed in a similar manner when testing transistor radios. Work backward, stage by stage, starting with the collector, then moving to the base.

The mini-tracer will not tell you specifically which component is defective. But with its help, you will be able to determine (and quickly) just where the signal has disappeared.

In vacuum-tube receivers, you can use it to track down sources of hum. You will also find it helpful in learning just where in a receiver distortion is being produced.

There are many other uses for the tracer. You can, for example, use it to check on the gain of a stage. For this it is best to work with a signal generator. Set the generator to any frequency in the broadcast band. The modulation of the generator should be turned on. You can now work from the front of the set toward the audio end, or from the speaker to the antenna. As you proceed from input to output of a tube or transistor, you should hear a louder sound out of the speaker.

You can also use the tracer to check on the effectiveness of bypass capacitors. If the tracer gives you a signal at a point that is supposed to be bypassed, it would be well to check on the capacitor.

The signal tracer is valuable for learning just what sort of signals you can expect in the various parts of a receiver.

This instrument will return the modest investment of parts and construction time a hundredfold by its usefulness and versatility. The old-timer knows the value of a good signal tracer, and the younger technician will be delighted with the help this servicing aid can give.

tv bar generator

THIS television bar generator occupies no more toolbox room than a couple of 5U4's. It is just the thing for either home-service calls or bench work. There are no vacuum tubes — transistors are used throughout — and the unit is entirely self-contained.

No dangling and tangling power cord is needed. A single 4-volt mercury battery supplies enough power for about 2 years of operation in a shop with plenty of work to get out.

The circuit contains three oscillators and uses four transistors. One oscillator generates a carrier signal in the 30-mc range. Harmonics from this oscillator fall within the TV channels, producing good signals even in the high end of the vhf band.

This 30-mc oscillator uses a surface-barrier transistor made by Philco.

Other transistors used in the unit are two G-E type 2N107 and a G-E 2N135. The 2N107 transistors function in a multivibrator that generates the horizontal bar frequencies for modulating the carrier oscillator. This audio-frequency signal is also very handy for signal-injection checking of amplifiers and audio stages of radios and TV sets.

The vertical bar generator oscillates at 10 times the horizontal sweep frequency. Since this is well into the rf region an L-C tuned-circuit oscillator is necessary for adequate frequency stability. A miniature transistor type if transformer, with additional shunt tuning capacitance, serves this purpose.

Circuit details

Looking at the schematic (Fig. 209), you can see that the circuit is simple and naturally divides itself into three sections: carrier oscillator, vertical bar generator and horizontal bar generator. Of course, the carrier oscillator is the heart of this unit.

As you probably know, we must apply a bias to transistors to cause collector current to flow. Also, the bias circuit should be designed to maintain a constant collector current, despite temperature changes and varying transistor characteristics.

Resistors R2 and R3 connect across the battery supply and provide a constant bias voltage to both the SB103 carrier oscillator transistor (V2) and the vertical bar 2N135 transistor (V1). This voltage is applied to the transistor base circuits. The emitter resistors of these transistors are chosen for the desired collector current.

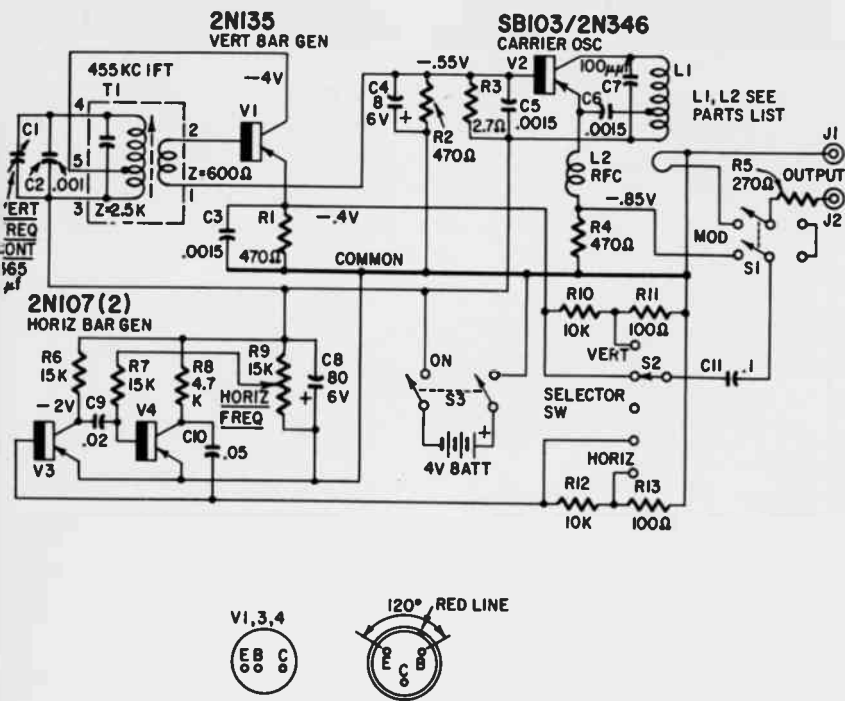

parts list for the tv bar generator

- R1, 2, 4—470 ohms
- R3—2,700 ohms
- R5—270 ohms
- R6, 7—15,000 ohms
- R8—4,700 ohms
- R9—pot, 15,000 ohms, miniature (Lafayette VC-35 or equivalent)
- R10, 12—10,000 ohms
- R11, 13—100 ohms
- All resistors ½ watt or less
- C1—10 to 365 μf , variable (Lafayette MS-274 single-gang Poly-Varicon or equivalent)
- C2—.001 μf , tubular ceramic
- C3, 5, 6—.0015 μf , disc ceramic
- C4—8 μf , 6 volts, miniature electrolytic
- C7—100 μf , disc ceramic
- C8—80 μf , 6 volts, miniature electrolytic
- C9—.02 μf , 75 volts, ceramic
- C10—.05 μf , 75 volts, ceramic
- C11—.1 μf , 75 volts, ceramic
- J1, 2—tip jacks

- L1—5 turns from Borker & Williamson No. 3003 Miniductor
- L2—rf choke, approximately 30 turns No. 26 wire, ½-inch diameter
- S1—dpdt, toggle
- S2—1-pole 5-position rotary
- S3—dpst, toggle
- T1—transistor if transformer (Lafayette MS-268-A or equivalent) 455 kc; primary, 25,000 ohms; secondary, 630 ohms
- V1—2N135 (General Electric)
- V2—SB103/2N346 (Philco)
- V3, 4—2N107 (General Electric)
- BATT—mercury, 4 volts (Mallory TR-233R, Eveready E233 or RCA type VS-400)
- Case—5¼ x 3¼ x 2½ inches (ICA 3797 or equivalent)
- Perforated, insulated chassis board
- Handle
- Knobs
- Miscellaneous hardware

Fig. 209. Circuit diagram of the tv bar generator. This unit is completely self-contained and can be used for home servicing.

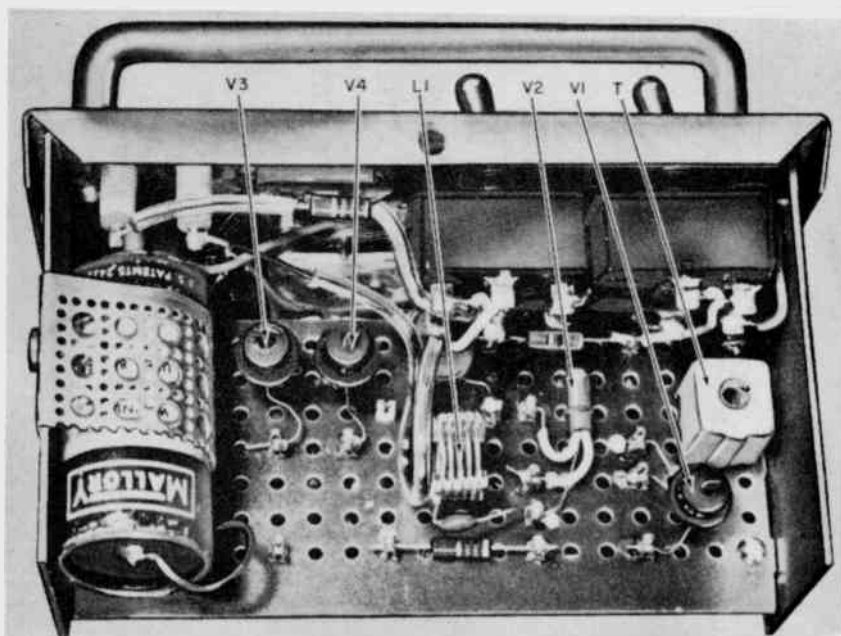

Fig. 210. This picture was taken looking down on the top of the chassis board. Sockets are not used, the transistor leads being wired directly into the circuit. The battery leads are also soldered.

Resistor R4 determines the nonoscillating current of V2. The assigned value of 470 ohms sets this current at about 1 ma. However, when the circuit begins to oscillate, rectification at the emitter-base junction changes this bias, automatically placing the operating point in the class-C region.

With V2 oscillating vigorously, the rectified signal may reach an average value of 0.3 volt. Notice the higher negative voltage of V2's emitter. Ordinarily, if this were an amplifier rather than an oscillator, the emitter potential would then be approximately 0.1 volt lower than the value of the base voltage.

Choke L2 is a simple coil of wire designed to keep the 30-mc carrier out of R4 and the bar-generating circuits. The exact wire size and turns are not too important.

A feedback tap for the emitter is placed approximately three-quarter turn from the -4-volt end of coil L1. This produces the strongest carrier. If you wish to experiment with this tap position, turn off all modulation, connect a low-range voltmeter across R4 and place the tap for maximum voltage reading.

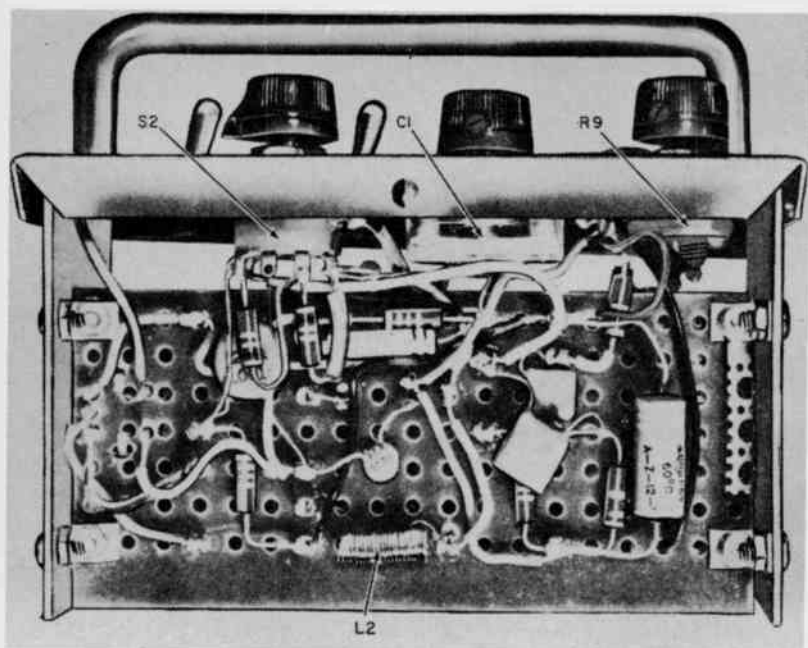

Fig. 211. This is a view of the other side of the chassis board. Most of the small parts are mounted here. The perforations in the chassis board simplify construction.

Although the oscillator is fixed-tuned, it could easily be made variable by replacing fixed capacitor C7 with a variable unit. Coil L1 is a five-turn section from a prewound type 3003 Mini-inductor. This coil has a diameter of $\frac{1}{2}$ inch and a pitch of 16 turns per inch. If you wish, you can wind your own coil from No. 20 wire. The exact wire size is noncritical, but the coil should be wound on a form and doped for rigidity.

Notice the oscillator coil (L1) is placed near the geometric center of the case. This reduces loading effects of the small steel cabinet. The positioning of this coil is shown in Fig. 210.

A single loop of stiff wire, insulated with spaghetti, couples the oscillator carrier to the output packs. A 270-ohm series resistor R5 is necessary to eliminate standing waves on the leads connecting the generator to the TV set.

Switch S1, in one position, connects the output of S2 to V2's emitter for modulation and also connects the pick-up loop to the output jack J2. This position of S1 is marked MOD on the panel.

The other position of this switch connects S2 directly to the output jack J2. The outputs of either the horizontal or vertical bar generators are then available for direct injection into video amplifiers.

In this generator, S2 is an eight-position switch, but only four positions are electrically active. One dead position is necessary to turn off modulation. Only a five-position switch is needed. You can use the extra terminals of the eight-position unit for tie points.

There are two switch positions for both of the modulating oscillators. One provides a signal attenuated by 100 for signal injection into high-gain amplifiers without overloading them. For modulating the carrier, S3 must be in the unattenuated positions.

Vertical bar generator

The vertical bar generator uses a 455-kc if transformer, shunted with both a fixed capacitor of $.001 \mu\text{f}$ and a variable tuning capacitor. This capacitor, C1, can be seen in the photo, Fig. 211. These capacitances are in *addition* to the capacitance inside the transformer can. Capacitor C1 is variable. The one shown in Figs. 210 and 211 is a two-gang superhet type. It was used *only* because it was on hand. This two-gang capacitor is a Lafayette MS-270 but, because of its lower cost, a single gang MS-274 is preferable. They are very compact, solid-dielectric types.

The if transformer is a Lafayette MS-268-A. This type is desirable because it can be tuned from top — in fact, from either end.

A vertical-bar modulating signal is taken from the emitter of V1. It might appear that C3 would bypass all this signal to ground. It does not. At the oscillator frequency, its reactance is roughly 700 ohms.

Two inexpensive G-E 2N107 transistors, operating in a multi-vibrator circuit, produce a horizontal-bar modulating frequency. Because of the non-linear operating conditions for this type of circuit and variations in low-cost transistors, the values of C9 and C10 *may* have to be varied somewhat. This is a job that must, of course, be left until the generator is completed.

If the frequency-varying control R9 does not have enough range to produce the number of desired bars, lower the values of these capacitors to increase the number of bars and vice versa.

Despite the low internal impedance of the mercury battery, a bypass electrolytic C8 is placed across the horizontal bar generator supply voltage. This prevents feedback through the collector supply.

Construction

The cabinet is a control and switch case, fabricated from steel with welded end plates.

This is a small case but there is enough room to mount all parts with a generous margin of space and accessibility. The completed electronic package is strong enough to drop from a service truck without major damage.

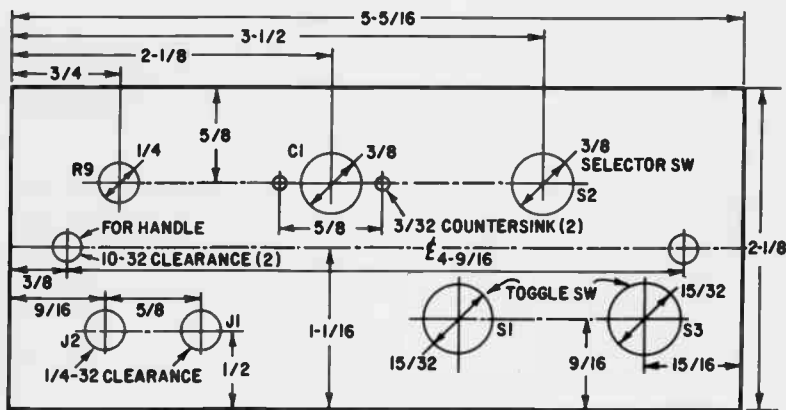

Fig. 212 This panel layout was found to be the best.

A front-panel layout (Fig. 212) shows where to place the controls and switches. This is an optimum arrangement — the result of several hours' planning — and it should be followed exactly.

The insulating-board chassis is supported by two aluminum brackets. In this model, these brackets are held to the front panel by the same screws that secure the chrome handle. If you do not want to use a handle, use the handle holes for ordinary screws. A 6-32 screw fastens the brackets.

Four small right-angle brackets hold the insulating board chassis to the aluminum brackets.

A strap of perforated aluminum, cut from a large sheet sold at the local hardware store, holds the mercury cell in place. One end of the strap hooks around the insulating-board chassis and the other end wraps over the aluminum bracket and is held there by a self-tapping screw.

Attach rubber feet to the case with aluminum rivets. These are also sold in hardware stores. The rivet is pushed into the rubber bumper and through a hole in the case. Then a short spacer (a

sawed-off piece of volume-control shaft works very well) is pushed against the rivet head inside the bumper and rested against the work bench. Then peen the rivet inside the case, using a punch if necessary.

Wiring the generator

Wire the horizontal bar generator first. When it is complete, it can be checked by connecting its output to headphones or into

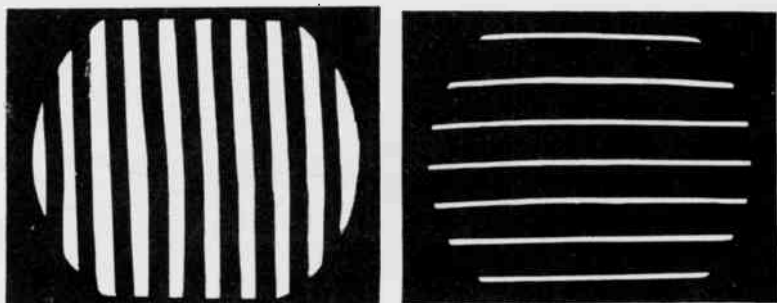

Fig. 213. Vertical and horizontal bars produced by the all-transistor portable generator.

the video amplifier of a TV set. An audio growl with a rather high pitch should be heard in the phones. Horizontal bars should be seen on the screen.

Now, assemble the carrier oscillator. If it is oscillating, the emitter voltage should be greater than the base voltage. If it does not oscillate, and the voltages check OK at the base and collector, add more capacitance to C7 or try changing the tap on L1. The SB103 (V2) is a hot little transistor and you should not have any trouble getting it to work.

Generous leads are left on all the transistors. This protects them from abusive soldering practices and breaking leads at the case.

Be sure of your wiring for the SB103. If it is wired correctly, nothing should go wrong. But even a momentary wrong voltage can ruin its microscopic internal connecting leads.

With this much wired, you should be able to receive the carrier with horizontal bar modulation. If not, check your switches and wiring for possible errors.

Next, wire the vertical bar generator. This will produce vertical stripes on the TV screen, of course. If the generator works except for these bars, try reversing the leads numbered 1 and 2 on the transformer or increase the value of C3. With variable capacitor

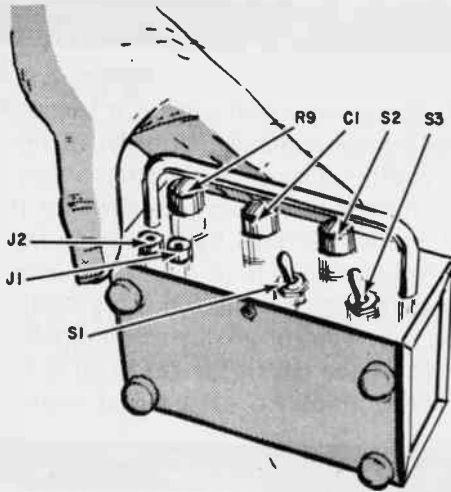

Fig. 214. The completed four-transistor miniature generator. It will supply horizontal and vertical bars, is easily built.

C1 in mid-position, adjust the transformer slug, with an insulated screwdriver (nonmetallic), until the desired number of vertical lines are obtained. (Vertical and horizontal bars produced by the generator are shown in Fig. 213).

As you can see in Fig. 210 leads were soldered to the mercury battery. It is easy to solder to a mercury cell if you scrape the surface and quickly tin it with a hot iron. Then tack a pretinned wire in place with the iron.

Here is one last construction note. If it is anticipated that high voltages may accidentally be applied to J1 and J2, use a .01- μ f capacitor, with a suitable voltage rating, placed in series with resistor R5.

The completed generator is shown in Fig 214. As you can see, this miniature unit isn't much bigger than some transistor radios.

Using the unit

This is simple. Just flip S3 to the ON position, connect J1 and J2 to the set's antenna terminals and switch on the modulation. The number of bars and their sync are adjusted from the front panel. Receiver brightness and contrast are adjusted for the best pattern.

The tuned-circuit constants will supply a signal on channels 5, 8 and 13. For other channels, vary the value of C7.

A-I-R generator

TECHNICIANS and experimenters who construct, test or troubleshoot radios need a three-way signal generator because a superhet must amplify three frequency bands. In order of increasing frequency, these are: audio, intermediate and radio frequency. Here is a compact transistorized instrument designed for this purpose. A suitable name for it was derived by combining the first letters of each frequency band, making it an A-I-R frequency generator.

The A-I-R generator puts out the following signals:

1. A fixed audio tone (af) of good sine quality is available at a subminiature jack (to the left in Fig. 215). It is excellent as a test tone for an audio amplifier, as a signal source for an ac

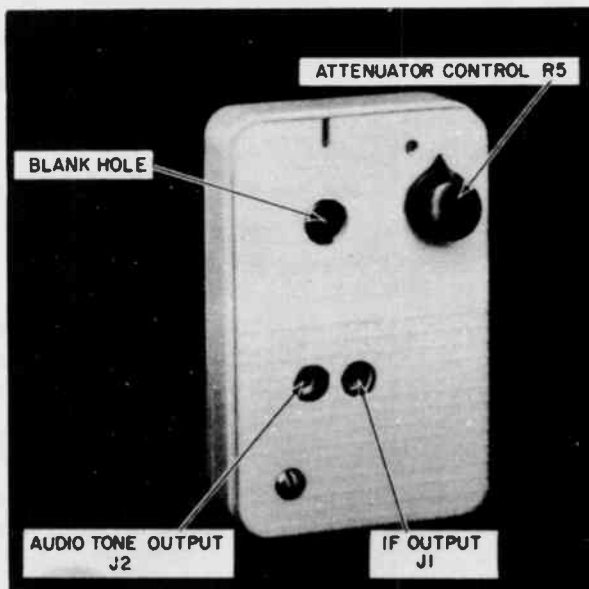

Fig. 215. This pocket generator produces audio, if and rf signals.

bridge or for code practice. An earpiece may be plugged directly into the jack. The output is approximately 100 millivolts (mv).

2. An intermediate frequency signal is available at the other jack. The if is modulated internally by the audio tone, making it suitable for if alignment, signal tracing, etc. The desired frequency, commonly 455 kc, is tuned in with a transformer core. However, the instrument can be retuned at any time for off-beat

if values, such as 450, 465 kc, etc. Later we will show how to tune accurately to the exact frequency you happen to desire.

For most applications, it is important that the if be variable, not only in frequency but in voltage as well. This requirement has been kept in mind here. An attenuator controls the output which may be set for any voltage from zero to about 100 mv. Maximum output may be required when feeding a signal to the

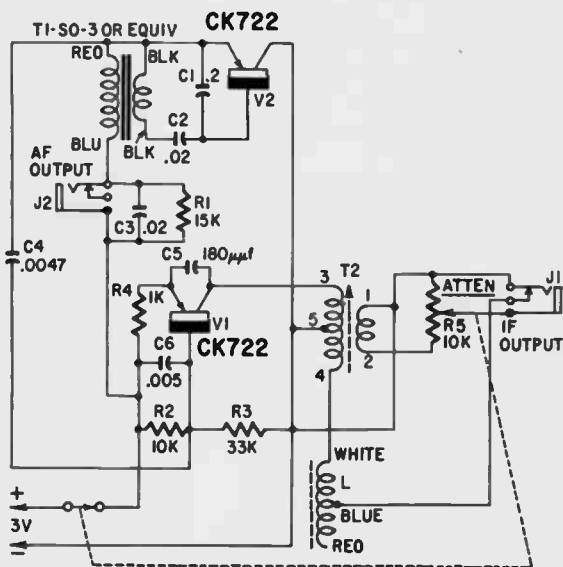

parts list for the A-I-R generator

- | | |
|--|--|
| R1—15,000 ohms | 25,000 ohms, secondary impedance |
| R2—10,000 ohms | 600 ohms) |
| R3—33,000 ohms | L—Ferrite-rod antenno (Lafayette MS-272) |
| R4—1,000 ohms | V1, 2—CK722 |
| R5—10,000 ohms, potentiometer, with switch | Sockets for transistors (2) |
| (Lafayette VC-28) | Jacks, Lafayette MS-282 (2) |
| All resistors $\frac{1}{2}$ watt | Penlight cells (2) (Eveready 912 or equivalent) |
| C1—0.2 μ f | Penlight cell holder (Lafayette MS-138) |
| C2, 3—.02 μ f | Knob |
| C4—.0047 μ f | Topped spacers and screws |
| C5—180 μ μ f | Plastic case, $4\frac{1}{2}$ x $2\frac{1}{2}$ x $1\frac{1}{2}$ inches (Lafayette MS-302) |
| C6—.005 μ μ f | Bokelite perforated board (Lafayette MS-304) |
| T1—UTC SO-3 | |
| T2—Lafayette MS-268A (Primary impedance | |

Fig. 216. Circuit diagram of the A-I-R pocket signal generator. Its small size and versatility make it an ideal unit for home servicing.

last if stage of a radio set. Preceding stages will require weaker signals if overloading is to be avoided.

In general, a modulated if is desired. This is obtained automatically. If modulation is not wanted at any time, remove the audio transistor, leaving only the high-frequency oscillator.

3. A radio-frequency signal near the low-frequency end of the band is fed into a ferrite-rod antenna. Its signal is propagated through the air, so there is no provision for a radio frequency (rf) jack. Like the if, it is modulated by the audio tone. The maximum distance over which the tone can be picked up depends upon the sensitivity of the receiver being tested. A sensitive commercial transistor set receives the signal more than 12 feet away. A sensitive home-made transistor set picks up the tone up to 10 feet or more. For maximum distance, the antennas in the A-I-R and the receiver should be aligned in parallel planes.

Fig. 216 is the complete circuit diagram of the A-I-R generator. V1 generates the if or rf, while V2 provides the audio and modulation signal. Two penlight cells supply all required power.

V2 is a conventional transformer-coupled stage. Positive feedback between emitter and collector results in oscillation. It is important that the windings be properly polarized. If one winding is reversed, for example, there can be no oscillation. Reversing *both* windings does not affect operation. In following the color code of the transformer, note there are two "blacks". The emitter black is the lead on the same side of the transformer as the red. If a different tone is desired, change the value of C1 or C2.

The audio tone across R1 may be fed to an earpiece (insert it into the af jack). Also, the audio voltage across the higher impedance winding of T1 is applied through C4 across R2. Therefore, it biases V1 at an audio rate and modulates the high frequency generated by that transistor.

When there is no plug in the if jack, V1 generates a frequency determined by T2 shunted by L. T2 is an if transformer. L is a ferrite-rod antenna. Actually only a portion of L (between the white and blue leads) is across part of T2 (between terminals 4 and 5). The tank frequency is *higher* than the if band because of the loopstick shunt. It will be in the neighborhood of 620 kc. If this rf is to be varied from time to time, a small capacitor across L may be added, but this has not been done here.

When a plug is inserted into the if jack, L is disconnected from the circuit. Then the tank is tuned in the if band since it includes

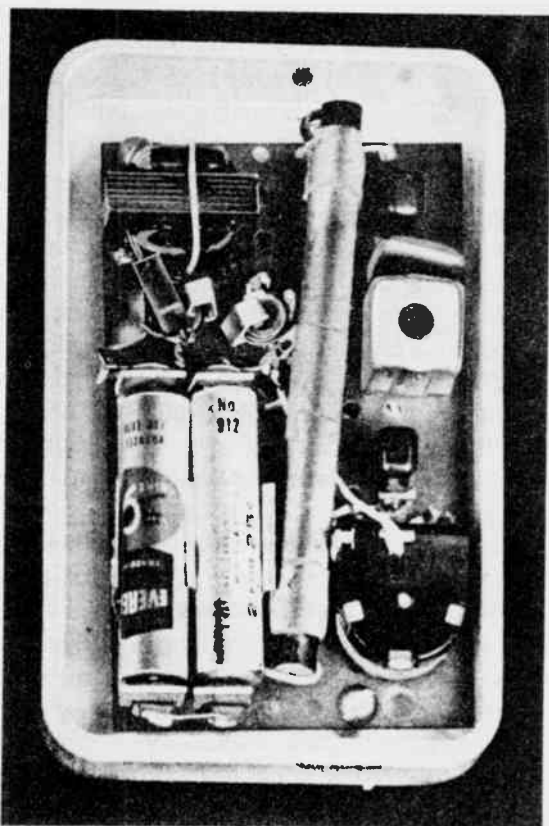

Fig. 217. Inside view of the A-I-R generator.

only T2. This transformer may be core-tuned to 455 kc or any other nearby frequency. The low-impedance winding is shunted by the attenuator R5 which controls the output voltage when a plug is inserted into the jack.

C5 is the regeneration capacitor. Not critical, it should be large enough to support oscillation.

To tune the if transformer correctly, place the A-I-R generator near a calibrated broadcast receiver. Tune the latter to the second harmonic of the desired frequency. For example, if 455 kc is wanted, tune the receiver to 910 kc. Adjust the transformer core with an insulated screwdriver until you hear maximum hissing noise in your radio receiver. If pickup is rather weak, connect terminal 2 of T2 directly or through a capacitor to the antenna terminal of your receiver. With T2 tuned to about 455 kc, add-

ing L as a shunt will raise the frequency to a spot within the low end of the broadcast band. If the actual broadcast frequency is immaterial, there is no need to tune L. Otherwise a small capacitor may be shunted across it, or a tunable type antenna should be used.

The circuit of the A-I-R generator is so simple that any type of construction may be followed. For convenience, a perforated plastic board cut to $2\frac{1}{8} \times 3\frac{3}{8}$ inches is used to support all parts and batteries (See Fig. 217.) The board is $1/16$ inch thick and has holes $1/16$ inch in diameter with $3/16$ inch spacing between hole centers. The board is held in place by a pair of threaded spacers which are screwed down inside a plastic case. This case has two large pre-cut holes on the front. One was used for the rf attenuator, the other left blank. The case drills very easily so the holes for the subminiature jacks are not difficult to make. The holes should be approximately $11/32$ inches to accommodate the plug. The attenuator control shaft extends from the perforated board through the front of the case. This shaft and the two screws are the only parts on the front of the case.

Use a small soldering iron, preferably of the pencil type, while wiring the generator. Remove transistors while the hot iron is being used on the conductors and parts, and be sure the transistors are inserted correctly into their sockets. You don't need special tools to construct the A-I-R generator but, if you have a scope, you can observe waveforms and peak values of each signal. The output from the af jack should be a high-quality sine wave. If the scope can operate at fairly high frequencies, you will also see a sine wave from the if jack when the sweep is set to about 100 kc. The *modulated* wave is observed when the sweep is lowered to some audio rate. With the values shown in the diagram, the modulation percentage came out to about 80%. It is controlled by the values of R1, R2, C3 and C6 to some extent.

The A-I-R generator will find many uses around the repair shop, hamshack and experimenter's corner of the kitchen. Also, if you go shopping for a transistor radio receiver, it can help you acquire the most sensitive set in the store. Have your friend carry the generator or you may conceal it in your own shirt or vest pocket. As you try out each radio in the store, tune it to the tone being broadcast from the A-I-R generator. For this purpose you need only turn on the switch. Do not insert any plug. The receiver that picks up the tone at the greatest distance is the one to buy.

black-box oscillator

WE are tempted to call this gadget a black box. But, speaking humorously, it is really just a gray box with two terminals and a switch on the outside.

But it does have an interesting black-box property. Connect a tuned circuit to the terminals and it oscillates. Feedback loops or taps are unnecessary. It works with quartz crystals, too!

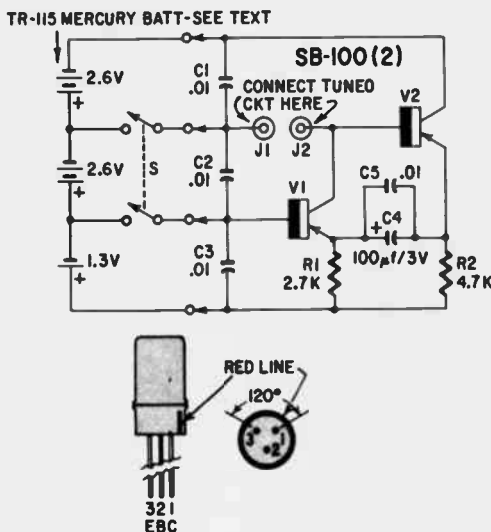

parts list for the black-box oscillator

R1—2,700 ohms, ½ watt	S—dpst toggle
R2—4,700 ohms, ½ watt	Battery—6.5 volts, (Mallory TR-115R mercury cell, or equivalent)
C1, 2, 3, 5—.01 µf, ceramic	Case—1½ x 2½ x 3¼ inches
C4—100 µf, 3 volt, electrolytic	Terminal board
V1, 2—SB-100 (or 2N135, 2N136, 2N137)	Miscellaneous hardware
J1, 2—Binding posts	

Fig. 218. Circuit of the two-transistor oscillator. It will function when a tuned circuit, a crystal or a resistor are connected across J1 and J2.

The tuned circuit can be anything from very low audio frequencies to those in the 10-meter band. The maximum oscillating frequency depends upon the Q of the tuned circuit and the particular transistors used. Without special attention to coil Q and by using a pair of SB-100 transistors, the black-box oscillator functions up to 30 megacycles.

There are few components inside: only a battery, a couple of transistors and a few small parts. The circuit is equally simple and uncomplicated (see Fig. 218).

Circuit theory

Two p-n-p transistors are connected to form a positive feedback loop. The output of one supplies the input of the other. One transistor is grounded-base and the other is grounded-collector connected. Neither configuration introduces phase shift (except for the phase shift of the transistors themselves).

For example, if the emitter of V1 goes positive, its collector passes more current and becomes less negative because of the

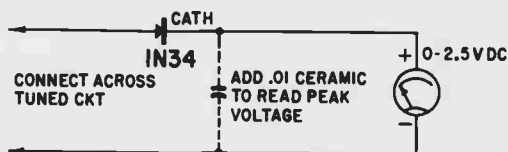

Fig. 219. Circuit for measuring the output of the black-box oscillator at radio frequencies. Use an oscilloscope at audio frequencies.

voltage drop across the tuned circuit. (Going less negative is equivalent to a positive signal swing.)

As V2's base goes more negative (less positive) the emitter voltage follows this change and also goes more negative—or vice versa.

If a tuned circuit is connected across J1 and J2, the voltage change across it will be amplified by V2 and coupled to the emitter of V1. More current will flow in V1 and, consequently, cause more drop across the tuned circuit. Thus V1's current climbs until the drop across the tuned circuit is equal to the available battery voltage. When this point is reached, current can no longer increase.

Capacitors C4 and C5 can couple only changing signals. Therefore, the signal buildup stops at this point and begins to collapse, since this is the only further change possible. When the collapse is complete, buildup starts over again.

This buildup and collapse continues at the resonant frequency of the tuned circuit.

If the tuned circuit is replaced by a 1,000-ohm resistor, another mode of oscillation, determined by the R-C time constants

of capacitor C4 and associated circuit resistances, results. The oscillator frequency, because of the large value of C4, is a slow putt-putt.

Low-Q circuits

When a very-low-Q tuned audio circuit is used, it may oscillate at either the L-C or R-C frequency. Suppose we use headphones with a parallel capacitor as the tuned circuit. Phones are poor inductors and most of their reactance is pure resistance. Because of this, the circuit, as the power switch is flipped on and off, may give either a putt-putt or audio-tone oscillation.

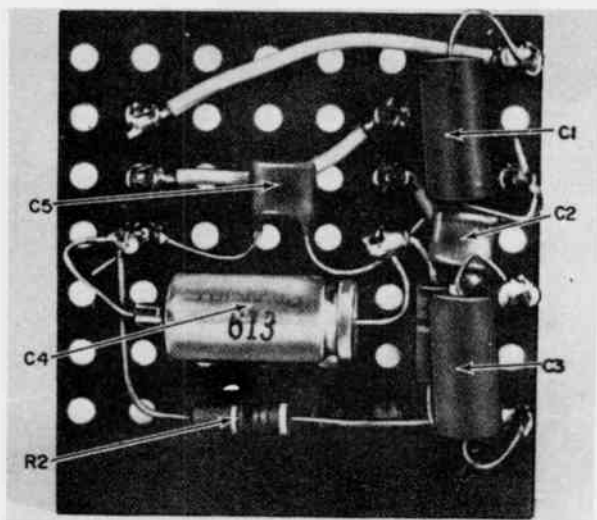

Fig. 220. Bottom view of the pegboard chassis.

Up to about 4 mc, the oscillator output is about 2.6 volts, which is the available collector voltage for a single transistor. Above this frequency, the output tapers off to about 0.5 volt at the highest operating frequency. The method of measuring the unit's output is seen in Fig. 219.

Three capacitors (C1, C2 and C3) are placed on the breadboard chassis. They bypass rf from the mercury battery leads. Capacitor C5, paralleling C4, is necessary because of the notably poor rf characteristics of electrolytics.

These capacitors should be miniature units. Ceramic or paper types are satisfactory. The photo (Fig. 220) shows we used two

ceramic and two paper units. The ceramics are smaller and less expensive, so they are recommended.

The battery voltages deserve some mention and explanation. A standard TR-115R Mallory mercury cell with a nominal output voltage of 6.5 powers the box. (See Fig. 221.) For our application, voltage taps at 1.3 and 3.9 volts are necessary. These

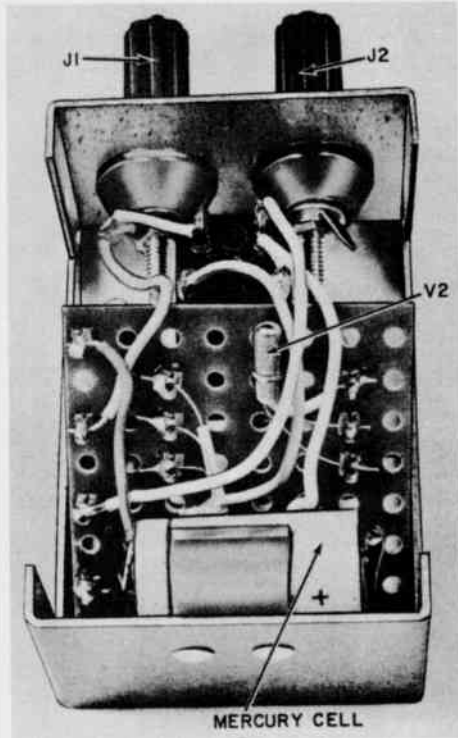

Fig. 221. Inside view of the black-box oscillator.

connections are made by puncturing the cardboard-cover sleeve and soldering two extra connections to the battery. This will be explained later.

The 1.3-volt tap biases V1 in the forward direction so it will conduct. This bias current flows through the base to the emitter and through resistor R1 back to the battery. V1's collector current is approximately equal to the bias voltage divided by the value of the emitter resistance.

A 2.6-volt section of the battery provides V1's collector volt-

age. This potential plus the 1.3-volt section is the bias voltage for V2. Finally, the 2.6-volt remainder is applied to the collector of V2. This arrangement ties the collector voltages and currents down to good, stiff voltage points, resulting in excellent immunity to temperature and transistor variations.

It might be well to mention that, generally, surface-barrier transistors such as the SB-100 have more uniform characteristics than alloy-junction types. The surface-barrier type also has a much lower value of temperature-induced leakage current.

Transistor substitution

You can use either the SB-101 (2N344) or the SB-102 (2N-345) to replace the SB-100.

Although the megacycle end of the oscillator-box performance will suffer, transistors other than the SB-100 may be used. A 2N137, 2N136 or 2N135 can be substituted without changes.

Construction hints

The case is an aluminum Flexi-Mount unit with two General Radio type binding posts mounted on one end and the on-off switch on top. The two transistors and other components are mounted on a small pegboard type terminal card. This card is held in the case by the connecting wires and is also the switch. A small piece of felt or foam rubber in the cover presses the card into this position when it is closed.

The battery is held in place with a clip riveted to the case. Use aluminum rivets like those on display in most hardware stores. They are very soft and really ideal for this job.

Making the tap connections to the TR-115R mercury cell is easy. First notice that the cell cases are the *positive* electrodes. All connections will be made to these. Because of this, the 1.3-volt tap is made *to the case of the second cell*. Locate the second cell from the positive end by running your thumb nail over the cardboard jacket. Now punch a hole in the jacket over this cell and enlarge it enough to scrape the cell case and make the solder connection.

Solder to the outermost circular spine. The surface must be scraped before soldering. Now, quickly tin a small spot of scraped area with a hot iron and a *good* grade of rosin-core solder. a pre-tinned lead can then be tacked to the tinned area of the cell. Use the same procedure for the second tap. Caution! *Overheating will ruin the mercury cell.*

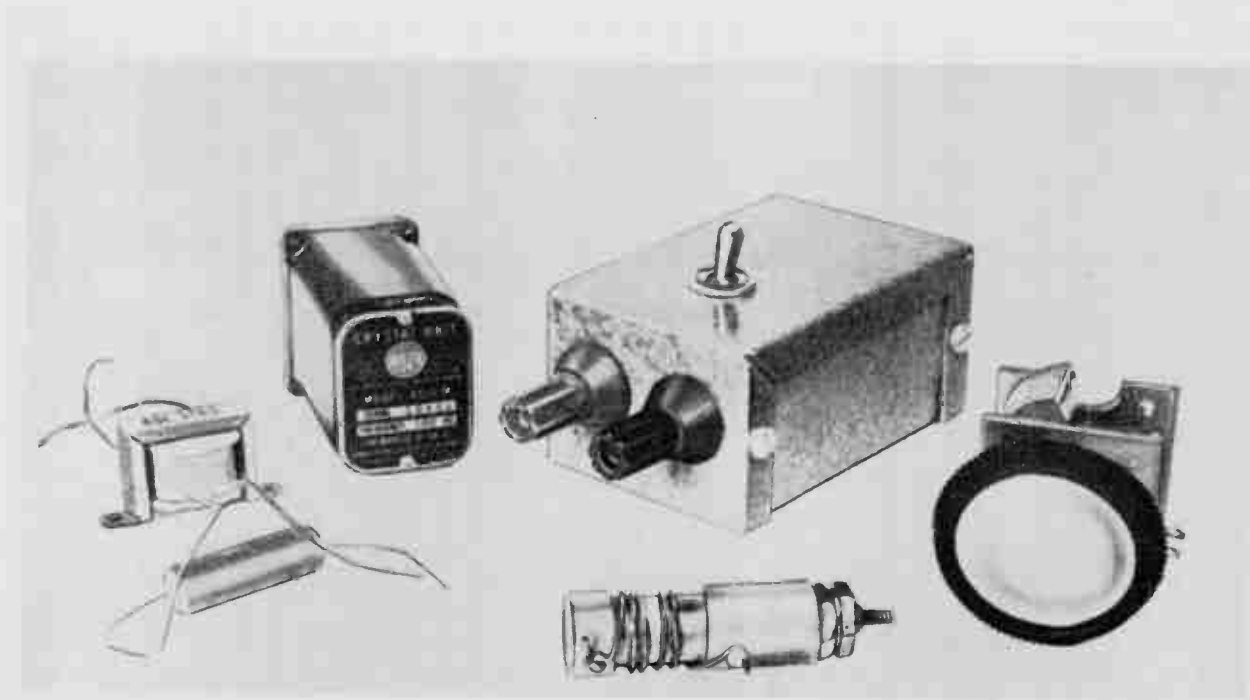

Fig. 222. Typical tuned-circuit components that will oscillate when connected to the box.

Long leads were left on the SB-100 transistors as a precaution against lead breakage near the glass seal and excess soldering heat reaching the interior. *Be sure* battery polarity is correct. Wrong battery polarity can damage the transistors.

Only two of the battery leads are broken, leaving a very small current drain — only about a microampere — on the battery when the unit is off. Practically speaking, we can forget it. It is usually interesting to note the expected battery life. Using the TR-115R about 160 hours of operation can be expected.

Using the unit

Fig. 222 shows an assortment of tuned circuit components for the box, ranging from a miniature transformer-tuned audio circuit to a five-turn coil for megacycle operation. Crystals also work

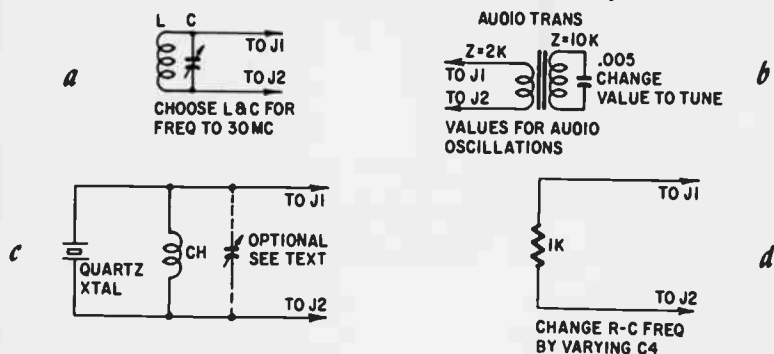

Fig. 223. Four tuned circuits that can be used with the black-box oscillator. The first (a) is a parallel-tuned L-circuit. In the next (b) we use the secondary of an audio transformer. A crystal can also be used (c), tuned with the help of a small variable capacitor. Finally, in the last circuit (d) a resistor is placed across J1 and J2.

if they are shunted with an rf choke to provide a direct current path around the crystal. This choke can be slug-tuned or shunted with a capacitor to vary the crystal frequency slightly.

Representative tuned circuit arrangements are shown in Fig. 223. The diagram in (Fig. 219) shows how a diode and multimeter can be connected to indicate the strength of oscillation of the tuned circuit at radio frequencies. At audio frequencies, it is better to use an oscilloscope. In any of these cases, the dc resistance of the tuned circuit should be as low as possible. Of course, this is no problem at radio frequencies, but miniature audio components and earphones possess quite a bit of built-in resistance and may cause oscillation at an R-C frequency.

scope calibrator

THIS transistorized calibrator supplies a square wave of definite amplitude, making your oscilloscope a wide-range electronic voltmeter for measuring amplifier gain, small ac voltages, plus TV and other complex waveforms. The calibrator is exceedingly accurate, very rugged and miniature in size.

Vacuum tubes are at a disadvantage in many instruments. It is here that they will be most rapidly displaced by transistors. We see this happening in portable receivers and automobile radios. Our prediction is test equipment will be next.

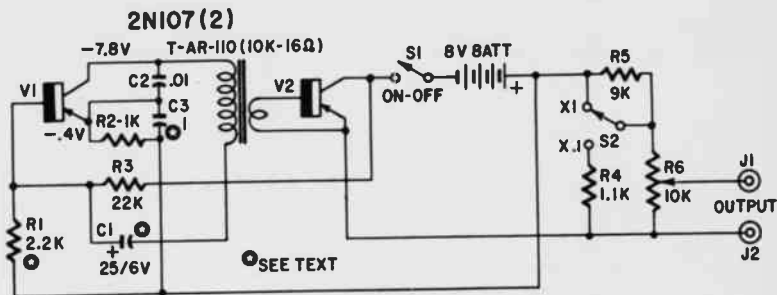

parts list for the scope calibrator

C1—25- μ f 6-volt electrolytic
 C2—.01 μ f, 200 volts
 C3—1 μ f, 200 volts
 R1—2,200 ohms
 R2—1,000 ohms
 R3—22,000 ohms
 R4—1,100 ohms, 5%
 R5—9,000 ohms, 5%, or 4,700- and 4,300-
 ohms 5% in series
 R6—pot, 10,000 ohms (Ohmite CU-1031)
 All resistors $\frac{1}{2}$ watt
 S1—Spst toggle
 S2—Spdt toggle
 T—10,000 to 16 ohms (Argonne AR-110)

V1, 2—2N107 (General Electric)
 J1, 2,—pin jacks
 Battery—8-volt mercury with (Mallory
 TR136R)
 Case—ICA 3797
 Knob
 Pegboard
 Decals
 Miscellaneous hardware
 To build using CK722 (Roythean)
 transistors substitute:
 R1—3,300 ohms
 C1—omit
 C3—0.25 μ f, 200 volts

Fig. 224. Circuit of the scope calibrator. The unit supplies a square wave.

Our calibrator is a case in point. It is far more accurate than a vacuum-tube unit, weighs less, costs less, is miniature in size and does not have a dangling power cord. If necessary, just pick it up and toss it in your tool kit; it is self-powered and rugged. And you don't need to worry about battery life. The one battery in this calibrator should last about 2 years with normal use.

Circuit details

The circuit (Fig. 224) is split into two distinct functions. One

transistor (V1) generates a 1,000-cycle sine wave. The other (V2) driven by the oscillator, behaves like a high-speed on-off switch, interrupting a highly accurate voltage standard. This action produces extremely accurate square waves.

Actually, square waves are not exactly square, but this does not detract from the calibrator's usefulness. Fig. 225 shows a typical waveshape from the calibrator, using type 2N107 transistors.

The oscillator is stabilized against temperature effects and inherently adjusts to sine-wave output. For these reasons frequency

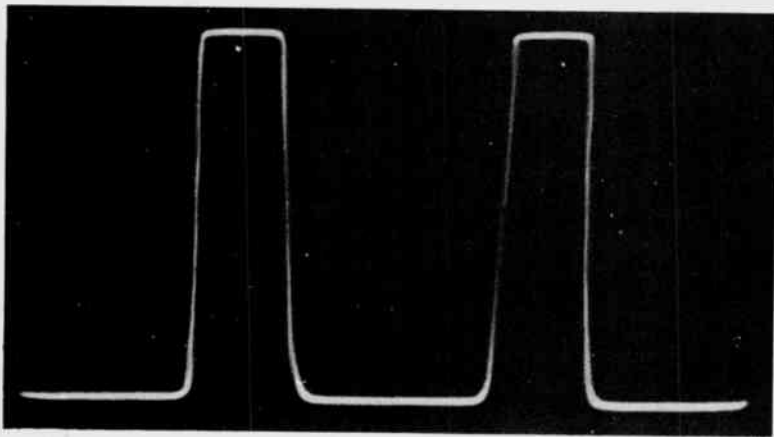

Fig. 225. Square wave output of the scope calibrator. Although not perfectly square, the waveform is sufficiently flat-topped to permit it to be used for calibration purposes.

stability is good. You can expect the frequency to drift no more than 2% under ambient conditions. For the component values given, the frequency will be approximately 1,000 cycles. The exact frequency can be adjusted by changing the value of the .01- μ f capacitor (C2).

Many transistor circuits are plagued by transistor leakage currents. This calibrator has built-in immunity to these effects. This trouble usually stems from poor circuit design that places large resistances in the base-to-emitter return path. The only resistance between the base and emitter of the switch transistor (V2) is the transformer's winding resistance. This resistance is only 2.5 ohms. Consequently, the quiescent drop across the 10,000-ohm potentiometer is not more than a few millivolts.

The overall accuracy of the calibrating square wave is very

good — at least the equal to any of the commercial or kit-built calibrators — with a full-scale accuracy of 2%.

The low output impedance of the calibrator is another advantage. More load can be placed across its output without affecting the accuracy of the square-wave amplitude.

Design considerations

Even though careful consideration is given to circuit design, troubles sometimes arise when transistor devices are built in quantity. This is doubly true for circuits using dollar-variety transistors.

To show what can happen, we built two of these calibrators. One used G-E 2N107 transistors and the other used Raytheon CK722's. Otherwise, there were no differences in the proposed components.

Fig. 224 is the circuit using 2N107's. When using CK722's, change R1 to 3,300 ohms, omit C1 and reduce C3 to 0.25 μ f. It is essentially immune to changes in transistor parameters. When CK722's were used with all components exactly as in Fig. 224, there was improvement in performance. The 2N107 calibrator gives a better square wave than the CK722 unit. This is a minor point since it does not affect the accuracy of either calibrator.

The modifications to the 2N107 calibrator essentially increased the feedback of the oscillator. The added bypass capacitor (C1) decreased losses in the base circuit. Increasing emitter capacitor C3 to 1 μ f provided a more favorable impedance match.

Building two of these calibrators, using different transistors, provided an interesting look into any difficulty that others might experience with the circuit.

Construction

The calibrator is built in an ICA 3797 switch base which features welded steel construction and a removable front panel. Because of the great rigidity of its design, the case is ideally suited for miniature portable test equipment that must undergo a rough-and-tumble existence.

The two calibrators were given somewhat different panel treatments as shown in Fig. 226. The panel of the CK722 was designed horizontally and the 2N107 calibrator vertically.

Some explanation of the decade-switch resistors (R4 and R5) is necessary. The specified values are 9,000 and 1,100 ohms. These are not standard values. To make the 9,000-ohm resistor,

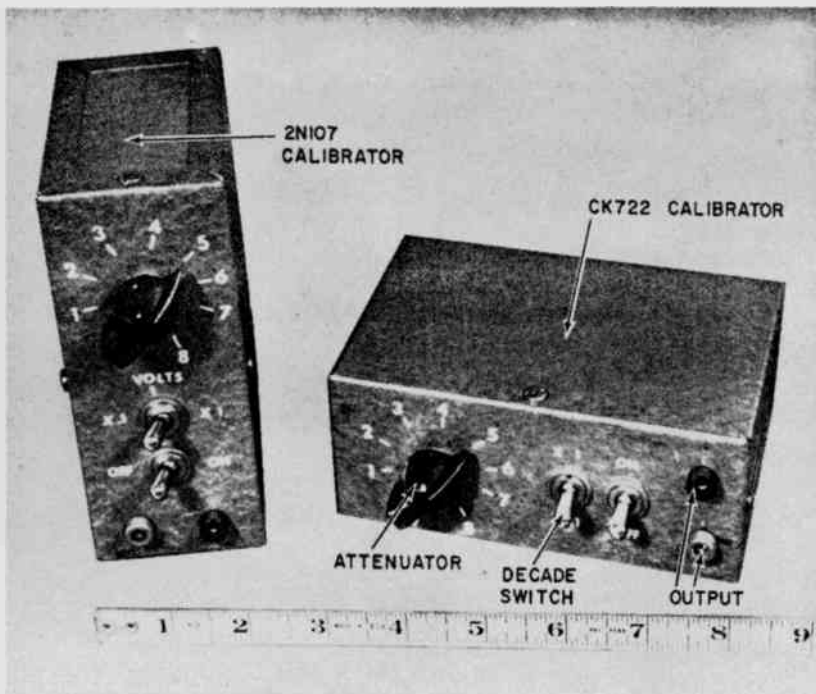

Fig. 226. Two possible arrangements of the scope calibrator. The unit on the left uses 2N107's while that on the right uses two CK722 transistors.

connect a 4,300-ohm and 4,700-ohm resistor in series. Both should have a 5% tolerance. The mathematically correct value of 1,100 ohms is shown on the diagram, but a standard 1,100-ohm 5% resistor is suitable.

A high-grade 10,000-ohm potentiometer, an Ohmite CU 1031, is used for the attenuator. This potentiometer, made for industrial and laboratory use, has fairly tight tolerances for both total resistance and linearity. However, it costs more than twice as much as a replacement control. A radio-replacement control, because of its looser tolerance, may require some changes in the decade resistor values. This will be pointed out in the calibration section.

In short, use the best 10,000-ohm *linear* potentiometer available. The Ohmite CU 1031 is preferred, a wire-wound control is second and an ordinary linear control last.

For reference, several voltage points are indicated on the diagram. These measurements are from the positive side of the bat-

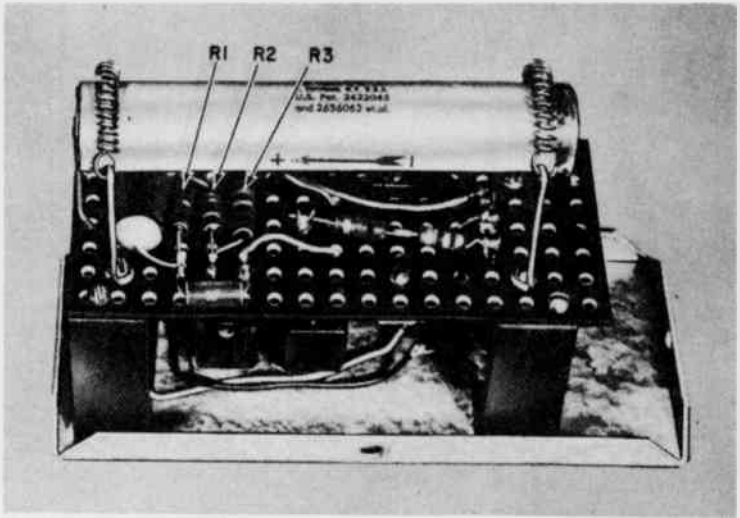

Fig. 227. Inside view of the scope calibrator showing the positioning of the resistors, capacitors and the mercury battery.

tery to the appropriate test point. The readings are dc and should be taken with a 20,000-ohms-per-volt meter.

An internal view is shown in Fig. 227. The pegboard chassis is mounted on a pair of brackets which are fastened to the front panel. The resistors, capacitors and support for the mercury battery are placed on one side of the board, while the transformer and transistors are positioned on the other side, as shown in Fig. 228.

Calibration

Because this device is inherently self-calibrating, this procedure could not be much easier. With the decade switch in the $\times 1$ position, rotate the attenuator to its extreme clockwise position. The output is then exactly 8 volts peak to peak. Connect the calibrator to the vertical deflection terminals of an oscilloscope and set the scope gain for 8 divisions of deflection. This represents 8 volts. Now rotate the attenuator until the deflection is only 7 divisions, then 6 divisions, etc., marking these divisions on the attenuator dial.

At zero and maximum rotation, there are a few degrees where the moving contact is completely shorted to either end of the potentiometer. This makes the dial look nonlinear between 0 and

1, and between 7 and 8. Actually, it is not. We placed our 0 and 8 decals at the absolute extremes of rotation, so the knob could be taken off and replaced without disturbing its calibration.

Now, check the calibration of the decade switch. It reduces the output by a factor of 10. To do this, again set the attenuator to maximum output, but this time, adjust the scope for 10 divisions of deflection. Now flip the decade switch to $\times 0.1$ and the deflection should decrease to 1 division.

If it does not decrease the output by exactly 10, shunt the 1,000-ohm resistor to *decrease* the output or shunt the 9,000-ohm

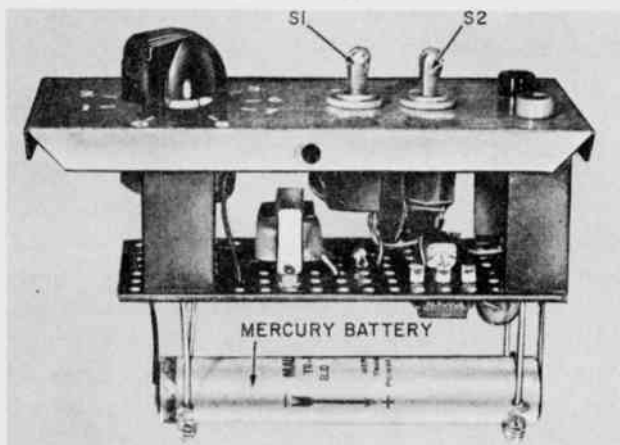

Fig. 228. The front panel forms the support for the completed scope calibrator.

resistor to *increase* the output. Shunts, 10 times larger than the resistors they are placed across, will produce, approximately, a 10% change. Shunting the 9,000-ohm resistor with 100,000 ohms, for example, would increase the output a little less than 1 division in 10. A 200,000-ohm resistor produces only half as much change.

Leads to the mercury battery are soldered in place. To do this, first scrape each end of the battery and *quickly* tin each area with solder. *Do not use too much heat.* Then solder pre-tinned leads to the battery. Observe the correct polarity. It is indicated on the battery jacket.

The calibrator is now ready for operation. Use it in the usual manner for calibrating your oscilloscope screen. It is also very useful for feeding accurate signals into audio amplifiers and audio preamps for determining gain and overload levels. It is useful wherever a fixed-frequency audio generator is necessary.

the kilovolt

SEVERAL electronic devices require a high voltage at low current for proper operation. Some that come to mind are breakdown testers, Geiger counters, photomultipliers, meggers (for measuring insulation and other high resistance) and photoflash lamps. For example, a conventional Geiger unit requires 900 volts at a few microamperes. The actual power is only a few milliwatts at most but the voltage must be *high*. This generator provides more than 1,000 volts at 50 μa from a 1.5-volt dc source. The low-voltage dc energizes a 2N255 power transistor which oscillates at an audio rate. The oscillator output is stepped up by a transformer.

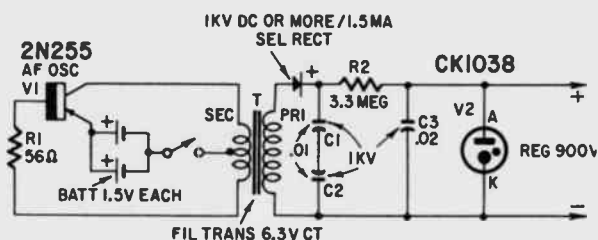

parts list for the kilovolt

R1—56 ohms, ½ watt

R2—3.3 megohms, ½ watt

C1, 2—0.01 μf , 1,000 volts, disc

C3—0.02 μf , 1,000 volts, disc

T—filament transformer, 117 volts ct primary, 6.3 volts secondary (Merit P-2945 or equivalent)

V1—2N255 (Clevite)

V2—CK1038 (Raytheon)

Sel rect—selenium rectifier

Battery—two 1.5-volt cells in parallel

Battery holder (Lafayette MS-176)

Perforated board 6¼ x 3¼ inches x 1/16 inch thick (Lafayette MS-305)

Socket, 9-pin miniature, for transistor

Switch, spst

Fig. 229. Circuit diagram of the kilovolt. Two 1.5-volt cells are indicated, but the unit will work with a single No. 6 dry cell.

A transistor oscillator eliminates the need for a vibrator which may cause noise, low efficiency and sparking. The transistor is a long-life oscillator that requires no attention. Also, it is easy to control the input power (and therefore the output voltage) when a transistor circuit is used rather than a vibrator.

Fig. 229 shows the generator circuit. The 2N255 can handle several watts with a maximum dc input of 15 volts. In this application it loaf! An input of 1.5 volts at about 225 ma provides an output of 900 volts at 25 μa . The input can, of course, be pushed much higher if needed. Evidently the efficiency is not very high

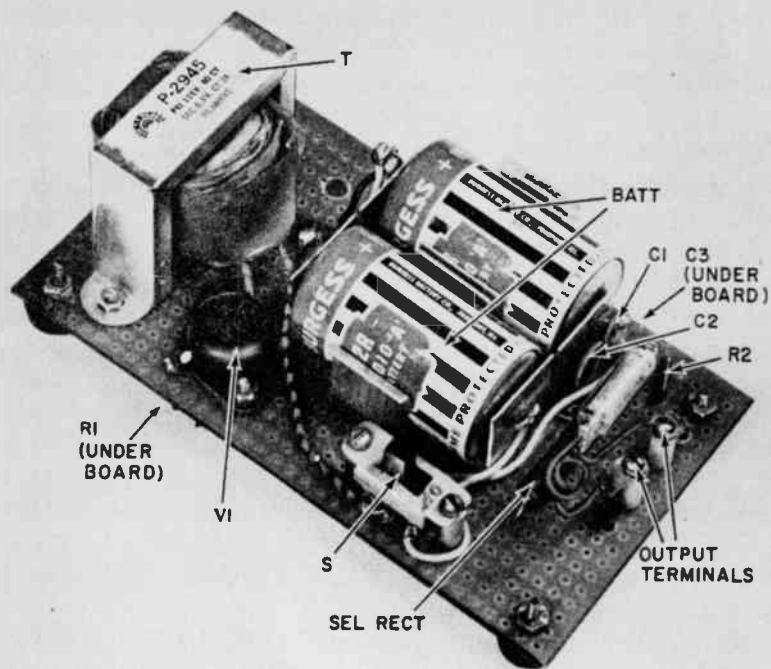

Fig. 230. Layout of the kilovoltmeter. The components are mounted on a perforated board. V1 is the oscillator transistor. Some components are under the board.

since we are using an ordinary filament transformer (which delivers 6.3 volts at 2 amperes) for stepup. Actually any filament transformer with a rating of an ampere or less is suitable, and should result in a dc output in the same range. The efficiency can, of course, be increased tremendously by using a special transformer with a high-efficiency core. These are not generally available and are expensive.

Fig. 229 shows a base resistance of 56 ohms. This controls and limits the transistor input and, therefore, determines the output power. For a *variable* output, substitute a rheostat, but include a series fixed resistor of at least 10 ohms to maintain minimum bias on the 2N255.

The rectifier may be a stack of conventional selenium 130-volt units or it may be a special high-voltage type rated for at least 1,000 volts dc at 1.5 ma.

The filter consists of a two-section R-C network consisting of C1, C3 and R2. Low values of filter capacitance are used since the ripple frequency is in the audio range. For some applications additional filtering may be required.

Voltage regulation

If the kilovolt generator is to be used in Geiger or similar work, the output voltage should be regulated. The Raytheon CK1038 is excellent for this purpose because of its tiny size (see Fig. 230). This diode has a current range of 5-55 microamperes and regulates within a few volts of 900. For Geiger work the tube flow may be adjusted far below the maximum value. For example, connect a microammeter in series with the tube. Now choose the transistor base resistor so that the current is 25 μa . Since the minimum CK1038 current is 5 μa , this allows a range of 20 μa for the Geiger or other load. This is more than ample for most purposes. If the load is to consume more current, reduce R1 until the regulator current is nearly 55 μa . *Do not exceed this limit.* With a 55- μa flow the load may consume anything from 0-50 μa with good regulation.

The regulator tube will not operate until its starting voltage (approximately 930) is exceeded.

Generator construction

All parts for the kilovolter are mounted on a perforated board measuring $6\frac{3}{4} \times 3\frac{3}{4}$ inches. The transistor plugs into a nine-pin miniature socket mounted beneath the board. You don't need a large hole for this socket — simply mount so that the two transistor pins can plug into the socket through board perforations, which may be slightly enlarged if desired. These pins are the emitter and base connections. (See Fig. 231.) The collector ties internally to the metal flange or case (of the transistor) which is painted black except for a small area surrounding one mounting hole. This exposed metal is for making good electrical contact.

Two small screws hold the socket in place. To provide additional support and a collector connection, a third screw is passed through the perforated board and the transistor case. As mentioned, the case is tied to the collector.

Before completing all your soldering, try reversing the high-voltage transformer leads. The output will be much greater one way than the other. This is because the oscillator does not gen-

erate a sine wave, but is interrupted or blocked periodically. Thus one half-wave of the ac output is highly peaked and contains more power than the other half. The more powerful alternation must be rectified for maximum output.

The photo (Fig. 230) shows a pair of cells for the power supply, but a single cell will do the job for short periods. By dividing the work cell life is prolonged. A single No. 6 dry cell will last for hundreds of hours.

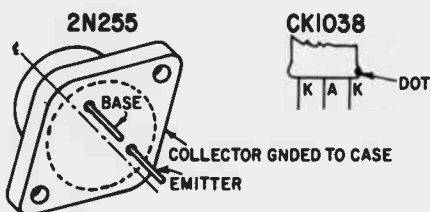

Fig. 231. External construction of the 2N255 transistor. The transistor has only two leads. The collector connection is through the case of the transistor.

Although this generator provides a high-voltage dc output, its shock is not dangerous. If you touch its terminals while power is on, you will feel a tingle, but since the voltage drops quickly, the shock is not serious.

An application

This device eliminates the need for the expensive, heavy batteries formerly required for certain applications. One of the most

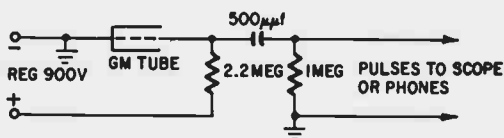

Fig. 232. A simple radiation indicator using the transistorized kilovoltter.

interesting, useful and easy-to-make is a Geiger counter. Besides the high-voltage generator, all you need is a counter tube, a few resistors and a capacitor. Fig. 232 shows a hookup that indicates radiation either on a scope or a pair of phones. You can use this

arrangement with counter tubes CK1049 and CK1026. The latter is only $2\frac{3}{8}$ inches in length and is a low-cost unit. The average pulse amplitude (even at high counting rates) is over a volt. The CK1049 is a larger tube and much more sensitive and will indicate *beta* as well as the more powerful *gamma* rays. Its output pulses have approximately 10 times the amplitude of the smaller tube. Counts are audible directly on phones with either tube, without any amplification. A slight tone is also audible (due to incomplete filtering) but this does not interfere with the clicks. On the oscilloscope the counts are quite easily visible as negative pulses.

Other uses

Experimental counts may be made with a radium-dial watch or clock. At a distance of about 6 inches the count comes to about 4-5 per second. Even at a foot away a count is still noticeable. Without a nearby radioactive source, the background count (due to cosmic rays, etc.) is less than 50 per minute.

For experimental work, a special socket or probe is not needed for these counter tubes. A metal clamp or even a turn of wire around the tube coating makes a good cathode connection. A battery clip on the center conductor of the tube connects to the anode.

Energizing a photomultiplier

The high-voltage generator is also suitable for energizing a photomultiplier type of tube. These ordinarily require about 1,250 volts, which this device can supply easily. Special phototubes in this voltage range are used in highly sensitive *scintillation* counters.

A scintillation counter is a device that uses a light-sensitive detector.

Megger

Some mention was made on page 84 of a megger. This is an abbreviation for megohmmeter. A megger consists of an ohmmeter and a hand generator for producing the high voltage. The high voltage is applied directly to the material being tested. The ohmmeter is also connected to the material, through a pair of resistors, one for each lead going into the ohmmeter. A high-voltage is needed in insulation testing, since we are working with resistances having values rated in terms of hundreds or thousands of megohms.

direct-reading af meter

A DIRECT-READING audio-frequency meter is worth its weight in gold when you have to measure unknown audio frequencies, test or calibrate audio oscillators or measure audio beat notes. In addition, you can plug a microphone into the meter and check the frequencies of pitch pipes, tuning forks, piano strings, sirens

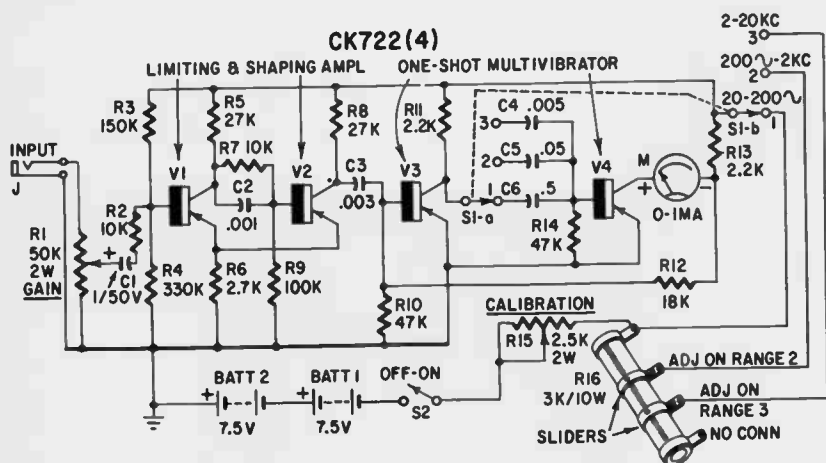

parts list for the direct-reading af meter

- | | |
|--|---|
| <p>R1—pot, 50,000 ohms, 2 watts
 R2, 7—10,000 ohms, 10%
 R3—150,000 ohms, 10%
 R4—330,000 ohms, 10%
 R5, 8—27,000 ohms, 10%
 R6—2,700 ohms, 10%
 R9—100,000 ohms, 10%
 R10, 14—47,000 ohms, 10%
 R11, 13—2,200 ohms, 10%
 R12—18,000 ohms, 10%
 R15—pot, 2,500 ohms, 2 watts
 R16—3,000 ohms, 10 watts, wirewound, adjustable with 2 sliders
 All resistors ½ watt unless noted
 C1—1 μf, 50 volts, 10%</p> | <p>C2—.001 μf, 10%
 C3—.003 μf, 10%
 C4—.005 μf, 10%
 C5—.05 μf, 10%
 C6—0.5 μf, 10%
 Battery 1, 2—7.5 volts (Burgess C5, Eveready 717 or RCA type VSO65)
 J—phone jack
 M—meter, 0-1 ma
 S1—2-pole 3-position rotary
 S2—spst toggle
 V1, 2, 3, 4—CK722
 Chassis
 Cabinet
 Miscellaneous hardware</p> |
|--|---|

Fig. 233. Circuit of the direct-reading af meter. V1 and V2 are in a limiting and shaping amplifier arrangement. This is followed by V3 and V4, a one-shot multivibrator.

or any other single-frequency sound-producing device. For greatest convenience, add portability and eliminate the need for supplying external power. The result is a valuable tool for audio-frequency testing, outdoors, in the shop or in the lab.

This all-transistor unit fills the requirements of portability, low battery drain, accuracy and sensitivity. It covers the entire audio spectrum in three ranges: 20 to 200, 200 to 2,000, and 2,000 to 20,000 cycles. It responds to 1 volt of audio signal, making it usable for most applications where low-level audio signals are measured. Nominally priced, noncritical components are used throughout. The entire instrument is self-contained and rugged enough for the roughest servicing use.

Circuit description

The circuit, shown in Fig. 233, uses four CK722 transistors operating in pairs. The first two, V1 and V2, are limiting and

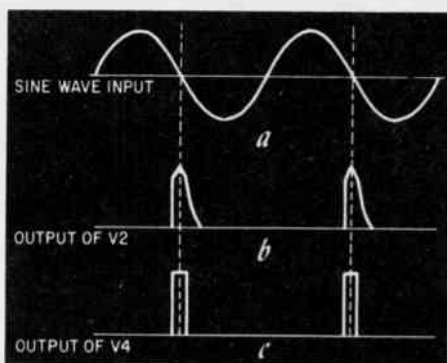

Fig. 234. Input and output waveforms. The input is a sine wave (a). Trigger pulses appear at the output of V2 (b) and V4 (c).

shaping amplifiers. They convert the incoming audio sine wave (Fig. 234-a) into sharply peaked trigger pulses (see Fig. 234-b). In addition, this transistor pair saturates and keeps the amplitude of the output pulses from V2's collector at a constant voltage level regardless of amplitude or frequency variations in the input sine wave. The net result, at the collector of V2, is an output which does not vary in amplitude, but whose frequency is identical with that of the input. A pulse is produced for each cycle of frequency. If the input frequency increases, the number of trigger pulses increases. If the incoming signal decreases in frequency, the number of pulses from V2 also decreases.

The second pair, V3 and V4, is arranged in a one-shot multivibrator circuit. This is a familiar resistance-coupled amplifier

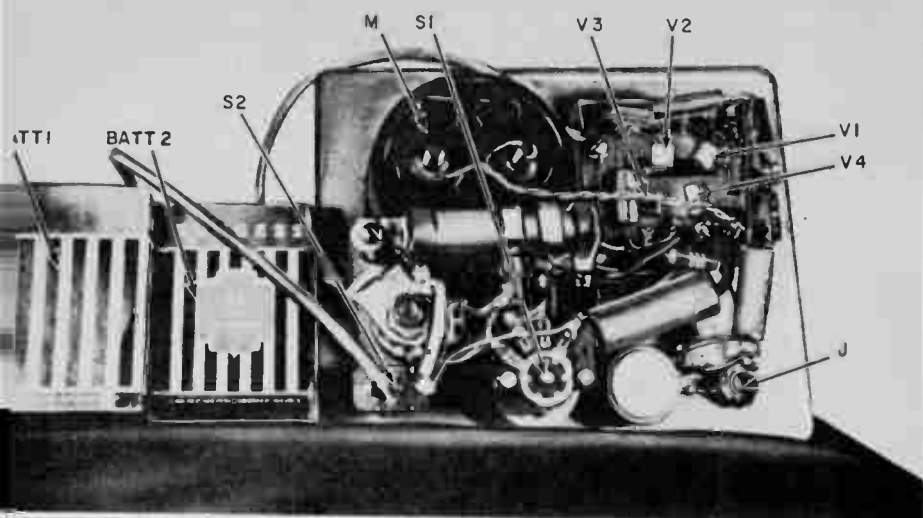

Fig. 235. Parts layout inside the direct-reading meter. All transistors are CK722's.

with feedback from V4's collector to V3's base (through R12). V3 is normally biased to cutoff and does not conduct until a pulse arrives from V2 to trigger the circuit and overcome the bias. V3 then conducts heavily and the resulting pulse is amplified by V4. When the pulse ends, V3 goes sharply back into cutoff and V4 stops conducting. The circuit is ready for the next pulse from V2.

The output from this pair is a series of amplified current pulses (see Fig. 234-c). The number of pulses is proportional to the frequency of the incoming audio sine wave at V1's input, and V4's collector current through the meter will deflect the meter needle higher for more pulses (a higher sine-wave frequency) and lower for fewer pulses (a lower sine-wave frequency). If you feed a known audio frequency into the unit and log the meter reading, you'll wind up with a standard by which unknown audio frequencies can be measured.

Since the circuit operates on a change of frequency, the coupling capacitors between V3 and V4 (C4, C5 and C6) must be changed to allow the multivibrator circuit to operate over the 20-20,000-cycle frequency range. This is done with the RANGE switch. The unknown audio frequency's input level to V1 is controlled by the GAIN potentiometer.

Power requirements vary from 7 volts at 3 ma to 11 volts at

7 ma. The lowest range, 20 to 200 cycles, uses the higher voltage and current. A 15-volt battery pack, made from two series-connected 7.5-volt batteries, is used as the power supply and appropriate voltage-dropping resistors are selected by the RANGE switch to provide the correct voltage for each range.

A CALIBRATION potentiometer (R15) is inserted in series with the battery to compensate for battery voltage drop due to aging and use. This provides long service from a set of batteries, because the CALIBRATION potentiometer is adjusted to compensate for battery age. When battery voltage drops below 11, the pack must be discarded.

Construction hints

There is nothing critical about building this test unit. The usual precautions must be observed if the transistors are soldered directly into the circuit. Keep soldering-iron heat away from the transistor by using long-nose pliers to hold the leads between the iron and the transistor body. Wire the GAIN potentiometer in the usual volume-control hookup, so its variable resistance decreases as the control shaft is turned counter-clockwise.

Any type of wood, metal or plastic chassis and case can be used. The instrument shown in Fig. 235 has a Plexiglas block on which several terminal strips were mounted for the chassis. All resistors, capacitors and wires are soldered to the terminals before the transistors are wired into place. The panel is cut, drilled, painted and all parts mounted before the chassis is attached. The final hookup is completed and the batteries are fastened inside the wood cabinet with metal straps.

If you desire, a large milliammeter (square or round) can be used, as long as it has a basic 1-ma movement. Also, it will be necessary to get an extra slider for R16. Two sliders are needed because the wirewound unit is used to drop the voltage for two ranges.

After construction is completed, connect the batteries (*observe proper polarity!*) and throw the switch to ON. The meter should indicate about 0.1 ma. If no reading is obtained or an appreciably higher reading is noted, something is wrong. Check the wiring, V3 and V4. The 0.1-ma reading is normal, static current. If everything seems to be in order, calibration can begin.

Calibrating the meter

An accurate signal generator is needed to calibrate the tran-

sistorized test set. The final accuracy of the frequency meter depends upon *the accuracy of the calibrating audio generator*. Be sure it is a good one. They are not as hard to find as you may think for most well-equipped service shops or schools have them. Arrangements can be made to bring the test set in for calibration. If you're in an area where these facilities are not available, try the local telephone-system maintenance shop. The shop supervisors are friendly people and most of them have good audio generators on hand. The unit described here was calibrated in a telephone maintenance and repair section.

If all else fails, you can use a less accurate generator, a scope and Lissajous figures, but this method is extremely tedious and should be used only as a last resort. Normally, with a good audio oscillator, calibration takes from 15-30 minutes.

First switch the RANGE selector to range 1, 20 to 200 cycles. The GAIN control should be turned to its farthest counterclockwise position (toward the grounded end). Feed a 200-cycle 2-3-volt audio signal to the input jack and slowly rotate the GAIN control clockwise. The meter reading will slowly increase, then suddenly jump toward full scale. Further clockwise rotation of the GAIN control will not result in any further increase of the meter reading. Back the GAIN control down and reset it about a quarter turn *after* the needle has jumped toward full scale. Do this two or three times and you'll find it easy to reach this point. This procedure sets the best input level for proper operation of the test set.

Observe the meter reading. It will probably be a little above or below the full-scale 1-ma level. Adjust the 2,500-ohm CALIBRATION potentiometer for exactly 1 ma with a 200-cycle input. Calibrate the rest of the range by decreasing the calibrating generator's frequency until the meter needle drops to the 0.9-ma mark. Log the frequency on the audio oscillator dial.

Go down to the next mark (0.8 ma), log the frequency and continue this procedure until you hit 20 cycles. This frequency will probably produce a reading somewhere around 0.2 ma, so the 0.1 static-current reading will not be within the frequency range. Several of these test sets have been built and none of them read appreciably below 0.2 ma for the lowest frequency in each range.

When range 1 is calibrated, switch the RANGE selector to range 2, 200 to 2,000 cycles. Feed 2,000 cycles into the frequency

meter and recheck the setting of the GAIN potentiometer. Move slider 1 (*nearest* the connected end) of R16 up or down the resistor for a full-scale reading of 1 ma at 2,000 cycles. When this reading is obtained, tighten the slider permanently and proceed with lowering the frequency and logging the meter readings all the way down to 200 cycles.

Finally, turn to range 3, 2,000 to 20,000 cycles, set the calibrating oscillator to 20,000 cycles and recheck the GAIN control setting. Adjust the slider *farthest* from the connected end of the R16 for a full-scale 1-ma reading at 20,000 cycles. After this, lower the frequency of the calibrating generator and log the readings versus frequency until 2,000 cycles is reached.

The chart on the test meter in Fig. 236 shows the meter readings and frequencies. The readings will vary between one test set and another because transistor gains vary, even among the same type and manufacturer. However, the variation will not be large. Type the chart, cover with cellophane tape or plastic and fasten it to the instrument's panel. The calibration is now completed and the unit is ready for use.

Using the frequency meter

Always start with the GAIN control turned fully counterclockwise when checking an unknown audio frequency. Rotate it a quarter more, after the jump point, and compare the meter reading against the chart to determine the frequency. It's very simple to use and the GAIN adjustment takes half a second to set the input to the best level.

Make sure the incoming level is 1 volt or better. The setting of the GAIN potentiometer quickly indicates whether the input level is high enough. If you cannot reach a point where rotating the GAIN control will not increase the meter reading, the input level is too low.

To check the frequency of an audio oscillator, simply hook the input test cable of the frequency meter to the output terminals of the oscillator. The input test cable is a shielded lead or a length of coaxial cable with clips and a phone plug.

Use a carbon microphone and microphone transformer to feed the input test jack to measure frequencies produced by tuning forks and other single-frequency sound-producing gear. A crystal microphone with a suitable preamplifier can be used for the same purpose.

Place the test cable across the speaker terminals of a receiver

to test for beat frequencies between two stations interfering with each other. Be sure the volume is high enough to supply the minimum 1-volt level. Use it as an indicator instead of a speaker when signal tracing public-address systems fed by an audio oscillator.

A high-output crystal phono cartridge with attached phono needle has been used for a relative vibration-frequency check of machinery. The phono needle is held lightly against the vibrating

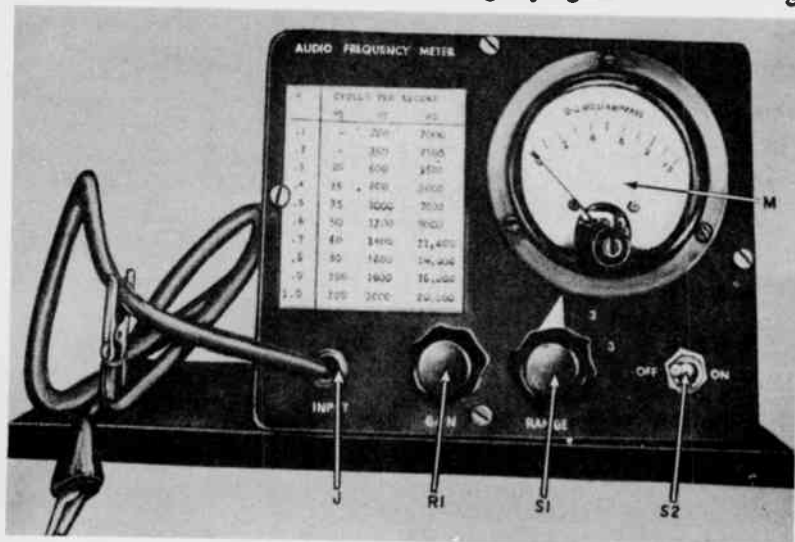

Fig. 236. An outside view of the completed test unit. A chart showing meter readings and frequencies is mounted on the front panel.

surface and the cartridge produces an output voltage that activates the frequency meter. All kinds of similar applications are possible with this test unit, limited only by the imagination and ingenuity of the experimenter.

Occasionally check to see whether the battery voltage has dropped. Feed a 200-cycle signal into the set and look for a full-scale reading on range 1. If the reading is low, indicating that the battery has aged, adjust the CALIBRATION potentiometer to bring the reading to full scale again. This adjustment automatically compensates for ranges 2 and 3.

This transistor test set is an extremely versatile piece of gear, with practically no limit to the life of its components. There are no complications in construction and it takes only a short time to build. It is a useful and welcome addition to the experimenter's and technician's stock of needed test equipment.

Tables and Data

Useful Information

To find the circumference of a circle, multiply the diameter by 3.1416.

To find the diameter of a circle, multiply the circumference by .31831.

To find the area of a circle, multiply the square of the diameter by .7854.

The radius of a circle $\times 6.283185 =$ the circumference.

The square of the circumference of a circle $\times .07958 =$ the area.

Half the circumference of a circle \times half its diameter = the area.

The circumference of a circle $\times .159155 =$ the radius.

The square root of the area of a circle $\times .56419 =$ the radius.

The square root of the area of a circle $\times 1.12838 =$ the diameter.

To find the diameter of a circle equal in area to a given square, multiply a side of the square by 1.12838.

To find the side of a square equal in area to a given circle, multiply the diameter by .8862.

To find the side of a square inscribed in a circle, multiply the diameter by .7071.

To find the side of a hexagon inscribed in a circle, multiply the diameter of the circle by .500.

To find the diameter of a circle inscribed in a hexagon, multiply a side of the hexagon by 1.7321.

To find the side of an equilateral triangle inscribed in a circle, multiply the diameter of the circle by .866.

To find the diameter of a circle inscribed in an equilateral triangle, multiply a side of the triangle by .57735.

To find the area of the surface of a ball (sphere), multiply the square of the diameter by 3.1416.

To find the volume of a ball (sphere), multiply the cube of the diameter by .5236.

Doubling the diameter of a pipe increases its capacity four times.

To find the pressure in pounds per square inch at the base of a column of water, multiply the height of the column in feet by .433.

A gallon of water (U. S. Standard) weighs 8.336 pounds and contains 231 cubic inches. A cubic foot of water contains $7\frac{1}{2}$ gallons, 1728 cubic inches, and weighs 62.425 pounds at a temperature of about 39° F.

These weights change slightly above and below this temperature.

Tables and Data

In accordance with the standard practice approved by the American Standards Association, the ratio 25.4 mm = 1 inch is used for converting millimeters to inches. This factor varies only two millionths of an inch from the more exact factor 25.40005 mm, a difference so small as to be negligible for industrial length measurements.

Metric Measures

The metric unit of length is the meter = 39.37 inches.

The metric unit of weight is the gram = 15.432 grains.

The following prefixes are used for sub-divisions and multiples:
 Milli = $\frac{1}{1000}$, Centi = $\frac{1}{100}$, Deci = $\frac{1}{10}$, Deca = 10, Hecto = 100, Kilo = 1000, Myria = 10,000.

Metric and English Equivalent Measures

MEASURES OF LENGTH

<i>Metric</i>	<i>English</i>
1 meter	= 39.37 inches, or 3.28083 feet, or 1.09361 yards
.3048 meter	= 1 foot
1 centimeter	= .3937 inch
2.54 centimeters	= 1 inch
1 millimeter	= .03937 inch, or nearly 1-25 inch
25.4 millimeters	= 1 inch
1 kilometer	= 1093.61 yards, or 0.62137 mile

MEASURES OF WEIGHT

<i>Metric</i>	<i>English</i>
1 gram	= 15.432 grains
.0648 gram	= 1 grain
28.35 grams	= 1 ounce avoirdupois
1 kilogram	= 2.2046 pounds
4536 kilograms	= 1 pound
1 metric ton	} = { .9842 ton of 2240 pounds
1000 kilograms	
1.016 metric tons	} = 1 ton of 2240 pounds
1016 kilograms	

MEASURES OF CAPACITY

<i>Metric</i>	<i>English</i>
1 liter (= 1 cubic decimeter)	= { 61.023 cubic inches
	.03531 cubic foot
	.2642 gal. (American)
	2.202 lbs. of water at 62° F.
28.317 liters	= 1 cubic foot
3.785 liters	= 1 gallon (American)
4.543 liters	= 1 gallon (Imperial)

Tables and Data

English Conversion Table

Length

Inches	×	.0833	= feet
Inches	×	.02778	= yards
Inches	×	.00001578	= miles
Feet	×	.3333	= yards
Feet	×	.0001894	= miles
Yards	×	36.00	= inches
Yards	×	3.00	= feet
Yards	×	.0005681	= miles
Miles	×	63360.00	= inches
Miles	×	5280.00	= feet
Miles	×	1760.00	= yards
Circumference of circle	×	.3188	= diameter
Diameter of circle	×	3.1416	= circumference

Area

Square inches	×	.00694	= square feet
Square inches	×	.0007716	= square yards
Square feet	×	144.00	= square inches
Square feet	×	.11111	= square yards
Square yards	×	1296.00	= square inches
Square yards	×	9.00	= square feet
Dia. of circle squared	×	.7854	= area
Dia. of sphere squared	×	3.1416	= surface

Volume

Cubic inches	×	.0005787	= cubic feet
Cubic inches	×	.00002143	= cubic yards
Cubic inches	×	.004329	= U. S. gallons
Cubic feet	×	1728.00	= cubic inches
Cubic feet	×	.03704	= cubic yards
Cubic feet	×	7.4805	= U. S. gallons
Cubic yards	×	46656.00	= cubic inches
Cubic yards	×	27.00	= cubic feet
Dia. of sphere cubed	×	.5236	= volume

Weight

Grains (avoirdupois)	×	.002286	= ounces
Ounces (avoirdupois)	×	.0625	= pounds
Ounces (avoirdupois)	×	.00003125	= tons
Pounds (avoirdupois)	×	16.00	= ounces
Pounds (avoirdupois)	×	.01	= hundredweight
Pounds (avoirdupois)	×	.0005	= tons
Tons (avoirdupois)	×	32000.00	= ounces
Tons (avoirdupois)	×	2000.00	= pounds

Tables and Data

English Conversion Table

<i>Energy</i>		
Horsepower	×	33000. =ft.-lbs. per min.
B. t. u.	×	778.26 =ft.-lbs.
Ton of refrigeration	×	200. =B. t. u. per min.
<i>Pressure</i>		
Lbs. per sq. in.	×	2.31 = ft. of water (60°F.)
Ft. of water (60°F.)	×	.433 = lbs. per sq. in.
Ins. of water (60°F.)	×	.0361 = lbs. per sq. in.
Lbs. per sq. in.	×	27.70 = ins. of water (60°F.)
Lbs. per sq. in.	×	2.041 = ins. of Hg. (60°F.)
Ins. of Hg. (60°F.)	×	.490 = lbs. per sq. in.
<i>Power</i>		
Horsepower	×	746. = watts
Watts	×	.001341 = horsepower
Horsepower	×	42.4 = B. t. u. per min.
<i>Water Factors (at point of greatest density—39.2°F)</i>		
Miners inch (of water)	×	8.976 = U. S. gals. per min.
Cubic inches (of water)	×	.57798 = ounces
Cubic inches (of water)	×	.036124 = pounds
Cubic inches (of water)	×	.004329 = U. S. gallons
Cubic inches (of water)	×	.003607 = English gallons
Cubic feet (of water)	×	62.425 = pounds
Cubic feet (of water)	×	.03121 = tons
Cubic feet (of water)	×	7.4805 = U. S. gallons
Cubic feet (of water)	×	6.232 = English gallons
Cubic foot of ice	×	57.2 = pounds
Ounces (of water)	×	1.73 = cubic inches
Pounds (of water)	×	26.68 = cubic inches
Pounds (of water)	×	.01602 = cubic feet
Pounds (of water)	×	.1198 = U. S. gallons
Pounds (of water)	×	.0998 = English gallons
Tons (of water)	×	32.04 = cubic feet
Tons (of water)	×	239.6 = U. S. gallons
Tons (of water)	×	199.6 = English gallons
U. S. gallons	×	231.00 = cubic inches
U. S. gallons	×	.13368 = cubic feet
U. S. gallons	×	8.345 = pounds
U. S. gallons	×	.8327 = English gallons
U. S. gallons	×	3.785 = liters
English gallons (Imperial)	×	277.41 = cubic inches
English gallons (Imperial)	×	.1605 = cubic feet
English gallons (Imperial)	×	10.02 = pounds
English gallons (Imperial)	×	1.201 = U. S. gallons
English gallons (Imperial)	×	4.546 = liters

Tables and Data

Metric Conversion Table

Length

Millimeters	×	.03937	= inches
Millimeters	+	25.4	= inches
Centimeters	×	.3937	= inches
Centimeters	+	2.54	= inches
Meters	×	39.37	= inches (Act. Cong.)
Meters	×	3.281	= feet
Meters	×	1.0936	= yards
Kilometers	×	.6214	= miles
Kilometers	+	1.6093	= miles
Kilometers	×	3280.8	= feet

Area

Sq. Millimeters	×	.00155	= sq. in.
Sq. Millimeters	+	645.2	= sq. in.
Sq. Centimeters	×	.155	= sq. in.
Sq. Centimeters	+	6.452	= sq. in.
Sq. Meters	×	10.764	= sq. ft.
Sq. Kilometers	×	247.1	= acres
Hectares	×	2.471	= acres

Volume

Cu. Centimeters	+	16.387	= cu. in.
Cu. Centimeters	+	3.69	= fl. drs. (U.S.P.)
Cu. Centimeters	+	29.57	= fl. oz. (U.S.P.)
Cu. Meters	×	35.314	= cu. ft.
Cu. Meters	×	1.308	= cu. yards
Cu. Meters	×	264.2	= gals. (231 cu. in.)
Litres	×	61.023	= cu. in. (Act. Cong.)
Litres	×	33.82	= fl. oz. (U.S.P.)
Litres	×	.2642	= gals. (231 cu. in.)
Litres	+	3.785	= gals. (231 cu. in.)
Litres	+	28.317	= cu. ft.
Hectolitres	×	3.531	= cu. ft.
Hectolitres	×	2.838	= bu. (2150.42 cu. in.)
Hectolitres	×	.1308	= cu. yds.
Hectolitres	×	26.42	= gals. (231 cu. in.)

Weight

Grams	×	15.432	= grains (Act. Cong.)
Grams	+	981.	= dynes
Grams (water)	+	29.57	= fl. oz.
Grams	+	28.35	= oz. avoirdupois
Kilo-grams	×	2.2046	= lbs.

Tables and Data

Metric Conversion Table (Cont.)

<i>Weight</i>			
Kilo-grams	×	35.27	= oz. avoirdupois
Kilo-grams	×	.0011023	= tons (2000 lbs.)
Tonneau (Metric ton)	×	1.1023	= tons (2000 lbs.)
Tonneau (Metric ton)	×	2204.6	= lbs.
 <i>Unit Weight</i>			
Grams per cu. cent.	+	27.68	= lbs. per cu. in.
Kilo per meter	×	.672	= lbs. per ft.
Kilo per cu. meter	×	.06243	= lbs. per cu. ft.
Kilo per Cheval	×	2.235	= lbs. per h. p.
Grams per liter	×	.06243	= lbs. per cu. ft.
 <i>Pressure</i>			
Kilo-grams per sq. cm.	×	14.223	= lbs. per sq. in.
Kilo-grams per sq. cm.	×	32.843	= ft. of water (60°F.)
Atmospheres (international)	×	14.696	= lbs. per sq. in.
 <i>Energy</i>			
Joule	×	.7376	= ft. lbs.
Kilo-gram meters	×	7.233	= ft. lbs.
 <i>Power</i>			
Cheval vapeur	×	.9863	= h. p.
Kilo-watts	×	1.341	= h. p.
Watts	+	746.	= h. p.
Watts	×	.7373	= ft. lbs. per sec
 <i>Miscellaneous</i>			
Kilogram calorie	×	3.968	= B. t. u.
Standard gravity (Sea level 45° lat.)	+	980.665	= centimeters per sec. per sec.
Frigories/hr. (French)	+	3023.9	= Tons refrigeration

Tables and Data

The following pages show temperatures on Fahrenheit and Centigrade thermometers.

Equivalent Temperature Readings for Fahrenheit and Centigrade Scales

Fahren- heit Degs.	Centi- grade Degs.	Fahren- heit Degs.	Centi- grade Degs.	Fahren- heit Degs.	Centi- grade Degs.	Fahren- heit Degs.	Centi- grade Degs.
-459.4	-273	-21	-29.4	17.6	-8	56	13.3
-436	-270	-20.2	-29	18	-7.8	57	13.9
-418	-260	-20	-28.9	19	-7.2	57.2	14
-400	-240	-19	-28.3	19.4	-7	58	14.4
-382	-230	-18.4	-28	20	-6.7	59	15
-364	-220	-18	-27.8	21	-6.1	60	15.6
-346	-210	-17	-27.2	21.2	-6	60.8	16
-328	-200	-16.6	-27	22	-5.6	61	16.1
-310	-190	-16	-26.7	23	-5	62	16.7
-292	-180	-15	-26.1	24	-4.4	62.6	17
-274	-170	-14.8	-26	24.8	-4	63	17.2
-256	-160	-14	-25.6	25	-3.9	64	17.8
-238	-150	-13	-25	26	-3.3	64.4	18
-220	-140	-12	-24.4	26.6	-3	65	18.3
-202	-130	-11.2	-24	27	-2.8	66	18.9
-184	-120	-11	-23.9	28	-2.2	66.2	19
-166	-110	-10	-23.3	28.4	-2	67	19.4
-148	-100	-9.4	-23	29	-1.7	68	20
-139	-95	-9	-22.8	30	-1.1	69	20.6
-130	-90	-8	-22.2	30.2	-1	69.8	21
-121	-85	-7.6	-22	31	-0.6	70	21.1
-112	-80	-7	-21.7	32	0	71	21.7
-103	-75	-6	-21.1	33	+0.6	71.6	22
-94	-70	-5.8	-21	33.8	1	72	22.2
-85	-65	-5	-20.6	34	1.1	73	22.8
-76	-60	-4	-20	35	1.7	73.4	23
-67	-55	-3	-19.4	35.6	2	74	23.3
-58	-50	-2.2	-19	36	2.2	75	23.9
-49	-45	-2	-18.9	37	2.8	75.2	24
-40	-40	-1	-18.3	37.4	3	76	24.4
-39	-39.4	-0.4	-18	38	3.3	77	25
-38.2	-39	0	-17.8	39	3.9	78	25.6
-38	-38.9	+	-17.2	39.2	4	78.8	26
-37	-38.3	1.4	-17	40	4.4	79	26.1
-36.4	-38	2	-16.7	41	5	80	26.7
-36	-37.8	3	-16.1	42	5.6	80.6	27
-35	-37.2	3.2	-16	42.8	6	81	27.2
-34.6	-37	4	-15.6	43	6.1	82	27.8
-34	-36.7	5	-15	44	6.7	82.4	28
-33	-36.1	6	-14.4	44.6	7	83	28.3
-32.8	-36	6.8	-14	45	7.2	84	28.9
-32	-35.6	7	-13.9	46	7.8	84.2	29
-31	-35	8	-13.3	46.4	8	85	29.4
-30	-34.4	8.6	-13	47	8.3	86	30
-29.2	-34	9	-12.8	48	8.9	87	30.6
-29	-33.9	10	-12.2	48.2	9	87.8	31
-28	-33.3	10.4	-12	49	9.4	88	31.1
-27.4	-33	11	-11.7	50	10	88.5	31.7
-27	-32.8	12	-11.1	51	10.6	89.6	32
-26	-32.2	12.2	-11	51.8	11	90	32.2
-25.6	-32	13	-10.6	52	11.1	91	32.8
-26	-31.7	14	-10	53	11.7	91.4	33
-24	-31.1	15	-9.4	53.6	12	92	33.3
-23.8	-31	15.8	-9	54	12.2	93	33.9
-23	-30.6	16	-8.9	55	12.8	93.2	34
-22	-30	17	-8.3	55.4	13	94	34.4

Tables and Data

Equivalent Temperature Readings for Fahrenheit and Centigrade Scales

Fahren- heit Degs.	Centi- grade Degs.	Fahren- heit Degs.	Centi- grade Degs.	Fahren- heit Degs.	Centi- grade Degs.	Fahren- heit Degs.	Centi- grade Degs.
95.	35.	134.	56.7	172.4	78.	211.	99.4
96.	35.6	134.6	57.	173.	78.3	212.	100.
96.8	36.	135.	57.2	174.	78.9	213.	100.6
97.	36.1	136.	57.8	174.2	79.	213.8	101.
98.	36.7	136.4	58.	175.	79.4	214.	101.1
98.6	37.	137.	58.3	176.	80.	216.	101.7
99.	37.2	138.	58.9	177.	80.6	215.6	102.
100.	37.8	138.2	59.	177.8	81.	216.	102.2
100.4	38.	139.	59.4	178.	81.1	217.	102.8
101.	38.3	140.	60.	179.	81.7	217.4	103.
102.	38.9	141.	60.6	179.6	82.	218.	103.3
102.2	39.	141.8	61.	180.	82.2	219.	103.9
103.	39.4	142.	61.1	181.	82.8	219.2	104.
104.	40.	143.	61.7	181.4	83.	220.	104.4
105.	40.6	143.6	62.	182.	83.3	221.	105.
105.8	41.	144.	62.2	183.	83.9	222.	105.6
106.	41.1	145.	62.8	183.2	84.	222.8	106.
107.	41.7	145.4	63.	184.	84.4	223.	106.1
107.6	42.	146.	63.3	185.	85.	224.	106.7
108.	42.2	147.	63.9	186.	85.6	224.6	107.
109.	42.8	147.2	64.	186.8	86.	226.	107.2
109.4	43.	148.	64.4	187.	86.1	226.	107.8
110.	43.3	149.	65.	188.	86.7	226.4	108.
111.	43.9	150.	65.6	188.6	87.	227.	108.3
111.2	44.	150.8	66.	189.	87.2	228.	108.9
112.	44.4	151.	66.1	190.	87.8	228.2	109.
113.	45.	152.	66.7	190.4	88.	229.	109.4
114.	45.6	152.6	67.	191.	88.3	230.	110.
114.8	46.	153.	67.2	192.	88.9	231.	110.6
115.	46.1	154.	67.8	192.2	89.	231.8	111.
116.	46.7	154.4	68.	193.	89.4	232.	111.1
116.6	47.	155.	68.3	194.	90.	233.	111.7
117.	47.2	156.	68.9	195.	90.6	233.6	112.
118.	47.8	156.2	69.	195.8	91.	234.	112.3
118.4	48.	157.	69.4	196.	91.1	235.	112.8
119.	48.3	158.	70.	197.	91.7	235.4	113.
120.	48.9	159.	70.6	197.6	92.	236.	113.3
120.2	49.	159.8	71.	198.	92.2	237.	113.9
121.	49.4	160.	71.1	199.	92.8	237.2	114.
122.	50.	161.	71.7	199.4	93.	238.	114.4
123.	50.6	161.6	72.	200.	93.3	239.	115.
123.8	51.	162.	72.2	201.	93.9	240.	115.6
124.	51.1	163.	72.8	201.2	94.	240.8	116.
125.	51.7	163.4	73.	202.	94.4	241.	116.1
125.6	52.	164.	73.3	203.	95.	242.	116.7
126.	52.2	165.	73.9	204.	95.6	242.6	117.
127.	52.8	165.2	74.	204.8	96.	243.	117.2
127.4	53.	166.	74.4	205.	96.1	244.	117.8
128.	53.3	167.	75.	206.	96.7	244.4	118.
129.	53.9	168.	75.6	206.6	97.	245.	118.3
129.2	54.	168.8	76.	207.	97.2	246.	118.9
130.	54.4	169.	76.1	208.	97.8	246.2	119.
131.	55.	170.	76.7	208.4	98.	247.	119.4
132.	55.6	170.6	77.	209.	98.3	248.	120.
132.8	56.	171.	77.2	210.	98.9	249.	120.6
133.	56.1	172.	77.8	210.2	99.	249.8	121.



